

JULY-AUGUST 1955

PRICE 50¢

**HI-FI**

# Music

**AT HOME**



**GWEN VERDON AND THE "DAMN YANKEES" RECORDING SESSION**  
HOW TO ASSEMBLE SIMPLE HI-FI UNITS FOR SUMMER ENJOYMENT  
84 REVIEWS AND RATINGS OF THE BEST RECORDED MUSIC

THESE PAGES PROVE HOW THE

# GARRARD RC80

has maintained its supremacy

Original RC80's  
already had  
these important  
features

**Pusher-type Platform:** Adjusts simply to 7", 10", 12" records, regardless of diameter or size of spindle hole. The only device that assures positive gentle handling of all records. No overhead bridge to damage or dislodge records accidentally.

**Automatic Stop:** Insures positive and unfailing action at end of any type or size of record.

**Pull-away Idler Wheel:** Avoids flattening of drive wheel when changer is not operating.

**Heavy Drive Shaft:** A unique feature, providing more consistent quality at critical low ( $33\frac{1}{3}$  and 45 rpm) speeds. Wows and wavers eliminated.

**Convenient Start-Stop-Reject Lever; and Triple-Speed Switch:** Controls are combined and located away from tone arm... an important precaution for safety of stylus.

**Heavily Weighted, Balanced Turntable:** Imparts flywheel action, so that any variations in drive motor are not reflected in record reproduction. No turntable rumble.

**Balance-Mounted Tone Arm:** Exclusive "parallel-lift" construction guarantees true-tangent tracking. Disturbing resonances eliminated.

**Interchangeable Plug-in Heads:** Engineered to accommodate user's personal choice of virtually any high fidelity cartridge... crystal, ceramic or magnetic.

**Advanced Heavy-duty Silent 4-Pole Motor with Absolutely no Rumble:** Assures no-hum when used with sensitive magnetic pickups! Speed maintained regardless of wide variation in line voltage. No appreciable speed effect operating unit "cold" with full load or "hot" with single record, regardless of weight, thickness or diameter of records.

**Watch-like Construction:** All levers fully adjustable... easy, inexpensive to service. Bronze bearings at all moving points for longer life! Precision ground gears perfectly meshed to insure constant, smooth action through years of service.

**Two Interchangeable Spindles:** Easily inserted and instantly removable so that records need not be ripped upwards over metallic spindle projections after playing, as on ordinary changers. The two Garrard spindles accommodate all records as they were intended to be played.  
(a) Garrard "bent" spindle for standard center holes. Heavily plated, perfectly smooth, as a spindle should be. No moving parts to nick and enlarge center holes of precious records.  
(b) Easily inserted wide spindle, available as an accessory for 45 rpm records.

**Muting Switch:** No sound while tone-arm is in changing cycle. Continuity of music undisturbed, by extraneous noises.

**A complete stock of replacement parts is readily available to all Garrard owners.**

When you buy the Garrard RC80, you benefit from millions of playing hours in the home, testing every basic feature.

\$49.50 net, less cartridge

(a) (b)

# World's Finest Record Changer

through advanced engineering, rigid quality control

By now-all RC80's  
have these  
additional  
features

Check craftsmanship, performance, price and service and you will understand why this is truly the world's number one high fidelity record changer!

There's no need to pay more for a record player regardless of other components in your high fidelity system.

**New! Stylus-pressure adjustment.** Accessible from top. Prolongs life of records by enabling user to keep weight of stylus, on delicate record grooves, correct for any type of pickup cartridge, easily and at all times.

**New! Foolproof Record Pawl Guide:** Lengthened to handle records even thinner or thicker than standard, for any record material, any speed.

**New! Exclusive Garrard Crowned Interwheel:** A costly feature preventing even the slightest flutter or rumble.

**New! Manual play . . . of selected record bands while tracking:** RC80 tone arm sets down and lifts up perfectly and automatically for years without slightest danger to record grooves. This is recommended as the safest manner to play records. However, professional-type finger lift permits manual handling of pickup arm, except only when unit is in midst of changing cycle. The arm is completely free to be moved by user to any part of record while tracking.

**New! Rumble-free Spindle thrust assembly . . . Supported by Garrard-designed washer of special plastic . . . more durable than metal, as on ordinary changers.**

**New! Main Turntable Spindle . . . prevents wow.** Bearings are sintered bronze, expertly burished to size . . . and revolve freely and smoothly in exclusive Garrard bakelite cage, eliminating noisy metal-to-metal contact and the binding "creepage" found in steel cup races used by many record changers.

**New! Exclusive Drive Belts . . . Insulate against any possibility of rumble and operate without slippage for years.** However, replacements cost pennies . . . are always available for changeover within minutes by owner. No long interruptions in use of changer . . . waiting for replacement gears or bearings.

**New! Special soft, flexible motor leads . . . Avoid any possibility of even slight vibrations being transferred to base plate.**

**New! Exclusive one-piece moulded condenser-resistor network . . . eliminates startling "plop" noise when changer shuts off at end of last record.**

**New! Exclusive! Motor armature dynamically balanced . . . super-finished and individually weighted to very fine limits, by special Garrard process.** Insures quiet, perfect speed through years of operation.

**New! Mounting grommets of exclusive material, designed to keep out vibration.**

**New! Exclusive "snap-mount" spring assembly . . . Permits instantaneous mounting of changer and adjustments to level from top of unit, with simple screw driver.**

**New! Completely wired . . . ready for plug-in!** RC80 comes with UL-approved line cord and moulded plug; and with pickup cable, terminating in standard jack.



A quality endorsed product of the British Industries Group:  
Garrard, Leak, Wharfedale, RJ, Genalex, Multicore and other high fidelity components.



For 16 page booklet, "Sound Craftsmanship" and names of dealers, mail this coupon.

British Industries Corporation, Dept. MAH 7-5  
164 Duane Street, New York 13, N. Y.

Gentlemen:  
Please send "Sound Craftsmanship" and Garrard dealers' names.

Name \_\_\_\_\_  
Address \_\_\_\_\_  
City \_\_\_\_\_ Zone \_\_\_\_\_ State \_\_\_\_\_

**AN ORIGINAL CAST RECORDING**

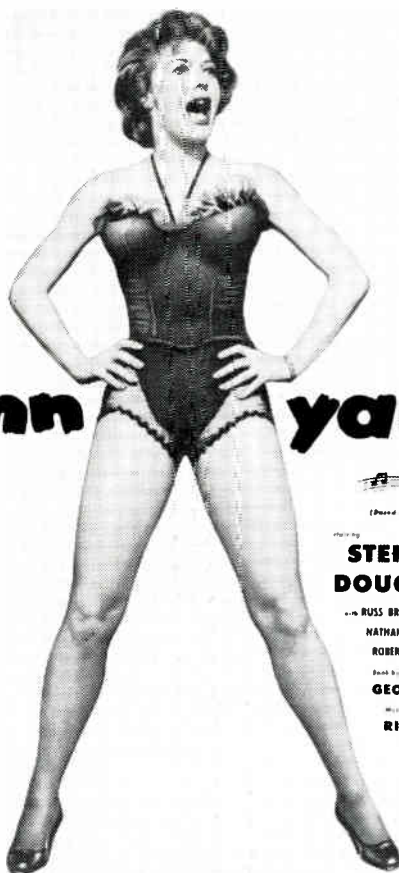

# "Damn Yankees"

FREDERICK BRISSON • ROBERT E. GRIFFIN • HAROLD S. PRINCE  
(In association with Albert S. Taylor)

**GWEN VERDON**

**A NEW MUSICAL**

(Based on the novel "The Year the Yankees Lost the Pennant" by Douglas Wallop)

starring **STEPHEN DOUGLASS** and **RAY WALSTON**

... RUSSELL BROWN • SHANNON BOLIN • JIMMIE KOMACK  
NATHANIEL FREY • RICHARD BISHOP • JEAN STAPLETON  
ROBERT SHAFER • RAL ALLEN • EDDIE PHILLIPS

Book by **GEORGE ABBOTT** and **DOUGLASS WALLOP**

Music and Lyrics by **RICHARD ADLER** and **JERRY ROSS**

Choreography by **BOB FOSSE**

Scenery and Costumes designed by **WILLIAM** and **JEAN ECKART**

Master of Cerimonies by **HALE HASTINGS** • Orchestration by **DON WALKER** • Dance Music Arrangements by **ROGER ADAMS**

Production Directed by **GEORGE ABBOTT**



starring Gwen Verdon, Stephen Douglass with complete Broadway cast and Orchestra. Long Play and 45 Extended Play, LOC/EOC-1021. **\$4.98** ea.

## RCA VICTOR SCORES AGAIN

with these exclusive original cast recordings in brilliant "New Orthophonic" High Fidelity Sound!

COLE PORTER  
"SILK STOCKINGS"



**ORIGINAL CAST**

**SILK STOCKINGS**, the Cole Porter musical, starring Hildegard Neff, Don Ameche with complete Broadway cast. LOC/EOC-1016.

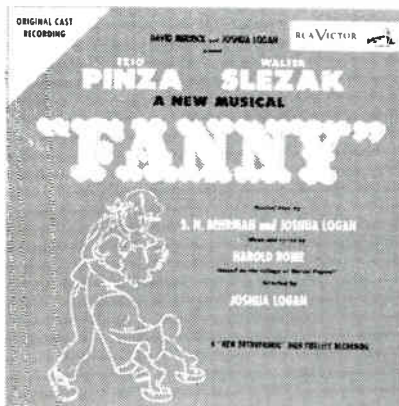

**FANNY** starring Ezio Pinza, Walter Slezak, Florence Henderson and William Tabbert with full Broadway cast. LOC/EOC-1015.

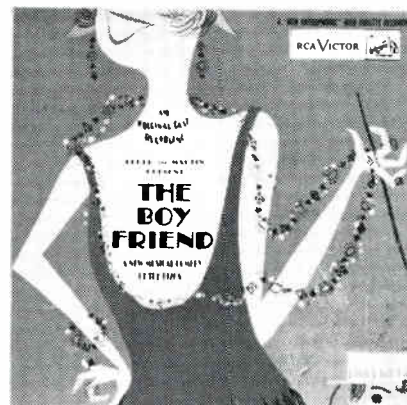

**THE BOY FRIEND** starring Julie Andrews, Ann Wakefield, Bob Scheerer with complete Broadway cast. LOC/EOC-1018.

All available now at your nearest RCA VICTOR Record Dealer — Long Play and 45 EP, \$4.98 ea.



Prices suggested list, incl. Fed. Excise Tax. Add local tax.

# HI-FI Music

## AT HOME

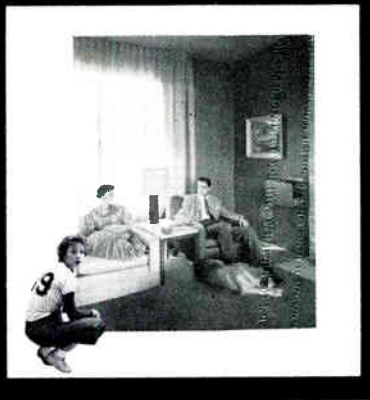

THE COMPLETE GUIDE TO HI-FI REPRODUCTION FROM RECORDS, TAPE AND FM RADIO

### Publisher:

Milton B. Sleeper

### Music Editor

Fred Reynolds

### Art Director

Walter Buehr

### Cover Design

Allan Melhada

### Photography

William Leftwich  
Winthrop Martan

### Advertising Manager

Fred Reynolds

### Production Manager

Mary Yiatis

### Circulation

Myrna Sassner

### Contributors to this issue

Oliver Daniel	Fred Reynolds
P. Glanville-Hicks	Allan Ruffin, Jr.
David Hall	Jan Syrjala
James Lyons	Edgar Villchur
Robert Prestegaard	Thomas A. White

HI-FI MUSIC AT HOME is published bimonthly by Sleeper Publications, Inc., Hi-Fi House, 207 East 37th Street, New York 16, N. Y. Telephone: Oxford 7-0542. THIS OFFICE IS CLOSED FROM THURSDAY NIGHT TO MONDAY MORNING. Editorial, advertising, and circulation departments are located at the address above. HI-FI MUSIC AT HOME is not connected or associated with any other magazine.

Subscription rates are \$3.00 per year (6 issues) or \$6.00 for 3 years (18 issues). Single copies, 50c. Outside the USA, Canada, and the Pan American Postal Union, rates are \$4.00 per year, or \$9.00 for 3 years. Copies are mailed on the 10th of January, March, May, July, September, and November. Allow time for delivery by second class mail.

Editorial contributions and interesting photographs are welcome, and will be paid for upon publication. No responsibility can be accepted for unsolicited manuscripts, and they will not be returned unless they are accompanied by return postage.

Entered as second class matter at New York City, and additional entry at Concord, N. H., under the Act of March 3, 1879. Printed in the U. S. A. by Rumford Press, Concord, N. H.

The cover design and contents of HI-FI MUSIC AT HOME\* are fully protected by copyrights, and must not be reproduced in any manner or form. Quotations are not permitted without specific authorization in writing from the Publisher.

\*Registered U. S. Patent Office

Copyright 1955 by Sleeper Publications, Inc.

Sleeper Publications, Inc.

207 East 37th Street, New York 16, N. Y.

Milton B. Sleeper, *President and Treasurer*

Ethel V. Sleeper, *Secretary*

# C O N T E N T S

VOLUME 2 • NUMBER 3 • JULY-AUGUST, 1955

## SPECIAL FEATURES

Editorial: Record Critics . . . . .	13
The Hi and the Fi . . . . .	15
The Benny Goodman Story—Fred Reynolds . . . . .	16

## MUSIC

Louisville Records—David Hall . . . . .	20
Music Festivals—Oliver Daniel . . . . .	21
Whatever Lola Wants—James Lyons . . . . .	24
2nd Newport Jazz Festival . . . . .	26
Hi-Fi Record and Tape Reviews and Ratings	
Orchestral Music . . . . .	27
Concertos . . . . .	29
Chamber Music . . . . .	30
Vocal Music . . . . .	30
Keyboard Music . . . . .	32
Jazz . . . . .	32
Popular Albums . . . . .	34
Music from the Theatre and Movies . . . . .	34
Miscellany . . . . .	35
Pre-Recorded Tapes . . . . .	35

## EQUIPMENT

Happily Ever After—Allan Ruffin, Jr. . . . .	40
Q and A—Thomas A. White . . . . .	41
New Loudspeaker—Edgar M. Villchur . . . . .	42
Workshop Project No. 6: Audio Oscillator—Jan Syrjala . . . . .	43
"Inside Information" . . . . .	45

## INSTALLATIONS

Growing up with Hi-Fi—Milton B. Sleeper . . . . .	36
---	----

## DEPARTMENTS

Records, Tape, and FM Radio . . . . .	4
Ideas for You . . . . .	8
Advertisers Index . . . . .	63
Special Services Directory . . . . .	63
Buy, Sell, and Swap Department . . . . .	64

## COVER PHOTO

Here is an unusual installation of an Ampex 600 tape recorder and the amplifier-speaker unit in the Northern California home of Mr. and Mrs. Barry W. Boland. Mr. Boland plays the violin, and Mrs. Boland the cello. Both perform regularly in the Symphony Guild Orchestra of Marin County. Daughter Nancy plays the piano. This living room installation of their tape equipment is planned so that they can take the units into their garden, to rehearsals, or to the homes of their friends. Sections of the storage wall also contain a Fisher tuner and a Garrard changer. Kibitzing at third base is Gwen Verdon. You'll find the account of the "Damn Yankees" recording session, by James Lyons, in this issue.

**W**e occasionally receive a commendatory letter. The latest one states that if we had good program material, our records would be *very good*. We are grateful for complimentary remarks, even though slightly tentative.

We surely cannot boast of a large library of program material; in fact, now that we reflect, there are only two claims we can make with complete confidence: (1) Our records are reasonably\* round and (2) We probably sell fewer records than any other company\*\*.

But some of our friends insist that our records sound good—despite the program material. This tends to confirm our hypothesis that music is a good means for demonstrating high fidelity.

We continue to expand our library with the fervent hope that we will one day hit upon program material that *everybody* will like. Accomplishment of the impossible is taking a little longer than it should.

If you are interested in our peculiar records, inquire at your dealer's—or shipment will be made, prepaid, from the factory.

A descriptive booklet is available at your request.

\*How round is "reasonably"?

\*\*An understatement.

## AUDIOPHILE RECORDS INC.

*High Quality Recordings*

SAUKVILLE, WISCONSIN



## Records, Tape, and FM Radio

### Audio Shows

Here is the timetable of audio shows scheduled for this fall:

CHICAGO: September 30 to October 2, at the Palmer House

NEW YORK: October 13 to 16, at Hotel New Yorker

BOSTON: October 21 to 23, at Hotel Touraine

PHILADELPHIA: November 4 to 6, at Benjamin Franklin Hotel

### More and Better Pre-recorded Tapes

Several of the pre-recorded tape companies have recently announced moves that are sure to meet with wide approval. In order to make tape more attractive, and to add to their catalogs, tape companies are entering into arrangements with record companies to release certain of their master tapes. A-V Tape will be issuing tapes of Vanguard, Storyville, and Elektra. Audiosphere is releasing tape of recordings on the Atlantic, Oceanic, Esoteric, and Riverside labels.

### Didn't They Know?

Recently the Right Honorable Hugo Winterhalter travelled to Nashville to record with "Heady" Eddie Arnold. He was given a royal reception, with huge signs proclaiming "Welcome Hugo," leading all the way from the airport to the hotel desk. What price fame! The hotel didn't have a room for him!

### Jazz and Its People

A new, interesting, and colorful story of jazz is told in "Hear Me Talkin' To Ya". A good part of the authentic story is told by the jazzmen themselves. Two Nats—Shapiro and Hentoff—have culled magazines, records, newspapers, and books endless to bring alive this compilation of statements by and of, and interviews with jazzmen from the world around. More than 100 greats have their say about jazz and its people, from Louis Armstrong to Lester Young, from "King" Oliver to Dave Brubeck. There are 432 pages, price \$4. Published by Rinehart & Company, Inc., 232 Madison Ave., New York 16.

### Going to Düsseldorf?

The annual German radio-phonograph-television show will be held there from August 26 to September 4.

### Stylus-Timing Meter

If you are looking for a meter to show how many hours your stylus has been  
*Concluded on page 6*

tone-arm teddy was a

## needle noodnik

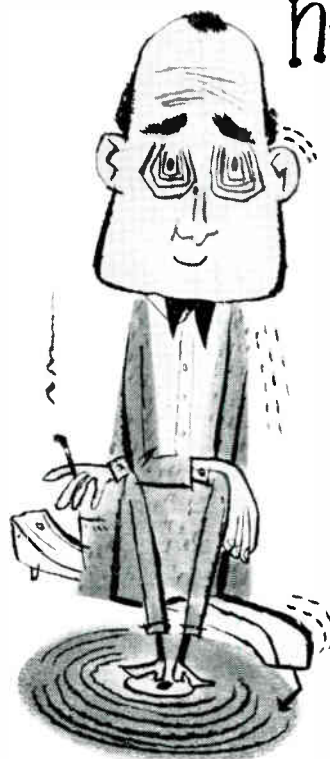

He had a 50 watt amplifier . . . two speakers in every room . . . but still his sound wasn't up to snuff. Why?? He was using a *hi-fi* turntable with a *no-fi* needle. But Teddy learned at last. He sent his old needle to Transcriber and had us custom re-tip it with genuine diamond.

If you are using anything but a diamond—or a diamond more than 12 months old—why not do the same. Remove your needle from its cartridge\*, scotch-tape it to a piece of cardboard and mail to Transcriber. Our experts will straighten and strengthen the shank . . . re-tip it with a new *guaranteed* diamond. A real bargain at only \$10.50 complete. 48 hour service.

*\*If you can't remove needle send entire assembly.*

## TRANSCRIBER COMPANY

Diamond Stylus  
Manufacturers

70 Pine Street — Dept. MH-2  
Attleboro, Mass.

*Guardian of Good Music*



## It's "Walking Hi-Fi" from Ampex...

### **The Ampex 600 Tape Recorder**

— superlative performance in a 28-pound package, a professional quality recorder in a portable case.

### **The Ampex 620 Amplifier-Speaker**

magnificent tonal quality in a 25-pound package — an exceptional system for sound reproduction from tape recorder, turntable, record changer, AM-FM tuner or pre-amplified microphone.

Here — in two hands, is the finest Hi-Fi system for its size available today. It is a revolutionary Ampex recorder-reproducer combination that can be carried **anywhere** — yet it is equally at home as part of a custom installation.

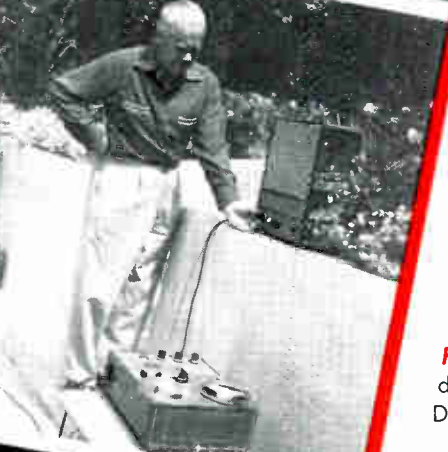

### **SUPERB PERFORMANCE ANYWHERE**

When you own an Ampex 600-620 combination, recording perfection and truly exceptional sound reproduction are at your command . . . PLUS portability that lets you enjoy true Hi-Fi wherever you go.

At home, listen to its matchless performance in any room. If you prefer concealed components, it's ideally suited for wall or cabinet installation, can be easily integrated with existing Hi-Fi systems.

Take it on trips or when you visit friends, lifts out of custom installations in just seconds, as ready to travel as a packed suitcase.

No matter how or where you use it, this great Ampex 600-620 combination offers fidelity in sound recording and reproduction — superb performance anywhere you want it.

**PRICES:** Model 600 Tape Recorder — \$545.00  
Model 620 Amplifier-Speaker — \$149.50.

**HEAR IT** . . . the real test is listening, so ask for a demonstration from your local dealer . . . or write to Dept. NN-2262, for full description and specifications.

*Signature of Perfection in Sound*

**AMPEX**  
CORPORATION

934 CHARTER STREET • REDWOOD CITY, CALIFORNIA

- Distributors in principal cities — see your local telephone directory under "Recording Equipment."
- Canadian distribution by Canadian General Electric Company

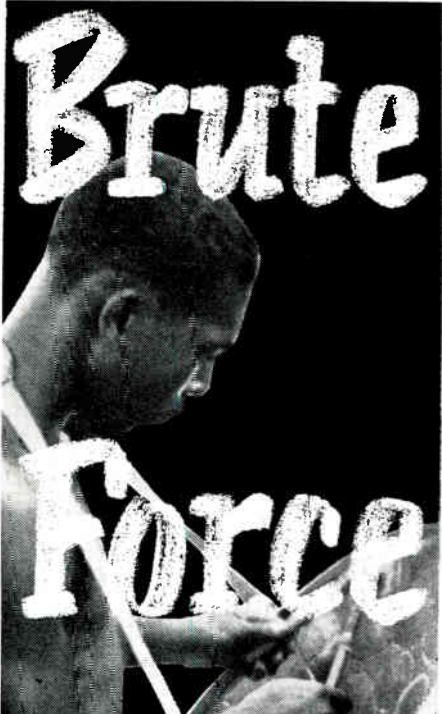

**First  
long-play  
record!**

**MAMBOS  
MERINGUES  
RUMBAS  
SAMBAS  
CALYPSO**

# Steel

3 Island Bands of native panbeaters each in its own style playing the new Caribbean sound. Easy to listen to — hard to forget (ask any tourist!)

# Bands

recorded in  
**ANTIGUA BWI**

39 sawed off lend-lease oil drums\*  
maracas, gourds, sticks,  
44 men, 1 cricket,  
igniting Latin rhythms with  
the jungle beat.

\*heads beaten in; tuned with cold chisel  
**12" LP — #1042 — \$5.95**

**IF YOUR DEALER DOES NOT  
STOCK — WRITE DIRECT TO:**

**COOK Laboratories**  
101 2nd St. • Stamford, Conn.

## RECORDS, TAPE AND FM

*Continued from page 4*

used, and at a bargain price, Radio Shack, Washington Street, Boston has a supply at \$6.95. Although removed from military equipment, they are in perfect condition.

### E. D. Nunn

Bossman of Audiophile Records to our Music Editor: "I liked your article on Mr. and Mrs. 'Sound'. Just by a rare coincidence, I read every word of it. When I came to page 57, I received quite a shock. 'How does one discourage deer?' Well, here is where I come in. An electric fence charger, made by Electro-Line Products Corporation of this address (Saukville, Wisc.) will do a fine job of same. Mary Ford's problems are over! Some day, if you see her you may tell her for me that if she wants to try such an idea I will gladly send her a charger and they can have some fun with it, and I will positively guarantee that deer will give their place a wide berth if they install the apparatus correctly." Note: Audiophile Nunn is also president of Electro-Line Products.

### Tube Life

In October, 1946, the first orders were placed for the famous REL 646B FM receivers. No. 1 went to Major Armstrong, No. 2 to Paul deMars, and No. 3 to Milton Sleeper. At that time, Frank Gunther of REL offered this advice: "Keep the tubes on all the time. That's standard practice in broadcast stations. Instead of switching the set off, just turn down the volume control. The tubes will last longer, and the set will be kept at constant temperature." Well, No. 3 has been running almost continuously for eight years. The original tubes were replaced only two years ago, and the receiver is still so sensitive that full limiting is obtained even on stations too weak to move the pointer of the signal strength meter!

### An Unusual Amplifier

We recently saw and heard a new type of 20-watt preamplifier remarkable both for its performance and design. A development of Webster Laboratories, Sheffield, Mass., it exemplifies the Rolls Royce philosophy that, when price is not a factor, finest performance and everlasting dependability can be most certainly achieved by eliminating all tricks and gadgets. The output has two Western Electric 300B's in a straight triode Class A circuit. Controls are limited to a switch for 78 or LP records, radio, and microphone; bass and treble adjustments; and volume control. Each unit is put through laboratory tests after it has run under power for 48 hours. The manufacturer lists associated components recommended for top performance. Price \$3.00.



## HIGH FIDELITY READER!

**"fabulously good!"**

"... the recordings made, processed and mailed by Columbia, are fabulously good; better, indeed than any of the Company's self-sponsored efforts to date. If one's ears will listen beyond 1900 invest promptly in the series —if solely for its extra-ordinary hi-fi demonstration value."  
*Chicago American • January 23, 1955*

**"... most significant recording project of the year!"**

"... this department is nominating as the most significant recording project of the year, the Louisville Philharmonic Society's commissioning and recording of works by more than 60 contemporary composers. The recording is by Columbia, and of the usual high Columbia standard."  
*Oakland (Cal.) Tribune • January 9, 1955*

## THE LOUISVILLE ORCHESTRA RECORD OF THE MONTH PLAN

Each month members receive a brand new 12" Columbia Masterworks recording made by the Louisville Orchestra, Robert Whitney, Conductor. These recordings, of brand new, especially commissioned works by leading, modern composers are not obtainable anywhere else!

**IT'S THE HIGH FIDELITY SENSATION OF THE YEAR!**



**LOUISVILLE PHILHARMONIC SOCIETY**  
824 South Fourth Street  
Louisville 3, Kentucky

Please send me free complete information about Louisville Orchestra Record of the Month Plan.

NAME: \_\_\_\_\_  
ADDRESS: \_\_\_\_\_  
CITY: \_\_\_\_\_  
ZONE: \_\_\_\_\_ STATE: \_\_\_\_\_



# Here's the turntable professionals want in their own Hi-Fi setups

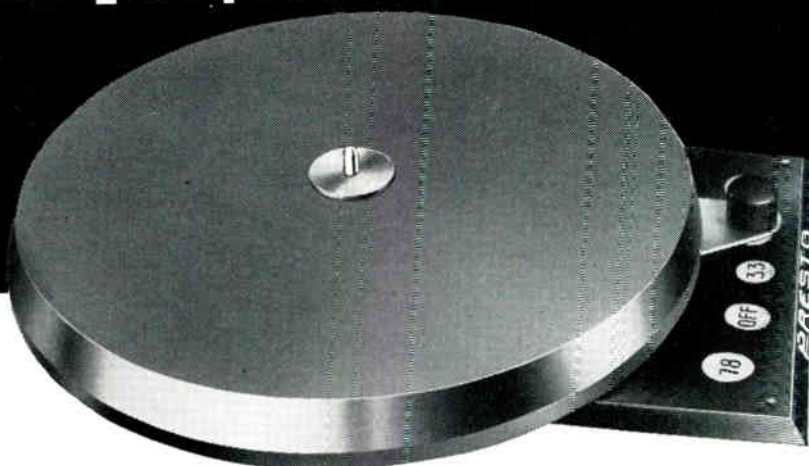

the all-new  
**PRESTO T-18**

streamlined inside and out  
...delivers top professional performance  
with incredible ease of operation

12" diameter...only \$53.50  
with hysteresis motor, \$108

Nobody knows better than the hi-fi expert how good the T-18 turntable really is. T-18 fills your every requirement for performance and value...is a natural choice for your home, as well as your studio and control room.

The most exciting feature of PRESTO's T-18 is a revolutionary 3-way shift — the flick shift. A simple sideway motion of the single control lever selects any speed — 33 $\frac{1}{3}$ , 45, 78 rpm. Complicated up-and-down motions are eliminated because the 3 idlers are mounted on a single movable plate. Just a flick automatically engages the proper idler for the desired speed! There are no trouble-making arms or shift cams. The mechanism is streamlined down to essentials—without sacrificing a decibel of quality.

Other advantages — extra heavy weight wide-beveled table, precision deep-well bearing, built-in 45 rpm adapter, and smart modern styling in brushed chrome and telephone black. A remarkable hi-fi instrument!

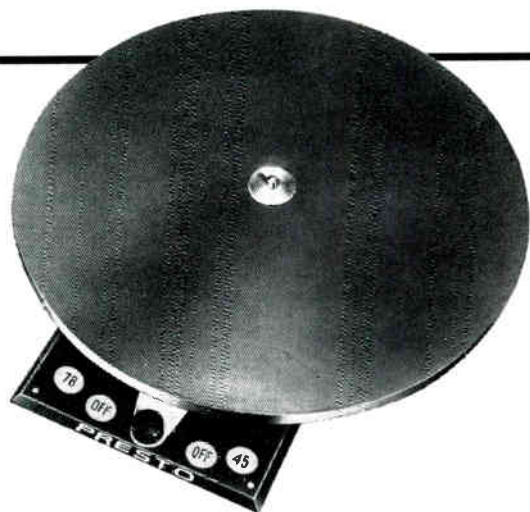

...and here's the 16" version  
for home or professional use!  
**PRESTO T-68 TURNTABLE**

The first completely professional 16" turntable that's moderately priced — thanks to PRESTO's streamlined shift design. Like all PRESTO units, T-68 offers the reliable performance that is vital in 24-hour-a-day transcription work. It's ideal for disc programs, sound effects, client auditions, dozens of jobs...and it's wonderful for the home with a fine hi-fi collection.

T-68 specifications: turntable speeds — 33 $\frac{1}{3}$ , 45, 78 rpm • weight—7 lbs. • panel size — 8" x 11" • speed accuracy—max. variation 0.25% • clarity — 50 db below 7 cm/sec. signal • \$79.50 with hysteresis motor, \$134.



**RECORDING CORPORATION**  
PARAMUS, NEW JERSEY

Export Division: 25 Warren Street, New York 7, N. Y.  
Canadian Division: Instantaneous Recording Service, 42 Lombard Street, Toronto

**WORLD'S LARGEST MANUFACTURER OF PRECISION RECORDING EQUIPMENT AND DISCS**

search no further for  
**CONCERT-HALL REALISM**  
 in your home!



**SHURE**  
*Music Lovers*  
**CARTRIDGE**

The "MUSIC LOVERS" Cartridge is a new, 3-speed, dual-needle ceramic cartridge, designed to enhance the quality of all the popular high fidelity equipment in use today. Mechanically interchangeable with magnetic pickups in practically all

record changers and transcription arms. Equipped for direct connection to magnetic inputs of amplifiers not yet provided with constant displacement ceramic inputs, thus allowing the full advantages of compensation circuits.

- ★ *Eliminates induced hum*
- ★ *Eliminates cartridge "drag" caused by magnetic attraction to steel turntables*
- ★ *Increases record and needle life*
- ★ *Provides higher output*
- ★ *Response not affected by load resistance*
- ★ *10-second needle replacement*
- ★ *Individual needle compliance eliminates needle interaction*

**FREE!** COMPARATIVE ANALYSIS BOOKLET ON THE "MUSIC LOVERS" CARTRIDGE

SHURE BROTHERS, INC., 225 W. HURON ST., CHICAGO 10, ILLINOIS

Please send analysis booklet on your "MUSIC LOVERS" Cartridge

Name .....

Address ..... City .....

M11



**IDEAS**  
 for  
**YOU**

**I**N ORDER to keep you up-to-date on new equipment and components that are being brought out, illustrations have been omitted in this Department, enabling us to bring more items to your attention in the space available. You will find the manufacturer's name and address after each description. Use the Catalog Request Cards bound into this magazine to send for bulletins and descriptive literature, so that you will have the full details.

**Shure Phono Cartridges**

Interesting features have been designed into the ML44 series of barium-titanate ceramic cartridges. Dual stylus assembly, with lever shift for 78 and 33-45 records, can be replaced by loosening a readily accessible thumb screw. Either sapphire or diamond styli are furnished. Built-in network makes this ceramic cartridge electrically interchangeable with magnetic types used with preamplifiers. Pickup head has standard plug-in mounting. *Shure Bros., Inc., 225 W. Huron St., Chicago 10.*

**Ercona Record Changer**

The Dekamix model is almost as free of mechanical parts above the mounting base as a plain turntable, except for the spindle-stack method of holding the records, a feeler-arm that tells the changer the diameter of the next record, and a control knob. Operating at 33, 45, or 78 rpm., it handles intermixed 12, 10, and 7-in. records, provided the latter are on top. Rubber-covered turntable is non-magnetic. Price with 2 pickup mountings \$44.95. *Ercona Corp., 551 5th Ave., New York 17.*

**Federal Tape Recorder**

Model 47A is a complete portable recorder with dual-track heads, operating at 7½ or 3¾ ips. Features include automatic counter, output jack for an external amplifier or for headphone monitoring, an input jack for microphone or radio, a jack for an external speaker, single control for rewind, record, or playback, and a safety lock to prevent accidental erase. Price is \$159.50. *Federal Mfg. & Eng. Corp., 215 Steuben St., Brooklyn 5, N. Y.*

**Stephens Speakers**

A new catalog of speakers, cabinets, and associated components, all with prices, is arranged in a very convenient manner for planning speaker systems. Eight combinations of units are illustrated and described, ranging from \$54 to \$393 without cabinets. Suitable cabinets, shown separately, are

*Concluded on page 10*

*Hi-Fi Music at Home*

*Encore* for a  
magnificent performance



long playing,  
authentic excerpts  
from the actual  
Master Tapes of  
famous High Fidelity  
Recordings

exclusively reproduced to introduce

*Encore* **WIDE LATITUDE**

A brilliant new innovation in recording perfection that insures flawless, professional tape reproductions with most recorders, regardless of the experience of operator or recording conditions.

*Tapes*

- Quality tape-recorded results
- Broad enough bias range
- Exceptional abrasion resistance
- Superior frequency response
- Top performance regardless of volume
- Performs well on any recorder
- Greater tensile strength
- Unaffected by storage conditions
- Consistent mechanical endurance
- New self-threading reel



LONG-PLAYING MYLAR  
PROFESSIONAL ACETATE



**SPECIAL MAIL OFFER:**

You pay only 59¢ for this Exclusive Encore Treasure Tape, "Excerpts from Dubbings Test Tape No. D-110" . . . THE MEASURE OF YOUR TAPE RECORDER'S PERFORMANCE. Tests for maximum and normal recording level, rough and fine head alignment, timing and tape speed, wow and flutter, signal-to-noise ratio. NOT for sale anywhere. Obtainable only by mailing this coupon.

*Because of the anticipated demand, this offer is necessarily subject to cancellation or change without notice.*

**TECHNICAL TAPE CORP., Morris Heights, New York 53, N. Y.**

**TECHNICAL TAPE CORP.** Dept. MH-7  
Morris Heights  
New York 53, N. Y.

Gentlemen:  
Please send me Treasure Tape "Excerpts from Dubbings Test Tape No. D-110". Enclosed is 59¢ plus 10¢ for postage and handling.

NAME: \_\_\_\_\_

ADDRESS: \_\_\_\_\_

CITY: \_\_\_\_\_ ZONE: \_\_\_\_\_ STATE: \_\_\_\_\_

# Klipschorn®

CORNER HORN  
LOUDSPEAKER SYSTEM

... the finest creation of Paul W. Klipsch,  
fabricated individually under  
his personal supervision.



Write for the name of your  
Klipschorn distributor and our  
latest literature on the Klipschorn  
and Shorthorn speaker systems.



KLIPSCH AND ASSOCIATES  
HOPE, ARKANSAS

TELEPHONES    PProspect 7-3395  
                     PProspect 7-4538  
                     PProspect 7-5575  
                     PProspect 7-5514

## IDEAS FOR YOU

*Concluded from page 8*

\$78 to \$161.25. Enclosures and complete speakers for various special purposes are also shown, ranging from portable and patio models to those for professional and theatre use. *Stephens Mfg. Corp., 8538 Warner Dr., Culver City, Calif.*

### V-M Phonographs

A portable phonograph, two table models, and a console design have just been brought out. All changers operate at 78, 45, 33, and 16 rpm. The lowest speed is for talking books. An interesting feature is a switch, actuated by the last record, which cuts off not only the changer motor, but the amplifier and current to a receptacle where a reading lamp can be plugged in — an ideal arrangement for people who read while they listen to music in bed! Also, there are output connections for a separate speaker, and a front-of-cabinet reject button. All models are very attractive in appearance, and moderate in price. *V-M Corp., Benton Harbor, Mich.*

### Star Record Cabinet

Designed to hold records vertically, in accordance with professional practice, this 5-section wooden cabinet, 11 ins. wide, 13 $\frac{3}{4}$  high, and 12 $\frac{5}{8}$  deep, holds up to 60 12-in. LP records in their jackets. This makes an attractive, practical means for filing records and keeping them in perfect condition. Finish is in natural, walnut, mahogany, or ebony color. Price \$9.95. *Star Record Products, 152 W. 42nd St., New York City.*

### G.E. Pickup

A new type of clip-in stylus is so designed that it can be slid in place or removed instantly. This method of mounting replaces the original type in all new G.E. cartridges. A further advantage is that the dual styli are clipped in separately, so that one can be used even though the other is removed for replacement. Any combination of styli can be selected; with diamonds or sapphires for 33 and 45, or 78-rpm. records, and NAB transcriptions. *General Electric Co., Electronics Park, Syracuse, N. Y.*

### Collins Tuner & Remote Control

This is the first FM-AM tuner for which complete remote control is available. Identified as the Custom Special, the tuner has all the features that the name would indicate as to design and performance, even to jacks on the top of the chassis where test meters can be plugged in, and provision for adding a unit for FM multiplex reception. Remote control of tuning, volume, and FM-AM switching can be added with a front-panel driving unit. Tuner is \$285; gold or gray cabinet \$11.40; remote control \$79.50. *Collins Audio Products, Westfield, N. J.*

*Hi-Fi Music at Home*

# SAVES TIME... MONEY... RECORDS

Now!  
**G-E CARTRIDGE**  
 with exclusive  
**CLIP-IN TIP**  
 stylus . . .



## anyone can replace G-E Styli...instantly!

● Years ahead clip-in stylus design turns this neat trick. With the G-E *CLIP-IN TIP*, replacement is made on a moment's notice . . . *at home*. No trips to a store . . . no long waiting period . . . no instal-

lation time or expense! The CLIP-IN TIP makes it easy to *always* use good styli . . . never worn edges that injure records. Best of all, it is the finest performer in all of G.E.'s famous cartridge history.

*General Electric Company, Radio & TV Department, Section R9675, Electronics Park, Syracuse, N. Y.*

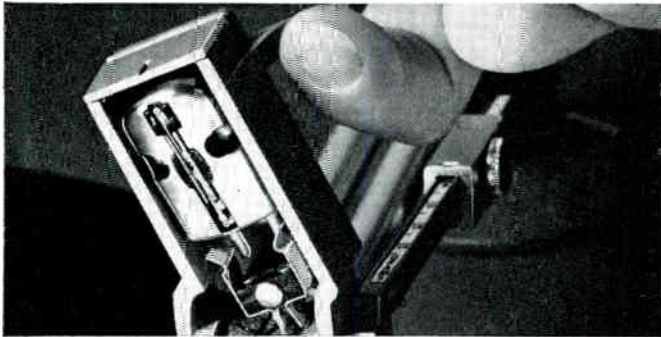

Simply raise the tone arm sufficiently to permit free rotation of the CLIP-IN TIP stylus. No more effort than is required when changing from 78 to LP playing position.



The worn stylus insert slides out easily and you insert a new one in its place. That's all with a G-E CLIP-IN TIP. Needs no diagram . . . requires little effort . . . little time.

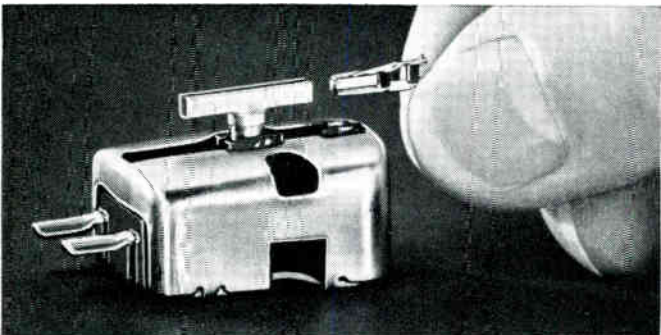

New single styli have this feature, too. Just raise the stylus shaft . . . replace the insert. A CLIP-IN TIP can be used in existing G-E dual cartridges or new single and dual types.



GENERAL  ELECTRIC



*More than a Tape Recorder . . .  
A Complete Home Sound Center!*

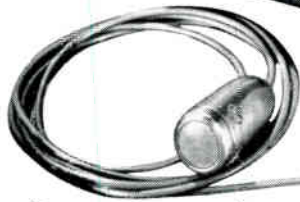
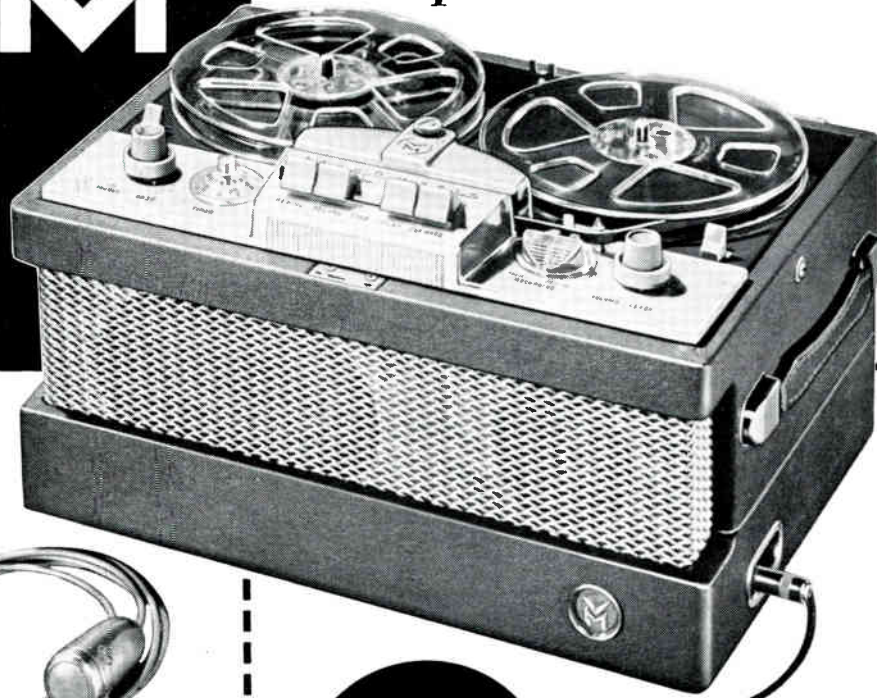

the **Voice**  of **Music**

## **TAPE-O-MATIC<sup>®</sup>**

### VOICE OF MUSIC TAPE-O-MATIC TOP FEATURES

- **Dual Track**
- **Dual Speed**
- **Precision Tape Index Timer**
- **"Record Ready" Light**
- **Automatic Shut-Off**
- **Monitor Switch**
- **Pause Button**
- **Dual Input and Output Jacks**
- **Professional Quality Microphone**
- **Push-Button Controls**
- **Safety Switch**
- **"Off" "Treble" "Bass" Controls**

Your V-M high fidelity *tape-o-matic* does everything.

You can record from radio, TV, voice, orchestra—any source of sound! When played back, through the magnificent *tape-o-matic* dual-speaker system, those treasured sounds you saved return with amazing fidelity . . .

over and over again! The Voice of Music *tape-o-matic* can even be used as a PA system!

In the V-M *tape-o-matic* you find TEN top features—many not found in expensive models. It's a wonderful gift for the home—at only \$179.95\*

Ask for a demonstration at your Voice of Music Dealer.

UL Approved \*Slightly Higher in the West

**V-M CORPORATION, BENTON HARBOR 6, MICHIGAN**

WORLD'S LARGEST MANUFACTURER OF PHONOGRAPHS AND RECORD CHANGERS

# MUSIC in YOUR HOME

FROM Randall Worthington, of Washington, Ohio, this letter: "I finally decided to renew my subscription when you added record reviews, but I'm still wondering why you made a statement of policy against them, and then reversed it a few months later."

If there has been an apparent inconsistency of policy in this Magazine, an explanation is in order, for the fact is that we are very much *for* record and tape reviews, but definitely *against* certain kinds of reviewing.

Perhaps the best way to make this clear is to cite some specific examples. First, though, let's examine the source of what we might call the "standard" type of reviews. They are written by professional critics who earn their living by comparing the musical content of compositions, and the manner in which they are conducted and performed, with their ideas of the way the music *should have been* composed, conducted, and performed in order to please not only themselves, but everyone else.

Ideally, a critic serves as a combination of audience and applause meter and, in that capacity, is a guide and mentor for composers, conductors, and performers. But the realities of making a living as a critic are such that he may be called upon to write about music of which he has no knowledge. Because editorial deadlines are inflexible, he may have to turn in his copy before he has had a chance to play all the records he is required to review. In some cases, he may not feel prompted to make any particular comment. But in any event, he must maintain his position as a critic. Under these circumstances, he may use his allotted number of column-inches to:

1. Produce some really devastating criticism. (This shows how much more he knows about music than the composer, conductor, or performers.)

2. Show himself to be a master of literary craftsmanship. (This skill is essential to the critic, particularly when he must review records he didn't have time to hear.)

3. Establish, not always subtly, that he roams freely in more rarefied atmosphere surrounding the world of music, where his readers would hardly know their way. (Readers should have their ears pinned back occasionally.)

4. Straighten out recording engineers who, being engineers, know so little about recording music. (A critic can do this so easily. It requires neither knowledge of engineering, nor experience with recording techniques.)

As a matter of editorial policy, HI-FI MUSIC AT HOME is very much *for* reviews which provide straightforward information, but very much *against* reviews containing material of the four types specified above.

DO THESE comments seem overly harsh, or unjustified? Let's look at some of the reviews and see exactly what kind of writing, although accepted by other publications, would be rejected by this Magazine.

1. DEVASTATING CRITICISM: "Leopold Stokowski's penchant for 'interpreting' symphonic masterpieces is on display in this recording — and to a rather doleful effect. He alters tempos and phrasing to suit his fancy, sweetens passages that should be rugged, hurries places that cry out for breath, and all in all destroys the power and vitality that are so essential to a proper reading of this exciting work." Another example: "All the notes are there, with virtuosity — but these must be little men from Mars playing, with baleful eyes and radomes on their heads."

2. LITERARY CRAFTSMANSHIP: "'Ballo' has a good enough score to bring Somma's weirdly Latinized Bostonians and their emotions to life. Given casting and conducting that are decent, it works in the theatre; and though it is recurrent rather than perennial in any given repertoire, it is almost always being given somewhere or other." Also: "Mozart all curved for seduction, without one masculine angle, perfectly sculptured in batter."

3. WRITING DOWN TO READERS: "It would be helpful if works by Vivaldi were identified by their Fanna numbers, as in the Complete Edition being published by Ricordi, or by their numbers in the Pincherle catalog." In a different way: "I cannot say that the French woodwinds and string tone are exactly what one wants to hear in this score, but their response to Schuricht is so wholehearted that the experience becomes a unified one." Or: "Perhaps the music isn't quite as sensitively perfumed as it might be ideally, but this smooth, suave performance is in good taste, and not overly hard-surfaced."

4. TECHNICAL KNOWLEDGE: "Acoustically the older record has the edge; the legato tone sings more in the studio environment and there is less blurring in moments of brio." Again: "The reticence of the Capital sound is of subtle high class, and preferable to Vox's bigger muscles."

These quotations are offered here without comment, except insofar as they were related to the editorial policies of this Magazine, because some people like to read record reviews as others read science-fiction books. It's fun, whether they mean anything or not.

The purpose here is only to explain the kind of reviews we are against. It will also help you to understand why our reviewers are not professional critics, but members of the musical profession, chosen because they look upon the writing of reviews as a means of sharing their knowledge of music with others. If anyone of them departs from that single objective, we shall sentence him to the awful fate of being "sculptured in batter."



**PICKERING** models **220** / cartridges  
**240**

*The Most Nearly  
Perfect Phono Pickups  
Ever Produced . . .*

they are sold separately for all standard arms or  
mounted back-to-back to make up the famous  
**PICKERING 260 TURNOVER PICKUP.**

**MODEL 220**—for 78 rpm records  
diamond or sapphire stylus



**MODEL 240**—for 33 $\frac{1}{3}$   
and 45 rpm records  
diamond stylus only

**MODEL 260**—turnover  
cartridge for 78 or 33 $\frac{1}{3}$   
and 45 rpm records  
(the 220 and 240  
back-to-back)



The **220** and **240** are engineered to  
maximize performance. By comparison they  
are without equal . . .

The **220** and **240** are

**Lighter**— 5 $\frac{1}{2}$  grams

**Smaller**— $\frac{5}{8}$  by  $\frac{3}{4}$  by  $\frac{3}{8}$  inches

The **220** and **240** have

**Highest Output**—30 millivolts/10cm/sec.

**More Compliance with Less Tracking Force**

**Lower Overall Distortion**

**Less Moving Mass**

**Wider Frequency Response**

**Mu-Metal Shielding for Less Hum**

*These characteristics have real meaning to those who understand that  
maximum performance depends upon components which meet professional  
standards. If you want the best that high fidelity can offer, ask your dealer  
to demonstrate the 220, 240 and 260 Pickering cartridges . . .*

*The Most Nearly Perfect Phono Pickups Ever Produced*



**PICKERING** and company incorporated • Oceanside, L.I., New York

**PICKERING COMPONENTS ARE PROFESSIONAL QUALITY**

*“For those who can hear the difference”*

. . . Demonstrated and sold by Leading Radio Parts Distributors everywhere. For the one nearest you and for detailed literature; write Dept. X-7



# the HI and the FI . . . . .

THE OTHER DAY we set forth brazenly in search of that person with the noisiest hi-fi rig in New York City. As we turned left on 3rd Avenue, the strange stillness of the newly-abandoned "L" tracks was abruptly shattered by a sound which assailed us with an intensity compared to which the composite cacophony of an audio show was as gentle as the twittering of birds at sunrise. Here, right before our very eyes and ears, was old man Slattery, the contractor, whose men are currently hellbent on ripping up 3rd Avenue pavements for the third time in as many months. His air-hammers were sending gobs of tumultuous sound rolling east, west, north, and south. Unquestionably, New York's loudest hi-fi merchant is Slattery. Next thing you know, Emory Cook will record him.

MENTION of The Tiger of Stamford brings to mind a report from the Midwest about unique goings-on near Chicago's Gold Coast. It seems that a certain prankster, and we're not at all sure of the sex, has an acute case of the dreaded hifinitis. At various times this spook places his (or her) loudspeaker at the open living room window of the third floor apartment, which borders on North Michigan Avenue. Then, with fiendish glee, he (or she) turns up the volume full tilt and places Mr. Cook's recording of *Rail Dynamics* on the turntable. The report concludes that the reaction of meandering Chicagoans to the realistic choo-choosings of old-fashioned steam engines charging down Michigan Avenue is quite impossible to describe.

DEPT. OF COUNTER REVOLUTION: The dangers of procuring phonograph records gratis were never more evident than in the divorce trial of a prominent executive of a prominent record company. His wife, in accusing him of cruelty, cited his extraordinary habit of breaking records by the score whenever he lost his temper. That would never, never happen with those of us who must pool our monthly resources in a feeble, but faithful attempt to keep up with the latest releases. Oh yes, there was something about a redhead in her husband's stateroom too.

FROM WHENCE cometh this term "hi-fi"? In this issue, we start a question-and-answer series on the general and untechnical aspects of hi-fi. Tom White, the first to be interviewed, told us: "To the best of my knowledge, we here at Jensen introduced the term *hi-fi* in 1935, when we developed a speaker system using two or more loud-

speakers, one of which was a new kind that we called a 'tweeter', while the other was more conventional in design and was called a 'woofer'. Compared to previous standards, this technique unquestionably permitted the reproduction of sound more faithful to the original. Since the fidelity was superior, we called the result 'high fidelity'." Any comments? We've often wondered if Nero fiddled at *super fidelitas*, since his achievements were so spectacular. Or are we confusing that with a hifalutin gee-wizz once uttered by a Roman legionnaire who sneak-peeked at Cleopatra. It's bewilderin'.

THE PERENNIAL honeymooner, Jackie Gleason, looks precisely as if he might have swallowed a glass of Duz just before he accepted a gold V-M phonograph from



Glenn E. Wallich, President of Capitol Records. The occasion was the celebration of Capitol's having sold 1,000,000 Gleason albums over the past 30 months. Makes you teary-eyed, doesn't it?

IT MAY take a long, long train with a red caboose to carry away your worries, but RCA Victor does it all with a flip of the olive. The Little Doggie pitched a party the other noon to introduce its latest line of hi-fi equipment. The Press was greeted by the Brass, and that's interesting, for Brass with RCA is like records — there's always enough to go around. Even Ye Olde Cape Cod Clam Digger, Vaughn Monroe, was about, with a notable new sound in that he had switched from the mambo to *Davy, Davy Crockett*. After a short course of conversation, we were privileged to hear RCA's stunning Mark I, a combination of woofers, tweeters, tape recorder, phono-

graph, tuner, and a cosy little home for your mother-in-law, and all at the low, low price of \$1600. It played beautifully, save for a Sauter-Finegan thingaling that sounded something like a flotilla of fossils on a tequila bender. Gradually, we were played on down the line, skipping over the Mark V, which just wasn't there. After hearing the Mark VI, last and smallest of the line, we were invited to step into the parlor for cocktails. This really broke our heart, we'd so been hoping to hear a Mark VII. You remember that lad on the West Coast? Isn't the name Webb? Ah yes, that's it, Jack Webb. At any rate, his hammer and iron impresses the Mark VII seal into each of his TV programs. So if RCA had only come along with a Mark VII hi-fi set . . . WOW! The ensuing clash between Sergeant Friday and the RCA *Corps de Brass* would make next fall's foray between the Rams and the Giants (Football, for crying out loud!) seem like a game of ring-around-a-rosy in Ding Dong school.

THE LANKY COLONEL, George R. Marek, who manages RCA Victor's Artists and Repertoire department, pointed out in a pre-demonstration talk that "one of the popular misconceptions about high fidelity is that it is primarily for classical music. This is definitely not true. Eddie Fisher, The Three Suns, or any of the other pop music artists sound just as thrilling in high fidelity as does a Beethoven piano concerto or a Brahms symphony". Could this be! This pronouncement shook our very boot straps. Were our ears playing tricks on us? No! He'd said it and he was glad. We rose to snap off a question, but then sank down again too weak with astonishment to stand. Here was a man of eminent character, warmly respected by every lover of classical music, admitting in so many words that Eddie Fisher's *Pretty Baby* sounds "just as thrilling" in hi-fi as does Beethoven's *Piano Concerto No. 5 in E Flat* by Vladimir Horowitz with Fritz Reiner and the NBC Symphony Orchestra. This changing world! Then Marek continued: "High fidelity is especially exciting for lovers of jazz as it brings out a new concept of quality in high and low tones". Well, we'll go along with that, and you can hear the jazz better too. Marek again: "Even those interested in country-style music will be amazed at what high fidelity does to the reproduction of string instruments". Sure they will! Mr. Marek, we agree whole heartedly with your principle that all *good* music sounds better at hi-fi. But ye Gods, Georgie, hereafter let's block those comparisons!

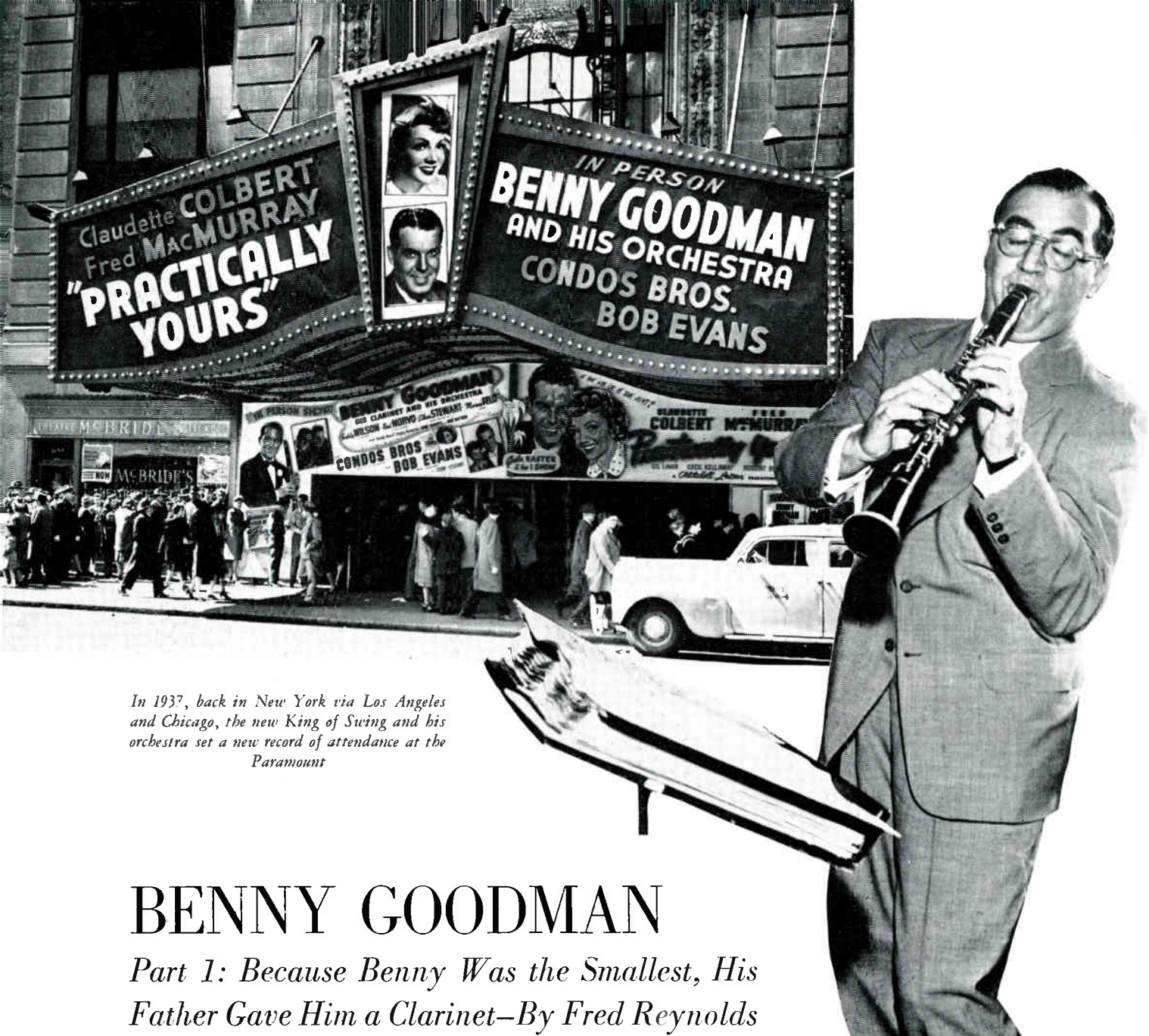

*In 1937, back in New York via Los Angeles and Chicago, the new King of Swing and his orchestra set a new record of attendance at the Paramount*

## BENNY GOODMAN

*Part 1: Because Benny Was the Smallest, His Father Gave Him a Clarinet—By Fred Reynolds*

**B**ENNY GOODMAN, Columbia's Irving Townsend, and I were fishing. Three friends with one line, all after the same thing, a fetching mermaid called Entertainment. The occasion was a luncheon in Goodman's luxurious office-apartment on New York's East 66th Street. We were talking over details of the script of the forthcoming motion picture, "The Benny Goodman Story", in which Universal-International will trace Goodman's life from his early struggles with the clarinet in Chicago to his famous Carnegie Hall Jazz Concert of 1938.

As we munched on a clam, I kept asking Goodman about one after another of the various little, yet significant things that had happened to him during his career, one of the great rags to riches stories of American history. Goodman would nod "Yes, that one's in the picture," or "No, that isn't." Townsend and I beat Krupa-like drums for crackerjack episodes and stories that were left out of the script. Then the light dawned. If we had had our way, we'd have ended up with a single motion picture 10½

hours long, and you couldn't get a theatre to run it or a person to sit through it.

The truth was so evident once we got our exuberance under control. When you make a picture of a man's life, no matter how unusual and exciting that life has been, you have to cut here and there, you have to double up on scenes and episodes, you have to take liberty with fact. For the primary purpose of picture making is still entertainment, entertainment so good and of just the right length that it will draw enormous numbers of people into the theatre. When you see "The Benny Goodman Story", which is now rolling on the U-I Hollywood lots and in Chicago, you are going to see a fine picture. The music will be terrific, for it will be Goodman's. But don't get excited, as some people did about errors in "The Glenn Miller Story", just because the facts aren't all according to life and time. If the picture entertains you, if it helps to perpetuate some of the most marvelous music ever played on the American scene, then it has accomplished its purpose.

Meanwhile, however, if you would like to compare the facts against those that will be in the film, I can tell you:

Benjamin David Goodman was born in Chicago on May 30, 1909, the 8th of 12 children. His father, David Goodman, was a tailor who had emigrated from Poland, and although he worked hard, there was never enough money to clothe and feed the whole family properly. Still, Papa Goodman, a deeply religious man, was determined that his sons should know about music, for which he had a sincere liking. So one day in 1919 he took Harry, aged 12, Freddy, 11, and Benny to the Kehelah Jacob Synagogue for music lessons. Since Harry was the biggest, he was given a tuba; Benny was the smallest, and he got a clarinet. In that most elementary manner, the die was cast.

After a few months of preliminary work with scales and exercises, Benny Goodman began on the easier pieces of Brahms and Mozart. These were to influence him the rest of his life, as Benny has always had a great attachment

Often the appearance of a boy clarinet player wearing short pants was a little distracting . . . one day in 1923 Benny showed up for a date on the excursion boat that ran from Chicago to Michigan City. He was going through a couple of warm-up choruses, when a voice cracked, "Get off that stand and stop messin' round with those instruments." That fellow was the legendary Bix Beiderbecke, then all of 19, and it took a little persuasion before Bix could be made to realize that Benny — short pants and all — was really to play right along with him.

Not long after that, Gil Rodin, who later was so responsible for the organization and success of the Bob Crosby Dixieland band, came into Chicago and hired Goodman for the Ben Pollack orchestra. He joined the outfit in California at a salary of \$100 a week. The going was good, and it was steady, but you can't stay in one location forever. The band headed for Chicago and then New York. Shortly after his arrival in the Windy City, the excite-

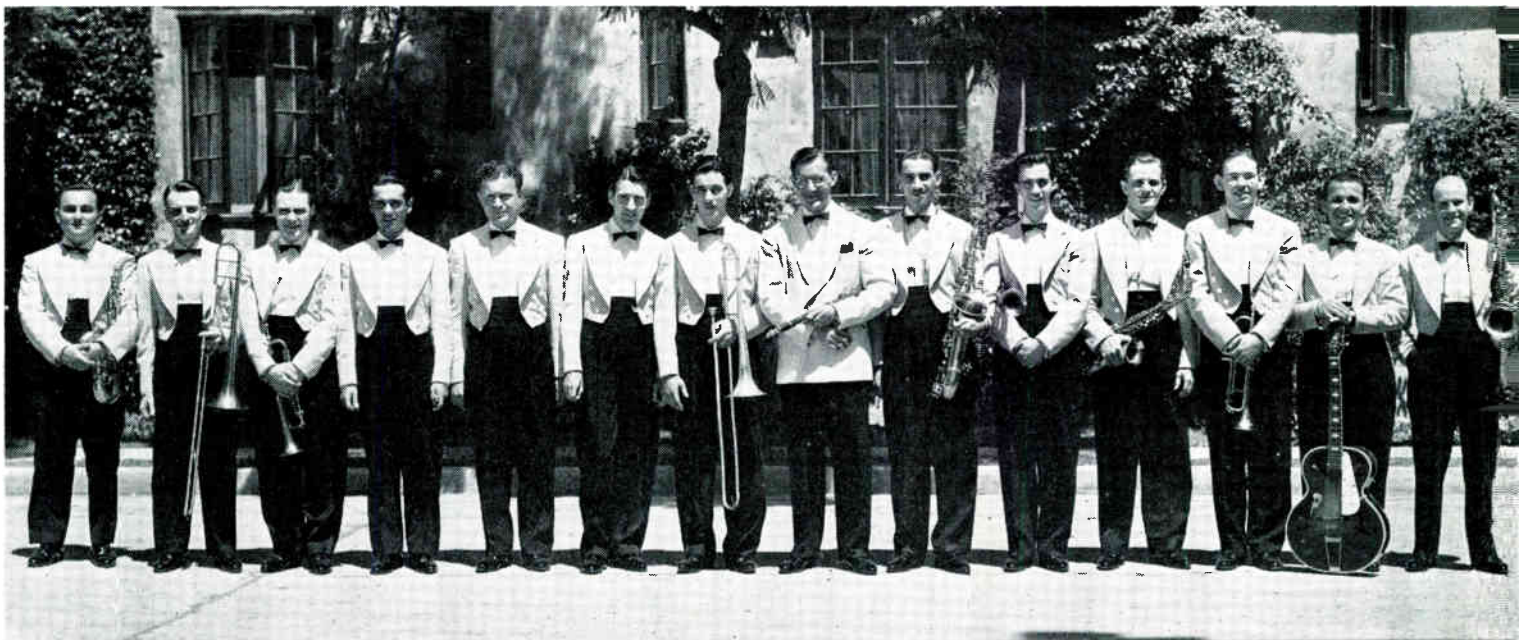

1936: *The Goodman Band at the Paramount lot in Hollywood, as you may have seen it in the picture "The Big Broadcast of 1937"*

for serious music. His first teacher and perhaps his most important was Franz Schoepp, who had nothing but scorn for jazz, or "the music of the street" as he called it. By the end of a year, both Benny and Harry were playing with Jimmy Sylvester in the Hull House orchestra, Hull House being one of America's great social institutions.

When young Benny entered Harrison High School he was beginning to take more than a passing interest in the jazz music that was being played all over Chicago. He met fellow students from other Chicago schools who were going around listening to jazz, fellows like Frank Teschemacher, Jimmy McPartland, Eddie Condon, Dave Tough, Bud Freeman, Milt Mezzrow, and Pee Wee Russell. Mostly they listened to King Oliver, Louis Armstrong, Leon Rappolo, Johnny Dodds, and Jimmy Noone. Around this time too, Benny started working on odd jobs. His first was at the old Central Park Theatre, imitating an early idol of his, Ted Lewis, sometimes called "The Poet of Circleville".

ment of his first real success before the home folks was dimmed by the death of his father. A new friend helped him over the sad moments, a friend and trombonist named Glenn Miller. After a brief excursion to Isham Jones' band, Benny and the Pollack aggregation set out for New York. It was there that Goodman made the first records ever issued under his own name.

When Pollack's band landed a job at the Park Central Hotel in New York, it was a good break all the way around. Work was steady, and there was the prospect of a sustaining radio program from the hotel. Dorothy Fields and Jimmy McHugh used to come into the Park Central to catch the band, and liked what they heard. So when they wrote the musical show, "Hello Daddy", they made a deal with Pollack to double into the show from the hotel. Tails were required for the show job, but Goodman and Gil Rodin, being of the opinion that the show wouldn't last too long, decided to rent their tails rather than buy them. This they did, and on opening night discovered to

*Benny dammed up a stream that flows through his back yard, and stocked it with trout and bass, but they take him no more seriously than he appears, from this picture, to take his fishing. The truth is that he'd rather look at them than catch them, anyway*

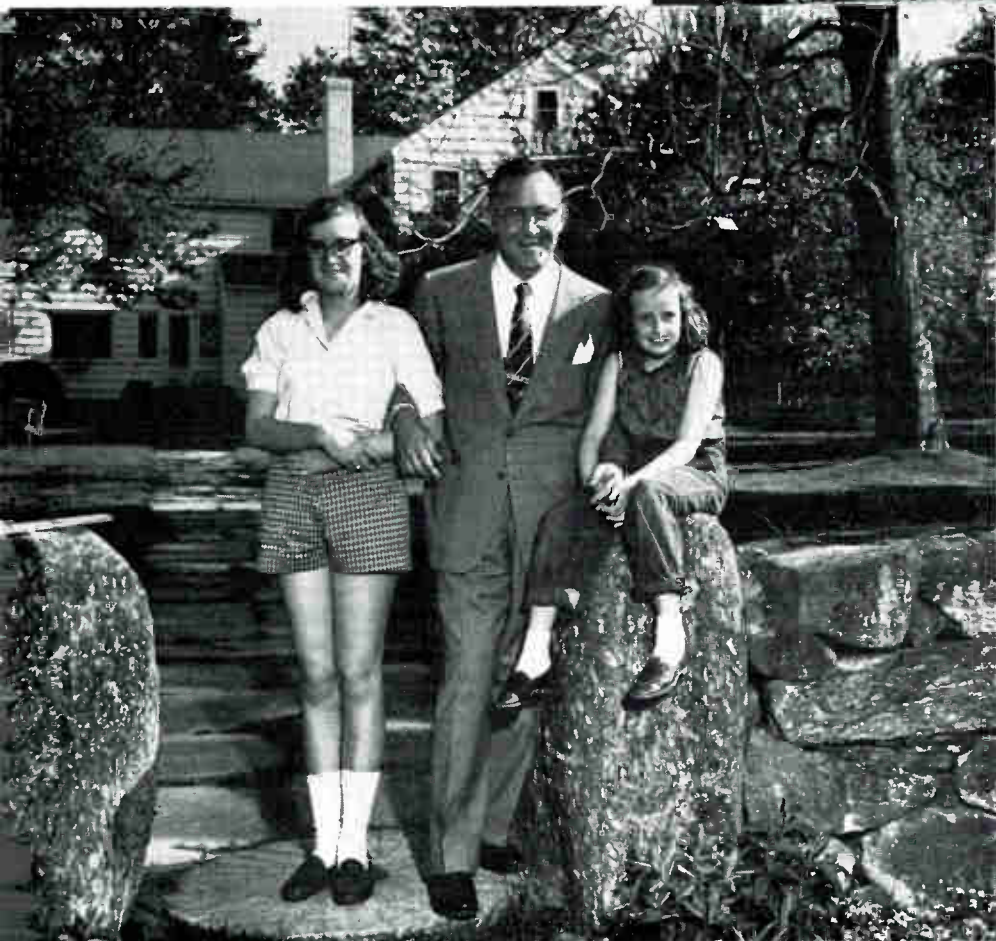
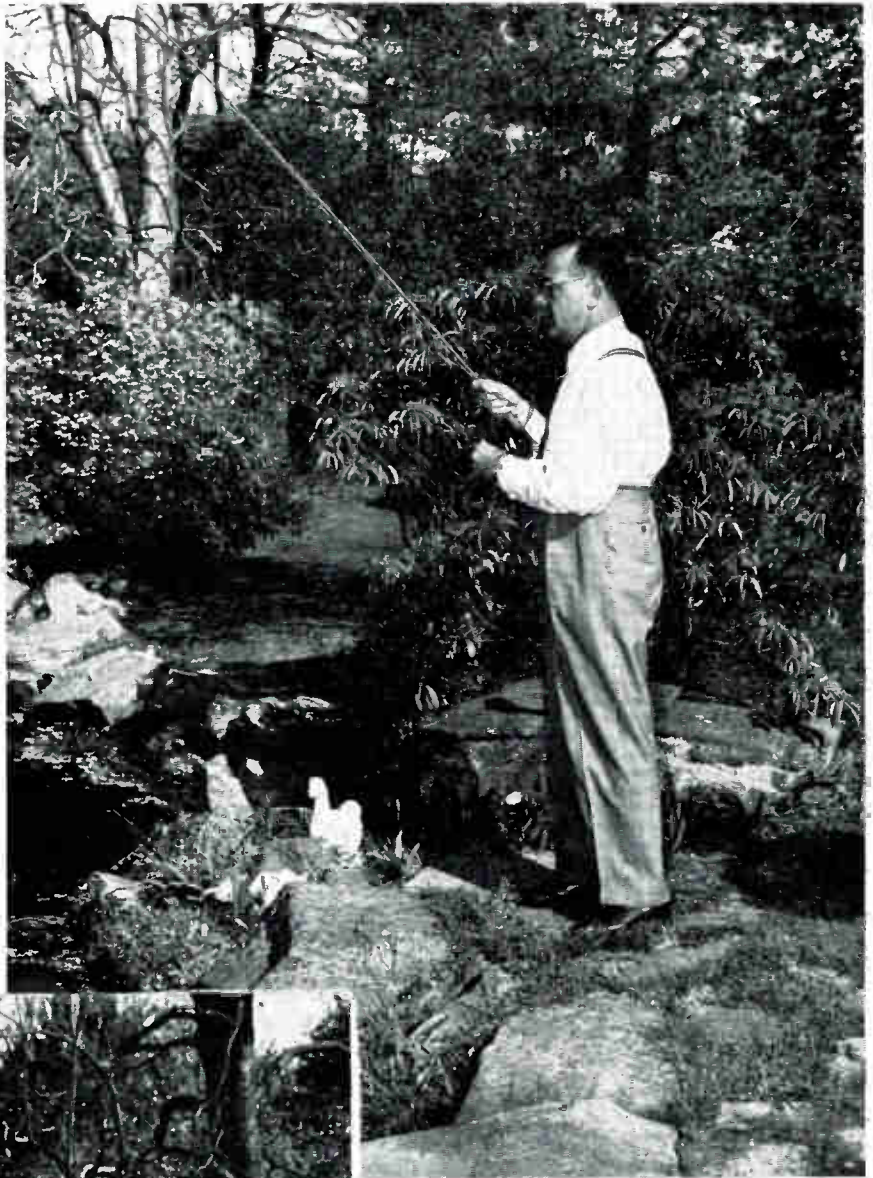

*The Goodman home in Connecticut was built some 150 years ago. The living room was once the original schoolhouse of Stamford's beautiful Long Ridge section. William Leftwich, who took these photographs, observed: "Mrs. Goodman has the place looking as if Alexander Hamilton and Frank Lloyd Wright were expected to arrive at any minute for tea." Here is Benny with his daughters Rachael and Benji*

their consternation that they had rented a couple of waiter's uniforms, with practically no shoulders. As Benny says: "There never was so much clarinet and saxophone played in a bent-over position as we did that night. We managed to cover up pretty well until the end of the act, when Pollack gave us the nod to take a bow. Then we had to stand up, and the band nearly broke up, the boys laughed so much."

In 1929 Benny Goodman left Pollack's organization and took a job with Red Nichols to play in the pit for the George Gershwin show, "Strike up the Band". About the same time Benny and Jimmy Dorsey took an apartment together on West 58th Street. Jimmy was playing with Ted Lewis at the Club Richman. An incident took place on New Year's eve that Benny likes to tell. "Strike up the Band" hadn't opened yet, so Benny booked himself with a society band for the big evening. It was this leader's habit, whenever something griped him, to pick out the musician nearest him and say: "Pack up your instrument and get out. You're through." Usually, the guy couldn't afford to do so, and would sit dejectedly and sulk, just as the leader expected. However, he pulled it on Benny, and Benny, being Benny, simply packed up and got out. When Goodman reached home, he was amazed to discover Dorsey curled up in bed dozing. Jimmy looked around and said: "What the heck are you doing back at this hour?" Goodman told him, and then it occurred to him to ask the same story of Dorsey. "Well", Jimmy replied, "I hit Lewis on the head with a clarinet." It seems that Ted Lewis hadn't appreciated an imitation Dorsey had done of him at the Club Richman.

The inevitable happened during the run of "Strike up the Band". Goodman and Nichols are both perfectionists, both are born leaders. They couldn't stay together without arguing, and it had to end in divorce. This left Benny free to play several prom dates, take a fling at running his own band for the Laurence Schwab-Oscar Hammerstein II show, "Free for All", which flopped, and pick up anything else that happened to come along. Hot records were on the decline, and for the first time Goodman started to get interested in radio. He also found it opportune to make several records with Ted Lewis, quite obviously because the dates happened to pay good money.

From 1931 through 1933 things went along fairly well with Benny Goodman. He wasn't doing what he wanted to do, but he was making money playing for radio. In September of '33 something happened that made a great difference. John Henry Hammond, Jr., eminent jazz critic and socialite, whose sister, Alice, Goodman later married, came to Benny with a proposition to make some records for sale in England, using the best jazz musicians available. Hot music was catching on with the King's subjects, and there was an increasing demand for new records. Benny got set with such fellows as Jack and Charlie Teagarden, Manny Klein, Joe Sullivan, and Artie Bernstein. The records were made and issued in England and, because they were good, Goodman somehow talked the Columbia people into releasing the first two sides in the U. S.

There were straws in the wind. The Casa Loma band had come to town and was getting a good play, especially

around the college towns. The new records were being heard. So Benny Goodman decided to go all the way and form his own band. John Hammond helped him. They worked quite awhile just looking for the right people, for Benny had certain ideas of what he wanted — and that was a big band that swung from the heels with a solid rhythm session. Goodman and Hammond spotted such able sidemen as Claude Thornhill, Red Ballard, Sammy Weiss, Hymie Schertzer, Sammy Shapiro, and George Van Eps. The contract with Columbia still held firm, and the real Benny Goodman band assembled for the first time at the old Columbia phonograph studios on Fifth Avenue, where such sides as *Basin Street Blues*, *Riffin' the Scotch*, and *Georgia Jubilee* were made.

Early in June of 1934 the Benny Goodman band auditioned for Billy Rose, and shortly thereafter it was signed for Rose's Music Hall, from which it broadcast over a local radio station. But a change in management of the Music Hall ended the engagement after some three months of work. Before that, Benny and the band were auditioned and signed for a three-hour program that the National Biscuit Company was proposing. The program was to be called, "Let's Dance." The format was simple — a sweet band for an hour, a rumba band for an hour, and then a hot band for the last hour. Meanwhile other things were happening. Willard Alexander of Music Corporation of America had started to take an interest in the clarinetist from Chicago. Some of the musicians had pulled out of the band and replacements were necessary. Toots Mondello came into the sax section, Pee Wee Erwin came into the trumpet section, Gene Krupa became the band's drummer, and Benny found a little girl named Helen Ward singing sustaining programs on radio station WOR. But more important than all, perhaps, was the fact that Benny lined up the great Fletcher Henderson as his arranger. George Basserman had written and arranged *Let's Dance*, and Gordon Jenkins had done the same for *Goodbye*. The recording contract had come to an end with Columbia, and the Goodman band had been signed by RCA Victor. The first disc the Goodman band made for Victor that could be called a hit — the one that started attracting real attention — was the fourth side cut at the first session. Dean Kincaide had made the arrangement, and Helen Ward sang Johnny Mercer's fine lyric. It was Benny Goodman and the orchestra and *The Dixie Land Band*.

However, it is wrong to form the impression that just because the Goodman band had made some sides for RCA Victor and one or two had begun to sell well that everything was peaches down on Broadway. It wasn't by a country mile, for there was still a long road to travel. But at least the band was on the right route. The end of the second thirteen weeks of the "Let's Dance" program was nearing a close, and there was the problem of what to do with the band through the summer. MCA fixed that one! The company booked the Goodman band into the Roosevelt Hotel, perennial home of Guy Lombardo and "the sweetest music this side of heaven." Benny wouldn't compromise. The Goodmanites played their music their way, and the date was a flop. But the rehearsals were getting better and so was the band. There was coming that

*Continued on page 54*



Robert Whitney, director of  
the Louisville Orchestra

# LOUISVILLE RECORDS

*Important Releases by Contemporary Composers, from the  
Louisville Orchestra's Commissioning Series — By David Hall*

COMPOSER-CRITIC Peggy Glanville-Hicks told us in the last issue of *Hi-Fi MUSIC at HOME* about the operatic aspects of the Louisville Orchestra's ambitious program on behalf of living composers. As for myself, having been largely responsible for the very first recording of a Louisville-commissioned contemporary score — William Schuman's *Judith* (Mercury MG10088) — I have been more than a little interested to observe the development of the Louisville project since my brief association with it in 1950.

It was after the disruptions attendant on World War II that a determined move was made among the cultural circles of Louisville, Kentucky, to do something about its symphony orchestra, and to make the city known for something else besides the Kentucky Derby and the manufacture of baseball bats.

Under the direction of Robert Whitney, the Louisville Orchestra had achieved a very respectable status as one of the better "second division" American symphony orchestras. The seasonal programming followed the conventional pattern of featuring top-name soloists with repertoire founded in large measure on the fifty pieces that form the staple fare of symphony concerts throughout the world.

With the moral and material backing of Charles P. Farnsley, then dynamic Mayor of Louisville and now

Chairman of the Commissioning Project, it was decided in 1948 that the Louisville Orchestra would make an all-out effort to establish an unique place for itself in the musical sun, and to make a permanent place for Louisville on the cultural map. The size of the Louisville Orchestra was cut down to 50 men — a sufficient number to play most of the significant musical repertoire of the past 200 years — and it was decided to allocate that part of the budget which went for extra players and star soloists toward the commissioning of new works from the foremost living composers of our day. Each program on the Orchestra's regular subscription series was to feature one of the newly commissioned scores.

The response to this brilliant new departure was such on both a local and national level that the Louisville Orchestra gave a highly successful concert in New York's Carnegie Hall in December of 1950, following this with the recording session that produced William Schuman's *Judith*.

By 1953 some 29 works had been especially written for and played by the Louisville Orchestra. Paul Hindemith, Arthur Honegger, Gian-Francesco Malipiero, Roy Harris, William Schuman, Heitor Villa-Lobos, Carlos Chavez, and Bohuslav Martinu being among the more illustrious composers represented, with a sampling *Continued on page 48*

*Under a grant from the Rockefeller Foundation, the Louisville Orchestra is recording some forty new scores by contemporary composers each year*



*This year, the season at Tanglewood will run from July 6 to August 14. Charles Munch, director of the Boston Symphony Orchestra, will have as guest conductors Thor Johnson, Leonard Bernstein, and Pierre Montoux*

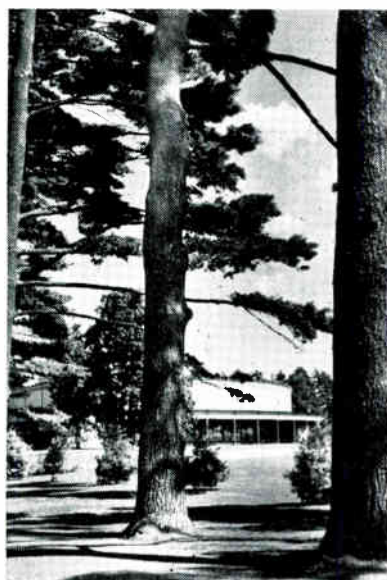
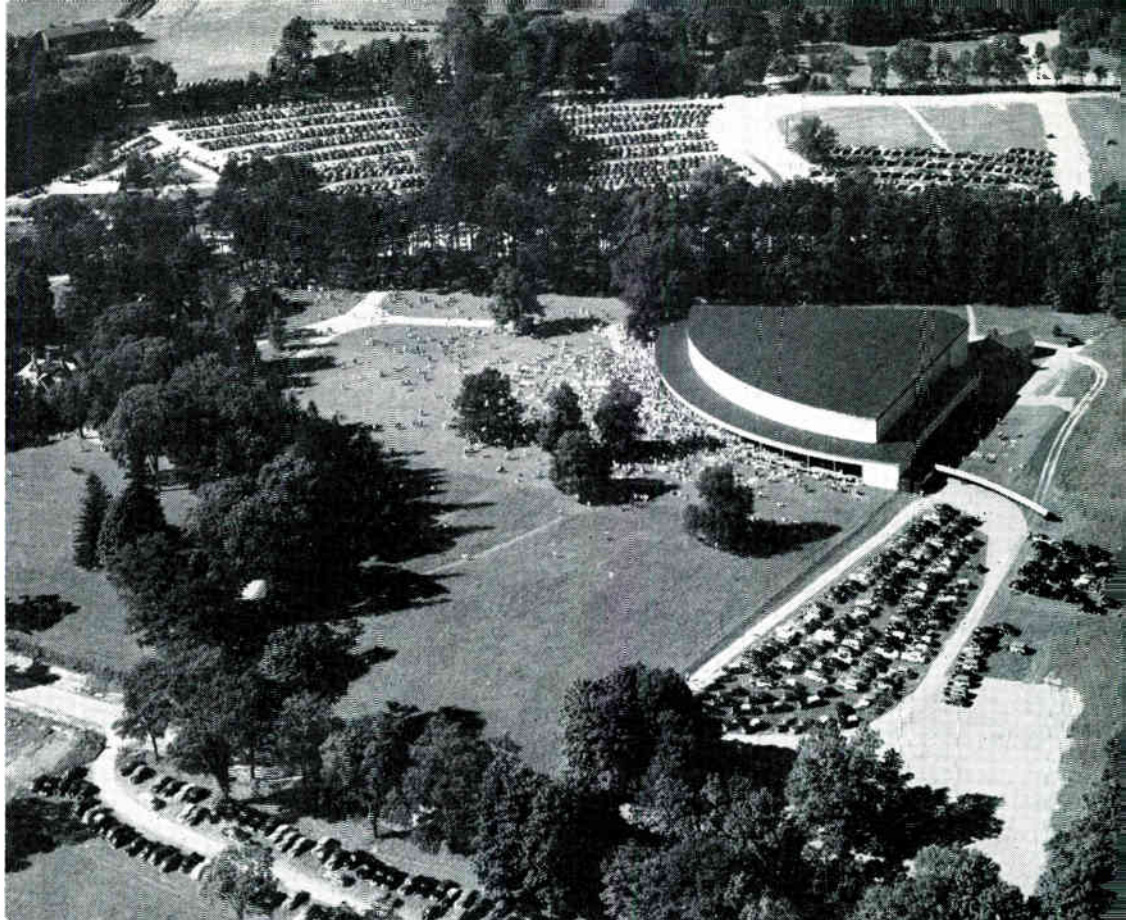

*There seems to be a special air of dignity about the tall pines which preside over the grounds at Tanglewood. If you have been there, this picture will surely bring to mind your experiences at this very dedicated, very democratic, and most famous shrine of music in Lenox, Mass., located about 130 miles from Boston and New York*

## MUSIC FESTIVALS

*When and Where They Are Held, and What They Are Playing — By Oliver Daniel*

ONE OF THE greatest revolutions in our concert life is taking place at this moment. As the summer is becoming euphoric, the whole complexion of concert life takes on a new hue. Perhaps our concert halls were stuffy after all. But what is happening in America is unprecedented in our musical development. Like the Straw Hat circuit, which the theater has developed, there is now emerging a phenomenal growth of new musical interest, expressed by our music festivals. Europe has been at it for some time, but the growth of the idea in America is a more recent one.

Not only have new festivals been organized, but new patterns of programming have evolved which draw audiences other than the "regulars" who go to symphonic programs during the winter season. It is a different audience — a younger audience. Tanglewood, Ravinia, the Stadium, and the Hollywood Bowl are among the festival grandpappies, but there are new groups presenting ideas that make their older pattern-makers seem a bit on the stodgy side. It is in the programs of some of the smaller and less touted productions that we find the most intriguing music being presented during this festival season.

Some of these festivals may seem new even to the music lovers who closely follow these trends. Among the more recent entries we have the Peninsula Festival in Fish Creek, Wisconsin, the Castle Hill Festival in Ipswich, Massachusetts, the Brevard Music Festival in Brevard, North Carolina, and the Pacific Coast Music Festival in Santa Barbara, California.

Perhaps the most elegantly beautiful of all festival sites is that of Castle Hill in Ipswich, Massachusetts, about an hour's drive north of Boston. It is the fabulous old Crane estate, which emulates, though minutely, the glories of Versailles. The big, chateau-like house, is used only in rainy weather. The

*The Crane estate, called Castle Hill, is situated high above the sand dunes at Ipswich, Mass., within easy driving distance of Boston. During the seven-week series of concerts, music lovers will have the opportunity of indulging champagne tastes most inexpensively, for tickets can be bought at prices which start at two dollars*

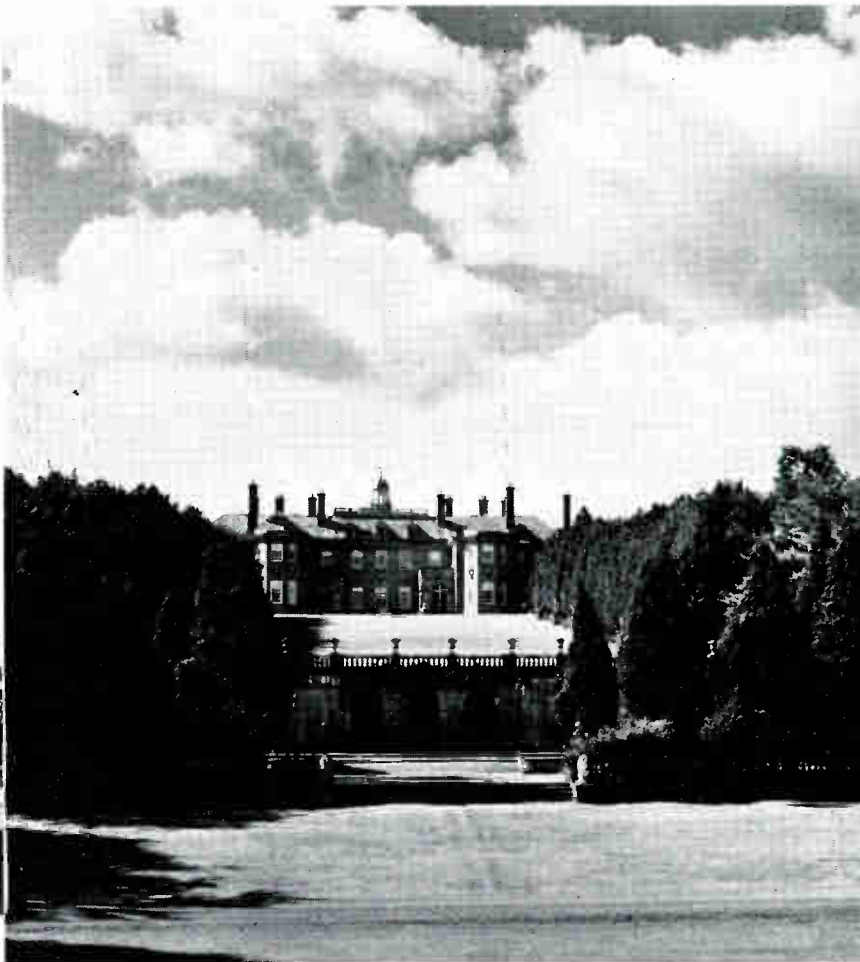

concerts are given in a spherical garden set in a really dense forest area. The air of Le Nôtre's Versailles is again present. There is a comforting sense of age, like a perfect wine, and that enters the picture during intermission. No one hawks hot dogs or soda pop; the audience strolls leisurely into the garden where champagne is served. Festive atmosphere is attained so smoothly that Castle Hill should become a place of pilgrimage for the music-hungry if the program interest is maintained at a high level. All the externals are there in superabundance.

Picnickers who want to enjoy the sumptuous grounds and gaze out over the ocean can buy a box lunch from chefs wearing the traditional white hat — a box lunch containing cold lobster or other such delicacies. Champagne corks pop merrily. And for all of its elegance, it is really inexpensive. Tickets are as low as two dollars, including tax.

Beginning July 8 and ending August 30, Castle Hill will have a seven-week festival with concerts each Friday and Saturday. This season the concerts begin with a jazz festival — a little incongruous in these settings — followed



*The Pacific Coast Music Festival, to be directed by Leopold Stokowski, is held on the grounds of the County Court House, Santa Barbara, Calif.*





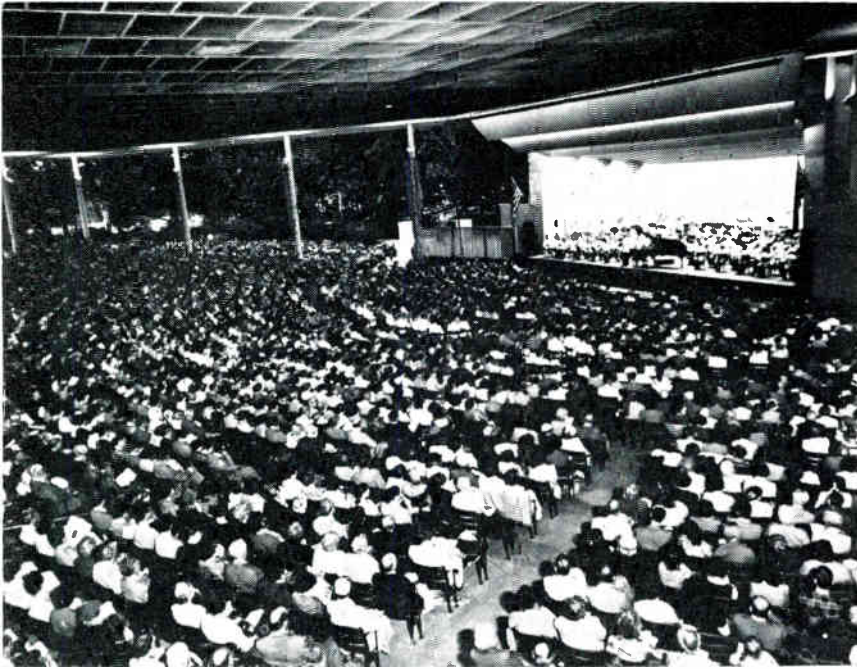

*One of the most famous of all meeting grounds for musical enjoyment is beautiful Ravinia Park in Winnetka, Illinois, just some 30 miles north of downtown Chicago. Here society and music lovers rub elbows as they listen to magnificent concerts by outstanding artists. The Ravinia Festival is a summer long affair, where one sits in rain-proof comfort within the shed, or loafs outside on the lovely grounds underneath the stars*

the second week by the Pro Musica Antiqua, playing music that might have sounded just as incongruous to the neighbors who hanged Rebecca Nurse nearby in 1692. The third concert of the series will feature music new to these audiences. Alfredo Antonini, conducting his string group which he has featured in CBS broadcasts, is introducing several new works along with those of a much earlier period. Among the former he has included a *Hymn and Fuguing Tune* by Henry Cowell, *Pieces for String Orchestra* by Daniel Pinkham (of the Lydia clan), and concertos by both Hovhanness and Turina. The first one, a new concerto, will be played by violinist Roman Totenberg, and the second, by Turina, is on the same program with Grace Castagnetta as piano soloist. Other Castle Hill programs, which are admirably selected by one of the wittiest and

sagest shepherds of such summer music life, composer Sam Barlow, contain provocative names of 20th century composers such as Hindemith, Villa-Lobos, and Alec Wilder. Barlow is tossing out the "old hat" concept of program building, and is setting out to make the program content of Castle Hill one of the more intriguing lists of festival fare.

Very new in the festival realm is the Pacific Coast Music Festival. Last season both Antal Dorati and Walter Hendl presented a series of eight orchestral concerts there with remarkable success. This season the festival will be turned over to Leopold Stokowski, who has planned a series including both early and unfamiliar works, with a healthy smattering of contemporaries to round out his programs. Planned to begin during the latter part of the

*Continued on page 52*



*Taking part in the Brevard Festival are an orchestra of 85, a little symphony of 65, a Hilltoppers band of 75, a junior chorus of 30, and a choral ensemble of 25*



# WHATEVER



# LOLA WANTS

How Music from "Damn Yankees"

was Recorded — *By James Lyons*

THIS IS ABOUT a certain diamond in the rough, and how it was cut and polished. Everyone knows that "Damn Yankees" has to do with baseball, which either strengthens the metaphor or ruins it. But no show is more than a diamond in the rough to the skilled cutters and polishers of the recording studios, who must make it into a smoothly succinct disc sampling of less than half its Broadway-successful and, hence, very precious length.

Such was the order of business on Sunday, May 8th last, in Webster Hall, a grimly gaudy emporium at 119 East 11th that is one of RCA Victor's three New York recording headquarters — the others being a battery of smallish studios on 24th Street and the ballroom of the old Hammerstein theater in midtown, latterly rechristened Manhattan Center.

The acoustic properties of Webster Hall are unique, and all the more so because its interior is a mass of mirrors and ugly, mica-textured stone. But mind, it was in these jazzy surroundings that Artur Rubinstein recorded much of his *nonpareil* Chopin, and anyone who can point to more magically realistic piano presence will please step forward. The keyboard being by far the prime anathema to engineers, it is no wonder that Webster's walls stand untouched.

Three separate sessions had been scheduled for *Damn Day*, which extended from 9 A.M. to 9 P.M. with short breaks for luncheon and dinner. For reasons of economy, the full-cast numbers came first, and then down the line with the star ensembles and solos bringing up the rear,

*The game is on! So are the microphones — all nine of them. Conductor Hal Hastings faces the orchestra, with the singers behind him*



long after the chorus had gone home for well-earned rest.

Since this is supposed to be a sort of eye-witness report, honesty impels my confessing that I wasn't on deck at the stroke of nine. The Sunday papers and Washington Square footpaths having intervened, it was tenish when I walked into Webster Hall. A red light was flashing in the foyer, and the doorman had a finger to his lips. A few seconds later the signal went black and I was waved to the stairs with another gentle admonition. I quickly discovered why. The main floor creaks, and soft shoe leather might as well be carborundum within microphone range.

All the main action seemed to be centered in the flat parquet area that was bounded by the unused stage and the front row of the overhanging balcony. Drapes and wooden panels were serried in a semi-circle under the rim. Over the conductor was a singularly ornate and massive chandelier that provided light enough for everybody. The orchestra faced the podium; over the conductor's left shoulder were the singers, sequestered in an accordion-like arrangement of multiple inner-lined plywood blinds. A fan-tail deflector augmented the massed string tone. Altogether there seemed to be nine mikes — a pair over the violins, another two spaced among the choristers, and one each for the saxes, brass, percussion, piano and, of course, the soloists.

All at once a command shot out from the control booth, which was built into the far corner of the floor below stage left, and in a trice everyone snapped to as the conductor emerged from a playback conference to deliver one of his innumerable qualified compliments: "All right, now, gentlemen. From the top, if you please. That was very good indeed but really there ought to be just a trifle less volume in the brasses, and will the woodwinds take it easier at the end if it's not too much trouble. Let's go, now, from the top."

For the benefit of the uninitiated, the *top* means the beginning of whatever section is under hand at the moment; this could be the opening of any given movement in a symphony, say, but in recording a score such as this it could only mean the start of the take, of which there were to be, strictly speaking, a total of fifteen to correspond with the number of bands on the disc, although most of the takes were repeated several times and some were revised drastically.

Anyway, having gone through this re-take "from the top" the conductor wheeled around in the direction of the control booth and spoke to *his* conductor: "What about that, Joe?"

*Hi-Fi Music at Home*

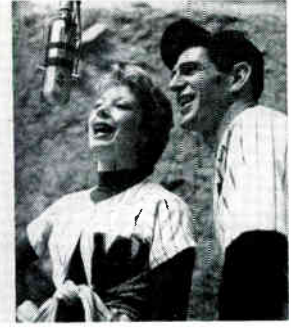

Joe still wasn't quite satisfied: "Gimme the ending just once more," the word came back.

"All right, gentlemen," the conductor said without a trace of annoyance. "Let's try it from bar 227." He raised his baton, and The Voice from the loudspeaker prefaced his down beat with a code tab that included "take eight". No wonder everyone looked either tired or tense; eight times over the same stretch of ground can be wearing. But how else can you insure an ideal recorded performance?

The rest of the morning went along about like this, with frequent communications between the podium and the control booth as engineers came out to change mike settings, and assorted producers, writers, directors, and composers were called upon to cut and splice with brutal objectivity. Then it was after one o'clock and the conductor was tapping his lectern, saying "All right, now, gentlemen, lunch break. Back promptly at two, please."

Most of the boys ate in, and I circulated to dig up the following miscellany. The conductor was Hal Hastings, one of Broadway's best. The orchestra was basically the one he directs nightly at the 46th Street Theater, where "Damn Yankees" has settled down for a good while to come. In addition to the twenty-eight regulars there were a couple of extra fiddles, a tuba, and a French horn. Also there was a non-participating, odd hand in the benign person of Sol Gusikoff, erstwhile cellist and living legend whose career as a musical contractor for Leland Hayward, Cheryl Crawford, the Theatre Guild, and Rodgers & Hammerstein has been an unbelievable saga of cumulative personal power. Gusikoff likes to sit in among the strings, puffing a big cigar when possible (as it was in this situation) and making sure everyone delivers the goods.

In the control booth I confirmed that "Joe" was Joseph Carlton, RCA Victor's chief recording director. Crowded around him or hovering about were Hugo Winterhalter, the firm's ace musical director; George R. Marek, artist and repertoire chief; Fred Elsasser and Ray Hall, associate engineers; Ed Welker, popular-album director; fast-talking Ben Rosner and his aide, Carl Bosler, who are the label's shorthair promotion department; and Jerry Thorp, Ben Kemper, and Anne Fulchino, the unobtrusive but highly efficient trio who handle RCA Victor press relations.

Virtually everyone listed in the "Damn Yankees" credits was there to see justice done to the show. Quietly overseeing all was George Abbott, who wrote the book

*In these pictures: Gwen Verdon; Dick Adler and Jerry Ross; Stephen Douglass, Gwen Verdon, and Roy Walston; Gwen Verdon and Stephen Douglass*

with Douglass Wallop, and who personally directed the stage production from its infancy. Brash young Dick Adler and his opposite number, cocky Jerry

Ross, were ever ready to defend their music and lyrics. Their personal physician, Dr. Richard Winter, was on hand to keep a professional eye on his free-wheeling patients. Frederick Brisson, co-producer with Robert E. Griffith and Harold S. Prince, kept a coolly dispassionate air but missed nothing. As you may have gathered, the control booth and its environs were no place to attempt an interview. Times Square would have been less hectic.

The lunch interval having passed, the chorus lounged around the stage waiting for the conductor's summons. Shannon Bolin, one of the supporting leads, spent these borrowed minutes with the orchestra — most of whom she knew through her husband, Milton Kaye, probably the busiest free-lance pianist in New York. Some of the musicians were running through tricky passages in anticipation of trouble. One was reading a paper; another had closed his eyes and was apparently dozing; the tympanist (who also doubled at xylophone) was energetically going through a complicated exercise routine to limber his muscles. Leading lady Gwen Verdon

*Continued on page 50*

*In the dugout: Joe Carlton giving the signals, Hugo Winterhalter scowling, Jerry Ross looking pensive; standing, George Marek and Dick Adler*



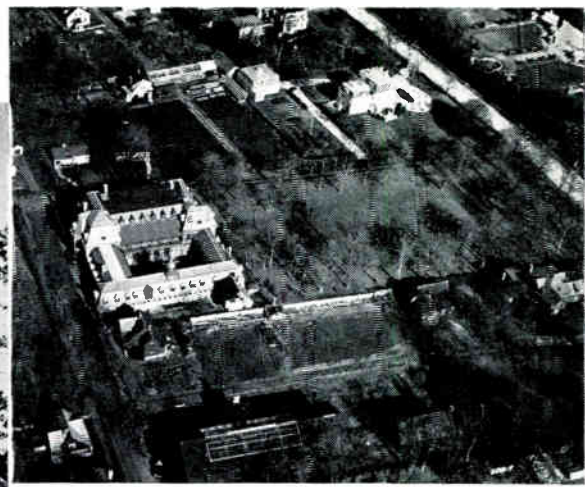
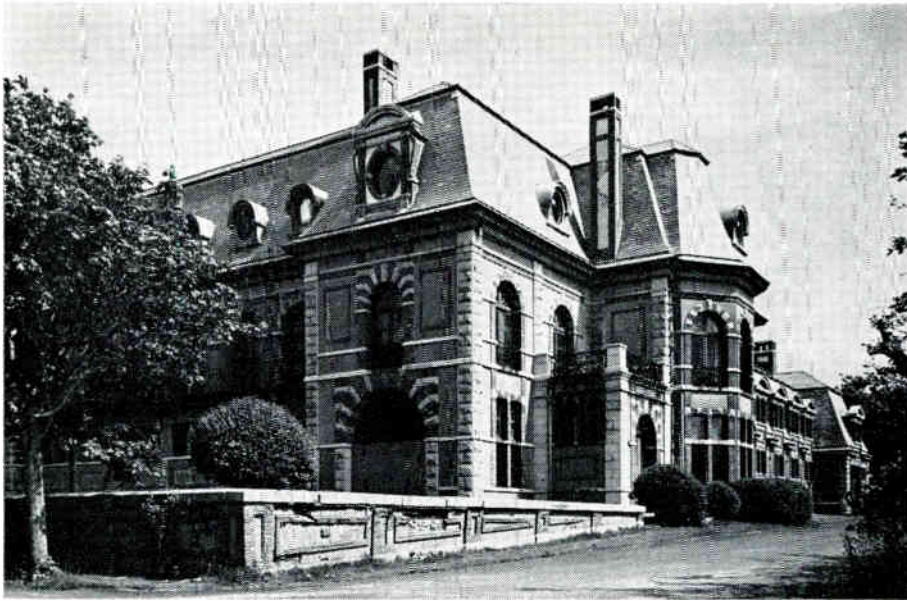

*Once known as Oliver P. Belmont's summer cottage, this is the property purchased by Louis L. Lorillard for the Jazz Festival, ousted after last year's event from the Newport Casino*

## 2nd NEWPORT JAZZ FESTIVAL

*Last Year's Success Promises to make it a Permanent Institution*

LAST YEAR'S opening Newport Jazz Festival was one for the books. If a little disorganized, if somewhat frantic, if a tiny bit soggy, it was still an experiment that worked wonderfully well. And the folks who attended had a marvelous time.

Then, during the winter, a loud flatted fifth was sounded when the Casino at Newport announced that it wanted no more jazz. But the local citizenry came immediately to the rescue, and estates were offered for the Second Festival. After looking over the situation from every angle, a "summer cottage" known as Belcourt was selected. This is the former mansion of Mr. Oliver P. Belmont. The property, centered in the most exclusive Bellvue Avenue area, was purchased by Louis L. Lorillard, sponsor of the First Jazz Festival, and a distinguished descendant of old guard Newport families, after the use of the Casino had been denied this project for 1955. The spacious, beautiful grounds will easily accommodate 10,000 people. Nearby are adequate parking facilities, a most important fact, as last year there developed in Newport one of the most super-duper parking jams of all time.

Once the place had been procured, George Wein, Boston jazz impresario and producer of the Festival, was free to set his dates and his talent. The second annual Newport Jazz Festival will take place on July 15, 16, and 17, with both afternoon and evening sessions. There will also be jazz discussions, featuring leading jazz critics and musicians. And if by chance you are thinking of staying away because you might not be sufficiently entertained,



you'll be reassured by the playing line-up, which includes Louis Armstrong's All-Stars, Chet Baker, Count Basie's great swinging aggregation, the Dave Brubeck quartet, "Wild" Bill Davison, Vic Dickenson, Erroll Garner, Woody Herman's Third Herd, Bobby Hackett, Coleman Hawkins, Lee Konitz, Jimmy and Marion McPartland, the Modern Jazz Quartet, Gerry Milligan, the Max Roach-Clifford Brown Quintet, Pee Wee Russell, Dinah Washington, Kai Winding, and Lester Young. And the Jazz Festival will introduce Miss Teddi King, a cute little trick from Beantown who sings good songs from the heart with style and true feeling. You'll like her.

So, as Mr. George Gobel might say — "You can't hardly find things so good around like this no more!" Certainly, the second Newport Jazz Festival should be a terrific affair. HI-FI-MUSIC AT HOME will see you there.

Postscript: On June 8, some 40 of the older Newport families and representatives of the Jazz Festival met with the local City Council to stage what may prove to be the last stand of the old guard against the encroachments of such enterprises as the Jazz Festival on the sacred precincts of what was once the world's most exclusive social summer resort. Outcome of the protest was the agreement that the evening concerts will be given at Freeway Park, the municipal stadium. Lectures on jazz music will be held in the afternoons at Belcourt, with the understanding that this will not set a precedent for the commercial use of the property.



By OLIVER DANIEL, PEGGY GLANVILLE-HICKS, DAVID HALL, JAMES LYONS, ROBERT PRESTEGAARD, FRED REYNOLDS

ORCHESTRAL MUSIC

**MAHLER: Symphony No. 9** 1  
**SCHOENBERG: Verklärte Nacht** 1  
 Israel Philharmonic Orchestra under Paul Kletzki 1  
 Angel 3526B 2-12"

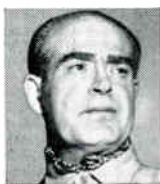

Judged by this recording, the Israel Philharmonic is indeed one of the great orchestras of the world. The tortured chromatism of Schoenberg is as transfixed as orchestral performers can transfix it. The Mahler is conducted with a passionate dedication, and all the elements are fused perfectly—a superb work of its kind. The angel—that silly-looking little cherub—should rise up and bow appreciatively. This is a bonner record! Give it four stars, an Oscar, a Pulitzer Prize, and a blue ribbon. A citation should go, too, to Lawrence Collingwood, who supervised the recording session. And Kletzki: he is excellent. OD

**PROKOFIEV: Symphony No. 5 in B-flat Major, Op. 100** 1  
**Symphony No. 1 in D Major (Classical), Op. 25** 3  
 Concerts Colonne Orchestra, Paris, under Jascho Horenstein 1  
 Vox PL-9170 12"

If for no other other reason than a purely technical one—a superior recording job—we would heartily recommend this disc. We're happy to report, however, that Horenstein's reading of the two presently best-known symphonies of the composer sacrifice none of the stinging irony, wit, and satire which pervade them. Prokofiev was a master of the mischievous. Although warmth and lyricism is a bit underscored here, this is expressive music with bright and compelling sound. RP



**WAGNER: Preludes to Lohengrin and Die Meistersinger; Overture to Tannhäuser; Liebestod from Tristan und Isolde** 1  
 3  
 2  
 Bombey Symphony under Joscho Horenstein 1  
 Vox PL9110 12"



These are perfectly adequate performances, and all of them well recorded. The problem with such omnibus programs is in the obvious fact that none exactly duplicates another, so that competitive factors are not fairly admissible. Ordinarily, the assortment of contents is decisive. At the same time, any sifting of values with respect to this disc must be conditioned by price. The nonpareil Wagner of Toscanini may be had for two-thirds of what one must pay for Horenstein, please note. JL

**PORTER: Poem and Dance** 2-3-2  
**DONOVAN: New England Chronicle** 3  
**HIVLEY: Tres Himnos** 1  
 Eastman-Rochester Symphony Orchestra under Howard Hanson 1  
 Mercury MG-40013 12"

Volume 14 in Mercury's worthwhile American Music Festival Series presents the record premieres of three unusually compelling works by three gifted American composers—Quincy Porter, Richard Donovan, and Wells Hivley. The latter composed his *Three Hymns in Mexico* and it received its first complete performance last October, under Dr. Hanson's baton. It is a moving, richly-textured composition. Mr. Porter and Donovan merit a solid round of applause as well. Audio is brilliant. RP



**AUBER: Famous Overtures** 1  
 L'Orchestre de la Société des Concerts du Conservatoire de Paris under Albert Wolff 1  
 London LL1157 12"



One does not think of Auber as a great composer, and of course he was not by any nominal standards. But his four renowned overtures—*Fro Diavolo*, *The Bronze Horse*, *Mosoniello*, and *The Crown Diamonds*—are ripstartin' warhorses that every bit deserve their recurrent popularity. In the hands of a virtuoso conductor who does not choose to condescend, they can be an exhilarating if not exactly an edifying experience. Wolff approaches them seriously, lets nothing go sloppy, shapes artfully. And the London engineers give these horses their heads, with sonic results that have to be heard to be appreciated. JL

**BERLIOZ: Fantastic Symphony** 1  
 Philharmonia Orchestra under Herbert Von Karajan 1  
 Angel 35202 12"

If any recording exists more crisp, powerful, delicate, and spectacular than this one of Berlioz' *Fantastic Symphony*, these ears have yet to hear it. Karajan's brilliance encompasses the breathless sweep of large forms and the detail and nuance that make them breathe life. He makes the Philharmonia sound like the best orchestra in the world, and the Recording Angel has surpassed itself in the matter of fidelity. PGH



## RATINGS OF CLASSICAL MUSIC

The following explanation of the Record Ratings which accompany the Record Reviews is given so that you will understand exactly the significance of the three numbers which appear at the left of each review.

### COMPOSITION (Top Number)

#### 1: Outstanding

Indicates that the composition is one of the composer's best works, or that it is outstanding in a particular class of music. Assignment of this rating is an unqualified recommendation.

#### 2: Important

This rating is but slightly below the No. 1 rank.

#### 3: Worthy

A composition which may merit representation in a library of the composer's works, or in a collection of that particular music.

### PERFORMANCE (Middle Number)

#### 1: Outstanding

Indicates a superb performance. Assignment of this rating is an unqualified recommendation.

#### 2: Excellent

A noteworthy performance, subject only to minor criticism.

#### 3: Satisfactory

A performance not without flaws, yet deserving public notice.

### RECORDING QUALITY (Bottom Number)

#### 1: Outstanding Realism

Representing the highest present attainments in acoustic and recording techniques.

#### 2: Excellent Quality

Slightly below No. 1 rating because of minor faults in the acoustics or recording, or because the noise is considered somewhat above the minimum currently attainable.

#### 3: Acceptable Quality

Representing the current average of the better LP records.

R: Indicates an original 78 now re-issued as an LP record.

**Important Note:** Records which are rated below No. 3 as to the composition, artist or orchestra, or recording quality are not ordinarily reviewed here. However, the omission of a record does not mean that it was rejected, as it may not have been submitted to HI-FI MUSIC AT HOME for review.

**Invitation To the Dance** 1  
 NY Philharmonic under Andre Kostelanetz 2  
 Columbia ML 4957 12" 1  
**Strauss Waltzes**  
 Kostelanetz and His Orchestra  
 Columbia ML 4993 12"



Two more splendid LP's by Andre Kostelanetz, who certainly is among the most prolific of the classical record makers. He is also one of the more popular, and his many discs have achieved a universal acceptance, save from the classical snobs. Many times his recordings have been the avenues on which the uninitiated have been led to the great pleasures of classical listening, and these LP's are wonderful examples. Neither may be at all provocative, but both are compellingly enjoyable. FR

**BRAHMS: Serenade No. 2 in A, Op. 16** 2  
 Concertgebouw Orchestra of Amsterdam 3  
 under Carlo Zecchi 2  
 Epic LC3116 12"

Since this is the only available recording, you are bound to take it or leave it. I would take it, but with reservations. As we knew from his *Rhenish* of earlier this spring, the redoubtable Zecchi inclines to slow tempi and oom-pah-pah. These predilections could not possibly conspire to reveal the secrets of this "tender piece"—as Brahms himself described the *Serenade*. Still, any conductor who can make the Concertgebouw sound like an over-sized German military band must command our grudging respect; this orchestra knows its Brahms and only a powerful podium personality could make it seem otherwise. Sound is over-emphasized top and bottom. JL



**RACHMANINOFF: Symphony No. 3, A Minor, Op. 44** 2  
 The Philadelphia Orchestra under Eugene 1  
 Ormandy 2  
 Columbia ML 4961 12"



Since the death of Col. McCormick, Columbia and the Philadelphia Orchestra have usurped one of the Chicago Tribune's ideas: like the "world's greatest newspaper," we now have "The World's Greatest Orchestra". One must reluctantly admit, despite Columbia's self-intoxication, that it is a superb recording of a neglected work. In fact, it is hard to imagine a better one. It is curious that this Rachmaninoff symphony has not had a more successful run. The well-known vocalise, less delicate than old performances by Koussevitzky, is still pleasing. All elements are first-rate. OD

**FALLA: El Amor Brujo (complete ballet); The Three-Cornered Hat—Dances** 1  
 Berlin Philharmonic Orchestra under Fritz 2  
 Lehmann with Dianna Eustrati 2  
**CHABRIER: España Rapsodie**  
 Bamberg Symphony Orchestra under 2  
 Fritz Lehmann  
 Decca DL9775 12"

The numerals here apply to the Falla works, but not to the Chabrier which is treated in perfunctory manner. The coupling of the two popular Manuel de Falla ballets make this disc more than usually attractive. Performances are vital and recorded sound is some of the best of the Decca Deutsche Grammophon series. As a bargain package of some of the best 20th century Spanish music, this one is hard to beat! DH



**MEDELSSOHN: Symphony No. 3 in A Minor ("Scotch"); Overture, Calm Sea and Prosperous Voyage** 1-3  
 Israel Philharmonic Orchestra under 2-2  
 Paul Kletzki 1-1  
 Angel 35183 12"

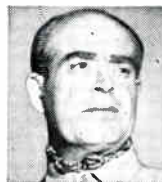

Among conductors who have recorded the *Scotch*, only Mitropoulos could fuse its disparate elements of romanticism and classicism. Also, his disc (Columbia) more economically includes the entire *Reformation* as well. The new Israeli orchestra is a superb instrument, and Kletzki builds the architectural mass of this symphony in wonderfully linear fashion, with no details misplaced anywhere. Temperamentally, however, he rejects any notions as to its inherent emotionalism. As a consequence the performance is less touching than impressive. JL

**R. STRAUSS: Till Eulenspiegel's Merry Pranks; Don Juan** 1  
**WEBER: Overtures—Der Freischütz; Euryanthe** 3  
 Vienna Philharmonic Orchestra under 3  
 Wilhelm Furtwängler  
 His Master's Voice LHMV19 12"

The numerical designations here may reflect our personal prejudice; but those who treasure the readings of the late, great Furtwängler will find all the familiar touches in this disc of Richard Strauss and Weber favorites—broad tempi, lingering over delectable detail. Recorded sound is somewhat below the Vienna average. For Strauss, compare with Fritz Reiner (Victor). For Weber, try Toscanini (*Freischütz*—Victor) or Böhm (London). DH



**MAHLER: Symphony No. 1 in D ("Titan")** 1  
 Israel Philharmonic Orchestra under 2  
 Paul Kletzki 2  
 Angel 35180 12"



Mahler's youthful *Nature* symphony appears here in its third recent LP release—and in a performance notable for its lyricism and stylistic finesse. Israel's Philharmonic Orchestra plays with more humanity than machine precision, but this is all to the good here. A small cut in the very last pages, but superb reading by Kletzki throughout. Recording, generally OK. We suggest comparison with Walter (Columbia) and Kubelik (London) before final choice. DH

**BIZET: Symphony No. 1 in C Major Patrie—Overture, Op. 19** 3  
 L'Orchestre de la Suisse Romande 2  
 under Ernest Ansermet 2  
 London LL-1186 12"

The charm of Bizet's *First Symphony* lies in its simplicity and its operatic character. There is much of the "Carmen" emotion in the score and, when we consider that it was written by a lad of 17 summers, it is worthy of attentive listening. Ansermet gives it a delicate, pleasant reading, but you may wish to compare the Cluyten version (Angel) when it comes to the matter of sound. The *Patrie Overture* is a bold, vigorous work, excitingly performed. RP



**MOZART: Symphonies No. 34, C Major (K 338); No. 38, D Major (K 504)** 1  
 The Vienna Philharmonic under Karl 1  
 Böhm 1  
 London LL 1198 12"



The joyousness that permeated the Austrian and Bavarian art of the late 18th century finds one of its best musical exemplifications in the conducting of Karl Böhm, performing the Mozart symphonies in C and D Major. There are no better recorded performances of these works. Böhm has a natural affinity for Mozart. He does not treat him in the mincing fashion of some other interpreters. Rich, full-bodied, and human is his concept of Mozart, but it is neither rough nor ribald. It is pleasant to find a recording so praiseworthy. All elements are of the highest order. Fifty per cent of our conductors might benefit by a bit of attention here. OD

**BORODIN: Symphony No. 2 in B Minor** 1-3-1  
**Symphony No. 3 in A Minor (Unfinished)** 1  
**"Prince Igor" Overture** 1  
 L'Orchestre de la Suisse Romande  
 under Ernest Ansermet  
 London LL-1178 12"

Many of the musical ideas Borodin was forced to discard from his unfinished opera, "Prince Igor", were utilized in both the *Second* and *Third* Symphonies. Of the *Third*, he had sketched only two movements when he died. The work was finished by Glazunov, and this marks its major appearance on long play. Ansermet gives these powerful symphonies and the *Overture* a brilliant reading. Clear, concise and dramatic, this is living music with recorded sound everything it should be. RP



**SMETANA: Vysehrad** ("The High Castle"); **Vltava** ("The Moldau")  
**MOZART: Symphony No. 38 in D, K. 504** ("Prague")  
 Chicago Symphony Orchestra under Rafael Kubelik  
 Mercury MG50042 12"

When this firm re-issues anything, you can be sure that it has not been "enhanced" because there is virtually no room for improvement in the engineering of any domestic Mercury product. All three of these pieces were otherwise coupled upon their respective first releases; they have been assembled in this new sequence as a lure to buyers who might have skipped the originals to avoid unnecessary duplication. The Smetana performances are perhaps definitive; the Prague rather more Bohemian than Viennese in its unfoldment but not inappropriately in this context. JL



**HAYDN: Symphony No. 44 in E minor; Symphony No. 85 in B Flat major**  
 Vienna Symphony Orchestra under Paul Sacher  
 Epic LC 3059 12"



Paul Sacher conducts two of the most attractive of the many Haydn symphonies, the No. 44 in E minor and the No. 85 in B flat major. The beautifully ordered parts and elegant simplicity of these performances stamps Sacher as a fine musician. For ears attuned to 20th century style and dynamic, these works are close to the borderline, where standard repertory recedes into the archaic. But for representative libraries they are musts. PGH

**Ports of Call**  
 The Philadelphia Orchestra under Eugene Ormandy  
 Columbia ML 4983 12"

Taking its springboard from Ibert's *Escapes (Ports of Call)*, the "World's Greatest Orchestra" takes us on a musical tour of Spain, Italy, France, and Tangier. To do this, Mr. Ormandy and the Philadelphians offer brilliant interpretations at splendid fidelity of Ravel's *Bolero*, *La Valse*, and *Pavane Pour Une Infante Défunte*, Ibert's *Escapes*, Debussy's *Clair De Lune*, and Chabrier's *España—Rhapsody*. Dreams and memories come easily with music like this. FR

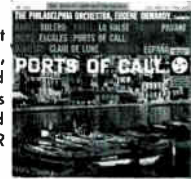

**Castles in Spain**  
 Orquesta Zarzuela De Madrid under Frederico Moreno Torroba  
 Decca DL-9763 12"



A keen sense of what would appeal most in Spanish music was employed in selecting the nine compositions for this album. *De Romeria* is a spirited little work, flavored after the folk dances of Leon, and the charming waltz from "La Gran Via"—*El Caballero De Gracia*—deserves lasting popularity. Torroba, one of Spain's leading conductors, is represented by his lovely *Madrilenas Suite*. Recorded in Spain, and expertly, striking use is made of percussion and castanet. RP

**SCHUBERT: Symphony No. 9, in C**  
 The Halle Orchestra under Sir John Barbirolli  
 RCA Victor Bluebird LBC-1085 12"

Schumann wrote in 1839: "Today I was blissful. A symphony of Schubert's was rehearsed. If only you had been there! It is indescribable; all the instruments are human voices, and immeasurably *geistreich*—and this instrumentation, pace Beethoven—these heavenly lengths, like a novel in four volumes." Barbirolli gives Schubert's great work a faithful, dependable reading, and the lower price Bluebird recording may make it an excellent buy for many. I still prefer the Toscanini version on Victor, however. FR



**HOLST: The Perfect Fool—Ballet Suite** 3-1-3  
**BUTTERWORTH: A Shropshire Lad—Rhapsody; The Banks of Green Willow**  
**BAX: Tintagel**  
 London Philharmonic Orchestra under Sir Adrian Boult  
 London LL1169 12"



Exquisite gems of this disc of British music are the orchestral poems of George Butterworth, whose creative fulfillment was tragically cut short in World War I. But the ballet music from Gustav Holst's (1874-1934) satire on Wagnerism, although excellent hi-fi material, and Arnold Bax's Celtic impressionist poem, *Tintagel*, fail to stand up under repetition. Performances can well be described as definitive, with recorded sound to match. DH

**MOZART: Piano Concerto No. 27 in B-Flat Major (K.595)**  
**Piano Concerto No. 17 in G Major (K.453)**  
 Hans Henkemans with the Vienna Symphony Orchestra  
 Epic LC-3117 12"

This record is one of the Mozart Jubilee Editions of 1956, a series being issued to commemorate the anniversary of the birth of the composer next January, and which, when complete, will embrace the finest Mozart music. Henkemans, whose primary assets are a clean attack and a bell-like tone, imparts a deft touch to both concerti—the poetical *G-Major*, composed in something like 3 weeks—and the light-hearted *B-flat*, Mozart's last. Enjoyable music with satisfying sound. RP



**ELGAR: Violin Concerto in B Minor, Op. 61**  
 Campoli with the London Philharmonic Orchestra under Sir Adrian Boult  
 London LL1168 12"



By any criteria whatever this will stand as a surpassing achievement of the phonographic art. My affection for the music is just now out of vogue, and I can only commend the work to your artistic olfactories with a warning that it would be unfashionable to like it. But surely this is the most luminous and loving performance imaginable of a much misunderstood masterpiece, and the recorded sound is presence itself. True, Campoli does not own the wizardry of a Heifetz. The latter's version (Victor) is all the same forbiddingly devoid of Elgarian virtues. If you are curious to know what these are, listen to this incredibly superior replacement. JL

**DVOŘÁK: Concerto in G Minor for Piano & Orchestra, Op. 33**  
 Rudolf Firkusny, Piano, with the Cleveland Orchestra under George Szell  
 Columbia ML 4967 12"

The solo part of Dvořák's *Piano Concerto in G Minor*, written in 1876, was revised by professor Vilém Kurz, and it is this revised work that is played by Mr. Firkusny and the Cleveland Orchestra. Not that it isn't played exceptionally well, but it is to be wondered how much, if any, Kurz's doctoring has helped. The original is played on a Vox recording by Friedrich Wüehr, and you may wish to compare. At any rate, sound here is best, and the work is rare in recorded annals. FR



**MUSIC OF VIVALDI: (Concerti) Vol. 4**  
 Virtuosi Di Roma under Renato Fasano  
 Decca DL-9729 12"

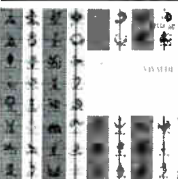

The redoubtable Toscanini, a man who minces no words when he has something on his mind, called the Virtuosi Di Roma "the great instrumental ensemble of this age". It should come as no surprise by now that the Maestro knows whereof he speaks. This new and welcome Vivaldi offering by the group contains the *Concerto Grosso in A Minor*, and the *Concerti in G Minor, C Minor and E Major*. The playing is fresh, fluid and, as Vivaldi's style demands, natural. Faithful reproduction. RP

CONCERTOS

**CHOPIN: Concerto No. 2 in F Minor, Op. 21** 2-2  
3-2  
**SAINT-SAËNS: Concerto, No. 4, in C Minor, Op. 44** 2  
Alexander Brailowsky, Piano, with the Boston Symphony Orchestra under Charles Munch  
RCA Victor LM-1871 12"

Although the unusual coupling strikes me as a good one, it is too bad that they couldn't have been carried off in more stunning fashion. Of the two, Brailowsky seems much more at home with the semi-popular Saint-Saëns two-movement work. The general structure of Chopin's Concerto No. 2, which was written before the No. 1, calls for subtle tones and warm understanding. Brailowsky's methodical playing shows a clear lack of subtlety and understanding. **FR**



**HOVHANESS: Khaldis Concerto for Piano, 4 trumpets and Percussion Piano Pieces** 3  
1  
2  
William Masselos, Piano, Orchestra under Izler Solomon  
M-G-M E 3160 12"



Side B of this recording, a set of piano pieces bearing such provocative labels as *Achtamar*, *Thala*, *Fantasy on an Ossetin Tune*, *Orbit No. 2*, *Hymn to a Celestial Musician*, and *Pastoral No. 1*, contain some of the most imaginative writing done for piano since Debussy. Only one other composer, Henry Cowell, on whom some of the Hovhaness effects depend, has done anything similar. This is not music for the local music teacher. It is filled with unorthodox procedures of string plucking, and string pounding by padded tympany sticks, which violate many restrictive tenets. But the result has a bit of Eastern magic about it. **OD**

**PROKOFIEV: First Violin Concerto** 1-2  
**LALO: Symphonie Espagnole** 1  
Nathan Milstein, Violin, with the St. Louis Orchestra under Vladimir Golschmann  
Capitol P8303 12"

Prokofiev's *First Violin Concerto*, written in 1917, and it is both truly representative of his style, and strongly reflective of the Russian nationalistic school of that time. It is full of vitality and freshness. Tchaikovsky wrote of Lalo's *Symphonie Espagnole*, which is more of a concerto than it is a symphony, that he very much enjoyed its "piquant rhythms and beautifully harmonized melodies." Milstein and Golschmann translate these works to the recording with zeal and understanding. The playing, like the fidelity, is superb. **FR**



CHAMBER MUSIC

**FRANCK: Violin Sonata in A Major** 1  
**FAURÉ: Violin Sonata No. 1 in A Major, Op. 13** 2  
Joseph Fuchs Violin, Arthur Balsam Piano  
Decca DL9716 12"



A brilliant inspiration it was to couple the two most important violin sonatas of the French repertoire on a single disc! I find the Fauré (written before Franck's more famous masterpiece) wears better with repetition. Both are essentially serene and lyrical in spirit. This is the first topnotch LP recording of the Fauré sonata; but the Fuchs-Balsam team face tough competition from Francescatti-Casadesus in the Franck. Good recorded sound! **DH**

**DOHNANYI: Quartet No. 3 in A Minor, Op. 33** 1  
**DVORÁK: Quartet No. 6 in F ("American")** 2  
Hollywood String Quartet  
Capitol P8307 12"

Belated first recording of the Dohnanyi work, which dates from 1926, and owns all the aspects of a modern masterpiece despite a surfeit of stylistic hand-me-downs. The fountainhead obviously is Brahms, but there are unmistakable references to polytonality and polyrhythms, and no ordinary old fogey would have waded quite so deeply into chromaticism. Another *American* we need like a hole in the head, although this one is every bit as good as the best currently offered. **JL**



**BEETHOVEN: Septet in E-flat, Op. 20** 2  
Vienna Octet Members  
London LL1191 12"



Beethoven's divertimento-like score for violin, viola, 'cello, string bass, clarinet, French horn, and bassoon still remains one of the most ingratiating of his youthful efforts. This, the fifth LP recording of the *Septet*, is by far the best sonically, but definitely on the Viennese *gemütlich* side performance-wise. If it's dynamism you want, try the Toscanini orchestral version on Victor! **DH**

**RAVEL: Introduction & Allegro** 1-1-2  
**DEBUSSY: Danses Sacree et Profane** 3-3-1  
**SCHORNBURG: Verklaerte Nacht** 1  
Hollywood String Quartet. Ann Mason  
Stockton with Concert Arts Strings  
under Felix Slatkin  
Capitol P 8304 12"

Ravel's cool, tranquil classic is here overinterpreted to a point of distortion. Even a fine harpist cannot compensate to the jarred sensibility. Debussy's *Danses* fare little better; Bach-like precision and purity are what these pieces call for, not Wagnerian ega-expression. Just that style does, however, suit the Schornberg, and this late romantic masterpiece is brilliantly given, and esthetically at home in the hands of these performers. **PGH**



**MOZART: String Quartets—D Major (K.499); B-flat (K.589)** 1  
2  
Netherlands Strings Quartet  
Epic LC3100 12"



The Netherlands ensemble is a new one to us, but they turn in a movingly lyrical reading of Mozart's superb late D Major Quartet. The reading is a shade sluggish in pages of the lighter B-flat work, but with many elegant touches. Recording is outstandingly lovely in sound. Mercury's Roth Quartet performances offer the only significant competition, and should be heard for comparison if the B-flat Quartet is your chief concern. **DH**

VOCAL MUSIC

**Fifty Years of Great Operatic Singing** 1  
Deluxe Edition  
RCA Victor LCT-6701 5-12" R

A truly magnificent collection, and one that no other record company could make, simply because RCA is the only one with the immense catalog. Each disc covers a decade, from 1900-1910 to 1940-1950. Oldest recording, Francesco Tamagno's *Di quella pira*; newest, Risè Stevens' *Non so piu cosa son*. In between—superb arias by Caruso, Gigli, Alda, Ponselle, Chaliapin, Pons, and so many others. Sound is quite remarkable, and the collection is indeed a rare treasure. . . . Let no one doubt that for a moment! There will be criticisms, of course, for omissions and inclusions, but they will be of the gratuitous sort. RCA Victor has its heart in this one. **FR**



**GOUNOD: Mireille (complete opera)** 3  
Janette Vivalda, Nicolai Gedda, Christian Gayraud, Michel Dens, and others, with the Aix-en-Provence Festival Choir and Paris Conservatory Orchestra under André Cluytens  
Angel 3532-C 3 12"



Gounod's treatment of the tragic love story, "Mireille", based on the poem by Provence's Frédéric Mistral, is pretty thin stuff for 20th century ears; but this first recording is of more than passing interest because of its connection with the Aix-en-Provence Festival and commemoration of Mistral. Principals Vivalda and Gedda do themselves proud vocally and the recording is of the better French standard. Prize of this Angel factory-sealed package is the accompanying booklet—a real little masterpiece that must be seen! **DH**



**Great Love Duets:** 2  
 Dorothy Kirsten, soprano; Richard Tucker, 1  
 tenor; with Orchestra of the Metropolitan 1  
 Opera, under Fausto Cleva  
 Columbia ML 4981 12"

**WOLF-FERRARI: The Secret of Suzanne** 2  
 Elemo Rizzieri, Giuseppe Valdengo, ond 1  
 Orchestra under Angelo Questa 1  
 Cetra A 1250 12"

Morio Mariello, Ester Orel, and Turin Sym- 2  
 phony under Alfredo Simonetti 3  
 Decca DL 9770 12"

**VERDI: Highlights from "A Masked Ball"** 1  
 Anderson, Milonov, Pearce, Peters & War- 2  
 ren, with Metropolitan Opera Orchestra 2  
 under Mitropoulos  
 RCA Victor LM-1911 12"

**CHABRIER: Un Education Manquée** 2  
 (operetta in one act) 2  
 Christiane Castelli, soprano, Caudine Col- 2  
 lart, soprano, Xavier Depraz, boss, and 2  
 L'Orchestre Symphonique de Paris under 2  
 Charles Bruck  
 Vanguard VRS460 12"

**WALTON: Facade** 2  
 Edith Sitwell and Peter Pears with the Eng- 2  
 lish Opera Group under Anthony Collins 3  
 London LL 1133 12"

**Memories of the Vienna Theatre** 1  
 Hilde Gueden with the Vienna State Opera 1  
 Orchestra and Chorus under Max Schön- 2  
 herr  
 London LL1116 12"

**VERDI: La Forza del Destino** 2  
 (Complete opera) 1  
 Maria Callas, Richard Tucker, others, with 1  
 Orchestra and Chorus of La Scala under 1  
 Tullio Serafin  
 Angel 3531 C 3-12"

**MAHLER: Kindertotenlieder** 1-2  
**BRUCKNER: Te Deum** 1  
 Kathleen Ferrier; Vienna Philharmonic 1  
 under Bruno Walter  
 Columbia ML 4980 12"

**Rosa Ponselle Sings Today** 1  
 Rosa Ponselle (soprano) with Igor Chicagov, 1  
 Piono 2  
 RCA Victor LM1889 12"

**RAVEL: L'Enfant et les Sortilèges** 1  
 L'Orchestre de la Suisse Romande under 1  
 Ernest Ansermet 1  
 London LL1180 12"

Beautifully caparisoned in some superbly rich sounds, lovers Kirsten and Tucker sing their very best in this opulent Columbia recording. The fi is hi, the canto is "bel," the orchestra is conducted with loving sympathy. Heroic is the engineer who recorded it. His name should be in small colored lights on the Columbia Seventh Avenue offices. This recording should put Columbia stock up several points. OD



Valdengo and Rizzieri give a fine performance of this unpretentious, but utterly charming little opera. As a work, it is a lesson in the small operatic form; as a performance—despite certain metallic tones in Rizzieri's voice—it is quite admirable. PGH

If there is any secret about recording this smokey little opus, Decca and Simonetti apparently are keeping it from one another. The orchestra races valiantly, but sound seems filtered through a sieve. The singers come off better, but have the intimacy one might expect of Grand Central Station. OD

When the great curtains of the Metropolitan Opera House were parted on the evening of January 7, 1955, no person could have felt more happiness, or humility, than Morion Anderson who was to make her operatic debut in the role of Ulrico. This record recalls highlights from that historic performance. A stellar cast was assembled, but the night belonged to the woman who had waited. Miss Anderson's appearance is altogether too brief, but nonetheless, here's a collector's item, corefully recorded. RP



Only in recent years have we begun to make up for an overlong neglect of this relatively unproductive but amazingly influential iconoclast. In the early 1900's Philip Hale did not hesitate to rank him with Franck or Debussy; by now that point of view has come full circle and Chabrier is the darling of the chi-chi set. This delicious one-acter, translatable *An Incomplete Education*, is perhaps best described as Rabelaisian, or real racy. The slender plot is all about how ignorance becomes bliss on the nuptial night, and this performance is, ah, mmm, dramatically convincing. Musically it is the berries. JL

The English Opera Group Ensemble should be safe in assuming that they have here the "authoritative" recording of Walton's extraordinary work, for they cast as reciter Edith Sitwell herself, and presumably Walton was around to supervise. Yet there are shortcomings; La Sitwell's voice is monotonous over a long pull, and the mixing does not separate speaker and musical context as it can, and should. An Australian recording of this work, issued in Melbourne by the Society of New Music is a far, far better thing, for those who care. PGH



The secret of Gueden's Metropolitan success, in *Arabella* especially, may be found almost anywhere on this treasure-laden disc. It contains fully twenty famous excerpts from the Viennese lyric theater, being a smidgen or two each from the locally most beloved operettas of Lehár, Ziehrer, Strauss, Straus, Ascher, Fall, Kálmán and, naturally, Fritz Kreisler. Gueden sings everything in the self-consciously sentimental but infectious *Alt Wien* style to which she was born; the conductor aids and abets her with unashamed alacrity. Owners of earlier Gueden recitals should beware; this is a refurbished sampling of two 10" discs. JL

In the matter of all around excellence, this unquestionably is the finest recording to date of this opera, and it may be a long day before another comes along to equal it. Miss Callas' marvelous affinity for the Leonora role is truly magnificent, and Mr. Tucker is quite thrilling as Don Alvaro. The dramatics of the work throughout are highlighted by the impressive conducting of Serafin. Sound and packaging are on a par with performances. For this the Angel can give a Peter Pan cock-a-doodle-doo. FR



For the *Kindertotenlieder* a better team could scarcely be found than Walter, Ferrier, and the Vienna Orchestra, all elements being trained in the very tradition from which this music was born. It is perhaps the high point of Mahler, and these artists do it justice. The Bruckner *Te Deum*, even in such loving hands, is indeed "tedium" for all but those who worship at the Bruckner shrine. PGH

Since retiring from the Metropolitan Opera while still in her vocal prime in 1937, Rosa Ponselle has become a legend in her own lifetime—even though reports of her singing in private indicated that she had lost none of her artistry and vocal magic. The magnificence of her vocal style and musicianship (as recorded in her own home) are manifested in the very first bars of Lully's *Bois epais* and continues unobotted (for the most part) through songs of Chousson, Schubert, Brahms, Wolf-Ferrari and others. DH



Ansermet directs this brilliant piece in a performance that matches it in brilliance. Clarity, precision, and a fine pacing make it a vivid listening experience, even without the important visual element. A large orchestra is used in chamber style; Ravel exercises a fabulous type-casting in his choice of instruments; each is used for specific color and behavior rather than for mass. Intense variety and drama are the result. PGH

KEYBOARD MUSIC

**CHOPIN: Sonatas No. 2, B Flat Minor, Op. 35; No. 3, B Minor, Op. 53** 1  
 Julius Katchen, Piano 1  
 London LL 1163 12'' 1

One of the very best pianists of our time is Julius Katchen. He has the grand manner. Chopin has been butchered, beaten, and badgered, but not by Katchen. His approach is at once brilliant, broad, and sympathetic. His is a brilliant technique, but with a kind of musicality that attracts. Sonorously this recording is most satisfying. Like Masselos and Gulda, Julius Katchen achieves interesting dynamic contrasts in his playing, melodic lines are sculptured sharply, but poetically. Fast passages, however, whirl by like a jet plane with an anxiety neurosis. He is best when being a bit moderate. But he is good—well worth investigation. And Chopin is Chopin. OD



**DEBUSSY: Piano Music** 1  
 Robert Casadesus, Piano 1  
 Columbia SL-222 3-12'' 3



In a beautiful collection, Mr. Casadesus plays both books of *Preludes*, both of *Images*, both *Arabesques*, the *Masques*, *Estampes*, *L'Isle Joyeuse*, and *Children's Corner*. With his wife, Gaby, he joins in presenting *En Blanc et Noir* and *Epigraphes Antiques*. Save for sound, it is a superb collection. No other artist except Gieseking can interpret and play Debussy piano music so well, yet the approach of each is quite different. Casadesus is more classic, more objective, less subtle, more delicate. Both are great! FR

**LISZT AND SCHUMANN RECITAL: Consolation #1; La Lugubre Gondola #2; Benediction of God in the Solitude; Humoreske, Op. 20** 2  
 Jean-Michel Damase, Piano 3  
 London International TW 91041 12'' 2

Schumann's *Humoreske* is a neglected work that can be deeply affecting. Here it is anemically unfolded. The adjective "nice" fits the playing perfectly. It is just that: almost too "good" to be true. But Schumann, who wrote the *Humoreske* for his beloved Clara, and in it alternated between tears and elation, surely would not have applauded this watered-down performance, and Liszt—well, he was a stormy one. The record is fair and warm. OD



**CHOPIN: Nocturnes, Mazurkas, Barcarolle, Fantasia in F Minor** 1  
 Alexander Uninsky, Piano 3  
 Epic LC3122 12'' 3



To his previous Epic recordings of the two big Chopin sonatas and both sets of *Etudes*, Mr. Uninsky now adds an excellent selection of *Nocturnes*, *Mazurkas*, the exquisite *Barcarolle* and the formidable *F Minor Fantasia*. He fares best in the *Barcarolle* and *Nocturnes*, but his *Fantasia* and *Mazurkas* seem to be on the low voltage side for music so highly charged with either explicit or implicit emotion. The recorded sound is a trifle tubby on the low end. DH

**Piano Music From Spain** 3  
 William Masselos, Piano 1  
 M-G-M E 3165 12'' 1

Masselos, who has given us splendid recorded performances of Ives, Satie, Hovhaness, and other moderns, turns out to be a topnotch interpreter of Spanish music. He is one of the best of the group of younger pianists. Not a product of technical exuberance, he is instead a poetically sensitive performer, playing a skill of the highest order to produce some of the most enjoyable piano recordings available. The performances are more important than the works. Anyone familiar with a few Albeniz chestnuts will relish the other little known items, and the *Surinach* and *Nin* works are music to make chestnuts of. This is meant as praise, not belittlement. OD



**Bach and Liszt Organ Recital** 1  
 Bach Organ Recital 2  
 Karl Richter, Organ 1  
 London LL-1174 and LL-1175 2-12'' 1



At the organ of the Victoria Hall, Geneva, Karl Richter plays Liszt's *Prelude & Fugue in G Minor on B-a-c-h*, the *Bach Toccata & Fugue in D Minor*, *Prelude & Fugue in E Minor*, *Passacaglia & Fugue in C Minor*, *Fantasia & Fugue in G Minor*, and four choral preludes. Small faults in technique and interpretation do not mar the intrinsic worth of either record. Mention should be made, however, that you need extra-good equipment to faithfully reproduce the vibrant, powerful tones of full organ. RR

**CHOPIN: The 4 Ballades; No. 1, G Minor, Op. 23; No. 2, F Major, Op. 38; No. 3, A Flat Major, Op. 47; No. 4, F Minor, Op. 52** 2  
 Frederick Gulda, Piano 1  
 London LD 9177 10'' 1

Gulda is one of the most satisfying of the newer pianists. Poetic, sensitive, instinctively musical, and a virtuoso of the first magnitude. If he errs it is on the side of speed; the faster parts of the *Ballades* might have been treated more grandiosely and less frenetically, but this is perhaps an arguable taste factor. This is a splendid addition to the Chopin repertory—well played and well recorded. Chopin in the hands of Gulda or Katchen fares well indeed. Recording sound is impressive. OD



JAZZ, THEATRE MUSIC, AND POPULAR ALBUMS

JAZZ MUSIC

**Jammin' at Condon's** 1  
 Eddie Condon All-Stars 1  
 Columbia CL 616 12'' 1



As the volatile Albert Edward remarks at the end of some 15 minutes of *How Come You Do Me Like You Do*: "There's nothin' like a strolling group"—this being the old time jazz musician's term for a pick-up gang. Well, this band, picked-up though it may be, is pretty terrific, and that especially goes for trombonist Lou McGarrity, trumpeter "Wild" Bill Davison, and clarinetist Edmond Hall. Even Bud Freeman is back in the groove after some awful forays into modern jazz. Fine spirit, good Dixieland warhorses, and excellent recording. A happy album. FR

RATINGS OF JAZZ AND POPULAR RECORDS AND TAPES

It must be obvious to everyone that popular music, jazz, and music of the theatre and motion picture, cannot be rated in the same manner as classical music, save for the audio quality of the records. Therefore, the following explanation is given so that you will fully understand the significance of the three numbers which appear at the left of reviews of popular, jazz, theatre and motion picture albums:

**COMPOSITION (Top Number)**  
**1: Extraordinary**  
 Indicates that the collection is of superior character, both from a standpoint of material and programming. Assignment of this rating means an unqualified recommendation.

**2: Good**  
 In general, the collection is excellent, but additions or substitutions might have made the work more attractive and more lastingly enjoyable.  
**3: Satisfactory**  
 A collection that is highlighted by only a few numbers, yet the over-all is quite acceptable. This might often apply to collections that have a limited appeal, yet are important to those who specialize in specific types of music. It might often apply to collections of historic importance where the artistic performance is the primary factor.

**PERFORMANCE (Middle Number)**  
**1: Extraordinary**

Indicates a superior performance throughout the collection. Assignment of this rating means an unqualified recommendation.

**2: Good**  
 In general the performance is excellent, save that there are minor imperfections or breaches of artistry.

**3: Satisfactory**  
 To all intents and purposes an enjoyable recording, yet one that does not qualify for No. 2 rating.

RECORDING QUALITY (Bottom Number)

**1, 2, 3:** The same as for classical recordings.  
**R:** Indicates a re-issue.

**The Creative Teddy Wilson** 2  
 Teddy Wilson Trio 1  
 Norgan MGM-1019 12" 2



Teddy Wilson, who you know best of all for his wonderful playing with the original Benny Goodman Trio, is still today one of our most imaginative, sensitive, and capable jazz pianists. With bassist Milt Hinton and drummer Jo Jones, Wilson is given his best album to date. The three lightly spin webs around such nifty tunes as *It Had To Be You*, *You Took Advantage of Me*, *Three Little Words*, *April in Paris*, and *Moonlight on the Ganges*. It's all very clean and tasty. FR

**The Genius of Art Tatum—Vols. 6, 7, 8, 9, 10** 1  
 Art Tatum (piano) 2  
 Clef MG C657/61 5 12" 2

Norman Granz's fabulous project of documenting that great jazz pianist of our day, Art Tatum, is comparable on its particular level to recording all the concert repertoire of Artur Schnabel. If you're a Tatum addict, you just can't get too much—even on ten LP's. If your tastes are more moderate, we'd pick Vol. 9 (*Ill Wind*, *I'll See You in My Dreams*, *Blue Skies*, *Lover Come Back to Me*, *Would You Like to Take a Walk*, *I've Got a Crush on You*, *Japanese Sandman*, *Aunt Hagar's Blues*) as the prize item in this crop. DH



**Chicago Style Jazz** 1  
 Original 1927-1935 Jazz Classics 1  
 Columbia CL 632 12" R



Probably the finest showcasing ever made of that peculiar brand of music known as Chicago style jazz, and this for the big reason that the LP contains those four classic sides by McKenzie-Condon's Chicagoans—*Liza*, *Nobody's Sweetheart*, *Sugar*, and *China Boy*. There are also excellent examples of Chicago jazz by Miff Mole and his Little Mole's, Paul Mares and his Friars Society Orchestra, Ed Condon's Footwarmers, and Bud Freeman's band. Sound is reasonable. FR

**Sarah Vaughan** 1  
 With Clifford Brown (trumpet), Paul Quinichette (tenor sax), Herbie Mann (flute), Jimmy Jones (piano), Joe Benjamin (bass), R. Haynes (drums) 1  
 Emarcy MG36004 12" R

Subtlety, musical resourcefulness and impeccable style mark Sarah Vaughan's special contribution to this disc of intimate jazz vocals, which is presented with beautifully integrated instrumental backing and exactly the right type of recorded sound. Selections include *Lullaby of Birdland*, *April in Paris*, *He's My Guy*, *Jim*, *You're Not the Kind*, *Embroceable You*, *I'm Glad There is You*, *September Song*, *It's Crazy*. DH



**The Mil-Combo** 2  
 Capitol T579 12" 2



This is a first recording by a group of young jazzmen from the city of Milwaukee, and it is most impressive. There's Ziggy Millonzi, a sparkling technician with a lovely sense of chord progressions; Don Mamblow, a guitarist who is both warm and inventive, and competently able to play everything and anything; and, behind them, bassist Connie Milano, the spokesman for the group, who keeps it all swinging. It's not the best jazz in the world, but it's a lot better than most. FR

**Charlie Christian** 1  
 The Benny Goodman Sextet 1  
 Columbia CL 652 12" R

Here are a dozen examples of Charlie Christian's swinging guitar work with the famed Benny Goodman Sextet, recorded from 1939 through 1941. Included are such special efforts as *Seven Come Eleven*, *Six Appeal*, *Wholly Cats*, *Air Mail Special*, *A Smo-o-o-oth One*, *Gone With "What" Wind*, and *Solo Flight* (Full band). Christian was an amazing musician, and modern jazz of today can trace some of its origins directly to his work as represented by these recordings. FR



**Tom Cat on the Keys** 2  
 Bob Zurke's Delta Rhythm Band 2  
 RCA Victor LJM 1013 12" R



Although he was one of the most mixed up musicians who ever lived, Zurke still was one of the best solo and band jazz pianists of all times. Around 1940 Bob experimented with a band of his own, cutting a dozen or more sides for Victor. These records, until this LP, have been quite unavailable. There's some corking jazz in this album, including such Zurke standards as *Honky Tonk Train*, *Southern Exposure*, *Tea for Two*, *Cuban Boogie Woogie*, and *Cow Cow Blues*. Try it for size. FR

**The Blues** 2  
 Jimmy Rushing 1  
 Vanguard 8011 10" 2  
 7½ speed, dual track  
 A-V Tape 701

It's been a spell since old "Mr. Five-by-Five" has had much to do in the way of records, which is too bad from nearly every standpoint that you can think of. Rushing became a name with the old Count Basie band for his superior way of singing the blues, and many of the tunes recorded here are those he did first with the Count: *Goin' to Chicago*, *I Want a Little Girl*, *Sent for You Yesterday*, and *Boogie Woogie*. Band at times overshadows his singing, but all in all it is Rushing's best disc. FR



**Rampart and Vine** 2  
 Rampart Street Paraders 2  
 Columbia CL 648 12" 1



The players—Matty Matlock, Eddie Miller, Joe Rushton, Abe Lincoln, Clyde Hurley, George Van Eps, Nick Fatool, Phil Stephens, and Stan Wrightsman—are as coolly a professional gang of torpedo merchants as you could get together. Their rapport is complete. With songs the calibre of *Sugar*, *Do You Know What It Means To Miss New Orleans*, and *Paducoh Parade*, with the fi flying hi, with nifty head arrangements by the incomparable Matlock, and with corking solo work on most everyone's part, this album is almost always a thing of beauty. Hurley, however, seems out of place with his roughhouse horn, and the intro to *Hindustan* is awful. FR

**Oscar Peterson Plays Jimmy McHugh, Harry Warren, and Harold Arlen** 1  
 Oscar Peterson Trio 1  
 Clef MG-C 648-650 3-12" 2

Some time ago Clef began a series of LP's featuring Peterson playing the great American composers: Porter, Rodgers, Berlin, Gershwin, Ellington, Kern, and Youmans. Now add McHugh, Warren, and Arlen, all of whom wrote marvelous songs. This series has an imagination about it, a warm respect for the melody, a rhythmic drive, and a fresh excitement that invests each album with a real lasting quality. With Peterson are bassist Roy Brown and guitarist Borney Kessel. FR



**The Bob Cats BOLL** 1  
 Bob Crosby and His Orchestra 1  
 Coral CRL 57005 12" R

The Crosby band of yore is still the best big Dixieland band of all times, and most of the selections in this LP are from that era. The "Bob Cats" title, though, is misleading, for the Bob Cats of the 40's, which were the small band within the band, have nothing to do here. *Charleston* and *Black Bottom* are played by the '52 version of the Bob Cats, and they weren't bad. But they hardly compare to the splendidly swinging pieces by the full aggregation of 1940. Odds are 10 to 2, and that ain't bad. Sound is fair. FR



**Hot Songs My Mother Thought Me** 1  
 Lizzy Miles with Tony Almerico's Band, Red 1  
 Camp (piano), Albert French (banjo) 1  
 Cook 1183 12" R



Imagine Leadbelly, Sophie Tucker and Sonny Terry rolled into one and you have Lizzy Miles—born Elizabeth Pajaude, one of the 1st of the Creole red hot mammas. As a documentation of such numbers as *Waitin' for the Robert E. Lee*, *Chinatown*, *Ballin' the Jack*, *Tishomingo Blues* and *Georgia on My Mind*, this disc is certainly unique; but the originals like *Dyin' Rag* and *Mama Don' Allow It* are items which alone are worth the price of the entire disc! DH

**Scott's Fling** 2  
 Tony Scott Septet 2  
 RCA Victor LJM-1022 12" 2

The emphasis in this album is much more on technique and unusual tone than it is on plain old-fashioned swinging jazz. There are six original compositions by Scott, none of which ever will appear in the Hall of Fame, although they show his clarinet work to its most effective. One of the few exciting numbers in the LP is *Forty-Second Street*, a grand old movie tune seldom given the jazz treatment. Good, too, are *But Not For Me* and *Our Love Is Here To Stay*. Liner notes are terrible. FR



**Duke Ellington, Vol. 1** 2  
 Duke Ellington and His Orchestra 1  
 "X" LVA 3037 10" R



1927-28 recordings by Duke Ellington, and some of his finest too, including *Creole Love Call*, *East St. Louis Toodle-oo*, *Black Bottom*, and *Jubilee Stomp*. In point of time they are not his earliest, but they're among the earliest from that period when he had settled into the style that brought him to the Dukedom of American jazz. This is rich listening indeed, and the RCA Victor engineers continue to do expert things with the old masters. FR

THEATRE MUSIC

**RODGERS AND HAMMERSTEIN II:** 1  
*Oklahoma/Carousel Suites* 3  
 Morton Gould and His Orchestra 3  
 RCA Victor LM-1884 12" R

The case where all that glitters is not gold. The cover and the music are just swell, but I take issue with Mr. Gould on his arrangements and presentation. Neither "Carousel" or "Oklahoma!" have a thing to do with Grand Canyon, yet Mr. Gould is in there cracking his whip and driving the mules up the steep slopes. His interpretations haven't always the lilt, the genuine beauty that Rodgers wrote into his marvelous melodies, and the emphasis is too much on sound. Does Gould understand simplicity? But despite these faults, there's still some fine listening here. FR



**MENOTTI: The Saint of Bleeker Street** 2  
 Original cast recording 1  
 RCA Victor LM-6032 2-12" 2



Named the best musical by the New York Drama Critics' Circle and winner of the Pulitzer Prize, "The Saint of Bleeker Street" may have had a disappointing run on Broadway, but it is, nevertheless, a sometimes thrilling musical drama which often gives the attentive listener something that could well be defined as Menotti goose pimples. The magnetic Act Two curtain, for instance. Some splendid singing, the album is handsomely packaged, and reproduction is above average. RP

**Damn Yankees** 2  
 Original Broadway Recording 1  
 RCA Victor LOC-1021 12" 2

Gwen Verdon, Stephen Douglass, and Ray Walston star in this fast moving musical version of the Douglass Wallop book, "The Year the Yankees Lost the Pennant". Young Dick Adler and Jerry Ross have written a score that is bright, clever, fun, and good but not great. Perhaps the funniest spot in the whole recording is Walston's *Those Were the Good Old Days*. Miss Verdon certainly has herself a ball with *Whatever Lola Wants*. Anyone can like this, not just the Broadway show goers. The whole affair is a sparkling series of ringing singles, doubles, and triples. FR



POPULAR MUSIC

**In the Wee Small Hours** 1  
 Frank Sinatra with Nelson Riddle's Orches- 1  
 tra 2  
 Capitol W581 12" R



Right at the outset a quiet, calm mood is established, and that emotion is maintained throughout. Everything is rather like warm, gentle rain falling on a summer night—late. The songs are among the greatest in the Tin Pan Alley repertoire, and Sinatra sings each one with the maximum of feeling and phrasing. Riddle's arrangements and accompaniments are entirely in keeping with Frank's singing, always tastefully in melody with the man and his song. FR

**A Visit to New York** 3  
 Arthur Godfrey, the Little Godfreys, & Will 3  
 Roland's Orchestra 2  
 Columbia CL 653 12" R

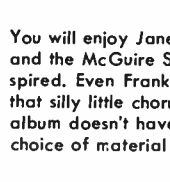

You will enjoy *Janette Davis' Lullaby of Broadway*, *Haleloke's Blossoms on Broadway*, and the *McGuire Sisters' Autumn in New York*, but the rest of the stuff is pretty uninspired. Even Frank Parker didn't do right by a song as lovely as *Manhattan*, with that silly little chorus making it all as cozy as a rendezvous in Yankee Stadium. The album doesn't have the zing or the ring, and it isn't a Godfrey affair. Nor was the choice of material good. It could have been wonderful. It isn't! FR



**Evening in Rome** 2  
 Frank Chacksfield and His Orchestra 2  
 London LL-1205 12" 1



England's Frank Chacksfield can jolly well chalk up another success for himself with this excellent record. The warm lyricism of Italian melody is found in every selection, and the arrangements, we're happy to say, are kept smooth and simple the way they should be. An evening in Rome? This is it. The Italian flavor is here and so, with a little imagination, is the cafe, the candlelight and the wine. Songs include *Santa Lucia*, *Mattinata*, *Come Back to Sorrento* and *O Sole Mio*. RP

**Lonesome Echo** 2  
 Jackie Gleason and His Orchestra 3  
 Capitol W627 12" 2



The cover of this LP is by Salvador Dali, and I don't know much about this kind of thing, but I like it. However, I cannot recommend more than mildly Mr. Gleason's switch in formula. Trumpeter Bobby Hackett has been replaced by a battery of mandolins, and oh, how the sound does ripple! I dunno, but it all gets boring and *comme ci comme ca*, and I was quite willing after my 12" of listening to bust a mandolin over Mr. Gleason's cranium. But then, he's done such lovely things in the past. FR

**Lombardoland, U.S.A.** 2  
 Guy Lombardo and His Royal Canadians 2  
 Decca DL 8097 12" 2

Save for *Tennessee Waltz*, which is one of the most twitterpating, nothing ditties ever written, this is a thoroughly enjoyable cross-country bus ride with the Lombardoites. And the Royal Canadians still play some of the finest dance music in the world—not flashy nor melodramatic, but steady and wonderfully on time. We visit lots of good spots with Guy and his tribe, and St. Louis in particular. Lombardo's *St. Louis Blues* remains one of the classics of American music. FR



**She Dances Overhead** 1  
 Matt Dennis with Harry Geller's Orchestra 3  
 RCA Victor LPM-1065 12" 2



Dennis is a singer of infinite charm and warmth, and the choice of Rodgers and Hart tunes for his first Victor album was particularly gratifying. But Geller's blatant, offensive, inartistic aggregation is as out of place here as her mother on your first wedding anniversary. Dennis has a nifty trio; his piano playing is a splendid counterpoint to his singing. By replacing the trio with the band, Victor has managed to destroy the intimacy, overshadow the singer, in what could have been a superb affair. FR

**Starring Sammy Davis Jr.** 1  
 Sammy Davis Jr. 2  
 Decca DL 8118 12" 3

Some of the sides are original singles and some are new for the LP; all are good, especially *Hey There*, *September Song*, *Easy to Love*, *Glad To Be Unhappy*, and *Birth of the Blues*. On the longer *Because of You*, junior Davis gives his impression of some of America's more popular singers, which brings up the conclusion that Davis is versatile enough to capture the styles of other vocalists, but they'd have a tough time getting all of S. Davis, Jr. down on wax. The kid's a showman. FR



**Music for Tonight** 2  
 Steve Allen and His Orchestra 2  
 Coral CRL 57004 12" 3



This makes mighty pleasant listening, and that's how it's intended. There are tunes like *Isn't It Romantic?*, *Long Ago, I'm Glad There Is You*, *Where Are You?*, and *The Man with the Horn*. There are also some Allen originals: *Tonight*, *Candlelight*, and *Stay Just a Little While*, which, surprisingly enough, stand up well beside the tough competition. Neal Hefti made the arrangements, Steve plays excellent piano, but the sound has been enhanced too much. Aside from sound, though, it's a restful, enjoyable record. FR

**Bonbons Caramels** 1  
 Annie Cordy 1  
 Angel 64016 10"

Call her saucy, sophisticated, or just a wee bit naughty, you'll love Annie and the eight delightful French songs this album offers. Annie sings with disarming candor and appeal, whether it's about the cowboy's daughter who threw her lover off a cliff to join the other 21, a rocking French version of *Seven Lonely Days*, or the story of the nice, friendly girl who amassed a fantastic fortune by selling *Bonbons, Caramels, Eskimo pies and chocolate*. Gay, refreshing and tuneful. RP



**Davy Crockett** 1  
 Original TV-Motion Picture Soundtrack Recording 1  
 Columbia CL 666 12" 2



This is the biggest and best of all the Davy Crocketts. It stars Fess Parker and Buddy Ebsen, and was taken directly from the soundtrack of the three TV shows that Walt Disney built around the life of *Davy Crockett, King of the Wild Frontier*. Boy! I like it just fine. In fact, when my Dad gave it to me for my birthday, I took it to school and played it there, and all of my friends have heard it at home. Even my sister's older friends love it. Gee, it's swell. Ward Reynolds, Jr.

**Smith-Glamann Quintet, Vol. 2** 2  
 A-V 252 7 1/2 ips, dual track 3  
 1

Here is some very good sound, and not much more. The Smith-Glamann Quintet seems to blend well together, and there is a pleasant balance in the recording and among the instruments. But the guitar, especially, is woefully inadequate, while the playing as a whole is weighty and somewhat too frigid. If this quintet would just sit around and play the songs and forget about techniques and intricacies, it would be a whole lot better off. Even as background stuff it seems cloying. Music of this kind demands a lilting swing, and the Smith-Glamann Quintet just don't pull it off. FR



**Concert Series** 2  
 Fine Arts Quartet and Guests 2  
 Webcor 2923 (1-4) 7 1/2 ips, dual track 1



Here is a series of instrumental music that is light, listenable, and unpretentiously enjoyable. The Fine Arts Quartet is not one of the world's best, but it is entirely adequate. For these tapes, the Quartet and several competent guests play selections the calibre of Dvorak's *Quartet in F Major*, Tchaikovsky's *Adagio Cantabile*, Bartok's *Roumanian Dances*, Schubert's *Quartet in F Major*, Brahms' *Quartet in A Major*, Granados' *The Lady and the Nightingale*, and Mozart's *Quartet in G Major*. Presence and recording are both excellent. FR

**ELGAR: Wand of Youth Suite** 3  
**SIEGMEISTER: Ozark Set** 3  
 Hamburg Philharmonic Orchestra 2  
 under Hans-Jurgen Walther  
 A-V 1514 7 1/2 ips, dual track

Two minor works are given rather stiff and heavy treatments by this relatively inadequate orchestra. This is a big, round, tough world, and the tape boys just aren't going to make it against the great competition with third-rate performances. Tape is out beyond the breakers now; the novelty is fast wearing off. In other words, just anything on tape is not going to sell just because it's presented on tape. Let's have better selections, especially with the limited catalog in pre-recorded tape at present, and by all means, let's pick out Grade A talent. FR



MISCELLANY

TAPES

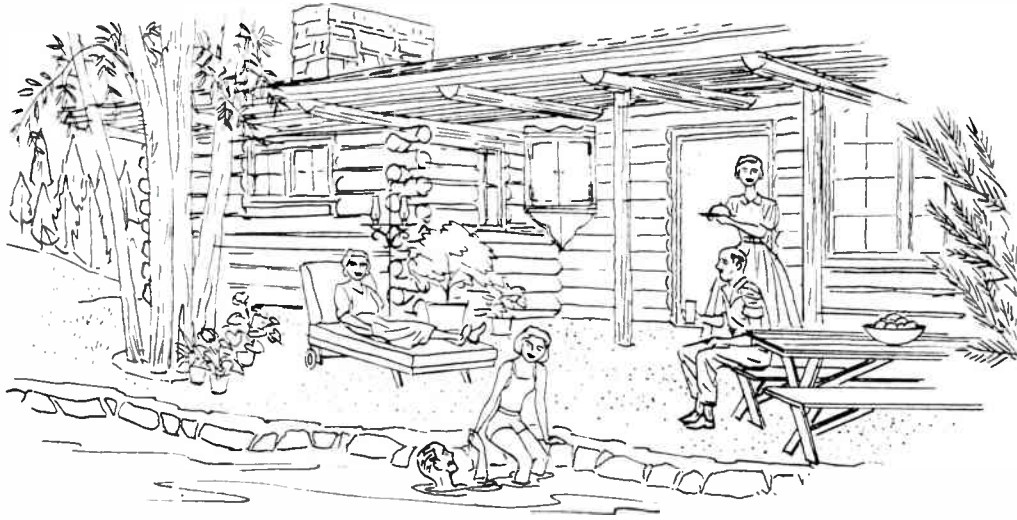

# GROWING UP

Here is the four-part story of Jack and Larry, and the interest in hi-fi music they shared with Joan and Linda. The story starts, as romance does so often, during summer vacation, to which music, appropriately supplied by Jack and Larry, is a fitting accompaniment

*Fig. 1. So versatile are the new tuner and amplifier units that they require no cabinet work, can be connected in a few minutes to a changer and speaker*

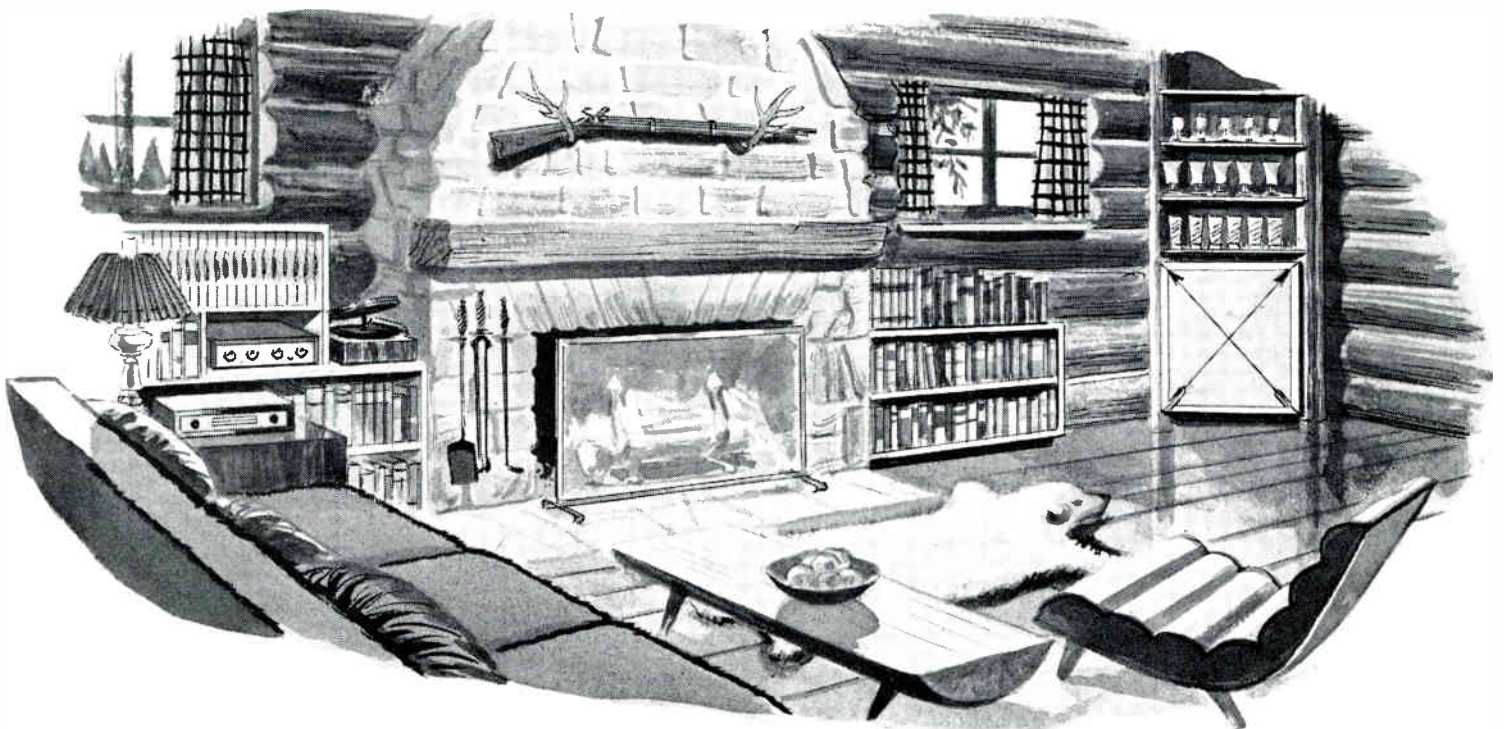

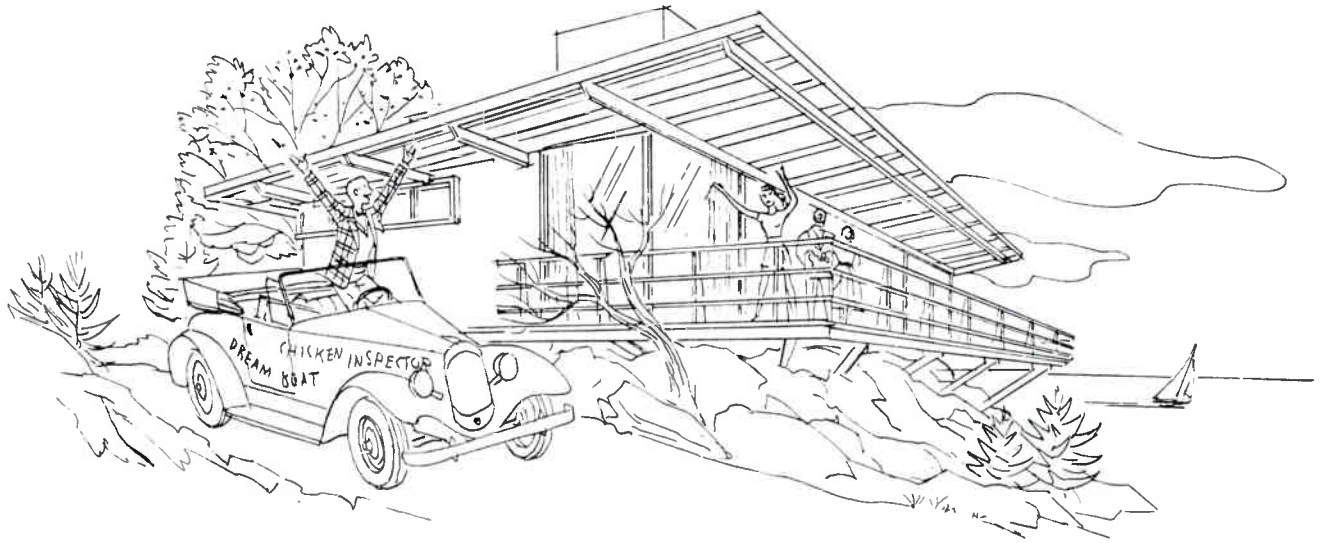

# WITH HI-FI . . . .

Part 1: As his contribution, Jack brought his radio and phonograph, built a record rack, a cupboard with a speaker in the base, and a weatherproof outdoor speaker. Larry brought his equipment, too, adding a phonograph in a cart to be wheeled around outdoors

*Continued on the next page*

*Fig. 2. There is always space to locate a tuner, preamp-amplifier, changer or turntable. This installation has a corner cabinet for the loudspeaker*





Fig. 3. Jack installed this extra speaker with a switch as shown in Fig. 6, diagram No. 3

**D**URING the last three years, audio equipment has been so simplified that anyone who is able to fix an extension cord for a reading lamp can arrange and connect the components for a really fine hi-fi installation. Moreover, a simple system, which is the logical starting point for a beginner, costs less than most people think.

Something new has been added to the design of hi-fi components — two things, actually. They are 1) simplified connections, and 2) small, attractive metal or wooden cases for the components. Now, it is possible to arrange and wire a complete system in a matter of minutes, using only a screwdriver and a pair of pliers.

This series of four articles will show eight installations in different types of homes, progressing from simple combinations that can be put together without any previous hi-fi experience, to more elaborate arrangements, still made up of standard items of equipment. The articles are presented as the story of Jack and Joan, and Larry and Linda simply because the account of their experiences is so typical of what is going on in so many American homes.

**D**URING their last two years of high school, when TV-looking and music-listening created a sort of social stratification among the students, Jack and Joan, and Larry and Linda became enthusiastic members of the latter group. Then, in their senior year, a further division split the music listeners into the Jukes and the Hi-Fiers. This distinction gave the Jukes an opportunity to make clever remarks about their long-haired classmates, and the Hi-Fiers to assume an air of superiority toward those who were satisfied with music available at a dime a tune.

With graduation in the offing, Jack and Larry were approaching the time for military service and, as the coming summer might be their last at home before they went into the Army, Joan's and Linda's parents decided to invite the boys to their respective summer homes. The boys, in turn, agreed to take along their hi-fi equipment to provide a source of music. For this occasion, Jack and Larry wanted to add the special flourishes illustrated in Figs. 1 to 4.

Joan's parents had warned: "You may have your music, but you're not to tear up the cabin!" So Jack and Joan went into a huddle, the outcome of which was Jack's promise to build a record rack, to mount a speaker in an enclosure which would be the base for some simple shelves, and to make a case for an outdoor speaker. Also, he would put up an FM antenna. These items he would leave at the cabin. He'd take along his FM tuner, preamp-amplifier, and record-player, but they would go back with him.

Linda said: "Can you make up some kind of a phonograph that we can use for dance music, Larry? Sometimes my folks like to have it quiet indoors at night, but

it wouldn't disturb them if we could have our music outdoors." To which Larry replied: "You just happened to ask the right man!" And he undertook the construction of a speaker cabinet that would also house an amplifier and turntable, with space for a few records. Two wheels

Fig. 5. Diagrams of the installations illustrated in Figs. 1 and 2

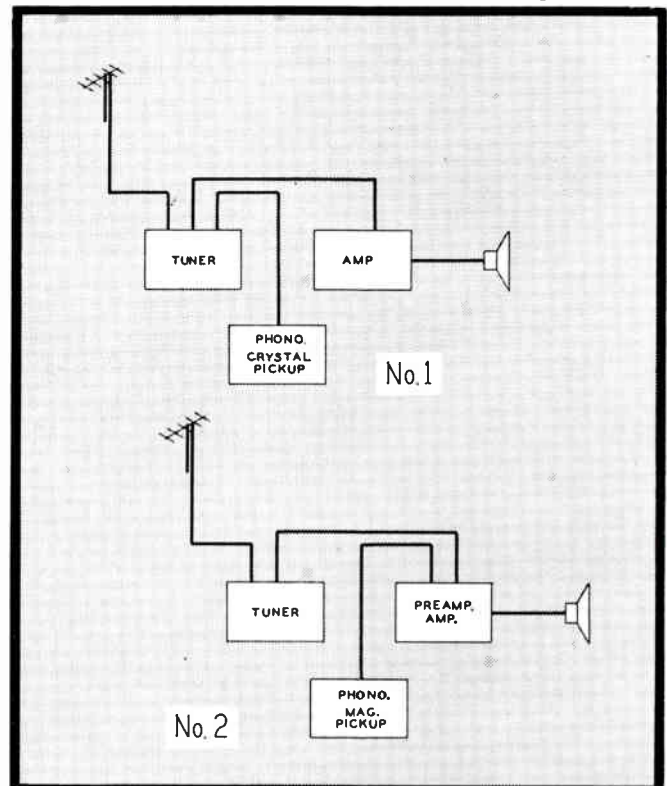



and a pair of handles made the unit as mobile as a tea cart.

The results of their efforts are shown here. These illustrations are deceiving in one respect: They look as if the installations were made by technical experts. Yet when you look inside to see just what is involved, you'll see that they call for neither knowledge of audio equipment nor skill in installing it, and that the cost is very moderate.

In fact, if you plan the arrangement of your equipment in advance, you can have your dealer make up the connecting leads for you, so that the installation will amount to nothing more than placing the instruments where you want them, and plugging in the leads — a matter of five minutes from start to music.

For example, the equipment shown in Figs. 1 and 2 is indicated by the blocks in Fig. 5. The tuner can be one of the inexpensive FM or FM-AM models, priced under \$100. Diagram No. 1 calls for a record changer or turntable with a crystal or ceramic pickup, costing as little as \$50, and a plain amplifier, without tone controls, at about the same price, together with a speaker at something less than \$25.

If you go to a magnetic pickup, diagram No. 2, you will need a combined preamplifier and amplifier. Then you will have a full set of tone controls. Extra cost, about \$75.

These instruments come in attractive metal or wood

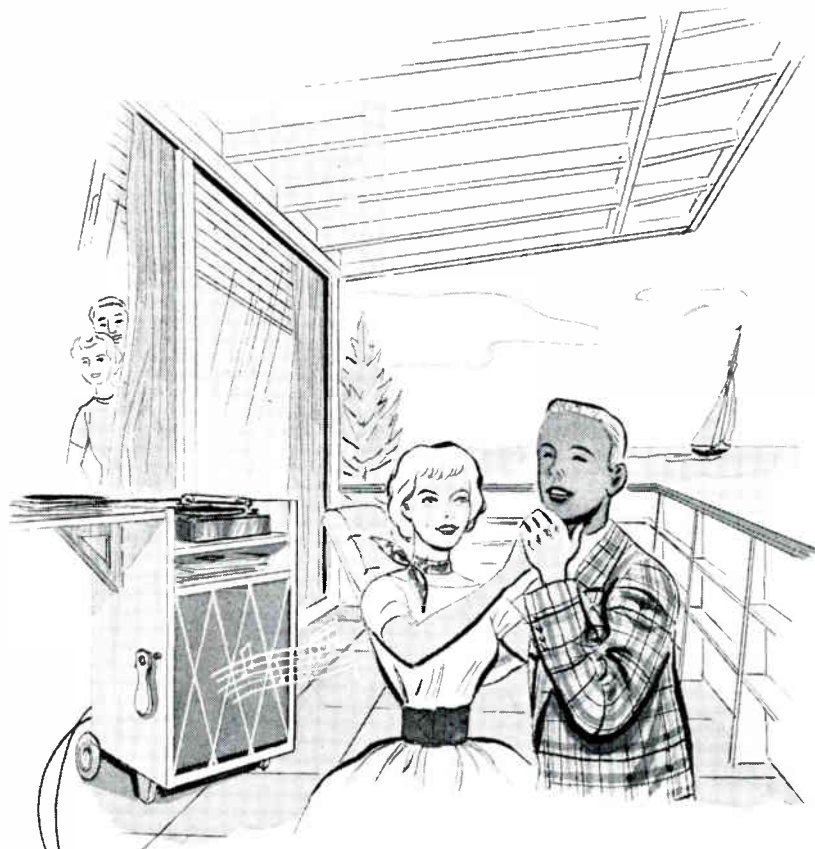

Fig. 4. The components used in this phonograph cart are shown in Fig. 6, diagrams 4 and 5

cases, so it is not necessary to hide them in special cabinets. When you have selected the items you want, your dealer can make up the connecting cables for you, and you can hear the assembly work in his store before you take it home. If there's anything you don't understand, you can straighten it out with your dealer right then.

Fig. 3 shows an extra speaker mounted outdoors. If you don't want to make a special case for it, you can get a standard patio model intended for just this sort of use. A simple switch, diagram No. 3, will enable you to use either of two speakers.

Components for the phonograph cart, Fig. 4, are indicated in diagrams 4 and 5. The former is made up of a changer or turntable with a crystal or ceramic pickup, a plain amplifier, and a speaker. These add up to perhaps \$125. Diagram No. 5 calls for a magnetic pickup with a combined preamplifier and amplifier. Or, if you start with No. 4, and want to graduate to No. 5, you can simply change your pickup and add a separate preamplifier, as shown at No. 6.

These are basic, practical, inexpensive starting combinations which can be installed and operated successfully by anyone whose knowledge of hi-fi only extends to an enjoyment of good musical entertainment. You can use these diagrams to show your dealer exactly what you want. And remember about having him make up the leads for you, and connecting up the instruments so that you can hear them work before you take them home.

PART 2: How the newlyweds built hi-fi systems for a small house and a 1½-room city apartment.

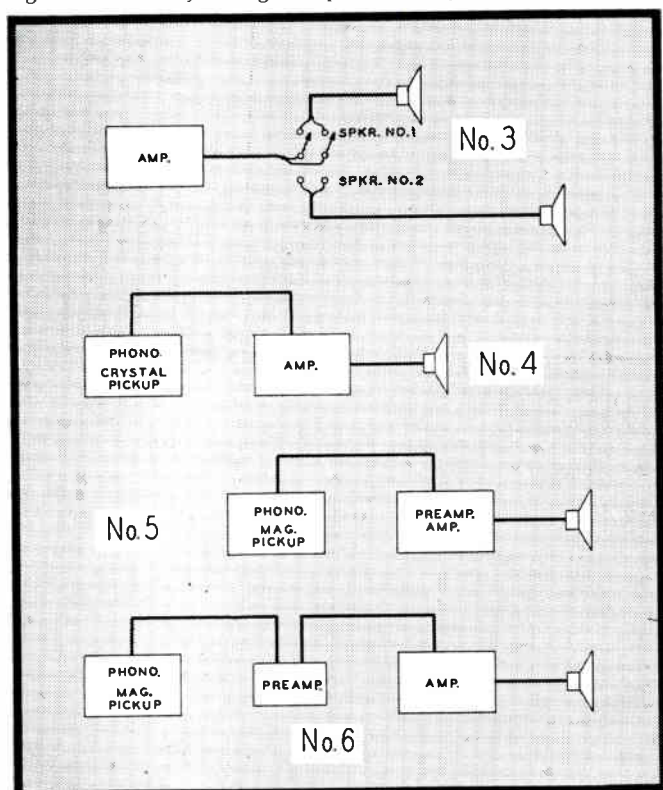

# . . . . HAPPILY EVER AFTER

*Confessions of an Unskilled Enthusiast Whose Family Has Now Advanced Him to the Rating of Audio Expert, 1st Class — By Allen Ruffin, Jr.*

 FITTING the cost of hi-fi components into the family budget is, at times, a difficult undertaking. The pain can be eased somewhat by purchasing some items in kit form, for then you can claim to be paying only for parts, and not for someone else's labor. This can be presented to other members of the family as a bargain, and it may alleviate the financial strain somewhat. Having recently done this with an amplifier for a second audio system, I can clear some of the doubts which may exist in the minds of those who are dubious concerning their skill with such an undertaking.

Starting with little more technical knowledge than a vague idea as to which end of the soldering iron gets hot first (shortly after the beginning of assembly, I learned a pointed lesson in this respect) and a general idea of what the insides of amplifiers look like, I decided that one of those kits would be ideal for my needs.

So I made my choice, and sent off my order. I spent the next two weeks in a state of anticipation close to pathological. This can lead to the Mailbox-Opening Compulsion, and is to be avoided. The day after the new hinges were installed on the mailbox, the kit arrived and the project was underway.

Once the parts were relieved of their shredded wrappings — which were *not* to be left on the rug — they were placed carefully on a trophy bridge table which had been set up to serve as a work bench. This was a mistake, called to my attention after the soldering iron had slipped from its cradle only once. It was then I learned my first technical lesson. I still carry the scar. From that point on, my endeavor was viewed with considerable disdain throughout the rest of the house. My first hurdle was the shock and feeling of dismay at seeing all the many disconnected parts lying about as if defying me to get them together in proper order. However, I was able to weather this by summoning up an attitude of good humor, aided in part by several draughts of cold lager.

Beginning at the logical jumping-off place, I calmed myself before settling down to read carefully all instructions, and go over all the charts. At first they seemed to make little or no sense, but after the third reading everything began to fall into reasonable order. That was enough for one evening. I decided to rest and then approach my project in a cooler frame of mind the next morning. The mere arrival of such things can be a bit exciting to a novice. This moderate line of attack is to be highly recommended.



Besides, I was tired. This was a harrowing experience.

The next morning found me hard at work. In a short time all the sockets, terminal strips, transformers, switches, and such were in place, and I was ready to start putting in leads and condensers. I was beginning to feel quite professional and competent. This was a fallacy that I should have recognized as a danger signal. It was so easy to follow the directions. They are written in a manner clear enough for a twelve-year-old to read. Well, I'll break down and admit that I made some mistakes. Trouble was that I'm not twelve years old. At least I found my errors before I progressed too far beyond them.

By the end of the afternoon, all was completed but for the equalizer circuits and their installation, a few tag ends of wiring, and the input connections. My hands were sprinkled with tiny burns and my temper was on the ragged side, but at last that dismaying confusion of parts was beginning to look like an amplifier, and I was exultant. I knew there was a creative instinct lurking somewhere in my personality.



The following day found me already at work while the rest of the household was just arising. The remaining connections were made with ease, and by noon the fuse and line cord had been attached. Tubes were put in the proper sockets, but for the two amplifiers — I had learned to recognize them by their type numbers — and the moment was at hand. Some grapevine signal gathered the family around me and, in an atmosphere of hushed tension, I switched on the power. Small glows appeared in all the tubes. Eyebrows were raised in a mixed expression of surprise and doubt still unresolved.

There followed the insertion of the amplifier tubes, and an examination of parts by touch for excess heat. All seemed to be well. Now it was time for the big test. The lead from the phono pickup was inserted at the proper input, a loudspeaker connected to the terminals specified, a record put on the turntable, and the machinery started. A feeling of bated breath pervaded my improvised workshop as I lowered the pickup on the disc. Then we heard . . . absolutely nothing. Hearts were heard sinking. I advanced the volume control, and still not a sound except silence. I learned how strong men's souls are tried.

"Well, that's the way she goes," I said, and idly snapped the function control switch from right to left. Then . . . the room was suddenly filled with as merciless a blare of sound as had ever been heard in our village in many a day. What had happened as you prob- *Concluded on page 60*



# Q and A

*First report on a series of interviews with oldtimers who know the answers to questions asked by newcomers. Here we quote Thomas A. White*



Is it possible to clearly define *hi-fi*? Yes, I think so, if we remember that the significant word is *fidelity*, meaning in this case a degree of faithfulness, while *high* simply indicates the degree of faithfulness achieved.

The reproduction of sound is art in one of its highest, most complex, and exacting forms. As in all forms of art, perfection in the reproduction of sound, or perhaps we should say re-creation of sound, is measured by the degree of stimulation, pleasure, and inward satisfaction experienced by the listener. In the case of a painting, it is the visual sense which is stimulated and satisfied, while in the case of sound it is the aural sense. Hi-fi therefore connotes a degree of faithfulness with which it is possible to reproduce sound, the ultimate object being to recreate the original with nothing added or omitted. The closer we approach literal re-creation, the greater becomes our listening satisfaction. It is when performance is within the limits of this zone of perfection that the results may properly be called "hi-fi".

Is hi-fi music something which can be enjoyed in all American homes? It certainly can be, except in cases where there is no electrical power circuit available and, naturally, in the relatively few homes where there is just no interest in the cultural or entertainment value of music.

It has been said that while everyone is talking about hi-fi and seems to be interested, it is difficult to select and install the equipment. What have you to say to that? I'm afraid there is considerable truth in the statement, and for several reasons. In the first place, and this is probably the most important contributing factor, the number of stores where hi-fi equipment could be seen and demonstrated was quite limited, with these locations being almost entirely confined to the centers of the larger cities. Now, the number is increasing, and spreading to new areas throughout the country.

Perhaps the next most important contributing factor to this circumstance is the number of articles by self-styled experts, even appearing in some national publications having no primary concern in hi-fi subjects, whose advice has confused the public, and led them to believe that enjoy-

ment of fine music in the home cannot be insured without the advice of such experts, or unless the prospective owner is himself an engineer. This is most unfortunate because it isn't true, as more and more people are discovering for themselves. Yet, in spite of the greatly increasing rate of hi-fi ownership, the number of families denying themselves its pleasure is enormous, simply because they have been given an entirely fallacious idea that they must be experts or engineers in order to select, install, and use the equipment.

Do you feel the technical aspects of hi-fi are being over-emphasized to the detriment of its real purpose of providing musical enjoyment at its best? It is true that hi-fi equipment is relatively unfamiliar to the average home owner when compared to such things as refrigerators and automobiles. The prospective purchaser might therefore be wise to put a little more than the usual emphasis on consideration of the record of accomplishments, demonstrated ability, and integrity of the manufacturer whose name appears on the products labeled "High Fidelity", and on the reputation of the dealer from whom hi-fi equipment is bought.

Is the public being misled about hi-fi? It is certainly not being misled as to the magnificent performance which you and I and many others know can be expected of hi-fi sound reproduction. On the contrary, I think only a comparatively small segment of the people are yet aware of the startling performance and listening pleasure readily available to them through ownership of hi-fi equipment. If, however, you are suggesting that the public is being misled by the offering of equipment and products labeled "High Fidelity" but which fall short of producing any reasonable facsimile of the original sound, then the charge would be true. In all industries, some participants use superlatives rather carelessly in an attempt to attract interest to their products. The hi-fi industry is no exception, for some participants obviously use the term "High Fidelity" with little regard for its true meaning. It must therefore be emphasized that mere use of the label "High Fidelity" does not insure performance within the true sense of the term.

*Continued on page 59*

# Small Enclosure Has a NEW SPEAKER

By EDGAR M. VILLCHUR

**C**RITICAL LISTENERS are very much concerned with obtaining natural musical timbre in reproduction towards the bass end of the musical scale. Not that the low end is more important than any other part, but that it is more difficult to reproduce.

Beginners sometimes put a misguided emphasis on quantity, accepting boomy and wooden bass because there is lots of it, but they soon acquire a growing awareness of the character of the real thing. Bass which is both full and undistorted cannot be imitated by boomy gadgets. The extreme lows, such as those produced by organ pedal pipes, the double bass, the contra-bassoon, or the bass drum, create sensations which involve not only hearing but feeling and, when reproduced accurately, there is no ringing about the ears or muddying up of the rest of the music.

Reproduction without compromise of low-frequency musical tones has involved the acceptance of an enclosure of somewhat monstrous dimensions in one's home. However good-looking and fine sounding, under many circumstances neither a large cabinet nor a wall installation is acceptable, and a small cabinet is the only answer to limitations of space, even at a sacrifice of bass quality.

Considerable interest has been aroused, therefore, by the AR speaker system, contained in a cabinet 25 ins. wide, 14 high, and 11 deep, offered as a no-compromise unit

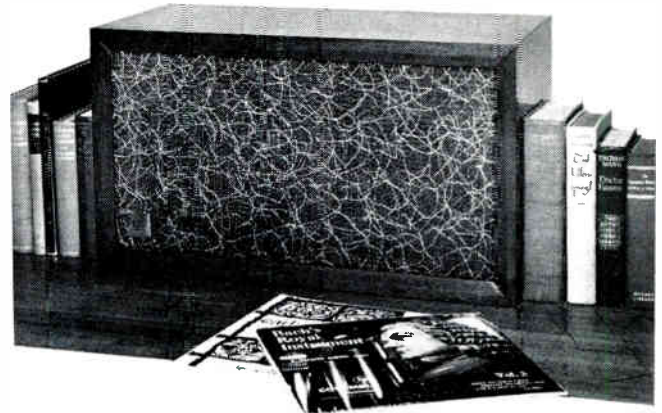

capable of reproduction quality equal to that obtained from very large enclosures. When it is realized that the small cabinet illustrated above houses both a 12-in. bass speaker and an 8-in. high-frequency mechanism, it becomes apparent that either the designer is indulging in pipe dreams or that this is not a conventional speaker system.

In point of fact, the speaker is designed on a new *acoustic suspension* principle, which requires a sealed cabinet of small size. If the new type of bass speaker were installed in a cabinet of twice the dimensions given above, half the cavity would first have to be partitioned off.

By way of explaining how the acoustic suspension system works, it is necessary to take a brief but not too chilly dip into enclosure theory.

The term *enclosure theory* sounds forbidding. It brings to mind labyrinthine acoustic passages, cavernous resonances, and cabinets of all possible shapes, sizes and materials, each with its own mystic equations. But most enclosure theory is concerned with a relatively simple problem. It is the problem of keeping the front of the speaker acoustically separated from the back, so that the air being pushed forward doesn't get sucked in by the partial vacuum behind the cone. The problem can be stated in another way: air set into vibration by the speaker must not be allowed to circulate back and forth around the outer edge of the cone, but must (Continued on page 61)

*Below: Cabinet is partly filled with sound-absorbing material. Special 12-in. acoustic-suspension speaker, left, has 3.3-lb. Alnico 5 magnet. Smaller speaker is an Altec 755-A. Right: Field test of free-space response at low frequencies*





*This instrument is for testing audio equipment*

## Hi-Fi Projects for the DRAWING TABLE WORKSHOP • No. 6

### *A Test Generator for 20 to 1,000,000 Cycles By Jan Syrjala*

WE ALL talk freely about audio frequencies, but who among us can whistle a tone of 600 cycles, or 2,000 cycles? We say that a particular audio system responds to frequencies from 50 to 12,000 cycles, but that is only an opinion unless we have used some accurate method of checking the response. Listening to music does not give us any real answer, because we have no way to judge the pitch of tones that can be heard for perhaps a fraction of a second. So if we want to really know what we're talking about when we discuss audio frequencies, or the performance of equipment, a means of generating specific tones is an absolute necessity. There are, of course, test records, but they give only a few frequencies, and it is not convenient to switch quickly from one particular tone to another. The most convenient source is an audio generator, since this can be set at any point on the musical scale, and kept there as long as we want to listen.

If you are interested in making tests, you'll probably want to build a generator of your own. It's easy to do, and an instrument such as the Heathkit model AG-8 is sufficiently accurate for all practical purposes. The accompanying photographs show the successive stages of assembly.

At the conclusion of this article, you will find notes on the use of the generator.

ASSEMBLY STAGE: Fig. 1 shows the kit of parts. Every item is furnished, including the case, line cord, and tubes. The instruction book calls for mounting the resistors on the multiplier switch, Fig. 2, and on the voltage range switch, Fig. 3, and all the parts on the chassis, Fig. 4. Not until that work is completed is the wiring begun. The instructions are very clear, and the work is straight forward, calling only for the use of pliers, cutters, and a screwdriver. The only delicate work is that of soldering the resistors on the switches. Special care must be taken at that part of the assembly to solder the connections very quickly, so as not to transfer heat to the resistors.

The total time required for the assembly stage was 2 hours and 10 minutes, of which 50 minutes were spent on the multiplier switch, Fig. 2, and 15 minutes on the voltage range switch, Fig. 3. One note may be helpful at this point. In the instructions, the pictorial diagrams are referred to as 1, 2, and 3. Actually, they are marked A, B, and C, so if you look for "Pictorial 1", you will find it identified as "Pictorial A".

*Fig. 1, center: Complete parts for the Heathkit audio generator. Fig. 2, left: Assembly of the multiplier switch. Fig. 3. The range switch*

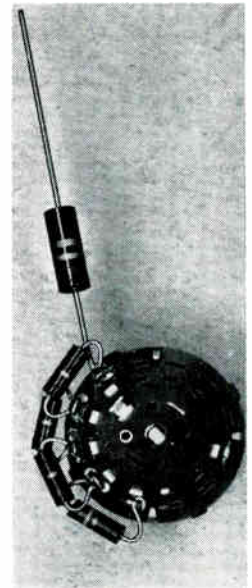
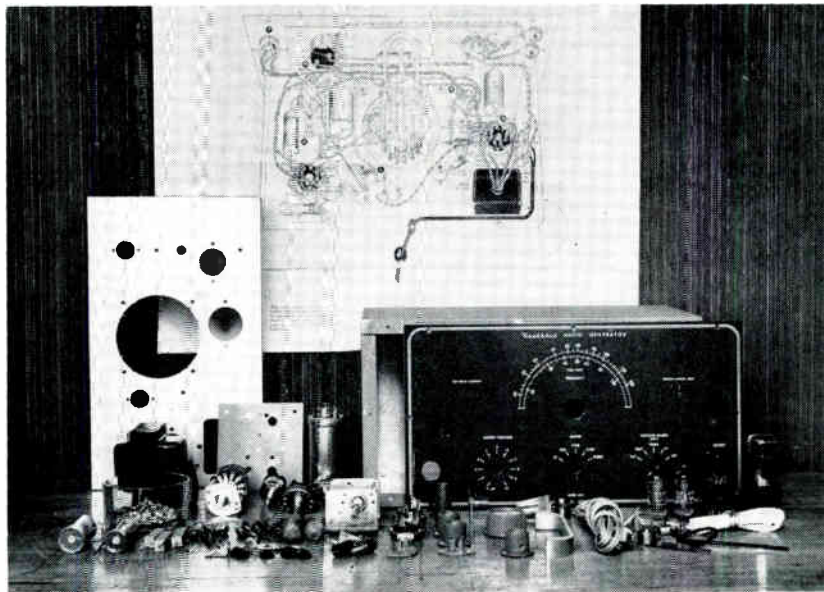
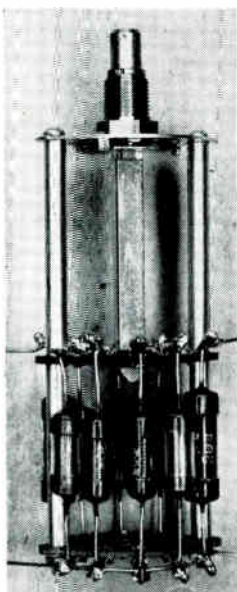

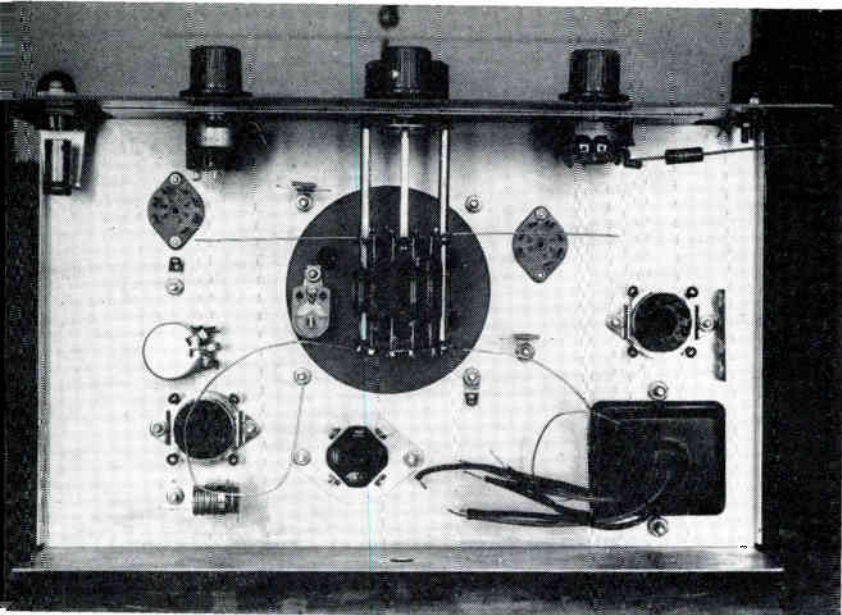

Fig. 4. Under side of the chassis, with all the parts in place, as the unit appears at the conclusion of the assembly stage, ready for wiring.

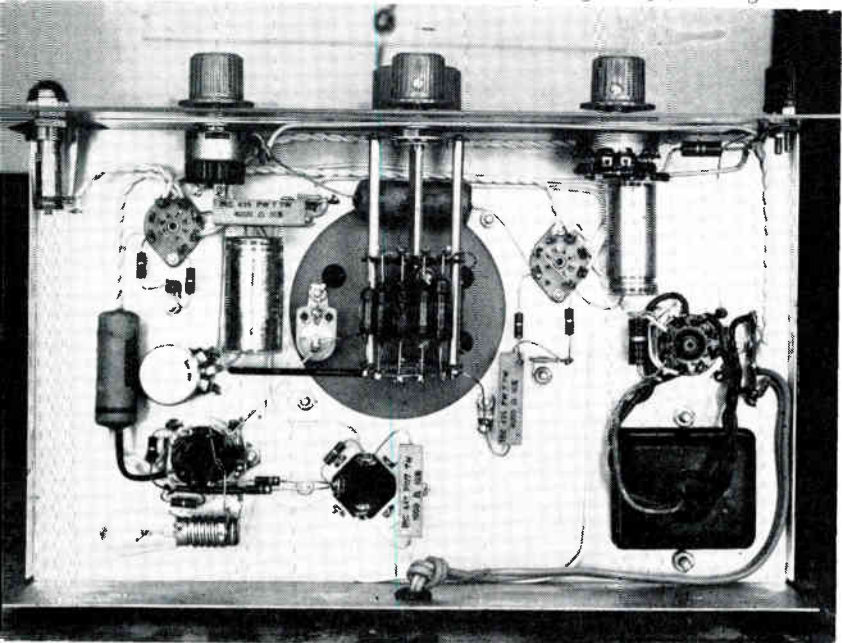
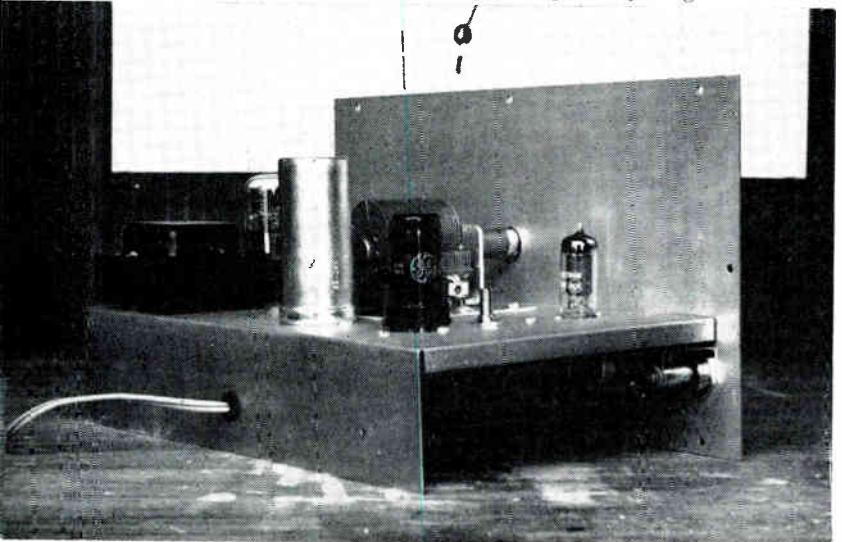

Fig. 5. In this view, the wiring stage is complete, and the chassis is ready to be put in the case. Fig. 6. Top view of the generator chassis



**WIRING STAGE:** As you proceed with the wiring, compare the diagrams and the instructions in the book with Fig. 5 on this page. You'll find it very helpful if you are puzzled about the way the wires should be run. In several cases, pairs of wires must be twisted together. Don't wrap one lead around the other. Make sure that both are twisted the same amount. Keep an eye out for drops of solder; sometimes they land where they may cause short circuits or grounds. When the wiring is finished, shake the chassis so as to drop out any spare bits of wire. Our time for the wiring stage was 2 hours and 45 minutes. That included mounting the chassis in the cabinet, and attaching the carrying handle. Time for the whole job, from start to finish, was 4 hours and 55 minutes.

If you have carried out the step-by-step instructions without any deviations, the frequency calibration should be very accurate. However, it's a good idea to check the calibration with your 60-cycle current. The instruction book explains the method of adjusting at 60, 120, 180 and 600 cycles. If the meter is correct at those points, it will be sufficiently accurate throughout the audible range for all practical purposes.

There are five frequency ranges on this generator:  
 20-200 cycles    200-2,000 cycles    2,000-20,000 cycles  
 20-200 kilocycles    200 kilocycles-1 megacycle

The first three ranges cover the audio frequency band. If the pointer is at 30 on the outer scale, and the multiplier switch at X1, the generator is set for 30 cycles. If you move the switch to X10, readings on the outer scale must be multiplied by 10. Note: 1 kc. (kilocycle) equals 1,000 cycles; 1 mc. (megacycle) equals 1,000,000 cycles.

Always use the minimum voltage possible for the work you are doing. This is determined by the voltage range switch, with fine adjustment from the output voltage control. On the former, the minimum (with the output voltage at 10) is .001 volt, or 1 millivolt. For most audio tests, less than 100 millivolts are sufficient.

To hear the different frequencies, you can connect a loudspeaker or phones to the terminals on the generator marked GND, and OUTPUT. Or you can connect those terminals to the input of your preamplifier or amplifier. Be sure to start with the lowest output, so that you will not damage your equipment or tear the voice coil from your loudspeaker.

If you want to check your equipment over the frequency range of the piano, the lowest key, A, is tuned to  $27\frac{1}{2}$  cycles. Remember, however, that this note is very rich in harmonics, while the fundamental is relatively weak. The top key, No. 88, is tuned to 4,186 cycles. Here, you can recognize a first harmonic at 8,372 cycles, although it will not be strong. Compare the sounds from the piano with the pure notes from the generator.

A particular advantage of this generator is that you can use it to hear dips and peaks in your speaker response by running back and forth over the range of the dial. If your system is perfectly smooth, the tone will vary in pitch, but not in strength. However, you may be surprised to hear considerable variations. Details of experiments you can make with the audio generator will be given subsequently in this department.

# "INSIDE INFORMATION"

*Exclusive Photographs and Data on the Design of New Equipment*

Most record changers switch off the driving motor after the last record has been played, but it is necessary to turn off the amplifier and tuner manually. When the music stops, it is easy to forget that the associated equipment is still running. Unless the latter have sufficient ventilation for continuous operation, they may be damaged by overheating, and possibly constitute a fire hazard. The Slumber Switch provides a simple means for switching off everything when the changer cuts off. Three wires in the cable are connected to the changer, as shown in Fig. 1. Then the tuner and amplifier are plugged into the receptable block. When the changer switch opens, all power is cut off automatically.

There is, however, a defeat-switch that can be used to turn on the system and to play the last record, if desired. The receptable block contains a filter to silence the "pop" in the speaker when the changer switches off the

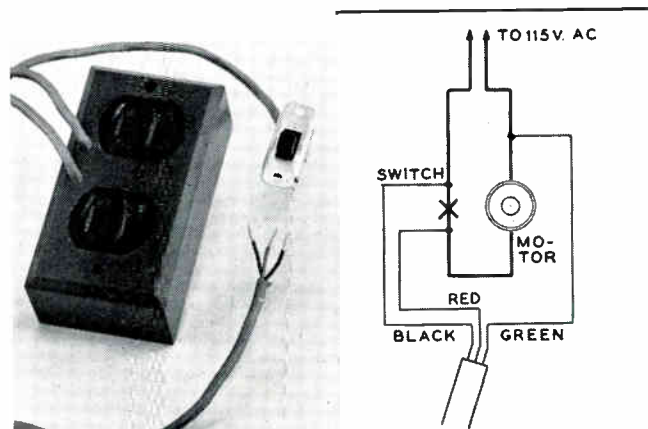

Fig. 1. All equipment is turned off when the record-changer stops entire audio system. Price, with cable, \$7.95. Hi-Fi Center, Inc., 2630 N. Downer Ave., Milwaukee 1, Wisc.

THEORETICALLY, the electrostatic type of speaker is the ideal design, since it has a very large diaphragm which is driven over its entire surface. This is in contrast to the cone speaker, driven only at its apex. Various types were brought out in England and Germany during the 20's. About 1930, the Kyle condenser speaker was produced in this Country, and used in Peerless radio sets. It was soon

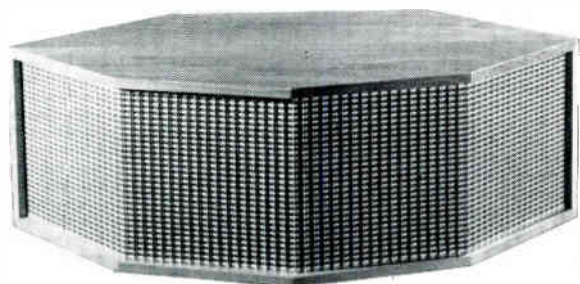

Fig. 2. This is a four-element Janszen electrostatic loudspeaker

abandoned because it was subject to both electrical and mechanical failures. Recently, the principle was revived and applied to tweeters, but their performance has not been outstanding.

Meanwhile, Arthur Janszen carried out an extensive investigation of the electrostatic principle at the Harvard Acoustic Research Laboratory. Subsequently, he developed a new design using materials and manufacturing methods not available previously, and extended the useful low-end frequency response to a point below 1,000 cycles. This work was disclosed in Patent No. 2,631,196, issued March 10, 1953.

Fig. 2 shows a speaker enclosure in which four elements are mounted for angular diffusion. One of the elements is illustrated in Fig. 3, as well as the rear connections of the

speaker. These comprise terminals of 8 or 16 ohms, fuse, and line cord and switch for the built-in bias supply. Each element has two grids of insulated wires, arranged in parallel planes, with a diaphragm between. The diaphragm material appears to be a plastic sheet, with a coating of metal so thin as to be transparent. Thus the "condenser plate" serves as an air barrier yet, with virtually no stiffness or weight, it acts as if it were not there at all!

Without going into the details of its audio characteristics, it can be said that the very smooth curve of measured performance was confirmed by listening tests in which a

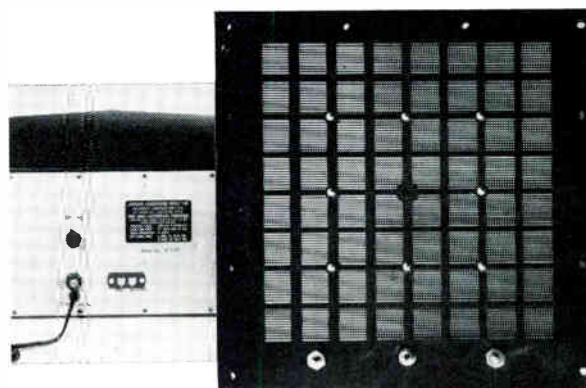

Fig. 3. One of the elements, and a view of the rear connections

McIntosh preamp and amplifier were used to drive a Bozak woofer and the Janszen speaker. The reproduction was remarkably clean in the middle and upper ranges, without dips, peaks, or harshness at any point. The electrostatic unit was connected in parallel with the woofer, and balance obtained by selecting optimum impedance value on the output transformer. Janszen Laboratory, Inc., 69 Harvey Street, Cambridge, Mass.

THE new Electro-Voice preamp for use with a separate amplifier is illustrated in Fig. 4, and the 20-watt preamp-amplifier in Fig. 5. The former, with its independent power supply, has nine controls, including power switch, selector, six-position equalizer, loudness control, presence control, treble and bass controls, three-position rumble filter for flat, 40, and 70 cycles, and a cutoff for flat, 4 kc., and 7 kc.



Fig. 4. Preamp provides all controls and switching for audio system

At the rear is an unswitched AC outlet for a changer or turntable, and a switched outlet for plugging in a tuner, plus two hum controls and a fuse. There are also five input connections with four level controls, and a switch to select a magnetic or amplitude-type pickup. In short, this unit is intended to serve as an audio control center for connecting and adjusting all the different sources of

audio signals. The metal case can be mounted in a cabinet, although its attractive appearance makes that unnecessary. For tubes there are a 12AT7, two 12AX7's, and a 6X4. Size of the pierced metal cabinet is 15 by 4 ins., and 7 ins. deep. Price \$119.50.

The 20-watt preamp-amplifier, Fig. 5, has the same controls and connections, with a Wiggins-circuit amplifier,



Fig. 5. Preamp and audio control center, with a 20-watt amplifier

employing a 12AT7, three 12AX7's, a 12BH7, two 6V6-GT's, and two 6X4's. There are a variable damping control at the rear, and output terminals of 4, 8, and 16 ohms. The metal case measures  $4\frac{1}{8}$  by 15 ins., and is  $14\frac{1}{2}$  ins. deep. Price \$169.50. Data presented here was taken from pilot models, as production designs were not finalized at this time of writing. *Electro-Voice, Inc. Buchanan, Mich.*

THESE Pilot tuners, Fig. 6, can be used for radio reception only, or combined with other equipment for complete audio installations capable of excellent performance at moderate cost. The FM-AM tuner, model AF-825, includes a preamplifier, and requires only the addition of a simple amplifier such as the Pilot model AA-410 or AA-904, and a loudspeaker for radio reception. However, there are a

The model 607A FM tuner can be used with one of the amplifiers mentioned above for radio reception, plus a phonograph with a ceramic or crystal pickup. With an 8-in. speaker and a small enclosure, the cost of an excellent FM installation can be kept below \$160, including an outside antenna, or slightly more than \$200 if a changer and ceramic cartridge are added. If a magnetic pickup is used,



Fig. 6. Two moderately-priced FM-AM and FM tuners. A wood cabinet is available for the former, and a pierced metal case for the latter

selector switch and terminals for connecting a phonograph pickup, tape recorder, and the audio channel of a TV set. Additional controls are for volume, treble and bass tone, and record equalization. An outside antenna is recommended for maximum FM range. Chassis measures  $14\frac{1}{4}$  ins. wide,  $7\frac{1}{2}$  high, and 9 deep behind the panel. Price \$129.50. A wood cabinet is \$16.95 or \$15.95.

a preamp-amplifier such as the Pilot AA-903 or the AA-420 must be used instead of the plain amplifier.

Controls on the tuner are for radio volume, FM, FM-AFC, phono switching, and tuning. Chassis measured  $10\frac{1}{2}$  ins. wide,  $6\frac{7}{8}$  high, and  $7\frac{1}{4}$  deep behind the panel. Price \$69.50. A metal case is available at \$4.95. *Pilot Radio Corp., 37-06 36th St., Long Island City 1, N. Y.*



# PSE\*



## 12 Pictorial Assembly Plans for Better Listening...

Now—for every high fidelity enthusiast—12 “Do-it-yourself” booklets, called Technigrams, which cover every one of the 36 different speaker systems featured in the original University PROGRESSIVE SPEAKER EXPANSION chart. These Technigrams contain all of the essential information, in words and pictures, required to assemble and install the speaker system of your choice. Even baffle board layout diagrams are included. All of this is available to help you to plan your listening the PSE way...to develop your speaker system in successive, relatively inexpensive stages...with no fear of obsoles-

cence, until what you have meets *your* listening tastes.

With vacations and long summer days upon us, the time is ideal for building that high fidelity system which will give so much listening enjoyment on the colder Fall and Winter evenings ahead. Take advantage now of extra leisure hours . . . and take pleasure in leisurely listening later. See your UNIVERSITY HI-FI distributor today . . . and ask for the free Technigram that features the University speaker system of your choice. If you haven't seen the original University descriptive folder on the PSE Plan, mail this coupon immediately for your copy.

### \* Progressive Speaker Expansion

—the plan that makes it possible to buy a speaker today in terms of the system you want tomorrow.



## University Loudspeakers

80 South Kensico Ave., White Plains, New York

University Loudspeakers, Inc., Desk 84  
80 South Kensico Avenue, White Plains, N. Y.

Please send me my free copy of “Progressive Speaker Expansion.”

Name \_\_\_\_\_

Address \_\_\_\_\_

City \_\_\_\_\_ State \_\_\_\_\_

78N32

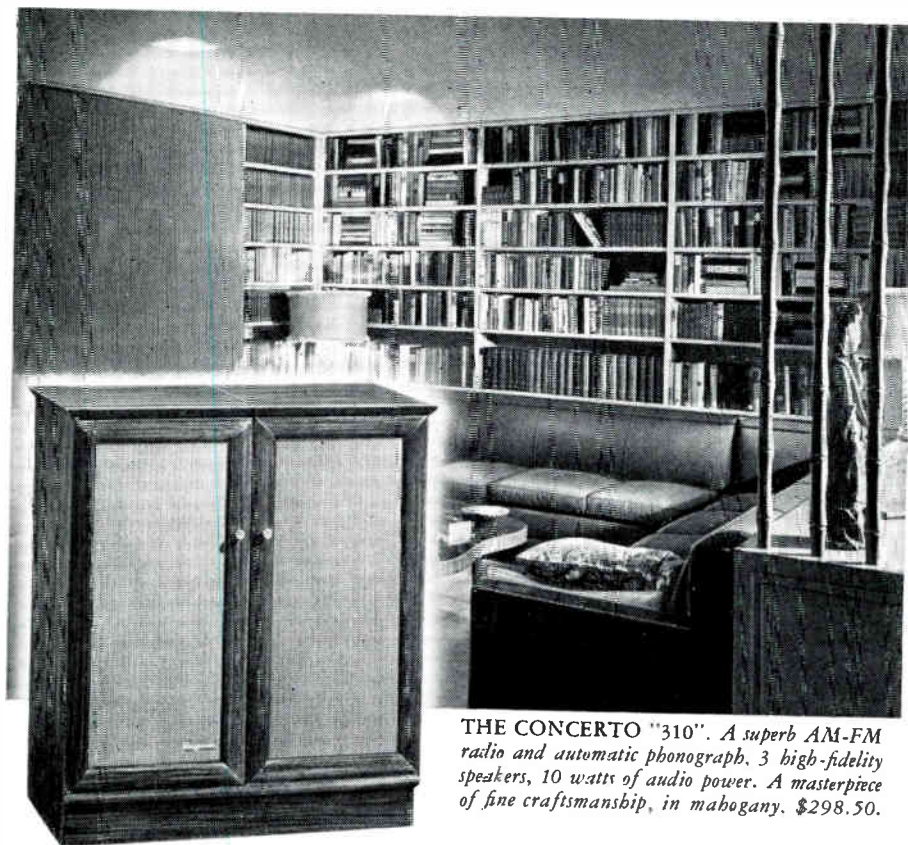

THE CONCERTO "310". A superb AM-FM radio and automatic phonograph, 3 high-fidelity speakers, 10 watts of audio power. A masterpiece of fine craftsmanship, in mahogany. \$298.50.

## Custom high-fidelity performance and fine furniture styling!

THERE is a new world of pleasure in music awaiting you in the new extended-range recordings—and in high-fidelity FM radio, too. You need only the *instrument* to release it—to re-create all the timbre, brilliance, and presence of the living performance.

Magnavox is *the instrument*, the finest music-reproducing instrument ever developed. And even more, a Magnavox instrument is always beautiful furniture, matching the finest perfected high-fidelity sound reproduction with the finest in beautiful cabinetmaking.

With Magnavox you can choose from the widest selection of styles, priced from as low as \$69.95 to \$495. You could pay up to a thousand dollars more and still get neither the fidelity, quality, nor value that you are sure of getting in Magnavox.

Visit your Magnavox dealer soon—the classified phone book lists his name under "Television." Discover how easily the full beauty of the new recordings and high-fidelity FM radio can be yours to enjoy. The Magnavox Company, Fort Wayne 4, Indiana.

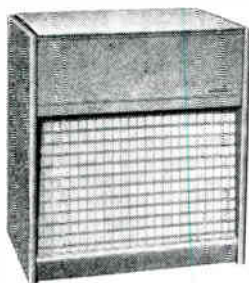

MAGNASONIC "210". High-fidelity console priced no more than many table-model phonographs! Three-speed changer, 12" and 5" speakers, 10 watts power, acoustical cabinet, sand or russet finish, \$149.50.

PRICES INCLUDE FEDERAL TAX AND ARE SUBJECT TO CHANGE.

## The magnificent **Magnavox**

high-fidelity television • radio-phonographs •  
Integrated Design component systems

## LOUISVILLE RECORDS

*Continued from page 20*

of works by the most gifted younger composers here and overseas. Villa Lobos's *Origin of the Amazon River*, Normal Dello Joio's *The Triumph of St. Joan*, Darius Milhaud's *Kentuckiana*, Martinu's *Intermezzo*, and Lukas Foss's *A Parable of Death* were among the commissioned pieces subsequently recorded by the Louisville Orchestra under Robert Whitney's baton for Columbia, the Dello Joio and Foss pieces being particularly impressive as dramatic achievements. Virgil Thomson's *Wheat Field at Noon* and *Five Songs*, after William Blake, have subsequently been recorded with the Philadelphia Orchestra (Columbia ML4919).

It was in 1953 that the Louisville Orchestra (and the contemporary composers) struck gold, both literally and figuratively; for the Rockefeller Foundation accorded a grant which has made it possible for the Louisville Orchestra to commission and record some 40 new scores each year (among them two operas) over a four-year period. The roster of composers commissioned thus far reads like a Who's Who of creative musical talent—veterans and youngsters—from all over the world. Truly no patronage comparable to this has existed for composers since the days of the renaissance and baroque, when princes and municipalities vied for the services of the top creative talents of the day. Only the Koussevitzky Music Foundation, whose nearly 70 commissions since 1942 have given us a half-dozen authentic masterpieces (Bartók's *Concerto for Orchestra*, Samuel Barber's *Prayers of Kierkegaard*, Martinu's *First Symphony*, Aaron Copland's *Third Symphony*, Walter Piston's *Third Symphony*, Wallingford Riegger's *Sextet for Piano and Winds*), operates on the same scale in our day. Indeed, it will be most interesting to see how the Louisville Commissioning Project measures up to the Koussevitzky Foundation in terms of batting average for works of major significance.

The importance of recording for any contemporary music commissioning project cannot be overestimated; for it is chiefly through the medium of the long-playing discs that the music of today reaches a truly wide public, as contrasted to the restricted audiences at symphony concerts, especially of contemporary music. The recording activity for the Louisville-Rockefeller Foundation commissions is being undertaken by the Louisville Philharmonic Society itself, with the technical assistance of Columbia Records.

At present the new Louisville Orchestra recordings of commissioned works are obtainable *by subscription only* through the Louisville Philharmonic Society, 830 South Fourth Street, Louisville 3, Ky. The 12 long-playing discs comprising the year's subscription cost \$5.95 each.

Thus far we have heard the first five

*Continued on page 49*

## LOUISVILLE RECORDS

Continued from page 48

discs, which include 15 out of the 34 works represented on the 1954-55 Louisville recording program. These comprise:

Paul Creston: *Invocation and Dance*; Heitor Villa-Lobos: *Dawn in a Tropical Forest*; Halsey Stevens: *Triskelion*.

Henry Cowell: *Symphony No. 11*; Alexander Tcherepnin: *Suite*; Bernard Wagenaar: *Concert Overture*.

Peter Mennin: *Symphony No. 6*; Wallingford Riegger: *Variations for Piano and Orchestra*; Ernst Toch: *Notturmo*.

Alan Hovhanness: *Concerto No. 7 for Orchestra*; Mario Castelnuovo-Tedesco: *Overture to Much Ado about Nothing*; Carlos Surinach: *Sinfonietta Flamenca*.

Jacques Ibert: *Louisville Concerto*; Gardner Read: *Toccata Giocosa*; Otto Luening & Vladimir Ussachevsky: *Rhapsodic Variations for Tape Recorder and Orchestra*.

To be released during the balance of 1955 are:

Peggy Glanville-Hicks: *The Transposed Heads* — Opera; Maurice Bomhard conducting.

Vincent Persichetti: *Symphony for Strings*; Robert Sanders: *Little Symphony No. 2*; Boris Blacker: *Study in Pianissimo*.

Luigi Dallapiccola: *Variations for Orchestra*; Jose Pablo Moncayo: *Cumbres*; Ulysses Kay: *Serenade for Orchestra*; Darius Milhaud: *Mediterranean Overture*.

Gottfried von Einem: *Meditations*; Karol Rathaus: *Prelude for Orchestra*; George Perle: *Rhapsody for Orchestra*.

Alberto Ginastera: *Pampeana No. 3*; William Bergsma: *A Carol on Twelfth Night*; Henri Sauguet: *Les trois Lys*; Robert Ward: *Euphony for Orchestra*.

Gian-Francesco Malipiero: *Fantasia di Ogni Giorno*; Vittorio Rieti: *Introduzione e Gioco delle Ore*; Ernst Bacon: *The Enchanted Island*.

Richard Mohaupt: *Double Trouble* — Opera; Moritz Bomhard conducting.

American-born composers account for 15 of the scores; Latin-American composers (Moncayo, Mexico; Ginastera, Argentina; Villa-Lobos, Brazil) contributed 3 works; works by foreign-born Americans numbered 9 in all (Tcherepnin, Russia; Wagenaar, Netherlands; Toch, Austria; Castelnuovo-Tedesco, Italy; Surinach, Spain; Glanville-Hicks, Australia; Rathaus, Poland; Rieti, Italy; Mohaupt, Germany). European composers were commissioned for 7 of the works represented on the first series of Louisville Orchestra-Rockefeller Foundation discs (Boris Blacher, Germany; Luigi Dallapiccola, Italy; Darius Milhaud, France; Gottfried von Einem, Austria; Henri Sauguet, France; Jacques Ibert, France; Gian-Francesco Malipiero, Italy). The result of this widespread distribution of commissions has been to produce in the Louisville recordings a representation of almost every shade of contemporary musical dialect ranging through 12-tone idiom

Concluded on page 50

PRECEDENT



## Musicians' delight

► No musician who hears the PRECEDENT needs to be told of this tuner's overwhelming superiority. For he recognizes that a high quality live FM broadcast received through PRECEDENT becomes a startling re-creation of the original music.

► Unlike ordinary mass-produced tuners, PRECEDENT is hand-crafted in limited numbers. Are you one of the fortunate few who can appreciate and afford the finest?

### RADIO ENGINEERING LABORATORIES • INC.

36-40 Thirty-seventh Street • Long Island City 1, N. Y.



# HIGH FIDELITY



**AF-860 AM-FM PILOTUNER**  
The Ultimate in engineering skill and sensitivity — symbolic of the complete line of superb Pilotuners.

# PILOTUNERS



**AA-904 PILOTONE AMPLIFIER**  
World famous Ultra-linear Williamson circuit — an electronic triumph characteristic of the wide range of Pilotone Amplifiers.

# PILOTONE AMPLIFIERS



**PA-913 PILOTROL**  
Professional Preamplifier-Equalizer, an innovation in audio control — and other fine products, including the portable Encore; reflect the Pilot "Standard of Excellence."

FOR TECHNICAL DATA AND BROCHURE, WRITE TO:

**Pilot**  
RADIO CORPORATION

37-06 36th Street  
Long Island City, N. Y.



## LOUISVILLE RECORDS

Continued from page 49

(Dallapiccola, Riegger, Perls); neo-classicism (Wagenaar, Stevens); nationalism (Surinach, Moncayo); experimentalism (Luening-Ussachevsky); to all the various in-between shadings of tonal language that characterize today's creative musical scene.

From the first five discs, the scores by Henry Cowell, Halsey Stevens, Peter Menin, Wallingford Riegger, Alan Hovhaness and Carlos Surinach were especially brilliant and striking — and in all respects well above the average in ear-interest and musical substance. We'll be interested to hear the works of Persichetti, Dallapiccola, Ginastera, and Malipiero on the discs to come, for these are composers from whom one can generally expect first-rate music.

Such is a summary of the Louisville achievement to date, stated mostly in terms of facts and figures. The facts and figures are impressive indeed; but what Louisville and similar projects of the present and future mean for the morale of the dedicated creative artist in this time is immeasurable, for Louisville has here not only provided a demand for the contemporary composer's work, it has also assured him of a substantial audience beyond the confines of the concert hall.

If I may put in a brief note of dissent, it is to express the hope that the Louisville Philharmonic Society will not restrict the sale of their recordings indefinitely to purchase only by mail, on an annual subscription basis. It seems to me that after a reasonable lapse of time following initial release, record buyers should be permitted to purchase *individual* discs, either by mail or through selected retail outlets, in addition to the single disc from the series released each year by Columbia, under its own label. The 1955 disc contains works by Creston, Ibert, and Cowell.

## DAMN YANKEES

Continued from page 25

came in quietly, without a hint in her unassuming demeanor that she would shortly let loose like a stick of dynamite.

I said earlier that there were to be fifteen bands on the finished recording. The morning session had been given over to *Shoeless Joe, The Game, You've Got to Have Heart* and the overture *Six Months*. These would be respectively numbers four, ten, three and one. The upcoming afternoon agenda consisted of the *Heart Encore*, which was the remainder of number three, and then the *Finale, Heart Reprise, A Man Doesn't Know* and its reprise, *Near to You* and *Those Were the Good Old Days* — these being respectively numbers fifteen, eight, six, fourteen, eleven and twelve in the projected sequence. On the evening schedule to come were *A Little Brains, Goodbye Old Girl, Two Lost Souls, Whose Got the Pain?* and, finally *Whatever Lola Wants*. All of

Concluded on page 51

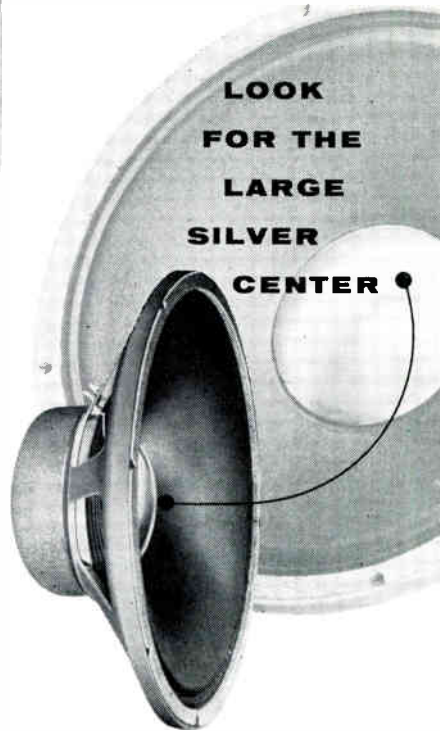

In your audio dealer's demonstration room where loudspeakers are lined up all in a military row . . . look for the speaker with the large, silvery dural dome in the center. Ear-test it with special care. This is the Jim Lansing Signature D130 — the 15" Extended Range Speaker with 4" voice coil of edge-wound aluminum ribbon. The coil is attached directly to the 4" dural dome. Together they give the piston assembly exceptional rigidity. This is one reason why bass tones sound so crisp and clean . . . why the highs so smooth . . . the mid-range so well-defined. You will find the D130 to be as distinguished to your ear as it is to your eye.

### THE SIGNATURE D130 (shown above) IS YOUR BASIC SPEAKER

Use it alone when you first begin your high fidelity system. Perfectly balanced with other Signature units, it later serves as a low frequency unit in your divided network system.

Additional Signature Precision Transducers with large domes and voice coils:



**SIGNATURE D131 . . .**  
the finest 12" speaker made  
O.D. — 12 1/8"  
4" voice coil of edge-wound aluminum ribbon  
Depth — 5"  
Power input — 20 watts  
Impedance — 16 ohms



**SIGNATURE D123 . . .**  
an innovation in speaker design  
Depth — only 3 3/8"  
O.D. — 12 1/8"  
3" voice coil of edge-wound aluminum ribbon  
Power input — 20 watts  
Impedance — 16 ohms



**SIGNATURE D208 . . .**  
an 8" precision transducer  
O.D. — 8 1/4"  
2" voice coil of edge-wound aluminum ribbon  
Power input — 12 watts  
Impedance — D208 — 8 ohms  
D216 — 16 ohms

See your audio dealer for complete catalog

precision that speaks for itself  
JIM LANSING  signature

JAMES B. LANSING SOUND, INC.  
2439 Fletcher Drive • Los Angeles 39, Calif.

## DAMN YANKEES

Continued from page 50

this added up to an LP-comfortable 43 minutes and 16 seconds on the advance estimate. By noontime, however, it was clear that there would have to be considerable further surgery.

These excisions were not to be accomplished without event, although mostly they were decided in congress assembled and well out of my hearing. One thing was sure: pride of authorship could not be considered if the 9 p.m. deadline was to be met.

Adler and Ross were visibly unhappy, though resigned, when Hastings at one point announced "A big cut, gentlemen, from the down beat of bar 81 to what now becomes the down beat of 129. Let's try it." They tried it. The composers didn't like it, but they were trying not to show it. After a requested time-out to study the score, they suggested instead that the cut should break from bar 78 to bar 127. Hastings reflected, decided that was worth trying. "All right, gentlemen," he said for the three hundredth time. As it turned out, the alternate suggestion was adopted, but of course the contraction had raised new problems of ensemble shading, and a jerky transition had to be avoided. "On those little answers in the trumpets, a bit crisper please, gentlemen." And then the control booth stopped the next take because it was picking up footsteps. Hastings threw a stern look around him, fastening his gaze of accusation on the chorus. But just between us, the culprit had been Adler, who slid into a chair behind the orchestra in time to elude the conductor's scrutiny.

These composer-boys are real talent, by the way, and I only wish that either or both of them had been more available for small talk. All I know about their background is that Dick is the son of a renowned piano pedagogue, Charles Adler, and that the two kids met for the first time two years ago in Tin Pan Alley. Their initial effort was a tune entitled *Rags to Riches* — and no true life story ever worked out so neatly in so short an elapsed time. Or didn't you know that the same pair turned out "The Pajama Game".

There remains one significant fact to be reported about this recording date, and that is what was going on at Victor's 24th Street studios concurrently and for several hours after the session was buttoned up. The aforementioned Ed Welker, I remember, kept coming in and out every hour or so during the sessions. What he had been up to, I now know, was selecting takes for inclusion on the recording almost as fast as they had been made ready for his comparative listening. So that early the next morning the finished master tape was in process at RCA's New York plant. And by three o'clock Monday afternoon, in at least one Manhattan record store, you could buy the performance that was still going on only twenty-four hours before! Clever, these Damn Yankees!

## Get the most for your money in quality KNIGHT HIGH FIDELITY COMPONENTS



**Knight "Bantam" Hi-Fi Amplifier**

Compact—no cabinet required. Full 12 watts output; response,  $\pm .5$  db, 20-20,000 cps; 3-position record compensation; loudness-volume control; tape recorder input and output jacks; microphone input; separate bass-treble controls; handsome black metal cabinet with etched gold trim,  $3\frac{1}{2} \times 13 \times 10\frac{1}{4}$ ".

93 SX 312. Net only.....\$59.50

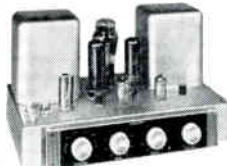

**"Golden Knight" 24 Watt Hi-Fi Amplifier**

Brilliant performance: response,  $\pm 0.75$  db, 20-40,000 cps; less than 1% harmonic distortion at 24 watts; 3 positions of record equalization; separate bass and treble controls; 4 inputs; 8 and 16 ohms speaker output impedance. Rich satin gold finish,  $8 \times 14 \times 9$ ". Removable escutcheon for custom panel mount.

93 SX 321. Net only.....\$79.50

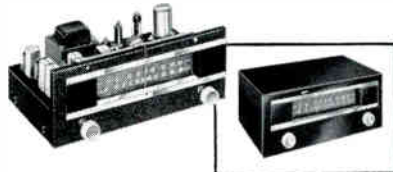

**Knight FM-AM Hi-Fi Tuner**

The ideal "space-saver" tuner. Highly sensitive drift-compensated circuit with AFC. RF stage on AM and FM. Loop for AM. Sensitivity: FM, 5 mv. for 20 db quieting; AM, 5 mv. Controls: tuning and selector. 10 tubes plus rectifier. Measures only  $5\frac{1}{2} \times 13\frac{3}{8} \times 7\frac{1}{2}$ ".

94 SX 728. Net only.....\$89.50

As above, but in black and gold metal cabinet,  $6 \times 13\frac{3}{8} \times 8\frac{3}{8}$ ".

94 SX 729. Net only.....\$95.50



**Knight Self-Powered Preamp-Equalizer**

Efficient, versatile control unit for any basic Hi-Fi amplifier. Response,  $\pm 1$  db, 30-30,000 cps; 3-position record compensator; 4 inputs; magnetic phono, tuner or crystal phono, tape, microphone; output, 2.5 volts; tape output, 1 volt; hum, -65 db. In compact black and gold metal cabinet,  $3\frac{1}{2} \times 11\frac{1}{2} \times 5\frac{1}{2}$ ".

93 SX 315. Special Price Until Sept. 1, 1955.....\$32.95

### designed and built to ALLIED'S specifications

KNIGHT High Fidelity components give you the most for your money in performing quality, appearance and dependability. These units are designed and built to ALLIED'S own high specifications by outstanding makers of hi-fi equipment. Because these components are offered as ALLIED'S own private-brand products, large savings are passed on to you. KNIGHT quality is backed by an unconditional guarantee for one full year, and a 15-day trial offer with money-back guarantee. KNIGHT gives you the best Hi-Fi for less.

### Knights System Value



**"Space Saver II" Hi-Fi Phono System**

Here's authentic Hi-Fi performance that fits in the smallest available space. No cabinets required. System includes: Knight 12 watt "Bantam" Amplifier, Webcor 3-Speed Changer (in Russet and Beige or Burgundy and Beige) with G.E. RPX-050 magnetic cartridge and dual-tip sapphire stylus; Electro-Voice "Baronet" enclosure with SP8-B speaker (in Mahogany or Blonde). Ready to plug in; hi-fi record included. Specify colors.

94 PA 159. Net only.....\$157.95

### FREE ALLIED'S 68-Page Hi-Fi Catalog

Your guide to a complete understanding of Hi-Fi. Shows you simply and clearly how to select a Hi-Fi music system at lowest cost; contains many handsome do-it-yourself installation ideas. Offers you the world's largest selection of complete systems and individual units (amplifiers, tuners, speakers, enclosures, changers, recorders, accessories) from which to make your money-saving choice. To understand Hi-Fi, to own the best for less, write for this FREE book.

ALLIED RADIO CORP., Dept. 76-G-5  
100 N. Western Ave., Chicago 80, Ill.

Send FREE 68-Page Hi-Fi Catalog.

Ship the following:.....\$.....enclosed

Name.....

Address.....

City.....Zone.....State.....

## ALLIED RADIO

America's  Hi-Fi Center

Send for FREE  
Hi-Fi Catalog 

# McIntosh



C-8P  
\$99<sup>50</sup>

without cabinet  
with cabinet \$107.50

## Professional AUDIO COMPENSATOR AND PRE-AMPLIFIER

Now self-powered, the McIntosh C-8P is easily connected to any system to provide the most advanced in high fidelity compensation control. Abundant flexibility is possible with five bass (turnover) and five treble (roll-off) switches; an aural compensator; a rumble filter; separate wide-range bass and treble controls; and a five-program-source selector for tuner, tape recorder, microphone, and two phonograph cartridges. The McIntosh assures greatest listening pleasure from any sound source.

Small separate power supply (not shown) brings maximum convenience of installation. Rear panel (shown below) features five inputs, three outputs, equalization switch for magnetic or amplitude cartridges, variable load resistor for magnetic cartridges.

Write for Details and FREE  
Record Compensation Guide

**McINTOSH**  
LABORATORY, Inc.

327 WATER ST., BINGHAMTON, N. Y.

Export Division: 25 Warren St., New York 7, N. Y. Cable: Simonrice, N. Y.



### SUMMER FESTIVALS

*Continued from page 23*

season, when the Santa Barbara weather is its most glorious (courtesy of the Chamber of Commerce), Stokowski begins his programs on September 10 and will conclude the series September 18. His programs are unhackneyed and eventful. Of the older works he has included concerti grossi of Vivaldi, Handel and Corelli, Mozart's *Sevenata Notturna for Strings and Tympani*, and a brace of early English works by Lawes, Locke, Purcell, and Humphries. In the contemporary field he has again tapped some of the richest veins. Henry Cowell has been commissioned to compose

a work for the festival, which will be given its world premiere on the first program. Other contemporaries will include William Schuman, Bloch, Hovhaness, Milhaud, Ives, Bartók, Vaughan-Williams, and Stravinsky.

These Santa Barbara concerts will be given in the sunken garden of the County Court House in the center of the town. A more attractive setting is difficult to imagine, though this location is temporary, since plans have been made to construct a shell along the lines of Tanglewood and, according to report, Frank Lloyd Wright is currently toying with the idea of out-festivaling all previous festival constructions with a shed or shell that will be

whatever the last word in festival construction should be.

Also planned for this occasion will be a presentation of the opera "The Transposed Heads" by Peggy Glanville-Hicks. Based on a libretto by Thomas Mann, it scored a remarkable success in Louisville, where it was performed after being commissioned through a Rockefeller Foundation Grant to the Louisville Orchestra. The first opera by a woman composer ever recorded (by Columbia for the Louisville subscription series), it has attracted much interest from audiences who have found it one of the most delightful and fascinating operatic presentations of our time.

The Santa Barbara or, more correctly, the Pacific Coast Music Festival, should become one of the meccas for music lovers. Not only are all the auguries most favorable, but so are the geographical conditions. Even Tanglewood, with superb location, cannot offer the foolproof weather conditions of Santa Barbara; and Stokowski today still exerts a magic that few other contemporary conductors can equal. This may well become one of the most attractive and important of all American festivals, and significant is the fact that it is in a town (or shall we say city?) which gives it a truly festive atmosphere in the Salzburg tradition. Nothing is more depressing for a visitor who arrives at a music *fest* and becomes oppressed by the sense of isolation that plagues a place like Lenox, locale of the Tanglewood Festival — that is, if one plans to remain there for several days. Santa Barbara, with its superb beaches and pleasant town atmosphere, is fortunate indeed.

The Peninsula Festival in northern Wisconsin can boast of no mountains such as those surrounding Aspen, nor of the luxurious settings of either Tanglewood or Castle Hill. The concerts take place in the auditorium of the Gibraltar High School in Fish Creek, Wisconsin. They begin August 6 and run through August 21. Thor Johnson has crammed nine orchestral programs into this short period. Nearly every program lists an American premiere, and several new works have been commissioned specifically for this festival.

Among the new works will be *Dance Rhythms* by Wallingford Riegger, commissioned in celebration of his seventieth anniversary. The work was actually given its world premiere by Thor Johnson in Albany, Georgia, in March, when the Cincinnati Symphony Orchestra was on tour. Albany, being the birthplace of Wallingford Riegger, the entire town turned out in celebration. Two companion pieces, *Harvest Star* and *Castor and Pollux* by Uno Nyman, were commissioned specifically for the festival, since Mr. Nyman is a local resident living in the adjacent town of Ephraim. The *Ninth Symphony* of Henry Cowell, commissioned a year ago by the Green Bay Symphonette, will have its first performance by a professional orchestra.

*Concluded on page 53*

## SUMMER FESTIVALS

Continued from page 52

Also new will be premieres of Otmar Nussio's *Rubensiana* and Robert Latham's *Symphony No. 2 in E Major*, being given its world premiere.

In addition to these works, Mr. Johnson has picked out a set of seven variations on a theme by Campra, on which seven distinguished French composers have written their own particular variations. Arthur Honegger begins the list, followed by Daniel Lesur, Roland Manuel, Germaine Tailleferre, Francis Poulenc, Henri Sauget, and Georges Auric of *Moulin Rouge* fame.

Thor Johnson has shown remarkable enterprise in developing this festival, and managers and conductors who are reluctant to present new works to more sophisticated audiences might profitably follow Mr. Johnson's example in their summer programming.

Equally unexpected areawise is the Brevard Festival in North Carolina. This is not a festival specializing in premieres or any modernities. The concerts are produced in conjunction with Transylvania Music Camp, and are conducted by James Christian Pfohl. The music camp was established in Brevard in 1945. From a minute orchestra of fifteen, the camp now boasts of an orchestra of over 85, in addition to a little symphony orchestra of 65, a "Hilltoppers" band of 75, a junior camp chorus of 30, and a choral ensemble of 25. Twenty instructors are part of the senior symphony, and ten play regularly with the little group. The festival orchestra is actually composed of members of the faculty, the most advanced students, and members who are brought in from other major symphonies particularly from Cincinnati.

What happens at Brevard is truly festive. What it lacks in programmatic content it makes up for in spirit and enthusiasm. This is really music in the making.

A new festival to watch for is that of Coonamessett. This may well turn out to be the snazziest of the lot, for which ticket buyers will have to hustle.

Although they are called festivals, there are two that don't seem quite to fit into this summer pattern. They are the Contemporary Music Festival in Urbana, put on by the University of Illinois, and that of the Eastman School of Music in Rochester, New York, under the direction of Howard Hanson. Perhaps the reason they do not take on the same festive atmosphere is because they occur in the same localities where concerts and music are produced during the entire year. While they do not have the outdoor atmosphere of other festivals, they have something that makes any music lover's ears tingle. They produce more fascinating music in a short space of time than almost any other festival happening, and anyone wanting to trek either to Rochester or Urbana will find the musical experience most rewarding.

# It gives you all the music—and none of the problems!

## NEW SONOTONE 1P CERAMIC CARTRIDGE

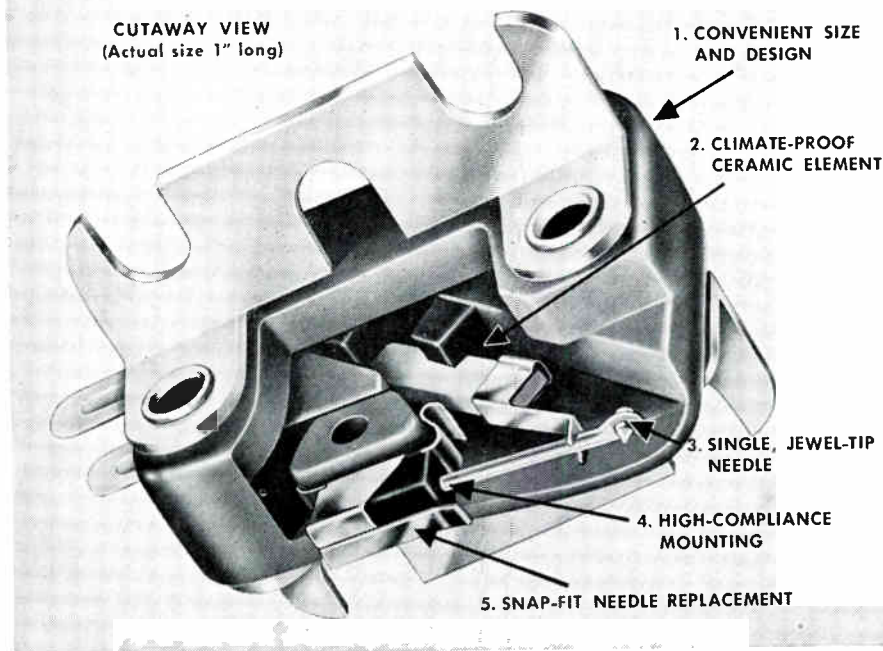

1. Easy to install. Fits most arms now in use.
2. Ceramic element gives superlative response (see curve)—requires no preamplification or equalization! No deterioration problem as with other types...virtually immune to hum pickup!
3. Replaceable needle, diamond or sapphire. Models for 33-45 rpm, or 78 rpm.
4. Extreme lateral compliance and low-mass design give superior tracking, low wear.
5. Needles snap in, snap out easily without tools.

### New, Simpler Way to Finest, Noise-Free Reproduction

A Sonotone 1P Ceramic Cartridge gives you superb response—compare it with any type of cartridge at any price! In addition, this Sonotone Ceramic Cartridge eliminates expensive, cumbersome equipment...along with all the noise inherent in such circuitry. You get full-range, quieter reproduction—more simply, and at lower cost. Model 1P with sapphire, \$8.50; with diamond, \$30 list.

#### RESPONSE 30-15,000 ± 3 DB!

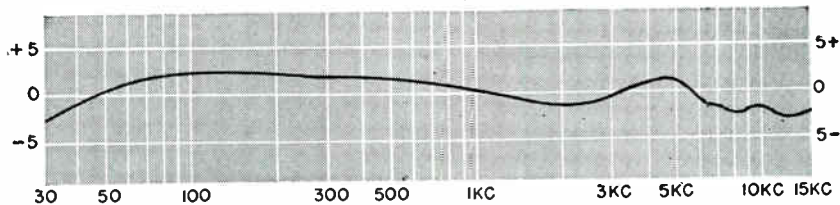

Response to new industrywide RIAA characteristic shows how 1P self-equalizes, because it works on "amplitude" rather than "velocity" principle.

# SONOTONE CORPORATION

ELMSFORD, N.Y.

Write Dept. CM-75 for free Specification Sheet

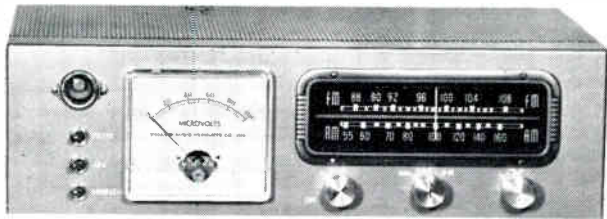

- ★ STRIKING DESIGN
- ★ CASCODE FM
- ★ VOLTAGE-REGULATED POWER SUPPLY
- ★ 18 TUBES
- ★ WIDE-RANGE AM
- ★ METER TUNING

## The COLLINS "Custom Special"

*Remote Control Available!*

*A New Concept of FM-AM Design, Engineered by Collins Audio Products Company*

THE NEW Collins "REMOTUNE" attachment allows complete remote control of your Custom Special tuner. Turn your system on, select FM or AM bands, tune, and adjust volume, all from your easy chair! 20' of cable is supplied with the push button control box, longer if you like. Another new development of Collins Audio.

OTHER DISTINCTIVE DESIGN features of this superlative tuner include: squelch for FM, eliminating all noise between stations; separate

switches to control AFC, squelch, and 10-kc. filter; 3-microvolt sensitivity for 20-db FM quieting; color-coded jacks for service and alignment tests; expensive 10-kc. filter to eliminate AM inter-channel whistle when present; delayed, amplified AVC on AM, with low-distortion detector; entirely new FM circuit with permeability tuning; Guaranteed response on AM to 10,000 cycles; chromium-plated bezels, aluminum knobs, hand-engraved panel; metal cabinets in gray or gold available.

*See and Hear it at your Local Hi-Fi Store. Write for the "Collins Custom Special" Bulletin*

**COLLINS AUDIO PRODUCTS CO.** P. O. BOX 368  
WESTFIELD, N.J.

the

# Audio Console

control preamplifier-equalizer



Quality Designed by  
**marantz**

Owners of the Marantz Audio Console invariably comment on the immediate improvement in sound quality of their systems. Such a fine instrument cannot be produced by the thousands, but only through careful assembly and thorough testing of each unit.

Naturally, its components are uncompromisingly chosen for superior quality. This and the character of its workmanship makes it the obvious choice for those who wish to improve their present installations. Chassis suitable for installation \$142.50, with cabinet \$155.00.

Write For Complete Details: **s. b. marantz** 44-15 Vernon Blvd., L.I.C., New York

## BENNY GOODMAN STORY

*Continued from page 19*

rapport between the musicians so necessary to any great band. Then, too, Benny had made a sterling addition to the trumpet section in the person of Bunny Berigan. When he came aboard, Benny felt they were ready to record the first arrangement Fletcher Henderson had made for the band — *King Porter Stomp*.

"As we went along playing the 'Let's Dance' program", Goodman states, "we began to get some good reactions. But we knew that the band didn't have the right material for the regular sequence of numbers. Sometimes they got off well, and sometimes they didn't. It was then that we made one of the most important discoveries of all — that Fletcher Henderson, in addition to writing big arrangements, could also do a wonderful job on melodic tunes such as *Can't We Be Friends*, *Sleepy Time Down South*, *Blue Skies*, *I Can't Give you Anything But Love*, and *Sometimes I'm Happy*. He had to be convinced of it himself, but once he started, he did marvelous work. These were the things, with their wonderful easy style and great background figures, that really set the style of the band."

After the slightly disastrous session at the Roosevelt, a trip to the West Coast was decided upon. Alexander fixed up engagements all along the way that would keep the band busy until it ended up at the Palomar. Some of the boys in the band didn't cotton to the idea of the long, hard trip. Replacements were necessary. Allen Reuss came in for George Van Eps, and Jess Stacy for Frank Froeba. The tour then got under way, starting off at the Stanley Theatre in Pittsburgh where nothing happened. Then came dates in Columbus, Toledo, Milwaukee, and finally a four-week stand at Elitch's Gardens in Denver. This was a 3-dances-for-a-dime proposition, and the band hadn't been playing for more than half an hour when the manager came up and asked, "What's the matter — can't you boys play waltzes?" The popular bands in Denver at the time were led by Bernie Cummins, Griff Williams, and a Kernel named Kay Kyser. Goodman's band almost died right then and there. But a hundred stock arrangements that Benny bought after the first night saw it through the four weeks. Things looked bleak indeed, however. The news about the not-so-fine business in Denver got around, and the office in California wanted to cancel out the booking at the Palomar. But Goodman and Alexander somehow staved off that calamity.

The Palomar Ballroom in Los Angeles is an enormous place. Benny Goodman and the boys didn't know quite what to expect. The band opened August 21st, 1935. There was a good crowd, and many of the musicians had come in from the various Hollywood studios. But let Benny tell the story: "I was anxious to please. For this reason,

*Continued on page 55*



## BENNY GOODMAN STORY

*Continued from page 54*

I guess, we took things kind of easy with the opening sets, playing some of the sweeter tunes and sticking to the softer arrangements. Some of the kids congregated in front of the bandstand, and they seemed to know what to expect of the different musicians. But the crowd as a whole didn't seem very responsive. This went on for about an hour, till I decided the whole thing had got to a point where it was make or break. For all I knew this might be our last night together, and we might as well have a good time of it while we had the chance. I called out some of our big Fletcher arrangements for the next set and the boys seemed to get the idea. From the moment I kicked them off, they dug in with some of the best playing I'd heard since we left New York. To our complete amazement, half of the crowd stopped dancing and came surging around the stand. It was the first experience we had with that kind of attention, and it certainly was a kick. That was the moment that decided things for me. After traveling three thousand miles, we finally found people who were up on what we were trying to do, prepared to take our music the way we wanted to play it. The first big roar from the crowd was one of the sweetest sounds I've ever heard in my life — and from that time on, the night kept getting bigger and bigger, as we played about every good number in our book."

After a lot of heart breaks and as tough a road as any trouper ever traveled, Benny Goodman and his swing band really clicked. Some of the things that made the band go at the Palomar were these: The "Let's Dance" program reached the West Coast three hours earlier than it was broadcast in New York, and that meant Benny and the boys were heard from 10 to 11 when the audience was reasonably large. Also, some of the local radio jockeys had started playing the Goodman records, and the kids had begun to go for them. Then too, Louis Armstrong had played several long engagements at the Cotton Club and that was bound to have an influence. The opening at the Palomar was tremendous, but Benny and the band kept wondering how it would go over a long stretch. They need not have worried. The crowds kept piling in and the original booking of four weeks was doubled.

Benny Goodman and his band had made it in Los Angeles, but what goes there most assuredly does not apply to the rest of the United States of America in most cases. Shortly after the affair at the Palomar came to a close, the Goodman band was booked for the Joseph Urban room of the Congress Hotel in Chicago. Here was a tough proposition. If the Goodmanites made it here they were pretty much in all over. The room had been dead for months, and there had recently been some trouble

*Continued on page 56*

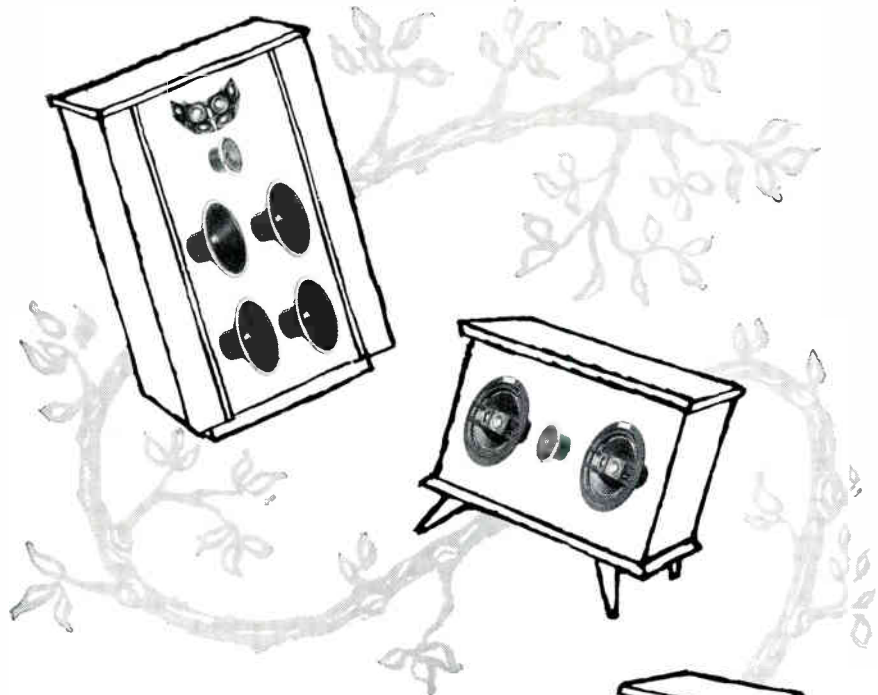

## SYSTEMATIC GROWTH

Start with Quality—  
add Power and Realism as you wish.

With Bozaks you will enjoy, at every step,  
the greatest listening ease your dollar can buy.

Build with Bozak.

The three matched drivers  
—Bass, Mid-Range and Treble—  
combine smoothly into two-way and three-way  
speaker systems from the modest B-207A to the  
supreme B-310, each peerless in its class.

You can build Power and Realism with Bozak Quality,  
without the heartaches of scrapping "outgrown"  
speakers, the tedious matching and balancing of  
incompatible units, and the fruitless tuning of a  
resonant enclosure to reduce bass deficiency.

The recommended infinite baffling of Bozak Speakers  
preserves their vanishingly-low level of distortion,  
perfection of transient response and unequalled  
balance—over the widest usable frequency and  
dynamic ranges available today.

Bozak Speaker Systems stand unchallenged for  
*The Very Best in Sound.*



**BOZAK**

**THE R. T. BOZAK COMPANY**

*Quality Loudspeakers*

PLANT AT: WEST POST ROAD • NORWALK, CONN.  
Export Office: Electronics Manufacturers' Export Co., Hicksville, N.Y.  
MAIL ADDRESS: P.O. BOX 966 • DARIEN, CONN.

One of a series on  
what makes one  
magnetic recording tape  
better than another



50% Extra Playing Time



Extra Strength  
Mylar<sup>®</sup> Base



Full Depth Oxide



Micro-Polished<sup>®</sup>



Lubricated Both Sides . . .

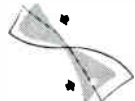

**YET  
COSTS  
NO  
MORE!**

**PLUS 50** Magnetic Recording Tape — newest in the famous Soundcraft line — brings you a combination of superior qualities that no other tape possesses. Qualities that let you capture and hear the true sense of violin strings, all the brilliance of brass, the color of wood winds . . . that faithfully echo the human voice in all its varied subtleties.

Plus 50's uniform output, inherently low signal-to-noise ratio, its 50% extra playing time, added strength and flexibility . . . its dimensional stability in any climate. These are the special qualities that make it the choice of professionals and amateurs, alike, wherever tape recording perfection is required.

And Soundcraft Plus 50 adds this special bonus: Its "Mylar" base assures virtually a lifetime of smooth, trouble-free service—at no more cost per foot than other quality tapes. Like Soundcraft "Red Diamond" Tape, Plus 50 is engineered and made by tape recording specialists. Get some at your dealer today.

\*Trade-Mark for DuPont Polyester Film

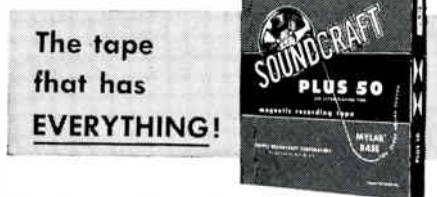

For Every Sound Reason

REEVES **SOUND-CRAFT** CORP.

Dept. Z-8, 10 East 52nd St., New York 22, N.Y.

## BENNY GOODMAN STORY

Continued from page 55

with the drinking water in the hotel. The room was not to be redecorated or its name changed. The hotel simply wanted to open the room up and do business. For the first time, actually, the band was billed as a "swing band", and for the first time they began to refer to Benny as "The King of Swing". A couple of Evanston jazz fans named "Squirrel" Ashcraft, the celebrated lawyer, and Helen Oakley routed out everybody they knew for the opening, and on November 6, 1935 it all came to a head. It wasn't sensational, not by a long sight, but it was good and the reviews the next morning in the Chicago papers were excellent. Gradually, it all began to build. The engagement was extended from month to month, and Helen Oakley devised the idea of a Sunday afternoon swing concert. The swing concerts, too, were successful! The band got a good commercial radio program for the Elgin Watch Company; it was signed to do the motion picture, "The Big Broadcast of 1937"; and several of the national magazines got into the act with articles on the "new-fangled swing music". It must have been especially gratifying for Benny Goodman himself, making his great success right in the same city where he was born.

The next step logically after all of this was New York, and the Benny Goodman band opened in the fall of '36 at one of the country's great dance spots — the famed Madhattan Room of the Hotel Pennsylvania. Almost at the same time it was signed aboard "The Camel Caravan", replacing the Casa Loma band which had been on the program for three years. It was one of the best and most popular shows on the air, and it mattered a great deal. All over America now Benny Goodman and his band were in! Swing had arrived!

What really proved to Benny Goodman that swing had arrived completely was a certain day in March of 1937. The band had been booked to double into the Paramount Theatre in New York, and the expectation was that it would do the average business. So, as Benny said: "When we arrived at the theatre for an early morning rehearsal before the first show, and found a couple of hundred kids lined up in front of the box office at about seven o'clock, we couldn't help feeling that every one of our most loyal supporters in the five boroughs was already on hand." But that was hardly the story. When the band finally came up on the rising platform for the first show, the theatre was jammed. The response and enthusiasm was electrifying. Actually, the members of the band didn't find out till after the first show that a near riot had ensued when a couple of kids had got up and started to jitterbug in the aisle. Others followed suit, and before long it was almost panic. But the management and ushers went to work just in time, and nobody

Continued on page 57

# AR-1

WHEN you listen to the AR-1 at your sound dealers' (a good time is soon after you have attended a live concert), we invite you to make comparisons with large folded horns or bass reflex systems, but we suggest that you make no allowances for cabinet size.

The AR-1 is an acoustic suspension speaker system<sup>®</sup>; it *requires* a small, sealed cabinet. The revolutionary engineering principle employed results in:

1. Full, clean, uniform reproduction to below 30 cycles. So far as we know the bass distortion levels of the AR-1 are lower than any that have previously appeared in published speaker data.
2. Determination of optimum cabinet size — for the AR-1, 25" x 14" x 11 $\frac{3}{8}$ ".

The small enclosure is a fortunate by-product, not the purpose of the acoustic suspension design, and is associated with an advance in rather than a compromise with quality. This fact is being recognized in technical press comment. For example, cabinet size was not even mentioned when Mr. Ben Drisko stated in his *Boston Post* audio column:

"The AR-1 definitely establishes a new high in direct radiator woof performance."

Or the *Audio League Report* of Pleasantville, N. Y., in describing the AR-1, wrote:

". . . a speaker system represented as comparable to any system regardless of price or size . . . To our audible judgment the system appears to live up to its claimed performance."

The AR speaker is available as a two-way system (12-inch acoustic suspension woofer and 8-inch cone tweeter in a sealed cabinet), or the cabineted woofer may be purchased separately. Prices are from 132.00 to 185.00.

You may write for our free brochure, which includes frequency response and distortion level curves, to:

ACOUSTIC RESEARCH, Inc.

23 Mt. Auburn St.

Cambridge 38, Mass.

<sup>®</sup>Pat. applied for by E. M. Villchur

## BENNY GOODMAN STORY

*Continued from page 56*

got hurt. Did the kids really like what they heard? By three o'clock in the afternoon 11,550 people had paid their way into the theatre, and the total for the first day's attendance was 21,000. That record has only been broken a couple times since, but the one that still stands at the Paramount is the day's sale at the candy counter, which was \$900.00.

I asked Benny Goodman the question: "Of all the records you've made what ones do you yourself like best?" Without hesitation Benny answered: "Oh, by all means the ones that were made at our first concert at Carnegie Hall." Well, what about the Carnegie Hall concert? Wynn Nathanson of the Tom Fisdale Advertising Agency got the idea first of all. If the King of Jazz, Paul Whiteman, could do a concert at Carnegie, so, by George, could the King of Swing! When the tickets were put on sale, however, not a few folks breathed a sigh of relief when they began to sell like tickets! It is interesting to note that Benny himself was so certain ducats would be available whenever he might want them that he had to go to a scalper during the last week when his family decided to come on from Chicago to attend his concert.

It was cold that night of January 16, 1938 in New York. Inside Carnegie Hall, however, there was a noisy air of excitement. Although the SRO sign had gone up long since, apparently all Manhattan decided that this was the place it wanted to be that night. Famous faces could be seen in the front row seats, and a jury-box had been erected on stage to care for the overflow. As the orchestra filed in, the tension tightened. There was a burst of applause as Goodman, in tails, strode forth, clarinet in hand, bowed, and counted off *Don't Be That Way*. The show was on! And the records testify as to what a show it was, as the band rode on from one great number to another.

The years of success rolled on, and there were things to be very happy about indeed. Goodman opened at the Ritz-Carlton Roof at Boston, home of a brand of music that had a predominantly schmaltzy character. The Goodman band swung, and the proper Bostonians were properly pleased. In 1942, Benny Goodman of Chicago married Alice Hammond of New York, and that was right as roses in June, too. They have two daughters, Rachel and Benji. There was an August 3rd evening at Ravinia Park in Winnetka, when *Roll 'Em* was terrific in the perennial land of Tchaikovsky's *Fifth Symphony*. There were movies and shows, such as "A Song is Born" and "Seven Lively Arts". There were appearances with the New York Philharmonic, the Rochester Civic Orchestra, the Boston Symphony, and the Budapest String Quartet, for Goodman has always been a creative musician of unlimited interests. That

*Concluded on page 58*

# Announcing!



THE NEW  
HIGH-QUALITY  
LOW-COST  
**FAIRCHILD 255**  
25 WATT

## POWER AMPLIFIER

Here's a mighty twin to Fairchild's big-power 260 Professional Amplifier. The new 255 delivers a full 25 watts of undistorted power for the finest sound, best reproduction!

This is the ideal power amplifier for the average home or apartment. The Fairchild 255 gives you full power from deepest bass to highest treble, and an instrument especially designed for minimum transient distortion as

well as lowest IM and harmonic distortion, resulting in exceptionally true natural sound. Superbly engineered, the 255 has a controlled frequency response of +0 to -1/2 db, from 20 to 20,000 cps.

You can always restore "new amplifier" performance to the Fairchild 255, even if tubes age unequally, by Fairchild's simple, exclusive distortion-cancelling balance control.

**COMPACT:** Only 6" x 9 1/2" base and 6 1/2" high

**INPUT IMPEDANCE:** 100K

**POWER GAIN:** 42db

**HIGH SENSITIVITY:** Less than one volt input required for full output

**and it's only \$89.50**

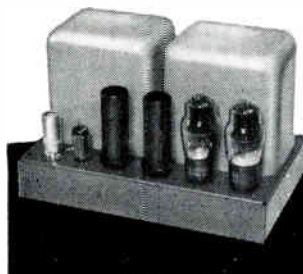

**FAIRCHILD 260**  
50 WATT

## PROFESSIONAL AMPLIFIER

When you need full 50 watts of power, get the Fairchild 260!

This high-power instrument offers complete stability under all loading conditions — won't ring with most

severe transients! And, thanks to Fairchild's exclusive distortion-cancelling balance control, you can always restore "new-amplifier" performance.

**only \$149.50**

# FAIRCHILD RECORDING EQUIPMENT

156th STREET AND SEVENTH AVENUE, WHITESTONE, NEW YORK

# Genalex

## THE ORIGINAL KT66



The name **GENALEX** on the tube and carton is your guarantee that you are buying the original **KT66** . . . world-famous power tetrode, often referred to as the finest audio tube ever made! The **GENALEX KT66** is the hallmark of the finest amplifiers. It is supplied as original equipment in amplifiers of the highest quality. Identical pins and connections as 6L6 tubes. Only \$3.50 net

For complimentary fact sheet, write Dept. MHX7-5



Quality endorsed product of the British Industries Group

**BRITISH INDUSTRIES CORPORATION**  
164 Duane Street • New York 13, N. Y.

# 10,000 MOTION PICTURE THEATRES USE ALTEC SPEAKERS AND AMPLIFIERS....

**ALTEC**<sup>®</sup>  
LANSING CORPORATION

Dept. 7-M

9356 Santa Monica Blvd., Beverly Hills, Calif.  
161 Sixth Avenue, New York 13, N. Y.

## BENNY GOODMAN STORY

*Continued from page 57*

is why I made the statement that Benny Goodman is the greatest clarinetist the world has ever heard. He knows no peer in jazz and swing, and he's certainly one of the best in classical music. There may be finer classical clarinetists, but no other man possesses his all around ability. He stands at the very top of his field.

After the bombs knocked out the battle-ships at Pearl Harbor, there were changes everywhere. The Goodman band felt the repercussions, and it began to come apart at the seams as one able man after another went into service. So Benny quite reasonably made up his mind that he'd had it as a bandleader who was going around the country playing swing music every night of every week of every year, and who can blame Alice if she helped in this decision.

Since he broke up the band, Benny Goodman has been what you might warmly describe as the nicest retired millionaire in the United States. Only he isn't . . . retired! In 1953 there was a tour with Louis Armstrong's All-Stars, when Goodman got together most of the old arrangements, along with Gene Krupa, Helen Ward, Ziggy Elman, and Mel Powell, but he had to drop out of that one because nature cracked down in an almost fatal way. It was a long road back to complete recovery. But once he was well again, Goodman, with a chosen quintet, tried a couple of weeks at Chicago's Blue Note and New York's large, expensive barn of a Basin Street, and the crowds he drew still stand as a record. BG on the marquee of a jazz spot is consistently one of the ace drawing cards in the music world. And, of course, there are always records.

This year, just about now, Goodman is off in Hollywood playing the music for the forthcoming motion picture of his life, with a band that includes Teddy Wilson, Lionel Hampton, Gene Krupa, Babe Russin, Eddie Miller, Buck Clayton, Urbie Green, and Hymie Schertzer. Next year it's a European tour. And in between, when he's at home, golf at a course he can walk to from his home, fishing for trout that are obviously Goodman fans, working in delightful surroundings at convenient hours, being interested, vital, and alive, and generally living the life of a country gentleman with swell kids and a marvelous wife.

Country or otherwise, Benny Goodman is a gentle man. He has it deep down in his heart, and those who see him love him very much. Music is his business, and like music he is universal. We hope he will emulate Tennyson's Brook, and flow on forever.

There's a wonderful old madrigal that tells us that *A Good Man Is Hard To Find*. Not true at all . . . not if you know the warm, bespectacled gentleman with the clarinet, Mr. Benny Goodman.

*Coming: "Benny and His Records"*

**Q AND A**

*Continued from page 41*

There are assuredly degrees of fidelity, ranging from performance which, for all practical purposes, enables the listener to enjoy in his home the same satisfaction he would experience at the original performance, down to the case where circumstances of economics, space, and the listener's own knowledge of music may find adequate satisfaction from a lower degree of fidelity. However, no assembly of equipment should be accepted as being of hi-fi quality unless the performance is such as to create a relatively close illusion to the original. By this test alone the public should be able to quickly rule out of consideration those products which are falsely labeled "High Fidelity". An exceptionally low price tag is another valid test in a more general way since, while very good performance can be achieved at quite modest cost, some instruments are obviously priced below any reasonable cost for hi-fi reproduction.

Shouldn't there be some standard by which hi-fi can be judged? If you mean some sort of an engineering standard, the answer is "no". All who are thoroughly conversant with the art will agree that such standards would be impossible of both definition and practical use. I have already said that the reproduction of sound is one of the most complex and exacting forms of art, and the stimulation and pleasure to be experienced by listening to a product reflecting the application of this art is comparable to that of the viewer of a fine painting. Yet who would suggest that a Rembrandt masterpiece was so judged simply because it measured up to some form of technical standard? However completely the painting might meet some set of technical specifications, that qualification alone would not distinguish the work of the master from that of the amateur. In a similar way, technical standards are not complete criteria of performance that will prove completely satisfactory.

Is there tendency among some components manufacturers to build into their products certain performance characteristics which produce exaggerated effects and, thereby, give re-produced music unnatural qualities? Yes, there is. The effects generally occur in the areas of both bass and the treble response. In the case of bass response, a non-scientifically designed acoustic enclosure is usually responsible. Many such devices have been described in magazines and other literature, and some have reached the market in the form of finished products. The conception and design of such devices, having come about without the advantages of a scientific approach, and complete laboratory test facilities, are usually characterized by a tendency to greatly over-emphasize certain bass frequencies.

The most common result is to produce an overall tub-thumping quality within a

*Concluded on page 60*

**be your own audio engineer...**

**HI-FI speaker-equipment cabinets**

**KITS by  
cabinart**

**ACOUSTICALLY ENGINEERED—ASSEMBLED WITH ONLY A SCREWDRIVER!**

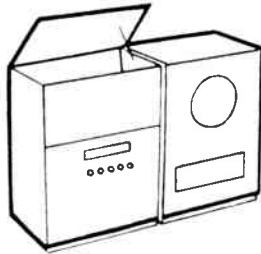

Model 80 has lift lid, removable panels. Bass reflex tuned for 12" or 15" speakers. Overall dimensions: 33 1/2"H, 23"W, 16"D. M80 tuner section, inside: 20"H, 21 3/4"W, 15 1/2"D. M8112, M8115 baffle volume: 6 cubic feet. 3/8" white pine

Model 80 equipment cabinet kit \$27.00  
Model 8112 12" speaker cabinet kit 18.00  
Model 8115 15" speaker cabinet kit 18.00

**FEATURING THE KLIPSCH-DESIGNED**

**Rebel\* 4**

DIRECT RADIATION OF HIGHS  
BACK RADIATION OF LOWS

REBEL enclosure development entails a cavity and slot port, to form a resonant chamber, and a horn coupled to the slot. The slot is loaded by the horn; the proportioning of slot, cavity and horn provide bass response below 100 cycles which corresponds in efficiency to the front-of-cone direct radiator response above this critical 100-cycle point. There are two ways one might consider the function of this horn. One

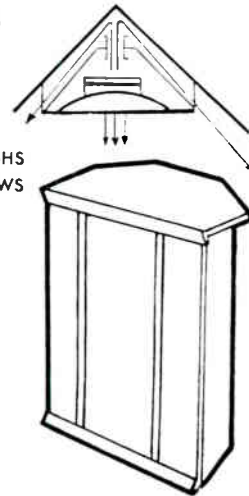

is a bass reflex with a horn acting as a resistive load on the port. System resonances are damped by useful radiation resistance while the horn does not cost anything. It is already formed by the room corner. Again, if a full horn were added below the 100-cycle point bass response would be boomy and unnatural. But, in the Rebel enclosures, the cavity-port combination acts as an acoustic low pass filter. And its design is such that low-end response will compare with response higher in the sound scale.

MODEL K-12—\$36.00  
MODEL K-15—\$42.00

ready-to-finish birch

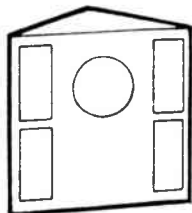

CORNER HORN

All kits precision-cut to size, baffles pre-cut for 12" or 15" speakers, Kits include Saran plastic acoustic cloth, glue, sandpaper, plastic wood, hardware, assembly instructions and finishing instructions. Write for complete catalogs and nearest Cabinart kit dealer.

Model 61, 12" speaker—\$19.95  
Model 63, 15" speaker—\$23.95

slightly higher west and south

\* Trade Mark

KIT FORMS BY



75 North 11th Street  
Brooklyn, N. Y.

# the world is your oyster

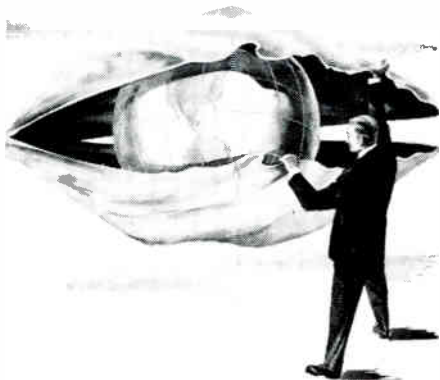

Here's a new delicacy to satisfy the taste of the audiophile — the entire world. Famous European music festivals, outstanding foreign symphony orchestras, quaint folk music or news from the capitols of the world are yours at the flip of a switch.

## THE "BROWNIÉ"

AM-Shortwave tuner (Model L-500) adds a new dimension to your hi-fi system. The shortwave reception is equal to that of a professional communications receiver, and the AM is of the highest quality. It's the first tuner of its kind — designed principally for your hi-fi system.

Price **\$8750**

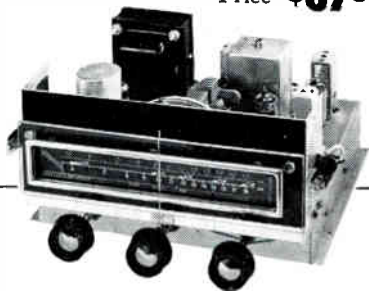

- Sensitivity 1 to 2 microvolts.
- IF amplifier for broad and sharp bandwidth
- 10 kc whistle filter.
- High gain RF stage.
- Covers complete broadcast band.
- Tape recorder output.
- International shortwave band — 17 meters through 49 meters.
- Built-in high gain ferrite antenna.
- Three controls — output level control with ON-OFF switch; 3-position selector switch, AM broad, AM sharp, shortwave control; and velvet tuning control.
- Self contained power supply.
- Cathode follower output for remote location.

# browning

LABORATORIES, INC.

750 Main Street, Winchester, Mass.  
Export Div., 25 Warren St., New York, N.Y., U.S.A.  
CABLE: SIMONTRICE

## Q AND A

Continued from page 59

narrow frequency range, compared to the smooth, musical quality to be desired throughout the whole range of bass frequencies. Good bass performance makes the bass fiddle sound like a stringed instrument, the bass saxophone should "grunt", and in particular bass timpani should have a soft musical quality instead of a hard, thumping characteristic. Scientifically designed acoustic enclosures are most likely to meet these requirements, while off-the-cuff or amateur designs are most likely to produce unnatural effects. Construction details of a number of acoustically engineered enclosures, made by responsible manufacturers, are available for those who are interested in building their own.

In the area of treble response, unnatural effects usually come from equipment where too much emphasis has been placed on extremely high frequency response. Fortunately, most hi-fi systems are provided with controls to minimize such effects, but the prospective buyer of a loudspeaker system should not be over-impressed with the importance of excessively high frequency response. If achieved, it is likely to be done at a compromise with more important performance in the middle and upper-middle frequency ranges, particularly if attempted with anything less than a three-unit loudspeaker system. Again, the test is listening. Some may choose performance characterized by special, exaggerated effects, and certainly no one should question their judgment. It is my conviction, however, that most people want reproduction that is the nearest possible equivalent to the original sounds.

## HAPPILY EVER AFTER

Continued from page 40

ably recognize, was that the function switch was at the RADIO position when I switched on the power and turned up the volume. No sound came out until I turned the switch to PHONO. But I had goofed before the members of my household, and goofing under such circumstances leads inevitably to local loss of face. I nearly lost my head!

However, time heals all wounds, even those inflicted by an audio amplifier on the rampage. In the end, confidence was established in the new amplifier to the extent that my wife and children essayed to operate it. This was a source of gratification to me, as my purpose in building it was to provide the children with a phonograph of their own — the only practical way to keep their little hot hands off my special hi-fi equipment. Now my family is so proud of my craftsmanship that I have been advanced in their esteem to the rating of Audio Expert, 1st Class, but it will be a long time before I undertake another such project. (*I do wish that tuner kit would get here before I wear the door off the mailbox again.*)

# World's Smallest Radio

with full  
FM  
Quality

**FM Jr.**  
TRADE MARK

only  
**\$2995**  
less batteries —  
Fed. Exc. Tax inc.

**NOW —**  
an FM Radio smaller  
than a pack of cigarettes

DESIGNED BY RICHARD FLORAC



Ounce for ounce, the most remarkable radio ever produced! Use it anytime in complete privacy . . . anywhere within FM range. FM Jr.'s extraordinary fidelity and sensitivity is the result of advanced circuit design and use of direct acoustic coupling between eardrum and hi-fi ear-piece. Hear it . . . See it . . . Thrill to new listening experience with FM Jr.

## fm car tuner

with special FM ANTENNA

**\$10500**  
complete



## FOR USE WITH CAR RADIO OR HASTINGS HI-FI AMPLIFIER

Add High Fidelity FM listening pleasure to driving by converting your AM car radio to a concert hall on wheels! Covers the complete FM band with "communications sensitivity"; fidelity assured by electronically controlled tone. Compact, chrome trimmed gray case . . . installs easily.

See these at your dealer's. FREE illustrated folders yours on request.

*Hastings* PRODUCTS, Inc.

171 Newbury St., Boston 16, Mass.

*Hi-Fi Music at Home*

## NEW SPEAKER

Continued from page 42

work against the air of the room into which the speaker faces. Otherwise, very little bass energy can be radiated by a loudspeaker.

The classical solution to this problem is to mount the speaker so that it faces its audience through a hole in a very large board, or baffle. How large, one may ask, is a large board? An open baffle with free edges would have to be about 14 ft. on each side for reproduction down to 40 cycles without losses. The practical method of using this type of mounting immediately suggests itself — to mount the speaker in the wall of the room.

Since such a procedure often creates more difficulties than it solves (such as the landlord's wrath) it has become customary to attain the required acoustical separation by enclosing the rear of the loudspeaker with a cabinet. That appears to be a simple solution, but it introduces a new and perhaps more difficult problem: what to do with air entrapped at the rear of the speaker cone?

Something must be done about it. A relatively small body of air tightly enclosed in the cabinet creates a stiff elastic cushion, in direct contact with the speaker, which has a profound effect upon the speaker characteristics. It is like attaching pneumatic springs to the cone, so that they impede its movement. The practical result in terms of performance is the loss of bass reproduction, possibly more than a full octave of it.

If you now count off various ways of dealing with the entrapped air, you will be listing the major types of speaker enclosures. The enclosed air may be rendered innocuous by making its cubic volume very great. Then the elastic tension of the air is so weak as to be negligible. This is an approximation of an infinite baffle: that is, a baffle of such large dimensions that acoustical separation between front and back is complete.

A solution that does not require such a large cabinet is to make use of acoustical resonances, either cavity or air column, to tune out or counterbalance the bothersome acoustic cushion inside the enclosure. The majority of modern speaker cabinets are of this type, the most popular of which are bass reflex designs and their near relatives. Such enclosures are effective if their design and construction are acoustically correct.

Infinite-baffle enclosures for 12-in. speakers usually run well over 10 cubic feet, and even bass-reflex cabinets only cut the volume requirements by about half. Properly designed folded horns are both excellent and big. Thus the general association between large speaker cabinets and full bass has been well grounded in fact. The hi-fi enthusiast who really wants to hear the fundamentals of the bottom pedal tones of the organ or of the open E-string

Concluded on page 62



Build it  
YOURSELF

### Heathkit HIGH FIDELITY PREAMPLIFIER



MODEL WA-P2

formance and most attractive in appearance. Fulfills every requirement for true high fidelity performance. Shpg. Wt. 7 lbs. **\$19.75**

### Heathkit WILLIAMSON TYPE 25 WATT AMPLIFIER (PEERLESS TRANSFORMER)

This latest and most advanced Heathkit hi-fi amplifier has all the extras so important to the super-critical listener. Featuring KT-66 tubes, special Peerless output transformer, and new circuit design, it offers brilliant performance by any standard.

Bass response is extended more than a full octave below other Heathkit Williamson circuits, along with higher power output, reduced intermodulation and harmonic distortion, better phase shift characteristics and extended high frequency response. A new type balancing circuit makes balancing easier, and at the same time permits a closer "dynamic" balance between tubes.

Aside from these outstanding engineering features, the W-5 manifests new physical design as well. A protective cover fits over all above-chassis components, forming a most attractive assembly—suitable for mounting in or out of a cabinet. All connectors are brought out to the front chassis apron for convenience of connection. Model W-5M consists of main amplifier and power supply on single chassis with protective cover. Shpg. Wt. 31 lbs. **\$59.75** Express only. Model W-5 consists of W-5M, plus WA-P2 Preamplifier shown on this page. Shpg. Wt. 38 lbs. **\$79.50** Express only.

### Heathkit HIGH FIDELITY 20 WATT AMPLIFIER



MODEL A-98

This particular 20 watt Amplifier combines high fidelity with economy. Single chassis construction provides preamplifier, main amplifier and power supply function. True hi-fi performance  $\pm 1$  db, 20 cps to 20,000 cps. Preamplifier affords 4 switch-selected compensated inputs. Push-pull 6L6 tubes used for surprisingly clean output signal with excellent response characteristics and adequate power reserve. Full tone control action. Extremely low cost for real high fidelity performance. Shpg. **\$35.50** Wt. 18 lbs.

# HEATHKIT High Fidelity "BUILD IT YOURSELF" amplifier kits

### Heathkit WILLIAMSON TYPE (ACRO-SOUND TRANSFORMER)

This dual-chassis high fidelity amplifier kit provides installation flexibility. It features the Acrosound "ultra-linear" output transformer, and has a frequency response within 1 db from 10 cps to 100,000 cps. Harmonic distortion and intermodulation distortion are less than .5% at 5 watts, and maximum power output is well over 20 watts. A truly outstanding performer. W-3M consists of main amplifier and power supply. Shpg. Wt. 29 lbs., Express only. **\$49.75** Model W-3 consists of W-3M plus WA-P2 Preamplifier listed on this page. Shpg. Wt. 37 lbs., Express only. **\$69.50**



### Heathkit WILLIAMSON TYPE (CHICAGO TRANSFORMER)

This hi-fi amplifier is constructed on a single chassis, thereby affording a reduction in cost. Uses new Chicago high fidelity output transformer and provides the same high performance as Model W-3 listed above. An unbeatable dollar value. The lowest price ever quoted for a complete Williamson Type Amplifier circuit. Model W-4M consists of main amplifier and power supply on single chassis. Shpg. Wt. 28 lbs., Express only. **\$39.75** Model W-4 consists of W-4M plus WA-P2 Preamplifier. Shpg. Wt. 35 lbs., Express only. **\$59.50**



COMBINATION  
W-5M and WA-P2



**HEATH  
COMPANY**  
A SUBSIDIARY OF DAYSTROM, INC.

BENTON HARBOR 5,  
MICHIGAN

Write FOR FREE CATALOG AND SCHEMATICS

### Exciting High Fidelity Firsts!

In these superb matched instruments—enjoy the foremost advances in High-Fidelity—startling realism—lowest distortion—precision craftsmanship—gleaming polished chromium chassis.

## INTERELECTRONICS

### Coronation 400 40 WATT AMPLIFIER



**\$99.50**

Greatest amplifier buy today! COMPLETELY NEW, NON-RINGING NEGATIVE FEEDBACK CIRCUITRY—over 50 DB feedback. CUSTOM CRAFTED—sealed transformers, encapsulated networks, finest molded components on Bakelite terminal board. DISTORTION-FREE—less than 0.05% at 30 watts. POWER RESPONSE  $\pm 0.1$  DB 16 to 35,000 cycles at 30 watts. Surpasses FCC requirements for FM broadcasting. 5 to 200,000 cycle response. 40 WATT WIDE-RANGE OUTPUT TRANSFORMER, sealed multiple section windings, thin strip core. FOOL-PROOF DAMPING CONTROL for startling speaker performance. BUILT-IN POWER for preamplifiers and newest electrostatic tweeters.

## INTERELECTRONICS

### Coronation 85 CONSOLE PREAMPLIFIER- EQUALIZER

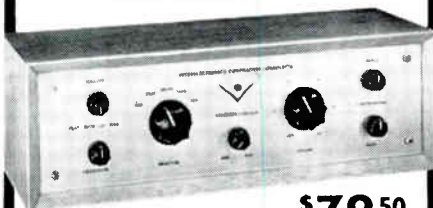

**\$79.50**

Incomparable companion to the "CORONATION 400". EXCLUSIVE NEGATIVE FEEDBACK CIRCUITRY. Over 50 DB—virtually eliminates distortion. Surpasses FCC requirements for FM Broadcasting. 5 to 200,000 cycle response. CUSTOM CRAFTED—polished chromium chassis, satin gold front panel. Encapsulated precision networks, molded components on Bakelite panel. LOUDNESS CONTROL, continuously variable. FIVE INPUT SELECTIONS, 16 PRECISION PLAYBACK CURVES. FULL 20 DB DISTORTION-FREE Bass and Treble compensation. Phenomenal lowest noise Z-729 input tube HUM IN-AUDIBLE with all controls on full. Highest gain. Built-in power for motion picture photo-cells, FM phono cartridges, condenser microphones. Ultra compact, easy front mounting.

Now at your local dealer!

## INTERELECTRONICS

2432 Grand Concourse  
New York 58, New York

## NEW SPEAKER

*Continued from page 61*

of the double bass has had to shop among the giants.

Let us now back away and get a new perspective on this problem. A small, totally enclosed cabinet gives the necessary acoustic separation between the front and back of the speaker cone. It also creates an unwanted pneumatic spring effect that ruins the bass performance of conventional speakers. Is it possible to design a speaker which isn't affected by the air cushion? The answer is probably no. Yet an examination of the mechanical system of a loudspeaker reveals the fact that the conventional cone suspension has the same kind of elasticity as the air cushion in the enclosure. If you press against the cone, it will spring back. But it is possible to make a special speaker with practically no springiness in the cone suspension. Such a speaker will then need an air cushion behind the cone!

That is exactly what was done in developing the acoustic-suspension type speaker. It is true that the reasoning which led to its design did not follow the path outlined above. Actually, the conclusion was reached from a different direction. The conventional elastic suspensions are now the major source of speaker distortion, creating percentages of false harmonics far exceeding those tolerated in good amplifiers.

The acoustic-suspension speaker was primarily designed to eliminate that source of distortion by taking advantage of the fact that air constitutes a spring of much higher quality than that of mechanical suspensions. Measurements show that the bass distortion of the AR speaker, compared to that of an equivalent conventional speaker mounted in an infinite baffle, has been reduced by a factor of 4. That the acoustic-suspension speaker requires a cabinet of 1.7 cubic feet internal volume was a welcome dividend to the fruits of the research project, but if the required cubic volume had turned out to be 7.1 cubic feet instead, the project would still have been considered successful.

It will undoubtedly be difficult for many people to think of such a small speaker enclosure as having been designed as anything but a compromise—good, bad or indifferent, but nevertheless a compromise. It has been argued, for example, that since bass instruments are themselves big, a large speaker enclosure is part of the nature of reproduction. But the reasons for making speaker enclosures bulky are not the same as for making low-tone organ pipes long. Creative devices are not governed by the same laws as imitative ones.

During the past twenty years, development workers in audio have advanced the design of amplifiers to such a point that they no longer need to be limiting factors in the quality of reproducing chains. It begins to look as if we will be able to do a similar job with loudspeakers.

# QUALITY

you can hear  
and feel

## FME

TAPE RECORDER



two-  
speed,  
dual-  
track

When buying any recording equipment you, as a high fidelity enthusiast, are interested in its many technical aspects. Frequency response, signal-to-noise ratio, flutter and wow are, certainly, all important. And in these aspects the FME Tape Recorder is incomparable in its price class.

Yet, in the truest sense only your ear can really distinguish the quality of fine recorded sound. Only your trained touch can really judge the simple, smooth operation of a tape recorder. It is for this reason that Federal, without bold reference to technical specifications, invites you, the real jury, to listen to the FME.

Hear for yourself Federal's triumph in sound. Feel for yourself its quality construction, its smooth, simple operation. Playback any tape—either 3 $\frac{3}{4}$  or 7 $\frac{1}{2}$  IPS. Test its single knob control, its fast forward and rewind, its separate volume and tone controls and many other wanted features.

Then look at the price—we're sure you'll be delightfully surprised.

Only \$139.95. Supplied complete with ceramic microphone, reel of magnetic tape, take-up reel, power cord and plug.

L-39

## FEDERAL MANUFACTURING AND ENGINEERING CORP.

215 Steuben Street, Brooklyn 5, N. Y.  
EXPORT DIVISION: 25 Warren St., N. Y. 7, N. Y.  
Cables SIMONTRICE NEW YORK all codes



**SPECIAL SERVICES DIRECTORY**

**ALLIED HIGH FIDELITY STUDIO**  
 Serving Chicago's North and Northwest  
 Suburbs and Chicago's North Side  
 Complete Demonstration Facilities  
**602 DAVIS ST., EVANSTON, ILLINOIS**  
 DAVIS 8-8822 SHeldroke 3-6233

**World's Largest Stocks of  
 High-Fidelity Music Systems  
 and Components**  
**ALLIED RADIO**  
 CORPORATION  
 100 N. WESTERN AVE. · CHICAGO 80, ILL.

**EVERYTHING IN HIGH FIDELITY . . .**  
 from pickup to speaker. Try and compare your  
 choice of hi-fi components on the "AUDIOMAT"  
 in ASCO's air-conditioned demonstration studio.  
**ASCO SOUND CORPORATION**  
 115 W. 45th St., 3rd floor, New York 36, N. Y.  
 Write for free catalog, or phone JUDson 2-1750

**ANNOUNCING . . . . . a new service**  
**MAIL CONSULTATIONS**  
 Send details of your audio questions and problems,  
 with \$2. Albert Turner, Physicist, will answer them  
 from both the audio engineer's and the musician's  
 viewpoints. Satisfaction guaranteed! P. O. Box 22,  
 Oakhurst, Calif.  
**AUDIO ARTS COMPANY**

**IN CANADA —**  
 There's one place where you can find — and hear — all  
 your high-fidelity equipment needs. We carry a com-  
 plete stock . . . come in, or write in, for a chat, a look,  
 and a listen.  
**ELECTRO-VOICE**  
**SOUND SYSTEMS**  
 141 Dundas St., West, TORONTO

**HARVEY RADIO CO., Inc.**  
 The best place to see, hear, and buy the newest  
 and finest in hi-fi equipment. Out-of-towners  
 —make Harvey Radio your audio headquarters.  
 One block from Times Square. Phone JU 2-1500  
**103 W. 43rd St., New York 36**  
**1123 Ave. of the Americas, New York 36**

**HIGH-FIDELITY HOUSE**  
 Largest distributor in the West  
 specializing in custom sound equipment  
 Phone: RYan 1-8171  
**536 S. Fair Oaks, Pasadena 1, Calif.**

**HOLLYWOOD ELECTRONICS**  
 "HI-FI COMPONENTS EXCLUSIVELY"  
 Since 1944  
**7460 MELROSE AVE., L. A. 46. WEB 3-8208**

EVERYTHING IN  
*Electro-Voice*  
**HI-FI EQUIPMENT & SOUND SYSTEMS**  
**KIERULFF SOUND CORP.**  
 820 W. Olympic Blvd., Los Angeles 15  
 Tel. Richmond 7-0271

in the PHILADELPHIA area  
**YOUR COMPLETE SUPPLIER IS**  
*Radio Electric*  
**SERVICE CO. OF PENNA., INC.**  
**HI-FI & COMMERCIAL SOUND STUDIO**  
 709 Arch Street, Philadelphia 6, Pennsylvania  
 Phone: LOmbard 3-7390

**INDEX of  
 ADVERTISERS**

Acoustic Research, Inc.	56
Allied High Fidelity Studio	63
Allied Radio Corp.	51, 63
Altec Lansing Corp.	55
Ampex Corp.	5
Asco Sound Corp.	63
Audio Arts Co.	63
Audiophile Records	4
Bozak Speakers	55
British Industries	Inside Front Cover, 1, 58
Browning Laboratories	60
Cobinort	59
Collins Audio Products Co., Inc.	54
Cook Laboratories	6
Electro-Voice, Inc.	Back Cover
Electro-Voice Sound Systems	63
Fairchild Recording Equip.	57
Federal Mfg. & Eng. Corp.	62
G & H Wood Products	59
Garrard Sales Corp.	Inside Front Cover, 1
General Apparatus Co.	64
General Electric Co.	11
Harvey Radio Co.	63
Hostings Products, Inc.	60
Heath Company	61
Hi-Fi Center, Inc.	63
High Fidelity House	63
Hollywood Electronics	63
Interelectronics	62
Kierulff Sound Corp.	63
Klipsch Associates	10
Lansing Phil, Inc., J. B.	50
Louisville Philharmonic Society	6
McIntosh Lab., Inc.	52
Magnavox Company	48
Mals Recording Service	63
Marantz Company	54
Pickering & Co., Inc.	14
Pilot Radio Corp.	50
Presto Recording Corp.	7
Radio Electric Service Co.	63
Radio Engineering Labs, Inc.	49
Radio Shack, Inc.	63
R.C.A. Victor Records	2
Reeves Soundcraft Corp.	56
Schwonn Catalog	64
Sherwood Electronics Lab.	63
Shure Bros., Inc.	8
Sonotone Corp.	53
Stephens Mfg. Corp.	Inside Back Cover
Sun Radio & Electronics, Inc.	63
Technical Tape Corp.	9
Transcriber Company	4
University Loudspeakers, Inc.	47
V-M Corporation	12
Wholesale Supply Co.	63

**FREE 224-PAGE CATALOG**  
**LARGEST STOCKS in the EAST**  
 Cook and Audiophile Records, Too  
**RADIO SHACK CORPORATION**  
 Boston 8, Mass., 167 Washington St.  
 New Haven 10, Conn., 230 Crown St

**SUN RADIO & ELECTRONICS Co., Inc.**  
 Largest Audio Demonstration Facilities!  
 3 Completely Equipped Sound Studios.  
 Send 35 Cents for "HI-FI FACTS"  
 booklet.  
**650 6th Ave., Cor. 20th Street, New York 11**  
 Phone OREGon 5-8600

**FM RECEIVING ANTENNAS**  
 Standard and Special Designs  
**WHOLESALE SUPPLY CO.**  
 Lunenburg, Mass.



**NOTICE TO TAPE RECORDER OWNERS**  
 We carry a full line of pre-recorded tapes including:  
**LIVINGSTON LIBRARY**  
**A-V-LIBRARY**  
**WEBCOR**  
**TAPE TOONS**  
**R.C.A.**  
**PHONOTAPE ETC.**  
 For Catalogues or information write  
**Mal's Recording Service**  
 Box 37, Rockaway Beach 94, N. Y.

*For function and beauty*  
**SHERWOOD HIGH FIDELITY S-1000 AMPLIFIER**  
 20 watt ultra-linear output  
 push-button record equalization  
 2729 low noise phono preamplifier  
 new "center-set" loudness control  
 rumble and scratch filters  
 speaker damping selector  
 tape recording provisions - 5 inputs  
  
 Model S-1000B, \$99.50 complete.  
 Add only speaker and record player  
 for professional hi-fi music system.  
*Sherwood*  
 ELECTRONIC LABORATORIES  
 Dept. 7M., 2802 W. CULLOM AVE. · CHICAGO 18, ILL.

**it's brand NEW!**  
  
 Now! For Hi-Fi and Phonograph Systems  
 . . . . . Automatic Shut-Off of ENTIRE SYSTEM at End of Last Record!  
**"SLUMBER SWITCH"**  
 No more worry or bother about "remembering" to shut off power after last record plays. SLUMBER SWITCH remembers for you! Shuts off entire system automatically!  
 USE IT with any phonograph that shuts off itself at end of last record • To restore ordinary operation at any time, simply flick defeat switch • Foolproof! No moving parts, nothing to wear or burn out • Easy installation. Just 3 simple connections. 3 Cables to permit convenient placement • Pop-filter lessens speaker-pop, when motor shuts off • No hum or magnetic fields. Use with ANY cartridge!  
**Money-back Guarantee. Sent Postpaid (No C.O.D.) . . . . . \$7.95**  
**The HI-FI CENTER, Inc. Dept. M-7**  
 2630 N. Downer Ave. Milwaukee 11, Wis.

# G.A. NETWORKS AND AIR-COUPPLERS

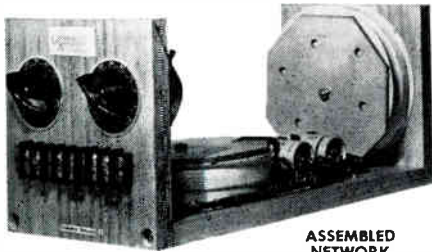

ASSEMBLED NETWORK

## G.A. Crossover Networks

As an added service to audio enthusiasts, G.A. is now supplying completely assembled networks, for use with the G.A. Air-Coupler. If you are not certain as to which networks you should use, send 10c for the G.A. network data sheet. Complete, as illustrated:

No. 9C, 8 ohms, 175 cycles.....	\$32.50
No. 5C, 16 ohms, 175 cycles.....	32.50
No. 6AC, 8 ohms, 2,200 cycles.....	18.00
No. 1C, 16 ohms, 2,200 cycles.....	19.50

## G.A. Network Kits

Of the various G.A. crossover networks, the following are recommended for use with the Air-Coupler. Complete kits include capacitors and level controls.

No.	Impedance	Crossover	2 Coils only	Complete
9	8 ohms	175 cycles	\$20.00	\$24.00
5	16	175	20.00	24.00
6A	8	2,200	6.00	12.00
1	16	2,200	7.00	13.50

## G.A. Air-Couplers

Since 1950, only G.A. is authorized to offer the officially approved Air-Coupler design in knocked-down or assembled form. Parts are precision-cut from high-quality 3/4-in. fir plywood.

Air-Coupler knocked down, ready to assemble, opening cut for 12-in. speaker.....	\$29.95
Air-Coupler assembled and glued.....	39.95
Altec 600B 12-in. speaker, 8 ohms.....	42.00
University 4408 tweeter, 8 ohms.....	17.50

## G.A. Variable Networks

Type A-VAC permits the crossover frequency to be varied from 90 to 1,100 cycles; type B-VAC, from 900 to 11,000 cycles. Eliminates power loss experienced with fixed networks. Kit is complete with punched chassis and tubes. Also supplied as a finished unit, laboratory-tested, ready to use.

A-VAC or B-VAC, knocked-down kit.....	\$39.95
Either type assembled and wired.....	56.95
Instruction book with circuits.....	1.00

PRICES ARE FOB NEW YORK

# GENERAL APPARATUS COMPANY

Formerly at Sheffield, Mass.

346 E. 32nd St., New York 16, N. Y.

## BUY, SELL or SWAP

The opportunity to buy, sell, or swap items of equipment or records through the use of this department is made available as a service to readers of MUSIC at HOME without charge.

Copy should be limited to 35 words. Items are not accepted from business firms. The Publisher reserves the right to reject copy which, in his opinion, does not conform with the standards of this Magazine. No box numbers, please.

**SWAP:** Very fine mint US and foreign stamps in complete sets for hi-fi, electronic, radio equipment. Please state what you have to swap and your philatelic interests. All correspondence answered. George Ulrich, Liberty, N. Y.

**SELL:** Presto T-15 Turntable in original sealed carton. \$40.00 prepaid. 6-ft. Air-Coupler assembled \$10.00, express collect. V. R. Parker, Lunenburg, Mass.

**SELL:** Heath W-3 amplifier with or without WA-P2 preamp. R. D. Huntley, Jr., 2927 Jefferson St., Augusta, Georgia.

**SELL or SWAP:** RC-80 Garrard changer with G.E. variable reluctance cartridge and diamond for 33's and 45's, or sapphire for 78's. Diamond used 250 to 300 hours. Want low-price tape machine or speaker. Martin Tytun, 1739 Pilgrim Ave., Bronx 61, N. Y.

**SWAP:** Stamps and coins, wide variety of medium value US and foreign, to trade for hi-fi components. Want good tape recorder, turntable, cartridge, LP records, etc. Give full particulars of what you want and have. Floyd Adams, Box 63, Carmel, Calif.

**SELL:** Wharfdale Super 12 CSAL or Wharfdale 15 woofer \$60 each. P. J. Sidney, 114 W. 64th St., N. Y. 23.

**BUY:** Used Rek-O-Kut Challenger disc recorder, or turntable with cutting mechanism in good condition. State price. Fred G. Patton, 92 Pinehurst Ave., Apt. 3K, New York 33, N. Y.

**BUY:** Second-hand Holt's Italian Language LP record and book set. Advise condition and price. E. L. Carter, P. O. Box 1500, Albany, Georgia.

**SELL:** Presto 6-N professional disc recorder with overhead lathe cutter, 16-in. turntable, playback arm. Portable case. 78 and 33 1/2 r.p.m. Excellent condition. Cost \$750, sacrifice \$225 FOB Chicago. Thomas H. Marshall, 1630 West Melrose, Chicago 13, Ill.

**SWAP:** Young man with huge record collection, many rarities, desires swap letters or tapespondence with others of similar interests. Likes discussing cylinder era or triaxial age. Monteverdi, lves, in between. Belden, Box 1001, New Brunswick, N. J.

**SELL:** Magnecordette, adapter kit for 10 1/2-in. reels, 4 10 1/2-in. reels used tape, 10 1/2-in. empty reel, Hack Swain tapes, 17 7-in. reels used tape, Shure mike, E-V stand, Brush head-phones, \$400 complete, express collect. Cost over \$600. Joseph A. Federspiel, 526 Green St., New Haven, Ind.

**SELL:** Air-Coupler 6-ft. model, 3/4-in. plywood. Solidly constructed, mahogany stain and satin varnish finish. Price \$16. O. R. Todd, 818 Peterson St., Fort Collins, Colorado.

**SELL:** Collector's library of classical 78's. Over 600 albums, many collector's items. George W. Riley, 1833 New Hampshire Ave., N. W., Washington 9, D. C.

**SELL:** Binaural Cook front end, Scott power supply, Livingston arm with two 215 Fairchild diamonds, bracket base, cables, Brociner triple-shielded input transformers, 22 binaural records. Everything like new, guaranteed. Best offer over \$150. William Elliott, 649 E. 14th St., New York 9, N. Y.

Over  
500,000  
record  
collectors  
read  
"schwann's  
long playing  
record  
catalog"  
every month  
before  
buying.  
are you one  
of them?

Available  
at your  
record dealer  
now.

Pick up your  
copy today.

# schwann long playing record catalog

137 Newbury St., Boston, Mass.

# KEEP UP-TO-DATE ON NEW PRODUCTS

Looking for additional data on products described in the Ideas for You department in this issue?

Planning a new installation? An addition to your present equipment, or a change that will give you better performance? To be sure that you choose wisely, study the brochures and catalogs which the manufacturers have prepared to help you.

Use the cards on this page to obtain detailed information on equipment you plan to buy, and the name and address of the nearest dealer who handles it.

If you want to ask the manufacturer for special advice, write a letter stating your requirements as briefly as possible, fill out one of the cards below, and attach it to your letter.

## HERE IS YOUR SUBSCRIPTION ORDER CARD

## HERE ARE YOUR INFORMATION REQUEST CARDS



**BUSINESS REPLY CARD**  
FIRST CLASS PERMIT NO. 4609, SEC. 34.9, P. L. & R., NEW YORK, N. Y.

**MUSIC at HOME**  
207 East 37th Street  
New York 16, N. Y.

J-A '55

**MUSIC at HOME**  
July-August '55



To: \_\_\_\_\_  
\_\_\_\_\_  
\_\_\_\_\_

**SPECIAL RUSH SERVICE REQUESTED!**



**BUSINESS REPLY CARD**  
FIRST CLASS PERMIT NO. 4609 SEC. 34.9, P. L. & R., NEW YORK N. Y.

**MUSIC at HOME**  
207 East 37th Street  
New York 16, N. Y.

**MUSIC at HOME**  
July-August '55



To: \_\_\_\_\_  
\_\_\_\_\_  
\_\_\_\_\_

**SPECIAL RUSH SERVICE REQUESTED!**

# GET YOUR INFORMATION FASTER!

**SPECIAL RUSH SERVICE:** To get literature and prices to you more quickly, the Readers' Service Department of HI-FI MUSIC at HOME now provides two request cards at the bottom of this page that you can send directly to the manufacturers. This arrangement eliminates the extra time required to forward your requests.

**REGULAR SERVICE:** If you prefer to have your requests for literature forwarded by HI-FI MUSIC at HOME to the manufacturers, use the postage-free card at the left, below. Space is provided for requesting information on five different products.

## HOW TO USE THE INFORMATION REQUEST CARDS

1. When you fill in a card, please PRINT your name and address clearly, so that the reply will not be misdirected.
2. Indicate the name of the product and the page number of this issue of MUSIC at HOME, for exact identification.
3. On the opposite side of the **SPECIAL RUSH SERVICE** cards, put the names and addresses of the manufacturers. Use the amount of postage required for an ordinary postcard. (2¢ in the USA and possessions; 4¢ for air mail.)
4. If the **REGULAR SERVICE** card is mailed in the US, postage will be paid by HI-FI MUSIC at HOME.

## SUBSCRIPTION RATES for HI-FI MUSIC at HOME

**Domestic Subscriptions:** The rate for subscriptions to MUSIC at HOME going to the U.S. and possessions, Canada, and Pan American Union countries is \$3.00 per year (6 issues), or \$6.00 for three years (18 issues)

**Foreign Subscriptions:** The rate for countries other than those specified above is \$4.00 per year (6 issues), or \$9.00 for three years (18 issues)

**Subscriptions Starting with Back Issues:** At present, back issues are available from Vol. 1, No. 1, dated March-April 1954.

You may order a subscription to start with any back issue. In that case, your remittance must accompany your order.

**Group Subscriptions:** Following are the rates for group subscriptions

- 2 1-year subscriptions \$2.50 each
- 3 1-year subscriptions 2.25 each
- 4 1-year subscriptions 2.00 each
- 5 or more 1-year subscriptions \$1.80 each

Remittance must accompany group subscription orders

## SUBSCRIPTION ORDER CARD



Please send complete information about.....  
 Manufactured by.....described in MUSIC at HOME, July-Aug.  
 My Name.....Street.....  
 City.....Zone.....State.....

Please send complete information about.....  
 Manufactured by.....described in MUSIC at HOME, July-Aug.  
 My Name.....Street.....  
 City.....Zone.....State.....

Please send complete information about.....  
 Manufactured by.....described in MUSIC at HOME, July-Aug.  
 My Name.....Street.....  
 City.....Zone.....State.....

Please send complete information about.....  
 Manufactured by.....described in MUSIC at HOME, July-Aug.  
 My Name.....Street.....  
 City.....Zone.....State.....

Please send complete information about.....  
 Manufactured by.....described in MUSIC at HOME, July-Aug.  
 My Name.....Street.....  
 City.....Zone.....State.....

**MUSIC at HOME Magazine** 207 E. 37th St., New York 16, N. Y.

Please enter a subscription for me starting with the issue of.....

3 years (18 issues) \$6.00  1 year (6 issues) \$3.00

Add 50¢ each for back issues. Add \$1.00 per year for foreign subscription

New subscription  Renewal subscription

Remittance is enclosed  Bill to address below

If your subscription order includes back issues, remittance must accompany your order

Name.....

Address.....

City.....Zone.....State.....

**Please send me details and prices of your**

As shown on page.....of MUSIC at HOME, July-Aug. issue.

Also, give me the name and address of my nearest dealer.

My Name.....

Address.....

I am an  Audio Enthusiast  Custom Set Builder  Dealer

I am  preparing to build my first installation

planning to improve my installation

Please have your representative phone me at.....

**Please send me details and prices of your**

As shown on page.....of MUSIC at HOME, July-Aug. issue.

Also, give me the name and address of my nearest dealer.

My Name.....

Address.....

I am an  Audio Enthusiast  Custom Set Builder  Dealer

I am  preparing to build my first installation

planning to improve my installation

Please have your representative phone me at.....

# Precious Quality comes in small packages

STEPHENS  
*Columbian*

fits apartment-size corners  
and restricted young coiffers

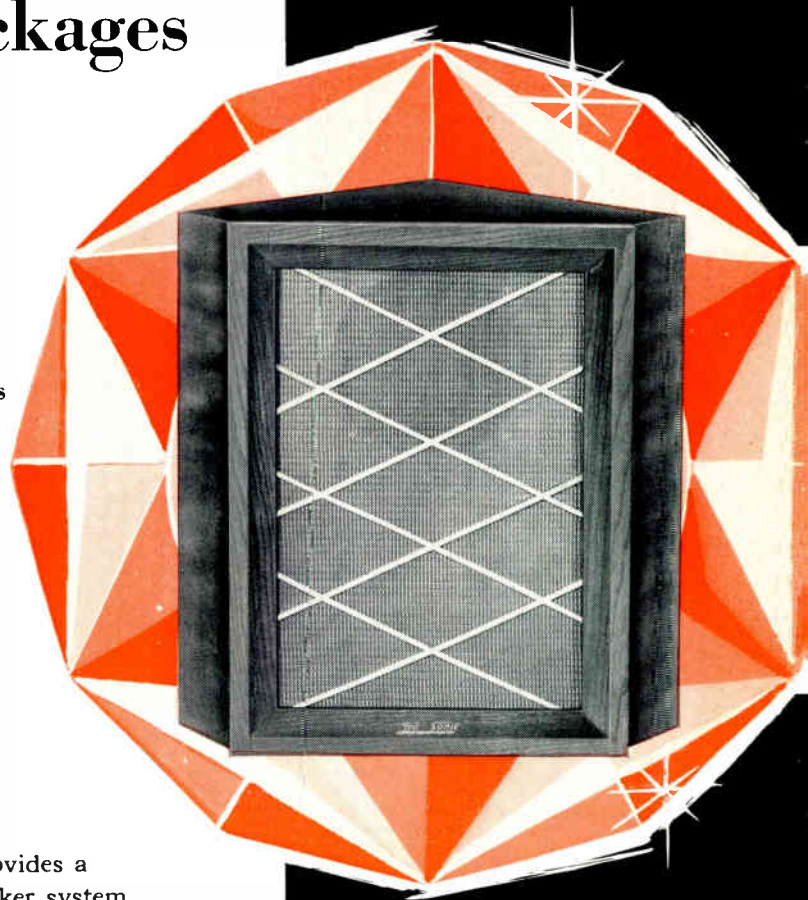

**C**olumbian, the gem of enclosures, provides a perfect setting for a flawless Stephens speaker system. New horn loading principle affords lower fundamental bass response. Sides and back of cabinet are completely enclosed. Offered in beautifully grained blonde or fine dark mahogany hand-rubbed finishes.

Cabinet Model 622 alone, Net \$78.00. 27½" wide, 29½" high, 18" deep. Shipping Weight 47 lbs.

Recommended Stephens Speaker 122AX 12" coaxial speaker. The 122AX has 2 voice coils, 1½ lb. Alnico V magnet, 5000 cycle network. Stephens Model 122AX alone, Net \$54.00. Shipping Weight 13 lbs.

Columbian with system installed, complete, Net \$132.00.

**STEPHENS**  
TRU-SONIC

Stephens Manufacturing Corporation  
8538 Warner Drive • Culver City, California



you are invited by **Electro-Voice**  
to...

**WIN!**

**1 "WEEK-END WITH HIGH FIDELITY!"**



**WIN!**

**2 LIFETIME OF HIGH FIDELITY MUSIC!**

CONTEST STARTS AUGUST 1, 1955

As always, Electro-Voice is FIRST! Now E-V sponsors this unique and exciting contest, that you might hear (perhaps win) today's finest matched high fidelity sound systems. For a lifetime after this

glorious listening experience, you will judge music reproduction equipment by its ability to approach the perfection already achieved by E-V matched high fidelity components and loudspeaker systems!

**WIN this "double-size" first PRIZE!**

- 1** WEEK-END WITH HIGH FIDELITY ALL-EXPENSE-PAID week-end trip for two . . . from wherever you enter the contest to Electro-Voice—the Home of High Fidelity! See hi-fi equipment take form before your eyes! Take part in the assembly of your own wonderful prize, if you wish.
- 2** LIFETIME OF HIGH FIDELITY MUSIC with your own incomparable *Patri-cian* 4-way audio reproducer and the beautiful *Peerage* console complete with all equipment!

and LOOK...9 more PRIZES, wonderful to WIN!

- 3 Second Prizes . . . magnificent E-V 15TRX 15-in. three-way speakers!
- 3 Third Prizes . . . outstanding E-V 12TRX 12-in. three-way speakers!
- 3 Fourth Prizes . . . powerful E-V 12TRXB 12-in. three-way speakers!

**IT'S EASY!  
HERE'S ALL YOU DO!**  
Just two pleasant steps: (A) Hear E-V high fidelity demonstrated by your E-V Distributor. A truly thrilling experience awaits you! (B) Fill in and mail the official entry blank, provided by E-V Distributor. (Be sure the salesman signs your entry blank.) Contest closes at midnight, September 30, 1955.

WIN the incomparable *Patri-cian* 4-way audio reproducer! Choice of Korina Blonde or Mahogany cabinet, four speakers, three level controls and 4-way crossover!

WIN the beautiful *Peerage* console plus 30-watt amplifier, pre-amplifier, remote control and FM tuner and record changer or turntable of your choice!

ELECTRO-VOICE, INC., BUCHANAN, MICH.

Gentlemen: I want a chance to win a "Week-End with High Fidelity." Please send me the names of nearest participating E-V Distributors.

Name \_\_\_\_\_

Address \_\_\_\_\_

City \_\_\_\_\_ Zone \_\_\_\_\_ State \_\_\_\_\_

My nearest large trading center is \_\_\_\_\_

**Electro-Voice**

ELECTRO-VOICE, INC., BUCHANAN, MICHIGAN