

Music

AT HOME

NOV.—DEC. 1954

Published by MILTON B. SLEEPER

PRICE 50¢

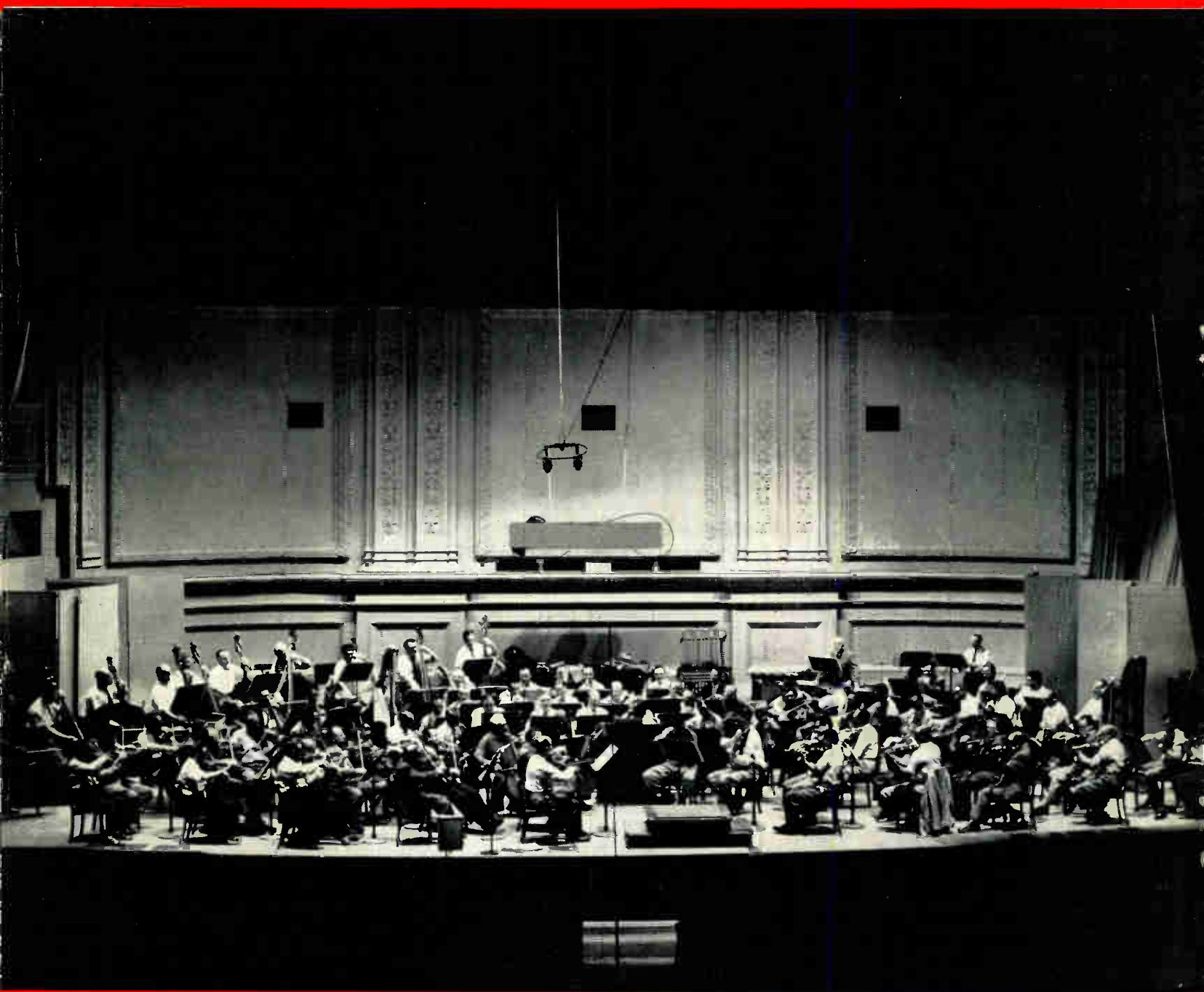

CARNEGIE HALL: Midnight Recording Session

"Toscanini's orchestra played as though the Maestro were on the podium... But with neither conductor nor audience they made a record that will be a collectors' item."—Don Gillis

THE TAPE YOU'VE BEEN WAITING FOR!

SOUNDCRAFT
PLUS 50
 (50% EXTRA PLAYING TIME)
 magnetic recording tape

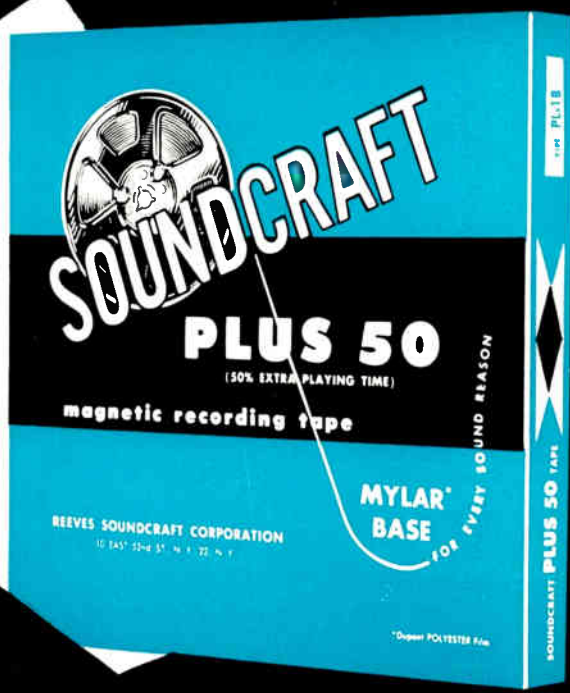

- 50% EXTRA PLAYING TIME
- EXTRA STRENGTH "MYLAR" BASE
- FULL DEPTH OXIDE COATING
- ... YET COSTS NO MORE

PLUS 50

is the *perfected* "long-playing" magnetic tape, bringing you 50% extra playing time with no compromise in strength or recording quality.

One reel of "Plus-50" is equal in recording or playback time to 1½ reels of standard tape. More listening per reel . . . less time changing reels. Best of all, Soundcraft "Plus-50" *actually costs less per foot* than quality acetate-base tapes!

The secret of "Plus-50" lies in its extra thin "Mylar" base (1 mil as compared to 1.5 mils in acetate tapes). "Mylar," DuPont's Polyester Film, con-

tains no plasticizer. It will not cup or curl. Elongation and shrinkage from heat, cold and humidity are barely measurable. And it's far stronger than the thicker acetate . . . one third as strong as steel!

There has been no compromise in the development of "Plus-50"—a big advantage for you! The oxide coating is *constant, full-depth*—to maintain correct frequency response, output level, and bias characteristics. No machine adjustments are needed. "Plus-50" can be interspliced with other fine quality tapes without level change.

See your Soundcraft Dealer for "Plus-50" as well as these other famous Soundcraft Magnetic Recording Tapes:

Soundcraft Recording Tape (in the box with The Red Diamond) the all-purpose "Standard of the Industry."

Soundcraft Professional Tape (in the box with The Blue Diamond) for radio, TV and recording studios. Splice-free up to 2400 feet. Standard or professional hubs.

Soundcraft LIFETIME® Tape (in the box with The Yellow Diamond) for priceless recordings. DuPont "Mylar" base. For rigorous use . . . perfect program timing. Store it anywhere virtually forever.

Soundcraft Tapes are the world's finest—and yet they cost no more.

FOR EVERY SOUND REASON

REEVES **SOUNDCRAFT** CORP.
 10 East 52nd St., New York 22, N.Y.

ASK TO HEAR *Regency* WHERE YOU BUY YOUR RECORDS

Only Regency has a complete line of
high fidelity available for you to hear
at your regular music store.
And you pay no premium.

REGENCY DIVISION, I.D.E.A., INC., 7900 PENDLETON PIKE, INDIANAPOLIS 26, INDIANA

Amplifiers, preamplifiers and tuners
from \$1,000.00 to \$69.95



Incomparable...

Since 1935
the Garrard has been
sold and serviced
throughout the United States.

It is recognized every where
for superior
performance, ruggedness
and reliability.

**CHECK CRAFTSMANSHIP, FEATURES,
PRICE AND SERVICE . . .**
and you will understand clearly why this is
the world's No. 1 high-fidelity record changer.



"RIGHTS" and "WRONGS"
of record changer design
(important in protecting your records).



RIGHT:
Garrard Precision Pusher Platform . . .
the only record changing device that insures
positive, gentle handling of records with standard
center holes.

WRONG:
"Overhead Bridges" (as on ordinary changers)
. . . which may damage or dislodge records
accidentally.



RIGHT:
Garrard removable and interchangeable
Spindles . . . Easily inserted; accommodate all
records, all sizes, as they were made to be
played; pull out instantly to facilitate removal of
records from turntable.

WRONG:
Fixed Spindles (as on ordinary changers) . . .
which require ripping records upwards over
metallic spindle projections after playing.

Other Garrard features include: 4 pole motor
—no rumble, no induced hum • heavy drive shaft
—no wows, no waves • weighted turntable—
flywheel action, constant speed • muting switch
—silence between records • silent automatic
stop—shuts off after last record; no disturbing
"plop". • easy stylus weight adjustment—
protects long-playing records • balanced-mounted
tone arm—true tangent tracking • universal shell
—fits all popular high fidelity cartridges

GARRARD "Triumph"

World's Finest Record Changer

... and this is the LEAK TL/10 HIGH FIDELITY AMPLIFIER
COMPLETE WITH "POINT ONE" REMOTE CONTROL PRE-AMPLIFIER



Most economical amplifier ever built by Leak. Despite amazingly low price, Leak standards have been maintained, with all the engineering skill and fastidious assembly and wiring that have won world-wide admiration. Incorporates an ultra-linear 10-watt circuit, with 2 of the new KT-61 beam power output tetrodes in push-pull. Harmonic distortion only one-tenth of one percent at 1000 cycles, for a power output of 8 watts . . . a noteworthy achievement insuring flawless reproduction.

High damping factor of 23, and low hum level of -76 db below full output, are ordinarily found only in far more expensive units.

4 MASTER CONTROLS

Control 1
Tuner, Tape, AES,
NARTB, FFRR,
COL LP

Control 2
Treble, 23 db
range of control

Control 3
Bass, 23 db
range of control

Control 4
On-Off and
Volume

EXCLUSIVE FEATURE: Tape recorder jacks (input and output) on front panels for instantaneous use

**WRITE FOR A COPY OF
"SOUND CRAFTSMANSHIP"**

Mail coupon today for a complimentary
copy of "Sound Craftsmanship" 16
pages illustrating and describing all
products of the British Industries Group.

BRITISH INDUSTRIES CORP., Dept. MH-11
164 Duane Street
New York 13, N. Y.

Please send "Sound Craftsmanship" to:

Name

Address

City Zone State

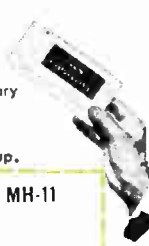

Music AT HOME

THE GUIDE TO HI-FI REPRODUCTION FROM RECORDS, TAPE AND FM RADIO



Photo by William Leftwich

Publisher:

Milton B. Sleeper

Art Director

Walter Buehr

Photography

William Leftwich
Winthrop Morton

Editorial Assistant

Ethel V. Sleeper

Advertising Manager

Frederick A. Klingenschmitt

Circulation

Myrna Scssner

Contributors to this issue

Oliver Daniel
Ben Deutschman
Don Gillis
David Hall
Dr. Herman Neuman
Fred Reynolds
Jan Syrjala
Alex Stevens
Dr. Hans Wolf

Sleeper Publications, Inc.

207 East 37th Street, New York 16, N. Y.
Milton B. Sleeper, *President*

MUSIC AT HOME is published bimonthly by Sleeper Publications, Inc., Hi-Fi House, 207 East 37th Street, New York 16, N. Y. Telephone: Oxford 7-0542. Editorial, advertising, and circulation departments are located at the address above. MUSIC AT HOME is not connected or associated with any other magazine.

Subscription rates are \$3.00 per year (6 issues) or \$6.00 for 3 years (18 issues). Single copies, 50c. Outside the USA, Canada, and the Pan American Postal Union, rates are \$4.00 per year, or \$9.00 for 3 years. Copies are mailed on the 10th of January, March, May, July, September, and November. Allow time for delivery by second class mail.

Editorial contributions and interesting photographs are welcome, and will be paid for upon publication. No responsibility can be accepted for unsolicited manuscripts, and they will not be returned unless they are accompanied by return postage.

Entered as second class matter at New York City, and additional entry at Concord, N. H., under the Act of March 3, 1879. Printed in the U. S. A. by Rumford Press, Concord, N. H.

The cover design and contents of MUSIC AT HOME are fully protected by copyrights, and must not be reproduced in any manner or form. Quotations are not permitted without specific authorization in writing from the Publisher.

Copyright 1954 by Sleeper Publications, Inc.

Vol. 1, No. 5 • CONTENTS • November-December, 1954

SPECIAL FEATURES

Nunn but the Finest — Fred Reynolds.....	25
Children Call It Fun.....	29

MUSIC

You're a Muen or an Auper?.....	28
Assistance for Collectors.....	36
Programs of Recorded Music	
Orchestral Music — Dr. Herman Neuman.....	37
The Intimate Opera — David Hall.....	38
Chamber Music — Dr. Herman Neuman.....	39
Keyboard Music — Oliver Daniel.....	40
Jazz for the Holidays — Fred Reynolds.....	41
Music from the Theatre — Ben Deutschman.....	42
"Gift for the Giver" — Don Gillis.....	43
Music Tape Reviews — Dr. Hans Wolf.....	54

EQUIPMENT

Better Bass Reproduction, Part 2 — Milton B. Sleeper.....	46
Inside Information.....	49

INSTALLATION

FM Tuning with a Telephone Dial — Jan Syrjala, Alex Stevens.....	32
Drawing Board Project No. 2.....	44

OPERATION

Check Your FM Antenna.....	35
----------------------------	----

DEPARTMENTS

Records, Tape, and FM Radio.....	8
Music for Your Home.....	23
Directory of Hi-Fi Record and Equipment Dealers.....	56
Ideas for You.....	66
Advertisers Index.....	71
Buy, Sell, and Swap.....	72

COVER PHOTO: We are very proud of this exclusive picture, and the one on page 43, because they were the only photos taken during the rehearsal and recording sessions for the discs and tapes to be distributed by the Symphony of the Air (formerly the Toscanini-NBC Orchestra) as a "Gift for the Giver." This view of the world's most renowned group of musicians at work in their shirtsleeves is one never seen by the public!



AA-902 PILOTONE AMPLIFIER \$39.95

Williamson type Amplifier with special inter-leaved wound Output Transformer and push-pull output. Contains 5 tubes including rectifier, Frequency Response ± 1 db, 15 to 40,000 cycles at 10 watt output. Distortion less than 1% at 10 watts and less than .1% at 1 watt from 30 to 15,000 cycles. Provided with speaker output impedances of 4, 8 and 16 ohms. Underwriters Laboratories Approved.



AA-903 PILOTONE AMPLIFIER \$69.50

Williamson type 10 watt Amplifier, with built-in Pre-amplifier. Seven tubes including Rectifier and push-pull output tubes. On-Off Volume, separate Bass and Treble Controls and Equalizer selector switch for LP, NAB, AES and Foreign recordings. Frequency Response ± 1 db, 15 to 40,000 cycles. Distortion less than 1% at 10 watts. Hum Level 70 db below 1 volt. Three inputs for Radio and Auxiliary equipment and one variable impedance input.

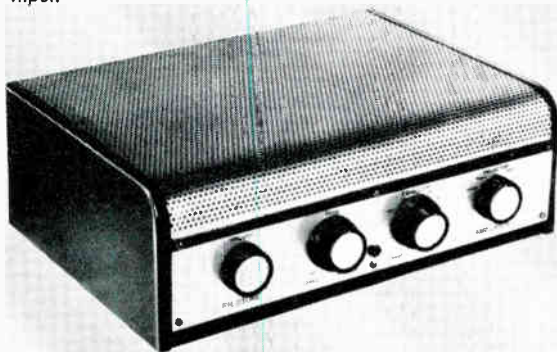

AA-420 PILOTONE AMPLIFIER \$99.50

Unsurpassed Williamson type high fidelity audio amplifier with push-pull 5881's for full 15 watt output combined with professional preamplifier for maximum efficiency and flexibility in most convenient space saving format. Six tubes plus Rectifier.

Frequency Response: ± 1.0 db, 15 cps. to 20,000 cps. at rated output. Total Harmonic Distortion: Less than 1%. Intermodulation Distortion: Less than 2% at rated output. Hum and Noise Level: 80 db. below rated output.

Dual equalization switches provide five positions of treble roll-off and five positions of bass turnover. Loudness control with individual level setting controls for three inputs.

PILOT RADIO CORPORATION

LONG ISLAND CITY 1, NEW YORK

Write for Free Booklet M-4



**PILOTONE
AMPLIFIERS**

*the ultimate in electronic
skill engineered by*

Pilot

RADIO CORP.

**Matched Companion to the
World-Famous Pilotuners**



AA-410 PILOTONE AMPLIFIER \$49.50

Unexcelled Williamson-type High Fidelity Amplifier for consistent, dependable performance employing rugged full power 5881's for full 15 watt output. Four tubes and Rectifier.

Frequency Response: ± 0.1 db, 15 cps. to 20,000 cps. at rated output. Total Harmonic Distortion: Less than 1%. Intermodulation Distortion: Less than 2%. Hum and Noise Level: 90 db. below rated output. Potted output transformer constructed with inter-leaved winding for reduced leakage inductance.



AA-904 PILOTONE AMPLIFIER \$89.50

World famous ultra-linear Williamson Circuit using push-pull KT-66's for thirty watts audio output, now in new, convenient compact size. Frequency Response: ± 1 db, 15 cps. to 50,000 cps. at 15 watts. $\pm .1$ db, 20 to 20,000 cps. at 1 watt. Total Harmonic Distortion: Less than 0.1% at 10 watts. Less than .3% at 25 watts. Intermodulation Distortion: Less than 0.5% at 10 watts. Hum and Noise Level: 90 db. below 10 watts.

Slightly higher West of Rockies

Announcing MUSIC-APPRECIATION RECORDS

TO HELP YOU UNDERSTAND MUSIC BETTER AND ENJOY IT MORE



ON ONE SIDE there is a full performance of a great musical work, featuring orchestras and soloists of recognized distinction in this country and abroad. You listen to this performance first, or afterward, as you desire, and then . . .



ON THE OTHER SIDE is an illuminating analysis of the music, with the themes and other main features of the work played separately with running explanatory comment, so that you can learn *what to listen for*.

A NEW IDEA OF THE BOOK-OF-THE-MONTH CLUB

ALL TOO FREQUENTLY, most of us are aware, we do not listen to good music with due understanding and appreciation. There is no doubt about the reason: we are not properly primed about *what to listen for*. MUSIC-APPRECIATION RECORDS meet this need—for a fuller understanding of music—better than any means ever devised. After hearing several of these records, all the music you listen to is transformed, because you learn in general what to listen for. This highly enjoyable form of self-education can be as thorough as the Music-Appreciation courses given in any university.

YOU SUBSCRIBE BUT TAKE ONLY THE RECORDS YOU WANT . . . A new MUSIC-APPRECIATION RECORD will be issued—for subscribers only—every month. Ultimately

all the great masterpieces of music will be included. The announcement about each forthcoming record will be written by Deems Taylor. After reading this descriptive essay (presented in a form that can be kept for long use) you may take the record or not, as you decide at the time. *You are not obligated as a subscriber to take any specified number of records.* And, of course, you may stop the subscription at your pleasure—at any time!

TWO TYPES OF RECORDS AT A RELATIVELY LOW COST . . . All MUSIC-APPRECIATION RECORDS will be high-fidelity, long-playing records of the highest quality—33 $\frac{1}{3}$ R.P.M. on Vinylite. They will be of two kinds: first, a so-called Standard Record—a *twelve-inch* disc—which will present the performance on one side, the analysis

on the other. This will be sold at \$3.60, to subscribers only. The other will be an Analysis-Only Record—a *ten-inch* disc—priced at \$2.40. The latter will be made available each month for any subscriber who may already have a satisfactory long-playing record of the work being presented. (A small charge will be added to the prices above to cover postage and handling.)

TRY A ONE-MONTH SUBSCRIPTION—NO OBLIGATION TO CONTINUE . . . Why not make a simple trial, to see if these records are as pleasurable and as enlightening as you may anticipate? The first record, BEETHOVEN'S FIFTH SYMPHONY, will be sent to you at once—at *no charge*. You may end the subscription immediately after hearing this record, or you may cancel any time thereafter.

As a demonstration
**WILL YOU ACCEPT
WITHOUT CHARGE**

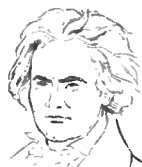

Beethoven's Fifth Symphony

A NEW RECORDING BY THE LONDON SYMPHONY ORCHESTRA

Norman del Mar, *Conductor*
Analysis by Thomas Scherman

YOU HAVE HEARD this great work countless times—what have you heard in it? And what may you have failed to hear? This demonstration will show you what you may have been missing in listening to great music.

PLEASE RETURN ONLY IF YOU HAVE A RECORD PLAYER WHICH CAN PLAY 33 $\frac{1}{3}$ R.P.M. LONG-PLAYING RECORDS

MUSIC-APPRECIATION RECORDS R19-11
c/o Book-of-the-Month Club, Inc.
345 Hudson Street, New York 14, N. Y.

Please send me at once the first MUSIC-APPRECIATION RECORD, Beethoven's Fifth Symphony, without charge, and enter my name in a Trial Subscription to MUSIC-APPRECIATION RECORDS, under the conditions stated above. It is understood that, as a subscriber, I am not obligated to buy any specified number of records, and may take only those I want. Also, I may cancel this subscription after hearing this first record, or any time thereafter at my pleasure, but the introductory record is free in any case.

Mr. {
Mrs. {
Miss {
Address (Please Print)

City Zone State

MAR 1

the new

HORIZON



HORIZON *Criterion*
AM-FM TUNER \$169.95



HORIZON 20
25 WATT AMPLIFIER \$84.95



HORIZON 10
10 WATT AMPLIFIER \$79.95

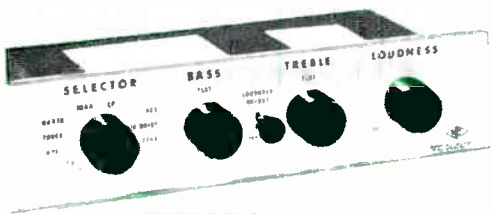

HORIZON 5
PREAMPLIFIER CONTROL UNIT \$49.95

Never before a tuner so versatile!

You can enjoy full-band AM!

You can listen to matchless, drift-free FM!

You can hear *both* at the same time, using dual sound systems!

You can receive revolutionary new binaural broadcasts as they are made available in your area! Two gain controls and separate tuning condensers are provided—one for AM, one for FM!

Exclusive Mutamatic FM Tuning eliminates all hiss and noise between stations, so annoying when tuning conventional tuners! Stations leap out of velvety silence—stay locked in automatically! Unit features new "linear impedance" detection. Superior design eliminates drift.

An exceptional capture ratio rejects all unwanted signals up to 80% of the strength of the desired signal.

THE FM SENSITIVITY IS TRULY PHENOMENAL— $.5$ MICROVOLTS!

To surpass the present high level of amplifier design, National proudly introduces new power amplifiers with a revolutionary new output circuit employing unity coupling.

With unity coupling, the output transformer is no longer required to supply the coupling between output tubes for distortion cancellation as in normal push-pull circuits. Instead, the transformer supplies only the impedance matching between the tubes and the speaker system, thus eliminating impulse distortion created by transformers. Music is reproduced with an unclouded transparency—at all listening levels—never before achieved!

The HORIZON 20 is a 20-watt amplifier with a total harmonic distortion of less than .3% and total intermodulation distortion of less than 1% at full rated output. Frequency response is ± 1 db 20 cps to 20 kcs; ± 1 db 10 cps to 100 kcs. Power response at rated output is $\pm .15$ db, 20 cps to 20 kcs. Hum and noise is 80 db below rated output.

Incorporating the revolutionary new unity-coupled circuit in a 10-watt amplifier design, the HORIZON 10 offers performance never before achieved at such a moderate price!

The built-in preamp-control unit offers a choice of 3 inputs, 3 record equalization curves, a loudness control and separate bass and treble controls.

Harmonic distortion is less than .5%; intermodulation distortion, less than 2% at rated output. Frequency response is ± 1 db, 20 cps to 20 kcs; power response, ± 2 db, 20 cps to 20 kcs. Hum and noise are better than 70 db below rated output on high-level input, better than 50 db on low level input.

The HORIZON 5 achieves a new high in frequency response (± 1 db, 20 cps to 100 kcs) and voltage output (up to 10 volts)—a new low in distortion (less than .2% harmonic, .3% intermodulation)!

Four inputs, 7 record equalization curves, a loudness-volume control and bass and treble controls are provided.

Entire unit slips quickly, easily into either the tuner or 20-watt amplifier.

in high fidelity



Furniture by Hans Knoll Associates
Gown by Cecil Chapman

Only a listening test can convey the magic of "Mutamatic" Tuning . . . the distortion-free difference of "Unity-Coupling" . . . the velvety silence of hum-free preamplifiers . . . the fabulous flexibility of complete tone control . . . the bedrock stability of National FM! Your National dealer is waiting now to give you a thrilling demonstration!

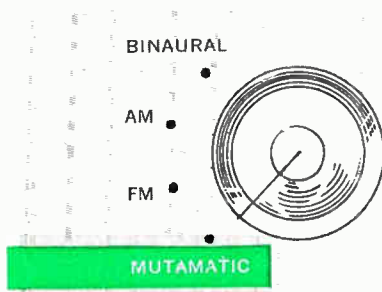

EXCLUSIVE *Mutamatic*

Completely eliminates all noise and hiss between FM stations. The entire FM band tunes with an "in-and-out," on-the-nose precision! Stations stay locked in without drifting. This is only one of the many advanced features which make the Criterion the finest tuner ever designed!

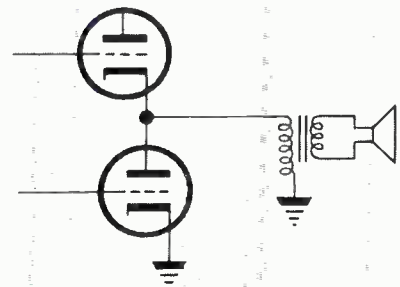

EXCLUSIVE *Unity Coupling*

With Unity Coupling in the Horizon 20 and Horizon 10, the output transformer is no longer required to supply coupling between output tubes for distortion cancellation as in normal push-pull circuits. Instead, the transformer supplies only the impedance matching between the tubes and the load, thereby eliminating transformer-caused impulse distortion.

tuned to tomorrow



National



FOR THE NAME OF YOUR NEAREST DEALER OR
FOR COMPLETE SPECIFICATIONS WRITE DEPT. M 114

Imagine Your Child LOVING Piano Lessons

A merry new "full-of-fun" way
Children 4-5-6 and 7 learn the fundamentals
of music and piano — AT HOME!

If you are a parent—or if you are looking for an excitingly different gift for a young child—here's good news. The Fred Waring Music Workshop has perfected an entirely new approach to teaching music to young children. Now your child can learn to read music even before he goes to school. Just as you prepare him for school by helping him to count and recognize his letters, so you can guide him as he takes his first steps in music...and have fun doing it.

Colorful PIANO SESSIONS

Everything you need is included in the gay PIANO SESSIONS package—large, colorful books, games, puzzles, cutouts, quizzes, pictures to color, child-size sheet music, rhymes and cartoon characters that will fascinate your child. Watch his delight when he finds that he can make the piano growl like the grumbly bear...or toot like a train whistle. He'll meet Bobby Bass and Bones, Trudy Treble and Tom, and he'll learn about rhythm from Creepy the Cricket. You'll share his thrill of real accomplishment as he plays his first simple tunes.

Parents Need No Music Training

PIANO SESSIONS opens an entirely new area of enjoyable parent-child playtime activities. To children it is like a game, but actually it is a carefully constructed method of teaching children the real fundamentals of music at the piano. A "session" normally spans about 15 minutes and most youngsters enthusiastically ask for lessons several times a day. Having once learned a lesson they will repeat it, over and over, by themselves.



Prepares For Formal Lessons

Traditionally, children begin piano lessons at 8, 9, or 10 years. This immediately puts music study 3 to 5 years behind school subjects, and only the occasional youngster ever catches up. Then, during the 'teen years, imposed lessons and practice that seem "childish" cause a great majority of students to give up the piano. With PIANO SESSIONS children learn to read music and ENJOY the piano during the most impressionable years. When the time for formal lessons arrives, their interest is maintained by their mastery of the fundamentals, happy associations, and immediate high level of achievement with a competent professional music teacher. Rapid transition can be made to other instruments.

Fully Tested and Proved

PIANO SESSIONS is the result of 5 years of research and testing by the staff of the Fred Waring Music Workshop. It has been tested with outstanding success in more than 3000 homes across the nation. It is being sold with a money-back guarantee if you are not thrilled by your child's achievements after only one month.



FRED WARING



A Distinctive Christmas Gift!

Piano Sessions
Fred Waring Music Workshop
Box 246, Delaware Water Gap, Pennsylvania

Please send me postpaid sets of PIANO SESSIONS
at \$9.95 per set. Check or money order is enclosed.

NAME

ADDRESS

CITY STATE

Note: If you would like to have sets of PIANO SESSIONS
sent directly to children as gifts, please write giving us
complete instructions with greeting to be enclosed.

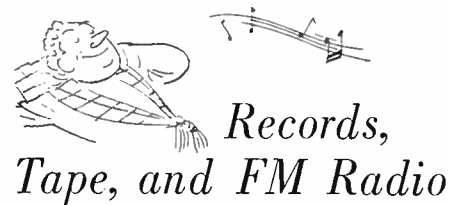

Los Angeles Audio Fair

Will be held at Hotel Alexandria, February 11 to 13. Holding the show from Friday to Sunday will enable many people to attend who could not get away on working days. On Thursday evening, the 10th, the show will be open for the trade only. The Los Angeles event ranks second among audio shows in number of visitors. Manager is William A. Cara, 3585 S. Bentley Avenue, Los Angeles 49.

Interference:

What does a little boy think about when he's caught playing with his father's hi-fi equipment? You can read all sorts of thoughts into the face of the little lad



pictured here. He is the son of John M. Coleman, manager of Audio-Vision, S. A., in Mexico City. A letter from Mr. Coleman suggests the title "Compensating for Flat Response." We'd be inclined to call it "Wow!" Incidental information: Mexico, as one might expect, is coming to take a serious interest in high-quality reproduction.

Curiosities for Collectors

Under the title "Curious Episodes for Collectors Only", Emory Cook of Stamford, Conn., has issued a listing of new record releases which range from stories related by one-time captains of sailing vessels, and Mississippi guitar blues, to a marimba band and a steam piano. Some are binaural. All are extremely interesting.

Missing Names of Jazzmen

Bob Smith, of Frederick, Md., wrote us about the pictures on page 22 of our Sep-

Continued on page 18

Music at Home

Never
**have you heard
such fidelity.....**

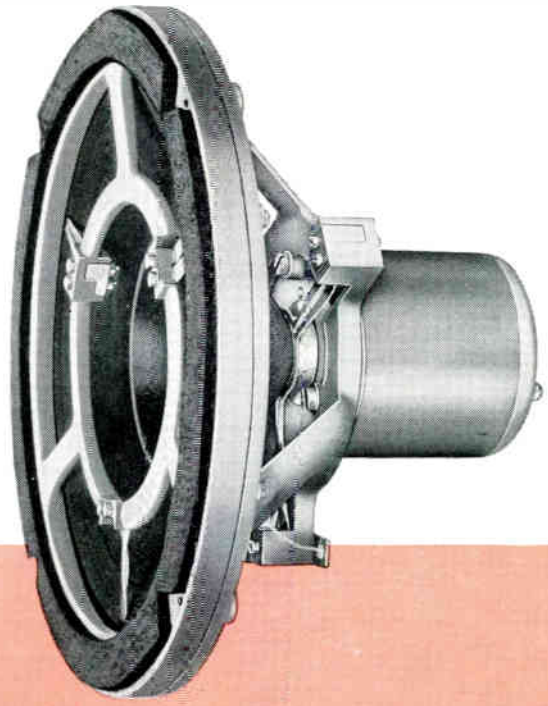

THE LOUDSPEAKER THAT OFFERS YOU THE
CLOSEST APPROACH TO ABSOLUTE FIDELITY

GOODMANS

Smooth Response from
20 to 20,000 cycles

Axiom **80**



\$68⁵⁰ *Slightly higher*
NET *on West Coast*

The most significant single contribution to the superb performance of the Axiom 80 is the cone suspension. Flexible cantilever struts are employed at 3 points only: on the rim and at the voice coil.

In this way, Goodmans has achieved the closest approach to free suspension — the theoretical ideal, and has kept the fundamental resonance to only 20 cycles. These are accomplishments unmatched by any speaker regardless of cost.

Some power had to be sacrificed to attain this end. Rated at 5 watts—considerably more than

required for home systems — the Axiom 80 can be used in multiples of 2 or more for large installations. The power handling capacity is thus proportionately increased.

These exciting design developments are of utmost importance to the listener. They represent a new experience in reproduced sound. Properly baffled, the Axiom 80 provides smooth response from 20 to 20,000 cycles, ± 3 db. The bass is crisp and clean with no trace of 'hangover' — you hear the true fundamentals. The middle register is clear and articulate. The high frequencies are present without intrusion — adding character and timbre.

Never... have you heard such fidelity

Write for complete data including suggested cabinet dimensions.

ROCKBAR CORPORATION, 215 East 37th Street, New York 16, N. Y.





Irving Rossman

President — The Pentron Corporation
Largest Exclusive Manufacturer of Tape Recorders

REASONS WHY MR. IRVING ROSSMAN USES

STERLING PERFORMANCE!

Encore is the newest of all recording tapes...scientifically developed for brilliant, artistic sound reproduction.

LABORATORY QUALITY!

Every inch of Encore Tape is precision-tested and laboratory bonded for uniformity, freedom from noise and distortion, and unvarying output from reel to reel.

EXCLUSIVE SCIENTIFIC MANUFACTURING PROCESSES!

These insure optimum sensitivity, without loss of quality, adherence of oxide coating, maximum tensile strength, longest shelf-life and splice-ability.

BUILT-IN CONVENIENCE AND EXTRA VALUE!

Without extra cost, Encore Tape provides the "extras" needed to preserve superior audio performance. Every reel is packed in a polyphane bag, with spliced color-coded leader for extra cue time, and 5 full inches of Encore splicing tape—a complete recording package!

Encore

RECORDING TAPE *

Developed and manufactured by
the Electro-Magnetic Products Division,

TECHNICAL TAPE CORP., Morris Heights, New York 53, N. Y.

Distributed in Canada by Canadian Technical Tape, Ltd., 5541 Papineau Ave., Montreal



Encore means more in recorded results — Just try it!

* **IMPORTANT!** Encore is *not* a pre-recorded tape. Treasure Tapes are not for sale, except as a demonstration of the recording quality *you* can obtain using your own tape recorder.

The *Encore* First *Treasure* Tape



A memorable achievement on tape ... *NOT* for sale in any other manner, at any price!

You pay only **50c** Returnable

(if you wish) with the purchase of a standard 5", 7" or 10 1/2" reel of Encore Recording Tape—the same quality as Treasure Tape.

An excerpt from the master tape of Westminster Recording Album #WL5282 containing: 1812 Overture Romeo & Juliet March Slav

WHAT IT IS ...

Simply stated—this is an excerpt duplicate of the actual master tape from which one of the finest high fidelity records now on the market has been made...

WESTMINSTER'S magnificent recording of the **1812 OVERTURE** by **TCHAIKOVSKY**

played by the London Symphony Orchestra
Conducted by Hermann Scherchen

Of the more than 12 long playing versions of this beloved music which are now available, we have no doubt that a huge percentage of the public and experts alike will consider this the finest! Westminster's entire reputation and meteoric success have been built upon recordings of such startling musical quality and realistic, "balanced" reproduction!

Now—to prove the superiority of *Encore* over all other recording tapes, regardless of price — we offer you a full 9-minute excerpt from this Westminster Album, made on the same tape recorder which processed the original master with a frequency response to 15,000 cycles! This *Encore* "Treasure Tape" is not "for sale" in the ordinary sense. Its purpose is to prove that you can obtain excellent results with your own tape recorder, on *Encore* Tape.

If you are fortunate enough to have a record player and a tape recorder, buy the Westminster Album, No. WL-5282 and enjoy the full 50 minutes of music it contains. Then compare the sound with this *Encore* Treasure Tape. You will never tire of the experience! Play the Treasure Tape and compare the sound with any other tapes you have used. Let the *Encore* "Treasure Tape" be the yardstick to measure the results you can achieve with your own tape recorder, on *Encore* Tape and *Encore* Tape alone!

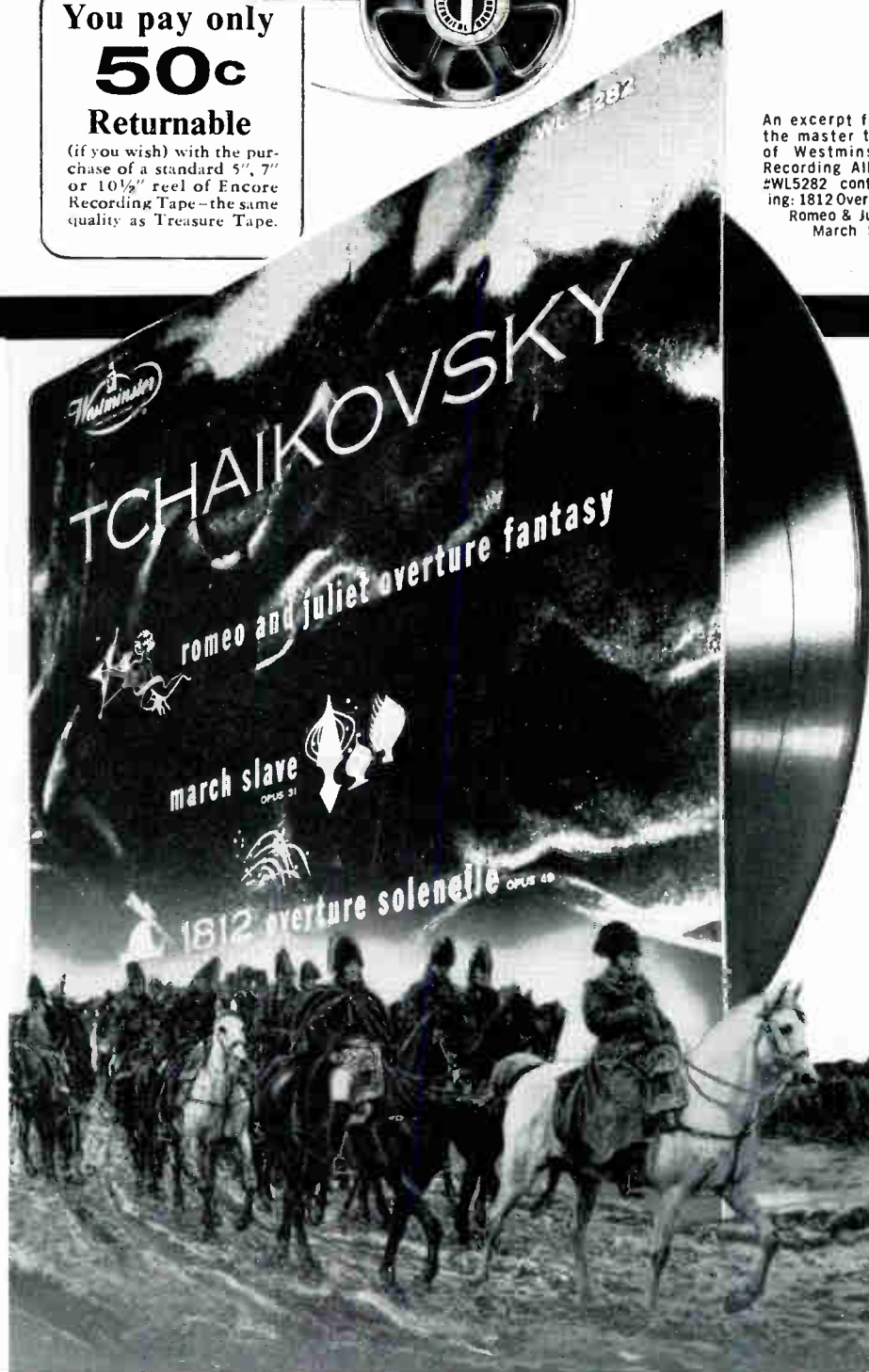

HOW YOU GET YOUR ENCORE TREASURE TAPE ...

The series of Treasure Tapes (this is the first) are not for sale in any other manner than as stated in this advertisement. Go to your nearest high fidelity dealer and ask for one. It will cost you 50¢, which is returnable, on the purchase of any standard reel of *Encore* Recording Tape. If your dealer cannot provide the Treasure Tape, or is "sold out", mail the coupon. Send no money. We will supply a list of dealers who will be glad to serve you with this and all future Treasure Tapes.

IMPORTANT! *Encore* is not a pre-recorded tape. *Treasure Tapes* are not for sale, except as a demonstration of the recording quality you can obtain using your own tape recorder.

For list of dealers — mail this coupon — Send no money!

SPECIAL OFFER:

You pay only 50¢

returnable (if you wish) with the purchase of a standard 5", 7" or 10 1/2" reel of *Encore* Recording Tape—the same quality as your *Treasure* Tape.

Because of the anticipated demand, this offer is necessarily subject to cancellation or change without notice.

TECHNICAL TAPE CORP.
Morris Heights
New York 53, N. Y.

MH-11

Gentlemen:

Please send me a list of dealers who carry the series of *Encore* Treasure Tapes.

Name: _____

Address: _____

City: _____ Zone: _____ State: _____

INTRODUCING

THE Solitaire



New Integrated Audio Amplifier

by craftsmen

Unquestionably, Craftsmen's new SOLITAIRE is today's perfect answer to integrated audio amplifier design. It combines an equalizer-preamplifier, a dual noise filter, and a 20-watt amplifier, with power sufficient to drive any speaker system perfectly. Its controls permit unequalled flexibility, yet retain operating ease. Its chassis is housed in handsome, leather-etched steel, a styling innovation.

Above all, the SOLITAIRE provides you with superior sound and more usable features per dollar — another engineering achievement from Craftsmen, at only \$113.50 net!

Specifications

Power Output: 20 watts-Reserve for 40 watt peaks.
Freq. Response: ± 1 db 10 cycles to 30 KC at 20 watts.
Hum and Noise: -60 db on phono. -70 db on high channels.
Distortion: Less than 0.1% IM at normal listening levels, measured through the total audio system—not the power amplifier alone.
Damping Factor: 12:1.
Size: 4 x 14½ x 11½", Weight: 22 lbs.
Inputs: (4) Phono, TV, Tuner, Tape.
Output: Cathode follower for tape recorder.

Equalization: 6 useable positions—AES, LONDON, RIAA, LP, EUROPEAN, NAB.
Bass Tone Control: 15 db boost and 13 db attenuation at 50 cycles.
Treble Tone Control: 15 db boost and 13 db attenuation 10 KC.
Loudness Control: FuH Fletcher-Munson compensation with front panel level-set. Loudness contour continuously variable from full to none.
Dual Filter System: Low cut filter, 3 positions: Flat, 40 cycles, 150 cycles, at 12 db per octave slope. High cut filter, 3 positions: flat, 6,500 cycles, 3,000 cycles, 12 db per octave slope.

For complete information send for bulletin 13.

World's Largest Exclusive Makers of High Fidelity Equipment

The Radio Craftsmen Incorporated, Dept. M11
4403 N. Ravenswood Ave., Chicago 40, Illinois

now! at prices you can afford... a true

exponential speaker system

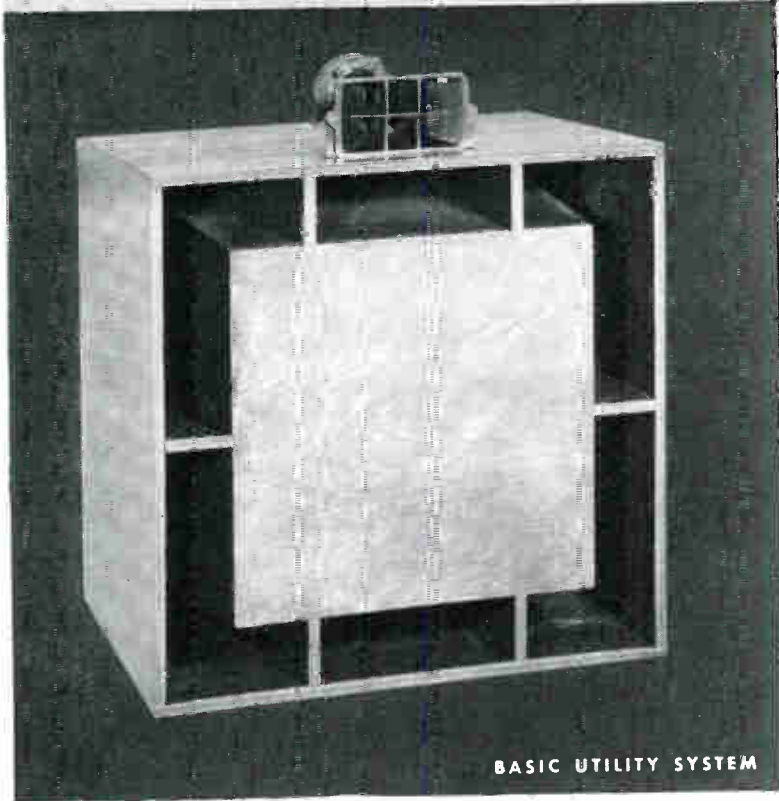

BASIC UTILITY SYSTEM



the new
Srazier-May
horn

a new dimension in sound reproduction

... at amazingly small cost

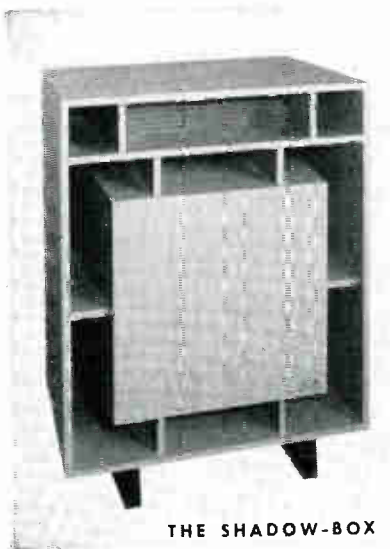

THE SHADOW-BOX



THE TRADITIONAL

*bench-crafted
cabinetry*

See the variety of beautiful F-M horn models in authentic bench crafted cabinets on display at the *Sight & Sound Exposition* at Chicago's Palmer House, Room 815, and at the *New York Audio Fair*, Hotel New Yorker, Room 533.

1. *Revolutionary New Damping principle* ... practically eliminates hangover and intermodulation distortion.
2. *Compactness* of unique design gives performance equal to enclosures three times the size.
3. *High Dispersion Factor* ... eliminates the "point source" of sound.
4. *Low Distortion* ... lower than many amplifiers.
5. *High Definition* ... each instrument is reproduced with authentic brilliance and clarity.

WRITE FOR FREE LITERATURE AND PRICE LIST.

International Electronics Corp.

159 HOWELL STREET
DALLAS, TEXAS

the professionals are adding

CONCERTONE

for Christmas... ❄️

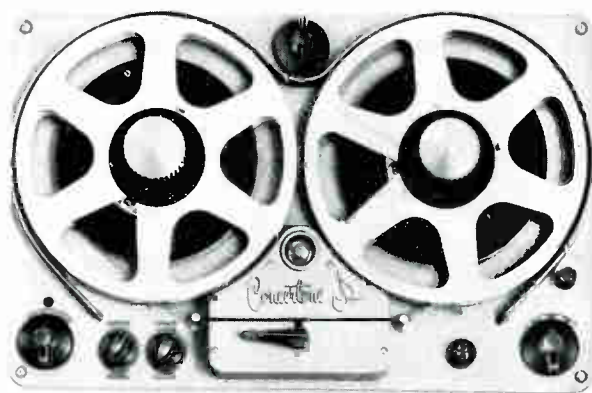

BECAUSE it completes
the home audio system.

- it's the lowest priced tape recorder with *all* of the listening and operating qualities of costly professional models.
- up to 2 hours continuous recording.
- monitors from tape while recording.
- flawless tape motion—3 separate heavy duty motors; 2-speed direct drive—minimum wow and flutter.
- horizontal or vertical operation.

BECAUSE with Concertone; "... just like being there!"

AND BECAUSE until Christmas 1501 Concertone is priced at \$345, CARRYING CASE INCLUDED!

WRITE FOR BROCHURE NO. 12 N



SPECIAL HOLIDAY GIFT OFFER:

Handsome carrying case
(Model 505C, user's net \$47.50)
free with any 1500 Series recorder.

Models 1501 and 1503,

Fair Traded at professional
users' net (including case)—**\$345**

Model 1502 (including case)—\$445.

SUPPLIES LIMITED. OFFER MAY BE WITHDRAWN AT ANY TIME WITHOUT NOTICE.



Berlant Concertone

4917 W. Jefferson Blvd., Los Angeles 16, Calif.

Manufacturers of Berlant studio recorders and accessories

THE FOLLOWING FRANCHISED DISTRIBUTORS ARE FEATURING THIS SPECIAL PROMOTION:

- | | |
|---|--|
| BALTIMORE
Hi-Fi-Shop, American Distrib. Co.,
2 No. Howard St.
BELLINGHAM, WASH.
Waltkus Supply, 110 Grand Ave.
BEVERLY HILLS
Talk-O Communication Co., 407 Commercial St.
CANTON
Grosman Camera Center,
331 Cleveland Ave. No. W.
CHICAGO
RFD Arthur Nagel, Inc., 918 E. 55th St.
Voice & Vision, 53 E. Walton Place
CINCINNATI
Customcrafters Audio, Inc., 2259 Gilbert Ave.
CLEVELAND
Olson Radio Warehouse, 2020 Euclid Ave.
Pioneer Electronic Supply, 2115 Prospect
COLUMBIA, S. C.
Dixie Radio Supply, 1628 Laurel St.
DETROIT
K.I.A. Laboratories, 7422 Woodward Ave.
GLENDALE
Glenvale Recorders Co., 319 No. Central Ave.
GRAND RAPIDS
Radio Parts, Inc., 542-518 So. Division
HOUSTON
Wrye Co. Ltd., 2045 Welch
Audio Center, Inc., 1633 Westheimer
JAMAICA, N. Y.
The Audio Exchange, Inc., 159-19 Hillside Ave.
JUNEAU, ALASKA
Alaska Radio Supply, Box 2538
LOS ANGELES
Gateway to Music, 3089 Wilshire Blvd.
Los Angeles Portable Recorders,
521 No. La Cienega
Magnetic Recorders Co., 7120 Melrose Ave. | MINNEAPOLIS
Paul A. Schmitt Music Co., 88 So. Tenth
NASHVILLE
Nicholson's High Fidelity, 105 Eighth Ave. North
NEW YORK
Goody Audio Center, Inc., 235 W. 49th St.
Grand Central Radio, Inc., 124 E. 41th St.
Heins and Bolet, 68 Cortlandt St.
Leonard Radio, 69 Cortlandt St.
Peerless Camera Stores, Inc., 415 Lexington Ave.
Sonocraft Corp., 115-117 W. 45th St.
Terminal Radio Corp., 85 Cortlandt St.
OAKLAND
W. D. Brill Co., 10th & Jackson Streets
PITTSBURGH
Radio Parts Co., 929 Liberty Ave.
RENO
Art Rempel Sound Service, 160 Wells Ave.
SAN DIEGO
Breier Sound Center, 3781 Fifth Ave.
SAN FRANCISCO
High Fidelity Unlimited, 211 So. San Mateo Dr.
San Francisco Radio Supply, 1282 Market St.
SEATTLE
Seattle Radio Supply, Inc., 2117 Second Ave.
Western Electronic Supply Co., 717 Dexter Ave.
SPOKANE
20th Century Sales, Inc., 1021 W. First Ave.
ST. LOUIS
Aeolian Co. of Missouri, 1004 Olive St.
TORONTO, CANADA
Custom Sound and Vision, 390 Eglinton Ave. W
TUCKAHOE, N. Y.
Boynon Studio, 10 Pennsylvania Ave. |
|---|--|



Through Magnavox the comic operas of Gilbert & Sullivan come to life.

Hear the world's greatest music as you've never heard it before

Magnavox brings music into your home with all the fidelity of a master performance in the concert hall. For a Magnavox is an instrument in the truest sense of the word. Without mechanical distortion, without the intrusion of unbalanced emphasis—faults of many so-called high-fidelity reproducers—Magnavox fills your living-room with the whole of the living performance. Whether the music is Gilbert & Sullivan or Grieg, you hear overtones and timbre with a fidelity

never heard before in recorded music. **The new Magnavox "Symphonic Modern,"** a master high-fidelity instrument combining AM-FM radio with phonograph and tape recorder, has an exceptional audio system with two 12-inch low-frequency speakers coupled in a cross-over network with a high-frequency horn speaker, to give true full-range reproduction. **Twenty watts** of undistorted audio power are produced by the high-fidelity amplifier—full power reserve

to meet the demands of the most expansive symphonic performance. And you can play any size record automatically. Famous Pianissimo Pick-Up, with dual diamond-sapphire styli, translates even the lowest frequencies without distortion. **High-Fidelity Phonograph** prices start as low as \$99.50. See your Magnavox dealer—his name is listed in your classified phone book under "TV" or "Radio-Phonograph." The Magnavox Company, Ft. Wayne, Ind.

"Symphonic Modern"
Radio-Phonograph

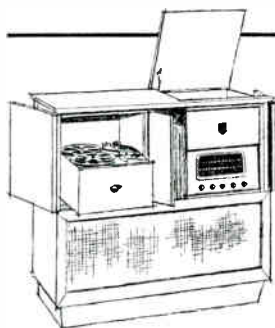

You are years ahead with Magnavox
New Magnavox "Symphonic Modern" AM-FM radio-phonograph includes a tape recorder and reproducer. You can record memorable musical radio broadcasts and build your own "tape" library or buy pre-recorded tapes. Note convenient record storage file at the center. The Symphonic Modern, illustrated above, closed, is available in either hand-rubbed mahogany or cherry and fine white oak. \$745.00

Better Sound . . . Better Buy

the magnificent
Magnavox
high-fidelity radio-phonograph



PRICES INCLUDE FEDERAL TAX AND ARE SUBJECT TO CHANGE—SLIGHTLY HIGHER IN FAR WEST

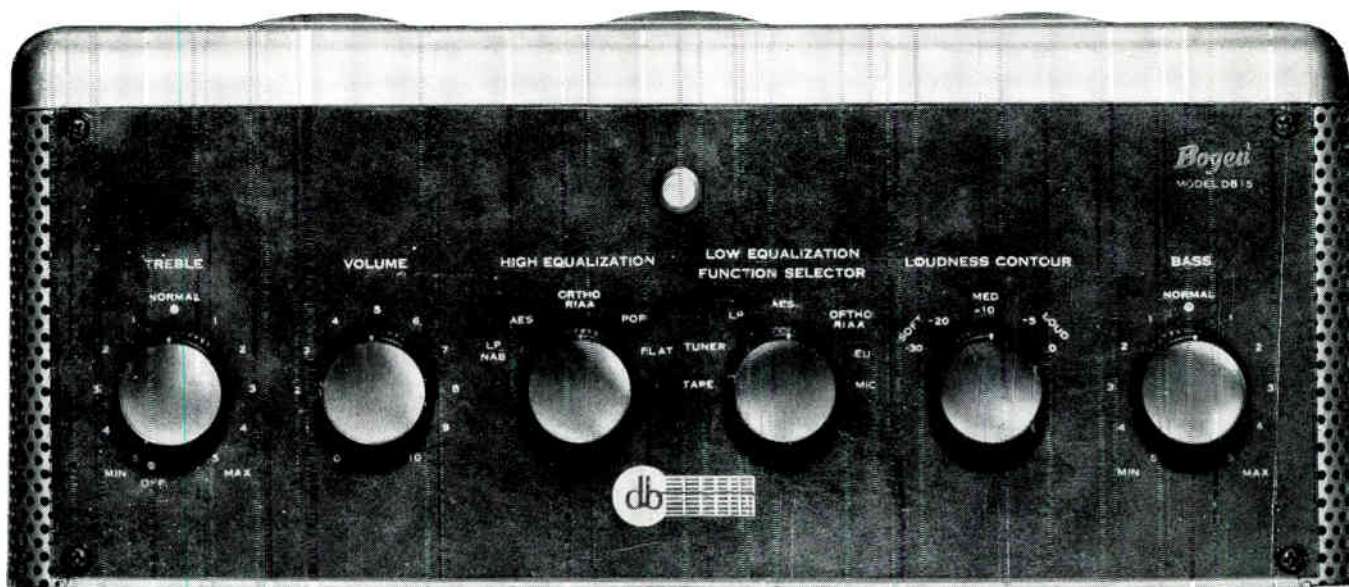

A Little Fellow with a 15 Watt Wallop

BOGEN DB15G AMPLIFIER

Now you can own custom audio components which combine superb quality with a mechanical design so compact that they provide the solution to almost any installation problem. This DB15 amplifier, for instance, gives you a full 15 watts with distortion of less than 0.5% at full power. As for flexibility: the DB15 features a two-section record equalizer

allowing a choice of 20 combinations of low frequency compensation and high-frequency roll-off, separate continuously-variable tone controls, exclusive Bogen Loudness Contour Selector, separate equalized inputs, and tape recorder output jack. DB15G—*Amplifier in Handsome Cage. Only 13½" x 9" x 6¼". No installation problems. \$99.00.* DB15—*Same unit without cage. 12¼" x 8¾" x 3¾". \$89.95.*

BOGEN R640G FM-AM TUNER



Perfect companion for high-performance amplifiers, this tuner is especially designed to avoid duplication of controls and to fit neatly into close quarters. Features high sensitivity (5 microvolts), high selectivity, negligible distortion and flat frequency response (within 1 db from 50 to 15,000 cycles on FM). A special, controllable AFC circuit prevents drift and simplifies tuning. R640G—*Tuner in Cage. Matches DB15G. Only 13½" x 9" x 6¼". \$112.95.* R640—*Same tuner without cage. The ideal mate for DB20, DB15 or DB10A amplifiers when installed in cabinetry. 13¼" x 7¾" x 5½". \$105.50.*

BOGEN DB20 AMPLIFIER



The magnificent DB20 is rated the "Best Overall Quality" by a leading consumer organization as well as by thousands of audiophiles all over the world. The DB20 combines 20 watts of undistorted power with remarkable flexibility of control. Even at full rated output distortion is only 0.3%! Other features include the exclusive 5-position Loudness Contour Selector, a 10-position input selector—phono-equalizer, output jack for tape recorders, and extremely effective non-resonant separate tone controls. \$99.00.

DB20DF. The DB20 is now available with the new exclusive Bogen Variable Damping Factor. This built-in control provides cleaner bass response by reducing speaker distortion and "tuning out" resonant peaks. \$108.00.

BOGEN DB10A AMPLIFIER



Here's Bogen's famous DB10A, priced to fit any budget. This compact marvel of tone delivers 10 watts of power at less than 3% distortion and has a flat frequency response (plus or minus 1 db) from 30 to 18,000 cycles. In addition to a built-in phono pre-amplifier, the DB10A features a special tape recorder output jack and a 3-position equalizer for LP, 78, and Pop. \$54.45.

Note: All prices slightly higher in the West.



SECOND PRINTING:

"Understanding High Fidelity" is fast becoming a standard manual of hi-fi theory and application. Clearly and concisely, this new enlarged 56 page edition presents invaluable practical information to help you get more out of any sound system. Send 25¢ for your copy.

Bogen
HIGH FIDELITY
BECAUSE IT SOUNDS BETTER

David Bogen Co., Inc. Dept. AK
29 Ninth Ave., New York 14, N. Y.

Send "Understanding High Fidelity" (25¢ enclosed) and free catalog.

Name _____

Address _____

City _____ Zone _____ State _____

Send free catalog only.

Announcing the New

FAIRCHILD 220 SERIES CARTRIDGE

An unparalleled achievement in high fidelity cartridge design and performance

From Fairchild now comes a development so startling that it virtually obsoletes every other quality cartridge on the market. Look at the response curve! No peaks—completely uniform response to 17,000 cycles—and slow roll-off beyond—giving smooth natural sound!

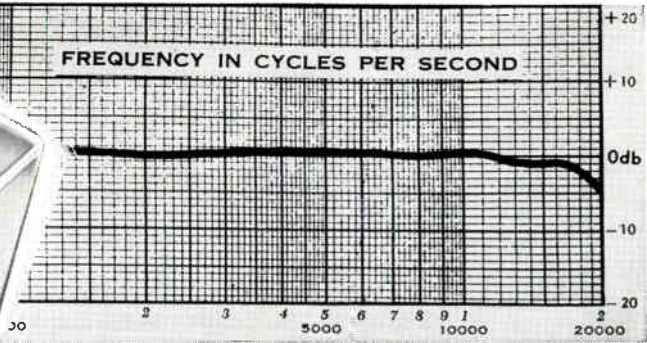
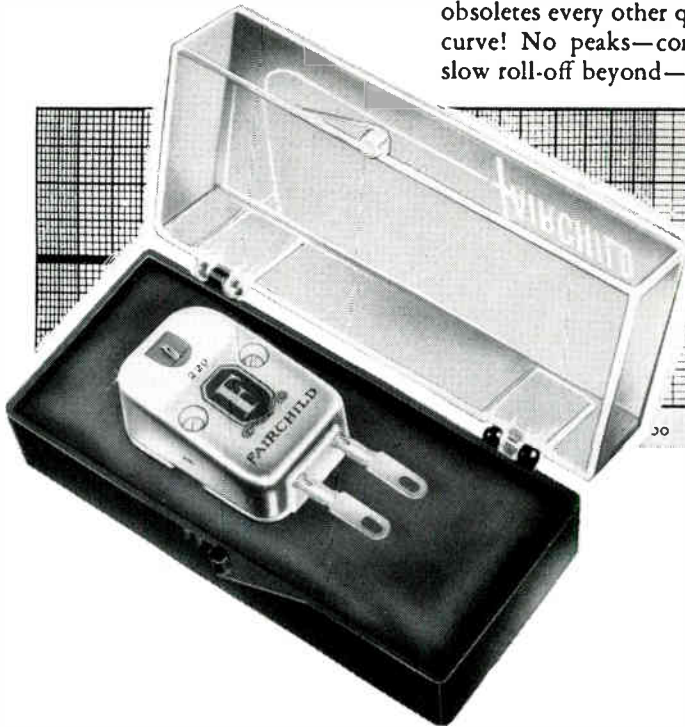

Then compare the Fairchild 220 to these other well-known cartridges. Peaks and jagged response curves mean rough sound—unnatural harshness even in the mid-range.

The NEW Fairchild 220 Cartridge incorporates the famed moving-coil design, the only truly linear reproducing principle.

Other features too!



- 4 to 6 db higher output!
- Still higher compliance!
- Still lower moving mass!
- Even less record wear!

Identify the NEW Fairchild 220 by its sparkling silver finish, symbolizing its peerless performance.

Hear the NEW Fairchild 220 Series Diamond Cartridges at your audio dealer. *You* compare! Unequaled performance at only.....

\$37⁵⁰

STILL AVAILABLE
 STILL UNEXCELLED
 BY CONVENTIONAL
 REPRODUCERS!
 The Fairchild 215
 Series Cartridges
 now at the lowered
 price of **\$29.75**

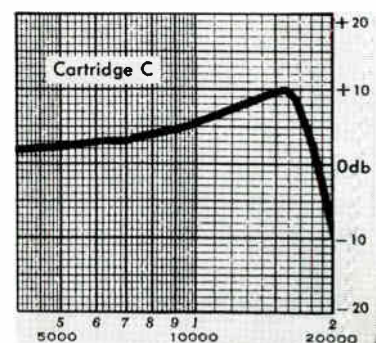
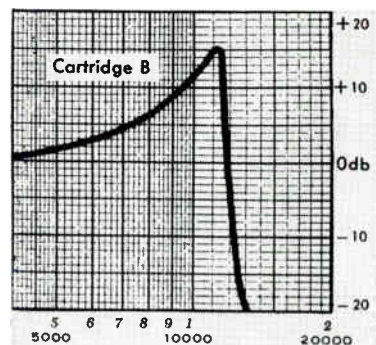
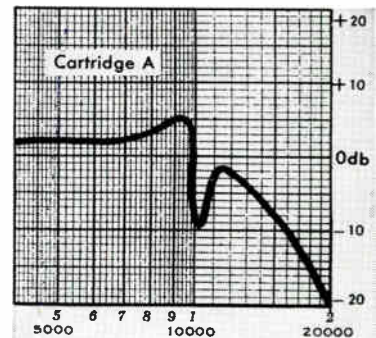

FAIRCHILD RECORDING EQUIPMENT
 156TH STREET AND SEVENTH AVENUE, WHITESTONE 57, N. Y.

amazingly quiet,

convenient,

the new

attractive,

H. H. Scott

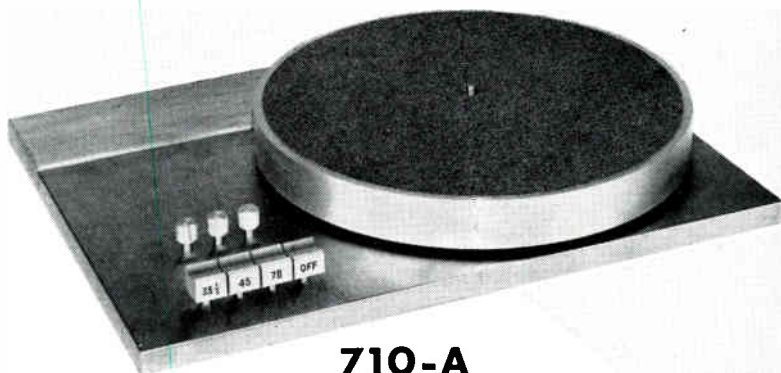

710-A TURNTABLE

Motor rumble down
more than 60 db

Wow reduced
to less than 0.1%

Instant
push-button selection
of three speeds

Stroboscopic speed
and pitch adjustment

Torsional
and dual-stage
mechanical filtering

6-lb.
cast aluminum
turntable

The 710-A Stroboscopic Broadcast Turntable achieves reduction of motor rumble more than 60 db below recording level, and decreases wow to less than 0.1%, by a unique torsional and dual-stage mechanical filtering system. Constant unvarying speeds are obtained with the heavy, non-magnetic, balanced turntable machined from a single aluminum casting. Instant selection of 33-1/3, 45 and 78 rpm speeds by convenient push-buttons. Automatic braking stops the free-wheeling turntable quickly when the off button is pressed, for quick record removal. Each speed is independently adjustable $\pm 5\%$ to permit exact tuning to the pitch of an accompanying musical instrument such as organ or piano, or to compensate for off-speed recordings. Built-in neon stroboscope permits precise speed adjustment regardless of line voltage. Pickup-arm mounting and turntable bearings are rigidly connected to minimize differential vibration and acoustic feedback. This system has shock mounting isolation from both motor and turntable base, facilitating installation since the unique mounting makes vibration isolation of turntable base from cabinet unnecessary. Effects of very low frequency arm resonance and system noise below 20 cps (where best sound systems begin to cut off) are reduced by more than 50 db, an outstanding design accomplishment. Quiet nylon spindle bearings never require lubrication. In our opinion, the 710-A Stroboscopic Broadcast Turntable affords a new standard of excellence in turntable performance, with unique convenience of installation, operation, adjustment, and maintenance, together with outstanding styling and moderate cost.

H. H. SCOTT inc.

FREE BOOKLET

385 PUTNAM AVENUE,

CAMBRIDGE 39, MASS.

Professional sound equipment by H. H. Scott, Inc. is designed for the discriminating music lover who recognizes and appreciates these extra features and engineering refinements separating the superb from the merely good. The medals, awards and ratings earned throughout years of pioneering in technical trends are but an indication of the unique "listenability" of H. H. Scott equipment.

Records, Tape, and FM

Continued from page 8

tember-October issue: "I believe the alto man in the center picture is Boyce Brown; the guitarist is Carmen Maestren, and the bass man is possibly Artie Shapiro. The superb alto man Benny Carter was completely left out of the bottom picture. There is some odd spelling of names at the top. The man at the keys is Gene Schroeder, while the drummer is Morey Feld." Thanks, Mr. Smith, and for your post-script: "The Magazine is getting better all the time."

Bix Beiderbecke's Band

From G.B. Moynahan, Darien, Conn.: "To complete the caption for the photograph of Bix's band in Fred Reynolds' article published in your September-October issue, the names are, left to right, Dick Voynow piano, Bob Gillette banjo, Bob Johnson tenor sax, Min Lybrook sousaphone or bass, Vic Moore drums, Jimmy Hartwell clarinet and, finally, the only and original Bix Beiderbecke cornet (not trumpet).

"The picture was probably made about 1927, and probably in Chicago. Successors to the Gennett Record Company could pinpoint it for you, since the Wolverines were recording for their label about that time. It used to be controlled by Star Piano Company, Richmond, Ind." Mr. Moynahan added: "All success to you with MUSIC AT HOME. It fills a much-needed void in our magazine list. We like particularly the way you handle the record reviews."

Binaural Playback

Members of Toscani's orchestra heard the playback of their first "conductorless" recording on October 5. It sounded very different to them when they listened from the other side of the footlights, of course, but they were highly pleased. To this listener, it was a magnificent recreation of what he heard during the recording session. The Symphony Foundation of America, Inc., now has the discs, with the overture from *Die Meistersinger* and the *Roman Carnival Overture* on one side (17:39 minutes) and the *Nutcracker Suite* (21 minutes) on the other side. Contributions of \$10. or more will be acknowledged with a presentation copy of the record; contributions of \$15 or more will be acknowledged with a presentation copy of the Livingston binaural tape, unless the record is specified. Such contributions are tax-deductible. Address of the Foundation is Carnegie Hall, Room 100, 7th Avenue and 57th Street, New York. Both the discs and tapes are destined to become valuable items because of the special circumstances under which they were made.

The President of the United States

It was a partisan, political speech, and the time segment had been bought by the

Continued on page 69

Music at Home

it's here!



The **NEW** FAIRCHILD 240 Balanced-Bar **PREAMPLIFIER**

Now from Fairchild, world famous for professional studio equipment, comes an outstanding development for home music systems.

The new Fairchild 240 is the result of extensive engineering research and an elaborate series of listening tests designed to discover and overcome weaknesses in existing preamplifiers.

These theoretical and engineering studies have brought

into reality this great new idea in high fidelity amplification—THE NEW FAIRCHILD 240 BALANCED-BAR PREAMPLIFIER!

Combining matchless external beauty with a new easy-to-service interior design, the 240 features amazing simplicity and flexibility of control. Operation is so simple it seems instinctive! Yet all conventional controls are included plus many exclusive with the 240.

BALANCED-BAR CONTROL—this great Fairchild innovation allows you to match tonal balance between your high fidelity system and the acoustical properties of your own listening room . . . automatically!

LISTENING LEVEL CONTROL—provides the most pleasant low-level listening you ever heard! Plus correct balance at normal listening levels—all achieved without complex adjustments or loss of control by operator. And the amazing LLC operates independently of volume control!

HIGHEST GAIN—LOWEST NOISE—achieved by modifying famous radar and TV cascade input circuit to audio amplification and by careful design, using highest quality components.

See the wonderful Fairchild Balanced-Bar Preamplifier today! An extraordinary achievement in performance, cabinet design and operating simplicity! Better audio dealers everywhere are proudly presenting the 240 . . . the greatest preamplifier ever produced . . . *at only \$98⁵⁰*

Note these exciting features!

- ✓ single knob selects channel or equalization
- ✓ tape output has own level control—unaffected by tone or volume controls
- ✓ "studio-type" wiring and layout
- ✓ optimum input impedance for all cartridges
- ✓ complementary-taper dual volume control eliminates need for more than one phono input
- ✓ 20 db additional gain easily available for high level input channels if needed

ASK ABOUT THE NEW 260 POWER AMPLIFIER. TREMENDOUS POWER IN AN EXTREMELY COMPACT UNIT.

Special features include:

1. no ringing at any level
2. output unaffected by load power factor
3. exceptional stability
4. exclusive fool-proof balance adjustment

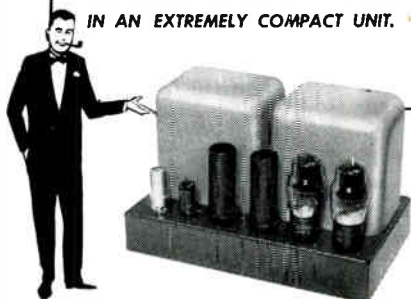

FAIRCHILD RECORDING EQUIPMENT
156TH STREET AND SEVENTH AVENUE, WHITESTONE 57, N. Y.

FIRST EVER DESIGNED

**WITH NEW CIRCLOTRON CIRCUIT*
WITH NEW CRITICAL DAMPING CONTROL**

*required for ideal operation
into high-fidelity speaker systems*

In a new historic development by A. M. Wiggins, ELECTRO-VOICE now brings you closer than ever to the goal of perfection in high fidelity reproduction! The E-V *Circlotron* Amplifier provides *exclusive E-V Critical Damping Control* to insure proper match to a high quality loudspeaker system—restores bass to proper balance—assures utmost pleasure from home music systems—provides new efficiency for professional operation. You need only compare to recognize the difference.

Electro-Voice **Circlotron**

E-V CIRCLOTRON CIRCUIT*

Advanced design removes all DC from the output transformer. Allows cool, optimum, efficient utilization of output tubes. Provides unity coupling between tubes. Completely eliminates all switching transients—greatly reduces distortion. Has less than one-quarter the plate circuit impedance found in conventional amplifier output circuits, assures vastly extended, distortion-free range response at full rated power. Provides trouble-free operation and long tube life.

*E-V Patents Pend.

E-V CRITICAL DAMPING CONTROL

Exclusive E-V damping factor control permits perfect match of amplifier output to the critical damping resistance of the loudspeaker, as well as to type of enclosure. Operates optimally into the variable impedance of a speaker load rather than a purely resistive load as in previous amplifiers. Control eliminates speaker bass losses from overdamping—minimizes low-frequency distortion—subdues hangover due to underdamping. Assures most efficient sound reproduction.

NEW E-V PREAMPLIFIER AND REMOTE CONTROL SETS *(shown at bottom right)*

Here is a further result of E-V planning, research and engineering...to help you obtain the fullest efficiency, operating convenience and enjoyment from your high fidelity equipment. The new Preamplifier and Remote Control Set (in two models) is designed for use with the E-V Model A-30 Circlotron Line Amplifier. The Preamplifier, with its Off-On and Function Selector Switches is used near the equipment location for easy hookup. The Remote Control is separated for convenience and flexibility to allow single cable connection to any remote position up to 75 feet, or may be used at preamplifier location. Each is housed in a beautifully styled hand-rubbed Mahogany or Korina Blonde cabinet.

Write for complete data and information

ELECTRO-VOICE, INC. • BUCHANAN, MICHIGAN

Export: 13 East 40th St., New York 16, U.S.A. Cables: Arlab

HIGH FIDELITY AMPLIFIERS, SPEAKER SYSTEMS, MICROPHONES, PHONO-CARTRIDGES, AND OTHER ELECTRO-ACOUSTIC PRODUCTS

TYPICAL PERFORMANCE DATA

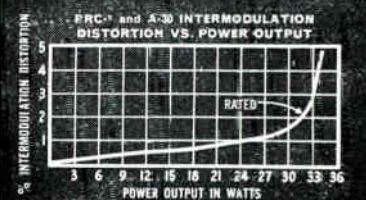
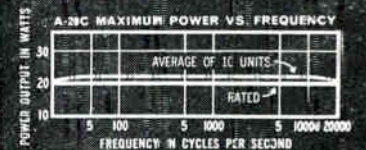
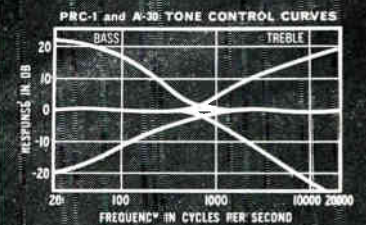

Your
Electro-Voice
Distributor
invites you
to see and
hear the
difference.

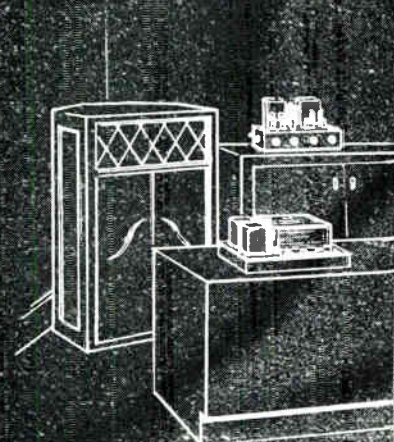

EXCLUSIVE NEW



Circlotron

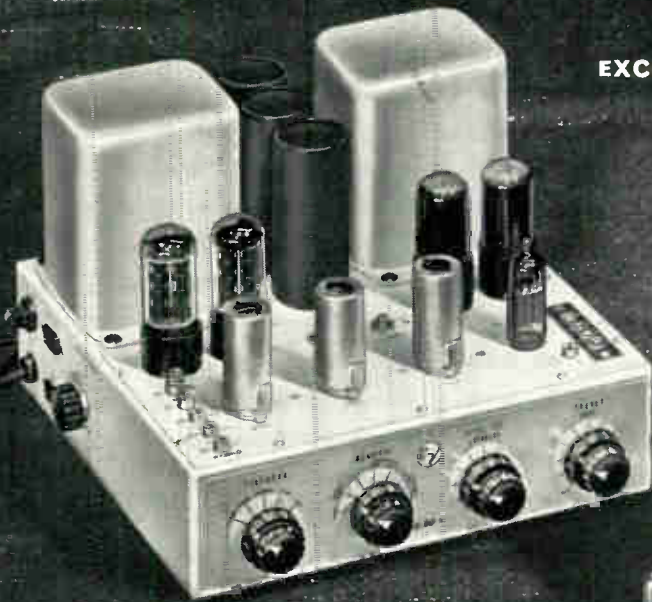

E-V Model A-20C 20 Watt Circlotron Amplifier

Compact, high quality, conservatively rated amplifier with all necessary controls for handling a complete high fidelity system. Power Output: 20 watts rated, 40 watts on peaks. Frequency Response: $\pm .1$ db 20-20,000 cps at full 20 watts. Inputs: Ultra-Linear phono, magnetic phono, tape or tv, tuner or tv, HI-Z microphone. Controls: Function selector, record compensation, level, loudness, bass, treble, damping factor, and two hum adjustments on chassis. High level output connector also available to feed tape machine. Size: 10 $\frac{3}{4}$ " wide x 11 $\frac{1}{4}$ " deep x 7 $\frac{3}{8}$ " high.

Model A-20C. List Price \$183.33. Audiophile Net \$110.00



E-V Model A-30 30-Watt Circlotron Line Amplifier

This professional-type amplifier sets a new standard for efficiency in high fidelity reproduction. Power Output: 30 watts rated, 60 watts on peaks. Frequency Response: $\pm .5$ db 20-50,000 cps. Controls: Gain, damping factor, hum adjustment, power switch. Easy mounting on baseboard, side, or rack. Volume control adaptable for front panel accessibility. Size: 13 $\frac{3}{4}$ " wide x 8 $\frac{1}{2}$ " deep x 7" high. Makes perfect combination with Preamp and Remote Control Set shown below.

Model A-30. List Price \$241.67. Audiophile Net \$145.00

AMPLIFIERS

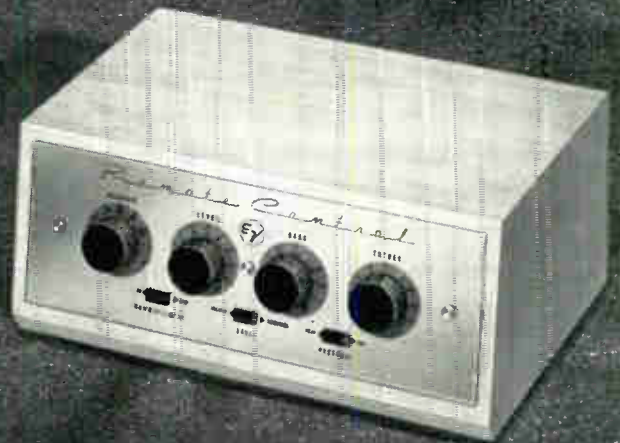

E-V Preamp and Remote Control Set—with Exclusive Vital Presence Control

For use with E-V Model A-30 Circlotron Amplifier. Model PRC-1 allows both Ultra-Linear ceramic and magnetic phono-cartridge inputs. Model PRC-2 is identical except without magnetic phono preamp. Frequency Response: $\pm .5$ db 20-20,000 cps. PRC-1 Inputs: Ultra-Linear phono, high-level magnetic phono, low-level magnetic phono, tuner, tape, tv, and auxiliary. Preamp Controls: On-Off switch, function selector, 5 individual input level controls. Remote Controls: Record compensation switch, level control, volume-loudness switch, rumble filter switch, presence switch, bass control, treble control. Size each of the Preamp and the Remote Control is 10 $\frac{3}{4}$ " wide x 7 $\frac{1}{8}$ " deep x 4 $\frac{3}{4}$ " high. Supplied with 5 ft. cable on each. Extensions available for Remote Control unit.

E-V Model PRC-1. Preamp and Remote Control Set. Includes Model M-1 Magnetic Phono Preamp plug-in unit. Complete with Mahogany or Korina Blonde cabinets. List Price \$200.00. Audiophile Net \$120.00

E-V Model PRC-2. Same, but without the M-1 Magnetic Phono Preamp unit. List Price \$175.00. Audiophile Net \$105.00

E-V Model M-1. Magnetic Phono Preamp plug-in unit. List Price \$25.00. Audiophile Net \$15.00

(Preamp and Remote Control units are also available without cabinets. Simply deduct \$8.33 from list price or \$5.00 from audiophile net for each cabinet.)

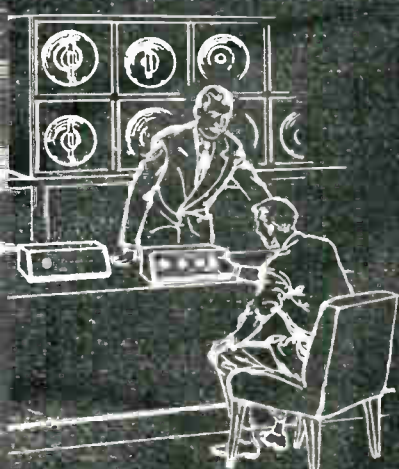

For High-Fidelity at its Best, Make Your Choice

Electro-Voice



- ▶ Love at first sight is something that happens between men and women and PRECEDENT. One glimpse of this frankly glamorous radio tuner, and you'll visualize the way its luxurious simplicity of styling can distinguish your own living room.
- ▶ PRECEDENT beauty is not veneer-deep, but instead is evident throughout its superb components and matchless hand craftsmanship.
- ▶ As the only truly professional FM tuner, PRECEDENT provides perfection of reception that no imitation can ever approach. Prices begin at \$325 in a handsome metal cover. Visit a dealer (below) today, and make PRECEDENT yours.

RADIO ENGINEERING LABORATORIES - INC - 36-40 Thirty-seventh Street - Long Island City 1, N.Y.

Hear the superlative new PRECEDENT at these high fidelity specialists:

CALIFORNIA

Beverly Hills: Crawford's, 456 N. Rodeo Dr.
 Hollywood: Hollywood Electronics, 7460 Melrose Ave.
 Pacific Radio Exchange, 1407 Cahuenga Blvd.
 Los Angeles: Henry Radio, 11240 W. Olympic Blvd.
 Menlo Park: High Fidelity Unlimited, 935 El Camino Real
 Pasadena: High-Fidelity House, 536 S. Fair Oaks
 San Francisco: Audio Engineering Assoc., 3525 California St.

CONNECTICUT

Guilford: Philip C. Kelsey & Assoc., White Birch Dr.
 Milford: Milford Tool Co., 108 Gulf St.

DELAWARE

Wilmington: Radio Electric Service Co., Third & Tatnall Sts.

DISTRICT OF COLUMBIA

Washington: Shrader Manufacturing Co., 2803 M Street, N.W.

FLORIDA

Miami: East Coast Radio & TV, 1932 N. W. Miami Ct.
 Pensacola: Grice Radio & Electric Supplies, 300 E. Wright St.

ILLINOIS

Chicago: Newark Electric Co., 223 W. Madison St.
 Voice & Vision, nc., 53 E. Walton
 Oak Park: Brewer Engineering Co., 229 N. Ridgeland Ave.

MASSACHUSETTS

Boston: DeMambro Radio Supply Co., 1111 Commonwealth Ave.
 Radio Shack Corp., 167 Washington St.
 The Listening Post, Inc., 161 Newberry St.

MICHIGAN

Ann Arbor: Ann Arbor Music Center, Inc., 300 S. Thayer
 Detroit: Radio Electronic Supply Co., 1112 Warren Street, W.

MINNESOTA

Duluth: Northwest Radio, 123 E. First St.
 Minneapolis: Lew Bonn Co., 1211 LaSalle Ave.

NORTH CAROLINA

Raleigh: Allied Electronics, Inc., 413 Hillsboro St.

NEW JERSEY

Montclair: Perdue Radio Co., 8 S. Park St.
 Paramus: Music Age, Inc., 171 Route Four

NEW YORK

Buffalo: Genesee Radio & Parts Co., 2550 Delaware Ave.
 New York City: Harvey Radio Co., 103 W. 43 St.
 Sonocraft Corp., 115 W. 45 St.
 Terminal Radio Corp., 85 Cortlandt St.

OHIO

Canton: Custom Classics, 13421 Euclid Ave.
 Cleveland: Audio Craft Co., 2915 Prospect Ave.
 Columbus: Electronic Supply Corp., 134 E. Long
 Hubbard: Siefert Sound Service, 548 S. Beechwood
 Lima: Lima Radio Parts Co., 600 N. Main St.
 Massillon: M. H. Martin Co., 1118 Lincoln Way, E.

PENNSYLVANIA

Bethlehem: The Audio Laboratory, 729 Delaware Ave.
 Philadelphia: Radio Electric Service Co., 701 Arch St.
 ten Cate Associates, 6128 Morton St.
 Reading: George D. Barbey Co., Inc., Second & Penn Sts.

WISCONSIN

LaCrosse: Terry's Music Store, Inc., 307 Main St.

MUSIC for YOUR HOME

THIS FALL, three topics are being widely discussed wherever hi-fi enthusiasts meet. The first, about which we heard a great deal at the audio shows, has to do with the prices of amplifiers, speakers, pickups, and other audio components. Apparently, many people thought that these items of equipment might cost less now that they are being produced in larger quantities to meet the increased demand.

However, it hasn't worked out that way, for very good reasons: The very factors that contribute most importantly to quality of reproduction are the principal items of manufacturing cost. Every ethical company in this field is carrying out a continuous program of research directed toward improved performance. And finer quality means higher prices. There's no way to get around that.

It's easy enough, for example, to design audio transformers that use less iron and fewer turns of copper wire. Engineers have even gone so far as to eliminate audio transformers entirely from radio and TV sets, as evidenced by their deteriorated quality of reproduction. But *improved* performance from audio equipment is being achieved through the use of finer materials, new manufacturing methods, and more exacting production controls.

Loudspeakers can be made to meet any price requirement. Those in most radio and TV sets can be bought for fewer pennies than the number of dollars that you pay for a hi-fi model. But when the best speakers now available are further improved, they will cost more because they will be larger, or they will have heavier magnets, or added features requiring precision workmanship.

Similarly, if rumble and wow are not important, the design of a turntable or changer can be cheapened substantially. Cheap models *have* to be good enough for people who want to spend only a few dollars for table phonographs, but the only way to please critical listeners who want *less* rumble and wow is to provide heavier construction, more accurate machining, and more expensive types of motors.

In short, the best equipment costs more this year because it is superior to what was the best last year. In the matter of price vs. performance, this basic fact still holds true: Costs can be reduced rapidly as quality is sacrificed, but it is very expensive to make further improvements in equipment that is already of highly perfected design.

THE second topic has to do with the purchase of records, and of equipment for playing them. More people are buying records now than ever before. But a very high percentage of these people — estimated at 65 to 85% — are playing their records on very inferior equipment which they think is "high fidelity" because it was advertised as such.

The reason so many people make this mistake is that they buy equipment that gives them what they assume to be the best quality of reproduction because they are told that what they hear is "high fidelity". They have no way of knowing that it's merely an improvement.

Only as those of us who have truly hi-fi equipment invite others to hear it can more people gain in appreciation of fine audio quality and the enjoyment it provides.

If, every week, each one of us would invite two people to hear our systems in operation, we could do a wonderfully effective job of helping others to acquire a true knowledge of what *we* mean when we talk about realism and presence-effect.

Another plan, even more effective, is to get a local hi-fi dealer to put on a demonstration in his store or in a public hall once a month during the winter. As a special attraction, the program might include one or two binaural tapes. Music on records and tape can provide an evening of fine music which is every bit as entertaining as a live performance, and with talent much superior to that heard at most concerts in the smaller cities. The problem of finding people to attend can be solved easily by asking the local newspaper to publish announcements. Ample publicity can be obtained without charge for projects of this sort when admission is free. Let's each one of us make a serious effort this winter to help the newcomers start out the right way.

ONE more matter, in which all hi-fi enthusiasts have a common interest, calls for cooperative effort. This has to do with service on audio equipment. Any radio service shop can repair an AM or a TV set, but few of them want to work on hi-fi components. Even if they are willing, it's dangerous to let them try. They are apt to do more harm than good.

In most cities, the only safe place to have audio equipment serviced is at the store where it was bought. Frequently, that is not convenient, particularly if the units were ordered by mail. The number of hi-fi specialists is growing, but there aren't nearly enough yet. Our Directory of Hi-Fi Dealers is revised from issue to issue so that we can add dealers' names and addresses as soon as we learn about them. But we're sure that we aren't listing all of them, and particularly the newer ones.

If you know of a dealer capable of handling service work on audio equipment, won't you send us his name and address so that we can list him in the Directory? If he's good, he deserves that recognition, and you may save other hi-fi enthusiasts in your area, who don't know about him, from having to send components all the way back to the factory for repair.



Pickering Audio Components...



In every field of endeavor . . . manufacturing,
the theatre, concert or contest . . .
there is always one standout.



In HI-FI equipment the standout is Pickering . . .
pioneer in this field, responsible
for the development and introduction of outstanding
components for highest quality performance;
every product bearing the Pickering name

is engineered to conquer the challenge of
optimum performance . . . in their manufacture
the most stringent quality controls are
exercised to assure and maintain the "Ne Plus Ultra"
reputation for products featured by the  emblem.



SYNONYMOUS WITH HIGHEST QUALITY

Design...Manufacture...Performance

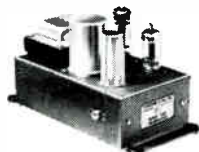

It's with good reason that professionals use
Pickering Audio Components . . . they know
the values built into Pickering equipment.

INVESTIGATE and you too will use Pickering
components for your HI-FI system. . . .

You'll thrill to new listening experiences . . .
you'll have the same high quality performance

as leading FM/AM good music stations, network
and recording studios . . . REMEMBER, leading
record companies use Pickering Components
for quality control.

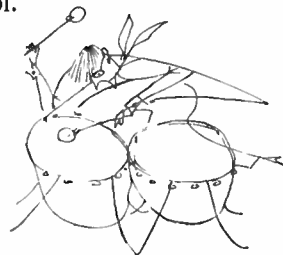

PICKERING and company incorporated •

PICKERING PROFESSIONAL AUDIO EQUIPMENT

Oceanside, L. I., New York

"For those who can hear the difference"

. . . Demonstrated and sold by Leading Radio Parts Distributors everywhere.

For the one nearest you and for detailed literature; write Dept. X-6



Mrs. Nunn shares her husband's enthusiasm for the hobby that wasn't intended to make a profit, but has, nevertheless, through the sheer excellence of the records they produce under the Audiophile label for "those whose physical and technical equipment enable them to be discriminating"

NUNN BUT THE FINEST

Making Records of Superlative Quality Was Only a Hobby Until People Offered Any Price "If You'll Just Make an Extra Copy for Me" — By Fred Reynolds

NOTHING could be more music-at-home than Ewing D. Nunn of Milwaukee and Saukville, Wisconsin. To prove this elementary statement of fact, you have only to stop off at his very pleasant home, as I did not so very long ago.

However, let's set down the facts in some kind of order. Farmers know Nunn because he is president of the Northern Signal Company, producers of electric fence controllers, and controls for infra-red brooding equipment. Audio fans know him because of his superb Audiophile records, probably the finest of the high-quality recordings made today. Northern Signal is his bread and butter; Audiophile Records is a hobby, but it is beginning to grow to the proportions of a serious business.

You meet Ed Nunn and immediately you like him. He's cordial, enthusiastic on a variety of subjects, and you know there are many topics on which this man speaks with authority. He's a gentleman. Guessing, I'd say he had recently passed the half-century mark, but right now he looks ready to step in as half-back for the Green Bay Packers. And if you happened to meet him walking along the street, you might size him up as, say, the perfect model for Dean of Men at the University of Wisconsin. He and Mrs. Nunn have three children, all of whom are married. When the whole gang gets together, there are six grandchildren, too.

Born in Texas, it seems that Nunn has had an interest

in electrical gadgets since he was old enough to read about Franklin, Edison, and Marconi. He didn't go to college, but by 1916 he had his operator's license, and his own radio business in 1921. He sold this out in 1931 to join Harley Davison, where he designed the first motorcycle radio receivers for police departments. He began his huge record collection back in 1920, the year before Enrico Caruso died and Arturo Toscanini cut his first disc for RCA Victor. It is this avid interest in recorded music that led him to making high-quality recordings for himself and, later, additional pressings for a few friends who had audio installations capable of doing justice to his records.

For years Nunn has been experimenting with amplifiers of his own design. He is continually improving his equipment, always moving ahead slowly and patiently, for he is well aware of the truism that "improvement is made in short jumps." By 1947, he had advanced the performance of his equipment to the point that he wanted finer records to use with it than were commercially available. That was when he determined to make his own records. The kids had grown up and left home. There was much more time, therefore, to experiment with a hobby that might and did become expensive, as so many do, but there was a possibility that it might show a profit eventually, as so many don't.

By the time he was ready to make his first recordings, he had arrived at certain specific decisions. Lacking the



Last September, Ed Nunn recorded the Red Dougherty Sextet at the Calhoun Beach Hotel, Minneapolis. Records are scheduled for release in December

kind of studio facilities at home that he wanted, he made plans to record on location. For making master tapes, he chose a Magnecord M-80, and had it modified at the factory for 15 and 30 ips. tape speed.¹ He rebuilt the amplifier in this recorder himself. He uses a single microphone — a converted Stephens type — for all recording sessions. And he determined to cut all his records at 78 rpm. except in the case of musical selections, primarily classical, which require the longer playing time obtainable only at 33 rpm. The Nunn opinion: "The best quality that can be engraved on a disc, regardless of cost, is obtained when a record is rotated at 78 rpm. and is played

¹ Mr. Nunn makes all his master tapes at 30 ips. in order to reduce intermodulation distortion. This, he admits, may not be warranted as a commercial practice, but it is one of a series of refinements he employs because his aim is to achieve the highest degree of quality, regardless of cost.

This part of the Nunn collection is devoted largely to old-time traditional American music played by Morton, Armstrong, Williams, and Oliver

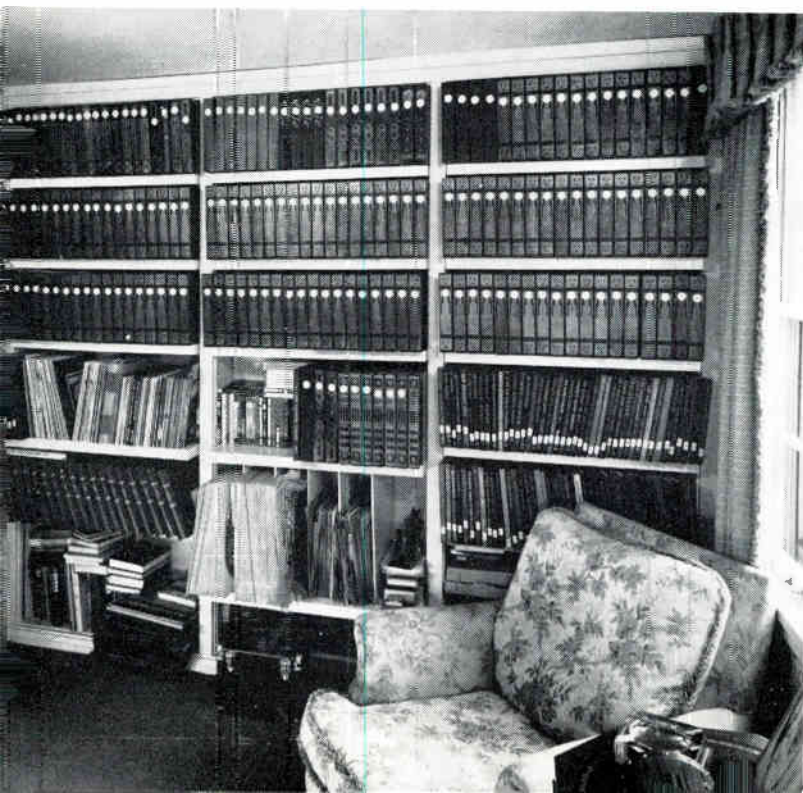

with a 1-mil diamond stylus. Since top quality is our objective, Audiophile records are made in this way for use by those whose facilities enable them to be discriminating."

Nunn's 78-rpm. records are not limited to the playing time of commercial pressings, however. The use of a 1-mil stylus makes it possible to cut the masters at a finer pitch. As a result, 12-in. Audiophile 78's give up to 19 $\frac{1}{4}$ minutes of music.

Of course, before this project could be launched, Mrs. Nunn had to give her consent — which she did quite readily. In fact, she loves the whole business, and manages to go along with her husband on most of his recording dates. She's a grand help, too. A charming woman with a keen ear, she has now become the No. 1 girl in charge of microphones.

Nunn made his first recording in December of 1950 at Mendota, Minnesota — a Dixieland jazz session by Harry Blons and his band. (Nunn is most partial to Dixieland.) Besides a group of standard Dixieland exercises, the band did "Pop Goes the Weasel", on which drummer Warren Thewis created a kind of cacophony by using a number of gadgets grouped together under the single title of "machinery". Nunn says, "This cacophony is excellent test material for playback equipment — it should all come through with sharp definition."

I'm sure Mr. & Mrs. Nunn didn't celebrate the occasion of the first Audiophile record by breaking a bottle of pop over its smooth edges, for they were probably much too busy. Even now that it is 1954, when the Nunns are shipping a substantial number of records each month, the entire business is still looked upon as a music-at-home hobby. In addition to a small and compact but very complete workshop in the basement of his home, Nunn has a much larger stock room that is jammed with boxes of all shapes and Audiophile records.

Music at Home

All Audiophile master records are cut on Nunn's own special equipment, using a Presto lathe which he rebuilt. Audiophile records, of pure vinylite, colored with a grainless red dye, are pressed by a small independent concern because this concern happens to be the only one able and willing to meet Nunn's exacting specifications. Every Audiophile record is guaranteed to perform as represented. And that, my friends, is something in this day when the terms "high fidelity" has degenerated into a virtually meaningless description.

Sitting around on any afternoon of the week with Nunn in his home listening to records is a rather marvelous experience. He has a flock of fascinating stories to tell about his experiences at recording sessions, and a large quantity of wonderful stuff on tape that has



Décor of the Nunn living room combines a cactus collection, oriental rugs, grand piano, tape recorder, and lathe for cutting master records



Making tapes and cutting master records may be a hobby with Ed Nunn, but there is nothing amateurish about his facilities, methods, or products. In fact, he has a distinct advantage over the engineers in commercial studios in that he can take as much time as he needs to achieve the results he seeks. If the test pressings fail to please him, it's his responsibility. He simply destroys the master, and makes plans for the next recording session. Nor does he have to be satisfied with standard equipment. He has rebuilt some of what he uses. The rest he developed and built himself. This photograph shows one corner of his laboratory

to be described as enormously un-commercial. In fact, it is so un-commercial that I'm having a terrible time convincing him to put some of it on records. His record collection (78's) is fabulous indeed, and choice, and he can pull out whatever he's talking about at the drop of a name. And best of all, you listen to all this on equipment so fine it makes you wish he'd ask you to move in with him.

His speaker installation, for example, is a Bozak 310B, comprised of 4 woofers, 1 mid-range speaker, and 8 tweeters. The low frequency response successfully reproduces fundamentals at 30 cycles. Of course, this isn't enough. His new speaker — that's the one that's going in the new home he's building around it — will be 40% larger in cubic con-

Continued on page 59

Closeup of the cutting equipment shown at the top of this page. Here is a rebuilt lathe, with a preamp, control box, and vacuum-tube voltmeter of Nunn's own design



When You Listen to Music, Would You Say That YOU'RE A MUEN OR AN AUPER?

DURING the last two or three years, there has been a continuing and increasingly acrimonious debate over the establishment of performance standards for audio equipment. For the most part, arguments have centered around the use of the term "high fidelity." Numerous efforts have been made to set up standards so that the use of the term as a definition of performance could be policed by the manufacturers and even the Better Business Bureaus. The only conclusion reached, however, is that there is no way to define audio performance in a manner sufficiently specific as to draw a line between what is and what is not a "high fidelity" component or a complete system.

Meanwhile, the quality of music available from records, tape, and FM has been improved so greatly, and so much publicity has been given to this improvement, that thousands upon thousands of people are becoming seriously interested in music for the first time.

Of these, some are *audio perfectionists*. They are the moving spirits of this whole activity — the critical listeners who are only satisfied with the best quality of reproduction they have been able to achieve until they can find a way to make it better. In this group are technically-minded individuals who "listen to sounds rather than the music," as well as those of highly educated tastes who want their music at home to sound exactly as they hear it sung and played in the concert halls.

For each member of that group, there may now be two hundred *music enthusiasts* — men and women, boys and girls — who have discovered that the inexpensive, improved phonographs, tape machines, and FM radios open up a new world of musical entertainment. The instruments they own are so much *better* than those they have heard in the past that they assume that they own the *best*. In this group are the uncritical listeners, as well as those who are not in a position to buy more expensive equipment, and a certain number who will become audio perfectionists as they gain listening experience, and develop critical faculties.

So a line can be drawn between the two groups, but not in a clearly definitive way, because the differences involve such factors as technical knowledge, musical experience, and financial capacity.

The manufacturers are more sharply divided into separate camps, one making top-quality equipment and maintaining programs of research aimed at further refinements, and the other devoted to the mass-production of instruments of performance dictated by the economics of competition in the popular-price field.

A New Point of View

Although no way has been found — and no way will be found — to establish and police specific standards of audio

performance, there must be — and probably is — a way to differentiate between equipment designed to meet the tastes of the audio perfectionists and the music enthusiasts.

Perhaps that is the answer right there. All we need is suitable names for these two groups. Following the practice of making short names from long ones, we could call them Aupers and Muens. Those may not be the best words; perhaps you can think of other, better ones.

It would help us greatly, in presenting articles in *MUSIC AT HOME*, if we could identify them as being intended for Aupers or Muens, as the case might be. In this issue, the picture story of youngsters listening to records shows a small table-model phonograph. It may shock the Aupers to see such an instrument illustrated in this magazine, but the truth is that this record-player does a completely satisfactory job for those little Muens!

If the manufacturers of \$49.95 phonographs would omit the "high fidelity" claims and say frankly, "Here is an excellent, inexpensive instrument for Muens (Music Enthusiasts)," their advertising would be just as forceful, and they would not arouse the indignation of the Aupers by their use of such terms as "super fidelity" and "final fidelity."

On the other hand, it doesn't mean much any more to advertise top-quality equipment as "high fidelity." It would be far more descriptive to say that it is "designed to meet the requirements of the most discriminating Aupers (Audio Perfectionists)."

This is also a way out for companies that produce a range of equipment from low to high prices. It can't *all* be "high fidelity," but what manufacturer would be frank enough to say so? However, he could properly present a group of Muen components, and a separate Auper group. Which is a way of saying that the less expensive models are intended to please the less critical listeners, but if you are going to be satisfied with nothing less than the very best, then you must pay the price for top quality audio performance.

Wanted: Your Opinions and Suggestions

What do you think of this idea? We want your comments, and your specific suggestions as to coined words to describe the people who can enjoy music even if the quality of reproduction is less than perfect, and those who can't if it is. Perhaps these new words should be derived from some other terms than audio perfectionists and music enthusiasts. And while you're thinking about that, can you invent a single word to indicate music from records, tape, and FM? We want your letters by the first of December, so that we can quote from them in the January-February issue. Let's see if we can make some useful contributions to the lexicon of audio terms.



Left: This group is listening to Train to the Zoo, visualizing the characters in the music, and deciding which they want to be when the record is played again. Right: They have been acting out monkey-see-and-monkey-do, and now these little monkeys are resting before they choose the next music

Grownups Call It "Auditory Participation" but

THE CHILDREN SAY IT'S FUN

RESPONSE to music is basic in children, and their natural gift for enjoying it should be encouraged. Good children's records are valuable aids to that end for, if they are chosen carefully, they assist in developing a taste for music that lasts a lifetime.

Recorded music calls forth both mental and physical participation. Youngsters respond by acting out what they hear in music, if they are free to do so. But first they may listen repeatedly to a selection while they work out elaborate plans or scenes in their imaginations. They see them-

Left: The little girl with her head down is playing the part of the donkey that tried to sing in the children's version of Midsummer Night's Dream, but the donkey could only say, "Hee haw." Right: Here is Queen Titania, delivering a deeply emotional speech to Oberon, who was far from her castle





Listening to Ship-A-Hoy, these hearty ones see land ahead. And there's no doubt about their seeing it. Here play acting is at its best, for it is combined with authentic sea-chanties which suggest things for the children to do, without actually telling them



Hold it, Pardner, while this Little Cow Girl tells how to tame an armchair bronc. With things to do, and songs to sing, this kind of play is a healthy outlet for overflowing energy, channeled and guided by rhythmic music. Singing their cowboy songs as brother and sister gallop off to a roundup is better for the children and their parents than having little brother chasing his sister around the house, and taking pot shots at her with his toy pistol!



The record The Little Brass Band was being played when this picture was taken. Each child was a musician, keeping time to the music in his own way. The one in front envisioned herself as a drum-majorette

Perhaps you have guessed that these are the cars of Three Little Trains chugging around the living room floor. Thus music calls forth coordinated activity, teaching the children to play together





Acting out the music of Rainy Day. Here the music said to jump, and it took this little girl right off the floor! The boy hasn't yet made up his mind

selves as the characters in the music. Thus, records must be chosen that are keyed to children's activities. They should provide guidance for action, yet they must always leave a broad area for individual interpretation. Often a child's interpretation is quite unpredictable. Music that suggests slow motion to the educated and regimented adult mind

may create a totally different response in the fresh and uninhibited mind of a child.

Each must be free to draw his own conclusions. Such an opportunity is an important part of the process of growing up. Notice how completely oblivious to the camera are the youngsters in the accompanying photographs.



FM TUNING with a TELEPHONE DIAL

By JAM SYRJALA and ALEX STEVENS

FM radio and phonograph system in Mr. Samuel Miller's New York apartment

All Manual Tuning Is Eliminated from This Crystal-Controlled FM Receiver

SOME TIME AGO, the authors came across a most indignant letter concerning the unreliability so often encountered in mass-produced products in general and, specifically, FM tuners so designed that the responsibility for perfect performance is upon the owner who must manipulate the controls. This letter, signed Samuel Miller, detailed some of the features he thought should be incorporated in FM tuners. Unknowingly, he described quite completely a tuner which we had already designed and built. So we called him.

An FM tuner, Mr. Miller told us, should be as simple to operate as other highly-perfected, automatic devices. He was only willing, he said, to push a button. Beyond that, he contended, the tuner should do all the work of bringing in the station he wanted to hear, freeing him from the necessity of knowing where to locate a given station on the tuning scale, turning a knob to the approximate setting, and then, finally, arriving at the exact spot by jiggling the knob back and forth until the tuning eye is closed as far as it will go.

There is one automatic way in which an FM tuner can be set precisely, and free of any possible drift. That involves the use of crystal control, and a switching arrangement operated by an ordinary telephone dial. On the dial, station call letters can be substituted for the familiar letters and numbers.

Lest we appear to claim credit for originating this idea, we hasten to explain that it was used for military equipment during the last war, but the tuner illustrated here is probably the first FM broadcast type to employ the system to be described.

Here Is Precision Tuning

To the initiated, the case for crystal-stabilized tuning of FM receivers is clear enough in the areas of performance, convenience, and elegance. However, so many people have inquired about its advantage over AFC (automatic frequency control) that we feel a word of explanation is necessary.

AFC depends upon tuning error voltage to introduce a correction. It also adds to the difficulty (some say this is understatement) of getting a weak station next to a stronger one on the dial. This is one of the more serious problems, hence the necessary recourse to an AFC cut-off switch, thoughtfully provided on the front panel of some tuners. Of course, when the AFC is switched off the listener is left to the mercies of a sometimes vagrant local oscillator. Furthermore, *perfect* tuning can never be attained from AFC, as the error voltage applied to the reactance tube becomes smaller as centre frequency is approached. There are other disadvantages associated with AFC, such as distortion, station-capture phenomena, and a false sense of security which results in inaccurate tuning; but we feel that these demonstrate the validity of our objections to its use.

In 1945, a crystal-stabilized FM receiver was designed for the old FM band (42 to 50 mc.), but the present FM broadcast band complicates the use of crystals somewhat because of the higher frequencies. While it is no trick to generate the frequencies required by the local oscillator (77.3 to 97.3 mc. in the case of a 10.7-mc. IF frequency) by using the harmonic-mode crystals, the cost of the crystals would be prohibitive. Although harmonic opera-

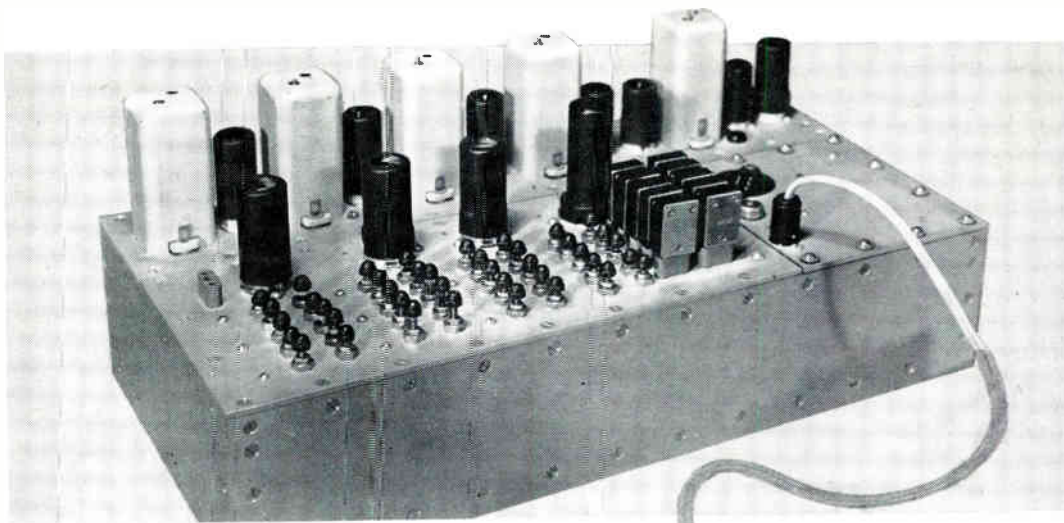

Fig. 1. The automatic tuner. The ten FM stations which can be tuned in on this receiver are determined by the ten plug-in crystals. If the owner moves to another city, he will simply substitute other crystals, according to the stations he wants to receive. This type of tuner is made practical by the availability of inexpensive crystals

tion of fundamental crystals has been employed by amateurs for some time, the resultant frequency is unpredictable, and not necessarily an exact multiple of the crystal's fundamental. However crystals at one-tenth the desired injection frequency are readily available at a reasonable price. This makes the design problem one of multiplying the fundamental frequency by five and then doubling in a subsequent stage to arrive at the desired injection frequency.

rigid. A few compromises had to be made, but they were done in the spirit of *de minimis non curat lex*,¹ but only after thorough consideration of what constitutes a trifle. Although the eye did not *have* to be pleased, we felt that since beauty is a very important factor in this sensual world of ours, natural beauty should be cultivated, but with no detriment to the operation of the unit. By the term *natural beauty* we mean that sense of correctness which can be seen in the works of a fine old watch, or under the hood of

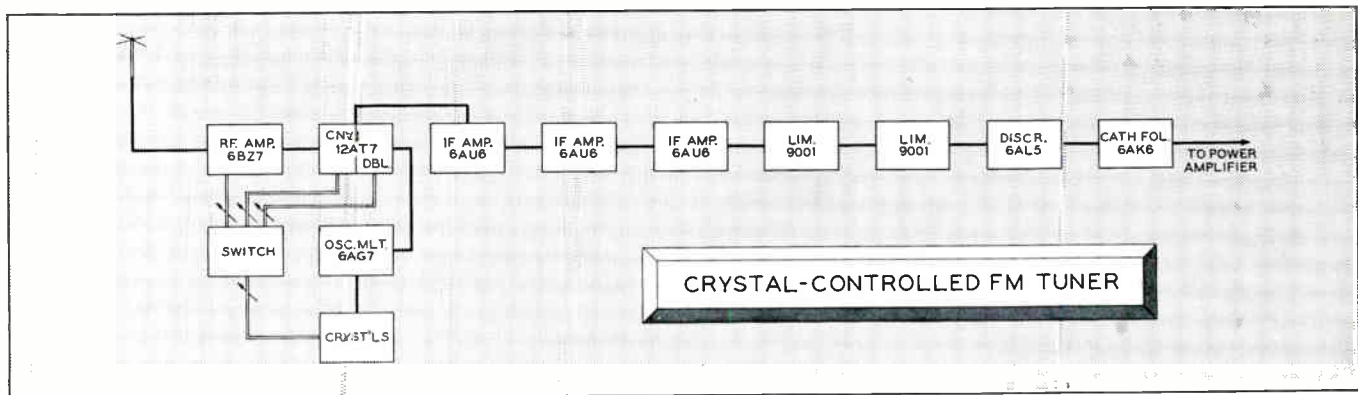

Fig. 5. Block diagram of the remote-controlled FM tuner which operates from a telephone dial. The interpreter switches four circuits automatically

Although crystals accurate to .005% can be used, an accuracy of .01% is adequate for FM broadcast receivers wherein the attendant maximum error in tuning at 100 mc., with an injection frequency of 89.3 mc., is only 8,900 cycles, and error voltages measured at the discriminator are negligible indeed.

Mr. Miller's Installation

Having satisfied Mr. Miller that dial tuning and crystal controls would relieve him of all responsibilities for operating an FM receiver beyond selecting the stations and adjusting the volume from the loudspeaker, he commissioned us to build an installation for his apartment. And he made it an ideal engineering project by specifying that while he would not be critical of the cost, he would be most exacting in the matter of performance.

Accordingly, we established mechanical and electrical limits which were, in a sense, quite

some foreign cars, *i.e.*, a beauty through function, not the false beauty or prettiness of thin chrome plating, for example, whose purpose is to hide flaws created by the file, saw, or stamping press.

Our standards, extravagant as they may at first appear, provided the only long-term insurance against such failings as drift, distortion, loss of sensitivity, interstation hash, tuning indicators of dubious dependability, or circuitry and associated components operated dangerously close to maximum ratings.

The result of the writers' efforts is shown in Fig. 1, and in Fig. 2, with the tuner on the left and the power supply on the right. The telephone dial controls the selection of ten stations. The other functions of control, *i.e.*, gain, tone, on-off switching, and operating the record changer are executed by simple remote controls which Mr. Miller had installed previously. Fig. 3 shows the underside of the tuner chassis,



¹ Editor's Note: The law does not bother with trifles.

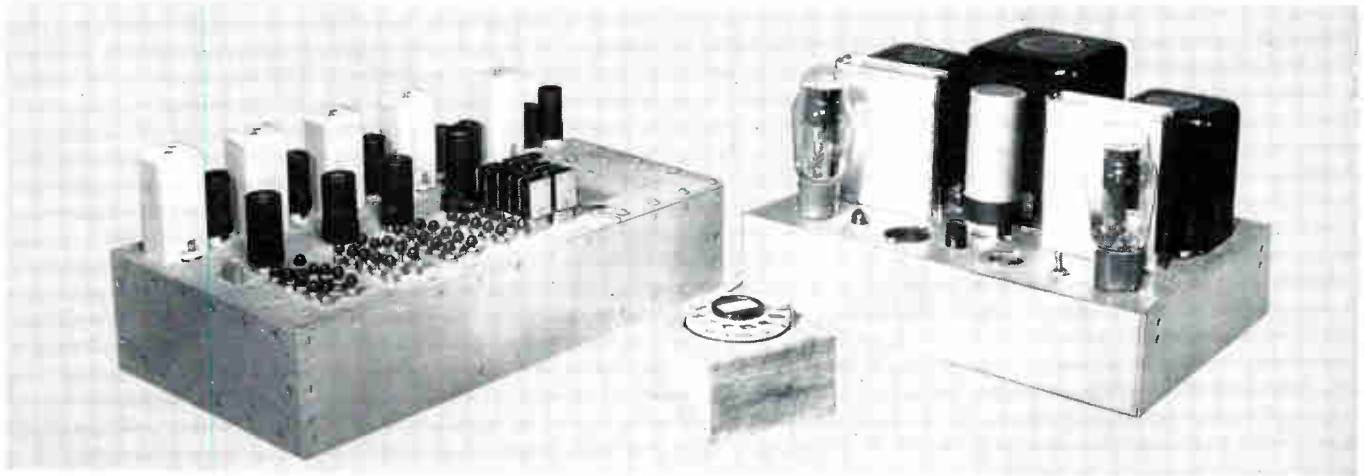

Fig. 2. The complete crystal-controlled tuner, with its power supply and remote dial. All components are operated well below their ratings

with the IF stages, limiters, discriminator, and cathode follower, from right to left above the transverse shield. In the lower portion of the chassis, below the shield, will be seen the front end on the right, extending to the drive motor assembly and the interpreter on the left. Fig. 4 presents the underside of the power supply chassis. The unwired rectifier tube socket at the lower left is merely a spare for the operating one on the right, a whim that could be indulged at little cost and which also improved the symmetry of physical layout.

Tuning Switch Has a Memory

The electro-mechanical design of the tuning switch or interpreter — the heart of the remote station selector — presented many problems. There was a self-imposed limitation of space, and the desire to have a minimum of moving parts, in the interests of trouble-free operation. It was planned to connect the control dial to the interpreter by a two-wire open-closed circuit, rather than a three-wire system which would have simplified the switching considerably. There was also the desire to have the selector

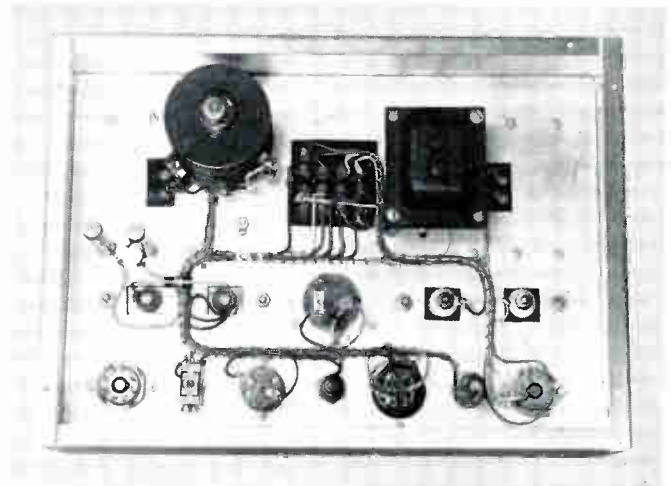
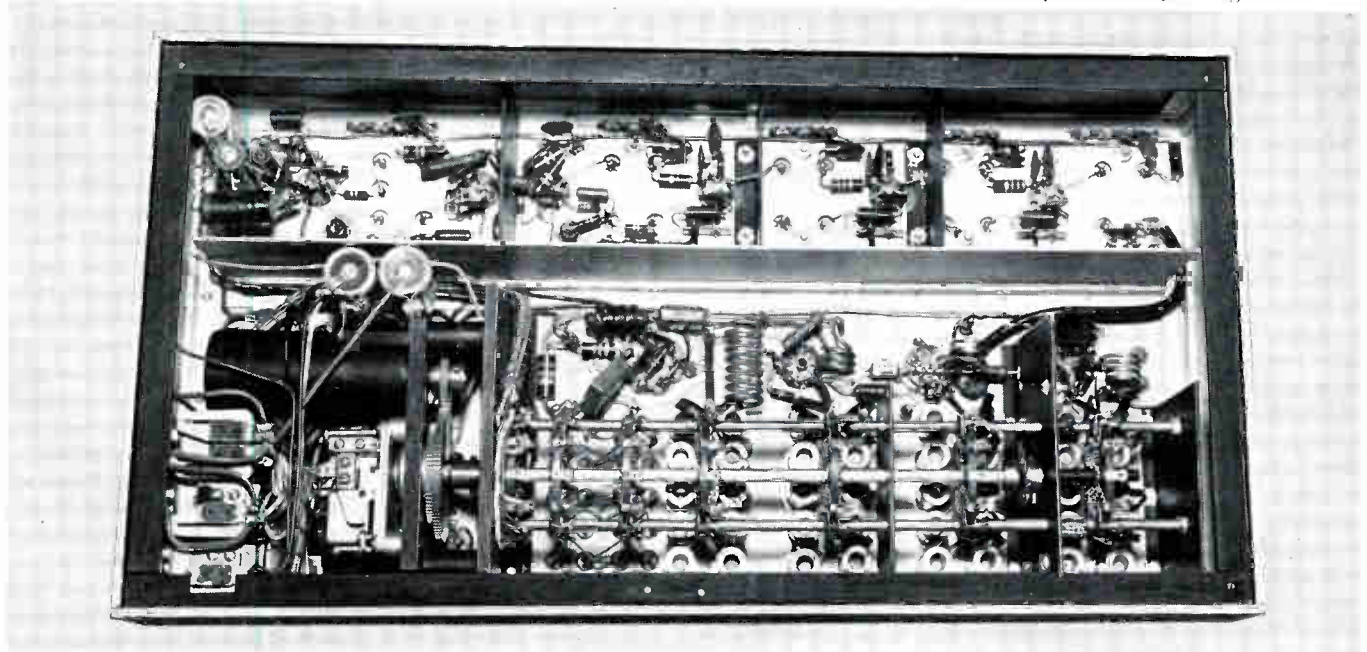

Fig. 4. This power supply operates at less than half its rated output fast acting, since we had some complaints on that score with our first model. It is amusing to note that our new interpreter can operate at a speed of 20 pulses per second, while the fastest we were able to accelerate the regular

(Continued on page 63)

Fig. 3. The underside of the tuner, showing the relays and motor-drive of the interpreter section, and the 10-position rotary tuning switch



KEEP AN EYE ON YOUR ANTENNA

If FM Reception Becomes Poor, Chances Are That Your Antenna Is the Cause

Most newly-installed FM antennas perform according to expectations. However, because antennas are normally mounted on chimneys and roof-tops, the effect of the weather and continued climatic exposure may reduce their effectiveness to the point where reception is seriously impaired. Since the antenna is out-of-doors and out of reach for convenient inspection, poor FM reception is generally blamed on the set, or the tubes, or the FM stations when, actually, the antenna is most likely to be at fault.

The average service life of an outdoor antenna being approximately three and one-half years, it should be checked at least once a year. Antennas that are installed on chimneys, in the city, or along the shore line, should get a semi-annual inspection if good year-round reception is to be assured.

Well-designed tuners and their associated amplifiers seldom suffer from deterioration of circuit components, because they are operated in a protected environment. On the other hand, antennas (which are usually constructed of aluminum) are subject to the ravages of the elements, and are vulnerable to chemical attack and mechanical fatigue to an extent that their electrical efficiency is easily impaired. Because this transition is necessarily gradual, any progressive change that takes place may go unnoticed until it becomes really serious.

Practically all receiving antennas are assembled from aluminum tubing, stampings, and castings. Nuts, screws, and bolts are usually made of steel, with zinc or cadmium plating. Over a period of time, corrosion steadily reduces the original conductivity and mechanical strength.

Antennas mounted on chimneys are subjected to the harmful effects of smoke, soot, and hot fumes which attack both the metal parts and the insulation. Thus the antenna elements soon deteriorate because of the accelerated oxidation and the premature rusting of the hardware. The insulation develops a high-resistance leakage to ground. The lead-in terminals become corroded, introducing a high resistance which changes the load characteristics into the tuner. Is it surprising, then, that reception may become unsatisfactory when the antenna is no longer new and shiny?

This, of course suggests the use of an antenna mounting that will facilitate inspection even at some sacrifice of height. The accompanying photograph shows seven points where trouble should be anticipated.

Mechanical fatigue or breakage may occur at any of points 1 to 7. Your dealer carries replacements for lost or broken elements. Examine the brackets that hold the

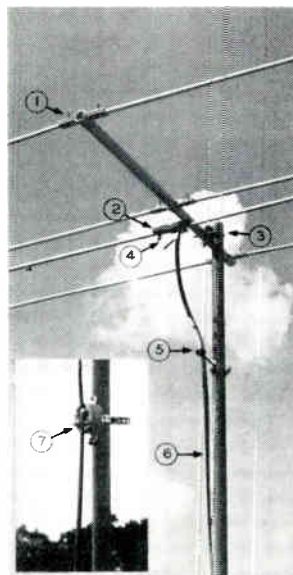

Poor FM reception can be caused by trouble at these seven points

elements to the boom, point 1, as well as the insulator, point 2, and the U-bolt, point 3. Replace any screws and thumb nuts that are badly rusted or cannot be taken up for tightening, because there must be no loose parts to vibrate in the wind. Poor mechanical connections cause noise when the wind whips the antenna. Make especially certain that the U-bolt holds the antenna securely to the mast.

Look for trouble at point 4. It is wise to remove the connector block and clean it thoroughly. Use steel wool or fine sandpaper to remove surface deposits. If sections of the tubing are held together with screws, remove the latter and brighten the surfaces of the tubing. Reassemble, *using new screws and nuts*, with a lockwasher under each nut, and make certain that they are zinc or cadmium plated. Better still, use stainless steel screws, nuts, and washers.¹

Insulator supports should be scrubbed with a brush in soap and warm water. Where the lead-in is connected, file the flat surfaces and insert new screws.

Finally, check the mast, guy wires, screw eyes, and turnbuckles for signs of failure. Use only galvanized metal parts for replacements.

The usual lead-in line, point 6, consists of two wire conductors spaced and insulated with Polyethylene plastic. This line has good electrical properties when it is new but continued outdoor exposure reduces its efficiency to the point of causing appreciable loss of signal strength. Rain and ultra-violet rays from the sun cause both electrical and mechanical deterioration. It is wise to replace the line every year.

Any outdoor antenna installation should include a lightning arrester. While the intent of the arrester is to by-pass lightning discharged safely to the ground, it also provides a bleeder path for neutralizing electrostatic voltages which would otherwise flow via the tuner circuit to ground. All lightning arrestors are UL-approved. However, they are not all satisfactory for FM. To determine the condition or suitability of the arrester, tune in a weak station. Then notice the difference in the signal strength when you connect and disconnect the arrester to the transmission line. Little or no effect should be discernible when a good arrester is employed.

Now, one note on safety. Before you venture on the roof to check your antenna, be sure that you have the proper ladders and any other facilities required to eliminate the possibility of an accident. If you can't do the job without risking your neck, call in a serviceman. Don't take chances!

¹These parts can be obtained from Star Stainless Screw Co., 100 Union Ave., Paterson, N. J.

ASSISTANCE FOR COLLECTORS

A Particularly Valuable Function of the Expertly-Planned Record Programs

A RADICAL departure from long-established-practice, such as the introduction of our programs of recorded music, is always disturbing, however well-founded the thinking behind the change. Like the introduction of pre-recorded tape in a field occupied by discs, for example.

Immediate reactions: 1) I prefer the old way; the new way won't last, or 2) this is the right way; it will replace the old.

But over a period of time, each new idea either drops into the limbo of the forgotten past, or it finds a permanent, useful place by obsoleting something that is old, or by providing an additional important service.

Each Has Its Usefulness

In the case of pre-recorded tapes, it has now become certain that they *will* last, although they *will not* replace discs. Reason: neither is a substitute for the other, because each has its distinctive advantages and spheres of usefulness. Therefore, some people will stay with discs exclusively, others will use only tapes, but a constantly increasing number, using both tapes and records, and will find more and more special services available from the former that are not provided by the latter.

So it is, we are learning, about our Programs of Recorded music. Certain readers who are most enthusiastic about other features of MUSIC AT HOME insist that the space occupied by the Programs should be given over to conventional record reviews. The fact that such reviews are available in a great many newspapers and magazines does not alter their views because, they say, they like to read reviews, and as many reviews as they can find of the same records, explaining that this is not a matter of seeking guidance in buying records, but interest in comparing their own reactions with the divergent opinions of reviewers.

On the other hand, we have many readers who like to devote particular evenings to record-listening, either by themselves or in the company of friends. They tell us that the programs for Music-at-Home Concerts help them to make these occasions really special events. Some follow the listed selections exactly, buying records called for if they do not have them already. Others use the Programs as a guide, making substitutions according to their own ideas. To this group, the Programs are far more useful than reviews of unrelated records.

Assistance for Record Collectors

Somewhat to our surprise, however, we find that the Programs are proving to be of greatest value as a guide to collectors. And by *collectors* we do not mean those who buy discs just to possess them, but those who seek to have the most enjoyable music available in their homes.

The basic difference between record reviews and the records listed and discussed in the Programs is that reviews are written about records because they are *new releases* while those listed in the programs are selected for the *importance of the music* in the opinions of the specialists who make up the programs.

To take a specific example: It is interesting to note Irving Kolodin's comment in his review of the Berlioz *Symphonie Fantastique* that Mercury's recording is "one of the loudest *Fantastiques* on record, and also very well played by the orchestra. However, there is more consistent musical purpose in this score than Dorati projects, and the current tendency to accentuate detail at the expense of mass of sound only fragmentizes the results more." This is very significant information if you are already familiar with the music of the *Symphonie Fantastique*, but if you aren't, you still won't know whether or not this is a record you will want to hear over and over again.

However, Dr. Herman Neuman picked this composition among the four Berlioz records "for the consideration of future Berliozians," listed in the 17th Program, and he offered the suggestion that: "For your Berlioz library, you will no doubt want at least one copy of his best known work — the *Symphonie Fantastique*."

That's not to imply that every record collector should rush out to buy this disc, or the other three. You may not like orchestral music in general, or the works of Berlioz in particular. But Dr. Neuman, who is quite an authority on Berlioz, chose the four records he listed as being, in his opinion, those you would probably select if you should listen to all the Berlioz recordings — which you probably haven't time to do! If you don't like *any* of the four records, chances are that you just don't care for Berlioz, and you might as well forget him.

Another special function of the Programs is to bring to your attention unusual music, or music which, for one reason or another, is of particular significance. So the Programs bear watching from issue to issue. As you check the record lists, here is something to bear in mind: the selections are not made *necessarily* from the latest releases, because they are chosen strictly for their musical value. But you may find notes about alternate choices, such as David Hall's comment, in the 21st Program, on the Victor recording of Grieg's *Violin Sonata No. 3 in G. Minor*: "In our opinion, this reading (recorded on 78's in the late 1920's) stands as one of the most treasurable experiences in the entire literature of recorded music. If you insist on up-to-date sound at all costs, then we can say that the Decca LP DL9571 of this work, with Joseph Fuchs and Frank Sheridan, is also endowed with many musical excellences, as well as good recording."

Whatever your tastes, these Programs deserve careful reading, because they do contain a wealth of authoritative information for everyone who loves fine music.

ORCHESTRAL MUSIC

25th Concert, 1954 Series

By DR. HERMAN NEUMAN

TO BE HEARD AT HOME

1. **Copland**—Fanfare for the Common Man—National Symphony Orchestra, Dr. Howard Mitchell conducting **West. WL-5286**
2. **Gould**—Tap Dance Concerto—Danny Daniels dance soloist, Rochester Pops Orchestra, Morton Gould conducting **Col. ML-2215**
3. **Creston**—Symphony No. 2, Op. 35—National Symphony Orchestra, Dr. Howard Mitchell conducting **West. WL-5272**
4. **Griffes**—Poem for Flute and Orchestra—Julius Baker with the Saitenberg Chamber Orchestra **Deuz 4013**

INTRODUCTION

FOR SOME fifteen years, New York City's municipal stations WNYC and WNYC-FM have devoted a large segment of their programs between Lincoln's and Washington's birthdays, to the annual American Music Festival. This is the most concentrated attempt on American radio to lend a helping hand to the American composers, native-born or American by adoption. In a Festival of more than one hundred programs contributed by various organizations, colleges and schools from one end of the Country to the other, a sizeable amount of new music by Americans is thus heard, for better or for worse. The public reaction to this altruistic venture has been interesting and highly vociferous in pro and con comment. That in itself is evidence of the success of the Festival. Regardless of any popularity ratings, it would seem to be a useful undertaking to afford the composers an opportunity to test their creative wares. Perhaps only a non-commercial enterprise like these municipally-operated stations can afford such idealism. The fact remains that the creation of a truly American culture is a long, steady evolution, growing out of the heterogeneous fabric that makes up this America—historically, geographically, socially, and ethically.

More and more we find the record companies doing their share in this search for the ultimate in the American musical art. The record enthusiast has a wide choice. This program is intended to point the way in a general direction.

PROGRAM NOTES

1. This is one of ten short pieces commissioned by the English composer-conductor Eugene Goossens when he was conductor of the Cincinnati Symphony Orchestra. The composer, Brooklyn-born Aaron Copland, intended it

as a tribute to those whose heroism marked the years of war. It is scored for brass instruments.

Copland is one of the most successful of our contemporary composers. This record also contains some of his best known works—*Appalachian Spring*, the *Billy the Kid Ballet Suite* and *El Salon Mexico*. All are performed expertly by the National Symphony Orchestra of Washington, D. C., conducted by an American, Dr. Howard Mitchell.

2. If you are looking for something novel in American music, this is it. The composer has "utilized the tap dance medium as an integrated rhythmic and dynamic part of the orchestral texture." The work is in the classical concerto tradition, including the usual cadenza. The movements are marked *toccata*, *phantomine*, *minuet* and *rondo*. It was written for the gifted dance soloist, Danny Daniels, who first performed it at the Eastman Theatre, Rochester, N. Y., with the composer conducting. On the reverse side of the record is another typically Gould piece titled *Family Album*, a suite of nostalgic reflections, with the old family album bringing back youthful and distant memories. The movements are marked—*Outing in the Park*, *Porch Swing on a Summer Evening*, *Nickelodeon*, *Old Romance* and *Horseless Carriage Galop*. It is all a witty bit of Americana.

3. Hats off to Westminster for this record! Think of it—two symphonies by one American composer on a single record. We are moving ahead. But then—we think Paul Creston deserves this high honor, for he is certainly one of the outstanding younger figures in contemporary American musical life. Both of these works have been given great praise by the critics.

Paul Creston was born in New York City. His Italian ancestry shows in his

melody. His musical message comes from the heart as well as the head. In composition, Creston is largely self-taught. He writes with fine craftsmanship, originality and vigor.

The *Symphony No. 2* is a sturdy work, American in spirit, "modern without being doctrinaire," melodic and strikingly alive. Like all new works, it should be listened to again and again. With each rehearing, its message will emerge more clearly. The *Symphony No. 3*, on the reverse side is cast in a different mood, leaning heavily on the Gregorian melodies and reflecting the deep rooted humility and devotion of a religious mind. While it is not included in this program, the *Symphony No. 3* adds greatly to the value of this disc.

4. Lest we forget the American composers of the past generation, we suggest a hearing of music by MacDowell, Loeffler, Foote, and Griffes. The last two composers are represented on the last record of this program, from which Griffes' *Poem for Flute and Orchestra* was chosen. Charles Tomlinson Griffes, only 36 at the time of his death, had just begun to come into his own as a composer of recognized merit. He is best known for his *White Peacock*. The *Poem for Flute and Orchestra* reflects a tinting of French Impressionism freshly developed in a more personal idiom. It is admirably recorded.

On the reverse side is the charming little *Night Piece for Flute and String Quartet* by the New England composer Arthur Foote, an important figure in that distinguished group of New Englanders who did so much to stimulate the musical life of Boston. Foote was little affected by changing styles in musical composition. He preferred to go his independent way writing music marked by good taste and sound craftsmanship. He reached the ripe old age of 84 years.

HI-FI RECORDS for a MUSIC-at-HOME CONCERT of

MUSIC of the INTIMATE OPERA

26th Concert, 1954 Series

By DAVID HALL

To Be Heard at Home

1. **Stravinsky**—Renard, a burlesque tale to be sung and played—William Hess tenor, Robert Harmon tenor, Warren Galjour baritone, Leon Lishner baritone, with Michael Zittai cymbalom, and the N. Y. Chamber Orchestra under Robert Craft (A-side) **Dial 10**
2. **Falla**—El Retablo de Maese Pedro (Master Peter's Puppet Show)—Chano Gonzalo bass, Francisco Navarro tenor, Blanca Maria Seoane soprano, with Champs-Elysées Theatre Orchestra under Ernesto Halffter (A-side) **West. WL-5238**
3. **Ravel**—L'Enfant et les Sortilèges (The Child and the Sorcerers)—a Fantasy in One Act, with Nadine Sautereau soprano, and the French Radiodiffusion Chorus and Orchestra under Ernest Bour **Col. ML-4153**

INTRODUCTION

SINCE the World War I period, a whole fascinating literature of intimate opera has come into being, of which we in this country still know little save through long playing records. This intimate, or chamber opera was designed for performance in small theaters with modest numbers of instrumentalists and performers. Although television did not exist when Stravinsky, Ravel, and Manuel de Falla wrote the little masterpieces we've selected here, the fact is that each of these works lends itself perfectly to the TV medium. While it may take quite a little time for the television impressarios to discover this music, we record lovers can for the time being regale ourselves, through a bit of visual imagination, with a listener's view of these charming scores.

ABOUT THE RECORDS

1. Igor Stravinsky's *Renard* might be called a connecting link between Aesop's Fables and George Orwell's *Animal Farm*. In this case, the story is based on a Russian folk tale which shows how the united action of the barnyard animals—Cock, Cat and Ram—does away with the scheming and vicious Renard the Fox. Little more than a dozen players suffice for the orchestra, which Stravinsky uses with consummate skill, and there are four singers. The musical style is terse, laconic, but extraordinarily vivid in its characterization and humor. This particular recorded performance is excellently sung

in English, which adds wonderfully to the fun of listening.

Also, if you have not heard it before, and the chances are that you haven't, you will be introduced to the cymbalom, or Hungarian dulcimer. That in itself is a reason for adding this record to your collection.

2. A more elaborate affair is Master Peter's Puppet Show, from the pen of the Spanish master, Manuel de Falla. Based on an episode from Cervantes's "Don Quixote," this score calls for the use of both marionettes and live actors. Where Stravinsky uses the exotic Hungarian cymbalom as the "keyboard" base of his chamber orchestra, Falla employs the harpsichord.

As the curtain rises, Don Quixote, the would-be knight-errant, and his faithful Sancho Panza are invited to witness a performance by Master Peter's puppets. The puppet play depicts the rescue of the beautiful Princess Melisendra from Moorish captivity by the valiant Don Gayferos. As the lady is abducted from her castle tower, the Moors, in hot pursuit, overtake her. Thereupon the deluded Don Quixote is so carried away by the proceedings that he seizes his sword and hacks the pursuing villains to pieces—with devastating results to the puppets and the stage. The action concludes with Don Quixote's air in praise of chivalry. This story has been embroidered by Falla with music of exquisite refinement, delightful effect, and subtle humor. There is none of the gypsy music familiar to

us in *El Amor Brujo*, but rather a tonal language which harks back to the 16th century Spanish manner on the one hand, but is completely contemporary (especially in the Moorish episodes) on the other. The recorded performance on the Westminster label is a delight to the ear.

3. It is Ravel's *The Child and the Sorcerers* which comes closest to full-scale opera in its orchestral and vocal demands; but the spirit is still of intimacy, tenderness, and humor. In essence, Ravel's fantasy takes the form of a dream sequence as it occurs to a naughty child who has been rude to his mother and, in a tantrum, has been cruel to his pets and destructive to the house. In the dream animals and furnishings take on a life of their own, and give voice to bitter reproaches against the child. They turn on him, and the terror of the moment makes him realize his wrongdoing. He tries to make amends, and in so doing wins forgiveness as his mother comes to the rescue. The various episodes afford Ravel the opportunity for some delightful jazz satire (1924-style), music evocative of the 18th century, an astonishing duet for cats, and an impressionistic garden nocturne that must rank as one of the most magically beautiful things in all his music. Though this recording dates from the early days of LP, it is still of excellent quality and offers a superb performance of a work that deserves to be far better known than it is. You are certain to enjoy it.

CHAMBER MUSIC

27th Concert, 1954 Series

By DR. HERMAN NEUMAN

TO BE HEARD AT HOME

1. **Juan del Encina**—Spanish Music from the Court of Ferdinand and Isabella—Pro Musica Antiqua **EMS 219**
2. **Antonio Soler**—Sonatas for Harpsichord—Fernando Valenti **West. WL5196**
3. **Juan Cristosomo Arriaga**—String Quartet No. 21—The Guilet String Quartet **C. H. Soc. 1068**
4. **Lopez Tejera**—Alegrias y Pensas de Andalucia (Joys and Sorrows of Andalusia)—Interpreted by Luis Marravilla, guitar, and Pepe Valencia, voice **West. WL5135**
5. Guitar Recital—Played by Luise Walker **Epic LC-3055**

INTRODUCTION

SPANISH music bridges a seven hundred-year gap between the Islam and Latin civilizations. Unfortunately, in the field of chamber music, the selection of recording is still comparatively limited, but it is growing, and there is enough to interest those who enjoy the rewarding experience of acquiring items that are off the beaten track. Most of our selections for this program are not exactly recent releases. They were selected for their particular musical values and importance to music enthusiasts who are interested in Spanish chamber music.

PROGRAM NOTES

1. This is an unusual recording of rare old Spanish chamber music. It takes us back to fifteenth century Spain. The Moors were finally vanquished by the Spaniards at Granada, and a new strength surged through the land. All of this political resurgence had a stimulating effect on the musical life of Spain. As was the custom in those days, the music makers of that time received most of their encouragement from the Court of Ferdinand of Aragon and Isabella of Castile. Unfortunately, with the passage of time, most of these creators of the tonal art have long since vanished from the chronicles of music. The outstanding exception is one Juan del Encina, a musician and poet of considerable talent, and a founder of the Spanish drama. He was born about 1470. Later he became a priest, served the Roman pontiffs as choirmaster. Encina's gift as a composer established him as a secular artist quite capable of writing music in any form, serious as well as popular.

On this record, you have a generous sample of his work, ably performed by the Pro Musica Antiqua of Belgium, under the knowing direction of Safford Cape. The instruments of the period—the minstrel's harp, the recorders,

viols, and the lute—blend with human voices to present a faithful tonal picture of music in the days of Christopher Columbus.

2. Once again we are indebted to a progressive American recording organization, and a gifted and enthusiastic artist, for the rediscovery of some fine music suffering from unjustifiable obscurity. To harpsichordist Fernando Valenti and Westminster Records goes the credit for a first rate restoration job of these charming *Sonatas for Harpsichord* by Antonio Soler.

The composer was born in the picturesque Catalan Province of Gerona in 1729. Like Encina, he entered the clergy early in life and became the chapel master of the Cathedral of Lerida. These sonatas represent only a small part of his creative output, which includes many works in the realms of religious, dramatic, and chamber music, plus a goodly number of instrumental works for strings, organ, and the harpsichord. Ten of his more than seventy *Sonatas for Harpsichord* were carefully chosen for this record. One cannot fail to notice the striking affinity with the single-movement sonatas of Domenico Scarlatti. The relationship between these composers has been keenly debated by musical scholars, some contending, with convincing proof, that Soler was a friend and a pupil of the famous Italian master. While the scholars settle the issue, if they can, the present day music lover will no doubt be content to settle down and enjoy the charm, wit, and energy of this music, with its deft touches of Spanish atmosphere.

3. Juan Cristosomo Arriaga was born in 1800 in the city of Bilbao. The famous Schubert epitaph "Music has buried here rich treasure, but fairer hopes" aptly applies to Arriaga. He lived less than twenty years. His opera *Los Esclavos Felices* was produced when he

was thirteen. The string quartets on this record belong to a set of three, the only works published during his brief life time. The music closely resembles that of Mozart, Schubert and, at times, even the mighty Beethoven. Like most young composers, past and present, Arriaga styled his creative efforts after the established models of his famous predecessors. However, for a youngster of fifteen, these quartets give evidence of sound musical thinking, mature and fertile in ideas. The second quartet is a little masterpiece, graceful, melodic, and original. The *pizzicato* variation is particularly listenable.

This is one of the Gold label series released some time ago by Concert Hall Society. The performers are the members of the Guilet String Quartet.

4. For a contrast, we have selected a record not strictly in the chamber music category. And yet, this is intimate music, folk music that has served to inspire most of the Spanish composers familiar to us such as Albeniz, Granados, De Falla, Turina and Halffter. The gypsies and their stimulating flamenco music have exerted a powerful fascination throughout the world of music.

5. It has been said that the guitar is second only to the piano as a household musical instrument. In America, organizations such as the Society for the Classic Guitar are striving to restore the traditions of Tarrega and Sor, the truly great Spanish pioneers in the field of classical guitar playing and composition. Miguel Llobet, a famous pupil of Tarrega and his pupils Andreas Cegovia and Luise Walker have exerted a profound influence in this trend.

On these two recorded selections, the discerning music lover will find a rewarding selection illustrative of the unique and pleasurable qualities inherent in this phase of old and new Spanish music.

KEYBOARD MUSIC

28th Concert, 1954 Series

By OLIVER DANIEL

TO BE HEARD AT HOME

- | | |
|--|----------------------|
| 1. Scarlatti —Sonatas for Harpsichord—Vol. 1, Valenti | West. 5106 |
| 2. Strauss —Burleske for Piano and Orchestra—Elly Ney and the Berlin Radio Symphony, conducted by Rothe | Urania 7108 |
| 3. Rorem —Sonata No. 2—Julius Katchen | London LL-759 |
| 4. Bowles —Concerto for Two Pianos, Winds, and Percussion—Gold and Fisdale, Saidenberg Orchestra | Col. L-2128 |

INTRODUCTION

THE choice of works on this program is a rather personal one. When I look at it, I realize that it really does not represent my musical likes and dislikes. It is, indeed, a rather slanted aspect of my musical interests. Thinking self-analytically about it, I realize why I selected these works. The essential reason requires a bit of explaining and in doing so I have to dip briefly into a bit of autobiographical lore.

Not that this is of any particular interest, but I was born and grew up in a small Wisconsin town called De Pere. It is pronounced "deep here" and I honestly thought for the first ten years of my life that it got its name from an Indian who fell into the Fox River which bisects the town, and came up burbling, "It's deep here." A town of five thousand naturally offered no concerts. Whatever music the local citizens wanted, they had to produce themselves. I had heard only one symphonic program before I was sixteen. But then, with no intermediary steps, I landed in Berlin where I began to tackle the problem of studying music with an avidity that shocks me as I think back and try to picture myself.

As if to make up for lost time, I began to go to concerts every night, and in those pre-Hitlerian days the concert life of Berlin was indeed brilliant. Many times, I would go to two concerts on the same evening. On Sundays, the Philharmonic began its programs at eleven in the morning. That left time for more concert-going in both the afternoon and evening. Although I heard all types of music, I was particularly attracted to piano recitals. The fare was much more Germanic than one would have found anywhere else, but in a very short time, one could become familiar with a major part of the great piano classics. The *Schumann Fantasy* could be heard three to five times per week. The Beethoven sonatas—the *Waldstein*, the *Appas-*

sonata, the *D minor, Opus 31*, the last set, all but the *Hammerklavier* which was performed less often—were heard regularly. The rest of the sonatas too were constantly included along with those of Mozart and Schubert. Then, and for many years thereafter, this powerful dose of the German classics dominated my thinking. I became for a while a concert pianist, and stormed through such warhorses as the Brahms sonatas, the Beethoven sonatas and variations, works of Bach, Schumann, and Schubert along with substantial amounts of Chopin and what then seemed very modern music. I still enjoy playing these works, and read through many volumes of others that I never actually worked on.

Paradoxically, what I choose to play for my own pleasure is totally different from what I choose to hear. Then, too, since I must perforce listen to a great deal of music at the CBS studios, I prefer to play records that are low in the *sturm* and *rang* quotient. I tend to avoid now many of the works in which I once reveled so thoroughly. The compositions I have selected here demand less concentration than those weighted down by complicated aesthetics. In short the music here is easy listening.

ABOUT THE RECORDS

1. The Scarlatti *Sonatas* should be taken in easy doses; like fine herbs or a superb wine, they should not be swilled or guzzled. No music in the world can stand the kind of overworking that radio and records are capable of giving it. And if one really wants to prolong the pleasure that this music affords, one should avoid spoiling it by frequent repetition. This applies to the Scarlatti particularly, since most of the sonatas are in a sense new discoveries. After all, how many people ever owned the whole edition of several hundred of them? These are some of the freshest works in the classical catalogue.

2. The Strauss *Burleske* is a youthful, joyous work. Played by Elly Ney, it has a kind of abandon that is honestly quite spectacular. There is not a knotted-brow moment in the whole work, and if a bit of *sturm* does bluster its way in, it is really a kind of belly-laugh that is still healthily refined, and not at all of the Bavarian pot-gutted variety. What I like about the playing of Ney is the spontaneous quality. She catches that Till-Eulenspiegelish quality the work demands. It is not a product of spit and polish.

3. Now for a change of pace. Ned Rorem's *Sonata* is a delight. He will be a newcomer to most listeners, and one whom they will watch with interest. The *Sonata* is one of the most pianistic of contemporary piano sonatas. Under the hands of Julius Katchen it becomes a little masterpiece. It has a Parisian flavor but also—if there is such a thing—an almost expatriot tinge. There is an American touch, and the wonder of it is that the Franco-American elements melt in a perfectly satisfying blend. Katchen as a pianist is a four-star performer.

4. Top this off with the *Concerto for Two Pianos, Winds and Percussion*, by Paul Bowles. It makes a better program to put the Bowles work after that of Rorem, but from the academic point of view it would be significant to reverse them, for Bowles decidedly influenced the writings of Ned Rorem. Ned himself told me this, and speaks with affection of Bowles' zarzuela *The Wind Remains*. This concerto is bright, fun-filled music that has discernible international influences: the neatness of the Parisian school; the languorous African flavor of the andante; and the Harlem-scented galop mixed with a dash of the French music halls.

After this, if you want an encore, there are always Bach's forty-eight preludes and fugues.

HI-FI RECORDS for a MUSIC-at-HOME CONCERT of

JAZZ for the HOLIDAYS

29th Concert, 1954 Series

By FRED REYNOLDS

TO BE HEARD AT HOME

- | | |
|---|---------------------------------|
| 1. Lu Watters' Yerba Buena Jazz Band | G. T. Jazz Set A |
| 2. Songs in a Mellow Mood—Ella Fitzgerald | Decca DL8068 |
| 3. Duke Ellington Plays the Music of Duke Ellington | Col. CL558 |
| 4. Claire Austin Sings the Blues | G. T. Jazz L24 |
| 5. Songs for Young Lovers, and Swing Easy—Frank Sinatra | Cap. H488, H528 |
| 6. Glenn Miller and His Orchestra—Limited Edition, Vol. 2 | Vic. LPT6701 or EPOT6701 |
| 7. Merry Christmas with Arthur Godfrey and His Friends | Col. CL540 |

INTRODUCTION

MORE THINGS happen in November and December that are both traditional and sentimental than in all the rest of the months of the year put together. So I have cast an eye and an ear towards the sentimental and the traditional in the preparation of this concert. Appropriately, it closes with a collection of Christmas songs and carols, a happy collaboration that has proved immensely popular, an ideal gathering at which you and your family are warmly welcomed.

ABOUT THE RECORDS

1. This is a set of three 12-in. LP's, splendidly attired and handsomely boxed. I would suggest you chose any two sides that appeal to you most and play those.

The famous Lu Watters' Yerba Buena Jazz band was the spearhead of the great Dixieland renaissance of 1946 and 1947, and it played largely in the style of old New Orleans. Watters himself shines forth, playing a sock lead with one of the most colossal tones ever blown from the bell of a trumpet. Although all of the sides were cut in '46, Good Time Jazz has used the latest audio techniques to reduce distortion as much as possible, and to improve the balance of the ensemble and the presence of the soloists. Whatever technical flaws remain are entirely justified by the musical and historical importance of the records. Lester Koenig's program notes are full and splendid.

2. Nowhere recently has Ella Fitzgerald quite so thoroughly proved that she is without peer in the artistic singing of popular music as she has here. Her work throughout the album is absolutely superb. Sometimes you gasp in astonishment at her fabulous ease of voice control, her warm, wonderful way with lyrics, her clean, true tone. Fortunately, her choice of songs was

right in line with her magnificent singing, as titles like *People Will Say We're in Love*, *Please Be Kind*, *Stardust*, *You Leave Me Breathless*, and *Nice Work If You Can Get It* will clearly indicate. Unfortunately the background by pianist Ellis Larkin leaves much to be desired. He merely fills in behind Miss Fitzgerald with unimaginative, modern chords. But forget about Larkin and listen to Ella's singing.

3. It isn't often you hear a collection of re-issues like this. Starting with the 1928 recording of *The Mooche*, the album runs through Ellington classics like *East St. Louis Toodle-O*, *Sophisticated Lady*, *Solitude*, and *Black and Tan Fantasy*, to the 1949 version of *Creole Love Call*. Naturally, fidelity cannot be full, although Columbia engineers have done a superlative job in bringing the old masters up to a level that is utterly amazing. If Ellington could re-create these great moments today, then there might be pause for thought. You have only to listen and compare, however, and you'll know that he can't. There simply is no possible substitute for the likes of Johnny Hodges, Ivy Anderson, Bubber Miley, Cootie Williams, Ben Webster, Tricky Sam Nanton, and Duke at his creative best.

4. Backed in lusty style by trombonist Kid Ory and his rhythm section, Claire Austin thrillingly sings eight classic blues, including *Caveless Love*, *Down Hearted Blues*, and *See See Rider*. Somewhere deep inside this woman is a world of honest emotion. And it comes through. Her voice is natural and true, and her singing is effortless. "Claire Austin Sings the Blues" is one of the finest album of blues in a long, long time, perhaps since the days of Bessie Smith and Ma Rainey. And the fit is as hi as an elephant's eye.

5. We put the two late Sinatra albums

together in one program, because pacing and over-all effect are far better that way. Besides, one package just isn't enough of Frankie these days, not the way he's singing. Sinatra's use of words, his impeccable phrasing, his control, his obvious sincerity, his warmth are virtues that are too easily taken for granted, and maybe you won't realize all these things are happening while you're listening to the albums. But they are, and there you have some of the reasons why the LP's are so terrific, together with the marvelous accompaniment and arrangements by Nelson Riddle and a select group of extremely capable jazzmen.

6. This is the second of the giant limited editions featuring Glenn Miller and his orchestra (five 12-in. LP's or 15 45-EP's, all richly packaged). It is much the better than the first, both from a standpoint of selections and fidelity. With Miller, the music was always mellow and harmonious. The dancing is good and so are the memories. In the edition are 60 performances, some of which were on Bluebird and Victor records, but all of the masters, taken from various broadcasts, are completely new to records. So it's easy to see that you can take as much of this as you choose, and I have a hunch you'll want the entire affair. To a whole generation Glenn Miller became a kind of evening star—"Star light, star bright, first star I see tonight . . ." Even today that star is shining clearly and wonderfully.

7. An evergreen of reasons why Christmas will sound better than ever this year. Throughout this album is a joyful feeling of warmth and merriment, like old and treasured friends gathered around your tree singing the songs of Christmas with you. Especially beautiful is Marion Marlowe's *Silent Night*, while the resounding, jolly version of *Jingle Bells* is simply corking.

MUSIC from the THEATRE

30th Concert, 1954 Series

By BEN DEUTSCHMAN

TO BE HEARD AT HOME

1. Movie Time—Morton Gould and his orchestra **Columbia ML4595**
2. Brigadoon—Book and lyrics by Alan Jay Lerner; music by Frederick Loewe; original Broadway cast **Victor LOC 1001**
3. South Pacific—Book adapted from Michener's "Tales of the South Pacific" by Oscar Hammerstein and Joshua Logan; music by Richard Rodgers. Original Broadway cast **Columbia ML 4180**
4. The King and I—Book adapted from Landon's "Anna and the King of Siam" by Rodgers and Hammerstein; original Broadway cast **Decca DL 9008**
5. By the Beautiful Sea—Book by Herbert and Dorothy Fields; music by Arthur Schwartz; original Broadway cast **Capitol S 531**

INTRODUCTION

IN ATTEMPTING to make up a program of music of the theatre, one is confronted with a rather large and varied choice of approaches. The theatre has used music from the time of the ancient Greek classic plays to the Broadway of 1954. All the periods of theatre music have one thing in common: the music either reflected the then popular trend, or it influenced the music of its time. However, any one program attempting to cover the whole field would become a hopeless potpourri. Even to try to build a program that would encompass the drama and comedy of today would be difficult and too complex in its substance. Therefore I chose for this program the music of the Broadway shows and the movies that can be classified as musical comedy.

ABOUT THE RECORDS

1. This program opens with a record that is an ideal overture to the musical selections which follow.

The numbers were composed by the men who can be called the real nobility of today's theatre music. Here is a superb recording of the music of Cole Porter, Jerome Kern, George Gershwin, Irving Berlin and Richard Rodgers.

The music is performed by a well-seasoned and nicely balanced orchestra under the direction of Morton Gould. In this overture you will hear *Long Ago and Far Away* from "Cover Girl," *I Dream Too Much* from the movie by the same name, *It Might as Well be Spring* from "State Fair," and other great movie tunes of the recent past. Morton Gould's suave and sophisticated arrangements are presented in a manner

that gives them a brilliant and polished glow. The music will awaken so many memories that you will probably catch yourself humming them for days after the concert.

2. "Brigadoon" came to Broadway a few years ago. Now we have a revival in the motion picture. The original play had a cast of players who seemed to have been made to order for the parts. Marion Bell, as Fiona MacLaren, was as pretty and musical a Scotch Lassie as ever was heard. David Brooks, as Tommy Albright, was a typical American boy deeply in love. With Lee Sullivan and Pamela Britton they made the story of the Scotch town and its mystic spell seem very real. Some of the outstanding tunes heard on this record by the original cast are *Once in the Highlands*, *Brigadoon*, *Almost like Being in Love*, *My Mother's Wedding Day* and *From This Day on*.

3. No program of music of the theatre would be complete without the great recording by Mary Martin and Ezio Pinza from "South Pacific." In the slang of Tin Pan alley here was a show where "Rodgers and Hammerstein done it again." However, much of the credit for its success can be found on this record. It was the superb singing by Mary Martin as Ensign Nellie Forbush, and Ezio Pinza as the planter Emile de Becque that made this show a hit for so many performances. Whether you saw the show or not, you will enjoy such great songs as *A Cockeyed Optimist*, *Some Enchanted Evening*, *There's Nothin' Like a Dame*. Also on the record are two tunes by the incomparable Juanita Hall, *Bali Ha'i* and *Happy Talk*. William Tabbert's *Younger Than Springtime* also deserves a good round of applause.

Although this recording cannot really be called hi-fi by our 1954 standards, the recording is so good that you will enjoy a wonderful forty minutes of memories.

4. Here is an album that might well be called a "Memorial to a Great Lady." When Gertrude Lawrence died on September 6, 1952, "The King and I" and Gertrude Lawrence had made for each other a wonderful and tuneful pedestal of greatness. Yul Brynner with his exciting patchwork background as a night club singer, circus acrobat, actor, and director, brought to the play a fresh approach that left Broadway breathless and applauding. Dorothy Saranoff, as Lady Thiang, and Doretta Morrow as the slave Tuptim were excellently cast. This is one record from which I will not pick tunes, the reason being that from the overture to the end it is one unity of great music and performance.

5. 1907 meets 1954 and Shirley Booth, as Lottie Gibson, does the introducing in a most elegant and musical manner. You may be planning to go see the play, so we won't spoil it by giving you the plot. Enough to say that this is a very good record to use as a curtain closer on this evening's program. You will go away from your phonograph feeling that you have heard show music as it should be recorded and tunes as they should be sung. Don't try, because it will be impossible, to keep tunes like *The Sea Song*, *Happy Habit*, *Good Time Charlie*, and the others out of your mind. The music is typical of today's music. In the hands of lesser characters, it might not fare too well, but Miss Booth, Richard France, Wilbur Evans, and Mae Barnes give it a champagne sparkle.



This photograph was taken during the rehearsal on the 20th, before microphones were added for stereophonic tape recording

“A GIFT FOR THE GIVER”

Toscanini's Orchestra Makes Plans for a Permanent Future—By Don Gillis

ON Carnegie Hall's historic stage at midnight on September 21st, the 92 members of Toscanini's former NBC Symphony Orchestra sat quietly while a voice from an intercom speaker, installed center-stage, said: "Stand by . . . Roman Carnival . . . Take One." Then the hall was filled with music from the orchestra that refused to go out of existence, playing for the first time since Maestro Toscanini's retirement.

The music continued to its dramatic finale. Applause from the small, invited audience of critics was almost lost in the great emptiness of the tiered hall. Nor was there any acknowledgement of the applause, for the podium was empty. There was no conductor!

No conductor in physical fact, that is, but during the critical three hours of that recording session, the men of this world-renowned group, most of *Continued on page 60*

MUSICIANS COMPRISING TOSCANINI'S SYMPHONY ORCHESTRA, 1954

VIOLINS

Guilet, Daniel
 Concert Master
 Antek, Samuel
 Bachman, Edwin
 Bergen, Eugene
 Bloom, Tobias
 Bolognini, Remo
 Edlin, Louis
 Eichenbaum, Bernard
 Galimir, Felix
 Gershman, Paul
 Goodrich, Frank
 Gomer, Joseph
 Graeler, Louis
 Herzog, Jasha
 Hollender, Max
 Jaffe, Charles
 Katz, Theodore
 Kissel, Samuel
 Margolies, Jacques

Nemkov, Sol
 Proto, Secondo
 Robbins, Bernard
 Rushking, Jascha
 Sarser, David
 Siegl, Henry
 Smit, Kalman
 Spielberg, Herman
 Sopkin, Stefan
 Steinhart, Laurence
 Suskind, Seymour
 Tryon, Jesse
 Weinstock, Rachmael

VIOLAS

Carboni, William
 Coletta, Harold
 Fregut, Leon
 Fuchs, Herbert
 Granick, Arthur
 Helfand, Maurice

Hillyer, Raphael
 Moldavan, Nicolas
 Posner, Selig
 Schwartz, David
 Vardi, Emanuel

CELLOS

Bernstein, Jacob
 Clement, Paul
 Gara, Emmerick
 Heifetz, Benar
 Koutzen, George
 Lake, Milton
 Prinz, Milton
 Rostal, Leo
 Shulman, Alan
 Ziegler, Carl

BASSES

James, Brennan
 Ghirlanda, Edgar

Gorodner, Murray
 Krasnopolsky, Michael
 Levitan, Sam
 Mancini, John
 Shachner, Harold
 Sklar, Philip
 Sollner, Frank
 Walter, David

FLUTES

Fulton, John
 Morris, Robert
 Renzi, Paul

OBOES

Ghignatti, Filippo
 Penza, Saverio
 Renzi, Paolo

CLARINETS

Allard, Joe

Freeman, Harold
 Weber, David
 Williams, Alexander

BASSOONS

Carmen, Elias
 Dickie, James
 Reines, Abraham

HORNS

Berv, Arthur
 Berv, Harry
 Berv, Jack
 Cerino, Arturo
 Miranda, Anthony

TRUMPETS

Crisara, Raymond
 Falcone, Frank
 Glantz, Harry
 Statter, Arthur

TROMBONES

Clark, John
 Di Biase, Neal
 Perlstein, Abraham

TUBA

Novotny, Joseph

TIMPANI

Glassman, Karl

PERCUSSION

Borodkin, Samuel
 Dorn, William
 Sittman, Harry

HARP

Vito, Edward

PIANO

Kohn, Joseph

Hi-Fi Projects for the DRAWING TABLE WORKSHOP • No. 2

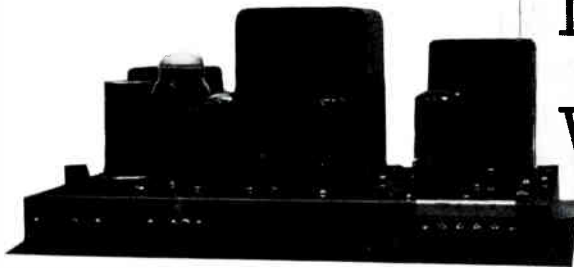

DO YOU THINK I can assemble an amplifier kit and be sure that it will work after I put it together?" This question has been asked in letters from readers who would like to have the satisfaction of building a part of their equipment, but lack experience with such work.

Because it is always dangerous to give advice without first hand knowledge, we decided to make a Workshop Project out of assembling a Heathkit Williamson-type amplifier, and in that way find out exactly how difficult it was, how much time it took, and if, by following the instructions to the letter, it would work perfectly when it was finished. So follows the odyssey of Heathkit W4-M.

By rights, this is a one-man job. But to double-check each step, we had an assistant to read the instructions and to mark the book as we completed each assembly step.

The book, by the way, is remarkably clear and complete. Such minor, initial difficulties as we encountered were due entirely to our impatience to get started. We did not stop to check the parts supplied against the parts list, as the book says to do in the fourth paragraph on page 4. Also, we were confused by the indications (S) and (NS) in the wiring stages, although it is stated quite clearly at the top of page 5 that "(S) means solder the connection. (NS) means do not solder yet." However, we didn't miss the pink slip bearing the admonition: "All guarantees are void and we will not repair or service instruments in which acid core solder or paste are used."

We tacked up the two big diagrams, as you will see in the accompanying photographs, got out our soldering iron, a roll of rosin-core solder, screwdriver, pliers, and an adjustable wrench. Those were all the tools we needed.

The parts had been very neatly packed. They were first-quality parts, too, and all were in perfect condition. You can see them laid out on the table, in Fig. 1, ready to start the first assembly steps.

The first 17 steps were devoted to mounting all the components that are carried on the chassis. We put on two sockets before we noticed that they must be oriented as to the position of the keyways, shown very clearly on the assembly diagram.

We had a minor hassle with the small rubber grommets. The trick, we found, was to squeeze the grommet into the shape of an oval. Then it could be started in the hole, and eventually pushed into place with a screwdriver. A similar technique was used on the four rubber feet. Fig. 2 shows the assembly stage completed.

TIME TO COMPLETE THE ASSEMBLY: 50 minutes.

No difficulties were encountered with the wiring. For the first 35 steps, we connected parts already mounted. The photograph in Fig. 3 was taken at that point.

Just to be fancy, we decided to cable the leads from the transformers, as you will see in Fig. 3. Since it was Sunday, we couldn't get the proper cord for that purpose. Instead, we bought a piece of beeswax from a nearby drugstore,

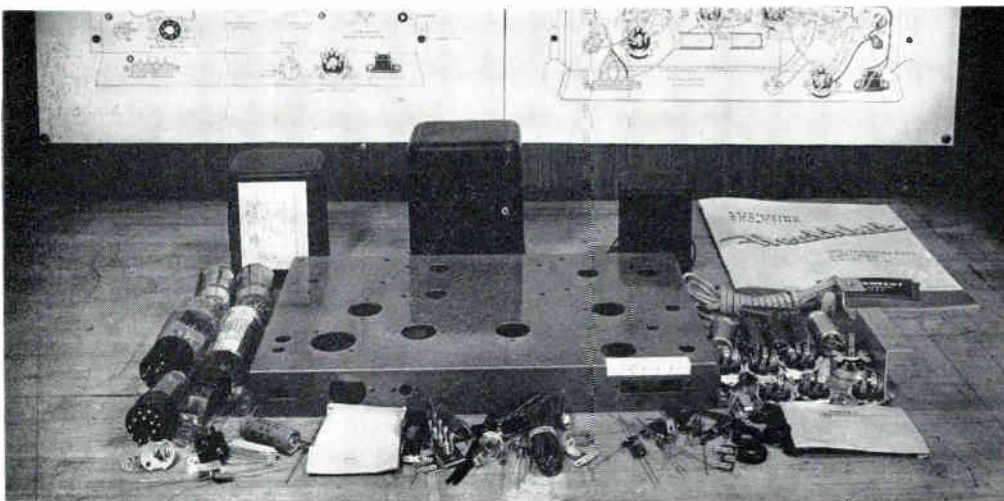

Fig. 1. Here are all the parts for the Williamson-type amplifier as we laid them out, ready to start on the assembly. Nuts, screws, and hardware were packed in envelopes. Two large diagrams, tacked up on the wall, were furnished with the book of step-by-step instructions

and pulled strong, light string over the wax. It worked beautifully!

If you tackle the assembly of this amplifier kit, and haven't experience with wiring and soldering, these notes may be helpful:

1. When you solder a connection, melt a little solder on the tip of the iron, apply that hot solder to the under side of the lug to heat it, while you hold the end of a strip of solder on the wire at the other side of the lug until the wire becomes hot enough to melt the end of the strip of solder. That is a complicated sentence, but if you read it three times, the meaning will be clear. Also, you will be more sure of getting a perfect joint than if you simply melt solder on the iron and then try to transfer it to the connection. If there is any excess solder on the joint, touch the iron to it just long enough to melt it off. *Always work quickly, so as to apply the least amount of heat possible, but be sure that both the rosin and the solder flow freely.*

2. When the instructions call for twisting wires together, be sure that you twist *both wires*. Otherwise, one wire will be simply twisted around the other.

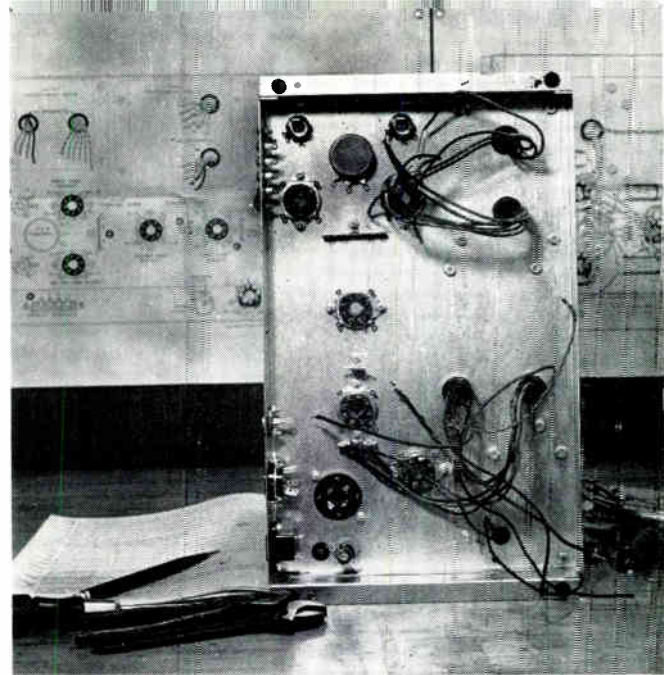

and only one departure from the descriptions of the components was encountered. Instead of a 250-ohm, 10-watt resistor described as "a fairly large, hollow tube marked

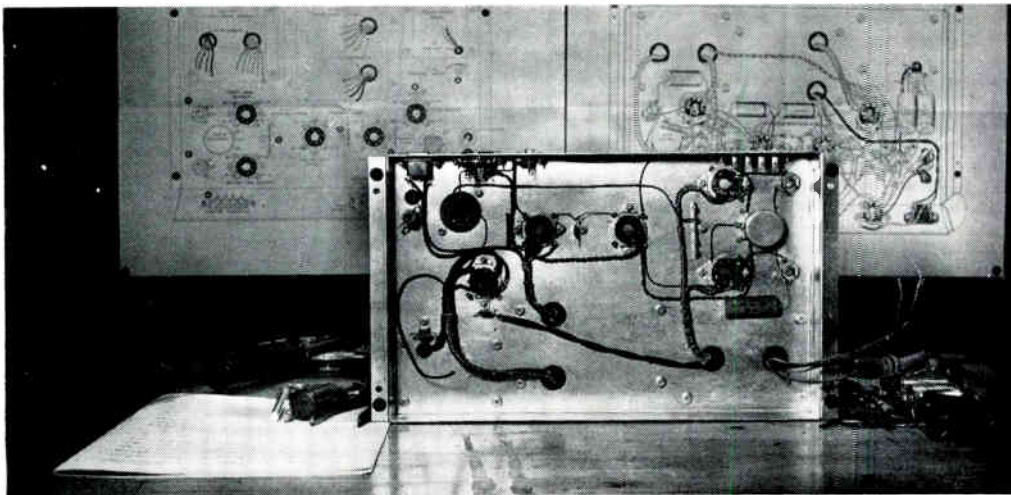

Fig. 2, above: At the end of the first 17 assembly steps, devoted entirely to mounting parts, the chassis looked like this

Fig. 3, left: During the next 45 steps, connections were made to the parts already mounted. The cabling, an extra touch of our own, gave the wiring a neat and tidy appearance

3. Be very quick when you solder plastic-covered wire. Too much heat will cause the plastic insulation to melt. **TIME FOR FIRST 35 WIRING STEPS: 2 hours, 45 minutes.**

There weren't any problems in the succeeding stages,

250", we found one of that value in a square ceramic case, 1 3/8 ins. long. However, we knew that was not a mistake, because we had read at the foot of page 4: "In order to ex-

Concluded on page 52

Fig. 4. This photograph shows the finished amplifier, ready for testing. Connections in this final stage of assembly, carried out in 49 steps, were made without any difficulty because we followed the instruction book right to the letter

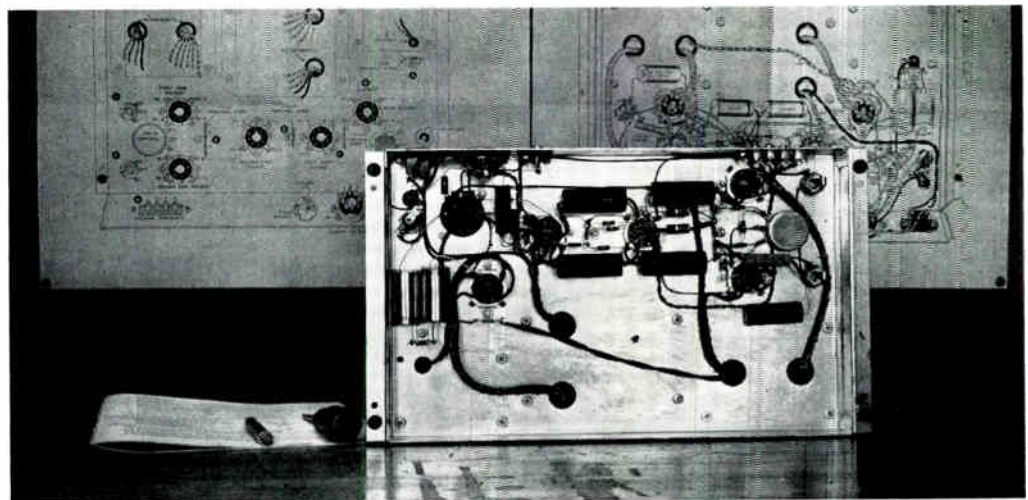

Better Bass Reproduction

Part 2. Purpose of Networks, and How They Divide Frequencies — How to Assemble Networks for Air-Coupler Systems — By Milton B. Sleeper

As explained in Part 1, full, true bass reproduction is important because it supplies the rhythm and substance of music. Construction details and dimensions of the Air-Coupler enclosure were also presented. Part 2 is devoted to networks for Air-Coupler installations — the reasons for using networks, and the circuits required.

BACK in the early 20's, the phonograph was a mechanical device, producing music without benefit of an electrical pickup, amplifier, or loudspeaker. We listened to radio broadcasting with headphones that were developed originally for wireless telegraph operators.

The first "loudspeaker" was made up of a single headphone mounted on a base which supported a metal goose-neck horn. Remember? I recall being very disappointed the first time I heard one of those early loudspeakers. Station WOR was carrying some public event, with speeches and a fife and drum corps to supply the music.

The speakers' voices came through surprisingly well, but the music was a total loss because the loudspeaker could not reproduce the low frequencies of the drums, nor the high frequencies of the fifes! In other words, the speaker was fairly good on speech, because that was limited to what we now call the *middle range*, but it couldn't handle the *low range* (drums), or the *high range* (fifes).

Why More Than One Speaker

In recent years, the tonal range of records, tape, and FM was increased beyond the capacity of any single speaker, at least, any speaker of reasonable price and size. Efforts were directed, therefore, toward designing speakers for specific frequency ranges which, when combined, cover perhaps 28 cycles to 15,000 cycles.

For example, one speaker can be designed for maximum efficiency at 30 to 240 cycles (about middle C to 3 octaves below); another for 240 to 1,900 cycles (middle C to almost 3 octaves above); and a third for 1,900 to 15,000 cycles (3 octaves above middle C to 6 octaves above). This may seem to be an uneven spread, but actually the top frequency in each case is 8 times the bottom frequency.

This is comparable to long-established practice in the

design of musical instruments, each of which is limited to creating a specific range of frequencies, or tones. For example, four different stringed instruments — the double-bass, violincello, viola, and violin — are required to cover the range from almost three octaves below middle C to three octaves above middle C.¹

To these ranges must be added the overtones or harmonics, which give character to individual instruments. They may run up to 15,000 cycles. If each instrument produced only pure tones (single frequencies without harmonics) a given note, such as middle C, would sound exactly the same when played on a piano, violin, saxo-

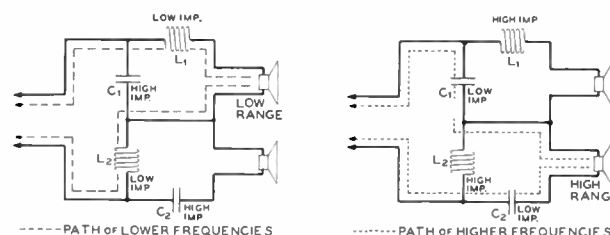

Fig. 7. Low frequencies follow the low-impedance path through the inductors. Fig. 8. Capacitors offer lower impedance to high frequencies

phone, or organ! That is why, to give full-range reproduction, an audio system must cover 30 to 15,000 cycles, even though music is not written for such a range, nor do fundamental tones of the instruments go so high.

Purpose of Networks

In a system employing three loudspeakers, the output of the amplifier could be fed directly to all of them. That would be a very inefficient arrangement, however, since part of the power would be wasted by feeding very high frequencies to the low-range speaker, and low frequencies to the tweeter.

To channel audio frequencies into groups, and to feed them to the corresponding speakers, dividing networks are employed. A speaker network is a combination of capacitors and coils designed to offer very low resistance to a particular range of frequencies, and very high resistance to frequencies above that range.

The *crossover point* of a network is the frequency at which the resistance (more properly called *impedance*) to

¹ A very complete chart showing the tonal ranges of instruments and human voices is contained in "Music Lovers' Encyclopedia" by Hughes and Taylor, price \$2.95, Garden City Books, Garden City, N. Y.

the flow of audio-frequency currents in one section becomes higher, or lower, than in the other section, with the result that currents below the crossover frequency can flow more readily in one section, and currents above the crossover frequency can flow more readily in the other section.

Most networks are designed to have a fixed crossover point, but types are now available which permit adjustment of the crossover point, in accordance with the characteristics of the particular speakers used.

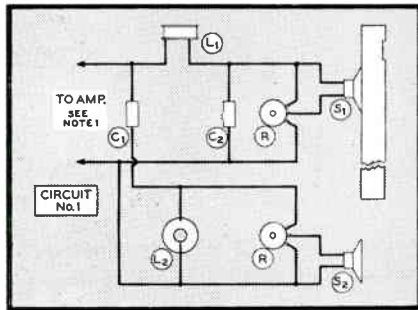

Figs. 9 and 10. For an Air-Coupler, and one additional speaker to cover the middle and treble ranges, choose one of these circuits, as indicated in Table 1, according to the impedance of the speakers. NOTE 1: Match the output impedance connections on your amplifier to the impedance of the speaker on the Air-Coupler

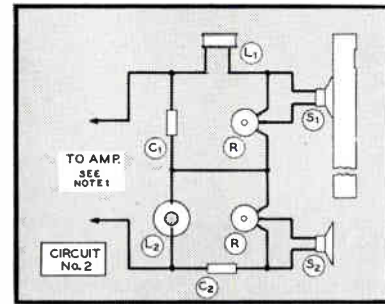

How Networks Divide Frequencies

Most of what has been written on the subject of electrical networks is so technical and complicated as to be more confusing than informative to the average reader. Reduced to the simple elements involved in audio systems, however, the network and its operation are simple enough if you bear these basic facts in mind:

1. The impedance to the flow of current offered by a capacitor decreases as the frequency goes up.

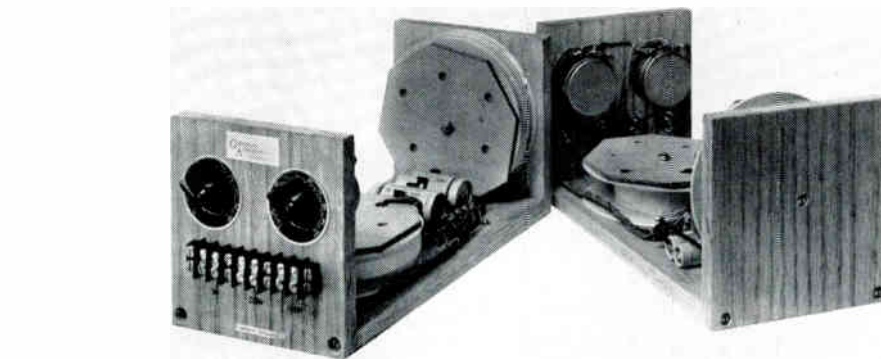

Fig. 11. Front and rear views of assembled networks for use with the Air Coupler, as supplied by General Apparatus. Note that the inductors are well separated and are mounted at right angles to each other. In a system requiring two networks, separate the network assemblies by at least 12 ins. to prevent inductive coupling between the two sets of coils

2. The impedance to the flow of current offered by an inductor decreases as the frequency goes down.

3. Electric currents always seek the path of lowest impedance. Figs. 7 and 8 show how these effects in an audio network direct the low frequencies to one speaker, and the high frequencies to the other speaker.

The *low frequencies* from the amplifier follow the dotted lines in Fig. 7, while the *high frequencies* follow the dotted lines in Fig. 8. Thus, in Fig. 7, the *low frequencies* are fed to the low-range speaker because the lower the frequency, the lower the impedance of coils L_1 and L_2 , and the higher the impedance of capacitors C_1 and C_2 . In Fig. 8, the high-frequencies are fed to the high-range speaker because the higher the frequency, the higher the impedance of coils L_1 and L_2 , and the lower the impedance of capacitors C_1 and C_2 .

There is a frequency, of course, where the impedance of one path is exactly the same as the impedance of the other path. That is the *crossover frequency*.

Networks for Two-Speaker Systems

You can perform endless experiments with Air-Coupler systems, if you are so inclined, but you will probably be repeating work that has been done by many others already, and you will probably arrive at the same conclusions.

Therefore, in the matter of networks, it is recommended that you first carry out the specific data presented here, because they represent the latest findings.

Originally, a crossover frequency of 350 cycles was used for the Air-Coupler. Subsequently, this was shifted to 175 cycles. The purpose was to keep voice frequencies out of the Air-Coupler, particularly when it is installed at some distance from the middle-range speaker.

Many highly successful installations combine the Air-

TABLE 1: 175-CYCLE CROSSOVER NETWORK

Ohms Impedance		CIR- CUIT	L_1, L_2 mh.	C_1, C_2 mfd.	R ohms	AMP. output ohms
SPKR. 1	SPKR. 2					
4	4 to 8	1	5.1	160	15	4
8	4 to 16	1	10.2	80	25	8
16	8 to 24	2	10.2	80	25	16

Coupler with a single wide-range speaker to cover the middle and treble frequencies. That is a simple arrangement, involving only one network. In that case, the design details of the network will be determined by the impedances of the two speakers, and connections will be made in accordance with circuit No. 1 or No. 2, shown in Figs. 9 and 10. Accordingly, you must know the impedance value of each speaker. It is probably marked right on the nameplate. If not, ask your dealer.

NOTE 1: See tables for proper amplifier impedance values

According to the impedance values of your speakers, you can find out from Table 1 whether to use circuit No. 1 or No. 2, the values of the inductors, capacitors, and variable resistors, and the correct output terminals on your amplifier output to which the network should be connected. For example, if you have two 8-ohm speakers:

1. Use circuit No. 1, in Fig. 9.
2. Coils L_1 and L_2 should be of 10.2 millihenries each.
3. Capacitors C_1 and C_2 should be of 80 mfd. each.
4. Variable resistors R , used as level controls, should be of 25 ohms each.
5. The network should be connected to the amplifier output at the common terminal and the 8-ohm terminal.

That's all there is to planning the network. Because of their lower price, good electrolytic condensers have been widely used. Some engineers frown on this practice, but many networks built as much as five years ago are still operating with the original electrolytics!

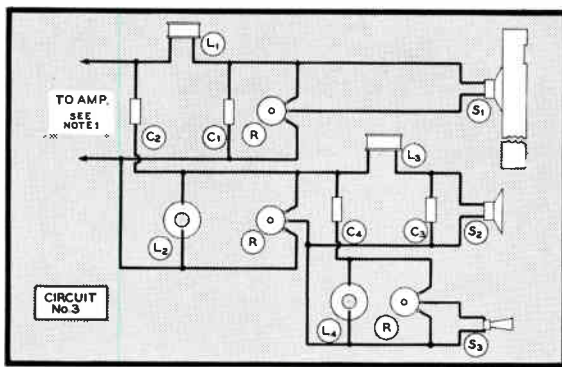

SPKR.	Ohms	Impedance	SPKR.	CIR- CUIT	L_1, L_2 mh.	L_3, L_4 mh.	C_1, C_2 mfd.	C_3, C_4 mfd.	R ohms	AMP. output ohms
1										
4	8	4 to 16	3	3	5.1	0.8	160	6	15	4
8	8	4 to 16	3	3	10.2	0.8	80	6	25	8
8	16	8 to 32	3	3	10.2	1.6	80	3	25	8
16	8	4 to 16	4	4	10.2	0.8	80	24	25	16
16	16	8 to 32	4	4	10.2	1.6	80	3	25	16

from Table 2. For example, if you have an 8-ohm speaker for the Air-Coupler, a 16-ohm type for the mid-range, and a 24-ohm tweeter:

1. Use circuit No. 3 in Fig. 12.
2. Coils L_1 and L_2 should be of 10.2 millihenries each, and L_3 and L_4 of 1.6 millihenries each.
3. Capacitors C_1 and C_2 should be of 80 mfd. each, and C_3 and C_4 of 3 mfd. each.
4. Variable resistors R , used as level controls for the speakers, should be of 25 ohms each.
5. The network should be connected to the amplifier output at the common terminal and the 8-ohm terminal.

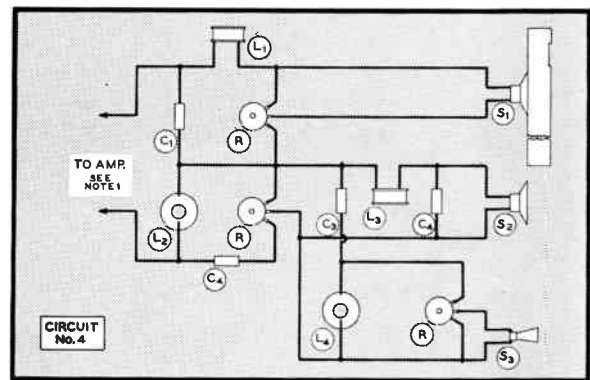

Figs. 12, 13. Table 2 shows which 3-speaker circuit to use. NOTE 1: match amplifier output impedance to the impedance of the Air-Coupler speaker

You can wind your own coils, but it is a lot of trouble, there is little saving in cost, and you will have to measure the inductance in order to detect shorted turns. Be sure to get air-core coils, of wire not smaller than No. 16 gauge.

Fig. 11 shows two views of a General Apparatus network designed for use with the Air-Coupler. If you assemble your own, bear these points in mind:

1. Keep the inductors several inches apart, and mount them at right angles to each other.
2. Do not mount the coils on a metal chassis. That will change the inductance value. Mount them on wood.
3. Keep the leads short, and solder all connections.
4. Provide sturdy terminal blocks for the connections to the speakers and amplifier. Then you can be sure of firm, permanent connections.
5. When you install the network, keep it away from any source of heat, as that will shorten the life of the electrolytic capacitors.

Networks for Three-Speaker Systems

You may want to use the Air-Coupler in conjunction with a mid-range speaker and a tweeter. In such a system, a crossover frequency of 175 cycles is recommended between the Air-Coupler and the mid-range speaker, and 2,200 between the mid-range speaker and tweeter.

Again, the circuit and the values of the components are determined by the impedance values, as you will see

The same notes apply to three-speaker systems as those given in the section on two-speaker systems. Be sure to keep the two sets of inductors separated by several inches, to avoid magnetic coupling, and mount the inductors of each set at right angles to each other.

Choice of Speakers

No particular combination of speakers has been found to give the "best" performance. Many people have asked if a 15-in. speaker is better for the Air-Coupler than a 12-in. type. Experience indicates the use of the smaller size. Nor is anything gained by increasing the dimensions of the Air-Coupler and using a 15-in. woofer.

For the Air-Coupler, use a high-quality, single-cone, 12-in. speaker. There is nothing to be gained by using an expensive coaxial type, since frequencies above 175 cycles will not be fed to it, anyway.

The choice between a single speaker to cover the mid-range and treble range, and a mid-range speaker with a separate tweeter is a purely personal matter. Reports from people who have installed Air-Coupler systems describe different combinations of speakers as giving beautiful performance, indicating that the choice of the correct network or networks is more important than the use of specific speakers.

The conclusion of Part 2, devoted to variable networks and binaural systems, will appear in the next issue.

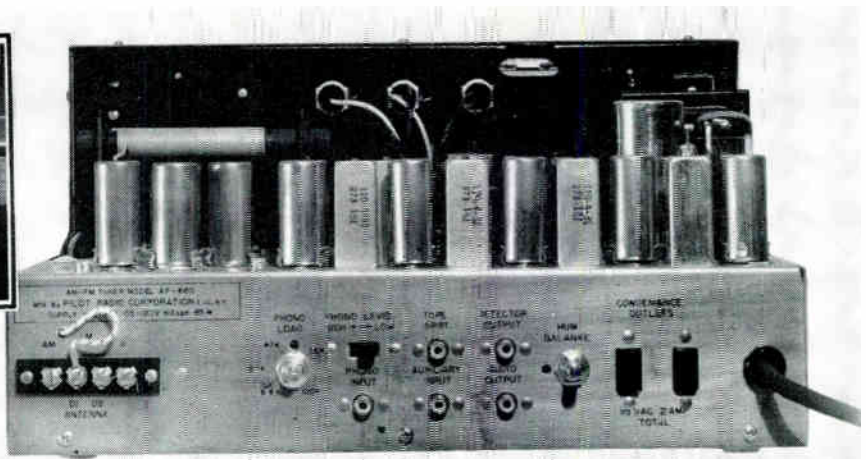
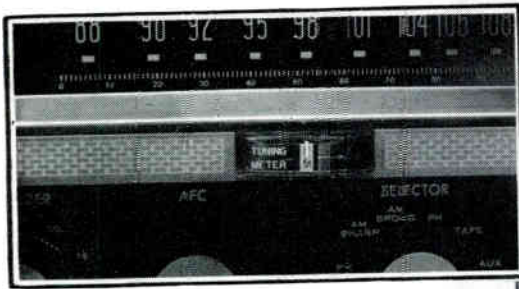

Fig. 1. Tuning indicator on the Pilot AF-860 FM-AM tuner and preamp is a center-zero meter of the new, horizontal type. Unusual flexibility is afforded by the connections and adjustments available at the rear of the chassis.

“INSIDE INFORMATION”

Interesting Design and Construction Features of New Audio Equipment

FIG. 1 shows the tuning indicator and the terminals of Pilot's AF-860 FM-AM tuner and preamp. The tuning indicator, which works on both FM and AM, has the mechanism of a sensitive panel meter, but with a special scale. Terminals at the rear of the chassis include a high and low-level switch for the pickup input, a calibrated pickup load adjustment, and input jacks for a tape recorder and for TV or a microphone. A power amplifier can be plugged in at the audio output jack, or an external preamp

can be plugged directly into the detector output. At the right are the hum-balance control, and then two AC outlets.

From Dallas, Texas, comes the International Electronics speaker, of which Fig. 2 shows a cross section. An example of new techniques in the use of 8-in. speakers, this construction provides remarkable bass and mid-range response from a conveniently small enclosure. Capacitors and the inductor behind the speaker are for a network connected between the speaker and a tweeter. The complete unit is available in an unfinished case, or mounted in a choice of handsome cabinets.

Inside views of the Telefunken FM-AM-longwave portable are shown in Fig. 3. The design of this AC-DC-battery set is typically European, packing an astonishing amount of components, trick switching, and convenience features into a small space. It has the special virtue of high sensitivity on FM, with the pull-out antenna which rolls up like a tape-measure when not in use. Among the circuit tricks is a switch that permits operation at reduced power consumption on strong signals. A simple adapter actuates a jack to change from batteries to AC or DC, and there is a rotary switch for operation on 110, 125, and 220 volts AC, or 110 and 220 volts DC.

Fig. 3. Rear views of the Telefunken FM-AM AC-DC-battery portable

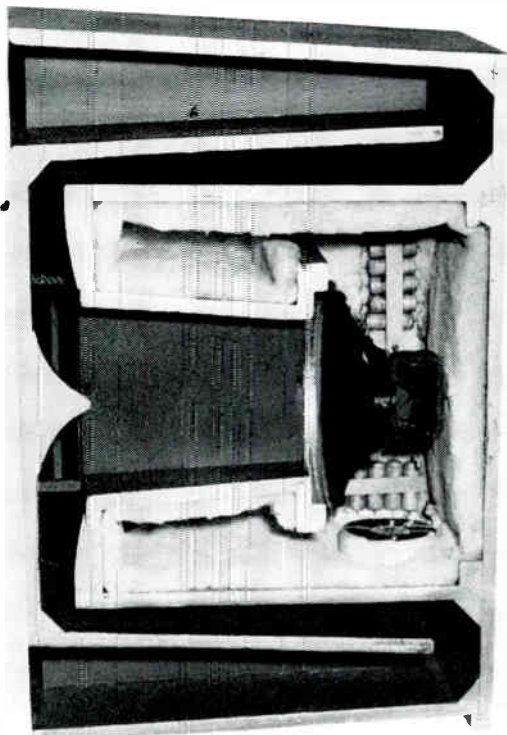
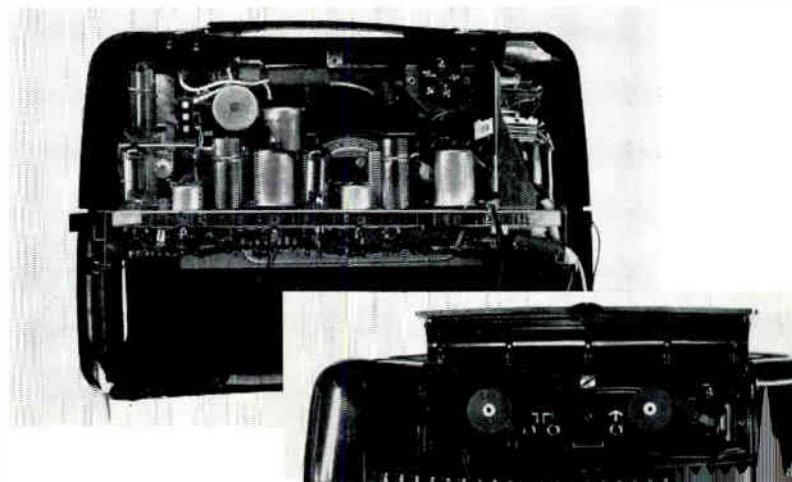

Fig. 2. Cutaway section of the International Electronics speaker enclosure, showing construction of the horn and chamber at the rear.



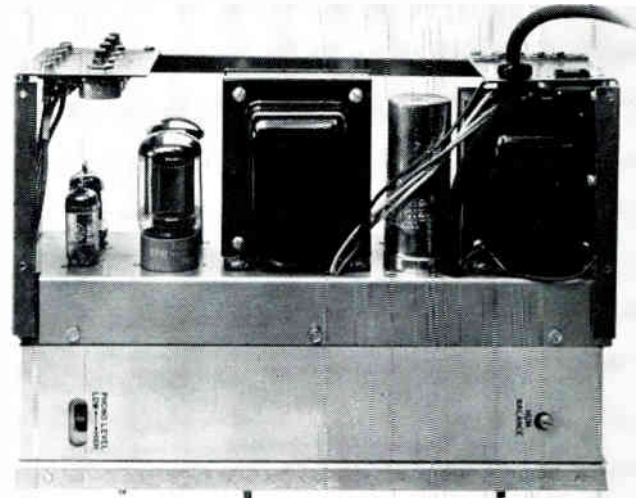
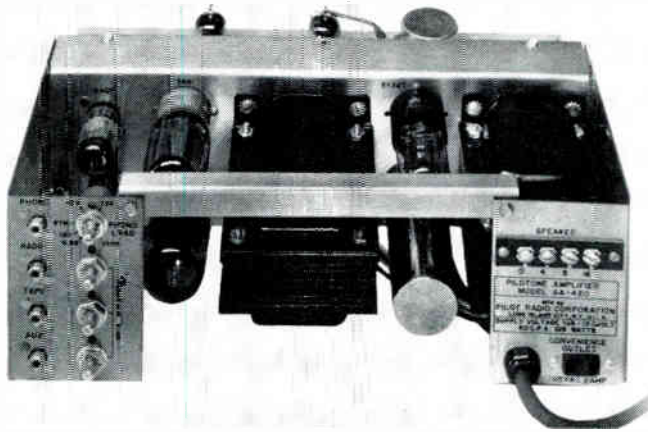

Fig. 4. In this Pilot unit, the preamp is carried on a separate chassis at the front, shielded from the 15-watt amplifier section at the rear. Under side of the preamp-amplifier is shown at the right

Pilot Radio has brought out a 15-watt preamp-amplifier, Fig. 4. Part of the secret of getting that much power inside a very small, flat case is the arrangement of the tubes, by which effective ventilation is obtained. The left hand rear panel carries jacks for plugging in a pickup, radio, tape machine, and TV or microphone. Also, in addition to a calibrated pickup load adjustment, there are individual level controls for the radio, tape, and TV inputs. The view under the chassis shows the pickup level control and the hum-balance adjustment.

Three inside views of the REL Precedent chassis are presented in Fig. 5. Of special interest is the fact that the design of this FM tuner is based on design techniques developed for commercial commu-

nication equipment. Circuitwise, and in mechanical construction it is an engineering byproduct of REL military research and the development of multiplex radio telephone relay apparatus. It also reflects the extensive experience gained from the famous 646-B broadcast station monitor receiver. This accounts for such features as the open cube arrangement which keeps the heat of the tubes away from the components and the use of three separate chassis for RF, IF, and power-supply circuits. The chassis carrying the tuning elements and the RF circuits can be seen in the upper right hand photograph, and at the left of the tuner in the illustration below.

The smooth exterior of Fairchild's Balanced-Bar preamplifier hides the very

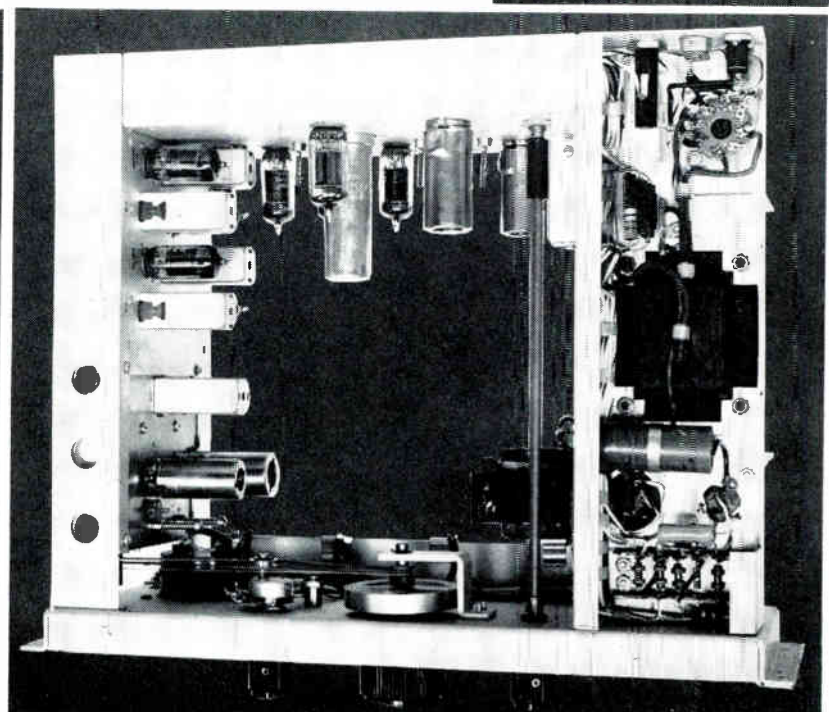
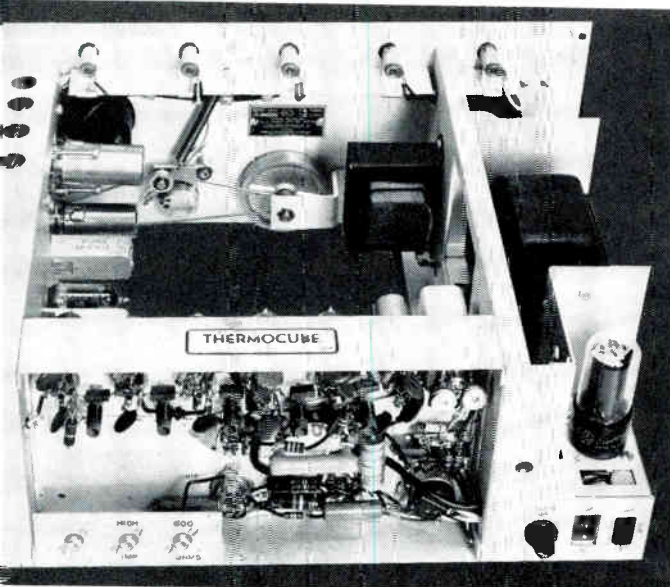
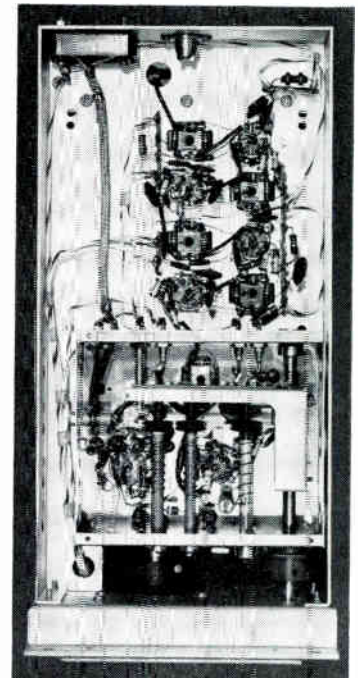

Fig. 5. Rear and bottom views of the REL FM tuner, in which the components are isolated and shielded by the use of three separate aluminum chassis. Upper right photo shows the tuning unit and the RF section



V-M high fidelity
Fidelis
with
tone-o-matic



complete musical

Pleasure

YOUR CHOICE OF MUSIC
ON YOUR VOICE OF MUSIC

Here is reality . . . authentic high fidelity recorded music reproduction . . . to bring complete musical pleasure to you at home. With exclusive *tone-o-matic* you may balance high and low notes simultaneously to achieve that "living" quality of music you prefer.

Within the well-built cabinet acoustic science rules, delivering to you an *audible* frequency range of 40 to 15,000 cps. The exclusive V-M record changer gently, silently, automatically, picks up the full beauty from records of all three speeds and sizes. After the last record, even the amplifier is shut off automatically by *Siesta Switch*™.

Two radiantly beautiful hand-rubbed cabinet finishes are offered for your pleasure. Choose from rich, glowing African mahogany or modern, sparkling Champagne blonde, both at the same price! Legs, black or brass finish, are optional. \$149.50*

Discriminating record enthusiasts have made V-M the world's largest manufacturer of phonographs and record changers.



the Voice  of Music



V-M high fidelity
Model 556 with *tone-o-matic*

Take musical pleasure anywhere you wish. Your choice of rich brown or rose and gray leatherette case. \$119.95*

*Slightly higher in the west. UL APPROVED.

• V-M CORPORATION, Benton Harbor 6, Michigan
 • Please send illustrated folder, "Bring Concert Halls Within Your Walls."
 • Name _____
 • Address _____
 • City _____, State _____

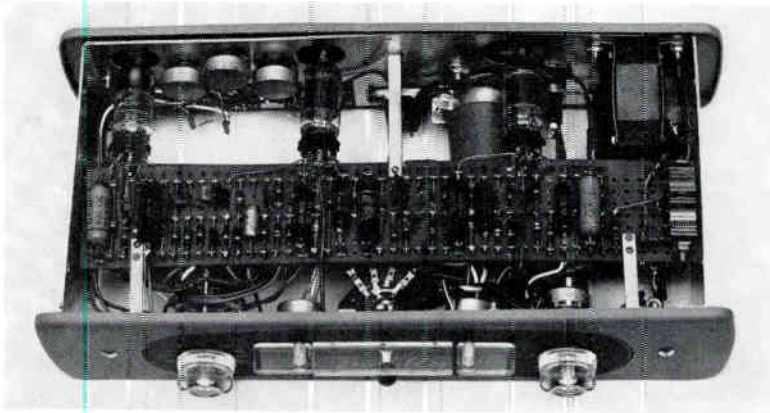

Fig. 6. The Fairchild Balanced-Bar preamplifier combines new features of tone and volume control with excellent mechanical design and construction. Panel carrying the resistors and capacitors is well removed from the heat generated by the tubes

interesting assembly shown in Fig. 6. Here, again, the design of the unit emphasizes the importance of ventilation, and of keeping the components away from sources of heat. Notice, in that connection, that all the capacitors and resistors are mounted as a unit on a single panel. This arrangement is an example of the improved design and workmanship in high-quality audio equipment, in contrast to the rat's-nest appearance of conventional TV and radio sets. Thus, failures are reduced, and at the same time service work, if needed, is facilitated.

This Leak Point One amplifier reflects the best in English audio equipment design. At the right is a view of the under side of the chassis, showing the layout of resistors and capacitors on a single terminal strip. An advantage of this practice is that any part can be replaced without disturbing the other wiring. At the left is a photograph of the chassis with the panel removed. The cabling not only improves the appearance, but supports the wires so as to reduce strain at the terminals, and makes it easy to trace the circuits.

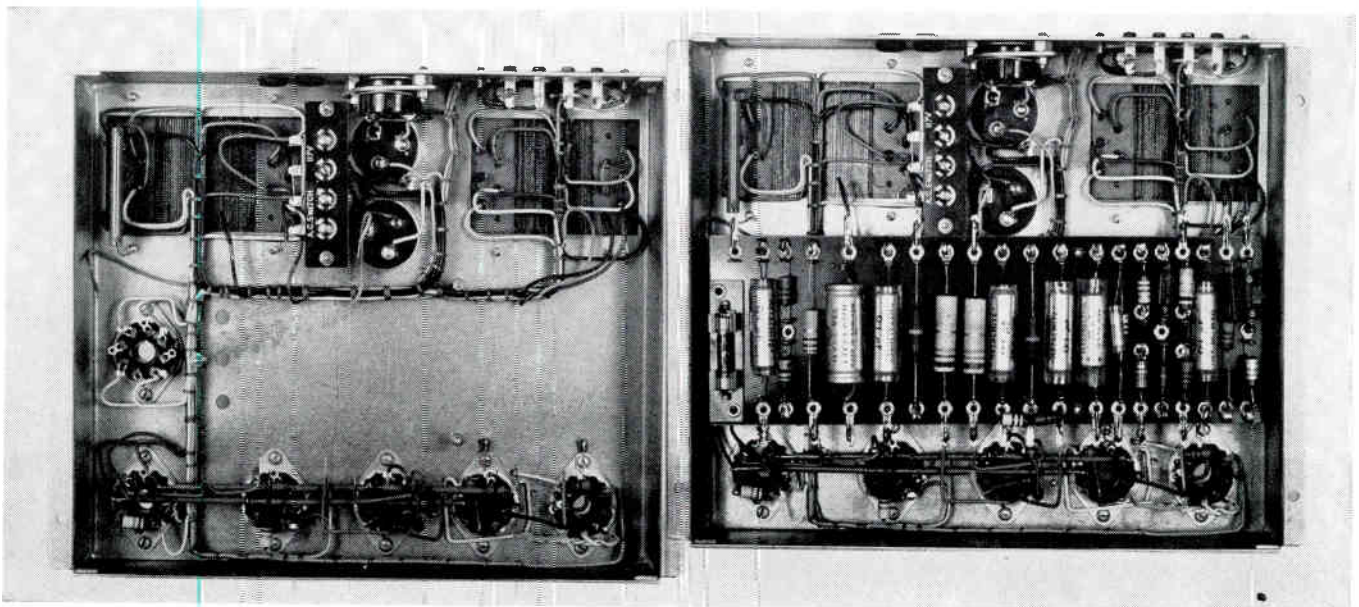

Fig. 7. The Leak Point One amplifier is an excellent example of the best of British designs. View at the left shows components panel removed

Continued from page 45 pedite delivery to you, we are occasionally forced to make minor substitutions of parts."

Everything went together so perfectly, the instructions were so clear, and the supply of components and hardware so complete that, when the last assembly step was finished, we were embarrassed to find three lock washers, one screw, and two nuts left over!

TIME TO COMPLETE REMAINING 49 WIRING STEPS: 3 hours.

The book didn't say so, as far as we could see, but this amplifier is intended for use with the Heathkit WA-P2 preamp which we didn't have, and the AC on-off switch is on the treble control of the preamp. Reference to the schematic showed that we could close the AC circuit by making a connection from 6 to 7 on the socket at the rear

of the amplifier, provided for plugging in the preamp. Then we were able to hook it up with an FM tuner that had a built-in preamplifier, plugging the cord from the amplifier into a receptacle on the tuner.

What happened then? *The amplifier worked perfectly!* We were so pleased with ourselves that we forgot that our success was due in a large measure to the care with which the instructions had been prepared, and the accuracy with which someone had assembled and packed the parts.

TOTAL TIME TO ASSEMBLE AMPLIFIER: 6 hours, 35 minutes.

This project worked out so well that we shall tackle the WA-P2 preamplifier kit next. It is a more difficult job of assembly and wiring, but we think that we can run up a perfect score on that, too.



Musically Authentic Reproduction

THE Styrocone speaker system, a basic de Mars invention, is outstanding for its amazing ability to deliver authentic reproduction over the entire audio frequency range. That is, the de Mars Styrocone neither adds nor omits, but reproduces with complete accuracy the audio frequencies fed to it. In that respect, it provides a performance standard, for if the reproduction is not literally perfect, it is certain that the fault lies in some part of the installation preceding the Styrocone speaker system.

de Mars Styrocone cabinet speakers are available in four models. All de Mars cabinets are noteworthy for the excellence of the design, materials, workmanship, and finish, comparable to the quality of cabinetwork found in fine pianos.

Also, the 17-in. and 20-in. Styrocone speakers and associated tweeters are available unmounted. Following are detailed descriptions.

“CONCERT” Cabinet

ESSENTIALLY FLAT RESPONSE
FROM 40 TO BEYOND 13,000 CYCLES

Combines the 17-in. No. 225 Styrocone speaker and two tweeters in a rigid, highly-damped cabinet available in mahogany or blonde finish. The cabinet can be used vertically or horizontally. Legs are furnished separately, so that they can be secured after you have decided how you want to use the cabinet. Specifications:

Cabinet height 35¾ ins.
Width 22 ins.
Depth 16 ins.
Internal capacity 6 cubic feet
Price, Model S-225VH \$250.

“SYMPHONY” Cabinet

ESSENTIALLY FLAT RESPONSE
FROM 35 TO BEYOND 13,000 CYCLES

Your choice of cabinet designs for wall or corner location, with the 20-in. No. 300 Styrocone speaker and four tweeters. Both cabinets are completely enclosed and highly damped to prevent

resonance effects. Audio performance is independent of the background wall, so that the cabinet can be placed in any part of the room where acoustic conditions are favorable. Your choice of walnut, mahogany, or blonde finish. Specifications:

Cabinet height 38 ins.
Width 41 ins.
Depth, wall cabinet 15 ins.
Depth, corner cabinet 26 ins.
Internal capacity 8 cubic feet
Price, Model SW wall cabinet . . . \$450.
Price, Model SC corner cabinet . . \$450.

“MAJESTIC” Cabinet

ESSENTIALLY FLAT RESPONSE
FROM 25 TO BEYOND 13,000 CYCLES

This cabinet is of a size and design intended to give performance virtually equivalent to that obtainable from an infinite baffle mounting. A 20-in. Styrocone speaker and four tweeters are provided. Very heavy construction and bracing eliminate all cabinet resonance. Furnished in mahogany or blonde finish. Specifications:

Cabinet height 60¾ ins.
Width 35½ ins.
Depth 20¾ ins.
Internal capacity 8 cubic feet
Price, Model SA-300 \$450.

Unmounted Speaker System

For the benefit of those who are making special installations, components of the Styrocone speaker system are offered unmounted, complete with mounting brackets. Used with a suitable baffle, the Styrocone system is ideal for installation in the home or in a public auditorium for reproduction from records, tape, and FM radio. The Styrocone system is particularly recommended for use with electric organs, because of its magnificent tone quality and high output in the lower register.

A 20-in. Styrocone speaker, 4 tweeters, mountings and the network comprise the Model S-300 series. The Model

S-225 system comprises a 17-in. Styrocone, 2 tweeters, mountings, and network.

Specifications, 20-in. Model S-300:
Impedance 8 chms
Response 16 to 15,000 cycles
Capacity 25 w. RMS; 50 w. peak
Weight, unpacked 30 lbs.
Dimensions 24 by 34 ins.
Price \$250.

Specifications, 17-in. Model S-225:
Impedance 8 ohms
Response 20 to 15,000 cycles
Capacity 20 w. RMS; 40 w. peak
Weight, unpacked 25 lbs.
Dimensions 34¼ by 20¾ ins.
Price \$200.

Unmounted Styrocone

Both the 17-in. and the 20-in. Styrocone speakers can be purchased individually, for use with auxiliary units to cover the range above 3,000 cycles, the crossover point ordinarily used with either Styrocone. Mounting hardware is provided.

The distinguishing feature of the Styrocone, by which remarkably high output at low frequencies is obtained, is the large radiating surface. The 20-in. Styrocone, for example, drives a surface at low frequencies, when piston action is the mode of vibration, equivalent to four 12-in. woofers, or two 15-in. woofers.

Specifications, 20-in. Styrocone speaker:
Cone piston 20 ins. diam.
Response 16 to 3,000 cycles
Capacity 25 w. RMS; 50 w. peak
Magnet 1½ lb. Alnico V
Resonant frequency . . . below 20 cycles
Dimensions 24 by 24 ins.
Price \$125.

Specifications, 17-in. Styrocone speaker:
Cone piston 17 ins. diam.
Response 20 to 3,000 cycles
Capacity 20 w. RMS; 40 w. peak
Magnet 1½ lbs. Alnico V
Resonant frequency . . . below 20 cycles
Dimensions 20 by 20 ins.
Price \$115.

For further information, and the name of your nearest dealer, address:

deMars Engineering & Mfg. Corp.

361 Merrimac Street, Lawrence, Mass. •

Phone: LA 8-5964

Music Tape Reviews

By DR. HANS WOLF

Richard Strauss, *Also Sprach Zarathustra*

Fritz Reiner — Chicago Symphony Orchestra

7.5 speed, binaural

RCA Victor TCS-1 (stacked heads) TCSD-1 (staggered heads) —

NARTB equalization

The fact that RCA Victor released their first stereophonic tape is a most significant event in recording history, and the very fact of this RCA release is highly encouraging and rewarding for the pioneers in the field. Note that this tape is available for use on machines with either stacked or 1¼-in. staggered heads.

If music means a great deal to you — if it gives you an emotional lift, which enriches your life, listen to RCA's first stereophonic release and you cannot but feel that here is a new value in the field of realistic home entertainment.

Fritz Reiner and RCA were wise in choosing the Strauss score as their first stereophonic release. The luscious masses of sound, the tremendous dynamic range of the score, the brilliant instrumental solo passages all guarantee the full impact of the binaural sound picture.

Just listen to the opening of the work which depicts, with ever increasing power and brightness, the rising of the sun. In binaural reproduction this opening is a full realization of music as that great transcendental, irresistibly mysterious force which has elevated mankind throughout the centuries.

Fritz Reiner shows such superb mastery of conducting that this reviewer could not imagine a more inspired interpretation of the musical and spiritual contents of this score of which the composer once said: "... I did not intend to write philosophical music or to portray Nietzsche's great work musically. I meant to convey by means of music an idea of the development of the human race from its origin, through the various phases of development, religious as well as scientific, up to Nietzsche's idea of the Superman." The joyful section of the Dance Song is rendered in ideal fulfillment of its description by Strauss's biographer Richard Specht: "... and then commences the joy of the dance, in which all the motifs contained in the work are lightly picked up, as if freed from earth's burden . . ."

RCA's stereophonic microphone spacing of 21 ft. gives the work the spaciousness it requires in its global concept of man and nature, though in order to achieve this

goal, certain of the score's *piano* passages lose somewhat in definition. All the same, this tape could very well become a turning point in the public concept of what realistic reproduction means in the truest sense of the word.



Dvořák, *5th Symphony*

Toscanini — NBC Symphony Orchestra

7.5 speed, double track

RCA Victor TC-7 — NARTB equalization

This monaural tape by Toscanini and the NBC Orchestra comes at a time when that famous ensemble is in the process of being welded into a completely new organization. The tape shows again how worthy a task it is to save this brilliant organization. Here we are listening to soloists of world class, bound together to a most exciting orchestral body and under the most fascinating conductor. Here we listen to a type of orchestral perfection which is the result of such efficient efforts as Toscanini's capacity as a conductor, and untiring cooperation his men always gave him.

Despite the maestro's terrific drive, interpretive power and splendor of execution there is something in Dvořák's *5th* which I do not find in this reading: it is a type of folklore flavor which involves a negligible portion of sentimentality. Could it be that "perfect" renditions at times can become somewhat too perfect?

Dukas, *Sorcerer's Apprentice*

Vittorio Gui — Florence May Festival Orchestra

Pfitzner, *Little Symphony, Opus 44*

Kurt Rapf — Vienna String Symphony

7.5 speed, binaural

Audiosphere BN708

Maestro Vittorio Gui and his Florence May Festival Orchestra lend Dukas' *Sorcerer's Apprentice* all the magic of his delightful score. The effect of the bassoons, characterizing a magician's broom going to fetch water; the apprentice's woeful calls in the French horns which are to stop the broom in his activity; the call of the com-

bined horns, trumpets, and trombones at the master magician's appearance to prevent disaster — all these are expertly interpreted binaural delicacies. Gui's reading is somewhat slower than Toscanini's rendition of the work, resulting in different interpretive effects.

The Pfitzner symphony (1935) has been seldom played. In a private conversation, Pfitzner once referred to it as a "sonatina for orchestra with small instrumentation." The symphony was written comparatively late in Pfitzner's life when he turned from opera to absolute music. It was then that he found the way to a new style which included features somewhat reminiscent of the classics, but also moving in the emotional vein of romanticism, confirming his reputation as the "last of the romanticists."

Kurt Rapf, who toured the US during the concert season 1953-54, conducts his Vienna String Symphony with a fine sense for this filigree-type music. However, at times there is a lack of intensity and continuity (*adagio*), and the last movement might have benefitted from more rehearsing before it was recorded.

von Dittersdorf, *Quartet in E flat major*
Fine-Art Quartet

2ND TRACK

Turina, *Prayer of the Toreador*
Wolf, *Italian Serenade*

Fine-Art Quartet

7.5 speed, double track

Webcor 2922

This Webcor tape could be called "gems of chamber music" because each selection is a glittering jewel. Dittersdorf, a forerunner and contemporary of Mozart, and one of the foremost violinists of his time demonstrates in this quartet his keen sense for string instruments, thereby greatly extending the instrumental advance started by the famous Mannheim School. The Fine-Art Quartet seems to thoroughly enjoy playing this little work, which is permeated with so much sparkling gaiety. Especially the last movement, with its turbulent principle theme, its original Hungarian-flavored middle part, and its delicate ending, is presented magnificently.

Sharply contrasting to the 18th Century von Dittersdorf are two delightful and most original compositions on the second track of this tape. *The Prayer of the Toreador* by the Spanish composer Joaquin Turina (Seville 1882) and the well-known *Italian Serenade* by Hugo Wolf are somewhat similar in their national idiom which both composers however use rather as a means than an end. Their harmonic and melodic ideas go well beyond the limits of

Concluded on page 62

The BUY of a Lifetime!

1 craftsmen

C800A
DELUXE AM-FM TUNER

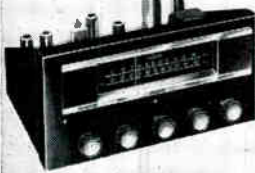

Latest production with higher sensitivity and improved tone balance. Incorporates Craftsmen's famous AFC, Phono Pre-Amp and Record Compensator.
Net \$159.50

2 craftsmen

C500A
ULTRA FIDELITY AMPLIFIER



Featuring the famous Williamson Circuit with superior KT66 Output Tubes. Full 15 watts 20 to 20,000 cps within 1/10 of 1 db. Distortion so low it can hardly be measured.
Net \$99.50

3 GARRARD

"TRIUMPH" RC80 AUTOMATIC
3-SPEED RECORD CHANGER



The standard of excellence the world over. Plays all records, 33 1/3, 45, 78 rpm records in 7", 10" and 12" sizes. Quiet, smooth-running 4-pole motor, weighted turntable. Automatic shut-off after last record. Muting switch cuts out sound during change cycle. Net \$49.50
SPECIAL '45' SPINDLE for Garrard "Triumph" Changer Net \$3.50

4 Electro-Voice

12 TRXB TRIAXIAL SPEAKER



Advance design full range easy to mount 12" TRIAXIAL 3-WAY SPEAKER SYSTEM. Electro-Voice laboratory research has combined Woofer, Midler and Tweeter into a near-perfect instrument for sound reproduction. Clearly and realistically reproduces all tones and overtones with unexcelled balance.
Net \$59.70



GENERAL ELECTRIC
RPX-050 TRIPLE-PLAY
VARIABLE RELUCTANCE
MAGNETIC PICKUP



For finest phono reproduction of all types of records. Considered by many engineers and music lovers the finest pickup at any price! Furnished mounted in changer ready for use. Supplied with genuine General Electric Double Sapphire Needle.
Net \$8.20

TERMINAL'S Sensational "5-STAR" Hi-Fi BUY!

Complete, Matched PHONO-RADIO SYSTEM

ALL BRAND NEW famous name components • ALL current models and production • ALL Fully Guaranteed • Supplied with ALL TUBES • Warranty Cards • Instructions • Indoor Antenna • GE Dual Sapphire Needle • ALL Cables and Plugs • Your '5-STAR' System consisting of ALL ITEMS ILLUSTRATED and DESCRIBED ABOVE . . . comes ready to plug together and play!

OUR BIG BUY YOUR BIG SAVING!

This Complete System for
Only \$259. f.o.b. our store
Total Regular Net \$379.90

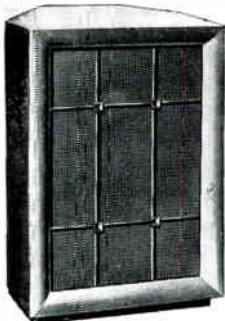

Electro-Voice
KLIPSCH
MATCHED
COMPANION CABINETS
for '5-STAR' SYSTEM

ELECTRO-VOICE ARISTOCRAT SPEAKER CABINET WITH KLIPSCH LICENSED FOLDED HORN Companion Speaker Cabinet for the PEERAGE Equipment Console. Corner enclosure designed to match the characteristics of the Electro-Voice 12TRXB Speaker. The patented KLIPSCH principle provides a full octave of added bass without boominess and greater speaker power handling capacity. 29 1/2" high, 19" wide, 16 1/2" deep.
In MAHOGANY Net \$66.00 • In BLONDE Net \$72.00

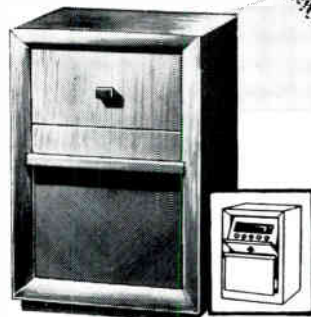

ELECTRO-VOICE PEERAGE EQUIPMENT CONSOLE Fashioned by furniture craftsmen. In Beautiful Blonde Korina or Tropical Mahogany Veneer, hand-rubbed finish. Supplied all cut out to house C800A Tuner, C500A Amplifier and RC-80 Changer. Tilting tuner compartment opens to easy-to-operate angle. Record changer mounts in drawer directly below tuner panel on roller slides for smooth operation. 29 3/4" high, 20 1/2" wide, 18 3/4" deep.
In MAHOGANY Net \$96.00 • In BLONDE Net \$102.00

"5-STAR" Hi-Fi SYSTEM

Complete with Both PEERAGE and ARISTOCRAT Matched Cabinets
(As Shown Here)

Available from Terminal Radio
ATTRACTIVELY PRICED
When Equipment and Cabinets
Are Ordered at the Same Time

Price on Request — Write Today!

SEPARATE ITEMS CAN BE ORDERED AT THE INDIVIDUAL PRICES SHOWN

MAIL ORDERS FILLED WITHIN 48 HOURS

If you cannot come to our store for this sensational value, order by mail. Send full remittance or \$25.00 on account. Balance C. O. D. Every item FULLY GUARANTEED.

DON'T DELAY — ORDER TODAY!
WE RESERVE THE RIGHT TO LIMIT QUANTITIES



Terminal Radio CORP.

85 COURTLANT STREET, NEW YORK 7, N. Y. • WOrth 4-3311

© COPYRIGHT 1954 TERMINAL RADIO CORP.

Directory of Hi-Fi Record & Equipment Dealers

To keep this Directory up-to-date, it is revised for each issue of MUSIC at HOME and, in order to make it as complete as possible, new names are added as soon as they are reported and checked

NOTICE TO DEALERS

Listings in this Directory are available without charge to hi-fi record and equipment dealers as a service to our readers. If you operate a hi-fi record or equipment store, and do not find your company listed, please write to the Directory Editor, MUSIC at HOME Magazine, 207 E. 37th Street, New York City 16. Information for qualifying for a listing in this Directory will be sent to you at once.

ALASKA

Bethel
Charlie's Radio Shop, Box 1717

ARIZONA

Bisbee
The Music Box, Box 340

CALIFORNIA

Berkeley
U. C. Corner, 2350 Telegraph Ave.
Burbank
Valley Electronic Supply Co., 1302 W. Magnolia
Hollywood

HOLLYWOOD ELECTRONICS

"HI-FI COMPONENTS EXCLUSIVELY"

Since 1939

7460 MELROSE AVE., L. A. 46. WEB 3-8208

Pacific Radio Exchange, 1407 Cahuenga Blvd.
Radio Recorders Equip. Co., 7007 Melrose Ave.
La Jolla
The Audio Workshop, Box 101
Long Beach
Custom Sound, 3687 Atlantic Ave.
Penny-Owsley Music Co., 4334 Atlantic Ave.
Los Angeles
Arco Electronics, Inc., 103 S. Vermont Ave.
Figart's Sound Un-Ltd., 6320 Commodore Sloat
Henry Radio Co., 11240 W. Olympic Blvd.
Kierulff Sound Corp., 820 W. Olympic Blvd.
Magnetic Recorders Co., 7120 Melrose Ave.
Shelley Radio Co., Inc., 2008 Westwood Blvd.
Universal Radio Sup. Co., 1729 S. Los Angeles
Oakland
Elmar Electronics, Inc., 140 11th St.
Olin S. Grove, 2904 Telegraph Ave.
Ontario
Rudi Pock—Records & Hi Fi Sound,
604 N. Euclid Ave.
Pasadena
Dow Radio, Inc., 1759 E. Colorado St.
High-Fidelity House, 536 S. Fair Oaks
Sacramento
The Sound Shoppe, Inc., 1910 16th St.
Tower Record Mart, 1518 Broadway
San Diego
Breier Sound Center, 3781 Fifth Ave.
Southern Calif. Music Co., 630 C Street
San Francisco
Hal Cox Custom Music, 2598 Lombard St.
Eber Electronics, 160 10th St.
Music San Francisco, 562 Kearney St.
The Hi-Fi Shop, 3525 California St.
Television Radio Supply Co., 408 Market St.

West Coast Radio & Elec., 409 Market St.
Zack Radio Supply Co., 1424 Market St.
San Jose
Peninsula Telev. & Radio Sup., 881 S. 1st St.
San Pedro
Bower's Music, 810 S. Gaffey
San Rafael
Catania Sound, 1607 4th St.
Santa Barbara
The Gramophone Shop, 9 E. Canon Perdido
Thermal
Custom Classics, 82-321 Ave. 56
Van Nuys
House of Sight & Sound, 14513 Victory Blvd.
Whittier
Lovell's Radio-TV Section, 175 N. Greenleaf

COLORADO

Denver
Chas. E. Wells Music Co., 1629 California St.
Grand Junction
Clark-Steen Music Co.

CONNECTICUT

Danbury
Heims Music Store, Inc., 268 Main St.
Hartford
Nathan Margolis Shop, 28 High St.
The Moses Radio-Electronics Co., 330 Locust St.
New Haven
David Dean Smith, Inc., 262 Elm St.
Westport
Music Systems of Westport, Inc., Post Road

DELAWARE

Wilmington
Radio Elec. Serv. Co. of Pa., 3rd & Tatnall
Wilmington Elec. Spec. Co., 405 Delaware Ave.

DISTRICT OF COLUMBIA

Washington
Discount Record Shop, 1327 Conn. Ave., NW
Electronic Wholesalers, 2345 Sherman Ave., NW
Hollywood Record Shop, 1706 Columbia Rd., NW
Shrader Mfg. Co., Inc., 2803 M St., NW
Sound Crafters, 1744 Columbia Rd., NW
Sun Parts Distr., 520 10th St., NW

FLORIDA

Jacksonville
Southeast Audio Co., 930 W. Adams St.
Melbourne
McHose Electronics, New Haven Ave.
Miami
Flagler Radio Co., Inc., 1068 W. Flagler St.
Pensacola
Grice Radio & Electronic Supplies, Inc.,
300 E. Wright St.
St. Petersburg
Better Listening Studio, 24 Beach Dr. North
Hi-Fi Music Shop, 6821 Central Ave.
Tampa
Burdett Sound & Recording Co.
3619-21 Henderson Blvd.

GEORGIA

Atlanta
Baker Fidelity Corp., 1429 Peachtree St., NE
High Fidelity SSS, 606 Peachtree St., NE

ILLINOIS

Champaign
The New Sound, 35 E. Springfield Ave.
Chicago

World's Largest Stocks of High-Fidelity Music Systems and Components ALLIED RADIO

C O R P O R A T I O N
100 N. WESTERN AVE. · CHICAGO 80, ILL.

Arpio Sales, Inc., 4305 N. Lincoln Ave.
Audio Workshop, Inc., 725 S. LaSalle St.
Chicago Electronics Distr., 420 E. 87th St.
Crittenton's TV & App., 4740 N. Broadway
De Haan Hi Fi Co., 1655 W. 79th St.
Electronic Expeditors, 2909 W. Devon Street
Lowe's Radio Co., 1217 E. 55th St.
The Lukko Sales Corp., 5024 Irving Park Blvd.
Marquette Records, 3215 W. 63rd St.
Newark Electric Co., 223 W. Madison
Voice & Vision, 53 E. Walton St.

INDIANA

Columbus
Ernie's Record Shop, 910 25th St.
Indianapolis
Graham Elec. Supply, Inc., 102 S. Penna St.
Lafayette
Golden Ear, 610 Main St.
Muncie
Seward B. Price, 105 Rose Court

IOWA

Iowa City
Woodburn Sound Service, 8 E. College St.

LOUISIANA

Baton Rouge
Louisiana Radio & Telev., 1645 Plank Rd.
Ogden Park Record Shop, 618 N. 3rd St.

MAINE

Portland
Bartlett Radio Co., 625 Congress St.

MARYLAND

Baltimore
Custom Music Systems, 2326 N. Charles St.
Hi-Fi Shop of American Distr. Co., Inc.
2 N. Howard St.
Music House, 5855 York Rd.
Radio Elec. Serv. Co., 5 N. Howard St.
Wholesale Radio Parts Co., 308 W. Redwood St.

MASSACHUSETTS

Boston
DeMambro Radio Supply Co.,
1095 Commonwealth
Lafayette Radio 110 Federal Street
The Listening Post, 161 Newbury St.
Mosher Music Co., 181 Tremont St.

FREE 224-PAGE CATALOG

LARGEST STOCKS in the EAST

Cook and Audiophile Records, Too

RADIO SHACK CORP.

167 Washington St., Boston 8, Mass.

Boston, continued

Yankee Electronics, 257 Huntington Ave.
Holyoke
Tel-O-Wire Sound Co., Inc., 24 Newton Place
Lunenburg

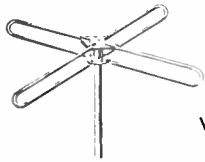

FM RECEIVING ANTENNAS
Standard and Special Designs
WHOLESALE SUPPLY CO.
Lunenburg, Mass.

Springfield
Soundco Electronic Supply Co., 47 Dwight St.
Taunton
David B. Dean & Co., 85 Cohasset St.

MICHIGAN

Birmingham
McCallum & Dean, 409 E. Maple Ave.
Detroit
Audio House, Inc., 19771 Conan
The Glen Music Shop, 14127 Grotiot
Haco Distributing Co., 9730 Burnette
The J. L. Hudson Co., 1206 Woodward Ave.
K. L. A. Labs, Inc., 7422 Woodward Ave.
Pecar Electronics, 10729 Morang
Reno Radio Co., 1314 Broadway
Sihler's Radio Shop, 15822 Grand River
Lansing
Tape Recording Industries, 3335 E. Michigan
Sault Ste. Marie
John P. LeBlanc, 321 E. Spruce St.

MINNESOTA

Minneapolis
Lew Bonn Co., 1211 LaSalle Ave.
Disc & Needle Record Shops, 1439 W. Lake
St. Paul
Fine Cameras & Records, 2060 Ford Pkwy.
Gopher Electronics Co., 370 Minnesota St.

MISSOURI

Independence
Don Cook's Electronic Equip.,
1020 W. Truman Rd.
Kansas City
Barnard's, 4724 Broadway
David Beatty Custom High Fidelity Sound,
1616 Westport Road
St. Louis
Commercial Electronic Serv., 2609 Olive St.

NEBRASKA

Omaha
Moss Recording Studios, 1910 California St.

NEW JERSEY

Morristown
M & M Telev. Co., Inc., 7 Maple Ave.
Newark
Federated Purchaser, Inc., 114 Hudson St.
Hudson Radio Co., 35 William St.
Lafayette Radio, 24 Central Ave.
Paramus
Music Age, Inc., Route 4
Paterson
TV & Electronics Co., 152 Paterson St.
Princeton
Princeton Listening Post, 164 Nassau St.

NEW MEXICO

Albuquerque
Sound Engineering & Equip.,
601½ Yale Blvd. SE

NEW YORK

Albany
Hi-Fidelity Centre, 11 N. Pearl St.
Otisonde, Inc., 380 Clinton Ave.

Binghamton
Audio Service Co., 145 State St.
Brooklyn
Brooklyn Hi-Fi Sound Center, 2128 Caton Ave.
Green Radio Distr., 472 Sutter Ave.
Buffalo
Frontier Electronics Inc., 1503 Main St.
Radio Equipment Corp., 147-151 Genesee St.
Hempstead
Island Radio Distributor, Inc., 412 Fulton Ave.
Standard Parts Corp., 277 N. Franklin
Jamaica
Harrison Audio Shop, 144-24 Hillside Ave.
Long Island City
Electronic Supply Corp., 4108 Greenpoint Ave.
New York
Arrow Electronics, 65 Cortland St.

EVERYTHING IN HIGH FIDELITY . . .

from pickup to speaker. Try and compare your choice of hi-fi components on the "AUDIOMAT" in ASCO's air-conditioned demonstration studio.

ASCO SOUND CORPORATION

115 W. 45th St., 3rd floor, New York 36, N. Y.
Write for free catalog, or phone JUdson 2-1750

Bennett Radio, 565 3rd Ave.
Concord Corp., 55 Vesey Street
Dorosin Distributing Corp., 149 W. 13th St.
Federated Purchaser, Inc., 66 Dey St.
Goody Audio, 235 W. 49th St.
R. Gordon & Co., 32 E. 59th St.
Grand Central Radio, 124 E. 44th St.
Harrison Audio Shop, 225 Greenwich St.

HARVEY RADIO CO., Inc.

The best place to see, hear, and buy the newest and finest in hi-fi equipment. Out-of-towners—make Harvey Radio your audio headquarters. One block from Times Square.

103 W. 43rd St., New York 36 Phone JU 2-1500

Heins & Bolet Co., 68 Cortlandt St.
Hudson Radio Co., 48 W. 48th St.
Hudson Radio Co., 212 Fulton St.
Lafayette Radio, 100 Sixth Ave.
Leonard Radio, Inc., 69 Cortlandt St.
Midway Radio & TV Corp., 60 W. 45th St.
Music Masters Records, 53 W. 47th St.
G. Schirmer, Inc., 3 East 43 St.

SUN RADIO & ELECTRONICS, Inc.

Largest Audio Demonstration Facilities!

3 completely-equipped sound studios. Ask for Free Catalog. Write or Phone OR 5-8600

650 6th Ave., Cor. 20th Street, New York 11

TERMINAL RADIO CORP.

LARGEST AUDIO DEPARTMENT

FAMOUS FOR "SOUND" VALUES

85 CORTLANDT STREET, NEW YORK 7, N. Y.

Rochester
Craig Audio Laboratory, 12 Vine St.
Jerry Fink Co., 358 Averill Ave.
Music Lovers Shoppe, 370 E. Main St.
Roslyn Heights
Segen Electronics, Inc., 118 Glen Cove Rd.
Schenectady
Concert-Craft, Inc., 1138 Waverly Place
General Products Co., 1008 Helderberg Ave.
Syracuse
W. E. Berndt, 655 S. Warren St.
Troy
Trojan Radio Co., Inc., 420 River St.
Yonkers
Westlab, 1587 Central Ave.

NORTH CAROLINA

Burlington
High Fidelity Sales, Box 1676
Chapel Hill
Kemp's, 207 E. Franklin St.
Charlotte
Music, Inc., 212 N. Independence

OHIO

Cincinnati
Customcrafters Audio, Inc., 2259 Gilbert Ave.
Rex Dale, 4114 Francis Ave.
Steinburg's, Inc., 633 Walnut St.
Cleveland
Audio Craft Co., 2915 Prospect Ave.
Custom Classics, 13421 Euclid Ave.
The Progress Radio Supply Co.,
413-415 Huron Rd.
Publix Book Mart, 930 Prospect Ave.
Radio & Electronics Parts Corp., 3235 Prospect
Columbus
Anderson's High Fidelity Sound Center,
2244 Neil Avenue
Electronic Supply Corp., 134 E. Long St.
Fairview Park
Counterpoint, Inc., 20971 Westgate
Lakewood
Music Unlimited, 13410 Detroit Ave.
Toledo
Torrence Radio, Inc., 1314 Madison Ave.
Warren Radio Co., 1002 Adams St.

OREGON

Eugene
Abar Radio & Television, 298 W. Broadway
Portland
Hawthorne Electronics, 700 S. E. Hawthorne
Salem
Cecil Farnes Co., 442 N. Church St.

PENNSYLVANIA

Allentown
Baker Communications, 9 S. 12th St.
Hazleton
S. J. Pensock, 136 N. Wyoming
Lancaster
John H. Troup Music House, 38 W. King
Philadelphia
Almo Radio Co., 412 N. 6th St.
Audio Electro Co., 4923 N. Broad St.
Danby Radio Corp., 19 S. 21st St.
W. P. Kelly Electronics, 6239 Frankford Ave.
Penn Electronic Ports Co., 5303 Frankford Ave.

in the PHILADELPHIA area

YOUR
COMPLETE
SUPPLIER IS

Radio Electric
SERVICE CO. OF PENNA., INC.

HI-FI & COMMERCIAL SOUND STUDIO
709 Arch Street, Philadelphia 6, Pennsylvania
Phone: LOmbard 3-7390

ten Cate Associates, 6128 Morton St.
Walker Radio Serv. & Sales, 3rd & Fern Sts.
Roslyn
High-Fidelity Music Center, 1373-83 Easton Rd.
York
York Radio & Refrigeration Ports
263 W. Market St.

RHODE ISLAND

Providence
DeMambro Radio Supply Co., 90 Broadway
TV-Radio-High Fidelity & Appliance,
790 N. Main St.

TENNESSEE

Memphis
Ferguson's Record Shop, 173 South Cooper St.
Nashville
Nicholson's, 105 8th Ave. N.

continued on page 58

NEW!

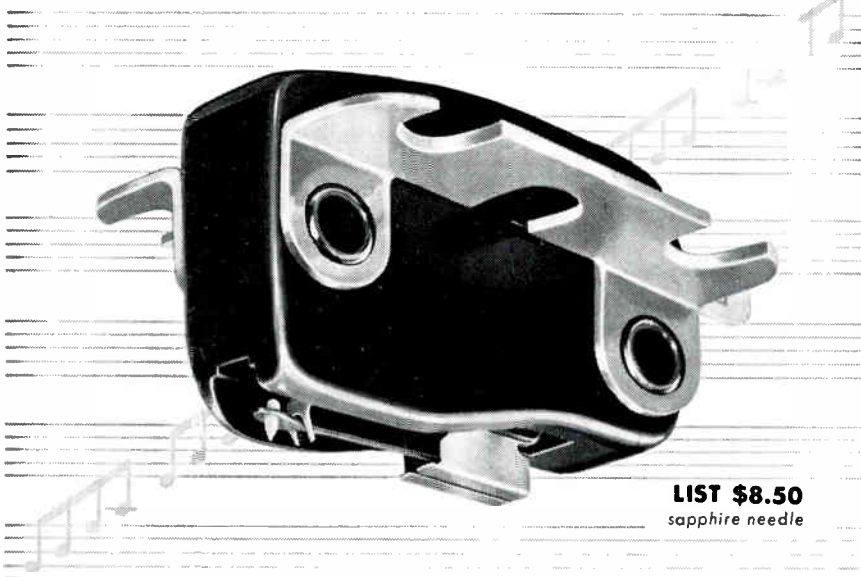

LIST \$8.50
sapphire needle

... another first from

SONOTONE

wide-range
high-compliance
single-needle ceramic cartridge

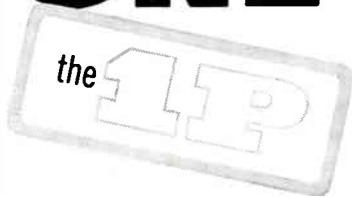

Here at last is a high fidelity cartridge at a moderate price,
available in either of two needle sizes —
one for 45 and 33 1/3 rpm, the other for 78 rpm.

Performance is at the same high level as the world-famous
Sonotone "Turnover."

Send coupon for free bulletin showing the exceptional specifications
of this new cartridge.

ELECTRONIC APPLICATIONS DIVISION

SONOTONE CORPORATION

Elmsford, New York

SONOTONE CORPORATION, DEPT. M
ELMSFORD, N. Y.

Please send me free bulletin describing your new 1P Cartridge.

NAME _____

ADDRESS _____ APT. _____

CITY _____ STATE _____

TEXAS

Fort Worth
Audio Associates, 2804 Race St.
Houston
Audio Center, Inc., 1633 Westheimer
Gulf Coast Electronics, 1110 Winbern St.
Sterling Radio Prods., Co., 1616 McKinney Ave.
Wrye Company Ltd., 2045 Welsh St.

UTAH

Salt Lake City
O'Loughlin's Radio Supply Corp.,
113 E. South St.

VIRGINIA

Arlington
Whitney's Audio Services, 3131 N. 10th St.
Charlottesville
Charlottesville Music Center, Inc.,
117 E. Main
Richmond
Harry Dalton—"Audio Workshop"
5813 S. Crestwood Ave.

WASHINGTON

Puyallup
Music Shop, 111 W. Main St.
Seattle
Electricraft, Inc., 622 Union St.
High Fidelity Headquarters, 603 Broadway N.
Olympic Engineering Co., 2008 Westlake Ave.
Pacific Electronics Sales, 1209 First Ave.
Radio Products Sales Co., 1214 First Ave.
Seattle Radio Supply Co., 2117 Second Ave.
Tacoma
C & G Radio Supply Co., 2502 Jefferson
Wm. T. Raymond & Associates
17 Oak Park Dr., SW

WEST VIRGINIA

Wheeling
James M. Black & Sons, 952 Market St.

WISCONSIN

Appleton
Valley Radio Distr., 518 N. Appleton St.
Milwaukee
Television Parts, Inc., 714 W. State St.

ALBERTA

Lethbridge
Leister's, Paramount Theatre Bldg.

BRITISH COLUMBIA

Vancouver
Hygrade Sound Sales, 971 Richards St.

ONTARIO

Toronto
Custom Sound & Vision, Ltd., 390 Eglinton West
Custom Sound Reg'd, 23 Park Road

IN CANADA —

There's one place where you can find—and hear
—all your high-fidelity equipment needs. We carry
a complete stock . . . come in, or write in, for a
chat, a look, and a listen.

ELECTRO-VOICE
SOUND SYSTEMS
141 Dundas St., West, TORONTO

QUEBEC

Montreal
Payette Radio Ltd., 730 St. James W.

SASKATCHEWAN

Regina
National Musical Supply Co., 1780 Hamilton St.

CUBA

Havana, Vedado
"California" Alta-Fidelidad, LaRompo 23Y "P"

ENGLAND

Croydon, Surrey
Classic Electrical Co.,
352 Lower Addiscombe Rd.

JAPAN

Tokyo
Nippon Gakki Seizo Kabushiki Kaisha, Tokyo Br.,
No. 1, 7-chome, Ginza, Chuo-ku

SOUTH AFRICA

Johannesburg
Recordia Photo & Gramophone Co.,
Ltd., Box 2400

Nunn but the Finest

Continued from page 27

tents, and will incorporate 15 units. The new home, by the way, will be complete with a control room studio, and will be far enough away from railroad tracks so that no trains will roar by when he's outside recording a thunderstorm.

You will understand this reference if you have read his catalog description of record AP-20, about which he wrote: "For years, we have wanted to record a rip-roaring, red-blooded thunderstorm. . . . Milwaukee had never been blessed with such a satisfactory thunderstorm as occurred one evening in June, 1952. It was sheer good fortune that we were able to set up our equipment quickly in a favorable location. Over one hour of the storm was recorded. This maze of material was subsequently condensed and edited in order to present it to you on a disc. Most fortuitous was the arrival of a train right in the midst of everything — it sounds just as though it were coming right into the room." What charms me is the transition, at the end of the record, from the earth-shaking thunder to the peaceful night scene created by the croaking sounds from a frog-pond, punctuated by an occasional, deliberative "glunk," as some over-size bull frog twangs his G-string. If you haven't heard it, you really must!

Reading the catalog comments on Audiophile records, you get the impression that Nunn gets a tremendous lot of enjoyment from the music he records. It would be hard to imagine his recording anything that he wasn't really excited about, just as you can be certain that he would never put out a new release unless he was certain that it would please audio enthusiasts whose tastes are as highly critical as his — and he is very critical indeed.

He even goes to the unprecedented extreme of identifying his 78's as Grade A, and his 33's as Grade B. In some cases, he specifies the pickups he considers necessary for the best reproduction.

Concluded on page 60

November-December 1954

the Hestons say...

"A truly remarkable achievement . . . You can hear its perfection."



(Mrs. Heston) is now starring in the Chicago Company of "The Seven Year Itch."

Charlton Heston, star of the forthcoming Cecil B. DeMille production, "The Ten Commandments"

Stan White

Ultra High Fidelity CABINET SPEAKERS

Designed to add refreshing smartness to room interiors and bring sparkling sound rendition (music you can feel) to your home.

Featuring • Curled, not folded, exponential horn (1% of formula). • Multiple flare formula (patent applied for). • Passive phasing chambers • 24db/octave acoustical crossover. • Distributed throat characteristic (not found elsewhere).

Stan White INC.

726 South LaSalle Street, Chicago 5, Illinois
A Division of Eddie Bracken Enterprises

YOUR EYE
ON THE ROAD
YOUR EAR IN
SYMPHONY HALL

Hastings
HIGH FIDELITY-F.M.
Car RECEIVER

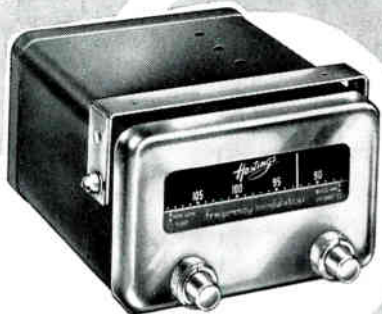

*You get Concert Hall
Quality AS YOU DRIVE.*

AVAILABLE IN 6 OR 12 VOLT MODELS
FOR USE WITH ANY AM CAR RADIO OR
WITH HASTINGS HI FIDELITY POWER
AMPLIFIER.

THESE FEATURES, PLUS DOZENS OF
OTHERS, ASSURE UNEQUALLED
PERFORMANCE.

- Covers 87 to 109 megacycles
- Full Armstrong circuit
- Automatic frequency control, locks in station signal
- 2 microvolt sensitivity. Full limiting action with 5 microvolts input
- Optimum selectivity for maximum image rejection. Adjacent channel 60 DB down
- 200 KC IF bandwidth
- New crystal limiter — superior clipping action
- Electronic tone control — increases bass response without attenuating highs
- Compact size: From panel 6½" wide x 4" high. Depth 7½" for case plus 1" for power cable input plug at rear and 1½" for knobs on front
- Chrome panel and metal knobs. Gray Hammertone case
- Rigid, rugged, non-critical construction
- Only highest quality components used.
- Fully guaranteed

CAR TUNER COSTS YOU

JUST \$99⁵⁰ FOB BOSTON

Hastings High Fidelity Car Power Amplifier
(for cars without existing AM
Radios) **\$63⁵⁰**

SEND FOR IT TODAY!

This colorful folder that contains
all the facts about this outstanding
HI Fidelity FM Unit. Your
copy is free and there's no
obligation.



Hastings
PRODUCTS, Inc.

171 Newbury St., Boston 16, Mass.

Nunn but the Finest

Continued from page 59

Nunn has some observations that may be interesting to audiophiles. I'm sure he has others, but we were so busy listening to records that I just didn't get around to asking him all the questions that came to my mind. Once started on records, it's really impossible switching this man to other thoughts. Like these. . . .

" . . . Audiophile records provide high-quality reproduction only when they are played on high-quality equipment. They are the beginning, not the end.

" . . . you can't possibly know how good your equipment is until you have the necessary equipment to test it. Unfortunately, the testing equipment is usually more expensive than the various units you're testing." (I meant to insert something in here about knowing how to make and interpret the tests. Somehow that seemed awfully complicated, but most essential to high-quality recording.)

" . . . Far too many records advertised as "high fidelity" are not "high fidelity" in any sense of the word. This not only hurts the manufacturers, but it misleads people, too. I'm afraid the record industry has acquired some aspects of Coney Island pitchmen."

See what I mean? An evening with this man Nunn is a most stimulating experience!

"A Gift for the Giver"

Continued from page 43

whom have worked together for seventeen years, were guided by their long experience and close association under the inspired leadership of Arturo Toscanini. And unquestionably he, as well as other conductors, were inspired by the amazing instrument that was the Toscanini ensemble.

Later that night, when the tape machines were rewinding the last reels of the *Roman Carnival*, *Die Meistersinger Overture*, and the *Nutcracker Suite*, and the musicians were quietly putting their instruments away, there were still remarks of amazement from both the seasoned engineers and the veteran critics that these men had played so magnificently without a conductor. But it had happened, and historic Carnegie Hall was once again the scene of further history-making.

The whole occasion had been arranged so that the newly formed Symphony of the Air (formerly the NBC Symphony Orchestra) might prepare their special album entitled "A Gift for the Giver." Functioning under the auspices of their own organization, The Symphony Foundation of America, Inc., a non-profit foundation made up entirely of members of the former Toscanini orchestra, the men of the orchestra had created a collectors' item, first because the recordings and tapes will never be sold commercially, and secondly because

Concluded on page 61

Walco
PRODUCTS

Just for
the Record



WALCO
STATI-CLEAN
ANTI-STATIC
RECORD SPRAY

STOPS STATIC DUST. Walco Stati-Clean is your best defense against dust—major cause of record and needle wear. Stati-Clean spray cleans the disc surface, stops static electricity that attracts dust. Handling and "dusting" no longer builds up static. Stati-Clean improves fidelity, eliminates static "crackle." Lasts dozens of plays, no need to reapply each time. Tested safe—thousands sold. Complete with special applicator cloth.

WALCO

DISCOVERS

PROTECTIVE SLEEVES
FOR RECORDS

Walco DISCOVERS—now with the new contoured bottom—are the perfect answer to record protection. You slide your records into DISCOVERS, then into the original jacket. No more scratches, moisture or finger marks from handling. DISCOVERS seal out dust, protect against extremes of temperature, accidental spillage of liquids. They keep the sound safe and sound! Packaged 12 12-in. sleeves or 15 10-in. sleeves.



WALCO
**REPLACEMENT
NEEDLES**

FOR LONGER RECORD LIFE

Osmium and sapphire-tipped styli are rated only about 20 to 60 hours of play, after which they develop chisel-edged flats. These flats shear highs from your records, ruin groove walls. Periodic needle replacement is an *absolute necessity* for the serious music lover. You replace with the finest when you replace with Walco needles (and the superb Walco Diamond)—first choice of major cartridge manufacturers.

SEND FOR FREE SAMPLE DISCOVER

AT LEADING MUSIC DEALERS EVERYWHERE

Walco

Trade Name of Electravox Co., Inc.
60-M Franklin St., East Orange, N. J.

"A Gift for the Giver"

Continued from page 60

the whole session had been carried out so superbly without benefit of a conductor. It was their way of saying thanks to the millions of Americans who have listened so intently to their hundreds of broadcasts, and who will now be asked to assist this orchestra in its dramatic struggle for survival.

The session itself was unique for other reasons, too. David Sarser, long one of the violinists in the orchestra, on this evening put aside his Stradivarius to handle the monaural tape equipment. This will be used for cutting a master disc. C. E. Smiley, of Livingston Electronics, was at the controls of the binaural tape machine, making a master from which tape copies will be produced. The work of both recording teams was magnificent.

All during the evening, the orchestra maintained the dignity characteristic of its seventeen years of disciplined association with the Maestro. It was the same orchestral tone, the same ensemble, and the same thrilling display of virtuosity that had been achieved by constant seeking for perfection. There were times when the playing was stopped for brief discussions among the men, because it was necessary to agree on that tempo or this interpretation. On these occasions the autocracy of the conductor was quietly replaced by the democratic spirit and *esprit de corps* of many men seeking a solution by working together.

Before the final Tuesday night session, there had been two previous rehearsals, the first in Nola's Broadway studios. During these rehearsals, the plan of this project was blueprinted by discussions. Up in the Symphony's offices in Carnegie Hall, the first-desk men had gathered around the scores and decided among themselves how the rehearsals and recording session should be carried out. They agreed that, as Toscanini himself had said so often, "It is the music — not the man." And sublimating their own temperaments, these ninety-two individualists worked harmoniously together. The tape playbacks proved that their faith in themselves and in each other had been justified on that memorable Tuesday night.

Their plan? They seek an endowment of ten million dollars. They feel that the countless friends they have made over the air and on tour will want to become patrons of this orchestra, to be a part of their future activities. To that end, the discs and tapes from their recording sessions will be given as receipts for contributions to the Symphony Foundation of America Fund.

NOTE: Don Gillis, president of the Symphony Foundation of America, is a composer, conductor, author, and commentator, and was the producer of the Toscanini-NBC Symphony broadcasts up to the time of Maestro Toscanini's retirement.

"Best Buys" in Hi-Fi Systems Selected from the new 308-page ALLIED 1955 CATALOG



New "Space Saver" Phono System

Now you can have authentic high fidelity performance in minimum space. No investment in cabinetry required. Components carefully selected and matched. Simple plug-in installation. System includes: quality Knight 12-Watt Amplifier (featuring 3-position record compensation, calibrated bass and treble controls, loudness-volume control, response ± 0.75 db, 20-20,000 cps at 12 watts) in black-wrinkle metal case only $3\frac{1}{2} \times 13 \times 10\frac{1}{4}$ "; Webeor 1127-270 Three-Speed Changer ($9 \times 14 \times 14$ ") with G. E. RPX-050 triple-play magnetic cartridge (dual-tip sapphire stylus); Permo-flux "Diminnette" speaker system (3 speakers in modified bass reflex enclosure, for bass, middle range and treble reproduction), $11\frac{1}{2} \times 23\frac{1}{2} \times 12$ ", choice of mahogany or blonde finish. System comes ready to plug in. Hi-fi demonstration record included. Shpg. wt., 56 lbs.

94 PA 129. Net only \$156.50

93 SX 312. Knight 12-Watt "Space Saver" Amplifier only. Shpg. wt., 14 lbs. Net only \$59.50



"Golden Knight" Phono System

The super-value high fidelity system. Top quality matched components at a remarkably low price. Complete system includes: "Golden Knight" 24-Watt Amplifier (3-position record compensator, response ± 0.75 db, 20-40,000 cps, 4 inputs, separate bass and treble controls), satin-gold finish, $8 \times 14 \times 9$ "; famous Garrard RC-80 Record Changer; deluxe G. E. RPX-052 triple-play "Golden Treasure" magnetic cartridge with dual-tipped stylus (diamond LP tip, sapphire standard tip); Electro-Voice 12TRX 3-way speaker with 3 coaxially mounted sections (response ± 5 db, 30-15,000 cps). This superb system is complete with all plugs, cable and hardware, plus hi-fi demonstration record—ready for plug-in connection. Shpg. wt., 92 lbs.

94 PA 134. Net only \$261.75

93 SX 321. "Golden Knight" 24-Watt Hi-Fi Amplifier only. Shpg. wt., 30 lbs. Net only \$79.50

EXPERT HI-FI HELP

Our Hi-Fi consultants are always available to help you select components and systems to satisfy your listening desires at the lowest possible cost to you.

EASY TERMS

Hi-Fi is available from ALLIED on easy payments: only 10% down, 12 months to pay. Write for details.



Free Send for our 16-page illustrated booklet: "This Is High Fidelity"

SEND FOR FREE CATALOG

Write today for ALLIED'S 308-page 1955 Catalog—your complete guide to the world's largest selections of Hi-Fi home music systems, amplifiers, tuners, speakers, enclosures, changers, recorders and accessories. If it's anything in Hi-Fi, it's in stock at ALLIED.

ALLIED RADIO

Everything in Hi-Fi

ALLIED RADIO CORP., Dept. 76-L-4
100 N. Western Ave., Chicago 80, Ill.

- Send FREE 1955 Catalog
 Send FREE Hi-Fi Booklet

Ship the following: _____

_____ \$..... enclosed.

Name _____

Address _____

City _____ Zone _____ State _____

THE
FIRST
Major Advance
IN A **Decade!!**

THE
LABORATORY of ELECTRONIC
ENGINEERING

Presents

"The Finest in
Speaker Systems"

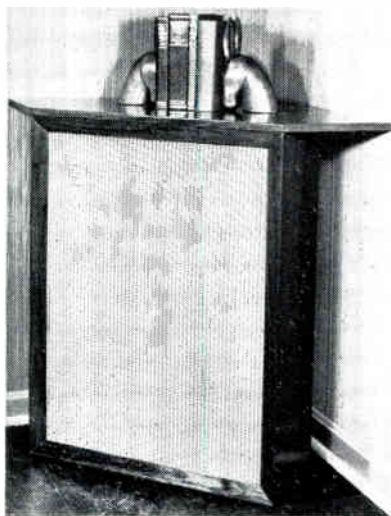

PRICED AT A MODERATE \$295

THE
CATENOID

A THREE-WAY CORNER
HORN SYSTEM

*Designed by Engineers
Built by Engineers*

WRITE FOR INFORMATION TO



LABORATORY of
ELECTRONIC
ENGINEERING, INC.

413-4 L ST., N. W., WASHINGTON, D. C.

Music Tape Reviews

Continued from page 54

folkloristic patterns, though they evolve from them.

Herman Kretschmar comments on the *Wolf Serenade*:

"Rarely was the . . . gracefulness of the Italian character put to music so attractively as in this *Serenade* movement. Wolf can be compared to Charpentier as to authenticity of national flavor. He differs from him in that he forgets in parts the Italian idiom and composes good German music. On account of that, he has ideas (such as the cello solo) which belong to the most beautiful that present-day music has produced." This is brilliant quartet playing.

Dvořák, *Symphony No. 4*

Thor Johnson — Cincinnati Symphony Orchestra

7.5 speed, single track
A-V Tape 1507

Dvořák finished his *4th Symphony* in November 1888, conducting its first performance in Prague, Czechoslovakia. Due to difficulties with his publisher, Simrock, the Austrian premier under the famous Hans Richter did not take place before 1892. Richter wrote about this artistic event to Dvořák: "You would certainly have enjoyed this performance. We all felt that it was a splendid work, and consequently we were all enraptured. Brahms had dinner with me after the concert and we drank to the health of the unfortunately absent father of *No. 4. Vivat sequens* — long live the next one."

Thor Johnson conducts this symphony with healthy musicianship. He also practices the rare art of "taking time," which means in musical terms that each phrase and each melody is allotted the time it needs to unfold its complete musical contents, rather than being rushed into faster speed in order to simulate coherence. Johnson's tempi are sound, and his phrasing is that of a sensitive musician.

It is a pity that at times there is a lack of balance in the woodwinds, *i.e.* weak oboes and bassoons at the beginning of the coda, 3rd movement; weak flutes in the flute variation, last movement; and a weak clarinet solo at the end of the last movement over the *pp tremolo* of the strings. Sometimes, also the brass is weakly defined, which impairs the clearness of orchestral texture. You may have the feeling that directional microphones were placed so close to the strings that their *forte* covered too much of the rest of the orchestra.

However, there is real beauty of sound in the prominent cello sections of the work which, except for the above shortcomings, is thoroughly enjoyable, especially for those who appreciate the improvisatory genius in Dvořák's symphony, in which he deviates from standard form patterns.

RECEIVE
**FULL
VALUE**

FROM YOUR
**FM
TUNER**

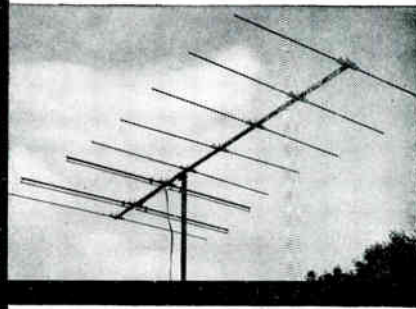

WITH A **VEE-D-X**
BBFM ANTENNA

This eight element Broad Band antenna designed especially for HI-FIFM reception delivers high gain (8 DB) over the full 20 MC band "plus" an unusually high front-to-back ratio (27 DB) assuring excellent interference rejection of unwanted stations. In fringe areas, where signal strength is of utmost importance, this antenna can be stacked

Engineered by the Research and Development Laboratories of LaPointe Electronics Inc., this VEE-D-X BBFM antenna is rugged, all-aluminum in construction, completely pre-assembled for effortless installation.

DON'T DELAY—order your VEE-D-X BBFM antenna now. The only Broad Band antenna designed for maximum performance of your FM tuner over the entire 88-108 MC band.

MAIL THIS COUPON TODAY

TO: LaPointe Electronics Inc.
155A West Main St.
Rockville, Connecticut

NAME _____

ADDRESS _____

CITY _____

STATE _____

PLEASE SEND ME

SINGLE BBFM

DOUBLE BBFM

Enclosed is my check or money order for
 \$27.48 SINGLE \$57.50 DOUBLE
I understand the order will be expressed collect

LaPOINTE ELECTRONICS INC.
ROCKVILLE, CONNECTICUT

FM Tuning with a Dial

(Continued from page 32)

telephone dial (203C type) was to about 14 pulses per second!

In the course of developing the interpreter, a great number of behavior patterns were encountered which had very close parallels with human neurological ailments. That is, a form of hysteria could be introduced by a mis-dial. This was stopped by building in an instruction which said to the interpreter: "If you get confused, stop at WNYC and stay there until you receive further instructions." (This station was chosen because of its freedom from sponsored advertising.) We incorporated a memory relay which keeps the tuner switched to the last station selected even if the power is switched off and then on again. Of course, if this relay failed, a very unlikely occurrence, the tuner would automatically turn to WNYC, the first position on the dial. Any degree of overshoot or undershoot had to be eliminated from the shaft rotation. This was achieved by careful relay sequencing, and the use of a Collins Autopositioner which, in spite of its apparently inflated price, does the job.

The moving parts of the interpreter consist of three small 24-volt relays, a 10-position stepping switch not visible in the photograph because of its location under other components, the Autopositioner previously mentioned, and the slow-speed drive motor coupled to one stage of gear reduction which, in turn, drives the switch-deck shaft. This runs through a ball bearing assembly that is force-fitted to the mounting bracket. The slow-speed motor with its single stage of external gearing rotates the switch shaft at a speed of about 1.75 revolutions per second, resulting in more than ample torque.

Twenty-four volts DC, well filtered at ample current, are supplied by a selenium rectifier located in the power supply chassis, Fig. 4. Through a series of circumstances, some planned and some not, the power supply at present is capable of delivering current in excess of its present requirements on the order of 150%! But as it is planned to use this extra available power to supply future equipment, the unit no longer seems so Gargantuan.

Technical Details

For the technically-minded, the comments that follow touch upon the reasons behind some of the departures from conventional design practice. The front end, while incorporating nothing radical circuitwise, does employ features which provide reassuring tolerances. For example, as shown in the block diagram, Fig. 5, a 6AG7 was used for the local oscillator. This may seem like a rather robust tube for the purpose, but since a usable fifth harmonic must be generated in this stage, and in keeping with the policy of operating components well below their ratings, such a tube was in-

(Continued on page 64)



ELECTRO-VOICE

Model 15TRX

TRIAxIAL 3-WAY REPRODUCER



The 15TRX is EV's latest contribution to the advancement of high fidelity sound. It is an effective 3-way speaker system with the added advantage that each of the reproducers are concentrically mounted and provide the smoothness of response associated with a single source. Frequency response extends from 30 cycles to 15,000 cycles. Two crossover points are employed: one is mechanical at 2000 cycles, and the other at 3500 cycles utilizing an electrical network. The free-air resonance point is 38 cycles. The entire unit weighs 44 pounds and its rated impedance is 16 ohms.

Model 15TRX complete with 'Brilliance Control' **\$13500**



**New
MAGNECORD
Portable TAPE RECORDERS**

Model M-30 Precision built to standards which have gained for Magnecord equipment an important position in the professional field, the Model M-30 has been priced within reach of the high fidelity enthusiast, the musician, and others concerned with high quality recording. Frequency response at 7 1/2"/sec. extends from 50 to over 10,000 cycles ±2db, and at 3 3/4"/sec. from 50 to 5,000 cycles ±2db. An oversize, 4-pole motor is employed for excellent speed regulation. An eye tube permits control of recording level.

Two inputs are provided for recording from high impedance microphone, and from phonograph, radio tuner, or other high level source. The output is high impedance, and can be fed into any conventional high quality amplifier. A monitoring jack permits the use of earphones or external VU meter. Uses tape reels up to 7" dual-track (full-width track optional). Weight: 35 lbs.

Supplied with AC card, 7" take-up reel, and maroon leatherette-covered case measuring 17 3/4" x 11 1/4" x 13 1/4". **\$29900**

Model M-33 Identical in all respects to the Model M-30, except that it has a built-in amplifier and loudspeaker, and an output connection for any external amplifier system.

Supplied as the Model M-30 plus one high quality ceramic microphone **\$32900**

Write to HARVEY, Dept. M-11 for the new High Fidelity Catalog

McINTOSH PROFESSIONAL AUDIO COMPENSATOR and PREAMP

Model C-108



A complete front end providing extreme flexibility with ease of operation. Has a 5-position input switch for AM, FM, Phono, Microphone, TV, Tape, or other sound source. A built-in rumble filter minimizes turntable noise. Five sliding switches are used individually or in combination, permitting at least 11 turnover points from 280 to 1350 cycles. Another series of five sliding switches, allows at least 11 roll-off characteristics to match record treble curves. In addition to a conventional volume control, there is a 5-position aural compensator which maintains proper bass and treble loudness at low volume levels. Power is obtained from the main amplifier or from a separate supply.

Complete with tubes in attractively styled cabinet **\$96.50**
Less Cabinet **88.50**

New REK-O-KUT *Rondine*

3-Speed, 12-inch PRECISION TURNTABLES



Represented to be the result of more than 5 years study, these new record playback units are offered as the closest approach to perfection in turntable performance. Like all Rek-O-Kut units, the turntable is cast Aluminum and exerts no pull on magnetic cartridges.

The following new features have been included: • single selector knob for setting speed: 33 1/3, 45 and 78 rpm. • built-in retractable hub for 45 rpm records — requires no external adapter • permanently offset 3-speed strobe disc for instantaneous speed checking • neon pilot light as 'on/off' indicator • special cork-neoprene mat material to eliminate record slippage • rectangular deck to fit conventional record changer boards.

Two identical Rondine models are available which differ only in the type of motor employed.

Rondine Model B-12 with 4-pole induction motor **\$ 69.95**
Rondine Deluxe Model B-12H with hysteresis synchronous motor **119.95**

NATIONAL *Criterion* AM-FM TUNER

Has separate AM and FM sections, with independent tuning and level controls. Permits binocular reception or feeding different programs to separate points or recording one while listening to another.

'Automatic' FM tuning eliminates noise and hiss. Other FM features include: 0.5 μV sensitivity for 20 db quieting . . . 4-section tuning capacitor . . . cathode follower output. Other AM features include: 10 μV sensitivity for 10 db signal-to-noise ratio . . . image ratio better than 60 db . . . cathode follower output.

A recorder output provides a constant 1 volt level. Cabinet provides space for recessing and flush-mounting the Horizon 5 preamplifier-control unit (as illustrated).

Complete with tubes (less preamplifier) **\$169.95**



HARVEY'S Audiatorium
... an ideal place to see and hear the finest in high fidelity equipment ... and to talk hi-fi with qualified experts.
NOTE: Prices F.O.B., N.Y.C.
Subject to change without notice.

HARVEY

RADIO COMPANY, INC.

103 W. 43rd St., New York 36, N.Y. • JU 2-1500

No long hair,
but long
on enjoyment!



You may know a little or a lot about music . . . you may prefer Teagarden or Toscanini. But one thing you're sure of . . . you like your music rich, full, complete . . . as it's actually played for broadcast or recording. For you, RCA has designed "New Orthophonic" High Fidelity . . . precision-engineered for precise, full-range sound reproduction.

The music you like to hear . . . that's all you need to know about RCA High Fidelity. Fine RCA components simply plug together—without tools—fitting easily into smart, tasteful cabinets. RCA record changer, stylus, amplifier and speaker—ready to assemble in your own cabinet or bookcase—for as little as \$143.22.* Hear them at your RCA dealer's now.

*Suggested retail price



RCA record changers, radio tuners, amplifiers, pre-amplifiers, speakers, tape recorders, cabinets and speaker enclosures can be assembled into any one of 32 combinations to give the customized music system of your choice.

RCA
Customized
HIGH FIDELITY



RADIO CORPORATION of AMERICA

FM Tuning with a Dial

(Continued from page 63)

icated. Under the cutoff conditions encountered in an oscillator, this tube draws a minimum of current, and operates well below its dissipation ratings.

A low-noise triode converter was employed, following an oscillator frequency-doubler stage to avoid the potential regeneration problems attending the use of double-triode conversion. One-half of a 12AT7 served admirably as a frequency-doubler in conjunction with the opposite half of another 12AT7 in the converter stage. Since only the filaments heating the particular halves in use are connected, these two tubes can be interchanged when the emission of one or the other deteriorates. Further, the location of the switch decks associated with these two stages made it seem unwise to use just one tube.

While tuners have been constructed using only a tuned input to the converter, an RF amplifier was considered an absolute necessity. Such a stage not only increases the sensitivity and selectivity of the receiver, but it isolates the local oscillator from the antenna, thereby preventing radiation to, and interference with, other receivers. We feel that such a practice should be required of all manufacturers by FCC ruling. A 6BZ7 in the currently popular direct-coupled cascode circuit serves this purpose.

All coils in the front end were wound from hard-drawn No. 12 copper buss, since the more common annealed wire tends to be less stable over a long-term period. We do, however, acknowledge that the hard copper is somewhat more difficult to form, but here again the extra effort was considered worthwhile. Since skin-effect becomes a factor at these frequencies, it is common practice to provide a surface of better conduction by silver plating. Nevertheless, in time, such coils will develop a black coating of silver sulfide which is esthetically, if not electrically, questionable. This undesirable condition was prevented by heavily gold-plating all coils, at a cost of no more than a few cents.

All stages in the front end are individually switch-tuned for each of the ten stations. Forty pyrex trimmer capacitors (ten for each stage), all accessible from the top of the tuner, insure perfect tracking on every station. Such tracking is very difficult to achieve by less fastidious means. All connections associated with these trimmers and the switch decks were made with beryllium-copper ribbon $\frac{1}{8}$ by .010 in.

Although the IF and discriminator transformers are of standard manufacture, and are in no way a special design, it was found that the passband of the IF amplifier was in excess of 350 kc. This provided a good margin on our minimum passband requirements of 300 kc., which is required for minimum distortion and maximum noise suppression.

(Concluded on page 65)

HIGH FIDELITY FM STARTS WITH THE antenna



Good FM reproduction demands a good antenna. To realize the full potentials of any Hi-Fi FM system the full signal from the station must be captured by an antenna specifically designed for FM. TACO, the oldest name in receiving antennas, has designed such antennas and is offering the following models for greater enjoyment of Hi-Fi . . .

TWIN-DRIVEN YAGI

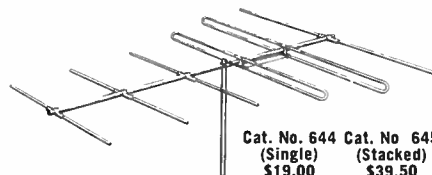

Cat. No. 644 (Single) \$19.00
Cat. No. 645 (Stacked) \$39.50

High-gain design for fringe or weak-signal areas. Provides FM signals at their best. Minimizes interference from other sources. Uni-directional—recommended for areas where all FM channels are received from one direction, or for use with mechanical rotator.

OMNI-DIRECTIONAL

The most popular FM antennas ever offered. Ideal for the average FM installation. Unique design provides equal reception from all directions with excellent gain. May be used as single antenna or stacked as illustrated.

Cat. No. 624L (Single) \$7.15

Cat. No. 624STL (Stacked) \$14.10

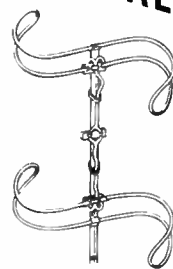

TACO

TECHNICAL APPLIANCE CORPORATION
SHERBURNE, N. Y.

WRITE FOR YOUR FM ANTENNA BULLETIN

Box MG,
Technical Appliance Corporation,
Sherburne, N. Y.

Name

Address

Music at Home

FM Tuning with a Dial

(Continued from page 64)

The IF stages are quite conventional, representing no more than careful design. Three stages of 10.7-mc. amplification are followed by two cascade limiters and a 6AL5 discriminator. The audio is fed to a 6AK6 cathode follower to provide an audio signal of fairly low impedance. This makes it feasible to run long lines to the amplifier with a minimum of high-frequency signal attenuation and, further, isolates the discriminator from subsequent output loading which might be encountered under some circumstances.

Two pin jacks were provided. One is beside the discriminator transformer, and the other just to the right of the shield between the two limiters. These jacks, associated with the limiter grid and discriminator output, are convenient test points for alignment purposes. To anyone who has had to align receivers, this feature will meet with enthusiastic approval.

While many ingenious circuits and physical arrangements have been used for alleviating the effects of heat and attendant drift in FM receivers, crystal-stabilized circuits have none of this problem. Crystals used in this tuner have a temperature coefficient of 2 cycles per degree C. per megacycle or better. But the heavy chassis dissipates the small amount of heat generated by the parts beneath so rapidly that it is doubtful whether the crystals ever reach a temperature which is 10° C. above the ambient room temperature.

The rotary switch wafers are of the double contact variety. That is, each side of the wafer has a complete set of stators and rotors which are tied together electrically. The wafers themselves are of Mycalex, which was considered sufficiently non-hygroscopic and strong enough mechanically to render trouble-free service.

Crystals with Manual Switching

Our experience with this type of FM tuner indicates that a modified version, using crystals and manual station selection, could be produced commercially at a price competitive with conventional models. In that case, the front panel would carry a row of buttons in place of a tuning dial, together with an on-off switch and a volume control. No tuning indicator would be necessary, since each station would be automatically tuned in more accurately than is possible with manual adjustment. Moving parts such as tuning condensers or tuning slugs, dial drive, and sliding pointer would be eliminated.

In fact, thanks to the initial encouragement given us by Mr. Samuel Miller, for whose patience, kindness, and financial assistance we are most grateful, we have reached the point of undertaking a crystal-tuned receiver with manual station selection, on which we hope to report before long.

THE JURY IS IN...

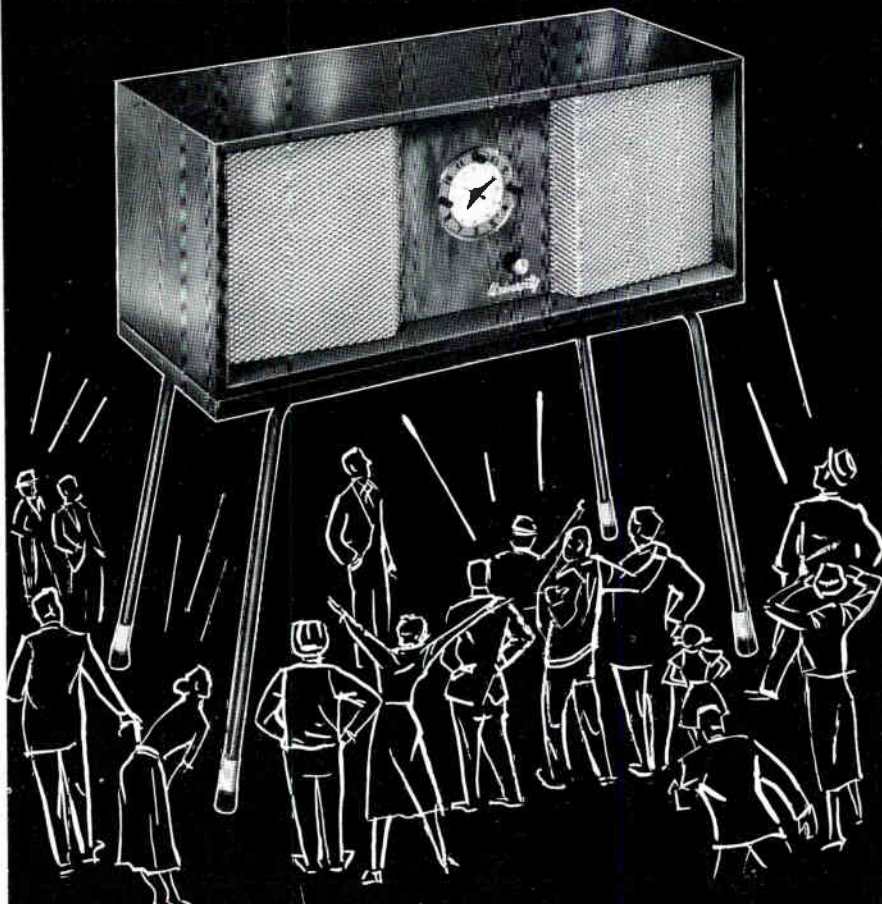

UNIVERSITY'S amazing new three-way speaker system—the **COMPANION**—has been judged by the foremost authorities in the high fidelity field. Read what they have to say:

High Fidelity

"The sound, for an enclosure of this size, is up to University's high standard. The level control on the tweeter is a good idea. Bass was surprisingly full, and definition in the middles and highs was good even at high levels... We're certain that a lot of people will like this, and with good reason."

HIGH FIDELITY

"It is a handsome piece of equipment, and does not engender listening fatigue on the part of its auditors—which is important with any loudspeaker."

AUDIO

"...easy to carry back and forth... simple and compact... attractive and useful piece of furniture..."

MUSIC AT HOME

AUDIO

Music AT HOME

As you can see, the verdict is overwhelmingly in favor of the University Companion.

FOR COMPLETE INFORMATION, WRITE DESK NO. 25



UNIVERSITY LOUDSPEAKERS

INC.

80 SOUTH KENSICO AVENUE • WHITE PLAINS, N. Y.

BOZAK B-310

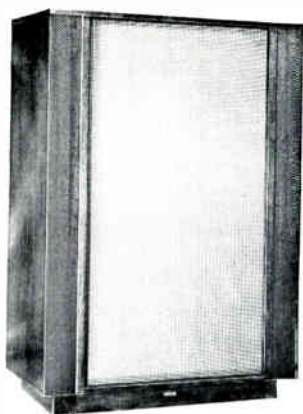

The supreme accomplishment
in the art of loudspeaker design...
the last stage of the
perfectionist's search for
the voice of a fine music system...

The Very Best in Sound
THE R. T. BOZAK COMPANY

BOZAK

Quality Loudspeakers

PLANT AT: WEST POST ROAD • NORWALK, CONN.
Export Office: Electronics Manufacturers' Export Co., Hicksville, N.Y.
MAIL ADDRESS: P.O. BOX 966 • DARIEN, CONN.

HERE IS TELEVISION FOR YOUR HIGH FIDELITY SOUND SYSTEM

Designed and custom-built to operate through your high fidelity amplifier and speaker system (or independently, if you wish). In this way, you enjoy the VIDEO quality of Tech-Master's advanced 630-type design and the AUDIO quality of your own high fidelity system.

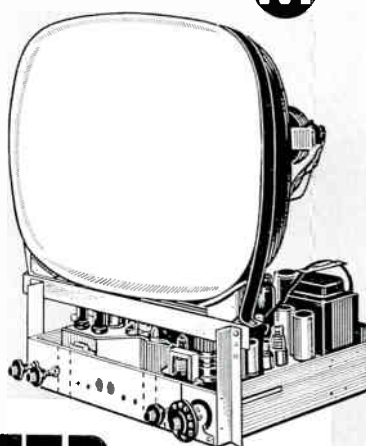

TECH-MASTER GOLD MEDAL TV CHASSIS

Designed for use with Home High Fidelity Systems

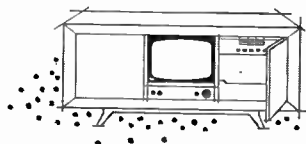

Illustrated Brochure Upon Request
TECH-MASTER CORPORATION
75 Front Street, Brooklyn 1, N. Y.

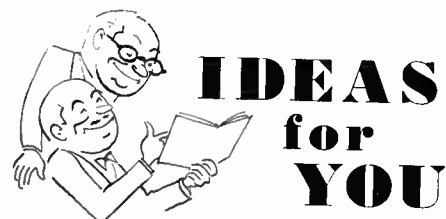

IDEAS for YOU

THE PURPOSE of this Department is to call attention to new products of interest to our readers. No attempt is made to rate performance of equipment shown, as that is not considered to be a proper function of this Magazine. Detailed specifications and descriptive literature can be obtained on request by writing the manufacturers. MUSIC AT HOME will appreciate your mentioning this Magazine.

Speaker Assembly

For those who want to make up their own speaker systems, this assembly is comprised of a B-207A woofer, a B-200X dual tweeter,



and a crossover filter, wired and attached to an aluminum mounting ring. A cabinet of 9 cubic feet is recommended. R. T. Bozak Co., Stamford, Conn.

Non-Magnetic Splicer

This splicer features 3 knives, 2 to trim the splicing tape to exact width, and another, which can be set at 90°, 67½°, or

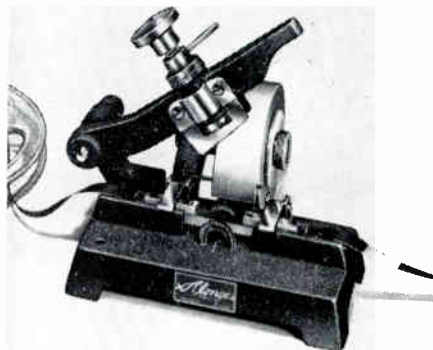

45°, to cut the tape. Operation is simple and very fast. Alonge Products, Inc., 163 W. 23rd St., New York 11.

FM-AM Tuner

Tuner with Armstrong FM circuits has a
Continued on page 67

built-in preamp and cathode follower output. Switch control handles 4 inputs, with a 3-position equalizer for records. Panel

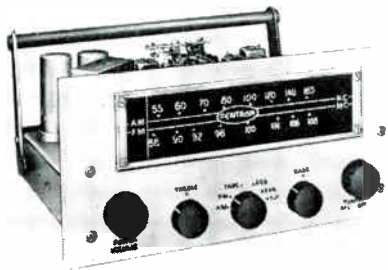

10⁵/₁₆ by 4⁷/₈ ins. matches Pentron HFP-1 tape preamp. Depth of tuner behind panel is 8 ins. Chassis has 2 AC outlets. *Pentron Corp., S. Tripp Ave., Chicago 24.*

Crystal Microphone

Relatively inexpensive slim-type microphone with moisture-sealed crystal is designed for 70 to 8,000 cycles. Output level is



—60 db. Can be used in horizontal position, or vertically for omnidirectional pickup. Furnished with ⁵/₈-27 coupler, and 18 ft. of cable. *Electro-Voice, Inc., Buchanan, Mich.*

Rack for Your Records

Here is a compact stand that holds up to 200 records in 10 stair-step sections, permitting them to be arranged by artist, com-

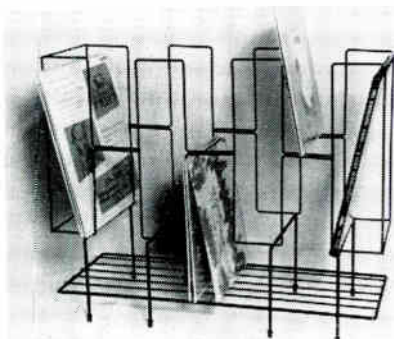

poser, or label. Rack is 19¹/₂ ins. high, 25 ins. long, 9¹/₂ ins. deep. *Leslie Creations, Depr. 187, Philadelphia, 49.*

FM Tuner

Extreme sensitivity and highly effective noise limiting are featured in this FM tuner. Automatic gain control prevents
(Concluded on page 68)

NEW STANDARD OF PROFESSIONAL TAPE RECORDING



the magnificent
Dynacord[®]
by Pentron

Now
for the
first time

... a professional tape recorder that offers both
MAXIMUM OPERATING CONVENIENCE
plus **UNMATCHED DEPENDABILITY**

Dynacord is engineered to exceed the rigid requirements of broadcast stations, sound studios, industry and government. Its wide dynamic range and many convenient operating features amaze engineers and audiophiles alike. Compare it in every way with any other professional tape recorder and see why Dynacord sets the new standard of professional recording.

Model DTM Tape Transport Mechanism, \$350 net.
Model DP-100 Broadcast Amplifier, \$150 net.
Model DS-10 Audiophile Amplifier, \$75 net.

Write for
details and
bulletin

Exclusive 2-speed, inside-out Hysteresis synchronous motor. Direct capstan drive.

Exclusive dynamic braking, fast, positive, fool-proof.
Frequency Response: 50-15,000 CPS at 15 in./sec. ± 2DB
Signal to Noise Ratio: better than 55 DB

THE PENTRON CORPORATION
777 South Tripp Avenue, Chicago 24, Illinois, Dept. M-11
Canada: Atlas Radio Corp., Ltd., Toronto
Largest exclusive makers of tape recorders and accessories

PENTRON

As you know...

YOUR HI-FI RECORDING SYSTEM IS ONLY AS GOOD AS YOUR MICROPHONE!

These important features are the reasons why the

SHURE GRADIENT¹ "300"

HIGHER FIDELITY MICROPHONE

is used by leading recording artists and Hi-Fi enthusiasts for consistently superlative reproduction:

- ✓ **REDUCES REVERBERATION** and pick-up of unwanted noises by 66%!
- ✓ **SMOOTH FREQUENCY RESPONSE** —40-15,000 c.p.s.
- ✓ **BI-DIRECTIONAL PICKUP PATTERN** —enables you to arrange the artists around microphone to obtain the best balance between the different musical components.
- ✓ **VOICE-MUSIC SWITCH**—for utmost flexibility in achieving highest quality recordings.
- ✓ **HIGH OUTPUT**—eliminates hum problems—by allowing recorder to be operated at normal gain settings.
- ✓ **MULTI-IMPEDANCE SWITCH** for LOW, MEDIUM or HIGH IMPEDANCE—provides added flexibility.



Model S33 Desk Stand List Price \$15.00



Model "300" Broadcast LIST PRICE \$135.00

SHURE BROTHERS, Inc.
Microphones and Acoustic Devices
225 West Huron St., Chicago 10, Illinois
Cable Address: SHUREMICRO

Please send me FREE Microphone Catalog 77A and list of Shure Distributors in my locality.

Name _____

Address _____

City _____ State _____

MHG-11

(Continued from page 67)

overloading on strong, local signals. Controls are for fine tuning, interstation noise

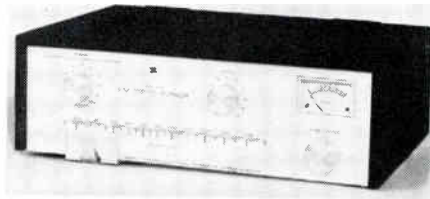

suppression, and level adjustment. *H. H. Scott, Inc., 389 Putnam Ave., Cambridge 39, Mass.*

Hi-Fi Components

Magnavox has brought out two series of hi-fi units, comprising two FM-AM tuners, a preamp, two amplifiers, and a record-



changer, all in matched cabinet designs, plus two speaker cabinets. *Magnavox Co., Fort Wayne, Ind.*

Portable Automatic Phonograph

This portable 3-speed record-player, with a Garrard changer and GE pickup, has a radio connection, output for additional



speaker, dual tone controls, and record equalizer. Demountable legs permit chair-side use. *Pilot Radio Corporation, Long Island City 1, N. Y.*

New Catalog

Name it and you'll probably find it in the new 304-page Allied catalog if it has any connection with radio, tape, records, or TV! Items range from replacement parts to test instruments, and from microphones to service tools. Special 64-page section is devoted entirely to hi-fi. *Allied Radio, Depr. 76-J-4, Chicago 80.*

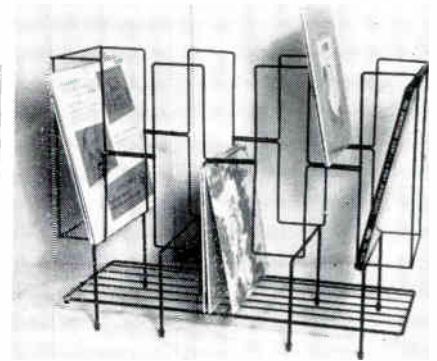

WROUGHT IRON RECORD RACK

Holds 200 LP's. Black finish with rubber tips. Size 19 1/2" high, 25" long, 9 1/2" deep. Sturdy construction. Ten separate sections allow for ideal storage of music by style, composer, artist. Several racks may be placed side by side to form a complete library of records. Please remit with order. Satisfaction guaranteed or Money Refunded. Shipped Express Collect. **\$9.95**

LESLIE CREATIONS
2116 ROBBINS STREET, DEPT. 202, PHILA. 49, PA.

This Is It!

A device for cleaning both record and stylus without risk of damage to either.

FREE your records of dust and grit by using this unique NO bristle brush, chemically treated for static, that operates with a "duster" action.

Not a cloth to rub with. Not a liquid to spray.

With the turntable revolving, a spring-like motion of the brush fans the dust from the grooves. A jet blast of air cleans the lint from the stylus.

Begin now to enjoy better sound from your system by using this new HI-FI BRUSH-BLOWER — only \$1.00 POSTPAID.

High Fidelity Sales

P. O. Box 1676

Burlington, North Carolina

CUSTOM RE-TIPPING

OF PHONOGRAPH NEEDLES WITH

Fine Diamonds

For more than 10 years, the Transcriber Company has been replacing worn-out diamonds and sapphires in phonograph needles with new, fine diamonds, precision ground and polished in our own plant. Modern equipment and long experience assure you of the highest quality at the lowest price.

Write:

The Transcriber Co.

Diamond Needle Manufacturers

70 Pine Street

Attleboro, Mass.

Records, Tape, and FM

Continued from page 18

Republican party, but when the President of the United States is speaking, there is something so disrespectful about cutting him off to switch on a singing commercial for beer that the policy which dictated such arbitrary action should be modified once and for all by the radio broadcasters. Perhaps we had been made particularly sensitive in this matter of disrespect to our Chief Executive for, while we were waiting for President Eisenhower to go on the air, we had been reading "Love Is Eternal", Irving Stone's story of Mary Todd Lincoln. This fascinating portrayal of two other people who finally came to live in the White House inevitably spotlights the indignities which, by intent or by thoughtlessness, are visited on Presidents and their wives.

Pre-Recorded Tapes

To encourage music enthusiasts to start tape libraries, Webster-Chicago Corporation is offering three 5-in. reels of pre-recorded music at \$12.—one-half the regular price—with the purchase of a Webcor tape machine. Information on the classical music selections available can be obtained by writing to the company at 5610 W. Bloomingdale Avenue, Chicago.

Newcomer in pre-recorded tape is Celestial Company, 2128 Westlake Avenue, Seattle Wash. High quality recording is featured on their first list of 15-minute tapes, at 7½ or 15 ips., single or dual-track.

More FM Tuners

Since the review of FM and FM-AM tuners was published in our July-August issue, three more companies have brought out new models. These are Magnavox, Pentron, H. H. Scott, bringing the total number of companies up to 21. Those manufacturing only complete, factory-built sets are not included in that count.

Stokowski Record Sets Record

For the second time in RCA Victor history, a Red Seal record passed the million sales mark. It was *The Blue Danube Waltz*, conducted by Leopold Stokowski. To mark the event, vice president Emanuel Sacks presented Stokowski with a gold copy of the record. First gold record went to Arthur Fiedler, whose recording of *Jalousie*, with the Boston Pops Orchestra, passed the million mark in 1952.

Note on Hearing Aids

Among our visitors at the New York Audio Fair was Walter Huth, an earlybird in radio whose successful development of subminiature tubes back in the 30's led him into the manufacture of hearing aids. Later, his interest in high-quality music reproduction prompted him to undertake

Continued on page 70

AVAILABLE ONLY IN THESE KIT COMBINATIONS

W-2 with Peerless transformer or W-3 with Acrosound transformer (be sure to specify) includes Williamson type amplifier, separate power supply and WA-P2 preamplifier kit. Shipping weight 39 pounds. Shipped express only. **\$69.50**

W-2M with Peerless transformer or W-3M with Acrosound transformer (be sure to specify) includes Williamson type amplifier and separate power supply. Shipping weight 29 pounds. Express only. **\$49.75**

W-4 with Chicago "super range" transformer includes single chassis, main amplifier and power supply with WA-P2 preamplifier kit. Shipping weight 39 pounds. Express only. **\$59.50**

W-4M with Chicago "super range" transformer, single chassis, main amplifier and power supply. Shipping weight 29 pounds. Express only. **\$39.75**

WA-P2 preamplifier kit only. Shipping weight 8 pounds. Express or parcel post. **\$19.75**



TRUE High FIDELITY

HEATHKIT WILLIAMSON TYPE AMPLIFIER KIT

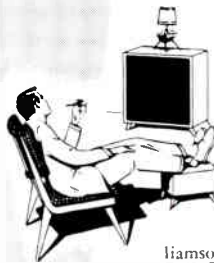

Here is the famous kit form William type high fidelity amplifier that has deservedly earned highest praise from every strata of Hi-fi music lovers. Virtually distortionless, clean musical reproduction, full range frequency response and more than adequate power reserve.

OUTPUT TRANSFORMERS—Three truly fine output transformers available for your selection. Peerless and Acrosound transformers specified for two chassis combinations W-2 and W-3 (main amplifier and power supply). New Chicago "Super range" transformer used in low priced single chassis Williamson type model (W-4). Response characteristics of all models virtually equal.

NEW PREAMPLIFIER—The exciting new WA-P2 preamplifier provides full control through its 5 individually controlled input circuits, 4 position turnover and roll-off switches—separate bass and treble tone controls. Attractively styled, beautiful appearance, baked gold enamel finish, functional in design. Will operate with any Heathkit Williamson type amplifier.

BUILD IT YOURSELF—Combined with brilliant performance of these units is the amazingly modest investment required and the fun of building it yourself. Detailed step-by-step construction manual complete with illustrations and pictorials insures success for even the most non-technical audio enthusiasts.

Complete specification and schematic sheet available upon request.

HEATH COMPANY, BENTON HARBOR 5, MICHIGAN

THE TAPE THAT MIRRORS THE ORIGINAL SOUND

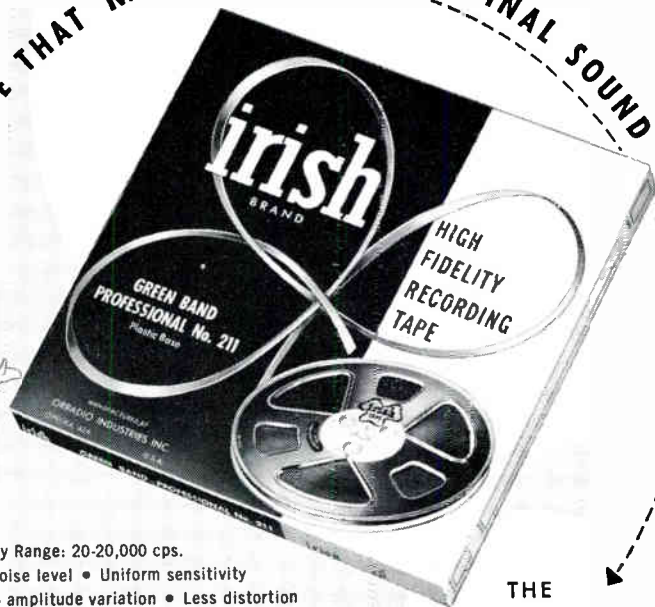

- ▶ Frequency Range: 20-20,000 cps.
- ▶ Lowest noise level • Uniform sensitivity
- ▶ Minimum amplitude variation • Less distortion

600 feet on plastic reel.....net \$2.10
1200 feet on plastic reel.....net 3.30
2400 feet on plastic reel.....net 7.71

At All Leading Sound Dealers

ORRADIO INDUSTRIES, INC.
OPELIKA, ALABAMA

Export Division: Morhan Exporting Corp., New York
In Canada: Atlas Radio Corp., Ltd., Toronto



THE
FINEST TAPE
YOUR RECORDER
CAN USE

Critics Agree

your ear
decides your
listening
pleasure

hear



STEPHENS

TRU-SONIC



True Fidelity SPEAKERS

Famous for their flawless clarity and full, rich mellow tones, Tru-Sonic Speakers will bring you thrilling new sound sensations full of emotional contentment.

Instruments of engineering genius, Tru-Sonic Speakers are a creation of the Nation's first High Fidelity pioneer.

Try the listening test... you'll choose STEPHENS Tru-Sonic Speakers for your listening pleasure. *The International Standard Write for descriptive literature and specifications.*

- ★ 7½ lbs. Alnico Magnet
- ★ Heavy Die-Cast Aluminum Frame
- ★ Low Frequency Cone Resonance - 35 c.p.s.
- ★ Frequency Response 30 to 18,000 c.p.s.

206AX 16 ohm 206AX 500 ohm
Price \$166.00 List Price \$179.00 List

STEPHENS



STEPHENS MANUFACTURING CORPORATION
8538 WARNER DRIVE • CULVER CITY, CALIF.

Records, Tape, and FM

Continued from page 69

the design of a wide-range hearing aid for the benefit of those who, wanting to hear music, are not satisfied with conventional devices. This new model, using four transistors in a case the size of a Zippo lighter, is the result of research aimed at achieving substantial reduction of distortion, with considerably broader audio response. It is made by Aurex Corporation, 1117 N. Franklin Street, Chicago.

Via WFLN Philadelphia

To help enlist support for the Symphony Foundation of America, FM station WFLN Philadelphia and Greystone Wines will present a series of programs entitled "Toscanini Conducts." These broadcasts of Toscanini records will be highlighted by taped interviews with first-chair members of the orchestra and the Foundation management. Further details are given in the WFLN Program Guide, copies of which can be obtained by writing to Raymond S. Green, general manager, Station WFLN, Philadelphia 28.

John Scott Award Winner

Marvin Camras, senior physicist at Armour Research Foundation of the Illinois Institute of Technology, credited as being the "inventor of modern magnetic recording," will receive the \$1,000 John Scott Award for invention which "definitely add to the comfort, welfare, and happiness of mankind." Mr. Camras joined the Foundation staff in 1940. As a result of his work, the Foundation now owns 250 patents. The original John Scott legacy has grown from \$4,000 in 1816 to \$110,000 now. Among those who have received the Award are Edison, Wright, de Forest, and Marconi.

New Way to Have Fun

Webster-Chicago has a novel idea called "Playhouse Package," for school or family groups who want to make tape recordings. The package contains scripts for a one-act mystery play entitled "The Last Will," together with a phonograph record of sound effects and music. Intended as a serious recording project, making a tape and playing it back will produce a riot of fun at a party.

Let's Keep It Simple

In the course of a recent press conference with Paul Klipsch, the terms *binaural*, *stereophonic*, and *auditory perspective* were used in rapid succession to identify the same method of recording and reproduction. There's enough confusion over this subject now without compounding it with three different names. For the purposes of the printed page, we like *binaural* because it is shortest. We see no reason why

Concluded on page 71

Over
500,000
record
collectors
read
"schwann's
long playing
record
catalog"
every month
before
buying.
are you one
of them?

Available
at your
record dealer
now.

Pick up your
copy today.

schwann
long
playing
record
catalog

131 Clarendon St., Boston 16, Mass.

INDEX of ADVERTISERS

Allied Radio Corp.....	56, 61	Music Appreciation Records.....	5
Asco Sound Corp.....	57	National Company.....	6, 7
Audiogersh Corp.....	72	Orradio Industries, Inc.....	69
Berlant Associates.....	14	Penron Corp.....	67
Bogen Co., Inc., David.....	16	Piano Sessions.....	8
Book-of-the-Month Club.....	5	Pickering & Co., Inc.....	24
Bozak Speakers.....	66	Pilot Radio Corp.....	4
British Industries.....	2	Radio Corporation of America.....	64
Brociner Electronics Laboratory.....	72	Radio Craftsmen, Inc.....	12
Collaro.....	Back Cover	Radio Electric Service Co.....	57
Concertone.....	14	Radio Engineering Labs., Inc.....	22
deMars Engr. & Mfg.....	53	Radio Shack, Inc.....	56
Electro-Voice, Inc.....	20, 21	Reeves Soundcraft Corp.....	Inside Front Cover
Electro-Voice Sound Systems.....	59	Regency Division.....	1
Fairchild Recording Equip.....	17, 19	Rek-O-Kut Company.....	Inside Back Cover
Fred Waring Music Workshop.....	8	Rockbar Corp.....	9, Back Cover
Garrard Sales Corp.....	2	Schwann Catalog.....	70
General Apparatus Co.....	71	Scott, Inc., Hermon Hosmer.....	18
Goodmans.....	9	Shure Bros., Inc.....	68
Harvey Radio Co.....	57, 63	Sonotone Corp.....	58
Hastings Products, Inc.....	60	Stan-White, Inc.....	59
Heath Company.....	69	Stephens Mfg. Corp.....	70
Hollywood Electronics.....	56	Sun Radio & Electronics, Inc.....	57
High Fidelity Sales.....	68	Tech-Master Corp.....	66
I.D.E.A.....	1	Technical Appliance Corp.....	64
International Electronics.....	13	Technical Tape Corp.....	10, 11
Laboratory of Electronic Engr., Inc.....	62	Terminal Radio Corp.....	51, 55
Lapointe Electronics, Inc.....	62	Transcriber Company.....	68
Leslie Creations.....	68	University Loudspeakers, Inc.....	65
Magnavox Co.....	15	V-M Corporation.....	51
		Walco-Electrovox Co., Inc.....	60
		Wholesale Supply Co.....	57

G. A. NETWORKS AND AIR-COUPPLERS

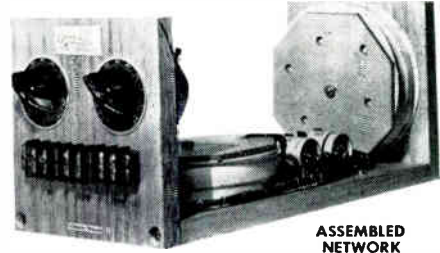

ASSEMBLED NETWORK

G.A. Crossover Networks

As an added service to audio enthusiasts, G.A. is now supplying completely assembled networks, for use with the G.A. Air-Coupler. If you are not certain as to which networks you should use, send 10c for the G.A. network data sheet. Complete, as illustrated:

No. 9C, 8 ohms, 175 cycles.....	\$32.50
No. 5C, 16 ohms, 175 cycles.....	32.50
No. 6AC, 8 ohms, 2,200 cycles.....	16.50
No. 1C, 16 ohms, 2,200 cycles.....	18.50

G.A. Network Kits

Of the various G.A. crossover networks, the following are recommended for use with the Air-Coupler. Complete kits include capacitors and level controls.

No.	Impedance	Crossover only	2 Coils	Complete
9	8 ohms	175 cycles	\$20.00	\$24.00
5	16	175	20.00	24.00
6A	8	2,200	5.75	9.70
1	16	2,200	7.00	11.50

G.A. Air-Couplers

Since 1950, only G.A. is authorized to offer the officially approved Air-Coupler design in knocked-down or assembled form. Parts are precision-cut from high-quality 3/4-in. fir plywood.

Air-Coupler knocked down, ready to assemble, opening cut for 12-in. speaker.....	\$29.95
Air-Coupler assembled and glued.....	39.95
Altec 600B 12-in. speaker, 8 ohms.....	42.00
University 440B tweeter, 8 ohms.....	17.50

G.A. Variable Networks

Type A-VAC permits the crossover frequency to be varied from 90 to 1,100 cycles; type B-VAC, from 900 to 11,000 cycles. Eliminates power loss experienced with fixed networks. Kit is complete with punched chassis and tubes. Also supplied as a finished unit, laboratory-tested, ready to use.

A-VAC or B-VAC, knocked-down kit.....	\$39.95
Either type assembled and wired.....	56.95
Instruction book with circuits.....	1.00

PRICES ARE FOB NEW YORK

GENERAL APPARATUS COMPANY

Formerly at Sheffield, Mass.

346 E. 32nd St., New York 16, N. Y.

Records, Tape, and FM

Continued from page 70

the use of that term should be limited to the headphone system, either. What do you think? We'd like to publish your comments and opinions.

That FM-AM Portable

We do not allow ourselves the privilege of expressing personal opinions of competitive makes of equipment. But since there is only one FM-AM portable set on the market, if you should ask us what we think of it, we would say unhesitatingly, "It's wonderful!" Performance is excellent on AM, but what delighted us is its high sensitivity and effective noise-limiting on FM. We are referring to the new Telefunken model, of course. Why such a set has not been made long ago in this country we can't understand.

Stereo Reproduction

At the recent audio shows where we operated binaural tape machines, we were surprised to find that many people think that binaural (or stereophonic) reproduction is obtained by merely connecting two speakers to a single amplifier output. In fact, a number of our visitors complained that the speakers weren't balanced because they didn't hear the same thing from each one! In the next issue of Music at Home, we shall have a detailed explanation

of binaural reproduction, with illustrations to show what it does, and how.

Why Not?

Sign in the window of an office supply store near Music at Home offers this cheery thought:

IF YOU CAN'T COME IN,
SMILE WHEN YOU GO BY
Not a bad suggestion, what?

STATEMENT REQUIRED BY THE ACT OF AUGUST 24, 1912, AS AMENDED BY THE ACTS OF MARCH 3, 1933, AND JULY 2, 1946 (Title 39, United States Code, Section 233) SHOWING THE OWNERSHIP, MANAGEMENT, AND CIRCULATION OF

MUSIC AT HOME Magazine published bimonthly at New York City, N. Y., and Concord, N. H. for October 8, 1954.

1. The names and addresses of the publisher, editor, managing editor, and business managers are: Publisher: Milton B. Sleeper, Monterey, Mass.; Editor: Milton B. Sleeper, Monterey, Mass.; Managing Editor: None; Business Manager: None.

2. The owners are: Sleeper Publications, Inc., 207 E. 37th St., New York 16, N. Y.; Ethel V. Sleeper, Monterey, Mass.; J. I. Benjamin, Forest Hills, N. Y.; D. J. Moscovitz, Rockville Center, N. Y.

3. The known bondholders, mortgagees, and other security holders owning or holding 1 percent or more of total amount of bonds, mortgages, or other securities are: None.

4. Paragraphs 2 and 3 include, in cases where the stockholder or security holder appears upon the books of the company as trustee or in any other fiduciary relation, the name of the person or corporation for whom such trustee is acting; also the statements in the two paragraphs show the affiant's full knowledge and belief as to the circumstances and conditions under which stockholders and security holders do not appear upon the books of the company as trustees, hold stock and securities in a capacity other than that of a bona fide owner.

MILTON B. SLEEPER, Editor
Sworn to and subscribed before me this 9th day of October, 1954.

[SEAL] CECIL BRATHWAITE, Notary Public.
(My commission expires Mar. 30, 1955)

BROCINER'S NEWEST!

THE MARK 30 AMPLIFIER



Mark 30A
Power
Amplifier

Mark 30C
Audio Control
Center



Available at better high-fidelity distributors. (Prices slightly higher west of Rockies). Literature on request.

BROCINER
ELECTRONICS LABORATORY

Dept. MH 11, 344 E. 32nd St., New York 16

Power Amplifier Mark 30A \$98.25

Uses military-proved "printed circuit" technique.

Phenomenally LOW intermodulation distortion insuring purest sound reproduction: at 10 watts—1/10%; at 20 watts—1/4%; at 30 watts—less than 1%.

Beautiful styling, low in cost. Ultra-linear circuit.

Compact. Only 3 1/2" x 12" x 9" over all.

Audio Control Center Mark 30C \$88.50

Self-powered preamplifier of military-proved "printed circuit" design. 2 phonograph plus radio, TV, tape inputs.

Turnover and Roll-Off separately adjustable for all record curves including new RIAA Standard.

Loudness or volume control with selector switch.

Multiple-loop negative feedback. I.M. distortion virtually unmeasurable.

Only 3 1/2" x 10 3/4" x 6". Attractive maroon and gold cabinet. For table top or cabinet installation.

BUY, SELL or SWAP

The opportunity to buy, sell, or swap items of equipment or records through the use of this department is made available as a service to readers of MUSIC at HOME without charge.

Copy should be limited to 35 words. Items are not accepted from business firms. The Publisher reserves the right to reject copy which, in his opinion, does not conform with the standards of this Magazine.

SELL: Jr. Air Coupler, new and unused 3-speed changer, AM-FM tuner. Dual amplifier, tubes, speakers, innumerable parts. Cleon Abell, 3544 Emerson So., Minneapolis, Minn.

SELL or SWAP: About 400 hill-and-dale records (Edison and Pathé) entire lot or singly. Ralph Reddington, Columbiano, Ohio.

SELL: Brook 12A4 preamplifier and amplifier. Latest model. \$150. Fred I. Sutton, Jr., Box 605, Kinston, N. C.

SELL: Practically new (August 1954) Radio Craftsmen C-800A 15-Tube FM-AM tuner perfect condition. Has built-in preamplifier, 3 position compensator. \$105.00 plus shipping. William E. Wilbur, Kilbourne Road, RFD 4, Rome, N. Y. Phone Rcm 5055-W-2.

SELL: Concertone 1501D recorder carrying case, amplifier and speaker, 2 10 1/2 NAB adapters, 2 empty 10 1/2 reels, Shure dynamic microphone 55S. 6 mos. old. \$345. Bob Lennie, 45-73 160 St., Flushing, N. Y.

SELL: Student will sacrifice Cabinetart folded horn corner enclosure for 12-in. speaker, model 63, with 36-in. grill cloth. Also 50 long-play records. C. Morrissey, 324 Streamside, Harvey, Illinois.

SELL: Aristocrat I system complete, mahogany \$125. Tech-Master Williamson omplifier with Peerless output transformer, 15 watts ultra-linear, \$40. Phone LU 8-7993. Write Ben Zale, 1454 Grand Concourse, Bronx 57, N. Y.

BUY: "When Johnny Comes Marching Home" RCA Red Seal (around 1940-41 vintage) by Minneapolis Symphony Orchestra. James C. Simmons, Box 437, Alice, Texas.

SELL: Scott 14 tube AM-SW receiver, 15 watt amp., Meisner FM tuner, McIntosh C-104 front-end, Garrard RC-80, GE d-s turnover, 15-in. speaker, primavera cabinet. George Kluge, 100 W. 55th St., New York 19, N. Y.

SELL: Rek-O-Kut 743; Weathers osc., pwr. supply, 12-in. arm with new LPd & S78; McIntosh model 20W2 with C104 preamp-equalizer; Collins AM-FM tuner. Or as trade-in. Wm. Dougherty, 3730 N. Percy St., Philadelphia 40, Pa.

SELL or SWAP: Fisher 50-R tuner, used approx. 10 hrs. \$140; Heath W-3M & WA-P2, \$50; Jensen K-310, \$25; old Webcor, G-E cart. \$20; G-E exchange in R-J cabinet. J. M. Clark, Corry Field, Pensacola, Fla.

Change of Address

The Post Office does not forward magazines when you move. To avoid missing copies of MUSIC at HOME, you must give us your new address at least one month in advance of your moving. A charge of 50c is made for each replacement copy.

Only the New
MIRACORD XA-100
has the "MAGIC WAND"
and push button control!



Stabilizing plates and pusher arms are no longer needed because of the unique construction of the "MAGIC WAND"

To the music lover the MIRACORD XA-100 has become a symbol of everything that could be asked for in a 3-speed automatic changer. Wow and rumble are eliminated and the "Pausamatic" feature allows the user to select "pause" time between records of from 5 seconds to 5 minutes. Send for descriptive literature to Dept. M10, or see this unit at leading distributors throughout the U. S.

AUDIOGERSH CORPORATION

23 PARK PLACE, NEW YORK 7, N. Y.

EXCLUSIVE DISTRIBUTORS IN THE U.S. FOR ELAC RECORD PLAYERS

Keep up-to-date on New Products

Your Readers' Service Department will have detailed information sent to you on any products mentioned in this issue. Simply cut out these postage-free cards, fill in the blanks, put your name and address on each blank used, and mail the cards. To assure prompt replies, be sure to **PRINT** your name and address clearly on EACH blank you use.

Special Rates for HOLIDAY GIFT SUBSCRIPTIONS

Two 1-year subscriptions.....\$2.50 each
 Three 1-year subscriptions.....\$2.25 each
 Four 1-year subscriptions.....\$2.00 each
 Five or more 1-year subscriptions.....\$1.80 each

Remittance must accompany group subscription orders

Name.....
 Address.....
 City.....Zone.....State.....

Name.....
 Address.....
 City.....Zone.....State.....

Name.....
 Address.....
 City.....Zone.....State.....

Name.....
 Address.....
 City.....Zone.....State.....

Name.....
 Address.....
 City.....Zone.....State.....

I WOULD LIKE TO HAVE COMPLETE DETAILS ON

Product.....Page.....
 Manufacturer.....
 My name.....
 Address.....

I am an Audio Enthusiast
 Custom Set Builder Dealer

MUSIC at HOME—THE HOW-TO-DO-IT MAGAZINE

I WOULD LIKE TO HAVE COMPLETE DETAILS ON

Product.....Page.....
 Manufacturer.....
 My name.....
 Address.....

I am an Audio Enthusiast
 Custom Set Builder Dealer

MUSIC at HOME—THE HOW-TO-DO-IT MAGAZINE

I WOULD LIKE TO HAVE COMPLETE DETAILS ON

Product.....Page.....
 Manufacturer.....
 My name.....
 Address.....

I am an Audio Enthusiast
 Custom Set Builder Dealer

MUSIC at HOME—THE HOW-TO-DO-IT MAGAZINE

I WOULD LIKE TO HAVE COMPLETE DETAILS ON

Product.....Page.....
 Manufacturer.....
 My name.....
 Address.....

I am an Audio Enthusiast
 Custom Set Builder Dealer

MUSIC at HOME—THE HOW-TO-DO-IT MAGAZINE

I WOULD LIKE TO HAVE COMPLETE DETAILS ON

Product.....Page.....
 Manufacturer.....
 My name.....
 Address.....

I am an Audio Enthusiast
 Custom Set Builder Dealer

MUSIC at HOME—THE HOW-TO-DO-IT MAGAZINE

I WOULD LIKE TO HAVE COMPLETE DETAILS ON

Product.....Page.....
 Manufacturer.....
 My name.....
 Address.....

I am an Audio Enthusiast
 Custom Set Builder Dealer

MUSIC at HOME—THE HOW-TO-DO-IT MAGAZINE

I WOULD LIKE TO HAVE COMPLETE DETAILS ON

Product.....Page.....
 Manufacturer.....
 My name.....
 Address.....

I am an Audio Enthusiast
 Custom Set Builder Dealer

MUSIC at HOME—THE HOW-TO-DO-IT MAGAZINE

I WOULD LIKE TO HAVE COMPLETE DETAILS ON

Product.....Page.....
 Manufacturer.....
 My name.....
 Address.....

I am an Audio Enthusiast
 Custom Set Builder Dealer

MUSIC at HOME—THE HOW-TO-DO-IT MAGAZINE

Holiday Gift Subscriptions

MUSIC at HOME Magazine
 207 East 37th Street, New York 16, N. Y.

Enclosed is my remittance for subscriptions at the reduced Holiday Gift rate of

- Two 1-year subscriptions @ \$2.50 each Four 1-year subscriptions @ \$2.00 each
 Three 1-year subscriptions @ \$2.25 each Five or more 1-year subs. @ \$1.80 each
 Names and addresses are listed on the back of this card. (Use separate sheet for extra names)

SPECIAL GIFT SUBSCRIPTION ANNOUNCEMENT CARDS

A Gift Announcement Card, bearing your name, will be sent to each person for whom you subscribe. So that we can do this for you, please fill in YOUR name and address below.

Your name.....

Your address.....

A FREE GIFT SUBSCRIPTION FOR YOU

If you order 5 or more gift subscriptions, MUSIC at HOME will send you a year's subscription ABSOLUTELY FREE. If you are already a subscriber, your subscription will be extended for 1 year. Please indicate below that your FREE SUBSCRIPTION is to be a:

- New Subscription Extension

This FREE 1-year subscription or extension will be sent to you at the address above ONLY if you order 5 or more gift subscriptions. Your remittance must accompany your order.



MUSIC at HOME
 207 East 37th Street
 New York 16, N. Y.

Readers' Service Dept. 5



MUSIC at HOME
 207 East 37th Street
 New York 16, N. Y.

Readers' Service Dept. 5



At the 3-year subscription rate, MUSIC at HOME is only \$2. per year,

or 33¢ per copy! For yourself, or as a gift to a fellow hi-fi enthusiast, this supply of ideas and information is an unusual value at such a very small price. Use the order blank at the top of this page.

Rates for GIFT SUBSCRIPTIONS

- Two 1-year subscriptions ... \$2.50 each
 Three 1-year subscriptions ... \$2.25 each
 Four 1-year subscriptions ... \$2.00 each
 Five or more 1-year subscriptions \$1.80 each

REMITTANCE MUST ACCOMPANY GIFT SUBSCRIPTION ORDERS

NOW YOU CAN BUY A

REK-O-KUT

PRECISION TURNTABLE

FOR ONLY \$49⁹⁵



THE
REK-O-KUT

Rondine **Jr.**

Model L-34, 2-SPEED, 12-INCH

For some time, there has been an expressed need for a high quality turntable with only the two currently popular record speeds. This has arisen mainly among the newcomers to high fidelity who have found that they can fill all of their music requirements with either 33 $\frac{1}{3}$ or 45 rpm records.

In considering this situation, Rek-O-Kut realized that the exclusion of one speed would simplify many of the design and construction procedures, and would permit a lower cost without compromising quality. The result . . . the Rondine, Jr. . . . is an achievement we regard with considerable pride.

The most significant feature of the Rondine, Jr. is the employment of the floating idler, now adopted in all Rek-O-Kut Rondine turntables. This development has virtually eliminated accoustical coupling between motor and turntable . . . thereby reducing vibration, rumble, and noise to below the threshold of audibility.

The Rondine, Jr. is powered by a 4-pole induction motor. Other features include a built-in retractable hub for 45 rpm records, a permanently affixed strobe disc, plus the many design and construction elements which have made the Rek-O-Kut name world-renowned in the field of sound reproduction.



For complete specifications write to Dept. TL-16

REK-O-KUT COMPANY

*Makers of Fine Recording and Playback Equipment
Engineered for the Studio • Designed for the Home*

38-01 QUEENS BOULEVARD, LONG ISLAND CITY 1, N. Y.

7 GOOD REASONS

WHY THE RECORD CHANGER IN YOUR HIGH FIDELITY SYSTEM SHOULD BE

Collaro

1 Accurate Speeds—Factory pre-set and pre-tested for 33 1/3, 45 and 78 rpm operation. Requires no adjustments.

2 Smooth, Constant Motion—Powerful, 4-pole induction motor and ball-bearing mounted, weighted table assure smooth, constant motion free from wow and flutter.

3 Quiet, Distortion-Free Performance—Balanced rotor, pulleys and couplers reduce rumble to an inaudible minimum. Automatic muting switch eliminates 'clicks'.

4 Simple, Foolproof Operation—One knob selects any speed—another starts, rejects, or shuts off with a simple twist.

5 Plays All Records—Handles 7, 10, and 12-inch records automatically—at all three speeds. Model 3/532 permits inter-mixing 10 and 12-inch discs in any sequence.

6 Automatic Shut-Off—Automatically shuts off and disengages after last side is played.

7 Absolutely Jam-Proof—Safety clutch prevents damage even with tone arm secured during changing cycle.

Only COLLARO offers you ALL of these advantages... and more: Ball-Bearing Mounted Tone Arm for maximum lateral compliance—Stylus Pressure Adjustments for good tracking with as little as 3 grams. COLLARO Record Changers were built for high fidelity and belong in your high fidelity system.

Available at Radio Parts Jobbers, Distributors, Hi-Fi Dealers.

	LIST	
Model 3/532 Intermixes 10 and 12-in. records	\$65.00	Prices slightly higher west of the Rockies
Model 3/531 Non-intermix	54.50	
Model 3/534 Single record player	33.60	



Write for complete details to Dept. PL-13

ROCKBAR CORPORATION, 215 East 37th Street, New York 16, N. Y.