

THE MAGAZINE
FOR THE
HI-FI ENTHUSIAST

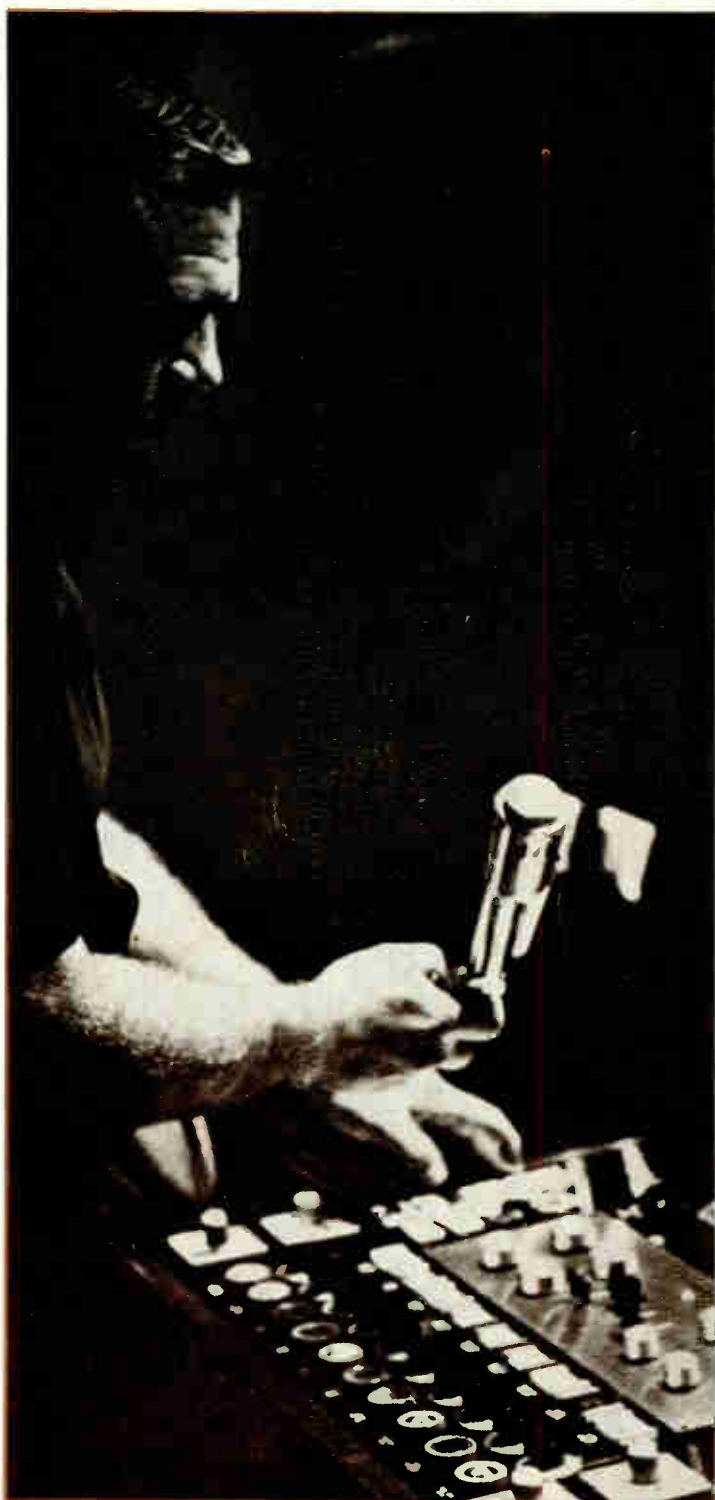

AF-08
WM HARRIS
5 ELM ST
AUBURN N Y

JULY 1966 VOL. 2 NO. 7 FIFTY CENTS



**NEW YORKER WINS Hi-Fi
PHOTO CONTEST**

—see page 10

YOUR SUBSCRIPTION IS SPONSORED BY

BARNETT BROS.

(PLEASE SEE OUR ADVERTISEMENT INSIDE BACK COVER)

Only the new Scott S-8 is designed for solid-state components!

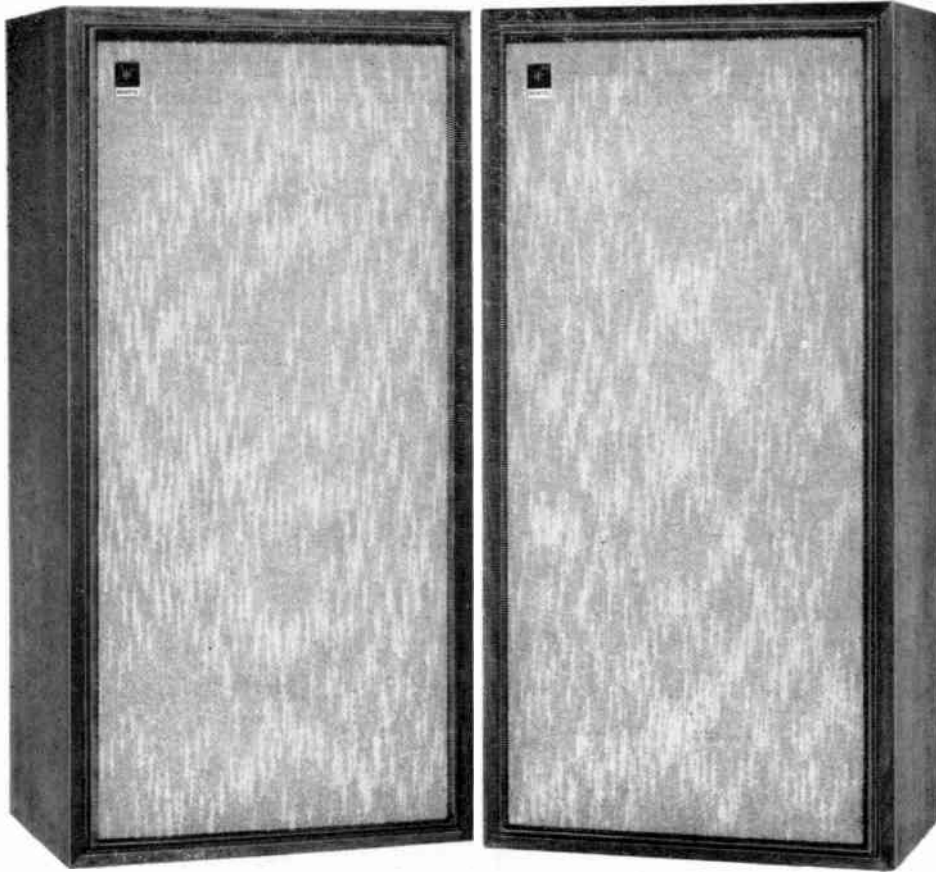

Only the new Scott S-8 is designed with Controlled Impedance!

Scott engineers have developed a new kind of speaker system, specially designed for finest performance from solid-state components. Of all speakers now on the market, regardless of price, only the S-8 is completely compatible with new solid-state equipment. Here is why:

Solid state amplifiers and receivers give best performance over a fairly narrow range of load impedance. The impedance of ordinary speakers, however, varies considerably as the frequency changes. With increased impedance, available power is reduced. Lowered impedance may overload the amplifier output circuits.

Even the most expensive speakers available today were designed for tube equipment where impedance is controlled by output transformers. These speakers do

not offer, for example, 8 ohms impedance to the amplifier at all frequencies. In fact, the impedance can vary from as little as 2 ohms to as much as 20 ohms at different frequencies.

Now, Scott has designed an 8-ohm speaker system specifically for use with transistor components. The impedance range is controlled by integrated engineering development of both speakers and crossover to match the capabilities of today's solid-state equipment. The S-8 gives you the kind of sound you wanted when you bought transistor components. What more could you ask? The price? Only \$69.95, each. Complete system, including S-8 speakers, Scott 342 solid-state FM stereo receiver, and automatic record changer, well under \$500 at most dealers.



Scott... where innovation is a tradition

SCOTT®

For further information and specifications on the new Scott S-8 speaker system, write:
H. H. Scott, Inc., Dept. 39-07, 111 Powdermill Road, Maynard, Mass. Export: Scott International, Maynard, Mass.



EDITORIAL

***where
did
the
hi-fi
go?***

It's not surprising to find the term "high fidelity" losing its full meaning. Where once it connoted superb reproduction of sound, wide use and abuse over the years by package home entertainment equipment makers through to perfume manufacturers has diluted it to a trite advertising phrase.

The fact is that many of the abusers have dropped the phrase altogether, substituting other ones. They're still trading on the reputation built by component equipment manufacturers, however, with shadowy expressions such as "componentability." This is the word coined by a giant phono manufacturer for its new line of portables. ". . . the turntable-amplifier slips right out of the cabinet . . . So the phonograph becomes a real *professional setup*." (Our italics.)

Now how gullible do they think people are? Plenty gullible, it seems. Another manufacturer raves about how its wood cabinet imparts a wonderful resonance to the sound. You'd think they were talking about a violin. The unfunny part of it is that the general public believes all this.

Hi-fi has become synonymous with mono to the majority of people, you know, while stereo is thrust into a super class unto itself. Thus, we find the new auto tape cartridges called "stereo" cartridges, but unfortunately, they're far, far from being hi-fi by any stretch of the imagination. It requires more than multiple channels to produce high quality sound.

Consequently, a mono record could be a hi-fi recording, while a stereo record may well not be a hi-fi disc. The converse might be true, too, of course. So enlighten your friends and relatives when the chance arises. When they ask where the hi-fi went, explain that it didn't go "out." They'll thank you for it.

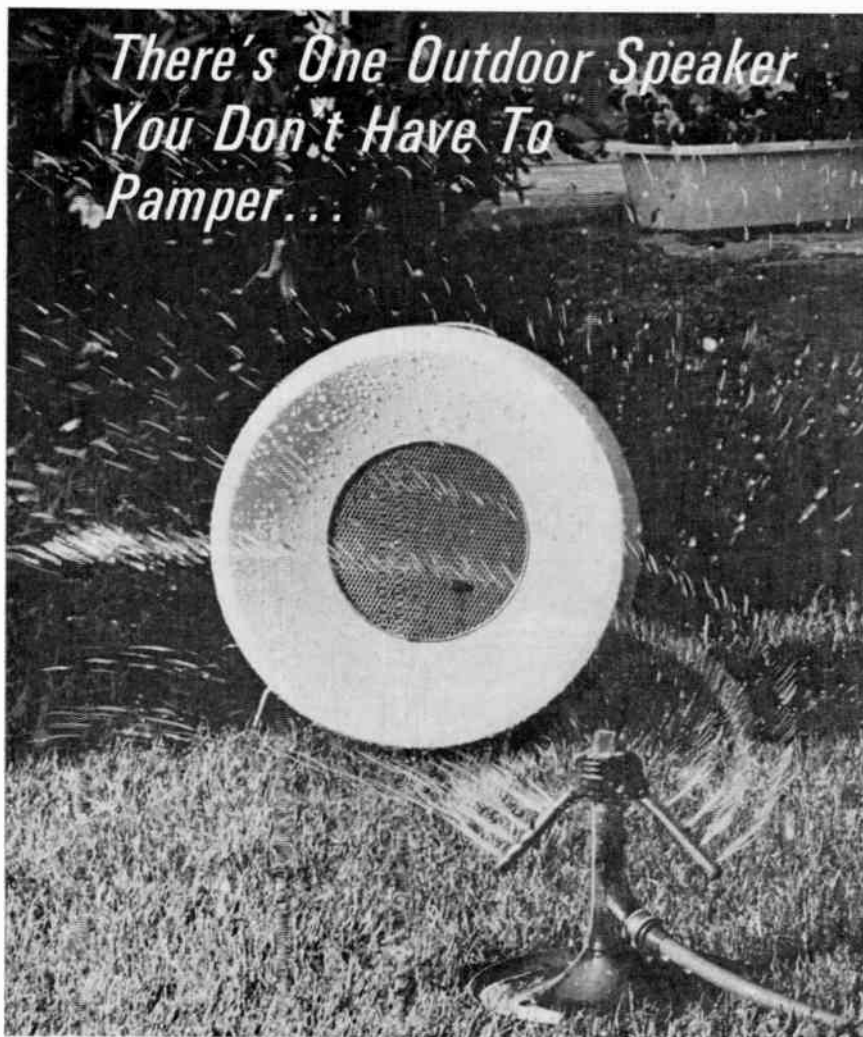

*There's One Outdoor Speaker
You Don't Have To
Pamper...*

It's Bozak's *bard*

A nagging thought like "what will happen to my loudspeakers if it starts to rain" could spoil the emotional impact of your outdoor music this summer.

With the Bozak BARD that worry never need cross your mind. The BARD is weatherproof and waterproof — not merely drip-proof or splash-proof. You can install the BARD anywhere and forget it. No need for a protective overhang or a sheltered corner. Hot or cold, rain or shine, summer or winter — the BARD is always ready when you want outdoor music.

What makes it all possible is Bozak's patented neoprene coated metallic diaphragm which sheds water like a duck's back.

Plus Natural Reproduction

Even more important to your listening pleasure than the way in which the BARD shrugs off the weather is the quality of the sound it produces.

The BARD provides the most natural reproduction available from any outdoor speaker intended for home music systems.

Don't take our word for it; hear it at your Bozak dealer.



DARIEN, CONNECTICUT

OTHER PORTION
OF THIS CARD!

Letters

Send your audio questions, problems, comments and suggestions to the Editor, AUDIOFAN, 25 West 45th St. New York, N.Y. 10036

doubting thomas

DEAR AUDIOFAN:

The March 1966 issue of AUDIOFAN made reference to a Stereophonic Club of Southern California in the "Profile of an Audiofan" feature. Does such a club really exist, or is it a product of literary license? If it does exist, I would appreciate receiving information which would enable me to contact the recording secretary.

Michael Silver

Sherman Oaks, Calif.

Cynic! Contact Don Springer, Stereophonic Club of Southern California, c/o Pasadena Athletic Club Building, Pasadena, California.—Ed.

AM receiver conversion

DEAR AUDIOFAN:

Will it be possible in some future issue to diagram or give some information on the method used in changing an AM radio receiver into an AM tuner?

William Callahan

Flushing, N.Y.

No doubt some information concerning converting an AM radio receiver into an AM tuner will be covered in some future issue of AUDIOFAN. Most AM receivers, however, do not have satisfactory tuner sections for hi-fi use.—Ed.

hi-fi mike inputs

DEAR AUDIOFAN:

I noticed (page 20, column 1) that AUDIOFAN indicated that "hardly any home music system is equipped for microphone inputs." This is just to let you know that the Dyna preamps all have a special input which can easily be wired for a dynamic mike. The special input lists options in the manual for several choices, but the mike arrangement is the most popular.

Robert Tucker

Philadelphia, Pa.

Perfection results from CHOICE...NOT CHANCE

Since no single phono cartridge can be all things to all people, we earnestly recommend that you employ these individual criteria in selecting your personal cartridge from the broad Shure Stereo Dynetic group:

YOUR EAR: First and foremost, listen. There are subtle differences in tonality that beggar description and are quite unrelated to "bare" specifications—yet add immeasurably to your personal listening pleasure.

YOUR EQUIPMENT: Consider first your tone arm's range of

tracking forces. Too, keep in mind that the cartridge ordinarily represents the smallest monetary investment in the system, yet the ultimate sound delivered depends *first* on the signal reproduced by the cartridge . . . "skimping" here downgrades your entire system.

YOUR EXCHEQUER: Shure cartridges cover the entire economic spectrum. And they are ALL Shure in quality, all Shure in performance. Even the least costly has received copious critical acclaim.

BEST SELLER



MODEL M3D

Where cost is the dominant factor, the M3D provides extremely musical and transparent sound at a rock-bottom price. The original, famous Shure Stereo Dynetic Cartridge . . . with almost universal application. Tracks at pressures as low as 3 grams, as high as 6 grams. For any changer. Only \$15.75

MUSICAL BEST-BUY

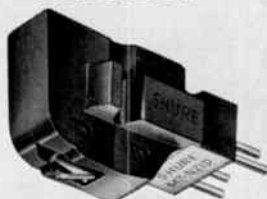

MODEL M7/N21D

Top-rated cartridge featuring the highly compliant N21D tubular stylus. Because of unusually clean mid-range (where most music really "happens") it is especially recommended if your present system sounds "muddy." For 2-gram optimum tracking (not to be used over 2½ grams). Only \$17.95 (Also, if you own an M3D or M7D, you can upgrade it for higher compliance, if tracking force does not exceed 2½ grams, with the N21D stylus for only \$12.50.)

ALL THE MOST WANTED FEATURES

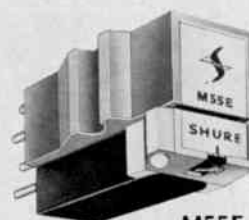

M55E

15° TRACKING, ELLIPTICAL STYLUS

Professional performance at a modest price. Compares favorably to the incomparable Shure V-15, except that it is produced under standard Shure quality control and manufacturing techniques. Remarkable freedom from IM, Harmonic and tracing distortion. Will definitely and audibly improve the sound of monaural as well as stereo records. A special value at \$35.50. Upgrade M44 cartridge (if you can track at 1½ grams or less) with N55E stylus, \$20.00

THE "FLOATING" CARTRIDGE

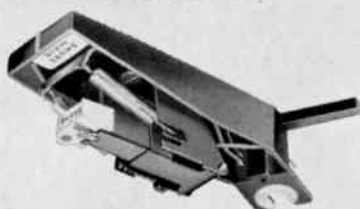

M80E GARD-A-MATIC®
WITH ELLIPTICAL STYLUS

Bounce-proof, scratch-proof performance for Garrard Lab 80 and Model A70 Series and Dual 1009 automatic turntables. Especially useful where floor vibration is a problem. Spring-mounted in tone arm shell. Stylus and cartridge retracts when force exceeds 1½ grams . . . prevents scratching record and damaging stylus.

Model M80E
For Garrard turntables, \$38.00
Model M80E-D
For Dual 1009 turntables, \$38.00

THE ULTIMATE!

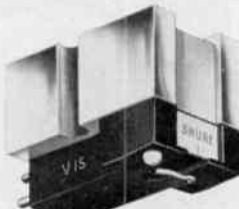

V-15

WITH

BI-RADIAL ELLIPTICAL STYLUS

For the purist who wants the very best, regardless of price. Reduces tracing (pinch effect), IM and Harmonic distortion to unprecedented lows. 15° tracking. Scratch-proof, too. Produced under famed Shure Master Quality Control Program . . . literally hand-made and individually tested. In a class by itself for mono as well as stereo discs. For manual or automatic turntables tracking at ¾ to 1½ grams. \$62.50

"THE BEST PICK-UP ARM IN THE WORLD"



SHURE SME

Provides features and quality unattainable in ANY other tone arm. Made by British craftsmen to singularly close tolerances and standards. Utterly accurate adjustments for every critical factor relating to perfect tracking . . . it realizes the full potential of the cartridge and record. Model 3012 for 16" records \$110.50; Model 3009 for 12" records \$100.50

SHURE

Stereo Dynetic®

High Fidelity Phono Cartridges . . . World Standard Wherever Sound Quality is Paramount
Shure Brothers, Inc., 222 Hartrey Ave., Evanston, Illinois

Grooveless record demonstrates anti-skating on the Garrard Lab 80

Due to the offset angle of any cartridge, and the rotation of the record, all tone arms have an inherent tendency to move inward toward the center of the record. This skating force, a definite side pressure against the inner wall of the groove, is a major cause of poor tracking, right channel distortion, and uneven record wear.

Your Garrard dealer has been supplied with grooveless records, which make it possible to visualize the skating force and how it is overcome in the Lab 80. With the demonstration below, he can show you how the Lab 80 protects your records and tracks both stereo channels more evenly, more perfectly than any other integrated record playing unit.



1 "This is a blank record with no grooves. I place it on the Lab 80."

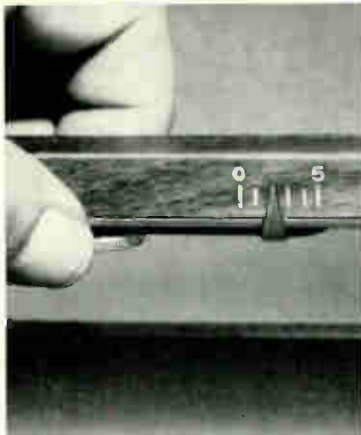

2 "I set the tracking force at two grams, for example. Since each click of the stylus pressure gauge on the tone arm equals $\frac{1}{4}$ gram, I turn it for 8 clicks."



3 "I then slide the counterweight on the anti-skating control to the second notch... equivalent to the tracking force I have just set on the tone arm."



4 "Now you can actually watch the strength of the skating force. I start the Lab 80, but flip the anti-skating control over and out of operation. Note that as soon as I put the stylus on the grooveless record, the arm moves rapidly... with force, toward the center."

TRACKING WITHOUT ANTI-SKATING CONTROL. SINE WAVE FORM SHOWS CONSIDERABLE DISTORTION



5 "Now watch me neutralize the skating force. I swing the anti-skating control back into position... and the arm tracks as perfectly as if there were a groove in the record! If I were playing a regular record—with the side pressure gone and resulting distortion eliminated—the sound would be cleaner."

TRACKING WITH ANTI-SKATING CONTROL. SINE WAVE FORM BECOMES A CLEAN PICTURE OF THE OUTPUT OF THE CAR RIDGE

[OSCILLOSCOPE READINGS BASED UPON 1000 CYCLE, 30 CM PEAK SEC. TEST RECORD AS SIGNAL SOURCE]

The patented Garrard method of neutralizing skating force is but one of a number of Lab 80 developments. Compare! You'll find this Lab 80 feature is simple and foolproof... works perfectly without springs, balancing devices or other delicate mechanisms. Visit your dealer and see it in operation, or send \$1.00 to Garrard for your own grooveless demonstration record. For complimentary copy of 32-page illustrated Comparator Guide, write to Garrard, Department GC-2096, Westbury, New York 11590.

Garrard[®]
WORLD'S FINEST



“
Everything here is fairly well automated. It's primarily an entertainment center.
”

**NEW YORKER
WINS
Hi-Fi PHOTO CONTEST**
audiofan designs own entertainment system

 No one could ever fault the Institute of High Fidelity (IHF) photo contest judges for selecting Robert Genin's high fidelity system as the winning hi-fi installation, earning for him a couple of free air flight tickets to Europe plus \$100 pocket expenses.

The Scarsdale, New York resident, who is president of Child Guidance Toys, Inc., owns what could only be called a hi-fier's hi-fi system. It has everything an audiofan could wish for in the way of components and operating conveniences, and then some.

But don't think for a moment that this is simply an affluent man's act of plunking down money. It took his enormous talent and considerable effort—14 months of labor—to create the winning hi-fi system, not to mention an understanding wife. Robert Genin designed the 10½' long x 7½' high x 38" deep cabinet straight through to electrical and electronic wiring. And except for the actual cabinet work, which a woodworking concern built from blueprints developed by Mr. Genin, he personally executed the entire installation.

If you think this was as simple as hooking

up some speaker lead wires to output terminals, take a long look at the photo here which reveals the system's innards. It contains more than 200 separately functioning circuits and 20 power relays. Have you ever seen trickier wiring outside a professional's studio?

Before we dazzle you with some of the prize-winning system's features, let's take a closer look at our audiofan. You'll no doubt agree that it isn't every hi-fi enthusiast who can put together a component system of this scope and size.

"I'm a tool and die maker by experience," Genin explained. "I studied mechanical engineering nights at Brooklyn Polytech—and worked at practising it all day long." As a result of such training, he attacked the challenge of designing a unique hi-fi system with full confidence.

"There's a complete set of blueprints on the system," Genin said. "And I can show you the actual scale size working model made from them. It would be impossible to visualize a setup this large without one. Besides Mrs. G. had to be shown what I intended to do to her living room."



Prize-winning high fidelity system is shown above in hi-fier's living room. Motorized, sliding doors enclose the rosewood unit when it's not being used.

His first hi-fi component stereo system was a Harman-Kardon unit, back in the middle Fifties. He later changed to a Marantz 7C preamplifier and McIntosh power amplifiers. "I just wasn't ready for all the controls at that time; it proved too difficult for my family to operate, so I traded it in for a Fisher." But now he's back to an even more complex system, and loves every moment of operating it.

"I have a very keen ear for sound," Genin observed. "It takes top quality equipment in excellent condition to satisfy me." He also noted that he was a professional dancer in his youth, which probably accounts in part for his sensitivity to realistic music reproduction.

Looking about the spacious (35' x 17' x 14'), living room for the hi-fi system failed to reveal it. Drapes covered sliding glass doors on one long wall; part of the other long wall included sliding glass doors which exposed a moderate-sized open air court with gardens and sculptured objects located in the center of the house; a rather large attractive, rosewood room divider separated one end of the living room from a

15' long dining area adjoining it, while the other end of the room was simply the room's short terra-cotta stone wall and fireplace decorated with oil paintings.

Anticipating my question, "Where is the hi-fi system?" Mr. Genin threw a switch on a panel at the side of an impressive, black formica-topped walk-in bar built into a wall of his living room. Glancing in the direction of a low, humming sound, I saw two giant doors on the rosewood room divider slide apart, exposing an elaborate hi-fi system. When the doors were fully opened, six spotlights automatically splashed light on the system, and an instrument panel board, slightly inclined from a horizontal position, was lighted, too. Translucent color-coded legend switches and button control plates glowed green, red, yellow, and white.

Actuating a push-button switch on the control board caused tambour doors at the sides of the system to rise, disclosing the speaker system enclosures.

Wow!

"Each speaker system enclosure has 26½ cubic

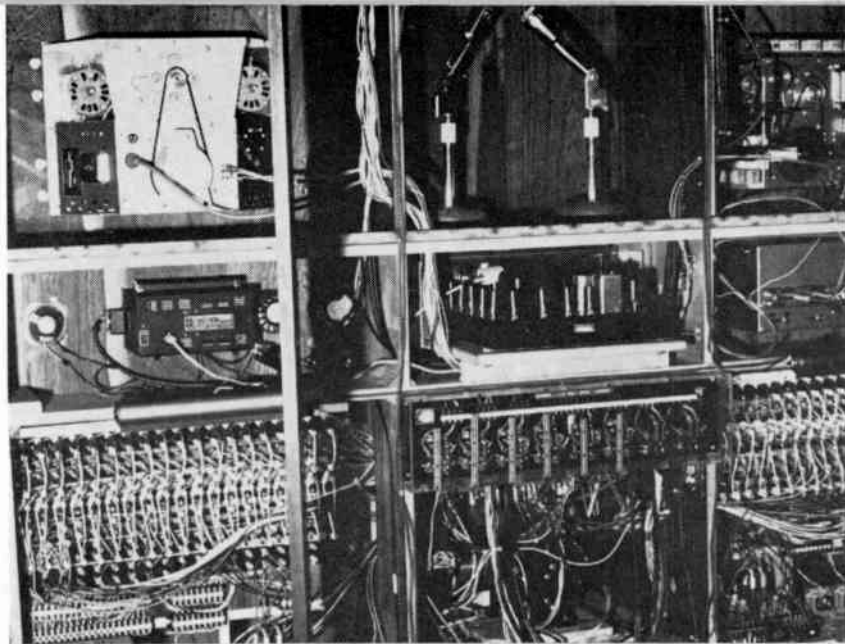

The reverse side of the entertainment center is easily accessible in the event some circuitry troubles occur (wood doors normally hide the elaborate circuit wiring and components revealed here). The control panel above gives Mr. Genin fingertip control over all functions of his system.

“

I have a very sensitive ear for sound so it takes top quality equipment in excellent condition to satisfy me.

”

feet of space,” our audiofan commented. “They’re specially designed cabinets, which house 14 loudspeakers each; all Bozaks—four bass speakers, two mid-range speakers, and an 8 speaker tweeter array are mounted on each side.”

“Everything here is fairly well automated. It’s primarily an entertainment center. The only sections that aren’t automated are the sliding tambour doors covering the turntables.”

At the left of the control panel is a Thorens TD-224 automatic turntable; in the right section is a Marantz SLT manual turntable. He’s using Ortofon stereo cartridges with elliptical styli.

“We’re operating on three power amplifiers, all specially housed under the floor.” In response to a raised eyebrow, Genin continued: “I just haven’t got the space for it here so I placed them directly under the cabinet, within dust proof enclosures in the crawl space. They’re two Marantz 9’s (70 watts each) for the Bozaks and a Fisher 1000 stereo amplifier (150 watts total) for driving my 14 extension speakers—tiny Maximus’.” He makes doubly sure they run cool by using Rotron fans and checks output circuit bias’ once per month.

Standing at the controls, Genin tapped a microswitch button and a door above us slid open. “This is where prerecorded tapes are stored,” he said. Each tape reel container has its own partition.

“I can store 60 10½” reels here,” he said. “I’ve

recorded and catalogued about 70 10½” reels of two and four track stereo and have collected about 100 commercially prerecorded tapes. We prefer opera, in particular, on prerecorded tape.” Pointing to the row of pushbuttons lined under his tape storage cabinets, 30 buttons under each of two storage areas, he pressed one. Two things occurred simultaneously: The pushbutton switch displayed a lighted number and a tape reel was partially ejected from its partition.

“Being primarily interested in tape,” Genin said, “and having always stored them in vertical partitions, it bothered me having to skin my fingers every time I wanted to pull a reel out. Consequently, I developed this spring system that, with solenoids, pops out the proper tape when I press its numbered pushbutton. It’s still a hair tight,” he observed, as some of the reels didn’t pop out a sufficient distance.

“When I get through with the system, the program contents of everything recorded on that tape will automatically appear on the TV screen (a Sony 5” TV receiver is incorporated into the system—Ed.) Genin explained: “An electronically controlled read-out system of projection will be incorporated so that, when a numbered tape push-button is depressed, a circuit will flip the proper microfilm in front of the read-out lamp and be projected onto the screen. The microfilm will detail the program material, artist, timing and all other info of that particular tape. Something like a miniature slide projector.”

Robert Genin’s plans to expand his enter-

FIRST PRIZE Hi-Fi SYSTEM

- | | |
|---|--|
| <ul style="list-style-type: none"> 2 Marantz Model 9 mono power amplifiers (70 watts each) 1 Fisher Model 1000 stereo power amplifier (150 watts IHF total) 1 Marantz Model 7 stereo preamplifier 1 Thorens Model TD-224 automatic turntable 1 Marantz Model SLT manual turntable 2 Ortofon stereo magnetic cartridges with elliptical styli 1 Marantz Model 10B stereo FM tuner 1 Crown Model SS824 4-track tape recorder and control amplifiers 1 Crown Model 300 4-track, self-reversible tape transport 2 Bzopak speaker systems, each containing: 2 Model B-199A bass speakers, 4 Model B-209B mid-range speakers, 1 Model B-200YA tweeter array (8 tweeters), and 1 Model N-104 crossover network 14 Maximus I extension speaker systems | <ul style="list-style-type: none"> 1 FM/Q Super antenna 1 Ham-M antenna rotator 1 Sony 5" TV receiver 1 Master Control Panel, 24" x 25" 2 Electro-Voice Model 664 microphones 1 Beyer stereo headphones 2 General Electric running timers 2 Cramer interval timers 2 Motorized tape storage drawers with 60 Switchcraft lighted pushbutton selectors 5 Motorized record storage drawers (store over 600 LP albums) 1 Motorized projection screen 1 Cabinet, rosewood, 10½' long x 7½' high x 38" deep with 2 motorized, large tambour doors and 2 motorized, speaker system tambour doors. <p>Provisions for a home video tape recorder and a master intercom system. Double key switch control panel mounted elsewhere in room.</p> |
|---|--|



At right, our hi-fi enthusiast reaches for a reel of tape in one of his two tape storage areas. Each reel of tape has its own compartment.

tainment center don't end here. He's setting up remote control operation for his Crown tape recorder and Crown tape transport, for example. But he's most enthused about video tape recording. "The center panel, between the tape recorder and tape deck, is all set up for a video tape recorder," he said excitedly. "You know, the theory of selling video tape as competition to a home movie setup is all wrong as far as I'm concerned. Cost comparison makes this obvious." He explained, "If you want to inventory video tape with motion pictures of the family, it's far more expensive, comparing black and white video tape with color movie film—and look at the loss in latitude and resolution." (*Editor's note: Actually, the price of video tape in a helical scan system is not much higher than that of 8 mm color film costs when you consider film's processing expenses. A disadvantage that accrues in video taping "family pictures," however, is a VTR's large size and AC power requirement, which restrict live video taping to the living room or other convenient areas.*)

"As president of my company, I'm on call 24 hours a day . . . 7 days a week. I'm interested in being able to see a TV show, sporting event or anything of importance that I couldn't normally see because of not being home . . . or because there happen to be two such shows or events on at the same time." He added, "The two automatic timers will readily take care of this."

The timing devices Genin refers to are the

built-in Cramer interval timers that are wired for automatic preselected operation of any component or combination in the system. (" . . . many of my stereo tapes were recorded live off Multiplex FM while we were out.") He also has two built-in General Electric running timers tied into the start and stop circuits of his tape recorder and tape transport so he knows how much operating time has elapsed before cleaning and demagnetizing his machines' magnetic heads.

Most of his tape recording efforts are taken straight from the air, so to speak. FM broadcasts, that is, from his Marantz stereo FM tuner. "It's fantastic," said Genin, watching the tuner scope's green phosphorescent wiggles as he manipulated a joy stick that controls the rotor on his FM/Q antenna.

He uses his Crown 824 4-track tape recorder to record and a Crown 300 4-track tape transport which reverses tape direction automatically when the end of the magnetic tape is reached. "We can play 1½ ips on a 10½" reel, two sides, all day long without touching a thing," he noted. "I use a portable Roberts tape recorder with 1½ ips speeds on trips or when on vacation to listen to prerecorded music."

Our July audiofan hasn't neglected records, either. He has about 1400 stereo albums—that's one thousand four hundred discs to prove it. He files them in the same way record dealers do: in record bins. Simply press the appropriate button on the control panel (there's a choice of 5

(Continued on page 32)

REPORT ON WEST COAST *Hi-Fi* SHOWS

1 A funny thing happened on the way to the National Electronics Week (NEW) trade show—the consumers got there first. At any rate, they saw many hi-fi products before many dealers did—simply because the consumer shows on the West Coast (Los Angeles and San Francisco) were held earlier than the dealer show, (San Francisco).

Past issues of AUDIOFAN covered highlights of the recent hi-fi music shows. Here are some more product details and photographs to whet your sonic appetites.

Of the tape recorder manufac-

turers, Roberts has probably attracted the lion's share of the attention due to their introduction of equipment to handle the Stereo 8 (Lear) cartridge format. For the man who has everything except 8-track, there is the 837-CC cartridge player component—a wood-cased unit designed to hook into existing hi-fi systems for \$99.95. But the real "first" is the 1638-L combination reel-to-reel cartridge unit for \$339.95. The unit shown in California consists of a 1638 deck with an added slot for the cartridge, provision for switching between reel and cartridge, and a



Tape recorder models are sprouting up like flowers in the Spring. Representatives of manufacturers provided show-goers with patient explanations, backing it up with vivid demonstrations. From top to bottom are Wollensak's Uher's and Concord's exhibition rooms. At left is Concertone's new system, cabinet and all.



device for changing tracks (or, to use Stereo-8 terminology, programs) on the cartridge.

Lear Jet showed its own units (including a home player to feed a hi-fi system) for the first time in a high fidelity show. (SJB and Viking were showing their Fideli-pack-type units.)

In other cartridges, Norelco and 3M were showing tape portables using the Philips (mono) cartridge for which prerecorded materials are now being issued and for which the Norelco auto adaptor is available. (Since the 3M machine is made for them in Hol-

land by Philips, it can be used in the Norelco adaptor.) The Wollensak cartridge unit was on display as well, but according to 3M's Pete Gavin, they are not planning to use the system in autos, although he admitted that 3M might well enter the auto field once the market and the mechanical standards are firmly established.

Sony's recent tape machine models were being shown with particular emphasis on the "Quadradial Sound" and "Retractomatic Pinch/Roller" features — both available on the 530 and on the

660 stereo recorders. In addition, the 660 features the "ESP" reversing system. Also plugged by Superscope was the Model 105, an updated version of the 102 with automatic level control (and defeat), the retracting pinch roller, auto shutoff, three speeds, and 4-track mono heads.

Wood cabinets were very much in evidence in the exhibits of several manufacturers. Magnecord featured the model 1020 in Los Angeles. Norelco gave the spotlight to their brand new, Stylish Continental 1420. Viking had the 88 stereo compact (and the new



Speaker system demonstrations always capture crowds at hi-fi shows. The West Coast audionics were no exception in this department. Top to bottom are University's, Aztec's and AR's displays. At right is part of Electro-Voice's display, which here exhibits component speakers spearheaded by a 30-inch woofer.



880 portable with twin speakers). Tandberg pooled resources with a West Coast furniture house to display recorders and the new Huldra multi-band radios in a home-style setting.

The most wood showing, though, held Concertone units. Recent additions to the Composium Series have cabinets styled in a Spanish Renaissance mood by designer Raymond E. Enkeboll: a long, low unit (Troubador) that includes JBL speakers; a tall, arched piece (Arcature) that includes exposed shelving; a unit (Linen Fold) similar to the first

Composium, but including its own base, containing a center-channel woofer. Also new in the Concertone room was the 727 battery-powered AC/DC stereo recorder.

Even for tape recorder manufacturers who lacked any really new product, there was news. Ampex had new speakers; Elpa was showing the ReVox recorder for the first time on the Coast. Martel gathered together those products not made by Uher, promoting them under the Telmar name (including everything except cartridge recorders specifically for

auto use, which are being marketed separately under the SJB name).

Seeing oneself on videotape continued to be a top-drawing sport with show-goers. Ampex used the model 6200 HVR. Sony, though their unit has been on the market for some months, drew a lot of questions about recent announcements of color capability for the Videocorder and a disc process for video recording. Neither is yet available for sale.

San Francisco did not draw the

(Continued on page 30)



The British Industries room shown above gave show attendees a good look at its wide line of hi-fi components—Garrard turntables and Wharfedale speaker systems. At top-right, Benjamin's new Model 50H is demonstrated, while below, onlookers watch a United Audio's Dual automatic turntable in action.



FM STEREO LIGHTS, WHISTLES AND SWITCHES

by Leonard Feldman

Hi-fiers today have it made. Many FM tuners and receivers automatically switch into stereo operation when a multiplex station is received, alerting hi-fiers to it with a lighted indicator lamp. In one instance you can actually see a stereo signal on an oscilloscope. Some tuners have an automatic and non-automatic mode, as well as a mono position.

What will the future bring? Well, Kenwood has an experimental model that zeroes in on succeeding stereo broadcasts, scooting across the dial as it skips all mono stations. It works in reverse, too.

 Almost before FM Stereo receiver sales really got started, manufacturers began adding refinements designed to make life easier for FM Stereo listeners. Nearly all high-quality receivers or decoders are now equipped with some form of visual or aural indicator to signal the presence of a stereo signal. Still others take all the guesswork out of FM Stereo listening by including automatic switching from FM to FM Stereo in addition to the indicator. It is these "refinement features" which we shall discuss here.

In two previous articles we examined the nature of an FM stereo signal, and the type of circuitry needed in a home receiver to unscramble its complex signal into recognizable "left" and "right" stereo programs.

If you remember the makeup of a stereo composite signal you will recall that a key element of that signal is the ever-present 19 kHz "pilot signal" used to syn-

chronize the locally generated 38 kHz sub-carrier with its suppressed counterpart at the transmitter. This pilot carrier is "ever present" only so long as stereo is being broadcast.

It follows, therefore, that this stereo-related signal would make a wonderful "triggering" signal for all of the refinements previously mentioned.

stereo lamp indicators

The incoming 19 kHz pilot signal can also be used, indirectly, to illuminate a pilot lamp, a neon indicator, or even a "tuning eye" type of fluorescent indicator. A block diagram showing one possible basic arrangement is shown in Fig. 1.

In addition to the usual decoder blocks, a parallel 19 kHz amplifier-limiter arrangement is used to actuate a #49 low-voltage, low-current miniature lamp. In the absence of a 19 kHz signal (and hence, the absence of any stereo signal), this stage is arranged so that it is "cut-off." That

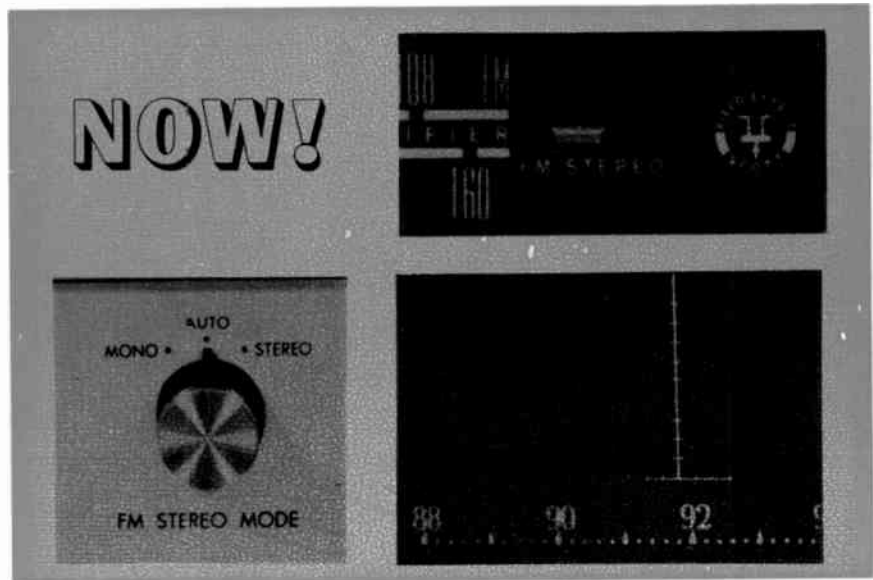

is, no current flows in the plate circuit (in the case of tube types) or in the collector circuit (in the case of transistor circuits).

The lamp is connected in series with this plate or collector circuit. The moment a 19 kHz signal is selectively fed to this stage, however, it begins to conduct and the resultant current serves to illuminate the stereo indicator. Countless variations of this simple idea have been put into practice by various manufacturers, but all with the same objective. For example, some circuits have additional tuner circuits to make certain that the lamp will not accidentally fire in the presence of some extraneous signals other than the desired 19 kHz pilot signal. Others have in some way tied this circuit to overall receiver sensitivity to insure against premature lighting of the lamp in the presence of a stereo signal too weak to be received in a noise-free manner. (You will recall that stereo reception generally requires greater signal strength than does equivalent monophonic FM reception.)

whistle indicators

A very inexpensive "aural indi-

cator" has been used by some manufacturers to detect the presence of a stereo signal while tuning across the FM band. A simplified schematic of the local oscillator section of such a decoder is shown in Fig. 2.

Under normal conditions, this oscillator is "locked in" to its accurate 19 kHz frequency by the incoming pilot carrier. The frequency-determining elements of the circuit are L1 and C3. When momentary switch S1 is thrown to the "test" position, C2 is paralleled across C3, altering the frequency of natural oscillation from 19 kHz to, say, 18 kHz. In the absence of a stereo signal, this high frequency oscillation is as inaudible to the average listener as was the 19 kHz oscillation. When stereo is received, however, the incoming 19 kHz "beats" with the internally generated 18 kHz to form a difference frequency of 1000 Hz, which can be heard by one and all as a steady whistle.

Thus, in using this indicator, the listener sets switch S1 to the "test" position, spins his tuning knob across the dial, and stops whenever he hears the familiar 1 kHz whistle. He then restores

the test switch to the "normal" position and sits back secure in the knowledge that he has, indeed, tuned into a bona fide stereo FM station.

automatic FM/FM-stereo switching

While it's all well and good to know *when* a station is broadcasting in stereo, it's undeniably a chore to get up from an easy chair and move the selector switch from FM to FM Stereo every time the lamp glows. Obviously, the handy 19 kHz pilot comes to the rescue once more.

It could, of course, be used to flip relays from the mono to the stereo mode. This, in fact, was the "brute force" approach used in some early circuits. Besides being extremely costly, objections were raised over noisy or chattering relays and the host of other complaints normally associated with "mechanical" switches of this kind. Soon, all-electronic circuit switching was perfected. Bear in mind that if no 38 kHz carrier or "switching" voltage is developed in a decoder circuit it will recover only an L+R (monophonic) signal. Thus, in the

1

Basic block diagram shows operation of stereo lamp indicators.

2

Switching S-1 to "test" will cause a tone to be sounded if the station is being broadcast in stereo.

3

If a multiplex signal is broadcast, the incoming 19 kHz pilot signal will automatically "turn on" the oscillator by developing a positive voltage to counteract the negative voltage normally applied to the oscillator emitter.

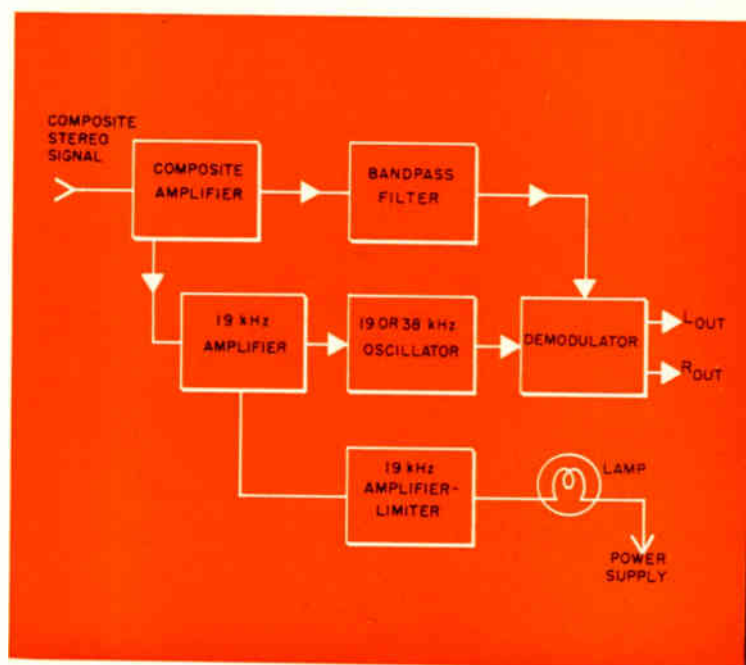

case of decoders containing local 19 kHz or 38 kHz oscillators, this means that the oscillator must be "turned off" whenever monophonic reception is present and must automatically be "turned on" whenever stereo is broadcast.

In the case of decoders having no local oscillators (those which depend upon direct amplification and doubling of the incoming pilot signal), practically no additional circuitry is needed for automatic switching, since no 38 kHz voltage will be produced unless the station tuned in is broadcasting in stereo.

A simplified schematic of a 38 kHz local oscillator circuit is shown in Fig. 3. The emitter of this oscillator stage is deliberately biased negatively by a voltage divider arrangement from the -12 Volt supply to prevent the oscillator from oscillating. Along comes the dependable 19 kHz pilot, which is fed to a diode. The diode rectifies the 19 kHz pulses to positive DC voltage.

This pulse voltage is applied to the emitter of the oscillator stage, counteracting the negative voltage and allowing the oscillator to do its job—oscillate. As soon as this happens, L-R information

is able to be recovered and mixed with the monophonic L+R signal to produce the usual L and R of stereo—and automatically, at that.

threshold and gating adjustments

Again, in order to avoid inadvertent triggering of this automatic switching feature, most manufacturers have tied in their automatic switching circuits with received signal strength. Thus, if, in a manufacturer's judgment, satisfactory stereo reception requires a signal strength of, say, 100 microvolts at the antenna terminals, he can arrange the circuit so that automatic switching takes place only in the presence of a stereo signal of at least 100 microvolts.

This is done by relating the AGC (Automatic Gain Control) voltage to the switching circuit in addition to the 19 kHz signal. Since such ills as "multipath distortion" can afflict the FM stereo listener even in strong signal areas, some manufacturers have provided a "defeat" switch which restores the circuit to monophonic performance even in the presence of a strong stereo signal, which

puts us just about back where we started!

Before concluding this discussion on FM Stereo Multiplex, a word about transistors as opposed to tubes in this field is in order.

The question of tubes vs. transistors has been debated in amplifier and tuner discussions, but not much has been said insofar as multiplex decoder circuits are concerned. Let us state at the outset that one form of decoder circuitry has no clear advantages over the other. Excellent separation characteristics and low distortion performance can be built into tube or transistor decoders. We have even seen excellent results obtained when feeding a tube-type tuner to a solid-state decoder and then a tube-type power amplifier as well as all combinations and permutations of these types.

The important thing to remember (especially if adding a separate decoder or adapter to an existing arrangement) is that the decoder be able to handle the level of signal input from the tuner circuit without overloading.

2

3

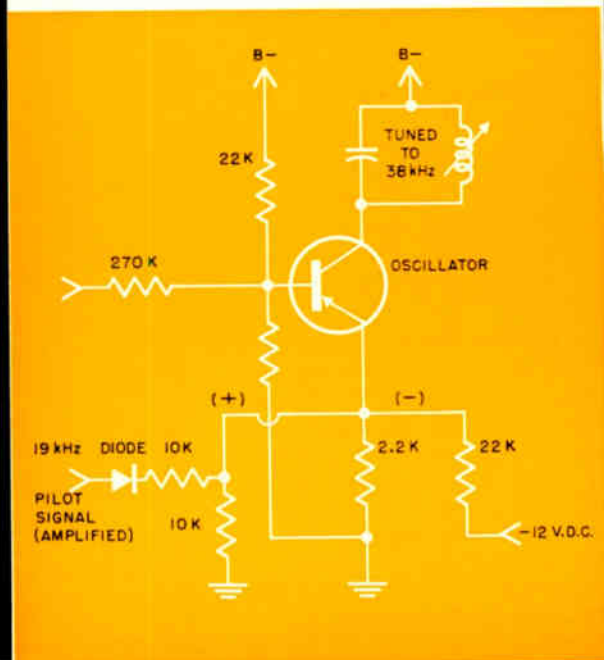
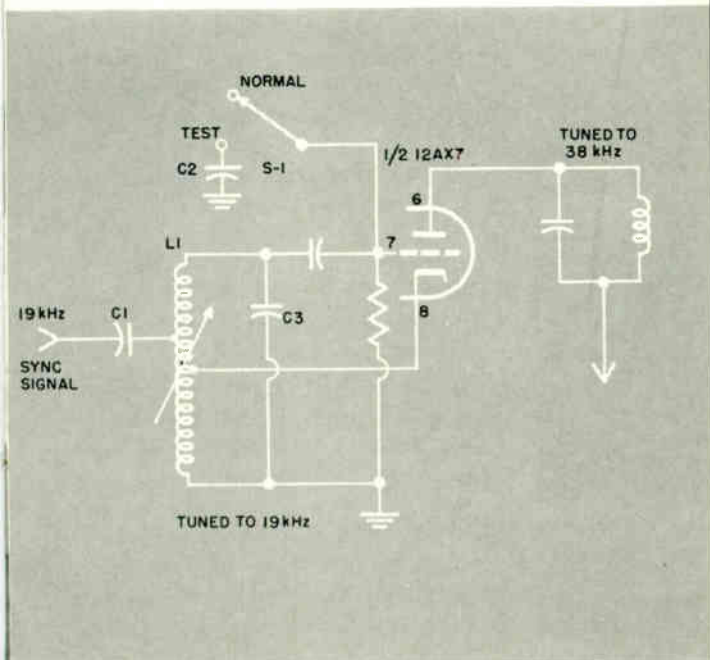



inquiring reporter

PLACE: 1966 LOS ANGELES AND SAN FRANCISCO HI-FI SHOWS.

QUESTIONS:

- (2) Are you planning to have stereo tape in your auto?
- (1) How do you like the show?

GORDON CAMPBELL

TEXACO OIL CO.: HEADPHONES WERE THE MOST INTERESTING THING THAT I SAW HERE. I DIDN'T REALIZE WHAT A DIFFERENCE THEY COULD MAKE. THE NEXT THING THAT I HAVE TO GET IS A BETTER AMPLIFIER AND ANOTHER SPEAKER. I HAVE JUST CONVERTED FROM MONO TO STEREO AND I DON'T HAVE ALL THE EQUIPMENT THAT I NEED FOR THE QUALITY OF SOUND THAT I WANT. I HAVE FM IN MY CAR NOW AND I DON'T LISTEN TO IT VERY MUCH. DON'T THINK THAT I WOULD BE INTERESTED IN ADDING THE TAPES.

BARRY BERKOWITZ

PHARMACIST, 6 YEARS HI-FI INTEREST: I ENJOYED THE SHOW. THE MANNING OF



THE VARIOUS ROOMS WAS ADEQUATE—I GOT GOOD ANSWERS TO THE QUESTIONS I ASKED. BUT THESE ROOM SETTINGS ARE REALLY NO HELP. YES, I SAW THE AUTOMOTIVE STEREO DISPLAY. IT DOESN'T INTEREST ME VERY MUCH, THOUGH.

ANONYMOUS

GROCERY BUSINESS, 7-8 YEARS HI-FI INTEREST: I LIKED THE SHOW, BUT I WOULD HAVE PREFERRED IT IF EVERYTHING HAD BEEN ON ONE FLOOR, ALONG WITH THESE ROOM SETTINGS. THE ROOM SETTINGS ARE WONDERFUL. YES, I'M INTERESTED IN PUTTING STEREO INTO MY CAR.

BOB DRAKE

SOCIAL WORKER: I WAS MOST INTERESTED IN THE MARANTZ TURNTABLE, IT HAS NO TRACKING ERROR. THIS HAS BEEN A BUG OF MINE FOR YEARS. HOWEVER, I WOULD RATHER SPEND THE MONEY ON BETTER SPEAKERS FIRST. I DON'T REALLY KNOW ABOUT STEREO TAPE FOR MY CAR. I HAVEN'T GIVEN IT MUCH THOUGHT. I SUPPOSE THAT IT'S ALRIGHT, BUT I'LL HAVE TO LOOK INTO IT BEFORE I REALLY KNOW HOW I FEEL.

JIM KIKISH

PRINTING, 15 YEARS HI-FI INTEREST: IT'S A GOOD SHOW—BETTER THAN ANY I'VE



BEEN TO BEFORE. I GET GOOD ANSWERS TO THE QUESTIONS I ASK; THE MEN REALLY KNOW WHAT THEY'RE TALKING ABOUT. THE IDEA OF STEREO IN MY CAR INTERESTS ME. MAYBE EVENTUALLY WE'LL THINK ABOUT INSTALLING A UNIT. WE GOT A LOT OF IDEAS ON HOW WE CAN USE OUR STEREO FROM THESE ROOM SETTINGS.

BOB PETERSON

STATISTICAL ANALYST: I LIKED THE SPEAKER DISPLAYS. THEY SEEM TO BE BETTER THIS YEAR, GIVE YOU A BETTER IDEA OF WHAT THEY CAN DO. I HAVE A SIX-YEAR OLD SYSTEM AND I'M INTERESTED IN CHANGING OVER TO MORE COMPACT UNITS. I THINK THAT I CAN GET BETTER QUALITY WITH LESS SPACE FROM WHAT I'VE SEEN HERE. NO, I'M NOT IN THE LEAST INTERESTED IN ANY KIND OF STEREO FOR MY CAR. I THINK THAT THAT'S CARRYING IT A LITTLE BIT TOO FAR.

JAMES (& Mrs.) BARNHOUSE

ELECTRICAL ENGINEER, 20 YEARS HI-FI INTEREST: I REALLY CAME LOOKING FOR



ONE SPEAKER MODEL THAT I WANTED MORE INFORMATION ABOUT. I HAVEN'T FOUND IT YET, SO THE SHOW IS A DEAD LOSS TO ME AT THE MOMENT. NO, I DON'T THINK WE'D BE INTERESTED IN HAVING STEREO IN THE CAR.



Can you imagine grade-school children learning college-level music theory, then going on to compose their own music?

This is just one of the wonders that takes place in Miss Lynnore Dagg's amazing new electronic piano class in North Hollywood, California—where children are seen and not heard!

Gone are the days of solitary instruction from Miss Dagg's classroom and hundreds of others across the country. The dreary scales and fingering exercises that had the piano teacher bending anxiously over her students have been all but abolished from these sessions, too.

Each student wears headphones that direct the music from his piano to his ears. Using an electronic communication center, Miss Dagg can tune in each pupil without disturbing the others. Through a microphone, she gives personal attention to each youngster, providing praise where it is due and commenting on improved technique. She may also demonstrate on her piano for the student's benefit.

For group playing, the students' headsets are unplugged. The electronic pianos then direct music from a speaker for all to hear.

Miss Dagg varies her weekly class sessions by tape recording individual and ensemble presentation on a closed electronic circuit. The tape recorder is plugged into the output jack on the back of the electronic pianos and records musical passages from each youngster's fingertips. At the close of the session, the tape is played back and the class discusses the passages and techniques.

The Multi-Piano Teaching System has not only motivated learning among youngsters—but now even the parents are getting into the act. The fascination of the older folks has evolved into a special adult class session, which parallels the development of the youngsters' course using advanced material.

ELECTRONIC ASSISTANCE AIDS PIANO LESSONS

Young girl (below) plays a phrase on her piano that only she and her teacher can hear.



Thanks to a Wurlitzer electronic piano, headphones, and an electronic center operated by the piano teacher (bottom photo), each pupil can be "tuned in" without disturbing another.

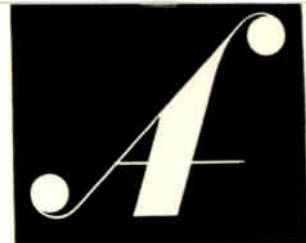

VU meter amplifiers for low-distortion tape recording

 The presence of recording level meters on tape recorders doesn't necessarily mean that you've got professional facilities at hand. An ordinary meter can be less accurate than a neon bulb indicator, you know.

There's more to a meter than a calibrated decibel scale. For a meter to qualify as a VU (Volume Unit) meter, which is the high quality type used by recording studio engineers and broadcast station engineers, as well as sophisticated hi-fiers, it must meet certain standards. Even with these characteristics, which will be discussed shortly, VU meters can introduce some distortion into an audio signal. Special circuitry to correct for this tends to reduce meter sensitivity, thus limiting its useful range.

These problems can be overcome, however, with a good drive amplifier to both isolate and ac-

tuate the VU meter. Plans for building such an amplifier are included here, making it possible for tape recording enthusiasts to improve the fidelity of their recordings, whether live, broadcast or disk-to-tape.

Just what makes a VU meter a VU meter? It has specific electrical and ballistical, that is, mechanical characteristics. For example, when the pointer of a VU meter connected in a specified way indicates zero, it means that a 1.228 volt sine wave signal is driving it. Another way of putting it is: it's a db meter that has a reference level when 1 milliwatt of signal power is impressed across a 600 ohm load. The meter movement has to be damped so that a sudden application of voltage doesn't cause the pointer to overshoot its mark beyond 1.5%. It has to respond very quickly to any audio signals, too, as well as

displaying a flat, wide-range frequency response.

Actually, VU meters can be considered to be wide frequency range AC voltmeters that respond to input signals in a standard manner. Consequently, every VU meter should respond to a given input signal by pointing to the same value; further, meter pointer movement should be at similar rates. VU meter scales are calibrated in both decibels and a modulation scale of 0% to 100%, however, instead of volts.

There are two meter scales in common use, as shown in Fig. 1. The "A" scale, favored in recording and playback system applications, features VU (that is, db) scale markings, while percent modulation markings are secondary. The "B" scale, favored in broadcast use, stresses percent modulation scale markings, with VU markings secondary. The "A"

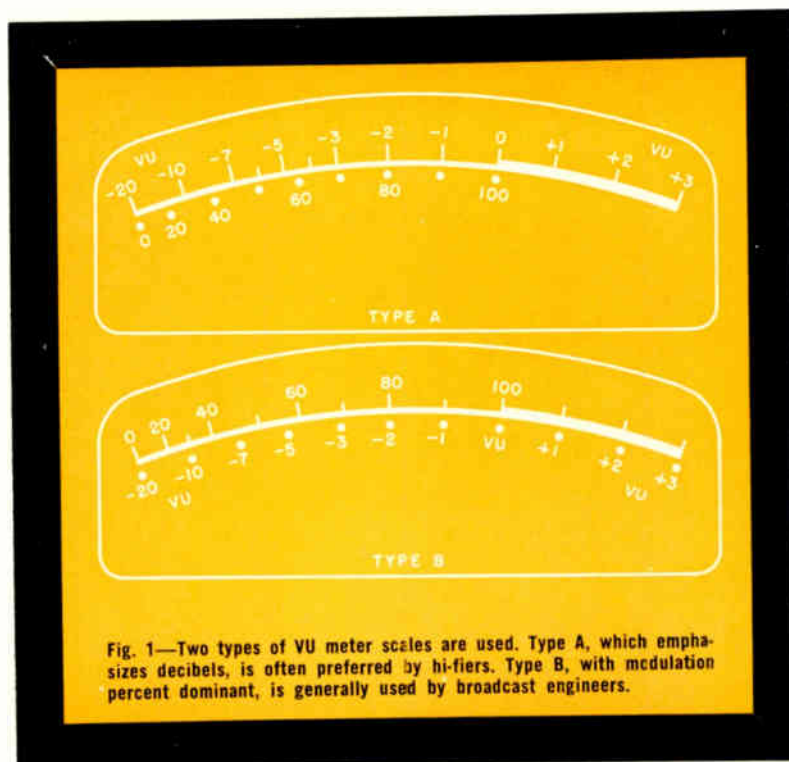

CONSTRUCTION PROJECTS

scale is more popular in audio-fan applications, although either "A" or "B" scales may be used since the meter is the same.

In the event you've wondered about current tape recorders that are marked, "VU," and don't have such scales, or meters that aren't marked as such, some of the meters are equivalent to true VU meters, some aren't. It all depends upon the manufacturer. It's interesting to observe that at least one major manufacturer of tape recorders has record level meters on its *lower-priced* line and neon lamp indicators on its *higher-priced* line.

In case you're confused by such a paradox, remember that a meter, though it can give a quantitative indication of recording level, has mechanical inertia to overcome and therefore cannot respond as quickly to an impulse as an electronic device can. Also,

much depends on the quality of the meter (true VU meters are costly). A meter drive system helps matters when matched with a true VU meter, of course, which is the substance of this construction project.

The VU meter as used in radio stations, recording studio consoles, public address systems and in tape recorders, gives an indication of the signal level which is either being sent out over the air, about to be recorded, or which has already been recorded. Once a standard VU meter (with its drive circuit) is calibrated, subsequent meter indications are used to monitor such parameters as signal level, power level or distortion. If used to monitor distortion while recording, for example, an excessive meter swing will indicate to the recording engineer that prescribed distortion limits are being exceeded.

Due to its mechanical inertia, the meter pointer does not follow the signal level in the precise manner of, say, an oscilloscope beam. Instead, the pointer follows a little behind the signal in time and stays a little longer wherever it goes, averaging out very rapid changes in signal. While this does not make for instantaneously accurate indications, and some practice in interpreting readings is necessary, repeatable numerical readings are possible, so that the same control settings can be made tomorrow as were made last month. Furthermore, a signal level can be correlated to either percentage of modulation, distortion level or power level. Thus, the VU meter has become an important aid to tape recording enthusiasts. Its effectiveness increases with the user's experience.

In addition to its broadcasting

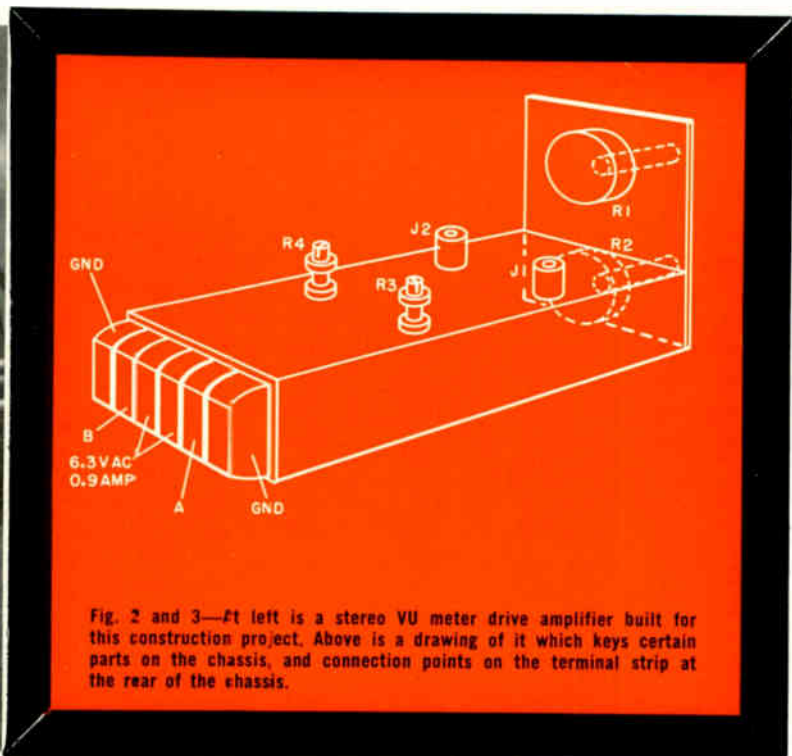
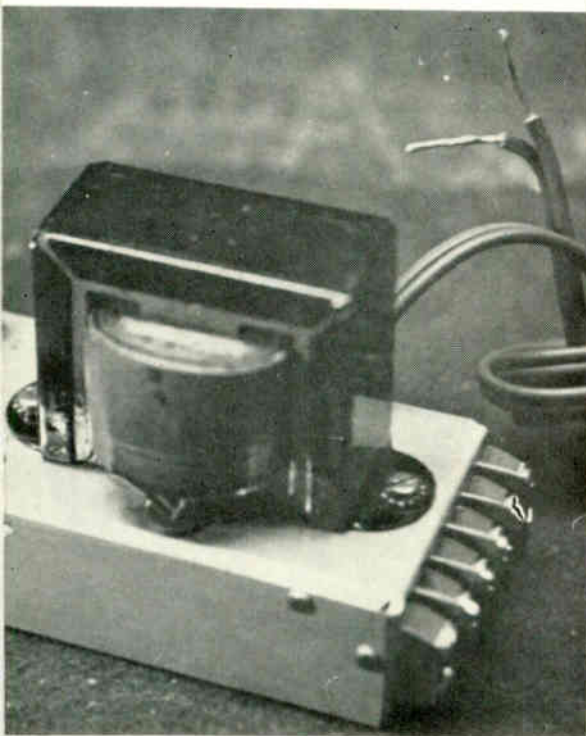

Fig. 2 and 3—At left is a stereo VU meter drive amplifier built for this construction project. Above is a drawing of it which keys certain parts on the chassis, and connection points on the terminal strip at the rear of the chassis.

and recording applications, the VU meter can be used in home audio systems to give meaningful indication of sound levels of discs or from FM tuners and other input sources. Such an indication is essential when comparing tuners or phono cartridges, since any fair comparison requires equal sound levels. When properly connected to an audio system, a set of VU meters can give indications of a record's level, stereo separation, and balance. It can be an aid in balancing the channels of a stereo system, and can indicate amplifier power being delivered to the speakers.

Since the VU meter was developed for other uses than home reproducing systems, the method of connecting a meter to an audio system becomes the key to its successful application. In order to understand how to hook-up a VU meter in this way, some of the characteristics of a VU meter must first be appreciated. It was mentioned earlier that a VU meter is an AC voltmeter with a specific sensitivity and damping to give it its unique dynamic characteristics. The meter contains a full-wave copper-oxide rectifier circuit which responds approximately to the root-mean-square (rms) value of the impressed voltage. The rectifier enables it to accept AC signals. After it is rectified, the DC current then drives a DC meter movement.

VU drive amplifiers

It is possible to connect a VU meter across the output of a preamplifier or an amplifier and get a meter deflection proportional to voltage or power level, but the meter's relatively low input impedance and its rectification circuit conspire to load down the circuit and introduce distortion.

One way to overcome this problem is to use a transformer which matches the impedances more closely. But while this may decrease distortion, the VU meter remains limited in the range of signal levels which it will accept. A satisfactory and practical solution for increasing the utility of

the VU meter is to use a VU drive amplifier.

The VU meter drive amplifier must have a high input impedance to avoid loading down whatever circuit it's connected to. Also, its amplification or sensitivity must be adjustable so that the VU meter may be set to a range of reference levels. In addition, a VU meter drive amplifier's output impedance should look something like the impedance which the VU meter was designed to match so that the motion rate of the meter is preserved. Since only a few VU meters actually conform to such stringent specifications, and accurate VU meter dynamics are not essential for home system use, a variation in drive amplifier output impedance may be permissible for the sake of convenience.

Normally, a VU meter is used in series with a 3600 ohm resistor to bridge the line between a 600 ohm source and 600 ohm load. See Fig. 4. In such an arrangement, a 1.228 volt (rms) sine wave at the source will drive the meter to 0 VU. In home audio systems we have neither a 600 ohm source nor a 600 ohm load. What we do have coming out of the preamplifier is anything between 100 and 20,000 ohms, feeding an amplifier with an input impedance of anywhere between 50,000' and 200,000 ohms and an output impedance of 1 to 16 ohms.

A two-channel VU meter drive amplifier, with an input impedance of 1,000,000 ohms per channel, can effectively be bridged across the stereo preamplifier audio outputs (or better still, its recorder outputs). See Fig. 5. The VU meter drive amplifier's sensitivity can then be adjusted for 0 VU when playing a 1000 Hz tone of a standard test record with a reference phono cartridge.

The sensitivity can be changed when using a cartridge with a different output, or it can be adjusted for a particular broadcast radio station's standard level tone received through an FM tuner. Connecting a VU meter drive amplifier to the preamplifier's audio output will change the VU meter reading as the preamp vol-

ume control setting is changed. As a result, once calibrated, the VU meter can be used to indicate power level.

Connected to the preamp's RECORD OUTPUT, a VU meter amplifier will receive a signal that is dependent only on the input source level, regardless of the preamp volume control setting. This is a useful connecting point for checking input source levels from phono cartridges and tuners. The schematic diagram of a VU meter drive amplifier is shown in Fig. 6 for construction convenience. With inputs shorted, R3 and R4 are adjusted for 100 volts DC at points X and Y. The 3600 ohm series VU meter resistors are built into the amplifier as R9 and R10. An input of 0.2 volts AC (rms) at maximum sensitivity should indicate 0 VU.

This VU meter drive amplifier is self-powered and can be plugged into one of the preamp convenience AC receptacles. Its filament transformer may be used to energize the VU meter illuminating lamps, which are usually 6 volts.

Other amplifier circuits (both tube and transistor) can be used for VU meter drive. Quality tape recorder circuits usually employ a stage or two for VU drive so that this portion of the circuit, together with a suitable power supply, may be extracted by the interested audiofan who wishes to "roll his own."

In constructing such an amplifier, standard shielding practices should be employed. It goes without saying that good grade components are essential for a trouble-free unit. The amplifier components can be arranged so that sensitivity adjustment potentiometers extend from the front. This makes it possible to install the unit behind a VU meter panel with potentiometer's shafts protruding through the panel, next to the meters. In this way the controls will be easily accessible for adjustment.

In one such installation, a pair of Triplett Model 420 illuminated VU meters was used with excellent results. Now all we need are some blinking lights. . . .

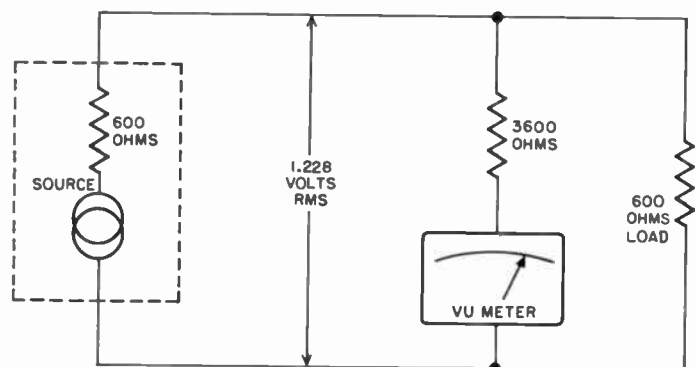

Fig. 4—Standard connection for a VU meter. The 3600 ohm resistor isolates the meter from the circuit.

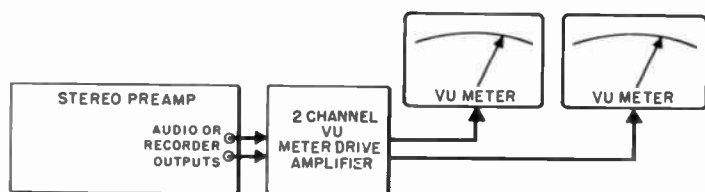
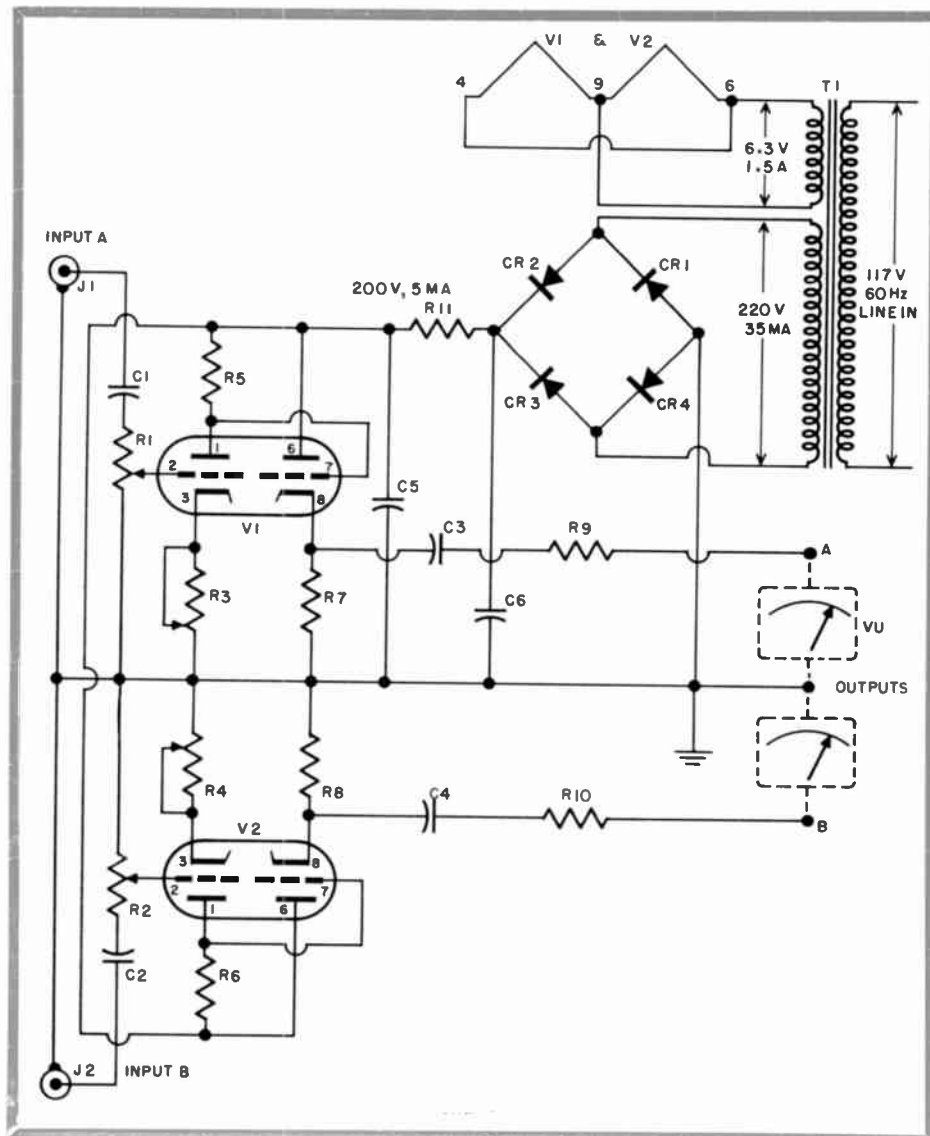

Fig. 5—Here's a VU meter connection drawing for a two-channel VU meter drive amplifier.

Fig. 6—A schematic diagram of a twin-channel VU meter drive amplifier, which will give you accurate VU meter readings with minimal distortion, is shown at right.

PARTS

- | | |
|----------|------------------------|
| R1, R2 | 1 Megohm pots |
| R3, R4 | 2K |
| R5, R6 | 56K |
| R7, R8 | 43K |
| R11 | 3.6K |
| C1, C2 | 6.8K |
| C3, C4 | 1 μ f |
| C5 | 8 μ f, 250V |
| C6 | 8 μ f, 500V |
| CR1, CR2 | 1N647 |
| CR3, CR4 | 1N647 |
| T1 | 117 to 220 V and 6.3 V |
| V1, V2 | 12AU7 tubes |



...As simple to use as Audio Tape Recorders

That's what they say about the new crop of video tape recorders (VTRs). Among the manufacturers joining Ampex and Sony with VTR models priced well under \$2,000 are Concord and Wollensak.

While the respective prices of the newcomers' VTRs are only \$1,150 and \$1,495 for recorders stacks up competitively against Ampex' \$1,150 and Sony's \$995 (both for the lowest cost models in the line), they are not at this time vying for consumers' dollars. Both Concord and Wollensak have announced plans to market their VTRs in industry, business, and education instead.

All four models employ the helical scan method of recording, where the head spins as well as tape moving past it to, in effect, produce a much higher effective tape speed. This is done to reproduce the very high frequencies (in the 2 mHz area) required for video recording.

You need only a cursory glance at the VTRs pictured here to realize that controls are indeed as simple to operate as sound tape recorders are.

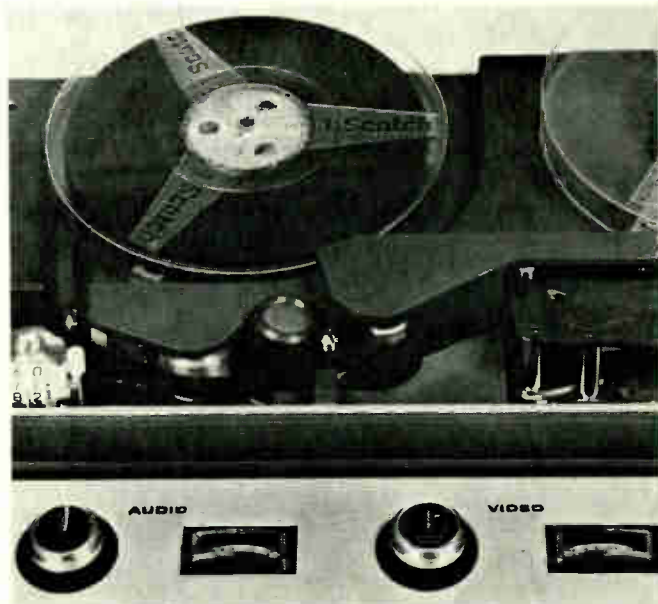

A closeup view of Wollensak's model VTR-150 tape recorder shows its simplified tape threading path and cylindrical recording and playback head. The unit, shown at right, proves the point that VTRs are not far removed in size and simple operation from audio recorders.



Above, are shown the latest Ampex and Sony VTRs. Ampex model 6200 has a video control control center ready to hook up to any home TV set. The Sony unit, which incorporates a clock timer for automatically turning on the record system at a pre-determined time, includes a TV receiver. Both units come in a walnut cabinet.



**SIMPLE
CHECK-UPS
THAT KEEP
YOUR
SYSTEM
TIP-TOP**



**HOLD
ON TO
HIGH
FIDELITY**

high and low end problems

A major reason why discerning people turn to high fidelity component equipment is to extend the frequency spectrum of reproduced music. Achieving truer highs and lows makes for more realistic sound, of course.

If your system loses its full bass capability, you'll miss the body it imparts to sound. This might be caused by as simple a means as your wife reversing speaker leads which she accidentally ripped off its terminals while vacuuming. The phase difference will destroy good bass response. Perhaps a rumble switch was switched in inadvertently, cutting low bass.

A power amplifier's power supply could well deteriorate over the years, leaving you with an insufficient reserve to feed power to speakers when strong transients, deep bass, etc., are called for. This is simple enough to check if you have a rectifier tube. If your amplifier is a solid-state one, however, it's best to leave the checking to a qualified technician.

Bass troubles can be caused by source equipment, too. For example, an FM station might emphasize the bass region of music—that's what tone controls are for! There are many cases on record where poor bass while playing records has been tracked down to a phono cartridge which has deteriorated over the years. Most often, the cartridge's innards, especially damping material, has lost its resiliency. The only cure here is to get a new cartridge. Bass response in tape recorders is limited on occasion by the type of tape heads incorporated in the machine. You could have an audio specialist substitute better tape heads.

In recent years a system's treble response has come under

scrutiny by hi-fi enthusiasts. This has become particularly true due to the widespread popularity achieved by stereo, where the directional characteristics of high frequencies could limit the feeling of spaciousness engendered by stereo playback.

An important consideration here is woofer-tweeter balance. With more and more speaker systems incorporating switches or controls to permit hi-fiers to adjust tweeters' levels, it rests with users to judge whether or not frequency balance is proper.

If you're the type of hi-fi enthusiast who thinks that maximum range is always the best, you may be sadly disappointed. In many instances, setting a speaker system tweeter adjustment for strongest highs can give you a sense of high-frequency peakiness; the *total* frequency response will simply not be smooth in this case. The same thing holds true adjusting a treble control.

Source equipment, too, can contribute to treble problems. For example, you might lose much of your high frequency response as your tape machine's playback heads wear because the head gap tends to widen. Incorrect tape recorder bias could affect treble response: too much can cause treble loss; too little bias could emphasize highs. Neither helps fidelity, obviously. You can lose treble response in other ways, too. If your tape heads azimuth alignment is off, for instance. A long run of cable from your tape recorder to a preamp will do it, also.

All it takes to retain a wide-range frequency response is a little effort and thought. It can mean the difference between good reproduction or unsatisfactory reproduction.

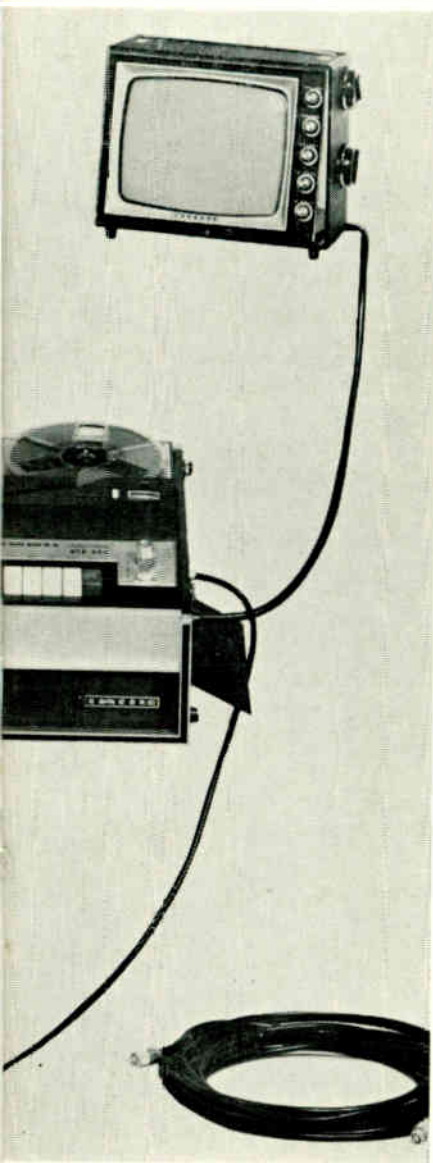

Compare these Sherwood features and specs!
ALL-SILICON reliability. Noise-threshold-gated automatic FM Stereo/mono switching, FM stereo light, zero-center tuning meter, FM interchannel hush adjustment, front-panel stereo headphone jack, rocker-action switches for tape monitor, noise filter, speaker disconnect and loudness contour. 100 watts music power (8 ohms) @ 0.3% harm distortion. 1M distortion 0.1% @ 10 watts or less. Power bandwidth 12-35,000 cps. Phono sens. 1.8 mv. Hum and noise (phono) -70 db. FM sens. (1HF) 1.6 μ v for 30 db quieting. FM signal-to-noise: 70 db. Size: 16½ x 4½ x 14 in. dp.

Sherwood Specs Speak For Themselves

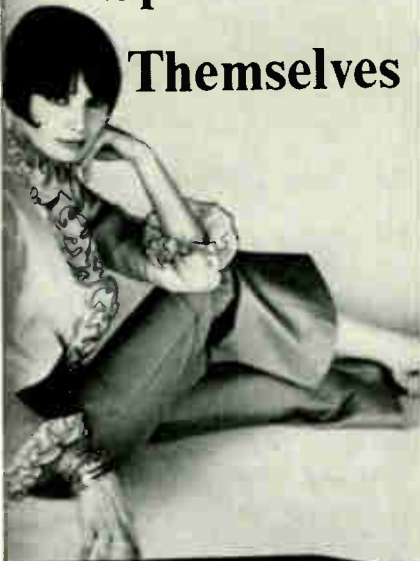

S 8800 100-W. FM Receiver
Chassis: \$359.50 Wal. Cab. \$9.00

No other FM receiver but Sherwood's new Model S-8800 has a pacesetter 1.6 μ v FM sensitivity, a remarkable 0.1% distortion rating and a 100-watt stereo output with ALL-SILICON reliability for the most true-to-life sound reproduction. Your proof of this reliability is our 3-year warranty—the industry's longest. How can Sherwood offer this warranty? Only because we said "No!" to germanium or nuvistor hybrid designs, and insisted on ALL-SILICON solid-state reliability.

Sherwood

Sherwood Electronic Laboratories, Inc.,
4300 North California Avenue,
Chicago, Illinois 60618 Dept. F-7

audio Quiz

Suppose you were given an experimental amplifier that did not yet have the controls identified by panel labels. There are 12 knobs in a row across the panel. We will assume that controls are set so that a disk recording will be heard if you put it on. You start a stereo recording of a piano concerto. Your job is to identify each control by its effects on the music. Finding the volume control is easy—you go quickly across the row moving each a small amount until you come to one that takes volume up and down. It turns out to be No. 12.

Here are the effects of the others:

No. 1 (a switch with several positions): Music stops unless control is in original position.

No. 2: Turned to the right, music concentrates in the right speaker; turned to the left, music is all in left speaker.

No. 3 Control started all the way on the left. As it goes right, music concentrates more and more in the center between the speakers.

No. 4 (switch with four positions): Started in position one. In the next position, the pianist jumps from his original position a little right of center, to one left of center: music gets an unfocused quality. In the next, music

*Puzzles are fun,
and they can
be instructive.
The quiz is a
regular feature
of AUDIOFAN.
Readers are
urged to send in
quiz questions (and don't
forget the answers!)
AUDIOFAN
will pay \$5 for
each one used.
Answers on page 30.*

is all in the center, violins prominent, while the rest of the orchestra sounds far away. In the last, music is in the center, cellos are prominent, with the rest sounding far away.

No. 5 (a two-position switch): It seems to make very little difference, but music gets a somewhat unfocused quality, the image of the pianist seems unsteady and jumps when you move your head.

No. 6 As the control goes far right, music takes on weight, eventually gets boomy, with slight emphasis on left side.

No. 7 Same results as No. 6, with slight emphasis on the right side.

No. 8 Advanced to right, the pianist jumps left when he runs up into treble, or perhaps on all notes; music gets brighter record and tape hiss louder and harsher in left channel.

No. 9 Same effects, as No. 8 but in right channel.

No. 10 (a two-position switch): The effect is hard to perceive, but on careful listening, you note that tape hiss on record, apparent only in quiet passages, drops down.

No. 11 (a two-position switch): Again the effects are hard to hear; on careful listening, just audible, very low pitched noise drops out, with no other change in music.

Up- grade your sound !

Whatever your receiver or amplifier is capable of doing, EMI loudspeakers have a unique way of making it sound better.

Perhaps it's the ease with which EMI loudspeakers project sound. So smooth and natural, it seems to float on the air in all its concert hall glory. Filling the room.

Or perhaps, it's the deep bass, the incomparable realistic midrange and the full, silky highs.

Or it could be the subtle detailing of their transient perfect response that catches you unawares.

So, for better sound from your receiver or amplifier, come on up to EMI loudspeakers.

There's an EMI loudspeaker to meet any requirement and budget. From \$49.95* to \$395.00*



**Slightly higher in South and West*

EMI / SCOPE

Scope Electronics Corporation
470 Park Avenue South
New York, New York 10016
Also available in Canada.

WHAT'S GOING ON

SPEAKERS

PIONEER Wouldn't it be nice to listen to music while swimming underwater during the summer months? Well, if you own a swimming pool you can enjoy music while swimming on the surface or below the water by installing an underwater speaker. A few companies make them for this purpose, including Electro-Voice and University. Pioneer recently



announced two models, UL-2 and UL-3. The latter model, shown here, is said to have a dynamic range from 50 to 20,000 Hz and is operational up to a depth of 16.5 feet. \$47.50.

HARMAN-KARDON Two new air-suspension speaker systems are offered by Harman-Kardon. The HK-40, the company reports, has a 10" woofer and 3½" tweeter, frequency response from 30 to 18,000 hz and continuously variable high frequency controls. Model KII-30 is a bookshelf with an 8" woofer and 3½" tweeter, frequency response of 40 to 18,000 hz and high frequency controls. It is priced at \$70; prices slightly high in the west.

TRUSONIC This new 5", 8-ohm speaker in the Trusonic (formerly Stephens) line is described as



weatherproof, has a die cast aluminum frame and plasticized cone and has a free air resonance of 85-90 hz, according to the company. Frequency response is listed at 80 to 15,000 hz and power handling capacity at 20 watts. Baffling instructions and additional specs are available from Trusonic. \$18.

TAPE RECORDERS

NORELCO Introduced at the Hi-Fi Music Show in Los Angeles recently, the Continental Model 420 stereo tape recorder is a 4-track unit with ganged stereo controls, a cardioid-moving coil stereo mike, modulation indicator and 4-digit tape counter. It's designed to provide for mixing, monitoring



and parallel playback operations. It has speakers built into the case and lid, boasts tone, volume and balance controls, and can be used as a fully integrated PA system, says the manufacturer. Priced less than \$230.

AMPEX The 840 portable stereo tape recorder offered by Ampex as an addition to their lowest-cost 800 Series includes two Ampex 701 mikes, two built-in 5" x



7" speakers, three speeds (7½, 3¾ and 1⅞ ips) and dual capstan drive. The unit has a solid state power amp that is listed at 8 watts continuous RMS per channel. The company points out that the unit represents the lowest price ever for a self-contained Ampex unit. Priced at \$299.95.

CONCORD A 3-speed solid-state monaural tape recorder, the Model 122 offers 12 hours of record/play time and, according to Concord, employs AC bias for both record and erase. A VU meter and variable tone control are among improvements to the model 120, which it will replace.

The 122 plays reels to 7", has a digital counter and volume, tone, fast-forward, play, record, rewind and speed selector controls. It operates at tape speeds of 7½, 3¾ and 1⅞ ips, the company re-

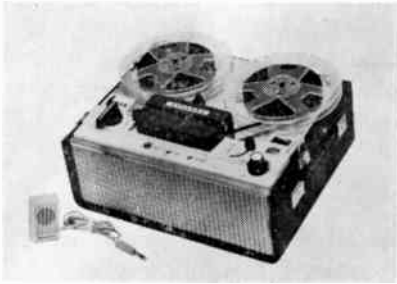

ports. Frequency response is listed at 50-12,000 hz. Under \$125.

COMPONENTS

Neither the girl nor the equipment shown here look familiar, but the components sure carry a



well-known name—Sony. (Sorry, we don't know the girl's name.) The company's new entrants to hi-fi componentry include a manual turntable (Model TTS-3000, priced at \$149.50), with a 12-inch tonearm (Model PUA-237, priced at \$85), a solid-state integrated stereo amplifier (Model TA-1120, priced at \$399.50), a 16-inch tone arm (Model PUA-286, priced at

\$99.50), a moving coil stereo cartridge (Model VC-8E, priced at \$65), and a solid-state power amplifier (Model TA-3120, priced at \$249.50). What, no speakers?

CABINETS

ALTEC LANSING Altec has introduced a line of cabinets to house hi-fi equipment. Shown here, for example, is the Model 880A "Valencia II" equipment cabinet, which features contemporary Tambour sliding doors, an insulated receiver section, alternate equipment drawer, ventilation features, and storage space for records and tapes. Overall dimensions of the hand-rubbed walnut cabinet are 29 $\frac{3}{4}$ "H x 49"W x 19"D. Another equipment cabinet, the 881A "Montecito" cabinet, utilizes

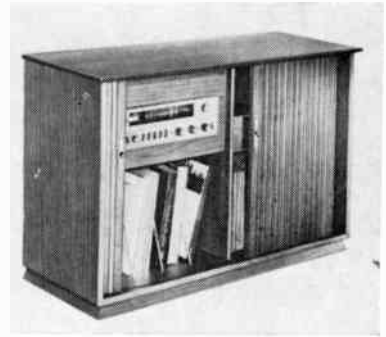

the fretwork grille pattern found on some of Altec's spanish-styled speaker enclosures. The unit is well over a foot wider than the 880A, above, measuring 63 $\frac{1}{2}$ " wide; other dimensions are the same. Among the benefits of the additional space are adjustable equipment sections for a record player or tape, more storage space and swing-out doors.

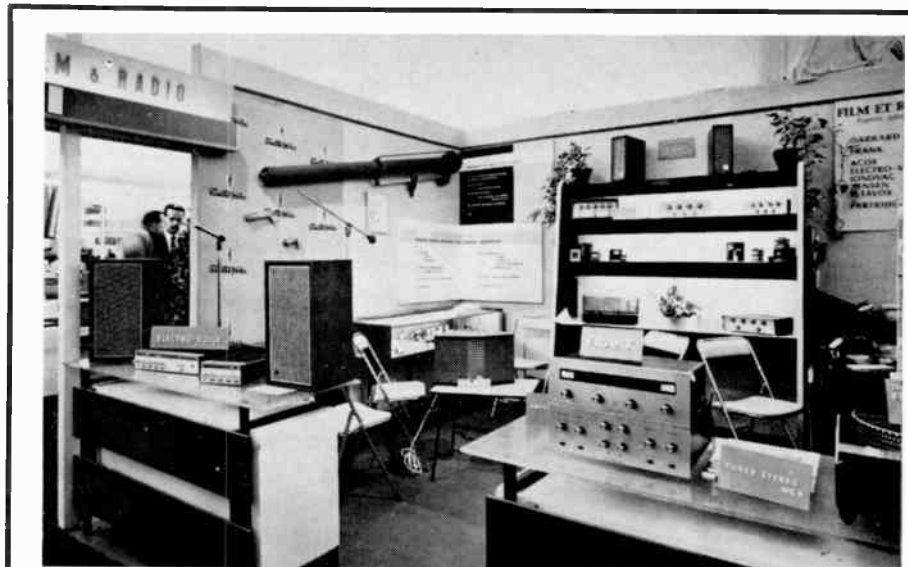

French and British hi-fi fans were recently exposed to U.S. audio components. Some 33 hi-fi manufacturers exhibited their latest components at the Paris High

Fidelity Show and the U.S. Department of Commerce high fidelity show in London. The Electro-Voice exhibit in Gay Paree is shown here.

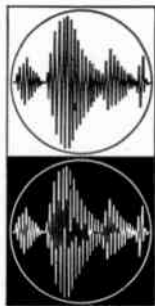

the technical quality of records and tapes

Reviews are concerned with audio reproduction qualities of recordings, not musical performance by James Quigley

original soundtrack tapes

The Wizard of Oz: original soundtrack (Judy Garland, Ray Bolger, Bert Lahr, Jack Haley, Frank Morgan), MGM STX 3996; That Darn Cat: original soundtrack, Buena Vista BVX 3334; Zorba the Greek: original soundtrack (Anthony Quinn, Alan Bates), 20th Century Fox TCC 4167; Doctor Zhivago: original soundtrack, MGM STC 4343; Man of La Mancha: original cast (Richard Kiley, Irving Jacobson, Ray Middleton, Robert Rounseville, Joan Diener), Kapp KTA 41109.

 The sounds on these tapes are about as diverse as you could hope to assemble from any one category of recording, even if you were looking to pick a mixed bouquet. The "category of recordings" here is the original soundtrack (with one Broadway musical comedy original cast recording thrown in for comparison).

The film version of *The Wizard of Oz* was released in 1939; and its freshness as a picture remains after almost thirty years.

Judging from aural evidence alone, there seems to be a good deal of innovation in the sound track. The BIG production number (or series of production numbers) that welcome Dorothy to Munchkinland seems to make use of chorus tracks that have been speeded up to achieve that curious, toy-like quality. Be that as it may, the sound for these sequences was certainly a complex job to record.

Perhaps that would excuse some muddy sound. For the sound is not only muddy, but frequently distorted. There are very few quiet passages due, presumably, to the technical requirements of

the sound-on-film medium.

The tape is at 3¾ ips. Aha! you say. There's your culprit. If they had copied it at 7½ . . .

However, a neighborhood six-year-old was kind enough to let me hear some tapes her Daddy had taken off the air the last time the film was shown on television. Not only was much of the same distortion audible on those tapes (at 7½), but they suffered as well from having, apparently, gone through a limiter somewhere in the process, evidently at the TV station. Still, A-B'ing the two revealed a bassier, duller, less convincing sound on the commercial tape.

In terms of continuity, the store-bought version was decidedly superior, even though Daddy had taken off about twice as much of the sound track. For one thing, Daddy's hand was not exactly expert at picking the best spots to start and stop. For another, the MGM tape is concocted specifically with the listener in mind. In effect, it condenses the story to a single reel.

"But that's not where she says that!" my consulting expert complained at one line delivered by the Wicked Witch. And sure enough, a check with Daddy's tape disclosed that certain dramatic liberties had been taken. Still, the rearrangement must be accounted more satisfying than the original for those listeners who have neither an over-active memory nor a Daddy with an audio-take-off on his TV.

By comparison with the other film scores in these tapes, the result is particularly notable. None has any semblance of a story line. The tape derived from *That Darn Cat* is even without any reference to the action film or its relationship to the music. Such titles as

"Mom's in Distress," "ABC's of the F.B.I." and "Take This and This and This" leave someone who did not see the film almost totally unenlightened . . . particularly while side 2 is playing. That is because these titles, the one slender clue to the dramatic intent of the music, appear only on the reel label (visible on side 1).

The liner notes on the box are singularly uninformative. The music, too, is not much help . . . it tends to be rather colorless, if pleasant. This fact has one attractive side effect: being bland as movie music goes, it has little tendency to overstrain the dynamic range of either the film



The lively sound of the Mustang! The more-than-you-pay-for performance of University's newest and liveliest line of Mustang speakers. New slim line profile permits easy installation. Read the full story of the Mustang in University's newest catalog. You'll also receive our brand new 1966 catalog "The Lively Sound." They're Free! Write today.

 LISTEN—UNIVERSITY SOUNDS BETTER
UNIVERSITY SOUND
Desk G633 Box 1056
Oklahoma City, Okla

Name

Address

City

State Zip

medium or the slow tape speed (3¾ ips). The result is a pleasant cleanness, encouraging the listener to focus on the neatly reproduced instrumental timbres more than the musical content. Most of the first side of the tape is devoted to music that has the texture of a modern jazz combo or a chamber orchestra, although the alternation of instrumental groups proves that there is a fair-sized orchestra in the studio.

When everyone gets going at once, the texture is not so cleanly rendered. Stereo effect is also not so convincing in these sections. In the opening rendering of the theme song (by Louis Prima), the stereo effect is altogether lacking. Surely this track is not derived from the same source as the rest of the recording!

This curious arrangement is, however, one up on *The Wizard of Oz*, which is not in stereo at all. Neither is *Zorba the Greek*, although the tape box carries the usual "electronic reprocessing" label and at one point an unaccompanied men's chorus is made to "march" across your living room. As though the intrusion of a "stereo effect" wasn't unhinging enough after better than twenty minutes of centered sound, the chorus, having progressed from the right wall clean out the left side, suddenly backs up to the fireplace, just in time for the entrance of the (mono effect) orchestra.

But the musical sound on the *Zorba* tape is still fairly good for this batch of tapes. It is lively (lots of twanged strings and accented, folksy dance rhythms) and focused . . . if somewhat heavy-handed in the bass.

Not all of the tape is music, however. Before each selection is a brief, epigrammatic quotation from the voice tracks, usually with a rather muffled pickup and often with a good deal of wind noise (the real thing and, therefore, annoying rather than stirring). The cumulative dramatic effect of this technique, employing as it does the intentionally rough-shod voice of Anthony Quinn, is something like what one might expect of a collaboration between Oscar Wilde and Shakespeare's Caliban.

Moreover, I found its relationship to the music difficult to follow.

I was delighted when I read in the booklet inserted with the tape from *Doctor Zhivago* that "a total of 20 microphones were used to record the full score for 6-channel stereo," together with data about the 110-piece orchestra, the 24-man balalaika group, the various Japanese instruments, the 4-voice chorus, and the "organ, novachord, electric sonovox, harpsichord, electric piano, tack piano and zither." Here, I said to myself, will be *sound*.

Some of its is. The big orchestra effects come through excellently at times. Some of the lower frequencies (thunder machine, by the sound of it) were simply more than my budget speakers could take, sending them off into spasms of helpless flapping . . . I don't know what else to call it. These passages are best saved as show-off stuff for your biggest battery. On my best, which happens to be folded horns, they sounded very grand, indeed.

At other times—particularly in

the passages involving the balalaika group or the chorus—it seems that the six tracks of the original recording simply would not squeeze down into 2-track stereo. The sound at these points becomes muddy, obscuring both the timbre of the individual instruments and the sense of separation between them. The effect is particularly disappointing after the thrill of the best moments.

The effect suggests that some groups have been recorded in stereo on at least two of the six channels (the opening drums seem to stretch in a long line to the horizon), whereas chorus and balalikas seem to be a tight knot of mono in the stereo matrix. Solo instruments picked up in stereo reproduce beautifully, however.

All-in-all, this is not a very satisfactory group of tapes. In fact, it's eminently unsatisfactory when you come right down to it. This fact was occupying my thoughts when I switched to *Man of La Mancha*. And the overture proved the point.

(Continued on page 30)

this leprechaun will charm you



It's incredible what happens when you put a few boxes of Irish Tape on your counter. Your wife becomes prettier. Business booms. Friends call you lucky—but you'll know the Irish Leprechaun was working for you. (Great tape and at popular prices too!)

WITH
 ferro-sheen®
 PROCESS



Hurry!
 Get happier. Write
 for the free catalog describing
 complete Irish line.

IRISH MAGNETIC RECORDING TAPE

MORHAN NATIONAL SALES CO., INC.

458 Broadway, New York, N.Y. 10013



the technical quality of records and tapes

(Continued from page 29)

Here was an orchestra . . . a real orchestra with dimension and life. The divided brass, answering itself antiphonally, the bite of the guitars, the insistent sharpness of the castinets . . . even a certain wheeziness in the winds conveyed the sensation of a real theatre orchestra. After the movie soundtrack tapes, listening to this phonograph-style recording (the miking perspective is different, you know) was like being let out of a cage.

The elation continued until the first word of Richard Kiley's introduction to the opening number. The voice is recorded so close-to and is so over-larded with echo chamber that the sense of space established by the overture is destroyed. When the singing voice is substituted for the speaking voice, however, the acoustic seems to regain some of its naturalness.

Careful listening seems to disclose no real difference in technique between the speech and the singing. I suspect, rather, that television has had its effect on my habits of listening. How often do we hear a close-miked voice suddenly take on an echo when it goes from the introductory patter into the song . . . even on live shows? And how often *can* we hear this sort of thing without becoming conditioned to expect it?

It took very little listening before the echo-y speech (of which there is not very much on the tape) began to sound reasonably natural. Since the singing voices are placed now on one side and now on the other, the recording avoids any rigid framework of spatial relationships. By the time the tape was over, I had come to the conclusion that, had it not

been preceded by the fixed acoustic of the soundtrack tapes, the variety of acoustical perspective in the *Man of La Mancha* might have been in no way objectionable.

It is, in fact, almost impossible to avoid becoming absorbed in *Man of La Mancha*. This is partly due to the quality of the material and the performance, of course (although some of the voices are less than ideal); but it is also due, I think, to the fact that this tape was produced, from scratch, with the listener in mind. It is conceived of as being reproduced in the home, and it strives to translate into phonographic terms the theatrical experience it celebrates.

REPORT ON WEST COAST Hi-Fi SHOWS

(Continued from page 12)

raw tape manufacturers that sometimes show elsewhere. 3M was there with the Wollensak line, but the tape line was not shown as such. Irish tape, a newcomer to the Coast, provided tape for a promotion offering free correspondence tapes for Viet Nam servicemen. They were not exhibitors, however.

Of the several companies showing microphones, Shure was particularly plugging a new model: the Unisphere I (Model 565) and Unisphere A (Model 585), featuring built-in wind/pop screen in cardioids starting at \$65.

Electronics-makers had less to show that could be called really new. Some rooms (Bogen and Kenwood, for instance) maintained very much the same appearance they had for the Los Angeles and New York Shows. Fisher, Scott and Sherwood were

audioQuiz

ANSWERS

No. 1 is the program selector switch: tuner, disc, tape, etc.

No. 2 is the balance control.

No. 3 is a blend control that mixes channels together as it is advanced.

No. 4 is the mode control. First position, normal stereo; second position, channels reversed; third, channel A fed to both speakers; fourth, channel B fed to both speakers.

No. 5—Phase reverse switch.

No. 6—Left-channel bass control.

No. 7—Right-channel bass control.

No. 8—Left-channel treble control.

No. 9—Right-channel treble control.

No. 10—Treble cut-off filter.

No. 11—Bass cut-off filter.

QUIZ ON PAGE 24

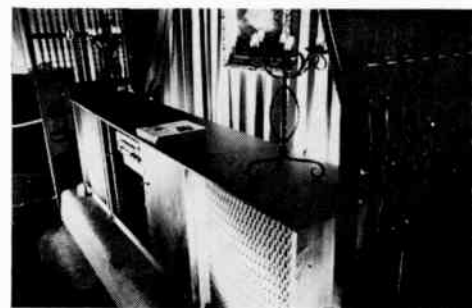

all plugging circuitry: FET or all-silicon, as the case may be. Harman-Kardon spotlighted the compacts, with four models now going (choice of two speaker designs, coupled with choice of AM/FM or FM stereo only in the tuner section).

Acoustech had one new model, an integrated amplifier, while Dynaco and Marantz were showing new transistorized models in what were all-tubed lines last year. McIntosh concentrated on demonstrating audio signal quality, comparing input with output via a "frozen-image" scope. JBL promoted the "analog computer-type circuit design" of the SA600. ADC's component line was all new.

Also new was the SA-10 Portable Solo-Phone System in the Shure room. What Shure had done, essentially, was to take its Solo-Phone headphone amplifier and build an ultra-simple, 19-lb. system around it: changer (Garrard 50), cartridge (Shure M44C), carrying case. Headphones (two pair will be accepted) are optional extras beyond the \$99.95 base

price. Some suggested uses: bedroom, office, hospital, barracks.

Some new loudspeaker systems were shown on the Coast. Most in evidence was the complete line produced by Aztec Sound Corporation of Denver, including bookshelf units, full-size floor (with an equipment cabinet to match) and two free-standing, table-style models.

Fisher, Ampex and Harman-Kardon were among equipment manufacturers adding speaker models to their lines. Scott did too, with particular play on the transistor matching properties designed into the S-8. First out at the LA Show was the Electro-Voice Five bookshelf system at \$88. University and Wharfedale were both plugging speaker growth—the idea of selling a speaker system that can be upgraded over the years.

In the smaller-than bookcase category, Martel had their Baby Grand speakers by Telmar very much in evidence. (Who could ignore that tiger-striped grille cloth on the display models?) UTC also had a new model the Ambassador I, displayed side-by-side with the Maximus I, which it closely resembles, but at a \$39.95 list. ADC's compact was also on display, as were miniature speakers featured by tape recorder manufacturers.

Most unusual of these is the Concertone's Spanish collection, with speakers by JBL. James B. Lansing themselves were featuring the Carnival and Festival outdoor speakers and the Lancer 101. Altec-Lansing, Bozak and Empire were also among the makers of larger speaker systems showing in San Francisco, with Empire featuring their convertible, bookcase/floor model.

New models in record-playing equipment were being shown by both Benjamin and Garrard. The Garrard manual unit, a simplified version of the Model 50, was first announced earlier this year. The Benjamin 50H, their premium model and the first Miracord with anti-skating, was premiered on the Coast. Dual concentrated on anti-skating demonstrations.

A variety of new equipment from electronic hi-fi manufacturers was evident at recent shows. Fisher's new short-wave/AM/FM receiver was an example, as well as Bogen's and Altec Lansing's line of hi-fi equipment. The latter company displayed some equipment cabinets that match its speaker lines, as shown in the bottom photo.

NOW FREE!

STEREO INFORMATION

FM Station Directory

The directory lists 1571 FM stations in the United States and Canada. All the stations broadcasting in stereo are listed.

Test Reports

Test reports full of facts. The test reports were made by independent laboratories. Tests cover tuners, preamps, power amp/preamps. Read the facts from test experts.

Big 36-Page Catalog

You get a 36 page catalog. It tells you about tuners, power amplifiers, preamplifiers, pre-amp/power amplifier combination and tuner preamps.

ALL FREE

McIntosh

PLEASE SEND ME YOUR CATALOG
McIntosh Laboratory, Inc.

16 Chambers St. Binghamton, N. Y. 13903

NAME _____
STREET _____
CITY _____
STATE _____ ZIP _____

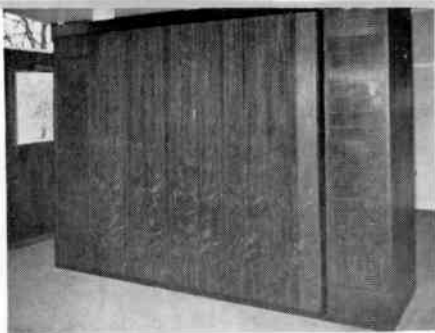

You'll never know it's a hi-fi system when the IHF-photo contest winner's entertainment center is not in use because wood doors hide all the equipment. At right, you can see record storage compartments that slide out when our audiofan depresses appropriate buttons on the control panel. There are five motorized compartments.



Motorized doors are caught in the act of closing, hiding the equipment from view.

I've got the center of my vertical panel, between the audio tape recorders, all set up for a video tape recorder.

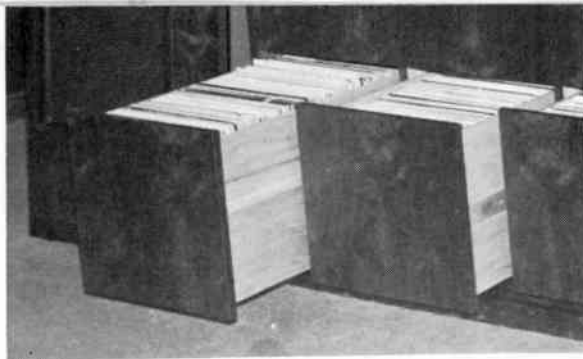

NEW YORKER WINS CONTEST (Continued from page 9)

record storage buttons) and the selected record storage drawer slides out from the lower part of cabinet, thanks to a motorized system. (If you're not careful, you can get more shin bruises this way. . . .)

"We don't have too many static problems with records," he said. "Our home air conditioning and heating system is equipped with electronic air filters that remove more than 90% of the normal static generally present in carpeted areas."

Automatic features on the prize-winning hi-fi system aren't limited to hi-fi. Remember that Mr. Genin calls the system an "entertainment center." One button controls the raising and lowering of a movie projection screen, for example. Another control electrically opens and closes 4 pairs of drapes in the room.

The toy company president said he likes all types of music—except for some of the kid stuff! As a result of his broad taste in music, he tapes straight across the board: heavy symphony, opera, modern jazz, etc.

In addition to his music taping efforts, Genin has used his tape recording know-how to provide "perfectly timed" announcements during fashion shows for fund-raising programs in Westchester. In nice weather, the shows are held at his swimming pool area, which accommodates about 350 people. Further, he's excited about a spot advertising radio commercial prepared for his company which employs sound effects on

tape in a children's anti-violence exposure campaign.

Our audiofan has many hobbies and interests. These include a fine collection of oil paintings, displayed in a long corridor of his home, among other areas. A Nikon F Photomic T and Nikon SP rangefinder 35 mm cameras and a Bolex 16 mm motion picture camera attest to his high interest in photography, as does his wall-mounted, enlargements of color photographs he has taken. He combines an avocation with a vocation with a fully-equipped, unusually carefully laid out and neat shop in his basement.

It's right in his workshop where many of his toy ideas are formulated and developed. He stocks a variety of pushbuttons, switches, etc., which he uses to design and build special automation equipment for his plant. It came in handy for his hi-fi installation, too, of course.

Holding up the scale model of his hi-fi system's cabinetry, he mused: "On seeing the set of mechanical plans, my cabinet-maker wondered which institution let me out. I had quite a job convincing him and his men that we could really make wood (always a "living" thing since it expands and contracts with the elements) into a mechanically operative unit . . . always to perform the same functions hot, cold, dry or damp. And you know," he said, looking up, "to this day he still tells me that it's not gonna' work!"

We're witnesses to the fact that it does work. And better than anyone could imagine.

Dear Audiophan:

How much is high fidelity worth?

Componentry has come of age for the consumer. For less than an ordinary so-called "Hi-Fi" console, you can enjoy *true* high fidelity sound from quality components.

Where should you buy?

Components should be obtained from a company specializing in all phases of sound. Our store is a company with the right expertise for you. Our personnel will be happy to advise the most suitable equipment for you and demonstrate its performance. We can supply—from the finest manufacturers—everything from the smallest components to the largest custom systems.

Come in and enjoy pleasant listening this summer.

Soundest regards,

BARNETT BROS.

Hi-Fi • Commercial Sound
Main Store
932 Arch Street
Philadelphia, Pa. 19107
WAlnut 5-9780

E-V The E-V SEVEN was born in the eerie silence of an anechoic chamber — the world's largest devoted to high fidelity design. This vast sound absorbing room let E-V engineers get right down to basic engineering. Nothing disturbed their silence — or their concentration on the subtle differences that distinguish a great speaker.

After months of experimentation, the E-V SEVEN met every design objective. Then expert listeners were invited to judge the sound — again and again — until engineers and critics were fully satisfied with E-V SEVEN performance.

But superb sound, once established, can easily slip away in the routine of mass production. We don't let it. A

completely equipped anechoic chamber — right on the production line — measures every speaker against perfection. And it's ruthless. All this may seem rather elaborate for a \$66.50 compact system...and it is. You can hear the difference!

Any fine component amplifier can display the E-V SEVEN at its best, but the new E-V 1144 stereo amplifier is uniquely suited to the purpose. Like the E-V SEVEN, the E-V 1144 is compact, handsome, and modest in cost (just \$124.50).

We threw tradition to the winds when we built the E-V 1144. Tossed out "old-hat" ideas about size and weight. Put 50 watts of stereo power in an

attractive walnut-paneled cabinet no taller than a coffee cup. It's easier when you can start from scratch — yet have years of experience in miniature solid-state electronics behind you. The young tigers in the E-V lab took it on as a personal challenge — and solved it beautifully.

So plug in any stereo phono, tape recorder, or matching E-V stereo tuner. Connect a pair of E-V SEVENS. Then turn up the volume of your E-V 1144. Natural sound? Absolutely. And that's what high fidelity is all about!

Window-shop through our complete high fidelity catalog for the answer to your high fidelity needs. It's free.

**Big sound.
A natural for these
compact E-V SEVENS.
All you need is a
very good amplifier...**

**like this one.
The new E-V 1144.**

Electro-Voice®

Systems and speaker systems, amplifiers, receivers • public address loudspeakers • professional audio electronics