

# TAPE RECORDING

STEREO FOR YOUR HOME

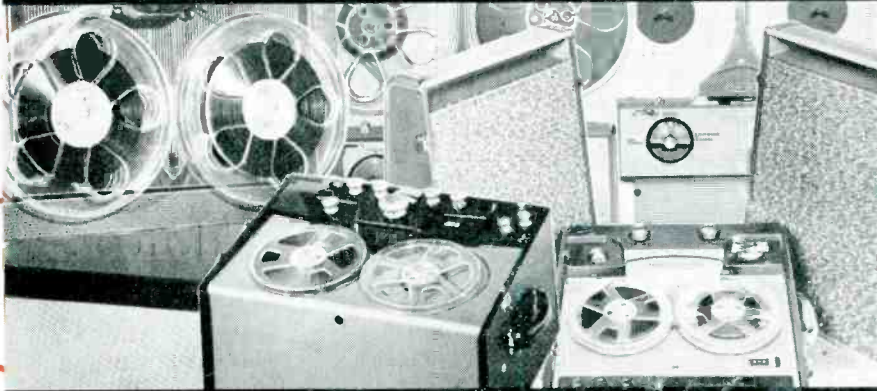

COMPLETE DIRECTORY OF STEREO EQUIPMENT



CUSTOM BUILDING WITH STEREO COMPONENTS

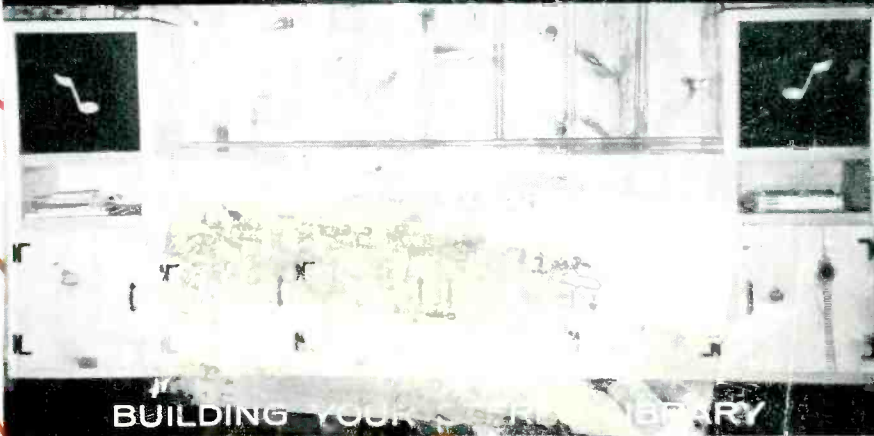

BUILDING YOUR OWN STEREO LIBRARY

# Master Low Print-Through audiotape

The **FIRST** and **FINEST** low-print tape . . .  
Cuts "magnetic echo" by 8 db

## What Is Print-Through?

Print-Through is the magnetic "echo" effect induced in adjacent layers of tape by any recorded signal. It continually increases with time while the recorded tape is in storage. To keep print-through from being too objectionable, conscientious recordists have heretofore had to lower recording levels as much as 6 to 8 db, with reduced signal-to-noise ratio and sacrifice in tone quality.

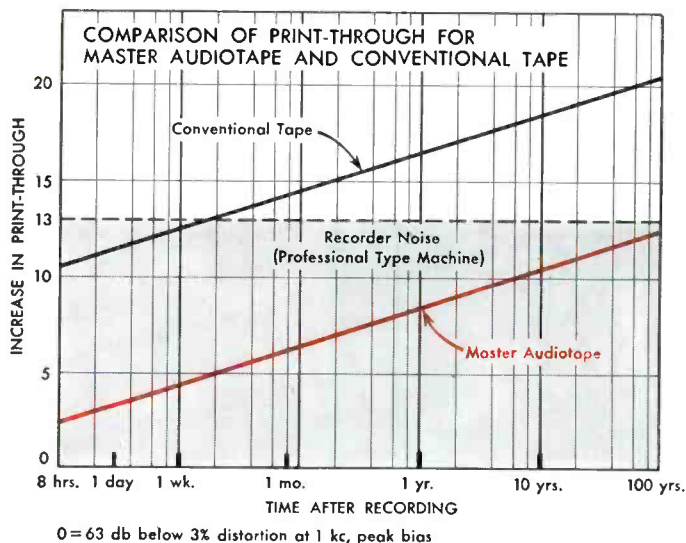

## How Is It Eliminated?

In Master Low Print-Through Audiotape, print-through has been reduced 8 db, by the use of specially developed magnetic oxides and special processing techniques — *without changing any other performance characteristics*. The curves at the left show the remarkable improvement obtained. Since print-through of Master Low Print-Through Audiotape remains well *below* the machine noise, it is "eliminated" for even the most critical ear.



Master Low Print-Through Audiotape on 1 1/2-mil cellulose acetate

Master Low Print-Through Audiotape on 1 1/2-mil "MYLAR" polyester film



Thoroughly **PROVED** in service,  
and now available in **AMPLE QUANTITY!**

Master Low Print-Through Audiotape has proved itself in over a year of actual service. Thousands of reels have been used by manufacturers of phonograph records and pre-recorded tapes and other top professional users. It has been in regular production since May, 1957, and is now available in ample quantity through dealers everywhere.

Laboratory studies indicate that stored Master Audiotape will take *more than 100 years* to reach the same print-through level that mars ordinary tape in one week! With an 8 db reduction in print-through, you can use higher recording levels, get better signal-to-noise ratio, and still have decades of freedom from harmful print-through effects. For a new high in hi-fi and new permanence for your priceless recordings, ask your dealer for Master Low Print-Through Audiotape. Available in 1200 and 2500 foot lengths in *two types* — on 1 1/2-mil acetate and on 1 1/2-mil Mylar\*.

\*DuPont Trade Mark

**audiotape**  
TRADE MARK

*it speaks for itself*

AUDIO DEVICES, INC., 444 Madison Ave., New York 22, N.Y.

In Hollywood: 840 N. Fairfax Ave.  
In Chicago: 5428 Milwaukee Ave.  
Export Dept.: 13 East 40th St., N.Y. 16, N.Y.  
Cables "ARLAB"

# Electro-Voice® Variable-D Cardioid Microphones

## Record the Quality You Want . . . and that's ALL!

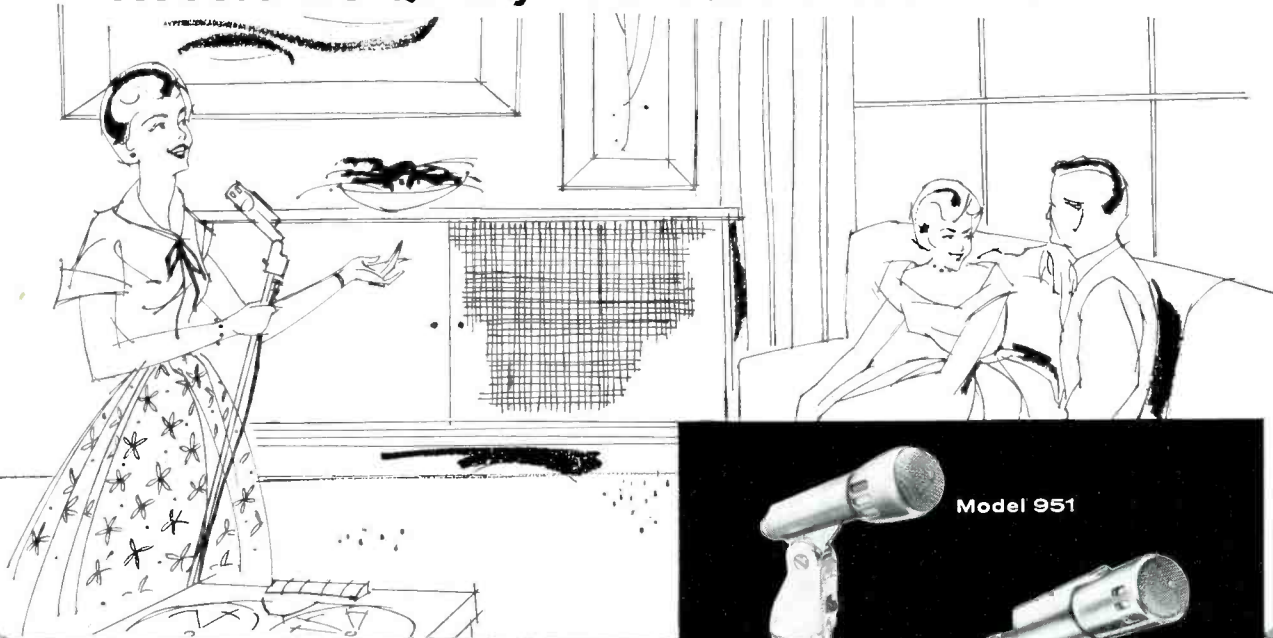

You'll make professional-quality, high-fidelity tape recordings with an Electro-Voice microphone — the choice of broadcast and TV engineers!

The secret of success is the unique E-V Variable-D, which stops background sound you *don't* want, picks up the sounds you *do* want. Work close — you'll record no "boom." Pick up from a distance — the sound is clean and free from "roominess." The single moving element is E-V's exclusive, virtually indestructible Acoustalloy diaphragm.

### NEW Model 951 Crystal Cardioid—Professional quality at a Modest Price

This newest addition to the E-V line uses the same Variable-D principle as E-V's broadcast cardioids to give you uniform directivity of pickup and high discrimination against unwanted sound. Response is 50 to 11,000 cps. Has chrome-finished pressure-cast case, On-Off switch. Just \$49.50, list, less stand.

### Model 664 Cardioid Dynamic—Finest of its Kind!

Without a doubt, Model 664 is the world's best general-purpose cardioid! It's guaranteed to outperform all others. Unidirectional high fidelity Model 664 gives you highly directional sound selectivity, reduces pickup due to ambient noise up to 50%, has smooth, peak-free response at all frequencies from 40 to 15,000 cps. Convenient on-off switch, chrome finish. List, \$85, less stand.

For the finest microphone, see your hi-fi dealer. For all the facts, write us for "The ABC's of Microphones," Booklet HT710.

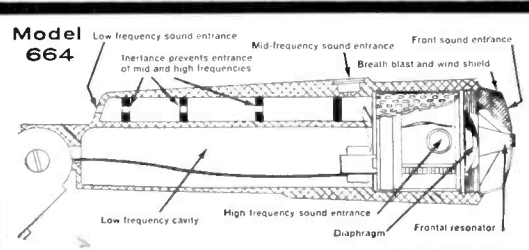
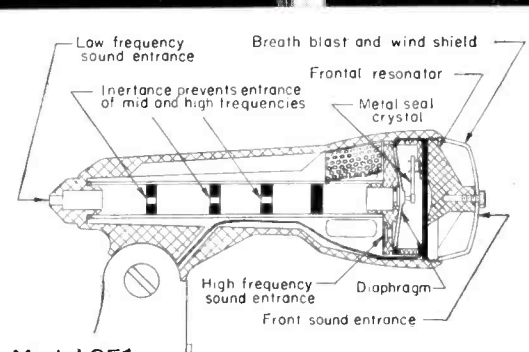

# Electro-Voice®

**ELECTRO-VOICE, INC. BUCHANAN, MICHIGAN**  
 Export: 13 East 40th Street, New York 16, U.S.A.  
 Cables: ARLAB

**Dictate reports accurately—promptly!**  
 make your car, boat or plane  
 a "rolling office"



with **ATR**  
**INVERTERS**

for changing your storage battery current to  
 A.C. Household  
 ELECTRICITY  
*Anywhere*  
 ... in your  
 own car!

mounted  
 out of sight  
 under dash  
 or in trunk  
 compartment!

**EASY TO INSTALL**  
**EASY TO OPERATE**

**ATR INVERTERS**  
 especially designed for operating  
 standard 110 volt A. C. . . .

- TAPE RECORDERS
- WIRE RECORDERS
- EXECUTIVES
- SALESMEN
- PUBLIC OFFICIALS
- POLICEMEN
- FIREMEN
- DICTATING MACHINES
- ELECTRIC RAZORS
- OUTDOOR MEN
- REPORTERS
- FIELD INSPECTORS
- DOCTORS
- LAWYERS, ETC.

See your jobber or write factory  
 ✓ NEW MODELS    ✓ NEW DESIGNS    ✓ NEW LITERATURE  
 "A" Battery Eliminators,    DC-AC Inverters,    Auto Radio Vibrators

**ATR** **AMERICAN TELEVISION & RADIO Co.**  
 Quality Products Since 1931  
 SAINT PAUL 1, MINNESOTA, U. S. A.

# HI-FI

# TAPE RECORDING

VOL. 4 NO. 11

OCTOBER 1957

MARK MOONEY, JR.  
 Editor and Publisher

JOHN L. ALLEN  
 Circulation Manager

JEAN COVER  
 Assistant Editor

ROBERT W. LAPHAM  
 Art Director

JAMES H. MILLS, SR.  
 Technical Consultant

ANTHONY J. MORIN, JR.  
 National Advertising Manager  
 274 Madison Ave., New York 16, N. Y.

GEORGIE SIGSBEE  
 Music Editor

## IN THIS ISSUE

STEREO SOUND FOR YOUR HOME .....	Mark Mooney, Jr.	28
BUILDING YOUR STEREO TAPE LIBRARY .....	Georgie Sigsbee	30
STEREO LOUDSPEAKER PLACEMENT .....	Robert Oakes Jordan and James Cunningham	32
GLOSSARY OF STEREO TERMS .....		34
WHAT IS GOOD STEREO? .....	Larry B. Lueck	36
CUSTOM BUILD WITH STEREO COMPONENTS .....		38
CONVERTING OLD RECORDERS TO STEREO .....	Bart Pierson	41
DIRECTORY OF STEREO EQUIPMENT .....	Jean Cover	43
DIRECTORY OF STEREO TAPE PRODUCERS .....		53
NEW PRODUCT REPORT: WEBCOR IMPERIAL STEREO .....		54
NEW TAPES .....	Georgie Sigsbee	6
TAPE IN EDUCATION .....	John J. Grady, Jr.	20
TAPE CLUB NEWS .....		21
TEEN TAPERS .....	Jerry L. Heisler	22
QUESTIONS AND ANSWERS .....		24
TAPES TO THE EDITOR .....		25
NEW PRODUCTS .....		26



HI-FI TAPE RECORDING is published monthly by Mooney-Rowan Publications, Inc., Severna Park, Md. (Severna Park 548). Entered as second class matter January 7, 1954 at the Postoffice, Severna Park, Md., under the Act of March 3, 1879. National Advertising Representative: J-V Associates, 274 Madison Ave., New York 16, N. Y. (ORegon 9-0030). Subscriptions, U. S. and Possessions, Canada and Mexico, \$3.75 for one year, all others add \$1.00 a year. Two years \$7.00. Contents copyrighted by Mooney-Rowan Publications, Inc., 1957. Printed in U. S. A.  
 POSTMASTER—Send all address labels clipped from undeliverable copies with Form 3579 to Hi-Fi Tape Recording, Severna Park, Md.

# Hear the *New Sound* ...Amazing all-new Stereofonic High Fidelity *by* WEBCOR!

**Imperial Stereofonic High Fidelity Tape Recorder.** (Model 2827). Today's stand-out stereo tape recorder! Binaural playback. Records and plays back monaurally in both directions without "reel-turnover." Automatic shut-off. Exclusive Webcor "Aural Balance" Remote Control included. Co-linear binaural heads. For use with Webcor separate external two-section sound system (Model 4827, optional extra). Also available with sensitive AM radio tuner (Model 2897).

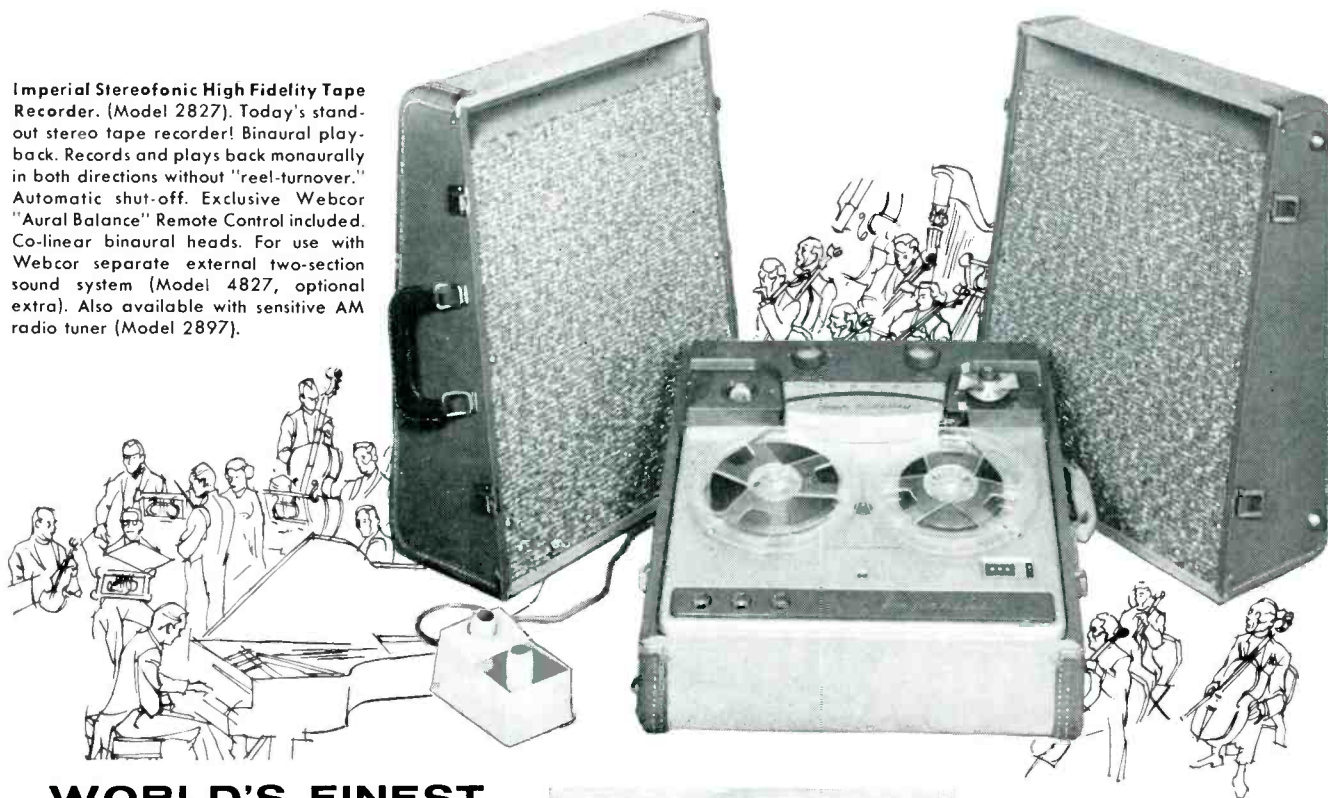

## WORLD'S FINEST TAPE RECORDERS!

All-new 1958 Webcor Stereofonic High Fidelity Tape Recorders outperform any sound system yet developed for the home—provide unequalled stereo music from binaural tapes! Webcor's new and exclusive "Aural Balance" Remote Control now makes possible perfect tuning of dual sound systems for the ultimate in true stereo reproduction—it is the *only* instrument capable of achieving this fine reproduction! And still another great Webcor convenience feature—it's the exclusive new 1958 automatic shut-off which turns off amplifier and motor when tape is finished and turns off external amplifiers, too.

See and hear this great new 1958 line of Webcor Stereofonic Tape Recorders, High Fidelity Tape Recorders and High Fidelity Fonographs at your dealer's now!



**Royal High Fidelity Tape Recorder.** (Model 2811). Has a world-wide reputation for tape recorder sales! Records and plays back in both directions without "reel-turnover." New automatic shut-off. New high fidelity recording heads. Printed circuit pre-amplifier. External speaker input receptacle. Recording level indicator. Tape counter. Detachable lid. Also available with supersensitive AM radio tuner as (Model 2891). Stereo version (Model 2821).

**Royal Coronet High Fidelity Tape Recorder.** (Model 2812.) Has "no reel-turnover" feature. Three speakers. Automatic shut-off. Printed circuit pre-amplifier. External amplifier output receptacle. External input, mike input and speaker receptacles. Recording level indicator. Tape counter. Also available with sensitive AM radio tuner as (Model 2892). Stereo version (Model 2822).

**LISTEN** ALL MUSIC SOUNDS BETTER ON A **WEBCOR**

# NEW TAPES

By Georgie Sigsbee

## CLASSICAL SYMPHONY

BRAHMS

SYMPHONY #2 in D Major, Op. 73 (CHT/BN 23)

SYMPHONY #4 in E Minor, Op. 98 (CHT/BN 33)

Frankfurt Opera Orchestra  
Carl Bamberger, Conductor

CONCERT HALL CHT/BN 23 and 33  
Stereo... \$17.90 each

Mr. Bamberger brings to Brahms Second a strong, energetic interpretation. Although he does not indulge too deeply in the glowing, lyrical aspect of this "Pastoral" composition, which such men as Monteux and Walter bring out to the fullest, nevertheless his reading is suffused with sparkling colors and shining textures. The sumptuous tones of the horns, strings and woodwinds result in a profusion of succulent sounds. This recording is certainly one to be reckoned with. You can wade about in the beauty of Brahms

music, monaurally, but you can swim in it, stereophonically.

Generally conceded to be his most profound symphony, Brahms' Fourth is rendered a very acceptable delivery by Mr. Bamberger and the Frankfurt Opera Orchestra. It took me several sessions to overcome the sonic impact of this recording and get down to the interpretative qualities. The clarity and separation of the instruments, the overwhelming effect of Brahms' rich orchestral panoramas via stereo, and the superb details brought out even more by the excellent engineering, had such a potent impact that, as I said, it took some while to come down from this high acoustical plane.

This work is directed with vigor and expression. In the first movement the beautiful dialogue between the pizzicato strings and staccato woodwinds is a delight to hear. The conductor gathers every nuance in the scoring of the andante with a sure touch and then flashes vividly through the scherzo. The final movement is based on a short eight-bar theme. This is given some thirty variations and is written in passacaglia form. Mr. Bamberger delivers it in a clear-cut, forceful style.

Altogether these two works are performed in an impressive manner and, topped with the grandeur of stereo reproduction, are certainly worth hearing.

## LISZT MEPHISTO WALTZ

Chicago Symphony  
Fritz Reiner, Conductor  
RCA ACS-25  
Stereo... \$6.95

This waltz, also known under the subtitle of "Dance in the Village Inn," is grouped under the main title "Two Episodes from Lenau's Faust." Incidentally, the seldom-heard companion piece is "The Nocturnal Procession."

Motivated, as were so many composers, by Goeth's poetic drama, Liszt went on to produce a second and a third Mephisto Waltz as well as a Mephisto Polka. All three were scored for piano. He began a fourth waltz but never completed it.

In this particular composition the music depicts a wedding celebration. Mephisto and Faust join in. The former enlivens the party by playing enticing, sensuous strains on the violin. The mood changes to one of excitement as Faust whirls off with one of the village maidens, then becomes sweet and placid once more.

The recording is expertly engineered. However, I am somewhat dissatisfied with the reading. After the fast, spirited introduction, Reiner concentrates heavily on the lyrical qualities. Arthur Rodzinski, on the other hand, puts forth a better-phrased, more dynamic interpretation on LP. He emphasizes the tempting, exciting devilry of Mephisto and brings more drama into the entire composition. However, the reproduction on the Rodzinski disc is inferior.

**Largest Tape Treasury in STEREPHONIC**

**NEW RELEASES**

**AUSTRIAN MUSICANA**  
Josef Kumerth and Radio Vienna Ens. in a sparkling tape of well-loved Austrian Waltzes and Mazurkas.  
Livingston 728 BN

**DANCING IN THE SHADOWS**  
Lenny Herman and "The Mightiest Little Band" in a brand new release... specially tailored for stereo.  
Livingston 1099 BN

**GYPSY MELODIES**  
Edi Csoka and his Gypsy Orch. supply a delightful continental atmosphere, with a dash of romantic gypsy flavoring. Ilonka Becsi is the captivating vocalist.  
Livingston 725 BN

**SUSAN REED'S FAVORITES**  
A distinctive stereo debut... with Susan Reed singing many familiar folk songs to her own accompaniment on the harp or zither.  
Elektra 7-5 BN

**THE NEW YORK JAZZ QUARTET**  
A new sound... by a top jazz group that has something to say!  
Elektra 7-3 BN

**VIENNA BAND PAGEANT**  
Encores of Old Vienna... by the Neue Deutschemeister Band.  
Livingston 726 BN

**and ANNOUNCING**  
**A NEW STEREO SHOWCASE**  
#3 by LIVINGSTON... containing complete selections and excerpts from the very latest best-sellers of the Livingston Library.  
LS-5-5 BN  
**5" STEREO \$6.95**

**STEREPHONIC**

**LIVINGSTON**

**Yours to choose and enjoy — from Bach to "Pops" — on such famous independent labels as:**

- ELEKTRA
- EMPIRICAL
- BOSTON
- ATLANTIC
- RIVERSIDE
- ESOTERIC
- LIVINGSTON

**All LIVINGSTON tapes are splice-free, fully guaranteed and packaged in attractive individual boxes.**

**STEREO, Stacked or Staggered (1200', 7" reels) \$11.95**

**Audition LIVINGSTON tapes at your High Fidelity — Audio Dealer or Record Shop. Send for our complete catalog and the name of your nearest dealer.**

**LIVINGSTON AUDIO PRODUCTS CORP. Box 202 CALDWELL, N. J.**

**THIS IS THE WAY  
A GREAT  
TAPE RECORDER  
IS BUILT...**

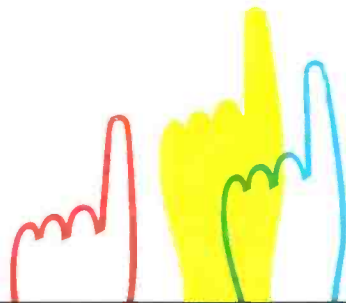
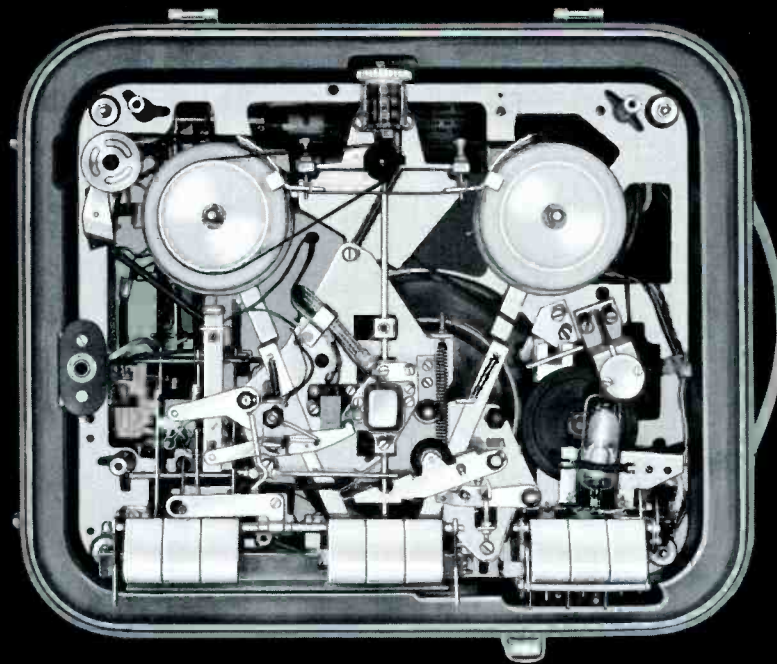

**THE NEW IMPORTED Norelco 'CONTINENTAL'**  
*world's most advanced all-in-one portable tape recorder*

**engineered by Philips of the Netherlands, world pioneers in electronic design**

**precision-crafted by Dutch master technicians**

**styled by the Continent's top designers**

**three speeds... twin tracks... push-button controlled**

**lightweight... easily portable... rugged**

**can also be played through external hi-fi system**



NORTH AMERICAN PHILIPS CO., INC.  
High Fidelity Products Division  
230 DUFFY AVENUE, HICKSVILLE, L. I., N. Y.

what the name "Norelco" means in a tape recorder

The three-speed dual-track Norelco 'Continental' was specifically designed by Philips of the Netherlands, world's largest electronics concern outside of the United States, to be the finest self-contained, single-case, portable tape recording and playback system ever offered to recordists, high-fidelity enthusiasts and music lovers.

Nothing has been spared by the world-renowned Philips engineering teams to make the 'Continental' the most advanced and versatile instrument of its kind in mechanical design, electronic circuitry and construction. Three speeds, rather than just the conventional two, have been incorporated to insure maximum versatility and economy in both speech and hi-fi music recording. At each speed — 1 7/8, 3 3/4 and 7 1/2 inches per second — the Norelco 'Continental' compares favorably in performance with other machines operating *at the next higher speed*. This is due primarily to the special Philips magnetic head with an air gap of only 0.0002 inches, which makes possible extended high-frequency response even at the slower speeds. The built-in loudspeaker is of the world-famous Norelco twin-cone, wide-range design, with extra-powerful magnet.

Impressive as its specifications may be, the Norelco 'Continental' was designed, however, to be used and to be listened to — not to be read about. Its actual numerical specifications were determined by measuring it *after* it sounded good enough, handled tape gently enough, and ran smoothly and reliably enough to satisfy the uncompromising Philips engineers.

The data below are therefore offered as examples of factual description and painstaking, conservative laboratory measurement, rather than advertising claims. Read them, if you are interested — but better yet, operate and listen to the Norelco 'Continental' for a while, and forget about specifications. Five minutes of actual use will demonstrate to you more forcibly than five pages of decibel figures and intermodulation percentages *how a Norelco tape recorder is built!*

## Norelco<sup>®</sup> 'CONTINENTAL'

( Model EL3516 )

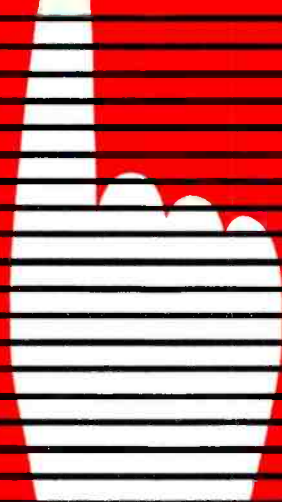

Tape Speeds:	7 1/2, 3 3/4 and 1 7/8 inches per second
Tracks:	Dual
Frequency Response:	40 to 16,000 cps at 7 1/2 ips; 50 to 8,000 cps at 3 3/4 ips; 60 to 4,500 cps at 1 7/8 ips
Signal-to-Noise Ratio:	54 db
Wow and Flutter:	0.2% at 7 1/2 ips; 0.3% at 3 3/4 ips; 0.35% at 1 7/8 ips
Volume Indicator:	Magic eye (Type EM-81)
Loudspeaker:	5-inch twin-cone
Controls:	Piano-key pushbuttons
Fast Forward and Reverse:	Less than 2 minutes for 1200' of tape
Automatic Stop:	At end of reel with metalized tape
Program Indicator:	Built-in
Inputs:	1 radio/phono; 1 microphone
Outputs:	1 for external speaker; 1 for external amplifier
Microphone:	High-impedance dynamic
Tubes:	EF-86, ECC-83, EL-90, EZ-90, EM-81, (one of each)
Line Voltage:	117 volts AC @ 60 cycles
Power Consumption:	55 watts
Dimensions:	15 1/4" x 13" x 8"
Weight:	Approx. 30 lbs.



NORTH AMERICAN PHILIPS CO., INC., High Fidelity Products Division, 230 DUFFY AVENUE, HICKSVILLE, L. I., N. Y.

Write for the name and address of your nearest dealer.



**MENDELSSOHN**  
**SYMPHONY No. 4 ("Italian") in A Major,**  
**Op. 90**  
 Pro Musica Symphony, Vienna  
 Edouard Van Remoortel, Conductor  
**PHONOTAPES SONORE S-705**  
 Stereo... \$11.95

It is interesting to note that Mendelssohn was but twenty-four when he composed this symphony. Numerically designated as No. 4, this work was actually written and performed before the Third ("Scotch"). These two are the most often heard of his symphonies. They both were inspired by recollections of his tours in the respective countries for which they are titled.

The first movement of the Fourth is a dashing, happy one and the orchestra portrays it with a brisk, almost breathcatching buoyancy. The solemn march-like rhythms of the andante are followed by a simple, charming minuet. Like Berlioz, Mendelssohn was captivated by the Italian dance, "The Saltarello." The fourth movement is based upon two themes in this rhythm and a third which is characteristic of the Neapolitan "Tarantella." This is a gay, vivacious finale to the composition.

Mr. Remoortel and the orchestra give an invigorating and dexterous performance. This is a reading I recommend highly. The sound is luminescent.

**PROKOFIEFF**  
**SYMPHONY #7**  
 Philharmonia Orchestra  
 Nicolai Malko, Conductor  
**RCA DCS-38**  
 Stereo... \$12.95

Prokofieff's last symphony, the Seventh, was written five years ago when he was sixty-one. This symphony is not as popular as the First (Classical) nor as profound as the Fifth. Nonetheless, it is quite a pleasing composition. Unlike some of his works, written during the period from 1922 to 1932 which were more complex and filled with innovations, this symphony possesses greater lyricism.

The first movement is taken at a leisurely pace and contains a warm, romantic main theme. The allegretto is ballet-like and I found myself imagining the choreography. It ends in a swirling finale with sonically brilliant brass and percussive work. The lovely andante provides a peaceful interlude which moves into a quick-paced final movement. The finale, with its rich orchestral patterns, is something of a stereo treat.

Mr. Malko and the Philharmonia perform admirably. The sound is incandescent but I turned up the volume to get its full benefit.

**MENDELSSOHN**  
**SYMPHONY NO. 3 ("Scotch") in A, Op.**  
**56**  
 The Netherlands Philharmonic Orchestra  
 Walter Goehr, Conductor  
**CONCERT HALL CHT/BN-25**  
 Stereo... \$17.90

This was the last symphony composed by

the  
 man  
 who  
 put  
 the  
 "oh"  
 in  
 stereo



**RUSS MOLLOY**

... brings you



- "Around the World in 80 Days" (ST-20—\$11.95)
- "Symphony for Glenn Miller" (ST-8—\$11.95)
- "The King and I" and "My Fair Lady" (ST-19—\$9.95)
- "For Whom the Bell Tolls" (ST-15—\$11.95)
- "Oklahoma" and "Symphony for Blue" (ST-13—\$9.95)
- "Scheherazade" (Movements 1 & 2... ST-21—\$9.95)
- (Movements 3 & 4... ST-22—\$9.95)
- "Nutcracker Suite" (ST-24—\$9.95)
- "Gershwin Medley" (ST-25—\$7.95)
- "Tribute to Tommy Dorsey" (ST-27—\$11.95)
- "Student Prince" and "Ritual Fire Dance" (ST-26—\$7.95)

Send for complete catalog of stereophonic tapes.

Russ Molloy, vice-president, technical director and A & R man of Bel Canto, gives you the finest library of quality stereo tapes available. Top artists and top selections recorded in the United States and Europe—the ultimate in listening pleasure both Stereo and Monaural.

**Bel Canto**® if not available at your dealer write direct.  
**MAGNETIC RECORDED TAPES**

DEPARTMENT Tc 4856 WEST JEFFERSON BOULEVARD, LOS ANGELES 16, CALIFORNIA

Mendelssohn. Thus, rightly, it could be numbered the Fifth; however, such is not the case. It took Mendelssohn about thirteen years to complete this work. His first notes were made in 1829 while traveling in Scotland but the symphony was not completed until 1842.

This work is a musical synthesis of impressions he gleaned while in that country. It begins with a slow, meditative andante and builds up to a dynamic allegro. This is followed by a cheerful, jaunty vivace movement after which the orchestra catches collective breath for a moment. The prescription for this work is that it be played without pause. The third movement is filled with rich string and woodwind passages, sometimes idyllic, sometimes fiery. The compo-

sition is then closed with a march-like theme of triumphant nature.

Mr. Goehr and the Netherlands Philharmonic perform capably. The third movement is particularly effective. The stereo reproduction gives more scope and substance to the entire work.

**RIMSKY-KORSAKOFF**  
SUITE FROM "LE COQ D'OR"

Boston Pops Orchestra  
Arthur Fiedler, Conductor  
RCA CCS 40  
Stereo . . . \$10.95

Rimsky-Korsakoff composed some 15 operas of which "The Golden Cockerel" was

the last. It was written in 1908, the year of his death, and was first produced in Moscow in 1910. He based the opera, and the suite he derived from it, on the poet-novelist Pushkin's "Golden Cock." The opera revolves around an enchanting, satirical fantasy about a King Dodon who is given a golden cockerel by an Astrologer. The cock serves a fine purpose by crowing whenever danger threatens. Embroiled in wars, the sons of the King are killed. Dodon meets the Queen of Shemaka and starts making some binding plans when the Astrologer claims her as his reward. Dodon then kills the star-gazer, and the cock, evidently figuring turnabout is fair play, does away with Dodon.

Fiedler spins a musical web interwoven with themes of romantic, exotic and warlike moods. The work displays, both musically and sonically, a wide variety of colorful rhythms and vibrant woodwind and brass work.

The fidelity is superior.

**LIGHT CONCERT**

MUSIC FOR A QUIET MOOD

- Sleepy Lagoon
- Narcissus
- Salut D'Amour
- En Badenant
- Fascination
- Une Chanson D'Amour
- Pizzicato Polka
- Barcarolle
- Waltz from "Coppelia"
- Rustle of Spring
- Valse Triste

Marco Gregory and Orchestra  
CONCERT HALL CHT/BN 34  
Stereo . . . \$11.95

This album has a present-day title but content-wise it dwells in the light semi-classical past. Represented are such composers as Coates, Elgar, Delibes, Sinding and Sibelius.

These pieces are tastefully presented by Mr. Gregory and his small orchestra. He gives these diversified compositions an easy, refreshing interpretation without the overloaded string work so common nowadays. I found this tape a charming and welcome change. The whole family has enjoyed it each time it has been played.

**STRAUSS WALTZES**

- Where the Citrons Bloom; Johann Strauss, Jr.
  - Secret Attractions; Josef Strauss
  - 1001 Nights, Johann Strauss, Jr.
- RCA CCS-45  
Stereo . . . \$10.95

**WALTZES BY THE STRAUSS FAMILY**

- Doctrines; Eduard Strauss
  - Music of the Spheres; Josef Strauss
  - Roses From the South; Johann Strauss, Jr.
- RCA CCS-46  
Stereo . . . \$10.95

Both tapes by the Boston Pops Orchestra  
Arthur Fiedler, Conductor

Mr. Fiedler gives the first three lovely



a

b

c

If your ears are as good as your eyes wait 'til you hear these new stereotapes by Concert Hall

**a** Gorgeous Tina Louise sings in a sweet and tender mood on **TIME FOR TINA** (900') EX-46

**b** Cootie Williams and Rex Stewart battle to a finish! Hear **JAZZ AT STEREOVILLE** (800') EX-40

**c** Norman Leyden and orchestra do so right by 12 Broadway hits. **BROADWAY SPECTACULAR** (1200') HX-41

These are just a few of the big and variegated catalog of superlative stereo waiting for you!



71  
Fifth  
Avenue  
New  
York 3  
New  
York

All tapes are available in stacked and staggered versions.

Revere's exclusive



makes the difference

# Revere TAPE RECORDERS

The incomparable high fidelity and rich tonal quality of Revere Tape Recorders is the direct result of a Revere exclusive, patented feature. "Balanced-Tone" is the control that coordinates amplifier and acoustic system response to emphasize both high and low tones, giving strikingly realistic HIGH FIDELITY sound reproduction, even on low volume. Compare and you'll choose REVERE!

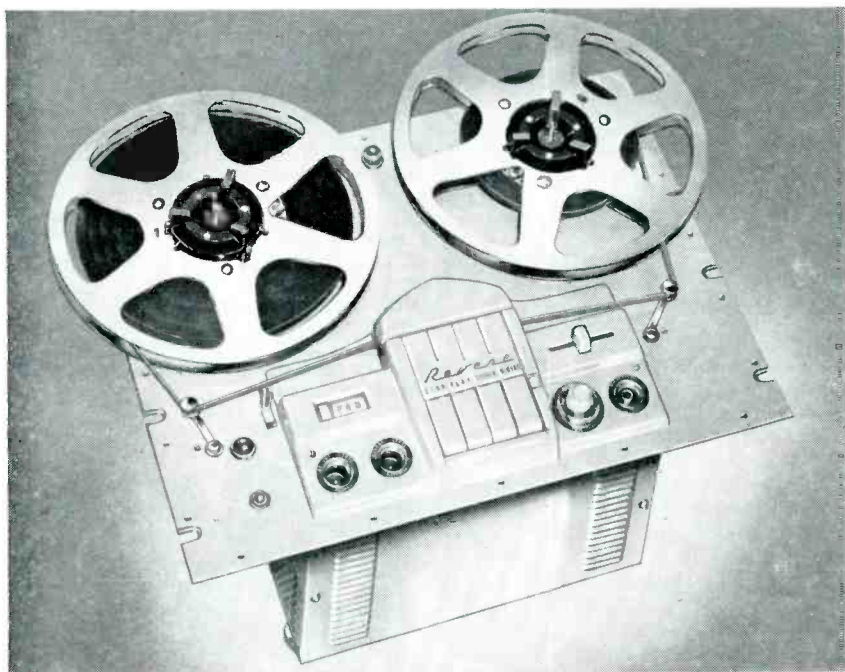

### T-11 HIGH-FIDELITY CUSTOM MODEL

For professional use and easy installation into any high fidelity system. Solenoid operated keyboard, push-button control. Outstanding Performance.

GUARANTEED SPECS: Freq. Resp. 40-16,000 ± 3 db., S.N. greater than 50 db., WOW-Flutter less than 0.2%, Overall-Dist. 0.65%.

FEATURES: 1-Volt cathode follower output; Accepts 3, 5, 7 and 10½ reels; Automatic head demagnetization; Tape counter; 2-hum balancing controls; Adjustable high freq. equalization . . . with reel adapters, cords and plugs \$284.50

SK-707 Stereophonic Kit—Converts all Revere T-11, T-1100 series and keyboard tape recorders to IN LINE High Fidelity Stereophonic playback and monaural recording. Simple installation; uses phono amplifier for record channel. Exceptional specifications . . . \$34.50.

REVERE CAMERA CO. • CHICAGO 16, ILLINOIS

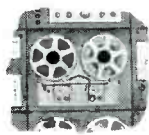

VERTICAL MOUNTING



HORIZONTAL MOUNTING



**T-700-D Dual-Speed** — Simplified automatic keyboard controls. Standard tape speed of 3.75 and 7.5 i.p.s. Records up to three hours per seven inch reel with new long-play tape. Exclusive index counter. Complete with microphone, radio attachment cord, two reels (one with tape) and case. . . . . \$225.00  
**TR-800-D**—Same with built-in radio \$275.00

**T-1100 Dual-Speed** — Single knob control. Tape speeds of 3.75 and 7.5 i.p.s.; records up to three hours with new long-play tape. Durable fibre-glass case; two acoustically matched excursion speakers. Complete with microphone, radio attachment cord, two reels (one with tape) and case. . . . . \$169.50  
**TR-1200**—Same with built-in radio \$219.50



The preference for Revere by artists of renown is your guide to recorder selection.



**ARTUR RUBINSTEIN**  
noted pianist



**MARIAN ANDERSON**  
famed soprano



**ANDRES SEGOVIA**  
foremost guitarist



**ZINO FRANCESCATTI**  
brilliant violinist



**ROBERT CASADESUS**  
piano virtuoso



**LAURITZ MELCHIOR**  
great Wagnerian tenor

Incomparable  
**VALUE**



THE SCANDINAVIA STYLED  
**Tandberg**

**A tape recorder of distinctive design**

Designed and built in accordance with the most advanced European Engineering Techniques . . . 3-speed (1 $\frac{7}{8}$ , 3 $\frac{3}{4}$ , 7 $\frac{1}{2}$  ips) half track tape recorder and playback unit—custom-crafted with a care that makes each one a perfectly produced image of the other.

**A tape recorder of incomparable performance**

Frequency response from 30 to 18,000 cps at 7 $\frac{1}{2}$  ips; from 30 to 10,000 cps at 3 $\frac{3}{4}$  ips; from 50 to 6,500 cps at 1 $\frac{7}{8}$  ips. Flutter and wow below 0.1% at 7 $\frac{1}{2}$  ips and low enough at 1 $\frac{7}{8}$  ips to be inaudible on piano recordings. Signal-to-noise ratio 60 db at high recording levels.

**A tape recorder of superior value**

It comes complete with fine luggage case, balanced playback amplifier, high fidelity Goodmans speaker, quality crystal microphone, heavy-duty input-output cord and 1,200 ft. reel of tape for only \$299.50.

Ask your dealer for a demonstration or write for full information to:



waltzes (CCS-45) a full, regal symphonic treatment. These are not over-sentimentalized versions . . . they are played with an elegant polish as though for a royal court ball. Fiedler does not penetrate deeply into the graceful abandonment of the Viennese "gemutlichkeit," but I found his approach a salubrious one.

On the second tape (CCS-46) are more of the waltzes composed by the Senior Johann's sons. All are delivered with a delicious tilting delicacy. Here Fiedler seems to be possessed with a complete affinity for the romantic waltz and yields to the seductive magic it can cast.

The sound is opulent and as tantalizing as the music.

**CHORAL**

**GLORY LAND**

- Walk Them Golden Stairs
- The Devil Can't Harm a Prayin' Man
- Where No One Stands Alone
- When the Mornin' Comes
- City Called Heaven
- Do Lord
- How Long Has It Been
- Somethin' Within Me
- This Old House
- Supper Time

The Watchmen  
STEREOPHONY, INC., B 135  
Stereo . . . \$7.95

The Watchmen, a small choral group who have done concert and radio work, perform these selections in a most likeable manner. Their animated renditions of such songs as "Walk Them Golden Stairs" and "City Called Heaven" are bound to produce some rhythmic foot-tapping on the part of the listener. Their voices are very pleasant and their enunciation is clear. There is some solo work ranging from the falsetto to the bass lead.

The Watchmen's flexible styling is well illustrated by "When the Mornin' Comes" and the quieter "How Long Has It Been." Somehow "This Old House" crept into the repertoire. At the end of it they give out with a snatch of the old Dixieland traditional "When the Saints Go Marchin' In."

The accompaniment for the group is furnished by a piano, guitar and bass. The stereo reproduction is excellent and is particularly effective with choral work as you will hear throughout this tape.

**CONCERTO**

**MOZART**

**CONCERTO FOR CLARINET AND ORCHESTRA IN A**

Benny Goodman, Clarinet  
Boston Symphony Orchestra  
Charles Munch, Conductor  
RCA DCS-39  
Stereo . . . \$12.95

Goodman, a musical split-personality, puts in a very commendable performance. He plays with formality and great care.

Last month when reviewing this concerto (Omegatape 9005) I voiced aloud the thought that Goodman would like to record it . . . and no more said than done! The

**DON'T  
LOSE  
YOUR  
HEAD!**

The most important part of your tape machine is the magnetic head. Protect it . . . prevent damage to precious tapes . . . insure peak performance with **LONG LIFE Fluids**, the only tape cleaner and lubricant safe and effective for *all* tape machines.

**DANGER SIGNS:**

- Loss of high frequency response
- Wow and flutter
- Poor uniformity of output
- Squeal or tape modulation

**CURE:  
LONG LIFE**

The **LONG LIFE Tape Maintenance kit** offers two solutions for complete tape and recorder protection. **LONG LIFE CLEANER** cleans and protects the heads and capstan of your machine. **LONG LIFE LUBRICANT** lubricates both the machine and the tape. Both solutions are absolutely guaranteed safe for use with any machine or tape. Only \$1.50 for complete kit from your quality high fidelity dealer. (Dealer inquiries invited.)



**How to Get Peak Performance  
from Your Tape Recorder  
Send for FREE Booklet**

**EMC Recordings Corporation**  
806 East Seventh Street  
St. Paul 6, Minnesota

Please send me my free copy of "Maintenance Guide for Tape Recorder Owners."

NAME \_\_\_\_\_  
ADDRESS \_\_\_\_\_  
CITY \_\_\_\_\_ STATE \_\_\_\_\_



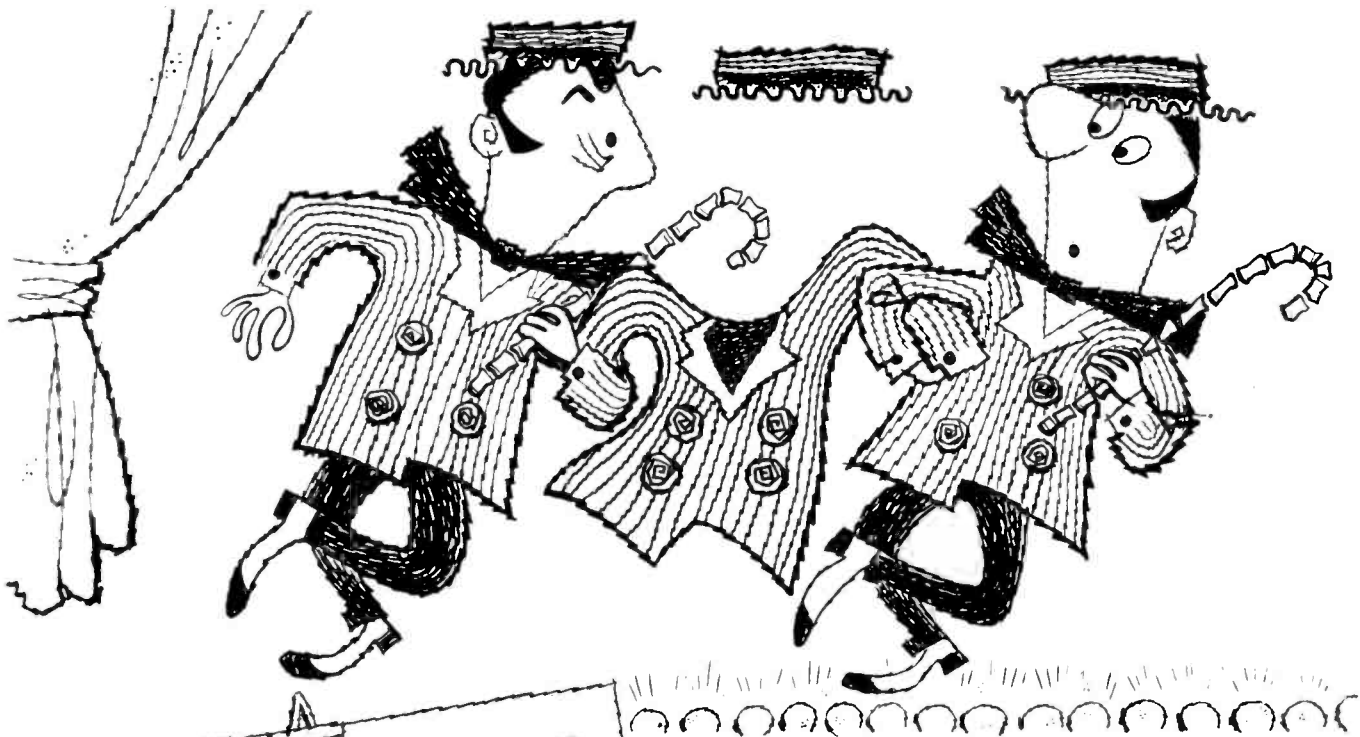

**WHAT HAPPENED  
TO THE MAN  
IN THE MIDDLE?\***

Something seem to be missing when you listen to stereo?

You hear music from the left, music from the right — but in between there's an unaccountable void. The "man in the middle" is missing.

Now listen to stereo as recorded by Stereophony, Inc. What a difference! This is true stereo — a perfect blend of left, right and middle... all of the realism and presence of a live performance. The "man in the middle" is in there as big as life. And it's all done with only two channels and two loudspeakers. That's all anyone needs to produce full stereophonic sound when the original recordings are made according to the exacting technical and engineering standards of Stereophony, Inc.

Be sure you get *all* the sound that's rightfully yours when you buy stereo. Ask your quality high fidelity dealer for Stereophony, Inc., tape recordings, or write us for the name of the Stereophony dealer in your locality.

**NEW RELEASES FROM STEREOPHONY, INC.**

**1. "RIGHT THERE!" with SAM DONAHUE**

Here's the first stereo release featuring a big name band. It's the same all-star aggregation presented on the NBC BAND STAND. Saxist Donahue leads a full complement of reeds and brasses through a series of excitingly arranged, eminently danceable jazz standards. Catalog C 125, 32 minutes, 7 in. reel, \$8.95.

**2. "GLORY LAND" with THE WATCHMEN**

Here's an adventure in stereo that will have the most sophisticated shouting, "Halleluiah!" One of the few surviving groups of itinerant revival singers, the Watchmen give out with an authentic brand of hand-clapping, foot-stomping camp meeting harmony. Catalog B 135, 22 minutes, 7 in. reel, \$7.95.

**3. "STRINGS BY STARLIGHT"**

**with THE STEREOPHONY STRING ORCHESTRA**

A lavishly orchestrated selection of melodies that linger in the memory; among them "Two Guitars," "April in Paris," "Adios" and "Body and Soul." A sentimental journey in superb stereo. Catalog C 155, 30 minutes, 7 in. reel, \$8.95.

**4. "CLUB STEREO"**

**with MACK SHEPPARD AND HIS ORCHESTRA**

Music in the familiar easy-to-dance-to mood of the country club and hotel dining room. Sample selections: "When Your Lover Has Gone," "Moon Over Miami," "Love Walked In." Catalog B 126, 22 minutes, 7 in. reel, \$7.95.

Available for both stacked (S) and staggered (Z) heads.

**SPECIAL INTRODUCTORY TAPE**

To introduce you to the new Stereophony, Inc., recordings, we have prepared a special Sampler Tape, a showcase of selections from each of our latest releases. The sound is fabulous and so is the price — 18 minutes of stereo for only \$3.95. Order: Catalog B 81, Stereophony, Inc., Sampler Volume II.

**ONLY  
\$3.95**

\*He went to EMC to make stereo recordings!

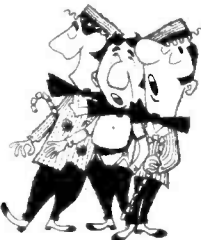

**STEREOPHONY • INCORPORATED**

DISTRIBUTED BY **emc** RECORDINGS CORPORATION • 806 E. SEVENTH STREET • ST. PAUL 6, MINN.

Export: EMEC Corp., Plainview, Long Island, New York

**NOW—**  
from the leader in sound...

# CAPITOL STEREO TAPE!

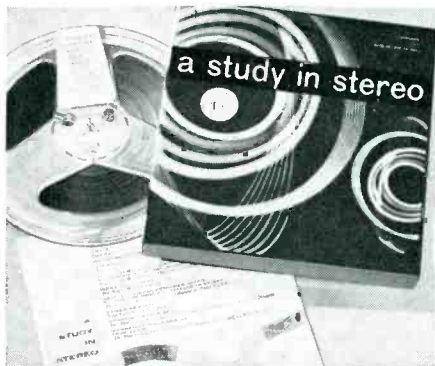

### A Study in Stereo

A breathtaking showcase of stereo's vast range featuring Capitol's big-name artists. 20-page booklet with introduction by Edward Tatnall Canby included. (ZH-2)

### Other "Full Dimensional Sound" stereo releases

#### LEOPOLD STOKOWSKI:

*The Orchestra* (ZH-8)

#### ROGER WAGNER CHORALE:

*House of the Lord* (ZF-9)

#### WM. STEINBERG, PITTSBURGH SYMPHONY:

*Toch: Third Symphony* (ZF-7)

#### HOLLYWOOD BOWL SYMPHONY ORCHESTRA:

*L'Italia* (ZF-3)

*Gypsy* (ZF-6)

*Symphonic Dances* (ZF-5)

*Bolero & Capriccio Espagnol* (ZF-4)

### Intro to Stereo

A narrated journey through the wonders of stereo — music and real-life sounds. (ZA-1)

### Top Stars in Stereo

#### NAT "KING" COLE:

*Love is the Thing* (ZD-11)

#### KENTON IN HI-FI

 (ZD-10)

#### GEORGE SHEARING: *Black Satin*

 (ZC-13)

#### FRED WARING & THE PENNSYLVANIANS

IN HI-FI (ZD-12)



2 CHANNEL — 7½ IPS — FOR IN-LINE HEADS

unknown artist on the Omega release turns in a more relaxed, poetic rendition of this work, but Goodman's is certainly not one to be ignored.

The RCA close-in miking of the clarinet, and the widespread stereo sound of the orchestra, further enhances the music. The tonal depth of the solo instrument gives the listener a sense of live, almost tangible, beauty. Even though Goodman's execution is not as supple as others I have heard, it is assiduous and certainly worth merit. Mr. Munch and the orchestra do a fine job, too.

#### RACHMANIOFF

PIANO CONCERTO #2, in C Minor

Philippe Entremont, Pianist

Netherlands Philharmonic Orchestra

Walter Goehr, Conductor

CONCERT HALL CHT/BN 19

Stereo... \$11.95

This, the most universally popular of his concertos, was written shortly after Rachmaninoff recovered from a nervous breakdown. There may be a strain of melancholy here but, if so, it is imbued with serenity and radiant melody. The concerto is a veritable showpiece for the virtuoso pianist. It is filled with swirling arpeggios and lyrical cadenzas. Although it has become a well-known, oft-performed composition, Mr. Entremont executes the concerto with loving care as though the beauty within had never before been heard. Where power is required he has it and where a soft, exquisite touch is necessary, this too, he provides. The orchestra gives discreet backing, quietly playing its part until full orchestral climaxes are scored. It is the piano with its gossamer, crystal-clear tones, played by a truly talented artist, which holds one in the grip of a beautiful musical experience.

#### ORGAN

##### ORGAN RECITAL

Arabesque for the Flutes; Jean Langlais "Gigue" from Concerto in F major; Albinoni-Walther

Carillon-Sortie; Henri Mulet

Harmonies of Evening; Sigfrid Karg-Elert

John Eargle, Organist

KLIPSCHTAPE KST-1002

Stereo, 15 IPS... \$10.95

On this tape John Eargle ably demonstrates his artistic, as well as technical, proficiency as a musician. The organ he plays is an Aeolian-Skinner located in the First Presbyterian Church of Kilgore, Texas, and his choice of selections highlights the fine features of this superb sixty-rank instrument.

Technically, the recording is excellent. Microphone placement was varied according to the heavy or light quality of the music performed. In the very lovely "Carillon-Sortie" several sessions were required to adjust to the "auditory perspective" achieved from the use of the "longitudinal" stereo technique. The notes supply details as to the recording procedures followed.

I did not derive the feeling of spaciousness as heard in the recording of Richard Purvis (HIFITAPE, April 1956); however, it must be pointed out that Mr. Eargle is perform-

# NOW

your dealer is featuring

## TAPE OF THE MONTH PRE-RECORDED TAPES

All your musical favorites... Symphonies, Operas, Folk Music, Jazz, Popular, Hymns, Rock 'n Roll, Readings or Novelties!

# WOW

You save money, and still get the very best! Binaural and Monaural tapes of such musical excellence and sound fidelity have never been available at so low a price!

**MONAURAL**—7" reel—7½ I.P.S.—Approx. 1200'—Single or Dual Track. **ONLY 6.95**  
**BINAURAL**—7" reel—7½ I.P.S.—Approx. 1200'—Staggered or Stacked heads. **ONLY 10.95**

SEND FOR NEW CATALOG, AND NAME OF TAPE OF THE MONTH DEALER NEAREST YOU!

If you will send the name and address of your photo store, record shop or Hi-Fi center, we will arrange for them to stock Tape of the Month recordings.

AVAILABLE ONLY THROUGH AUTHORIZED DEALERS  
Dealer Inquiries Invited

**TAPE OF THE MONTH**  
449 West 51 St. • New York 19, N. Y.

## ALLIED has the BEST BUY IN THIS GREAT TAPE RECORDER

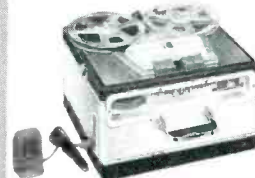

only **\$94.95**

- Push-Button Operation
- Transistorized Pre-amplifier

### ALLIED'S own PORTABLE KNIGHT AUTOMATIC TAPE RECORDER

Judged "Best Buy" among recording experts. Features Push-Button keyboard for instant recording with remarkably faithful reproduction. Has 2-speed dual-track recording mechanism and efficient erase system. Records up to 2 hours on standard tape (3 hours on long play). For instant playback, just push a button; also push-button control of forward, reverse and stop functions. Records from mike, radio or phono. Built-in quality amplifier and speaker. Simple to operate. Compact—only 23 lbs. With microphone, 600-ft. reel of tape and take-up reel. **91 RZ 751. Only \$94.95**

**Free!**

### 404-PAGE 1958 ALLIED CATALOG



Buying guide to everything in electronics, including all equipment for the tape recordist: complete recorders, basic mechanisms, amplifiers, mixers, mikes, heads, phone pickups, tape, splicers, and accessories. Write for your FREE copy of the 1958 ALLIED Catalog.

### ALLIED RADIO

100 N. Western Ave., Dept. 83-K7  
Chicago 80, Ill.

# New Stereophonic Rental Library Plan

Enables you to enjoy the finest  
prerecorded stereophonic music  
... for only pennies a day

Provides you with an ever-changing  
library of stereo listening pleasure  
... without investing in costly tapes



Library Includes Practically Every  
Stereophonic Tape On The Market

Choose From These Famous Brands:  
RCA VICTOR • SONOTAPE  
OMEGATAPE • CONCERT HALL  
LIVINGSTON • PEN TAPE  
CONCERTAPES • BEL CANTO  
—and many others

Listings of Available Tapes  
And New Releases  
Sent To You Each Month

Send Coupon  
For Details Now  
No Obligation

## Full 30-Day Rental Costs Only \$1.65 Per Tape

This plan was specially devised to enable you to enjoy all the different stereophonic tape recordings available, without the big investment. Undoubtedly, there are many recordings you would like to listen to, but because of the high cost of purchasing tapes, you haven't done so. Well, now you can treat yourself to the luxury of expensive recordings. No need to buy costly tapes... you can rent them for 30 days for only \$1.65 per tape... less than 6¢ a day. Play the tapes as often as you wish, then after 30 days, return them and order out other selections. This gives you an ever-changing library of wonderful stereophonic recordings. Instead of playing the same few tapes over and over again, you can constantly have new selections to enjoy. This plan also enables you to listen to various recordings and then select the tapes you might wish to put into your permanent collection... you can try, before you buy. Take advantage of this opportunity to hear all of the great recordings on the market, for just pennies a day. Send coupon for full details now!

**STEREOPHONIC RENTAL LIBRARY**  
Division of Donan Distributing Company  
5007 N. Kedzie Ave., Chicago 25, Illinois

Please send complete details on your Stereophonic Rental Library Plan. No obligation.

NAME \_\_\_\_\_

ADDRESS \_\_\_\_\_

CITY \_\_\_\_\_ ZONE \_\_\_\_\_ STATE \_\_\_\_\_

for the first time!

## CONTEMPORARY'S TOP JAZZ STARS IN **new stereo**

...with distinct separation between the speakers, yet part of the sound actually seems to come from the middle! Uncut versions of Contemporary Records' famed 12" Hi-Fi long-playing albums on extra-play 1-mil tape; almost 50% more playing time than ordinary tapes, but just \$11.95 each.

nationally advertised price  
AVAILABLE STACKED OR STAGGERED



**CT1—Shelly Manne & His Men: "Swinging Sounds in Stereo".**  
America's No. 1 drummer and his great group in "Moose the Mooche", "The Wind", "Tommyhawk", "Quartet", etc. "... Joyful listening" says Billboard!



**CT2—Music to Listen to Barney Kessel By.**  
The nation's No. 1 guitarist, with a unique woodwind orchestra and rhythm section. In his own beautiful arrangements of "Laura", "Mountain Greenery", "Carioca", etc.



**CT3—The Curtis Counce Group.** Stunning stereo on the first album of this fabulous five about which Down Beat says "... powerful integration"; Billboard: "... abounds with great solos, excellent drive!" "Landslide", "Time After Time", "Sonar", etc.



**CT4—My Fair Lady: Shelly Manne & His Friends: Andre Previn & Leroy Yinnegar**  
The best-selling modern jazz album of the season! The 8 hit Broadway tunes: "Get Me to the Church on Time", "I've Grown Accustomed to Her Face", "Show Me", etc.



**CT5—Howard Rumsey's Lighthouse All-Stars: Music for Lighthousekeeping.**  
The colossal Coast crew in a swinging session "made" for stereo! "Topsy", "Love Me or Leave", 2 Latin's with cowbells, maracas, claves, ram's horn and conga drums; etc.



**CT6—Art Pepper Meets the Rhythm Section.**  
Spontaneous combustion in hi fi, this blowing bout between West Coast alto star Pepper and the East's famed Red Garland, Paul Chambers, Philly Joe Jones! "You'd be So Nice to Come Home To", "Red Pepper Blues", etc.

at record and hi-fi shops everywhere, or write  
**CONTEMPORARY TAPE**  
8481 melrose place, los angeles 46, california

ing on an instrument in a church while Mr. Purvis' organ is located in a cathedral. The latter structure is naturally more capacious. You will find the reproduction on this tape is both warm and natural.

Mr. Eargle's playing is flawless and in perfect accord with the moods of these less-commonly heard selections. We are looking forward to the first releases of Klipschtape's 7½ series (scheduled for mid-September) as Mr. Eargle will be among the artists represented.

Reviewed by Dr. John Leaby of Washington, D. C.

### POPULAR

#### AFTER HOURS

- Blues After Hours
- Chasing Chopin
- First Romance
- Saki
- Fishorn Fantasy
- Little Brown Jug
- Isle of May
- Dark Eyes
- First Love

Warren Baker's Little Jazz Band  
OMEGATAPE ST 2014  
Stereo ... \$11.95

This tape features Bobby Hammack at the keyboard and George Poole on flute. Another member of the band who renders some sparkling mallet work throughout is Jerry Friedman. Arrangements by Joe Hooven and Bobby Hammack are easy-going and danceable. A good jazz beat is given to "Dark Eyes" and "Chasing Chopin." The latter is just a re-title to the pop tune (lifted from Chopin), "I'm Forever Chasing Rainbows."

Stereo reproduction is well-balanced and clear.

#### STRINGS BY STARLIGHT

- Duke Ellington Medley
- I Concentrate on You
- Two Guitars
- As Time Goes By
- Moon Over Miami
- Donkey Serenade
- Sweet and Lovely
- April in Paris
- Adios
- Body and Soul
- Lady of Spain

Stereophony String Orchestra  
STEREOPHONY, INC., #155  
Stereo ... \$8.95

The Stereophony String Orchestra is composed primarily of members of the Des Moines and Minneapolis Symphony orchestras. This orchestra was formed for the exclusive use of Stereophony, Inc.

I was quite pleased with their initial recording. They give these old favorites a youthful blush. The shimmering, plucking strings predominate but there is also some fine horn and piano performances as well as a few percussive effects. The arrangements are excellent as you will agree when you hear the twinkling productions of "Two Guitars" and "Lady of Spain."

The reproduction is flawless.

available now ...

## the much talked about **ISI Tape Recorder** with the magnetic clutch drive

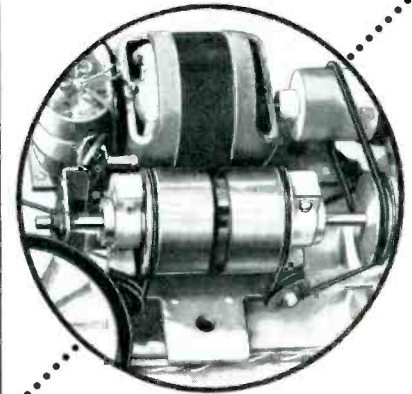

the most talked about  
development in the industry

#### features

- Magnetic clutch braking and tape tension control — foul proof and virtually fool proof. Handles tape under all conditions and at all speeds without the possibility of spilling or breakage.
- Synchronous tape drive at 3¾ and 7½ ips or 7½ and 15 ips.
- Mounting space for six heads in all presently used head configurations.
- Designed for rack mounting with integral amplifier.
- Dual inputs and controls for mixing line and high impedance inputs.

**THE ISI IS AVAILABLE NOW FOR EARLY DELIVERY ON A DIRECT FACTORY TO USER BASIS.**

A truly professional piece of recording gear, the ISI is ideally suited for the serious audiophile, military and industrial data recording and the commercial recordist — priced from \$345. The price of the machine is determined by the head compliment and accessory fittings.

For comprehensive information on this outstanding recorder write to:

**Mid-Continent Engineering, Inc.**  
1712 Marshall N.E. Minneapolis, Minnesota



## FilMagic PYLON

(PAT. PENDING)

**AUTOMATIC SILICONE LUBRICATION**

**CLEAN AND LUBRICATE YOUR TAPES AND FILMS WHILE THEY PLAY!**

Guaranteed Better, Cleaner, Cooler Re-production on any equipment. Complete PYLON KIT (specify suction-cup or permanent flange-type mounting) with re-loader bottle and six FilMagic Cloth Sleeves \$2.95 from your dealer or

**THE DISTRIBUTOR'S GROUP, Inc.**  
204 - 14th St., N.W. ATLANTA 13, GA.



SKETCHES BY SKITCH

- Soon
- All Through the Night
- Farewell Armanda
- Simplice
- In A Sentimental Mood
- As Long As I Live
- East of the Sun
- Mood Indigo

Skitch Henderson and His Orchestra

RCA CPS-69  
Stereo... \$10.95

Skitch, another musical Schizo, (see Mozart Clarinet Concerto, Benny Goodman) has had a hankering to show that pop tunes could be presented by a dance orchestra in a distinctively different style. He did not want the typical dance, mood, jazz or abstract musical productions, but rather popular tunes fashioned with tones of classical coloration. His experiments are interesting and agreeable. He injects classical hints in "Soon," and does a fast, slightly atonal version of "All Through the Night." In "Simplice" he takes a theme from the third movement of Tchaikovsky's Piano Concerto #1, modernizes it and plays it in an effective pianissimo. Skitch has a great deal of talent and ability. His classical background, both as a student of piano and serious conductor, as well as his popular dance band experience, has given him a broad understanding of music.

Top engineering by RCA.

RIGHT THERE

- Theme for Dreaming
- Roses of Picardy
- September Song
- Right There
- There's a Small Hotel
- Heart of My Heart
- Ivory Tower Blues
- Blue Moon
- Poor Butterfly
- All the Things You Are
- Jingle Jangle Jump
- Beer Barrel Swing Polka

Sam Donahue and His Orchestra

STEREOPHONY, INC., C 125  
Stereo... \$8.95

Donahue's 20-piece orchestra is rated high in the dance band field. Many of his musicians were members of the former Billy May orchestra. Here they provide 32 minutes of standard tunes styled for dancing. From the slow "September Song" to the upbeat of the "Beer Barrel..." you will be able to find something to suit your dancing mood, or ability.

The arrangements and solo work are good. The solo sax man seems to be featured throughout and you will hear him show off his talent in such numbers as "Heart of My Heart" and "Right There."

This tape should help keep the party going. Judging from the popularity of Lennie Herman's orchestra (Livingston Tape Library) Sam Donahue should fare as well.

The reproduction is good.



# WHAT? TR and TV for 3D!

For a high fidelity sound system that will play stereophonic tapes at their best we recommend the *Stereophonic Ampro Hi-Fi Tape Recorder*. This new Ampro recorder has built-in stereophonic playback heads and a preamplifier that can be used with any television or radio

set that has a "phono jack." You just set up your Ampro recorder on one side of the room and plug the stereophonic lead into the "phono jack" of your TV or radio. Then you, too, can enjoy living presence sound ... at a budget price!

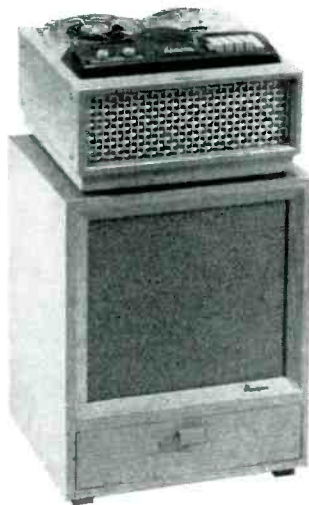

## ampro

- Hi-Fi Tape Recorder ..... \$249.95
- Hi-Fi Recorder with AM Tuner 284.45
- Stereophonic Hi-Fi Recorder... 284.45
- Hi-Fi Console Speaker ..... 69.95

*Prices include federal tax where applicable and are subject to change without notice. Graflex, Inc., Rochester 3, N. Y.*

# GRAFLEX®

A SUBSIDIARY OF GENERAL PRECISION EQUIPMENT CORPORATION



# NEW!

## 10 BRILLIANT STEREOS FROM RCA VICTOR,

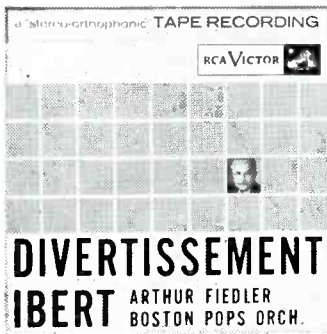

ACS-54, \$6.95.



BCS-52, \$8.95.



CCS-53, \$10.95.



DCS-51, \$12.95.



ECS-67, \$14.95.

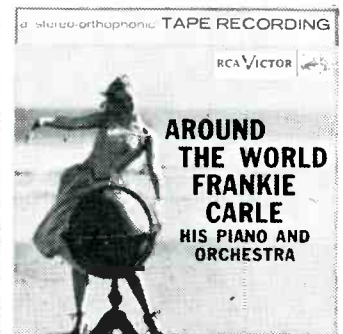

CPS-70, \$10.95.

**FREE!** the first complete catalog in RCA Victor's recorded tape history! Up-to-date, handy, and easy-to-read, this catalog gives detailed listings of the entire RCA Victor tape repertoire. Get one at your RCA Victor dealer's or in a new RCA Victor tape package today!

# THE GREATEST NAME IN RECORDED TAPE!

RCA VICTOR adds 10 *new* titles to the world's most extensive library of pre-recorded tape! From the glittering bravura of Ibert to the lush romance of Tchaikovsky, from the nostalgic piano stylings of Frankie Carle to the smooth vocal blending of the Ames Brothers, here are dual track stereo tapes that rival the sound of live, in-person performance.

With this new release, RCA Victor gives you your choice of 54 stereo tapes, more than 100 monaural tapes, all in brilliant New Orthophonic High Fidelity Sound! Handsomely boxed in album style, complete with liner notes, these tapes come on standard 7-inch reels for all lengths, each clearly labeled for instant identification.

The world's greatest artists . . . the greatest advances in sound . . . the widest range of selections—RCA Victor brings you *more* on tape!



CPS-73, \$10.95.

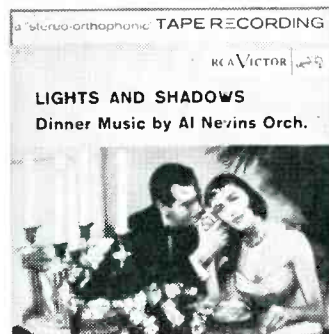

CPS-74, \$10.95.



CPS-75, \$10.95.

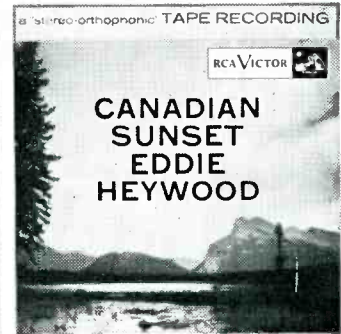

CPS-76, \$10.95.



**RCA VICTOR**  
TM&C) © RADIO CORPORATION OF AMERICA



Nationally advertised prices

# JOIN THE STEREOPHONIC MUSIC SOCIETY



and enjoy  
these  
benefits...

- MAXIMUM SAVINGS ON STEREOPHONIC TAPES
- NO MINIMUM PURCHASE REQUIREMENT
- IMMEDIATE SHIPMENT FROM MOST COMPLETE STOCK ANYWHERE
- CATALOG OF STEREO TAPES DISTRIBUTED QUARTERLY

plus  
**4  
STEREO  
TAPES  
FREE**

S.M.S.'s 1st anniversary new membership bonus gives you almost 1 hour playing time . . . featuring highlights from the superb stereo recordings of Concertape, Livingston, Omegatape and Replica, attainable only through S.M.S.

**ALL FOR  
\$9.00 FULL YEAR  
MEMBERSHIP**

Use this handy  
application  
form:

TO: STEREOPHONIC MUSIC SOCIETY, INC.  
303 Grand Avenue, Palisades Pk., N. J.  
Please enroll me for a 1 year period as a member of the Stereophonic Music Society. I understand that I am under no obligation to purchase any specified minimum of tapes under the Society's Group Purchase Plan. I am to receive the S.M.S. 1st Anniversary Bonus of 4 stereo tapes by return mail, as well as quarterly listings of all stereophonic tapes currently on the market.

My  Check  Money Order for \$9.00 is enclosed herewith (payable to the Stereophonic Music Society, Inc.)

NAME .....  
ADDRESS .....  
CITY ..... ZONE ..... STATE .....

MAKE OF RECORDER  
 Stereophonic  Staggered  
 Stacked  Monaural

Please send additional information concerning the Society.

ORGAN  
WELDON FLANAGAN AT THE PALACE  
IN DALLAS  
Mambo Number Five  
The Yellow Rose of Texas  
Boogie  
Petticoats of Portugal  
My Darling  
Honkytonk Train

Weldon Flanagan, Organist  
KLIPSCHTAPE KST-1006  
Stereo, 15 IPS... \$10.95

Some of the most pleasant added attractions on the bill at the Palace Theatre in Dallas, Texas, are the intermission programs performed on the theatre organ by young Weldon Flanagan. It is not difficult to understand his popularity when you listen to this tape. He plays with a cleanness that indicates his absolute command of the instrument and knowledge of exactly what it will do without overcrowding its many tonal resources. His rendition of "The Yellow Rose of Texas" is especially delightful.

Flanagan has almost singlehandedly rebuilt this 4-manual, twenty-rank Wurlitzer instrument and he is still working on the project.

The Klipsch engineers have done an excellent job of coping with the difficult problems presented in recording this thirty-year-old instrument. Some of their headaches were caused by noise level due to the multiple blowers, motors and pumps as well as air leaks. Meanwhile, Mr. Flanagan continues his worthy do-it-yourself campaign of repair and perhaps when the next recording is made the engineers will be faced with an easier task.

Reviewed by Dr. John Leahy of Washington, D. C.

THIS IS IT!  
Fanfare: This Is It!  
September Song  
Tiny Tot Tarantella  
Pool of Enchantment  
Midnight Chimes  
Bolero  
Once In a While

Warren Baker's Orchestra  
OMEGATAPE ST 7010  
Stereo... \$11.95

This is a 7-inch re-issue of the original 5-inch reel. Three selections on this reel are not listed on the label, or on the box, so I have included them above for your convenience. You won't find the closing theme as listed on the label, but that is of small matter.

The Baker's dozen is both a versatile and skilled aggregation. These men are capable of playing more than sixty instruments (not all at one time) and Baker makes use of these varied talents by using instruments not always heard in dance band music. You will hear the piccolo, bassoon, chimes, flute, French horn, tuba, etc., producing dance music of different tonal textures.

The notes supplied by Warren Baker gives

## Cameo Series STEREO TAPES

for  
**\$4.98**

At last — complete stereophonic tapes in the popular price range! *THE CAMEO SERIES*: perfectly balanced two-channel recording, providing spectacular distortion-free reproduction.

- 7 1/2 SPEED — STACKED ONLY
- COMPLETE MUSICAL SELECTIONS
- TEST TONE FOR SETTING LEVELS

**BARBER SHOP QUARTET**  
of the West Point Cadet Glee Club SC 401

**HAVANA RHYTHMS**  
Big band mambos and rhumba. Don Marino Barreto Jr. and His Cuban Orch. SC 402

**TCHAIKOVSKY: WALTZ FROM "EUGENE ONEGIN"**  
Bamberg Symph., Heinrich Hollreiser, cond. SC 403

**PONCHIELLI: DANCE OF THE HOURS**  
Württemberg State Orchestra, Stuttgart. Jonel Perlea, conductor. SC 404

**SOUNDS OF SPORTS CAR RACES**<sup>®</sup>  
Grand Prix Race of Watkins Glen, N.Y. SC 405

**GRIEG: TWO ELEGIAC MELODIES**  
Pro Musica Symphony, Vienna. Edouard van Remoortel, conductor SC 406

Write for complete stereophonic catalogue.

**PHONOTAPES INC.**  
248 West 49th St. New York 19, N.Y.

CONVERT YOUR TAPE RECORDER INTO  
A CONTINUOUS MESSAGE REPEATER

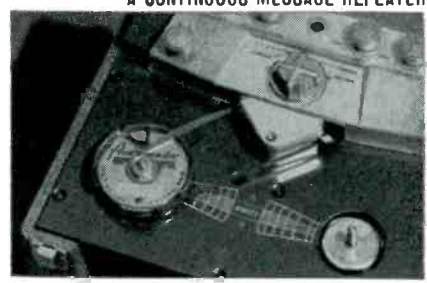

**AUDIO VENDOR**  
**MODEL U-300-C or U-300-CC**  
**Loaded with 180 ft. Cousino**  
**Friction-Free Tape**  
**\$12.50 Postpaid**

*Satisfaction Guaranteed*

The AUDIO VENDOR will convert your tape recorder into a continuously repeating mechanism. Successfully used to teach, sell, announce, dictate and for sleep learning. Plays from 5 to 10 minutes. Double time with a MOBIUS LOOP. No rewinding necessary. Repeats message or music continuously hour after hour. Send for literature on our longer playing models and accessories. Advise make and model of your recorder.

*If not available at your Dealer,  
order from*

**COUSINO, INC.**

2011 Ashland Ave., Toledo 2, Ohio  
Canadian Distributor: Dominion Sound Equip-  
ments, Ltd., 4040 St. Catherine, W., Montreal  
6, Quebec.

interesting background on all of the performers in the orchestra.

The stereo reproduction is fine.

**MY FAIR LADY AND THE KING AND I**

- My Fair Lady: Overture,
- On the Street Where You Live
- Wouldn't it be Lovely
- Show Me
- Why Can't the English
- I've Grown Accustom to Your Face
- With a Little bit of Luck
- Finale
- The King and I: Overture
- I Whistle a Happy Tune
- Hello Young Lovers
- March of the Siamese Children
- Getting to Know You
- We Kiss in the Shadow
- Shall we Dance
- Finale

**BEL CANTO—19**  
Stereo . . . \$9.95

Tunes from Broadway musicals continue to provide excellent material for recording companies and their artists. Their popularity and appeal is not to be denied and My Fair Lady and the King and I rate high. The music is played by the 70 piece New World Theater Orchestra. I especially liked the spirited rendition of "Why Can't the English" and the smooth delivery of "Getting to Know You." These are particularly good and the stereo reproduction is just fine.

**JAZZ**

**JAZZ AT SHREVEPORT—Volume II**

- Fine and Dandy
- Indiana
- Pennies From Heaven
- Perdido
- Holland's Holiday

Joe Holland Quartet

**KLIPSCHTAPE KST-1004**  
Stereo, 15 IPS . . . \$10.95

This is the first opportunity I have had to hear the Joe Holland Quartet, and I was so delighted with what I heard that I have played this tape over and over. In the first four selections Joe Holland's drums are ever-present, but not so much as to detract from the smooth and well-balanced playing of the rest of the quartet. But in "Holland's Holiday" Joe moves his drums to the center of the stereo-stage and really takes off! This is certainly the most exciting example of the jazz drummer's art that I have encountered on tape . . . or elsewhere.

As with all of the Klipschtapes, the quality of the recorded sound is superb. However, I was a little dissatisfied with the mixing on the last selection . . . I had the feeling that I would like to move my speakers closer together since the drums were stretched out too far across the room. I also got the impression that the recording was in a big empty hall which doesn't seem to fit the mood . . . a hall would never be empty when a group like this is playing!

Reviewed by Dr. John Leahy of Washington, D. C.

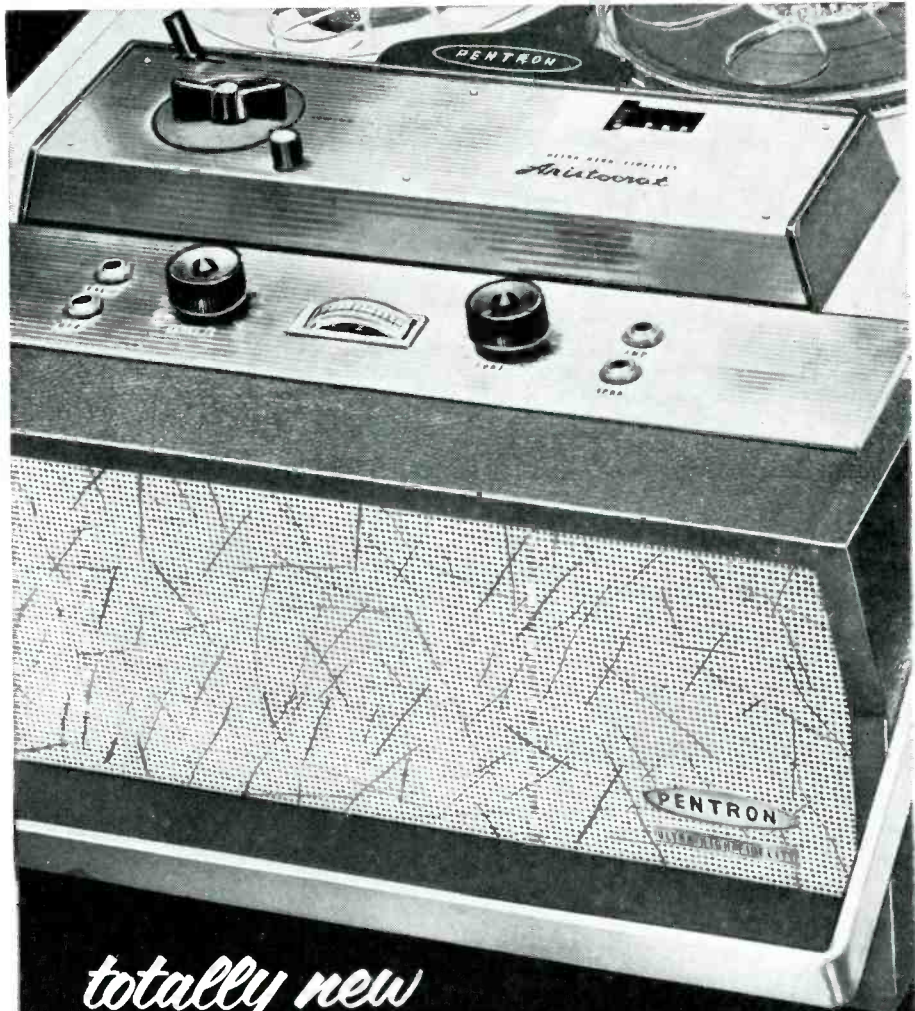

*totally new*

**PENTRON**  
high fidelity Tape Recorders

Each of the new Pentron recorders offers performance, simplicity and exclusive features that set it apart from the ordinary. Each Pentron is the finest in its price class, bar none! See and hear . . . then choose the Pentron that suits you best.

**BRILLIANT FEATURES exclusively PENTRON**

- FINGER FLITE SINGLE ROTARY CONTROL
- ENTIRE LINE AVAILABLE STEREOPHONICALLY (STACKED ONLY)
- BIGGER AMPLIFIERS AND EXTENDED RANGE SPEAKER SYSTEMS
- QUIK-FLIP SPEED CHANGE CONTROL
- MODULAR DESIGN HEAD ASSEMBLY WITH AZMUR-X HEAD ADJUSTMENT
- SEVEN OTHER PENTRON EXCLUSIVES

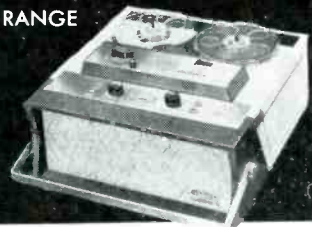

*important notice!*

Your dealer is now demonstrating new Pentron integrated tape components for custom installation. See them!

**"PLAY AS YOU PAY PLAN"**

ONLY 10% DOWN  
UP TO 24 MONTHS TO PAY

Write for full color literature



784 S. TRIPP AVE.  
Chicago 24, Illinois

Canada: Atlas Radio Ltd., Toronto

# TAPE IN EDUCATION

BY JOHN J. GRADY, JR.



In recent years, in schools of all kinds, from the primary class of the elementary schools to the senior class of the great universities, numerous uses have been developed for the versatile magnetic tape recorder. In many cases, what were once experimental uses have advanced into approved instructional routine. Other uses, being tested now, are on their way to approval and installation. Magnetic tape, definitely, has been accepted by educators as a beneficial aid to modern teaching. And students, because of contact and training with this marvel of Audio, are becoming better equipped for the future as the result of the knowledge acquired through the aid of the new scientific teaching tool.

Even in kindergartens, the tape recorder is a valuable helper to instructors. Activities, accompanied by taped music, are better supervised by teachers free to participate and individually instruct. Now, it is recognized in educational circles, that the microphone of the tape recorder provides inspira-

tion to youngsters to sing well and to speak clearly. At the other end of the educational structure, students in adult education and post-graduate courses attain their objectives of a new proficiency—or a refresher in modern technique—through the auditory help of magnetic tape. Therefore, it's obvious that all scholars, beginning with those of earliest legal age, derive benefits from tape recording in education.

However, it's a saddening fact that there are children under legal school age, who must be provided with a specialized form of education, or there will be an intensification of sorrow and heartbreak for innocent children and for their unhappy parents. Each one of us should breathe two sincere prayers—one of deep sympathy, and one of thanksgiving—as we consider the plight of darling children—pre-school children of from 18 months to 5 years of age, who are hard-of-hearing or are permanently deaf. The faculty to speak exists. The problem is to teach speech sounds to little ones, who cannot

hear those sounds, so that they may communicate with others, using their voices to utter words they cannot hear. There is satisfaction and some resultant happiness when little girls and little boys, through alert senses of sight and touch master their own system of communication, which includes the understanding of the speech of others, and the use of their own voices. It is heartening that tape recording has a part in this noble work.

Fortunately, for many such children and for their parents, one mother dedicated her life to improving the unhappy conditions imposed on children with defective hearing. All children, deaf at birth or with only limited hearing, and those children, who became afflicted—through illness, perhaps—before they learned to speak, all of them became the objects of this one mother's bountiful care. This mother, because of the affliction of her son, was inspired to found a clinic in California for the free instruction of pre-school deaf and hard-of-hearing children. And necessarily, the instruction of the children's mothers was—and is—included in the program of educational activity of the John Tracy Clinic, at Los Angeles. An associate activity was the establishment of a course of free instruction through correspondence. This helped to make the John Tracy Clinic known all over the world. In addition, in association with the University of Southern California, a course is available for the training of teachers in the instruction of deaf children of pre-school age. The John Tracy Clinic, a truly noble humanitarian institute, which has attracted the support of numerous benevolent people, exists to dispense good to others because of the indomitable energy and spirit of Mrs. Spencer Tracy, the wife of the famous motion picture star.

## CONCERTAPES Has Everything in Stereo! Top Hits! Top Package! Top Artists!



Classics,  
Pops and  
Jazz  
by Names  
You  
Know!

ONLY CONCERTAPES has stereo recordings by THE SYMPHONY OF THE AIR! Carnegie Hall recordings by this famous orchestra: TCHAIKOWSKY: THE NUTCRACKER SUITE. BERLIOZ: ROMAN CARNIVAL OVERTURE and WAGNER: OVERTURE TO DIE MEISTERSINGER.

NANCY WRIGHT SINGS! And the NBC TV star does it "just for you" in her intimate style.

MARIMBA TROPICALE! NBC TV's Jose Bethancourt and his orchestra play it Latin style in a sure best-seller.

INVITATION TO ROSELAND. Wendell Tracy takes you dancing in a tape that makes stereo history.

REVERIES. Accordion virtuoso Vince Geraci in another sound-on-sound excursion into stereo.

Exclusive CONCERTAPES Stor-A-Tape 'Sound in the Round' package keeps dust out, moisture in. Commended by Hi-Fi Music at Home. 75c list.

Only CONCERTAPES offers such a wide and wonderful variety of talents and tempos on stacked or staggered stereo tapes and dual-track monaural tapes, 7" reels, 7½ ips, \$11.95 list. 5" reels, 7½ ips, \$7.95 list.

See your Dealer and write us for current catalog.



**CONCERTAPES, INC.**

'Sound in the Round'

522 Green Bay Road, Winnetka, Illinois

TAPE IN EDUCATION is grateful to Edgar L. Lowell, Ph.D., the Administrator of the John Tracy Clinic, for information relative to the use of tape recording in the instruction of deaf and hard-of-hearing children. The program of instruction includes the mother, as for years she will have to be the guide, companion and teacher of her little loved one. In the case of children with adequate residual hearing, head-sets route the amplified tape instruction directly through the ear channels. Combined with visual and touch instruction, understanding of words is expedited. With understanding established, sight, touch and amplified sound are marshalled by competent teachers to help the child articulate correctly. The complete process requires patience, love and compassionate understanding. A tape of a child's utterances is the evidence of progress that prompts mothers to strive and hope, hope and strive. And there really are happy smiles at the John Tracy Clinic, for the method of instruction is productive of real understanding on the part of the children, and from that understanding, accomplishment of a vocal victory will come eventually.

The sight of a pretty three-year-old girl, with head-set on, listening intently to catch the sound of her own voice on a tape playback, supplies our idea of a vision of heavenly hope. TAPE IN EDUCATION, at least, is doing a repeat on two sincere prayers—one of deep sympathy and one of thanksgiving.

# TAPE CLUB NEWS

We note that an Arkansas T-R-I member who tapes a friend in Holland passed along a tape which included a few "meows" from the family cat, and it was returned with an answer from the equally catty pet of his Holland tape buddy. All of which "shows to go you" that this purr-fectly wonderful tape correspondence business is really for the hep cats. All nonsense aside, a few remarks from the family parakeet, parrot, dog, cat, canary, and so on and so on, might add a little more interest on some of those tapes to your friends. How about it—have you an American dog who might like to hear from a British four legged pal?

Voice-pondence club member Evelyn MacDonald of Washington firmly believes that tape recorders and dancing make a good pair, and, of course, we agree. Evelyn works out a dance program on tape before a dance. Her format, for instance, runs something like this: a dance mixer to start things off; easier dances first so that everyone can participate; throw in a complicated one now and then to keep those dancers who have progressed further happy; a slow dance before and after the more violent ones; another mixer once in awhile to give everyone a chance to dance with the other fellow. Evelyn is particularly interested in folk dances, which are varied and numerous and which can provide a funfderful evening. She also points out that some of the dance program reels make grand dinner background music.

By the time this issue is out, the Northeast District "Tapevention" and picnic of The Voicespondence Club will be over. More than 100 tape recorder enthusiasts from the seven northeastern states and other parts of this country and Canada are expected to attend this meeting, held September 1 at Roselawn grill and park, New York Mills. There will be a buffet luncheon, a speech on "Tape Recorders and Hi-Fi" by an electronics engineer, a "Tape In Education" discussion by a professor of zoology, a stereophonic demonstration, talks by the club secretary and district deputy, etc. In all, it appears to be an interesting and entertaining gathering.

"Are you an active member, or do you just belong?" This line is quoted from a poem entitled "Which Are You?" which appeared in one of the "Resound" bulletins of The Australian Tape Recorders Association. Most apropos we feel for all tape clubs. Enjoyment derived from being a member of any club is tenfold for those who actively attend local meetings, keep up a steady, interesting tape exchange, support club projects, submit ideas for club unity, write items for club bulletins, etc. Why not be among those who really further tape exchange, and the countless enjoyable wonders that tape can provide.

Three Tape-Respondents International

club members pooled forces to help promote T-R-I and the use of tape response as an aid to the study of English as a foreign language at the Northwest Conference of the National Association of Foreign Student Advisors held at the University of Washington in Seattle. Club member Bob Council of Vineland, N. J. prepared a tape discussing the educational advantages of tape exchange and sent it along to Seattle. Two local T-R-I mem-

bers, Frank Stewart and Bruce Gordon, attended the conference to participate and to answer any questions following the playing of Bob's tape. Bruce also brought along his new binaural equipment and presented a stereo demonstration.

American Tape Exchange member, Darrell Howling of Ontario, Canada has an English tape pal who records the top ten songs in Britain, plus some new releases, and sends them on to him. Darrell called up a local radio station and asked if they would like to dub the songs and play them on the air. The station representatives were not only willing, but delighted.

(Continued on page 23)

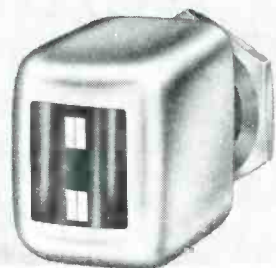

## CONVERT YOUR TAPE RECORDER TO IN-LINE STEREO

- USE YOUR HI-FI for ONE CHANNEL
- USE RECORDER, TV or RADIO for 2ND CHANNEL

Now you can convert your tape recorder to the new *in-line stereo* for as little as \$22.50! Use one of the five Dactron *in-line DYNAMite* conversion kits and improvise *two* audio channels from hi-fi, TV, radio or recorder.

The shielded DYNAMite two-channel tape-head incorporates all latest design features. Flux gap of .00015 produces a smooth, extended frequency response at 7½ IPS. Core width is the new .070 in. standard. Will drive any standard pre-amp.

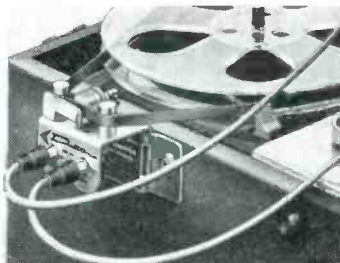

### THE STERADAPTER

Your easiest introduction to stereo. An attachment that converts most tape recorders for in-line stereo. Easy installation with hand tools. Model 4902. \$22.50.



### "SHURE" CONVERSION KIT

Replaces the Shure head in many thousands of recorders. You get spectacular in-line stereo *plus* improved monaural performance. Model 4200. \$20.00.

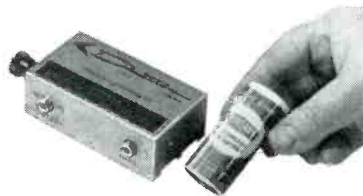

### TRANSISTOR PRE-AMP.

Ingenious battery powered pre-amp suitable for use in the second channel when feeding into radio or TV audio system. Model 4501-A (Less battery) \$18.75.

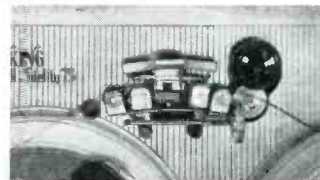

### "Viking" CONVERSION KITS

Three different kits. Model 4800 for in-line tape only, \$32.50. Model 4801 for staggered tape only, \$32.50. Model 4802 for *both* in-line and staggered, \$39.95. Features new phasing Micro-Adjustment to accurately "phase" staggered tape while playing.

Dealer inquiry invited.

**Dactron** ONE OF THE MANY ADVANCES IN STEREOPHONICS FROM THE INTERNATIONAL MAGNETIC ELECTRONICS CO BOX 987, MINNEAPOLIS 1, MINNESOTA

call in the family  
call in your friends  
... get ready to

"SING-A-LONG" with  
Bill Andrews'

## "OLD TIMERS"

64 old time songs  
played on the ALLEN ORGAN

Never before have so many old favorites been recorded on a one hour tape. You'll love listening to (singing along with) Bill Andrews' original styling as he brings you 64 old time songs... some lively and gay... some soft and sweet. It's truly A TREASURE FOR YOUR TAPE CHEST. Enjoy...

Let Me Call You Sweetheart, Margie,  
If I Had My Way, Peg O' My Heart,  
Sally, Mexicali Rose, Cuddle Up A Little  
Closer, Honey, Heart Of My Heart,  
Melancholy Baby... and 54 others

VT-OT 120 M..... \$11.95 ppd.  
VOTO SAMPLER..... 1.50 ppd.

.....

... if you missed VOTO-Tapes' first  
release, why not order now and wander

## "DOWN MELODY LANE"

with Bill Andrews as he plays

September Song, Autumn Leaves,  
Ramona, Beautiful Ohio, Tenderly,  
Laura, My Wonderful One... and  
18 others on a one-hour tape.

VT-SP 112 M..... \$10.95 ppd.  
VOTO Sampler..... 1.50 ppd.

All tapes are monaural... Dual track  
... 7 1/2 I.P.S.

Order from your dealer now or send direct to:

VOTO RECORDING COMPANY  
Richlandtown, Pennsylvania

## Record Anything, Anywhere with "The Magnemite"

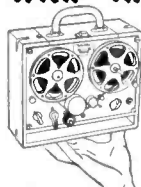

Battery-operated, spring-motor  
tape recorder designed for  
professional field use. Assures  
complete independence from  
AC power. Meets National  
Association of Radio and Tele-  
vision Broadcasters standards.  
60 Models available.

Write for free literature and direct factory prices to Dept. TR.

AMPLIFIER CORP. of AMERICA  
398 Broadway • New York 13, N. Y.

© T.M. Reg. Pat. Pend.

## TEEN TAPERS

BY JERRY HEISLER, National President



SUMMERTIME has given me the opportunity to prove the idea I had long held; tape is a year-round activity well suited to the outdoors.

I had the opportunity of spending the summer as a counselor in a summer camp. I'm sure many of you also spent the summer at camp or have been at camp sometime during your life. Well, the uses of a recorder at a camp are great and so we'd like to go back over the summer giving you some ideas and letting you recall all of the fun you had at camp.

Our camp had a terrific problem with dances. Since we had older and younger kids we used to have two separate dances on Saturday night. We had only limited numbers of records and both groups seemed to like the same music. We solved this problem by taping all of the records. One group played the tape and the other used the actual records. Incidentally, many of the campers had records of their own which the camp would have liked. One rainy day we got together and had all of the kids bring their records in. We taped them all and now the camp has a big selection of music at very low cost and containing the records that the campers like the best.

Camp shows are a favorite activity at most any camp and sometimes after the camp season has ended we like to think back at all of the fun we've had. We made it a practice at our camp to record each play and make it a part of the camp records. Anyone wanting a copy of the tape was welcome to make a copy of it at anytime. We also recorded some camp songs and any other important events worth noting. In our final production, which was quite lengthy, we recorded the cues for the leading parts and let them use the recorder to help memorize their lines. The play also required a recorder as a property.

Most camps use bugles to signal various events of the day and our camp was no different. Every morning Reveille sounded bright and early and we always pitied the poor fellow who had to get up at 6:30 so he would be ready to play the record at 7:00. This situation was remedied by putting the bugle call on tape and connecting it to an inexpensive time clock which automatically blew reveille each day. The same thing can be done for other bugle calls. The only drawback is that a power failure could slow up the clock, but then who objects to sleeping an extra hour and, after all, it was "beyond our control." The camp director may not like it but you'll certainly be popular with the campers.

We made considerable use of the recorder in square dancing as was mentioned in a previous issue. Calls we omitted from the tape and live calls were added to the recorded music.

Since most camps are located in woods

of some kind away from city life, it is a good chance to make a collection of the sounds of nature which are many and fascinating. We made some good tapes of these sounds.

Sound effect tapes can be very useful at campfires too. We had several games of guessing sounds. We always played the sounds back very loud so as to fool the campers. You might try something like this at your camp if you return next summer.

Of course tape corresponding is a natural at camp with a recorder handy. I never seemed to have time enough to handle all my correspondence and I found that as long as I was using the recorder I might as well send tapes. You'll also find camp the best place to pick up new tape pals. I met so many people that I wanted to correspond with here. Think over your list of camp friends and see if you can't correspond with some of them. I'm sure you'll have many camp experiences to relive together.

Many schools make tapes about their school to send to foreign countries. A good project to work up over the winter months would be how to make a tape telling all about your camp. Your camp director would no doubt welcome such a tape for use to get new campers interested in attending. Most camps have movies, and a sound story would be a big help. We made a sound track to be used with our camp movies which proved to be loads of fun.

And of course we all know how much fun it is listening to good music and the recorder is always welcome in a cabin to provide music for rest hours. Yes, summer camp is loads of fun and an experience that provides us with lots of memories. A recorder is loads of fun at camp and of considerable service. I can still relive the memories of my summer at camp because I have the biggest moments down permanently on tape.

You will recall that a while back we asked for people to submit their ideas for an original tape recorder. We've had a number of replies and one of them will appear next month—we don't have room for it this issue. It is from Robert Hamel of New York. We are pleased to present Robert with a one-year subscription to TAPE RECORDING magazine.

Let's hear from some of the rest of you as to what you'd like to see in a tape recorder that was made to your own personal specifications.

Next month we'll all be back at school and we hope to get more clubs started. Enjoy the rest of your vacation.

I'll be at the Hi-Fi  
TAPE RECORDING EXHIBIT  
ROOM 707  
CHICAGO HI-FI SHOW  
Palmer House, September 13-15  
See You There



(Continued from page 21)

The British Amateur Tape Recording Society Hospital Service, noted in previous issues, is expanding. Four more hospitals are being covered; it is hoped shortly to exchange tape programs between all hospitals concerned. Any member who can assist in making the programs, or who is willing to help in any hospital S.O.S. call is requested to contact club member Alan Lovell.

World Tape Pal Ed Bush, of Edinburg, Indiana, who has done such a grand job the past two years managing a club booth at the Indianapolis Star Hobby Show is calling upon fellow club members for help with this year's exhibit. The primary purpose of this exhibit is the promotion of tape recording exchange and to publicize the People-to-People program. Ed would like to receive suggestions for displays and welcomes literature or magazines relative to the tape recording field to hand out to visitors at the booth. He is also seeking volunteers to help set up and tend the display, and would like to form a committee to handle the project. Since the exhibit depends a great deal on available funds, donations from members are appreciated. Any member wishing to contribute may do so by sending his donation to the club secretary marked "For the WTP People-to-People Exhibit."

We have received a copy of World Tape Pals second large (100 page) directory, which contains a complete membership roster. This edition gives a short summation of each member, including his or her interests, as well as tape mailing information. There are over 2100 listings in 57 countries and possessions around the world. It is a printed testimonial to the ever-increasing popularity of this club.

#### JOIN A CLUB

##### TAPE RESPONDENTS INTERNATIONAL

Jim Greene, Secretary  
P. O. Box 125, Dept. T., Little Rock, Ark.

##### THE VOICESPONDENCE CLUB

Charles Owen, Secretary  
Noel, Virginia

##### WORLD TAPE PALS, Inc.

Marjorie Matthew, Secretary  
P. O. Box 9211, Dallas 15, Texas

##### AUSTRALIAN TAPE RECORDISTS ASSOC.

Jack A. Ferry, Federal President  
Springbank Rd., Clapham, S. Australia

##### UNITED RECORDING CLUB

Richard L. Marshall, President  
2516 S. Austin Boulevard  
Chicago 50, Ill.

##### THE NATIONAL TAPESPINNERS

Carl Lotz, Secretary  
Box 148, Paoli, Pa.

##### THE BRITISH AMATEUR TAPE RECORDING SOCIETY

Ted Yates, Secretary  
210 Stamford Road  
Blacon, Chester, U. K.

##### AMERICAN TAPE EXCHANGE

Stuart Crouner, Secretary  
181 E. Main St.  
Gouverneur, N. Y.

# NOW-STEREO-SOUND for YOUR HOME

**V-M** new model 714 tape-o-matic®

Here is V-M's brand new portable tape recorder that plays all stereo tapes—stacked AND staggered! In addition it records and plays back monaurally. It obsoletes none of your present equipment—pair it with your present radio, phonograph or any other amplifier-speaker system for the awesome, all-enveloping sound of stereo music. No other portable tape recorder does so much so well. **See it! Hear It!**

**The FIRST Portable Tape Recorder to play ALL Stereo Tapes!**



Model 714—Two-channel, dual-speed monaural record and playback. All-stereo playback. Two-tone gray leatherette \$225.00\*

\*Slightly higher in the West.

the **V-M** of Music®

V-M CORPORATION - BENTON HARBOR, MICHIGAN  
WORLD'S LARGEST MANUFACTURER OF PHONOGRAPHS AND RECORD CHANGERS

#### RECORDS FROM YOUR TAPES

Meetings, concerts, training aids, etc. economically re-recorded on permanent hi-fidelity discs. Professional quality—overnight service—all speeds—any quantity. Write for Free Folder and Prices.

**RECORDED PUBLICATIONS LABS.**  
1556-1570 Pierce Ave., Camden 5, N.J.

#### STEREOPHONIC TAPES

SAVE TIME & MONEY  
All Brands over 300 Titles.

1200 ft. Plastic Recording Tape \$1.59  
Write for complete catalog & prices  
We mail everywhere.

**Hi-Fidelity Electronic Sound Corp.**  
368 Montgomery Ave., Merion Station, Penna.

## TAPE RECORDERS

Tapes—Accessories  
Nationally Advertised Brands  
**UNUSUAL VALUES**  
Send for Free Catalog

**DRESSNER**  
69-02 AA; 174 St.  
Flushing 65, N. Y.

**MERITAPE**  
Low Cost,  
High Quality  
Recording  
Tape—in  
boxes or cans.



**Magnetic Tape Splicer**  
Satisfaction Guaranteed  
Complete with new pre-cut  
lylar tape tabs.  
**ONLY \$1.50 Postpaid**  
if your dealer can't supply  
it—  
Order direct from Cousins,  
Inc., 2011 Ashland Ave.,  
Toledo 2, Ohio  
Dealer and Distributor  
Inquiries Invited.  
Canadian Distributor: Domin-  
ion Sound Equip. Ltd., 4040  
St. Catherine St., W. Mon-  
real 6, Quebec.



Stereo sound has brought living music to the home. Shown above is a system which uses a tape transport mechanism, or deck, on the right to feed a dual channel amplifier, center. The output from the amplifier is fed to the two speakers built into the room. Transport and amplifier are by Bell Sound Systems.

## Stereo Sound for Your Home

by  
Mark Mooney Jr.

*. . . . Stereo for the home may be had in component form, portables or beautiful furniture units.*

**A**BOUT this time last year, when our first special stereo issue was published, the new sound was on the threshold of real commercial acceptance. The work of the pioneers was beginning to bear fruit. As more and more people heard stereo at audio shows, or in the salesrooms of dealers, more and more bought it and, in turn, became salesmen for stereo themselves when they invited the neighbors in to hear the new outfit.

A year ago a cataloging of stereo tapes available took very few pages. Today, as the latest edition of the Hi-Fi Tape Recording Catalog of Stereo Tapes shows, there are more

than 400 reels available covering all types of music.

Two things point to the continued growth of stereo for the home. One is the fact that all but one of the major recording companies either has tapes on the market or is planning to release them shortly. Another reason is that the variety of stereo equipment available is increasing with a rapidity that equals the growth in tapes. Now you can have stereo in your home just the way you like it. Do you wish to convert a recorder to stereo playback?—you can. Do you want to build it yourself with hi-fi components?—you can. Do you want a ready-to-go portable outfit?—there are a

number of fine ones on the market. Do you want a stereo tape player to hook into a present hi-fi system?—you can get it. Do you want a complete package housed in a beautiful cabinet that would grace any living room?—it's available.

No matter what your tastes, or the state of your pocket-book, there is something that will fit your needs. When this stage is reached in the growth of a new type of product you can be sure it is here to stay. Its continued growth is assured by the fact that stereo offers the most realistic reproduction of music and sound. Only those with impaired hearing cannot enjoy the full, living sound provided by stereo.

The directory of stereo equipment that begins on page 43 likewise has more than doubled within the past year, indicative of the increased demand for stereo and the potential yet to be realized.

Stereo differs from regular sound reproduction because there are two separate channels, from the time the sound is picked up by separate microphones until it is again recreated from the two tracks on the tape and emerges from the two loudspeakers.

If you already have a hi-fi rig, it may pay you to investigate the possibility of adding a stereo deck and using your present system as one channel. You will need a duplicate amplifier and speaker to take care of the other channel. The picture at the head of this article shows such a system built from components. In this case, a two-channel amplifier is used, rather than two separate amplifiers.

Many units on the market today are constructed so that the recorder plays one side and the second channel is provided by a TV or radio set that has a phono input jack. Other units, such as the one shown on this page, are complete in two cabinets, or portable cases. Still another variation is a separate player which drives two separate speakers. These too are available in portable cases. In most instances, the recorder also functions as a regular monaural recorder in addition to the stereo playback feature.

Beautiful, both in sight and sound, is the only way to describe the complete console units manufactured by

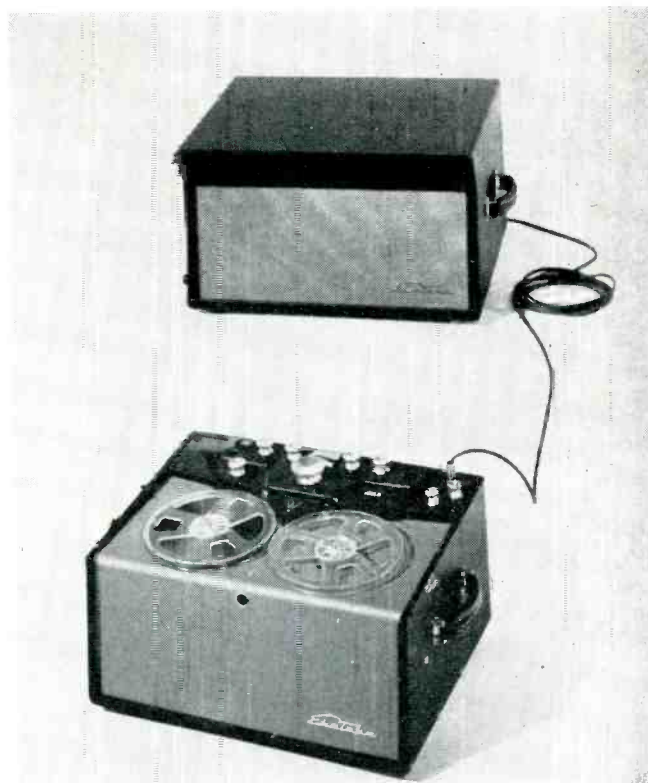

The Ekotape features regular recorder functions plus stereo playback through the matching speaker unit or other speakers. Most of the machines in this price class are portable and use external amplifier-speakers or radios or TV sets for the second channel.

Ampex, V-M, Fisher, RCA and Bozak. These sell for \$1000 or more and are complete home music centers, including radios, monaural recording, stereo playback and a record changer.

Whatever course you take, from converting a recorder you now have to purchasing a complete console, you may be sure you will increase your enjoyment of sound and music many times over.

The most complete systems manufactured are console units which are really home music centers. They contain a recorder with stereo playback, radios, AM and FM and a phonograph. Usually there is an elaborate switching system permitting the use of any of the components singly or together. Units such as this Ampex console, are marketed for \$1000 and up. The speakers are housed in the ends of the cabinet, pointing outward to distribute the two channel sound for stereo. The cabinets are beautifully finished. Bozak, Fisher, RCA, and V-M, in addition to Ampex are offering the complete centers.

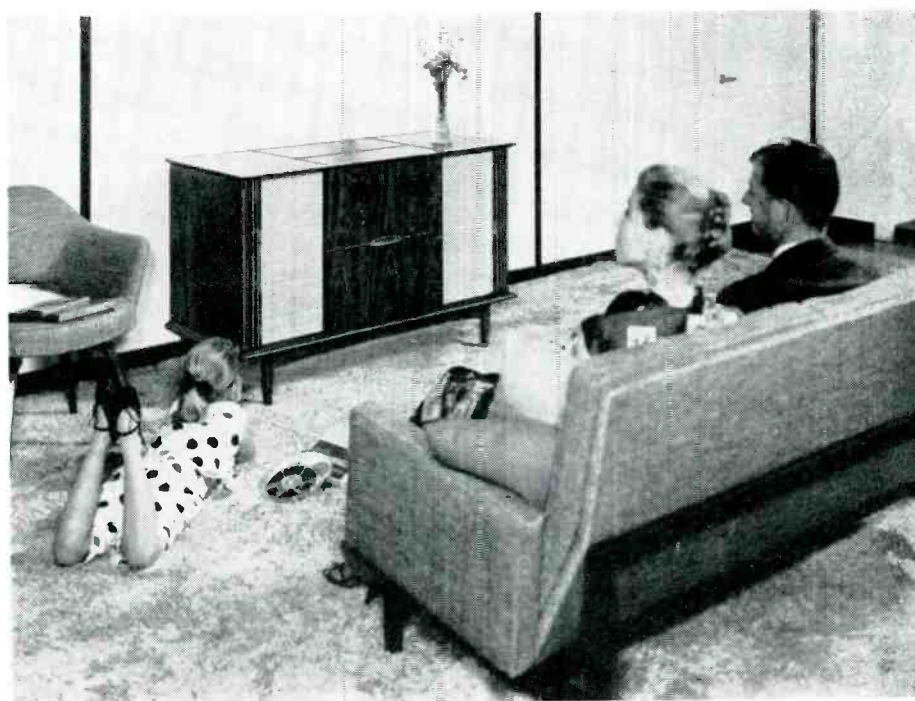



Livingston

# Building Your Stereo Tape Library

by  
Georgie Sigsbee

*... here are a few suggestions  
to help you get started in stereo*



Stereotape



Concertapes



Omogatape

**S**OUND reproduction, above all things should be realistic. Not only the realism of an individual note that sounds clear and clean as it comes from the tapes but realism too in the balance of sound, with each of the instruments in its proper audio perspective.

As the years pass it seems to me that we, as a people, are searching more for the basic truth and realism of all things. It is my opinion that from the old Edison wax cylinder to the more modern phonograph, to high fidelity and now to tape with stereophonic sound, the trend shows that progress is, always, toward the ultimate in *realism*.

Another industry that comes to mind, as an example, would be the movies. From silent films to sound on film, from poorly reproduced black-and-white to clear, sharp pictures and on to color, wide screen and Cinerama.

All this progress is for one result... realism; a "you are there" feeling.

Music on tape has given us truer fidelity. Stereophonic sound has brought us the realism of having the balance of sound where it should be. For one who loves music and wants to hear it at its best, stereophonic sound makes it a thoroughly satisfying experience, like receiving a gift one has long desired.

If you are one of those who are just beginning to break into the tape field, or if you have not yet done so, you are in for more pleasure in the future.

The steady, and almost amazing growth in the number of stereo tapes available has been brought about because those who love music have found stereo to give them the realism they seek. The current edition of the *Hi-Fi Tape Recording Stereo Tape Catalog* lists more than 400 reels of stereo music from which you can choose.

Because stereo is new, most people will, in a sense, be "starting from scratch" in building a library of stereo tapes. With this in mind we would like to offer a few suggestions that represent our own thinking on the building of a tape library. In our very pleasant task of listening to and reviewing tapes we have come to know and love a good many of them. We hope that these few suggestions will prove helpful to you if you are confused by the multiplicity of offerings, titles and composers.

Because there are those who love classical music to the exclusion of all other types and because there are those who prefer the lighter tunes and pops and care little for the classical we will endeavor to steer a middle course in our recommendations so that the net result will be a well



RCA Victor



Replica



Bel Canto

balanced stereo library. It is also hoped that those who do not feel that the grass is greener on the other side of the fence, might at least be tempted to try it and see if perhaps both sides might not prove interesting, as well as digestible.

We feel that everyone should strive to enjoy all kinds of music. There is no necessity to "understand" certain kinds of music in order to enjoy it. If you are one of those who is wedded to one kind of music, resolve to dabble a bit outside your chosen field—you'll find you will widen your experience and enjoy music more.

In compiling these suggested compositions from the stereo section of our library as well as from current stereo listings, we have tried to cover enough of the essential ones to give anyone's music library a firm foundation. You will find this comprehensive, but far from complete.

For those not too familiar with the classics (and keep in mind that we are now speaking within the limitations of stereo releases) we would recommend the music of Brahms, Beethoven, Rachmaninoff and Tchaikowsky as composers whose music will be bound to afford much inspiration and enjoyment. On the lighter side would be Grofe, Offenbach, Ravel and Johann Strauss, Jr.

In the field of the symphony we would suggest Beethoven's Fifth (the "Victory") and the rhythmic, energetic, Seventh. His last, the Ninth, is the "Chorale" symphony which ends with the magnificent "Ode to Joy," and is a most worthy addition to anyone's tape library.

Berlioz's "Symphonie Fantastique" will contribute a variety of moods from dreams of a ball, or a meadow, to wild witch dances.

Mozart's Symphony No. 1 (the "Jupiter") is a wonderful example of the fluid tonal beauty and forceful, triumphant emotion his music evokes.

Serge Prokofieff's "Classical Symphony" lends a more modern yet melodic listening experience.

Tchaikowsky's Symphonies, Nos. 4 and 6, contain familiar themes for, as you know, many have been lifted for use in the popular music field. His music is filled with color, melody and charming flourishes.

From the symphony we progress to the concerto. Among the violin concertos we believe you would enjoy Beethoven's Violin Concerto in D and Brahms's Concerto in D. For the piano you will find the very popular Piano Concertos Nos. 1 and 2 by Franz Liszt, Rachmaninoff's Piano Concerto No. 2 and Tchaikowsky's Concerto No. 1, and for classical piano, Beethoven's Piano Sonatas Nos. 23 and 8.

There are many orchestral selections available. In a more serious vein are Mozart's "Eine Kleine Nachtmusik," Debussy's "Prelude to the Afternoon of a Faun," Musorgsky's "Pictures at an Exhibition," Respighi's "Pines and Fountains of Rome," and Tchaikowsky's "Romeo and Juliet."

As to lighter works, there are the "Polovetzian Dances," by Borodin, Dukas' amusing "Sorcerer's Apprentice," Grofe's popular "Grand Canyon Suite" and Ravel's "Rhapsodie Espagnole" and "La Valse" and "Bolero," Gershwin's "Rhapsody in Blue," Offenbach's "Gaiete Parisienne" and Tchaikowsky's "Nutcracker Suite."

The stereo tapes which contain diversified selections are a valuable augmentation to the music shelves. As examples there are "Waltzes and Polkas" of Johann Strauss, Jr., and "Origin of Life," "Song of Your Heart," "Finlandia" and "Pohjola's Daughter" by Sibelius.

Your own taste should guide you beyond this point as any recommendations we might make would reflect our own thinking.

There is a world of material from the inspiring excerpts from Handel's "Messiah" to the latest and hottest jazz combos and quintets. There is an excellent selection of religious and choral music. Solo instrumentalists are present, too, including Guitarists Oscar Moore and Sabicas, and on the organ Kurt Rapf (serious organ recitals) and George Wright and Gordon Kibbee whose performances on giant theater organs bring back the days of the silent movies. Anton Karas playing the zither and Oistrakh performing on the violin are also present.

In the field of popular and popular-latin music you can find almost anything to fit your mood of the moment.

Perhaps every tape library should contain one novelty tape such as "Sound in the Round," or the "Clear the Grid" which features sportscar races. Don't overlook the demonstration tapes, many of which are sold at low prices and contain excerpts from the stereo tape library of the firm which issues them.

"Pops" are on the increase and there is now more music available on tape than was available on LP's when they were introduced to the public.

After four years of reviewing tape offerings we can say that almost without exception the offerings of the various companies are good, some are excellent and some superb. All in all there is plenty available to suit anyone's tastes and inclinations. Good hunting!

# Stereo Loudspeaker Placement

by James Cunningham  
and Robert Oakes Jordan

*. . . . proper speaker positioning assures  
better sound reproduction.*

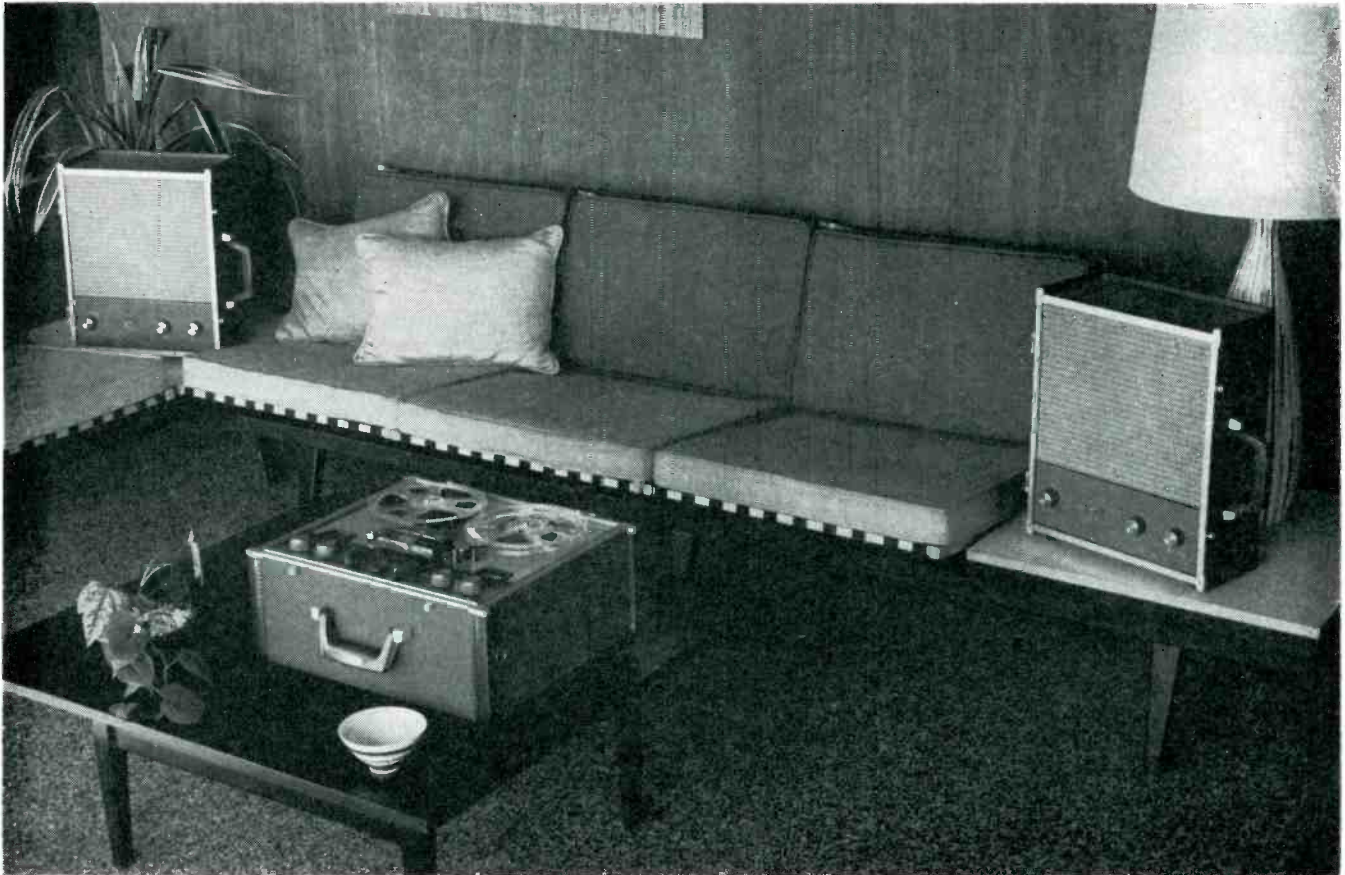

In a stereo loudspeaker placement setup such as this, the best listening position would be on the opposite side of the room from this arrangement. Since too many reflection sources in a room tend to diffuse the sound, items such as drapes or similar material provide excellent absorptive mediums.

**S**TEREO loudspeaker placement has long been a subject of considerable controversy. This is to be expected since individual listening rooms as well as the preferences of the people who own them, vary rather widely. Unfortunately, no hard and fast rules can be given about stereo loudspeaker placement, but a number of suggestions can be given from which it is possible, with some experimenting, to arrive at a good stereo placement.

In Figure 1, opposite, are shown a number of possible placements. These will be discussed in detail shortly, but first if you can't or don't prefer to experiment, Figure 1A has been found to work well in the average listening room and should provide a good stereo effect. Also there are several "packaged" stereo systems which are complete in one cabinet and carefully designed to work well in most listening rooms. These are made by Ampex, Fisher, and VM. Also a dual speaker system in one cabinet is offered by Bozak.

If you have followed this series of articles on stereo, you know that the stereo effect is produced by a combination of intensity, time, and frequency differences at the two loudspeakers. It follows that we must not upset these conditions by using the wrong loudspeaker placement. For example, if we arranged the loudspeakers so that the listening position was much closer to one speaker than another, the balance of time and intensity would be upset resulting in a poor stereo effect. Also, it should be remembered that the wall which the speakers face into should be as non-reflective as possible. Drapes, tapestry, or similar material hung on the wall will provide excellent absorptive qualities. The reason for this is that too many reflections in the listening room will tend to diffuse the sound, destroying the intensity differences between the loudspeakers. As proof of this statement, listen to stereo outdoors—the effect is astounding.

Figure 1A shows what is probably the most used stereo

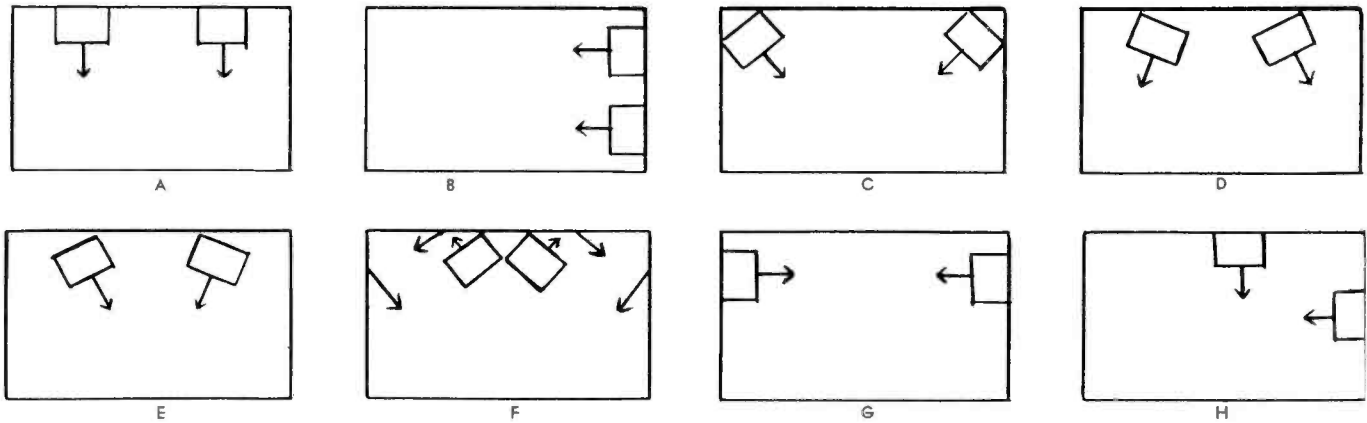

Figure 1: A—probably the most used stereo loudspeaker setup; there should be considerable experimentation to determine the proper distance between the speakers. B—loudspeakers face into the long dimension of the room; this is preferable to A if the wall opposite the speakers was the most heavily draped. C—loudspeakers in the corners; although the position of the listener is more restricted, the speakers radiate more low frequencies in a corner position. D—gives the best stereo effect; speakers are toed out at about a 15 degree angle to the wall. E—the stereo effect in this case will be good since the mixing will be at a minimum due to the non-reflective walls. F—unusual speaker arrangement; speakers face the wall at about a forty-five degree angle so that the sound from the speaker is reflected from this wall to the adjacent wall and then to the listener. G—this setup is not recommended in most cases because it has the disadvantages of C and none of its advantages. H—this may be the only solution for an "L" shaped room in the newer ranch type homes which have a combination living-dining room, and can provide good stereo if the walls the speakers face are fairly non-reflective.

loudspeaker set-up. The distance between the speakers can best be arrived at by experiment. If the speakers are too close together, there will be little stereo effect because the sound from the two speakers will be mixed together before it reaches our ears. Of course some mixing takes place in any stereo set-up, but in order for the spatial effect to work we must be able to perceive the direct sound coming to our ears from one location and the delayed sound from another. If, however, the speakers are too far apart there will seem to be a "hole" in the music midway between the speakers and some types of music will sound very unnatural. In addition, the optimum listening position will be more critical since movement from the center position will cause greater time and intensity differences between the speakers. Figure 2 should make this clear.

Figure 1B shows a similar placement to figure 1A. Here the loudspeakers face into the long dimension of the room. Such a placement would probably be preferable to 1A if the wall opposite the speakers was the most heavily draped wall of the room. There is some danger, in this placement, that the listener will be too far away from the speaker resulting again in the mixed sound. Ideally, the listener's ears

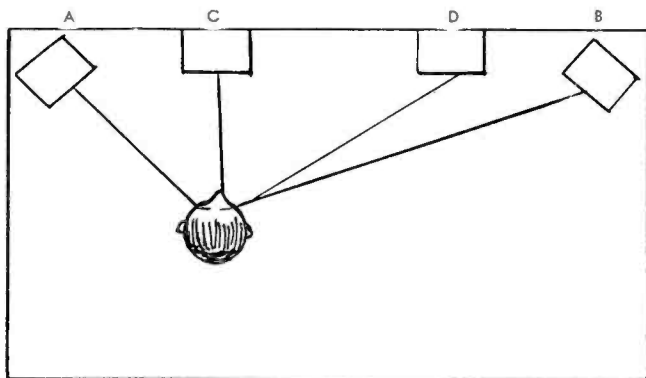

Figure 2: This shows how movement by the listener out of the center position effects the stereo balance. With the speakers in the C and D positions movement will upset the balance less than positions A and B. See text.

should subtend an angle of not less than 20 degrees with the loudspeakers.

Figure 1C shows the loudspeakers in the corners. This placement has some merit since most loudspeakers radiate more low frequencies in a corner position than any other. As Figure 2 shows, however, the position of the listener will be more restricted.

Figure 1D will most likely give the best stereo effect of any of the positions discussed here. As can be seen, the speakers are toed out at about a 15 degree angle to the wall. This placement seems to give the least mixing and therefore the best stereo effect. The placement will not work well, however, in a room where all walls are largely non-reflective. The stereo effect will still be apparent, but most of the high frequencies will be lost because many speakers are very directional with respect to higher frequencies.

In contrast, Figure 1E should be used in such a room to ensure the higher frequencies from being absorbed by the walls. Actually the stereo effect in this case will be good since the mixing will be at a minimum due to the non-reflective walls.

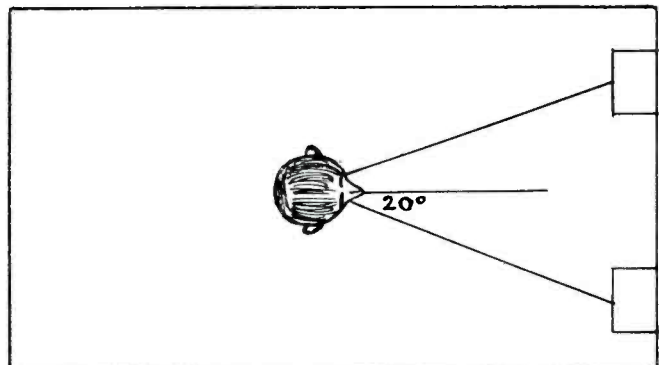

Figure 3: This illustrates how the listener's ears should subtend at least a 20° angle with the plane of the loudspeakers. In some placements, there is danger that the listener will be too far away from one speaker, resulting in his hearing mixed sound.

Figure 1F shows a rather unusual speaker arrangement, but one that could prove effective in some listening rooms. The speakers face the wall at about a forty-five degree angle so that the sound from the speaker is reflected from this wall to the adjacent wall and then to the listener. This placement is, of course, limited to a room which has reflective walls on three sides, but in such a room it can give an interesting "spread" to the stereo with no feeling of the "hole" in the center. There may be a bit too much mixing of the sound for some ears, however, since in such a reflective room the sound will tend to become evenly dispersed.

Figure 1G is for the fellow who would rather wear ear-phones to listen to his stereo. It is not seriously recommended because it has all the disadvantages of 1C with none of its advantages. Also the effect it produces is rather unnatural because we don't often hear an orchestra playing on either side of us. You might try it, during your experimenting, however, just for fun.

Figure 1H is shown here because there are many "L" shaped rooms in the newer ranch type homes which have a combination living-room-dining-room and such a placement may be the only possible solution. This placement can provide a good stereo if the walls which the speakers

face into are fairly non-reflective. The listening area will be somewhat limited, but possibly the furniture can be arranged so that the listener's easy chair is in the area of the best stereo effect.

Another thing to consider in stereo loudspeaker placement, is that the speakers should be as nearly alike as possible, otherwise the frequency differences, which contribute to the stereo effect, will be upset. Also when you are making these experiments you should play the same passage of music for each speaker placement, otherwise you will not be able to make proper judgments about each placement. The reason for this is that the music itself is variable with regard to the stereo effect. Try to find some music with percussive sounds in it, in short one that shows off the stereo effect to the best advantage. If possible have someone else move the speakers for you while you move around listening for the best area of stereo listening. The placement that produces the best stereo effect for the largest area will probably be the most suitable one for most situations.

In any case, you will learn a good deal about stereo and have a most interesting time trying these different placements, and perhaps discover a few of your own.

---

## GLOSSARY OF STEREO TERMS

**AMPLIFIER, DUAL CHANNEL.** An amplifier which amplifies both channels of the stereo system. Usually contains one power supply and two separate amplifiers on the one chassis.

**BALANCE.** Refers to the proper adjustment of volume controls on two channels so they are equal and stereo effect is secured. Also applied to loudness range of lows and highs.

**BINAURAL.** Having or relating to two ears; anything involving the use of two ears.

**BINAURAL RECORDING.** Term applied to recordings made with two separate channels, one for each ear. Technically, the microphones are spaced a head width apart on making the recording and playback is heard through headphones. Term has become synonymous with stereo in audio usage.

**CARTRIDGE.** A device which holds a continuous reel of tape and permits unlimited play.

**CHANNEL.** One side of a stereo system. In recording from the microphone to the tape, in playback, from the tape to the loudspeaker.

**CROSSTALK.** The bleeding of the sound from one channel into the other. May be caused by poorly made inline heads or interchannel leakage in the pre-amplifiers or amplifiers.

**DECK.** Term applied to a tape transport mechanism only, without pre-amplifiers or amplifiers.

**EQUALIZATION.** Changing the frequency response of a system, by means of a tone control or other means, to

get the recording or playback effect desired and to more nearly match the original sound source.

**FLUTTER.** A rapid variation in the true sound of a tone caused by the tape being drawn over the head at an uneven rate of speed by a mechanical fault in the tape transport mechanism.

**HEAD, COLINEAR.** See head, inline

**HEAD, INLINE.** A recording or playback head for stereo which has two component heads mounted one above the other with their gaps in line. Each of the component heads picks up the signal from one of the two tracks on the tape.

**HEAD, STACKED.** See head, inline

**HEADS, OFFSET.** See heads, staggered

**HEADS, STAGGERED.** Two separate recording or playback heads mounted so their gaps are 1/4" apart. The head to the left picks up or records the signal from the top track of the tape; the head to the right picks up the signal or records the lower track on the tape.

**KIT, STEREO CONVERSION.** A kit of parts necessary to convert a monaural recorder to stereo. Usually includes a stereo head, a preamplifier and necessary wire, pressure pads, etc.

**PREAMPLIFIER.** An amplifier designed to take the tiny current from the head and amplify it, without adding noise, to the point where the power amplifier can handle it.

**SEPARATION.** The distance between microphones on pickup or between

speakers on playback. Too great separation will cause a "hole in the middle" effect.

**STEREOPHONIC.** Actually means "solid." As used in the audio field refers to sound which is produced giving an illusion of depth and three dimensional quality, achieved by using two or more separate channels from recording to playback so that the original aural perspective is maintained. Microphones may be placed at any distance for pickup and playback is heard over loudspeakers.

**TAPE, STEREOPHONIC, COLINEAR.** See Tape, Stereophonic, Inline.

**TAPE STEREOPHONIC, INLINE.** A tape recorded using inline heads. At any point on the tape the signal on one track is in line with the signal on the other. Cannot be played on a staggered head machine.

**TAPE, STEREOPHONIC, STACKED.** See Tape, Stereophonic, Inline.

**TAPE, STEREOPHONIC, OFFSET.** See Tape, Stereophonic, Staggered.

**TAPE, STEREOPHONIC, STAGGERED.** A tape recorded with the head gaps spaced 1/4" apart. At any point on the tape the signal on one track is 1/4" offset from the similar signal on the other track. Cannot be played on an inline machine.

**TUNER, STEREO.** A tuner containing complete and separate AM and FM channels for the reception of stereo broadcasts.

**WOW.** A slow variation in the true sound of a tone. See Flutter.





**HERE'S WHY YOU SHOULD  
RECORD ON TAPES  
MADE WITH "MYLAR"**



**STABILIZED FIDELITY** — Condensed and flattened-out sounds are eliminated . . . recordings made on cold, crisp days are faithfully reproduced . . . even in hot, humid weather.

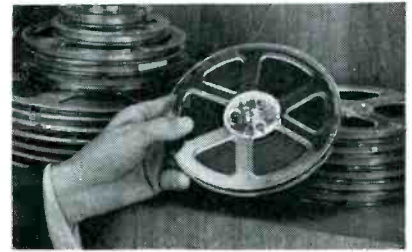

**EASY STORING** — No special storage facilities are needed for tapes made with "Mylar" . . . they won't dry out or become brittle with age, regardless of temperature or humidity conditions.

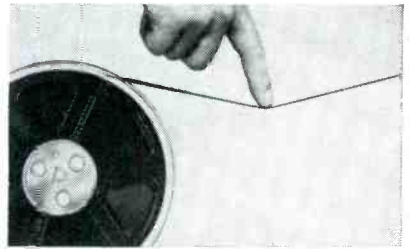

**NO BREAKAGE OR STRETCHING PROBLEMS** — Under normal operating conditions, tapes made with "Mylar" will not break or stretch. There's an extra safety margin — offered in no other tape.

**MARTIN BLOCK TELLS WHY HE PREFERS TAPES MADE WITH MYLAR®**

*"In 1,000 hours of broadcasting . . . not a single instance of tape breakage"*

"There was a time when tape breakage in the middle of a show was a real production problem," reports Martin Block, M.C. of the all-time favorite Make Believe Ballroom. "But since we began using recording tapes made with 'Mylar', we've had over 1,000 hours of smooth-running performances."

In addition to the nation's top audio personalities, engineers, scientists and businessmen have come to recognize the outstanding qualities found in tape made with "Mylar". Every day, more and more of the people who operate control equipment for guided missiles and computers are switching to long-last-

ing, better-performing tapes made with "Mylar".

And now you can get all the top qualities of tape made with "Mylar" at approximately the same cost as the old type of tape. That's right — when calculated on a linear-foot basis, long-play tapes made with "Mylar" (1,800' per 7" reel) assure far better performance at no extra cost over the older-type tape (1,200' per 7" reel).

So before you buy, check all these important features. Then ask your dealer for *your favorite brand* of tape now made with "Mylar". Look for the words "Mylar"\* polyester film on the box.

\*Du Pont manufactures the base material "Mylar" — not finished recording tape. "Mylar" is Du Pont's registered trademark for its brand of polyester film.



BETTER THINGS FOR BETTER LIVING  
... THROUGH CHEMISTRY

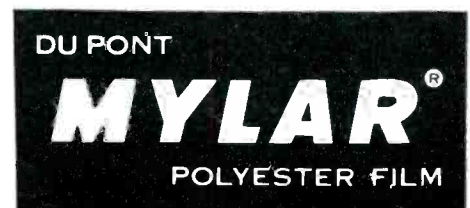

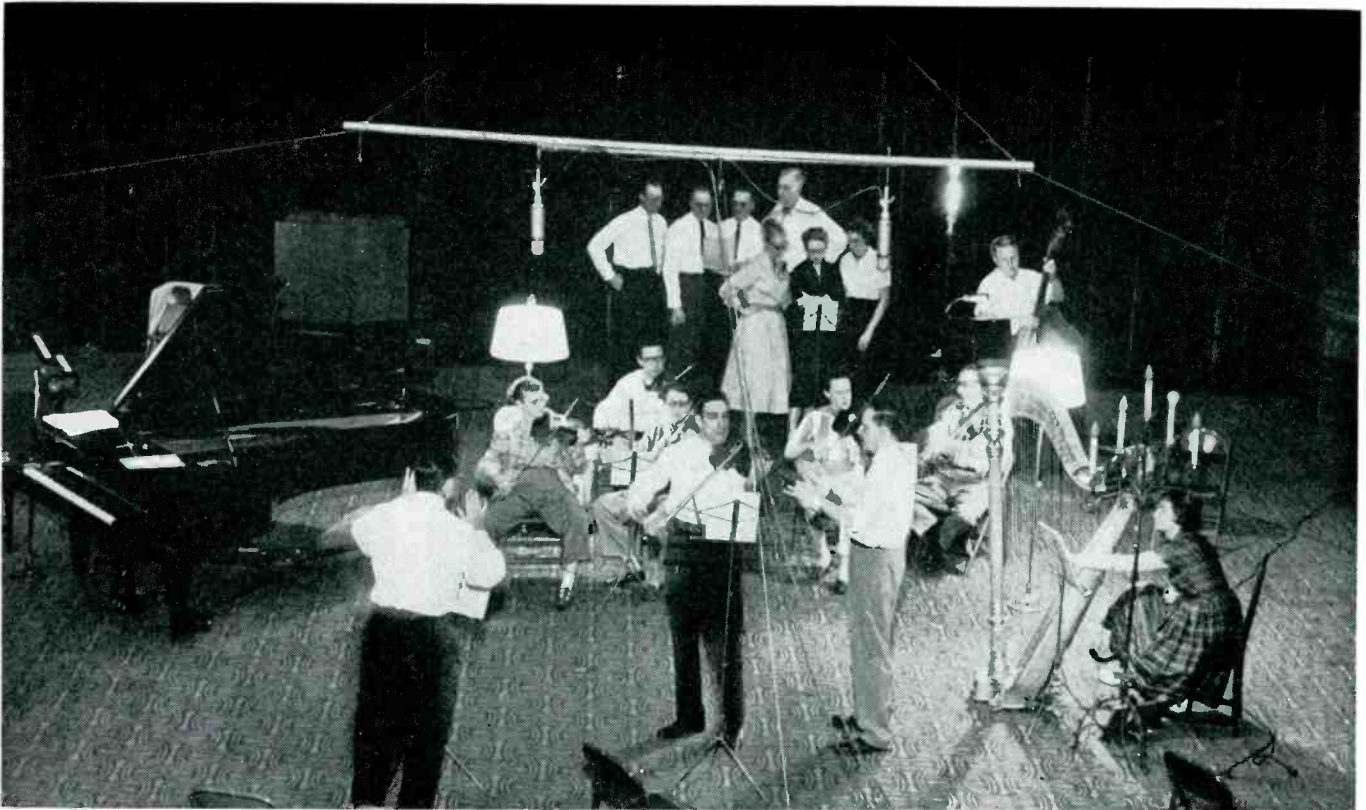

The arrangement of a recording set-up for an orchestra and vocal group. The depth of field here is approximately 40 feet. Note the two microphones on the boom swung over the group.

## What is Good Stereo?

by Larry C. Leuck\*

. . . . *Stereo can't be realistic unless it is properly recorded.*

**“W**HITHER stereo?” There’s a corny title for you, but a natural and appropriate one nevertheless. As a matter of fact, if I had thought the editors would let me get away with it, I would have used it for this article.

Whither stereo, indeed. Well, wherever it’s going, it’s going there in a big hurry. Not many months ago, this thrilling new form of recording was the exclusive domain of the cultist. To the average record buyer, “Stereophonic” was only a word on a theatre marquee. Now stereo is well on its way to becoming generally popular as a medium for home music listening. The demand for recorded tapes is steadily growing. More and more companies are entering the field. The number and variety of available stereo tapes increases daily. The field has been moving too rapidly for anyone to formulate any critical dicta or standards of judgment. The time has come to ask the question: What is stereo—good stereo?

At first, stereo was little more than an entertaining novelty. The fascinating possibilities of the medium naturally led to experiments with bizarre and spectacular effects. Hence the “ping pong” sound effects, the trains roaring by (“Here she comes! Thereshegoes! Zowie!”) and the jet planes diving out of the speakers. (“Hit the dirt!”)

The history of the visual arts offers a precedent for this preoccupation with novel effects. When 16th Century painters first discovered the secret of perspective, they

revelled in exhibiting their new-found skill. A favorite pastime was painting *trompe-l'oeil*—pictures designed to “trick the eye.” For example, an artist might paint a wall to look for all the world like an adjoining room. The payoff came when an unsuspecting guest would go to step into this illusory room and run smack-bang into a solid wall.

Later on, as the novelty of their new discovery wore off, painters made use of perspective, not for its own sake, but to enhance the overall effect of a picture by adding greater realism. It became subordinated to the picture as a whole.

The early exhibitionistic stereo recordings were, like the *trompe-l'oeil*, designed to startle and amaze. But, all the same, they were fun and they did help popularize stereo.

Now, however, stereo is reaching maturity. Its main value lies in its marvelous ability to recreate music with utmost fidelity. But how fully its potential as a medium for music listening will be realized is still open to question. Unfortunately, the tendency toward exhibitionism has carried over from the “ping pong era” into the field of music. This type of recording has resulted in highly exaggerated, extravagantly colored music. It is produced through the use of anywhere from three to ten mike channels. When making this type of recording, the orchestra or chorus is divided into several distinct groups with a microphone placed directly in front of each section. In recording, the sound picked up by all of the microphones on the left side is mixed into the left channel and the sound from the microphones on

\*Vice President and Technical Director EMC Recordings Corporation.



Left: the author adjusting microphone levels for a two channel recording. He maintains that with proper placement of mikes and arrangement of musicians, two mike channels produce more realistic recordings than multi-mike pickups. Right: vocalists and musicians taking part in the recording session listening to the playback.

the right mixed into the right channel.

The final product of this multi-channel recording technique is extremely interesting. Each mike has recorded its particular section or instrument with great clarity and definition, which is not surprising since that is virtually the only sound the mike picked up. As far as the individual section is concerned, it might just as well have been playing solo. In fact, with the multi-channel technique you might record one section in one room and another section in another room and then mix the two. The effect would be interesting but it would not be stereo. So it is with all multi-mike recordings. The result is interesting. It is startling. It is exciting. It is also freakish. It would take a freak with 10 prodigious ears, properly placed to pick up the sound of one section at a time to listen to live music in this way.

When listening to multi-miked recordings, your ear immediately tells you that music like this was never heard on land or sea. Such recordings are undeniably exciting, even disturbing, but this writer submits that they are not stereo.

What, then, is stereo?

First and foremost, good stereo should recreate living sound as faithfully as possible and in reproducing music should create as nearly as possible the effect of a live performance. Good stereo can be judged by simply listening to the speakers. There should be no distinct impression of left and right, no extreme directionality. You should hear not only left and right, but MIDDLE as well. Moreover, there should be an overall blend of natural, lifelike sound, with no exceptional definition of section or instruments.

We have sought to achieve this effect by limiting ourselves to one microphone per channel, with no mixing of any kind. The two microphones, one to the left and one to the right, are suspended above and somewhat remote from the orchestra to pick up an overall blend of sound. The engineer then arranges instruments and voices in the way he feels will give him the best overall perspective. The sound from the mike on the left is fed into one channel and that from the mike on the right is fed into the second channel, but each mike is, of course, picking up some sound from the opposite side.

The resulting recording creates an effect of great depth and spaciousness. It seems to have *both* depth and breadth. This is what we at EMC mean by stereophonic recording.

One of the two recording techniques described above will

ultimately be the base on which the stereo industry grows. Which will it be—multi-miking, with its often exaggerated and spectacular effects or the two-microphone technique with the more natural and realistic effect of music as you hear it in a live performance?

The issue is still in doubt. There is a strong trend toward multi-microphone mixing techniques. Several major recording companies are recording on three channels, producing two-channel releases by mixing part of the third channel to the left and part to the right. The present writer feels, however, that through proper recording techniques and the intelligent placement of components in the home, two channels are perfectly capable of conveying a vivid and fully satisfying stereo effect.

We at EMC feel confident that the public will finally choose two-channel recordings as the preferred medium of stereo listening in the home. Our experience with recorded tapes has given us an opportunity to form a rather clear picture of the typical stereo listener of today. He is, as we see him, a man somewhere between 35 and 50. He likes good sound reproduction, yet he is not an extremist who would just as soon watch pulses on the oscilloscope as listen. He likes music, yet he is not an extremist in that direction either, being tolerant or even enthusiastic about other forms of music besides classical works or progressive jazz. He likes Dixieland, dance music, close harmony, symphonic band music, harp solos, choral groups and even ocarinas. He is primarily interested in music and he likes stereo, not as an aural phenomenon, but as a medium for enjoying music. This is why we feel the stereo public will choose the natural realism of two-channel recordings. They like familiar, unspectacular music and it follows that they like a familiar, unspectacular sound when they listen to it.

If this attitude is as prevalent as we feel it is, we feel sure that true two-channel recording will eventually assume the leading role in the stereo field.

We feel sure also that the overall cost of stereo tape recordings will come down gradually as acceptance increases and the economies gained by volume operation come closer to those enjoyed by the disc record field.

In brief, stereo tape recording will eventually become as accepted and familiar as present LP discs. In fact, it might well assume the position of the primary medium for music listening in the home.

# Custom Build with Stereo Components

*. . . with components it is possible to build a stereo rig to suit your individual requirements, or to convert an existing hi-fi system to stereo.*

**S**ECURING stereo for the home from components rather than "package units" should be of interest to three groups of people. One group is comprised of those individuals who want to build the music center into the home, perhaps in a club basement. Another group is those who already have a hi-fi rig, usually a tape deck or record player plus an amplifier and speaker system. The third group numbers those who would like to have the greatest amount of flexibility in their outfits.

The person who desires to create his own home music center, to harmonize with his home is, many times, starting from scratch and will need a tape deck, preamplifiers, amplifiers and speakers, either in cabinets or as plain units he can fit into his home built cabinets. He will also want a tuner, probably AM-FM, or stereo, if he is in an area where stereo broadcasting is done. He perhaps might also want

a record changer or player to make the rig complete. This could play through one side of the stereo system, or both. However, even though both speakers might be used, the result will not be stereo from records. It will just be the same music from two speakers.

However, the usual reaction of a person who has heard stereo may perhaps best be expressed by the words of a World War I song—"How You Gonna Keep 'Em Down on the Farm After They've Seen Patee." Once stereo sound is readily available, monaural takes a back seat whether it is played from tape or disc.

Those who already own a hi-fi rig are halfway to stereo already. They usually have a tape deck or record player, a preamplifier and amplifier and one speaker. To secure stereo all they need do is convert their present tape deck (see article on converting older recorders to stereo) or buy one

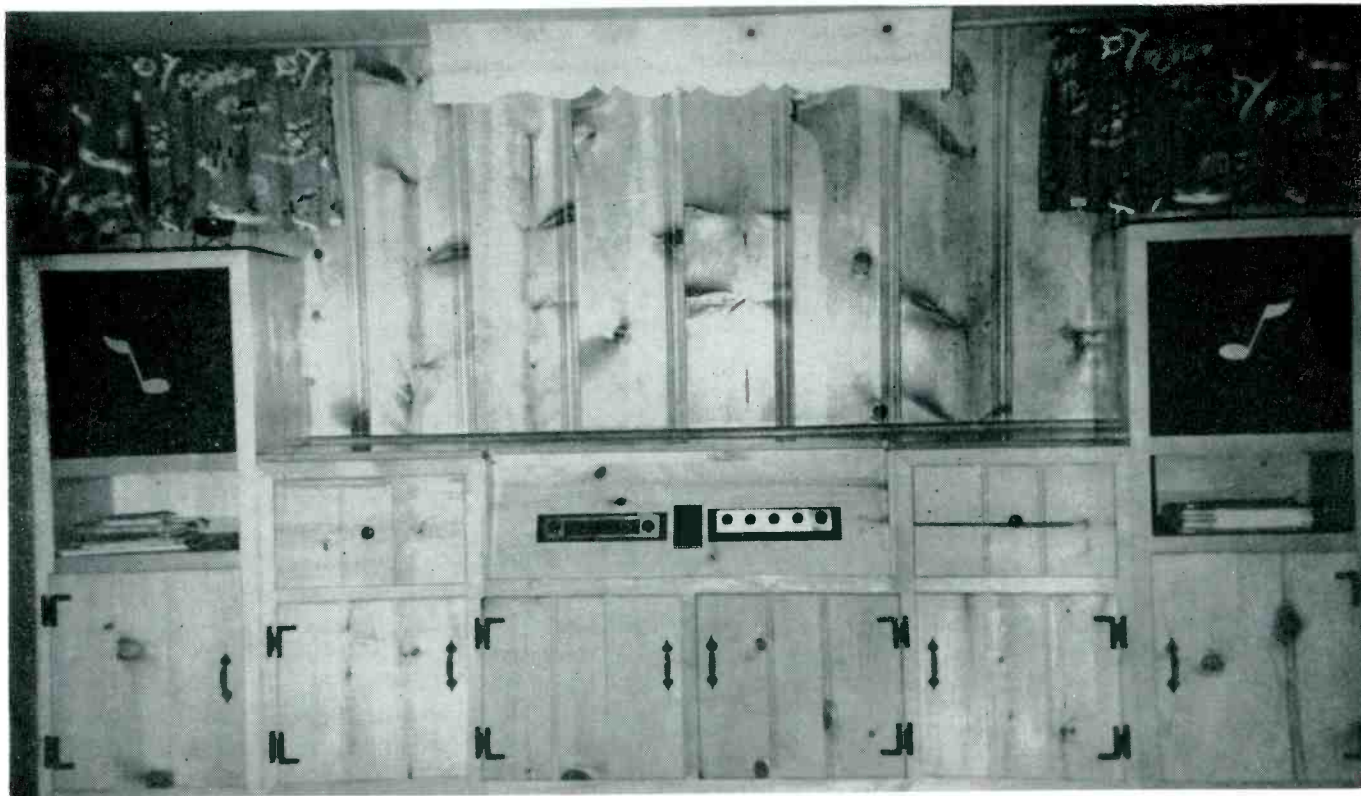

This excellent knotty-pine custom-built stereo music center for a basement clubroom was designed by Calvert Upton. Drawers contain a V-M stereo Tape-O-Matic recorder and a Collaro record changer. In the center can be seen the 15 watt Harmon Kardon amplifier and the FM tuner. Twelve-inch speakers were used in the cabinets at the ends of the unit. The design and construction was awarded a "Golden Hammer Award" by *Mechanix Illustrated* magazine.

of the new decks now available with stereo heads already installed. Another preamplifier, amplifier and speaker for the other channel puts them in business.

The third group, those who want the greatest flexibility, are the hobbyists who get as much fun from experimenting as they do from listening to the music.

Let's take the new Pentron line as an example of what can be done in the way of variety. They have just brought out three tape decks and three preamps. One deck has a monaural head, the second has a staggered head arrangement, the third has both stacked and staggered heads. One preamp is a single channel tape playback unit, the second is a preamp that may be used for both recording and playback and the third is a stereo dual channel playback preamp.

Depending on your choice of components, here are the combinations that are possible:

1—Monaural playback only (monaural deck, single channel playback preamplifier).

2—Monaural recording and playback (monaural deck, recording and playback preamp).

3—Stereo (staggered system) plus monaural record and playback (staggered head deck, record/play preamp and one playback preamp).

4—Stereo (staggered system) play only. (Staggered deck, dual channel preamp).

5—Stereo (staggered system) both stereo play and recording plus monaural play and record. (Stereo deck plus two play/record preamps).

6—Stereo (stacked and staggered) play plus monaural record and play. (Stacked-staggered deck plus one record/play preamp and one play preamp).



A switching system permits playing records, tapes or stereo tapes through the unit, in addition to FM broadcast music. The knotty-pine doors, hung with black antique hinges conceal plenty of storage space.

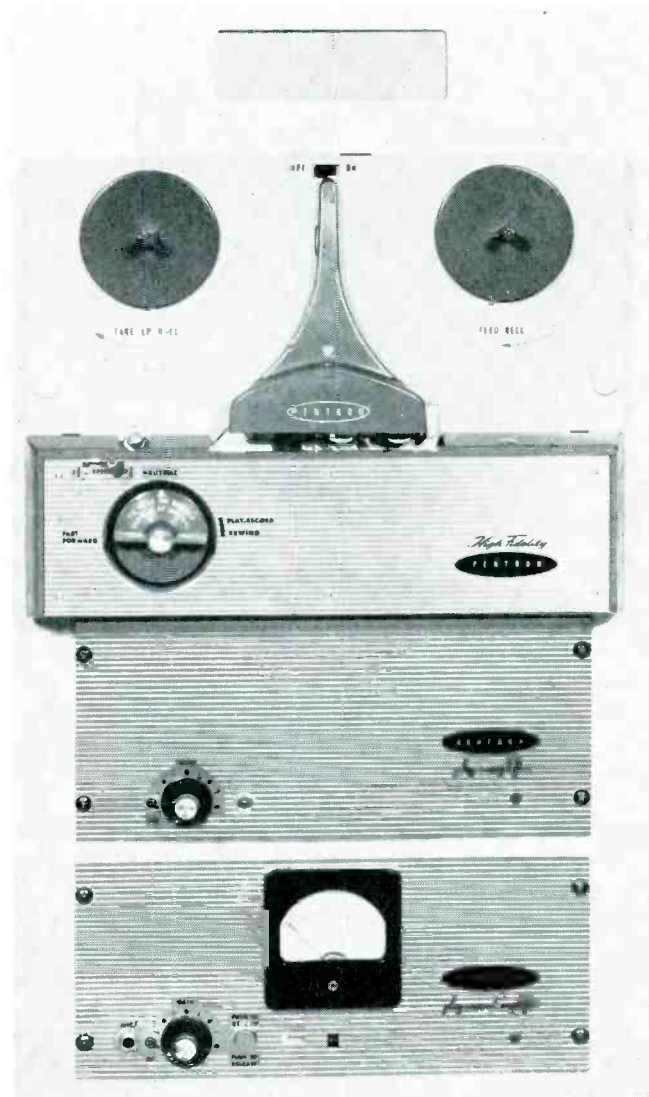

Three units of the new Pentron line showing how they may be custom installed in a vertical panel. With individual components you can design and build a system to suit your exact needs and to match the home surroundings.

7—Stereo (stacked and staggered) deck both play and record stereo plus monaural record and play. (Stacked-staggered deck plus two record/play preamps).

8—Stereo (stacked and staggered) play only. (Stacked-staggered deck plus dual channel playback preamp).

This wide variety enables you to choose the kind of system you want. Further, if the bank account is on the low side you can start simply, say with a monaural deck now and later add a stereo head, preamps, amplifiers, etc., building your system a bit at a time.

You'll note that the above mentioned systems end at the preamp stage. You will need to add an amplifier and speaker on each side for stereo, or a dual channel power amplifier that can feed two speakers.

In putting together a number of components, it is well to know what task each of them must perform. The tape deck, or mechanism, is simply a device to hold the reels and to draw the tape across the heads at a constant speed. A record/play preamplifier provides for both recording and playback. In the play position it takes the tiny currents from the head and amplifies them, without adding hiss or noise, to the point where a power amplifier can take over. In the

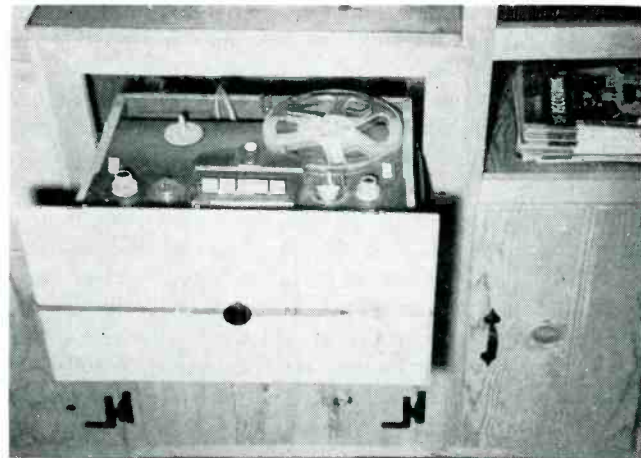
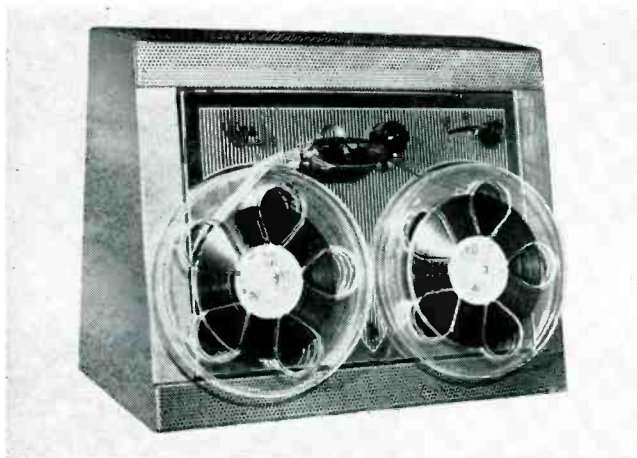

Individual components such as this deck can be mounted to suit in the home-built stereo system or a recorder with a stereo playback can be placed in a drawer as shown at the right. This will permit its removal for transporting to other locations.

record position, it takes the very weak current that comes from the mike and amplifies it to the point where it is strong enough to excite the head and record the magnetic pattern on the tape.

At the same time, it adds the necessary high frequency bias current, which insures proper recording, and furnishes current to the erase head to clean the tape of any signals before it is recorded.

The power amplifier is a device which has sufficient output to drive a loudspeaker and make the cone of the speaker move back and forth to produce the air waves that our ears interpret as sound. The power amplifier cannot operate directly from the heads, a preamplifier must be used between the heads and the power amplifier to boost the current to the point where the power amplifier can handle it.

A playback preamp will only amplify a current from the head and pass it along to the power amplifier. It cannot be used for recording because it does not produce a bias current nor power for the erase head.

A dual channel preamplifier is one that will take the output from two heads, or a stacked head, and amplify both at the same time. Actually, it is two preamplifiers in one case with a common power supply. Some units contain both a dual channel preamplifier and a dual channel power amplifier. An amplifier of this kind can thus take power directly from the heads, amplify it through the two independent systems and deliver it to the speakers. (*See the equipment directory, page 50.*)

So far we have not mentioned the speakers themselves. For stereo, they should be of equal quality, especially in the mid-range of tones. If you already have one speaker and plan to install stereo, your best bet would be to buy a similar unit for the second side.

If one speaker is better than the other, the better one should be put on the right hand side. Usually a better qual-

ity speaker will have better bass response and since most bass in orchestras is on the right side, a better reproduction will be obtained.

As the frequency becomes higher, the sound issuing from a speaker becomes more directional. The greatest stereo effect lies in the region of 500 cycles per second and above. But at the higher frequencies the sound almost becomes beam-like. The low notes tend to diffuse and do not aid materially to the stereo effect. As mentioned previously, the mid range of tones is the most important and, fortunately, this is the very range in which most speakers shine.

If you are planning to build in a custom job using components it is a good idea to hook them up in a temporary fashion and experiment with the location of the speakers for best results before making them part of the premises.

The acoustics of the room will sometimes greatly affect the reproduction of sound, either monaural or stereo and speaker placement can become quite important.

If you build your own speaker cabinets be sure to allow the proper amount of "cubage" for the speaker you use. Properly made enclosures are available in knock-down kit form, ready for assembly and if you can include them in your plans you will save on materials and still be sure of the right amount of cabinet space for best results.

If you presently own a hi-fi rig with an amplifier and speaker you can also purchase a tape recorder that has stereo playback as a feature. Then, using your present outfit as one side, you can add an external speaker to match your present one and drive it by a connection to the external speaker jack on the recorder. Most of the recorders with stereo playback have built-in preamplifiers.

If you are so inclined, the creation of your own built-in audio center can be fun. You can make switching arrangements to your heart's content (use shielded wires) and have things just as you want them.

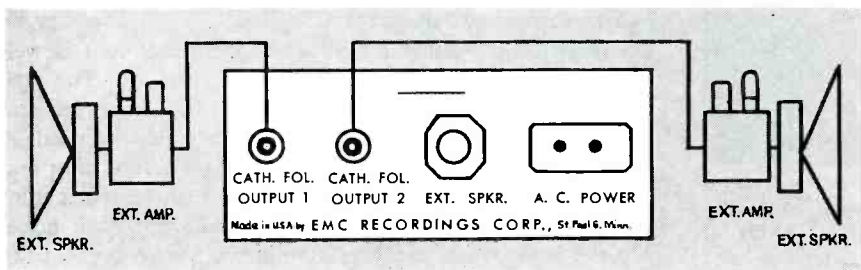

A tape player which contains its own preamps may be built-in if desired. Connections from the preamps are made to the amplifiers and speakers as shown. It is also possible to use this EMC unit with a single amplifier and speaker on one side and a speaker only on the other side if the external speaker jack is used thus employing the unit's own power amplifier.

# Converting Old Recorders to Stereo

by

Bart Pierson

*. . . . Your old recorder can be converted to stereo at small cost with a conversion kit.*

ONE of the keys to the American economy is a factor known as "progressive obsolescence." It applies to everything from automobiles to zithers and basically it is a process of outmoding existing models by constant improvement. This year's cars are vastly improved over last year's and naturally we all want the latest, even though the old bucket of bolts is probably good for quite a few thousand miles.

If it were not for this progressive obsolescence we would tend to wait until the final version of a product made its appearance on which no further improvements could be made. If this attitude is adopted, our wives would still be scrubbing clothes by a rock in the stream instead of loading the garments into a chrome plated gizmo that not only washes them but dries them too.

For the reproduction of music in the home there is no question but that the introduction of stereo has made completely out of date any monaural system, tape or disc.

But the owner of a tape recorder has not been left with an obsolete machine on his hands for it is possible, and at relatively small cost, to convert any recorder, and there are anywhere from a million and a half to two million of them in use, to stereo at relatively small cost.

The first company to make available a kit to convert their recorders to stereo was the V-M Corporation. In fact, they had planned for stereo long before it caught on. The head plates of their recorders were already fixed to take the additional head.

Other companies followed suit and conversion kits are available for the Berlant Concertone, the Bell model 75, the Pentron line, Symphonic, and the Revere T-1100 and

keyboard series recorders. Tandberg will have a kit in a few months. There is a distinct possibility that other manufacturers have them under consideration.

But even if there is no "official" kit for your particular recorder, you can still convert it to stereo through the use of a "Steradapter."

This device, shown below, is simply a stacked stereo head mounted on a frame which contains the jacks for making the connections to the amplifiers. A spring loaded arm holds a pressure pad against the head and guide posts keep the tape in line. One unusual feature of the device is that it can be removed at will, by merely slipping it out of its holder, which is screwed to the recorder. It may be mounted on practically any machine and does not affect the operation of the recorder in any way.

International Magnetic Electronics Company, who makes the device also has available a small transistor preamplifier to boost the tiny currents from one channel on the head. The other channel is secured by connecting the wires to the play head of the recorder through a jack which disconnects the recorder head when the plug is inserted. In this way the recorder itself may be used for one channel and the output from the transistor preamplifier run to a radio or TV set having a phono jack, or to the amplifier of a hi-fi rig. The transistor amplifier, which is powered by a dry cell battery, eliminates any hum problem and gives clean sound. Our tests on it showed it to be a very fine little device.

The jack mentioned above should be one of the Telex miniature variety to allow adequate clearance when mounted in the head cover. Be careful when soldering or unsolder-



First step in installing a Steradapter is to place the bracket on the recorder and line it up so that it is level and at the right height to make the tape go squarely across the head. After the bracket has been fastened to the recorder with the screws furnished, the Steradapter may be removed for storage when not in use. The Steradapter is shown in playing position, right. Note how the tape feeds off the reel, across the Steradapter and then through the regular recorder channel.

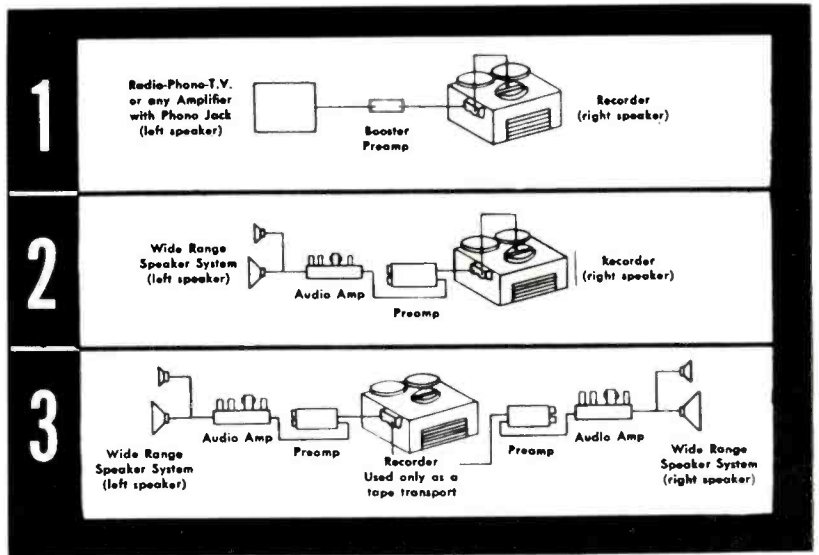
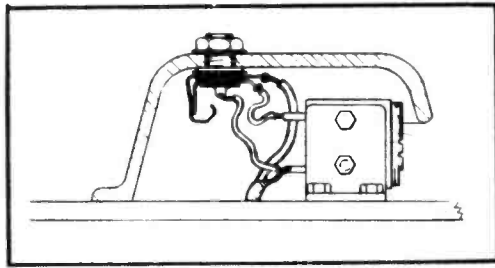

Upper left: the drawing shows how a small Telex type jack is installed in the head cover and connected so that when the jack is inserted the recorder head is disconnected and the current from the Steradapter fed to the amplifier. Lower left: the transistor pre-amplifier which may be used with the Steradapter. Above, three ways of making the connections for stereo sound.

ing connections. Do not allow too much heat from the iron to reach the heads. The drawing above shows how the jack is mounted and the connections made. The jack is a normally closed type which opens the circuit between the head and the recorder's preamplifier and makes the connection to the Steradapter head.

V-M also has a new kit which will convert its recorders to play either stacked or staggered tapes. A switch, mounted below the pushbuttons controls the selection of either stacked or staggered play. The photo and drawing below will make clear how the heads will appear when installed.

The Revere stacked head replacement to convert to stereo is merely plugged into the chassis in place of the monaural head and the connections made to the preamplifier.

Pentron has three kits available, the SA-1, SA-2 and SA-3. The SA-1 is a staggered head kit designed for the older recorders. The SA-2 is a stacked head kit for older machines and the SA-3 is a stacked head kit for the new models just

coming on the market. The new models may be obtained with the heads already installed, as is also the case with the other recorders mentioned above.

Installing new heads can be done by anyone who has a good do-it-yourself instinct and is able to follow directions step by step. The instruction booklets which accompany the kits are rather complete and if you have a good acquaintance with wiring and soldering you should have no difficulty whatever. If you are a beginner in such matters, you can still do the installation if you are careful and check each step very carefully.

If you do not feel that you can make the installation then the best bet is to take the recorder and kit to a reliable service man who will install it for a nominal cost.

The installation of either a kit head or a Steradapter will not affect the regular operation of your recorder in the least and will provide you with a means for playing stereo tapes on your present machine.

Below: the appearance of the V-M head lineup the installation of a stacked-staggered head knit. The top track of the tape is recorded by the second head (the first head is the erase unit). To play staggered head stereo tapes, the top track of the second head and the lower track of the third is used. To play stacked head tapes, the stacked head picks up both the upper and lower tracks. Full directions come with the conversion kit which may be home installed or put in by a serviceman. Right: furnished as part of the kit is this "staggered-stacked" switch and plate. This is attached to the recorder after cutting a small slot for the switch. The plate is attached by means of screws to the deck of the recorder immediately in front of the push buttons. Also available is a staggered-head kit.

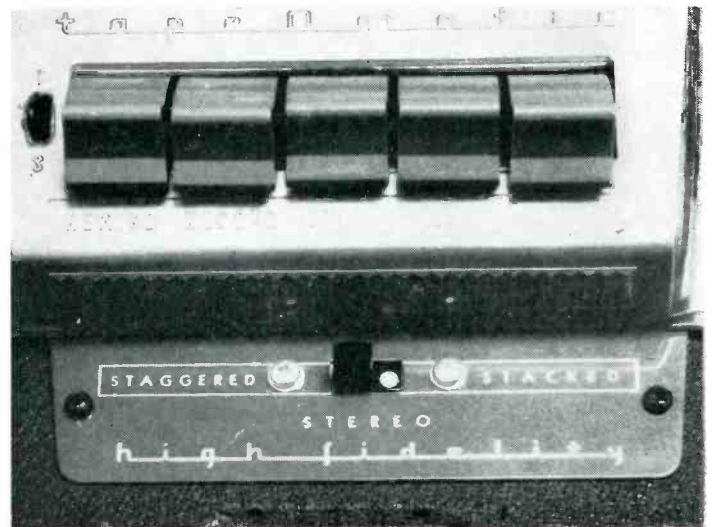
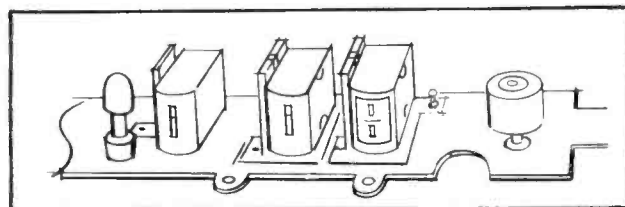



# DIRECTORY OF STEREO EQUIPMENT

Compiled and Edited by Jean Cover

*Specifications, features and price information contained herein were obtained from the manufacturers and are correct as of date of publication.*

## RECORDERS - PLAYBACKS



**AMPEX A-121-ST CONCERTO UNIT.** Each Concerto model consists of three matched modular units; a recorder-stereophonic reproducer (stacked heads), and two separate amplifier-speaker systems. Comes in four designs; and the speaker-amplifier systems can be located anywhere in a room. The A-121 recorder (with stereo playback) by itself is priced at \$425. Frequency response is 30 to 16,000 cps. The complete stereophonic music system is priced at \$895.

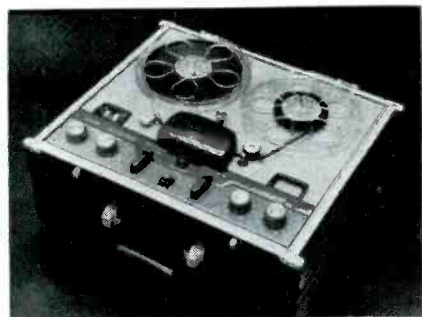

**AMPEX A-122-P CAPRICE PORTABLE.** Monaural record and playback, plus stereophonic playback (stacked heads). Monaural dual track speeds  $3\frac{3}{4}$  and  $7\frac{1}{2}$  ips. Frequency response of 30 to 16,000 cps; two amplifier outputs; two inputs. Matching amplifier-speakers available (A-692-P). The stereo portable is priced at \$495; the complete matching system is \$849.50.

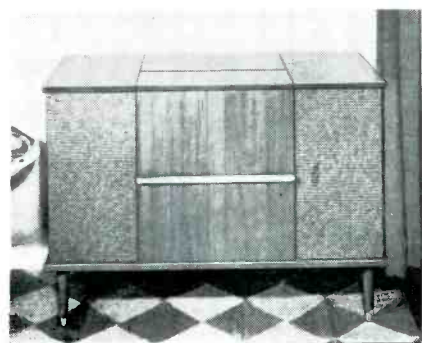

**AMPEX A423 CRESCENDO CONSOLE.** There are six models available in the Crescendo series. Includes a magnetic tape recorder—stereophonic reproducer (stacked heads), two separate speaker-amplifier systems, a Garrard fully-automatic, 4-speed record changer with a diamond stylus, a custom-built Fisher precision AM-FM tuner and a microphone—all combined in a single unit. Console stereophonic systems in the Crescendo series are priced from \$1495 to \$1795.

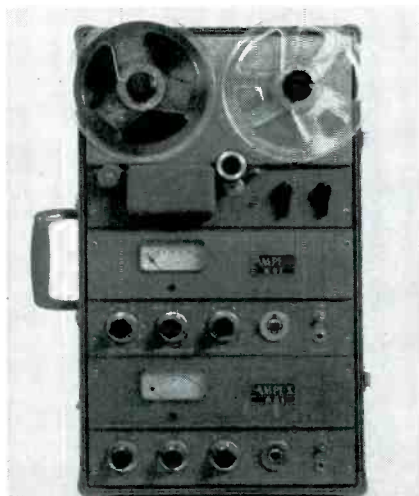

**AMPEX 601-2 PORTABLE.** Two-track stereophonic recorder, stacked heads. Records both stereo and single-channel tapes and plays back stereo, full or half track tapes. Frequency response 30 to 15,000 cps, no more than 4 db at 15,000 plus or minus 2 db from 40 to 10,000 cps; over 50 db at 3% harmonic distortion; flutter and wow below 0.17%; and separate record, playback, microphone and line input amplifiers (each channel) are used. Price: \$995.



**BELL BT-76.** Dual track monaural record and playback, plus staggered head stereo playback. Three speeds; frequency response 30 to 12,000 cps; two high impedance inputs; three outputs; 3.5 watts output wattage; has 3 panel lights, pilot, recording signal, and neon level indicator. Connect stereo output jack to any TV,

radio, or amplifier with phono input, thus supplying 2nd power amplifier and speaker for stereo. Price: \$189.95.

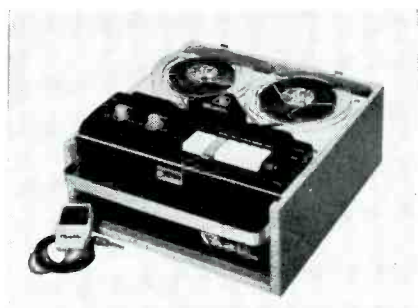

**BELL PLAYMATE.** Model BT-205 IB—monaural record/erase with stereophonic playback, stacked heads. Model BT-205 OB—monaural record/erase with stereophonic playback, staggered heads. Speeds of  $3\frac{3}{4}$  and  $7\frac{1}{2}$  ips; 5 watts output wattage; frequency response of 30 to 12,000 cps; two high impedance inputs; two external speaker-amplifier outputs; three heavy-duty 4-pole motors; and piano-key touch controls. Price: BT-205 IB, \$224.50 —BT-205 OB, \$209.95.



**BELL PORTA-PAIR STEREO SYSTEM.** Combines the Bell stereo tape recorder (either stacked or staggered heads available), with its matching carrying case that contains a built-in 5 watt amplifier plus two extension speakers. A 117 volt AC receptacle is provided in back of the unit; back panel opens for tape storage. For price of pair, contact manufacturer.

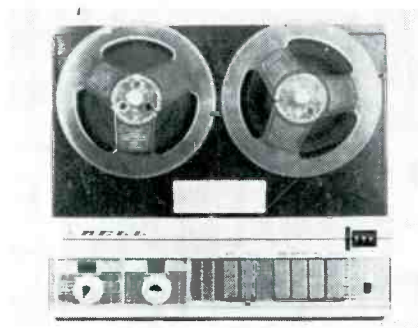

**BELL SOUND STEREO TAPE DECKS.** T-201 stacked or staggered playback transport. T-202 monaural erase-record playback with stereo stacked or staggered playback. T-203 monaural erase-record playback with stereo stacked and staggered

playback. Model 200 CC carrying case available for decks. Frequency response 40 to 10,000 cps, plus or minus 2 db; 20 to 15,000 cps, plus or minus 4 db (both record and playback). Signal-to-noise ratio better than 50 db; flutter less than 1/4 of 1% at 7 1/2 ips; distortion less than 1% at maximum indicated recorded level; electro dynamic positive braking; uses three heavy duty, 4-pole motors; average fast forward or rewind speeds 30 feet per second. Can be used with T-100 and RP-120 preamplifiers. Prices: (All prices slightly higher Denver and West). \$109.95—T-201; \$119.95—T-202; \$139.95—T-203.



**BELL STEREOGRAPHIC CONSOLETTA.** This smart stand for the Bell stereo tape recorder provides second amplifier and large extension speaker—a complete stereo system where you tune both channels from one location. Self-contained 5 watt amplifier has a frequency response of 60 to 15,000 cps and is controlled with two knobs located on the front panel. A 117 volt AC receptacle is built into back panel. Price: Contact manufacturer.

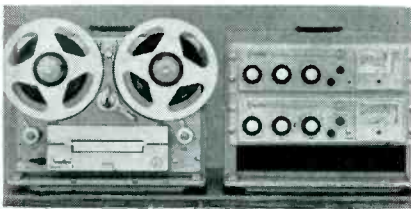

**CONCERTONE SERIES 20 (23-2 shown).** Series 20 includes Models 21, 22 and 23. The 21 and 22 machines can be modified to include stereo. Model 23 contains stacked heads for record and playback. Speeds: 3 3/4, 7 1/2 and 15 ips. At 3 3/4 ips—frequency response is 50 to 5000 cps, plus or minus 2 db; signal-to-noise ratio is over 45 db; flutter and wow .35%; recording time is 2 hr. 8 min. At 7 1/2 ips—frequency response is 50 to 12,000 cps, plus or minus 2 db; signal-to-noise ratio is over 50 db; flutter and wow .25%; recording time is 1 hr. 4 min. At 15 ips—frequency response is 50 to 15,000 cps, plus or minus 2 db; signal-to-noise ratio is over 50 db; flutter and wow .15%; recording time is 32 min. Prices: Model 21 (full track)—\$495; Model 22 (half track)—\$495; Modification ST for 21 and 22—\$189; Model 23—\$795.

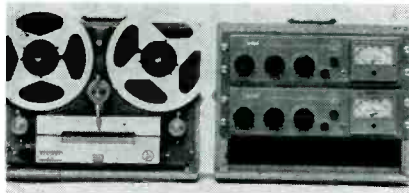

**CONCERTONE SERIES 30.** Series 30 includes Models 31, 32 and 33. The 31 and 32 machines can be modified to include stereo. Model 33 contains stacked heads for stereo record and playback. Speeds: 3 3/4, 7 1/2 and 15 ips. At 3 3/4 ips—frequency response is 50 to 6500 cps, plus or minus 2 db; signal-to-noise ratio is over 50 db; flutter and wow .3%; recording time is 2 hr. 8 min. At 7 1/2 ips—frequency response is 50 to 12,000 cps, plus or minus 2 db; signal-to-noise ratio is over 55 db; flutter and wow .2%; recording time is 1 hr. 4 min. At 15 ips—frequency response is 50 to 15,000 cps, plus or minus 2 db; signal-to-noise ratio is over 55 db; flutter and wow .1%; recording time is 32 min. Prices: Model 31 (full track)—\$695; Model 32 (half track)—\$695; Modification ST for 31 and 32—\$204; Model 33—\$995.

**CONCERTONE SERIES 60.** Includes Model 61—half track playback, stereo modification is available; 62—half track, full track and stereo playback; 63—half track, full track, stereo record and playback. Speeds: 7 1/2 and 15 ips. At 7 1/2 ips—frequency response is 40 to 12,000 cps, plus or minus 2 db; signal-to-noise ratio is 45 db; flutter and wow is .25%. At 15 ips—frequency response is 30 to 15,000 cps, plus or minus 2 db; signal-to-noise ratio is 55 db; flutter and wow is .15%. Takes up to and including 10 1/2" reels; weighs under 35 lbs. (case included); push button controls; and hysteresis synchronous motor. Prices: Model 61—\$495; Model 62—\$595; Model 63—\$695.

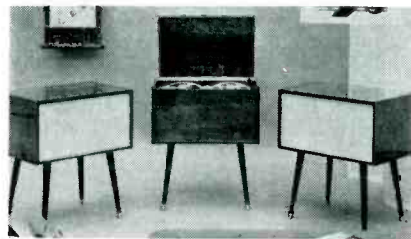

**CONCERTONE 29-7.** Stereo playback unit. Same specifications as Series 20, except it will not record.

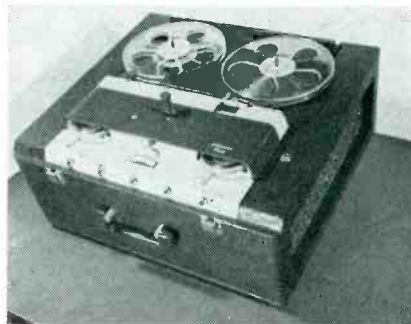

**EDUCATIONAL LABS. MODEL M-6A EDUCORDER DUAL.** Two channel magnetic tape recorder-reproducer; two independently operated amplifiers and record-play-erase heads; frequency response of 70

to 7,500 cps; signal-to-noise ratio of 35 db; wow and flutter of 0.3%; standard high impedance telephone input jack for each channel; three outputs—Channel 1, Channel 2, and "Dual;" and recording level indicator meter. Price: \$295.



**EDUCATIONAL LABS. REED K-3 TRANSCRIBER.** Because tape speed is continuously variable between two tenths of an inch and forty ips, playback of the original sound in full fidelity is possible with any one-quarter inch magnetic tape recorded on standard American or European tape recorders. Single channel, binaural or staggered binaural tapes can be reproduced on this machine. Wow and flutter less than 0.5%; signal-to-noise ratio better than 40 db; self-contained two watt power amplifier; speaker and high impedance headphone jacks; synchronous drive motor; and designed for optional remote control. Price: \$1100 F. O. B. Washington, D. C., less foot pedal and headset.

**ELECTRONIC TEACHING LABS. MODEL E-3 ELECTRO-DUAL MONITOR.** Binaural portable. Dual parallel track professional language laboratory recorder. Unique "split" amplifier used to minimize controls and simplify operation, but preserving the two independent record/play channels. Frequency response of 50 to 9,000 cps; signal-to-noise 45 db; separate heads with azimuth adjustment; volume level meter. Price: \$297.

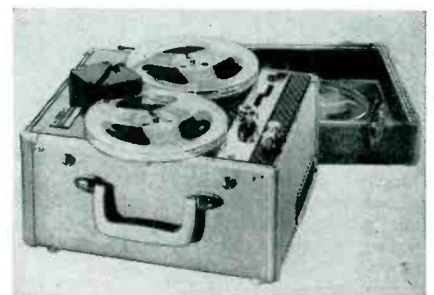

**EMC CONSTELLATION STEREO TAPE PLAYER.** Plays stacked or staggered tapes, full track or dual track monaural. Has two preamplifiers, speaker and one power amplifier in case. May be connected to radio or TV for second channel. Frequency response 40 to 12,000 cps, plus or minus 3 db; 30 to 15,000 cps, plus or minus 5 db. NARTB equalization 6 volts at 1300 ohms; power amplifier output 3 watts at 5% distortion; signal-to-noise at least 50 db in either channel; wow and flutter less than .25%. Models and Prices: Model 2000 L (case is not Samsonite), stacked heads, \$189.95; Model 2000 S (Samsonite case), \$199.95; Model 3000 L (case is not Samsonite), stacked or staggered heads, \$209.95; Model 3000 S (Samsonite case), \$219.95.

EMC MODEL 2000-D STEREO TAPE DECK. Stacked heads. Specifications are same as those for EMC Constellation. Price: \$89.95.

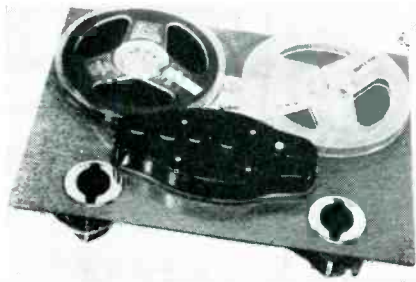

FENTON BRENNEL MARK IVB TAPE DECK. Four staggered stereo heads, three motors. Operates at 3¾, 7½ and 15 ips; wow and flutter less than 0.2% at 15 ips; matching preamps available. Price: \$182.

FENTON BRENNEL MARK VIB TAPE DECK. Will be available after September 1. Similar to the Fenton Mark IV, and will also contain two built-in preamplifiers for record and playback through an external amplifier. Price: \$347.

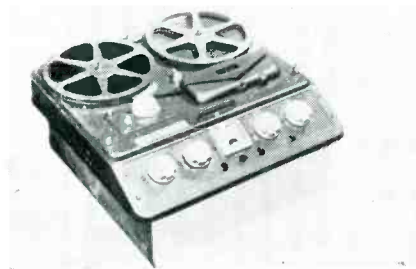

FERROGRAPH STEREO 88. A simultaneous dual-channel stereophonic recorder/playback machine for speeds of 7½ and 15 ips, fitted with inline or stacked heads. Frequency response 40 to 15,000 cps; wow and flutter less than 0.2%; recording level meter; two recording amplifiers; three independent motors—two to operate the tape reels and the third to drive the capstan. Price: \$595.

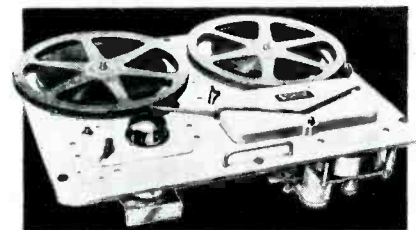

FERROGRAPH TAPE DECKS. F-121 C Deck, type 88, full track erase head, stereophonic record/replay head—\$275. F-122 C Deck, type 77, upper track erase head, upper track record/replay head, stereophonic replay head (stacked)—\$275. F-106 C Deck (staggered), full track erase head, upper track record/replay head, lower track record/replay head—\$250. Tape Speeds: 3¾ & 7½ or 7½ & 15 ips; frequency response plus or minus 2 db, 50 to 10,000 cps at 7½ ips; plus or minus 3 db, 40 to 12,000 cps at 7½ ips; plus or minus 2 db, 40 to 15,000 cps at 15 ips. Wow and flutter, less than 0.2% at 7½ ips; signal to noise ratio better than 50 db 200 to 12,000 cps.

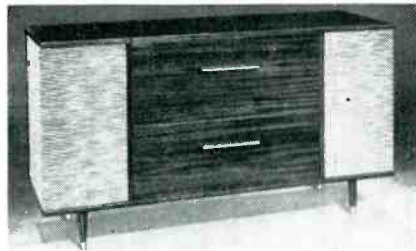

FISHER 1000 SERIES EXECUTIVE. 32-tube instrument, built on four separate chassis. Contains an extreme-sensitivity FM-AM tuner, two-channel stereophonic Fisher amplifier, the Fisher Master Audio Control Center, an Ampex stereophonic tape reproducer, with monaural recording head, a Garrard four-speed record changer, two specially designed, four-speaker stereophonic sound systems (a total of eight speakers) and an automatic program clock. Price: \$1,595.



FISHER 3000 SERIES PRESIDENT. Has facilities for reproduction of FM, AM, records and recorded tape, plus multi-channel reproduction of FM-AM binaural broadcasts and the rapidly growing library of recorded stereophonic tapes. 38-tube instrument constructed on six separate chassis. Has separate FM and AM radio tuners; two indicating meters; two separate audio power amplifiers; full-flexibility stereophonic master audio control center with program clock and timer; two completely independent triple speaker systems; and an Ampex stereo and monaural tape playback. Price: \$2,495.

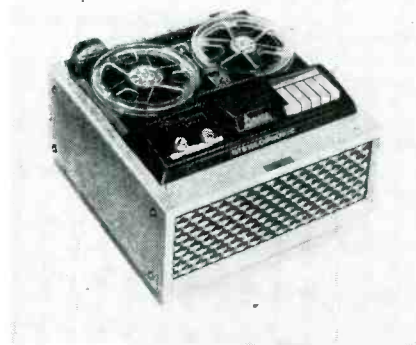

GRAFLEX 758S. Monaural record and playback, plus stereophonic playback. Frequency response 40 to 15,000 cps; additional built-in preamplifier; speakers—one 6 x 9 elliptical Alnico-5 woofer, and one 3.5" round Alnico-5 tweeter; electromagnetic "Piano-Key" controls; electronic recording level eye; automatic selection locator; two input receptacles, and two outputs. Also contains automatic tape transport shut off which instantly stops tape travel when tape has completely run through; record safety tab which eliminates danger of accidental tape erasures; two-speed control switch for switching from one speed to another. Price: \$284.45.



MAGNEMITE MODEL 611 STEREO. Battery and spring driven portable. 50 to 7500 cps at 7½ ips, plus or minus 2 db. Also available in 3¾ and 15 ips speeds. Stacked heads. Price: \$355 to \$435 depending upon speed.



MAGNECORD P 60 SERIES. Monaural or stereo record and playback. Stacked heads. Speeds of 7½ and 15 ips; frequency response of 40 to 15,000 cps; signal-to-noise ratio 55 db based upon 3% total harmonic distortion point (full track); flutter and wow at 15" per second less than 0.2%; electrical pay-off and take-up torques; hysteresis synchronous direct drive; push button control; 4 inch VU meter and monitor phone jack; NARTB equalization; 100% editing and programming. Price: \$830 Monaural; \$1245. Stereo.

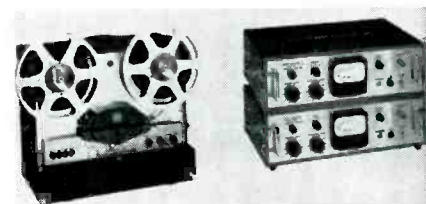

MAGNECORD M 90 STEREO. Two-channel recorder/reproducer. Stacked heads. Speeds of 7½ and 15 ips; frequency response 30 to 15,000 cps; wow and flutter 0.1% at 15 ips; signal-to-noise ratio better than 50 db per channel; two 4" VU meters for bias record and playback on each channel; two microphone inputs; two line outputs; push button controls; automatic tape lift; straight slot loading; separate record and playback gain for each channel. Price: \$2165.

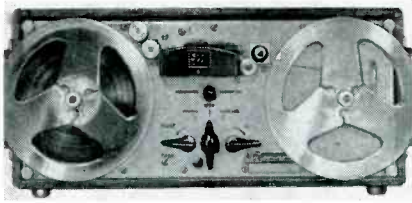

**MAGNECORD PT6-BA2HZ.** Stereophonic recorder in portable carrying case. Two speed motor and capstan change give speeds of  $3\frac{3}{4}$ ,  $7\frac{1}{2}$ , and 15 ips. Solenoid actuated pressure roller allows remote control. Full track erase head, two half track combination record-playback heads for two channel operation. Hysteresis synchronous drive motor. Connector cables furnished with amplifier. Staggered heads. Used with PT6-BN amplifier. Price: \$495.

**MAGNETIC RECORDING INDUSTRIES MODEL ML-65 SYNCHRO-MAGNETIC DUAL.** Two separate channels permitting simultaneous recording on channel 1 and playback of channel 2; simultaneous playback of channel 1 and channel 2;  $3\frac{3}{4}$  ips speed; single control operation for record, listen, fast forward, fast reverse and stop. Price: \$225; in portable case, \$245.50.



**PENTRON MODEL NL-1S MERCURY.** Monaural record and playback, plus stereophonic playback, stacked heads. Frequency response 40 to 11,000 cps; 6" round PM extended range speaker; Finger-Flite single rotary control; signal-to-noise ratio 45 db; flutter under 0.4%; two high impedance inputs; two outputs—one high impedance for external amplifier, and one low impedance for external speaker; and accurate record level indicators. Price: \$139.95.



**PENTRON MODEL NL-2S CHAMPION.** Monaural record and playback, plus stereophonic playback, stacked heads. Frequency response 40 to 13,000 cps; speakers—one 6" round PM woofer; one exponential 4" tweeter with solid basket; 5 watts output; signal-to-noise ratio 48 db; Finger-Flite

single rotary control; two high impedance inputs; one high impedance output for external amplifier, and one low impedance output for external speaker; wow and flutter under 0.4%. Price: \$179.95.

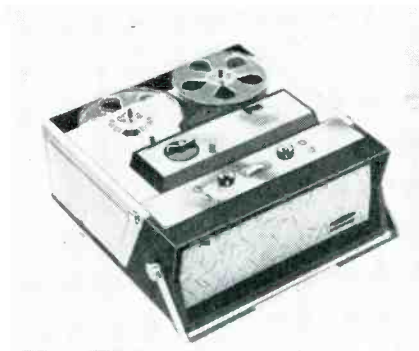

**PENTRON MODEL NL-3S ARISTOCRAT.** Monaural record and playback, plus stereophonic playback, stacked heads. Frequency response 40 to 15,000 cps; speakers—two 6" round PM woofers, one 6" round PM mid-range, one extended range exponential tweeter with solid basket; one input for microphone or magnetic phono cartridge and one for radio, TV, crystal and ceramic phono cartridge; one output for external amplifier and one for external speaker; 10 watt output wattage; and signal-to-noise ratio of 50 db. Price: \$219.95.



**PENTRON MODEL PT-1S CONCERTO.** Monaural record and playback, plus stereophonic playback. Comes complete with an additional stacked head and preamplifier. Frequency response 40 to 11,000 cps; built-in 6 inch round PM extended range speaker; two separate inputs and two separate outputs; Unimagic single lever control; signal-to-noise ratio 45 db; and flutter under 0.4%. Price: Contact manufacturer.

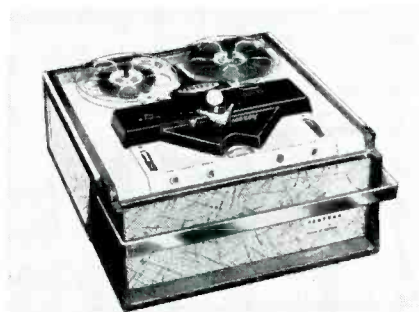

**PENTRON MODEL PT-74S VICEROY.** Monaural record and playback, plus stereophonic playback. Comes complete with an additional stacked head and preamplifier. Frequency response 40 to 15,000 cps; four speakers—two 6" round PM woofers; one

6" round mid-range; one exponential tweeter with solid basket; 10 watt push-pull amplifier; signal-to-noise ratio 50 db; two LC crossover networks; and flutter under 0.4%. Price: Contact manufacturer.



**PENTRON MODEL PT-72S VIRTUOSO.** Monaural record and playback, plus stereophonic playback. Comes complete with additional stacked head and preamplifier. Frequency response 40 to 13,000 cps; signal-to-noise ratio 48 db; hi-fi dual speaker system—one 6 inch round PM woofer, one extended range exponential 4" tweeter with solid basket, plus crossover network for clean clear sound; Unimagic single lever control for Play, Record, Fast Forward, Fast Rewind; flutter under 0.4% at  $7\frac{1}{2}$  ips; powerful heavy duty 4 pole motor. Price: Contact manufacturer.

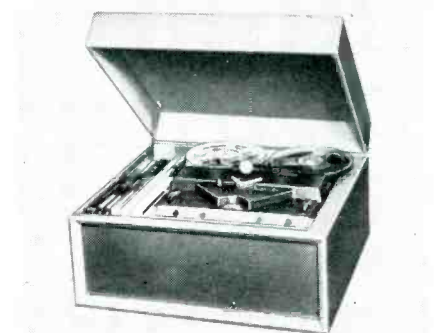

**PENTRON MODEL PTW-3S VIRTUOSO SR.** Monaural record and playback, plus stereophonic playback (inline heads). 3-speaker distribution system includes two heavy duty matched woofers, permanently mounted in the recorder case. A third speaker (tweeter) is contained in its own separate baffle. Frequency response 40 to 12,000 cps; 10 watt hi-fi push pull amplifier, illuminated VU recording meter; Unimagic single lever control; LC crossover network at 1000 cycles; and automatic shut-off at end of reel. Price: Contact manufacturer.

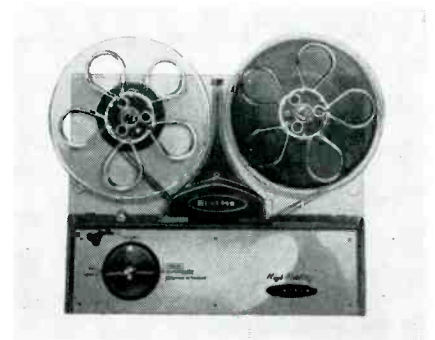

**PENTRON TM SERIES TAPE SYSTEM COMPONENTS. TM-3 MECHANISM**—For stereophonic (staggered system) recording and playback plus monaural recording and playback. Equipped with two half-track combination record/play/erase heads. Price: \$95.00, Net.

**TM-4 MECHANISM**—For stereo (stacked and staggered systems) recording and playback plus monaural recording and playback. Equipped with one half-track combination record/play/erase head and one stacked stereo head. Price: \$109.95, Net.



**PHILCO TR-200.** Staggered heads for stereophonic playback. Has speeds of  $7\frac{1}{2}$  and  $3\frac{3}{4}$  ips; a monitor switch which lets you hear recordings while they're being made from radio, TV, etc. used when operating as PA system or phonograph amplifier; an output receptacle for external speakers and amplifiers; a precision tape index timer; push button control; a dual speaker system with acoustically matched separate  $6 \times 9$  woofer and  $3\frac{1}{2}$  tweeter; frequency response from 40 to 15,000 cps; wow and flutter less than .5%; and precision aligned heads for playing recorded tapes. Suggested List Price: \$219.95.

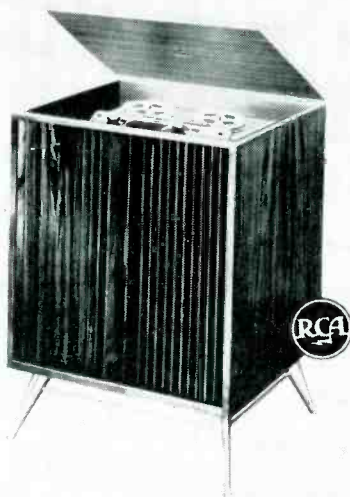

**RCA MODEL STR2 STEREO TAPE PLAYER.** Monaural record and playback, plus stereophonic playback (stacked heads). Power amplifier delivers a maximum output of 16 watts to the speaker system; recording signal indicators and counter; Panoramic speaker system—has four separate loudspeakers—two 12" and two 3.5"; simplified push-button operation; finishes—Modern, Natural Walnut and Light Rift Oak; Traditional, Mahogany and Maple. Price: \$595.

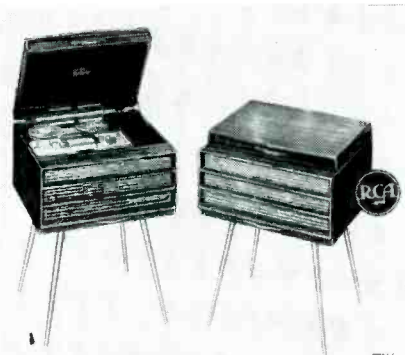

**RCA MODEL STR66 STEREO TAPE PLAYER AND MATCHING SS6 SPEAKER SYSTEM.** Monaural record and playback, plus stereophonic playback, stacked heads. The master unit contains tape transport, dual amplifier, and one Panoramic 3-speaker system. The matching cabinet contains a Panoramic 3-speaker system. Three loudspeakers—one 8" and two  $3\frac{1}{2}$ ". Dual amplifier produces undistorted outputs of 3 watts to speaker system of each unit. Simplified push button operation; recording signal indicators and counter; finishes—Mahogany, Light Rift Oak, Maple, Black Mink and Natural Walnut. Price: \$350, player in Mahogany—\$370 other finishes; \$85 speaker system in Mahogany—\$90 other finishes.

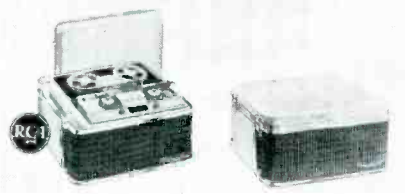

**RCA MODEL STR88 STEREO TAPE PLAYER AND MATCHING SS8 SPEAKER SYSTEM.** Monaural record and playback, plus stereophonic playback, stacked heads. Master unit contains tape transport, dual amplifier and one Multiple 3-speaker system. Its matching companion unit contains another Multiple 3-speaker system. Three speakers—one  $6\frac{1}{2}$  inch and two  $3\frac{1}{2}$  inch; dual amplifier produces undistorted outputs of 3 watts to the speaker systems of each unit; simplified push-button operation; recording signal indicators and counter; finish is gray with contrasting brown grille. Price: \$295 player; \$50 speaker system.

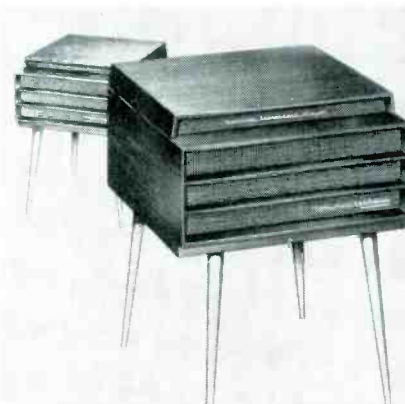

**RCA MODEL 8STP1 STEREO TAPE PLAYER AND MATCHING SPK 2 SPEAKER SYSTEM.** The master unit contains the tape transport, simplified controls,

two-channel amplifier and one Panoramic 3-speaker system. The right channel reproducer contains the second Panoramic 3-speaker system. Each speaker group of the stereo system consists of one  $6\frac{1}{2}$  inch speaker and two  $3\frac{1}{2}$  inch speakers. This unit employs stacked stereo heads. Matching luggage-type cases are designed in brown and tan simulated leather. Price: \$250 for stereotape player—\$50 for right channel speaker system.

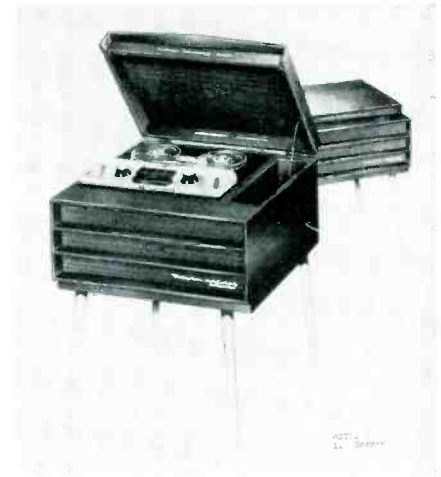

**RCA MODEL 8STP2 STEREO TAPE PLAYER AND MATCHING SPK3 SPEAKER SYSTEM.** The master unit contains the tape transport, simplified controls, two-channel amplifier and one Panoramic 3-speaker system. The right channel reproducer contains a second Panoramic 3-speaker system. Each speaker group consists of one  $6\frac{1}{2}$  inch speaker and two  $3\frac{1}{2}$  inch speakers. Stacked heads are employed in this unit. Finished in Mahogany—\$275 player, \$85 speaker system; Light Rift Oak—\$295 player, \$90 speaker system.

**REVOX STEREO PHONIC TAPE DECK** will be available in a few months. Price: \$499.

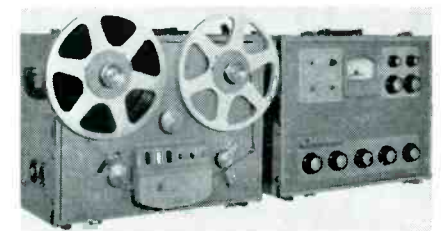

**STANCIL-HOFFMAN MODEL R-5.** Made in 1 to 4 or more channels. 2 channels on  $\frac{1}{4}$ " tape, more on  $\frac{1}{2}$ " tape.  $10\frac{1}{2}$ " reels. Speeds of  $7\frac{1}{2}$  and 15 ips; frequency response 50 to 15,000 cps, plus or minus 1 db at 15 ips; signal-to-noise ratio over 60 db. Price: \$1575.

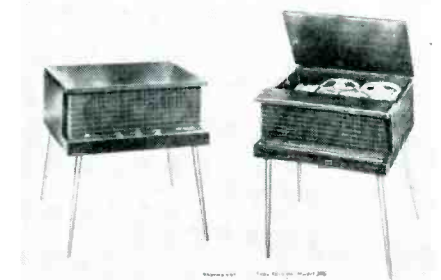

**SYMPHONIC MODEL 340.** A deluxe combination complete home music system consisting of a high-fidelity phonograph and a stereophonic tape playback, each of which can be played separately through the amplifier of the instrument with either disc or tape. The tape playback plays monaural, plus stacked and staggered. Price: \$419.95, Mahogany & Blonde; \$439.95, Walnut.



**SYMPHONIC MODEL 300.** Stereophonic recorder and external speaker combination. Frequency response 80 to 12,000 cps; speakers—one 5 x 7 woofer and one 3.5" tweeter; two external speaker outlets; two input jacks; push button controls; precision tape index timer; and recording level indicators. The speaker unit contains two hi-fi speakers—one 5 x 7 oval Alnico V PM woofer and one 3.5" Alnico V PM tweeter. Both units are identically styled. Price: \$249.95.



**SYMPHONIC MODEL BR1200.** Monaural record and playback, plus stereophonic playback, available either stacked or staggered heads. Frequency response 40 to 12,000 cps; two input jacks; two output jacks; speakers—one 6 x 9 woofer and one 3.5" tweeter; push button controls; recording level indicator; precision tape index timer; and monitor switch. Tone Control Knob: "Off" position is full counter-clockwise. Turn clockwise and recorder is "On". Bass frequencies will be at maximum and the treble frequencies at minimum. Turning the knob further increases treble frequencies. Adjusts to desired tonal balance. Also has a safety switch which locks "Record" button to prevent erasing, and comes equipped with a high quality mike, shielded cable and shielded phone plug, price: \$208, staggered—\$229.95, stacked.



**SYMPHONIC MODEL 320.** Monaural record and playback, plus stereophonic playback, stacked heads. Frequency response 40 to 12,000 cps; equipped with two speakers—one 6 x 9 woofer, and one 1-3 1/2" tweeter; power output is 5 watts undistorted, 7 watts peak; two inputs and two outputs; and has push button control. Price: Contact manufacturer.



**SYMPHONIC MODEL 330.** Monaural record and playback, plus stereophonic playback, stacked heads, table model. Frequency response 40 to 12,000 cps; equipped with 3 speakers—two 6" woofers, and one 3.5" tweeter; recording level indicators; push button controls; precision tape index timer; two output jacks; two input jacks; and monitor switch. Price \$249.95 Mahogany & Blonde; \$259.95 Walnut.

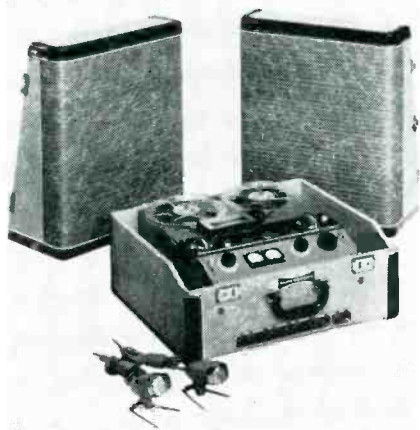

**SUPERSCOPE "STERECORDER."** Records and plays back stereophonic sound from one compact unit. Available with the unit are

two separately enclosed James B. Lansing Signature (D123) 12" speakers and two high impedance dynamic microphones. Also features a hysteresis synchronous motor, 2 V. U. meters, cueing and editing facilities, and 2 self contained independent channels of pre-amplification and power amplification. This unit has a frequency response of 50 to 12,000 cps, plus or minus 2 db, and contains stacked heads. Price: \$525.



**VIKING STEREO PRO RECORDER.** Dual channel inline stereo recording. This recorder has speeds of 7 1/2 and 3 3/4 ips; frequency response of 30 to 14,000 cps, plus or minus 3 db at 7 1/2 and 40 to 7,000 cps, plus or minus 3 db at 3 3/4 ips; two "Magic Eye" record level indicators (one for each channel); and separate record and playback level controls for each channel. The Stereo Pro consists of the Viking FF75SR deck in combination with an RP61 record/playback preamplifier and RP61S (slave) record/playback preamplifier for the second channel. Price: \$299.00.

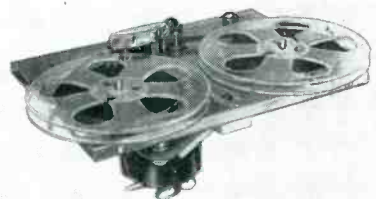

**VIKING 75 SERIES TAPE DECK.** These deck models differ primarily in the head complement provided. All decks utilize a single four-pole induction motor and a simple, four-position mechanical shift to provide forward, fast-forward, stop and rewind functions. They may be operated at either 7 1/2 or 3 3/4 ips. Model FF75S is the inline stereo only deck, priced at \$99.00. Model FF75SU is the inline, staggered or monaural deck, priced at \$106.00. Model FF75SR is the inline stereo, monaural erase-record deck, priced at \$113.00. Model FF75B is the staggered head deck, which has been discontinued and is available only on special order.

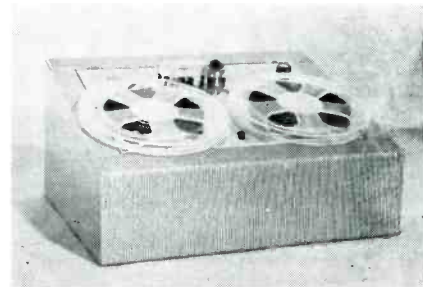

**VIKING BASE.** This attractive metal furniture type base accepts any Viking deck, and may be combined with one or more matching 401 amplifier enclosures to house a complete recorder or stereo combination. It is available in neutral tan or black, and is priced at \$14.00.

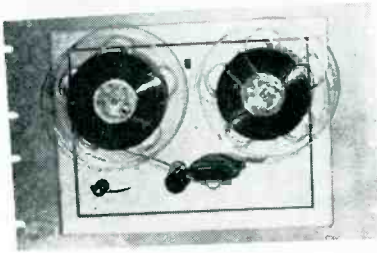

**VIKING RACK-MOUNTED DECKS.** All Viking 75 Series decks (all head combinations) are available in rack-mounting styles. Transport is floated on rubber shock mounts in standard 12 1/4 by 19 inch relay rack panel. Panels are supplied in hammerloid finish. Rack mounting kit, \$11. For mounted unit add \$11 to price of deck models.



**V-M 711 STERE-O-MATIC.** Dual track monaural record plus stereophonic playback, staggered heads. Speeds of 3 3/4 and 7 1/2 ips; speaker sizes—6 x 9 and 3.5"; frequency response 40 to 15,000 cps; external amplifier and speaker outputs; two inputs (mike, radio, TV, phono, magnetic pick-up); monitor switch, timer pause button; and cathoptic tuning eye. Price: \$209.95. Model 714 is similar to 711 and plays both stacked and staggered tapes. Contact manufacturer for details. Price: \$225.

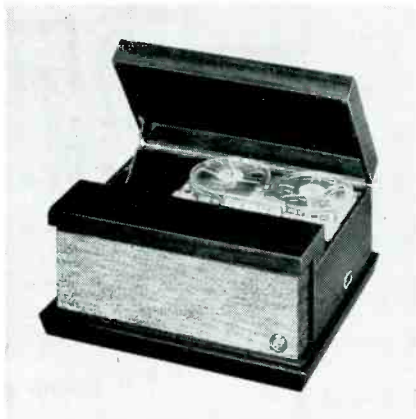

**V-M 750 CELESTE.** Dual track monaural record plus stereo playback, stacked or staggered heads. Speeds of 3 3/4 and 7 1/2

ips; speaker sizes: (2) 8" and (1) 3.5"; 10 watts output; frequency response 40 to 15,000 cps; inputs—mike, radio, TV, Phono, magnetic pickup; outputs—external speaker and amplifier; counter, pause button; monitor switch; and cathoptic tuning eye. Price: \$259.95.



**VM 1000 STEREO FIDELIS.** Console unit includes a complete dual-speed, dual-track stereo-play tape recorder, a four-speed record changer, an FM/AM radio tuner, twin dual-speaker-and-amplifier systems, a clock timer which can be pre set to start or stop any function and a complete push-button control panel. It plays either stacked or staggered-heads stereophonic recorded tapes. Price: \$1,000.



**WEBCOR MODEL 2821 ROYAL.** Monaural record and playback, plus stereophonic playback, stacked heads. Speeds of 3 3/4 and 7 1/2 ips; 5 watts peak power amplifier; two wide-range speakers; frequency response 50 to 12,000 cps; two 4-pole motors; input, external amplifier, speaker jacks; recording level indicator; monitor control; separate built-in pre-amplifier; equipped for use with "Aural Balance" remote control unit. Price: \$239.95.



**WEBCOR MODEL 2822 ROYAL CORONET.** Monaural record and playback, plus stereophonic playback, stacked heads. Speeds of 3 3/4 and 7 1/2 ips; 8 watts peak power amplifier; three wide-range speakers; frequency response 40 to 15,000 cps; two 4-pole motors; input, external amplifier, speaker jacks; recording level indicator; monitor control; 4-way master control; separate built-in pre-amplifier; equipped for use with "Aural Balance" remote control unit. Price: \$289.95.



**WEBCOR MODEL 2827 IMPERIAL.** Monaural record and playback, plus stereophonic playback, stacked heads. Matching stereo speaker units available. Speeds of 3 3/4 and 7 1/2 ips; power amplifier and two pre-amplifiers; two 4-pole induction type motors; recording level indicator; monitor speaker control; built-in storage compartment; "Aural Balance" remote control unit provided. The Imperial is also available with a radio (Model 2897). The ideal sound system for this 2827 recorder is Model 4827 shown with recorder. Price: \$319.95, 2827 recorder: \$119.95, 4827 speaker system with external amplifier: \$359.95, radio model 2897.

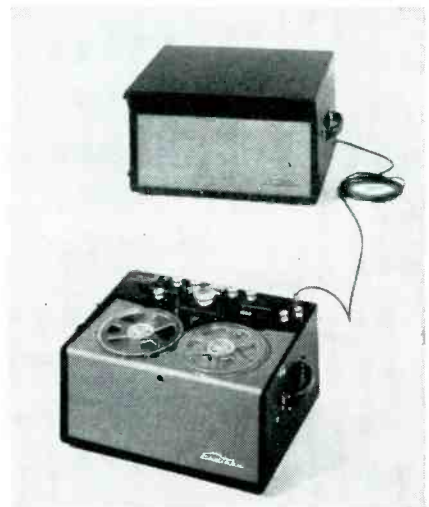

**WEBSTER ELECTRIC 290.** Monaural record and playback, plus stereophonic playback, stacked heads. Speakers—one 6 x 9 and one 3 inch; two amplifiers, output 8 watts each; speeds of 3 3/4 and 7 1/2 ips; record level indicator; program selection finder; frequency response 30 to 15,000 cps; signal-to-noise ratio 43 db; wow and flutter 0.2%; silver-flake black pyroxylin coated fabric covering, dark grey panel and grille, brushed aluminum accents. Price: \$399.50.

Perfect mate for the 290 is the SS658A stereo-speaker. 3" and 6" x 9" speakers with crossover network, generous baffle for fine bass response, clearest tone. Exact impedance match. Contact manufacturer for price.

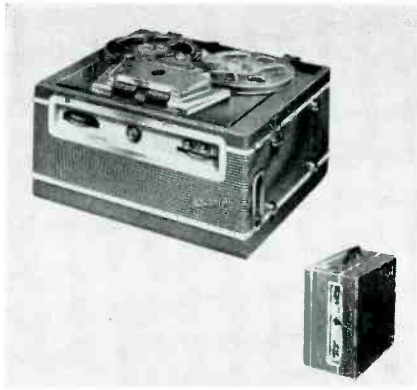

**WILCOX-GAY MODEL 772 PRESIDENT.** This new unit is entirely self-contained except for one speaker. It contains stacked heads for stereo. It has both the necessary amplifiers right in the unit itself. It has two dual cone wide range speakers and tweeter. Frequency response is 70 to 15,000 cps. Price: Contact manufacturer.

#### AMPLIFIERS & PRE-AMPS.

**ALTEC LANSING 344A QUARTET COMPOSITE AMPLIFIER.** New stereo amplifier. This new amplifier will be exhibited for the first time at the Institute of High Fidelity Manufacturers 1957 Chicago Show. Write to manufacturer for price and details.

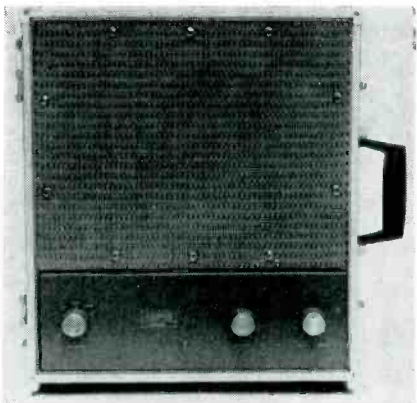

**AMPEX A-692-P AMPLIFIER-SPEAKER.** Matches A-122-P Caprice portable. Peak 13 watts. Contains indicator light, tone and volume controls. Encased in rugged, luggage-type cabinets of two-tone grey. Price: \$199.50 individually—complete stereo system comprised of Caprice portable, and two A-692-P amplifier-speakers—\$849.50.



**ARKAY MODEL SA-25 STEREO CHANNEL PRE-AMP.** Available in kit or wired form. Contains two separate identical channels that are regulated simultaneously by a single ganged volume control. Channel 1 drives a 25 watt amplifier of exceptional high fidelity, while channel 2 may drive any existing amplifier to provide stereo playback. Kit: \$59.95 Wired: \$89.95.

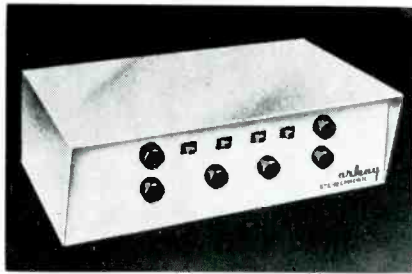

**ARKAY MODEL SP-6 STEREO-BIN AURAL DUAL PRE-AMP.** Available in kit or wired form. Has cathode follower outputs for use with a tape deck, mag. phono tuner and auxiliary equipment; left and right balance control; and individual input level controls are provided for each channel. Frequency response plus or minus .5 db—20 to 40,000 cps. Kit: \$34.95 Wired: \$47.95.



**BELL MODEL 3DTG STEREO AMPLIFIER.** Two separate amplification channels, with single-knob tone, loudness, gain controls for perfect balance. Complete with power and pre-amplification. A reverse speaker switch makes it possible to switch the two stereo channels into opposite speakers. Can be fed direct from tape head, or stereo tuners. Can also be used as straight amplifier. Power output 24 watts (12 watts each channel) with less than 0.5% distortion; frequency response 20 to 20,000 cps; four inputs—dual aux. (tape), dual radio, dual tape heads, dual mag. phono; four outputs—rear panel—dual 4, 8, 16 ohms, dual Hi-Z tape recording; three AC outlets. Price: \$159.95.

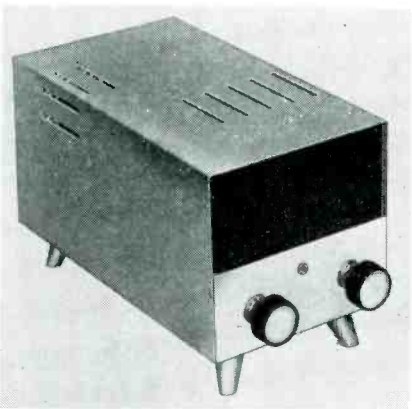

**BOGEN ST-10 STEREO PLAYBACK AMPLIFIER.** Incorporates dual preamplifiers and a 10 watt amplifier in a single unit, plus volume control and tone control. When used with a tape playback deck, the outputs of a stereophonic tape head are fed into both preamplifiers of the ST-10. One of these drives the built-in amplifier (Channel 1), and the other drives an external amplifier (Channel 2) from a cathode follower. Frequency response is flat (within 2 db) from 20 to 20,000 cps; distortion is 1% at 10 watts (Channel 1)

and 2% at 1/2 volt (Channel 2). Price: \$52.50 in chassis form; \$59.50 with cage and legs.

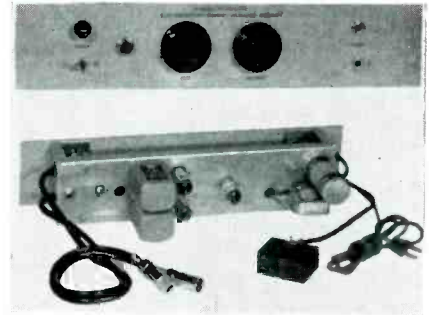

**EDER STEREO PREAMPLIFIER.** Playback preamplifiers with balance and gain controls. Separate models for disc and tape.

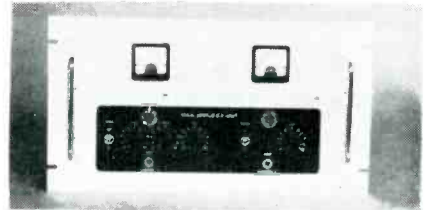

**FERROGRAPH STEREO AMPLIFIER MODEL FS-103.** Suitable for use with C deck. Twin 3-stage recording amplifiers and stereophonic preamplifiers and main amplifiers (15 watts per channel) complete with power pack, bias and erase oscillators, twin VU level meters. Tone controls operate in record or playback. Price: \$450.



**MAGNECORD PT6-BN STEREO AMPLIFIER.** Two low level, low impedance microphone inputs, two VU meters, three gain controls (one master, two single channel), calibration circuit. Panel 19" x 7". Grey hammertone finish. NARTB response. Price: \$540.

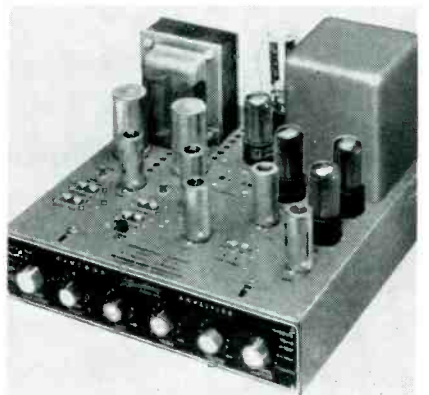

**NEWCOMB STEREO AMPLIFIER MODEL 3D-12.** Two complete preamps and amplifiers in one unit. Single knob control of both channels, hum balance controls, 12 watts output each channel. Price: \$179.50.





**PENTRON DUAL CHANNEL STEREO PLAYBACK PREAMPLIFIER MODEL CA-15.** 20 to 20,000 cps; can be used in conjunction with TM-4 mechanism or the TM-1 converted to equal the TM-4; has left and right equalization control; left and right individual gain control; one master control after equalization has been attained which is also an on-off switch. Price: \$79.95.

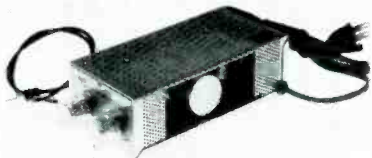

**VIKING PB60 PREAMP.** This preamp is offered as the ideal companion to the FF75 tape deck series. Two controls are provided: a volume level control and a variable equalization control. The volume level control may either be set at a level that does not overload the music system amplifier, or may be used as the system volume control. The variable equalization control provides for any desired response from 7 db above, to 7 db below the NARTB response curve at 10,000 cps. Signal to noise ratio is 60 db without selected tubes; compensation—NARTB, variable above or below curve at 10 kc., with bass boost to 25 cps; and output is 1 volt, high impedance. Price: \$29.50.

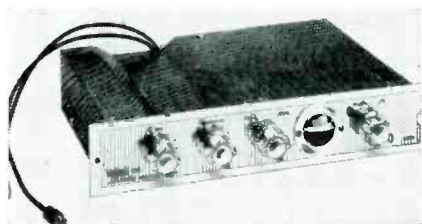

**VIKING RP-61 PREAMPLIFIER.** Is always used in conjunction with the RP61S record/playback preamplifier. The RP61S is in every way equivalent to the RP61, except that the bias oscillator has been omitted and an R/C network is substituted to permit derivation of recording bias from the RP61. The basic noise level of each is 60 db or better; frequency response extends to 12,000 cycles; and bass response is extended to below 40 cycles. Price: \$77.50 each (RP61 and RP61S).

## TUNERS



**ARKAY MODEL ST-11 AM-FM BINAURAL TUNER.** Available in kit or wired form. Separate tuners combined in an integrated unit. Each section is a complete tuner, containing its own tuning condenser. Frequency response AM—20 to 8,500 cps; FM—20 to 20,000 cps, plus or minus .5 db. Kit: \$47.95 Wired: \$69.95.

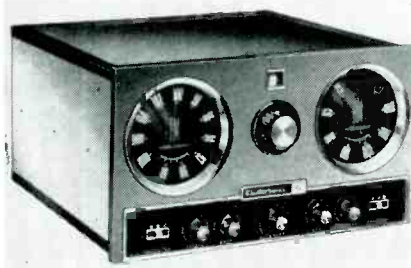

**ELECTRO-VOICE MODEL 3303 STEREO FM-AM TUNER.** Completely independent AM and FM sections, including separate tuning dials, permits reception of stereophonic broadcasts. Dual limiters; variable AFC allows complete versatility in tuning; AM section has squelch circuit as well as RF amplifier stage; additional FM and AM output jacks bypass preamplifier allowing simultaneous separate operation if desired; frequency response plus or minus 1 db, 20 to 40,000 cps; harmonic distortion less than 0.2%; controls include selector for tuner, tape, TV, auxiliary and phono inputs, 3-position "Presence" switch, 3-position loudness control, phono switch, bass, treble, and volume. Price: \$279.50.

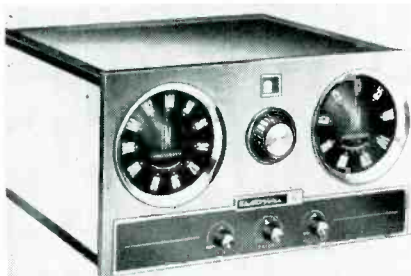

**ELECTRO-VOICE MODEL 3304 STEREO FM-AM TUNER.** Similar to Model 3303, but for use with separate preamp and amplifiers having complete set of controls. Has AFC, volume and FM-AM level balance controls. Price: \$239.50.

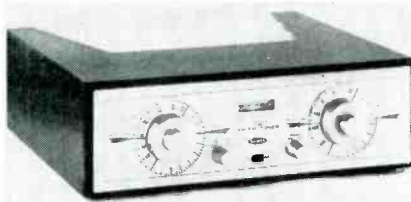

**SCOTT H. H. 330-C AM-FM STEREO-PHONIC TUNER.** May be used with any amplifier. Complete and separate AM and FM sections for stereo operation. FM sensitivity 2 microvolts for 20 db quieting on 300 ohm antenna terminals. Separate AM and FM level controls at rear of chassis; separate output jacks for binaural operation and tape recording. FM vernier and quick tuning; AM vernier and quick tuning; power on-off; Function Selector switch (FM, AM Wide Range, AM Normal, AM Distance); accessory case covered in durable leather-finish plastic, or solid mahogany; new construction for extremely simple panel or cabinet mounting. Price: \$199.95.

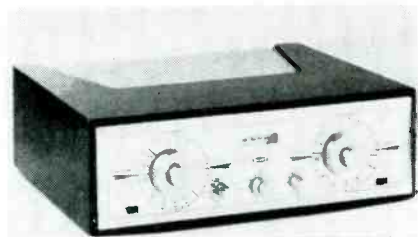

**SCOTT H. H. 331-C AM-FM STEREO-PHONIC TUNER.** Includes all the features of the 330-C, plus a complete equalizer and preamplifier. Needs only a power amplifier to make a complete installation, which will include a flexible "front-end" and versatile stereo AM-FM tuner. Price: \$259.95.

## SPEAKER SYSTEMS



**BOZAK B-304 STEREO - FANTASY SPEAKER SYSTEM.** Contains two complete, independent speaker systems in a handsome cabinet. The two channels of sound are directed outward from opposite ends of the cabinet where hinged doors throw the sound forward. The ruggedly built cabinet is heavily lined with acoustical-damping material to prevent cabinet resonance and cavity resonance. Price: \$720 in Contemporary model; \$820 in Provincial model (shown).

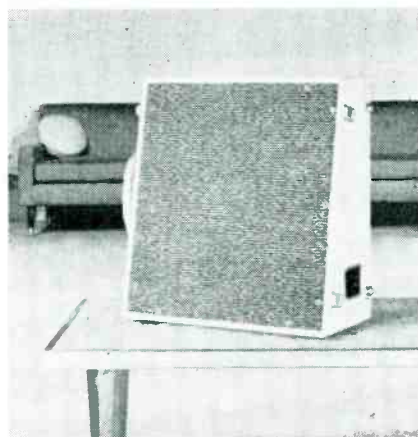

**WEBCOR MODEL 4820 SPEAKER SYSTEM.** For use with Webcor models 2821 and 2822 stereo machines. Powerful push-pull power amplifier provides 8 watts peak power output with negligible distortion. Preamplifier for this unit is built into Webcor stereo tape recorders. Three permanent magnet speakers—8" woofer; 6" mid-range; 4" tweeter. AC power input receptacle, amplifier input. Detachable lid. Convenient, portable carrying case. Compartment in lid for storage of cords; "Aural Balance" control is optional; power requirement is 110 v, 60 cycle, 42 watts. Colors: Ebony EP-4820; White WP-4820. Dimensions: 17 1/2" wide, 10" high, 16 1/2" deep. Weight: 22 1/2 lbs. Price: \$79.50.



**WEBCOR MODEL 4827 SPEAKER SYSTEM.** For use with Model 2827 Webcor Imperial. Two section system. Section A: Powerful push-pull power amplifier provides 8 watts peak power output; preamplifier for this unit is built into stereo tape recorder; three permanent magnet speakers with cross-over network—8" woofer, 6" mid-range, 4" tweeter. Section B: Three permanent magnet speakers with cross-over network—8" woofer, 6" mid-range and 4" tweeter; input jack to connect plug on speaker input cord. Price: \$119.95.

#### CARTRIDGES

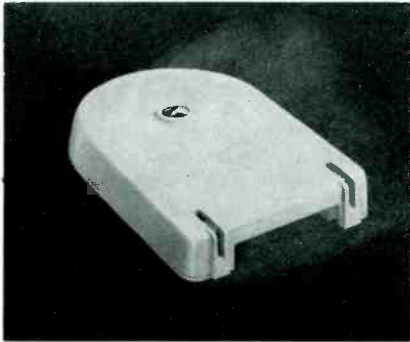

**COUSINO ECHOMATIC.** Self-threading tape magazine. Available in left to right and right to left winds. There are a number of machines available to play this cartridge, including Pentron, Wilcox-Gay, and Cleveland Electronics. These magazines are simply inserted in the player, and the switch thrown to "Play." They are removed by putting the lever in the "Eject" position. Provision has been made for removing the tape reel from the unit for recording on a regular recorder. These cartridges are available with either 300 or 600 feet of  $\frac{1}{4}$ " tape. Cousino also manufactures the Audio Vendor continuous playback reel, which is adaptable to standard recorders. These reels contain 180 to 600 feet of tape. Prices: Contact manufacturer.

**FIDELIPAC** is a continuous reel type cartridge where the tape is pulled from the center and, after passing through the

machine, is automatically wound on the outside of the reel. The Viking Model 35 cartridge handler is designed expressly for this cartridge. All "35" handlers are available in a variety of head configurations which fit them for almost any presently used tape application, including stereo. At present,

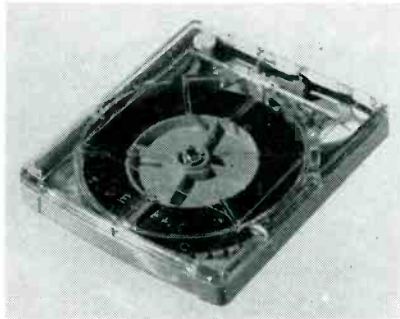

there are only a few manufacturers of equipment designed to take this cartridge and all of these except one use the Viking mechanism. Empty cartridge, \$1.98; loaded with single or double oxide coated tape, \$7.85; with 100 feet of tape or less, \$4.25 (add 75c for each additional 100 feet).

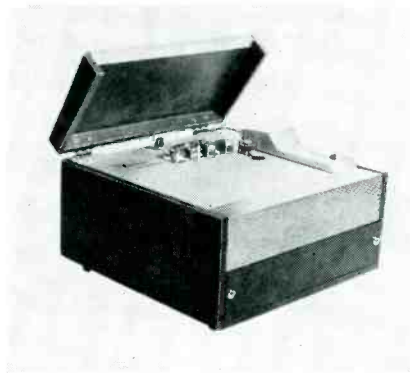

**VIKING SERIES 35 HANDLER.** These handlers have been designed to fill the need for a cartridge handler. They have head configurations to fit most tape applications, including stereo. This series unit has speeds of  $3\frac{3}{4}$  and  $7\frac{1}{2}$  ips and frequency response and low flutter and wow characteristics comparable to Viking's "FF75 Series." This handler is designed expressly for the Fidelipac continuous loop tape cartridge. Model 35S—Inline Stereo for Playback of Stereo Tapes, \$70.00. Model 35SR—Monaural Erase-Record, Stereo Recording and/or Stereo Playback, \$85.00.

#### CONVERSION KITS

The following conversion kits are available from the manufacturers for their machines.

**VM**—Two kits—binaural conversion kit; 8905 stacked-staggered conversion kit. **PENTRON**—Three kits—SA-1 staggered head kit for older models; SA-2 stacked head kit for older machines; SA-3 stacked head kit for newer models.

**BELL**—BTK 1 staggered head conversion kit.

**REVERE**—Stacked head conversion kit.

**AMERICAN ELECTRONICS**—102646-2 triple-play stereo playback conversion kit; 102651 stereo record and playback conversion kit.

#### MISCELLANEOUS



**DACTRON STERADAPTER.** Stacked stereophonic tape recorder device. Mounts on the side of most tape recorders, and is simply slipped into a bracket which may be mounted permanently on the machine. The tape is then threaded directly from the supply reel through the Steradapter's tape guides over the capstan to the take-up reel. Model 4902—Price: \$22.50.

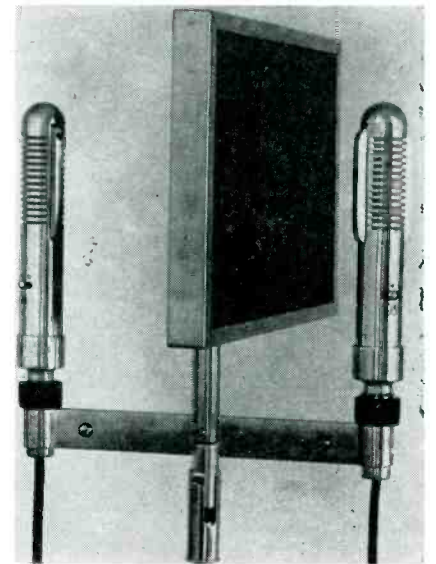

**FENTON BINOR STEREO RIG (B & O).** Has acoustical separator and mounting brackets. Provides stereo separation cancellation of feedback and perfect response pattern. Designed for Fenton B & O mikes. Price: \$38.95.

# DIRECTORY OF STEREO TAPE PRODUCERS

Audio Fidelity Inc.,  
770 11th Ave.,  
New York 19, N. Y.  
4 Popular, 1 Jazz, 1 Marches, 3 Novelty  
A-V Tape Libraries  
396 George Street  
New Brunswick, New Jersey  
2 Classical, 1 Popular, 1 Jazz, 1 Choral, 1  
Religious  
Bel Canto Magnetic Recorded Tapes  
4856 Jefferson Blvd.  
Los Angeles 16, Calif.  
1 Classical, 4 Semi-Classical, 1 Classical  
Miscellaneous, 4 Musicals, 6 Popular, 1  
Popular-Latin, 1 Jazz, 1 Seasonal, 2 Novelty,  
1 Demonstration  
Capitol Records  
1483 Vine Street  
Hollywood 28, Calif.  
7 Classical, 4 Popular, 2 Demonstration  
Celestial Tapes  
9015 20th Street, N.E.  
Seattle 15, Wash.  
5 Popular, 1 Folk, 1 Choral, 1 Demonstration  
Columbia Records  
799 Seventh Ave.  
New York 19, N. Y.  
10 Tapes, Classical and Popular  
Concertapes, Inc.  
522 Green Bay Road  
Winnetka, Illinois  
17 Classics, 1 Semi-Classical, 2 Musicals,  
1 Classical-Miscellaneous, 6 Popular, 2  
Popular-Latin, 2 Jazz, 1 Seasonal, 2 Novelty,  
3 Choral  
Concert Hall Society, Inc.  
43 West 61st Street  
New York 23, New York  
31 Classical, 2 Classical Miscellaneous, 2  
Jazz, 2 Demonstration  
Contemporary Tapes  
8481 Melrose Place  
Los Angeles 46, Calif.  
1 Musical, 1 Popular, 4 Jazz  
Craft Recording Corporation  
1650 Broadway  
New York 19, New York  
1 Popular, 7 Jazz  
EMC Recording Corporation  
806 East Seventh Street  
St. Paul 6, Minnesota  
1 Demonstration  
Experiences Anonymes  
20 East 11th Street  
New York 3, New York  
6 Miscellaneous  
Hallmark  
383 Concord Avenue  
New York 54, New York  
12 Popular  
High Fidelity Recordings, Inc.  
6087 Sunset Blvd.  
Hollywood 28, Calif.  
3 Classical-Miscellaneous, 6 Popular  
His Master's Voice  
c/o Addison Foster  
1226 Montgomery Avenue  
Narberth, Pennsylvania  
21 Classical, 1 Classical-Miscellaneous  
International Pacific Recording Corp.  
858 Vine Street  
Hollywood 38, Calif.  
3 Classical, 1 Classical-Miscellaneous, 4  
Semi-Classical, 19 Popular, 1 Popular-Latin,  
1 Jazz, 2 Novelty, 2 Demonstration, 2  
Marches, 1 Miscellaneous

Jemo Recording Enterprises  
5800 West Third Street  
Los Angeles 36, Calif.  
2 Popular  
Kandy Tapes  
203 N. Wabash  
Chicago 1, Illinois  
Popular  
Klipschtape Division  
Klipsch and Associates  
Hope, Arkansas  
1 Classical-Miscellaneous, 2 Popular, 2 Jazz,  
1 Demonstration  
Livingston Audio Products  
P. O. Box 202  
Caldwell, N. J.  
17 Classical, 4 Semi-Classical, 14 Popular,  
2 Popular-Latin, 8 Jazz, 3 Folk, 1 Religious,  
2 Demonstration, 1 Miscellaneous  
Mercury Record Corporation  
35 East Wacker Drive  
Chicago 1, Illinois  
5 Classical, 1 Musical, 3 Popular, 1 Popular-Latin,  
2 Miscellaneous  
National Tape Library  
1731 New Hampshire Avenue, N.W.  
Washington, D. C.  
1 Popular, 2 Jazz, 2 Choral, 2 Demonstration  
Pentron Corporation  
777 South Tripp Avenue  
Chicago 24, Illinois  
10 Popular, 1 Popular-Latin, 3 Jazz, 1 Miscellaneous  
Phonotapes, Inc.  
248 West 49th Street  
New York 19, New York  
8 Classical  
RCA Victor  
155 E. 24th Street  
New York, N. Y.  
41 Classical, 2 Popular, 1 Miscellaneous  
Recorded Tape of The Month  
449 W. 51st Street  
New York 19, New York  
1 Classical-Miscellaneous, 5 Popular  
Recotape  
2847 Effie Street  
Los Angeles 26, Calif.  
1 Popular, 1 Popular-Latin, 1 Jazz  
Replica Records  
7210 West View Drive  
Des Plaines, Illinois

3 Popular, 1 Jazz, 1 Seasonal, 1 Miscellaneous  
San Francisco Record Corporation  
217 Kearny Street  
San Francisco 8, Calif.  
1 Jazz  
Sonotape Corporation  
275 Seventh Avenue  
New York 1, New York  
10 Classical, 1 Classical-Miscellaneous, 3  
Popular, 1 Popular-Latin, 1 Seasonal, 1  
Choral, 2 Religious, 1 Novelty, 1 Demonstration  
Sony Stereocord (Intersearch)  
7 Arcadia  
Cincinnati, Ohio  
1 Classical, 1 Semi-Classical, 2 Choral  
Stereophony Incorporated  
806 East Seventh Street  
St. Paul 6, Minnesota  
2 Classical-Miscellaneous, 10 Popular, 2  
Jazz, 1 Demonstration, 1 Stereophonic Test  
Tape  
Stereotape  
Audio Arts, Inc.  
5607 Melrose Avenue  
Hollywood 38, Calif.  
1 Classical, 1 Semi-Classical, 6 Popular,  
1 Demonstration  
Urania Records Distributing Co.  
625 8th Avenue, Room 2032  
New York 18, New York  
8 Classical, 1 Jazz, 1 Demonstration, 1  
Miscellaneous  
Vanguard Record Sales Corporation  
256 West 55th Street  
New York, N. Y.  
5 Classical, 4 Classical, 4 Jazz  
Verve Records  
451 N. Cannon Drive  
Beverly Hills, Calif.  
Popular and Jazz  
WFB Productions Inc.  
637 E. Broad Street  
Souderton, Pennsylvania  
4 Marches  
Zodiac Recording Co., Inc.  
501 Madison Avenue  
New York 22, New York  
4 Classical

*(Editor's Note) New tapes are being issued so rapidly that the numerical listings of the kinds of music available changes almost daily.*

## NEW STEREO TAPE CATALOG

We are now offering the Hi-Fi Tape Recording Catalog of Stereo Tapes. This is available on Subscription—four issues for one dollar. It is revised and issued quarterly.

- Lists all available stereo tapes.
- Complete description of each tape—no more guessing when you order.
- Presently lists 427 tapes from 30 companies.

USE BLANK BELOW TODAY

### STEREO TAPE CATALOG Serverna Park, Md.

Please enter my subscription to the Stereo Tape Catalog. I enclose \$1.00.

Name .....

Address .....

City ..... Zone ..... State .....

# NEW PRODUCT REPORT

STA **OK** STED



## WEBCOR IMPERIAL STEREO RECORDER

... features remote control for balancing and volume, stereo playback, single control

**I**N designing the Imperial, Webcor has come up with a unit that is completely portable and, at the same time, attractive enough to grace the living room. Finished in Ocean Blue and Grey, with scuff resistant material, the recorder and its associated speaker system are housed in two neat luggage cases.

The ease of threading and the one knob control have been retained from previous Webcor models. The no reel

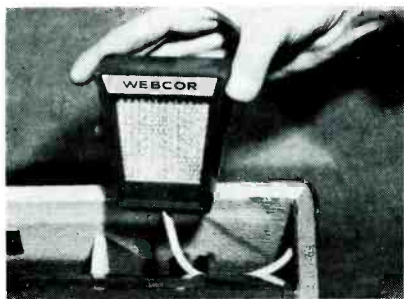

A storage compartment is provided at the top of the recorder. The microphone is a ceramic unit which is not affected by heat or humidity.

turnover to play the second track of monaural recordings or when making a recording is also a feature of this machine.

In addition to the two directional play, the unit will also play stacked stereo tapes. For this the full reel is placed on the right hand spindle and the tape motion is to the left. An automatic cutoff switch, which cuts both the motor and the amplifiers, including the amplifier in the extension speaker, is incorporated also.

Volume level on recording is noted by means of a cathode ray "magic-eye" indicator and there is an odometer type counter, which may be reset, to locate specific numbers on a reel of tape.

The Imperial will record and play back monaurally through its own speaker which is mounted in the side of the cabinet or through external speakers. This speaker may also be used as a monitor to hear recordings as they are being made.

The recorder has two recording heads, one a single head and the other a stacked stereo head half of which

*Product: Webcor Imperial Model 2827*

*Price: \$319.95, speaker system \$119.95*

*Manufactured by Webcor, Chicago 39, Ill.*

also acts as a monaural head for right to left monaural recording. The drive is supplied by two 4 pole induction motors. Speed change is accomplished by turning a slotted head in the center of the tape deck.

In the front edge of the deck are the jacks for the input, mike or phono, an external amplifier jack to connect the recorder to an outside unit and a two-way speaker jack which may be used to connect the recorder to an external speaker.

In a well on the side of the case are jacks to take the remote control, a jack to connect the output of the stereo preamp to a power amplifier and speaker and a volume control to operate the second channel. There is also an AC outlet to furnish power to the amplifier of an external sound system. This is cut off automatically along with the machine by the automatic stop which operates when the tape breaks or the end of the tape comes through.

One of the most unusual features of the machine is the "Aural Balance Remote Control." This device, shown in the photo, incorporates a volume control and a balance control. A 15 foot cord allows the listener to sit up to that



The recorder and matching twin speakers with the cases closed. The recorder weighs 43 pounds, the speakers about 20 pounds. Interconnecting cords are furnished.

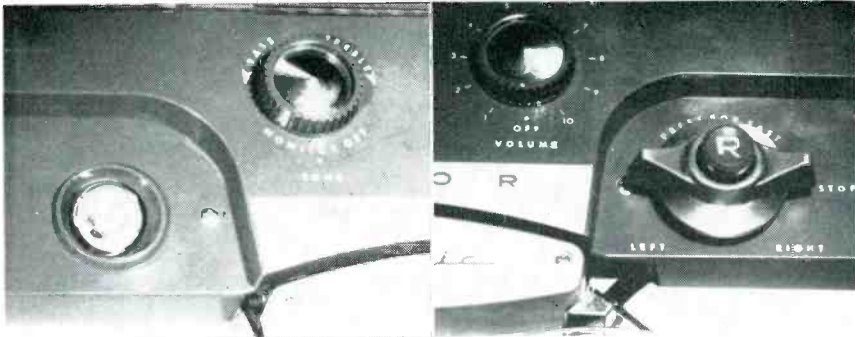

Left: the recording level is indicated by the cathode ray magic eye. Next to it is the tone control which also serves as an on-off switch for the monitor. Right: the volume control and on-off switch for the recorder. All tape movements are controlled by the single control shown. The center button is depressed for recording.

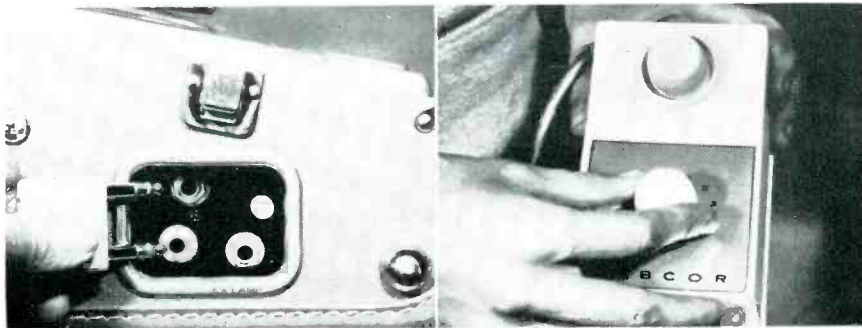

The well in the side of the case contains the dual jacks for the remote Aural Balance Control, a volume control for the second channel and an external amplifier jack. Right: the Aural Balance control has a 15 foot cord attached. The unit controls both the volume and the balance of sound between the two speakers.

distance from the recorder and control both the volume and the balance of sound between the two speakers. It has a dual plug on the end of the cord which is plugged into the jacks on the side of the recorder.

To operate it, the volume controls for both channels should be turned full on and the volume is then adjusted by the knob on the Aural Balance Control.

The two-section speaker system, No. BP-4827 consists of one speaker only unit and an amplifier-speaker unit. The latter has a push-pull amplifier with 8 watts output. The two units fit together to make one easily transportable case. Each unit contains an 8" woofer, a 6" mid-range speaker and a 4" tweeter. The case is finished to match

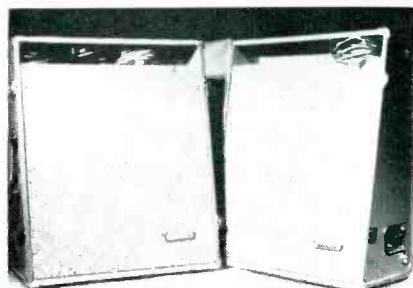

the recorder.

When used with the recorder as a P.A. system or for monaural playback, the combined amplifiers will produce 16 watts of audio power.

The tone control, which is effective for playback, also acts as an on-off switch for the monitor speaker.

If the recorder alone is bought, it may be used to power any existing system.

Our tests indicated that this is a well made machine. The three speakers in each cabinet give excellent listening pleasure and approximate studio quality. The dual channel amplifiers operated with a minimum of hum and hiss. We do not hesitate to recommend it.

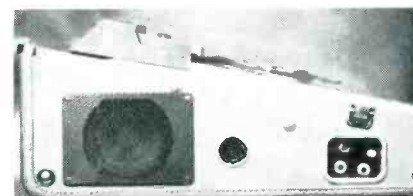

Left: the speaker unit consists of two parts, one of which contains an 8 watt amplifier to power the second channel. Above, a side view of the recorder.

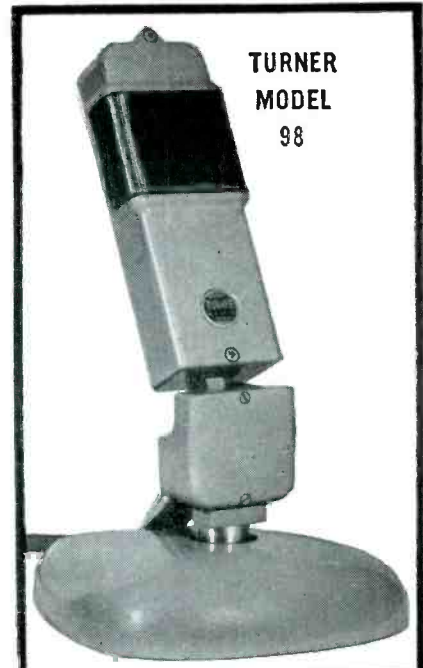

TURNER  
MODEL  
98

## A Quality Cardioid

*at a low price*

The Turner model 98 is a directional microphone ideal for use in broadcasting, recording and public address applications. Directional characteristics make it "live" to sounds in front, "dead" to sounds from the rear. Reduces unwanted audience, mechanical equipment, and background noises. Eliminates acoustical feedback in public address work. Check the specifications, compare the prices. You'll see for yourself why the Turner Model 98 is such an outstanding value in cardioid microphones.

### SPECIFICATIONS:

Frequency response—65 to 11,000 c.p.s.; Output level—-52 db; Impedance—Specify 50, 200 ohm or high; Dimensions—6¼ x 1½ x 1; Cable—Detachable 20 ft. single conductor (high impedance) or two conductor (50, 200 ohm) shielded.

### LIST PRICES:

Model 98 .....\$59.50  
Model S-98 (with on-off slide switch) ..... 63.50  
Matching G-7 Shockmount stand ..... 8.00  
Models 98 or S-98 with chrome finish add \$10.00 to list prices and specify "chrome finish".  
Matching C-7 chrome Shockmount stand \$9.50.



**THE TURNER COMPANY**  
948 17th St., N. E.,  
Cedar Rapids, Iowa

IN CANADA:  
Canadian Marconi Co.,  
Toronto, Ontario and Branches

EXPORT:  
Ad Auriema, Inc.  
89 Broad St., New York 4, N. Y.

# Here is the "KNOW-HOW" you need

NOW IN STOCK FOR IMMEDIATE SHIPMENT

ORDER BOTH OF THESE NEW BOOKS TODAY

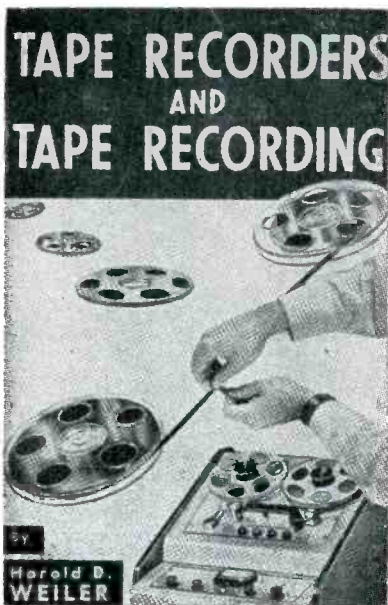

Library size 5 1/2 x 8 1/4 inches profusely illustrated—13 fact packed chapters, 190 pages

## TAPE RECORDERS and TAPE RECORDING

Written so that anyone can understand it—profusely illustrated so that anyone can easily follow directions—this new layman's manual

by

**Harold D. Weiler**

*(author of the popular book, "High Fidelity Simplified") is a "must" for every owner of a tape recorder.*

Library size—just 5 1/2 x 8 1/4 inches—this wonderfully helpful new book by an author who knows his subject and knows how to write so that everyone can understand him perfectly, contains over 100 illustrations and diagrams—13 chapters of practical, down-to-earth suggestions that spell better recording results for each of your customers.

**Tough Paper Binding . . . . . \$ 2.95**

**Handsome Cloth Binding . . . . . \$ 3.95**

## TAPE RECORDERS—How They Work

Written in a popular style—profusely illustrated this excellent volume tells "what's under the cover." Service technicians, Hi-Fi enthusiasts and tape recordists will benefit from this book

by

**Charles G. Westcott**

Chapters include: Theory of Magnetic Recording, The Motorboard, Tape Transport Mechanism, Drive Motors, Volume Indicators, The Bias Oscillator, Equalization Circuits, The Record and Playback Amplifier, Magnetic Recording Heads, Magnetic Recording Tape, Test Procedures and Index. Has 167 illustrations.

**Tough Paper Binding . . . . . \$ 2.75**

*order from your dealer or use coupon below.*

NOW IN STOCK FOR IMMEDIATE SHIPMENT

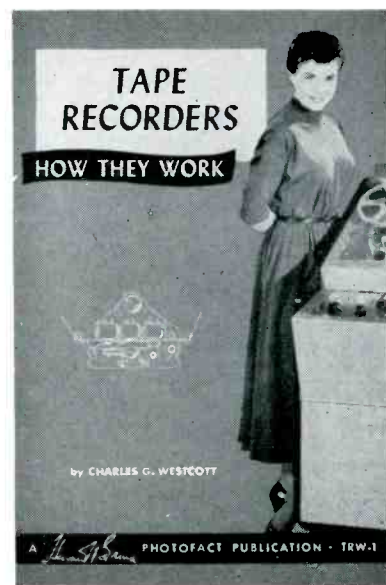

Library size 5 1/2 x 8 1/4 inches profusely illustrated—11 fact packed chapters, 177 pages, 167 illustrations

**Book Department  
TAPE RECORDING  
Severna Park, Md.**

- Please send me the books checked below. I enclose . . . . .
- Tape Recorders and Tape Recording, cloth bound . . . \$3.95
  - Tape Recorders and Tape Recording, paper bound . . . \$2.95
  - Tape Recorders—How They Work, paper bound . . . \$2.75

Name . . . . .

Address . . . . .

City . . . . . Zone . . . . . State . . . . .

## Order Yours Today

# NOW HEAR THIS...

... THE WORLD'S FIRST

## TAPEBOOK®

### ALL ABOUT TAPE—ON TAPE

Will give you the information you need in sound, not in the written word. A new first in publishing history.

#### MEET THE AUTHOR



Jack Bayha

JACK BAYHA is a prominent young audio engineer, writer for numerous technical publications and has been an audio hobbyist for over fifteen years. He is the host of the Hi-Fi House program on WHFB. He has been an engineer in the audio and tape recording fields for the last twelve years.

### ORDER YOUR FIRST EDITION COPY TODAY

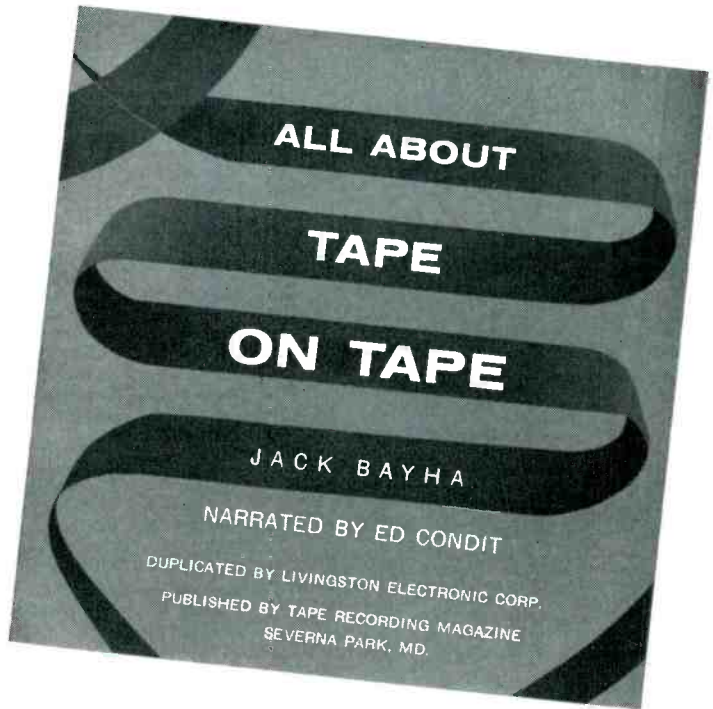

... authored by Jack Bayha ... a book to which you listen ... the first book specifically designed and produced on tape instead of the printed page ... Now you can actually HEAR what good recording, over-recording, wow, flutter, distortion, wrong mike placement, etc., sound like. A test section allows you to adjust the head of your recorder for best results. Chapters include: How a Tape Recorder Works, A Demonstrated Glossary, Recorder Operation, Home Recording, Field Recording, Low Impedance, Microphones, Recorder Maintenance and Testing.

... Playing time of the Tapebook is one hour. Accompanying each reel is a 28 page booklet containing 80 illustrations to supplement the spoken word. It is unique, enjoyable and instructive.

7 1/2 IPS, 7" Reel, Dual Track ..... \$6.95 postpaid  
3 3/4 IPS, 5" Reel, Dual Track ..... \$5.95 postpaid

Including a 28 page manual of illustrations

#### ASK YOUR DEALER OR USE COUPON BELOW

**HI-FI TAPE RECORDING**  
Severna Park, Md.

Please send me a first edition copy of "All About Tape—on Tape" as indicated below.

- 7 1/2 IPS, 7 inch reel, dual track ..... \$6.95 postpaid
- 3 3/4 IPS, 5 inch reel, dual track ..... \$5.95 postpaid

I enclose \$.....

NAME.....

ADDRESS.....

CITY.....ZONE.....STATE.....

**A High Fidelity Control Unit  
of Unlimited Flexibility  
and Matchless Performance**



**THE FISHER Master Audio Control**

**Model 80-C**—The single, most popular, self-powered preamplifier with controls in high fidelity history. THE FISHER Model 80-C is of a quality normally encountered in broadcast station console equipment. No other unit offers all of the features found in THE FISHER 80-C—uniform response within 0.25 db from 20 to 20,000 cycles; IM distortion and hum virtually non-measurable; calibrated 4-position Loudness Balance Control; Balanced-Spectrum Bass and Treble Tone Controls; separate equalization and preamplification directly from tape playback head; 5-position mixing and fading facilities on two to five channels; 16 combinations of phonograph equalization; push button Channel Selectors, which simultaneously operate the AC power to auxiliary equipment; individual channel indicator pilot lights. DC on all filaments; two cathode follower outputs. Tube Complement: 3-12AX7, 1-12AU7A. Size: 12 3/4" wide x 7 1/2" deep x 4 1/2" h. **Chassis, \$99.50**

**Mahogany or Blonde Cabinet, \$9.95**

*Slightly Higher in the Far West*

*Write For Full Details*

**FISHER RADIO Corporation**  
21-27 44th Drive • L. I. City 1, N. Y.

We'll be glad to see you in Room 707 at the Chicago Hi-Fi Show, Palmer House, September 13, 14, 15.

**Hi-Fi Tape Recording  
Severna Park, Md.**

**A SOUND INVESTMENT**

When we find one we don't hesitate. HI-FI TAPE RECORDING Magazine will pay many future dividends in recording and listening pleasure. Fill out the coupon below and get it in the mail. We'll be glad to bill you if your check book isn't handy at the moment.

**2 Years ..... \$7.00**  
**1 Year ..... \$3.75**

**HI-FI TAPE RECORDING  
Severna Park, Md.**

Please enter my subscription as indicated below:

- 2 years ..... \$7.00
- 1 year ..... 3.75
- Payment enclosed.     Bill me later.

Name .....

Address .....

City..... Zone..... State.....

**SHOP OR SWAP**

Advertising in this section is open to both amateur and commercial ads. TAPE RECORDING does not guarantee any offer advertised in this column and all swaps, etc., are strictly between individuals.

**RATES:** Commercial ads, \$30 per word. Individual ads, non-commercial, \$0.5 a word.

Remittances in full should accompany copy. Ads will be inserted in next available issue. Please print or type your copy to avoid error. Address ad to: Shop or Swap, Hi-Fi Tape Recording Magazine, Severna Park, Md.

**WILL BUY:** Radio Transcriptions. Dance, Light Concert, and South American. Sam Kiamie, 930 Grant Avenue, Pelham Manor, N. Y.

**AMPEX 600 and 620 Amplifier, new condition, \$495; Electro-Voice PC1 Preamp, \$60. Satisfaction guaranteed. Write Box 136, Vandalia, Ohio.**

**TAPE RECORDER OWNERS** who wish to mail a tape message of 30 minutes, 4-inch tape. I can furnish a low priced tape at 75¢ or hi-fi tape at \$1.00, including strong lightweight box and mailing sticker, delivered anywhere in the U. S. at above price. Postage only costs you 3¢ per box. George F. Bischof, 1503 E. Vickery Blvd., Fort Worth 4, Texas.

**WANTED:** Married Sophomore medical student needs financial assistance in finishing medical education. Interested in General Practice. Will locate in any area in return for loan. Character and scholastic references upon request. If you have any helpful information please respond with Norris A. Biggerstaff, 1147 West Fourth Street, Winston-Salem, North Carolina.

**SCOTCH PLASTIC TAPE, Used, but not abused. 2400'x10 1/2" (NARTB aluminum reels) 3 reels \$10, 6—\$19, 12—\$37; 4800'x14" (NARTB hubs) 3 reels \$13, 6—\$25, 12—\$49; 600'x5" (plastic reels) \$9.50 dozen; empty 7" aluminum Audio reels \$1.50 dozen. Priced FOB, R. Lackner, 2029 Bradley, Chicago 18.**

**SCHOOL BANDS—RECORDING FANS, Attention:** Disc Cuttings, Multiple Pressings from your tapes. Professional quality, lowest prices. Also, nationally advertised high fidelity components. Write for quotations. Patmor Sound Systems, 92 Pinehurst Ave., New York 33, N. Y.

**EDISON CYLINDER RECORDS** taped from 1888 Edison phonograph. For titles and prices: Johnson's, 434 Coles Mill Road, Haddonfield, N. J.

**\$100.00 WEEKLY Spare Time** with a Tape Recorder! Fabulous new business. Entire country wide open! Record weddings, parties, sports events, stereophonic sound, sound-on-sound multiple recordings. Make radio commercials, sound effects. Have fun and make big money in the glamorous business

**TAPE RENTALS!!**

Enjoy the finest in pre-recorded tapes—RENT up to 7 selections for the cost of one purchase!

**WE RENT—SELL—BUY—LEADING BRANDS**

For full particulars, price lists, and introductory choice of any rental, send \$2.00 to:

**NATIONAL RENT-A-TAPE SERVICE**

P. O. Drawer 1, Winnetka, Illinois

of tape recording. Moneymaking facts free! Dixieland Publishers, Asheboro 18, N. Y.

**FOR SALE:** R.C.A. Wire Recorder including mike and three cartridges, like new, \$35.00. T.V. Labs., 111 Main Street, Waterville, New York.

**GREAT CHOIR ANTHEMS, Hymn Singing, Inspirational thoughts (Southern Baptist).** Ideal for shut-ins, missions, churches. Fifteen or thirty-minute programs on your tape free. Include postage. Charley Summers, Box 986, Mobile, Alabama.

**LEARN WHILE ASLEEP** with your recorder. Amazing book gives full instructions, \$2.00. Guaranteed. Research Association, Box 610-TR, Omaha.

**BUILD YOUR OWN Automatic Shutoff, 10 1/2" reel adapter and tape player. Kits and prints. LeROI Engineering, Box 251, Elmhurst, Illinois.**

**INTRODUCTORY OFFER—Famous Branded Recording Tape—A-1 quality, fresh, new stock—1800' 1 Mil Acetate, \$1.79. 1200' 1 1/2 Mil Acetate, \$1.43. Boxed, on 7" reels. Include 20¢ per reel postage. Florman & Babb, Inc., 68 W. 45th Street, New York 36, N. Y.**

**RECORDS FROM YOUR TAPES. Average price \$3.00. Box 287, Bellingham, Wash.**

**LEARN HYPNOTISM, SELF-HYPNOSIS** from tape! Other helpful recordings! Free Information. Drawer TR10-697, Ruidoso, New Mexico.

**FOR SALE:** New Viking record/play/monitor tape deck and RP61 record/play preamp, \$130; R.C.A. 3 speed portable phonograph, diamond stylus, \$70; Garrard Model "T" with Sonotone 3TS cartridge, \$30; Collaro model 3/544 3 speed manual player, \$20; Miller crystal AM tuner, \$15. R. W. Long, 7426 Harvard Ave., Cleveland 5, Ohio.

**SYNCHRONIZER HOOKUP:** Make sound movies with your tape recorder, \$10.00. Anderson, 2424 Phelps Street, Stockton, Calif.

**HAVE SEVERAL DOZEN 10 1/2" Aluminum NARTB empty reels (boxed).** Most are new, some slightly used but perfect. Prepaid \$2.25 each in any quantity. Send check to Edward Schultz, 91 Whittingham Terrace, Millburn, N. J.

**WANTED:** Disc Recorder. State condition and price in your letter. Hugh J. O'Connor, 7313 East End Ave., Chicago 49, Illinois.

**STEREOPHONIC TAPES** for Inline Heads for sale. Will also swap. William Van Laube, 50 Church St., Chatham, N. Y.

**UTAH 12" co-axial speaker, 40-15,000 cycles, never used, \$13; Emerson FM table radio \$19; new phono-oscillator with tubes \$4; pair wireless intercoms \$45; priced FOB; Wanted: bulk eraser, splicer, tape vendor, telephone pickup. R. Lackner, 2029 Bradley, Chicago 18.**

**FOR SALE:** New DeJur TK 820 Tape Recorder, including mike, etc.; used only a few times for demonstration. Original carton, \$250. Reg list \$399. T.V. Labs., 111 Main Street, Waterville, New York.

Buy your next recorder from a specialist in recording for over 8 years. Highest trade-in allowances toward professional equipment—Ampex, Berlant, Crown, Ferrograph, Presto, etc. Full line of accessories.  
**BOYNTON STUDIO**  
10 Pennsylvania Ave., Dept. TR  
Tuckahoe, N. Y. Tel. SP. 9-5278

**TAPE RECORDERS**  
EXCEPTIONAL VALUES  
**HI-FI COMPONENTS**  
NATIONAL BRANDS

WRITE FOR FREE CATALOGUE  
**CARSTON** 215-C E. 88 ST.  
NEW YORK 28, N. Y.



**if you think  
that all brands of  
recording tape are alike . . .**

**wait  
till  
you  
try**

**irish**

BRAND



**ferro-sheen**

*available wherever quality recording tape is sold*



**irish**

**BRAND  
RECORDING  
TAPE**

ORRadio Industries, Inc., Opelika, Alabama  
Export: Mo-han Exporting Corp., New York, N. Y.  
Canada: Atlas Radio Corp., Ltd., Toronto, Ontario

# TAPE EXPERT

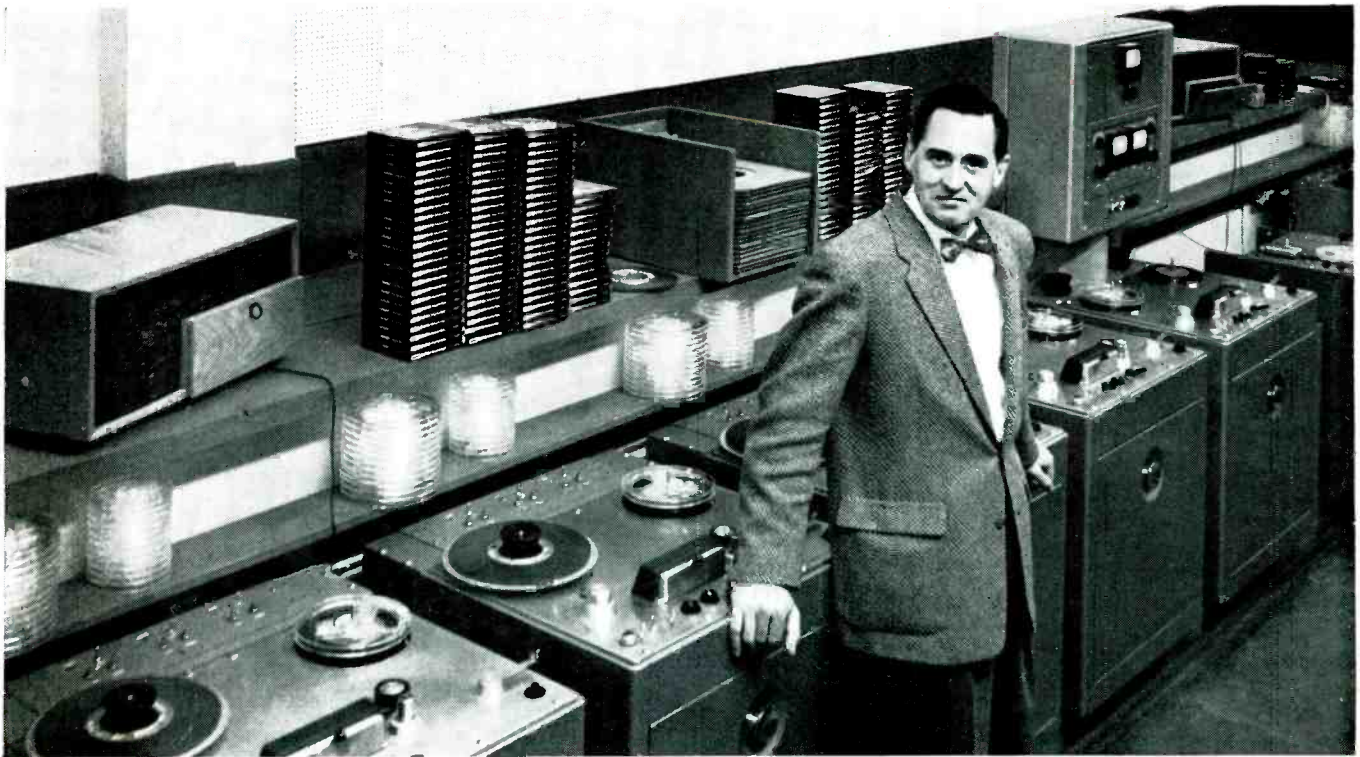

Cliff Whenmouth, President of Magnetic Tape Duplicators, whose firm duplicates thousands of reels of "Scotch" Brand Magnetic Tape each day.

## One of the world's largest duplicators tells why he uses "Scotch" Brand Magnetic Tapes exclusively!

Meet Cliff Whenmouth, President of Magnetic Tape Duplicators, young man with "a million miles of tape duplicating experience", and authority on magnetic tape quality.

This company, located in Hollywood, California, duplicates for at least 20 recorded tape firms, as well as Audio Digest and The Los Angeles County Tape Library. The success of the business depends on maintaining the high quality of its duplicate tapes.

No wonder Cliff has used only "Scotch" Brand Magnetic Tapes for the last 2½ years. He's found no other tape which offers the same reel-to-reel uniformity and dependability as "Scotch" Brand. And he knows the value of "Scotch" Brand's

built-in silicone lubrication for reducing head wear and loss of resolution.

Professionals like Cliff Whenmouth use "Scotch" Brand Magnetic Tape. Why don't you try it—for professional results? Hear what a difference "Scotch" Brand quality makes!

**ONLY "SCOTCH" BRAND HAS  
SILICONE LUBRICATION**

