

June 1991

\$5.00 £2.00

# STUDIO SOUND

AND BROADCAST ENGINEERING



**PREVIEW  
APRS LONDON**



9 770144 594017

# Focusrite

The Focusrite Studio Console has been introduced to the world of music recording to meet the aspirations of recording engineers seeking perfection in all that they do. Whether recording in the analogue or digital domains, the means with which the audio signal reaches tape is of paramount importance.

The microphone pre-amplifier and summing amplifiers must be completely transparent whilst the equalizer should enhance the sound in precisely the way desired. The rest of the console must offer similar levels of perfection and also ease

of use throughout the recording, overdubbing and mixing process.

The Focusrite Studio Console successfully addresses all these objectives. Based around the Focusrite transformer coupled mic - pre and equalizer, the console offers such features as 48 bus routing 12 mono and 2 stereo sends and 3 stereo buses. Optional features include left-centre-right panning for mixing to picture.

200 kHz bandwidth throughout the console and ultra low-noise balanced buses ensure optimum phase coherence and noise performance. Transformer

balanced insert sends and line outputs ensure electrical isolation from external sources.

The unique facility of global horizontal switching and other group status controls accelerate initial setup. The choice of GML or SSL moving fader automation systems offers familiarity without compromising the sonic performance of the console.

For those recording engineers who seek perfection, and for the studios that serve them, we offer you the excellence of the Focusrite Studio Console.



Metropolis Studio, London

## Designed for Perfection



Focusrite Audio Engineering Ltd.  
Unit 2 Bourne End Business Centre,  
Cores End Road, Bourne End,  
Bucks., SL8 5AS, England.  
Tel: +44 (0)628 819156  
Fax: +44 (0)628 819113



# STUDIO SOUND

AND BROADCAST ENGINEERING



Prism Power at London's Wembley Arena

<b>Editorial:</b>	Studio Sound's viewpoint on events and trends, and their implications	<b>5</b>
<b>News:</b>	Events, news, moves and comment from inside and outside the recording industry	<b>10</b>
<b>Products:</b>	Product updates, developments, upgrades and software updates	<b>16</b>
<b>Music News:</b>	This month's column is devoted entirely to a perennial favourite, the Hammond organ. Compiled by Zenon Schoepe	<b>22</b>
<b>AES Conference, Will you be legal?:</b>	The new rulings on Electro-Magnetic Compatibility will be with us next year. Tim Frost reports on an AES Conference	<b>24</b>
<b>Live Sound:</b>	Keeping abreast of live sound news and equipment. Compiled by Mike Lethby	<b>31</b>
<b>Prism Power:</b>	Sound reinforcement company Showco have developed the Prism system especially for large arenas. Mike Lethby tries to access all of its areas at a George Michael concert	<b>33</b>
<b>APRS Preview:</b>	A guide to manufacturers, agents and services exhibiting at the June show in London	<b>43</b>
<b>Air Movements 2:</b>	David Mellor continues his fly-on-the-wall look at the building of the new Air Studios	<b>55</b>
<b>Ultimation:</b>	The new moving fader automation system from SSL. Patrick Stapley reports on this long awaited addition to the SSL range	<b>61</b>
<b>Cyberzone Sound:</b>	Zenon Schoepe goes into a state of virtual reality and finds a new game show with a daring approach to audio production	<b>64</b>
<b>Voyageur II:</b>	Guillaume Schouker reports on a busy French mobile recording operation, based in Paris	<b>67</b>
<b>Videaudio:</b>	This Belgian studio is catering for the burgeoning film industry in the country. Sue Sillitoe reports	<b>72</b>
<b>Akai DD1000:</b>	Jim Betteridge takes a second look at this unique optical disk recorder, including its software for the Macintosh	<b>77</b>
<b>Signal Chain:</b>	How healthy is your signal path? Ben Duncan gives advice on how to find out and how to keep it that way	<b>85</b>
<b>Business:</b>	A new 'Copycode' system rears its ugly head; using a redundant CD royalty logger; and CD-R lost in Belgium. By Barry Fox	<b>93</b>
<b>Perspective:</b>	People are talking about CD prices; oiling the wheels of change; and customised exhibitions. US columnist Martin Polon joins in	<b>95</b>
<b>Creating New Images:</b>	With the introduction of Roland's RSS system, there has been renewed interest in stereo processing and imaging. Francis Rumsey surveys the fundamentals	<b>101</b>
<b>Practical Networking:</b>	The networking of digital recording/editing systems is now upon us. Yasmin Hashmi looks at some examples	<b>106</b>

# ULTIMATION™

## THE 'ULTIMATE AUTOMATION' SYSTEM

ULTIMATION is an entirely new concept in console automation, designed to let engineers choose the type of system most appropriate to the task in hand.

It can work as either a dedicated VCA system, a dedicated moving fader system, or in a way that combines the best features of both systems. The engineer is free to decide.

By using SSL's unique dual signal path circuitry, ULTIMATION really is the ultimate in console automation.

*Main features include:*

- ▶ Works as standard G Series VCA system, or as a full moving fader system
- ▶ Dual signal path technology allows *combined* operation, providing the benefits of both systems
- ▶ Automatic selection of gain element most suitable to task
- ▶ Reads existing G Series mix data

In keeping with SSL's commitment to system compatibility, ULTIMATION reads all existing G Series mix data, and can be retrofitted to any console using the G Series computer.

**At last studios can provide an automation system to suit any client, yet retain the familiarity of the world's most respected console system.**

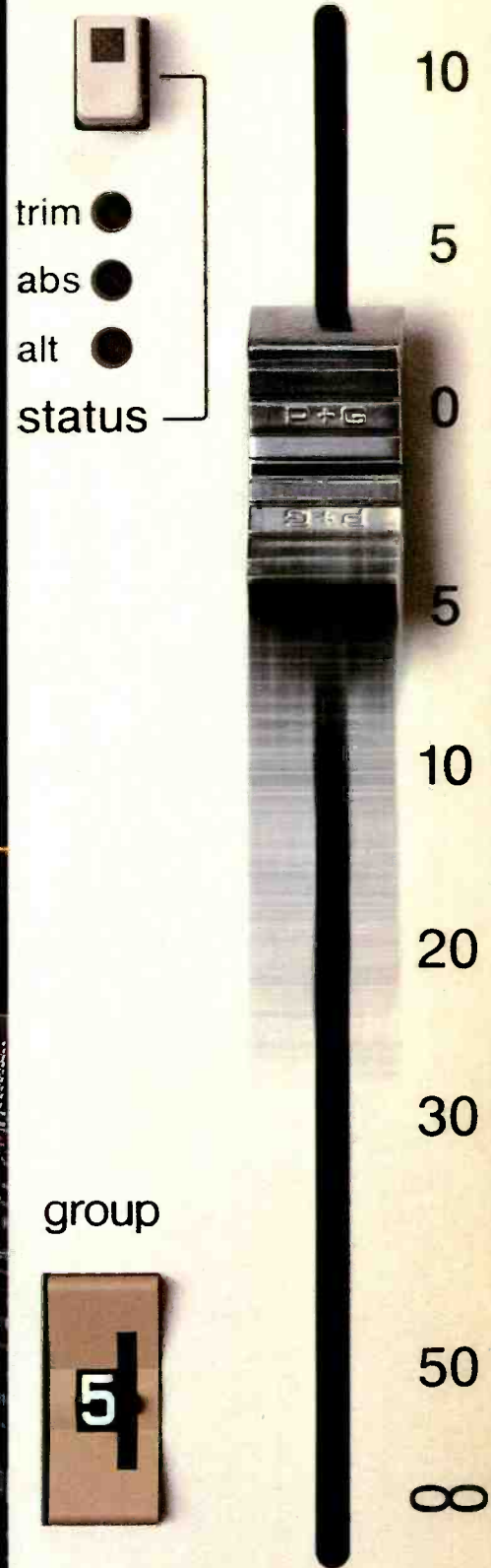

### Solid State Logic

*International Headquarters*  
Begbroke, Oxford, England OX5 1RU · Tel: (0865) 842300

Paris (1) 34 60 46 66 · Milan (2) 612 17 20  
Tokyo (3) 54 74 11 44 · New York (212) 315 1111  
Los Angeles (213) 463 4444 · Toronto (416) 363 0101



# STUDIO SOUND

AND BROADCAST ENGINEERING

June 1991  
Volume 33 Number 6  
ISSN 0144 5944

## EDITORIAL

**Editor:** Keith Spencer-Allen  
**Assistant Editor:** Julian Mitchell  
**Co-ordinating Editor:** Ann Lowe  
**Secretary:** Elaine Sweeney  
**Consultant:** Sam Wise  
**Columnists:** Barry Fox, Martin Polon (US)  
**Regular Contributors:**

Janet Angus	Mike Lethby
James Betteridge	David Mellor
Mike Collins	Terry Nelson
Ben Duncan	Francis Rumsey
Dave Foister	Zenon Schoepe
Yasmin Hashmi	Patrick Stapley

## ADVERTISEMENTS

**Executive Ad Manager:** Steve Grice  
**Deputy Ad Manager:** Phil Dearing  
**Advertisement Production:** Alicia Smith  
**Secretary:** Lianne Davey

## CIRCULATION

**Circulation and Development Manager:**  
Colin Enderson  
**Controlled Circulation Manager:**  
Maria Udy  
**Enquiries:** See classified advertisement

**Director:** Doug Shuard  
**Publisher:** Steve Haysom

## EDITORIAL & ADVERTISING OFFICES

Spotlight Publications Ltd, 8th Floor, Ludgate House, 245 Blackfriars Road, London SE1 9UR, UK. Tel: 071-620 3636. Fax: 071-401 8036.

## NEWSTRADE DISTRIBUTION (UK)

UMD, 1 Benwell Road, London N7 7AX, UK. Tel: 071-700 4600. Fax: 071-607 3352.

## AMERICAN OFFICE

**Publishing Services Manager:** Fred Vega  
Studio Sound, 2 Park Avenue, 18th Floor, New York, NY 10016, USA. Tel: (212) 779-1212. Fax: (212) 213-3484.

## JAPAN & FAR EAST AGENT

**Contact:** Mikio Tsuchiya, Media Sales Japan Inc, Tamuracho Bldg 3 3 14, Shimbashi, Minato-Ku, Tokyo, Japan. Tel: (03) 504-1925. Telex: J25666. Fax: (03) 595-1709.

© Spotlight Publications Ltd 1991 all rights reserved

Origination by Lawrence-Allen (Colour Printers) Ltd, Gloucester Street, Weston-super-Mare, Avon BS23 1TB.

Printed in England by Andover Press, St Ives plc, Telford Gate, West Portway Industrial Estate, Andover, Hants SP10 3SF.

Studio Sound and Broadcast Engineering incorporates Sound International and Beat Instrumental

Studio Sound is published on the third Friday of the month preceding the cover date. The magazine is available on a rigidly controlled requested basis, only to qualified personnel (see classified advertisement for terms)

ABC

MEMBER OF THE AUDIT  
BUREAU OF CIRCULATIONS



Total average net circulation of 19,166 per issue during 1990.  
UK: 6,655. Overseas: 12,511.  
(ABC audited)

EDITORIAL

## Confused?

There is undoubtedly something very contradictory going on within the business side of our industry. I had hoped that it would become clear whether the climate was getting better, worse or was stationary. So far, even with access to all the opinion and information that we have, it just seems that the only point we can make is that things still aren't very good.

Let's take a look at some of the signs. Earlier in the year there was a spate of studios running into severe financial difficulties but there have been few over the last couple of months. Does this mean that things are getting better? We have heard from a wide cross section of manufacturers and dealers that demand at all levels is there but the finance providers have very little interest in taking on the risk at any level. For the manufacturer this could be seen as worse than there being no demand at all as customer interest and expectations remain high but they will/cannot back this up with cash. The manufacturer still has to promote and exhibit but for low return in sales. The NAB Convention was a prime example of this—largest show ever; attendance breaks records but few major sales announcements.

So there are confusing signs in the economy. In the UK other matters such as the pending TV franchise auctions are combining to further complicate the market. Martin Polon suggests in his column that we are now a mature industry and that there should be no illusions about returning to a boom market in any of the pro-audio areas—all the immediate growth and equipment needs have been satisfied. He argues that although there will be an improvement in general economic trends, the market situation will remain close to the present without a major change in attitude from a key player such as the record companies. There are no golden prizes awaiting.

In the middle of the pro-audio exhibition season we need to balance the downside advocacy of Mr Polon against the outwardly smiling faces manning the booths. You actually don't need to decide who is right but business futures depend on correct decisions and an awareness of situations that may exist beyond the end of next week is a mark of wisdom.

## And now for something else

A sizable chunk of magazine history comes to an end with this issue. In June 1964 Link House Publications acquired a couple of titles from a small central London publishing house and moved them to their Croydon base.

These were *The Tape Recorder* and sister publication *Hi-Fi News*. A few years later *The Tape Recorder* became *Studio Sound* and we are now in our 33rd year of publication.

In the mid '80s Link House became part of the United Newspapers Group, a very large diversified publishing company. Internal restructuring of this group means that by the time you read this we will have acquired a new central London location and no longer be Link but Spotlight Publications (you'll find our new details to the left of this column). Nothing else about the magazine will change although shaking off 27 years residence in Croydon (UK readers will understand) may have some effect.

Have a good APRS.

Keith Spencer-Allen

Cover: Ultimation from SSL

# A MEGA NEW STUDIO CONSOLE

(IN EVERY AREA BUT THE PRICE)

THE WORD MEGAS—FROM WHICH THE MODERN WORD 'MEGA' IS DERIVED—MEANS, LITERALLY, 'GREAT'.

AND 'GREAT' IS EXACTLY WHAT OUR NEW MEGAS RANGE OF CONSOLES HAVE BEEN DESIGNED TO BE.

MEGAS IS THE PRODUCT OF BOTH ADVANCED AUDIO DESIGN TECHNOLOGY AND PRACTICAL THOUGHT; COMBINING UP-TO-DATE COMPONENTS WITH MODERN MANUFACTURING METHODS.

THE RESULT IS A RANGE OF LOW COST CONSOLES THAT PROVIDE AN IMPECCABLE DEGREE OF AUDIO QUALITY TOGETHER WITH UNMATCHED STANDARD FACILITIES AND FEATURES.

FOR EXAMPLE, THE MEGAS STUDIO RECORDING CONSOLE IS FITTED WITH MIDI CONTROLLED MUTING AS STANDARD, AND CAN EASILY BE INTERFACED WITH A SEQUENCER TO PROVIDE AUTOMATED MUTES.

THE STUDIO CAN BE SPECIFIED IN EITHER 16 OR

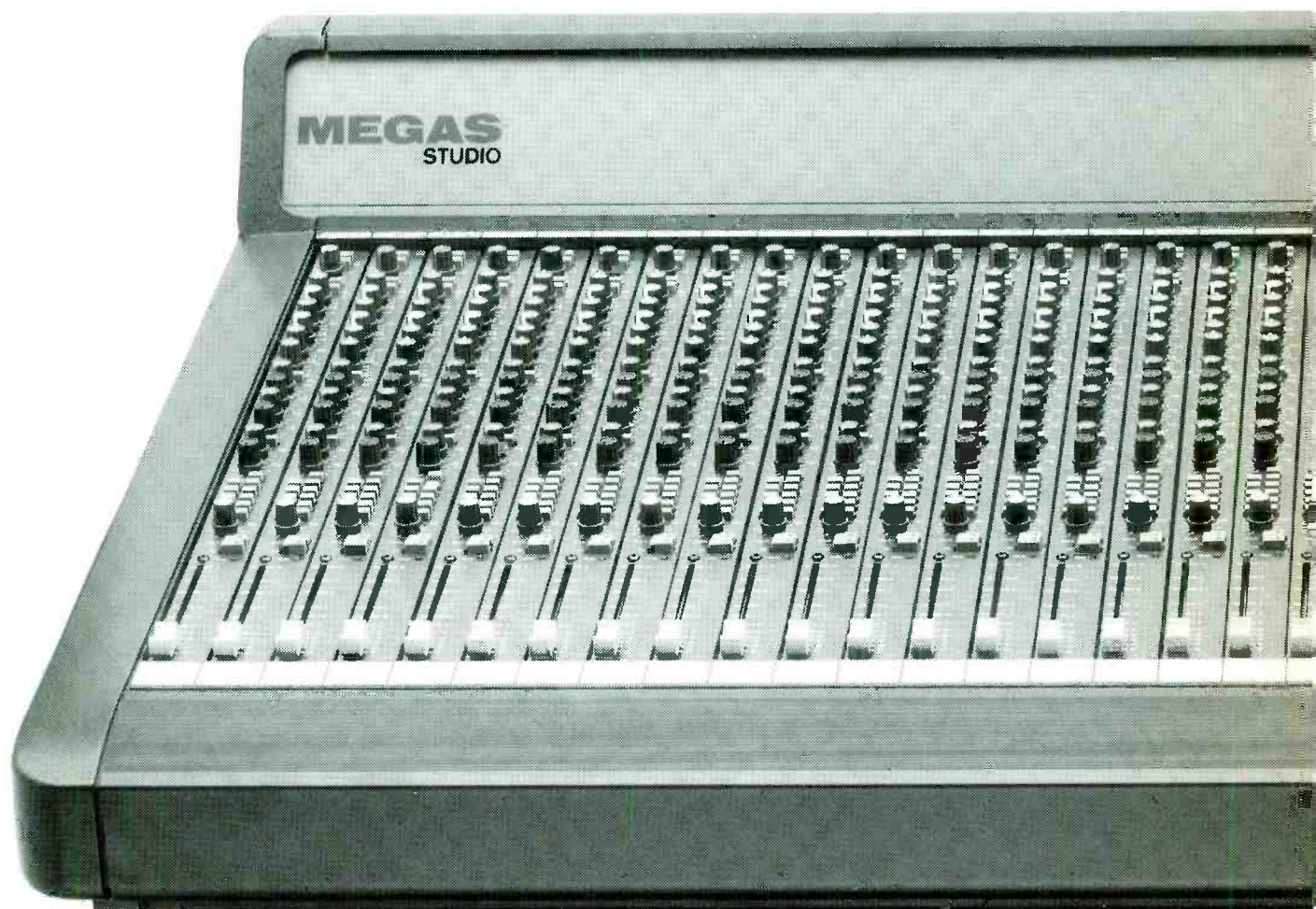



24 GROUP BUSS FORMATS. FOUR DIFFERENT FRAME SIZES CAN ACCOMMODATE A COMBINATION OF MONO OR STEREO INPUT MODULES PLUS UP TO TWELVE DUAL GROUP MODULES, A COMPREHENSIVE MASTER MODULE AND AN INTERNAL PATCHBAY. IN FACT, IT'S EXACTLY THE MIXER THAT YOU NEED IT TO BE.

WE'VE PAID SPECIAL ATTENTION TO AREAS YOU'LL NOTICE VERY QUICKLY.

SUCH AS OUR NEW EQUALISER DESIGN THAT NOT ONLY PROVIDES VERSATILE AND TRANSPARENT CONTROL OF THE AUDIO SIGNAL BUT ALSO SOUNDS, WE THINK YOU'LL AGREE, AS SWEET AS THOSE ON

CONSOLES COSTING MANY TIMES MORE.

AND A REMARKABLE NEW SWITCHING TYPE POWER SUPPLY UNIT THAT OPERATES AT LOW TEMPERATURES FOR HIGHER EFFICIENCY AND FAR GREATER RELIABILITY. EVEN THE HEADPHONE SOCKET HAS BEEN POSITIONED TO BE EASY TO REACH AND YET OUT OF THE WAY.

IN SHORT, THE MEGAS STUDIO IS THE PERFECT SOLUTION FOR THE TWO GREAT PROBLEMS IN LIFE; CREATIVE NECESSITY AND ECONOMIC REALITY.

**MEGAS**  
STUDIO

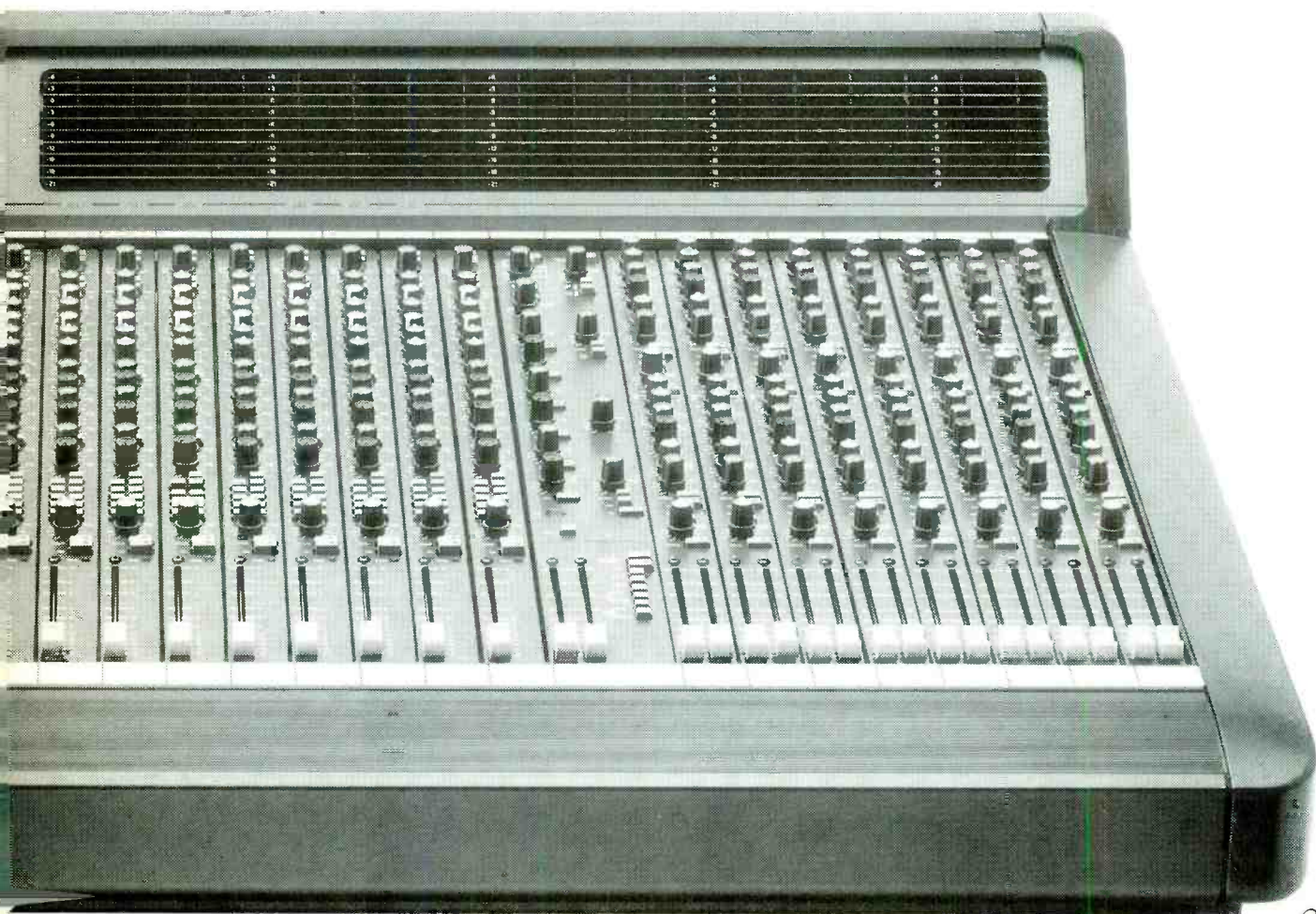

TECHNICAL SPECIFICATIONS: NOISE  $-127.5\text{db}$ , CROSSTALK  $>90\text{db}$ , CHANNEL MUTING  $>90\text{db}$ , INTERCHANNEL  $>80\text{db}$ .

Stand No. 004A

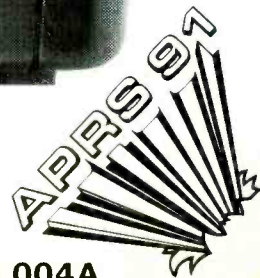



## Coach Audio Sales

GÜNTHER KUTSCH AND STEFAN MEYER, GBR  
SCHÜREN 12, D-6670 ST INGBERT, GERMANY  
TELEPHONE (06894) 4717 AND 4727  
FAX (06894) 383379

### USED EQUIPMENT FOR SALE/MAY 1991

#### CONSOLES:

- MCI 636, 36 frame, 36 channels
- SOUNDCRAFT TS 24, 56 frame, 56 channels, LED,  
2½ years old
- AMEK 3500, 56 frame, 52 channels
- AMEK 2500, 48 channels (36 mono + 12 stereo),  
Mastermix II, 8 aux, bargraph
- D&R AVALON, 32 frame, 32 channels
- SSL 4040 E, 40 frame, 40 channels, VU-Meter, patchbay,  
2½ years old
- SSL 4048 E, 48 channels, patchbay, producer desk, total  
recall, bargraph, 8 years old
- SSL 4040 E, 40 frame, 32 channels, Automation
- WESTEC 3020, 56 frame, 48 channels, Automation
- TRIDENT "VECTOR", 56 frame, 48 channels, Automation
- Various SSL-parts: channels, total recall, computers, etc.

#### OTHER USED MACHINES:

- AUDIOFRAME WAVEFRAME + direct-to-disk
- FOSTEX G 16
- AKAI-ADAM 12-track digital
- AKAI DD 1000 Optical Recorder
- SONY 3348 + locator/remote 48-track digital, 1 year
- SONY 3324 A, 24-track digital + locator/remote
- LYREC TR 532 + locator/remote
- LYREC TR 533 + locator/remote
- MITSUBISHI X-850 32-track + locator/remote
- MITSUBISHI MX-80 2-track digital
- OTARI DTR 900 B, 32-track + locator/remote, 9 months
- OTARI MTR-90 MK II + remote
- OTARI MX-80
- OTARI MTR-100 + remote + 24-track DOLBY SR
- QMS 215 speaker + amplifier, complete system
- QMS 405 speaker
- SYNCLAVIER + 8 direct-to-disk
- DAR — digital workstation 4 channels
- LEXICON 480 + LARC
- TASCAM ATR-80 24-track + locator/remote
- AKAI S1100 Sampler
- 2 x DOLBY A 361
- YAMAHA NS 40 M
- KURZWEIL 250 19" Expander
- TANNOY Super Red speakers
- SUMMIT AUDIO equaliser TPA-200
- SUMMIT AUDIO compressor TLA-100
- STUDER TLS 4000 Synchroniser
- SONY DAE 3000 PCM 1630 editing system
- Plus Complete studio 24-track/master/console (GBP 25,000.00)
- Offer without obligation, but subject to prior sale!
- For further details contact
- Mr Günther Kutsch, phone no. 0049-6849-4717!**



# YES! WE HAVE THE BEST PRICES



### EXPORT PRICES

### POUNDS STERLING

AIWA HHB PRO 1 .....	*£995
ADAM SMITH ZETA 3 .....	*£1,895
AKAI S 1100 .....	*£2,410
AKAI DD 1000 .....	*£6,600
AKAI DR 1200 COMPLETE .....	*£9,800
ALESIS QUADRAVERB .....	*£295
AMCRON DC 300 .....	*£749
APHEX TYPE C .....	*£235
ATC SCM 20 (PAIR) .....	*£1,190
BOSE 802 (PAIR) .....	*£995
BSS DPR 402 .....	*£680
CAD EQUITEK 2 .....	*£435
CAD DUAL COMPRESSOR .....	*£395
CAD 32 8 32 IN LINE .....	*£8,500
DBX 166 .....	*£395
DBX 160X .....	*£295
DIGIDESIGN SOUNDTOOLS .....	*£1,920
DOLBY SR 24 .....	*£12,700
DRAWMER DL 241 .....	*£400
EVENTIDE H 3000 SE .....	*£1,810
ELECTROVOICE SENTRY 100 (PAIR) .....	*£395
ELECTROVOICE PL20 .....	*£300
EMU PRODEUS .....	*£560
FOCUSRITE ISA 115 HD WITH PSU .....	*£2,855
JBL UREI 1178 .....	*£870
KLARK-TEKNIK DN 360 .....	*£995
LEXICON PCM 70 .....	*£995
MEYER SOUND HD 1 (PAIR) .....	*£3,695
NEUMANN U 87 .....	*£945
NEVE .....	CALL
REVOX PR 99 .....	*£1,380
SYMETRIX 525 .....	*£395
SHURE SM 58 .....	*£75
SONY DATSSS .....	CALL
TASCAM M 3500 32 INPUTS .....	*£4,750
UREI 809 (PAIR) .....	*£995
YAMAHA DMR 8 .....	CALL

\* OR EQUIVALENT CURRENCY + LOCAL TAX

*We are importers for:*

#### CAD

- CAD MEGAMIX AUTOMATION (runs on Mac or Atari)
- CAD microphones including EQITEK II studio mike
- CAD IN-LINE STUDIO MIXERS from 16 to 46 channels
- CAD CGMR stereo compressor for studio

#### SOUND DYNAMICS — studio monitors nearfield.

- 00 TI — 80W 2-way speakers 45Hz 21KHz 86db
- 50 TI — 40W 2-way speakers 55Hz 20KHz 85db
- 00 TIA — 80W powered speakers

#### SABINE — FBX Feedback exterminator

#### ATC — Professional Studio Monitors

#### RADIO SYSTEMS RS DAT — DAT for Broadcast

**AIWA HHB Pro** — AIWA DAT with professional features (AES, EBU etc).

### WE SHIP WORLDWIDE

## DENIS THE FOX

234 RUE DE CRIMÉE

75 019 PARIS

TEL: 33-1-40-38-01-12

FAX: 33-1-40-35-02-72



## OUR MONITORS

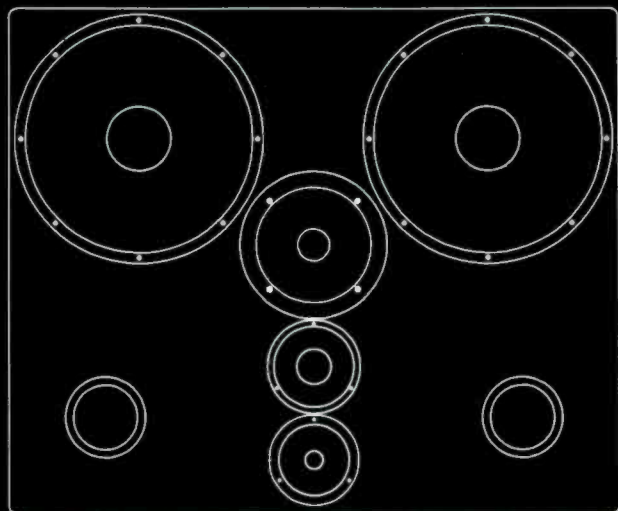
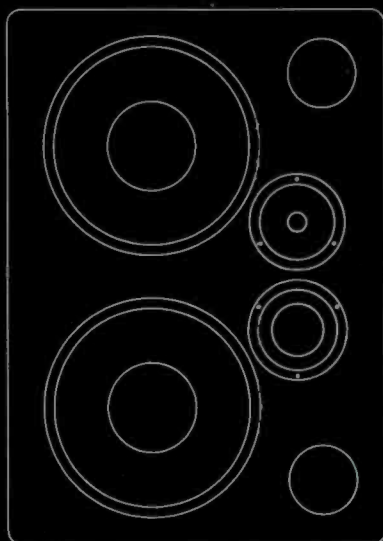
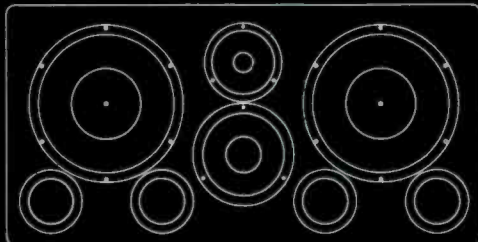
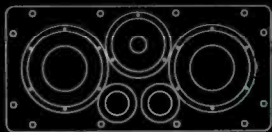

*Still*  
 ^ can't speak for themselves...

"Never in my life have I ever seen a pair of nearfields come in for test, be placed on top of the console, and simply stay there from that moment on. Totally natural. Clients just come in, record, mix, go away again completely happy. Now my beautiful M4s are only used when they need that little bit of extra level (8 kW of amps), and to get that real deep bass down to 20 Hz. Bloody awful little M1s, I hate them!"

**Freddy Hanssen, Sweet Silence Studios**

"I do about 70% of my work at home, and then go into the studio to overdub and mix. The more accurate I can get at home, the less work I have to do later. I auditioned dozens of small monitors that I could carry from place to place as a reference, and the M1s have the perfect combination of large monitor power and extended frequency response, whilst retaining the 'punch' that I'm used to from the 'Standard' nearfield monitor. They're also extremely accurate and consistent when moving from room to room."

**David Motion, Producer and Composer**

"The M2s are absolutely fantastic. We love them. I'm so pleased to have a smallish monitor which doesn't compromise on the bass end, and has such a detailed, accurate stereo image."

**Terry Britten, Composer and Producer**

"The monitor speaker systems M3, M2 and M1 are the most impressive speakers that I have ever heard. Their sound is crystal clear, sharp, transparent and perhaps most important of all, the sound image is harmonious as never before, however high the volume may be. These systems are a milestone for the '90s, a tremendous leap forward, and will make an enormous difference in the conception and design of any music production... What a wonderful experience in sound recording engineering!"

**Gerard Mandalka, Audio Design Engineer,  
 Euro Disney Paris**

**dynaudioacoustics®**

The Studio  
 13-16 Embankment Gardens  
 London SW3 4LW  
 England  
 Telephone 071-352 8100  
 Telefax 071-351 0396

**Listen to the mix, not the monitors!**

Denmark: New Music; Tel. (86) 19 08 99 Fax: (86) 19 31 99 France: Hilton Sound SARL; Tel. (01) 46670210 Fax: (01) 47698171  
 Germany: MEGA Audio GmbH; Tel. (06721) 2636 Fax: (06721) 13537 Ireland: Ideal Systems Ltd.; Tel. (01)-177-4663 Fax: (01)-774 675  
 Japan: General Traders Ltd.; Tel. (03)-3293-2274 Fax: (03)-3293-5391 Sweden: TonKraft Import AB; Tel. (031) 13 49 50 Fax: (031) 11 34 72  
 UK: Stirling Audio; Tel. (071)-624 6000 Fax: (071)-372 6370 USA: 21st Century Ltd.; Tel. (213) 463 4718 Fax: (213) 463 1209

## Otari acquires Digital Dynamics

The US Otari Corporation has announced the acquisition of the assets and rights to the products of Digital Dynamics Inc of Greenlawn, NY. No further details of the purchase have been revealed.

Digital Dynamics was founded in 1988 and specialises in competitively priced hardware and software for digital audio recording and editing. Their main product is the *ProDisk-464*, a disk-based recording and editing system expandable from 4- to 64-tracks in units of four tracks. It uses a *Mac* interface for running the screen display and addressing the system. The *Mac* is not involved in the processing itself which is handled in external equipment racks. Digital Dynamics say that the largest system they have assembled to date is a 32-track system with the largest being a 24-track to 525 Post in Hollywood. A DSP option will be added in the near future.

The *ProDisk-464* joins the other disk-based recording editing system of Otari's, the *DDR-10*, a 2-track system resulting from a collaboration with DigiDesign. Otari VP of sales and marketing, John Carey said that

it was hoped to develop the *ProDisk* system into the core of Otari's disk-based record and editing system and it will exist alongside the *DDR-10* in the same way the reel-to-reel tape machines do with both mastering and multitrack systems.



The ceiling of the large missionary hall in Lyndhurst Hall, Hampstead, the new home for Air Studios, London, has now been completely stripped back leaving this unusual star-shaped timber pattern. Full story of the studios' progress can be found on page 55 of this issue.

## Philip Clarke leaves KT

Klark-Teknik has announced that managing director Philip M Clarke is leaving the company to pursue other interests and to spend more time with his family.

Clarke founded Klark-Teknik some 20 years ago with his brother Terence and built up one of the most successful British professional audio groups, including the successful acquisition of DDA and Midas. Klark-Teknik were acquired by American company Mark IV Group late last year.

Tony Smithson, Klark-Teknik's finance director has been appointed managing director designate. Smithson has been with Klark-Teknik for five years and served on the executive committee with Philip and Terence Clarke.

## WEA introduce DIGalog duplication

During the recent NARM (National Association of Record Merchandisers) show in San Francisco, WEA introduced *DIGalog*, a new cassette manufacturing process that allegedly improves the sound quality for mass produced cassettes. These cassettes are playable on all existing analogue cassette players.

WEA Manufacturing chief engineer Pat Shelvin demonstrated *DIGalog* to NARM attendees and explained that the *DIGalog* sound improvement was

## Channel 4 buy TV's first CEDAR

Channel 4 Television has become the world's first television company to order the *CEDAR* production system.

Channel 4 has bought the system primarily to guarantee the highest quality audio for their vintage film and early television programme

transmissions. The system was delivered on March 7th this year.

Peter Marshall, Channel 4's assistant chief engineer, "It is a sad fact that a lot of the world's heritage of feature films has not been well looked after. Channel 4 is often faced with a dilemma when the best available print falls short of normal standards of acceptance.

"*CEDAR* is proving very effective in reducing hiss and crackles and is remarkably free from side effects. It currently can take a full day's work to restore a 90 minute feature, but we hope to halve this with improved software in due course."

Channel 4 are working on the Alec Guinness film *Man in the White Suit* and the *Avengers* series for transmission in the Autumn.

## Gateway robbery

Robbers have relieved the Gateway organisation in Kingston, UK, of £40,000 worth of high tech equipment. Gateway's complex that they share with Kingston Polytechnic on Kingston Hill is one of the most heavily protected studio and teaching complexes in the UK. However, the determined villains removed slates from the roof, broke through joists and came in through the ceiling of one of the teaching rooms. Any information should be directed to Gateway on 081-549 0014 or the Kingston police on 081-541 2867.

## Address changes

- **Euphonix Inc** have moved to 220 Portage Drive, Palo Alto, CA 94306. Tel: (415) 855 0400. Fax: (415) 855 0410.
- **Chrysalis Television Mobiles** have moved to 3 Chrysalis Way, Langley Bridge, Eastwood, Nottingham NG16 3RY. Tel: 0773 718111. Fax: 0773 716004.
- **Yamaha-Kemble UK** can now be contacted at Sherbourne Drive, Tilbrook, Milton Keynes MK7 8BL. Tel: 0908 366 700. Fax: 0908 368 872.





Every audio professional knows that the DAT format is ideal for portable recording. But at HHB we believe it need not cost the earth.

That's precisely why we've joined forces with Aiwa to design our own professional DAT portable – the HHB1 Pro.

In spite of its compact dimensions, the rugged HHB1 Pro offers a wealth of features for the professional user. A single

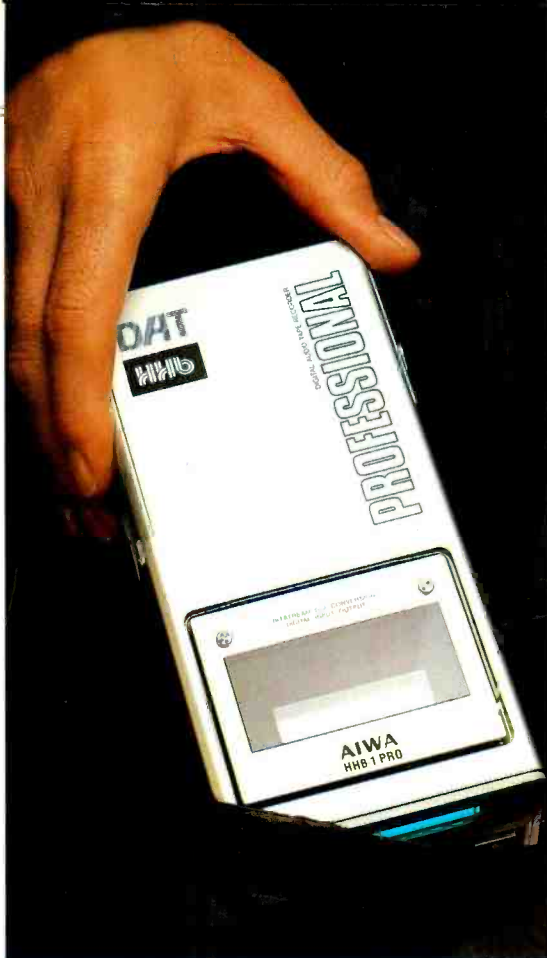

The HHB1 Pro stripes tape with 'absolute time' information as it records. So whenever you insert a recorded cassette, you can see precisely where you are on the tape. With Sony's PCM-7000 range of studio DAT recorders capable of editing to absolute time as well as time-code, you can be confident that your HHB1 Pro will function as their ideal low-cost acquisition partner.

The HHB1 Pro records for

# A professional DAT recorder that goes easy on your pocket. And in it.

5-pin XLR switchable mic/line input allows stereo recordings in the field, while audio quality is assured thanks to the latest single-bit oversampling conversion technology. Of course, AES/EBU as well as SPDIF digital interfaces are provided as standard. And because the Pro's informative LCD display can be illuminated, monitoring in low-light conditions could not be more convenient.

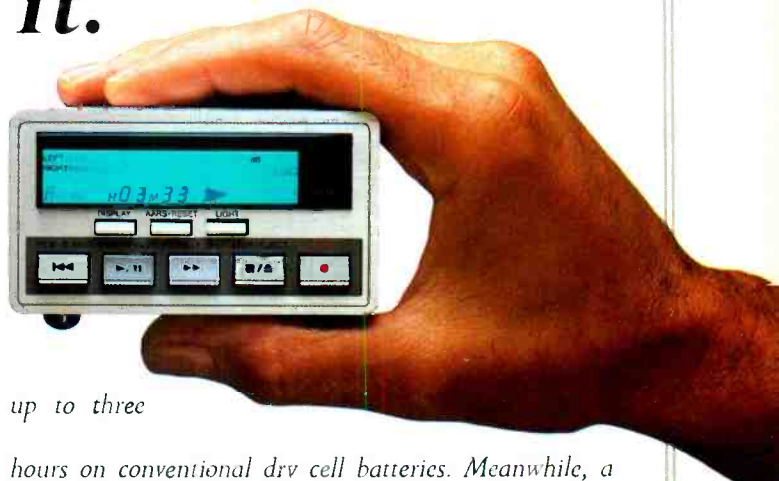
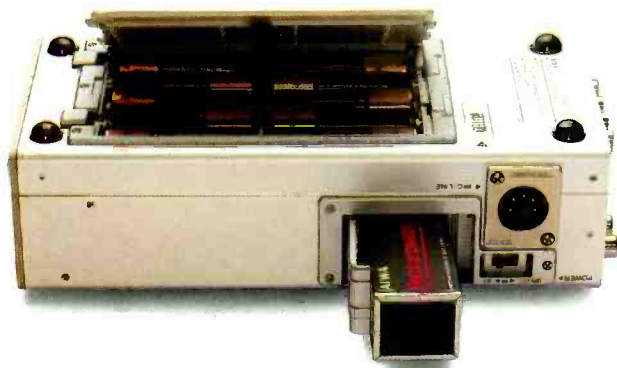

up to three hours on conventional dry cell batteries. Meanwhile, a multi-voltage transformer and a NiCad battery pack – together with a selection of useful professional accessories including a wired remote controller – are supplied as standard. Since it weighs in at under £1,000 and less than a kilogram, picking up an HHB1 Pro from the world's number one DAT centre just couldn't be easier.



# DAS-90. The AES/EBU-SPDIF Channel Status Editor by Prism Sound

Digital Audio signals are not so easy to monitor as analogue signals; they cannot drive headphones or a level meter. They contain Channel Status data which can be as useful for some as it is problematic for others.



Consultant engineers in DSP real time control software

## Prism Sound Limited

Intercell Building, 1 Coldhams Lane,  
Cambridge CB1 3EP England U.K.  
Tel: UK (0223) Intl (+44-223) 464739  
Fax: UK (0223) Intl (+44-223) 464741

Distributor details: Gerhard Picklapp at F.F.D. Vertriebsges m.b.H., Germany, Tel: Nat (089) 15 16 17 Int (+49 89) 15 16 17, Fax: Nat (089) 157 10 31 Int (+49 89) 157 10 31  
Johnny Karlsson at Intersonic AB, Sweden, Tel: Nat (08) 744 58 50 Int (+46 8) 744 58 50, Fax: Nat (08) 18 43 54 Int (+46 08) 18 43 54  
Henry Dienn at Timelord, Japan, Tel: Nat (0468) 73 6226 Int (+81 468) 73 6226, Fax: Nat (0468) 73 5206 Int (+81 468) 73 5206  
NB: F.F.D. Vertriebsges m.b.H will act as distributors for Germany, Switzerland and Austria.



## DAS-90 AES/EBU-SPDIF CHANNEL STATUS EDITOR

Available ready-installed or as a PC-AT expansion card.

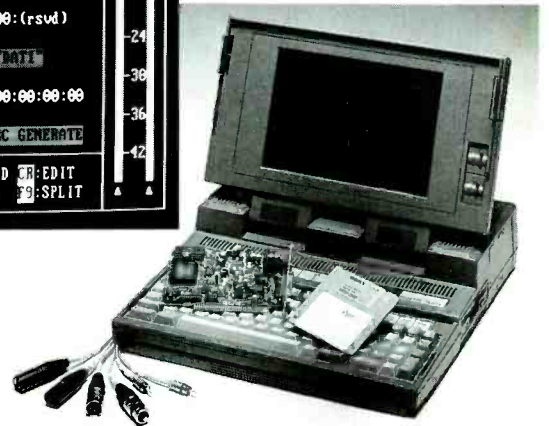

The DAS-90 solves the problem of access to Channel Status, making possible its exploitation and solution of related problems. The DAS-90 also provides metering and monitoring.

This unique publication has been designed specifically for the use of people involved in professional music recording. It offers a number of special features which allow access to important information on recording studios across Western Europe, and thereby saves both time and money in finding the right studio.

- ★ A comprehensive listing of all 24 track + recording studios in Western Europe in an easy-to-access style detailing all necessary contact details.
- ★ A unique grid system which allows you to access information on studios without needing to know the name of the studio in advance.
- ★ Information on outboard, monitors, recent work, rates etc.
- ★ Multi-lingual guidance information.

Now, after proven success throughout European record companies and producers, we have a limited number of copies left available at the special price of £10 per copy. Either call John on 071-586 6086 or fill in the coupon below.

# THE A&R STUDIO handbook 1991

THE COMPREHENSIVE GUIDE TO EUROPEAN RECORDING FACILITIES

**MEDIA DIRECTORIES INTERNATIONAL**

Please send  copies of the A&R Studio Handbook at the special price of £10 each inc. VAT & P&P.  
Send your cheque or Postal Order (overseas customers must send international money orders) to:  
A&R Studio Handbook  
PO Box 8, Spotlight Publications Ltd  
Ludgate House, 245 Blackfriars Road, London SE1 9UR

# The Sixteenth SOUND BROADCASTING EQUIPMENT SHOW



Thursday 3rd October, 1991  
Albany Hotel, Birmingham

*The essential exhibition for all who are involved in SOUND broadcasting. Admission is by invitation only, available from any exhibitor or the organisers*

## POINT PROMOTIONS

PO Box 46, Wallingford, OXON. OX10 0XP

Telephone: 0491 38575



## Contracts

- Chiquita Banana, an audio post-production company in Lisbon, Portugal, have bought a **DAR SoundStation II** Digital Audio Production system.
- Independent Television News in Grays Inn Road, London, now employ **Avitel 3200 series** modular audio and video distribution equipment throughout their new headquarters.
- **Studer's A827** multichannel and **A820 2-track ½ inch** recorder were recently delivered to Total Recall, a new 24-track recording studio on Long Island in New York.
- **Studio Plus XXX**, which six years ago was one of the first recording facilities in France to use **DASH** format technology, have taken delivery of a second **Sony PCM-3348** digital multitrack recorder.
- Recent sales of **Amek Classic** consoles include a 32/12 desk to the University of Anatolia and to TRT (Turkish Radio and Television). Classic's have also been ordered by Magyar Synchron in Hungary, Kratky Film in Czechoslovakia and Witornia Film in Poland.
- **Anglia TV, Norwich**, has bought two additional **Audio Kinetics Eclipse ES.Lock** systems, with 9 and 6 **ES 1.11s** respectively, for use in combined film and video suites.
- **M2 facilities in London** has bought a **SSL ScreenSound** digital audio post-production centre.
- **FWO Bauch Systems Group** has been awarded a contract from TV Asahi of Japan, for the design and installation of transmission and editing facilities for their London news bureau. The News Bureau will be located in the new Worldwide Television news complex based in Camden, London.
- **JBL Professional** have announced the sale of a **Soundcraft 32-channel 3200** multitrack console to Rose Studios in Lamont, Illinois. A further sale is for a **Soundcraft 36-input TS12**, supplied to WTVI public TV station in North Carolina. Recent **200 Delta** sales include **Bridges Auditorium** at Claremont University Center, **Black Entertainment TV** in Washington, and the in-house post-production facility at the **Boeing** headquarters in Seattle.
- **Clyde Electronics** have sold 15 audio workshop packages to the **BBC** at Bush House, London.
- **HDK**, the German training institute for radio sound engineers, has recently ordered a 40-channel

**Solid State Logic SL 4000 series** console.

- **Decca** has invested in an **X-880** digital recorder, bringing its total of **Mitsubishi 32-track** machines to three.
- **TAC** recently celebrated the 100th sale of their multitrack recording console, the **Magnum** to Phil Johnston, keyboard player in the **Robert Plant** band.
- **Sonic Solutions'** Dutch distributors **TransTec** installed their first **Sonic Solutions/Sony/Taiyo Uden CD Maker** package at **Audiostudio Joop Wesselius**, Rotterdam.
- **Otari Corporation** have announced the installation of a **Otari/Sound Workshop series 54/Film** console into **Zeotrope's** film mix facility in California.
- The New York production of **Miss Saigon** features a 70-input **Cadac 'E'-type** console plus a specially commissioned side frame.
- Sales of the **Fostex G16** recorder include the lead singer of **Deacon Blue**, **Ricky Ross**; singer **Leo Sayer**; and producer **George Martin**.



**Point 12 Studio's Yannick Chevalier with their new AudioFile Plus**

- One of the first 16-output **AudioFile PLUS** systems from **AMS** has been bought by **Point 12 studio**, Paris, for installation in a new digital audio suite.
- **West End post-production house Saunders and Gordon** has bought an **Audio Kinetics Reflex VCA** automation system for its **Studio Five**.
- **Calrec Audio** have installed the third of three **M-series** custom sound desks and complete studio systems for the **BBC World Service**, **Bush House**, London.
- **Neve** has received an order for a customised 96-channel **VRP** console with **Flying Faders** from **BOP Recording Studios**, **Bophuthatswana**, Southern Africa.

## News from the AES

Our next lecture will be held on **Tuesday 11th June 1991**, and will be given by **George Thorn** on the subject of the **Roland Sound Space Processor**. This new production tool has caused a lot of interest in the audio world in the last few months and the presentation will be in the form of a workshop and include demonstrations which are intended to enable the audience to take part in a discussion on the uses of such devices and their future in recording.

The lecture will be held at the **ITC (formerly IBA)**, 70 Brompton Road, London SW3. The ITC is opposite **Harrods** and **Knightsbridge Underground**, between the **Nationwide Anglia Building Society** and **Boots**. The evening starts with coffee at 6.30pm followed by the lecture at 7.00pm.

On 19th March 1991, the **AES British Section** held a Conference with the title **'Will You be Legal?—Implications of EC Directives for Audio and Video**

**Engineers'**. This covered the effects of legislation which will be implemented on January 1 1992, and the Chairman was **Allen Mornington-West**.

This legislation affects manufacturers, designers and installers of professional audio and video equipment and systems. The Conference revealed the extent and scope of the legislation and discussed the strategies for coping with both the legal and engineering consequences of the European performance standards which are involved. Ignorance of the law is, we are advised, no defence.

This Conference covered a very important subject, and if you were not able to attend, there is a set of Papers available from the address below, priced at £15.

For further details on the above, or on any other aspects of the **AES**, please contact: **Heather Lane, AES British Section, Lent Rise Road, Burnham, Slough, Berks SL1 7NY, UK. Tel: 0628 663725. Fax: 0628 667002.**

- London-based studio design and construction company **Eastlake Audio** are currently working on projects in Italy, Spain, Saudi Arabia and Nigeria.

- **Fairlight ESP** of Sydney, Australia, have announced delivery of the first of the Canadian **AFX Digital Audio Production System** to **Digital Music Inc** of Toronto, Ontario.

- The **BBC** has recently placed an order for a further 25 **Audio Developments AD145-E** mixers.

- The first new **Drake 2000 series** stereo audio production console has been ordered by London-based **TV-am**.

- New equipment on the hire books of **Hilton Sound** include the latest from **George Massenburg Labs**, the **8900 2-channel compressor/limiter**; the **Lexicon 300 effects unit**; the **SSL Logic FX G384**; the **MTR-12** from **Otari**; a **Mac-based Sound Tools** system from **DigiDesign**; and the latest generation portable test rig from **Audio Precision**.

- **API** have sold its third **Discrete Series** console. The first console with

the new reset features, is going to **Pinebrook studios** in **Alexandria, IN**.

- **Anglia TV, Norwich, UK** has taken delivery of a **Pro-Bel** vision and audio presentation switching and mixing system.

## People

- **Guy Hawley** has returned to **Harman UK** following a year with sister company **JBL International**. He has been appointed product and marketing manager.

- **Wayne Jones** has joined **Audio Precision, Inc, USA**. He will be responsible for applications and technical communications for **Audio Precision's** line of audio test equipment.

- **David Hudson** has been appointed **Joint managing director of Fairlight ESP**, responsible for international sales and marketing.

- **Otari** have announced that **Saul Walker** has joined the **Otari Corporation** as its new director of engineering.

## In brief

- **Sandy Brown applies:** Sandy Brown Associates have submitted a planning application to the Royal Borough of Windsor and Maidenhead to give life to a cinema shell in Maidenhead, Berks. They envisage converting the premises into a seven day a week, two-performance cinema in the evenings and a fully equipped conference facility and audience participation TV studio during the day. Completion of the project is projected for early 1992.
- **2nd Tapeless Directory:** SYPHA have recently published the 2nd edition of the Tapeless Directory which has been completely updated.
- **Tam Studio's CD test:** Tam Studio are offering a CD test service to complement their one-off CD recording service. The new CD test system compares a CD's performance against *Red Book* standards, indicating how well a disc has performed and providing a printout of results.
- **Free design consultancy:** Industrial Acoustics Company (IAC) of Staines, UK, is offering a free one-day consultancy to any broadcasting company making serious applications for one of the new ILR/INR franchises, or which are currently engaged in designing or converting an existing building for broadcast use. IAC is making this offer because it fears that one of the side effects of the Broadcasting Act 1990 could be a reduction in the quality of broadcast sound.
- **Keith Monks from the ashes:** Following the collapse of Keith Monks Ltd, Jon Monks has now set up KM Products to represent and market selected lines direct from the engineering factories. These include cable drums, fishpole handbooms and record cleaning machine spare parts. For further details contact: Jon Monks, KM Products, 20 Dunbar Road, Paddock Hill, Frimley, Surrey GU16 5UZ. Tel: 0252 837556. Fax: 0252 377850.
- **d&b audiotechnik open UK office:** d&b has finally opened its UK office in the village of Nailsworth in Gloucestershire. The office will serve as a base for both the support and the marketing group. The technical support group is represented by Simon Johnston. Bob Kelly, responsible for international marketing will be paying particular attention to the UK market. The new address is d&b audiotechnik AG, Locks Mill, Brewery Lane, Nailsworth, Stroud, Glos GL6 0JQ. Tel: 0453 835884. Fax: 0453 834193.
- **Les Lewis goes out in style:** One of the most respected figures in the pro audio industry has retired after 22 years at Neve. Les Lewis's retirement was marked by a special surprise party at CTS studio in London on the evening of his 64th birthday.
- **When is a studio not a studio?:** Those people who have received a certain circular promotional giveaway from a studio called The Beat Farm should beware as much of the equipment photography used was taken at the nearby Berwick Street Studios—without their permission!
- **WaveFrame offers automation:** WaveFrame Corporation is now offering clients the addition of Audiomation System's *Uptown 2000* Moving Fader console automation system to its own *AudioFrame* and *CyberFrame* disk-based recording systems.
- **The System Z studio:** Munro Associates has entered into a joint venture with studio builders KFA, to

design and market a complete range of prefabricated control rooms and a modular acoustic treatment system for the music recording, video and film post-production industries. The custom-designed rooms, which are being marketed under the *System Z* logo are designed as modular standalone units. They are built to Munro Associates' specifications at KFA's factory in Wood Green, London, and then assembled on-site.

● **CD for AMS mic:** A CD is now available explaining the operation and applications of the AMS *ST250* switchable format stereo microphone. The CD has been designed to take the listener step by step through the features of the system, and explains the *ST250s* use in various applications such as broadcast, film, studio, location, etc. Details from AMS on 0282 57011 UK.

Nr Royston, Herts. SG8 0AB. Tel: 0223 207979. Fax: 0223 207952.

● LMC audio systems in London have been awarded the sole distribution of **Crest Audio** products for the UK and Eire. LMC, Unit 10, Acton Vale Industrial Park, Cowley Road, London W3 7QE. Tel: 081-743 4680. Fax: 081-749 9875.

● **Digital Audio Research** have appointed London's HHB Communications as the exclusive distributor of DAR's *DASS 100* multifunction digital audio interface in the UK. HHB Communications. Tel: 081-960 2144. Fax: 081-960 1160.

## People

Colin Sanders, CBE, founder of **Solid State Logic**, has announced the appointment of John Jeffrey as Managing Director of SSL. Jeffrey is currently Chairman of Digital Audio Research and has held other Carlton Communications Company directorships, including a period on the board of video equipment manufacturer Abekas. Colin Sanders now becomes Chairman of the Carlton Audio Group, with responsibility for overseeing the future development of audio products with the parent company.

## Agencies

- **Drawmer** have appointed Audionord of Arhus as their distributor for Denmark. Audionord Prof. Mindegade 13, 8000 Arhus C, Denmark. Tel: 45 6193499. Fax: 45 86128259.
- **Axis Audio Systems** have been appointed exclusive UK distributor for **Allen & Heath's Sigma** console. Axis Audio Systems, 3 Waterloo Road, Stockport, Cheshire. Tel: 061-474 7626. Fax: 061-474 7619.
- **Thatched Cottage Audio** have announced they have been appointed exclusive UK distributor for the new **Allen & Heath Spectrum** multitrack console launched recently. Thatched Cottage Audio, North Road, Wendy,

## Correction

In our April console feature we inadvertently printed the wrong contact information for Neve International. The correct information is Tel: 0763 260776. Fax: 0763 261886.

## Exhibitions and conferences

**June 5th to 7th** APRS, Olympia 2, London, UK.

**June 13th to 18th** International Television Symposium, Centre des Congres, Montreux, Switzerland.

**June 25th to 27th** Multimedia 91 conference & exhibition, Olympia 2, London, UK.

**July 10th to 12th** Pro Audio Asia 91, World Trade Centre, Singapore.

**July 10th to 14th** International Music Show, Olympia 2, London, UK.

**September 8th to 11th** PLASA Sound & Light Show, Olympia 2, London, UK.

**October 4th to 7th** AES New York, Hilton Hotel & Sheraton Centre, New York.

**October 17th to 21st** Mediatech 91, Milan Fiera, Lacchiavella, Italy.

1992

**March 24th to 27th** AES Convention, Vienna, Austria.

**October 2nd to 5th** AES Convention, San Francisco, CA, USA.

## Radio Station correction

Within the May issue's Live Sound page, there were a number of inaccuracies regarding *The Radio Station* personal monitor system. *The Radio Station* system was designed by Martin Noar of The Stage Radio Company, a wholly owned subsidiary

of Hardware House (Sound) Ltd. It is also manufactured by The Stage Radio Co. Personal Radio Systems (UK) Ltd have been involved in the financing and marketing of the product.

## SSL addendum

The April issue editorial showed an element of confusion on the part of the editor. The recently introduced SSL network system was referred to

as 'ScreenNet' whereas he should have known that while the record editing system is called *ScreenSound*, the network is actually called *SoundNet*.





# Carver can handle it!

Whatever the size of your venue Carver can handle it.

Carver amplifiers are in use at the largest stadia in the world and at the smallest clubs.

There is a new range of six models from the PM-120 offering 40 watts per channel into 8 ohms up to the PT-1250 offering 465 watts and weighing



an unbelievable 11lbs.

Carver professional amplifiers are renowned for their pure sonic excellence, portability and the ability to produce awesome power.

Whether your audience numbers a hundred or a hundred thousand, Carver won't let you down

**CARVER**  
P R O F E S S I O N A L

Sole UK Distributor: HW International, 3-5 Eden Grove, London N7 8EQ. Tel: 071-607 2717



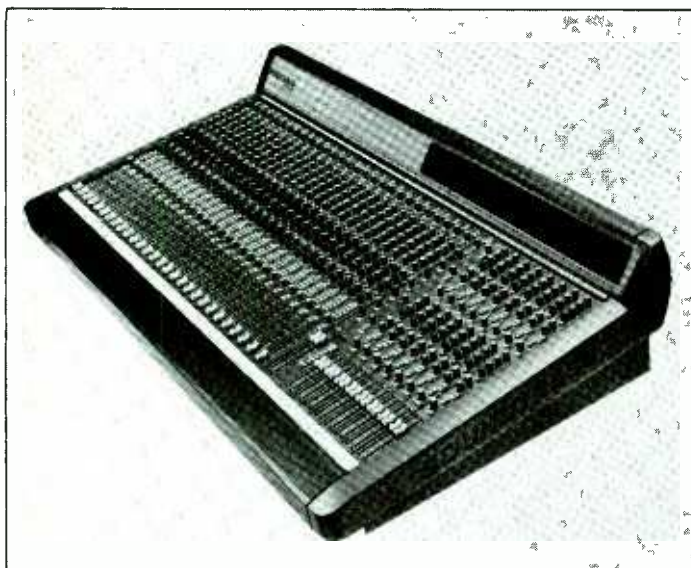

## Soundtracs Megas range

A new range of consoles have been announced from Soundtracs. The *Megas* range which is being produced from a new facility in Scotland, comprises of three console types—*Megas Mix*, *Megas Stage* and *Megas Studio*.

The *Mix* is a general purpose console with four group buses, which is available in four frame sizes. Three types of input module and two dual group modules provide configurations ranging from 12-2 up to 32-4-2.

The *Stage* is a dedicated 8 bus sound reinforcement console having full vu metering and 6 mute groups as standard. It is also available in four frame sizes, accepting a mixture of module types; configurations vary between 24-8-2 and 44-8-2.

The *Studio* comes in three frame sizes and is a dedicated recording console with either 16 or 24 group

buses. Mono and stereo input modules can be fitted, and along with the dual group modules configurations varying between 20-16-2 and 40-24-2 are available. MIDI muting and full metering is standard, and there is the option of a comprehensive patchbay.

All *Megas* consoles are supplied with a new, 2U high, 19 inch rackmount power supply unit called *The Source*. Soundtracs claim to have placed considerable emphasis on the development of this PSU which is of the 'switching supply' type and will tolerate mains voltage variations between 85 V and 270 V.

**Soundtracs PLC, 91 Ewell Road, Surbiton, Surrey KT6 6AH. Tel: 081-399 3392. Fax: 081-399 6821.**

**USA: Samson Technologies Corp, 485-19 South Broadway, Hicksville, NY 11801. Tel: (516) 932-3810.**

## Sound Ideas deals on wheels

Canadian company Sound Ideas have released a new sound effects library called *Series 5000 Wheels*. The collection consists of 3000 car and motorbike sounds spread across a total of 24 compact discs. Twenty five different vehicles were digitally recorded including Porsche 930 Turbo, Cadillac Sedan de Ville, Mack 18 wheel truck, 1923 Ford T, 1956 Chevy Belair, Harley Davidson etc.

The company advertise long

recorded passbys with no premature fadeouts, and more than 140 interior and exterior sounds per vehicle. As an introductory offer the collection is being discounted for a limited period.

**Sound Ideas, 105 West Beaver Creek Road, Suite 4, Richmond Hill, Ontario, Canada L4B 1C6. Tel: (416) 886 5000.**

**UK: FWO Bauch Ltd, 49 Theobald Road, Borehamwood, Herts WD6 4RZ. Tel: 081-953 0091.**

## Yamaha's CD maker

Yamaha have introduced the *YPDR601* Professional Disc Recorder and its remote controller, the *RC601*. The *YPDR601*'s use of Yamaha recordable CDs allows 63 or 74 minutes of audio recording time dependent on CD blank length selected. By use of acceleration testing the shelf life of the discs has been estimated at over ten years. The unit allows a full TOC (table of contents) to be written to disc either before or after recording, both TOC information and audio data recording comply with the CD format

standards, established in the Red and Orange books. Direct input and output connections to the *YPRD601* can be either analogue or digital and up to seven *601*'s can be controlled by a single *RC601* unit.

**Yamaha Corporation, PO Box 1, Hamamatsu, Japan.**

**UK: Yamaha-Kemble, Mount Avenue, Bletchley, Milton Keynes MK1 1JE. Tel: 0908 717771.**

**USA: Yamaha International Corp, PO Box 6600, Buena Park, CA 90620. Tel: (714) 522-9105.**

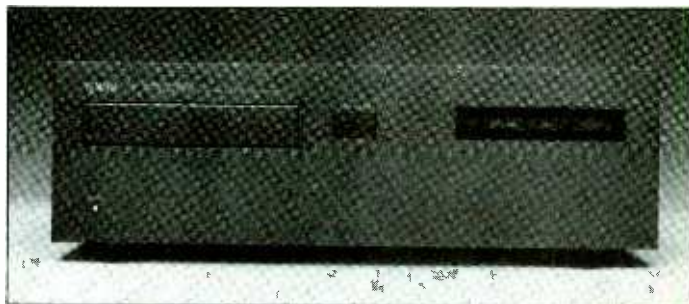

## Audio-Technica expand range

Audio-Technica, manufacturer and distributor of professional microphones, cables and accessories, have released a large number of new products. The *PRO series* of intermediate, mid priced mics has been extended to include the *PRO 4C* condenser, *PRO 8* dynamic headset microphone, *PRO 10HE High Energy* microphone, *PRO 25* Hypercardioid Dynamic, and the *PRO 35R* and *37R* remote-power condensers.

A new range of microphones has also been introduced called *High Energy ATM*, which feature neodymium magnets—they are the *ATM41HE* and *ATM61HE* dynamics. Other new additions are the *ATM35* condenser, and the *AT804* omnidirectional microphone which has been designed for interviews, sportscasting etc—housed in an all-steel case the mic is said to be virtually indestructible.

A new *AT8106* metal frame 'pop' filter has been designed for the 40 series of studio microphones, and two new types of cable have been launched—series *I* and series *II Supercable*.

**Audio-Technica US Inc, 1221 Commerce Drive, Stow, Ohio 44224. Tel: (216) 686-2600. Fax: (216) 688-3752.**

**UK: Audio Technica Ltd, Technica House, 11 Lockwood Close, Leeds LS11 5UU, West Yorkshire. Tel: 0532 771441.**





# You don't have to be wild about Harry to be bowled over by new generation ScreenSound.

You don't have to run a digital video environment to make full use of ScreenSound's powerful new capabilities. Following an intense period of R&D, ScreenSound is now fully equipped to perform as the essential digital audio command centre for film and video.

As the name suggests, ScreenSound is all about editing audio, visually. Music, dialogue and effects can be edited, polished and laid back to film or video with sub-frame accuracy. Meanwhile, all this is achieved without incurring the generation losses that have always afflicted analogue audio. It couldn't be easier to use, thanks to a highly intuitive user interface that brings operator and system closer together. Simple, gestural movements of the cordless pen on ScreenSound's tablet provide control over all functions. No fiddly keystrokes, no mousey manoeuvres. At HHB we like to say that if you can hold a pen, you can explore ScreenSound's creative possibilities.

With SSL's new 'SoundNet' technology, archiving and uploading are instant procedures. You can even share and copy work between multiple ScreenSound command centres or play back as many as 56 channels of digital or analogue audio. Audio tracks appear on screen as "reels" of tape that can be edited, timeslipped, and crossfaded. Gain and pan position can be automated against timecode while an 'audio scrub' facility permits accurate manipulation of edit points. Thanks to powerful search and sort routines, ScreenSound helps you maintain an

accurate record of sound clips held within the system, while a WORM optical disc subsystem can provide massive off-line storage. With the 'SoundNet' option you can obtain instant on-line access to as much as 48 hours of audio. Naturally, a unique degree of operational speed and production efficiency are principal system benefits: ScreenSound can control up to sixteen VTRs, videodisc

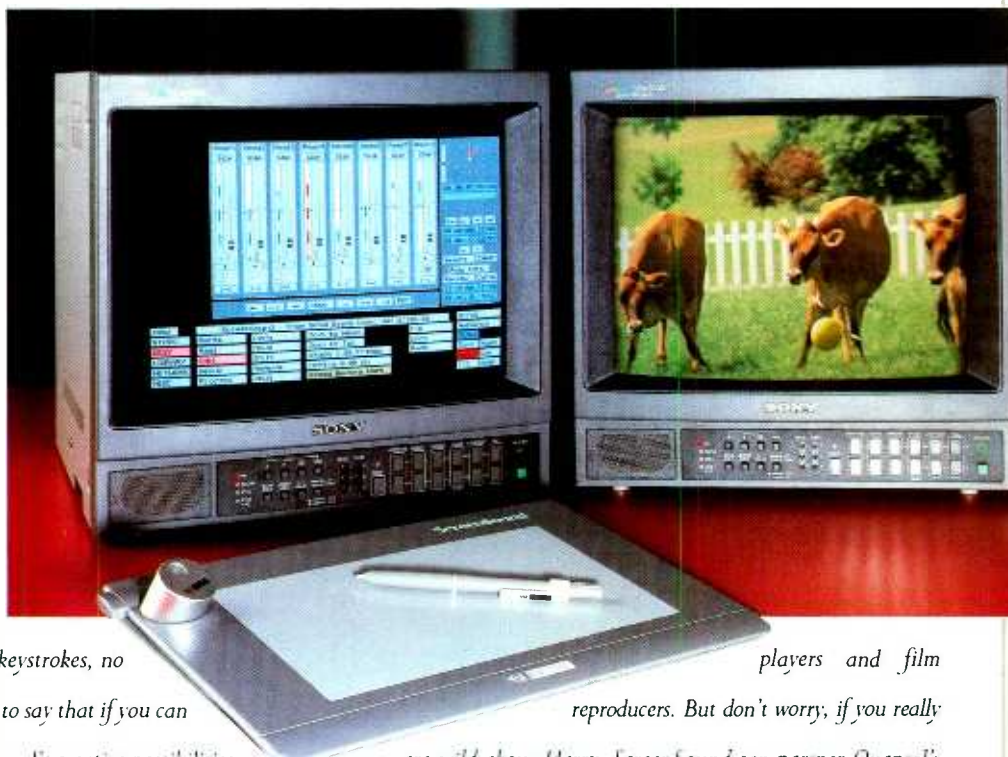

players and film reproducers. But don't worry, if you really are wild about Harry, ScreenSound can partner Quantel's system to provide operators with unparalleled levels of control.

Of course, ScreenSound comes from Solid State Logic, one of the world's most respected pro-audio manufacturers. But in the UK, new generation ScreenSound can be found only at HHB. And since HHB is widely recognised as Britain's leading source for digital audio technology, you also access the best expertise and the finest service in the business. So contact us now for a demonstration or to receive more information on ScreenSound's expanding facilities.

**SSL DIGITAL**

## Battery powered mini Sanken New connectors from Deltron

Sanken have introduced a battery pack version of their *COS-11* ultra miniature lavalier microphone. Especially suited for field or remote applications, the *COS-11BP* operates with standard AA batteries or 12-52 V phantom power. Other features include a vertically mounted PPS (Polyphenylene-sulphide) diaphragm, and a built-in triple layer windscreen.

The mic which measures 4 mm x 16.1 mm, is complemented by a full range of accessories. **Sanken Microphone Co Ltd, 2-8-8 Ogikubo, Suginani-Ku, Tokyo 167.** UK: Stirling Audio Systems Ltd, Kimberley Road, London NW6 7SF. Tel: 071-624 6000. Fax: 071-372 6370. USA: Audio Intervisual Design, 1032 North Sycamore, Los Angeles, CA 90038. Tel: (213) 469-4773.

Electronic component manufacturer Deltron have launched a new range of XLR-type audio/video multipole connectors called the *7000 series*. The range contains panel sockets and plugs, and free cable sockets and plugs in 3, 4, and 5 contact versions. A colour coding system of clip-on rings and push-in inserts has been



developed to aid identification, and the connectors are locked by a squeeze release clip. Connector contacts can be soldered to the cable prior to assembly (assembly is a slide and screw together operation) and the collet arrangement will accommodate a wide range of cable sizes. All body parts are precision die cast.

**Deltron Components Ltd, Atlas Road, London NW10 6DN, UK.** Tel: 081-965 5000. Fax: 081-965 6130.

## Digitech effects processors

A number of new products have become available from Digitech. Two effects processors have been released—the *DSP 256XL* is an improved version of the *DSP 256* and is said to have enhanced reverb and chorusing effects; the *DSP 16* contains 128 MIDI changeable programs based around 16 reverb and delay effects with variable decay and delay times—it also includes an equaliser section.

Three guitar effects processing units are also available. The *GSP Tube* features two 12 AX7 Groove Tubes and offers seven effects of which six can be used at the same time. The *GSP 7* advances the facilities found in the *GSP 5* offering five distortions plus 17 other effects—seven being available simultaneously. The *GSP 21 Pro* features 54 presets which have been specially written by a number of well

known guitarists; the unit provides 23 different effects ten of which can be at once, and like its predecessor (*GSP 21*) it comes with a full function foot controller providing the user access to programs, patches and parameters. All of the new guitar processors are MIDI controllable. **Digitech, 5639 S. Riley Lane, Salt Lake City, Utah 84107.** Tel: (801) 268-8400.

UK: John Hornby Skewes, Salem House, Garforth, Leeds LS25 1PX. Tel: 0532-865381. Fax: 0532-868515.



- 16 CONVENTIONAL NOISE GATES
- 16 MIDI MUTES
- 16 PROGRAMMABLE NOISE GATES
- 16 DUCKERS

## MIDI GATE = 16 NOISE GATES

With the Midi Gate offering 16 Conventional Noise Gates, 16 Programmable Noise Gates, 16 Duckers, 16 Midi Mutes and 8 Auto Panners all in a 1U high rack mounting package, there must be a catch.

There isn't.

With low noise and distortion figures to rival any professional noise gate on the market, coupled with an extremely fast attack time for even the most demanding of signals, the Midi Gate will complement any professional audio system. Be it a full blown 24 track studio, a live venue or the simplest of musical instrument set-ups.

And as it does all this, and more (without mentioning the 96 patch memories and extensive Midi control), maybe there is one catch

- trying to find a dealer who hasn't sold out!



Midi Gate is distributed in the UK by: LA Distribution Limited, 15 Cam Square, Wilbury Way, Hitchin, Herts SG4 0TZ. Tel: 0462 421919. Fax: 0462 421171.







## Sapphyre from Soundcraft

Soundcraft have launched a new console aimed at the mid-range recording market. The *Sapphyre* is a compact in-line console which boasts facilities and spec more akin to larger studio consoles. Each I/O channel incorporates a noise gate, and has a 4-band equaliser which can be split between channel and monitor paths. Channels either feed direct to multitrack or route out via eight floating groups. Optional dual line input modules have been specifically designed to provide additional inputs for MIDI-sequenced instruments

running live during mixdown.

The console is available with 20, 28, 36, 44 or 52 inputs, and although primarily marketed for 16- and 24-track use, can accommodate a 32-track machine.

**Soundcraft Electronics Ltd, Unit 2, Borehamwood Industrial Park, Rowley Lane, Borehamwood, Herts. WD6 5PZ. Tel: 081-207 5050. Fax: 081-207 0194.**

**USA: Soundcraft Electronics USA, PO Box 2200, 8500 Balboa Boulevard, Northridge, CA 91329. Tel: (818) 893-4351.**

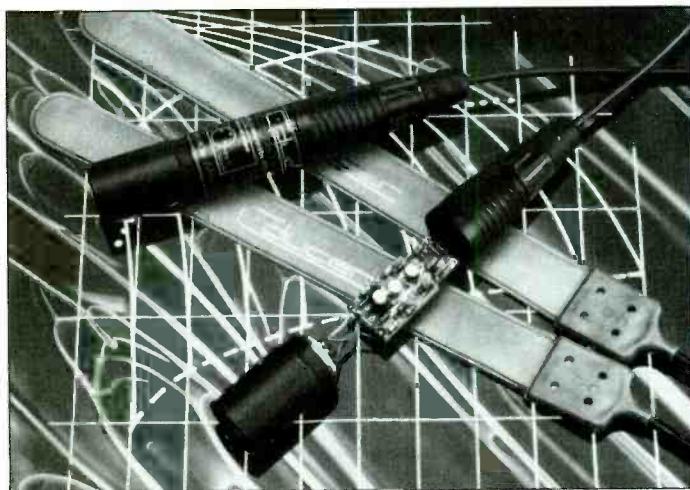

## C-Ducer compact contact

A new series of C-Ducer contact microphones has been launched which do not require separate preamp boxes. Instead the new *CP* series builds in miniaturised phantom-powered electronics directly inside the XLR plug. The new electronics are said to improve both signal-to-noise and to extend

frequency response. The mics are available in 3 inch and 8 inch strips  
**USA: C-T Audio Marketing Inc, South Tech Industrial Plaze, 3050 SW 14th Place, Suite 3, Boynton Beach, FL 33426. Tel: (407) 738-0622.**  
**UK: AMG, 2 High Street, Haslemere, Surrey GU27 2LY. Tel: 0428 658775. Fax: 0428 658438.**



**MILLIONS of knobs as standard . . .**

**or manufactured to your custom design**

**SIFAM FOR A COMPREHENSIVE RANGE OF COLLET, PUSH ON, SLIDER & PUSH BUTTON KNOBS.**  
*A detailed and colourful catalogue is yours for the asking.*  
**SIFAM LIMITED—ACCESSORIES DIVISION**  
 WOODLAND ROAD TORQUAY  
 DEVON TQ2 7AY ENGLAND  
 Telephone: 0803 613822  
 Fax: 0803 613926. Telex: 42364





# SOUNDSTATION

# DSP



SEE US AT  
APRS AND  
ITS

YOU HAVE A CHOICE IN  
DIGITAL AUDIO EDITORS,  
UNLESS YOU WANT...

- ① 2 to 16 Channels
- ② Ease of use
- ③ Affordable Power and Speed
- ④ Rewritable Optical Disk
- ⑤ WORDFIT
- ⑥ TIMEWARP
- ⑦ Machine Control and Autolocate
- ⑧ Full Expandability
- ⑨ Digital Interfaces
- ⑩ Chase Sync

ONLY AVAILABLE ON SOUNDSTATION

The unique and essential disk based recorder and editor for video, film and audio post-production.

## NEW

### SEGMENT BASED PROCESSING

A revolution in speed and convenience - now available on the powerful new, 16 channel SOUNDSTATION DSP system. Segment Based Processing lets you add digital parametric EQ, gain and panning to every individual audio segment via the SOUNDSTATION DSP console.

DIGITAL AUDIO RESEARCH LIMITED

2 SILVERGLADE BUSINESS PARK · LEATHERHEAD ROAD · CHESSINGTON · SURREY KT9 2QL · ENGLAND  
TELEPHONE (0372) 742848 · FAX (0372) 743532

DIGITAL AUDIO RESEARCH





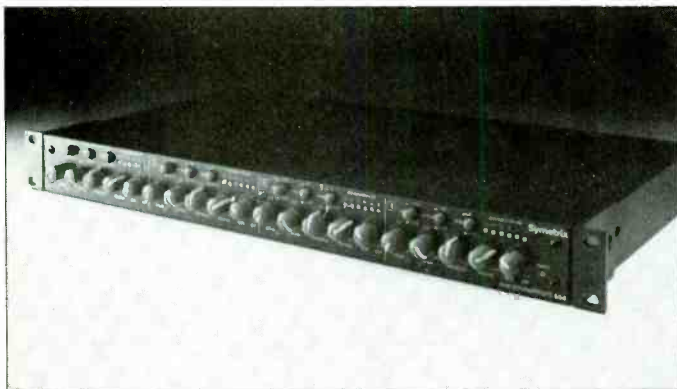

## Symetrix 564E gate

A new expander/gate has been launched by Symetrix which is said to be 'the first Symetrix product aimed at the highest levels of the pro-audio market... engineered to go head to head with pricey British gates'. The 564E offers four gates in a 1U rack unit—each channel will function either as a gate or downward expander depending on the position of the Ratio control. Key Listen along with High and Low Pass Filters are included, and gain reduction indication is via six LEDs. A fast attack mode causes the gate to

open in 50 ms, and specially designed sensors track signals as low as 20 Hz.

Construction features are a solid steel chassis, double-sided printed circuit boards and a toroidal transformer. Inputs and outputs are via XLR accepting both balanced and unbalanced signals.

**Symetrix, 4211 24th Avenue West, Seattle, WA 98199. Tel: (206) 282-2555.**

**UK: Sound Technology plc  
6 Letchworth Business Centre,  
Letchworth, Herts SG6 2HR. Tel:  
0462 480000. Fax: 0462 480800.**

## B&W nearfield

The British speaker manufacturer B&W have announced the launch of a new nearfield monitor that was originally developed for Abbey Road Studios, London. The *Matrix 805* has a 6.5 inch mid/bass driver featuring a Kevlar cone with a 30 mm high temperature voice coil wound on a Kapton former; the tweeter is a modified version of that used in the *801*, having a 1 inch metal dome design with ferrofluid fluid cooling and a high temperature VC. A sixth order Butterworth bass filter crossover delivers a bass extension down to 35 Hz, and the physical placement of the drivers aids the crossover in producing time alignment. Gold plated terminals are fitted allowing bi-wiring or bi-amplification. The *Matrix* cabinets come in two formats, vertically

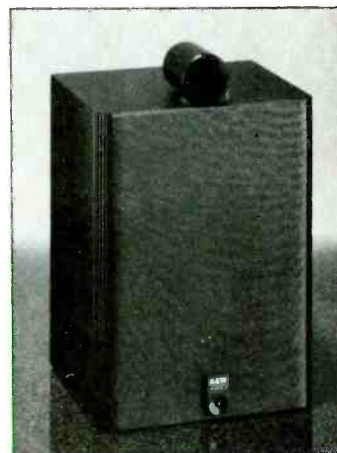

standing (805V) or horizontally standing (805H); a number of finishes are available.

**B&W Loudspeakers Ltd,  
Marlborough Road, Lancing, West  
Sussex BN15 8TR. Tel: 0903  
750750. Fax: 0903 750694.**

## Automated outboard with Systems TCB

The Californian company Systems TCB who specialise in the design and development of automated systems, have introduced the *M1001S* Real Time MIDI Controller. The unit interfaces outboard equipment to an automated console so that parameter and program changes can be made using up to eight of the console's faders as controllers. The fader

control voltages are routed via the unit to MIDI and CV ports on the outboard processors; by storing the fader moves in the console's automation system, effect data can be stored along with the rest of the mix. **Systems TCB, PO Box 1014, Burbank, CA 91507-1014. Tel: (818) 955-9552. Fax: (818) 566-7450.**



## Noise abatement from Sennheiser

Sennheiser have developed a portable noise compensation system comprising of a headphone and rechargeable battery pack. The *NoiseGuard Mobile* system is said to suppress unwanted and harmful ambient noise whilst allowing useful audio information to pass. The effect is based on the principle that sound and anti-sound (phase inverted by 180°) cancel out; its development began when a German airline approached Sennheiser to design a headphone that could electronically reduce disturbing cockpit noise

(approx 80 dB) to aid radio intelligibility.

*NoiseGuard* is said to have applications in noise-polluted industrial workplaces, during air journeys or even when travelling by car. It incorporates an audio socket allowing the user to listen to music, and has a battery life of eight hours.

**Sennheiser Electronic, D-3002, Wedemark 2. Tel: 05130 583-0.**

**UK: Sennheiser UK, Unit B2,  
Knaves Beach, Loudwater, High  
Wycombe HP10 9QY. Tel: 0628  
850811.**

## Amek/TAC live teleproduction

Amek/TAC have launched the *TAC SR6000* console, which is primarily intended for sound reinforcement applications and in particular live audience teleproduction studios.

The console has 40 inputs routed to 8 subgroups and a stereo output. It also includes 8 VCA groups. Equalisation is 4-band swept, and there are eight auxiliaries which can be split equally between the inputs allowing the console to be used for two entirely different setups.

The company have also announced an enhanced version of the G2520 console, the B2520, which is adapted for teleproduction applications where simultaneous multitrack and live outputs are required. This has been achieved by adding a second routing

section to each routing channel which gives access to 8 stereo subgroups with panning. Due to the console's in-line design different mixes can be set up on channel and monitor paths feeding separately to the 24 multitrack buses and new subgroups. The first B2520 has recently been installed at Limehouse Studios in London.

**Amek Systems and Controls Ltd,  
New Islington Mill, Regent  
Trading Estate, Oldfield Road,  
Salford M5 4SX. Tel: 061-834 6747.  
Fax: 061-834 0593.**

**USA: Amek/TAC, 10815 Burbank  
Boulevard, North Hollywood, CA  
91601. Tel: (818) 508-9788. Fax: (818)  
508-8619.**

# Old Hammonds never die

As touchy a subject as the preference for single coil or humbucking pickups, rosewood or maple fingerboards and analogue or digital synths, many organists cannot weigh up the pros and cons of a traditional monster tone wheel organ over a modern slick digital equivalent with any great conviction. Few, however, dispute the magnificence of a *C3/Leslie* combination in full flight as long as it's not them that have to take it out to the van after the show. Laurens Hammond started building the world's first electronic organs in America in 1934 and they quickly achieved household name status. The 1960s saw their unmistakable sound immortalised on vinyl and made them as much a part of rock culture as Gibson, Fender and Ludwig.

The speed of technological progress eventually prohibited the cost-effective manufacture of what are now regarded as the classic tone wheel designs still being used today. Hammond had to adapt to compete with an influx of competing products, fell on hard times and was eventually bought by Suzuki and now manufacture a range of digital organs. So the legend continues, kept alive by the actions of fanatics and in the memories of modern sample-based organs.

The most highly treasured of the old Hammonds are the *C3* and its derivatives the *B3*, *A100* and *RT3*. The *B3* is much the same as a *C3* but is mounted on spindly legs instead of the latter's flat sided shell. The *A100* is a *C3* with internal amplification and speakers down at the organist's legs and the classical music oriented *RT3* is a *C3* with a 32-note pedal board instead of the usual 25 notes.

For the cost conscious player the so-called spinet models—*L100* and *M100*—could be of interest offering two 44-note manuals, instead of the *C3*'s twin 61-notes, and a 13-note pedal board. Essentially offering the Hammond sound but with fewer drawbars (one bank of drawbars for manual A instead of two) and fewer preset sounds, the vibrato system is also less comprehensive than its bigger brothers but at £350-£550 (\$670-\$1,050) plus *Leslie* they represent a cheap way into 'the sound' that was good enough for Keith Emmerson and Manfred Mann in the 1960s. On the other hand a good *C3* with a *Leslie* could set you back between £1,500-£1,800 (\$2,800-\$3,500).

It has to be said that for all the wonders of the sampling technology employed in the modern and quite excellent approximations of these old organs, predictably they are criticised for falling short on the sonic qualities of the originals. In much the same way that sampled pianos can sound

staggeringly realistic, they remain imitations which lose out on the finer points of character that make all the difference to those who really care. As is usual with electro-mechanical devices, peculiar combinations of factors sum to produce quirks in an instrument that cannot digitally be replicated faithfully enough to fully convince a single-minded *C3* driver.

But it would be untrue to imply that there is no downside to the oldies as anyone who has ever had to lug a *Leslie* and its command post up a flight of stairs will testify. Size and weight, not to mention the fragility of moving parts taken in the context of a busy and rough handling touring schedule, have always been the curse of the old Hammond. Modern designs have addressed these points with Roland's *Rhodes VK1000* discussed last month and Hammond's quite surprising entry back into the rock musician fray with the *XP-2*.

At the bottom of Hammond's range of MIDI digital organs, the *XP-2* stands apart from the company's more monolithic products by being portable and by retailing for around £1,300 (\$2,500); £1,800 (\$3,500) cheaper than the next model up. With its release in July, the price and the fact that the instrument is quite obviously geared towards the expectations of modern musicians will attract a lot of attention.

Offering 61 keys on one manual, an in-depth MIDI spec is not yet available but bearing in mind that Suzuki have had involvement with Kurzweil we can surmise that the implementation will be comprehensive. It will certainly be able to operate as a mother keyboard of some distinction with splits and layers complemented by a combination of velocity sensitivity, switchable on and off for internal and external control, and 61 note polyphony of course. Velocity can also be used to control the instrument's own harmonic percussion characteristics—something that

players of classic Hammonds would give their eye teeth for. What the instrument isn't yet is another multitimbral sound source with a keyboard stuck on for the heck of it, the *XP-2* is clearly oriented towards performance and convenience.

Initial reports on the sonic qualities of the organ have been favourable and the *XP-2* is likely to shepherd in a new generation of organists spared the hernias and the dislocated vertebrae for the price of perhaps a little drop in authenticity of sound and general dyed-in-the-wool kudos. *Leslie* technology is also continuing abreast and the *XP-2* comes with the statutory 11-pin connector and its own internal rotating speaker effects.

However, there will always be a hardcore of organists who would not be seen dead on anything other than a classic Hammond. While most will stack a modern synth atop a *C3* for controlling the expanders that few can now leave home without, the hand of MIDI has been extended towards the tone wheel organ in



Flight-cased Hammond C3P

some act of reconciliation for all the years of neglect that it has suffered as a result of the five-pin DIN.

UK Kenton Electronics offer an interface board which enables MIDI out data of a basic nature to be derived from the two manuals and the pedal board. Each transmits note on and off information at a fixed velocity, which can be preset, on independent channels and requires extra contacts to be fitted in the

organ itself. A MIDI off switch cancels notes, program changes can be sent from the keyboard and a sustain pedal socket is provided. The board costs in the region of £250 (\$480) and Kenton work in association with Hammond specialists William Dunne and Co who fit the board and the handmade contacts under the upper manual. A *C3* can be equipped for MIDI out operation for about £700 (\$1,400) and musicians choosing this route include Keith Emmerson.

Bill Dunne is widely regarded as the man to see if work needs doing to a tone wheel organ and while he handles the whole range of Hammond products he specialises in the desirable *C3*, *B3* and *A100*.

Dunne reconditions Hammonds, splitting them for portability and flight-casing them and he has noticed a resurgence in the popularity of the older models in the last 18 months a fact that has been accompanied by a jump in price of at least 100% in the same period. The tone wheel models are blessed with near immortality if regular care and attention is paid to them and being relatively scarce also represent something of an investment.

The Northern Organ Centre specialises in restoring old Hammond innards and outers and selling the reconditioned units. In addition to splitting manuals from their bass pedals and supports the company also offers what it calls the *C3P* with all the wood stripped away and the guts of the beast rebuilt into a flightcase shell. Considering the amount of work involved and the practical benefits to the user the price of £1,950 (\$3,700) is attractive against the cost of a modern first division synth. Organs have been supplied to U2, Status Quo, Tears for Fears and Talk Talk together with the essential valve or transistor amp *Leslie*.

It's ironic in an industry that almost prides itself on its speed of succession that so much energy and ingenuity has been targeted at replicating and maintaining an instrument that is now considerably long in the tooth. Some things are right from the start and simply cannot be bettered.

**Hammond USA: (708) 620 6633**

**Hammond UK: 0296 720787**

Other UK contacts: Kenton Electronics: 081-974 2475, W Dunne & Co: 071-837 2070, Northern Organ Centre: 0532 667034

Studio Sound's Music News is compiled by Zenon Schoepe



*p r o f e s s i o n a l i s m*

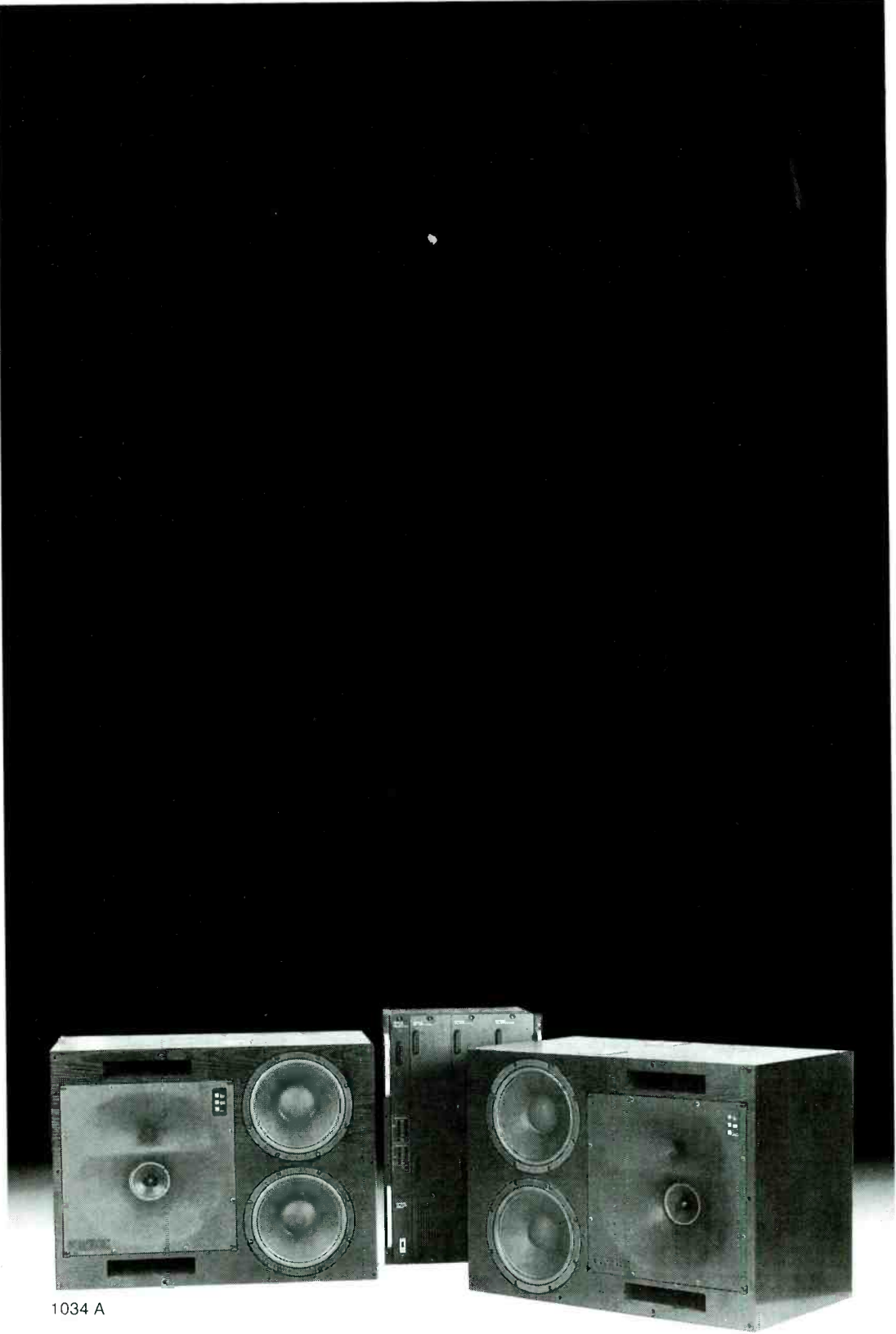

1034 A

# GENELEC

Tehtaantie 17, SF-74100 Iisalmi, Finland  
Tel Int. +358 77 13311  
Telefax int. +358 77 12267

AUSTRIA: Audiosales tel. 02236-26123, BELGIUM: Hes Electronics tel. 02-4662917, DENMARK: DA Distribution Aps tel. 31610755, FRANCE: SCV Audio tel. 01-48632211, GERMANY: Audio Export George Neumann & Co. GmbH tel. 07131-62470, GREECE: Kem Electronics tel. 01-647 8514, HONG KONG: Power Source Development tel. 4283013, ITALY: Audio Equipment S.R.L. tel. 039-2000312, JAPAN: Otartec Corporation tel. 03-33323211, KOREA: Seoul Sound Technology tel. 2-5844311, THE NETHERLANDS: Audioscript B.V. tel. 02155-20400, NORWAY: Siv.Ing. Benum A/S tel. 02-145460, PORTUGAL: Amperele Electronica Industrial LDA tel. 01-532227, SPAIN: Promovisa tel. 01-5352017, SWEDEN: Intersonic AB tel. 08-7445850, SWITZERLAND: RTG Akustik AG tel. 061-231912, TAIWAN: Acesonic International Co Ltd tel. 2-7168896, TURKEY: Ömer Trade & Representation tel. 04-1380296, UK: SSE Marketing tel. 071-387 1262, USA: QMI tel. 508-6509444.

# AES 'Will You Be Legal?' Conference

The principles of a free market within the European Economic Community (EC) are supported by an industry heavily involved in export. The UK has more than its fair share of studio equipment manufacturers, most of whom export substantial percentages of their production; around two thirds of all the mixing consoles built in the UK go abroad. At present, electrical safety regulations, and the standards applying to such things as electromagnetic radiation levels, vary from country to country. To meet the regulations of each country, an exporter has to modify products for each market.

At best, this creates additional costs in ensuring that the products meet each country's rules; at worst, standards can be used as a trade barrier, to protect the indigenous manufacturing base.

To encourage free trade, the EC is putting in place pan-European standards, so that if an item meets the single EC standard it can be sold in any of the EC member countries. This has already been done for consumer items like toys, which now must carry the CE mark inferring that the product meets the EC's standards. The EC is now introducing similar laws to deal with electrical safety and electromagnetic compatibility, EMC.

It is these latter proposals that have generated considerable concern within the audio industry, as virtually none of the UK manufacturers were aware of their existence until last year, just a few days before the closing deadline for public comment.

Since then there have been moves to publicise the implications of these and other new EC standards for the industry in general. In January there was a meeting at the London headquarters of the British Standards Institution. There some 60 industry representatives came away from a meeting that seemed to raise more questions than it answered.

In March, the British section of the AES put together a wide ranging conference, entitled *Will You Be Legal?*, under the chairmanship of Allen Mornington-West at which over 100 delegates gathered to try to find out how the new laws will affect them.

The conference topics were more widely based than many had expected, with only three of the 11 speakers directly addressing themselves to the EMC laws and one more dealing with EMC design considerations. The majority of the speakers dealt with general

standardisation and legal topics, including how companies can work towards quality management systems and the overall legal consequences of supplying equipment that doesn't do what it should, or goes on to damage the user or his property.

The first speaker of the day was Tony Bond from the Manufacturing and Technology Division of the UK's Department of Trade and Industry. He had a very strong grasp of the opportunities and problems raised by the new EC Directives. In dealing with the outline of the proposals and the time scales involved, he confirmed that the new Directive relates to all electrical and electronic products that are placed on sale within the Community, no matter where they are manufactured. Also that the EMC specifications define both the levels of EMC radiated by a piece of equipment (emission) and the equipment's sensitivity high ambient levels of EM radiation (immunity).

Although the enabling Act will be

passed in July of this year and the law will be effective as from January 1st, 1992, the specifications that the law refer to will not be formalised for several years yet. During the interim period—which may be as short as one year but probably be set at four years—companies can legally supply equipment providing either they meet existing national standards, or they meet the proposed EC standards and qualify for the Community's CE mark. After the interim period, only products that carry the CE mark can be legally sold within the Community.

Many delegates wanted to know what a manufacturer had to do to qualify a product to carry the CE mark. "You can use a recognised test organisation, but you can also do your own tests and present the data," Bond told his audience, "... Where a standard does not exist or is inappropriate for a particular product, then the company can create a Technical Construction File that shows how the product is designed and produced, and this is certified by a Competent Body (a recognised testing facility).

"Self declaration is the cheapest way; a company does the measurements itself and declares the product meets the Directive and that's it."

Since failure to comply with the requirements will be made a criminal offence, at Q&A sessions throughout the day Bond was further questioned on how the system would be enforced.

"The DTI has no plans to police the standards. The method of

enforcement will be complaints driven. It may be like the American technique which relies on manufacturers 'shopping' each other. Also the local trading standards officer will go to companies within his normal work activities and look at the relevant paperwork. If it's OK then nothing else happens; if there are questions, then he will report back to the DTI; and if it is obviously not right, then he will formally contact the manufacturer and the EC, and the product may be withdrawn from sale in all EC countries. The Radio Investigation Service may also be used and maybe the Departments of Transport and Energy and the MOD."

Privately, delegates had opposing views on the effectiveness of this form of policing. While some saw it as an opportunity to cut competition out of the market by reporting non-complying products, another said:

"We expect most companies to keep quiet about competitors' products. If one starts reporting everyone else, he'd better be certain his own house is in perfect order, because they will then be gunning for him."

The wider issue of how rigorously each national government will apply the standards was raised. Bond responded, saying: "We don't know. We have had two meetings and they haven't got that far. It will probably be left to individual states, and some will be more rigorous than others."

Speakers from Ampex and test organisations, BSI and ERA Technology, explained some of the details of the test possibilities and how the EC standards will integrate with the existing standards making bodies. Standards produced by the EC's Standards Committee (CEN for general standards and CENELEC for electrical standards), by the international standards body (ISO) and the national standards body (BS) will be unified, explained Justin Underwood of Ampex. Although each will have its own reference number they will all be saying the same thing. So the British standard for a quality management system—BS5750—is identical to the European standard EN29000, which in turn is identical to the ISO9000 standard.

The Directive determines a legal minimum performance aspect but as Ted Pease of the BSI pointed out, the use of the CE mark is no guarantee of quality of safety.

"The CE mark could equally mean *caveat emptor* as it does not claim to be a mark of quality, safety or environmental protection for the



AES Conference Chairman, Allen Mornington-West





**HIRE TO CURE  
YOUR PRODUCTION  
HEADACHES.**

When choosing the right technology becomes a major headache, Hilton Sound's hire service provides the perfect remedy.

With over ten years behind us – and the biggest selection of equipment in Europe – we make it our business to know all there is to know about audio. Our resident experts can prescribe the ideal synchronisation solution. Or help you select the most suitable recording medium, be it analogue, digital tape or hard disk. And when it comes to signal processors and microphones, we offer a wide array of collector's items, alongside the latest and best.

Hiring doesn't just defer a buying decision, it's

frequently more cost-effective. So give Hilton Sound a call if you want objective advice. We're not saying we're the universal panacea for all production and post-production ills, but it makes sense to check out the options before you apply the cure.

---

# HILTON SOUND

---

HILTON SOUND PLC

10 Steedman Street London SE17 3AF. Tel: 071-708 0483  
Hilton Sound sarl 2 Villa Ghis 92400 Paris. Tel: +33 1 46 67 02 10

**PIONEERS IN AUDIO ACCESSIBILITY**

# Another "8in1" Swiss Tool



## A1 THE PROFESSIONAL AUDIO TEST & SERVICE SYSTEM

- Sweeping Generator
- Distortion Analyser
- Wow & Flutter Meter
- Oscilloscope
- Level & Crosstalk Meter
- Noise Meter
- Curve Tracer
- Printer & PC-Interfaces

The A1 measures level, noise and crosstalk in absolute or relative terms, frequency, THD, wow & flutter, drift and noise with dependable reliability and cost efficiency.

A large backlit LCD shows single measurements numerically or as bargraph *and* sweeps in graphical form (response curves). Hard copies of screens available from a standard matrix printer. Optional: RS 232 interface plus very comfortable software package.

This thoroughly user-friendly instrument is autoranging, -tuning, -nulling, -scaling, -calibrating and replaces up to eight conventional instruments.

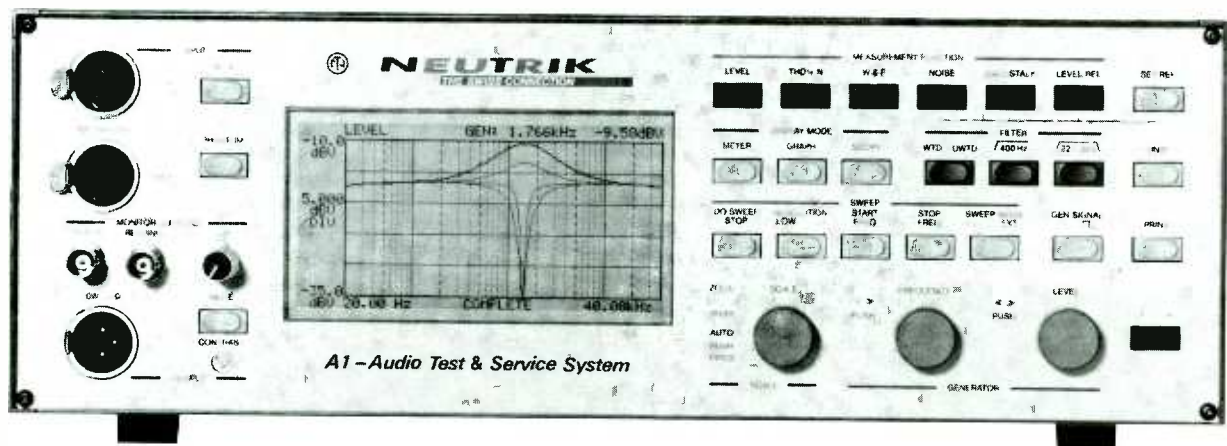

Don't wait to try all these advantages, ask for a demo today!



# NEUTRIK

**CONNECTING THE WORLD**

NEUTRIK AG  
Liechtenstein  
Tel 075/29666  
Fax 075/25393

NEUTRIK USA INC.,  
USA  
Tel 201/901 9488,  
Fax 201/9019608

NEUTRIK Marketing Ltd.  
United Kingdom  
Tel +44/71/792 8188  
Fax +44/71/792 8187

NEUTRIK Zürich AG  
Switzerland  
Tel 01/7340400  
Fax 01/7343891



consumer. Already we have seen the CE mark brought, into disrepute with products like toys self-declared by manufacturers to be compliant with the rules, while being blatantly dangerous.

"There is still a demand for higher safety standards such as BEAB."

IEEE legal expert Dick Jones reinforced the need for independent evidence that products are safe to help protect manufacturers from legal claims, saying:

"The law of contract has turned around in favour of the consumer and the small business so that it is no longer 'buyer beware', rather 'seller and manufacturer beware'."

Since criminal liability can extend down the manufacturing chain to component suppliers, companies should minimise their risk of liability by a combination of options, which can include: ensuring the products meet anticipated expectations by installing a quality management system such as ISO9000; or transferring the risk by keeping paperwork to allow faulty components to be traced back to the supplier, getting indemnities from the suppliers and customers, or taking out insurance. Even going out of business does not entirely eliminate the risk, he explained, "as there may still be liability for equipment already in circulation".

### ...this bias towards the testing of TV equipment can cause problems when the specifications are applied to high quality audio equipment

One of the final speakers, Stephen Kirk of the FIR test facility, made some unwelcome observations about the test procedures and standards laid out in the new Directive. He has been working with the hi-fi manufacturers' body, the Federation of British Audio, to see how high quality hi-fi equipment, with its similarity to studio equipment, its use of very low level signal paths and requirement for high audio performance, fared under the EC procedures.

He seriously questioned the validity of the measurement techniques described in the Directive, which were originally developed for testing TV and radio receivers.

"Unfortunately this bias towards the testing of TV equipment can cause problems when the specifications are applied to high quality audio equipment. Particular areas of concern relate not only to the accuracy and repeatability of the measurements but in some cases their relevance to the real world.

"But there will have to be a trade-off in increasing immunity to EM radiation and the sound quality."

At the end of the final session delegates queried many aspects of the Directive. They found that while some areas were clear—such as secondhand equipment, not coming under the Directive nor any product, first sold before January 1st, 1992—a lot of other areas were uncertain.

For example, complete installations like OB vehicles, supplied by a single contractor may be considered as an entity which has been shown to comply with the directive, or alternatively it may be looked on as the sum of its parts, so that providing each item complies then the whole installation could be judged as complying.

The conference was not designed as a base for action by manufacturers, but delegates were given a wider perspective on the scale of the problem facing them. It would seem that it will be difficult for audio manufacturers to comply with all the proposed EMC standards without compromising audio quality and product cost. But costs involved in proposing changes to the specifications could

run into six or even seven figures, which may be difficult to find from an industry which is predominantly made up of small and medium sized companies.

The situation will not be helped by the fact that members of the relevant standardisation committees have little knowledge of the pro-audio industry. One influential committee member responded to the question of how will mixer manufacturers be able to comply with the Directive if it means compromising audio quality.

"Since the majority of the equipment for your industry is made in Germany, I'm sure they will meet all of the specifications." (!)

Tim Frost

## Your days as an Octopus are numbered

If you work with an unautomated desk, you've probably longed for the day when affordable automated mixing makes the nightmare of manual mixing a thing of the past. Thanks to Optifile 3D that day has arrived.

Optifile 3D is a very cost-effective pro SMPTE system that's fittable to any console. Its stunning array of mixing applications makes it the first choice for many console manufacturers.

Contact The Home Service today for the new brochure and discover how easily you can have Optifile 3D fitted to your desk.

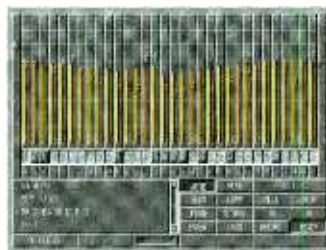

**NOW**  
WITH TOTAL  
MACHINE CONTROL



OPTIFILE



Manufactured by AD Systems, International representation: The Home Service, Unit 2, 10 William Road, London NW1 3EN, Tel: 071 388 0339

Australia: Greater Union Village Technology - (02) 550 5188 Belgium: EML - (011) 34 83 39 Brazil: Libor - (11) 54 83 39  
France: AD Système - (1) 42 53 31 18 Hong Kong: Audio Consultants Co Ltd - (852) 551 36 28 Italy: Audio Palombi - (02) 254 07 21  
Malaysia: Meteor Sound & Lighting Systems - (03) 291 65 59 New Zealand: Protel - (04) 854 871 Norway: Auditoron A/S - (02) 35 20 96  
Switzerland: Decibel SA - (021) 921 75 93 Sweden: Soundtrade AB - (08) 730 04 00 Spain: Twin Cam Audio - (03) 675 50 11  
Singapore: Swee Lee Co - 336 7886 Taiwan: Linlar Engineering - (2) 321 11516 Venezuela: Acoustilab - (02) 987 48 45  
W.Germany: Mega Audio - (067) 21 26 36



For Performance Freedom – Go Wireless



## The Incomparable L2/Beta 58® System

Take a step beyond conventional wireless technology. The unique L2/Beta 58 from Shure combines unparalleled performance freedom, consistent reliability, ruggedness, and the distinctive sound of a Shure cabled mic—without the compromises:

### The Sound of the Supercardioid Beta 58®

Around the world, superstars depend on the L2/Beta 58 for their most demanding live performance applications. And while they rely on its singular durability, it's the microphone's unique sound and true supercardioid pickup pattern that really makes the difference. It provides the same crisp, clear sound and gain-before-feedback as its cabled counterpart, the innovative Beta 58. In fact, the L2/Beta 58 is tested acoustically through the wireless link to assure the same optimized response that you'd get from the cabled unit.

### The Outstanding L2 Transmitter

To achieve this unsurpassed level of audio performance, the L2 Transmitter body is manufactured with an individually tuned and totally enclosed loop antenna. This sophisticated design ensures that the sound quality remains stable and unaffected by hand position. Efficient Shure-developed circuitry makes possible 12 continuous hours of operation from a standard 9 volt battery!

### The Breakthrough MARCAD™ L4 Diversity Receiver

Only Shure could produce a receiver worthy of these transmitters—the MARCAD™ (MAXimum Ratio Combining Audio Diversity). Through its "intelligent" circuitry, MARCAD™ provides a significant increase in RF gain, improved reception, and exceptional freedom from dropout.

Shure Wireless Microphone Systems—performance that's truly as good as it gets.

Call or write:

Shure Brothers Inc.  
International Division  
222 Hartrey Ave., Evanston, IL  
60202-3696 U.S.A.  
(708) 866-2200

Shure GmbH  
Lohtorstr. 24  
7100 Heilbronn  
Germany  
49-7131-83221

# SHURE

Wireless Microphone Systems



# ABACUS ELECTRICS

For exacting engineers, a precise instrument, the **ARTA 80** third-octave audio analyser.

- Incorporates precision pink-noise generator.
- Ultra-bright LEDs for clear display and battery power saving.
- Thirty non-volatile memories. View any memory simultaneously with "live" display.
- RS232 serial port for down-loading memory data to a personal computer.

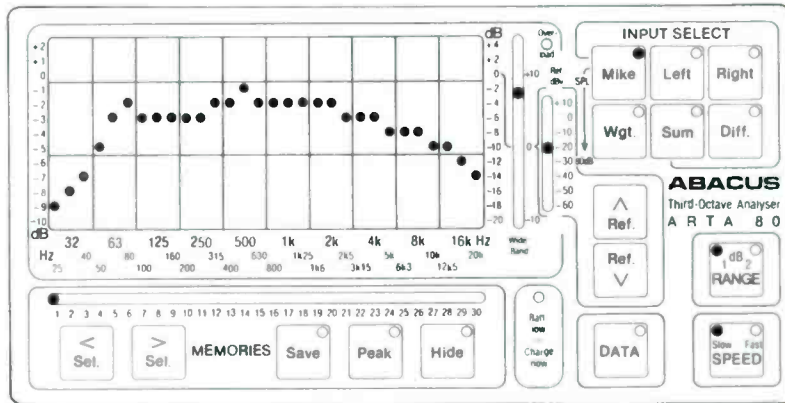

Battery portable – size 24 x 16 x 8 cms. weighs only 1.5 kg.

Microphone plus two line inputs.

Parallel printer port for plotting spectrum graphs directly on dot-matrix printers.

12dB or 24dB display range, fast or slow response.

## ABACUS ELECTRICS

10 Barley Mow Passage, Chiswick, London, W4 4PH, U.K.  
Telephone (081) 994 6477 Telex 8811418 SPACES G

# Rycote

Beware imitations!

The result of continual original research

**WINDSHIELDS,  
SHOCKMOUNTS  
WIND-JAMMERS**

Rycote Microphone Windshields Ltd  
Unit 6, New Mills  
Slad Road, Stroud  
Glos. GL5 1RN England  
Tel: (0453) 759338  
Fax: (0453) 764249

# THE WEDGE WITH THE EDGE!

The TFM 250 and TFM 350, two-way active monitor wedges (passive option available), are professional products with a proven performance record through extensive BETA testing with Europe's leading sound rental company.

Design emphasis is on excellent intelligibility, even at high SPL's and the flat response of the TFM 250 and 350 means high resistance to feedback, whether on tour or in fixed installations. All this is achieved without the complexity and expense of a dedicated processor.

Every aspect of the TFM 250 and 350 design has been considered, from the strongly built cabinet with cloth covered steel grille through to the connectors which are recessed to prevent interference and accidental damage.

The TFM 250 and 350 have been designed to be compatible in profile and crossover point frequency, allowing them to be easily combined on stage to suit a wide variety of different monitoring applications.

Few loudspeaker manufacturers can equal our understanding of the needs of the professional sound engineer. None exceeds it.

**TFM 250** 1 x 300 W 12" Precision Devices bass/mid driver plus 1 x 2" compression driver. Bi-amped with cross point of 1k6Hz, 24 dB/octave.

**TFM 350** 2 x 300 W 15" Precision Devices Bass/mid drivers plus 1 x 2" compression driver. Bi-amped with crossover point at 1k6Hz, 24 dB/octave.



**Turbosound** An **AKG** group company

Turbosound Limited, Star Road, Partridge Green, West Sussex RH13 5EZ.  
Telephone: (0403) 711447 Facsimile: (0403) 710155 Telex: 878723 TURBO G



## A GROWING FAMILY...



DBM-1A Digital Audio Meter for Sony PCM-1610/30 systems

**NEW!**

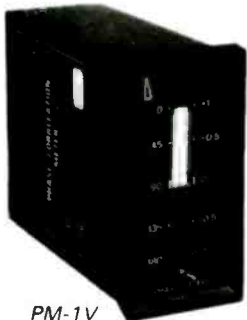

PM-1V  
Analogue phase meter

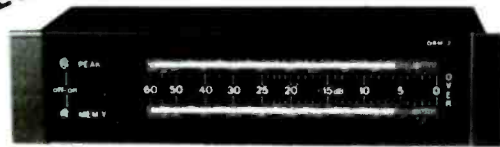

DBM-2 AES/EBU Digital Audio Meter



PM-1H  
Analogue phase meter

PHONE OR FAX US FOR DETAILS



SPA-1 Eight stereo channel professional Pre-Amplifier



**TOTALSYSTEMS, 41 Windermere Ave, Basingstoke, Hants. RG22 5JH ★ Tel & Fax 0256 468555**



## Live news

- **Audlease** had equipment out with Julian Cope, the Philip Glass Ensemble in Europe and EMF in May (with the new A-2 SR system).
- **Britannia Row's** June schedules are dominated by long-running tours which started in April or May—including The Pet Shop Boys' indoor arenas tour with its attendant MIDI mountain. An in-depth review of their tour technology—both the MIDI end and the first use of the *Flashlight* SR system in such venues—will be featured in this *Live Sound* section shortly. The Gypsy Kings and Judie Tzuke used BRP for a few shows each, while Joe Jackson, Lenny Kravitz, and the roving TV showcase *Rock Steady* were out through May and into June. They're also tackling this year's June *Fleadh*—the second annual festival of Irish music, staged in north London's Finsbury Park and headlined once again by Van Morrison. Mike Lowe noted that "Various people have been attempting to set up an 'alternative Glastonbury' in the West Country" as we closed for press. BRP's other news concerns people and premises. Ian Horne—formerly engineer to Madness and Ian Dury and latterly house engineer at Liquidator Studio (once owned by Madness), has joined BRP as operations manager, overseeing technical details of tour contracts. The move also sees Chris Hey focusing on a client contact/sales role. The company moves in June to new south London premises—see *News* for details.
- **Canegreen** is adding Eastern Acoustic Works to its speaker inventory. Yan Stile said the 'first phase' of what will eventually form a 48-cabinet system has been delivered—to run alongside their existing Meyer SR stock. The EAW 850 system—complete with sub-bass enclosures—is simple to fly (with two pick-up points and a ratchet system for angling arrays) and will be driven by Canegreen's Crest amps via an amended crossover panel. Stile also said production runs of the *Radio Station* headset monitor system had been held up but should be available 'imminently'. Canegreen continued its participation on Deep Purple's US tour, and has European dates with American band The Replacements. Stile ruefully confided: "We've got a contract out on their bass player—he has an appetite for smashing up our wedges." May, however, saw less

## News round-up

- **Birmingham** is firmly on course to be Britain's second musical city with the June official opening by HM the Queen of its prestigious new International Conference Centre. Highlight of the venue is the Symphony Hall, with innovative and widely-praised 'variable acoustics' design by New York-based acousticians Artec. Alongside the ICC is the next venue on the list—the 20,000-seat National Indoor Arena.
- **Britannia Row Productions and Sales** move from the eponymous street in Islington to new premises, scheduled to take place in June. The Wandsworth, South London site is at 2 Osiers Road, SW18—Mike Lowe says the extra space will allow the company to bring all its operations and hire stocks under one roof—the main objective.
- **Encore** has opened a Scottish depot. The Glasgow site houses some 18 kW of Martin F2 SR plus control equipment. And the firm is now proud owner of a new Midas XL-3 console, along with a stock of BSS's latest amplifier, the *EPC780*. The company have already taken delivery of its second XL-3.
- **JHE Audio**, hire division of John Henry Enterprises, have purchased 16 C-Audio SR707 and RA2000 amplifiers to drive its custom-designed bi-amplified monitor wedges.

arduous dates with Elaine Page in Britain and Ireland, and considerable sub-hire business.

- **Clair Brothers'** European activities include Paul Simon's tour, which kicked off in Norway, Alexander O'Neal, Sting, White Lions and Bob Dylan. Stan Horine confirmed the company's console project has been 'put on ice' but was very optimistic about the near future with business prospects looking good as US and European economies move into what looks like post-recession recovery mode.
- **Electrotec** are currently tied up with Rod Stewart's massive world tour.
- **Entec's** sound hire manager Steve King said the new Northolt-based operation had had—like most of the industry—a very quiet first quarter, but added "business is quickly



The model for Birmingham's new ICC Centre

- **Orbital Acoustics** of London recently had a gig with a difference—the launch of British Telecom's new corporate image at its City of London Newgate Street HQ in March. A series of one hour-long presentations were staged in the building's 9-storey high central atrium in a specially-built amphitheatre using an A/V presentation, an Imagination-designed Vari\*Lites rig and Orbital's Midas/Hackney Cab/Bose SRS. A Midas XL-3 was used for the broadcast side.
- **TAC** has finished its largest-yet installation of SR9000 'Superconsoles'. The Sydney Opera House has taken no less than four in a contract worth around £450,000 (\$810,000). A custom touch was the provision of a remote control unit which enables many of the master functions of two consoles to be controlled from up to 100 metres distance. Frank Hinton of ATT Audio Controls, Australia's

Amek/TAC distributor, represented the company in the deal.

- **TAC** were also busy at Frankfurt Musik Messe, launchpad for their latest high-end SR console, the *SR6000*. Joining the fray in an increasingly tough market, the *SR6000* is aimed squarely at Yamaha's aging *PM3000*. Chief features include a compact rigid steel frame, an EQ based on the Amek *M2500* EQ with 2 parametric mid bands and swept HF and LF bands, a 'split auxiliary system' providing up to 16 aux sends and a single VCA output group fader capable of controlling all group outputs in unison. Says product manager Carl Reavey, "The audio quality of the EQ is much higher than the *PM3000*'s; the board is quieter and has better specifications." Price: £25,000 (\$45,000) for a 40-input console.

picking up". They retain a 20-bin Martin rig—but now also offer around 40 kW of JBL *Concert Series* SRS. Among their gigs are Zen—a big 'rave' in unlovely Slough with 30 kW of JBL; monitors for Paul McCartney's rehearsals down in Sussex; a Clannad tour and Hammersmith Odeon dates with Anita Mui—an Amsterdam-based Chinaman. June dates include Roachford and a Summer Ball in Oxford, while July takes them to Reading for the Womad Festival.

- **SSE** had UB40, MC Hammer, more WWF Wrestling in Britain and Europe, the Little Angels and "many more to come", says John Penn, who also observes that margins across the business are being increasingly squeezed as firms put more and more equipment out at static prices. "There is a degree of over-supply in

the market," he adds, "but more seriously, a lot of people—including some tour managers—just don't understand what it really costs to put a PA on the road. And that's bad news for re-investment in new equipment. The return on capital can be pathetic—service companies are really taking a pounding."

- **Theatre Projects Sound & Vision**—part of the London-based Samuelsons Group—has installed a large SR system at the Queen's Theatre in London for the new musical *Matador*. A pair of customised and linked Yamaha *PM3000*s, Meyer *UP-1A* speakers and various effects have been supplied.

Studio Sound's Live Sound news page is compiled by Mike Lethby

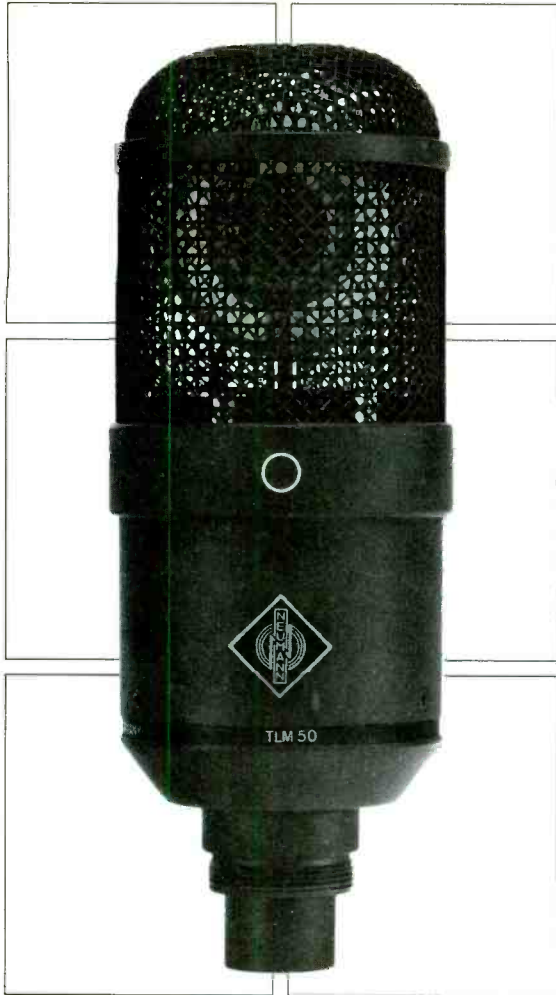

new  
from

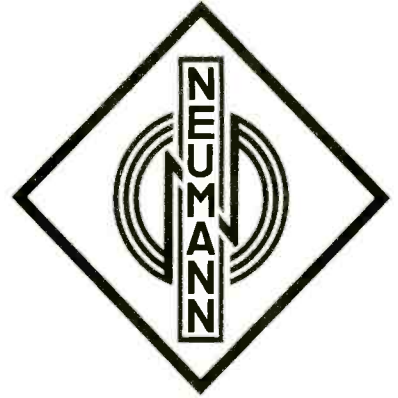

neumann

See us at the 5913  
International Television  
Symposium, Montreux



### TLM 50 Pressure Microphone

- polar pattern omnidirectional
- high loadability, transformerless circuit
- small pressure capsule built-in in a 40 mm sphere
- nickel membrane



### KMS 140 and KMS 150 Condenser Soloist's Microphones

- polar patterns: KMS 140 cardioid / KMS 150 hypercardioid
- built-in very effective protection against pop- and other explosive sounds
- high-loadability, transformerless circuit
- extraordinarily true sound transduction free of coloration



Exporter  
 AUDIO EXPORT GEORG NEUMANN & CO GMBH  
 Postfach 1264  
 Badstraße 14 · D-7100 Heilbronn  
 Tel.: (49) 7131-6247-0 · Telex: 7 28 558 audex d





The Prism system in London's Wembley Arena

# PRISM POWER

When George Michael presented his 'Cover to Cover' tour ShowCo used their *Prism* system for the sound. Mike Lethby tried to uncover its secrets.

It struck me, I must confess, as slightly surprising that it's nearly five years since ShowCo launched their *Prism* system onto the world's arenas. I say surprising, because ShowCo have managed to keep the lid on the details of their SRS to the extent that even to many sound engineers it's still something of an unknown quantity. As a result, few in the industry—outside of a tight coterie of ShowCo's regular engineers—have got close enough to *Prism* to get under its skin and discover whether factors besides the company's sheer size have helped make it so demonstrably successful at the top end of the market.

An example. A British SR company boss related a tale of how, when a certain major artiste's tour manager expressed interest in using *Prism* and enquired what was inside the boxes, he was told "speakers". His reply, so the story went, was "Thanks, I'll call MSI." The tale may well be apocryphal, but it does illustrate how widely-known is ShowCo's reluctance to divulge its speaker technology.

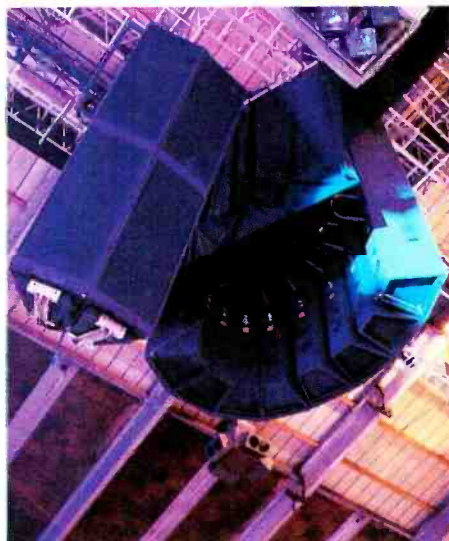

Prism from below

If you know the basic details—standard JBL components, a variety of black boxes, a particularly neat flying system and smart digital control racks—you might well ask, what is all the fuss about? Is it just so much hype, a smokescreen in ShowCo's amicable tussle with Clair Brothers, with whom it yearly jockeys for pole position on the US arena circuit? Or is the genuine company really concerned to protect innovations from predators? In short, how different—really—are those anonymous 'speakers'?

I put these and other questions to the ShowCo people best-placed to respond, and listened to *Prism* in action on a fairly demanding show. The Company's top crew—all *Steel Wheels* veterans—were ensconced at Wembley Arena for George Michael's March dates. General manager Clay Powers and Robin Magruder, senior vice-president, sales & marketing, filled in the corporate story. They were, as we shall see, supremely accommodating, friendly and informative. Except, alas, when it came to the matter of those infernal 'speakers'...

## ShowCo: a recap

Like Clair Brothers, ShowCo's history stretches back to the early '70s—but while the two companies have occasionally pooled their expertise over the years, there the similarity ends. ShowCo has followed its own inimitable rules ever since to evolve a PA that's unlike any other.

ShowCo were formed in 1969 by a triumvirate of Rusty Brutsche (a former musician, now president and CEO), Jack Maxson (studio engineer, now chairman) and a third partner—a promoter no longer in the organisation. The current management team is completed by Howard Page—vice-president, field operations.



# Examine your Options

The complexity of today's studio environment demands an operational flexibility not available in a single console, until now! The VECTOR 432 from Trident.

Equally comfortable in Music or Post Production and built to Broadcast standards, the VECTOR is truly the console of choice. All this and Trident sonics at an affordable price.

Examine our competition and then investigate the VECTOR. We are sure you will find your options are few.



## TRIDENT VECTOR AT SOUNDSHOP STUDIOS, NASHVILLE

- ▲ 32 balanced multitrack routing buses.
- ▲ A/B/C/D balanced stereo buses with mix matrix and Main Output Bus compressor.
- ▲ Grouping and automation of 12 switches per module via SMPTE or MIDI.
- ▲ P & G faders. Sealed conductive plastic pots throughout.
- ▲ Four band Parametric equaliser splittable between both Channel and Monitor with individual bypass switches.

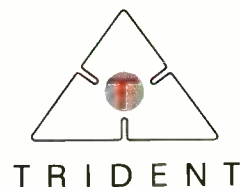

The VECTOR 432 is available with a wide range of options including:-

- ▲ LCRS Film, Stereo Input, Effects return & 4 way Dynamics modules. VCA grouping, VU or bargraph meters.
- ▲ Single VCA (channel), Dual VCA (channel & monitor), or Moving fader automation systems, any of which may be integrated with the Trident Machine Control, enabling sophisticated cue list management, cycles and 'drop in' of master, slave and MIDI (virtual) transports.





FOH Harrison desks feed the ShowCo control racks

One of the first SR companies to tackle large shows, ShowCo swiftly had some of the big names of the early '70s under their belt—including Led Zeppelin, Three Dog Night and Mountain. Propelled into the big league, they diversified into virtually the whole gamut of touring activities—becoming probably the first hire company, to offer lighting, trucking, crew transport, hotel bookings, staging, set design and (eventually) lasers and video facilities under one roof. As they moved into the '80s, though, there was a corporate decision to focus on sound technology. Peripheral activities were subcontracted out, and by 1982 an R&D programme had been embarked on to design the SR system ShowCo had always felt they wanted.

The goal, says Robin Magruder, was “to create the perfect left and right sound source—radically different to everyone else’s ideas—to put fidelity, headroom, power and coverage to every seat in any venue.” It was the genesis of the *Prism* system—a ‘completely integrated’ design to take on competitors such as Clair Brothers, Audio Analysts, Electrotec and Maryland Sound. “The technology then just wasn’t good enough,” he adds, “including ours.”

Today, a 60,000 ft<sup>2</sup> headquarters in Dallas houses both ShowCo and Vari\*Lites offices, including hire operations, manufacturing and engineering facilities. ShowCo have a core staff varying seasonally between 30 to 40 including full-time load crew. Overseas sites are deliberately minimalist. There’s a UK warehouse in Ruislip, serving Europe, and Clay Powers says ShowCo will soon open a UK office. The only independent hire outlet is in Japan, where Hibino claims its *Prism* inventory makes it the largest SR company in the country. The overall total is impressive in Europe and the US, ShowCo can muster around a dozen George Michael-sized systems at any one time—roughly on a par with Clair’s current capability.

## George Michael: Cover to Cover

One music paper’s reviewer described the Cover To Cover tour as an ‘unusual career move’. But George Michael, with his latest album *Listen Without Prejudice Vol 1* a huge commercial success, opted to give his fans a completely fresh insight into his talents. Playing extended runs in just a few cities, including Rio, Tokyo and London, he served up a ‘covers’ showcase of some of his favourite songs, with a few of his own and Wham!’s hits for good measure. There were plenty

of '60s and '70s soul numbers and some brilliant surprises such as a superbly soulful re-working of Adamski’s *Killer* house hit.

It was obviously part of the overall Grand Master Plan which is positioning him as a serious artiste: the band’s musicianship was of the highest standards and little expense had been spared in devising the production. If ever an SR company was going to put its credibility to the test it could hardly choose a tougher gig than his. Michael is a renowned perfectionist with a ‘Midas touch’ for commercially successful productions—and he likes to get involved at every stage. As ShowCo themselves said, “we’ve sold ourselves to him as the best, now we have to prove it.”

Roy Bennett’s lightshow confirmed the point. A dazzling kaleidoscope of fixed lights, Vari\*Lites and exotic specially-designed multi-coloured gobos, it danced over the set, the white backdrop and a pair of triangular ‘wings’ on either side of the stage. Bennett rarely deployed the same effects twice and frequently co-opted the front third of the Arena as a projection screen—creating 3-D visual theatre much bigger than the performing stage.

The 11-piece band comprised drums, percussion, two keyboard players, two guitarists, bass, three backing vocals—and George. A sequencer/sampler centre provided extra tracks on certain songs, as in Soul II Soul’s *Back To Life*.

The set list included *Killer*, *Ain’t No Stoppin’ Us Now*, Terence Trent D’Arby’s *Sign Your Name*, Wham!’s *I’m Your Man*, *Freedom, Faith*, Elton John’s *Don’t Let The Sun Go Down On Me* and, for an encore, *Careless Whisper*.

## Controlling the show

Most of the team have worked together (and with ShowCo) for many years, most recently in the Stones’ *Steel Wheels/Urban Jungle* extravaganza, and the empathy was obvious.

At the controls was Benji Lefèvre, with ShowCo’s David ‘Cowboy’ Conyers as systems engineer. Chris Wade-Evans (known to his friends as ‘Wevans’) mixed monitors. Cowboy (he used to break horses in his youth—“and there’s too many Davids on the road!”) and Lefèvre make a matching pair, with identical ponytails and facial hair in the style known in the Royal Navy as a ‘full set’.

Their FOH mix position displayed an eclectic blend of old and new technologies. Venerable Harrison consoles feed ShowCo’s latest digital

control racks—(of which more later) and there was a DMP-7 for sequencer sub-mixes.

Lefèvre: “It’s the House version of the Harrison. It has 16 auxiliary sends and in the centre section I’ve got 16 line level FX returns, plus a small 4-way matrix which allows me to access four group outs for recording on DAT or whatever. The delays come straight off the main mix. Below all that is the VCA section, 1 thru 8.

“I’ve had a few modifications made. The main one is the last VCA fader—it’s no longer accessible through the faders on the desk; it’s hooked up to the VCA master on the drive rack. So this is my master volume control—rather than using conventional stereo left and right master outs. There’s also a 20-channel ‘stretch’.”

Although ShowCo has used Harrison desks since the '70s—and there was an early collaboration with Clair Brothers in their design—such has not always been the case.

Lefèvre: “The first tour I did with them, we had these little yellow mixers with treble, bass and volume, rackmounted—that was Led Zeppelin in 1972! Ha!

“We’ve also got a DMP-7 out front, which is fed by the sequencers and allows me to create my own discrete EQ balance for the house for all the drums sequencer voices. That feeds into the main desk.”

ML: “You have a remote control panel for the DMP-7: why?”

Lefèvre: “The DMP-7s are real good, but changing parameters on the channels is a pain because you have to call each one up, select the parameter and step up or down, then store it. With this if you punch ‘Channel 1’ you’ve got every facility for that channel at once—3-band EQ, SPX-90, all the rest. It’s much, much quicker.”

Effects included AMS reverbs, delays and pitch changers, REV-7s, an SPX-90 stereo Drawmer gates, a Roland 555 tape echo, dbx comp/limiters, UREI 1176s, TEQ graphics, and further racks of 900 dbx compressor/limiters and 904 gates. Any unit can be accessed through the patchbay in one connection.

A neat touch was a small Toshiba laptop PC with a mono monitor through which Lefèvre can step through a display of cue sheets for each song, detailing FX settings and instrument line-ups. (“It’s just a word processor,” he says, “but it’s better than having cards which blow away in the wind. I’ve got every song we’ve rehearsed in there—about 35—so if he chooses to change the set I can call up the details.”)

## On stage

The Wembley stage was kept tight and clean—no messy backline gear in sight. Cleanliness, too, was ShowCo’s policy for choosing microphones.

Lefèvre: “The system is good, so the microphones we use are very important to me. We have some expensive mics but it’s well worth it, and with the technicians we have I’m always confident they’ll be taken care of. For instance, we’ve got three Neumann 87s hanging from a bar which is lowered down for the 24-voice choir on two numbers.”

Moving round the stage, Lefèvre explained the setup.

“The percussionist is a very animated player and I wanted to get a stereo picture of what he’s playing.” A square booth was built from 1 inch thick perspex to prevent sound from other wedges blowing into his mics. “That enabled me to mic the main percussion set-up with just two 414s,





Prism digital control racks and drive rack

which gives it a really nice space. Some things that stand out in the mix are close mic'd—like an AKG 460 on the bells, 414s on the chimes and wood blocks and a Sennheiser 409 on each conga.

There's a similar idea on the kit, with perspex screens to keep direct sound out of the mics. The kit is mic'd with a Sennheiser 421, an AKG 414 on the snare bottom with a B&K 4011 on top; a 460 on hi-hat, 421s on all the toms and two sets of ambient mics—all 414s.

"For the drummer's monitors, I wanted to avoid having half the PA behind him and flooding into the mics so we gave him a pair of small ShowCo 450 monitors, which he has close to his head like giant headphones—like Keith Moon's old monitors. They make drummers feel really happy because they're like part of the kit. Plus a B1 sub bass cabinet (nicked from ShowCo's last AX SR) to give it warmth—not just to kick his kidneys!

"There are five keyboard setups in all. The two 'official' keyboard players are David Clayton and Chris Cameron, plus Andy Hamilton, who plays sax and an Akai Wind Instrument, and the two guitarists, who play string pads in a couple of songs.

"The three backing vocalists use Shure SM58s and George has a Sony radio mic system which Wevans and myself have used for five years. We've tweaked it and tuned it and it's really exceptional. Mike Allison is our microphone expert—it's really good having experts on hand! He did an amazing job on the Stones with us; their stage was 300 feet wide and you could go anywhere with one of those mics and have perfect reception. When we took the tour to Japan we invited Sony down and they couldn't believe what we'd achieved. But that way you get good relationships with your suppliers."

Alongside the stage was the MIDI station, with two racks of hardware (monitored by a technician) including a pair of Roland MC-500s and Akai S1100s which ran drum sequences on various songs.

Lefevre: "George likes very specific drum sequences and they're not disguised as anything else. Plus some bass lines and backing vocal pads on two songs."

These were all routed through Yamaha DMP-7s and backed up by UPSs, emerging at the monitor desk as stereo feeds with individual sounds pre-balanced and pre-EQ'd. The musicians used MIDI footpedals switch through patches during each song.

Wevans: "In rehearsal once the keyboard players have got their patches together I spend two days going through each patch with them to make sure that what sounds good to them will sound good in the PA. And I try to persuade them to use our little monitors because they're consistent with the sound of the PA—then fine tune them so they sound perfect here and perfect out front. I find them (the DMP-7s) very reliable; there's a lot of stuff we couldn't do without them. The sound is very Yamaha but they fulfil an important function."

Wevans outlined the monitor system: "There's a Harrison SM-5 monitor desk with a 20-channel extender. There are 16 main mixes and more from the matrix section such as foldback to the sequencer technician, and wedges for the choir. At least, that's what's happening this week!

"There's a big mixture of things but it's a very controlled show. There's a lot of people out there and George is running about all the time waving a radio mic around." The set, he says, "is fairly structured from day to day and from song to song.

Rather different from doing Dylan—that was 'hang on and see what happens next'. Or the Stones—we were in the hands of whatever they decided to do on the spur of the moment."

ML: "Presumably George is fairly particular about his sound?"

Wevans: "He's very particular. He's a perfectionist. It's got to the stage now where he wants cues and levels changed on his voice from line to line to suit his range: More so when the whole band is playing than when he's singing ballads—then he's more concerned with the tone. He's spent a lot of time in the studio recently, so he's used to hearing sound the way he wants it."

ML: "He seems to like a lot of reverb on his vocal..."

Wevans: "Yes, but not as much as on the 'Faith' tour where he wanted it absolutely swamped in reverb. Now he's more concerned with every note coming out audibly than with effects."

Lefevre: "When he goes very low he still has perfect pitch but without as much power, so you have to increase the mic level. Like Chris was saying, you have to ride it line by line—on the fader and the EQ as well. But it's good fun to go with it and understand his singing style."

Wevans had a pair of ShowCo 600 bi-amped floor wedges, with Crown amplifiers and TEQ equalisers like the FOH system. He concluded: "It's very keyboard-orientated so you don't have that backline distortion and noise like a rock tour with loud guitars. Marshall stacks on stage would just destroy everything. All the monitors are ShowCo's so everybody has a similar sound and they don't have to worry about getting their own backline sounding good."

## SR tour

Here we begin to approach the heart of the matter, although the phrase 'proprietary information' soon becomes familiar whenever speakers are mentioned. One aspect that ShowCo are happy to discuss, though, is their all-singing digital control system.

The digital rack, which includes VCA master levels and digital crossovers, is the product, says Lefevre, "of what I used to do with the old system, and it's turned into something beyond our wildest dreams. With a conventional PA, you get a desk which you plug into the crossover and then system limiting which is set by the company to protect its system.

"ShowCo's system limiting is a 5-way insert on my programme material. So whereas conventionally, to get a sound louder you'd turn the fader up—making it compress more—with this, you can achieve a level of compression and then turn that sound up or down. The final VCA output comes into the graphics through the processor, then it's divided up into 5 bands and from there back to the drive, so the VCAs provide my final full range stereo volume control.

"The drive rack comprises as standard one K-T DN60 analyser, two TEQ/ShowCo modified graphics, dbx 900 series system limiting divided into 5 bands and the ShowCo 1043 Prism Status Monitor. This tells you that the correct frequency is going to the correct drive line. If something went wrong with the digital and it started spurting lows into the high channel, it would shut right here. It monitors the frequency response, and it also monitors both processors continually; if one should go down it automatically switches to the other.

"The other side of the rack has two ShowCo Prism 1040 System Controllers—crossovers which



• PERFECT SOUND • PURE VISION •

PERFORMANCE  
CRAFTSMANSHIP  
RELIABILITY

T

he Sennheiser name has been associated with high quality yet affordable audio products for nearly half a century. In order to fully service and support the ever-growing customer base, Sennheiser now announce the opening of their UK offices in High Wycombe.

Staffed by dedicated professionals and demonstrating the company's total commitment to the UK market, Sennheiser UK is the number to call for sales enquiries, product information and technical support.

Details of our complete range of innovative audio equipment including Studio, Vocalist and O.B. microphones, headphones, acoustic systems and the new range of M.K.H. Studio Condenser Microphones featured here, are available from Sennheiser.

For further information call Sennheiser UK on (0628) 850811.

 **SENNHEISER**

Sennheiser UK Ltd. • B2 Knaves Beech Business Centre • Loudwater  
High Wycombe • Buckinghamshire HP10 9QY • Tel. 0628 850811  
Fax: 0628 850958



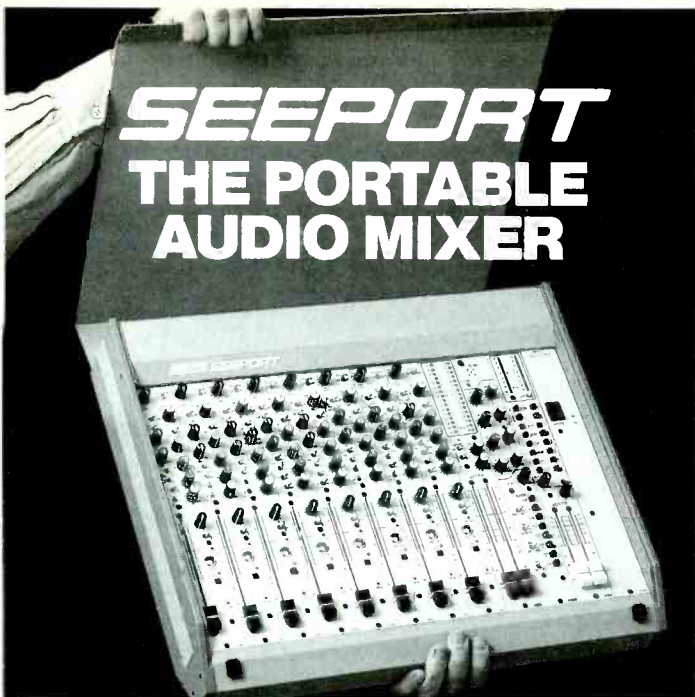

# SEEPORT THE PORTABLE AUDIO MIXER

- 8 input channels, mono or stereo
- 4 auxiliaries, with returns
- 2 band equalizer in each channel
- Pre fader listening and channel on switches
- M/S switch in each channel
- Penny & Giles long scale faders
- 2 stereo instruments
- DC or AC powered
- Weight 9.8 kg
- Fits in a 19" rack

**SEEM AUDIO R/S** Broadcast telecommunication Audio Video

P.O. Box 115 - N-1380 Heggedal - Norway  
Tel. + 47 2 79 77 30 - Fax + 47 2 79 61 54 - Telex 79207 SA N

## DACS MODULAR MONITOR SYSTEMS

*The simple and effective choice for monitoring*

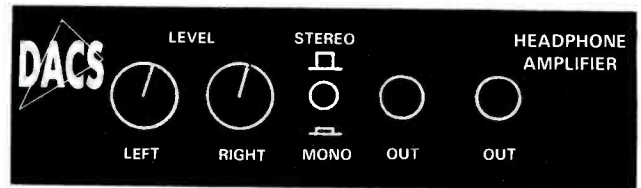

Monitor Mix 1 - 8 into 1 audio (line or unbalanced mic)  
Monitor Mix 2 - 4 into 2 (pan and vol per channel)  
Headphone amplifier - Stereo or 2 into 1 mixing. Clean power to 2 pairs of stereo headphones

Panel size - 5.2" x 1U high

These modules are extremely high quality. Using them, complex and effective monitoring systems can be assembled easily. Call us and speak to Douglas Doherty to discuss your monitoring requirements.

### Audio Interface Accessories

**Line Boost** - 8 inputs at -10dBV, 8 outputs at +4dBm, balanced outputs available as purchase option or retrofit.  
(Distortion at Max Output <0.011%, S/N into 600R >96dB, Crosstalk >93dB)

**Passive Level Match Board** - 8 inputs at +4dBm, 8 outputs at -10dBV, balanced input version available.

**Unbalanced Distribution Amplifier** - configurable as 1, 2, 4 or 8 in to 8 out with adjustable gain.

**Modular Balanced Distribution Amplifier** - 1 in - up to 8 out housed to user specification

**Balanced Input and Output Boards** - Unity gain transformer action electronic balancing boards.

(Output Boards 1 1/2" by 1 1/4", Input Board 1" by 1 1/4")

**Stereo Pro Interface Board** - Line level balanced inputs and outputs to unbalanced outputs and inputs respectively. These boards are factory set to operate for nominal balanced in and out at +4dBm, unbalanced side at -10dBV, but gain settings can be adjusted to user specification (3 1/2" by 2 1/4")

**48 Volt Power supply board** - Regulation circa .003%, .5A output

For Retail outlets, UK & foreign trade enquiries and further information

**DACS Ltd, Stonehills Complex, Shields Road  
Pelaw, Tyne & Wear NE10 0HW  
Tel: 091-438 5585 ★ Fax: 091-438 6967**



# RTW Digital Peakmeters

RTW makes them all: digital and analog PPM's as well.

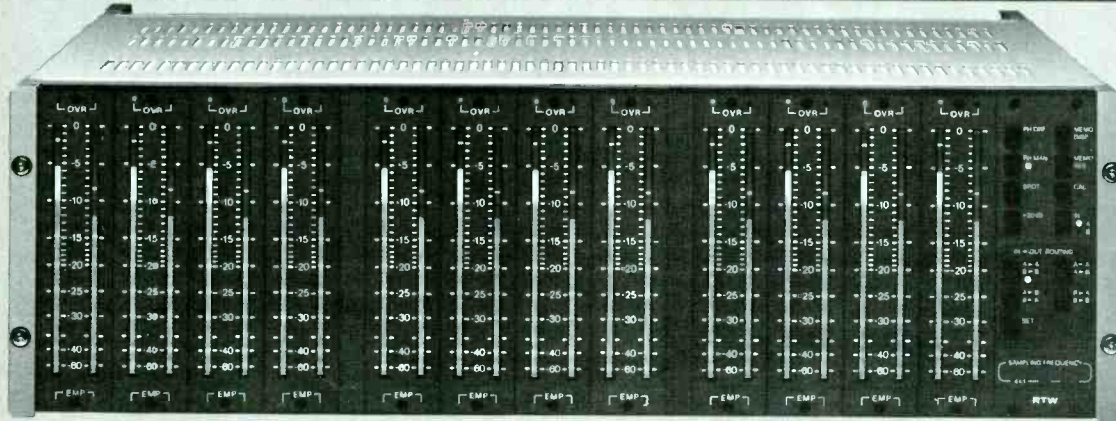

**RTW 1190 DMS**

24 channel Remote Metering System 1190 DMS for connection to the PCM-3324 (A) SDIF data format (RS-422).

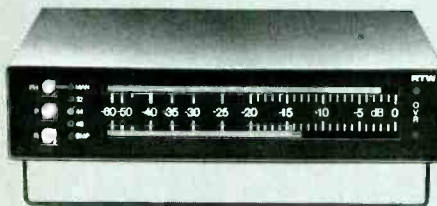

**RTW 1152 EBU**

2 channel Digital Meter 1152 EBU for connection to the AES/EBU digital format.

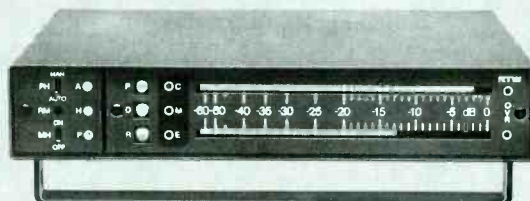

**RTW 1150 DA-T**

2 channel Remote Meter 1150 DA-T for connection to the PCM-1610/1630 status port.

**RTW RADIO-TECHNISCHE WERKSTÄTTEN GMBH · D-5000 Köln 71 · W.-Germany**  
Post Box 7106 54 · Telephone (221) 70913-0 · Tx 8885217 · Fax (221) 70913-32

Australia: SYNTEC INTERNATIONAL, Tel (2) 4064700 · Austria: ACOUSTA ELEKTRONIK, Tel (662) 846164 · Belgium/ Netherlands: P.A.C., Tel NL: (40) 424455 · Canada: J-MAR ELECTRONICS LTD., Tel (416) 4219080 · Denmark: S.C. Sound APS, Tel (2) 998877 · Finland: AV-POINT ICS AB, Tel (0) 5666733 · France: SCV-Audio, Tel (1) 48632211 · Great Britain: AJDIO & DESIGN LTD., Tel (0734) 844545 · Italy: AUDIO EQUIPMENT SRL, Tel (39) 2000312 · Japan: SANIX CORPORATION, Tel (3) 7025315 · Korea: DAESAN INTERNATIONAL INC., Tel (2) 7368442 · Norway: SIV. ING. BENUM AS, Tel (2) 145460 · South Africa: ELTRON LTD., Tel (11) 7870355 · Spain/Portugal: SINGLETON PROD., Tel E: (3) 2377060 · Sweden: AV MEDIA AB, Tel (755) 65498 · Switzerland: AUDIO BAUER AG, Tel (1) 4323230 · Switzerland: TECNAD A.S., Tel (21) 8060606 · USA: ESL ELECTRONIC SYSTEMS LAB., Tel (305) 7911501



operate in the digital domain and which are obviously proprietary in the way they work (obviously, indeed). It's a digital network that monitors itself continuously.

"There are three VCA units in the rack; you select one as master unit for your main PA; once it's set up and tuned you introduce the one for the front fill until it's fitting in nicely and finally the third one for the delays. After that the master VCA automatically tracks whatever you do on the 'main' channel."

*Cowboy*: "You can't always fly the PA in exactly the same relationship to the stage in different buildings; you may have to move it back or forwards five or six feet to get the flying points. And that means your PA and sub bass aren't lined up together. But the FOH rack has a sweepable time delay for the sub bass enclosures; so if the PA moves out six feet you can time align it manually—which is really neat."

## Prism SR: proprietary design

*Lefevre*: "In their blurb, ShowCo says the *Prism* delivers sound to seats and not to the roof—which is true. Its directivity is exceptional. With a conventional PA you build one or two boxes that sound really good but when you put eighty into an arena and expect them to sound as good, of course they don't." ShowCo, he says, tackled the problem in reverse order. "They said 'most of our work is in arenas; let's design a system specifically to take care of arenas'. So in their R&D they looked at about 25 American stadia, took the average height, width and length and so on, and designed this system to cover that area most efficiently at any given height."

*Magruder*: "We used computer modelling to build a definition of what would create our ideal results in any arena, and designed an array to meet those goals. We started with the premise of a pair of stereo speakers and then worked out how to split them into modular form."

*ML*: "So was it designed as a long-throw system?"

*Lefevre*: "It's a complete throw system. If you walk around with a dB meter, you'll find that when it's tuned up there's no more than 2 dB loss at any point in the room, which is remarkable. Of course that's great as a spec, but in a reverberant room like this you add things like delays to help put the sibilance and diction and clarity to everywhere."

*ML*: "What is in each cabinet?"

*Cowboy*: "JBL loudspeakers—but even JBL doesn't know what's in those cabinets! That's proprietary information!"

*Lefevre*: "We have a choice of eight different types of cabinet for our tours. Full range, a sub bass and four different types of PA cabinet plus the small delay cabinet. Each vertical column has the same configuration of cabinets but within each column each of four speaker cabinets contains different components."

We seemed to be getting a shade closer to the nitty-gritty here. Gently, I prompted: "And those are...?"

*Cowboy*: "Proprietary information. The information is out there—it's not a big secret (he could have fooled me)—but how we've achieved what we've done is a secret."

We moved onto the Wembley PA and its flying system, supporting an 8-column grid, four high.

*Cowboy*: "Each side flies off three 2-tonne points, so that riggers only have to put up six points

which is a vast saving in time. Two are critical on either side; the third is just a cable point."

*Lefevre*: "The system is so responsive and accurate that positioning it correctly in the room is vitally important. I think of it like positioning hi-fi speakers in my living room in deciding where it's going to go: how high would I want it, and where in the room?" ShowCo's flying system involves a rigid array bar of unorthodox geometry.

*Lefevre*: "Looking straight up, the arc has the shape of a human ear—although that's coincidental. The curve gets tighter at the side; it's actually two radii joined together—one for the front arc and a smaller arc for the side. This single array will handle the front sound and cover the side seating properly.

"I'm a stickler for having as much time as possible to tune the system to a particular room. And to that end, the amp racks have an adjustment for the amount of horn drive in the nearfield and farfield. (Clearly part of the secret.) Each frequency band is driven by its own amplifier so that if the seats are steep and close to the PA we can set up a nominal level at the desk for the arena and then trim the amps so that as you walk backwards and forwards it's smooth all round."

*ML*: "So everybody gets a fair deal."

*Lefevre*: "Yeah—but a lot of people don't do that. Either they don't have time or they're not interested. But in big stadiums it's a real challenge because in theory, the further from the stage you are, you should get a better sound 'cos you get a raw deal on the visuals."

*ML*: "Does every *Prism* array follow this shape?"

*Lefevre*: "The grid is rigid and the cabinets always hang off it in the same pattern. You can rotate the whole thing but it covers 270° wherever it is; thus improving sightlines. It can be extended in width for larger arenas and all you ever need to add is backfill clusters if you're sending to 360°."

The cabinets in each column slot together and to the fly bar using a neat system of interlocking recesses and slide-in steel locking pins. Because vertical dispersion is catered for within the cabinets (proprietary information, of course) most ShowCo arrays do not require the usual strapping-up to form vertical curves. *Lefevre*: "It's like putting together kids' building blocks. We've assembled this system in panic situations in two hours from opening the truck to being ready to go. It's lovely for the engineer—you've got more time to tune it and play with it. You can be making noise by midday."

Attention to detail, he says, is all-important. "The first two days of rehearsals, I won't even fire the PA up; I'll join Wevans on stage and work that end out so that it's not 'the monitors versus the house'. I hand-pick my own crew, so I know the team can work together—it's half the battle. I always go to Dallas a week or so before a tour to assemble my own racks personally, the way I want it to be done. It's the whole idea of maintaining everything at 100%; you owe it to the punters."

Completing the SRS were eight sub bass enclosures—each with two 18 inch drivers. Are they a reflex design? This casual query elicited a prompt and familiar response.

*Cowboy*: "Proprietary information."

A central delay cluster used eight of ShowCo's small mid/high cabinets. How were they configured?

*Lefevre*: "Mathematically—and then by ear. The highs and mids come from the desk into K-T

DN716 delays—130 ms delay since we're about 128 feet from the stage."

*ML*: "What's in the delay system?"

*Cowboy*: "That's proprietary information. Man, how many times do we have to tell you? JBL speakers!" (Well, I tried.)

Crown amplifiers power the whole rig and ShowCo has a system of universally-exchangeable 32 pin cables, eight of which go up to the columns with jumpers between the cabinets. "Each component in any cabinet will be picked up on its own wire within the amp racks. All the AC racks are self-balancing, and there's a star-point ground system with no possibility of loops. Plus you have assigned talkback intercom which can be picked up off the bottom of any amp rack. Yet you could run a truck over these cables and connectors and nothing would happen to them. And we have our own main AC connect for backline and PA, with a constant readout of voltage and ampage. It's our own on/off switch."

Buried deep below the stage was a mobile workshop—christened 'Motronix'—where a service engineer maintained amps, effects and racks after everyone else had gone home with the aid of function generators, oscilloscopes, parts 'and tools for days'.

Clearly, ShowCo has all the angles covered when it comes to the heat of the action. Yet churlishly, I was still angling for more information about those 'speakers'. So I 'phoned Clay Powers in search of illumination.

"The secret is a combination of electronics and driver angles," he confirmed (to no-one's surprise). "Selecting, combining and placing equals complete pattern control."

"The system is configured to act like one large speaker enclosure on each side, and the only reason it breaks down into small modules is so it can be transported. Instead of figuring how to put a bunch of boxes together. That's the main difference between us, Meyer, Turbo and everyone else. *Prism* took three years to develop and all the upgrades since have been to the control system."

## In conclusion

My first remark to Cowboy was "you guys are in here early"—midday was the appointment and they'd been at their posts for some while beforehand. And so they were too when I returned at midday on the fifth and final show, still tweaking obscure things like sequencer EQ settings on the *DMP-7* rather than enjoying a good lie-in. And doing it was a feat of concentration with Wevans simultaneously 'one-two'-ing his stage monitors at full volume.

Dedication is what makes ShowCo one of America's (and thus the world's) top two SR companies. As to what makes the *Prism* System... well, whatever the proprietary explanation may be, this modular multi-throw system certainly possesses a delicately extended and uncoloured top end. It shows its qualities most clearly when the upper harmonics of percussive instruments (triangle, acoustic steel-strung guitar or hi hat, for example) shine through with a glistening sheen amidst a complex mix at high volume. Sub-bass qualities were muddled by the 'Wembley boom'; hardly unusual.

One found one's toes inclining to tap; the audience went suitably wild and paying customers received excellent value from a well-rounded show. If the 'speakers' remain almost as mysterious as before, George Michael must have been content to know that his ideas were in safe hands. □



Whether you're in the business of acquisition, post production or transmission, the Sony professional DAT range now offers the digital answer.

Low cost, high density, fast access, 16-bit PCM stereo recording - the strengths of the DAT format

already benefit thousands of professional users throughout Europe.

With the PCM-7000 series, Sony combines these strengths with new technology and operational features, tailored precisely to the needs of both

**SONY**<sup>®</sup>

For further information contact:

Athens 01 2818273 Basingstoke, UK 0256 55011 Brussels 02 7241819 Cologne 0221 59660 Copenhagen 042 995 100  
 Dubai 04 373472 Helsinki 0 50291 Jeddah 02 6440837 Lisbon 01 859 4269 Madrid 091 3581335 Milan 02 618381  
 Netherlands 020 6581911 Oslo 02 303630 Paris 01 49454000 Rome 06 5920 801 Stockholm 08 7336100 Vienna 0222 61051  
 Zurich 01 733 3511 Eastern Europe, Vienna 0222 554606 Middle East, Geneva 022 7336350 Africa, UK 0256 55011



# Sony professional DAT.

Designed by professionals  
for professionals

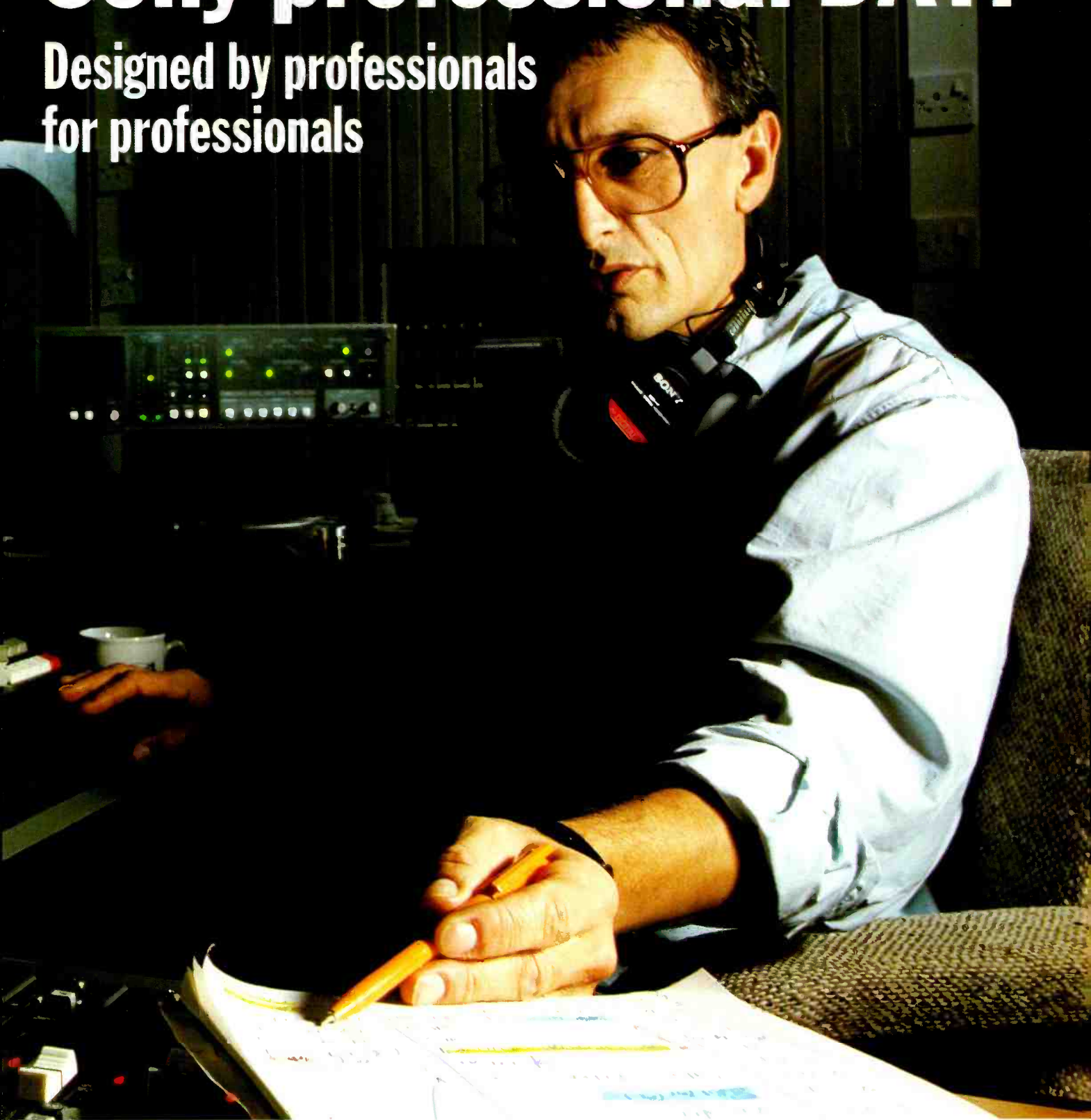

broadcast stations and production houses.

Sony professional DAT includes SMPTE/EBU time code recording, chase lock synchronisation, memory start and electronic editing with variable crossfade. At surprisingly affordable prices, the

leap from analogue to digital is an attractive and realistic proposition.

Contact your nearest Sony dealer for full details - you won't regret it.

Sony Broadcast & Communications European Headquarters  
Jays Close, Viabes, Basingstoke, Hampshire RG22 4SB, United Kingdom  
Tel: (0256) 55 0 11, Telex: 85 84 24, Fax: G2/G3 (0256) 47 45 85

Sony Broadcast  
& Communications 

# ONLY BLACK & WHITE CAN DO JUSTICE TO A COLOURLESS MONITOR...

We could have shown you the MONITOR ONE REFERENCE in glorious colour. We could have written reams about the fact that many consider it to be the most accurate and impressive mid/near-field monitor speaker they have heard. Instead, we decided you'd probably prefer to judge them for yourself, so call your local distributor to arrange an audition and hear the truth in black & white.



## MONITOR TECHNOLOGY

P.O. Box 1102, Nedergade 35 C  
DK-5100 Odense C, Denmark  
Phone: +45 6613 9981 / +45 6614 5958  
Fax: +45 6614 9181

**DISTRIBUTION:** Denmark/Norway/Sweden: Monitor Technology, +45 6613 9981/+45 6614 5958 France: Coach Audio Sales, +33 8777 0000 : England: Raper & Wayman Ltd., +44 81 800 8288 Germany: Coach Audio Sales, +49 6894 4717/4727 Holland/Belgium: Ampco Audio Products B.V., +31 30 433 134 Rep. of Ireland: Control Techniques Ireland Ltd., +353 1966 866 Switzerland: Gotham AG., +41 1840 0144 Italy: Professional Equipment SRL., +39 2891 0241 Japan: Heavy Moon Inc., +81 33 797 6765 Singapore/Malaysia: Swee Lee Company, +65 336 2307/+65 336 0752.

### NOTE

The work print or copy master is one of the most important links in the Post Production chain. Whether it is Video Off-Lining, Dialogue Replacement or Audio Sweetening the quality of the Work Print brings out the creativity in both Actors and Operators alike.

*On further details call  
GTC or your local dealer.*

UK: F.W.O. Bauch LTD  
(44)81.953.0091  
FRANCE: VIDEODIO  
(33)148219129  
SWEDEN: MSI Broadcast AB  
(46)87680975  
SPAIN: FADING S.A.  
(34)3772400  
TURKEY: UTIN Trade Co.Ltd.  
1404037-1262919

# A new type of Film to Tape... TELESCAN



GTC have, since the late 70's, been leaders in the field of timecode referenced multi-format machine synchronising. Now the 90's see us once again at the forefront of control techniques, bringing fast, accurate, system automation within the reach of all production facilities.

The heart of the TELESCAN is the SCANSCOPE, a newly developed optical system which provides flicker free moving and still pictures. Combining this with an innovative transport and a 3 CCD scanner results in the most cost effective high quality FILM TO TAPE transfer system currently available.

- User Friendly, easy operation
- 16/35 mm Formats
- Interlock Capability to LTC, VITC & Pulse
- Evolution Transport
- Anti-Scratch condensor feature
- Continuous Motion
- Vari-Speed
- Careful Film Handling



**GTC**  
BROADCAST  
PROFESSIONALS

g.t.c. Film- und Fernseh- Studiotechnik GmbH  
Woehrendamm 19, D2070 Grosshansdorf  
Phone: (0)4102-62062, Fax: (0)4102-64907



# APRS PREVIEW

This year's annual exhibition of the Association of Professional Recording Services will be held at Olympia 2, Olympia, London from June 5th to 7th. As usual we have compiled a preview of the exhibits from information available to us at the time of writing. Studio Sound will be exhibiting in conjunction with sister publications One to One and Broadcast Systems International. Both editorial and advertising staff will be in attendance at the stand and around the show

## A

● **Acoustic Design Group:** will be displaying photographs and drawings of completed and current projects in the UK and continental Europe, Japan, USA, Malaysia and Singapore. ● **ACME:** a Belgian organisation formed 10 years ago to serve the needs of those involved in electronic music. ● **Akai:** featuring the *DD1000* optical disk recorder/editor; the *DR1200* digital recorder; and the *S1100* sampler. ● **AKG:** will be exhibiting for the first time a new wireless microphone system designed for multi-channel operation in sound reinforcement systems. Also on show for the first time will be the *Orban 400 A* transmission limiter. AKG will also feature their range of dbx signal processors; the *DSE 7000* digital workstation; and a full complement of studio and broadcast microphones. ● **Allen & Heath:** featuring the *Saber Plus* console which is

the latest version of the *Saber* and includes a new software package for the mute automation; the *Spectrum*, known as the *Saber 8* in certain overseas markets; and the *Scepter Monitor* which is the latest addition to the *Scepter* family of rack mount mixers. ● **Amek:** featuring the new machine control option, which interfaces the Amek/Steinberg *Supertrue* automation with the *Motionworker* synchroniser controller. Also new is the Amek *Hendrix* multitrack console which is based upon the design aspects of the *Mozart* console but at a lower price. The normal configuration is a 40-channel in-line console with dual path channels and eight stereo returns.

● **Ampex:** will be exhibiting a full line of professional audio tape products and accessories including *478* Low Print mastering tape. ● **AMS:** featuring the worldwide launch of the *Logic 2* digital audio mixing console incorporating total dynamic automation. *Logic 2* features up to 256

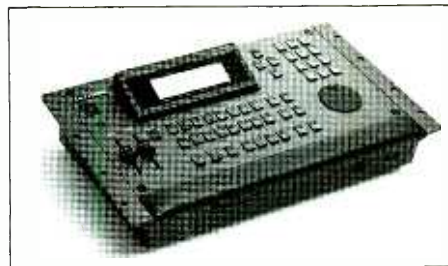

Akai DL1000 remote controller



B&K 4006 with new accessory

audio channels accommodated in a frame less than 2 m long. Also seen in the UK for the first time will be the 16-output version of *AudioFile Plus*. ● **Audio Animation:** will be showing the *Paragon* range of audio signal processing computers. On show for the first time will be the *Paragon Studio* offering four channels of expandable DSP. ● **Audio Design:** range of hard disk recording and editing systems, featuring the *SoundMaestro* stereo programme editing system. As well as all the *Probox* digital format interface units. ● **Audio Developments:** will be showing their range of sound mixers and ancillary equipment. ● **Audio Kinetics:** featuring *ES.Lock* synchroniser products, including the *ES 1.11* single machine synchroniser and *Penta* and *Eclipse* multi machine controllers. The new *ES 1.11 R* package will also be displayed constituting an *ES 1.11* synchroniser plus a separate remote unit with the alphanumeric display and major controls. Also an *ES 1.11* interface to the Sony *3348* transport is being introduced at the show. ● **Audiomation Systems:** will be demonstrating their updated automated music recording system that utilises motorised faders. Also on show will be their new 'live sound' system. ● **Audio Systems Components:** products include the *CART* remote for the ASC broadcast CD player and the latest software for the *CD Jukebox*. ● **Audix:** featuring *ACC* series mixers; *ARM* series of rackmounting amplifier modules including microphone distribution, line send and line receive amplifiers. ● **Autograph Sales:** will be exhibiting the full range of Meyer Sound *Studio* series products and sound reinforcement products and for the first time in Europe the *VX-1* stereo programme equaliser. Autograph will also be exhibiting Klark-Teknik, BSS and Lexicon signal processors; Micron radio mic systems and the *Saje Memory* console. ● **Avcom:** will be showing the complete range of cassette duplication equipment from Telex. Two new models are the Telex *MCD Duplicator* and the Telex *Stereo Copyette 1+3* duplicator. ● **Axis Audio Systems:** will be showing the Allen & Heath *Sigma* 24-track in-line console as well as the Fostex *G24S* 24-track recorder.

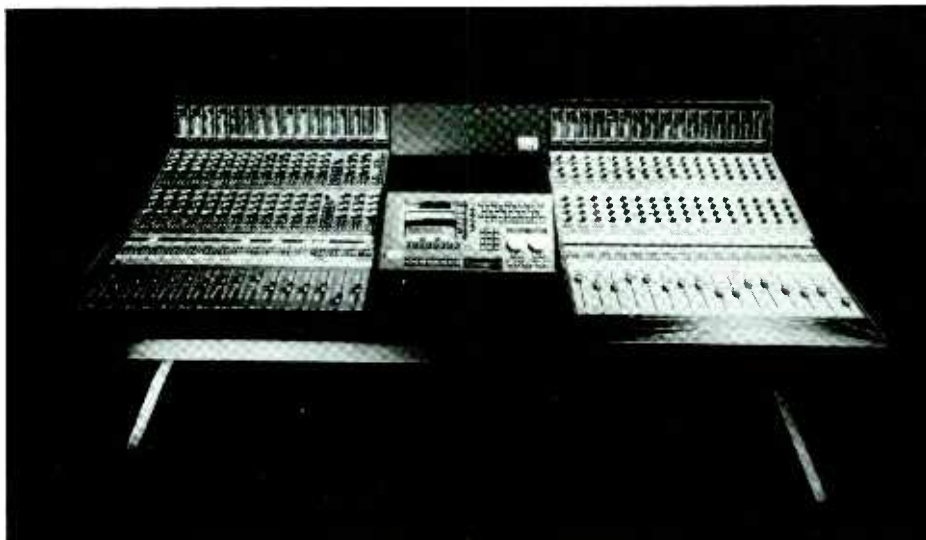

AMS Logic 2 mixing desk



## B

● **BASF**: showing their full range of audio and video tape products. ● **FWO Bauch**: new products to the UK include the Studer *D740* standalone CD recorder; the *D920* digital broadcast mixing console; the *NVision NV2000* audio distribution system; and the Gefell range of cardioid condenser omnidirectional and switchable condenser mics. Also included will be the *Dyaxis* hard disk system; Lexicon *Opus* post-production system; Sonic Solution's CD maker software; and the Gotham range of audio and Multicore cable. ● **Beyerdynamic**: dynamic, condenser and wireless microphones; dynamic headphones and headsets, gooseneck mics and mic accessories. ● **British Record Producers Guild**: with details of their membership. ● **Brit Row Sales**: will be exhibiting products by AEG; Westlake; Precision Power; Aquarius; Ramsa and Apex of Belgium with their new range of equalisers. ● **Bruel & Kjaer**: will be exhibiting the complete series *4000* range of omnidirectional and cardioid microphones, together with a new acoustic equalisation attachment for both the *4003* and *4006* omni mics. The new attachment, the *NA0609*, was launched at last year's AES in Los Angeles, and functions as both a directional and spectral equaliser, changing the mic's frequency and polar response.

## C

● **Cadac**: launching the *Concert* series of live mixing consoles which has been designed to provide a modular solution for a wide cross-section

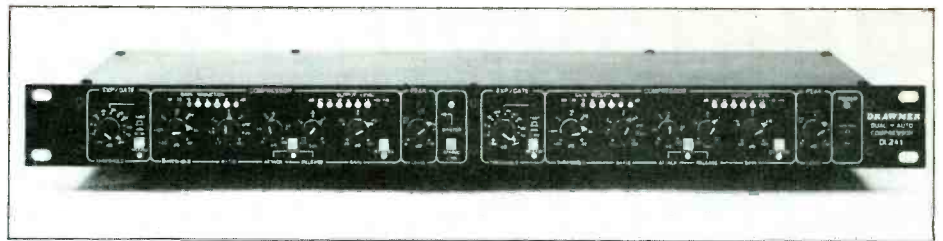

**Drawmer DL241 dual-auto compressor**

of budgets and specifications. Also launched for the show is the Cadac *Creative EQ* package, integrating Cadac's EQ design within a rackmounted package. ● **Calrec**: are showing for the first time the *Q-series* range of production audio consoles. The *Q-series* is suitable for studio, OB or post-production use where 36 or more channels are required. ● **Canare Cables**: range of cables and cable systems. ● **Canford Audio**: featuring their distributed products, from cable drums to selected wines. ● **Cedar Audio**: will be demonstrating the CEDAR Restoration system including their latest developments in DSP processing. Two new CEDAR processes will be shown for the first time anywhere. CEDAR Distortion Reduction, and the CEDAR infinitely variable sample rate converter. ● **Chilton Audio**: introducing a new family of modular broadcast/production consoles, with frame sizes up to 32 inputs, 4 or 8 group out. ● **Cummings Recording Associates**: specialist supplier and manufacturer of professional tape recorders.

## D

● **DDA**: showing new product the *Profile* 24-bus

mixing console, designed around a similar concept to the *DMR-12*. *Profile* features 56 modules in a 2.4 m frame. Also featured will be the *DCM224V* post-production console with the *Uptown* moving fader system. ● **Digigram**: will be showing for the first time at an APRS the *XTRACK*. Based on the *PCX3* card, *XTRACK* is a 2-, 4-, 6- or 8-track studio/post-production multitrack system. ● **Digital Audio Research**: will be showing *SoundStation II*, *SoundStation DSP* and *DASS 100* standalone multifunction digital audio interface. ● **Dolby**: featuring Dolby *SR* for recording, broadcast and video post-production, Dolby Surround and *AC-2* digital audio coding technology for transmission systems. ● **Philip Drake Electronics**: will be showing new products including the *PD 9375* 20-bit single card A to D converter; *PD 5050* 20-bit A to D and D to A converter; the *PD 9368* digital distribution amplifier; and the *FC-1* digital audio format processor; as well as the *2000* series post-production console. ● **Drawmer**: new products include the *DS404* Quad Gate which is a 4-channel expander/gate switchable for hard or soft gating. All four channels can be linked if required. Also on demonstration will be the

## BROADCAST FOR NOW AND THE FUTURE



The EELA AUDIO S 240 is a versatile broadcast mixer, designed in collaboration with broadcast engineers. Therefore it is equipped with many facilities required by broadcasters in the nineties. It is appreciated by producers and operators for its ergonomics and simplicity in operation.

- Full range external fader control
- ON/OFF logic
- Cough mute on microphone channels
- Fader inhibit
- Channel inhibit
- Ducking
- Overall limiting
- Selective limiting/compression
- Multiple Clean Feed

# eela audio

Parmentierweg 3, 5657 EH Eindhoven Airport, Phone: 040-510484, Fax: 040-570482



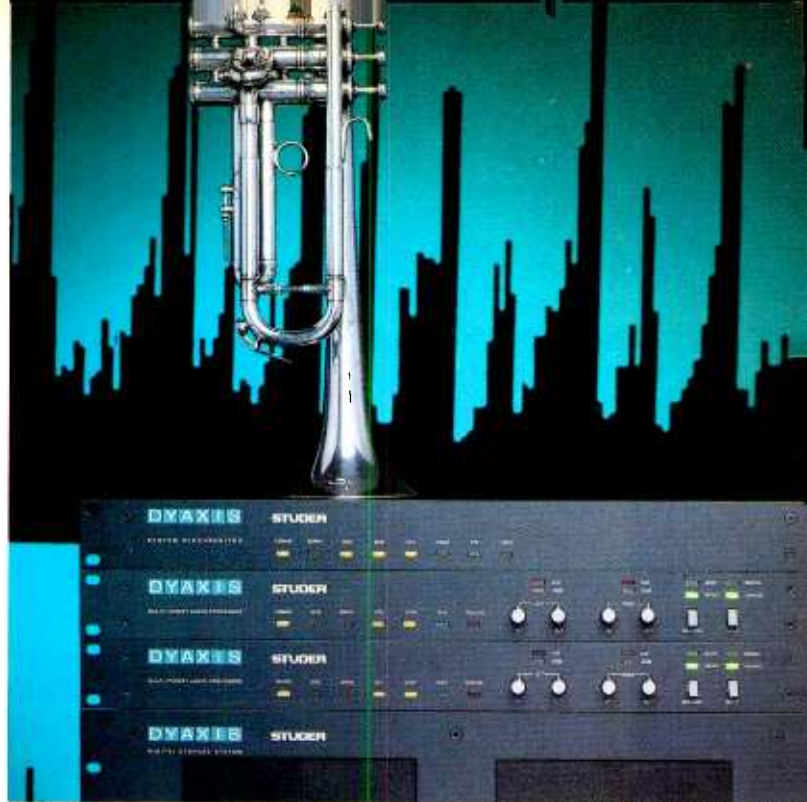

# Visual hearing

The new dimension in sound processing.  
Made possible by hard disk editing systems.  
And with the introduction of Dyaxis, hard disk digital audio has also become affordable.  
For any studio that processes audio signals: in the recording studio, in the midi suite, in program production of radio and TV, in video post production and film dubbing, in the commercial recording studio, in CD production... because of its flexible architecture, Dyaxis can be customized. And so achieves an optimum cost/performance ratio and greater production efficiency. This is what professional users expect of a professional tool.  
Since the introduction of Dyaxis by Studer, the future of hard disk digital audio also has a pedigree: Dyaxis is a Studer thoroughbred, representing true innovation in audio technology, reliability and worldwide support and service.

**BAUCH**

F.W.O. Bauch Limited  
49 Theobald Street, Borehamwood, Herts. WD6 4RZ  
Tel : 081-953 0091 Fax : 081-207 5970

**STUDER**

PROFESSIONAL AUDIO EQUIPMENT  
**Worldwide:** Studer International, Switzerland, CH-8105 Regensdorf-Zurich, Althardstr. 10, Phone +411 870 75 11, Fax +411 840 47 37, Telex 825 887 sti ch

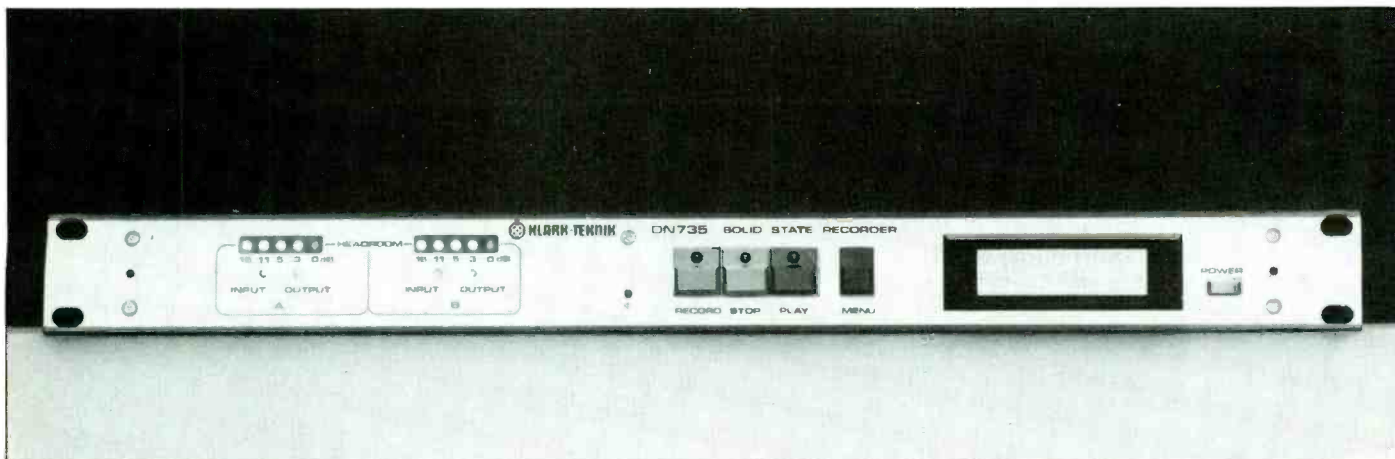

**Klark-Teknik DN735 solid state audio recorder**

recently introduced *DL241* Dual Auto-compressor.  
 ● **Dyer Audio Systems:** will be showing the new *S440* Broadcast Control Centre for 'on-air' or production in broadcasting stations. There will also be a complete range of EELA Audio broadcast products on show. Also there will be a range of BNS self-powered broadcast monitor loudspeakers.

## E

● **Eardley Electronics:** displaying high quality components for the pro-audio industry. Also the full range of Neutrik connectors. ● **Elliott Brothers:** presenting details of their latest installation contracts. ● **EMO Systems:** will be showing their new Mains Power Monitor, the *MPM3*, designed to provide comprehensive realtime information on the state and consumption of mains power supplies. Another new product on display will be the EMO microphone combiner, which provides an economical method of feeding two mic signals to one input when individual level control is not needed.



**Aiwa HHB1 Pro DAT player**

## F

● **Focusrite:** showing their range of dynamics modules and the Focusrite *Studio* console. Also news of further orders for each. ● **Formula Sound:** demonstrating their System *2000* modular mixing console; *AMX6* 6-channel mixer; and the prototype *PM-90* modular mixer. ● **Fostex:** new for the show will be the Fostex *2412*, a new

compact 24 into 12 production console which offers assignable 4-band EQ, and MIDI muting with snapshot scene recall and preview. Fostex will also be demonstrating the new IEC timecode software update for the *D20* DAT player, and the newly launched *G24S* linc 24-track recorder using Dolby S. ● **Future Film Developments:** products on display include an extended range of Soundex PPM Drive Cards; pre-wired plug-in

patchfields; Canare dual video jacks; and the Telzon Cross Connect Systems, featuring both high density and modular design.

## G

● **Goutam:** showing their complete range of audio mixers including the *Aries*; *Astrid Monitor*; and *Artemis 12-buss*.

## H

● **Harman Audio:** on Harman's stand JBL will be showing their range of loudspeakers, studio monitors and electronics. The JBL *CADP2*, the new and improved version of JBL's Computer Aided Design Program will also be demonstrated. Harman will also be showing products from ART; Audio Logic; C-Audio and Monster Cable.

● **Hayden Labs:** showing the ranges of Denon and Nagra professional products. ● **HH Electronic:** will be showing for the first time the new *MX* range of installation and SR amplifiers. Initially four *MX* models will be available ranging in output from 500 W to 1600 W. ● **HHB Communications:** displaying their range of DAT machines including two new DAT recorders from Panasonic, the *SV3700* and *SV3900*. Also showing

SDIF-MULTITRACK SP-PATCH X880-AES/EBU-PCM1630-PD-DAT-X88-CRC-24BIT  
 -SP-PATCH-X880-AES/EBU-PCM1630-STATUS-DAT-X88-CRC-24BIT-STATUS-USER  
 24BIT-X880 -AES/EBU- MULTITRACK  
 -PCM3324- DIGITAL -SDIF-PD- AES/EBU-  
 -SDIF-SP-PATCH-X850-AES/EBU-PCM1630-DAT-PD-X88-CRC-MULTITRACK-24BIT  
 X880-AES/EBU-1630 INTERFACES -PATCH-X880-1610  
 -CD-PATCH-X880- SDIF-PD-DAT-X88-  
 PATCH-SDIF2-TWOTRACK-SP-X880-PCM1630-STATUS-AES/EBU-SDIF2-DAT-USER-  
 -PCM3348-X850-SDIF2-MULTITRACK-SP-PATCH-AES/EBU-CD-USER-CRC-24BITS-

**MUSICOMP** 3 Petley Rd London W6 9SU ENGLAND  
 Tel 071-386 8019 Fax 071-385 1667



*Media*

14 The Markham Centre, Station Road,  
Theale, Berkshire RG7 4PE,  
United Kingdom.  
Telephone: (0734) 303800  
Fax: (0734) 323121  
(IDD +44 734)  
Telex: 858893 FLETEL G

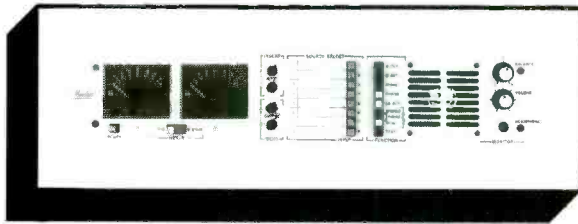

## AMU 8S

*Audio Monitoring Unit*

- Can monitor up to 8 stereo lines
- Integral multi-standard ident generator
- Dual P.P.M.'s and integral speaker
- Stereo speaker and line level outputs
- Compact 2U high rack mounting
- Full remote control facility

With 50 years' experience in the design and manufacture of several hundred thousand transformers we can supply:

## AUDIO FREQUENCY TRANSFORMERS OF EVERY TYPE

**YOU NAME IT! WE MAKE IT!**

OUR RANGE INCLUDES:

Microphone transformers (all types). Microphone Splitter/Combiner transformers. Input and Output transformers. Direct Injection transformers for Guitars. Multi-Secondary output transformers. Bridging transformers. Line transformers. Line transformers to B.T. Isolating Test Specification. Tapped impedance matching transformers. Gramophone Pickup transformers. Audio Mixing Desk transformers (all types). Miniature transformers. Microminiature transformers for PCB mounting. Experimental transformers. Ultra low frequency transformers. Ultra linear and other transformers for Valve Amplifiers up to 500 watts. Inductive Loop transformers. Smoothing Chokes. Filter. Inductors. Amplifiers to 100 volt line transformers (from a few watts up to 1,000 watts). 100 volt line transformers to speakers. Speaker matching transformers (all powers). Column Loudspeaker transformers up to 300 watts or more.

We can design for RECORDING QUALITY, STUDIO QUALITY, HI-FI QUALITY OR P.A. QUALITY. OUR PRICES ARE HIGHLY COMPETITIVE AND WE SUPPLY LARGE OR SMALL QUANTITIES AND EVEN SINGLE TRANSFORMERS. Many standard types are in stock and normal dispatch times are short and sensible.

OUR CLIENTS COVER A LARGE NUMBER OF BROADCASTING AUTHORITIES, MIXING DESK MANUFACTURERS, RECORDING STUDIOS, HI-FI ENTHUSIASTS, BAND GROUPS AND PUBLIC ADDRESS FIRMS. Export is a speciality and we have overseas clients in the COMMONWEALTH, EEC, USA, MIDDLE EAST, etc.

Send for our questionnaire which, when completed, enables us to post quotations by return.



PO Box 36, Ipswich IP1 2EL, England.  
Phone: 0473 252794 & 0473 219390 -  
Telex: 987703G Fax: 0473 236188

# Back To Reality Brüel & Kjær

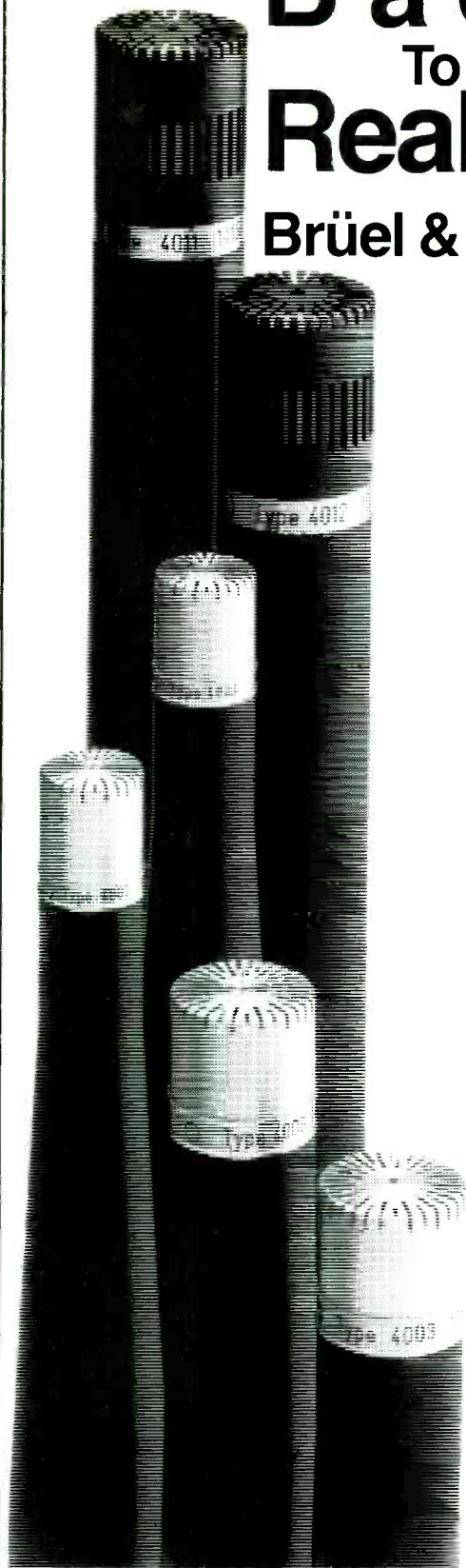

FOR DETAILED  
INFORMATION  
FILL COUPON &  
RETURN TO:

Brüel & Kjær  
Pro Audio (UK)  
Harrow Weald Lodge,  
92 Uxbridge Road,  
Harrow,  
MIDDX HA3 6BZ.  
Tel: 01-954 2366

Brüel & Kjær  
Pro Audio  
18 Nærum  
Hovedgaade,  
2850 Nærum,  
Denmark  
Tel: + 45 42 80 0500

## Series 4000 Microphones

Name \_\_\_\_\_

Address \_\_\_\_\_

\_\_\_\_\_

\_\_\_\_\_

\_\_\_\_\_

S/S



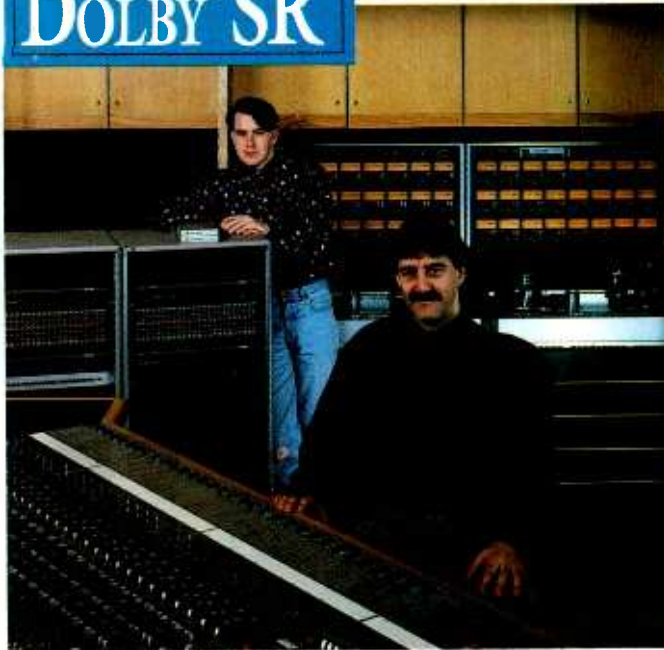

Nik Milner

## “Our clients insist on Dolby SR.”

“We provide our clients with the very best as a matter of course. That’s why we offer Dolby SR on our analogue tracks.

“I was startled by the absence of tape modulation noise. From the looks on their faces, so were my engineers!”

“Dolby SR allows analogue recording to compete with digital without a cost penalty.”

*Malcolm Atkin, Studio Manager*

“With Dolby SR, you hear what you should hear: good warm low end, no muddiness in the top end, and no noises. Analogue with Dolby SR is definitely my preferred mastering format.”

*Lance Phillips, Chief Engineer*

*Built by the legendary George Martin,  
most of the famous names in music  
have worked at AIR London*



Contact Dolby or your Dolby professional audio dealer for more information.

Dolby SR: over 50,000 channels worldwide

Dolby Laboratories, Inc. • 100 Potrero Avenue San Francisco CA 94103-4813 • Telephone 415-556-0200 • Telex 34409 • Facsimile 415-863-1373  
346 Clapham Road London SW9 9AP • Telephone 071-720-1111 • Telex 819109 • Facsimile 071-720-4118  
Dolby and the double-D symbol are trademarks of Dolby Laboratories Licensing Corporation © 1991 Dolby Laboratories S919190



SSL’s *ScreenSound* audio post-production system; the Roland *Sound Space* (RSS) system; the Yamaha *DMC1000* digital mixing console; the *DASS 100* from DAR; and various signal processing units from Eventide; Klark-Teknik; BSS; Drawmer; SSL; Yamaha; and Roland. ● **Hill Audio:** new products include the *Chameleon* studio monitor power amplifier which produces 2000 W in a 1 U size; exhibits include the *Concept 200* and *400* series modular mixing consoles; the *Datum* series of three modular consoles; the *Omnimix* rackmount mixing console; and *The Stagemix* rackmountable 12/6 stage monitor console. ● **Hilton Sound:** will have details of all their existing and new hire inventory; also details of the Elephant Suite and Hilton offices around Europe. ● **HW International:** showing products from Carver including the *PT-2400*, a 3 U touring amplifier, which can produce 1200 W/ch into 4 Ω or 2400 W bridged. Other UK debuts include the Shure *VP64* ENG microphone and the *FP410*; new products from British manufacturer 3G include a range of power amplifiers, effects units 8-, 12-, and 16-channel mixing consoles and a modular professional mixing system.

## K

● **Klark Teknik:** showing the recently released *DN735* Solid State Audio recorder with new software; also on show the Series *500* dynamic modules; the series *700* digital delay lines; the *DN780* digital reverb system; and *DN60* Real Time Spectrum Analyser. ● **KGM:** showing products from distributed ranges including Soundcraft, Otari and Akai Digital. ● **Klotz:** will be displaying examples of the full ranges of audio cables; pre-made leads and multicore systems; stagebox accessories; cable drums and accessories. ● **Korg:** at this year’s APRS Korg will launch *Soundlink*, a digital audio workstation demonstrated in its full capacity linked with video and MIDI equipment. It will offer 8-track recording direct to hard disk and includes automated mixing, EQ and digital effects. ● **KW Electronics:** will be showing further developments in the *Audio Stream* system designed to send digital audio through the new ISDN standard telephone. Also on show the *BC 1204* broadcast mixer.

## L

● **Lindos Electronics:** exhibiting the *LA100* audio analyser measuring system with the latest software. ● **LMC Audio Systems:** products distributed by LMC include, Crest Audio; the Nexys computer control system range; the EAW range for live sound applications; the Stage Radio in-ear monitoring system; and some of the latest Soundcraft products. ● **Lyrec:** new for the show is the timecode version of Lyrec’s compact studio recorder the *FRIDA*. Also on show is the *FRED* editing tape deck; the *P-4400* high speed tape transport; and the Tachos *90B* cassette loader.

## M

● **Marquee Audio:** will be showing the full range of Adams-Smith systems for audio editing, tape synchronisation and timecode processing. New features include Cross-Lock mixed-frame synchronising; Vari-Lock time compression/expansion; and MIDI event sequencing will be introduced for the Adams-





Adams-Smith 2600E A/V editor on Marquee Audio's stand

Smith System 2600E. Other products on show include JBL studio monitors; Yamaha and BSS signal processing equipment and Soundcraft and DDA mixing consoles. ● **MBI Broadcast:** the first UK showing of the new MBI Broadcast Systems Series 20 broadcast console. The series 20 is a new design and is available in frames of 8, 16, 24, 32, 40, 48 module widths. ● **Meridien Communications:** featuring products from Audio Animation; NTP; Pearl microphones; RTS intercom systems; and Telos digital telephone hybrids. ● **Michael Stevens & Partners:** displaying products from Bel Electronics; Chromatec; The Studio Box; KEF; Rogers; and

Nemesis. ● **Minim:** will be showing their range of presenter's clocks; Ambisonic decoders; and television sound tuners. ● **Mitsubishi Pro Audio:** showing two new products on show in the UK for the first time; the *PDX Eight Eighty Two* 64-track digital recording system; and the *PDX 8620* 2-track digital recorder. ● **Mosses & Mitchell:** range of audio and video jackfields. ● **MS Audio:** showing details of their range of used pro-audio equipment, including SSL and Neve consoles; digital multitracks and outboard equipment.

## N

● **Neal:** showing the full range of Neal cassette recorders including the 402 studio recorder available with XLR balanced inputs and outputs. ● **Neutrik:** will be exhibiting the full range of Neutrik XLR type connectors, including the new G series. Also the latest A1 Test and Service instrument; the TT402A Transmission Test Set and the Infomatic Digital Recording and



Neve 33609/C limiter/compressor

# PPM10: IN-VISION PPM

APRS  
STAND  
001

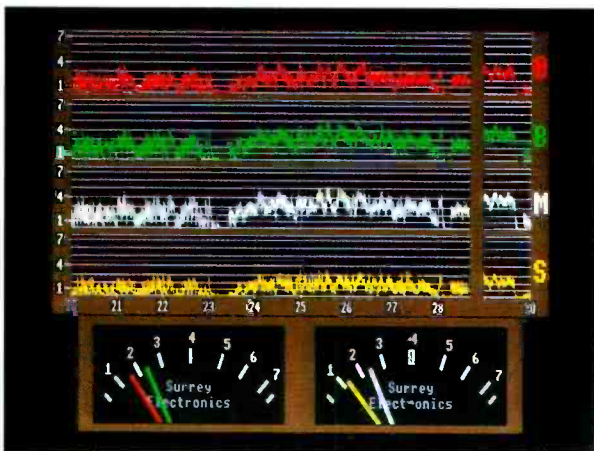

COLOUR VIDEO PRINTER

ALSO Stereo Variable Emphasis Limiter 3. \* 10 Outlet Distribution Amplifier 4 \* Stabilizers and Frequency Shifters for Howl Reduction \* Broadcast Monitor Receiver 150kHz-30MHz \* Advanced Active Aerial 4kHz-30MHz \* Stereo Disc Amplifier 3 and 5 \* Broadcast Stereo Coders \* Peak Deviation Meter \* Twin Twin PPM Rack \* Twin PPM Box \* BBC licenced PPM9, PPM7 and PPM5 20 pin DIL Hybrid \* PPM8 IEC/DIN - 50/+6dB scale.

**SURREY ELECTRONICS LTD.**

THE FORGE, LUCKS GREEN, CRANLEIGH,  
SURREY GU67BG TEL: 0483 275997 + FAX: 276477

- TWIN TWIN POINTER DISPLAYS
- CHARTS PROGRAMME LEVELS - A POWERFUL ANALYTICAL TOOL
- RGB OUTPUTS, OR SUPERIMPOSED ON PAL PICTURES

PPM10 takes stereo audio inputs and generates a high definition colour video display emulating the well known coaxial twin movements, long regarded as a most satisfactory way of monitoring stereo audio levels and mono compatibility. The eye can judge the level displayed, at a glance, from the angle of pointers, without needing to refer to scale markings.

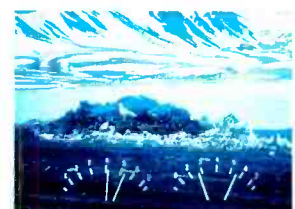

UNTOUCHED SCREEN PHOTOS

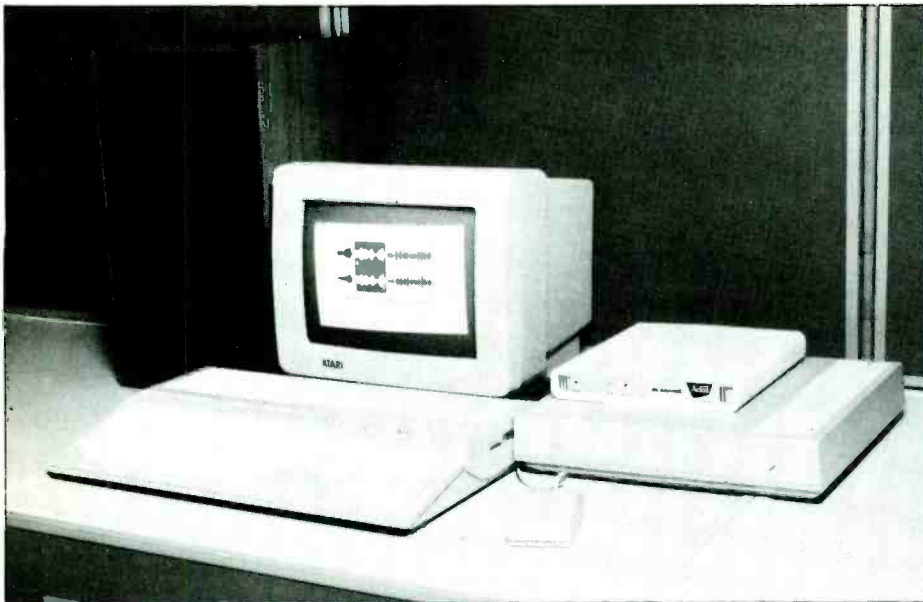

**Plasmec ADAS hard disk recording/editing system**

Announcing Systems. ● **Neve:** UK debuts of the 44 series broadcast console; *Flying Faders* retrofit system; *HRC-1* stereo high resolution A-D/D-A converter; V series module; 33609/C limiter/compressor; and the new EQ and Dynamics modules. ● **New England Digital:** new software and interface options for their *PostPro* and *PostPro SD* recorder/editors, including an enhanced version of *EditView*, a tape style software editing package that allows users to manipulate disk and *Synclavier* RAM samples simultaneously, while offering BVH/BVU and VPR-3 machine control for edit-to-picture applications. ● **Northwood O'Neill:** independent financial and insurance advice.

their new range of product built to Lab Standard and now available to the wider OEM market. ● **PRECO:** products from Sound Technology; Composite Video; CRL; Versadyne; Apollo Masters; Audiopak; Techniques Digitales; Weircliffe International; Pacific Recorders; Leever-Rich. ● **Pro-Bel:** will be showing the new HD series 64x64 AES/EBU serial digital audio routing switcher; also included the HD series 64x64 analogue routing switcher together with associated control systems. ● **Protape:** range of professional tape products. Also displaying BNS loudspeakers including the A4 and A3 active monitors.

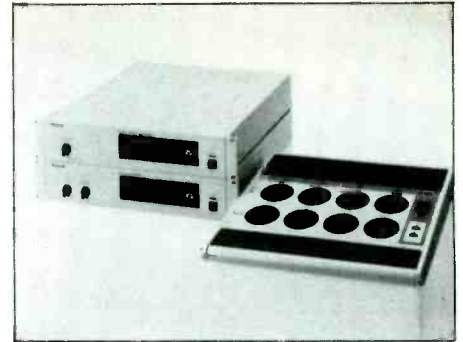

**Roland RSS system**

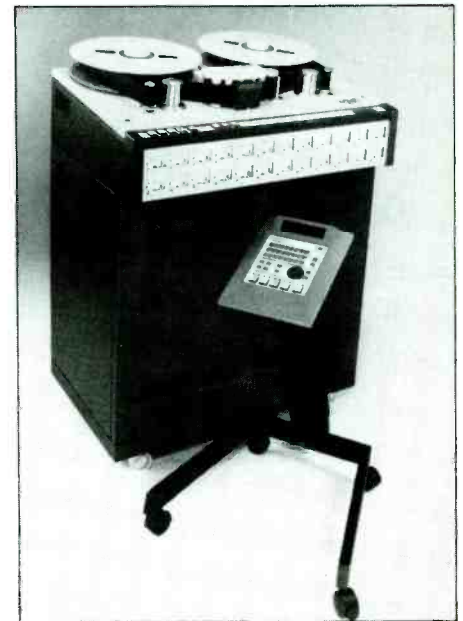

**Saturn 624 multitrack**

## O

● **Omniphonics Research:** showing their range of specialised audio amplification for studio and installation use. ● **Omitec Circuits:** range of motor and manual faders. ● **Otari:** new for the show is the *DTR-900II* 32-track PD digital recorder; also on show the series 54 studio recording console; *Premiere* film/video re-recording console; the Otari *T-320II* VHS video cassette loader; the *DDR-10* hard-disk based stereo recorder/editor and a new multi-track hard disk-based recorder editor resulting from the recent Otari acquisition of Digital Dynamics.

## P

● **Peavey:** showing their new *DPM-2* synthesiser and *DPM-SP* sample playback module. Peavey's AMR division will be demonstrating their full range of studio/MIDI environment products. ● **Penny & Giles:** range of studio faders and audio visual controllers. ● **Plasmec Systems:** will be introducing the 2 row in 1 U ¼ inch *Flexipatch* jackfield. The system exploits the latest PCB technology and has two rows of 24 jacks connected to four 56-way EDAC connectors mounted on a rear chassis with both insulated and chassis earth studs. Also recent developments to the ADAS range of low cost hard disk recording and editing systems. ● **Prism Sound:** displaying the *HDE 1000* disk recorder and *DEQ 2400* digital equaliser. ● **Precision Devices:** will be exhibiting a selection of loudspeakers from



**Quad 240 power amplifier**

## Q

● **Quad:** will be showing their new amplifier the *Quad 240*. The standard version produces 80 W/ch. Quad will also show examples from the 520 and 510 series units and the *ESL63-Pro* monitor loudspeaker. ● **Quested:** two new products for the show are the *HQ 410* large passive system and the *H 208* passive monitor designed for use in Broadcast pre- and post-production.

## R

● **Raindirk:** exhibiting the latest version of their *Symphony* in-line recording console. ● **Raper & Wayman:** will be demonstrating the new Monitor Technology, *Monitor One* Reference loudspeakers from Denmark. Also on show the *Summertone Timecode Monitor*, a device for ensuring that timecoded tapes, generators, are free from errors. ● **Roland:** will be showing and demonstrating the *DM-80* hard disk recorder; the *RSS Roland Sound Space System*; *SN-550* Noise Reduction System; *S-750* Digital Sampler and *SBX-1000*

MIDI Cueing Box. ● **RPG Europe:** making their debut at APRS RPG Europe will be exhibiting a wide range of new products, including the *VAMPS* portable performance shell system, the *Diffractal*, and *QRD* diffusors made from Kydex, a new thermo-plastic formulation.

## S

● **Saturn Research:** showing their 824 and 624 2 inch multitrack recorders. ● **Sellmark:** showing their full range of linear and rotary carbon potentiometers, including the company's latest 11 mm and 14 mm sealed rotaries, of which eight styles are now available. ● **Sennheiser:** range of microphones, headphones and accessories. Including the new *MD 422* dynamic microphone with applications on-the-road as well as in the studio; the *MKE 300* video microphone; the *BF 530* personal microphone with super cardioid polar pattern; and the new *HD 490* headphones. ● **Shep Associates:** with details of customised Neve consoles. ● **Shuttlesound:** showing products from Electro-Voice including the *S-40* compact monitor loudspeaker system; Rane; Amcron including the *Geodyne 1* power amplifier; Samson; Greystone; and Soundtracs including the new *Megas* range of consoles. ● **Sifam:** will be showing their new illuminated panel meters, soft touch push-on knobs and illuminated push buttons. ● **Solid State Logic:** showing *Ultimation* the new moving fader system from SSL on a *SL 4000 G* Series desk. Also *SoundNet* a digital audio network for *ScreenSound*. Established products include the *SL 4000 G* series Master



HE SAID,



*“You can write almost anything you want about this machine and put my name under it.”* SO WE DID.

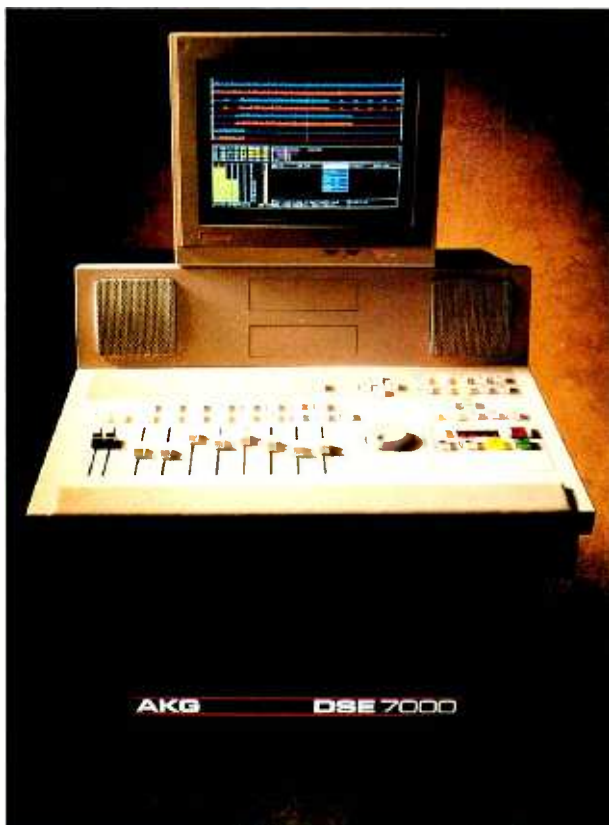

THE DIGITAL SOUND EDITOR. STATIONS FROM BOSTON TO SAN DIEGO ARE MAKING IT THE HOTTEST BOX IN RADIO.

Dan McCoy was the first production director in radio to use the DSE 7000, and he saw it revolutionize the way production is done at



WZOU-FM, one of the top stations in Boston. A spot that used to take an hour to produce now takes 20 minutes. Without tape.

Without razors. Without a single dB of generation loss. Even agency dubs now go right to the

DSE for levels, sound enhancement 

and tags; then onto carts. Creativity has exploded, too. With the DSE's instant UNDO feature, the fear of trying new things is gone. You simply try another take, assemble a different edit, or test a new effect. If you don't like the results, UNDO it instantly. No wonder WZOU has

designed their production facility around the DSE. 

And no wonder Dan McCoy calls this machine “the most impressive thing that's ever happened to radio.” His words, not ours.



DSE 7000 • THE NEW SPEED OF SOUND <sup>TM</sup>



AKG AKUSTISCHE U. KINO-GERÄTE GESELLSCHAFT M.B.H.  
Brunhildengasse 1, P.O.B. 584, A-1150 Vienna/AUSTRIA  
Tel.: (1) 95 65 17-0\*, Telex 131839 akgac a, Fax: (1) 95 65 17-245

AKG ACOUSTICS, LTD.,  
Vienna Court, Lammas Road, Godalming, Surrey GU7 1JG/GREAT BRITAIN  
Tel.: (483)425702., Fax: (483)428967, Telex: 859013 akgmic g

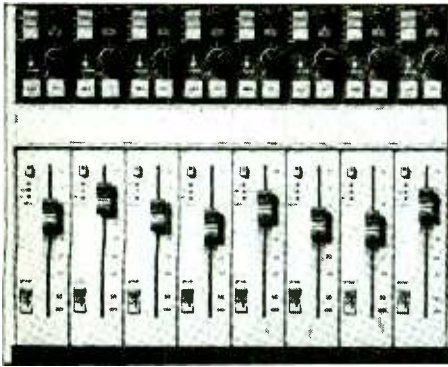

SSL's Ultimition faders

Studio System and *ScreenSound* digital audio editing, mixing and recording system. ● **Sonifex:** are showing *Discart*, a new digital audio storage system for radio broadcasting. The system uses 3.5 inch disks and operates manually or through a PC. ● **Sony:** featuring the *PCM-3348* DASH multitrack recorder which has gained on-board timecode synchronisation and improved sampling memory and now has reverse playback mode plus a looping facility for trimming edit points; the *TCD-D10 Pro II* is an enhanced version of the *TCD-D10 Pro* portable DAT player; APRS debuts from the *PCM-2700* and *PCM-2300* DAT recorders and the *CDP-2700* CD player. Also on show the *DAD-A2000* A/D and D/A converter; the *DPS-D7* digital delay and the *DPS-R7* digital reverb. ● **Soundcraft Electronics:** will be showing a new live SR console called *Europa*, a dedicated Front-of-House console. *Europa* will be available in three frame sizes—24, 32- and 40-input—with 8 group/stereo modules fitted as standard. Also new to the UK will be the *Sapphyre* in-line recording console, designed for professional home recording and post-production applications. Also new will be the *Spirit* range of consoles including dedicated *Live* and *Studio* models. Established products include the *3200* multitrack recording console. ● **Sound Technology:** wide range of products from Alesis; Aphex; C-Lab; Digidesign; JL Cooper and Symetrix. ● **Soundtracs:** showing the new *Megas* console range including the *Megas Stage*; *Studio*; and *Mix* models. Also being shown will be the *Eric* production console; the *Quartz* production console; and the *Sequel* sound reinforcement console. ● **Stirling Audio Systems:** exhibit includes the introduction to the UK of the new *Euphonix* Crescendo digitally controlled production console; Dynaudio Acoustic's new *PPM1* monitor; *DAWN*, a *Macintosh*-based multi-channel hard disk system at a budget price; *AudioFrame* and *CyberFrame* from WaveFrame, two digital



Soundtracs Megas range

audio production systems for post-production and film sound; the full range of Soundcraft products; DDA desks and Otari tape recorders. ● **Studio Magnetic:** featuring the *AR2400* 24-track 2 inch analogue multitrack recorder. Also featured the *Seca* range of sound reinforcement products. ● **Studiospares:** their exhibit is based on the new 72-page catalogue which illustrates, describes and prices over 1000 items of recording studio accessories and equipment. ● **Surrey Electronics:** including the *In-Vision* PPM; the stereo variable emphasis limiter 3; twin PPM and PPM9; PPM7 and a stereo and ambisonics decoder. ● **Symetrix:** showing a new product to APRS the *DPR-44* recording/editing station which includes a unique full colour 'object oriented editing projection' and custom-designed graphics tablet control. Also new is the *564E* Quad expander/gate.

## T

● **Tam Studio:** details of their mastering and post-production facilities. ● **Tannoy:** is exhibiting the new range of studio monitors featuring the use of Differential Material Technology (DMT) in every aspect of the monitor design. The series ranges from the *System 215 DMT* through to the small *System 2 NFM*. ● **Tape Automation:** range of automatic tape loaders. ● **Tape One Studios:** details of digital post-production facility and their recordable CD service and CEDAR system. ● **TEAC:** featuring the *M-3700* integrated automated console with VCA fader automation and automated switching of channel mutes, aux mutes and EQ in/out in either realtime or snapshot modes. Also on show will be the 24-track 1 inch and 16-track ½ inch *MSR-24* and *MSR-16*; and the *DA-800* 24-track DASH format recorder. ● **Thatched Cottage Audio:** showing products

from Allen & Heath including the *Spectrum* multitrack console. Also many other products from their distributed ranges. ● **3M:** UK launch of a new audio tape called *3M 996*, designed to provide exponents of analogue recording with a viable alternative to digital tape. ● **TOA:** launching the *IX-9000* digital mixing system which incorporates a 64/48 matrix unit featuring a 256-channel fully digital input/output patch system. Also being shown is *SAORI*, an integrated digital sound processor which now incorporates two new DCD modules with built-in horn equalisation and up to 1.3 s DDL. ● **Tony Larking:** featuring AJ Studio Furniture range of studio racks; PODS; workstations and studio chairs. The *VTL CR-3A* new large capsule condenser microphone. ● **Transco:** details of mastering service. ● **Trident:** will be featuring the *Vector 432* console complete with Trident machine control system and moving faders. Trident will debut enhancements to the *Vector* automation system plus two new modules, a stereo input, complete with stereo mic-amp and an FX return module. ● **TSC:** products from Diki-Devices; Zoom; Opcode; SoundTracs; and Studio Electronics. ● **Turbosound:** first UK showing of two new active Wedge monitors, the *TFM 250* and *350*. Also on display will be the *Flashlight* system, a fully integrated sound reinforcement system comprising loudspeakers and all drive and control components necessary in a compact and manageable form.



Turbosound's TFM 250/350

## Y-Z

● **Yamaha-Kemble:** will be showing the new *YPDR-601* professional disc recorder and its remote controller, the *RC601*. The *YPDR601*'s use of Yamaha's recordable CDs allows 63 or 74 minutes of audio recording time dependent on CD blank length selected; the *DMR8* digital mixer/recorder, an integrated digital recording system offering a 28/32-bit 24-channel digital mixer with total automation; *DMC1000* digital mixing console, which offers a total of 22 inputs; *S1520S* speaker system. ● **Zonal:** showing their full range of magnetic tape products. □

## Standards Are Wonderful... Aren't They?

Standards are wonderful — that's why we have so many of them. The proliferation of different formats in digital audio inevitably leads to problems in transferring audio within the digital domain. And solutions don't come easy... except when they come in the form of Audio Digital Technology's multi-purpose



FC1 digital audio problem solver.

The cost-effective FC1 features two independent stereo signal paths for processing digital audio data, and basic functions include format conversion (AES/EBU, SPDIF, SDIF-2), the stripping of emphasis, phase inversion, coincident time correction and channel reverse. Real time digital mixing and channel crossfading are also possible with the optional remote control. So, if you're serious about digital audio and care about quality, contact ADT now.

- Two independent stereo signal paths
- 24-bit internal architecture
- AES/EBU, SPDIF and SDIF-2 in and out
- The stripping of emphasis and associated flags
- Truncation and digital dither
- Coincident time correction (CTC)
- Manual override of status bits on output
- Digital mixing and crossfading
- Internal 1kHz oscillator
- Channel reverse
- 1Hz, 20Hz and 100Hz high-pass filters
- Phase inversion
- Real-time fader control

**adt AUDIO-DIGITAL-TECHNOLOGY**

The Coach House, Manor Road, Teddington TW11 8BG.  
Telephone 081-977 4546. Facsimile 081-943 1545.



# FUTURE PERFECT

# YAMAHA

DIGITAL SYSTEMS



Few things are certain in the future of an audio production facility. But it does seem likely that the successful ones will be those equipped to serve a broad range of clients – from film and television to the record industry – and certain that they'll be working largely in the digital domain.

With this vision in mind, Yamaha has developed a new, all digital 8:8:2 console, the DMC1000.

With 28 bit mixing and effects, and 32 bit Eq, its sound quality is sensational. Extensive automation includes control of all conventional mix parameters and, being software reconfigurable, the DMC1000 will adapt quickly to a wide range of applications.

All the major digital formats are handled on-board and analogue auxiliary returns, MIDI, Wordclock and timecode sockets complete an extensive range of interfacing options. In addition, a cascading facility enables expansion using multiple DMC1000s.

And this console of tomorrow, once configured, will be extremely familiar to the engineer of today.

Are we right in our vision of the future? You can find out right now. Call Yamaha Digital Systems to arrange a demo.

# YAMAHA

DIGITAL SYSTEMS

0908 366700

Yamaha-Kemble Music (U.K.) Limited  
Professional Music Division



A black and white advertisement for the D&R Avalon Studiosystem. The background is a vast, scenic view of the Grand Canyon under a blue sky with scattered clouds. In the foreground, a large, professional studio mixer is perched on a rocky ledge, overlooking the canyon. The mixer is a large console with numerous sliders and knobs, and it is angled towards the viewer. The text is centered over the canyon scene.

The Avalon Studiosystem.  
Some things are just beyond compare.

D&R. Every sound under control.

The logo for D&R, consisting of the letters 'D' and 'R' in a stylized, bold font, with an ampersand between them.

D&R: Headoffice, D&R Electronica b.v., Rijnkade 15b, 1382 GS Weesp, The Netherlands, Phone (..) 31 2940 18014, Fax (..) 31 2940 16987.  
U.S.A. Office, D&R USA, Rt. 3 Box 184-A, Montgomery TX 77356, USA, Phone (409) 588 - 3411, Fax (409) 588 - 3299

[www.americanradiohistory.com](http://www.americanradiohistory.com)





Where the organ used to be in the big hall

# AIR MOVEMENTS 2

The continuing story of the construction of the new AIR Studios. David Mellor follows recent developments as work begins

At the end of my first visit to the proposed site of the new AIR Studios at Lyndhurst Hall in Hampstead, North London (*Studio Sound* December 1990) I left a company which was still in search of funds for what is, in recording studio terms, a venture of massive proportions. At that time the only work being done was to maintain and improve the condition of the existing building. But AIR Studios have an enviable reputation and the name of George Martin counts for a lot so it was only a matter of time before the right business partner came along and work could proceed in earnest. John Burgess, one of the original founders of AIR, explains how a Japanese connection came into being:

"Whilst thinking of potential partners, George (Martin) remembered his old friend Kazunaga Nitta, former managing director of EMI Records Japan and now running a very successful record label, Funhouse, in Tokyo. Kazunaga introduced Pioneer—a major Japanese manufacturer of audio and video equipment—to the project and the president, Seiya Matsumoto, and his colleagues visited the site, were tremendously impressed

with the potential and agreed immediately to become partners with AIR and George Martin.

"The possibilities offered by Lyndhurst fit in well with Pioneer's new laser disc factory in Wakefield and it makes great sense for them in their ambition to broaden their scope to cover the European leisure industry."

## Macademy

To handle the building work at Lyndhurst, AIR haven't gone for one of the existing companies working in the field but have decided to go it alone. At some levels of the studio industry this might be rightly seen as a recipe for disaster, but they have the experience and in fact, have set up a company to design studios called Macademy Ltd. Dave Harries explains:

"Macademy is a little company based around Angus McPherson, who did all the design work, apart from the acoustics, and masterminded the building work of Studios One and Two at Oxford Circus (AIR's current premises) when we redid them in about 1980. He then went to Australia

but we persuaded him to return for this project. The purpose of Macademy is to build studios and loudspeakers, in this case for Lyndhurst Hall. But while we have been biding our time, waiting for the finances to be arranged, Macademy has done work for other people. Macademy will finish the design of Lyndhurst and do all the design and production of the interiors rather than the expensive alternative of going out to tender to fit all the studios and control rooms.

"The acoustic consultancy work is being done by Richard Galbraith and Ian Knowles of Sandy Brown Associates. Based on that, and on what Angus is drawing up now, we'll do all the interiors starting with the main hall. That has to be the first one because all the other rooms depend on structural work in the main part of the building, whereas the main hall only depends on moving a few things about and digging out the footings, and then it can be got underway. We'll soon be able to start building something instead of knocking it down."

## Progress so far

At the moment, Lyndhurst Hall looks in a pretty sorry state, with gaping empty spaces where there used to be elegant wood panelled rooms (which Lyndhurst Hall's original owners, the United Reform Church, used as their missionary training school). But you have to plough the field before you can sow the seed—reaping the harvest is a long way off yet.

"The situation at the moment is that we have done all the major demolition in the centre part of the building, the floors and some of the internal walls; we have demolished the organ and parts of the main hall to renovate dry rot damage; we have cleared the areas underneath the two side seating galleries to make way for the construction of the booths. We are now ready to start the construction of the studio and control room in the main hall. It isn't going to be drawn up and sent out to tender as one big job because we are actually project managing the work as well. We do have a main contractor but they are only on site for their parts of the project. So far we have had demolition work and renovation work to the timber, these were drawn up and sent out to tender separately."

An important part of the project is the basement, which will support and provide acoustic isolation for three studios. Basements may often be seen as damp empty spaces of no particular interest, but this is one element that has to be right for the rest of the project to succeed.

"We designed the basement with the structural engineers, the quantity surveyor and the architect, Bernard Parker of Heber-Percy & Parker. They did the specifications and we are now in the middle of making it larger so that we can accommodate all of the plant, the air conditioning and the electrical intake room, and also that it acts as a structural slab or raft for the main centre part of the building which will take all the weight of the three control rooms. The problem with it is that it's not like we are constructing the building in the middle of a field. It would be easier if we could just bring in a load of JCBs and some lorries, dig it out and chuck in the concrete. But unfortunately we have the constraints of the existing building. The walls surrounding the basement area are all structural so they can't be removed, so the basement is going to have to be dug out by hand—or rather with spades—and then all the concrete poured in small areas at a time. It has turned out to be



# SCHOEPS

Colette series with interchangeable capsules for a variety of applications

unequalled for expertise  
in design and  
engineering

with a  
constantly  
expanding  
range of products



**SCHOEPS**  
STUDIO  
CONDENSER  
MICROPHONES



**BLM 3**  
professional  
boundary layer



**BLM 03 C**  
professional  
boundary layer



**MK 2 S**  
special omni



**MK 21**  
wide  
cardioid

## CONTACT

**AUS** dB audio  
Junction Terrace,  
16 Princess St.  
Kew, Victoria, Australia, 3101  
Tel.: (03) 862 1070

**A** Studer Revox Wien  
Ges. m. B. H., Ludwiggasse 4,  
1180 Wien, Tel.: (02 23) 4733 09

**B** Heynen Audio V deo N.V.,  
De Koelen 8, 3530 Houthalen,  
Tel.: 011-52 57 57

**CDN** Elnova Ltd.,  
325, Rue Clément Ouzet,  
Lasalle, Québec H8R 4B4,  
Tel.: (001) 514-364 2118

**DK** PSS, Gørttervej 4,  
2400 København NV,  
Tel.: 01-35 82 15 82

**SF** Lounamas Electronics Oy,  
Hollantilaisentie 32,  
00331 Helsinki,  
Tel.: 90-35 80 48 81 33

**F** Eino S. A., 16-20, rue du  
Val Notre Dame, 95100 Argen-  
teuil, Tel.: (1) 39.98.44.44

**HK** Audio Consultants Co., Ltd.,  
21/F, 8 Luk Hop Str., Sze Po Kong  
Kowloon, Hong Kong,  
Tel.: 852-3 51 36 28

**I** TDS - Tecniche del Suono  
S.r.l., Via Del Cignolo 9,  
20151 Milano, Tel.: 33.49.03.50

**IL** Kohner Ltd, 18 Ha'arba's  
Street, Tel-Aviv, Tel.: 03-5 81 01 62-4

**J** Inai & Company Ltd.,  
1-6 Tomihasecho, Shinjuku Tokyo,  
Tel.: (03) 357-0401

**NL** Heynen B. V.,  
P.O. Box 10, 6590 AA Gennep,  
Tel.: 08851-96111

**N** Siv. Ing. Banum A/S,  
Boks 145 Vinderen, 0319 Oslo 3,  
Tel.: 472-14 54 60

**P** G.E.R. Lda Av. Estados  
Unidos de America, 51-5º, Oito,  
1700 Lisboa, Tel.: (01) 80 46 77

**E** Singleton Productions,  
Via Augusta, 58, Desp. 804  
Edif. Mercurio,  
08006 Barcelona, Tel.: 2 37 70 60

**S** Sateb Akustik AB,  
P.O. Box 5016, 55006 Jönköping,  
Tel.: 036-14 24 80

**CH** Tecnod SA  
Au Glajin  
1162 St-Prex,  
Tel.: (021) 8 06 06 08

**GB** SoniC Sounds Equipment  
Marketing Ltd., 10 William Rd,  
London NW1 3 EN,  
Tel.: 071-3 67 12 62

**USA** Posthorn Recordings,  
142 West 28th Street, 10th Floor,  
New York City, N.Y. 10001,  
Tel.: (212) 242-3737

Schalltechnik Dr. Ing. Schoeps GmbH P.O. B. 41 09 70 · Fax: (07 21) 49 57 50  
7500 Karlsruhe · TX. 7826 902 · Tel.: (07 21) 9 43 20-0

very expensive.

"Once that's done then we put in the steelwork above. The steelwork literally sits on the basement and comes up in the centre section of the building to support new concrete boxes, which are on rubber pads. We'll end up with a big basement in solid concrete, all the steelwork then three concrete slabs and three boxes which we can start fitting out. While this is going in we have to leave all the voids and all the cutouts for air conditioning and electrical access. In parallel to that we have to put in the lift mechanism as well, part of the basement will be the lift motor room.

"To try and save money we were looking at two types of basement. You can get the fully tanked variety which is pretty dry, or there is what they call the 'utility' basement which doesn't have a damp proof membrane. Although concrete is fairly solid it will let in a certain amount of underground water and you have to have what's known as an egg crate floor, which gathers the water underneath and drains it away through a sump pump. We went to have a look at one of these utility basements and although it's amazingly dry considering, I feel that for the extra little bit of money it's worth having one that's fully tanked and properly dry.

"Although we're a long way up the side of a hill, there's a lot more hill above us and there's probably quite a bit of water pressure here. Hampstead is a sort of loam cap sitting on the clay, and as you get further away from the top of Hampstead the loam comes nearer the clay so the water table gets higher. We're fairly near the edge of it so we guess that quite a bit of water will fill up, but we won't know until we excavate what kind of pressure is actually there. We attend meetings where the consultants and everyone argue. One wants 6 inch concrete, another says you can't have that because there's no room for the air ducts, then Malcolm (Atkin) comes along and says he wants his machine room 2 feet wider, George Martin says he wants the control room 2 feet wider because it's not as wide as AIR's Number One. So all of these have to be accommodated so that we get the maximum out of the building, and also so it's all designed so that we don't get any problems in the future. We have to ensure that everything's going to be as perfect as possible to start with. We can't run any risks on things like acoustics and air conditioning because we all know what happens if you do. It's too big a project for that. It's all a compromise, everyone has to compromise a certain way, but we'll get what we all want in the end I hope."

## Restoration

Since Lyndhurst Hall ceased to be a church it had been allowed to fall into a state of some disrepair. Because it is a Grade II listed building, interested parties such as English Heritage had to cope with the dilemma of watching it fall to pieces or be taken over and be rebuilt as a recording studio. But AIR's aims are very much in accord with preservationists in one respect, both parties want to see Lyndhurst Hall as an impressive, elegant building and kept in a well-maintained condition. There is a lot of detailed work involved, which most recording studio owners would never have to consider, starting with the guttering.

"Because a lot of the gutters were in poor shape they have been replaced by aluminium gutters to a slightly larger pattern than that which was designed by Alfred Waterhouse (the original architect) in the 1890s. The gutters, in the opinion of our gutter experts, are not big enough



for this building and never have been. So over the years they have blocked or rotted away and that means that water has run down the sides of the building and run onto the little flat roofs and in places worn the lead away completely. Where it runs down the walls it eats away the mortar, the bricks crack when water in them freezes, and then water gets into the structure of the building. You get a general decay of the building fabric. The roof has now been restored and all the tiles and gutters replaced. Lower down the building there are decorative bricks which are very soft and have weathered badly. All of these will be replaced eventually. Some of them, especially around the windows, have had to be hand fired for us because they are an odd shape. We want the building to look immaculate when we open, if we can.

“The organ has been removed because it was beyond restoring in the way that we need it. It would have cost £200,000 because it had been vandalised and parts of it stolen. It wouldn't have been any use to us anyway because it's a church organ which apparently isn't the kind of organ you need for recording; it has to be an accompanying organ or a solo type organ. It would have had to be modified and unfortunately we didn't have the funds for that. It has all been removed and the area will be used to accommodate a large duct which will go up to the roof and feed all the control rooms with fresh air. The front part of the organ will be replaced and all the lovely timber work, ironwork and pipes will be restored, so it will look exactly as it did but unfortunately it won't work.

“The pews in all the galleries will be replaced and restored. We are going to use all the pine panelling out of the upstairs rooms in the main hall as a wall covering. The stained glass windows I assume we will restore one day but not yet. Some of these are in a pretty bad state but a

lot will be double glazed inside and out so they'll be trapped within two sheets of glass and be protected from the elements. The plaster ceiling has been removed because of the dry rot and so we can add extra acoustic mass to both the outer and inner skins of the roof to ensure we have good acoustic isolation. The floors will all be relaid. All the floor blocks, the majority of which are 3 inch-thick pine, will be relaid as the main hall floor.”

## Contractors

Since AIR are doing the work themselves, rather than employing one contractor who will then subcontract, they have to deal with the selection of contractors for all the individual parts of the process of rebuilding Lyndhurst Hall. The current contract is for the erection of steelwork above the concrete basement. The selection procedure goes like this:

“As soon as the design is finalised by the structural engineers and the architects, then it's drawn up together with an outline specification. That then is put into a full specification drawn up by the quantity surveyor who has a rough idea of what it should cost. Then we go out to four or five companies that we know are good and are the sort of size companies that could do our job efficiently and cheaply—or shall we say competitively, then basically we take the cheapest one that comes in assuming that they can do the job properly and within the time span. You have to remember that there can't be any hold ups, we have a programme to meet, so everything has to meet the programme dates in terms of completion because the whole thing can snowball and the final job gets delayed. Any delay in the centre section of the building—whether it's deciding a budget, problems with design, deliveries or water

seepage—puts the whole job back and sets back the opening date. Every day that we delay now is another day that we don't open. So as well as the price the contractor quotes, they also have to say how long it's going to take them to do it, and we hold them to that because we can't afford not to. Provided that they come in with the lowest price and the right time schedule, then on top of that we also try to negotiate the price down a bit further if we can, and then they start.”

## The disappearing fireplace

Every large scale project has its share of interesting stories. Lyndhurst Hall's story involves the disappearance and later reappearance of an antique fireplace.

“We had a break-in on New Year's weekend 1990 and they stole a very valuable fireplace. It's quite a common occurrence in London apparently. We got the police in but nothing was really done so we put in an insurance claim. The problem was that we didn't know how much it was worth, but fortunately Malcolm had taken some photographs when we first came to look round, including a good one of the fireplace. I took a copy to a woodcarver and asked him how much it would cost to replace it, he said around £8,000. The upper part of it, the overmantle, was apparently made in around 1730. We had a rough price to go by and I went to several antique shops to get an idea of how much it was worth claiming off the insurance. At one of the places I went to, they recognised the fireplace as being one they delivered to Lyndhurst from a house in Windsor about 10 years ago, so we knew it wasn't original to the building. I left copies of the photograph with the shops and the police. Anyway, quite a while later I had an anonymous phone call saying that this fireplace was for sale in a shop in East Finchley. So I went up there with a couple of police officers from West Hampstead police station and we interviewed the guy in the shop and asked him where the fireplace came from. He said that it came from a house in Rottmgdean and it was for sale for £3,400, whereupon the police stepped in and took over—it was quite good fun really.

“It was obviously our fireplace from the photograph, it was absolutely unique. But since the shop owner hadn't pinched it himself we couldn't get it back. The insurance company said that since the fireplace hadn't been damaged or destroyed, and that it couldn't be lost since we knew where it was, that they weren't going to pay for it. We went mad and they have now agreed that we can go to the shop owner and buy it back for the price they paid for it and the insurance company will give us our money back. For the time it's taken us, I wish we had never found it, but we do know we are going to put it back in the building.”

There have, of course, been other problems, such as a tiny part of the building, around 1m<sup>2</sup>, being on consecrated ground, which apparently causes legal problems, and there will inevitably be many more before the studios open. As Dave Harries says, this is the worst point, but when the concrete starts pouring into the basement then the building will start to come together. Next time we take a look at Lyndhurst Hall there will be people banging nails into walls and actually constructing something rather than tearing it down and the new AIR Studios should be rising magnificently from the rubble.□

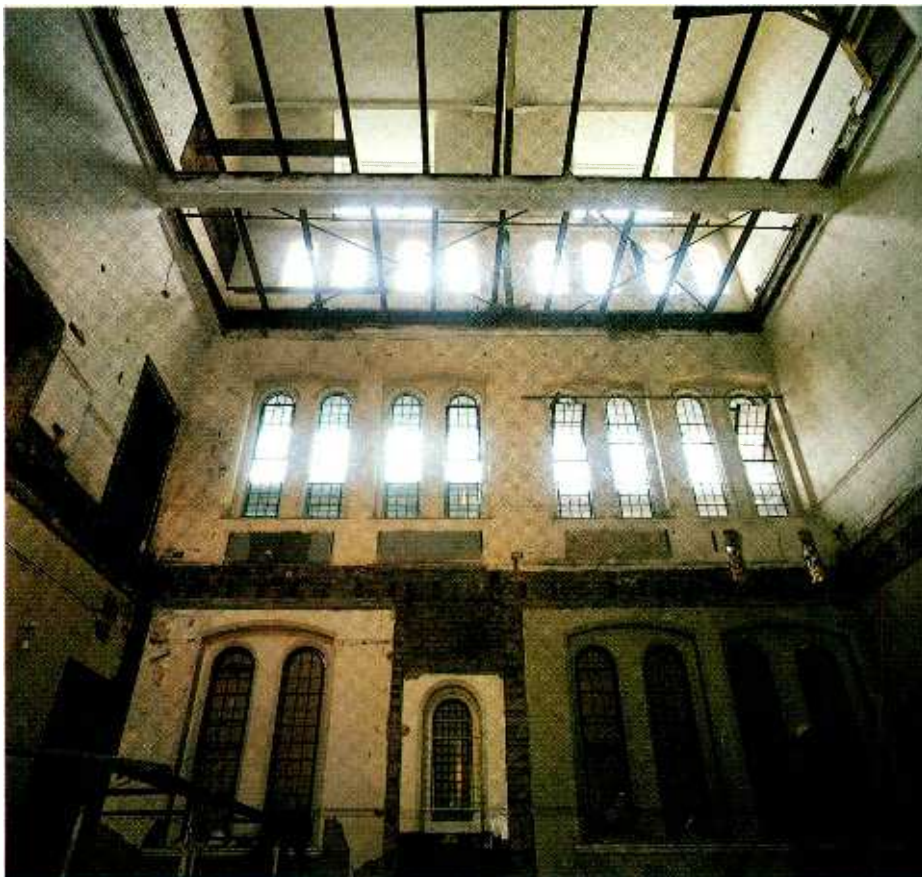

This will be the rear hall control room with two mix rooms above it

# THE COVER VERSIONS





# THE ORIGINAL

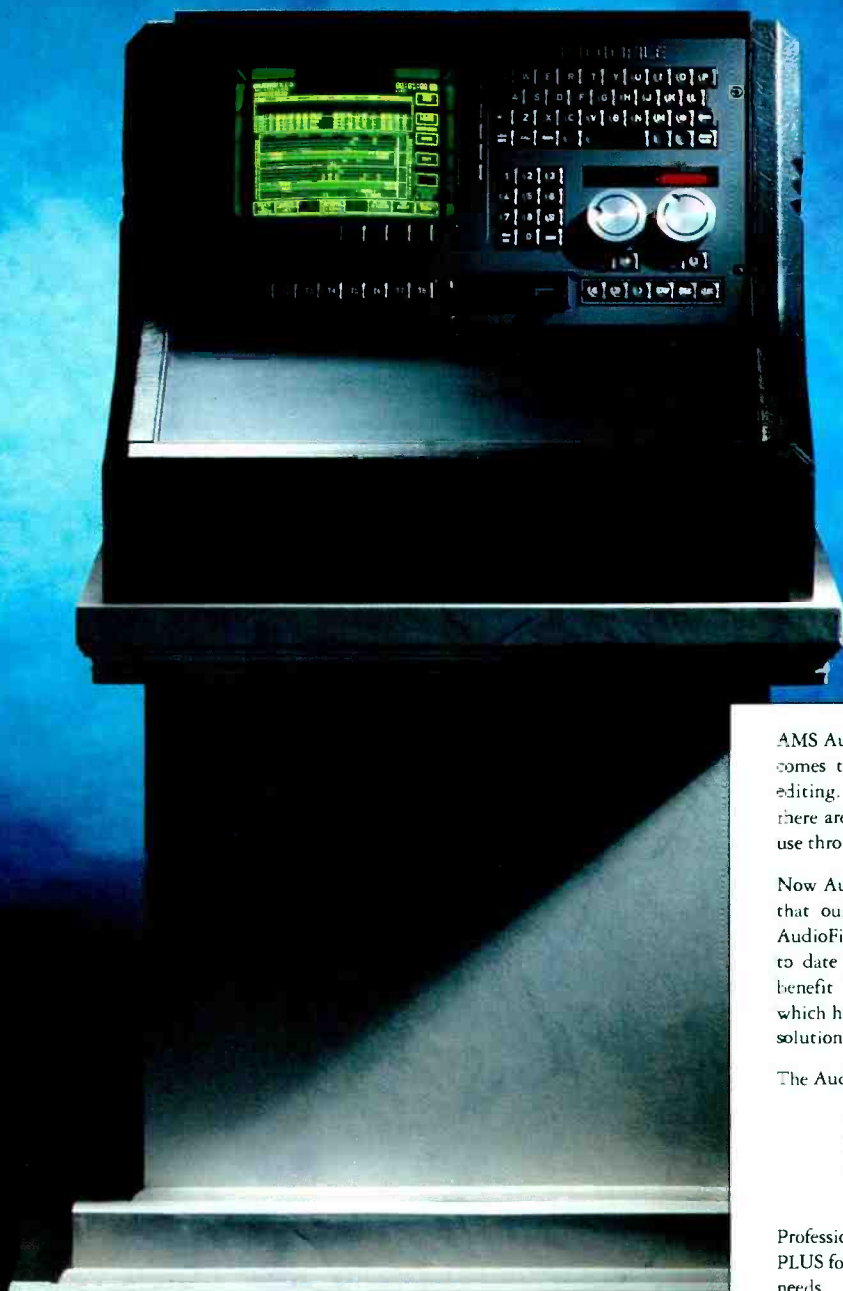

AMS AudioFile PLUS is the all time number one when it comes to hard disc based, digital audio recording and editing. Naturally there have been cover versions but there are still many more AudioFile units in commercial use throughout the World than any other.

Now AudioFile PLUS gives users an expanded capability that our imitators will find hard to match. Existing AudioFile users already know that AMS keeps them up to date with advancing technology. All our customers benefit from our "user feedback development policy" which has ensured that AudioFile remains a cost effective solution to audio production problems.

The AudioFile PLUS 16 now includes these new features.

- 16 Outputs
- New 16 track Event List, large display
- 8 or 16 track Cut and Splice display with simultaneous Events List

Professionals Worldwide continue to choose the AudioFile PLUS for its proven ability to meet their audio production needs.

*The AMS AudioFile PLUS - Has the Competition Covered.*

For more details on The Original complete the coupon below and we'll send you further information.

**ams**  
A Siemens Company

AMS Industries plc, Billington Rd, Burnley, Lancs BB11 5ES, UK.  
Tel Int. +44 282 57011. Fax Int. +44 282 39542.

AMS Industries Inc., 7 Parklawn Drive, Bethel, CT 06801, USA.  
Tel Int. +1 203 792 4997. Fax Int. +1 203 730 8549.

Name \_\_\_\_\_  
Position \_\_\_\_\_  
Company \_\_\_\_\_  
Address \_\_\_\_\_  
Tel: \_\_\_\_\_

SS/6/91





# Megas Studio Console

Utilising technology developed for the Quartz and IL mastering consoles Soundtracs have now developed a console that can reach a wider sector of the recording market.

The audio performance of the Megas Studio Console makes it a perfect match for 2" professional analogue and digital machines while the affordability brings it into the budget 16 & 24 track range.

Available in 5 frame sizes the Megas Studio Console can be supplied with a patchbay and 16 or 24 metered sub groups. Console sizes range from 20 into 16 to 40 into 24 with Patchbay.

#### Primary features:

- Split type console
- Programmable MIDI muting on Channels, Monitors & Aux masters
- 99 MIDI patches with external mode
- 2 Stereo speaker outputs
- 2 Stereo master machine returns

#### Channel Module

- 4 band EQ, with 2 sweepable mid ranges
- 6 Aux sends - aux 6 switchable to variable channel direct output
- 24 Bus routing
- In Place Solo & pfl with adjustable master
- Programmable MIDI muting
- Stereo channel option

#### Group/Monitor module

- 2 band EQ
- 4 Aux busses
- Sub Groups routable to remix bus
- In Place Solo & pfl with adjustable master
- Programmable MIDI muting



# ULTIMATION

Patrick Stapley takes a look at SSL's recently introduced moving fader automation system

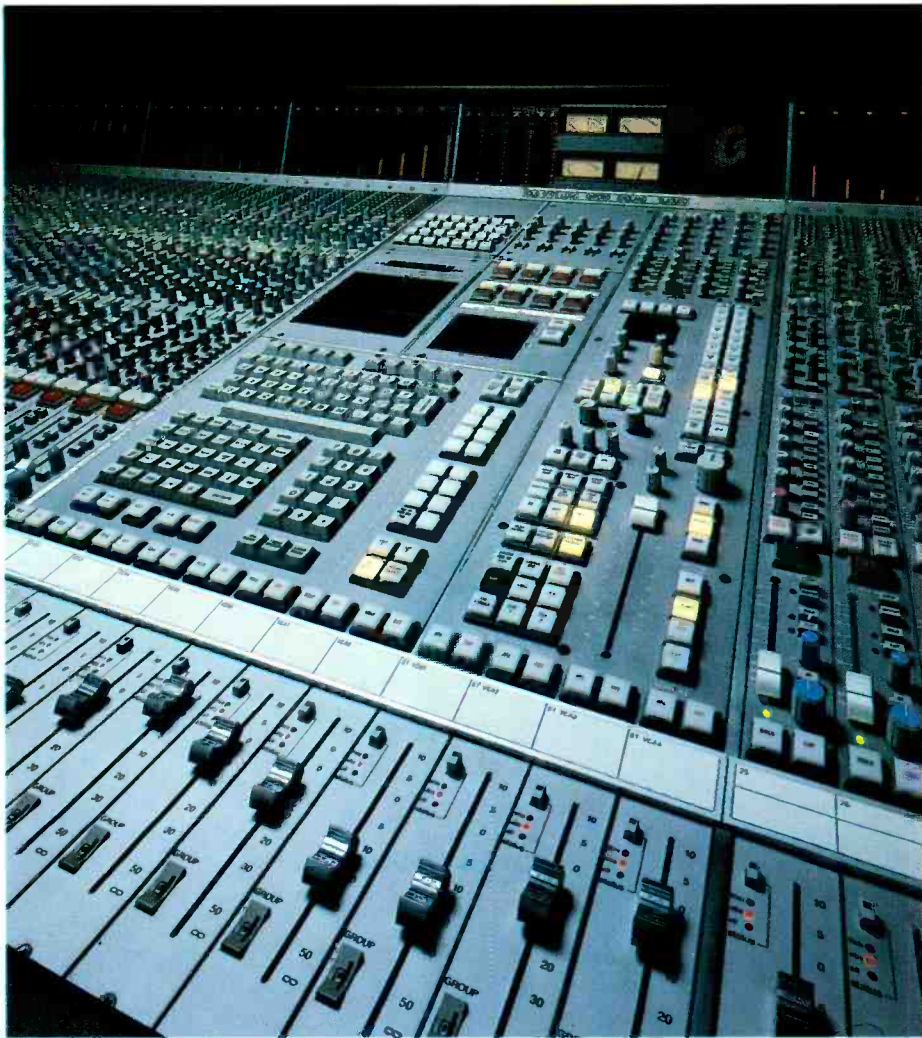

The concept is so simple, and from a marketing point of view so obvious, that one wonders why SSL didn't take this route years ago. One reason may be the ever-increasing interest and consequent competition arising from other moving fader systems, especially considering Neve's bullish announcements on the widening range of retrofit packages for the *Flying Faders* System. The release of *Ultimation* coincides with the release of *G3.00* software, and all *G3.00* features are included in *Ultimation* software—I will outline some of the major changes brought about by *G3.00* separately.

Moving faders are not in fact new to SSL; the *5000M* series film console incorporated them but with some fundamental differences. The *5000* fader is a VCA whereas the *Ultimation* fader contains a *dual signal path*; the signal will either be under VCA control, or fed directly through the

fader wiper. Another important difference is the size of the fader assembly, and great pains were taken to ensure the new faders would retrofit to *4000* and *6000* consoles without having to modify the dimensions of the fader tray. To achieve this a Penny & Giles *3200* fader was used in a fader module which includes two surface mounted boards dealing with the servo, and the law shaping between the VCA and fader elements (the VCA follows the audio law of the logarithmic fader). The difference in fader scaling between an original VCA fader and an *Ultimation* fader is such that the new fader will fade a little quicker around the middle of its track. Externally the fader is little changed apart from the addition of a yellow Alt (Alternative Status) LED, an LED window built into the fader status button (at present not used), and a polycarbonate face plate which replaces the familiar brushed aluminium. The fader has a 10-bit resolution which divides it

into 1024 linear segments, and has a top to bottom speed of 80 ms. The channel cut button is now more accurate, being scanned every ¼-frame as opposed to single frame.

The whole system has been designed to retrofit easily to consoles with *G* series computers—it will not function with an *E* series computer. On average installation takes from two to three days and apart from the faders themselves the following changes are made—new bus cards for the faders to plug into, new VCA cards in the channel, different lights/switches card and analogue output card in the computer, and additional power supplies for both the motors and the fader electronics.

## Operation

*Ultimation* really has been designed to offer the best of both worlds: the system can be used in a number of different ways combining VCA and moving fader operations, or exclusively in one mode or the other—it's the client's choice, but whichever method is preferred, the controlling factor is the familiar *G* series software.

The start of the mixing process is exactly the same as before with all the faders switching to Absolute. The computer defaults to moving fader operation at power up, but can be switched to VCA by typing MO (Motors On/Off) EXECUTE—this command acts as a toggle between the two operational modes and may be implemented at any time. As before, the tape can be rewound and played back in Mix Review to check or update current moves; if the motors have been left on, the faders will assume their previous positions as soon as the tape is played—note that the motors are disabled during rewind and fast forward to prevent high speed tracking. In Mix Review, during a New Mix, the status will switch to Replay, and the faders will follow previous moves unless they are touched, in which case they will switch back to Absolute. The user then has the choice to return the fader to its previous level or to carry on writing new data at its present level. There are two methods of nulling a moving fader, either the familiar manual method of Autotakeover where the fader returns to Replay as soon as it passes through the null point, or by using the Snap facility. Snap automatically returns the fader to its previous level as finger contact is removed; this is carried out at a set fast speed—a variable crossfade or 'Vector' time was considered unnecessary due to the availability of Autotakeover. Snap is a global function and can be switched on/off using the SO EXECUTE command; the yellow Alt LED on each fader will light to indicate Snap On. With Snap turned off, a fader will remain writing at the position it was left—although if Autotakeover were selected, and if the mix level rematched the fader level, it would then switch to Replay and track the previous moves. One of the enhancements present on both *G3.00* and *Ultimation* software, is the ability to drop in and out of Absolute during a New Mix, while retaining previously created moves.

Once a mix has been saved to disk it changes from a New Mix to an Update Mix, and the starting status, which used to be Trim in previous versions and remains so in *G3.00*, now defaults to Replay. The status can be changed at the head of the mix if desired, but if not the associated write status entered by touching the moving fader or pressing the fader status button is Trim. Direct manual trimming of a moving fader (that is actually moving) is impossible on other systems,





which rely on subgrouping techniques to get around the problem; however, the SSL system neatly switches the signal through the VCA path as Trim is selected, enabling standard VCA trim control from the same fader—once the move is completed, the channel can be returned to Replay and the signal will switch back through the moving fader path. All familiar *G* series mix status are still available. *Ultimation* displays a degree of intelligence when it comes to fader stall—ie the fader can't move because the producer's coffee cup is in the way—instead of just coming to an abrupt halt it senses all is not well and switches to VCA; the computer alerts you of a foreign body on the tracks by flashing all the LEDs on the 'offending' fader and puts up a message on the screen.

Another modification introduced through the new software has changed the source mix the computer uses as its reference during updates: instead of basing updates on the Input Mix (the currently selected mix from disk) the computer now updates to the Previous Mix (the most current moves)—this is particularly beneficial when frequently using the Rollback facility to build the mix. There is also a Status Lock feature which will allow the pre-rollback status of the faders to be retained. Both these facilities are described under *G3.00* Software updates.

The Level Match facility operates for moving faders in the same sort of way as Snap mode; if switching from Trim to Absolute it's obviously important that the faders should be in their true positions and Level Match automatically moves them either globally or locally ready for the status transition. Immediate Pickup (IP) operates as before for VCA faders, automatically switching status once movement is detected from the fader or cut; with a moving fader this is confined to cuts which display normal IP operation with motors on. The facility to compare current and previous levels in Preview Absolute, is not extended to moving faders and remains a VCA feature.

The system is very simple to use and anyone who is familiar with *G* series should be able to operate it comfortably in a short period of time. The compatibility between the two signal paths appears consistent certainly in terms of level, but there will undoubtedly be debate over the sonic advantages of audio faders vs VCAs—the beauty of it is that the user has the choice; it's a simple matter to record tracks and lay the final mix to tape with the faders switched in the audio path while mixing entirely with VCAs. Another advantage of the dual signal path is that if a fault occurs in one of the fader elements, the other can be utilised without necessitating fader replacement or channel swap.

## Groups

The original hardware groups in the centre of the console are now also motorised and follow Motors On/Off commands—they provide motorised grouping with the automation switched on or off. In addition *Ultimation* provides an extra 15 software groups which operate in the traditional sense of designating a channel fader as master and attaching other channels to it as slaves. A special Group Setup menu is accessed by pressing the Preset key, and with the aid of individual fader status buttons and the Rub key, groups can be created and disbanded. At the time of writing, there were three types of slave—Slave Cut Only (slave cuts follow the master cut button), Slave Cut Inverted (slave cuts do the opposite of the master), and Slave Status Only (slaves sharing the same status as the master will follow status changes made on that master). Two other slave modes are planned—Slave Fader and Cut, and Slave Fader Only. (Both included now—Ed). It is quite possible to have a group that contains a

mixture of slave types, but it is not possible to have faders belonging to more than one software group; however, software and hardware groups can overlap in which case their effect is additive.

All group activity is monitor based, that is to say that slave moves are not written to disk but are dependent on the group master—so if the master is disconnected the associated slave data will cease to function. The software groups have a Group Merge facility that allows group data to be 'burnt in' to the mix; this can be for the entire mix or up to a point specified by the timecode at the time of the merge command. Once a merge has been performed the original group is automatically disbanded—otherwise disk and monitor data would double up.

Software groups are stored along with the rest of the mix information, and will be automatically reinstated when a mix is loaded. However, if the mix is being reset on a different console, grouping information will not follow Track Swap or Track Copy functions, so it is essential to merge all group information prior to channel reorganisation. A GROUPING ON message appears at the top right of the screen whenever software groups exist. At present software groups are not available outside of mixing.

## Conclusion

*Ultimation* looks set to be a popular addition to the SSL automation system—SSL already boast many enquiries as well as firm orders. By virtue of its duality, the system should cater for the majority of mixing tastes, and this will obviously appeal to studio managers. Operationally it is simple to use, versatile and unobtrusive; it should be considered more as an extension to *G* series, than a new type of automation, and in this respect it represents a major step forward for the system. □

## G3.00 software

Perhaps the most important change brought about by the new software is Insert Mixing. The previous software, *G2.12*, did not allow data to be inserted into a mix without losing some of the current moves. For example during a New Mix if the tape were rolled back to correct an earlier move on a specific channel; as soon as Absolute was entered all the subsequent data on that channel would be overwritten and lost. With *G3.00* the user can drop in and out of Absolute and still retain previous moves; to enable smooth transitions to or from Replay, Autotakeover and Level Match are now available in a New Mix. Similarly in an Update Mix using the previous software, as soon as Trim was entered after a Rollback, all the following current moves would be destroyed, the computer taking its reference from the Input Mix (the mix on disk that is being updated). What happens now is that although the reference is still made to the Input Mix, on coming out of Trim to Replay, the previous moves are retained and the last pass can be Trimmed without losing any correct moves upstream. As a result of all this a mix can be built up without having to continually press END—every time the tape is wound back and an update made it will be automatically inserted in the previous pass; it should be remembered that although it's now easier and quicker to update moves, it may also be more difficult to 'undo'

mistakes. The Mix Compare facility that allowed mixes to be A/B'd in realtime, has been removed.

A few changes have been made to status selection—during a New Mix, UA (Update Absolute) and RC (Revise Cuts), have been removed from the Status Options Box, simply because they were never available in the first place; and faders switched to Manual will now remain in Manual during subsequent passes, but will switch to Absolute by pressing the Fader Status button.

It is now possible to lock a fader's status prior to Rollback, enabling it to update in that status rather than switching to the write status determined by the Status Options Box. Once locked, faders will be unable to switch status and UA and RC will disappear from the Status Box. The Fader Status Master key is used to toggle Status Lock on/off during Mix Running or Mix Review.

Changes have been made to the Tape Machine Setup Menu to automatically adjust the tach rate from digital machines; the program will now accommodate non-integer tach rates (up to one decimal point) caused by sample rate changes.

Synchroniser offsets are now based on a 12 hour positive and negative format, so for example instead of showing 23:59:59:24 for a single frame negative offset, the display will now read -00:00:00:01.

All the software grouping facilities outlined for *Ultimation* are also included in *G3.00*.





# DD 1000. EDIT ORDER YOU IN ANY LIKE...

... and re-assemble quickly and easily! The DD1000 allows you immediate access to any combination of cuts and takes and can perform all editing functions without lengthy calculation times. The removable optical disk eliminates downloading and offers a generous 650mBytes of recording time. You can replay two or four tracks simultaneously, with full SMPTE and MIDI compatibility. The DD1000 works the way *YOU* want to work, whether it be for studio mastering, post production or broadcast applications. The

one-touch keys offer instant access to every function from the front panel or from the optional remote.

There's computer software for the Mac and Atari too! As you'd expect, we've supplied analogue and digital I/Os, and included sample rate conversion. The DD1000 cuts mastering and editing down to size – and that includes the price!

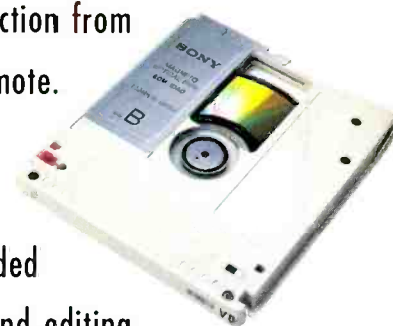

**AKAI**  
DIGITAL

FOR FURTHER INFORMATION CONTACT:  
AKAI (U.K.) LTD, HASLEMERE HEATHROW ESTATE,  
SILVER JUBILEE WAY, PARKWAY, HOUSLOW, M10X 1W4 6NQ  
TEL: 081-897 6388 FAX: 081-759 8268

**DD1000**

WHERE INNOVATION TRIUMPHS

MAGNETO OPTICAL DISK RECORDER



# CYBERZONE SOUND

Zenon Schoepe investigates the use of MIDI for generating sound effects in an innovative TV game show



Virtual reality has remained in the domain of the interactive media and the computer games boffins for some time now, but the concept may soon be brought into the homes of the unsuspecting British television browsing public if the efforts of production company Broadsword come to fruition.

*Cyberzone* is a TV game show, currently at pilot stage, that involves two teams of contestants racing each other to a Centre Point in a computer generated landscape. What makes the game unusual is that two computer generated 'Borgs' move within this landscape controlled by the actions of each team's so-called 'Explorer' contestant who stands on a 'mobility station' with pressure sensitive pads underfoot, direction controls in each hand and a waist slung gun and holster while monitoring passage through the Zone's virtual world via a large Videowall.

Each team's computer Borg moves independently—walking and running in accordance with his controlling Explorer's foot movements and directional instructions generated on the mobility station and drawing a gun and firing at targets dotted around the landscape to collect points. Each team's Explorer is aided by a guiding team mate who shouts directions to the Centre Point goal and the position of targets gleaned from an overview map of the landscape



### Saturn Saturn 624

- 24 Track 2" recorder
- 42Hz - 29kHz bandwidth sync & replay
- Low-noise, low crosstalk
- 14" spool capability

- Fast spooling Max, 62 secs 10.5" reel
- Instant cycle, instant last play point



### Soundtracs Quartz

- 32 channel In Line console
- 24 balanced busses, all
- 100 Programmable MID
- In Place Solo and pfl with
- All inputs can access EQ,



15 Cam Square, Wilbury Way, Hitchin, Herts SG4 0TZ.

Offer also applies to Saturn 624 + Quartz 48/24. Price £34,438 plus vat.



shown on the guide's VDU. Borgs can also shoot each other, adding the excitement of combat to a fast moving and, for the contestants, energetic game that will eventually add a tiered series of progressively more difficult landscape levels to graduate through.

Introducing virtual reality into a TV games show is a risky business from a programming standpoint because while the contestants may be seen to be totally engrossed in what is without doubt a fairly unique bit of fun, there is a danger that the all important viewer may feel isolated from the action and therefore lose interest. The skill of the director in co-ordinating the networked output of *Cyberzone's* four ICL 80486 computers via his own PC is essential for involving the viewer but sound makes another contribution to punter enjoyment by generating a backdrop of familiar noises that steer the contestants and viewers alike to the same state of play conclusions.

Computer-based TV games normally use the sound generating potential of the computer being used to provide the audible cues and hooks that punctuate the flow of a programme. The drain that the speed of the *Cyberzone* landscape puts on the mental capacity of the show's ICL office computers meant that any sound generation ability had to be forfeited for out and out fast graphics. Nothing could be allowed to slow down the visuals. It was originally intended to leave the sound effects until the post-production stage as standard practice. An alternative method of generating sound, live and in time with the action was mooted, kicked around and finally adopted with the benefits of increasing the enjoyment and audio feedback for the participants and viewing audience as well as saving time and money.

Using sub-routines within the *Cyberzone* game program, each defined action is assigned to a MIDI note number which in turn triggers an Akai S950 sampler loaded with all the sound effects needed. Thus a walking Borg generates footsteps samples, a pull on the gun trigger fires a gun-shot sample and a target strike emits a characteristic and easily identifiable noise that can be heard clearly above a screaming audience.

*Cyberzone* is currently at the pilot stage with hopes high that the go ahead to produce a series will be granted and justify additions to the memory expanded S950's portfolio of 24 sounds. At present, screen actions supported by sound effects include footsteps (five walking, five running), gun shots, missile sounds, mine laying and explosions, and all are configured for single

shot playback with proximity to the Borg being relayed through velocity information to the relevant note number to give an impression of distance.

In the wider scheme of things, the MIDI generated sampled sounds, prepared by Dawn Leeder from the Norwich School of Music Technology, were recorded straight to MII master at the studios of Anglia Television, Norwich, Norfolk, where the game show pilots were made. Hosted by Craig Charles, of comic series *Red Dwarf* fame, it remains to be seen if this ambitious and innovative project will be deemed suitable enough to stimulate the imagination of the viewing public and whether it will pave the way for a spate of similarly interactive game shows. □



# Unique 24 Track Offer

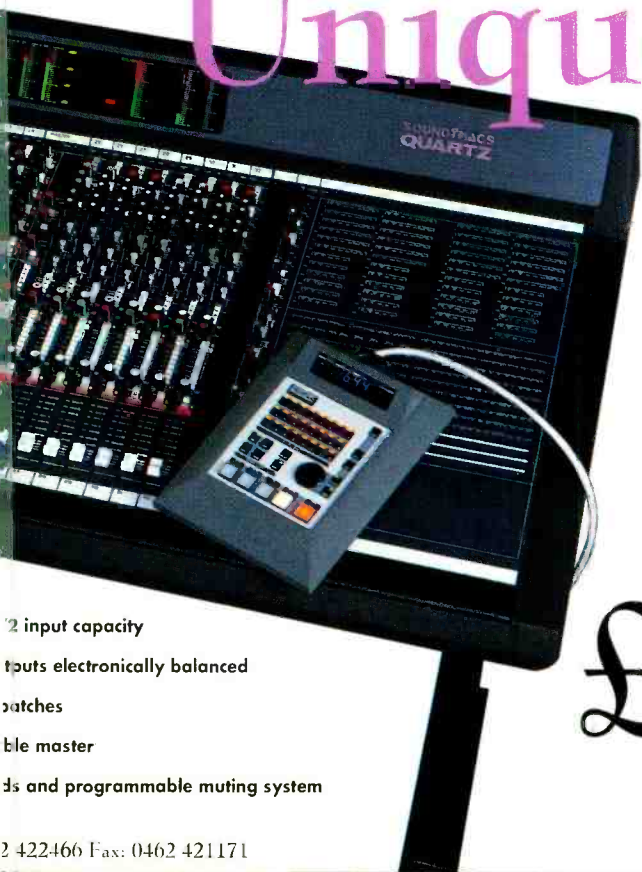

LA are celebrating the launch of the new Saturn 624 recorder with a unique 24 Track package offer.

For a limited period you can purchase a Saturn 624 with a Soundtracs Quartz console for an amazing price.

- Place your order by June 30th, and we will even throw in the looms.

Come and see us either on the Soundtracs PLC or Saturn Research stand at the APRS exhibition.

# £29,995

plus vat

2 input capacity  
 outputs electronically balanced  
 patches  
 ble master  
 ds and programmable muting system

2 422466 Fax: 0462 421171



# One Investment Many Opportunities



**Diversification** – that's the way many leading facilities are meeting the challenges of today's competitive environment. If diversification is a part of your business plan, a New England Digital PostPro™ SD or Synclavier® TS system can help you maximize your opportunities.



**Intuitive interface** – with our new color, graphics-based software, the industry's most powerful workstations are now among the simplest to learn and use. Only NED systems offer a choice of application interfaces – like EditView®, for tape-style editing; SoundDroid™, for film-style editing; and CMX® Autoconform, for video control and EDL compatibility. What's more, an off-line version of SoundDroid is now available that works with any Macintosh® II, allowing you to spot foley, dialogue and hard effects, without tying up your on-line equipment.



**Service** – we back up our technology with the only extended warranty program for workstations available today – our NEDcare™ coverage – and with regular software updates to enhance your system's performance. So, invest in a system you'll profit from for many years to come – call us today for complete information or to arrange a hands-on demonstration.



## PostPro SD

New England Digital can configure a workstation for your specific applications, with a combination of sound design, DSP and up to 16 tracks of hard disk recording integrated within a single system.



## EditView

**Flatten the learning curve!** EditView presents a tape-style interface that makes random access editing point-and-click simple.

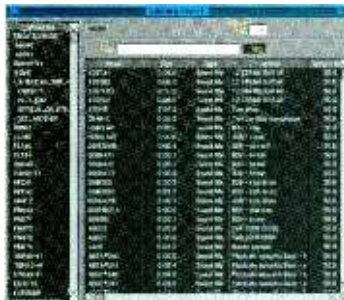

## TransferMation™

**Stop waiting around!** Our new librarian, TransferMation, knows where all your disk cues and optical soundfiles are, on-line and off-line.

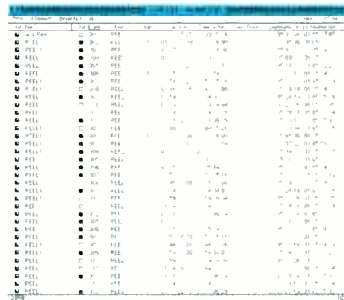

## CMX Autoconform

**Save on overhead!** CMX Autoconform software automates the transfer process, with machine control and video EDL compatibility.

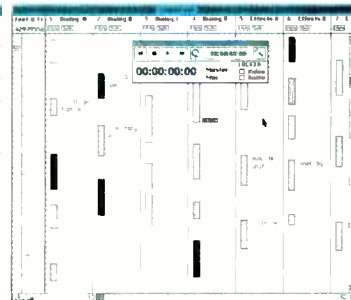

## SoundDroid

**Cut the paperwork!** SoundDroid prints up-to-date cuesheets, "to be recorded" lists, ADR scripts and other project management reports.

New York (212) 977 4510 • Chicago (312) 266 0266 • Nashville (615) 297 8766 • Los Angeles (213) 651 4016  
London (81) 335 3356 • Munich (89) 46 50 21 • Madrid (1) 268 3260 • Italy (39) 200 0312  
Tokyo (3) 3709 6254 • Singapore (65) 732 7905 • Taiwan (2) 321 4454

SoundDroid is a trademark of LucasArts. Macintosh is a registered trademark of Apple Computer, Inc. CMX is a registered trademark of Civtron Corporation. EditView and Synclavier are registered trademarks and PostPro, NEDcare and TransferMation are trademarks of New England Digital. © 1991 New England Digital Corporation. Product specifications subject to change without notice.



Unit 5, Sundial Court, Tolworth Rise South, Tolworth  
Surrey KT5 9NN.  
Tel: (44) (0) 81-335 3356 Fax: (44) (0) 81-335 3533



**B**ased on the northern outskirts of Paris, Le Voyageur II is a mobile studio equipped to handle any kind of live concert, television transmission, video/film production or post-production. It is the newest of two remote vehicles owned by Yves Jaget and Vincent Pitras, partners in CJA Le Voyageur company.

Le Voyageur was originally a division of SELT (Societe d'Enregistrement Laurent Thibault—Laurent Thibault recording company) who ran Le Chateau d'Herouville, a major French residential recording facility during the '70s. They had designed and built the truck. In 1984, recording engineers Yves Jaget and Patrice Cramer set up CJA (Cramer Jaget Associates) to purchase Le Voyageur mobile studio and run it. Three months later, Cramer was so busy with numerous other productions that he could not continue the mobile business at the same time and the company had barely been registered when he sold his 50% share to Pitras. Jaget and Pitras had worked together on a number of projects and had become friends in the process, thus they became associates in CJA Le Voyageur.

"We hit it off together," recalls Pitras, "and so originated our partnership. We decided to keep the name of Le Voyageur, which was nice; there was no reason to change it."

The 8 tonne truck is 8×2.5×3.9 metres (lwh) with a 5×2.3 metre control room. Since 1986, it has been equipped with a Saje ULN console, the first one—a sort of prototype—made by Patrick Aufour.

Business was brisk and CJA were doing well but they found themselves having to turn away a certain number of clients and projects. Pitras explains, "We had to refuse deals like the Frank Zappa tour about 2 years ago, Tina Turner and Prince, among others, because the international clients were asking for equipment that couldn't fit in Le Voyageur. It was really impossible. In 1989, we refused something like 50 days of recording. In the mobile business that is enormous. So in order to reach an international level we had to propose a really different facility, an alternative to Le Voyageur, something unique in France and in Europe.

"With 1992 on the skyline and 'the big Europe', instead of creating just another new mobile, there was a demand for an up-market mobile. Apart from opening out on the coming European market, we would have a second advantage: owning two mobile studios, we can have two different clients at the same time, instead of losing one or the other like in the past. Refusing clients was not a good policy but developing bigger projects was positive. So we decided to create Le Voyageur II mobile studio. Of course, Le Voyageur still has its own clientele. There is undoubtedly competition for Le Voyageur but not Le Voyageur II. The new mobile has a real control room with real main audio monitoring as in fixed recording studios. So far I think what we have achieved is unique."

At the beginning of 1988, plans for the up-market mobile were born. They underwent a period of continual development until work began on the truck in April 1989. The concept was a studio with a 'real' control room that would be mobile. Many acousticians—among them Eric Vivie and Tom Hidley—were contacted and they eventually engaged a young man, Christian Malcurt, who was working at IRCAM and had founded his own company, APIA, in 1986. He was very keen on their project and it was his motivation that made Jaget and Pitras want to work with him.

Malcurt had some problems with Le Voyageur II's dimensions: 11.3×2.5×3.9 metres (lwh). Pitras: "In order to have good stereo monitoring, we needed good control room dimensions. With the coachbuilder, we studied the possibility of extensions. The control room ended up with an extended area of 16 m<sup>2</sup>/172 ft<sup>2</sup>. A Scania truck was chosen because of its reliability and for having the longest body possible for a 19 tonne laden weight. From there Malcurt worked on the acoustics. It is a large well-appointed 4×4 metres/13×13 ft control room featuring LEDE-type acoustics."

The hydraulic jack system takes 5 minutes to extend the control room to an operable condition.

The console, a Neve 48-channel VR series, is mounted on rails so it can move forward or backward. In the working position, the gear is moved forward to be nearer the integrated ATC/MDF active 3-way main monitors. During transport, the 1.2 ton console is moved backward and locked in the middle of the floor to maintain the centre of gravity. Ten air cushions under the



## LE VOYAGEUR II

Guillaume Schouker visits a Paris-based mobile recording operation. Extending sides on their newest truck improve the control room acoustics and allow the use of a full 48-channel desk

floor raise the whole slab and the console for operation then the two extension floors slide under the slab. In the closed position, the console comes down again and is placed back above the two extension floors. You cannot walk inside the control room when it is not extended as there is only 1 cm clearance at each corner between the console and the walls. When the two extensions are opened out, outboard equipment comes down from the ceiling.



**TANNOY**  
**MONITOR**  
**SERIES**

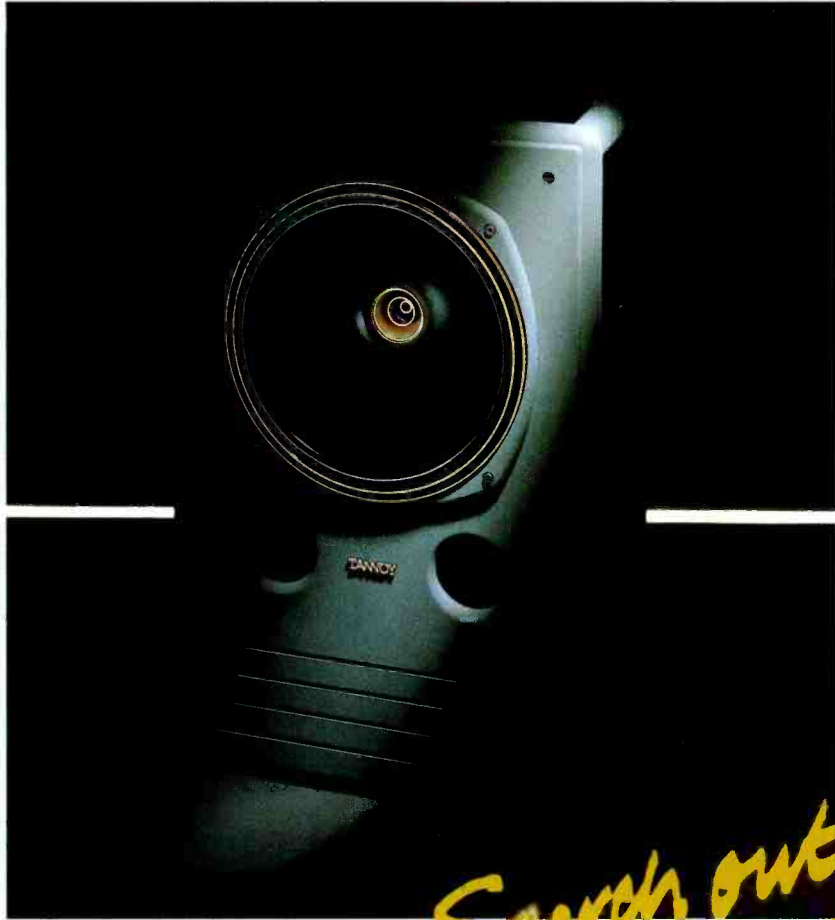

*Search out the  
Grey and Gold*



TANNOY LTD., ROSEHALL INDUSTRIAL ESTATE, COATBRIDGE, STRATHCLYDE ML5 4TF, SCOTLAND.  
TEL: (0236) 20199. TLX: 778621 TANMFGG. FAX: (0236) 28230.

TGI/TANNOY, 300 GAGE AVENUE, KITCHENER, ONTARIO, CANADA N2M 2C8.  
TEL: (519) 745 1158. FAX: (519) 745 2364.

[www.americanradiohistory.com](http://www.americanradiohistory.com)



"For live recording, the outboard equipment we have is enough. It would, of course, be different if we were to often mix in Le Voyageur," says Pitras.

The truck is divided into separate rooms each with a different purpose: the driver's cabin at the front, then the small lounge, the machine room, the control room and finally the access and storage room at the back.

Access is by the side door towards the right front, or through the door in the rear. When recording, the back door is locked: "Otherwise, it would be constant ins and outs within the control room," says Pitras. "One of the reasons why we decided to separate the lorry into three different parts was to leave the engineer alone and quiet when recording. Instead, people can have a drink and, if they want, relax or watch television. Although, the door in the rear is very useful for going straight into the control room or when looking for something like microphone stands or cables in the storage room."

The Augereaux company participated in the building of the mobile and the finished item was delivered mid-July 1989 when Jaget and Pitras tackled all the wiring. By mid-October 1989, Le Voyageur II was operational.

The outer insulation, as well as the acoustic treatment, has been carefully studied. The coachwork has a polyurethane coating, underneath which is a layer of about 2 ton of sheet lead all around the control room to insulate against low frequencies. Being an acoustic and thermal insulation material, polystyrene is placed in the middle of this sandwich and the final coat is simply plywood. The floor of the control room is a solid slab.

There are bass traps in front of the console next to the main audio and video monitors. In the moving ceiling more bass traps are filled with high density Rockwool covered with acoustic foam and Texaa fabric. Sound is reflected by the solid wood on the wall at the rear of the engineer and the diffusers, 20 cm/8 inches thick (max) made of solid wild cherry. These diffusers are, in fact, made up of four identical panels fitted together. Around these are more diffusers made of the same wood but of only 10 cm/4 inches thickness.

When you enter the control room the VR console is the



centrepiece. It was the first VR to enter a French recording facility. Two TV monitors are installed horizontally between the main speakers. Pitras explains, "Most of the projects we work on are video synchronised. Thus with one TV monitor we can see what's going on, for example, on the stage. When not video-synchronised, we put one or two video cameras in to see what's in the concert hall or on stage. The other TV monitor is for the final mix monitoring."

The truck has extensive patching facilities with a large patchbay dedicated to 120 microphone lines.

Pitras: "We own two Sony/MCI JH-24 analogue machines but seldom use them in Le Voyageur II—clients mostly ask for digital recording. Unfortunately, the Sony PCM-3324 we have is usually not enough. In that case, we have rather close agreements with 44-1, Paul-Rene Wagner's audio rental company. We can have 24-track and 48-track recorders very quickly. He also rents our 3324 to other people. As far as digital 32-track machines are concerned and if clients ask for it, we

## PUTTING YOUR PERFORMANCE INTO SHAPE

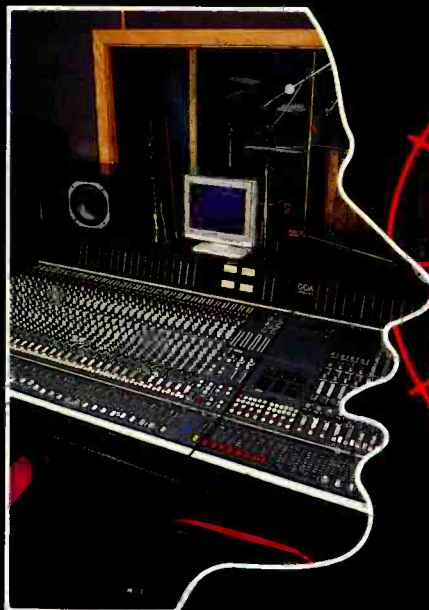

# Milab

Milab VIP-50 - looks and sounds different. Technically superb, this sophisticated variable pattern studio condenser microphone captures vocal sound accurately, yet adds that extra dimension with its own unique characteristics. Hear the VIP-50, and let your ears be the judge.



**EXPERIENCE THE CREATIVITY**

Milab LSR-2000 - for maximum expression on stage. This vocal cardioid microphone is made for a rugged life on the road - but provides outstanding studio quality. With switchable pad and 80Hz high pass filter. Put one to the test today.

DISTRIBUTED BY KLARK TEKNIK PLC  
a MARK IV company

Klark Teknik PLC, Klark Industrial Park, Walter Nash Road, Kidderminster, Worcestershire DY11 7JH, England. Tel: (0562) 741515 Telex: 339821 KLARK G Fax No: (0562) 745371.

Klark Teknik Electronics Inc., 200 Sea Lane, Farmingdale, N.Y. 11735, USA. Tel: (516) 249 3660 Fax No: (516) 420 1863. Klark Teknik (Singapore) Pte Limited, 7500A Beach Road, 04-308 The Plaza, Singapore 0719. Tel: 293 9736 Fax No: 293 9738.



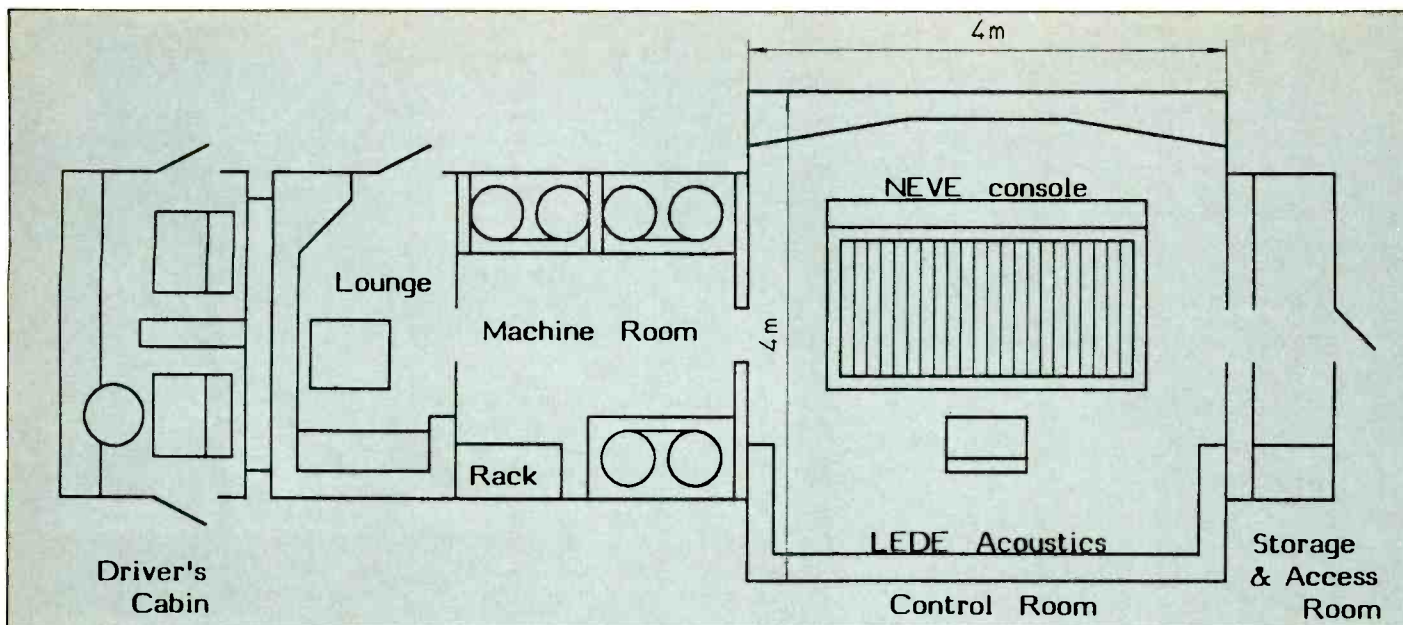

rent equipment from Hilton Sound. Anyhow, *Le Voyageur II* is patched and wired to even run with two Sony *PCM-3348s* linked together. Outside tape machines can also be plugged in and linked to the studio."

Off the control room is the machine room with a list of equipment including multitrack machine, 2-track master recorder, amplifiers, U-matic, cassette, DAT and CD players, connection systems. Believe it or not, there is still room for more outboard equipment in the rack and also for an auxiliary console.

The truck does not have its own generator but triphase power, without neutral, is used from outside. In order to avoid electrical fluctuation, power is stabilised, regulated and filtered at the main input, Emergency back-up power supply turns on in case of a power cut. *Le Voyageur* can also run on a standard domestic supply. As the air conditioning comes from the front of the lorry it keeps the machine room and the control room very silent and cool.

*Le Voyageur II's* activities include live audio recording, with or without video, TV shows, live broadcast for TV and audio for films.

Jaget takes care of equipment maintenance with the occasional help of the manufacturers concerned!

A regular team of five to six freelancers help with the day-to-day operation of the truck. "We noted that most projects and productions have their own freelance engineer. When renting the mobile, a client must be assisted by three persons representing our company," says Pitras. "*Le Voyageur II* could not function without the help of people who know the vehicle

and its equipment well. Among the three, there must be a lorry driver because a special driving licence is needed. When not driving, he can do various technical tasks, either setting the equipment or pulling out wires."

Short-term plans include the acquisition of *Flying Faders* and recall automation system for the Neve *VR* series console in order to be able to do a final mix in the mobile.

Pitras reveals their longer-term plans: "*Le Voyageur*, the first mobile studio we owned, is something like 10 to 12 years old and the lorry itself is really getting old. We have already started making plans to renovate this mobile. It will be exactly the same equipment but in a brand new lorry. We'll stay in the limits of our *Le Voyageur* clients' budgets. Actually, *Le Voyageur* is rented for less than half the price of *Le Voyageur II*, with the same arrangement for extras—extra recorders, tape, technicians, travelling expenses. We are already working with Christian Malcurt for the acoustics. I am glad to see that Christian is as much motivated with the new project as with *Le Voyageur II* before its achievement. The Saje *ULN* console is fine, so there's no reason to get rid of it. Instead, we're thinking of buying two new analogue multitrack machines to replace the old Sony/MCI *JH-24*. *Le Voyageur* will definitely be different from the previous one but I can't tell more than that. We should leave some suspense!"

When asked about the future of mobile studios Pitras says, "It mostly depends on the future of records. We all know now that the number of vinyl records sales is falling but the CD market is in full expansion. Unfortunately, the record companies are actually more interested in compilations, remixes, re-releases, but not in real productions. That's one of the reasons for slack times in the recording industry. Though, the people in the record companies all know that live records sell well. Furthermore, it costs less to release a live LP/CD than any other production. Also CD-Video is the future. For example, we did the one for Serge Gainsbourg. Stereo TV is coming soon, so we should still have business. In other respects, we're not at all in rivalry with fixed recording facilities, but complementary. When we do any live recording, they get the clients afterwards for mixing over 15 days, three months or even more."

A list of CJA *Le Voyageur* clients reads like a *Who's Who* of the music industry with such diversities as Jane Birkin, Ray Charles, Stanley Clarke, Johnny Clegg, Chick Corea, Miles Davis, George Duke, Mylène Farmer, Golden Gate Quartet, Imagination, Jean-Michel Jarre, Michel Jonasz, Kassav, B B King, Manu di Bango, Nana Mouskouri, Claude Nougaro, and many others. In 1990, *Le Voyageur II* clients included Sting, Johnny Hallyday, Sylvie Vartan, Patrick Bruel, Eddie Mitchell, Julien Clerc, Michel Sardou . . .

At just over a year old, *Le Voyageur II* has already been to Italy, Bulgaria and the UK, as well as operating in France around Paris where most business is generated. □

**Le Voyageur II, 2 rue de Montigny, 93500 Pantin, France. Tel: 48 91 0228.**

## Equipment list

### Mixing console

Neve *VR* series 48-channel

### Recorders

- 1 Sony *PCM-3324*
- 2 Sony/MCI *JH-24*
- 1 Sony *PCM-3324* on request
- 2 Sony *PCM-3348* on request
- 1 Mitsubishi *X-880* on request
- 1 Sony/MCI *JH-110* ¼ inch with centre timecode channel
- 1 Sony *U-matic 5630*
- 1 Sony *PCM-3402* on request
- 1 Mitsubishi *X-86* on request
- 1 Sony *DAT*
- 1 Tascam *122 MkII* cassette player
- 1 Tascam *CD* player

### Monitoring

- ATC/MDF active 3-way main monitors with Amcron *Macrotech 2400* amp
- Electro-Voice *Sentry 100* nearfield monitors with Amcron *Macrotech 1200* amp
- Yamaha *NS-10M*
- Meyer *HD-1*

### Outboard

- 2 *Zeta III* synchronisers+remote
- 1 Lexicon *480*
- 1 Yamaha *REVI*
- 2 Lexicon *PCM-70*
- 1 Lexicon *PCM-42*
- 1 Eventide *H-949 Harmonizer*
- 60-channel BSS active split system
- Sub D patch system with RS-232 & RS-422 interface
- Clear Com 2-wire/4-wire intercom system



COMING FACE TO FACE WITH THE FUTURE  
IS A LOT MORE FAMILIAR THAN YOU MIGHT THINK!

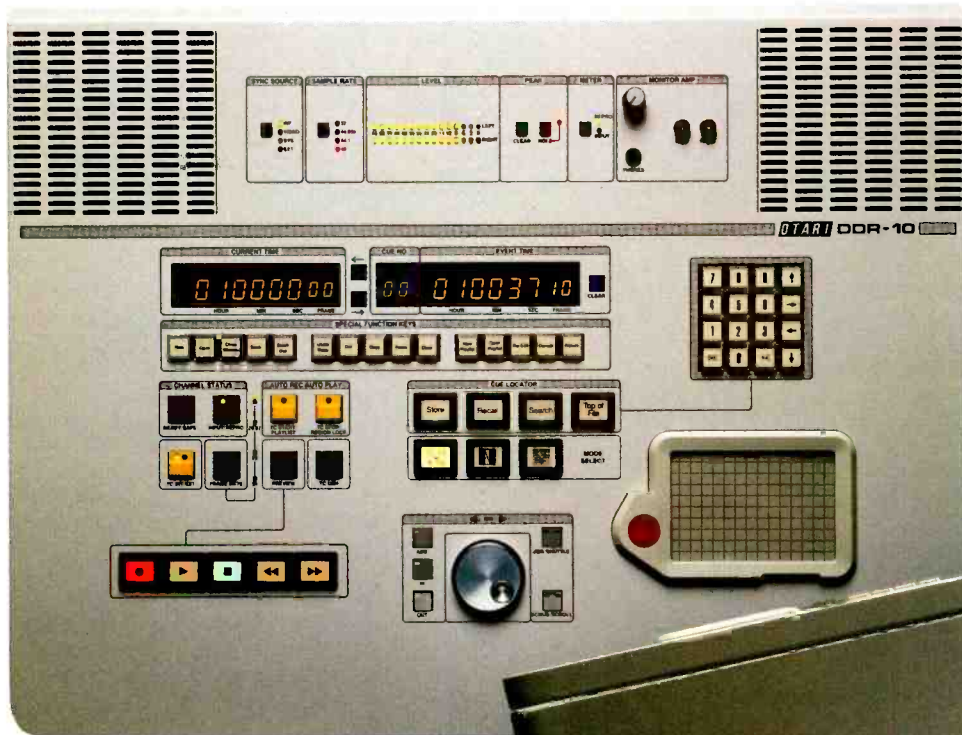

We don't ship tape recorders to you in pieces; you won't get our new disk recorders that way either.

Our new DDR-10 digital disk recorder is a fully integrated system that comes ready to roll in and turn on. There's no assembly, no cabling, nothing more to buy. *And because it looks great, clients simply love it!*

If you know tape recorders, you're ready to go the minute you sit down at the DDR-10's control panel. The buttons and knobs are familiar, and they do what you expect. It's the only audio disk recorder in the world designed in this way — designed for the professional.

With up to 60 hours of the highest quality, full-bandwidth digital audio, *and* extensive editing capabilities, the DDR-10 delivers the best "power-to-price" ratio you can buy. And its standard Macintosh<sup>®</sup> SCSI

buss (rather than a proprietary design), means you're free to take advantage of future advances in the computer industry. This way, you're not locked-in to a system which seemed "special" at first, but quickly became *ancient*.

For your convenience, CD replication directly from your DDR-10 soundfile is now available. For more information about this service, and the DDR-10, call your nearest regional office below for information from Otari; a company famous for technical support and customer service, worldwide.

**OTARI**

Otari, Inc., Tokyo (0424) 81-8626  
Otari Corp., California (415) 341-5900  
Otari (UK) Ltd., United Kingdom (0753) 580777  
Otari Singapore Pte., Ltd. (65) 743-7711  
Otari Deutschland GmbH., West Germany 02159/50861-3

© Otari 1991  
Macintosh is a registered trademark of Apple Computer, Inc.

**T**he first thing that strikes you about Brussels is the number of new office blocks going up everywhere. As the main base of the European Commission, Brussels is in the middle of a rapid expansion programme.

Office space is in great demand, not just to house the expanding European Parliament but also to provide space for the multinational companies which are being attracted to the city.

While knocking down small buildings and putting up tower blocks may be one way of meeting the demand from the multinationals, it doesn't do much for small, independent companies which may want to stay in Brussels but are literally being squeezed out by the escalating price of property. Property prices are still rapidly increasing and with 1992 approaching they are not likely to peak for some time yet.

One company which is currently assessing its future in Brussels is Videaudio, a film and video dubbing facility set up eight years ago by partners Alek Goosse and Michel Coquette.

Videaudio is a young company run by a dedicated team who have been quick to capitalise on the work created by Belgium's growing film, video and TV industries. When Goosse and Coquette started the company all they had was an 8-track, a U-matic and a small Soundcraft desk. Now they have a sound editing and track laying studio and two sound recording and mixing studios, all of which are equipped with AMS *AudioFiles*.

Videaudio's newest studio, a massive 100 m<sup>2</sup> room which officially opened last December, is a major achievement for the company because it represents a workable answer to a complex series of problems which have been worrying Goosse and Coquette for some time.

As long ago as 1988, Videaudio was in a position where it needed to expand its existing facilities in order to attract more business from more diverse sources. But, as Alek Goosse explains, their current premises is only 500 m from the building site which will soon be the new European Parliament building.

Once that opens property prices in the area are likely to rise even more and, with only two years left on Videaudio's lease. Goosse didn't want to spend a lot of money on a new studio if the company would eventually have to move.

Goosse: "Commercially we needed a second studio and we had reached the point where our clients were getting tired of waiting for us to open a second room. We had been holding them off for a couple of years but it was at the stage where we had to act fast or lose business.

"But the problem was the new European Parliament building. We don't know how it is going to affect our future and, with Brussels changing rapidly, it is getting very difficult to find suitable property at the right price. This makes things very difficult for small companies like ours. There is a possibility that we may be forced out of Brussels all together, so for this reason we were reluctant to commit large amounts of money to building and investing in our current property."

Tossed about on the horns of this dilemma, Goosse says he didn't know what to do until he heard about a venture between studio designers Munro Associates and studio builders KFA.

The two companies had come up with a range of prefabricated control rooms, marketed under the *System Z* logo, which are designed to the client's specifications by Andy Munro, then constructed in 60 cm wide panels at KFA's factory in Wood Green, London. The panels can be quickly assembled on site and better still, as far as Videaudio was concerned, taken down again at a later date and reassembled somewhere else.

Goosse: "I went to the APRS exhibition last June to take a look at the demonstration model and was very impressed. The fact that Andy Munro was involved interested me. By using this type of construction we could go ahead with the second studio without worrying about the future. If we have to move we can simply take our new room with us and also it makes sense from a tax point of view because unlike normal building work we can actually write it off against tax in the same way we can with equipment."

After seeing the demonstration model at APRS, Goosse gave Munro Associates and KFA the go-ahead to build the second room with the proviso that it had to be done quickly. Contracts were signed in July and then Munro Associates and KFA got straight down to the task of designing and building the studio.

The whole project was designed on CAD using interactive networking at Munro Associates which fed AUTOCAD work stations at KFA. All of the details and amendments were fed to database for costings. The prefabricated panels were then shipped over to Videaudio where they were erected on site by a team from KFA who handled the construction. The building work was started in August and completed in record time, with the studio completely finished by the end of November.

Once Videaudio gave Munro Associates and KFA the go ahead, the initial plans for the room changed rapidly resulting in a studio which goes far beyond its original specifications. To begin with Goosse and Coquette wanted a room similar to their existing video dubbing studio but with better sound isolation because they were handling more broadcast work. But the changes that were taking place in the French-speaking Belgium film business made them think again.

The film business in Belgium has been going through a major revival thanks to investment from the US, and a lot more new films are now being produced. Added to this a huge 24-screen cinema complex, Kinopolis, has recently opened just outside Brussels and this has breathed new life into the cinema business. All 24 are equipped with THX and Dolby *Stereo* sound systems and films are shown on 35 and 70 mm projectors.

However, Belgian film makers had to go to Paris or the Netherlands in order to find film mixing and dubbing facilities which were THX compatible because nothing of the sort existed in their own country. After speaking with their clients and with representatives from Kinopolis, Goosse and Coquette took the decision to gear their new room towards film post-production so that they could pull in the business that had previously been moving to Paris.

In order to do this the room had to be THX compatible—in other words it had to fit in with the acoustic and format criteria specified by THX for the optimum reproduction of cinema sound. It also had to have a vocal booth so that they could do sound effects and dialogue replacement.

# VIDEAUDIO

Sue Sillitoe visits a studio in Belgium that has expanded to meet the needs of a growing film industry



The staff of Videaudio and designer Andy Munro (far right)



# MORE 'BITS' FOR YOUR DIGITAL STUDIO

**NEW**

**HD Series AES/EBU Serial Digital Audio Routing Switchers:**

- 64 x 64 in 6U with dual PSU
- 128 x 128 in 16U with dual PSU
- 256 x 128 in 32U with dual PSU

**NEW**

**5015 AES/EBU Fader Module**

- Employs DSP for audio gain control with RS422 control interface

**NEW**

**5243 Digital Audio Reframer with 2 x 1 switch**  
– Eliminates bitstream corruption following switching transition

**NEW**

**5245 Digital Audio Reference Generator**

- Generates AES/EBU Grade 1 Reference locked to PAL/NTSC video



**5220/21 ADC Converter**

- 128 x oversampling Delta-Sigma conversion
- 105dB dynamic range using all 20 programme audio bits
- AES/EBU outputs locked to local reference
- Enhanced channel status implementation
- Line test facility

**5230/31 DAC Converter**

- 20 Bit oversampling architecture
- Two inputs and line up check facility
- Invalid or non-synchronous input indication
- Provision for access to 'user', 'status' and 'auxiliary' data bits

- 48kHz/44.1kHz standards compatible
- Up to 5 converters housed in compact 3U frame

**5241 AES/EBU Distribution Amplifier**

- Input and output interfaces conform to AES/EBU specification (AES-3 1991)
- Ten outputs with individual buffers
- Selectable input cable equaliser
- Selectable clock regenerator
- Direct replacement for our 6241 analogue DA permitting economic upgrade from analogue 'mono' to digital 'stereo' using existing cable circuits

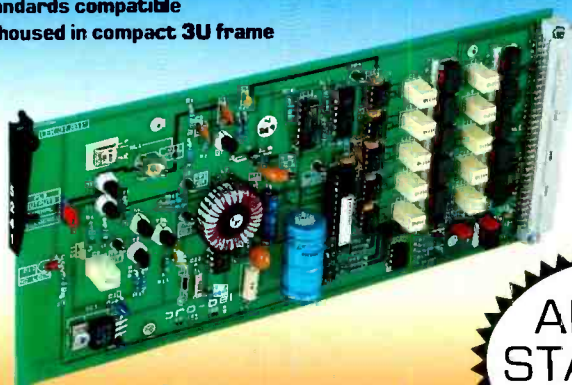

APRS 91  
STAND 121  
LEVEL 1

**5012 Digital Audio Waveform Generator**

- Switchable 48kHz or 44.1kHz
- Independent left and right channel controls of frequency, amplitude and waveform
- Master oscillator lockable to an external AES/EBU bitstream or TTL compatible reference
- U and V bits may be set in any pattern
- Channel status implemented, ensures RDATE compatibility



**pro-bel** PROFESSIONAL DIGITAL AUDIO



# QUALITY USED EQUIPMENT

from Tony Larking

## CONSOLES

DDA AMR24 36 channels, p/bay Immaculate £25,995  
 DDA AMR24 44 channels + Mastermix Immaculate £POA  
 HARRISON 40 channel 24 series VCA subs, 6  
 aux; installed in private studio for the past 5 yrs VGC OFFERS  
 NEVE 8068 32 channels, p/bay VGC POA  
 NEVE 542 broadcast console, 12 ch frame, fitted 8 into 2 VGC £1,995  
 RAINDIRK SYMPHONY 48 channel console New £POA  
 SOUNDCRAFT TS24 36 channel console with p/bay, bargraphs VGC £19,995  
 SOUNDCRAFT SERIES 2 16/8 8 ch. 4 band EQ, 8 ch parametric VGC £995  
 SOUNDTRACS MRX24 24/8 16 40 inputs in remix Ex Demo £2,995  
 SOUNDTRACS CMX4000 32/24 p/bay, CMS3 New £9,995  
 automation 56 inputs in remix  
 SOUNDTRACS CM4400 32 inputs, 24 monitors, 56 line  
 inputs in remix VGC £5,500  
 SOUNDTRACS IL4832 with automation, 96 inputs in  
 remix Immaculate £24,000  
 line inputs VGC £4,500  
 SOUNDTRACS 16/8/16 34 line inputs in remix VGC £1,195  
 SOUNDCRAFT 200 SERIES 24/4/2 VGC £1,750  
 SECK 24/8/8 VGC £995  
 TRIDENT 80B 30/24/24 with p/bay, private use only Immaculate £POA  
 TRIDENT TSM 32/24/24 p/bay VGC £11,995  
 TRIDENT SERIES 24 36 channel frame fitted 28/24/24 VGC £5,995  
 MCI 636 30 channel console with JH500 automation VGC POA  
 Subject to availability. Exclusive of VAT E&OE

## RECORDERS

AKAI ADAM 12 track digital recorder with remote &  
 meter bridge Ex demo £11,500  
 AKAI 24 TRACK SYSTEM 2xMG14D+autolocate+Postex 4030 £2,995  
 AMPLEX 102 2 track with 1/2" & 3/4" head blocks, little used VGC £POA  
 ACES 24 TRACK with remote. Budget 2" 24 track To clear £1,995  
 FOSTEX D20 R-DAT Little used As new £POA  
 MCI 24 TRACK with remote, a large, early 2" recorder  
 looking for a good home, for spares or repair To clear OFFERS  
 MITSUBISHI X850 32 track digital, with remote & meter bridge, VGC £35,000  
 very low hours VGC £13,500  
 OTARI MTR90 MK2 24 track, remote/auto, well maintained VGC £POA  
 OTARI MTR100 24 track, very low hours VGC £POA  
 OTARI MX70 professional 8 track 1" recorder with remote VGC £POA  
 OTARI MTR12 2 track 1/2" VGC £450  
 REVONX A77 2 track, recent overhaul, new heads £450  
 SATURN 24 track with remote & auto, demonstration  
 use only, recent factory overhaul & upgrade, supplied  
 with Soundcraft warranty Immaculate £13,995  
 STUDDER A80 MK2 narrow body 16 track VGC £7,000  
 STUDDER A80 MK3 24 track with remote & auto, low hours VGC £24,000  
 STUDDER A80 MK1 16 track with remote VGC £3,995  
 STUDDER A80 MK2 1/2" m 2 track £POA  
 STUDDER B67 in console 7 1/2/15/30ips (2 available) VGC £1,500  
 STUDDER B67 in console 3 1/4/7 1/2/15ips (2 available) VGC £1,500  
 SOUNDCRAFT 24 track, 9 memory autofremote, private  
 use only Immaculate £9,995  
 SOUNDCRAFT MK3 24 track with 9 memory auto VGC £6,995  
 SOUNDCRAFT MK3 24 track NEW £POA  
 SONY 3324A 24 track digital recorder VGC £POA  
 SONY MCI 24 track, little used Immaculate £POA  
 SONY MCI 2 track in console, private use only Immaculate £2,500  
 3M M79 24 track, excellent electronics & mechanics. Nice £5,995  
 Saki heads just had first relap Immaculate £POA  
 3M M79 16 track Immaculate £POA  
 Subject to availability Exclusive of VAT E&OE

## VARIOUS

BEL BD80 8 second DDL Sampler VGC POA  
 LEXICON PCM70 £995  
 NEUMANN U67 VALVE MIC £POA  
 NEUMANN M50 £POA  
 NEUMANN U47 £POA  
 NEUMANN M49 VGC £POA  
 NEUMANN VF14 VALVE POA  
 FAIRCHILD 666 COMPRESSOR £POA  
 NEVE 33115 EQ MODULES VGC £600  
 NEVE COMPRESSORS (6 available) VGC £600  
 AUDIO & DESIGN Vocal Stresser Offers  
 BEL BE20 Stereo Flanger Boxed As new £250  
 BEL BC4 24 channel noise reduction system New £950  
 BEL BC3 8 channel noise reduction £225  
 ART PITCH TRANSPOSER with display, Boxed As new £295  
 DOLBY SP24 24 channels Dolby-A VGC £3,750  
 DENON DTR2000 R-DAT 20 bit Lambda. SLC meets SCMS  
 standards, full remote New £625  
 EMT 140 stereo transistor echo plate with remote, 1 owner VGC £750  
 SOUNDCRAFT 2" 16 track head block VGC £500  
 PULTEC ME5 val EQ VGC £795  
 UREI 809 STUDIO MONITORS As new £1,000 pair  
 TELCOM 24 channel noise reduction system in rack with psu £POA  
 SIMMONS midi trigger MIDI £295  
 chx 903 & 907 MODULES stereo over easy compressor £295  
 REBIS MODULES RA210 RIAA pre amp RA215 stereo  
 panner, 2xRA216 dual VCA Offers  
 Subject to availability. Exclusive of VAT E&OE

## EXPORT ENQUIRIES WELCOME

Tony Larking Professional Sales Ltd.

TEL: 0462 490125  
 FAX: 0462 490126

All prices are exclusive of VAT



Videaudio's new control room

Andy Munro: "When Videaudio decided to make the new studio a film mixing and dubbing facility we had to change our plans so that we could create a control room with the same spec as for THX but with a more analytical quality than one would normally expect from a cinema environment."

"A bit of judicious equalisation and plenty of testing using our MLSSA system gave us the overall result we wanted. In the end the results we were getting from the JBLs were much better than we had initially anticipated."

While the room was being built Goosse and Coquette heard about the new Kodak/ORC cinema sound system, *Cinema Digital Sound*, and decided to stay one step ahead of the competition by gearing it up for this as well.

The CDS system features six discrete channels of audio which surrounds the audience with dialogue, effects and music. There are five full bandwidth channels and one sub-woofer channel with limited bandwidth for low-frequency or bass signals. With CDS, sound is recorded on the same piece of film as the pictures, providing digital sound without the opportunities for errors or the extra costs associated with the two component systems. There is no crosstalk from one channel to another, no discernible distortion or flutter, and the dynamic and frequency ranges are extended to the limits of the ear's ability to hear.

CDS is compatible with standard sampling rates making it possible to utilise existing digital technology, and its in-built electronics allows it to detect and correct errors so that the quality of the digital soundtrack remains consistent throughout the run of the film. With conventional 35 mm analogue optical and 70 mm analogue magnetic soundtracks, audio quality begins to deteriorate (*Only slowly. Ed*) with the first run of the film.

Goosse: "We felt that while Dolby was fine, we ought to be able to offer more. We looked at the CDS system and were very impressed. It seemed to us that CDS was going to be the way ahead for the future." Having sorted out the sound, Videaudio turned its attention to the picture. Goosse felt that in order for the sound to define the picture his clients would need to mix in a cinema environment rather than a control room environment. He opted for a massive projection screen which stretches from the edge of one

speaker to the other and built a special projection room behind the control room as well as a separate machine room which serves the other two studios as well.

When Videaudio opened its new room it installed its old Amek *Angela* desk. Goosse: "We felt the main criterion had to be getting the room right first, then we could worry about the equipment. We have ended up with something that our clients are happy working with."

"As we are a very young company we have to bear in mind what our clients want before we commit to buying expensive pieces of equipment. That doesn't mean we are not prepared to take risks just that we look carefully at whether the equipment is right for us as well as whether we can afford it."

"When we bought our first *AudioFile* we took a huge risk and people thought we were crazy but it worked out OK and now we have three of them, one in each studio and one in the edit room which is designed solely for film with no EQ, just eight tracks straight to picture. That is the direction we want to go, making all this new technology available to film people. Hard disk virtual systems are a huge development and we are convinced they are the way ahead for the future. Pretty soon we won't need tape at all, which is why we have not bought a multitrack."

"For me, the success of Videaudio is about being business-like yet still remaining creative and occasionally being prepared to take risks." The new studio is a good example of Videaudio's philosophy, it ended up being far larger and far more complex than was originally anticipated because Goosse and Coquette felt that it was a viable risk.

"It is very different from the facility we initially planned but we are delighted with it," Goosse says. "When Kinepolis first opened everyone said they were crazy, no-one was going to the cinema any more so why open a complex with 24 theatres? But it was a success and that gave us the confidence to do what we have done. Our new studio is now the only THX spec studio in Belgium and we are sure it will attract a lot of business." □

Videaudio, Wierzstraat, 11-13 Rue Wiertz, 1040 Brussels, Belgium. Tel: +322 649 0187.



# Westlake Audio Is Your Only Choice...



## When You Want All These Monitor Choices:

- The Lowest I.M. distortion and best sound imaging in the industry.
- Biwired, mono, bi, tri, quad or pentamplified systems.
- Any one of 15 high resolution reference monitors.
- Black or furniture grade hardwood finishes.
- Horn or soft domes.

from acoustic design  
to down beat...

**Westlake  
Audio**

Manufacturing Group  
2696 Lavery Court, Unit 18  
Newbury Park, California 91320  
(805) 499-3686 • FAX (805) 498-2571

# AUDIO SCREENS



THESE QUALITY ACOUSTIC SCREENS USE HIGH DENSITY ROCKWOOL MEMBRANES FOR MAXIMUM ABSORPTION AND HAVE SHATTERPROOF SAFETY GLASS WINDOWS.

3 STANDARD MODELS AVAILABLE.



11-12 CAM SQUARE, HITCHIN, HERTS SG4 OTZ. TEL: 0462 435572 Fax. 0462 432760

# OVER BRIDGE



THE STAND EASY MIXER OVERBRIDGE IS AN ATTRACTIVE AND FUNCTIONAL WAY OF HOUSING OUTBOARD EQUIPMENT AND EXTERNAL PATCHBAYS.

2 STANDARD AND CUSTOME SIZES ARE AVAILABLE.



11-12 CAM SQUARE, HITCHIN, HERTS SG4 OTZ. TEL: 0462 435572 Fax. 0462 432760

# STUDIO RACKS



THE INDUSTRY STANDARD 19" EQUIPMENT RACKS. STAND EASY RACKS COME SUPPLIED WITH BLACK SUEDE FINISHED SIDES AND CAN BE FITTED WITH HEAVY DUTY CASTERS AS AN OPTION.



11-12 CAM SQUARE, HITCHIN, HERTS SG4 OTZ. TEL: 0462 435572 Fax. 0462 432760

# SPEAKER STANDS



THE STAND EASY SPEAKER STANDS, STYLED TO MATCH THE REST OF THE STAND EASY RANGE, ARE CUSTOM DESIGNED SO YOU CAN GET THE BEST FROM YOUR SPEAKERS WHILE MOUNTING THEM SAFELY.



11-12 CAM SQUARE, HITCHIN, HERTS SG4 OTZ. TEL: 0462 435572 Fax. 0462 432760





# Akai DD1000

## Jim Betteridge takes a second look at this unique optical recorder

I first wrote about the *DD1000* last year (*Studio Sound*, July 1990) following a lengthy demonstration of a late prototype model. Early this year I had the opportunity to spend some time working with the unit, its new software and the *Macintosh* controller—and form some opinions on it.

It is not always the most complicated pieces that pose the greatest challenge to the reviewer. A simple device often has operational ramifications that may go far beyond the device itself, witness the wheel. Although far less pure in form than the wheel, the Akai *DD1000* is also in principle, simple. It has been designed specifically with an open architecture so as to be as flexible as possible, and provide several ways of approaching a single task. In this article I have avoided the long list of isolated button descriptions and have tried to give an overall feel of how the machine might fit into a real operation.

For those who missed the preliminary review, a brief recap. The *DD1000* is a digital sound recording device that uses MOD (Magneto-Optical Disks) almost exclusively as its recording medium. Often referred to as a 4-track system, it is probably simpler to think of as a 2-channel machine where either or both of the channels can be stereo. The main point is that it doesn't offer

three or four independent tracks. Also only one channel (mono or stereo) can be recorded at a time. It has a single stereo digital input and two stereo digital outputs, A and B. In each case they comply with the AES/EBU specification but will also transmit and receive SPDIF signals without a problem. There is a balanced stereo analogue input plus two balanced stereo analogue outputs.

Material is recorded onto disk as a self-contained file called a Take, which can be named. This Take can then be divided into as many as 50 Cuts with sub-frame or even sample accuracy, and again each Cut can be named. Then any number of Cuts from any Takes on the disk can be assembled—wild or against an external timecode, to create a composite whole—a song, film score, voice-over, sound effects fitted to picture, etc.

### Audio to go

If you intend your operation to be even vaguely busy, the advantages of having a removable recording medium are not to be underestimated. Most potential users are now aware of the uploading/downloading drawbacks with hard disk systems; any material to be worked on must first be uploaded into the system—that's generally a realtime operation. Then, at the end of the session everything must be downloaded to some

form of archiving medium—again, that's generally no faster than realtime. The reasons for this latter process are twofold: firstly, the programme has to be stored or possibly transported to another compatible suite for further work; secondly, the studio has to clear its hard disk to make way for the next session. For most people, scheduling an archiving period between sessions means an unacceptable loss of profitable studio time. One solution is to run some form of automated archiving routine overnight, but then who's to say you won't be working through the night? Even if the nights are clear you are always in danger of running out of disk space during the day unless you either stick to short, production-intensive jobs, or you have a huge amount of disk space. I know of one successful organisation blessed with two high powered hard disk systems. One has 6½ track hours of recording time, the other has 13 track hours. They are shortly to upgrade the first system to 13 track hours because they consistently have problems with disk space—an expensive exercise.

Given this context, the advantages of using a removable MOD cartridge as the main recording medium come sharply into focus. In the case of new clients it will obviously still be necessary to load any existing audio on to disk before operations can commence but once there, the cartridge can act as both operating RAM and archiving medium. Some doubts have been expressed concerning the cost of cartridges for archiving, and for long term storage it is certainly a little steep. What I'm really talking about here is storage for the duration of a project, and for a period after its initial completion. This is especially relevant for an in-house production where you might want to grab any spare couple of hours between sessions, or at the last minute when a session is cancelled, to do a little bit more. Currently, there is no facility to stream the *DD1000*'s full data set to any tape format. Obviously, you can digitally record the audio to tape without loss of quality but all the editing data will be lost. How much of a problem this would be in practice depends on the nature of the work. In many cases, once the final mix/dub has been completed, subsequent detailed editing will be unlikely. It's hardly ideal, however, and an archiving mode is on the list for future software updates.

The addition of a second disk drive is undoubtedly worthwhile for a number of reasons. A recent software update allows seamless recording across drives so that, by repeatedly overlapping drives, continuous recording time could be expanded infinitely. A second drive would also allow copying and compiling between disks and, if you intended to store sound effects and samples on MOD it would let you simply slip your effects disk in and directly access those files as part of a Cue List. With only one drive you would have to dump any required files to an external medium and then load them back on to your working disk before they could be used in an integrated way. Also, via SCSI, either drive can be used as a storage medium for data from other systems—mix automation, sequences, etc. While the 45 Mbyte removable hard drive format is

seen as something of a currency in the industry it is relatively unreliable. Personally, I would be very happy to have everything at least backed-up to MOD. And with the capacity ratio being about 14:1, the optical option is comparatively very economical.

## No tape recorder

Recording on the *DD1000* is not like using a tape recorder but rather more like sampling. Having entered the record page by pushing the dedicated button marked Record, you name your Take and then create a record 'Set Up', setting such things as sampling rate, stereo/mono, time log source and whether it's an analogue or digital input. These details can be saved to disk specifically for the Take you're about to record and can be recalled whenever you recall the Take in the future. Having established a Set Up, any subsequent Take will then be recorded to the same spec, unless you change it. Recording is started manually at the touch of a soft button. Currently there isn't an auto-trigger (amplitude threshold) or MIDI trigger to start recording, but they're in the pipeline for the next update. Once recording you can either abort the whole thing or press the Finish soft key to capture the data. Now you have a named Take which exists as an independent file. Any number of Takes can be named and recorded and are stored on disk in the order that you recorded them. While currently these can't be sorted alphabetically or numerically, there is a tagging system whereby each file can be tagged with a letter, A to Z, and is subsequently held in that letter group. Then, when looking for a file you can limit your search to a single group. This is particularly useful if you're storing large numbers of sound effects or samples and need to categorise them for speedy access. File sorting facilities will probably be expanded in future software. Having selected your tag you can sequentially run through the Takes on disk using the data wheel or the nudge buttons, their names appearing one at a time in the Take field on the screen.

To edit a Take you simply push the dedicated Edit Cuts button and you're given a wave form display automatically scaled to fill the width of the screen, irrespective of the Take's length. This is where you define your 50 (or less) Cuts. They can be as long or short as you like and overlap or not, and all decisions are non-destructive.

When you call up the Edit Cuts screen directly after recording, Cut 1 represents the entire Take. The extent of a Cut is very clearly highlighted on the screen. During the recording process, you have the option of entering, on the fly, three markers: Start, End and what's called the General Purpose Marker (GP). If you've taken the option, you'll find these entered on Cut 1. The Start and End points act to top and tail the Cut while the GP mark can be placed anywhere of importance—the start of a second verse or where you think there might have been a mistake, etc. You can then play the Cut from its start or from the GP mark. Any of these three points can be moved and, by progressively zooming in on a portion of the waveform, easily trimmed with

minute accuracy, down to a single sample. Each of the 50 possible Cuts has its own Start, End and GP markers.

The first 10 Cuts can be entered on the fly by punching the keys of the numeric keypad as you listen through on playback. Each key sets the Start point for the Cut of that number, and the Start of three is the End of two, the Start of four the End of three, and so on. Subsequently, you can call up each Cut (which is then highlighted on the screen) and accurately edit its Start, GP and End points as described. Using a combination of the data wheel and the nudge buttons, the whole process is quick and easy.

## One easy application

Rather than remain entirely in the abstract, I'll describe one application that I found for the *DD1000* that entailed recording a large number of fairly short tunes, each with a brief voice-over before and after it. The tunes were on a combination of a MIDI sequencer locked by EBU timecode to multitrack tape containing vocals and acoustic parts, and had been done before the arrival of the *DD1000*. With reference to timecode they were recorded at 4 minute intervals along the tape, leaving ample space before and after each tune for its voice-over. My task, then, was to start the first half of the VO so that it ended comfortably before the tune it was introducing. In a couple of cases the end of the VO actually counted in the tune, crossfading with it.

One simple facility greatly speeds up what might otherwise be the rather time consuming process of naming each successive take before recording it: 'Take 1', for instance, can be made 'Take 2' simply by placing the cursor in the Take window and pressing '2' followed by the Enter button. The same process works for any name with a number after it. Typing in a completely new name is not difficult: you enter the Letter mode by pushing the button of the same name, whereupon 26 of the front panel keys produce letters while the numeric keypad provides numbers.

The 325 Mbytes on each side of the MOD (you can turn the disk over to use the other side) shake down to approximately 53 track minutes, 58 track minutes and 81 track minutes at sampling rates of 48 kHz, 44.1 kHz and 32 kHz, respectively; you can halve those times for stereo recording. The subjective quality of ADCs and DACs is always open to debate, but I found the sound of the *DD1000* to be excellent. For my purposes I chose mono recording at 32 kHz—more than adequate for speech. The only thing to watch here is that you can't chain together Takes recorded at different sample rates so if needed to incorporate high quality music via the *DD1000* at a later date, I would be in trouble. Also, if I wanted to record digitally to an external medium from the *DD1000*, I would obviously need a machine capable of recording at 32 kHz. Usefully, the *DD1000* itself has onboard sample rate conversion facilities, so that you can record digitally from an assortment of 32 kHz, 44.1 kHz

and 48 kHz sources, and have them all on disk at the same rate. Once on disk, however, you can't re-record them digitally at a different rate (unless you go to and from an external digital medium to do it). Nor can you transmit digital data at a rate other than that at which it's been recorded.

Returning to the job in hand, each Take contained both halves of the voice-over. So during recording, as the voice artist commenced I hit the Start button, as he started the second half. I hit the GP button, finishing off with the End button. After every recording I flipped to the Edit Cuts page and, at the touch of a button, quickly saved the Cut/marker details to disk (Cuts are not automatically saved). Thus I had all my main points roughly marked out, ready for chopping into two discrete Cuts in the Edit Cuts page after the session.

One of the advantages of disk-based recording is the facility to execute non-destructive edits. You are free to fall upon your original recording, razor blade flying (figuratively speaking) safe in the knowledge that no permanent damage is being done. While this brings many rewards, there are times when a little destruction is a good thing. Dropping in (and out) in the middle of a phrase while recording a vocal or voice-over, for instance; or cleaning up page turns, coughs and mains spikes from a take. Currently, the *DD1000* has no facility to do this. If my VOs had been longer or the voice artist less proficient, this could have made things cumbersome. A 'tape recorder' mode is on the list of software updates to come within the next few months.

## Paste-up

There are basically two ways in which to edit together Cuts: the simplest is to create what is called a Song. This is accomplished in the Song mode where you can very quickly butt together Cuts, very much like a simple sequencer or drum machine. As the name suggests this mode is intended for editing music, to create extended mixes, etc, where sections of a song simply need to be moved around, repeated and butted up against one another. I used this mode to edit a couple of previously completed tunes which had been judged too long. One of them was an unaccompanied vocal with lots of harmonies and not much rhythmical definition. To do it with a razor blade would have been a nightmare. With the *DD1000* it was a comparatively simple matter of carefree trial and error.

Within a Song each Cut can be repeated up to 99 times, assigned to stereo output A or B and given a stereo position within it, given a fade in and fade out time and a percentage overlap, which moves the next Cut progressively back to overlap with the current one. This allows subjective, aural assessment of an edit's smoothness and timing/musical feel, rather than adjusting it by subframes.

There is a facility to have timing displayed as bars, beats and clocks and for all adjustments to be made in these units. You can enter the beats per bar, beats per minute and clocks per beat, so that the *DD1000* has a precise time reference, but as it stands the bar starts at the beginning of the



# LISTEN

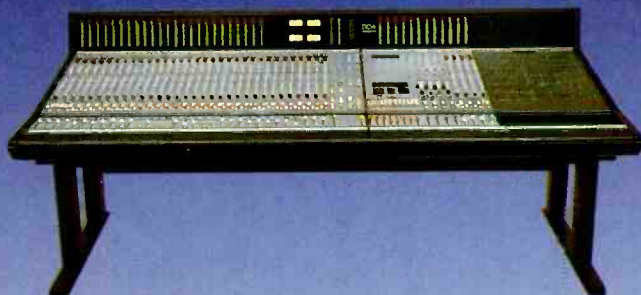

first Take, which is very unlikely to be correct. A future software revision will apparently include a number of extra facilities in this area. Obviously it would be very useful to be able to indicate the first down beat, and also, where a MIDI sequencer is part of the system, to use the *DD1000*'s MIDI IN socket to sync to MIDI timecode. Currently it will only sync to SMPTE/EBU. Even so, if you want to know roughly where you are in a song, it is of some use.

The other way to combine Cuts is in the Cue List mode. In fact, as you create a sequence of Cuts in the Song mode, the *DD1000* is automatically creating a corresponding Cue List, and this is one way of quickly pasting things roughly in place before finely aligning them via the Cue List. A similar level of control over each individual Cue is afforded in this mode, although you can also address and edit groups of Cues rather than just one at a time. The big difference is that the Cue List is timecode based; Cuts are laid down against a timecode reference. Going back a couple of stages—when recording material it is possible to reference its recording to an external timecode. This is clearly useful when laying off sound from a video or timecoded audio source, where you need to sync it up again at a later date. If it has been logged in this way, when it is pasted up in the Cue List it can either have its original timing, or you can slip it in either direction, or you can enter a new time altogether. The Cue List is also where the multitrack playback can be used, to have two mono or stereo tracks sounding simultaneously simply by having their timecodes overlap.

This was the mode I used to position my voice-overs. The length of each Cut is displayed in the Edit Cuts mode, and so it was a simple matter to start it at the right point to end just before start of the music. There was no really slick means of execution where the VO needed to count in the music. I positioned it quite accurately by calculation and then nudged it by frames and subframes to be aurally correct. Not that slick but still very quick. Again, a future software revision will allow a Take's GP marker to be placed at a specific timecode point on the Cue List, which would have been handy in this case.

There are a number of cut, paste and copy functions on the Cue List page which, increasingly as you get to find your own way of using them all in combination, get things moving very quickly. A new Cue is created by copying an existing one and then editing the details that aren't right. Thus, you don't have to completely type out each new Cue. Any field on the screen (a name, a number or whatever) can be copied at a key stroke into a clipboard memory, and then pasted into any other relevant field in virtually any other mode. You can have a Cue automatically butt up to the previous one, or have it so that it starts at a given point in the previous Cue (marked by the GP marker) so that, for instance, a sound effect can trigger on a particular beat of a musical passage (this did not apply to my situation because I wanted to place a point in a Cue on a specific future timecode point. This it can't currently do).

Another very useful facility is called Grab: the

most obvious application for this is when locking a Cue List playback to an external timecode—either a picture or an audio tape recorder. As you run the tape and the Cue List runs parallel to it, you use the Grab button to mark all points at which you're going to need to place Cues. When you stop the tape and return to your Cue List, all the new Cue points are listed at the end of the existing list, regardless of their timing, so you can clearly see the points you've selected. This is a wonderful tool for roughly spotting a video for effects or music inserts, etc. Then you subsequently go through and fill in the details of the Takes, Cuts and all the other parameters. Finally, a Sort function allows all Cues to be sorted according to time.

Similarly to many modern synths that use semi-hierarchical menus, access to a given page can be greatly speeded up by using the Tag and Jump buttons. On the *DD1000* these allow the user to mark any two menu pages, one with the Tag button the other with Jump, and then to toggle between them.

## Or simpler still

A third mode on the *DD1000*, called Playsheet, allows nine Cuts to be assigned to keys 1 to 9 on the numeric keypad and replayed simply by pressing them. The use of small solid state RAM buffers means that there's absolutely no delay. The zero key is reserved for selecting the next Playsheet of nine Cuts, and up to 300 Playsheets can be lined up. One simple application for the Playsheet mode is in the replacement of cartridge machines in radio stations, etc. An extension of that is for club DJs who could assemble their own cuts and mixes live, playing the buttons like an instrument. Well almost. In the music studio, parts could be flown in to a multitrack with ease. Or to integrate the process with an external MIDI system, a MIDI note can be assigned to each numeric key to allow parts of a song (or any other production) to be triggered remotely and for the triggers to be recorded to a sequencer and trimmed for timing there, or even quantised.

Also within the Playsheet mode there's a facility called Record To Q. This can be used rather like the Grab function so that, as you're running through your track or video, you punch the loaded buttons as and when you need your music, voice-over, sound effects or whatever, and all the details contained within each key are written to a Cue List, including the timing as related to the external timecode. That makes for very quick audio post-production. A limitation here is that you can't create a 'multitrack' Cue List in this mode; ie you can't trigger a new Cue while an existing one is still running, without cutting off the current one. For such applications the Grab function is better and, just to complete my production tale, this is how I positioned the VOs after each tune: I simply let the tune run through to completion and, after a suitable pause, hit the Grab button. It all worked very well.

Having created your perfect Cue List you can run it and re-record it as a single Take using the Retake function, still preserving the parameters

of each individual Cue. In this way you can, repeatedly if necessary, free-up a spare channel of the *DD1000* in order to add another layer of sound.

## Overdubbing

In many cases I imagine that the multitrack facilities of the *DD1000* will be used simply to play back two independently recorded files simultaneously. For instance, in my case I might have wanted to have music behind the VO or a few sound effects dotted here and there. However, there is also an Overdub mode where you can listen to one track while recording the other. Again, this is not quite as simple as with a multitrack tape recorder, although it is pretty straightforward. From the Record page, you allot a name to the overdub (Take) to be recorded, push the soft key marked Overdub and select the Cut to be played. You then set the in and out points for both the record and play tracks, hit Record and away you go. To play back the two tracks, you have to create a Cue List and enter the two 'tracks' as Cuts. If both are given the same timecode readings they will play in sync; or they can be slipped in the usual ways. (At the time of going to press new software allows any Take to be automatically entered in a Cue List, so that replay of an overdub, or any sequence of recordings, can be played back instantly).

A Help button on the *DD1000* brings instant advice concerning most fields on most screen displays. If you need more, the manual is very thorough and well written by Steve Howell and includes an extraordinarily complete index apparently the result of some new indexing software. It makes life so much easier—please take note all other manufacturers.

## The Mac front end

As I write this, two programs are currently being completed for the Apple *Macintosh* to allow control of the *DD1000* via the computer screen and keyboard. They should be finished by the time of publication. The versions I looked at were not completed and so any final judgement must be reserved. Given sufficient RAM it should be possible, using *Multifinder*, to use the software alongside other *Mac* programs—automation or MIDI sequencer, for instance. Thus it wouldn't necessarily entail the purchase of a dedicated computer.

There are a few good reasons for considering using a remote control such as the *Mac*. Firstly, the LCD screen on the *DD1000* itself (the same size as that on the *S1000* sampler), while actually surprisingly useful is relatively small and limited in what it can display. It requires that you spend all those operational hours just a few inches from it, and anyone else in the studio with you just has to trust that you're doing something useful. The idea of having a large, clear, colour monitor sitting at eye level just beyond the desk and a finely weighted tracker ball beneath your fingers, certainly has appeal. You can also generally show more information and look at several *DD1000* displays



"I need to automate  
my effects sends  
and EQ in"



The central computer section of the DCM224V console enables 24 channel functions to be automated dynamically against timecode.

Auxiliary on/off, EQ in/out, and pre/post switching are among the facilities which can be automated for frame-accurate repeatability.

For a demonstration of this remarkably flexible console call DDA, or Stirling Audio Systems in the UK.

WE LISTENED

DCM224V



by

**DDA**

a Klark-Teknik Company

Dearden Davies Associates Limited Unit 1, Inwood Business Park, Whiston Road, Hounslow, Middlesex TW3 2EB, United Kingdom. Telephone: 081 570 7161 Fax: 081 577 3677  
Klark-Teknik Electronics Inc., 200 Sea Lane, Farmingdale, NY 11735, USA. Telephone: (516) 249 3660 Fax: (516) 420 1863  
Klark-Teknik Singapore PTE, 7500A Beach Road, #04-308 The Plaza, Singapore 0719. Telephone: 293 9736 Fax: 293 9738

Distributed in the UK by:  Stirling Sdring Audio Systems Ltd, Kimberley Road, London NW 6 7SF Telephone 071 624 6000 Fax: 071 372 6370

# ENTER THE NEW REALM OF TONAL CONTROL

Announcing the MPE 28, MPE 14 and MPE 47 MIDI Programmable Equalizers

M

Meet the new generation of tonal controllers. More than mere equalizers, these are flexible instruments that actually give you power to enhance your music and your performance. Imagine a device that could give you this:

**CREATIVE CONTROL:** your guitar screams with sizzling brilliance on your lead cuts, then instantly switches back to a gutsy punch for your rhythm chops. Right on cue. And completely automatic through MIDI sequencer control.

**POWERFUL EXPRESSION:** the after-touch command from your synthesizer builds an earth-shaking rumble into the lingering sound. At your next patch change, the new voice instantly becomes crystalline with presence.

**CONSISTENT SOUND QUALITY:** you get the perfect PA sound at one of your regular clubs, then punch the EQ settings into memory. Next club, next button. Instant recall. Great sound.

This is but a small sample of the kind of magic you can achieve with the new MPE Series of MIDI programmable equalizers. The MPE 28 1/3-Octave design. The MPE 14 dual 2/3-Octave format. The MPE 47 four-channel fantasy machine. We've combined our proven leading-edge filter technology with micro-processor control and an exclusive built-in software package. The result: actual expressive capabilities never before achieved by any equalizer.

Discover for yourself the new creative dimension that an MPE Series tonal controller can give you. Then let your musical imagination soar.



**RANE**

10802-47th Ave. W.  
Everett, WA 98204  
(206) 355-6000



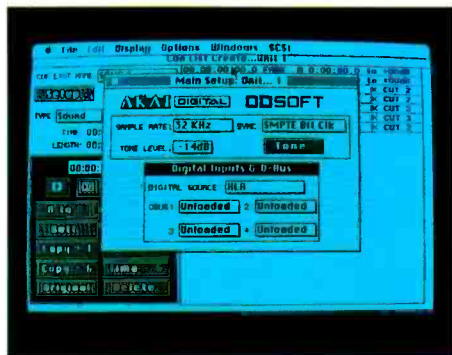
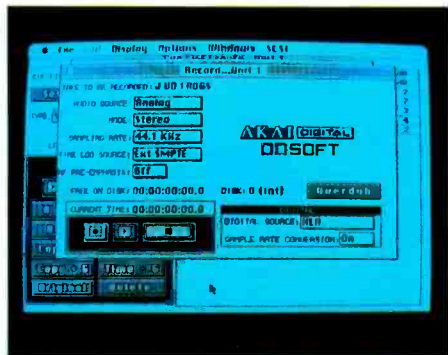

simultaneously. Entering names is far easier with the QWERTY keyboard and, along with the Control and Option combinations, it provides a very wide range of key combinations for direct access to specific menu pages and functions—once you've learned what they all are, of course. It will also be possible to run more than one *DD1000* from a single *Mac*, should you wish to expand, and then the larger screen would be of even greater significance.

Another consideration is that the cooling fan on the *DD1000*, and the comparatively gentle whirr of the MOD drive, combine to make a quite considerable noise level. It isn't exactly deafening, but it's certainly very much louder than a *Mac*, for instance, and if you've gone to the trouble of acoustically isolating all your noisy pieces of equipment, and to the expense of reasonably low velocity air conditioning, you probably won't want the crystal stillness spoiled. The problem may possibly be mitigated by mounting the *DD1000* in a solid and absorbent rack with plenty of cool air pumped in at the rear, where the fan is. Alternatively, you could shut it away behind a glass door somewhere, cool and insulated and operate it remotely from the *Mac*.

There are two software packages to be made available. The first, called *DumbDD*, simply emulates the *DD1000*'s display and allows full control from the computer keyboard. There are no extra displays or facilities, however. This should be very inexpensive and a version will also be available for the Atari *ST* using a double speed MIDI interface (the Atari has no SCSI interface).

The second package is called *DD Soft* and is substantially more complex offering the benefits of sophisticated displays and data manipulation. To run satisfactorily the *Mac* must have at least 2 Mbytes of RAM. Although the program will work with machines such as the *Plus* and the new *Classic* that use a 8 MHz processor, a processor speed of 16 MHz or more is advised to avoid noticeable delays with screen updates (the new *LC* or above should be fine). *DD Soft* won't be available for the Atari.

I should mention that, apart from the noise (I had the review model free standing, not in any kind of rack) I found working on the small inbuilt screen to be no problem. My limited experience with the *DD Soft* makes me think that it has to be a good idea for a permanent studio installation. The more information that can be

laid out clearly in front of you and the less ducking, diving, bending and peering that has to go on, the less tired the engineer/producer will get. It was also useful to be able to click on, say, the Take field, and be given a scrollable list of file names, rather than having just the single name field on the *DD1000* itself.

An alternative to the *Mac* route is to wait for the *DL1000* controller, due out later in the year, although this too has the same, limited LCD window. It will, however, include a pair of faders for manual control of fades and the ability to control up to seven *DD1000*s running in parallel.

## Final thoughts

With the current rate of technological advancement, we are all rather nervous about committing to any given line. With this in mind it's good to know that, with the *S1000* sampler, Akai have proven themselves very reliable in terms of the hardware and software they produce; the *DD1000* didn't crash on me once during the several weeks I was testing it, which is more than can be said for a number of other disk recording systems. Akai have also proved reliable in satisfying the requests of users with regard to free or affordable software revisions. The *DD1000* has so far received a very positive response from the industry together with a long list of useful suggestions for future software updates, over 20 of which have already been implemented, free of charge, since its release. We can be confident that most of the other important ones will be addressed, many over the next few months. The updates will probably be offered in the form of a ROM exchange, where you take your machine into the Akai appointed centre and they will swap old for new.

Akai are reticent to give dates for major additional facilities such as stereo Time Stretch, various forms of signal processing and the integration of the *DD1000* with major, computer-based MIDI sequencing software programs to allow the two systems to be addressed via the one screen. Discussions are underway, however. Updates that are simply improvements to existing functions will tend to be free of charge, while for major new functions there will be a modest charge.

While its 2-channel/4-track operation makes it more flexible than a purely stereo editing system, the *DD1000* is no replacement for a multitrack tape recorder; indeed it wasn't designed as such. But used in conjunction with multitrack tape it offers much of the power of far more costly disk based recording systems, at a very affordable price and, by its use of removable optical disks, greatly mitigates the problem of uploading/downloading time. There's also room for expansion. If and when you need more tracks, you can chain up to seven systems together under the integrated control of a single *Mac* or *DL1000*, to each of which can be attached seven disk drives. This expandability, coupled with its relatively low cost, unusual level of flexibility, and the promise of an exciting, ongoing programme of product development should make the *DD1000* an attractive proposition to a wide range of users. □

# THE

APRS  
STAND 023A

# NEW DIGITAL MASTER.



When it comes to digital multi-track recording, there's now a new master. The Otari DTR-900 II. New from the ground up. The DTR-900 II is the smallest, lightest machine of its type you can buy. It's compatible PD format gives you 32 digital tracks allied to the world renowned MTR-100A pinchrollerless tape transport. With all the service, support and reliability you expect from Otari, the choice of professionals throughout the world.

Only one thing is going to come as a surprise. The price. So you could have total flexibility by equipping with two DTR-900 II's with expandable remote control unit, given 32 or 64 track operation. Now recording studios, broadcast and post production facilities everywhere can afford to go digital, thanks to the Otari DTR-900 II. THE NEW MASTER.

UK: Sterling Audio Systems 071 624 000 · NORWAY: Benum 2 145 460 · SWEDEN: Intersonic B 74 458 53 · FINLAND: Studiotec (9) 0-592 055 · DENMARK: S.C. Sound 42 99 88 77 · FRANCE: SCV (1) B6632211 · ITALY: T.D.S. (2) 11 40 03 50 · GREECE: Bon Studio (1) 1602942 · SPAIN: Fading (1) 4086700 · PORTUGAL: Amperel (1) 5322227 · BELGIUM: LEM (2) 4665010 · AUSTRIA: Siemens 222-71715255 · SWITZERLAND: Audio Bauer (1) 4323230.

# OTARI

OTARI INC. 4-33-4 Kokuryo-cho, Chofu-shi, Tokyo 182, Phone: (0124) 81-8626, Fax: (0124) 81-8633, Tlx: J26604 OTRDENKI · OTAKI CORPORATION: 378 Vintage Park Drive, Foster City, California 94404, Phone: (415) 341-5900, Fax: (415) 341-7200, Tlx: 6503028 132 MCI UW · OTARI (H.K.) LTD: Unit 13, Elder Way, Waterside Drive, Langley, Slough, Berks SL3 6EP, Phone: (0753) 580777, Fax: (0753) 42600, Tlx: 849453 OTARI G · OTAKI DEUTSCHLAND GmbH: Rudolf Diesel Strasse 12, D-1005 Meerbusch 2, (Osterrath), Phone: (02159) 50861, Fax: (02159) 1778, Tlx: 8531638 OTEL D · OTARI SINGAPORE PTE. LTD: 625 Aljunied Road, #07-05 Aljunied Ind. Complex, Singapore 1438, Phone: (713) 7711, Fax: (713) 6430, Tlx: RS36935 OTARI · KING INSTRUMENT CORPORATION: 80 Turnpike Road, Westboro, Mass. 01581, U.S.A. Phone: (508) 366-9141, Fax: (508) 870-5932, Tlx: 94-8485.



# THE SIGNAL CHAIN

## Have you ever measured the performance of the longest signal path in your studio? Using a computer model Ben Duncan illustrates the potential for uncertainty and accumulated response deficiencies in analogue electronics

Equipment designers, maintenance engineers and reviewers put a lot of effort into measuring discrete equipment and the component parts therein. By and large, the results are widely disseminated in the makers' sales and technical literature; and in the review pages of journals. By contrast, formal studies of the performance of cascaded audio stages are virtually unknown while *ad hoc* measurements of complete electronic signal paths in systems are carried out solely by conscientious owners and their maintenance crew; and by reputable studio installers.

### Complete system measurements

There are at least four good reasons for the absence of widely circulated overall system performance data, both for recording and PA setups. First, finite resources usually thwart any attempt at a truly comprehensive set of measurements because there are just too many potential permutations. Second, even if a sophisticated audio tester (like Audio Precision's) is used, there may not be any inclination to spend time printing out and organising reams of hard copy. If a few major configurations produce plots and figures that look OK at a glance, why bother with the extra clutter? Third, the measurement results are confidential. They might be less than perfect! Fourth, the performance at the time of measuring is a fleeting, fairly arbitrary series of snapshots of a specific setup, one that's only valid (at best) until the next time a cable or patch or outboard routing configuration is changed; or channel strips are swapped around; or a new console or crossover gets installed. . .

As studio setups have become more convoluted,

the instincts of the home audiophile have been diametrically opposed: to minimise the number of components in the chain. This is no fancy; the minimalist approach to home hi-fi has been developing for over a decade. A number of perfectionist recording engineers have followed a parallel path, preferring to avoid passing the signal through any more equipment and processes than is strictly essential. Are these people Luddites, merely fooling themselves that less technology sounds clearer? Or could they be on the right tracks?

The performance of large signal chains in recording studios begs attention, not just because the phenomenon hasn't been discussed much in print, but also because the end result isn't (for most people) necessarily what you'd intuitively expect, given the specifications of the constituent equipment. In some ways, it will be worse; in others, better than you might anticipate.

It's quite a feat to make satisfactory and rigorous measurements on a complete studio or PA system setup. Solving inevitable snags with grounding, polarity and interconnects rapidly eat into the time budget, as does the need to re-run any measurements that don't 'feel' right. Finally,

TABLE 1 24 stages—a breakdown

- 1 Channel input
- 2 Channel insert buffer
- 3 Channel fader buffer
- 4 Mix amp
- 5 Subgroup mix-amp/buffer
- 6 Group mix-amp/buffer
- 7 Output buffer
- 8 Tape input buffer
- 9 Tape processing
- 10 Replay processing
- 11 Tape output driver
- 12-18 As 1-7 above
- 19 Monitoring EQ input buffer
- 20 Monitoring EQ output driver
- 21 Crossover input buffer
- 22 Crossover output buffer
- 23 Power amplifier input buffer
- 24 Power amplifier output stage

the results are likely to be circumscribed by the existing setup; one cannot readily add substantial amounts of equipment or rewire someone's studio without good reason. Then the advantage of measuring a real, working situation is lost. So the question is, do we need to measure a real working setup to get an initial feel for what's happening?

### System modelling

In this article (and without ruling out measurements of a real studio in the future) the answer is no. Instead, computer-driven circuit simulation has been used to model and render visible some of the performance specifications that demand exploration. Circuit models built on anything short of a Cray (supercomputer) can't be expected to replicate every detailed nuance of real equipment comprising many thousands of components and parasitic elements, but then they don't need to. Practical circuit models are judicious simplifications, in this case designed to include all the elements that significantly influence the audio specifications under scrutiny. For software, I have used Spectrum's *Micro-CAP III*, which has been developed over 11 years and is arguably the friendliest and most powerful electronic circuit simulator for use on a PC or Mac. Still, like any simulator, it can take hundreds of hours to learn how to fly without crashing or going places you didn't expect. . .

Modelling involves first devising and drawing a suitable circuit on the screen. The network's nodes are automatically numbered. The data on connectivity and component values is then 'Parsed', converting it into a 'SPARSE'\* matrix. The machine's co-processor then churns through millions of computations, iterating for each time point until a high level of accuracy is certain. In a matter of seconds, the circuit's predicted response in the time or frequency domain is plotted on the screen. Realistic details (such as cables) can be individually modelled and tested and then progressively inserted. By appending tolerances to the component values, *Monte Carlo* statistical routines can be used to generate multiple plots, showing the outcome of normal (Gaussian) or worst case spreads in the part values. In this way, the computer can 'build and test' hundreds of circuits, plotting the performance of a population that includes freak 'Friday Afternoon/Monday Morning' specimens.

A notable benefit of circuit simulation is that it's noise free, so effects and inflexions lurking below the noise floor are fully revealed. Also, the 'signal generator' and 'test analyser' have perfect

\*SPARSE: A matrix so called because a majority of the placeholders are filled with zeros

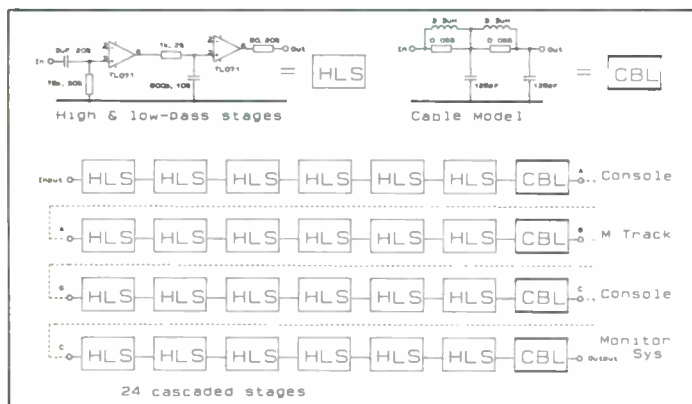

FIG 1: Model of a studio equipment chain

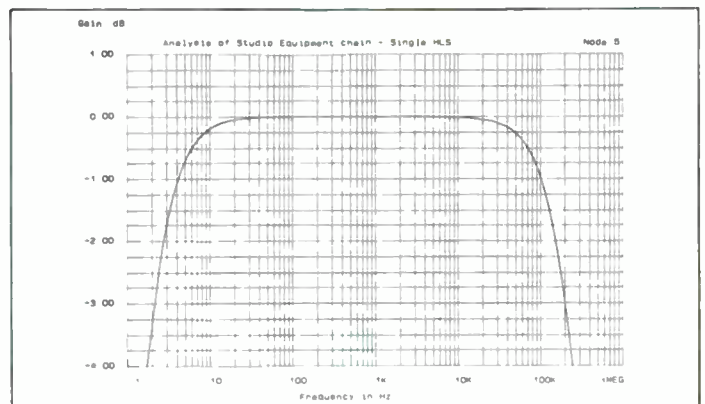

FIG 2

connections, free from parasitic impedances and any phase or timing error. Overall, it's a compromise between the complete abstractions (and potential for obsfuscation) of mathematics, and real systems, with their infuriating tendency to develop irrelevant performance variations (eg dodgy or mistaken connections) during critical measurements.

## Band constriction

No less than in individual equipment, the frequency response of a complete, reference standard audio system should be equal throughout the audible range of frequencies, from 20 Hz to 20 kHz. At the same time, frequencies below and (especially) above need to be disposed of. To achieve this without exciting the system's time/transient response, brute-force is out. For individual equipment, the initial roll-off needs to be a gentle slope, progressively attenuating the immediate out-of-band signals at no more than -6 dB/octave, ie a first order response, ideally Bessel. A conflict arises once it is appreciated that the attenuation begins several octaves before the -1 dB point is reached. Attenuation in this lead-in zone is always a fraction of 1 dB, but spread so wide, it's enough to colour the system sonics if allowed to occupy either end of the audio band. The amplitude rolloff's lead-in is accompanied by a small but increasingly significant phase shift numbering tens of degrees. Faced by this, some equipment designers opt for a wide window, placing the -1 dB points well below 1 Hz and above 100 kHz, so the response is less than (say) 0.1 dB down at the audible extremes. Others live by the motto 'The wider you open the window, the more the dirt blows in'. So it's not uncommon to find the response of some pro-audio equipment to be -½ dB at the band limits. In particularly noisy circumstances, notably D/A conversion, or to dispense with pops and blasts in vocal recording, there's no dispute about the need for a bold

roll-off but it can be tailored with greater and lesser degrees of subtlety.

Now, what happens when four or more items of equipment are cascaded, each containing multiple bandwidth defining circuitry? Looking at the top left of Fig 1, the generic circuit block 'HLS' comprises a pair of unity-gain stages with alternate RF filtering and DC blocking. Overall, it gives a buffered low- and highpass response, like many of the individual stages inside real equipment. Looking below at the signal path schematic, 24 HLS are cascaded. Table 1 details how they can be taken to represent the analogue (and purely electrical) signal path sequence from the front-end of the console, through the multitrack electronics (excluding the tape path and heads), to the back end of the monitoring chain. The following simplifications are assumed:

- there are no transformers;
- all EQs and filters are switched out;
- there are no FX processors in the path;
- crossover filters are excluded

The 24 HLS have been grouped into four blocks, symbolising the console, multitrack, tape returns and the monitoring system, coupled together with three 2 m/6½ ft lengths of standard foil-shielded cable (boxes marked 'CBL' in Fig 1). In many ways, this is an optimistic model.

Fig 2 shows the nominal response of an individual HLS block. With the amplitude just -1 dB down at 4.1 Hz and 100 kHz and less than -0.1 dB at 20 Hz and 20 kHz, the bandwidth is generous enough. Turning to Fig 3, the phase response is equally faultless at 0°, ±6° throughout the audio band. Group delay is 1 µs above 3 kHz, rising monotonically to 1 ms at 20 Hz. So far, not bad.

## 24 windows later

When 24 such stages are connected in series, the bandwidth is not so wide, as you might expect. How bad is the damage? Looking at Fig 4, the

response is now -1.2 dB and -1.1 dB at 20 Hz and 20 kHz respectively. It would pass unnoticed with drama and speech but isn't so acceptable for a serious music recording facility. And if just one item of equipment in the chain has a narrower response than that shown in Fig 2 (in proportion to the number of effective HLS it contains), the premature frequency response curtailment will be even greater. Now the performance irregularities of tape heads and loudspeakers may numerically outstrip response deviations of this kind. But it needn't mask them; numeric superiority is no measure of exclusive or even dominant audibility. And if a modest change in the electronics can provide an invariant, precision platform, so much the better for transducers and their designers.

The home audiophile swears blind that his equipment has to be powered up for several hours to optimise its sonic quality. So much, that he never turns it off. Fig 5 lends support in the context of a complex system, showing how the bandwidth of our studio model varies from when the equipment (maintained when off at a steady 20°C by the air conditioning) is first switched on, to the point of maximum internal temperature (50°C), occurring several hours later. The visible difference occurs solely below 100 Hz, with the response at 20 Hz increasing by ½ dB as the system warms up! Once again, narrower bandwidths would shift the effect higher. In weighing the significance of this, it's useful to note that at low bass frequencies, and subject to adequate SPL so they are audible in the first place, a mere 5 dB increase is perceived as a doubling in loudness, so on this basis, a ½ dB change is more like a 1 dB change at mid frequencies. In Fig 5 the variation at HF is too small to be visually discernible, because the model assumed the small capacitors used would have a low temperature coefficient, eg polystyrene types. However, if all the circuits' HF rolloffs were defined by mylar (polyester) or worse, ceramic capacitors (as is common in older equipment, particularly of US origin) the

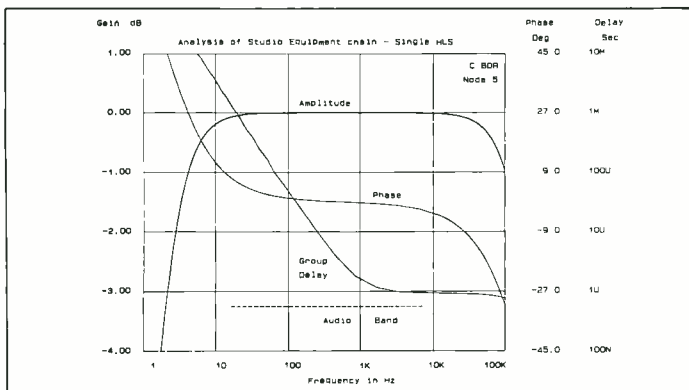

FIG 3

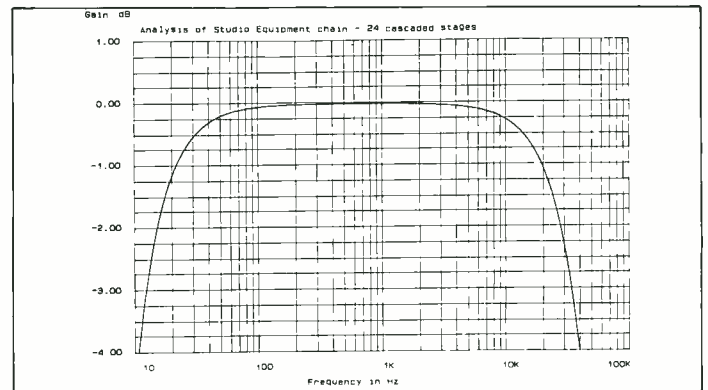

FIG 4

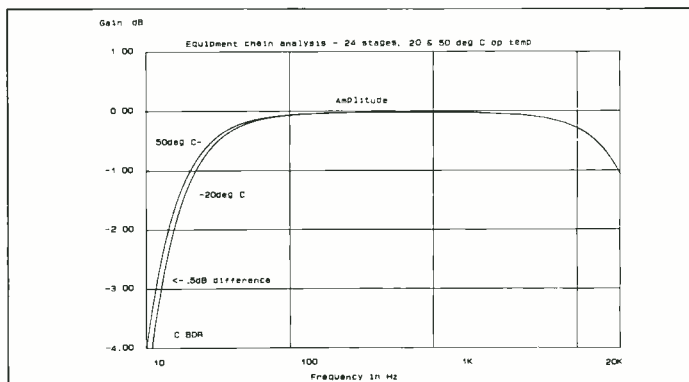

FIG 5

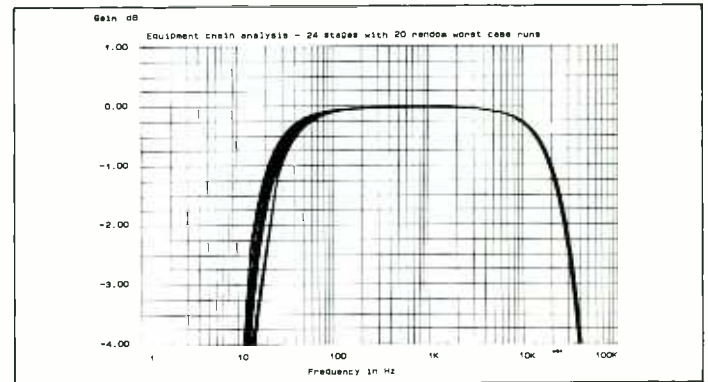

FIG 6



variation would be much larger, although still not as great as at the bottom end.

## Tolerances and time smearing

Hitherto, the effects of manufacturing tolerances and variations on the performance of a given equipment combination have been limited to calculated guesswork or politely shrugging it off. To get a general picture of what happens (with computers, it's still guesswork but many times more to the point) realistic tolerances were appended to the 192 components in the chain model. Fig 1 cites tolerances for each HLS, while the cables' capacitance and inductance were set to vary up to  $\pm 50\%$ . Fig 6 then predicts bandwidth variations with 20 randomly selected worst case combinations. Working with high accuracy, a multiple plot of this size with so many components takes several hours and involves many Mbytes of data. Yet the worst deviation is less than you might expect with so many variables—although after many more samples (or 'runs') an even worse sample might emerge. Mercifully, the central limit theorem—a tool of statisticians—indicates that there's a sharp limit to the worst case variations in complex systems. The graphs show that the LF (highpass) response varies more than the high end roll-off, mainly because of the broad tolerances of the electrolytic capacitors universally used for DC blocking. In fact, the LF response's  $-2$  dB point can be seen to vary over nearly one octave, from 14 Hz to 22 Hz. This degree of variation would become distinctly disturbing in any system with a more limited bandwidth, as it would be displaced rightwards into more 'crucial base' frequencies.

Fig 7 includes phase and group delay plots and 'zooms out' to display the broader picture for amplitude. Successive highpass filtering has made

the group delay over  $10\times$  greater. It's now  $20\ \mu\text{s}$  above 3 kHz, and 10 ms at 20 Hz. Meanwhile, the 2 kHz corner and the shape of the trajectory are unchanged. Phase (relative to the input) is a whopping  $1440^\circ$ , or nearly four cycles in the midband, and is shifting between  $200^\circ$  and  $400^\circ$  at the extremes of the audio spectrum. Even if bandwidth isn't curtailed enough to detract from the fullness of a type of music, up to 10 ms of group delay and a phase shift approaching  $4\times 360^\circ$  is worrying. Turning to amplitude, notice the steepness of the out-of-band roll-off. Between 20 Hz and 2 Hz, the response dives by over 115 dB. The principal slope at both extremes is now between  $-54$  and  $-72$  dB/octave. Shouldn't this affect the transient response?

In Fig 8, the simulator's transient analysis routine has been used to take a snapshot of signal transmission in the time domain, beginning at the beginning, when  $T=0$ . It shows the answer is no. The cascading of multiple first order roll-offs gives steep ultimate rates of attenuation without any loss of control. In fact, the output's leading edges are no longer square but rather rounded. Notice, too, how the output is delayed differentially by between 15 and  $30\ \mu\text{s}$ . Fig 9 is another snapshot, this time covering the first 1.5 ms of an HF music waveform, something akin to  $1/1000$  second portion of a hi-hat's 'zishhh'. The same 15 to  $30\ \mu\text{s}$  delay is evident. The harmonic structure appears to be intact but a longer 'time window' might show otherwise. Fig 10 shows a similar complex waveform but  $7\frac{1}{2}$  octaves lower (around the low notes of an electric bass) and spread over  $1/10$  second. The absolute delay is now far greater and clearly varies as the programme progresses, depending on the dominant instantaneous frequency component. The delay's highest value is 8 ms in the lowest frequency portion at the leading edge of the wavetrain. The delay then fluctuates between 0 and 5 ms. This is time smearing, often banded but rarely pictured so graphically. Overall, the model shows how

musical signals passing through it are subjected to a delay that increases to encompass musically significant periods with decreasing frequency, while the delay itself varies in time according to the frequencies present! The large scale cascading of band-limited equipment creates a nasty mess sensitive to our ears in varying degrees.

Fig 11 revisits the squarewave to demonstrate how the delay might vary with manufacturing tolerances, for 10 randomly selected worst case systems. Insofar as a substantial part of the signal chain comprises separate paths for individual channels, groups and stereo signals, the spread in the curves indicates the extent to which any two channels could be displaced in time. At under  $10\ \mu\text{s}$  worst case, it doesn't appear very serious but it might be enough to upset stereo localisation at high frequencies.

## Noise in concert

The dominant source of noise in competently designed analogue audio circuitry is from the active devices. At most, the difference in noise output between the standard bipolar (eg *NE5534/5532*) and BiFET (eg *TL071/051*, *LF351*) op-amps is no more than 12 dB. Excepting EQ circuits set to boost, the noise output of most individual stages stands a high chance of being of a similar level, assuming that stages needing appreciable gain ( $>+10$  dB) employ low noise devices (like *NE5534* and even better), whereas BiFET op-amps are commonly restricted to positions requiring unity (0 dB) or slight make-up ( $+2$  to  $+5$  dB) gain.

The individual noise sources are wholly random (for simplicity we'll disregard esoteric factors like mutual resonance in disparate crystalline semiconductors and plastic dielectrics) so assuming most of the stages in the chain do have a similar noise output, when they're cascaded the build up in noise at the ultimate output is brisk

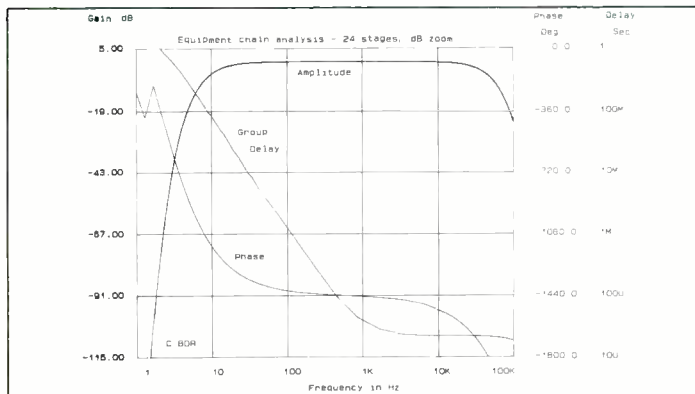

FIG 7

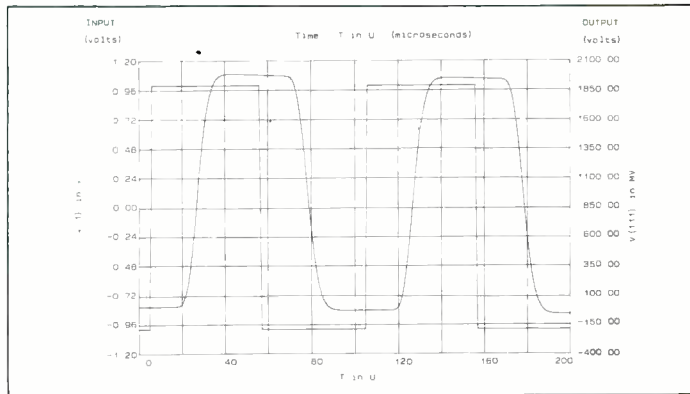

FIG 8

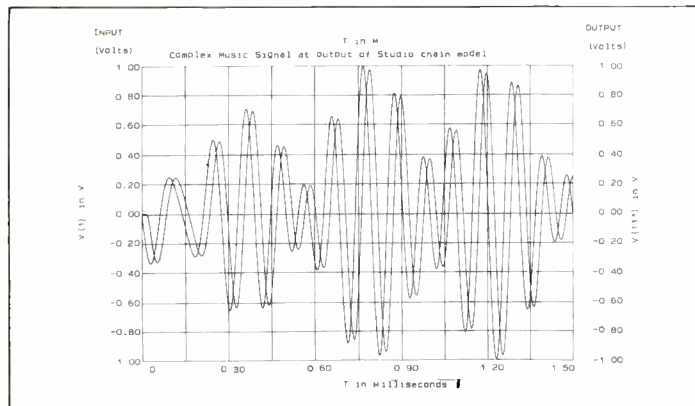

FIG 9

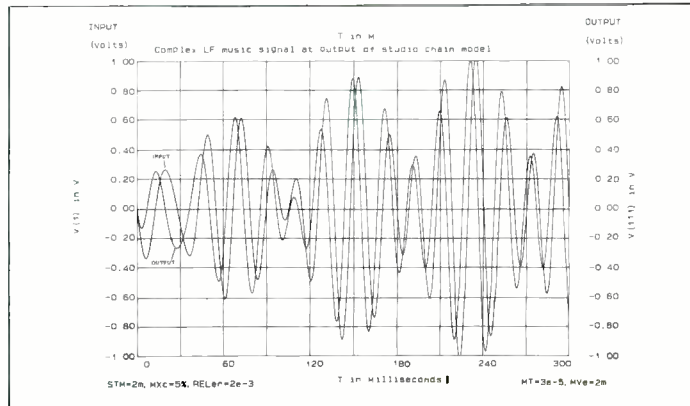

FIG 10

for the first few stages. But for each extra stage the added noise is proportionately less. This is one occasion when the law of diminishing returns is on our side. Human perception of system complexity is linear and arithmetic, while noise build-up follows a more leisurely equation. And any stages or subsidiary noise contributing parts (such as resistors) having a lower noise output (say >10 dB below) won't appreciably contribute to measurements or have any significant audible effect unless there are a lot of them, at least more than eight.

Overall, each doubling of the number of stages or noise generating components degrades S/N by just 3 dB. For a typical circuit yielding a noise figure of (say) -115 dBu, a seemingly large cascade of 64 identically noisy stages will only in theory degrade the S/N by 15 dB, to -100 dBu. In practice, mixed down channels are included in noise summation (whereas they don't affect bandwidth), so many more HLS are summed together—maybe another 80 when 16 faders are set at similar positions. Still, the build-up of noise is less than you might expect. Looking at Table 2, you can see the worst of the damage is over before the signal gets very far. The proportion is such that when the new generation of op-amps, with noise figures 10 dB lower than the norm, begin to appear in analogue equipment chains, the potential will exist for either reducing noise as if you'd reduced the number of cascaded stages in the system by eight times or being able to increase the length and/or breadth of analogue system chains eightfold while maintaining a given noise floor.

## Distortion

Simulation can be used to predict distortion but the modelling required is more intense requiring op-amps to be entered as dozens of discrete transistors. In lieu of simulation or measurements on an actual system, what are the preliminary observations? Well, individual distortion harmonics will add in a complex fashion, depending on their order (2nd, 3rd...13th, etc), magnitude and the progressive phase of the signal. Accordingly, the overall THD figure of one studio set-up compared to any other can be expected to vary widely. For example, if

TABLE 2 Noise build up

No of stages (mixed & cascaded)	Cumulative increase	Output noise arbitrary starting point
1	—	-115 dBu
2	3 dB	-112 dBu
4	6 dB*	-109 dBu
8	9 dB*	-106 dBu
16	12 dB	-103 dBu
32	15 dB	-100 dBu
64	18 dB	-97 dBu

\*The perceived noise level doubles here

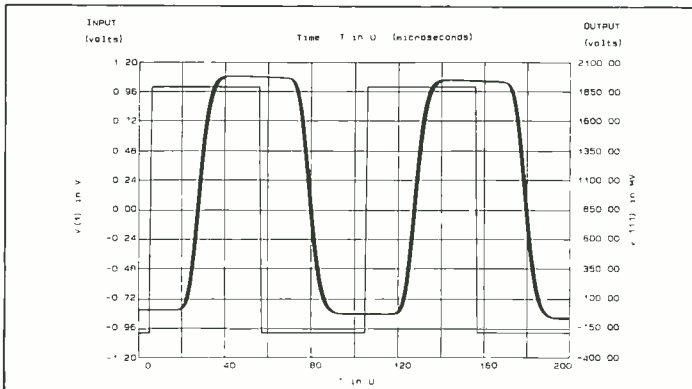

FIG 11

each stage generates only very high harmonics (due to very high feedback) and these are only large enough to be individually significant with signals above the midband (ie >1 kHz), then the HF/RF filtering of successive stages will mean harmonics are mostly attenuated away before they have a chance to build up or create even more complex intermodulation products.

## Ramifications

In setting out not to be sensationalist, the frequency response of a good deal of pro-audio gear, particularly outboard processors, is more modest than has been modelled here. It's enough to impair the response of an intensely populated studio equipment chain more severely than has been demonstrated. Too often, manufacturers have not needed persuasion to cut low frequency extension to the bone because it saves a few pennies on elcaps. Or they may subject it to ruthless filtering because a minority of users (or their monitoring or PA speakers) are having problems with handling the low bass parts of 'real' music. It's a recurring problem with vented 'Thiele-Small' enclosures. Protective -12, -18 or -24 dB/octave—highpass filters are especially damaging to the phase/time response when they're repeated unnecessarily. Only one should be needed to protect the bass drivers. However, more than one may be present by default, lurking in the monitor system's graphic EQ, crossover and power amplifier. Maybe the installer felt more was better, or forgot to switch them out.

To provide a high standard target response for an entire system—one that's never more than -0.2 dB down at 20 Hz and 20 kHz in a worst-case equipment configuration—bandwidths of all the internal stages could be increased by a factor of  $\times 5$  to  $\times 10$  over the generic circuit in Fig 1. For equipment inputs though, this would seem to be disastrous, leaving the system more open to RF energy at diverse points, though modern op-amps with high gain-bandwidth products and (especially) J-FET front ends, are relatively immune to RF up to at least 1 MHz. What is needed above 20 kHz is an almost flat interval up to a decade above (ie to 200 kHz), so treble harmonics don't suffer unduly in the system chain. The decade above audio is followed by a lazy roll-off (circa -6 dB/octave), turning into a much steeper descent above 1 MHz, so discrete equipment can reject RF garbage to a high degree while its individual contribution to audio band roll-off is miniscule. Moreover, transient response must be well damped. How closely can this particular sphere be boxed? Fig 12 shows the response of a possible input filter, developed in hours rather than days by iterative simulation. Using just a handful of extra passive components, RF frequencies above the shortwave are

attenuated in excess of -60 dB, up to a predicted maximum in excess of -100 dB, while the response dip at 20 kHz is only -0.042 dB. If a standard HF response curve of this kind were agreed upon for 'Grade A' recording equipment, and implemented, equipment designers could look beyond their noses and tailor the performance of discrete equipment in the context of a reasonable estimation of the whole for once.

At low frequencies, and assuming the studio is decoupled from environmental rumbles, a global bandwidth extension into subsonic realms is less hazardous, given that switchable highpass filters can be applied to any channels really needing it. Reducing the roll-off frequency of the dominant DC blocking capacitors by just one order of magnitude would also diminish the significance of capacitor tolerance, pushing the accompanying variations out of the audio band. A lot of equipment is still coupled internally and profusely with DC blocking capacitors, as a precaution against the ICs' DC offset voltages stacking up to create pips, pops and 'splatts'. With modern precision op-amps, precautionary DC blocking wouldn't be needed. The culprits are the NE5534/5532 and clones. Their input offset voltage and current lags behind modern devices by a factor of 10 to 10,000 fold. By daring to install 1990s IC technology, the hundreds of internal DC blocking capacitors per average console (or multitrack, graphic or crossover) would become redundant and could be cast out. Having rebuilt your system in this manner, you might even notice the bass sounds tighter, less smeared; the low mid that 'never did sound right' does and your favourite 'sonic optimiser' doesn't affect the sound in quite the same way as it did.

Overall, plugging together  $n$  items of equipment that is adequately specified by existing standards provides no assurances that the whole system will have an ideal audio performance. This investigation hopes to illustrate some of the hidden costs of system complexity and conversely, the benefits of minimising the amount of equipment in any individual signal path. In showing the cumulative effect of small details, it should give installers and owners something to think about when specifying equipment, wiring it up or planning revamps; and to equipment manufacturers and designers, in setting specifications that involve a deeper cognisance of the needs of the whole. □

### References

Duncan B, 'MicroCAP III under test', *Electronics World & Wireless World*, Jul 1990  
 Ott H, *Noise Reduction in Electronic Systems*, Wiley, 1977  
 Brown, J W, 'The effects of cable on signal quality', *Sound & Video Contractor*, Sep 1990  
**Acknowledgements:** Michael Gerzon, Neil Grant, and John Szymanski at Spectrum Software, USA. All graphs produced using Spectrum Software's *MicroCAP-III* analogue circuit simulator program.

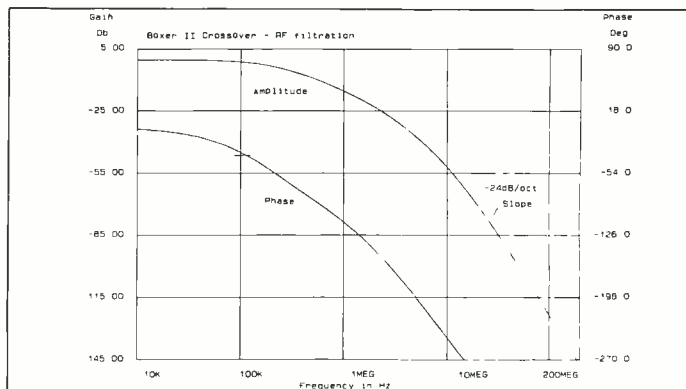
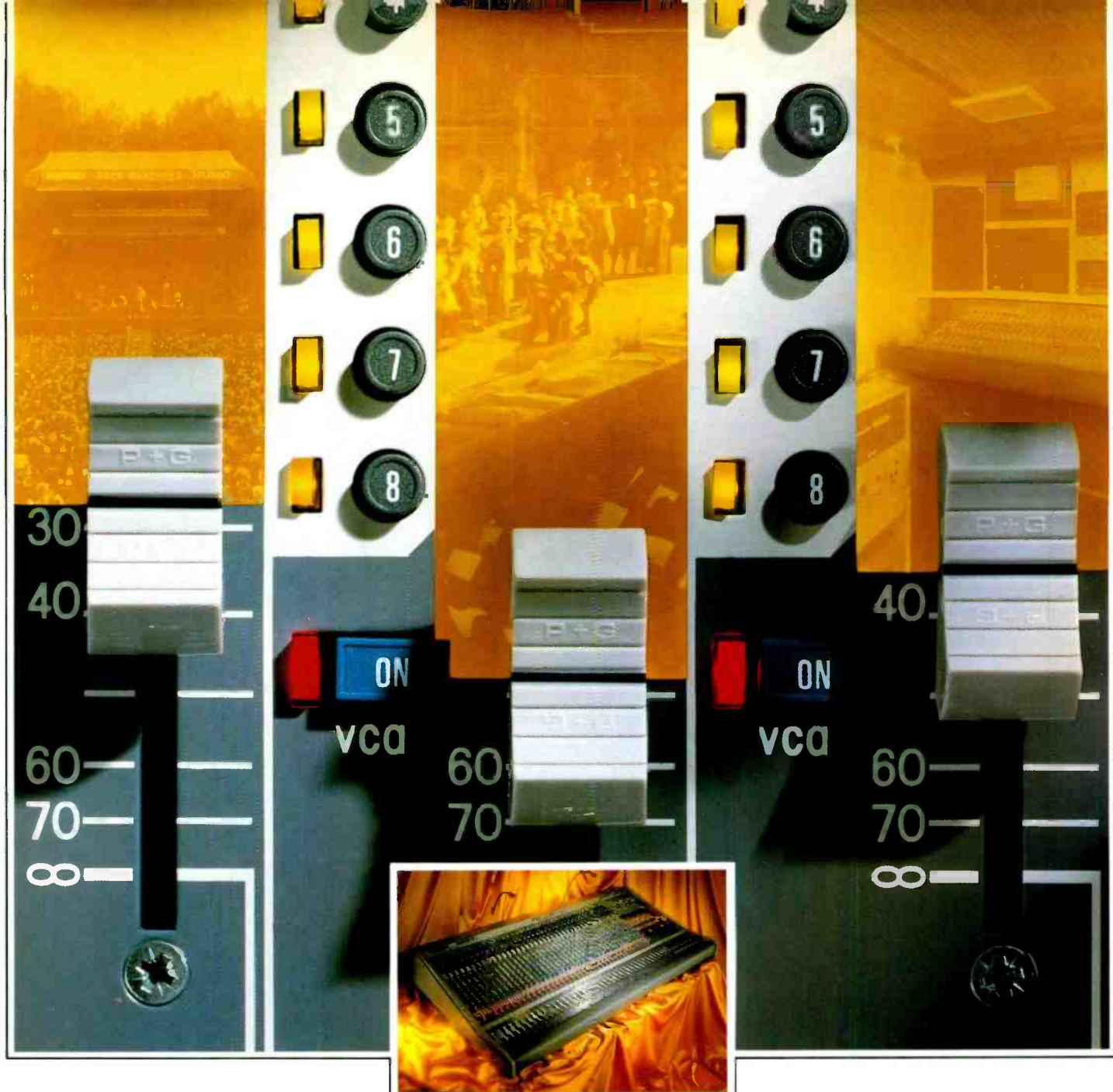

FIG 12





# Every performance needs the Midas touch

The new Midas XL3 Live Performance Console is a remarkable step forward in console design.

Created by Midas and Klark-Teknik, it combines in one console front of house and monitor mixing for live performances in sound reinforcement, theatre, major installations and broadcast.

For each input channel, no less than 18 sends can be individually routed to 16 fader controlled outputs which function either as sub groups or aux send masters assignable

## *XL3* LIVE PERFORMANCE CONSOLE

via 2 VCA output groups into stereo masters. In addition, any input can be assigned directly to stereo masters and 8 VCA sub groups. That's why the XL3 is the only console that can give you a 40 channel front of house mix on 8 right and 40/18 channels

of monitor mix the next. And if you need further outputs, the Midas XL88 external 8 by 8 line level matrix mixer provides the perfect answer to signal distribution in any live environment.

Add to this outstanding versatility, a crystal clear, logical control surface, plus Klark-Teknik's renowned electronic design and the result is a console with superb sonic performance that's pure joy for the engineer.

Call Midas today and experience the Midas touch for yourself.



# Ready to Rack™



**Sixgate™.** Six noise gates in a single rack unit package. Ultra low noise and fast. Features include Key Inputs/Sidechain Inserts.



**Quadcomp®.** Four compressor/limiters in a single rack unit package. Features include balanced Ins and Outs, Sidechain Inserts, multi LED gain reduction metering and stereo linking.



**Multi Q™.** Six channels of parametric EQ, with exclusive internal patching system to link channels without patch leads. A unique creative tool for any EQ situation, in one rack unit. Balanced Ins and Outs.

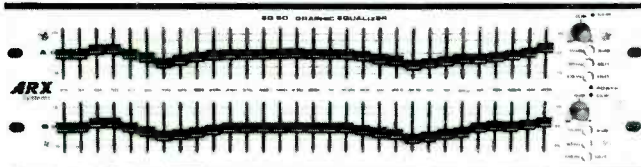

**EQ 60.** Dual channel 'Constant Q' graphic EQ. Balanced Ins and Outs, compact design, and ultra Low Noise circuitry. The EQ that DB magazine called "The most accurate we have ever tested" Hear it for yourself!

## ARX Systems

USA and Canada		Germany	
ARX Systems USA	714 649 2346	ARX Germany	06 174 23433
Great Britain		Italy	
MTR Ltd	0923 34050	Armonia Nova	39 51 765 068
Spain		Austria	
Excel SA	811 2563	MTEC	43 7242 60860
Belgium		Sweden	
Eurocase	3 239 6995	Tal & Ton	(0) 31 80 3620

Introducing

## The Amazing New Frame Master Plus

### Time-Code Calculator for Film and Video Professionals

Put an end to complex production problems with the all-new **Frame Master Plus™** Time-Code calculator. Designed specifically for video and film professionals, it is ideal for everything from finding Durations to Edit Decision Lists to Logging Tapes — even On-Line Editing!

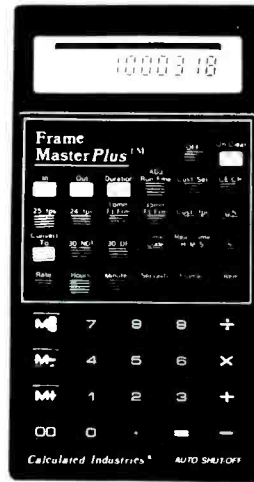

### The New Frame Master Plus:

- Works Directly in 30 Non-Drop-Frame, 30 Drop-Frame, Frames and Real Time (H:M:S)
- Converts Between Non-Drop, Drop, Real Time and Total Frames
- Features Manual or Auto-Entry. Just Like an Editor
- Figures Rates/Costs for Any Time/Time-Code Format, Including Frames
- Calculates Edit Points with In/Out/Duration Keys
- Frame Rates
  - ✓ 24 frames per second
  - ✓ 25 fps (PAL/SECAM)
  - ✓ Custom (user-set) fps
- Feet-Frames
  - ✓ 16mm
  - ✓ 35mm
 Including Full Conversions
- Adjusted Running Time Multipliers/Frame Rates and % (Percent Change)
- Continuous Memory and Display Retention
- User's Guide, Carrying Case, Long-life Batteries, Auto Shut-Off, 1-Year Warranty

European distributor:  
Burnie Productions  
Postbox 643  
5400 AP Uden  
The Netherlands  
tel. \*\* 31 4132 60264  
fax. \*\* 31 4132 51950

SEE US AT



JUNE  
5th - 7th 1991  
OLYMPIA 2, LONDON  
Booth 176 A

## M.S. AUDIO

### EUROPE'S LEADING SPECIALIST IN USED PRO-AUDIO EQUIPMENT

### NEW YEAR BARGAINS AT M.S. AUDIO

- LYREC 532.** 24 track. Auto/remote. This machine has undergone a full major overhaul in the last 6 months costing £4000.00 including new Lyrec heads. **Bargain Price: £5,750.00**
- LYREC 532.** 24 track. 16 memory autolocator. 6500 hours. Private use only. Excellent condition. **Bargain Price: £5,000.00**
- KLARK TEKNIK DN780** reverb. **Bargain Price: £995.00**
- SCAMP** equipment including racks/ S01, S03, S04, F300, S100 modules. **Phone for Bargain Prices.**
- BARGAIN AMPLIFIERS:** Harrison X11000 new. **£650.00**  
QUAD 405 2. **£250.00.** YAMAHA PC 2602. **£375.00**

IF YOU DON'T SEE WHAT YOU WANT  
PLEASE RING MIKE OR JENNY

**RING NOW  
ON  
(0932)  
872672/874768  
FOR MONTHLY  
MAILSHOT**



NORTH LODGE, STONEHILL ROAD, OTTERSHAW, SURREY KT16 0AQ.  
TEL: 0932 872672. INTERNATIONAL + 44 932 872672  
FAX: 44 (0) 932 874364

### MASTERING MACHINES

- \* Please telephone for complete list of mastering machines including:
- OTARI MX55. 1/4" with CTC. 15/30 ips. As new. **£2,750.00**
  - STUDER A80-VU. 1/4" 15/30 ips. Very low hours. **£2,250.00**
  - SONY D1C1000ES. Dat. Ex Demo. 2 machines available. **£875.00 each**

### OUTBOARD EQUIPMENT

- Our comprehensive selection of outboard equipment includes:
- LEXICON 480L. Version 3 software. **£4,995.00**
  - LEXICON 224 with remote. **£2,250.00**
  - LEXICON PCM70. **£1,050.00**
  - AMS RMX16. **£2,150.00**
  - ROLAND SDE2000. **£275.00**
  - YAMAHA Q2031 GRAPHIC. **£275.00**
  - URSA MAJOR 551-282 Space Station. **£300.00**

### MIXING CONSOLES

- SSL 4056E. 48 channel. G Series computer. Patchbay/Producers desk. Excellent condition. **£P.O.A.**
  - SSL 4048E. 48 channel. G Series computer. Patchbay/producers desk. Immaculate. **£95,000.00**
  - SSL 6048E. 48 channel. G Series Computer. Total recall. Patchbay/producers desk. Immaculate. **£P.O.A.**
  - SSL 4040E. 40 channel. G Series computer. Total recall. Patchbay/producers desk. Immaculate. **£P.O.A.**
  - NEVE V3. 60 frame. 60 channel. Nevecam 96 automation. V.G.C. **£P.O.A.**
  - NEVE 8108. 48 channel. Nevecam 96 automation. Available immediately. **£P.O.A.**
- \* Please telephone for selection of small and broadcast Neve consoles:
- TRIDENT DI AN. 40 frame. 40 channel. Reflex automation. Currently on demonstration at M.S. Audio. **£69,000.00**
  - TRIDENT Series 80C. 32 frame. 32 channel. Optitrack 11 HD automation. **£23,500.00**
  - AMEK MOZART. 56 frame. 48 channel. Supertone automation. Immaculate. **£48,000.00**
  - AMEK G2520. 40 frame. 40 channel. Mastermix 1 automation. V.G.C. **£45,000.00**
  - SOUNDTRACS ERIC. 56 frame. 56 channel. 40 channels of Tracmix automation. Immaculate. **£42,000.00**
  - SOUNDCRAFT 1524. 48 frame. 48 channel. with automation. V.G.C. **£P.O.A.**
  - DDA AMR24. 36 frame. 36 channel. Immaculate condition. **£25,500.00**
  - DDA AMR24. 44 frame. 44 channel. Immaculate condition. **£40,000.00**
  - MCI 600 SERIES. 36 frame. 32 channel. Patchbay. Complete recent refurbishment. Absolutely immaculate. **£14,000.00**

### 24/32 TRACK MACHINES

- STUDER A827. with auto/remote. New machine. Cancelled order. **£23,500.00**
- STUDER A820. with auto/remote. Private use. Under 1000 hours. **£P.O.A.**
- STUDER A800 MKIII. with auto/remote. Low hours. **£22,000.00**
- STUDER A80 MKIII. with auto/remote. Low hours. Ex. cond. **£12,950.00**
- OTARI MTR90 MKII. with autolocator. Low hours. V.G.C. **£15,950.00**
- MITSUBISHI X850. Low hours with remote. 2 machines available immediately. Excellent condition. **From £55,000.00**
- SONY 3324. with 3310 remote. Excellent condition. **£P.O.A.**
- OTARI DTR900. 32 track digital. Auto/remote. Excellent condition. **£P.O.A.**

\* Please telephone for additional list of multitrack machines \*

VIEWING BY APPOINTMENT ONLY ALL PRICES SUBJECT TO VAT

**SEE US  
ON  
STAND  
149  
AT  
APRS  
'91**



# Drake - sound ideas with an eye to the future

Take our 9000 series. A unique frame design enables an extensive range of audio, video and digital audio Eurocards to be freely combined to suit individual requirements.

For off the shelf solutions to audio monitoring, signal error and interfacing problems, the 5000 series now includes the Automatic Stereo Corrector and the latest 20 bit A to D and D to A Converters.

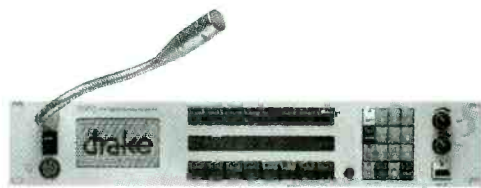

Then there's our 6000 series. Its highly developed software and flexibility of expansion add up to the most powerful communications system available.



The 2000 series Broadcast Consoles combine technical excellence with simple operation to suit the most demanding productions.

To complete the picture, Drake Broadcast Systems will manage the design and implementation of an entire facility - professionally.

So for a single module, or the whole installation, Drake provide solutions to meet your needs.



## Philip Drake Electronics Ltd.,

The Hydeway, Welwyn Garden City,  
Hertfordshire AL7 3UQ, England.  
Telephone: (0707) 333866.  
Telex: 25415 DRAKE G.  
Fax: (0707) 371266.

# For peak performance from PPM Indicators, VU Meters and AL Indicators...

Mixing complex audio signals from multiple sources is difficult enough, so you need to be sure of the meters.

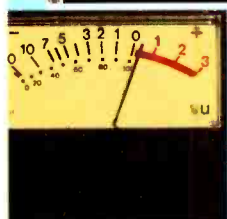

Are they accurate and reliable? Can you read them quickly and clearly?

Sifam is a world leader in meters and ancillary components for the professional broadcasting and audio industries - backed by more than sixty years experience.

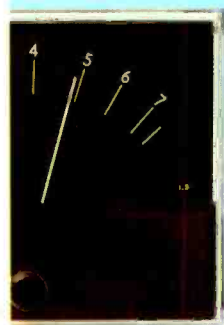
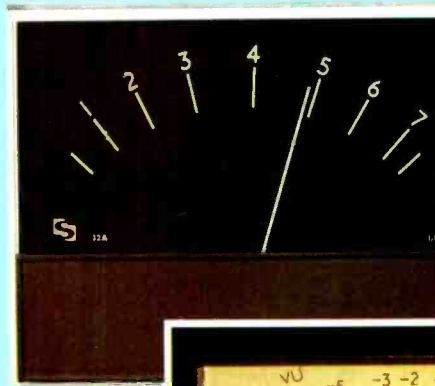

If you need VU meters or PPM indicators to the highest international standards - or something close, but less costly - then it's sure to be in the Sifam range, waiting to give you peak performance.

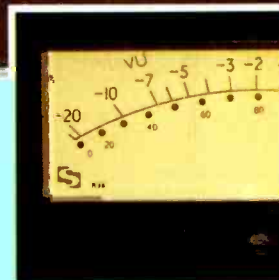

## ...Sifam meters

FOR LITERATURE ON OUR RANGE OF METERS, PLEASE CONTACT:

SIFAM LIMITED—METERS DIVISION  
WOODLAND ROAD TORQUAY  
DEVON TQ2 7AY ENGLAND  
Telephone: 0803 613822  
Fax: 0803 613926. Telex: 42864



# TOMORROW'S VINTAGE MIC TODAY'S REVOLUTION



INTRODUCING

## EQUITEK II

Multipattern Side Address  
Condenser Microphone

A dual capsule condenser microphone featuring a frequency response of 10-18,000Hz, cardioid, Figure 8 and omnidirectional patterns, and exclusive I.N.R.<sup>™</sup> (Impact Noise Rejection) internal shock mount system.

From Conneaut Audio Devices, a revolution in performance at an absolutely incomparable price.

**1-800-762-9266**



CTI Audio P.O. Box 120 Harbor & Jackson Streets Conneaut, Ohio 44030-0120





If you thought Copycode was dead, think again. Its ugly head is rearing from the grave. The record industry is cooking up new ways of messing up sound recordings.

In October 1990 Philippe Kern of the IFPI prepared a briefing document, *New Technologies; New Opportunities for the Music Industry*. This looked at the ways in which sound recordings may be delivered to the public in the future. Already it is possible to transmit compressed audio by telephone line, using the new ISDN (Integrated Services Digital Network). Eureka researchers have been working on a digital audio broadcasting system for four years. They have now solved the technical problems and are waiting only for the international allocation of radio frequencies.

Copyright identification, and copy control, is easy if the system remains in the digital domain. But once the signal is decoded into analogue form, identification and control become much more difficult. That is how Copycode was visited on us.

In 1980 Stan Gortikov, then President of the Recording Industry Association of America, wrote to universities and research centres across the USA, asking them to try to come up with a workable spoiler system. The CBS Technology Centre in Connecticut told the RIAA that it was 'futile' to look for a single-ended spoiler system, which made records impossible to copy onto ordinary recorders, even though they played perfectly on ordinary playback equipment. Instead CBS came up with Copycode, a double-ended system intended to block copying on recorders equipped with record-blocking circuitry.

The original Copycode system developed by CBS, sucked a narrow notch out of the music frequency spectrum at 3.84 kHz. In a recorder, a comparator would sense any unnatural dip in the signal at this frequency and switch off the recording function.

On being told that the notch was audible during normal playback, CBS narrowed it. On being warned that narrow notches might be more audible than wide notches because of phase shifts, CBS then said it was working on digital filters to avoid phase shifts. And so it went on, until the National Bureau of Standards in the USA ran independent tests on Copycode and rejected it out of hand.

But behind the scenes there are still people tinkering with Copycode. Word has it that Mr Copycode himself, David Stebbings, is doing the tinkering.

The grave door is still open because, in the now famous Athens agreement between the hardware and software industries on the use of SCMS (Serial Copy Management System) to limit digital cloning, there is also agreement to look for a technology which would allow the same kind of control over analogue recordings. Those who thought this part of the Athens agreement was just a placebo should think again. (The record industry is getting deadly serious again about analogue copy control.) They don't talk about 'spoilers' any more, or 'Copycode'. There is a new phrase. It's 'Base Band Signalling System', or BSS.

When talking about the use of the ISRC

---

## Barry Fox

---

### Copycode's back again; CD subcode logging; CD-R hiccup

---

(International Standard Recording Code) for identifying digital recordings, the IFPI's senior legal adviser, Trevor Percy, casually referred to Base Band Signalling as a way of making similar identification possible for analogue recordings. And the IFPI's briefing document explains "BSS identification codes will be embedded in the music track itself." While warning that BSS will take at least two years to develop, the IFPI predicts that it will "make the recording industry completely independent from the hardware manufacturer's specification as the code is buried within the music signal itself.

"It must be stressed," continues the IFPI document, "that in the framework of the Athens agreement, the consumer electronics companies are bound to co-operate with the recording industry in the development of such a system."

Base band signalling will be used not only to identify recordings but trigger copy limitation circuitry in recorders and control the automatic debiting of money from a credit or smart card every time the recording is copied.

So what exactly is BSS and how does it work? In short, it adds noise to a recording to convey a message.

---

### The record industry is getting deadly serious again about analogue copy control

---

In the mid '80s, Thorn-EMI's Central Research Laboratories at Hayes, Middlesex, worked with the IFPI on just such a modification of Copycode. The idea was to insert identifying digital code in the Copycode notch, at low sound level. EMI commissioned Gallup to poll a cross-section of 'average' people who owned CD players.

Fifty subjects in five age groups were given a test CD on which there were 10 test tracks of music. Each track was repeated three times, sometimes coded and sometimes not. The test subjects were asked to fill in a form, saying whether they could hear any difference between versions and, if so, to describe what they heard. As a reward they got to choose a free EMI CD. The poll results showed that people could hear the code, at least some of the time on some types of music. Seeing these results and the opposition to Copycode, which was then growing in the audio industry, EMI put the system on the back burner. It went even further back when the National

Bureau of Standards later voted Copycode a loser.

But now, 10 years after Gortikov's letter, the RIAA has started the hare running again.

The RIAA has teamed up with acoustic consultants Bolt, Beranek and Newman of Massachusetts. We only know this because the RIAA and BBN had to get permission from the US Government's Department of Justice! They feared that the Attorney General might deem the joint venture an antitrust activity by the record industry, and thus illegal. The US Government has Draconian laws to prevent cartels of companies ganging up to fix prices or curb free market competition.

But the Attorney General has now given the RIAA and BBN the green light. The RIAA can pay BBN \$1 million to develop new technology that will "prevent or control the duplication of copyrighted works". This follows the RIAA's admission to the Attorney General that CBS had "already tried and failed".

In the US both the RIAA and BBN have been refusing to talk to the press. They are clearly embarrassed that the news has leaked out from the US Government's Department of Justice. But I can give you a very good idea of what BBN are working on.

Instead of notching the sound and adding coded pulses to the notch, BBN are experimenting with the addition of a wide spread of low level noise at points across the frequency spectrum of a recording. This spread of noise is then switched between two states, to represent digital ones and zeros. Comparator circuits detect and read the code.

In theory (as was the theory with Copycode) the noise is inaudible so RIAA/BBN are relying on masking effects, much like DCC sub-band coding or Dolby noise reduction. The human ear is less likely to hear quiet sounds when they are played alongside loud sounds of similar frequency.

But in practice the spread spectrum idea is very likely (as was the case with Copycode notching) to be audible on some material, some of the time. Also, the compression used by radio stations, with equipment like *Optimod* boosting quiet passages, could make the coding very much more noticeable.

This is an early warning. Beware innocuous talk of Base Band Signalling. Beware glib reassurances that masking will make spread spectrum noise inaudible. Above all else, be warned that IFPI and RIAA have their teeth into this, to the tune of \$1 million. They are even more serious about this than they were about Copycode. If they have their way, they will add noise to your recordings and tell you that no-one will hear it.

**You have been warned.**

In sister publication *BSI*, I have explained how the record industry has one last chance to use technology that would give performers and composers more accurate and more speedy payments for music broadcasts. (The technology, which relies on inaudible code buried in a digital recording to trigger automated payment logs, was built into the CD system

before it was launched in 1983.) But only one record company, Polygram (now owner of Decca), has bothered to use it. So broadcasters do not bother to install the logging equipment. The BBC is now trying to catalyse the industry into action.

At a closed seminar in Broadcasting House earlier this year, representatives of the record companies, their trade bodies, the copyright agencies and the BBC all agreed that copyright logging was in everybody's best interest and would save money.

Says Tony Churcher, head of broadcasting administration at the Performing Rights Society, one of three copyright bodies involved in paying musical artists, "If we don't make a start now, we will never do it."

## The technology to trigger payment logs was built into the CD system before it was launched

To cut a long story short, the CD standard, as laid down by Philips and Sony, defines eight subcode channels in the digital bit stream which carry information related to the music. The P and Q channels carry timing codes which control the CD player, telling it when musical selections begin and end. The Q channel can also carry copyright information. Digital tape formats can

carry similar codes.

In 1986, after 15 years discussion, the International Standards Organisation agreed a code format that is applicable to any digital recording medium. ISO 3901-1986 defines the International Standard Recording Code. Twelve alphanumeric characters can unambiguously identify a recording by date, name and company owner. A modified CD player in a broadcast studio would strip this code out of the bit stream and deliver it to a computer in the transmission chain. The computer's internal clock logs when the recording was played and for how long.

The radio station then gives a copy of the log to the appropriate copyright bodies (Phonographic Performance Ltd, Performing Rights Society and Mechanical Copyright Protection Society), which then match the identifying number with their own database record to calculate what royalties the performers and composers should be paid.

It would all be so easy. But most CDs now have a string of zeros where the code should be because record companies do not give the pressing plant an ISRC number to insert.

The BBC meeting was an attempt to get everyone moving. There is no opposition, just inertia. "Why aren't we doing it—what's the catch?" several people have asked.

There is no catch. Coding costs nothing. The broadcasters, the record companies, the copyright bodies and the artists all stand to benefit. All it needs is the will to do it. A working group, including the BBC, APRS and copyright bodies, is now trying to stimulate that will.

The IFPI has a special interest in coding. Once records are coded, it is easier to log copying and get payment by credit or smart card system.

# Everything to keep you on-air.

In these days of round-the-clock radio, there are plenty of things you can do without. Breakdowns. Equipment misalignment. Carts grinding to a halt in the middle of a break.

But there are other things you can't. With ever-tighter budgets and schedules, you need to find what you want—when you want it. Without twenty phone calls.

That's where we come in. PRECO—the professional supply service for broadcast and industrial audio equipment and accessories. At PRECO, we offer one of the widest selections of lines—from sophisticated test instrumentation to blank carts. We've been doing it for almost ten years. And we're just a phone call away—081 946 8774. Ask for a free copy of our newsletter, *Pre-Fade News* and our latest catalogue, and see for yourself.

PRECO—the professional service for the professionals. We'll keep you on-air.

# PRECO

The Professional Recording Equipment Co., Ltd.

21 Summerstown London SW17 0BQ Tel: 081-946 8774. Fax: 081-944 1326



Sony have been countering Philips Digital Compact Cassette, DCC, by secretly showing the record companies a system called Mini Disc. This is a small erasable optical disc that can cope with 20 bit code. If you don't want DAT, Sony have been telling the record companies, try MD for size.

It is no secret that Philips have also been working on a recordable disc system. At MIDEM Philips boss Jan Timmer made it clear that he regards the Athens agreement with the IFPI (on using SCMS copy restriction for DAT) as also applying to DCC and CD-R.

Hardly surprisingly Timmer did not mention the bizarre story of how Philips lost their CD-R prototype, before Christmas.

What happened was this. Philips built a fancy prototype for the Tokyo Audio Fair last autumn. It was demonstrated but no-one was allowed near it. The prototype then went back to the Advanced Development Labs in Eindhoven. From where someone stole it.

It obviously wasn't commercial espionage because the thief sold it—as a CD player—in a Belgian bar for £50. The unit had non-standard sockets so the purchaser took it to a shop in Maastricht and asked for matching leads. The shopkeeper smelled a rat, bought it for £85 and sold it back to Philips. Security at Eindhoven has now been tightened. □



People are talking about the continued high price of music sold on compact discs. What everybody seems to be saying is, "Isn't it time that the CD really begins to live up to everybody's expectations as a mass medium for music—priced for the masses?" The record industry's galling resistance to any suggestion of a price break for the now standard CD music media is only the first on a list of many CD issues that impacts both the audio/recording industry and the consumer. The continued high price charged for the silvered digital pressings continues to get the most attention from the print press, video editorialists on local and network television on both sides of the Atlantic, consumer advocates, record store customers and staff, etc.

As we all remember, the initial cost of both CD manufacturing plants and of the CDs themselves mandated to some extent the high debut price tags of the discs. Mind you, at that time of inception for the CD, it was generally not the major labels who had invested in the manufacturing facilities or the research and development. It was the big audio innovators such as Sony and Philips (who developed and licensed the whole CD process) and other major players in Japan such as JVC and Denon plus large presences in the chemical industry such as Du Pont and the Entrepreneurial types in the US and the UK (Shape and Nimbus among others).

Now, the point is that the major record labels were 'Johnny-come-latelys' to the CD development process but they still used the high cost of initial investment as one of the excuses for high retail prices. Today, one frequently hears the same argument, as though the major record labels were still paying off some enormous long-term debt from the founding of the CD industry. It is interesting to note these days that one even hears about the need to 'raise' the price by a pound or so, or a dollar or two to adjust for the occasional short-term price 'blip' on the petrochemical raw material horizon caused by such incidents as the Persian Gulf mess. This despite the fact that the polycarbonate raw material prices tend to rise only a marginal percentage of the per-barrel rise, according to oil industry experts.

Considering that the polycarbonate raw material accounts for only about 20% of the CD's approximately 50p/\$1 manufacturing cost, the change of, for example, 10% in materials cost adds about 1p or 2c to the total (20% of \$1 is 20c—a 10% increase=2c). Normally, there is very little change in the price of the vinyl plastic used for the jewel box or of the inks used in marking the disc or in printing the jewel box liner. Pending some geopolitical catastrophe, the oil experts predict that the price of oil ultimately always returns to its normal ranges. It is expected to stabilise this year at a point only several pounds or dollars higher if at all, than the level held before the latest Middle-Eastern version of 'Let's Make A Deal' with Saddam Hussein as your gracious host.

Lowering the price of a CD to the \$10 (before sales tax) or £5 (before VAT) price tag would spur music sales, according to electronic entertainment industry forecasters. The generous profits

---

## Martin Polon

---

### Our US columnist airs three points of concern

---

currently experienced by the record companies would not be reduced because increased CD sales volume would buoy the industry and aid the entry of the resistant over-30s to the CD marketplace. That in turn could help punch the CD player penetration through the 30% wall currently in place. Increased sales could spur the recording of new music and new musicians and accelerate the re-release of existing LP catalogue. Everybody in the combined audio/music industry would benefit. Or is that not supposed to happen, after all?

People are talking about how the formerly so-called 'bullet-proof' audio entertainment industry has been anything but, during this, the first economic slowdown at the beginning of the last decade of the 20th century. The sense that many people in the world audio industry have, is that since the ratio of sales has not increased at the same rate as in past 'economic slowdowns', there must be the proverbial 'trouble in River City' as the ubiquitous Professor Harold Hill would tell us (in the musical 'The Music Man'). In fact, the audio industry is doing much better than it might under similar circumstances—considering that the total size of the industry has increased significantly while the customer base and the sales base have increased only moderately. The fact is that there are so many more players eating the 'sales pie' in each of the segments of the audio arena that the individual slices have shrunk or stayed the same for most. The really big players have become so much bigger and are taking larger shares than ever. Merger talk is now as common place among audio manufacturers as the discussion of the relative merits of various noise reduction systems once was.

The audio industry has got 'hot', while basically the customer base has not. The sale of audio equipment is generally dependent upon the business conditions of the industry's customers. If recorded music is selling off the charts; if live concerts are filling halls, arenas and performing arts centres at an unbelievable clip; if major recording studios are booked 20 hours a day, seven days a week; if television stations are broadcasting live music productions 25% of their on-air prime time; in short, if the audio business is burning the proverbial barn down—then all will be well with the audio industry as a whole. That this not happening in total is quite evident. There are segments of the industry—especially consumer sales of anything portable or transportable and professional sales of anything digital—that are indeed 'bullet proof'. But whether problems in other areas are the result of internal conditions within the audio industry or of the general

economic malaise plaguing the western world is really not the point. What the point should be is that all-in-all things are really not so bad. In fact, all the doomsayers in the industry might try to consider that on measure, the situation is really quite good and could well get a whole lot better in coming months and years. The only constant in the audio industry today is that there aren't any constants any more. Change is the norm.

Now this is clearly a radical purview but it just might be on the mark or near enough to it for government work. The real dilemma in the audio industry is fourfold. The consumer base has shrunk as the vast majority of the baby boomers who built recorded music consumption to its current high level have entered the second half of their lives (assuming a 70 year life span). They are buying less music and less music is being made available to them. The second part of the dilemma is the replacement of big ticket hand-wired hand-built top end audio products throughout all levels of the professional and semi-professional audio user base with less expensive mass produced products of slightly lesser capability—but nonetheless, still formidable designs and formidable products.

The third part of the conundrum, is the extension of a major business and cultural lifestyle change to the audio arena. The home office has arrived... huzzah... huzzah... and is now the home studio—thank you very much. Artists of every stripe who used to depend upon the network of flagship recording studios now do everything or close to it—in their home recording or scoring or composing or creating environment. The last of our fearless four horseman of audio change is the fact that we have achieved real saturation of all our user bases: home consumer, home studio, artist studio, semi-professional and professional recording and reproducing installations. This industry grew while its equipment user bases across-the-board possessed little or nothing of real audio fidelity and/or quality when the dawn of the age of high fidelity came upon us after the close of the Second World War. The industry has matured with the advent of the LP record followed by the transistor, the IC, the CD and digital recording. Forty years later nearly everybody has sound recording and reproduction systems and machinery that surpasses the studio quality of just five or six years ago. In short and in total—it's 'mature industry time'.

All puns aside, the point is that we are going to continue to change. Conventional studios are going to evolve into computer-based recording environments with direct recording transfer to optical compact discs. CDs and DATs and DCCs (Digital Compact Cassette) will come and go and music may be sold to consumers via ROM chips. The business of recording technology will segue from hardware to software engineering. But let us ignore all the historical spilled milk and pick up the rhythm section's beat and keep moving ourselves and our industry into the fast lanes. Nothing is going to change where we are or bring us back to where we have been. What we need to do now is to accept the '90s as really being here and do business 'as it is', rather than attempting

to recreate the 'as it was'. The '90s hold the promise of being a renaissance time for music and audio at all levels. Let us all help to make it so.

People are talking about how the costs, timing and location of professional meetings and trade shows directly related to or important for the audio business are denying access to these very events. The problem is not new—nor is it confined to just the AES or SMPTE or BKSTS or SPARS or ITS or NAB, etc, but it is reaching the crisis level for many potential attendees, member and non-member alike. A number of factors are at work.

The unfortunate practice of locating professional audio meetings and/or audio/video meetings in the most obtuse places on the map is part of the problem. So is the selection of event dates at the very point in the calendar cycle when the selected location's weather forecast either has the barometric reading dropping through the floor of that good instrument or the thermometer touching top or bottom or all of the above. The rules of planning espoused over and over again by professional show planners are the same three rules quoted over and over again by commercial real estate agents—'Location, Location, Location'. You put your meeting or show in the place where the maximum show-going population is in proximity either locally or via affordable transportation options. You also make sure that the location is attractive to the community you serve at the time frame chosen for your event.

You probably do not place your meeting in one of the coldest spots on the North American continent during the dead of winter, if you expect to have 'smash' attendance figures. You could always book into the Yukon, if cold was what you were really all about. Perhaps a meeting on the impact of cryogenic freezing of optically recorded audio media could be held in a really cold climate to simulate and stimulate! Instead, how about doing something really radical like holding an event where it might actually be pleasing to attend. I realise that this idea of choosing a desirable event site and even possibly having some fun, is an earth-shattering concept to the 'single-minded' technical community that seems to run the trade shows and meetings. The problem is the sense of monastic devotion that the 'audio chosen' feel is necessary to the promulgation of electroacoustic dogma.

A paper read in Miami Beach's excellent convention facility with 80° weather outside at the beginning of February, would just not be the same as a paper read in a town where a step outside the conference hotel could easily bring a mugger's blow or pneumonia via freezing weather or possibly all of the above. The basic concept, I suppose, is that one must be forced into near-religious contemplation of the paper one is hearing—read verbatim from the printed copy nestled safely in your show packet. No distractions, such as a setting pleasing in both aesthetics and weather, can obviously be allowed to distract from the main cause. Yet most other trade organisations in the business world choose their convention or event sites based on

desirability as well as logistics. You do not find a national computer engineering organisation anywhere near the frozen land mass of Michigan in winter. Try San Diego instead.

Now, none of this is motivated by any overzealous desire on my part or on the part of others to 'boogie' our lives away at AES meetings or other such professional gatherings. Frankly and honestly, I do not think that even the presence of 200 gorgeous blonde women at an AES Convention held in say... Hawaii, could even convert that sombre gathering into a festive event. Seriously, the reason to hold events in more advantageous settings is to encourage attendance and to create an atmosphere for professional exchange outside of the formal settings. One problem that has plagued the AES Conferences for years has been the practice of having the esteemed attendees listen to the equally esteemed panelists reading their own papers from the event preprints... with nary an opportunity for open dialogue and interface that so marked the earlier AES offerings. Obviously, a change of climate must be accompanied by a change of event architecture. But in total, the bottom line is that technical event organisers of any stripe must recognise that the horrendous inflation in event attendance costs that plagues every organisation in every location worldwide make event attendees much more demanding in terms of pleasing surroundings and climates.

As to cost, the extraordinary price levels reached by the latest AES 'package' to the Paris Convention combined with Gulf War scares, reducing significantly the number of North American attendees. This is not necessarily meant to criticise the effort to provide a travel package, but rather to address the question of rising travel costs in certain geographic locations. For one to travel alone to the recent AES Paris meeting would have required an expenditure of nearly \$3,000 from North America. The AES package with its single supplement hovered at about the 2k level. Add the expense of meals and incidentals and taxis—in a city which is expensive even to its own inhabitants, let alone with the devalued dollar or pound—and you have a recipe for true penury. Attendees from the United Kingdom were equally concerned about the costs of getting to and from Paris plus the high price of hotels and food. One English audio expert quipped, "This is really more expensive than an American going from somewhere in the US to an LA or New York venue. Travel costs intra-Europe are simply stunning and Paris is hardly affordable even to the Parisians."

New York City is another meeting venue which has become prohibitively expensive, with its nearly 25% tax rate on hotel rooms for a starter. Considering that New York is one of, if not the most expensive hotel towns in the world with its approximately \$200 median price tag per night before taxes and you have another financial disaster brewing for members of the audio community. Needless to say, future European audio meetings in ultra-expensive Vienna and Berlin do not bode well for those less fortunate members of the 'Audio Budget Buster Brigade'.

These meetings are vital to the 'socialisation' of

## TASCAM European Distributors

Hi-Fi Stereo Center Kain  
Muenchner Bundesstrasse 42,  
5013 Salzburg,  
AUSTRIA.  
Tel: (0662) 37701

Teac Belgium NV/SA,  
Woluvelaau 14 3C,  
1831 Diegem,  
BELGIUM.  
Tel: +32 27256555

So and Hoyem A/S,  
Bulovsgarden,  
Bulovsvej 3,  
1870 Frederiksberg C,  
DENMARK.  
Tel: (031) 22 44 34

Studiovox Oy,  
Hoylaamotie 8,  
SF-00381 Helsinki,  
FINLAND.  
Tel: 0506 1311

Teac France Sa,  
17 Rue Alexis de Torqueville,  
92182 Antony,  
FRANCE.  
Tel: (01) 4237 0102

Teac Deutschland GmbH  
Bahnstrasse 12,  
6200 Wiesbaden-Erbenheim,  
GERMANY.  
Tel: (06121) 71580

Elina SA,  
59/59A Tritis Septemvriou St.,  
Athens 103,  
GREECE.  
Tel: (01) 8220 037

Greenlands Radio Centre,  
PO Box 119,  
3900 Godthab,  
GREENLAND.  
Tel: 299 21347

GBC Italiana spa,  
Viale Matteotti, 66,  
Cinisello Balsamo, Milan,  
ITALY.  
Tel: (02) 618 1801

Hjodriti — Hot Ice,  
PO Box 138,  
Hafnarfirdi,  
ICELAND.  
Tel: (01) 53776

AEG Nederland NV,  
Aletta Jacobslaan 7,  
1066 BP Amsterdam,  
NETHERLANDS.  
Tel: (020) 5105 473

Audiotron A/S,  
Seilduksgt, 25,  
PO Box 2068 Grunerlokka,  
0505 Oslo 6,  
NORWAY.  
Tel: (02) 352 096

Goncalves,  
Avenida 5 de Outubro, 53, 1,  
Lisboa 1,  
PORTUGAL.  
Tel: (01) 544029

Audio Professional SA,  
Francisco Tarrega, 11,  
08027 Barcelona,  
SPAIN.  
Tel: (93) 340 2504

Erato Audio Video AB,  
Asogatan 115,  
116 24 Stockholm,  
SWEDEN.  
Tel: (08) 743 0750

Telion AG,  
Rutistrasse 26,  
CH. 8010 Zurich,  
SWITZERLAND.  
Tel: (01) 732 1511

## TASCAM





# LEARN SOMETHING TO YOUR ADVANTAGE

TASCAM innovations have changed forever the face of music recording and with the release of the dbx-equipped MSR-24 the power and flexibility of 24 track recording became available to musicians and engineers at a previously unheard of price.

Now that DOLBY S-type noise reduction is available on the MSR-24S a further level of choice has been opened up to the recording engineer.

The increasing sophistication and performance of our recorders has placed heavy demands on mixing console

technology and at TASCAM our expertise has allowed us to design and build consoles which perfectly partner our multi-track recorders. A long line of consoles renowned for their sonic quality has now been joined by the M3500 Series.

Designed from the ground up to partner our MSR Series tape recorders

using distributed in-line monitoring (effectively doubling input capacity during mixdown) and a design philosophy in tune with today's production requirements we believe the M3500 simply surpasses all competition in its class.

The cost of financing traditional mixing consoles and multi-track recorders has proved to be the death of many studios both large and small... The competitive edge which TASCAM equipment gives you has never been more valuable than today.

Contact your TASCAM dealer today to learn something to your advantage.

**TASCAM**  
the right track

Teac UK Ltd, 5 Marlin House, The Croxley Centre, Watford, Herts. WD1 5YA. Tel: 0923 225235. Fax: 0923 36290



the audio community and a must-do for all of us in terms of keeping up technically. Recently, however, it is becoming commonplace for many people to say, "I just cannot afford to go," and the more-guarded to comment, "I'm just too busy to get away!" The answer for the technical world of electronic entertainment may be to select a site where a wide range and variety of travel options, hotel accommodations and restaurants offer price variations to suit everyone's needs.

Las Vegas is one such place and home to the two largest and most prestigious shows in audio today, in terms of total attendance, number of exhibitors and the gross financial product of the

shows. The winter international Consumer Electronics Shows (CES) and the National Association of Broadcasters (NAB) both call Las Vegas home. Both shows attract members of the international audio and video community in prodigious numbers and are considered to be truly worldwide in scope. Not the least of Las Vegas' attractions are the nearly 100,000 hotel rooms and restaurants plus a world class airport. Las Vegas may not be exactly the right answer for shows such as the AES meetings but some answer has to be found. The members of the world audio community haven't the financial resources to continue to 'put on the Ritz' forever. □

## Letter: Who's supporting whom?

Dear Sir, The whole question of customer support and how much users should expect is quite rightly coming under greater scrutiny (*Studio Sound*, November 1990). As specialist manufacturers, we would like to add some general comments.

Despite the increasing complexity of pro-audio equipment, good quality engineering continues to carry with it an inherent guarantee. The Cadac equipment is primarily installed within the theatre sound environment—an area which has traditionally always been hard on use and low on technical support staff. In this type of situation, the onus is on the manufacturer to build into the design such features as easy maintenance, component modularity, back-up operation and when all else fails, to provide fast on-site support. In our belief, this should be a standard approach. As manufacturers, we would be deeply concerned if, in the future, users felt that they had to request additional support because the original design concept or construction was in some way lacking.

When bespoke development is called for, be it on the console or in the software, the support situation is somewhat different. In this case the product becomes something of a unique entity to that customer, and support in this context becomes a tailored service based on a mutual agreement between supplier and user.

In order to avoid the many pitfalls of service contracts in general—one only has to read the computing magazines to verify this—perhaps the pro-audio industry should look at the following two particular areas.

Firstly, the need to encourage a higher level of technical expertise among users, enabling technicians to differentiate between faults that stem from poor design, faulty installation or general lack of maintenance. As a former 'white coat' wearer, I feel certain that many oft-written-about problems could be overcome by a sound knowledge of audio engineering principles.

Secondly, the industry needs to bring together a consensus of ideas as to what level of support it believes it should a) expect and b) pay for, from suppliers in general. If we all wait for this debate to become acrimonious, the whole issue will become far more difficult to resolve.

Surely this is a case where users and suppliers should pool their ideas and resources to strengthen the industry as a whole through their common trade association—the APRS?

Yours faithfully, Clive Green, Managing Director, Clive Green & Co Ltd, 1 New Street, Luton, Beds LU1 5DX, UK.

The Editor welcomes letters for publication. If you want to air your points of view on any audio related topic please drop us a line at this address:

The Editor, STUDIO SOUND, Spotlight Publications Ltd, Ludgate House, 345 Blackfriars Road, London SE1 9UR, UK.

**STEREO DIGITAL EDITING**

**RADIO & NEWS AUTOMATION**

**DYNAMIC PROCESSORS**

**RECORDABLE CD**

**AUDIO & DESIGN**

**DIGITAL AUDIO INTERFACING**

**AMBISONIC SURROUND SOUND**

**R/DAT PRODUCT ENHANCEMENT**

"See us at APRS 91 Stand No. A12"

For details contact:

**AUDIO & DESIGN. Unit 3, Horseshoe Park, Pangbourne, Berkshire RG8 7JW. Tel: 0734 844545 Fax: 0734 842604**



# Drawmer

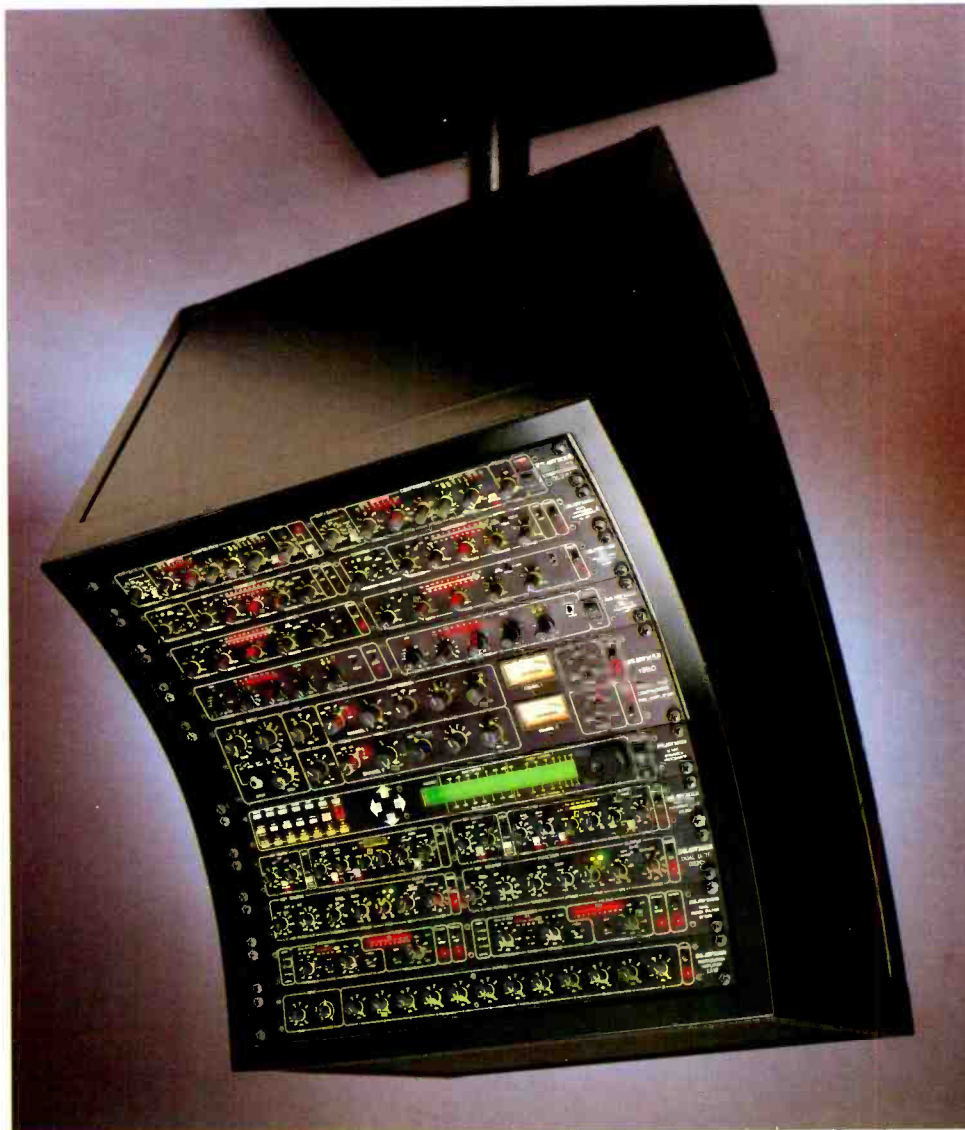

A CRAFTSMAN DESERVES  
THE FINEST TOOLS

**Australia** Amber Technology Pty Ltd. Tel: (2) 975 1211 Fax: (2) 975 1368 **Austria** Audiosales MbH Tel: (2336) 26123 Fax: (2336) 83223 **Belgium** E.M.L. Nv. Tel: (11) 491 660 Fax: (11) 491 662 **Brazil** Sterling Do Brasil Tel: (21) 722 0141 Fax: (21) 714 2195  
**Canada** Headwater Imports Co. Ltd. Tel: (519) 2562454 Fax: (519) 2562522 **Cyprus** Radex Sound Equipment Ltd. Tel: (2) 466423 Fax: (2) 473165 **Denmark** Audionord Danmark A/s Tel: (619) 3499 Fax: (861) 28259 **Finland** Studotek Ky Tel: (0) 592 055 Fax: (0) 592 090  
**France** Lazare Electronic Tel: (1) 4010 0900 Fax: (1) 4010 1810 **Germany** Expotus Ltd (U.K. Office) Tel: (71) 405 9665 Fax: (71) 831 6017 **Greece** K.E.M. Electronics Oe. Tel: (1) 6475 659 Fax: (1) 3639 234 **Hong Kong** Tom Lee Music Co. Ltd. Tel: 7301098 Fax: 7303573  
**Italy** Audio Equipment Srl Tel: (39) 200711 Fax: (39) 382565 **Israel** R.B.X. International Ltd. Tel: (3) 298 252 Fax: (3) 296 452 **Japan** M.T.C. (Japan) Ltd. Tel: (3) 295 4731 Fax: (3) 293 2454 **Netherlands** Audioscript Bv. Tel: (2155) 20400 Fax: (2155) 22806  
**New Zealand** Oceania Audio Ltd. Tel: (9) 893 114 Fax: (9) 893 307 **Philippines** Audiophile Components Inc. Tel: (2) 583032 Fax: (2) 8187577 **Portugal** Eduardo E. Bizarro Lda. Tel: (1) 575 252 Fax: (1) 577 983  
**Singapore** Team 108 Technical Services Pte. Ltd. Tel: 7489333 Fax: 747 7273 **Spain** Satepra Sa. Tel: (1) 356 0737 Fax: (1) 356 9954 **South Africa** Tru-Fi Electronics Pty. Ltd. Tel: (11) 462 4256 Fax: (11) 462 3303 **Sweden** Tonkraft Import Ab. Tel: (31) 134950 Fax: (31) 113 472  
**Switzerland** Audio Systems AG. Tel: (1) 910 4545 Fax: (1) 910 3544 **Tahiti** Oceanic Garage Telex: 324 TRANSAIR FP **Taiwan** Yangs Audio Visual Laboratories. Tel: (2) 5110408 Fax: (2) 5214346 **U.S.A.** Q.M.I. Tel: (508) 650 9444 Fax: (508) 650 9476

Drawmer Distribution, Charlotte St Business Centre, Charlotte St, Wakefield, W. Yorks, WF1 1UH, England.

Tel: 0924 378669 Fax: 0924 290460

[www.americanradiohistory.com](http://www.americanradiohistory.com)

# In France, a mixer you've never heard of outsells the ones you have.

## Why?

Standard features of the dazzling



include :

- Integral console/tape machine automation
- Multi-function dynamics on every channel
- Powerful parametric equalisation
- Twin mix concept, 2 line inputs
- 2 stereo busses
- 14 automated sub groups
- Individual status control
- Reverse talkback
- 2 stereo fold backs
- 5 stereo echo returns
- Bargraph option
- Lo noise and hi dynamic range
- Sophisticated soloing system
- 32 track routing
- Stereo output compressor

When Jean-Pierre Lafont began designing mixers in 1973, he started building a strong reputation. Within a few years of launch, his Producer consoles had become the most successful of their price range in the country.

Thankfully, Lafont Audio Labs consoles are no longer France's best kept secret. The innovative **Twin Mix 800** makes its début to the rest of the world through the Home Service.

The mixer comes with an integral computer system for tape and console automation.

Sound it out for yourself and we are convinced you'll agree Jean-Pierre makes consoles par excellence.

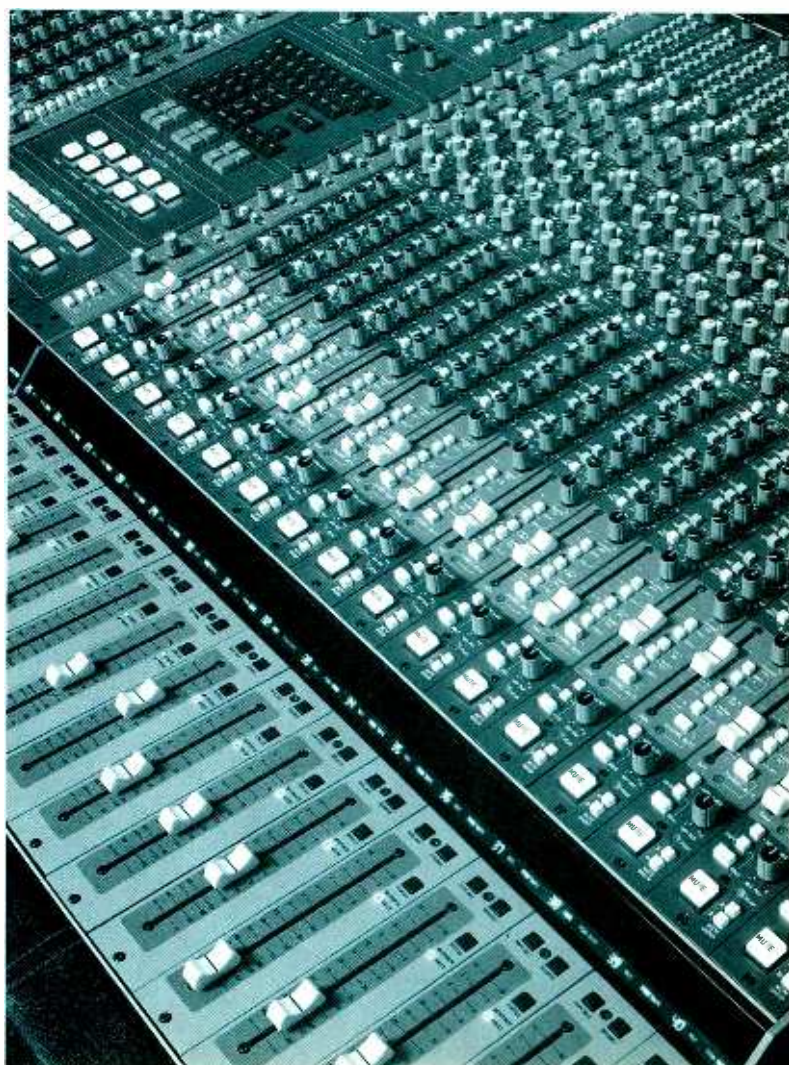

MANUFACTURED BY  
LAFONT AUDIO LABS

INTERNATIONAL REPRESENTATION :  
THE HOME SERVICE  
UNIT 2, 10 WILLIAM ROAD, LONDON  
NW1 3EN  
TEL : 071 388 1820 FAX : 071 388 0339



# CREATING NEW IMAGES

There is currently a growing interest in obtaining more from 2-channel stereo. Francis Rumsey looks into head-related and transaural stereo

**S**tereo sound imaging is probably the longest lasting area of controversy in audio engineering. Although it is a story which has already run and run, it is still a wonderful subject for conjecture, and one which will keep academics and practitioners occupied for many years to come. The reasons for this are not hard to see, since although we have been able to listen to good 'stereo' reproduction for many years there will always be room for improvement in the 'listening experience', either with regard to greater accuracy of reproduction (if that is the aim) or an enhanced usage of three-dimensional space for creative effect. Furthermore, although the mechanisms of directional and spatial perception are much better understood in 1991 than ever before, the psychological and psycho-acoustical models of perception are constantly being updated.

The reason for raising what might otherwise be a tiring re-discussion of a known situation is that we are being asked to evaluate some new ideas in stereophony which have previously been largely confined to experiments, but which are now appearing in commercial form. Two specific developments are particularly interesting, since they represent apparently opposed schools of thought on the way in which the listener should be presented with reproduced sound, and they require us to reconsider our preconceptions about what is 'binaural stereo' and what is 'loudspeaker stereo'. In one corner we have two new stereo microphones: the Schoeps 'sphere' and the Crown SASS (see *Studio Sound*, March 1991), and in the other corner we have recent spatial enhancement systems such as Roland *Sound Space (RSS)* and *QSound*. Now they do not all claim to offer the same thing, but they ask us to accept certain 'stereo truths' which, on the surface, conflict with each other.

## Stereo so far

One might be forgiven for asking what is wrong with stereo reproduction as we know it. In fact a discussion with a colleague the other day resulted in the conclusion that perhaps it was only academics who bothered to pursue the subject further, since the majority of listeners would say that they were happy with the current state of affairs, riddled as it is with inconsistencies between imaging theory and practice. Usually we use panpots to position mono sources between two loudspeakers by splitting the signal two ways and introducing level differences between the channels, and we use a variety of 'purist' mic techniques (crossed pairs, spaced pairs, etc) either on their own or in conjunction with panpotted multi-mics for the recording of live ensembles, where it is important to capture the acoustics of

the recording location. Then we sometimes use artificial reverb if we don't like the sound of the location or if we want to change the sound of the location, or to add 'spatial' effects to multitracked, panpotted balances.

The balances thus produced are only moderately compatible between headphone and loudspeaker listening, and the reproduced image on loudspeakers is restricted almost entirely to the space between the speakers. On headphones, a 'spatial effect' is achieved, with left being left and right being right, although the image is often very much 'in the head', and may have a 'hole in the middle'. For a balance to work well on headphones it is normally necessary either to record or simulate the binaural signals which would have been present at the ears for a live source, and this involves the introduction of a time delay equivalent to the path-length difference between the ears (max  $\sim 600-700 \mu s$ ) and equalisation to represent the effects of the head and pinna on the signal at each ear. Traditionally it has been found that untreated binaural recordings do not reproduce particularly well on loudspeakers, although this tenet has been challenged, as discussed below.

## Spaciousness or imaging accuracy?

Stereo reproduction through the last half century has been principally concerned with re-creating at the ears a reasonably close approximation to the sound pressures and timings which would have existed for real sources in particular positions, using two loudspeakers, but it would be fair to say that most techniques only approach this (if at all) in the frontal horizontal plane, and do not attempt to recreate any impression of front-back or up-down position or movement. There are of course notable exceptions, such as Ambisonics, but this involves more loudspeakers. For many practitioners and listeners, straightforward 'Blumlein stereo' (that is based purely on level differences between the loudspeakers) is quite acceptable, and the evidence of many thousands of recordings made with coincident pairs is that level-difference stereo is capable of excellent imaging on transients and continuous sounds alike. It can be even better if suitable attenuation is used in the difference channel at high frequencies (as described by Gerzon<sup>1</sup> and others).

But Blumlein stereo is based on the precept that it is the signals at the ears that matter, not those at the loudspeakers. It is a so-called 'summing' theory of stereo, based on the concept that signals from two loudspeakers combine at each ear to produce a *sum* which is close to the correct amplitude and phase difference required for a

source in a particular position. Such theories model the listener as a subject who is made to perceive 'virtual sources' or 'phantom images' in between the loudspeakers, dependent on the differences in time and level between them. Spaced microphones produced time and level differences between the channels, whereas coincident microphones produce only level differences. Spaced techniques rely principally on the precedence effect which makes the direction of the sound appear to be towards that of the signal which is advanced in time. The more advanced one loudspeaker signal is with relation to the other, the closer the virtual source will appear to the advance speaker, with the maximum effect for stereo loudspeakers noted between about 2 and 4 ms delay.

There are those who believe that time and level differences can be traded off directly, indeed this effect is noticeable in tests with natural sound sources, and Williams<sup>2</sup> has described a whole family of mic techniques which rely on combinations of time and level difference. 'Blumleinists' find this hard to accept, since time differences give rise to phase differences, and Lipshitz<sup>3</sup> has pointed out that spaced microphones can result in summed signals at the ears which are completely contradictory in the directional clue given by the precedence effect and that given by the summed sound pressure at the ears! He has said that 'phasiness' due to spaced microphones is often mistaken for 'spaciousness'. A problem is that many people find slightly-spaced microphone balances very pleasing to listen to, and thus one must look to the psycho-acoustic evidence in order to discover which clues the ear/brain accepts and which it ignores in a wide range of listening conditions and for different types of source. There is strong evidence<sup>4</sup> to suggest that the brain's directional processing may 'lock onto' certain transient timing elements in the signal, only to be re-triggered by suitable 'release' cues, ignoring intervening information in the meantime.

The crux of the above summary of the spaciousness-versus-imaging-accuracy argument is that two-loudspeaker stereo techniques, such as those described, are all trying to project sounds which in reality came from *all around* the microphones (reverb and reflections included) onto the angle between the speakers. Imaging accuracy of virtual sources is thus not enough, since it will be at the expense of the decorrelation between the ear signals which is a symptom of real-life listening in enclosed spaces. Slightly-spaced or near-coincident techniques using *directional* mics (such as the so-called ORTF pair and others) can be perceived as good by listeners for the very reason that they offer the best of both worlds: that is they are close enough together to give moderately-good Blumlein-style imaging due to level differences and do not have excessive LF phase difference, include an element of precedence effect, and introduce a degree of decorrelation between the channels which is good for the subjective quantity of 'spaciousness'. Indeed in subjective tests performed at the University of Iowa<sup>5</sup> the near-coincident pairs consistently scored the highest overall. This should be remembered when we come to consider proposals, such as



Theile's, for the reproduction of binaural signals on loudspeakers.

## Surround sound from two loudspeakers?

The field again divides when we come to consider whether or not sounds can be reproduced accurately outside the angle between only two speakers, or even behind the listener and above or below him. Techniques which aim to achieve this are mostly from the so-called 'transaural' stable, and it is this technique which Roland's recent *Sound Space* system uses. Transaural stereo is still a 'summing theory' of stereo, since it aims to recreate the correct SPLs and timings at the two ears of the listener for virtual sources in different positions, except that it goes further than Blumlein stereo in attempting this for positions all around the head, as well as at different heights. It does this using only two loudspeakers which are fed with processed binaural signals.

Binaural signals such as those derived from a dummy head, as already described, work well on headphones, giving varying degrees of all-round spatial reproduction, since the ears are presented with signals which are very close to those they would have heard in real life. The left ear is presented with the left ear signal and the right ear with the right ear signal. Typical dummy heads simulate the shadowing effect of the head on high frequency signals, as well as the timing differences between the ears. Many also simulate the pinna effects which are vital for accurate front-back and vertical perception, although it is

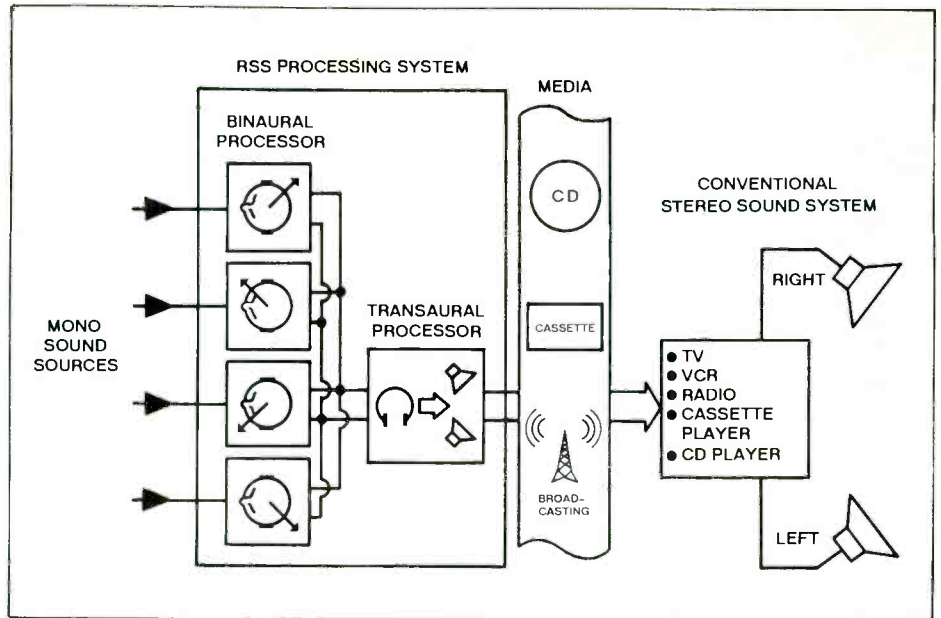

The Roland Sound Space processing chain

important that these effects are not introduced twice: once on recording (the dummy's pinnae) and once on reproduction (the listener's pinnae). This depends rather on the headphones used, their equalisation, and how much they occlude or disturb the pinna region, as well as on exactly where the microphone is placed in the dummy's ear.

Transaural stereo acknowledges that if binaural signals are reproduced on loudspeakers there will in effect arise delayed crosstalk between the ears, as the left ear will also hear a delayed and

equalised version of the right speaker signal (due to having travelled around the head). The process is based on the premise that if this crosstalk could be removed then it would be possible to listen to binaural signals, with all their heightened directional cues, on loudspeakers. It therefore acts (in simple terms) to cancel this crosstalk by introducing a filtered and delayed crossfeed between the two channels, before they are reproduced, which is introduced in antiphase to the likely crosstalk which would occur between a listener's ears. Thus the left loudspeaker would

# 3G GUARANTEED TO WORK

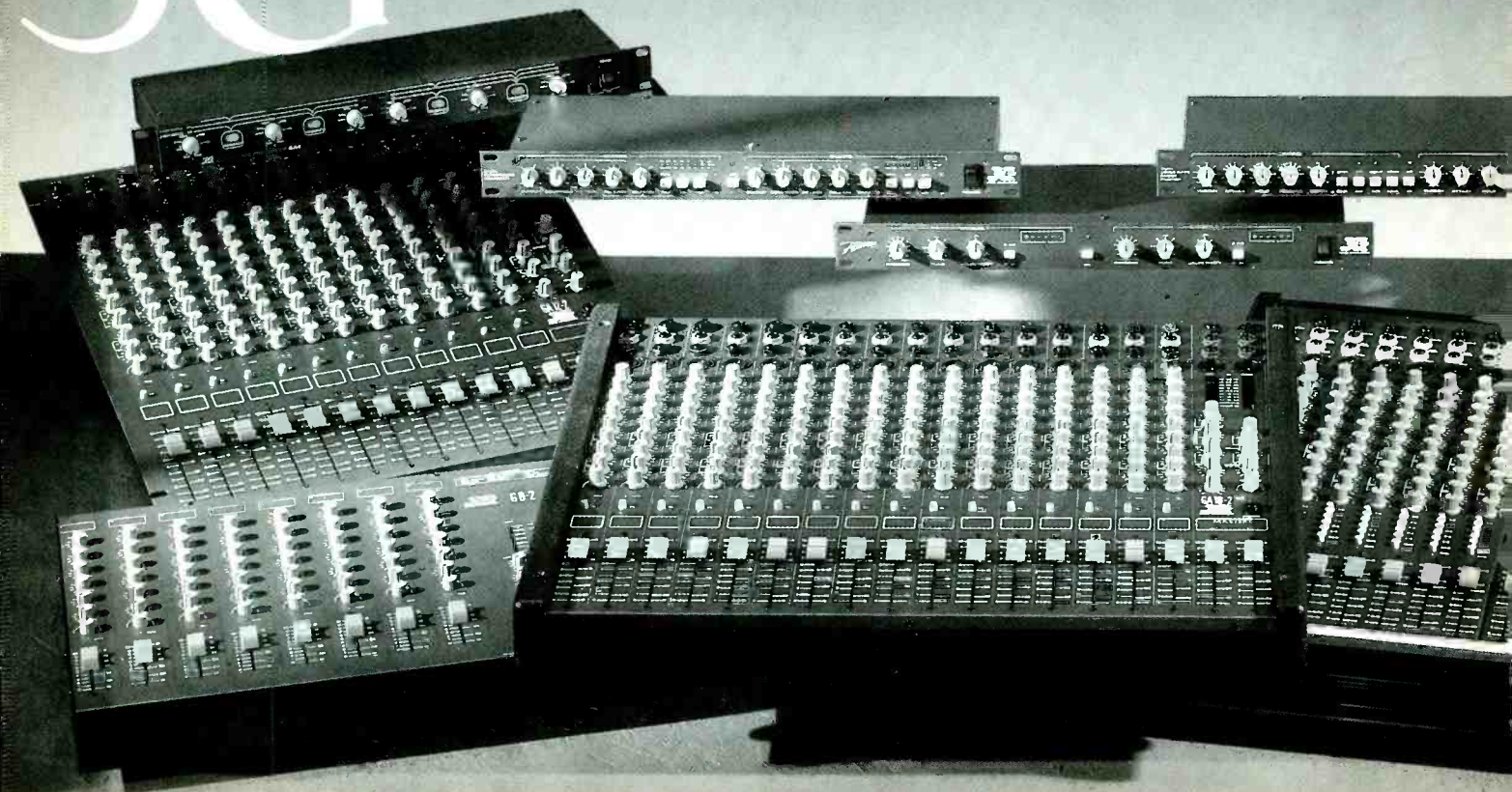



be fed with the 'left ear signal' (L) plus a component to cancel the anticipated crosstalk from the right channel's loudspeaker (which we could call R'). Of course the right ear would also get crosstalk from the left ear which would include a delayed proportion of the R' signal, but the impulse response of the cancelling circuit can be designed to anticipate this gradually-decreasing 'crosstalk of crosstalk-cancelling components'.

The problem with early transaural stereo (it is not new, an example of a project by Atal and Schroeder exists from 1961) was that it only worked for particular listeners who sat in an anechoic room within centimetres of the correct position, where the cancelling was effective. For other positions little or nothing was noticed. Recent developers have worked on making the filter characteristics simpler and more general (whereas previously they had modelled very specific and intricate pinna and head responses), so that the system might work over a wider range of listeners and positions<sup>6</sup>. In some cases this has been at the expense of a reduced effect, although subjective tests have also indicated strikingly good effects over a range of listeners and positions, particularly when the two loudspeakers are equidistant.

## Binaural synthesis in RSS

Roland's RSS system works on the principle of binaural synthesis followed by transaural processing. In other words, a number of mono sources are taken and split into two, then panned

both 'around the head' and vertically using digital filters which simulate the delay and head/pinna effects for the chosen position. These simulated binaural signals are then mixed together and fed to the transaural processor which introduces the crosstalk-cancelling elements necessary for loudspeaker reproduction, as described above (see Fig 1).

A preliminary audition of the demonstration CD on very average loudspeakers was not as impressive as one might have been tempted to expect, but there are a number of points to be made here. Firstly, since the simulation of sources in certain positions depends so much on correct equalisation, any anomalies in the frequency and phase response of the reproduction chain would have a degrading effect on the image, and secondly, the sources used in the demonstration were electronically synthesised, thus not having the naturally-anticipated timbre in the first place. Thus the synthesised 'cow-moo' which is supposed to appear behind the listener is hard to perceive as such, since it doesn't sound much like a cow in the first place. It would be necessary to experiment more with natural sound sources before passing any further judgement. A third point is that an improvement in the spatial effect of the system was noticed after a number of listenings, perhaps confirming the results of others (eg Blauert) which suggest that the aural perception mechanism gradually adapts itself to the equalisation of the programme under audition, accepting it, after a while, as the norm.

Other audible attributes of the demonstration suggest that the system is capable of reproducing sounds outside the loudspeaker base-line, and sometimes around the sides of the listener, as well as suggesting elements of height to some

extent. Again, more exhaustive subjective tests would be of great value, and have been proposed.

## QSound

Although there is little available information on the principles of the QSound system, the patent document, as reported recently<sup>7</sup> suggests that it involves a process which takes mono sources and splits them two ways, equalising and delaying the components in such a way as to simulate sources in positions around the head of the listener. It is not claimed to be a transaural system, although the process described suggests a similar result arrived at through different means. Rather than attempting a theoretical model for the spatial hearing process in conjunction with loudspeaker reproduction, the designers have adopted an experimental means for arriving at the necessary processing of sounds of different types so that they appear in different locations, storing these values in a large database.

Recent information suggests that there may be problems with the mono compatibility of recordings processed by the system, this usually being the result of substantial out-of-phase information between the two channels. Out-of-phase components will be cancelled to a greater or lesser extent when the two channels are summed to mono, thus causing the offending signal components to disappear. The question of mono compatibility is clearly an aspect of considerable importance for the acceptability of music for broadcast, where the mono signal will remain relevant for many years, just as monochrome compatibility remained important when colour television was introduced.



Take a close look at 3G mixing consoles, amplifiers and signal processors and you will see a range of products designed with extraordinary attention to detail and hand built to the highest specification by British craftsmen. It is this uncompromising commitment to quality that confidently allows 3G to offer a 3 Year Guarantee on all products.

3G professional audio products are renowned for excellent ergonomics, robust chassis' and superior sonic performance. They offer a choice of sizes, features and options to meet the many different needs of sound professionals.

With all this you could be forgiven for thinking that 3G professional audio products are expensive, however you will be pleasantly surprised to find very competitive prices throughout the range.

For further information complete the coupon below.

**3 YEAR WARRANTY**

**3G** • MIXING CONSOLES  
• SIGNAL PROCESSING  
• POWER AMPLIFIERS

Sole UK distributor:

HW International, 3-5 Eden Grove, London N7 8EQ. Tel: 071-607 2717

To: HW International, 3-5 Eden Grove, London N7 8EQ. Please send me details of 3G Professional Audio.

Name \_\_\_\_\_

Address \_\_\_\_\_

Postcode \_\_\_\_\_



# Loudspeaker-compatible binaural signals

Although entirely untreated signals from dummy heads or binaural synthesisers are rarely suitable for loudspeaker reproduction, there is considerable evidence to suggest that if a binaural pair of signals is equalised so as to have a flat average response (some sources suggest a flat diffuse-field response, whereas others suggest the need for a flat response averaged over the frontal hemisphere, although Griesinger<sup>8</sup> found that the spatially-averaged response curves measured for a Neumann KU81i dummy head were surprisingly similar to each other for angles of  $\pm 30^\circ$  to the front, and similar again to those obtained for diffuse field measurements) then the results become much more impressive on loudspeakers, sometimes being judged subjectively superior to traditional techniques intended for loudspeakers. The equalisation does not appear to destroy the imaging abilities of binaural signals. Griesinger further suggests that transaural crosstalk cancelling could be used to further enhance the loudspeaker reproduction of such signals, and in this he appears to disagree with Theile.

Theile<sup>9</sup> proposes that we forget all about summing theories of stereo and learn to accept 'head-related' signals from loudspeakers. He suggests that an A-B comparison between a coincident pair and a dummy head in front of an orchestra shows the dummy head to be audibly superior both on headphones and loudspeakers, and he states that we should consider not the ear-related simulation of a soundfield but the head-related 'simulation plane' between the loudspeakers. In stating this he makes the point that the perspective of the sound stage is much more accurately captured by the head-related pickup and that it is akin to the viewing of a picture on a screen, within which there is perspective. The distance of the viewer from the images is the distance from the screen, just as in sound the distance from the simulation plane—the 'sound picture'—is the distance of the listener from the loudspeakers.

Although he does not directly say so, he must be referring to a dummy head equalised as described above, since otherwise the experience of decades of stereo listeners (that dummy heads do not tend to sound good on loudspeakers) is dismissed in a moment. This supposition is further supported by examining Theile's 'sphere' microphone, the *Kugelflächenmikrofon*, recently introduced by Schoeps in the form of a commercial product, and currently doing the rounds as a prototype for assessment, since this 'sphere' contains two pressure microphones mounted flush with the surface of a sphere 200 mm in diameter (roughly head-sized). It is said to offer superior stereo imaging, and even be capable of height information on loudspeakers, without using transaural processing (which, by the way, is dismissed by Theile as being unworkable since it cannot cover a sufficiently wide listening area). Such a sphere would exhibit dummy-head-like characteristics in terms of timing differences between capsules, as well as having similar head-shadowing attributes, but is easier to equalise for a flat frontal response since it does not have 'ears' as such, and is a simpler shape compared with a head.

According to Theile, the brain is able to accept the transaural crosstalk which results from listening on loudspeakers, and adapts its

perception to what it hears in the 'simulation plane', ignoring the crosstalk. Such adaptation processes are convenient explanations, and serve to justify an unusual microphone technique, and yet one cannot help but accept the explanation to some extent, since there are increasing reports of successful loudspeaker stereo using techniques of this type. It is interesting to note how the equalised dummy head has some similarities to the very successful near-coincident pair from traditional microphone techniques described earlier, having microphones which are almost time-coincident as far as LF signals go, but which exhibit level differences due to their directionality, and which offer precedence effect cues due to the spacing, as well as providing decorrelated HF signals which have been linked to the subjective effect of 'spaciousness'. Perhaps there is less of a gulf between the summation-at-the-ear theories and the head-related theories than we might originally have thought.

From such a sphere microphone one would get signals which differed in time, and which would have increasing level difference at high frequencies for off-centre sources. At HF, the shadow for the distant ear would be significant, and thus it is claimed that mono compatibility would not suffer unduly, since, although there would be a significant phase difference between the channels, the level from one capsule would be very much lower than that from the other, and thus have little effect on the mono sum. This seems unlikely at middle frequencies (say 700-1500 Hz) where the phase difference would be very significant between the capsules but the level difference not adequate to make the cancellation effect unimportant.

## Crown SASS

The Crown Stereo Ambient Sampling System (SASS) is another microphone in a similar vein to the 'sphere' which this author originally regarded sceptically due to the confused description of its principle of operation (it seemed to imply that it defied all the traditional theories of stereo recording and reproduction and yet sounded good on loudspeakers!). If one looks at Griesinger and Theile to see how a binaural pair equalised for a flat averaged frontal response can be appropriate for loudspeaker reproduction then it is much easier to accept a system like SASS, since it is basically a binaural pair without 'ears', having a nominally 'flat' averaged frontal response. It consists of two *Pressure-Zone* (boundary-layer) microphones mounted on either side of a wedge-shaped baffle.

## What about the practicalities?

It is all very well coming up with unusually-shaped microphones that make good stereo recordings which may be compatible between headphone and loudspeaker listening, but are they practical? Certainly there would be little difficulty in using them for classical music recording, since the mic remains stationary, and the appearance doesn't matter too much. Theile has suggested so-called room-related balancing techniques<sup>7</sup> for multi-microphones to supplement the 'sphere' functioning as the 'main pair', but these demand complex digital mixing desks with algorithmically defined delays.

What about television and film usage? One

cannot easily imagine a dummy head or a sphere on the end of a pole or attached to a boom, or indeed anywhere in TV recording, since the weight would be prohibitive, the physical size a nuisance and the direction of pickup difficult to see. Also, the treatment of multimics would be more complicated than with conventional stereo, and more prone to operator error. The techniques described above all rely on very careful equalisation, and poor listening conditions or poor loudspeakers/headphones would reduce their effectiveness considerably, although some adaptation of the hearing mechanism is possible in these circumstances. All the care taken to set up the psycho-acoustic sound balance to be correct could be destroyed at a number of points in the signal chain.

More tests must be made before the mono compatibility of binaural signals such as these is pronounced adequate, especially in the case of spatially-synthesised signals which may contain substantial out-of-phase components. A lack of mono compatibility will kill any system intended for music recording because of the problems with broadcasting the results on radio. Furthermore, if transaural recordings are made for domestic release on cassette or CD there will be a problem with headphone listening on *Walkmans*, since the signal must be appropriate in this case would be the output of a binaural synthesiser or head *prior* to transaural processing! Are we to expect two types of pre-recorded cassette—one binaural and one transaural? This would be too messy. Better would be for everything to be released as a binaural balance equalised as described for a flat averaged response over the frontal hemisphere, which could then be subjected to transaural processing in a domestic 'black box' if required. Then perhaps everyone would be happy.

One must question whether attempts to achieve full surround effects from two loudspeakers are simply an unnecessarily-complicated and delicately-balanced means of avoiding more loudspeakers. Naturally the protagonists are encouraged to try, since many multi-loudspeaker systems have failed commercially in the past. Clearly an important consideration is the application intended for such technology, since a system which is optimal for large-screen viewing systems such as HDTV or wide-screen television may be less appropriate for music releases which are going to be auditioned largely on headphones. □

### References:

- 1 Gerzon M. (1986) "Stereo shuffling: new approach, old techniques", *Studio Sound*, July.
- 2 William M. "Unified theory of microphone systems for stereophonic sound recording", presented at 82nd AES Convention, London 1987, Preprint 2466.
- 3 Lipshitz S. (1986) "Stereo microphone techniques: are the purists wrong?" *Journal of the AES*, 34.9, September.
- 4 Hafter *et al* (1988) "Onset coding in lateralisation: its form, site and function". In *Auditory Function*, eds Edelmann, Gall and Cowan, Wiley, NY; cited in Moore (1989) *An Introduction to the psychology of hearing*.
- 5 Cross L. (1985) "Performance assessments of studio microphones", *Recording Engineer/Producer*, February.
- 6 Cooper D H and Bauck J L. (1989) "Prospects for transaural recording", *Journal of the AES*, 37. 1/2, Jan/Feb.
- 7 Fox B. (1990) Business column. *Studio Sound*, November.
- 8 Griesinger D. (1989) "Equalisation and spatial equalisation of dummy head recordings for loudspeaker reproduction", *Journal of the AES*, 37. 1/2, Jan/Feb.
- 9 Theile G. (1991) "On the naturalness of two-channel stereo sound". *Proceedings of the 9th International AES Conference*, Detroit, Feb 1-2.



# RELIABLE PLAYERS

## SCOTT PAGE ON QSC.

"Powerful sounds and dynamic images are what make a live performance great.

On world tours with Supertramp,

Toto, and Pink Floyd there are no second chances on the bandstand.

I depend on my equipment to work every night."

*QSC Power Amplifiers... as reliable as the players who use them.*



# QSC

A U D I O

QSC Audio Products, Inc.  
1926 Placentia Ave., Costa Mesa, CA 92627  
714-645-2540



# PRACTICAL NETWORKING

Networking of digital recording/editing systems is now a technical possibility and for a few manufacturers, a proper product. Yasmin Hashmi and Stella Plumbridge examine the practicalities

**A**lthough new to the world of audio, networking has been around for some time. Its most common use has been in offices, research and education centres and communications facilities. In large offices, for example, networking has generally consisted of terminals spread around the building which are all connected to a mainframe computer located in a remote room. The mainframe stores all the text files and software operating packages for the entire company on hard disk. There is normally one person in charge of maintaining the system, including archiving and restoring data, formatting the hard disk(s), etc.

## The advantages of networks

The fact that many terminals can be connected to and co-ordinated by the same system means that in theory, any user has access to any file on the system. Having direct access to each other's work eliminates the need to copy files onto a transportable medium (such as floppy disk for business or tape streamer for audio) in order to transport them to another user.

In addition to terminals being connected to the network, other devices such as printers and tape streamer backup can be connected. Thus, system resources such as disk storage, file management (including databases, accounting systems, etc) archiving and printers can be shared by many users rather than each user having to have their own.

## Types of network

An in-house networked system can be generally termed a 'Local Area Network' (LAN). A LAN can cover a building or area over a distance of a couple of miles and generally deals with business information such as speech, data, text and graphics. LANs can be formed in three basic configurations—the star, the ring and the bus (Fig 1). With the star configuration, the central unit is in charge of controlling all traffic within the system. With the ring and bus configurations any device attached to the network can be the system controller. There are advantages and disadvantages to each configuration both in functionality and cost. In addition to the configuration used, other factors which will determine the capabilities (and ultimately the

cost) of a network include the standard used, the connecting medium (such as coaxial cable, optical cable, etc), and the operating system used. There are a number of advanced networking operating systems developed by companies such as Novell and Intel.

Although a number of different standards for LANs have been established, there are two which are more commonly used in the business sector than others. These are Token Passing (or Token Ring sponsored by IBM) and Ethernet (developed primarily by Xerox). Token Passing uses the ring configuration while Ethernet uses the bus. A consideration when looking at Ethernet or Token Passing protocols for audio purposes is how fast the system can transfer data. In general, audio consists of much more data than text (megabytes rather than kilobytes) and if it is to be transferred at a reasonable rate (realtime or faster) it will require much higher transfer speeds than text.

Ethernet uses shielded coaxial cable as the connecting medium and operates at 10 Mbit/s (10 mega bits per second). In theory this equates to a possible transfer rate of 625 kHz for a single 16-bit audio channel or 312.5 kHz for a stereo signal. This means that a stereo signal recorded at 44.1 kHz could be transferred at around 7 times faster than real time, ie a 21 minute recording would take just 3 minutes to transfer. However, the greater the number of channels to be transferred, the longer the time it takes. In this case, transfer would be slower than real time if the number of channels to be transferred were greater than 14. The Token Passing protocol now has an increased transfer rate from 4 Mbit/s to 16 Mbit/s but this still not practical for use with bulk audio transfer. However, a useful network may not require the transfer of audio data at all and although Ethernet and Token Passing are primarily designed for business information purposes, for audio purposes they could be used for transferring the smaller data files such as events lists, edit decision lists and sound effects.

## Digital audio network requirements

The current problem for digital audio networks is that appropriate standards have not yet been developed. For the very high rates required for transferring continuous bulk audio, fibre optic cable would appear to be the prime candidate. A new standard being developed called FDDI II uses

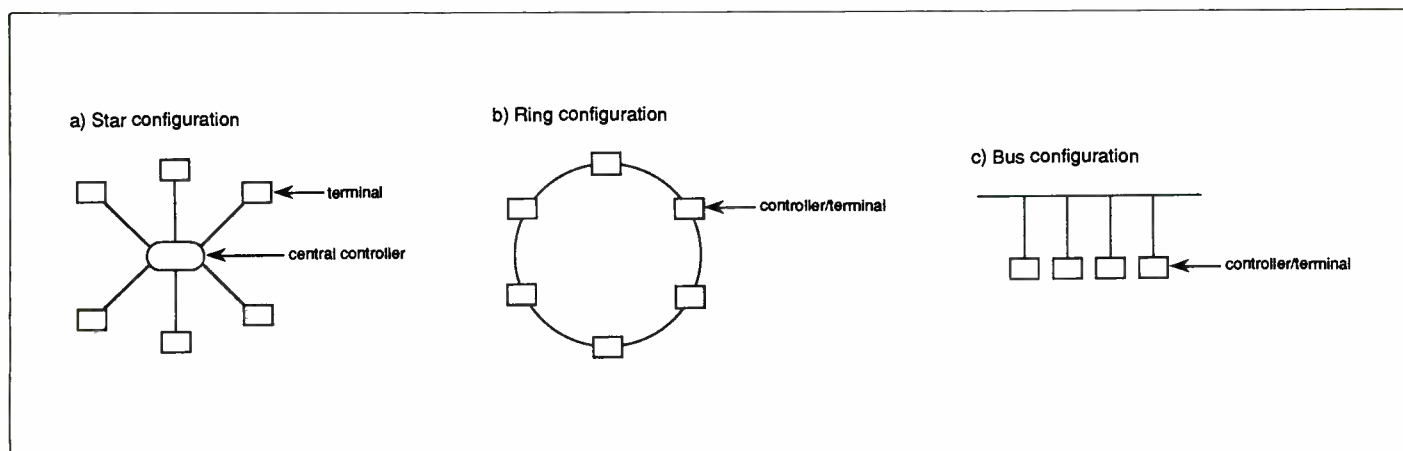

Fig 1





Photograph: Ian Kainowski Hand Printing: Neal Jackson

# WARNE LIVESEY

When it comes to capturing the spirit and originality of an artist, producer Warne Livesey has few equals:

Listen to *Diesel and Dust* and *Blue Sky Mining* by Midnight Oil; to *Infected* or *Mind Bomb* by The The; to Deacon Blue's *When The World Knows Your Name* or Paul Young's *Other Voices*; to *Saint Julian* by Julian Cope or *Satellite* by The Big Dish.

Each album has been as different in feeling and style as the next; all have achieved worldwide critical and commercial success.

Eighteen months ago Warne started using Neve VR consoles. Since then, the Neve desk has determined his choice of studio.

Warne is currently producing the new album by All About Eve - recorded using the Neve VR with Flying Faders automation.



A Siemens Company

THE LEGEND CONTINUES



Neve Electronics International  
Cambridge House, Melbourn,  
Royston, Herts SG8 6AU.

Tel: 0763 260776. Fax: 0763 261886.



optical cable and will be capable of a transfer rate between 100 Mbits-200 Mbits. This could potentially allow 48 continuous channels of 44.1 kHz audio to be transferred at around six times faster than real time.

In order for a digital audio system to be networked so that multiple users can operate the system at the same time, the system must be capable of dealing with multiple instructions simultaneously, ie it must be capable of multitasking. How well it deals with its tasks will depend on the operating software. Finally a decision must be made as to how the hardware can be configured in order to meet both cost and capability requirements.

In assessing how a network should be configured, the possible demands which may be made on it must first be examined. From discussions with potential users, the following emerged as the main possible requirements:

- to allow multi-user access to a central store of sounds (such as sound effects)
- to have multi-user access to recordings anywhere on the system
- to transfer edit decision lists, events lists and automation from one terminal (or workstation) to another
- to have multi-user access to the system's resources (such as inputs, outputs, signal processing, archiving, etc.).

## Applications

The area in which networking of tapeless editing systems would be of most interest is undoubtedly audio post-production where the final mix is preceded by various specialist stages. These stages could consist of dialogue editing, sound effects laying and music editing with each stage being performed in a different room (or location) by a specialist. If each specialist had their own self-contained tapeless editing system, once a particular stage had been completed, the project would have to be downloaded onto a portable medium and uploaded onto the next system. It would be far more convenient if all systems had direct access to the project.

Another example is when several projects are on the go at the same time. Rather than each sound effects specialist only having direct access to their own sound library, it would be convenient and

more cost effective if they all had direct access to each other's library or even to a common sound library—thus avoiding the need for duplication in terms of sound effects and equipment. In addition to audio post-production applications, there is a great deal of interest in the area of automated broadcast stations where networks can be used for controlling and distributing programme material.

## Configurations

There are a number of ways in which tapeless systems can be configured in order to satisfy the possible requirements already mentioned. One of the simplest is to allow a central store of hard disks to be controlled by a number of terminals which transfer control information only. As far as we know, the *Sirius-100* from FOR.A was the first disk-based recorder to provide such multi-user access. The system is mainly aimed at cart replacement for broadcast applications. The configuration of the system is similar to that shown in Fig 1a (a star). It allows up to eight remotes to be connected to a central controller which consists of a computer, hard disks, inputs and outputs. Each remote can be up to 300 metres distant from the central controller and each can control a mono recording (or four remotes can each control a stereo recording). One of the remotes is the main input controller, which controls the recording of takes, simple editing and recording of takes into the desired sequences. The other remotes control playback only. If two remotes wish to playback the same recording at the same time, a copy of that recording will have to be made internally from disk to disk so that each remote can access its own recording.

SSL have recently introduced *SoundNet*, a networking system for *ScreenSound* which uses SSL's own proprietary operating software and serial control network. *SoundNet* is basically a SCSI switcher which allows up to 16 SCSI devices such as hard disks, optical sound library drives, digital tape streamers etc to be accessed by up to eight *ScreenSounds* as shown in Fig 2. Each hard disk in the central store provides eight audio channels. Each user can allocate themselves exclusive control of one hard disk at a time and use it as the working disk. Because the link between the *ScreenSound* processor units and *SoundNet* is SCSI, they have to be in close proximity to *SoundNet* and the central disk store.

However, the *ScreenSound* terminals are connected to their respective processors via an RS 422 link, which means that they can be several hundred metres distance.

No audio passes between *ScreenSounds* themselves. Any transfer of audio takes place either within the central disk store and/or between any of the other SCSI devices. However, as well as operating within the network, each *ScreenSound* can also have its own hard disk and optical library, thus operating as an individual system if disconnected from the network.

The central optical sound library does not need to be allocated to any particular user. A centrally held database provides search facilities for all sound files on all opticals whether in the drive or not. Provided it is not currently being used by someone else, audio can be copied from the sound library to the user's working disk as required and then control of it will be relinquished back to the system.

In addition, any user can search any hard disk on the system, provided it is not currently being used. For example, should user A need to search a hard disk which is currently allocated to user B, user A will have to (politely) ask permission to interrupt user B in order to search the disk and then, if necessary, make a copy of the desired recording from user B's disk to user A's disk. The copy is made at 5 times faster than realtime (for a mono recording). In addition to audio, other data pertaining to a project, such as edit decision lists, automation and synchronisation information, may also be transferred from one disk to another.

The network also allows any *ScreenSound* to act as a master to the others. Thus if eight *ScreenSounds* were connected to the network, one of them could act as master to the seven others, allowing playback of up to 56 channels of audio.

In order to manage the network, a terminal can be set up in the control room (or nearby) which would allow a network administrator to monitor who is allocated to which drive and to perform tasks such as up or down loading audio from the tape streamer. So, for example, if user A has finished a project, they can telephone the administrator in the control room and ask them to download the project. While backup is taking place, user A can allocate themselves another free disk and commence a new project.

There are a number of systems aimed at cart replacement/replay automation for the broadcast market which claim to provide networking capabilities. They generally consist of a bus structure with several terminals, a control processor, a sound library and playback modules attached. They tend to use data compression on the audio and only allow limited editing. Some are aimed at in-house networking, allowing control of traffic, production, billing and playback by multiple users. At least one, namely *WIM* from the French company XIS, uses Ethernet for its LAN and ISDN (Integrated Services Digital Network) for its WAN (Wide Area Network). ISDN is an internationally agreed network based on public digital telephone transmission systems. The WAN can be used to transmit programme material prepared in a central station to a number of remote stations for broadcast.

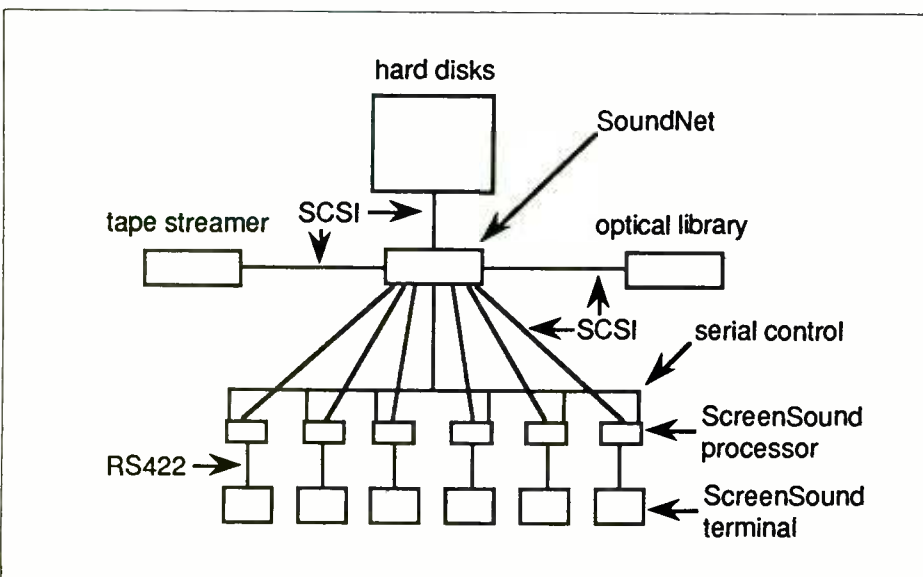

Fig 2

## Future Developments

The idea of having a central pool of resources such as hard disks, a tape streamer and sound library seems like a cost-effective way of



maximising resources. However, along with the advantages there are naturally some constraints which may be overcome by adopting alternative configurations and/or operating systems. For example, if a network had eight users on it who each wanted to upload a project from a single tape streamer, there could be a great deal of waiting time involved if all projects contained a large amount of audio and/or yours is the last project to be loaded. In addition, although a central pool of disks are available, this does not mean that everyone on the network has access to any disk at any time, ie two users may not be able to share a disk if it must be allocated to one user only.

Another possible constraint would arise if users were, out of necessity, located in different buildings or sites (ie remote instead of local). This would require actual transfer of audio from one location to another. Depending on the type of network used, it may be possible to transfer, for example, continuous multichannel audio in real time (thus allowing multichannel auditioning and/or playback from remote sites) otherwise it is likely that the audio will have to be transferred from a local disk store to a remote one before it can be played back. In addition, remote systems will need to be synchronised to a master reference clock. Using a standard such as Ethernet for this purpose would limit how much (or how fast) audio can be transferred to remote systems, so a standard such as FDDI using optical connections would seem more suitable.

This is a proposition that DAR have in mind for networking *SoundStation II*. Although they have no plans to announce networking software in the immediate future, they are committed to its implementation. In fact *SoundStation II* already

contains the essential elements in order to perform networking. It uses multiple processors to distribute processing tasks, performs multitasking and uses an Intel real time operating system. There are also spare plug-in slots for third party networking hardware. The principle behind DAR's networking will be that instead of sharing central resources, each *SoundStation* can operate as an individual system as well as being accessed by other *SoundStations*.

The principle features of DAR's networking system will include:

- 48 channels of throughput in real time
- background transfer of mono, stereo and multichannel recordings
- audition of mono, stereo and multichannel recordings from anywhere on the network, including varispeed playback
- full implementation of access rights and protections
- dual optical rings using FDDI protocols at 125 Mbps (or optionally single coaxial cable)
- synchronisation to an accuracy of one audio sample of all local and remote *SoundStations*
- attaching of additional tracks from remote *SoundStations* for real time playback.

NED and AMS are also planning to provide networking for their respective systems. NED intend to implement networking by using their DSP option. This will be a separate module and will provide multitasking as well as multichannel digital I/O and digital signal processing. Using NED's proprietary hardware/software the DSP option will be able to act as a central processing and control system between *PostPro/Synclavier*

resources and multiple user interfaces. AMS will doubtless take advantage of the *AudioFile Plus'* parallel processing capabilities. The difference between parallel processing and multitasking may best be explained by an adaptation of a surreal analogy kindly provided by Doug Ford of AMS: "multitasking can be seen as having to write two letters with one pair of hands. You write a little on the first, stop, move on to the second, write a little, stop, move back to the first and write a little more and so on, thus gradually building up your two letters. Parallel processing is like sprouting a second pair of arms, allowing you to write both letters at the same time."

## Conclusion

Networking is in its early stages in digital audio applications, but it promises to make tapeless systems far more attractive to the audio post-production and broadcast markets in particular. Although the development of standards is being led by the communications industry, and may therefore not completely accommodate the needs of high quality digital audio, the technology for designing competent digital audio networks already exists. It is only a question of time before the manufacturers who have indicated an intention to provide networking take advantage of it. There are questions raised as to what constitutes a true network and what, in reality, is simply reallocation of resources providing a degree of multi-user access. Whatever the theory, if it results in a more efficient use of resources, both technological and human, it has to be a good thing. □

# STUDIO AUTOMATION

RECITAL gives you the opportunity to automate your audio system, sixteen audio channels in this slim 1u rack mounting unit. To achieve full automation of your audio levels you simply connect your audio outputs, to RECITAL's audio input ie. mixer send, keyboards, drums etc then, connect the output back into your mixing desk (mixer return input) or amp, 16trk, etc. Insert your MIDI signal, to MIDI IN socket and you are ready to have full control over your mix. Now simply send a MIDI controller to RECITAL by means of a sequencer, sequencing software package or R-TECHNOLOGY's fader page, to change the level of the audio channel. Recital powers up at unity(0dB), by sending MIDI control change 16,1,112. (MIDI channel, audio channel, audio level) the audio channel 1 will drop in level by -5db. There are 127 control changes, which enables you to have fine control over audio levels.

- dbx 2150A VCA's
  - Assignable stereo mix bus
  - Operates under MIDI control change
  - Based on modular card system ● NE5532 Op-amps
  - Enables up to 112 audio channels on one MIDI channel
  - Maximum attenuation -110dB ● THD .004% DIN
  - Cross talk (vca card's) -100dB ● MIDI channel select switch ● MIDI thru connector
  - MIDI online led ● Earth lift switch ● Voltage select switch ●
- RECITAL I Phono unbalanced inputs/outputs ,1U Rack mounting unit  
 RECITAL II XLR Electronically balanced inputs/outputs ,2U Rack mounting unit

### R-TECHNOLOGY

Wynn House,  
 20 Church street,  
 Tankerton,  
 Kent CT15 1PH.  
 Tel: 0227 264862  
 Fax: 0227 771600

There's more, not only does RECITAL give you 16 audio channels, but there is a mix bus in/out. Eight audio channels are connected to the left bus output, the other eight are connected to the right. This feature allows you to mix your sixteen audio levels onto a stereo mix, also it is possible to have MIDI control over the level of the stereo mix bus this turns RECITAL into a stand alone line level mixer..... There are ten fader configurations, each are selectable by one MIDI controller, for example, you can MUTE all audio channels, INVERT faders, REDUCE all levels, by sending the appropriate MIDI controller at the right time in your mix. This can be achieved by setting your levels on a sequencer or our MIDI WORKSTATION, and transmitting them to RECITAL at a preset MIDI clock, SMPTE timecode, or event controller. All modes of operation are in real time and at a truly affordable price....



MIDI WORKSTATION 700  
 The workstation has been designed to let you have full control over your audio via MIDI by moving the faders to control audio levels, pushing a button to mute a channel .... It will give the mouse a rest !  
 16 faders + master fader ,16 channel mutes, dump switch, MIDI out .



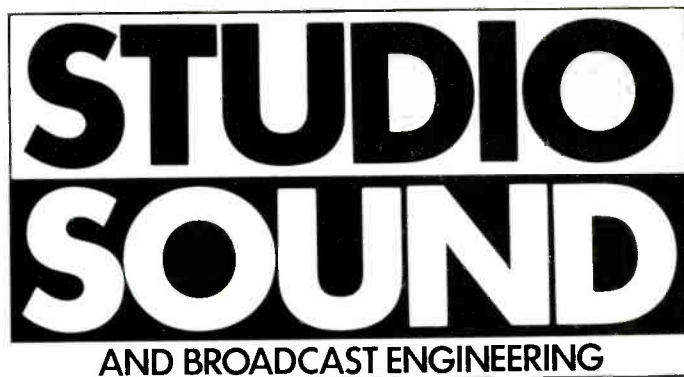

# **HAS MOVED!**

**As from 27 May 1991  
our new address is**

**STUDIO SOUND  
SPOTLIGHT PUBLICATIONS LIMITED  
LUDGATE HOUSE  
245 BLACKFRIARS ROAD  
LONDON SE1 9UR  
Tel: 071-620 3636**



PRODUCT PROFILE

PRODUCT PROFILE

Acoustic Treatment Acoustiile Aerosols AGFA AKG ALESIS AMPEX Audio Oscillators Bantam Plugs BASF BEYER Blanking Panels Boom Arms BRADY BSS Bulk Erasers Cables Cable Drums Cable Markers Cable Ties Cage Nuts CALREC Cassettes Cassette Deck Cassette Labels C.D. Players Chlinographs Compressors CONNECTRO DAT DBX De-gausser DENON D.I.Boxes DRAWMEF EDAC EDITALL Effects Units Editing B ELECTRO Empty S Fishpole F.M.Tur FOSTER Gaffer Tape Goosenecks G.W.INSTRUMENTS Headphones Headphone Amp Headphone Splitter Headsets

ROCKFLEX RYCOTE SENNHEISER SHAPE

Leads LED Bargraph Mains Cable

ROCKFLEX RYCOTE SENNHEISER SHAPE

Leads LED Bargraph Mains Cable



**Chrome & Ferric Mastering Cassettes**  
 BASF tape in Swiss ICM bodies. C5-C90.5 We supply over 250,000 a year at easily the UKs lowest prices Library case included.

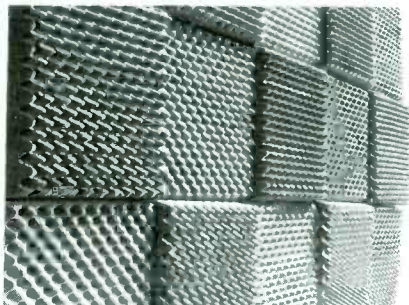

**Acoustiiles**  
 The UKs most popular acoustic tile.

**NEWS UPDATE**  
**60,000 customers can't be wrong.**  
 Our 60,000th customer was The Eurythmics who ordered Switchcraft XLRs for same day delivery. A magnum of celebration champagne accompanied the order.  
**The 1991 reference catalogue out now.**  
 It includes, over 60 types of studio cables, 100 different plugs/sockets and adaptors, chrome cassettes from 40p. New products from Sony, Drawmer, Alesis, ART, Tascam, Denon, EMO etc.  
**Make sure YOU are on the mailing list.**

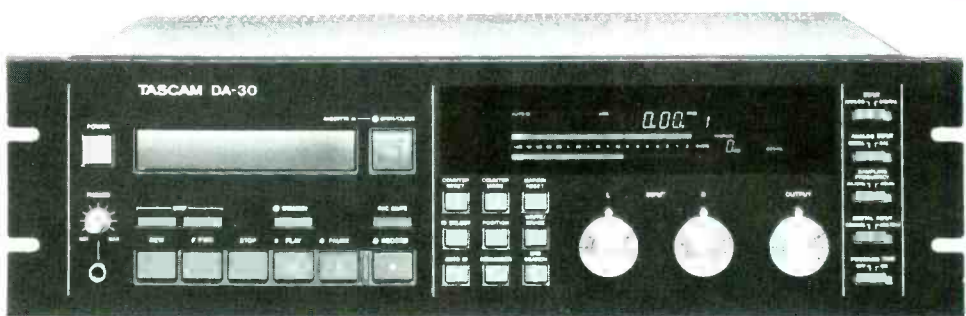

Tascam DA30 DAT Recorder. Designed specifically for the studio at under £1200.

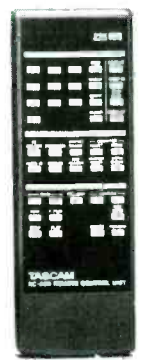

**WE DIDN'T REACH NO. 1 BY BEING OUT OF STOCK OR EXPENSIVE**

Save time-phone

**Studiospares**

61/63 Rochester Place, London NW1 9JU  
 tel 071-482 1692 FAX 071-485 4168

first

Please send free 68 page catalogue

Please send account application form

NAME .....

ADDRESS .....

.....

.....

# CLASSIFIEDS

Advertisements for this section must be pre-paid. The rate is £1+VAT per word, minimum £20.00+VAT. Box Nos. £10.00+VAT. VAT (UK only) \$ rate \$2.00 per word, minimum \$40.00, Box No. \$20.00 extra. Semi-display rates on application. Copy and remittance for advertisements in AUGUST '91 issue must reach these offices by 21st JUNE addressed to: The Advertisement Manager, Studio Sound, Link House, Dingwall Avenue, Croydon CR9 2TA. Cheques made payable to Link House Publications (Croydon) Ltd. Note: Advertisement copy must be clearly printed in block capitals or typewritten.

Replies to Box Nos. should be addressed to the Advertisement Manager, Studio Sound, Link House, Dingwall Avenue, Croydon CR9 2TA, and the Box No. quoted on the outside of the envelope. The district after Box No. indicates its locality. **SEX DISCRIMINATION ACT 1975:** No job advertisement which indicates or can reasonably be understood as indicating an intention to discriminate on grounds of sex (e.g. by inviting applications only from males or only from females) may be accepted, unless (1) the job is for the purpose of a private householder or (2) it is in a business employing less than six persons or (3) it is otherwise excepted from the requirements of the Sex Discrimination Act. A statement must be made at the time the advertisement is placed saying which of the exceptions in the Act is considered to apply.

The attention of advertisers is drawn to "The Business Advertisements (Disclosure) Order 1977", which requires that, from 1st January 1978, all advertisements by persons who seek to sell goods in the course of business must make that fact clear. From the above date consumers therefore should know whether an advertisement relates to a sale by a trader or a private seller.

## SERVICES

**CASSETTE DUPLICATING:**  
**GAUSS Loop-Bin / TELEX In-Cassette**  
**High Quality Blanks / Label Printing**  
**OPEN REEL DUPLICATING**  
 (ANY SPEED - ALSO TO BROADCAST SPEC.)  
**SPEECH RECORDING**  
 (VOICE-OVERS; LANGUAGES; AUDIO-VISUALS)  
**SPEECH-PLUS RECORDINGS LTD.**  
 UNIT 32, NO. 19, PAGES WALK, LONDON SE1 4SB. TEL: 071-231 0961

### FOR ALL YOUR RECORDING NEEDS

AMPEX · BASF · MAXELL · AGFA · JVC  
 AUTHORISED NATIONAL AUDIO/VIDEO TAPE DISTRIBUTOR  
 Spools, boxes, blades, splicing and leader tape. Blank custom wound cassettes C1-120, labels, library cases and cards, C-zeros, pancake, etc. Broadcast Cartridges.

  
 12 Britannia Road  
 Sale, Cheshire M33 2AA  
 Tel: 061-905 1127  
 SOUND AND VIDEO SERVICES  
 FOR QUALITY, PRICE AND SERVICE

### EAST MIDLANDS AUDIO STUDER-REVOX NEW AND USED SALES SERVICE — SPARES

APPROVED CONVERSIONS  
 A807-A807 VU: POA

**MACHINES CURRENTLY IN STOCK**

STUDER A62 STEREO	£600.00
STUDER C37 STEREO	£800.00
STUDER B67, STEREO	£1,700.00
STUDER A80, STEREO	£2,000.00
STUDER B62, STEREO	£1,000.00
REVOX PR99, TROLLEY	£1,400.00
REVOX A77 H/S IEC	£480.00
STUDER A80 8 TRACK	£3,000.00
STUDER A80 16 TRACK	£6,500.00
REVOX PR99 MK III	£1,890.00
REVOX B77 MK II HS	£1,300.00
REVOX B215 CASSETTE	£1,000.00
REVOX C270 TC NEW	£4,000.00
REVOX B242 POWER AMP	£950.00

ALL PRICES PLUS VAT

**TEL 0246 275479**  
**FAX 0246 550421**

STUDIO 24, FRANCE: Sold duplication equipment Lyrec P2000 — double master — 4 slaves pancakes — 1400 tapes/day — 120,000 FF — Tel: 79.32.61.32.

QUALITY CASSETTE MASTERING AND COPYING, any quantity, Video duplication PAL/NTSC/SECAM transfers, 24 hour, seven days a week service. G.W.B.B. Audiovision, 42 Lancaster Gate, London W2 2NA. Tel: 071-723 5190.

LOCKWOOD, TANNON, etc. New and used equipment bought, sold, serviced. Authorised Tannoy specialist. Lockwood Audio, Tel: 0923 210254 Fax: 0923 240558.



THE CASSETTE DUPLICATING SPECIALISTS  
 Real time & high speed loop bin duplication, printing & packaging. Blanks wound to length  
 TEL: 061-973 1884



### TAPELINE

Blank & Duplicated Cassettes

New Tapematic Loop Bin Duplication & Loading High Spec Professional Bin Mastering

- \* 120x Real Time Duplication
- \* Ferric & Chrome Cassette supplies
- \* Printing & Packaging, cases & accessories.

FOR HIGH PERFORMANCE CASSETTES  
 CALL 061-344 5438

Tapeline, Unit 2, York Works, York Street  
 Audenshaw, Manchester M34 5HD

### jbs records

#### MUSIC-SPEECH-DATA

REAL-TIME/HIGHER-SPEED Quality Cassette Duplication and Blanks from 1-1000. Computer printed Labels. Solo. 1/4 1st, Sony Betamax or R-DAT recording. Fast Security Delivery service.

FILTERBOND LTD, jbs records div, FREEPOST  
 19 SADLERS WAY, HERTFORD, SG14 2BR 0992-500101

### MASSED NAKAMICHI'S IN LONDON!

ULTIMATE QUALITY REAL TIME CASSETTES  
 UNBELIEVABLE RATES \* DAT TO DAT COPYING  
 AND EDITING \* BLANKS WOUND  
 \* COMPUTER PRINTED LABELS

**AURAL CASSETTES 081-460 7435**

FASCAM/SENN/BEYER, trade counter. Erricks VCD, Brighthouse 722121. (X)

## THE COMPLETE SERVICE.....

### DIRECT

- Record Pressings
- Cassette Duplication
- Compact Discs
- Post Mastering
- P.Q. Encoding
- Print & Reprographics
- Video Duplication
- Competitive Prices
- Free Quotations

Make it with us  
 We make the hits



MARKET LEADERS

☎ 081-446 3218 LONDON  
 ☎ 0480 61880 CAMBRIDGE

### HIGH SPEED HIGH QUALITY LOOP-BIN DUPLICATING BY SRL TAPE SERVICES

REEL REEL	IN...OUT	QUALITY CASSETTES
FF PCM DIGITAL		QUALITY CASSETTES
AUDIO CASSETTE	IN...OUT	QUALITY CASSETTES
		QUALITY CASSETTES

THE BETTER THE MASTER, THE BETTER THE COPY!  
 HOW MANY WOULD YOU LIKE? 100-5000  
 081 888 8888 081 466 8888 PHONE FOR PRICE CHECK



**FOR SALE**

**PARTRIDGE ELECTRONICS**

**REPORTER Model T26**

- ◆ Two Mic. Inputs + Line Input ◆
- ◆ Auto — Manual Control ◆
- ◆ D.T.M.F. or L.D. Dialling ◆



**OUTSIDE BROADCAST UNIT**

**EASY TO CARRY**

**FLIGHT CASE**

**BROADCAST OVER**

**STANDARD PHONE NETWORK**



UNIT D  
318 HIGH ROAD  
BENFLEET  
ESSEX SS7 5HB  
TELEPHONE: 0268 793381

**SERVICES**

**"BULLETIN BOARD"**

- 1 x Sony 3348 Digital multitrack, low hours, superb condition..... **£34,500**
- 1 x Studer AB20, inc. SR cards, v.ry very low hours, immaculate..... **£14,950**
- 1 x Otari MTR 90 MkII, 1,500 hours, remote in excellent condition..... **£3,995**
- 1 x Otari MTR 12 1/2" 2-track tape machine, immaculate..... **£20A**
- 1 x Mitsubishi X880 32-track digital, new A/D/oc inc. bargraphs..... **£14,500**
- 1 x SSL 4056E, 56 fitted with E Computer & Total Recall..... **£75**
- 1 x pair GENELEC 1034A, unused, as new, perfect in every way!..... **£150**
- 1 x Lexicon PCM60..... **£485**
- 1 x Lexicon PCM70..... **£295**
- 2 x Marshall time modulators both in need of repair..... **£895**
- 1 x Roland SDE 3000..... **£2,000**
- 2 x TC 2240 mc amp/Parametric equalisers..... **£895**
- 1 x pair Westlake BBSM 6's..... **£2,000**
- 1 x pair GENELEC S30 active monitors in flight cases, superb..... **£250**
- 1 x Yamaha SPX 90..... **£250**

**CLEARANCE ITEMS INCLUDE**

- Neumann U89 **£425**, Sennheiser 421 **£110**, AKG D12/D222 **£95**, AKG 451 + CK1 cap **£125**, SONY Profel TV's **£295**, 19" equipment racks various prices, mic wall boxes **£5.00** each, 19" rack **£35.00**, XLR plugs **£1.00** each, Barco 26" TV monitor **£250**, Linn Mill drum machine **£275**, Casio CZ1000 **£225**, Cheatah master keyboard **£225**, Pukke guitar amp **£50**.

The above is just a TINY example of the massive amount of equipment we have for sale all at prices intended to guarantee a very quick sale! Including outboard and microphones.

TELEPHONE: 081-994 4433 or Fax: 081-994 9321 or Mobile: 0831 319111  
Studio TimeLine, Lamb House, Church St, Chiswick, London W4 2PD

**SITUATIONS VACANT**

**AKAI JAPAN**

**SOFTWARE WRITER — SALARY UP TO £40K**

We are looking for a software engineer to write operating system code for sophisticated musical products. It will be written mostly in 80X86 assembler (with some DSP56000), requiring detailed attention to low-level control of peripheral devices and speed optimisation. For non-time-critical routines, C could be used. Applicants should have several years experience of this type of software. Experience of MIDI and SCSI interface software and general electronic music engineering will be an advantage.

**Location:** preferably working from home, within easy travelling distance of Oxford and West London.

If you are interested, please send your CV to Box. No. 1.6.91



Digital and analogue editing, mastering, duplicating of any format including

**One-off CDs from £45**  
Also CD testing, custom wound blanks and voice-over recording.

Ref SS591, 13a Hamilton Way  
London N3 1AN  
Tel: 081-346 0033  
Fax: 081-346 0530

**SELECTA**



**SOUND**

REAL TIME AND LOOP BIN DUPLICATION

EXACT LENGTH CASSETTES  
STUDIO SUPPLIES  
**COMPACT DISCS FROM 95p**

TEL 04024 53424  
FAX 04024 55565

**R&D MANAGER**

**AUDIO ELECTRONICS GUILDFORD**

CANON RESEARCH CENTRE EUROPE IS CANON'S FIRST OVERSEAS RESEARCH AND DEVELOPMENT CENTRE, WORKING ACROSS A BROAD RANGE OF RESEARCH PROGRAMMES FOR THE CANON GROUP THROUGHOUT EUROPE.

IN JANUARY THIS YEAR A NEW COMPANY, CANON AUDIO, WAS FORMED TO MANUFACTURE AND MARKET AUDIO PRODUCTS ON A GLOBAL BASIS.

WE NOW REQUIRE AN EXPERIENCED ELECTRONICS ENGINEER TO SET UP AND LEAD A TEAM RESPONSIBLE FOR DEVELOPING NEW PRODUCTS FOR CANON AUDIO.

YOU SHOULD HAVE EXCELLENT ELECTRONICS SKILLS, IDEALLY GAINED IN AN AUDIO ENVIRONMENT AND A WELL ORGANISED AND MOTIVATIONAL MANAGEMENT STYLE. IN SHORT WE NEED SOMEONE WHO GETS THINGS DONE!

OUR AIM IS TO PRODUCE INNOVATIVE AUDIO ELECTRONICS PRODUCTS, INITIALLY TO COMPLEMENT A NEW RANGE OF SPEAKERS. BUT IN THE LONG TERM TO DEVELOP A FULL RANGE OF AUDIO EQUIPMENT. IT IS ENVISAGED THAT SOME OF THESE PRODUCTS WOULD NOT BE PURELY ELECTRONIC AND WOULD INTEGRATE WITH OTHER TECHNOLOGIES WHERE APPROPRIATE.

THE REMUNERATION AND BENEFITS PACKAGE OFFERED IS UNLIKELY TO DISAPPOINT.

IF YOU FEEL YOU HAVE THE EXPERIENCE, SKILLS AND DRIVE WE ARE SEEKING PLEASE WRITE IN THE FIRST INSTANCE, ENCLOSEING YOUR C.V. TO: DR. PAUL OTTO, CANON RESEARCH CENTRE EUROPE LTD, UNIT 17, FREDERICK SANGER ROAD, GUILDFORD, SURREY GU2 5YD.



## SERVICES

### MEET YOUR NEED

FOR 5", 7" and 10 1/2" white tape boxes; 5" and 7" tape spools  
Leader and splicing tape; Ampex mastering tape (all lengths and sizes)

Phone us on **0372 460135** for full details and prices

**MEDIA TAPE LIMITED**  
PO Box 120C, Esher, Surrey KT10 9JS

**FOR SALE ON BEHALF OF VIETNAM CINEMA.** Two Neumann U67's plus PSU's. Full electro-mechanical overhaul by FWO Bauch. Tel: Nick Lowe 0703 834208.

**PENNY & GILES MOTOR FADERS.** With stereo audio taper tracks. 15 unused faders offers around £150 each; Jackfield 4 row x 24 hole wired to Dolby NR connectors and XLRs. VGC £200 o.n.o. 0753 859420 office hours.

**FOR SALE:** Offers are invited for the sale of the following equipment as a whole: 1) Amek BC11 Post-production desk with Switchcraft patch bay and data cards; 2) Otari MX55 Multitrac recorder with roll around; 3) Ferrograph RT52 and HYO25 test units; 4) 2 x Neumann 87 microphones with shields and shock mounts; 5) Beyer Dynamic M201 microphone; 6) Lexicon LXP-1 amplifier with transformer power supply; 7) Lexicon LXP-5 amplifier with transformer power supply; 8) 2 x Quad 306 amplifiers; 9) Sonifex HS200 and HYO25 amplifiers. Contact Mr A. Reeves, Arrow Auctions — tel: 0527 66393.

**WANTED:** For purchase or evaluation: Pre-1935 electric and acoustic recording equipment, cutting machines, cutter heads, microphones, amplifiers, etc. Also any books, documents, photographs or drawings produced on the then contemporary way of recording. Please contact: Mr Gerald Reynolds, Nimbus Records Limited Wyastone Leys, Monmouth NP5 3SR. Tel: 0600 890682.

**PAIR ATC LOUDSPEAKER CABINETS,** 34" x 16" x 18", 12" bass, 3" superdome midrange, and 1 1/4" dome tweeter. Teak veneer. ATC active crossover. On demonstration West London. £1,350. Quad 405/11s £175 each. Home use only. Tim 081-992 5518 DAY/ANS. 0860 322 477 mobile.

# STUDIO SOUND

AND BROADCAST ENGINEERING

## CIRCULATION DETAILS

STUDIO SOUND is available without charge to key personnel actively engaged in sound recording in any part of the world. Copies must be individually requested. Non-qualifying readers will be notified in writing and invited to take out a subscription (see below for details)

**NEW READER ENQUIRIES:** Spotlight Publications, 8th Floor, Ludgate House, 245 Blackfriars Road, London SE1 9UR. Tel: 071-620 3636.

**EXISTING READER ENQUIRIES:**  
Circulation Dept, Studio Sound, Link House Magazines Ltd, Central House, 27 Park Street, Croydon CR0 1YD, UK

Changes of address should be notified in writing to this address and the label containing the old address and reference number should be enclosed to ensure accuracy

**SUBSCRIPTION ENQUIRIES:** Subscription Dept, Studio Sound, Link House Magazines Ltd, 120-126 Lavender Avenue, Mitcham, Surrey CR4 3HP, UK  
The cost of an annual subscription to Studio Sound is:  
UK £24.00

Overseas surface mail: £30.50/US\$52

Overseas air mail: £52.50/US\$89

USA airspeeded delivery \$70

The publishers reserve the right to refuse applications considered inappropriate and restrict the number of free copies sent to any one company or organisation

Studio Sound is available without charge to qualified readers: these are key personnel actively engaged in sound recording in any part of the world. The Publisher reserves the right to refuse applications considered inappropriate and restrict the number of free copies sent to any one company or organisation. Non-qualifying readers can buy Studio Sound at an annual subscription of £24.00. Published by the proprietors Spotlight Publications, Ludgate House, 245 Blackfriars Road, London SE1 9UR. Originated by Lawrence-Allen (Colour Printers) Ltd, Gloucester Street, Weston-super-Mare, Avon BS23 1TB. Printed in England by Andover Press Ltd, Telford Gate, West Portway Industrial Estate, Andover, Hants SP10 3SF.

## SITUATIONS VACANT

**City Poly**  
City of London Polytechnic

## SENIOR LECTURER IN MUSIC TECHNOLOGY

£19,608 – £23,979 p.a.

The successful applicant will join a team of electronics and acoustics specialists teaching 'electronics for the music industry' specialisms on a variety of further and higher education courses.

Applicants should have a degree or equivalent and possibly a higher degree in electronics or a related specialism and previous teaching experience.

Industrial experience in the general field of electronics will be an advantage particularly if related to the audio industry.

Candidates with experience in one or more of the following will have an advantage: sound systems and recording and studio systems; electro-acoustic systems; analogue and digital audio electronic systems; microprocessor and DSP systems; computer applications to music and sound; sound and vibration analysis; CAD systems for electronic circuit analysis and design.

For further details and an application form please write to

The Personnel Department, City of London Polytechnic,  
31 Jewry Street, London EC3N 2EY,  
quoting reference number. 91/42.

Closing date for receipt of applications is: 28th June 1991.

The Polytechnic is committed to a policy of equal opportunities for all.

**P.D. AUDIO**  
PROFESSIONAL SOUND EQUIPMENT

This list represents a small selection of equipment available. Please call for a complete monthly mailshot  
15 Stockton Drive, Chisleley,  
Stockport, Cheshire SK12 6DG.  
Tel: 0663 750948. Fax: 0663 751099

Chilton 12 4 mixer	£750
Neve 542 4/2 in 12/2 frame	£985
Neve 12 channel broadcast operator's desk. Extensive spec	£1,850
Studer 12 2 small broadcast mixer	£785
Tascam MS16, 16x N/R, AQ65 autolocate and trolley, 1 year old	£4,560
Orari MX1308 8 track 1"	£1,100
Orari MX5050 stereo	£1,050
Revox PR99 brand new 18 months old	EDFFERS
ITC 95 Cartridge player and record mono machine	£680
Roland DEP 5	£360
Scamp rack & PSU (empty) inc. 2 x double blanks	£80
1 x dual gate, 8 x SO1 compressors, 2 x expander gates	£125
ibanez DM 2000	£175
Bel BPT0 Backmount phaser	£125
Rotel 2 channel 10 band graphic	£80
REBIS rack inc: 2 x 203 compa, 2 x 201 noise gates and 4 x para's	£525
Yamaha SPX900 Digital multi-effects processor as new used once	£460
Yamaha GC2020BII 2-channel compressor/limiter as new used once	£190
Yamaha C2031A stereo 31 band graphic equaliser as new used once	£320
Yamaha GC1031BI mono 31 band graphic equaliser as new used once	£175
Neumann UB7 brand new, 1 year old, inc. subp mount and windshield	£850
2 x AKG 4511 with CK1 capsules	each £120
New Scamp modules including warranty, available various	£20A
Yamaha NS10M-stud studio monitor speaker per pair	£200
Yam PZ350 175W stereo 8 ohm, 250W stereo 4 ohm, 500W mono 8 ohm, 3U/475	

**Large recording studio, Pimlico.**  
Superb Steinway Concert Grand ★ AMS ST250 Microphone  
Panasonic DAT 3700 recorder ★ Cassette transfer facility  
Highly competitive  
£105 plus VAT per hour  
Phone 071-834 6120 office hours

**DIGITAL SIGNAL PROCESSING... REMOVE THE CONFUSION**  
For a comprehensive, professional DSP consultancy service including noise and crosstalk removal by adaptive digital filtering, DSP hardware and software design, digital filtering and all other DSP related work, contact  
**DIGITAL REAL TIME SYSTEMS LTD**  
Epsilon House, Chilworth Research Centre  
Southampton, Hants. SO1 7NS. Tel: 0703 769741

## ADVERTISERS' INDEX

A&R Handbook	12	Monitor Technology	42
Abacus Electronics	29	Musicomp	46
AD Systems	27	Neumann GmbH	32
AKAI	63	Neutrik	26
AKG	51	Neve Electronics	107
AMS Industries	58/59	New England Digital	66
Audio Design (Recording) Ltd	98	Otari Electric	71/84
Audio Digital Technology Ltd	52	Philip Drake Electronics	91
Audio Precision	IBC	Prism Sound	12
Audio Research & Technology	90	Preco	94
Bruei & Kjaer	19	Pro-Bel	73
Burnie	90	QSC Audio Products	105
Coach Audio Sales	8	RTW	38
CTI Audio	92	Rane Corporation	82
D&R Electronica	54	R Technology	109
DDA	79/81	Rycoote Microphone Windshields	29
Dacs	38	SBES	12
Denis The Fox	8	Seem Audio	38
Digital Audio Research	20	Sennheiser	37
Dolby Laboratories	48	Shure Bros	28
Dring Schoeps	56	Sifam	19/91
Drawer Distribution	99	Solid State Logic	4
Dynaudio Acoustics	9	Sony Broadcast	40/41
Eela Audio	44	Soundcraft Electronics	0BC
Focusrite Audio Engineering	IFC	Soundtracs	6/7
FWO Bauch	45	Sowter	47
Genelec	23	Studio Spares	111
GTC	42	Surrey Electronics	49
HW International	15/102/103	Tannoy Products	68
HHB Communications	11/17	Teac UK	96/97
Hilton Sound	25	Tony Larking Professional Services	74
Klark Teknik	69/89	Total Systems	30
Lafont Audio Labs	100	Trident Audio	34
Larking Audio	18, 60, 64, 65, 76	Turbosound	30
MS Audio	90	Westlake Audio	75
Media Products	47	Yamaha-Kemble	53



# We maintain a Double Standard

The Audio Precision product line now includes two different standard-setting products.

**The automated System One - the industry standard for lab bench and factory test station.**

- Graphic results on PC screen, copies to printers and plotters.
- GO/NO-GO testing, automated procedures.
- State-of-the-art performance and speed.
- Complete analog and digital domain testing.
- 2 to 192 channels.

**The new self-contained Portable One - for service bench and field.**

- Compact and affordable.
- An easy-to-use test set for applications not requiring automation.
- Comprehensive capability, high performance.
- Robust polycarbonate purpose-designed case.
- Full stereo capability.

System One and Portable One - two test sets designed for different jobs, each with the quality and performance that you have come to expect from Audio Precision.

System One

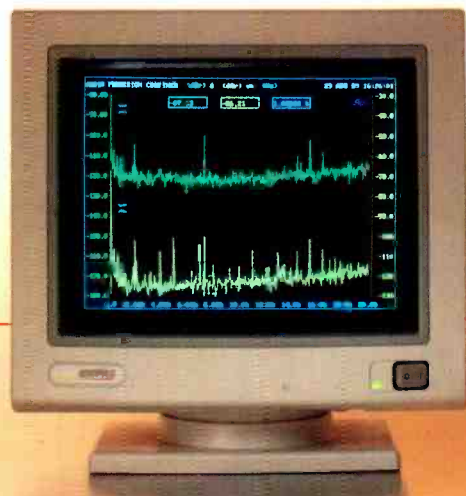

**Audio precision**

P.O. Box 2209, Beaverton, OR 97075-3070  
503/627-0832 1-800/231-7350  
FAX: 503/641-8906, TELEX: 283357 AUDIO UR

Portable One



INTERNATIONAL DISTRIBUTORS: Australia: IRT (02) 439 3744 Austria, Eastern Europe: ELSINCO elektron GmbH 222 812 17 51 Belgium: Trans European Music NV, +02/466.50.10 Canada: GERR Electro Acoustics, Ltd. (416) 866 0528 China, Hong Kong: ACE (HK) (852) 424-0387 Denmark: AudioNcrd Danmark npn 86 57 15 11 Finland: Genelec OY, 77 13311 France: ETS Mesureur (1) 45 83 66 41 Germany: RTW GmbH 221 70 91 30 Holland: Trans European Music, +03-08 70717 Israel: Can-El Technologies Ltd 3-544 1466 Italy: Medea S.r.l. 2 4840 1780 Japan: TOYO Corporation 3 (5E8) 5800 Korea: Myoung Corporation 2 784 9942 New Zealand: Audio & Video Wholesalers, Ltd. 71 73 414 Norway: Lycconsult (09) 19 03 81 Portugal: Acutron ELA 1 941 40 47 Singapore & Malaysia: TME Systems FTE Ltd 298 2608 Spain: Felco Electronics, S.A. 231 7840 Sweden: Tal & Ton AB 31 30 36 20 Switzerland: Dr. W.A. Gunther AG, 01/910 41 41 Taiwan: Litz Technologies Ltd 2 558 3173 U.K.: SSE Marketing Ltd 7 387 1262





## FOR THE ARTIST IN EVERY ENGINEER

If you've ever tried putting together a studio, you know the big problem: the console. What you want is too big—for your room and for the bank. The console you can afford lacks the important facilities you need. Too few inputs. Not enough outputs. And audio quality that just isn't up to your standards.

Soundcraft's SAPPHYRE gives you 32-track performance worth many times the price—better than a digital system. A noise gate on every channel. Great-sounding 4-band EQ. A variety of modules to suit the way you record. And five frame sizes.

SAPPHYRE. Its unique, flexible, ingenious approach to routing and design offers the things you need and throws away the rest. Eight buses you can use for anything you like—direct tape feeds for everything else. An in-line design that takes up less space and is even easier to use than many split-group consoles. It couldn't be simpler. And everything's under your fingertips.

SAPPHYRE. It's a brilliant way to work. Whether you're building a home studio, adding a video post suite or designing Studio Two. A console that brings out the artist in you.

Now you can afford the best. Hear SAPPHYRE today—at your authorised Soundcraft dealer.

# Sapphyre

## Soundcraft

SOUNDCRAFT ELECTRONICS LTD. UNIT 2, BOREHAMWOOD INDUSTRIAL PARK,  
ROWLEY LANE, BOREHAMWOOD, HERTS. WD6 5PZ, ENGLAND. TEL: (+44) 81 207 5050  
FAX: (+44) 81 207 0194 TLX: 21198 SCRAFT G ■ A Harman International Company