

STUDIO SOUND

AND BROADCAST ENGINEERING

A LINK HOUSE MAGAZINE

ALLESIS
MICROOVERS III



ALLESIS QUANTIZER
THE DIGITAL FILTER, THE DIGITAL EFFECT PROCESSOR

CLIP -6dB -12dB -18dB

INPUT OUTPUT

REVERB 1 REVERB 2 REVERB 3 REVERB 4 REVERB 5
COMP 6 REVERB 7 REVERB 8 REVERB 9 REVERB 10
STORE COMP 6 REVERB 7 REVERB 8 REVERB 9 REVERB 10

PROG PAGE VALUE

ON OFF

ALLESIS QUANTIZER 822A

FUNCTION

AUTO IN OUT

CLIP +

MANUAL I

MIN CHANNEL

LO-CONTOUR HI-CONTOUR DEFINITION HI-CONTOUR PROCESS FUNCTION

CLIP +

MIN CHANNEL

LO-CONTOUR HI-CONTOUR DEFINITION HI-CONTOUR PROCESS FUNCTION

ALLESIS QUANTIZER 822A

ADVANCED SIGNAL PROCESSOR

34

CLIP -6dB -12dB -18dB

INPUT OUTPUT

REVERB 1 REVERB 2 REVERB 3 REVERB 4 REVERB 5
COMP 6 REVERB 7 REVERB 8 REVERB 9 REVERB 10
STORE COMP 6 REVERB 7 REVERB 8 REVERB 9 REVERB 10

PROG PAGE VALUE

ON OFF

ALLESIS QUANTIZER 822A

FUNCTION

AUTO IN OUT

CLIP +

MANUAL I

MIN CHANNEL

LO-CONTOUR HI-CONTOUR DEFINITION HI-CONTOUR PROCESS FUNCTION

CLIP +

MIN CHANNEL

LO-CONTOUR HI-CONTOUR DEFINITION HI-CONTOUR PROCESS FUNCTION

ALLESIS QUANTIZER 822A

ADVANCED SIGNAL PROCESSOR

34

CLIP -6dB -12dB -18dB

INPUT OUTPUT

REVERB 1 REVERB 2 REVERB 3 REVERB 4 REVERB 5
COMP 6 REVERB 7 REVERB 8 REVERB 9 REVERB 10
STORE COMP 6 REVERB 7 REVERB 8 REVERB 9 REVERB 10

PROG PAGE VALUE

ON OFF

ALLESIS QUANTIZER 822A

FUNCTION

AUTO IN OUT

CLIP +

MANUAL I

MIN CHANNEL

LO-CONTOUR HI-CONTOUR DEFINITION HI-CONTOUR PROCESS FUNCTION

CLIP +

MIN CHANNEL

LO-CONTOUR HI-CONTOUR DEFINITION HI-CONTOUR PROCESS FUNCTION

SIGNAL PROCESSING

Focusrite

The Focusrite Studio Console has been introduced to the world of music recording to meet the aspirations of recording engineers seeking perfection in all that they do. Whether recording in the analogue or digital domains, the means with which the audio signal reaches tape is of paramount importance.

The microphone pre-amplifier and summing amplifiers must be completely transparent whilst the equalizer should enhance the sound in precisely the way desired. The rest of the console must offer similar levels of perfection and also ease

of use throughout the recording, overdubbing and mixing process.

The Focusrite Studio Console successfully addresses all these objectives. Based around the Focusrite transformer coupled mic - pre and equalizer, the console offers such features as 48 bus routing 12 mono and 2 stereo sends and 3 stereo buses. Optional features include left-centre-right panning for mixing to picture.

200 kHz bandwidth throughout the console and ultra low-noise balanced buses ensure optimum phase coherence and noise performance. Transformer

balanced insert sends and line outputs ensure electrical isolation from external sources.

The unique facility of global horizontal switching and other group status controls accelerate initial setup. The choice of GML or SSL moving fader automation systems offers familiarity without compromising the sonic performance of the console.

For those recording engineers who seek perfection, and for the studios that serve them, we offer you the excellence of the Focusrite Studio Console.



Metropolis Studio, London

Designed for Perfection



Focusrite Audio Engineering Ltd.
Unit 2 Bourne End Business Centre,
Gores End Road, Bourne End,
Bucks., SL8 5AS, England.
Tel: +44 (0)628 819156
Fax: +44 (0)628 819143

STUDIO SOUND

AND BROADCAST ENGINEERING



Control room 145 Wardour Street

Editorial:	Studio Sound's viewpoint on events and trends, and their implications	5
News:	Events, news, moves and comment from inside and outside the recording industry including a report from the Frankfurt show	11
Products:	Product updates, developments, upgrades and software updates	17
Music News:	Products updates and developments from another side of the business. Compiled by Zenon Schoepe	23
Live Sound:	Keeping abreast of live sound news and equipment. Compiled by Mike Lethby	24
Crescendo Audio Mixing System:	David Miles Huber looks at a new digitally controlled analogue desk from Californian company Euphonix	27
Adaptive Digital Filtering:	Francis Rumsey looks at a promising new application for digital filtering within the audio field	34
145 Wardour Street:	'The heart and soul of rock'n'roll'. Simon Croft visits a new studio in the West End of London	37
Bill Price/2:	Ralph Denyer continues his interview with Bill Price, and finds out how to get the best out of a Sex Pistol	40
The Truth about SCMS:	Francis Rumsey attempts to make the world of Serial Copy Management System clearer	46
SoundStation DSP:	The new DSP function for DAR SoundStation provides some new and useful facilities. Patrick Stapley reports	48
Perspective:	Audio goes to war. US columnist Martin Polon looks at the role of audio in the recent Gulf conflict	53
Business:	Sony's 3.5 inch Irister MOD challenge; disks for film sound; and sticky tape developments. By Barry Fox	58
BBE 822A:	Dave Foister reviews the latest version of the BBE Sonic Maximizer	61
Lexicon 300:	Patrick Stapley reviews the latest digital effects unit from Lexicon	64
Alesis QuadraVerb Plus:	Patrick Stapley reviews two effects unit from the Alesis range	66
Zoom 9010:	Patrick Stapley reviews a flexible multi-effects processor	70

ULTIMATION™

THE 'ULTIMATE AUTOMATION' SYSTEM

ULTIMATION is an entirely new concept in console automation, designed to let engineers choose the type of system most appropriate to the task in hand.

It can work as either a dedicated VCA system, a dedicated moving fader system, or in a way that combines the best features of both systems. The engineer is free to decide.

By using SSL's unique dual signal path circuitry, ULTIMATION really is the ultimate in console automation.

Main features include:

- ▶ Works as standard G Series VCA system, or as a full moving fader system
- ▶ Dual signal path technology allows *combined* operation, providing the benefits of both systems
- ▶ Automatic selection of gain element most suitable to task
- ▶ Reads existing G Series mix data

In keeping with SSL's commitment to system compatibility, ULTIMATION reads all existing G Series mix data, and can be retrofitted to any console using the G Series computer.

At last studios can provide an automation system to suit any client, yet retain the familiarity of the world's most respected console system.

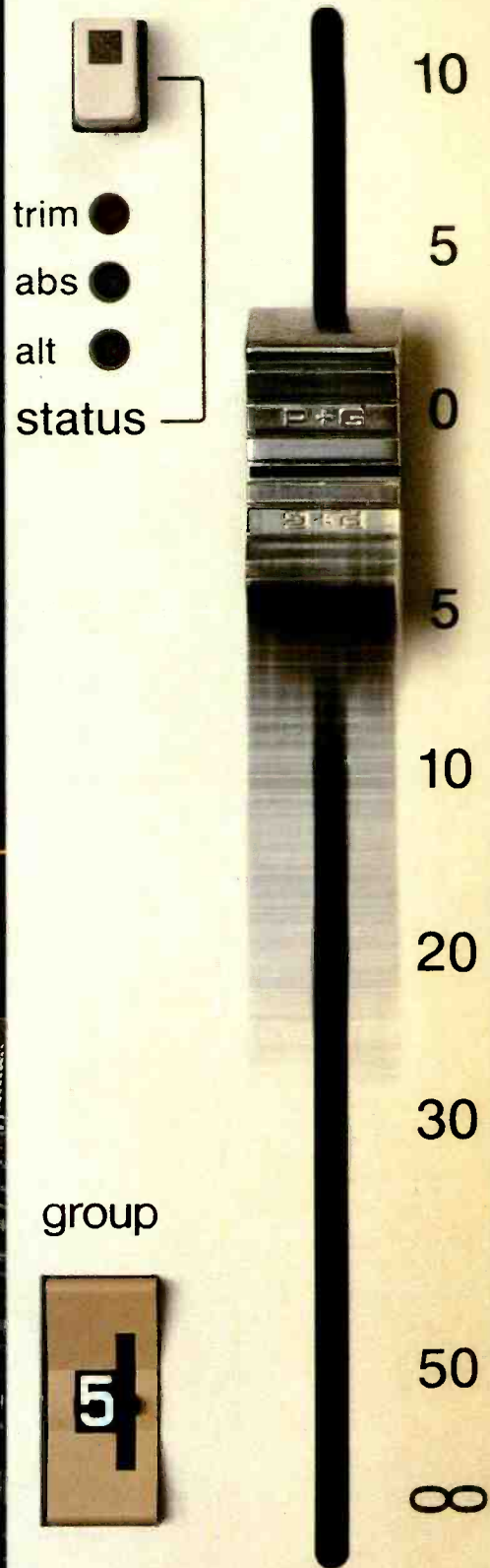

Solid State Logic

International Headquarters
Begbroke, Oxford, England OX5 1RU · Tel: (0865) 842300

Paris (1) 34 60 46 66 · Milan (2) 612 17 20
Tokyo (3) 54 74 11 44 · New York (212) 315 1111
Los Angeles (213) 463 4444 · Toronto (416) 363 0101

STUDIO SOUND

AND BROADCAST ENGINEERING

May 1991
Volume 33 Number 5
ISSN 0144 5944

EDITORIAL

Editor: Keith Spencer-Allen
Assistant Editor: Julian Mitchell
Co-ordinating Editor: Ann Lowe
Secretary: Elaine Sweeney
Consultant: Sam Wise
Columnists: Barry Fox, Martin Polon (US)
Regular Contributors:

Janet Angus	Mike Lethby
James Betteridge	David Mellor
Mike Collins	Terry Nelson
Ben Duncan	Francis Rumsey
Dave Foister	Zenon Schoepe
Yasmin Hashmi	Patrick Stapley

ADVERTISEMENTS

Executive Ad Manager: Steve Grice
Deputy Ad Manager: Phil Dearing
Advertisement Production: Alicia Smith
Secretary: Lianne Davey

CIRCULATION

Circulation and Development Manager:
Colin Enderson
Controlled Circulation Manager:
Maria Udy
Enquiries: See classified advertisement

Director: Doug Shuard
Publisher: Steve Haysom

EDITORIAL & ADVERTISING OFFICES

Link House, Dingwall Avenue, Croydon CR9 2TA,
UK. Tel: 081-686 2599. E-mail: 78:DGS1071. ESI:
STUDIOSOUND-UK/US.
Fax: 081-760 5154/0973.

NEWSTRADE DISTRIBUTION (UK)

UMD, 1 Benwell Road, London N7 7AX, UK.
Tel: 071-700 4600. Fax: 071-607 3352.

AMERICAN OFFICE

Publishing Services Manager: Fred Vega
Studio Sound, 2 Park Avenue, 18th Floor,
New York, NY 10016, USA. Tel: (212) 779-1212.
Fax: (212) 213-3484.

JAPAN & FAR EAST AGENT

Contact: Mikio Tsuchiya, Media Sales Japan Inc,
Tamuracho Bldg 3 3 14, Shimabashi, Minato-Ku,
Tokyo, Japan. Tel: (03) 504-1925. Telex: J25666.
Fax: (03) 595-1709.

© Link House Publications plc 1991 all
rights reserved

Origination by Lawrence-Allen (Colour Printers)
Ltd, Gloucester Street, Weston-super-Mare, Avon
BS23 1TB.

Printed in England by Andover Press, St Ives plc,
Telford Gate, West Portway Industrial Estate,
Andover, Hants SP10 3SF.



A LINK HOUSE
PUBLICATION

Studio Sound and Broadcast Engineering
incorporates Sound International and Beat
Instrumental

Studio Sound is published on the third Friday of
the month preceding the cover date. The
magazine is available on a rigidly controlled
requested basis, only to qualified personnel (see
classified advertisement for terms)



MEMBER OF THE AUDIT
BUREAU OF CIRCULATIONS

Total average net circulation of 19,166 per issue
during 1990
UK: 6,655. Overseas: 12,511.
(ABC audited)



Changes affected

One of the results of the continuing march of technology is that products are not what they used to be. Once upon a time there were items of equipment that had clearly defined functions: the equaliser equalised; the console combined audio signals; the tape recorder recorded audio; the amplifier made signals louder; and so on. Even before the arrival of digital audio there were units that performed more than one function but these were normally seen to be related. So we had the dynamics processor that performed five dynamics-related functions but that was OK as they were all related processes. The arrival of digital audio led to the greater integration of processing and so gradually the same item of equipment just processed and what it processed was just a matter of programming. The signal processor as a generic unit had arrived and we became used to a single box doing almost everything we might wish. It still was a block of hardware though. The next generation would appear likely to be just a software program to run on a large processor and the concept of products under precise classifications takes another body blow.

In this issue we have tried to look at products of both types—real and virtual. Patrick Stapley looks at the DSP option recently introduced for the Digital Audio Research *SoundStation II* which is obviously one step nearer to the fully integrated studio-in-a-box concept. On a slightly different tack Francis Rumsey examines how a signal processing product developed for a completely different type of application is finding an exciting use in audio. Adaptive Digital Filtering is a technique being applied to the removal of an unwanted sound component from a signal provided the processing can accurately identify the unwanted aspect. Initial applications are limited by the speed and accuracy of the processing but I have witnessed convincing demonstrations of the removal of unwanted random sound from speech and music. The removal of traffic, helicopter noise and other audio problems even at a quite high level are certainly possible. If we extrapolate from this with the processing of the near future we could look at the removal of microphone spill or handling noises from live-on-stage recording. In the studio we could consider the complete removal of any signal from a mic other than the intended instrument—without unnecessary screening. Every mic on a drum kit could be treated to sound like each drum was an overdub—and so on. Such precision is perhaps a little way off just yet but not that far.

In our review section, the variety continues. We look at the BBE 822A which in terms of its operation is about as traditional a product as possible in its design although maybe not in the processing. The Alesis *QuadraVerb Plus*, Zoom 9010 and the Lexicon 300 are fine examples of multi processing units that function at different levels of sophistication and complexity, with the possibility to evolve should the need arise. And squeezed in at the end we have the Alesis *MicroVerb III* that produces, what is by the standards of some of the previously mentioned products, a rather restricted choice of reverberation effects but at a price and audio quality that leaves any counter argument totally deflated. It is products like this that, possibly far more than the more sophisticated processors, that underline what changes have taken place in effects and signal processing from the tools available to the studio of the past. From the echo plate that was often noisy, limited in possible variation, needed mechanical maintenance and was many times more expensive (even 20 years ago), is a giant step. Can we expect to see a similar evolution from current products and if so what will it look like? Will it be easy to use or complex? Will it even be a stand alone device or part of a greater whole? Will processing decisions be in the hands of the musician, producer or engineer or will those functions simply just not exist?

One point thrown up in the reviews is the complexity of devices or the rather inconsiderate interface, and their role in pressured situations. The increased demands made by equipment on users to learn the device before use are perhaps reaching unacceptable levels. Such devices might be fine within a situation where money is tight and time is not, but in a studio environment with an hourly-paying client it may be better to invest in the racks of simple, single function products like the *MicroVerb*. The choice is clearly to be based upon the relationship between pressure, time, money that affects you and perhaps not so much on the more technical aspects of the devices themselves.

Keith Spencer-Allen

Cover: Photography by Tony Petch

Back To Reality Brüel & Kjær

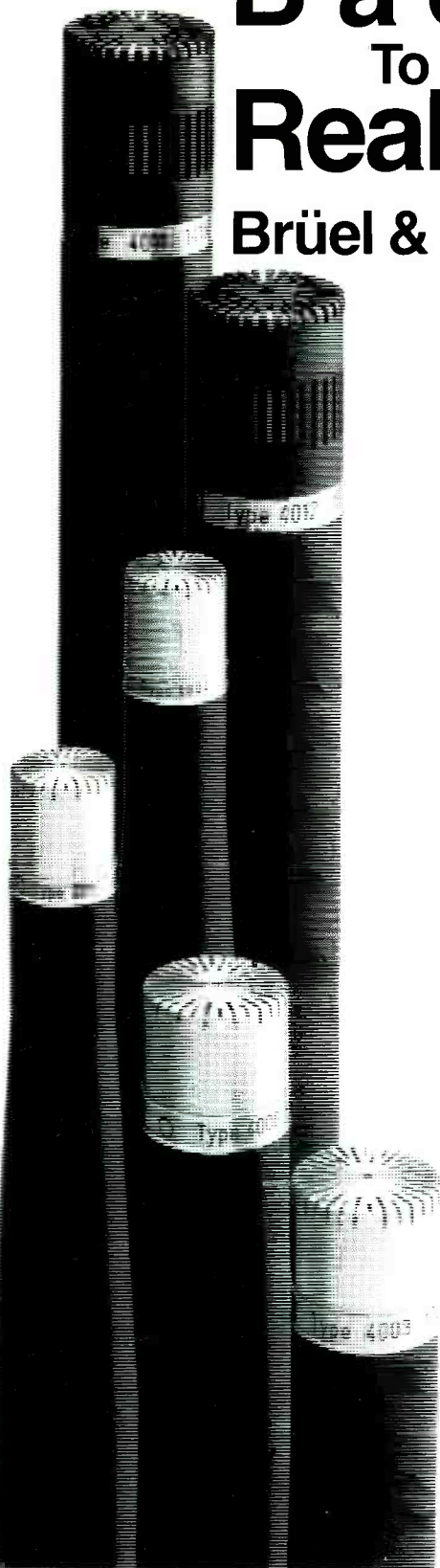

FOR DETAILED
INFORMATION
FILL COUPON &
RETURN TO:

Brüel & Kjær
Pro Audio (UK)
Harrow Weald Lodge,
92 Uxbridge Road,
Harrow,
MIDDX HA3 6BZ.
Tel: 01-954 2366

Brüel & Kjær
Pro Audio
18 Nærum
Hovedgaade,
2850 Nærum,
Denmark
Tel: + 45 42 80 0500

Series 4000 Microphones

Name _____

Address _____

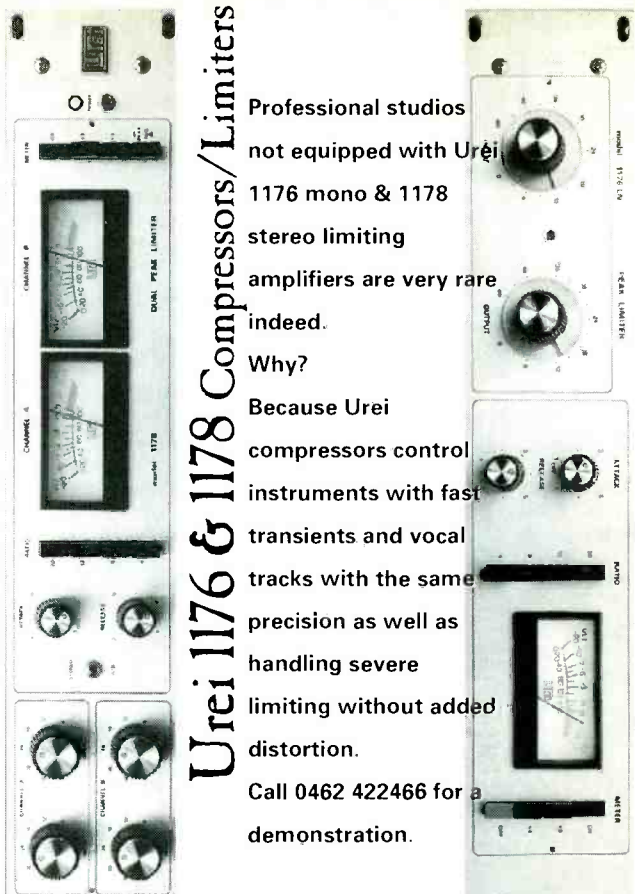

Urei 1176 & 1178 Compressors/Limiters

Professional studios
not equipped with Urei
1176 mono & 1178
stereo limiting
amplifiers are very rare
indeed.

Why?
Because Urei
compressors control
instruments with fast
transients and vocal
tracks with the same
precision as well as
handling severe
limiting without added
distortion.

Call 0462 422466 for a
demonstration.

Distributed in the UK by:
Larking Audio, 15 Cam Square, Wilbury Way, Herts SG4 0TZ.
Tel: 0462 422466 Fax: 0462 421171

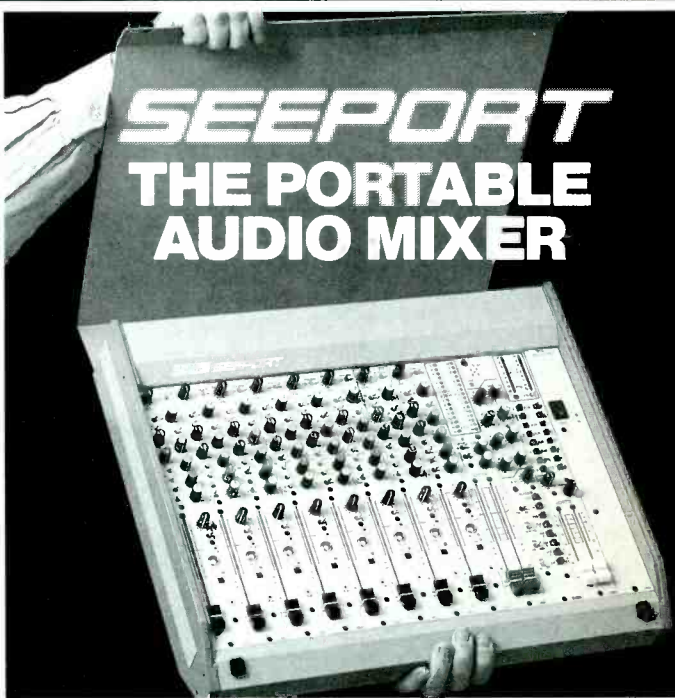

SEEPORT THE PORTABLE AUDIO MIXER

- 8 input channels, mono or stereo
- 4 auxiliaries, with returns
- 2 band equalizer in each channel
- Pre fader listening and channel on switches
- M/S switch in each channel
- Penny & Giles long scale faders
- 2 stereo instruments
- DC or AC powered
- Weight 9.8 kg
- Fits in a 19" rack



P.O. Box 115 - N-1380 Heggedal - Norway
Tel. + 47 2 79 77 30 - Fax + 47 2 79 61 54 - Telex 79207 SA N

HENDRIX

FROM THE MAKERS OF MOZART

LEVELS

One Meter per input channel with Stereo VUs give comprehensive, at-a-glance indication of the state of your mix.

CLASSIC SOUND

AMEK's 4-band fully-parametric equalizer with swept pass filters. This is the equalizer which established AMEK's envied reputation for audio performance through hundreds of hit records over the last decade. Why settle for anything less?



PROVEN

AMEK/Steinberg SUPERTRUE automation - Faders, Mutes and 7 Channel Switches automated in real time or off-line with full SMPTE and MIDI interface. Compatible either way with AMEK MOZART mix information, generated from any MOZART installation worldwide. Can you afford not to join the fastest-growing console automation user group?

OPTION

Computer-controlled SUPERTRUE Digital Dynamics on every channel. Compressors, Gates, Limiters, and other Dynamics devices controlled from the computer and stored with the mix. A new first in automation.

PRICE

All of this comes for a ridiculously reasonable price. Buy your ticket to audio perfection and bring reality a little bit closer.

VERSATILITY

Two panning and monitoring modes allow HENDRIX to be used for Recording (two channel stereo) and Film (3-channel stereo with Surround).

INTERFACING

Balanced inputs, outputs and busses are all carefully designed to give HENDRIX clear, quiet, crosstalk-free interconnections.

AUXILIARIES

12 balanced auxiliary busses give you the flexibility to address a wide range of Effects devices. All the control you need in today's complex, heavily-processed mixing environment.

INPUTS

Each channel has two discrete paths; Eq can be split between them, giving 80 Equalized inputs. In addition we give you 4 complete stereo inputs with 4-band Eq and sends, and 4 stereo Effects Returns. Enough inputs to cover most recording and mixing situations, in a console under 2 metres wide - including the jackfield!



Head Office, Factory and Sales: AMEK Systems and Controls Ltd., New Islington Mill, Regent Trading Estate, Oldfield Road, Salford M5 4SX, England. Telephone: 061-834 6747. Telex: 668127. Fax: 061-834 0593.

AMEK/TAC US Operations: 10815 Burbank Blvd, North Hollywood, CA 91601. Telephone: 818/508 9788. Fax: 818/508 8619.

AMEK SYSTEMS & CONTROLS LTD. part of AMEK TECHNOLOGY GROUP Plc

THE COVER VERSIONS



THE ORIGINAL

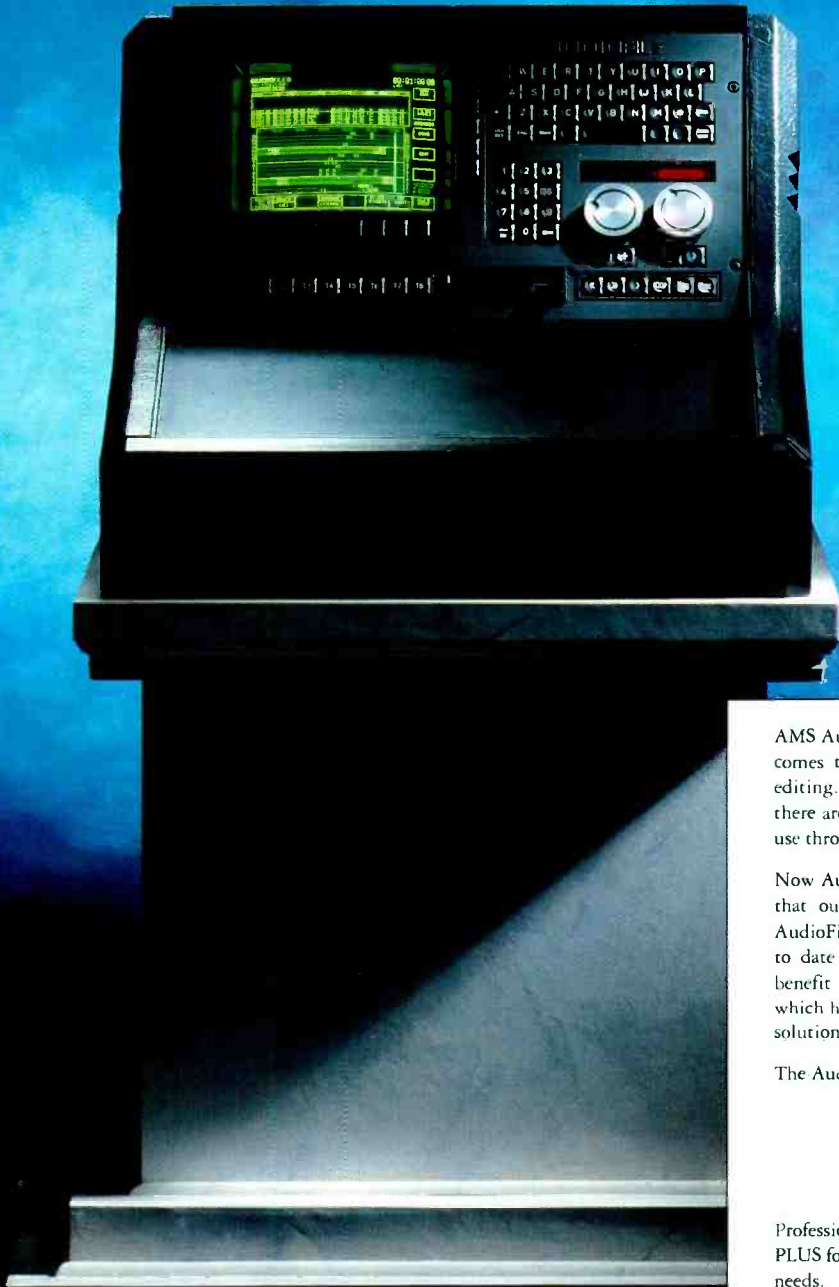

AMS AudioFile PLUS is the all time number one when it comes to hard disc based, digital audio recording and editing. Naturally there have been cover versions but there are still many more AudioFile units in commercial use throughout the World than any other.

Now AudioFile PLUS gives users an expanded capability that our imitators will find hard to match. Existing AudioFile users already know that AMS keeps them up to date with advancing technology. All our customers benefit from our "user feedback development policy" which has ensured that AudioFile remains a cost effective solution to audio production problems.

The AudioFile PLUS 16 now includes these new features.

- 16 Outputs
- New 16 track Event List, large display
- 8 or 16 track Cut and Splice display with simultaneous Events List

Professionals Worldwide continue to choose the AudioFile PLUS for its proven ability to meet their audio production needs.

The AMS AudioFile PLUS – Has the Competition Covered.

For more details on The Original complete the coupon below and we'll send you further information.



AMS Industries plc, Billington Rd, Burnley, Lancs BB11 5ES, UK.
Tel Int. +44 282 57011. Fax Int. +44 282 39542.

AMS Industries Inc., 7 Parklawn Drive, Bethel, CT 06801, USA.
Tel Int. +1 203 792 4997. Fax Int. +1 203 730 8549.

Name _____
Position _____
Company _____
Address _____
Tel: _____

SS 5/91

We're Proud To Introduce

Electro-Acoustic

Simulator for Engineers*

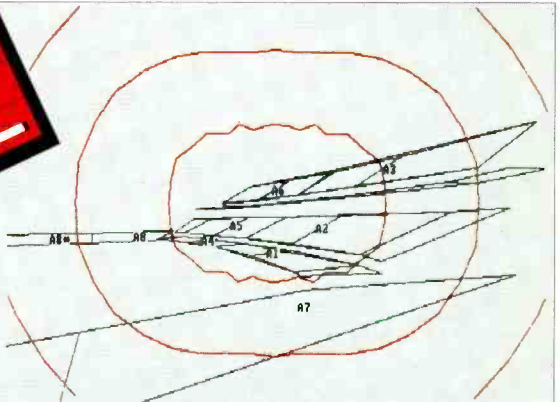
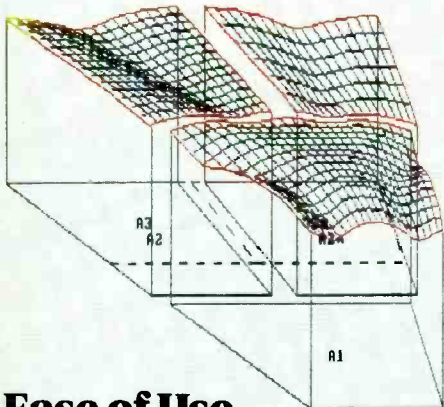

Ease of Use

- Menu Driven, Intuitive
- Logical Step-by-Step Operation
- Simplified Room Data Input
- Accepts AutoCAD Room Files

Superior Graphics

- Full Color Screen Presentations and Print-Outs
- Coverage Display Options: Isobars, Paint and Patch
- Versatile Speaker and Audience Views
- 3-D Energy Grid Shows Multiple Source Interference Effects

*The ultimate
acoustic analysis
tool for
Acoustical
Consultants
and
Engineers*



IBM PC's or Compatibles

Accuracy

- Advanced Algorithms Provide Highest Accuracy Simulations Available
- Precisely Calculates and Displays Reflections, Shadowing Effects, Multiple Source Comb Filtering, Relative Arrival Times

Expandable and Versatile

- Open Loudspeaker Data Base
- Cluster Drawings with AutoCAD
- Applications Range from Simple Coverage Calculations to In-Depth Scientific Analysis
- Outstanding Sales Presentation Aid

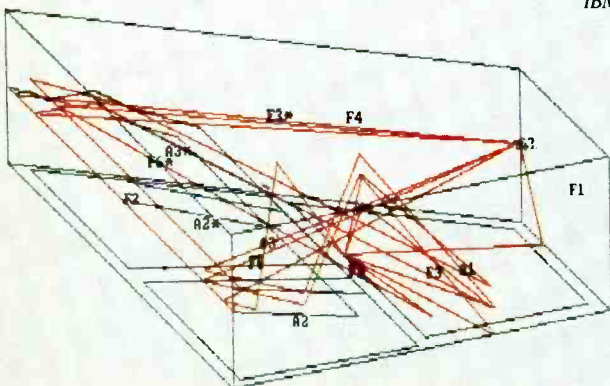

For a Free Demo Disc, Full Technical Details,
or Further Information - Contact:



RENKUS-HEINZ

Manufacturers of Professional Sound Products

17191 Armstrong Avenue
Irvine, California 92714
Tel 714/250-0166
Fax 714/250-1035

17 Edith Road, Faversham
Kent ME13 8SD, UK
Tel 44 795 53 65 74
Fax 44 795 53 65 73

Solligrenda 48
N-0491 Oslo 4, Norway
Tel 47 2 71 18 80
Fax 47 2 71 18 85

*EASE Software - © Copyright ADA (Acoustic Design Ahnert), Germany

First 'service only' company from Thear

A newly established service company called Thear Technology has already secured a number of service contracts from dealers, manufacturers and end users.

Thear Technology, headed by Rod Thear formerly of Stirling Audio, is the first corporate body within the pro-audio industry to set up as a 'service only' specialist.

Rod Thear commented, "The last few months have been incredibly busy. Our first priority had to be setting up the organisation, recruiting the correct personnel, finding the right location and, of course, attracting business whilst at the same time introducing a concept that is new to our particular industry".

One of Thear Technology's first contracts is with FWO Bauch as the sole 'service only' Revox centre within the UK. Bauch ex-warranty repairs are now handled by Thear who have employed Revox-trained engineers specifically to service this product. Spares are to be kept in stock and turnaround times are hoped to be quite short.

Thear Technology will continue Otari and DDA servicing which Rod Thear himself has been involved with since 1982. The latest Thear Technology contract has come from

Akai, with the company becoming an 'Authorised Akai Professional Products Service Centre'.

Thear's other interest, the Association for Technical Support (ATSA) has from necessity taken a temporary back seat becoming a more formal group.

Final steps for AGFA takeover by BASF

BASF AG has taken the final steps to acquire AGFA-Gavaert's worldwide magnetic tape business.

The announcement follows approval of BASF's purchase of the AGFA tape business by German antitrust authorities and by the board of directors of the respective companies.

The BASF acquisition creates one of the largest sales, marketing and technical service companies serving the magnetic tape industry. For the time being BASF will continue to offer products of both companies. Products will be manufactured in the same factories with the same technology used at present.

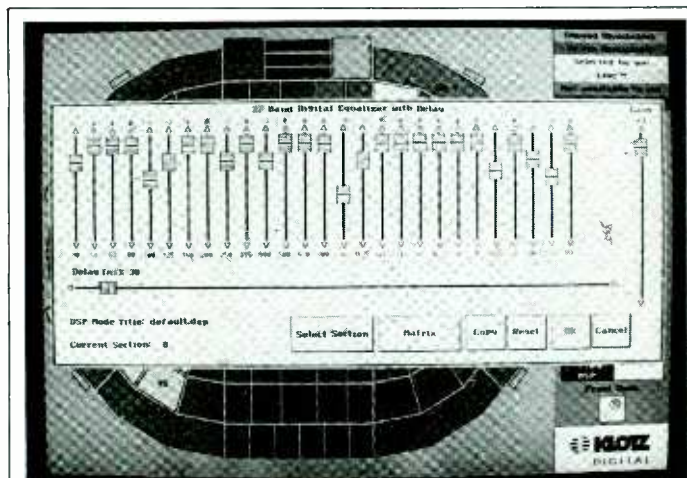

A screen shot taken for the Klotz computer control system installed in Wembley Stadium, West London, last year. The screen shows a dedicated 27-band digital equaliser with delay capabilities and input/output faders which can be applied to each one of the 86 channels used for the sound distribution. The installation was developed from the Klotz Oaklink fibre optical distribution system. Two complete fibre optic rings are employed allowing 100% redundancy and these feed into 12 receiver racks.

Exhibitions and conferences

April 26th to 28th MIDI Music Show, Novotel Hotel, Hammersmith, London, UK.

May 18th to 19th SPARS Technical conference on digital audio workstations, Orlando, FL, USA.

June 5th to 7th APRS, Olympia 2, London, UK.

June 13th to 18th International Television Symposium, Centre des Congres, Montreux, Switzerland.

June 25th to 27th Multimedia 91 conference & exhibition, Olympia 2, London, UK.

July 10th to 12th Pro Audio Asia 91, World Trade Centre, Singapore.

July 10th to 14th International Music Show, Olympia 2, London, UK.

General MIDI

A proposal was accepted by the MIDI Manufacturers Association at the January NAMM for the specific definition of a base class of MIDI synthesiser. Named General MIDI (GM), any member of this genre of synth will have certain general capabilities, so leading to a high degree of compatibility and ease of use.

GM is aimed at the consumer market, where MIDI sequences are starting to become available on disk. The problem has always been one of ensuring that a song recorded using the voicing of one synth would sound correct when played back later on another synth. An acoustic piano might end up with the sound of a bagpipe while the drum kit could end up with the bass drum sounding like

a high-hat and the high-hat like a cowbell.

The main point behind GM is an instrument mapping table where MIDI program changes select specific sounds. While the names on the synth may not correspond with these; a user will know that selecting a particular MIDI program number will give a specific type of sound, irrespective of the name shown on the screen. Drum sounds will also be key-mapped and named for a similar purpose.

General MIDI, Level 1, dictates that a synth must have either 24 dynamically allocatable voices or 16 specifically for melody instruments and a further 8 for percussion. Each MIDI channel must be able to play a different timbre and a minimum of

128 presets must be on-board. The preset sound will be individually assigned to MIDI program changes but the arranging, numbering and naming of the presets will be down to the manufacturer. On the hardware side, only master volume, left and right audio sockets and MIDI In, Out and Thru are mentioned along with a headphone socket.

Names are often misleading. For instance, what are the attack and release characteristics of a preset with the name of *Ooh Choir*—slow or fast? A timbre needs to respond in a set manner, and this manner has to be set down in a precise manner. It is a fact of life that ambiguity leads to incompatibility and the Voice Definition Table which will accompany General MIDI will ensure that a degree of rigidity exists with set characteristics for the envelope, MIDI key range and relative loudness at a MIDI volume level.

Various MIDI controllers will also be included within General MIDI.

Bearing in mind that General MIDI is intended to be a mode that the synth can be told to enter, there will be two System Non-Real Time messages to turn GM on and off.

The above list is beyond many of the current 'workstations' and, if adopted, will take a great deal of commitment from manufacturers to make the system viable. The advantages of General MIDI to the education and consumer market are obvious and is a very important aspect in the continued existence of MIDI. Roland have already defined their extension to GM, called GSS or the GS Standard and this goes beyond a single bank of 128 sounds, making use of the MIDI Bank Select command defined last year. There is every likelihood that other manufacturers will follow suit.

Vic Lennard, UKMA

Contracts

- Sam Toyoshima and John Flynn, **Acoustic Design Group**, have been appointed to carry out its second major commission for Abbey Road studios in London. An application has been lodged for an extension to the studio complex to house a new control room and related ancillary accommodation for studio 2.
- UK musician and TV presenter Jools Holland has bought a **Soundtracs Quartz** production console for his own recording studio. Holland has also recently bought a **Saturn 824** multitrack recorder for the studio.
- **Saturn** multitracks had also recently gone to artists Neneh Cherry, Double Trouble and studios Roll Over and Chapel studios. Orders for the low cost 824, the 624, have come from F2 studios and Imagine Records.
- Recent DAT recorder sales through **HHB Communications** include four **Radio Systems DAT** recorders to London station Kiss FM; five **Fostex D-20** recorders to Anglia TV; and two **Sony PCM-2500** recorders to Jaguar cars.
- **DAR** have recently sold three of their **SoundStation II** to Japanese clients. Osaka's Kansai TV, and the Prosen and Daicolo companies in Tokyo have all installed 8-channel versions with rewriteable optical disk storage in their audio/video post production facilities.
- **BSS Audio** sales include a **DPR-402** comp/lim/de-esser and **DPR-504** 4-channel noise gate to La Musique Studio in Mahalaxmi, India; the government of India Films Division have installed four each of the **DPR-402** comp/lim/de-essers and **DPR-502** dual MIDI noise gates for multi-language mixing and music scoring.
- Recent **SSL SL 4000** console sales include a 40-channel **SL 4000** with **Total Recall** installed in Jean-Michel Jarre's private studio near Versailles, Paris. Two studios in Germany have recently installed **SL 4000** desks.
- Dierks Studios at Pulheim near Cologne and Master Music Productions.
- BOP studios in Bophuthatswana have bought a number of **Studer** products including a **D820-48** as main digital 48-track recorder with internal synchroniser; **D820X**, 2-channel **DASH** recorder in all three studios together with a mobile **DE4003** digital editor; **A820-24** and

A820-2CH-TC with Dolby SR/A in all studios; and **A723** and **A623** active loudspeakers for studio monitoring.

- **Turkish Radio & Television** in Ankara, Turkey have ordered seven **Amek Classic** broadcast production consoles, all of which are to be equipped with Audio Kinetics **Mastermix II** hard disk based automation.
- **Ideal Systems**, the Dublin-based television, audio and video consultancy and design company, recently completed the video and audio systems designs for the televising of the upper and lower houses of the Irish parliament.
- **Munro Associates** has recently completed a number of studio projects including a major rebuild at Sweet Silence studios, one of Copenhagen's largest music facilities. The rebuild has resulted in a new 32-track digital control room designed by Andy Munro and equipped with a Neve **VR** console and the new DynaudioAcoustics **DAM4** monitor system. Munro Associates have also been commissioned to design a new post-production facility for Logic Studios, Milan.
- **Neve** have won orders to supply three of the latest generation **DSP** consoles to German broadcast companies West Deutscher Rundfunk and Bayerische Rundfunk.
- **Magmasters** is the first recording studio in London to fit **Audimation's Uptown 2000** moving fader console automation system. Recently upgraded **Uptown 2000** now offers automated EQ and the option to switch insert points.
- The installation of technical facilities at the new BBC Radio 1 workshop audio production suite has been completed by studio design consultancy **Harris, Grant Associates**.
- **The Enterprise Recording Studios**, Burbank, California, has become the world's first recording studio to feature **Solid State Logic's** new console automation system, **Ultimation**. The system is installed on a new 80-channel **SL 4000 G** Series console.
- Recent sales of **Quad Eight** consoles include a 36-input **Virtuoso** to Hilltop studios, Madison, TN. A 28-input **Virtuoso** to Stebbing recording studios, Auckland, New Zealand. A 36-input **Virtuoso** to GEW studios, Japan and a 40-input **Screenstar** to APU studios, Japan.
- Thatched Cottage Digital have announced the first **Yamaha DRM8** digital workstation sale to Dave Stewart of the Eurythmics.

News from the AES

On 19th March 1991, the AES British Section held a Conference with the title 'Will You be Legal?—Implications of EC Directives for Audio and Video Engineers'. This covered the effects of legislation which will be implemented on January 1 1992, and the chairman was Allen Mornington-West.

This legislation affects manufacturers, designers and installers of professional audio and video equipment and systems. The Conference revealed the extent and scope of the legislation and discussed the strategies for coping with both the legal and engineering consequences of the European performance standards which are involved. Ignorance of the law is, we are advised, no defence.

This Conference covered a very important subject, and if you were not able to attend, there is a set of Papers available from the address below, priced at £15.

Our next lecture will be held on **Tuesday 14th May** and will be given by **Quentin Howard, of GWR Radio**. This will be on the subject of **OB Techniques for ILR**

and will cover some of the experiences which arise from setting up and operating Outside Broadcasts. GWR operates one of the larger independent local radio networks in the west of England. From the outset of station operations it has been attempted to bring the radio station out to its public by operating OBs. The problems start with attempting to achieve a usable off-air cue signal and at the same time feed the base studio with high quality signals. Every OB poses a fresh set of problems which require ingenuity and resource to overcome.

The lecture will be held at the ITC (formerly IBA), 70 Brompton Road, London SW3. The ITC is opposite Harrods and Knightsbridge Underground, between the Nationwide Anglia Building Society and Boots. The evening starts with coffee at 6.30pm followed by the lecture at 7.00pm.

For further details on the above, or on any other aspect of the AES, please contact:
Heather Lane, AES British Section, Lent Rise Road, Burnham, Slough SL1 7NY. Tel: 0628 663725. Fax: 0628 66702.

Agencies

- **C-Audio** have appointed Harman Audio as their exclusive UK distributor. Harman Audio, Mill Street, Slough, Berks. SL2 5DD. Tel: 0753 76911.
- **Amek** have announced the appointment of the following distributors. AEG Nederland as exclusive distributor for Holland; AEG Nederland NV, Aletta Jacobsaan 7, 1066 BP Amsterdam, Netherlands. Tel: 20 510 5911. Fax: 20 154581. APEX as exclusive distributor for Belgium; Apex NV, Prins Bisschopssingel 50, 3500 Hasselt, Belgium. Tel: 11 272983. Fax: 11 274 553.
- **AKG Acoustics** have become the exclusive distributor for **Orban Professional Audio Products** in the UK. AKG Acoustics, Vienna Court, Lammas Road, Godalming, Surrey GU7 1JG. Tel: 0483 425702. Fax:

0483 428967.

- All sales and service enquiries for **Turbosound** products should now be directed to Turbosound's UK office in Partridge Green, West Sussex. Tel: 0403 711447.
- **Samson Technologies** has appointed EML Sound & Light Industries to handle distribution, marketing, advertising and sales of its range of wireless microphone systems in Belgium. EML Sound & Light, Maastrichterstraat 323, 3740 Mopertingen, Belgium. Tel: 32 11 41 52 78. Fax: 32 11 49 16 62.

Correction

In our March 1991 issue we featured The Mill Recording studio in our studiofile section. Unfortunately we published their fax number not their telephone number at the end of the article. Their phone number is 0628 810788.



Every audio professional knows that the DAT format is ideal for portable recording. But at HHB we believe it need not cost the earth.

That's precisely why we've joined forces with Aiwa to design our own professional DAT portable – the HHB1 Pro.

In spite of its compact dimensions, the rugged HHB1 Pro offers a wealth of features for the professional user. A single



The HHB1 Pro stripes tape with 'absolute time' information as it records. So whenever you insert a recorded cassette, you can see precisely where you are on the tape. With Sony's PCM-7000 range of studio DAT recorders capable of editing to absolute time as well as time-code, you can be confident that your HHB1 Pro will function as their ideal low-cost acquisition partner.

The HHB1 Pro records for

A professional DAT recorder that goes easy on your pocket.

5-pin XLR switchable mic/line **And in it.**

input allows stereo recordings in the field, while audio quality is assured thanks to the latest single-bit oversampling conversion technology. Of course, AES/EBU as well as SPDIF digital interfaces are provided as standard. And because the Pro's informative LCD display can be illuminated, monitoring in low-light conditions could not be more convenient.

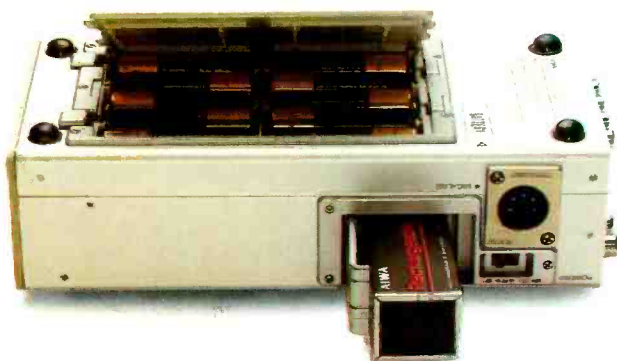

up to three hours on conventional dry cell batteries. Meanwhile, a multi-voltage transformer and a NiCad battery pack – together with a selection of useful professional accessories including a wired remote controller – are supplied as standard. Since it weighs in at under £1,000 and less than a kilogram, picking up an HHB1 Pro from the world's number one DAT centre just couldn't be easier.



Saturn 824

•New Total Remote with LED metering

With only enough space for 49 words to describe the world's most sophisticated multitrack we can't even begin to describe the Saturn 824's advanced digital alignment, the technology behind one of the fastest transports, or the feature packed remote with LED metering and 10 memory autolocator, Reverse



Saturn Multitracks are distributed in the UK by:

**LARKING
AUDIO**

15 Cam Square, Wilbury Way, Hitchin, Herts SG4 0TZ.

Tel: 0462 422466 Fax: 0462 421171

Frankfurt Music Fair Report

The problem with writing a report on the Frankfurt show is that it follows so closely on the heels of NAMM and AES. Some manufacturers are obviously aware of this as new products are launched at Frankfurt while some of the prototypes shown two months before at NAMM were only seen in a mock-up form here.

Mixing Desks

Soundcraft were showing their *Sapphire* console, the result of using the philosophy that the public know what they want so let's offer it to them. The four desks in the range have between 20 and 44 in-line input/output modules, each with a fully-featured noise gate.

TAC launched the *SR6000*, a 40 input desk with a powerful output configuration of a 10 by 8 matrix and VCA control so letting you fade and mute groups of outputs. It also includes a 15 W headphone amp.

D&R have become known for their *Avalon* desk and were showing two new units; the 24 bus *Marilon* and 16 bus *Triton*. Made to order, the costs are between \$20,000 and \$50,000 (£11,000 to £27,000).

To produce their new *Megas* consoles, Soundtracs have a new automated production facility in Scotland. The *Megas* is available in three versions: *Mix*, *Stage* and *Studio*. The latter has either 16 or 24 buses with MIDI muting.

Having launched the *Spectrum* desk at NAMM, Allen & Heath now have version 4 of their *Saber Mute Automation* which only requires MIDI Clock and Song Position Pointer information, so preventing strain on an external sequencer.

Digital Audio

A lot of movement in this end of the market — anyone with a name seems to be currently involved in this technology.

At the high end, Korg were showing their *Digital Audio Workstation*. This had been previewed at some of the shows last year but is now up and running and expected to be available from the Autumn. Impressive set of stats; 8 track recorder with simultaneous recording on all 8 via analogue inputs or 2 tracks via digital. Mixer and Effects pages, remote control over a connected U-Matic via the RS-422

interface, SMPTE, VITC, 50,000 note MIDI sequencer and a 640 MByte hard drive with tape back-up. Perhaps the word 'Workstation' finally has a true meaning.

Yamaha launched the *DMC1000* at the AES show. This is a 22 input digital console with 10 buses and 4 auxiliary buses, including full fader, EQ, pan and bus assignment automation which is written to a 3.5" disk by an internal, time-code referenced computer. This matches up with the 8 track *DRU8* Digital Recorder. Yamaha were also showing the latest version of their *DMR8* Digital Mixer and Recorder which uses static heads and the proprietary Yamaha digital format. One surprise was the launch of the *DTR2* DAT recorder, 44.1 and 48 kHz sampling frequencies with digital outputs and a price around £1,100 (\$2,000). When one of the major manufacturers launches a DAT machine, you can be certain that DAT is here to stay.

Roland have also been developing a hard disk recording system, the *DM-80*. Two versions with 4 or 8 tracks and a 100 MByte drive as standard with seamless overflow to an external unit via SCSI. This is partnered by the optional *DM-80R* dedicated hardware remote and the *DM-80F* Fader unit. Inputs are analogue with optional AD converters so keeping the cost of the basic unit down to around £4,000 (\$7,600). A *Macintosh* front end will also be available.

At the other end of the market, DAC had the *DR2000* which is the *ADAS D2D* recorder from Plasmec in a 19" 1U rackmount with an internal 250 MByte hard drive, 16 bit A/D and D/A converters and a 25 MHz DSP. It uses an Atari *ST* for the front end and can run with most of the *ST* sequencer packages. More to the point, it is priced at less than £2,500 (\$4,750).

Akai's optical recorder, the *DL1000*, has impressed many people by the manner in which it achieves fast replay time from an inherently slow medium. Frankfurt saw the launch of their 2 remote controls; *DL1000* is a remote clone of the front panel with the ability to control up to 7 *DL1000*'s while the *DL500* is a DJ's remote control for triggering the *DL1000*'s playsheets. Front end emulation software for the Apple

Macintosh was also shown with one of the focal points being the graphic editing of the Cue Edit page.

Studio Equipment

Arsonic released *The Equaliser*, a single-ended noise reduction unit with a 3-band parametric EQ and Signal Refresher. They claim a dynamic range of 120 dB which takes it into the realms of 20 bit digital.

Behringer manufacture various exciters and noise-reduction units and have two additions to their range; the *Multiband Exciter* incorporates an exciter of the frequency-dependent phase shifting variety with a noise reducer and a surround processor. The *Suppressor* is an automatic sibilance and feedback processor which constantly analyses the input signal for either of these traits and then attempts to eliminate it.

Drawmer now have a quad noise gate in the shape of the *DS404* and have also re-designed the *DS301* expander/gate, launched a year ago, to include MIDI gating.

While not being renowned for their signal processors outside of effects units, Roland were showing their *SN-550* digital, single-ended noise reduction unit. Using multi-band technology, it certainly appeared to be totally invisible in use.

Korg had their *A1* multi-effect processor taking pride of place amongst their new effects units. Up to 7 simultaneous effects from a selection of over 60, the unit is based on the *A3* but also has SPDIF digital input/output connectors.

MIDI

Akai have kept various items for Frankfurt. The *S1100EX* is an expander version of the *S1100* without the recording or editing functions which will give a total of 32 voices when used with an *S1100*. The *ME80P* is the replacement for the *ME30P*, an 8 by 10 MIDI patchbay with filtering and two-way MIDI merging. There was the *EWI3000*, the Electric Woodwind Instrument. This is the up-to-date version of the old *EWI* but now with clip-on note keys and is partnered by the *EWI3000M*, a 4 oscillator analogue synth (with MIDI In and Out). Finally, a separate breath controller, the *X335i* so that a keyboard player can control the

breath and vibrato sensors without using an *EWI3000*.

Roland released their new GS Standard products, the *SB-55 Sound Brush* and *SC-55 Sound Canvas*. The *SC-55* offers 315 sounds and 9 drum kits with built-in reverb and chorus, and boasts 24 note polyphony with the ability to play 16 independent parts simultaneously. The *SB-55* is a sequencer, principally for replaying MIDI Files created on other sequencers, and with an emphasis on simplicity. There was also a place for their new *JX-1*, a 24 note polyphonic, 5 octave keyboard with D-series sounds but with ease of editing parameters via sliders.

On the professional side, Roland launched the *SBX-1000* MIDI Cueing Box, A SMPTE/MIDI event generator and synchroniser using a cue sheet system with up to 30,000 events and 100,000 sequencer steps.

On the software side, Steinberg were showing version 1.8 of *Cubase* on the *Macintosh* while C-Lab were demonstrating the next upgrade (3.1) for *Notator* which includes a graphic arrangement display, 32 tracks per pattern and the ability to save notation as a file for importing into a DTP program. They also had a version of *Polyframe*, their generic synth editor for the Atari *ST*, close to completion.

Surrounded

Pride of place has to go to a product which is likely to alter what we hear on vinyl, tape and CD. The Roland *Sound Space Processing System (RSS)* is a psycho-acoustic system which encodes music during a mixdown in such a way as to present a three dimensional aural image on playback on a normal machine. The equipment has 18-bit A/D and 20-bit D/A converters and a processor utilising four 24-bit micro processors. While Roland are being very careful not to describe the system as creating a 3-D effect, there is little doubt that this is precisely what it does. Where *RSS* scores over any other comparable system is that it is fully mono compatible. The price – around £25,000 (\$47,500).

Vic Lennard

Saturn 624

Our Advertising Agency said we only had enough room for 63 words to describe the most powerful low-cost tape recorder in the world. - So if we run out of space please call for full details.



Professional 14" reel capacity, 400ips variable spooling, 42Hz-29kHz frequency response with 72dB

s/n on both Replay and Sync, Reverse Play, choice of two remote options, superior head design



Saturn Multitracks are distributed in the UK by:

LARKING AUDIO

15 Cam Square, Wilbury Way, Hitchin, Herts SG4 0TZ.

Tel: 0462 422466 Fax: 0462 421171



Coach Audio Sales

GÜNTHER KUTSCH AND STEFAN MEYER, GBR
SCHÜREN 12, D-6670 ST INGBERT, GERMANY
TELEPHONE (06894) 4717 AND 4727
FAX (06894) 383379

USED EQUIPMENT FOR SALE

CONSOLES:

- MCI 636, 36 frame, 36 channels
- SOUNDCRAFT TS 24, 36 frame, 32 channels, LED, 2½-years-old.
- AMEK 2500, 32 channels, VU-meter, 8-years-old
- AMEK 2500, 48 channels (36 mono + 12 stereo), Mastermix II, 8 aux, bargraph
- D&R AVALON, 32 frame, 32 channels
- SSL 4040 E, 40 frame, 40 channels, VU-Meter, patchbay, 2½-years-old
- SSL 4048 E, 48 channels, patchbay, producer desk, total recall, bargraph, 8-years-old
- SSL 4040 E, 40 frame, 32 channels, automation
- WESTEC 3020, 56 frame, 48 channels, automation
- TRIDENT 'VECTOR', 56 frame, 48 channels, automation
- Various SSL-parts: channels, total recall, computers, etc.

OTHER USED MACHINES:

- AUDIOFRAME WAVEFRAME + direct-to-disk
- MCI JH 24, 24-track + autolocator III
- FOSTEX G 16
- TELEFUNKEN M15A + locator — NEW —
- TELEFUNKEN M15 24-track + locator/remote
- AKAI-ADAM 12-track digital
- AKAI DD 1000 Optical recorder
- SONY 3348 + locator/remote 48-track digital, 1 year
- SONY 3324 A, 24-track digital + locator/remote
- LYREC TR 532 + locator/remote
- LYREC TR 533 + locator/remote
- MITSUBISHI X-880 32-track + locator/remote
- MITSUBISHI MX-80 2-track digital
- OTARI DTR 900 B, 32-track + locator/remote, 9 months
- QMS 215 speaker + amplifier, complete system
- QMS 405 speaker
- SYNCLAVIER + 8 direct-to-disk
- DAR — digital workstation 4 channels
- LEXICON 480 + LARC
- TASCAM ATR-80 24-track + locator/remote
- AKAI S1100 Sampler
- 2 x DOLBY A 361
- YAMAHA NS 40 M
- KURZWEIL 250 19" Expander
- TANNOY Super red speakers
- SUMMIT AUDIO equalizer TPA-200
- SUMMIT AUDIO compressor TLA-100
- STUDER TLS 4000 Synchroniser
- SONY DAE 3000 PCM 1630 editing system

Offer without obligation, but subject to prior sale!

For further details contact

Mr Günther Kutsch, phone no. 0049-6894-4717!



YES! WE
HAVE THE
BEST PRICES

EXPORT PRICES

POUNDS STERLING

AIWA HHB PRO 1	* £995
ADAM SMITH ZETA 3	* £1,895
AKAI S 1100	* £2,410
AKAI DD 1000	* £6,600
AKAI DR 1200 COMPLETE	* £9,800
ALESIS QUADRAVERB	* £295
AMCRON DC 300	* £749
APHEX TYPE C	* £235
ATC SCM 20 (PAIR)	* £2,300
BOSE 802 (PAIR)	* £995
BSS DPR 402	* £680
CAD EQUITTEK 2	* £435
CAD DUAL COMPRESSOR	* £395
CAD 32 8 32 IN LINE	* £8,500
DBX 166	* £395
DBX 160X	* £295
DIGIDESIGN SOUNDTOOLS	* £1,920
DOLBY SR 24	* £12,700
DRAWMER DL 241	* £400
EVENTIDE H 3000 SE	* £1,810
ELECTROVOICE SENTRY 100 (PAIR)	* £395
FOCUSRITE ISA 115 HD WITH PSU	* £2,855
JBL UREI 1178	* £870
KLARK TEKNIK DN 360	* £995
LEXICON PCM 70	* £995
MEYER SOUND HD 1 (PAIR)	* £3,695
NEUMANN U 87	* £945
NEVE	CALL
REVOX PR 99	* £1,380
SYMETRIX 525	* £395
SHURE SM 58	* £75
SONY DATSSS	CALL
TASCAM M 3500 32 INCHES	* £4,750
UREI 809 (PAIR)	* £995
YAMAHA DMR 8	CALL

* OR EQUIVALENT CURRENCY + LOCAL TAX

WE SHIP WORLDWIDE

DENIS THE FOX

234 RUE DE CRIMÉE

75 019 PARIS

TEL: 33-1-40-38-01-12

FAX: 33-1-40-35-02-72



Studer CD recorder

Studer chose the Paris AES to launch the *D740* CD recorder. This is a joint venture with Philips. Studer describe the *D740* as the first compact CD recorder with all aspects of the recorder housed in the one unit. The recorder meets the Orange book standard for CDR and the recorded CDs are playable on any standard CD player. The table of contents can either be constructed from the front panel by pushing the New Track button or by an auto mode which looks for level drops of greater than 60 dB. A temporary TOC can be written for work to be continued as

well as there being a feature that allows a sectioned of recorded audio to be ignored when replaying. When copying a CDR the track information can be automatically copied across. Both analogue and digital I/Os are provided.
Studer International, CH-8105 Regensdorf, Althardstrasse 10, Switzerland. Tel: 1 870 75 11.
UK: FWO Bauch Ltd, 49 Theobald Street, Boreham Wood, Herts. WD6 4RZ. Tel: 081-953 0091.
USA: Studer Revox America Inc, 1425 Elm Hill Pike, Nashville, TN 37210. Tel: (615) 254-5651.

SSL Ultimation

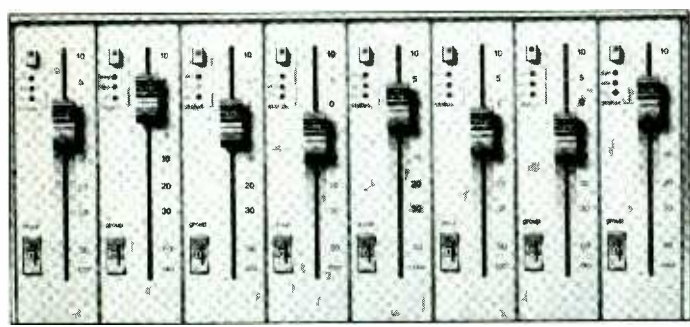

SSL have introduced a moving fader system, *Ultimation*, as an extension of the existing *G* series automation. The system has the ability to work as a dedicated VCA system, a dedicated moving fader system or a mixture of the two. The fader contains a VCA element as well as an audio path through the fader so that when writing or playing absolute levels the audio passes through the fader. When the fader is touched, the audio is routed through the VCA element to allow a standard SSL Trim update.

As an extension of the *G* series it is able to read *G* series mix data and will be available as a standard option or as a retrofit on all *G* series consoles.
Solid State Logic, Begbroke, Oxford OX5 1RU, UK. Tel: 0865 842300.
USA: SSL, 320 West 46th Street, New York, NY 10036. Tel: (212) 315 1111. SSL, 6255 Sunset Boulevard, Suite 1026, Los Angeles, CA 90028. Tel: (213) 463-4444.

Sony PCM-2700 DAT

Sony have introduced a new 'low cost' four head DAT recorder intended for uses that do not need the facilities of the *PCM-7000* range. The *2700* is able to record and locate to Absolute Time (A-Time) while a parallel interface allows operation with the *RM-D7100* remote control permits a certain degree of integration with the *7000* range. Supplied with an infra-red remote control, it has the ability to rewrite Stat and Skip subcode IDs after

recording. Both analogue and digital I/Os are provided with balanced XLRs and unbalanced AES/EBU or IEC 958 Type 1 consumer formats respectively. Delivery is from August.
UK: Sony Broadcast & Communications, Jays Close, Viables, Basingstoke, Hants. RG22 4SB. Tel: 0256 483506.
USA: Sony Corporation of America, Professional Audio Division, Sony Drive, Park Ridge, NJ 07656. Tel: (201) 930-1000.



Mitsubishi extend PD format

The Paris AES Convention saw two new PD format products from Mitsubishi. The first is the *PDX 8620* reel-to-reel digital mastering machine which is a formal partnering of 20-bit A/D and D/A converters with the *X-86* two-track digital machine. The *PD 5050A* converters are designed and manufactured by Philip Drake Electronics and are housed in a rack under the transport and connects to the *PDX 8620* via the AES/EBU interface. The existing Mitsubishi *X-E2* digital editor will allow electronic editing of 20-bit recordings.
 On the digital multitrack side a pair of 32-track digital machines (master and slave) were being shown as the *PDX Eight Eighty Two* system. The master comes complete with a 64-track autolocator which gives full control of both machines to a lock-up accuracy of the digital

word. Offsets can be set in increments of a single sample allowing accurate electronic edits. Claimed lock-up of machines is less than three seconds from stationary and chases over a wide range of speeds with audio output available on $\pm 10\%$ nominal speed. Both machines will be available separately or as a system. (An *X-850* and *X-880* can function as a slave of a master.) The *PDX* slave is described as competitively priced as it lacks certain circuitry that it shares with the master machine.
UK: Mitsubishi Pro Audio, Mitsubishi Electric (UK) Ltd, Travellers Lane, Hatfield, Herts. AL10 8XQ.
USA: Mitsubishi Pro Audio, Rupert Neve Inc, Berkshire Industrial Park, Bethel, CT 06801. Tel: (203) 744-6230.

Digigram recording card

Digigram have introduced a Nubus card called *compreSound* for recording directly onto the hard disk of any *Macintosh II* computer. The card has been jointly developed and distributed by Arcomis but manufactured by Digigram and offers one hour mono or 30 minutes stereo recording on a 60 Mb hard disk producing 16-bit audio sampled at 48 kHz. Digigram are using a data

compression system under license from CCETT, a French Telecommunications research centre, which uses two 24-bit Motorola *DSP 56001* signal processors. The minimum computer hardware requirement for *compreSound* is a *Mac II* with at least 2 Mb of RAM.
Arcomis, 121 Rue Chanzy, 59260 Hellemmes-Lilles, France. Tel: (33) 20 67 59 68. Fax: (33) 20 67 59 70.



Amek Hendrix

The Amek *Hendrix* is a multitrack recording console based upon the design aspects of the *Mozart* console but at a lower cost. The normal configuration is a 40-channel in-line console with dual-path channels and eight stereo returns.

Included as standard is a version of the Amek/Steinberg *SuperTrue* automation system that also allows realtime control of eight switches on each input channel. Channel features include 4-band parametric EQ with swept pass filters, 24-bus routing, 12 aux buses and a multi-mode panning

system allowing two- and three-channel stereo mixes. In addition to the monitoring source selection there is also a basic three-channel routing matrix for film sound monitoring.

Amek Systems & Controls Ltd,
New Islington Mill, Regent
Trading Estate, Oldfield Road,
Salford M5 4SW, UK. Tel: 061-834
6747.

USA: Amek Consoles Inc, 10815
Burbank Boulevard, North
Hollywood, CA 91601. Tel: (818) 508-
9788.

Bel stereo sync delay

Bel have introduced the Bel *BDE-7000S* stereo delay-synchroniser to bring audio back into sync with video signals routed through different signal paths. The standard unit provides 660 ms of stereo delay expandable to 1.32 secs. A special version will also be available up to 2.8 mins. There is provision for eight user defined programs to be stored and a lock button to prevent

tampering. The LCD display shows selected mode and delay time which may be set in msec, fields or frames. A digital I/O will be available as an option. A separate unit, the *BDE-7500S* will shortly be introduced to add automatic time tracking when used with a *BDE-7000S*.

UK: Michael Stevens & Partners Ltd,
Invicta Works, Elliott Road, Bromley,
Kent BR2 9NT. Tel: 081-460 7299.

Fairlight MFX

Fairlight ESP have announced that the *MFX* Digital Audio Production System is now in production. The *MFX* is a multitrack hard disk recording and editing system designed for post production work. It provides 24 tracks of digital recording and editing using push buttons and a jog knob for the control of all functions. The system also includes a large colour monitor and a LCD panel screen for displaying 24 tracks of audio, system options and status.

The *MFX* can support up to six disk drives providing 215 minutes of track-time each at 44.1 kHz giving a maximum of 21 hours storage. Back-

up is Exabyte 2.2 Gbyte 8 mm drive for both audio and edit data. The *MFX* has two AES/EBU digital I/Os, two 64x oversampled analogue inputs and 24 analogue outputs with 16 tracks of simultaneous replay. Also included are facilities for direct serial control of Sony 9-pin protocol machines and allows audio freeze frame in sync. The system will slave to serial and longitudinal SMPTE timecode at 24, 25 30DF and 30 fps formats while generating LTC and MIDI timecode in sync.

Fairlight ESP Pty Ltd, 30 Bay Street, Broadway, Sydney, NSW, Australia 2007. Tel: (2) 212 6111.



● For those of you hygiene conscious, a range of disposable headphone covers have been brought to our attention. They are made from a white lightweight polypropylene material and can be colour coded to identify specific units. Designed to be placed over the headphone reducing

the spreading of dirt, sweat or ear infections and disposed of after use. We have no details of any affect on audio performance but of course they also keep the headphones clean.

W M Supplies (UK) Ltd, Park Mill, Oldham, Lancs OL2 6PZ, UK. Tel: 061-624 5641.

MICROPHONES SHOULD...

NOT BE SEEN

The **C-ducer** Tape Microphone has always been discreet but the preamps were bulky. The new **CP** has its electronics packed into the XLR making it truly compact.

AND, NOT BE HEARD

The **C-ducer CP** Series gives you crystal clear sound, with much improved noise performance so all you will hear is the instrument and not the microphone.

- SN 86 dB (A)
- Phantom Powered
- Fre-rep 35 Hz-50 KHz
- Piano, guitar, violin, harp, percussion almost any acoustic instrument
- Distortion - 0.5%

UK: Audio Marketing Group

2 High Street, Haslemere
Surrey GU27 2LY
Tel: (0428) 658775
Fax: (0428) 658438

USA: C-T Audio Marketing Inc

Call 1-800 C-T Audio
Fax: 407 738 0319
Int + 0101 407 738 0622

Canada

West Tel: 416 360 5940
Fax: 416 362 2477
East Tel: 604 222 8190
Fax: 604 222 9884





Cuemaster CD

The *Cuemaster* CD player from Consolidated Electronics is a professional machine designed to suit a number of applications. It uses a CD ROM drive that reduces the effects of physical impact and accepts CDs only in the standard CD ROM caddy. Cueing is with a rotary knob and operation has been simplified for ease of use. Full remote control

capabilities from hard wire or RS232. Available in horizontal and vertical (as photo) configurations. Consolidated Electronics, Australia. Europe: John A Steven Ltd, 4 Crescent Drive, Shenfield, Brentwood, Essex CM15 8DS, UK. Tel: 0277 215485.

Neve digital converters

Neve have introduced the *HRC-1* stereo 20-bit A/D and D/A converter based upon the existing circuits (EV11323 and EV11324). Additional circuitry has been added to provide synchronisation, digital interfacing, DC processing and digital re-dithering functions. The unit has line level analogue I/Os and AES/EBU digital I/Os with limited channel status support. The

AES/EBU output is available on two separate independently-driven sockets.

Neve Electronics International Ltd, Cambridge House, Melbourn, Royston, Herts SG8 6AU, UK. Tel: 0763 260776.

USA: Rupert Neve Inc, Berkshire Industrial Park, Bethel, CT 06801. Tel: (203) 744-6230.

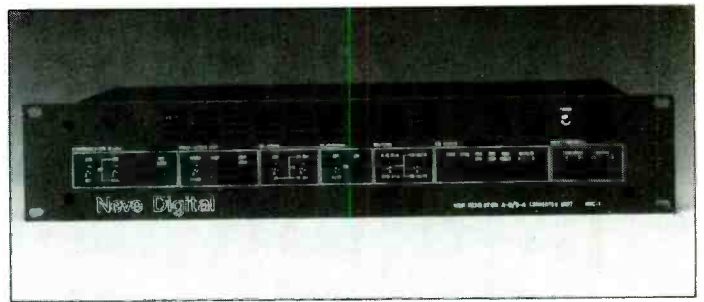

RTW Digital Peakmeters

RTW makes them all: digital and analog PPM's as well.

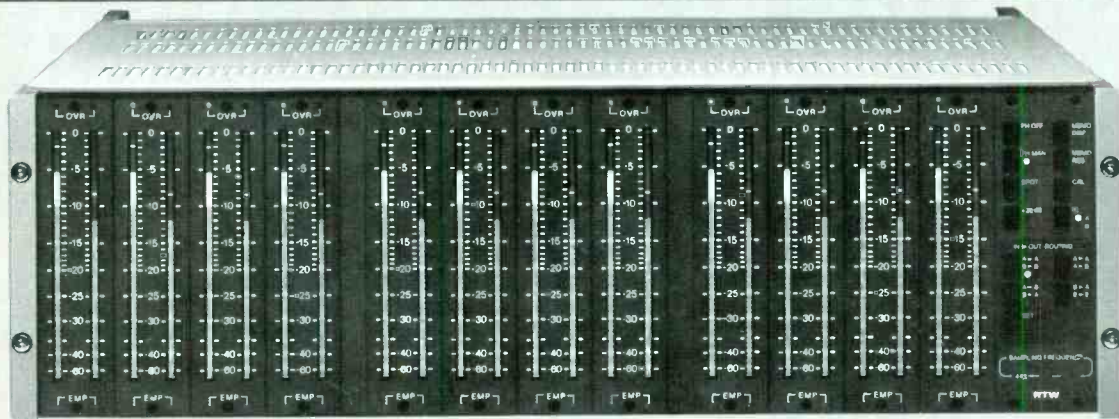

RTW 1190 DMS

24 channel Remote Metering System 1190 DMS for connection to the PCM-3324 (A) SDIF data format (RS-422).

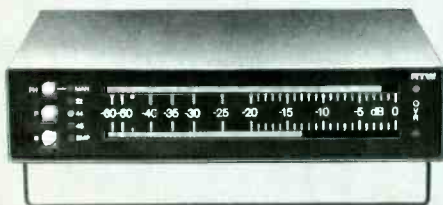

RTW 1152 EBU

2 channel Digital Meter 1152 EBU for connection to the AES/EBU digital format.



RTW 1150 DA-T

2 channel Remote Meter 1150 DA-T for connection to the PCM-1610/1630 status port.

RTW RADIO-TECHNISCHE WERKSTÄTTEN GMBH - D-5000 Köln 71 - W. - Germany
Post Box 7106 54 · Telephone (221) 70913-0 · Tx 8885217 · Fax (221) 70913-32

Australia: SYNTEC INTERNATIONAL, Tel (2) 4064700 · Austria: ACOUSTA ELEKTRONIK, Tel (662) 846164 · Belgium/ Netherlands: P.A.C., Tel NL: (40) 424455 · Canada: J-MAR ELECTRONICS LTD., Tel (416) 4219080 · Denmark: S.C. Sound APS, Tel (2) 998877 · Finland: AV-POINT ICS AB, Tel (0) 5666733 · France: SCV-Audio, Tel (1) 48632211 · Great Britain: AUDIO & DESIGN LTD., Tel (0734) 844545 · Italy: AUDIO EQUIPMENT SRL, Tel (39) 2000312 · Japan: SANIX CORPORATION, Tel (3) 7025315 · Korea: DAESAN INTERNATIONAL INC., Tel (2) 7368442 · Norway: SIV. ING. BENUM AS, Tel (2) 145460 · South Africa: ELTRON LTD., Tel (11) 7870355 · Spain/Portugal: SINGLETON PROD., Tel E: (3) 2377060 · Sweden: AV MEDIA AB, Tel (755) 65498 · Switzerland: AUDIO BAUER AG, Tel (1) 4323230 · Switzerland: TECNAD A.S., Tel (21) 8060606 · USA: ESL ELECTRONIC SYSTEMS LAB., Tel (305) 7911501



Whether you're in the business of acquisition, post production or transmission, the Sony professional DAT range now offers the digital answer.

Low cost, high density, fast access, 16-bit PCM stereo recording - the strengths of the DAT format

already benefit thousands of professional users throughout Europe.

With the PCM-7000 series, Sony combines these strengths with new technology and operational features, tailored precisely to the needs of both

SONY®

For further information contact:
 Athens 01 2818273 Basingstoke, UK 0256 55011 Brussels 02 7214950 Cologne 0221 59660 Copenhagen 042 995100
 Dubai 04 373472 Helsinki 0 50291 Jeddah 02 6440837 Lisbon 01 573046 Madrid 091 3581335 Milan 02 618381
 Netherlands 02966 81911 Oslo 02 303530 Paris 01 49454000 Rome 0396 5920237 Stockholm 08 7336100 Vienna 0222 61050
 Zurich 01 7333311 Eastern Europe, Vienna 0222 554606 Middle East, Geneva 022 7336350 Africa, UK 0256 55011

Sony professional DAT.

Designed by professionals
for professionals

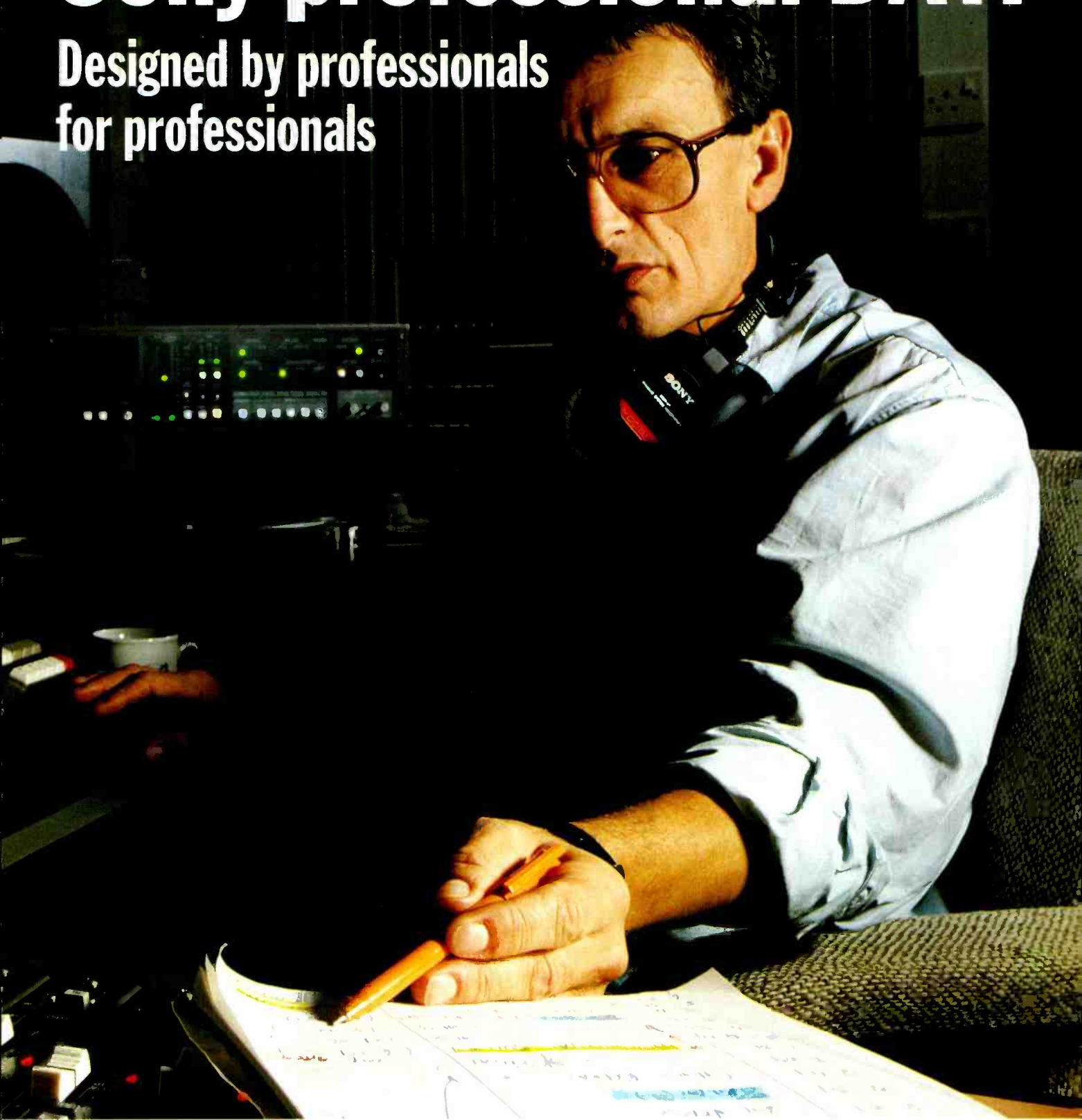

broadcast stations and production houses.

Sony professional DAT includes SMPTE/EBU time code recording, chase lock synchronisation, memory start and electronic editing with variable crossfade. At surprisingly affordable prices, the

leap from analogue to digital is an attractive and realistic proposition.

Contact your nearest Sony dealer for full details - you won't regret it.

Sony Broadcast & Communications European Headquarters
Jays Close, Viables, Basingstoke, Hampshire RG22 4SB, United Kingdom
Tel: (0256) 55 0 11, Telex: 85 84 24, Fax: G2/G3 (0256) 47 45 85

Sony Broadcast
& Communications 

QUALITY USED EQUIPMENT from Tony Larking

MULTITRACKS

AKAI ADAM 12 track digital recorder with remote & meter bridge Ex demo £11,500
 AKAI 24 TRACK SYSTEM 2xMG14D-autolocate+Postex 4030 £2,985
 AMPEX 102 2 track with 1/2" & 1/4" head blocks, little used VGC £POA
 ACES 24 TRACK with remote Budget 2" 24 track To clear £1,995
 FOSTEX D20 R-DAT Little used As new £POA
 MCI 24 TRACK with remote, a large, early 2" recorder looking for a good home To clear £1,995
 MITSUBISHI X850 32 track digital, very low hours VGC £POA
 OTARI MTR90 MK2 24 track, remote auto, low hours VGC £15,995
 OTARI MTR100 24 track, very low hours VGC £POA
 OTARI MX70 professional 16 track 1" recorder with remote VGC £POA
 OTARI MTR12 2 track 1/2" VGC £POA
 REVOX A77 2 track, recent overhaul, new heads £450
 SOUNDRAFT SATURN 24 track with remote & auto, demonstration use only, recent factory overhaul & upgrade, supplied with Soundcraft warranty Immaculate
 STUDER A80 MK3 24 track, one owner, with remote & auto VGC £9,995
 STUDER A800 MK3 24 track with remote & auto, low hours VGC £24,000
 STUDER A80 16 track, remote, only 3,200 hours VGC £3,995
 STUDER A80 MK1 16 track with MK3 head block conversion, remote auto VGC £3,995
 STUDER A810 2 track recorder 3 1/2" 15 30ips almost unused & boxed 2 available As new £2,995 ea
 STUDER A80 MK2 1/2" 2 track £POA
 SOUNDRAFT 24 track, 9 memory auto remote, private use only Immaculate £4,995
 SOUNDRAFT MK3 24 track, factory rebuilt just completed, new heads, supplied with Soundcraft warranty Immaculate £POA
 SONY 3324A 24 track digital recorder VGC £POA
 SONY MCI 24 track, 3 yrs approx, little used Immaculate £POA
 3M M79 24 track, excellent electronics & mechanics. Nice £5,995
 Saki heads just had first relap
 3M M79 16 track 2" with remote & cm50 autolocator Immaculate condition £5,995

CASSETTE RECORDERS

REVOX A710 £POA
 TECHNICS cassette decks, Dolby B-C, boxed As new £25
 Subject to availability. E&OE

VARIOUS

A.R.T. 31 band graphic EQ, Boxed, 2 available As new £150 each
 AUDIO & DESIGN Vocal Stresser Offers
 BEL BF20 Stereo flanger Boxed As new £250
 BEL BC 4 24 channel noise reduction system New £295
 BEL BC38 channel noise reduction £225
 ART PITCH TRANSPOSER with display, Boxed As new £295
 BEYER 201 MICS 3 available VGC £75 each
 AKG D12 VGC £95
 BEYER DT100 HEADPHONES VGC £55
 DOLBY SP24 24 channels Dolby-A VGC £3,750
 EMT 140 stereo transistor echo plate with remote, 1 owner VGC £750
 SOUNDRAFT 2" 16 track head block VGC £500
 PULTEC ME5 valve EQ VGC £795
 UREI 809 STUDIO MONITORS As new £1,000 pair
 TELCOM 24 channel noise reduction system in rack with psu £POA
 NEVE COMPRESSORS 6 available As new £600 each
 SIMMONS midi trigger MIDI £295
 dbx 903 & 907 MODULES stereo over ear compressor £295
 REBIS MODULES RA210 RIAA pre amp RA215 stereo panner, 2xRA216 dual VCA Offers
 STAND EASY AUDIO SCREENS 4 full size with window, 2 half size £POA
 STUDER TLS2000 SYNCHRONISER Offers
 Subject to availability. E&OE

CONSOLES

AMEK 2520 40 channel console with Mastermix VGC £POA
 DDA AMR24 36 channels, p bay Immaculate £25,995
 AMEK BC2 BROADCAST CONSOLE £POA
 DDA AMR24 44 channels + Mastermix Immaculate £POA
 HARRISON 40 channel 24 series VCA subs, 6 VGC £12,000
 auxs, installed in private studio for the past 5 yrs
 NEVE 5106 36 channel broadcast console with p bay VGC £POA
 NEVE 8068 32 channels, p bay VGC £29,950
 NEVE 5316 36 channel broadcast console Immaculate £Offers
 NEVE 542 broadcast console, 122 frame, fitted 4 2 £995
 SOUNDTRACS MRX24 24/8 16 40 inputs in remix New £2,995
 SOUNDTRACS MRX32 32/8 16 48 inputs in remix New £3,995
 SOUNDTRACS MRX34/P.BAY 50 inputs in remix New £4,995
 SOUNDTRACS CMX400 32 24 p bay, CMS3 New £9,995
 automation 56 inputs in remix
 SOUNDTRACS CM4400 32 inputs, 24 monitors, 56 line inputs in remix VGC £4,950
 SOUNDTRACS IL4832 48 channel in line console, p bay, 96 inputs in remix, fader automation available, private use only VGC £24,000
 SOUNDTRACS PC MIDI 24 with FX return modules, 56 line inputs VGC £4,500
 SOUNDTRACS 16/8/16 34 line inputs in remix VGC £1,495
 SOUNDRAFT 2400 28/24/24 with patchbay, private use only VGC £POA
 SOUNDRAFT 200 SERIES 24/4/2 VGC £1,750
 SQN 4 channel, stereo portable mixer As new £1,495
 TAC SCORPION 40 frame, fitted 28 mono channels & 12 stereo channels 68 line inputs! Built into beautiful professionally made ash console with integral 19" rack each end. Looks like a £30,000 console Immaculate £5,995
 TASCAM MODEL 15 24/8/16 complete with stand £985
 TRIDENT TSM 32/24 24 p bay VGC £11,995
 TRIDENT SERIES 24 36 channel frame fitted 28/24 24 VGC £5,995
 Subject to availability. E&OE

EXPORT ENQUIRIES WELCOME

Tony
Larking
Professional
Sales
Ltd.

TEL: 0462 490125
 FAX: 0462 490126

All prices are exclusive of VAT

PRODUCTS

Trackmate TM-271

For those of you using a VCR for video or audio applications, the Trackmate TM-271 VCR maintenance cassette would appear to present a different approach to head cleaning. The cassette uses four specially engineered brushes, rather than cleaning tape. The brushes are 175% wider than video tape allowing cleaning over a greater area and apparently contain 80,000 flexible absorbent filaments that remove the dirt. A marker pen is supplied that allows application of measured amounts of isopropyl alcohol to the brushes. When the tape is loaded it simulates the action of a video tape, times the cleaning cycle and then retracts the brushes. A counter records the number of cleanings indicating when the brushes should be removed for their cleaning.

WEST, Unit 9, IDA Enterprise Centre, East Wall Road, Dublin 3, Eire. Tel: 353 178 8955

(manufacturer and non-UK distribution information).

UK: Bandridge Ltd, Premier House, 18 Deer Park Road, Wimbledon, London SW19 3TU. Tel: 081-543 3633.



VRS high energy eraser

VRS Data have launched a new bulk eraser to cope with high energy tape formats being used in audio and video applications. The V91M is a simple to use table-top unit designed to handle DAT, D2, MII, 8 mm and Betacam SP for the small volume user. Erasure figures of -75 dB on metal tape with an average erasure time of 5 secs per cassette are claimed by the manufacturer.

VRS Data Ltd, Unit F, Holder Road, Aldershot, Hants. GU12 4RH, UK. Tel: 0252 317000.

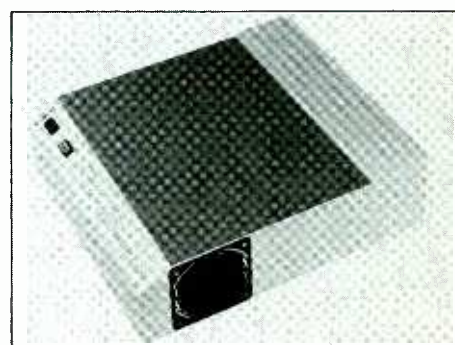

In brief

- Neve have announced that the SSL 4000 series console has been added to the list of consoles that can now be retrofitted with *Flying Faders* automation.
- AKG have introduced a dedicated amplifier to power a pair of *K1000* headphones. The frequency response of the class A amp has been tailored to match the headphones.
- JBL have announced additions to the *Control* series of mini speakers—the *Control 1AT* for 100 V line use or 4 ohm; the *ICM* flush ceiling mount version of the *1AT*; and the *1AW* weather-proofed version of the *1AT*.
- The International Tapetronics Corporation (ITC) has announced an extension of the warranty period for their NAB cart machines to four years.
- Ampeg have announced the addition of a 30 minute DAT cassette (R-30). The existing 45 minute DAT cassette will be lengthened to 46 minutes.

Roland's new wave

Roland has experienced something of a quiet time since the introduction of its LA Series of synths—culminating recently with the powerful *D70* and punctuated most significantly by the *W30* workstation and *S770* professional sampler. However, the new wave of developments has resulted in the arrival of a spate of price-busting and very thoughtful products.

Aside from those mentioned here it's important to note that Roland has subtly been addressing new markets with the promise of the *DM80* hard disk recorder and *RSS* 3-D sound processor. It's also been active in the MIDI Manufacturers' Association discussions in the General MIDI format which hopefully will result in the widescale adoption of standardised sounds, mappings, channel allocations and presentation of MIDI to the user in different instruments. Roland is the first to produce a unit (*SC55*) that conforms to the initial set of requirements suggested by the MMA. One gets the distinct impression that things are moving apace.

Keyboard players have been mourning the loss of the knob-encrusted synth ever since manufacturers told the world that they had become too expensive to make and were no longer what musicians wanted. With the *JD800*,

Roland is the first to rise to the challenge of developing a modern synth with the control possibilities of old.

Comparisons to the cosmetics of the *Jupiter* series of Roland synths are unfair as the *JD800* offers the player/programmer a sophisticated user interface while the *Jupiters* merely had their innards on top. Thus the *JD800* offers over 50 slider-type controls and a similar number of buttons that reflect this digital product in analogue terms. Including 108 high sampling rate waveforms with TVF, TVA, two LFOs and pitch TVF and TVA, the unit is 24-voice polyphonic, six-part multitimbral and very performance oriented. With inbuilt effects and a 61-note weighted keyboard it remains to be seen if the £1699 *JD800* is what the doctor ordered. I suspect it will be.

At last, a digital drawbar keyboard and from Rhodes of all people. The *VK1000* uses 13 drawbar-type controls to modify high-quality organ waveforms. Three-part multitimbral in nature, the keyboard can be split for left and right hands as well as allowing a MIDI pedal board to be connected. An additional keyboard can be used as an upper manual. Because the instrument uses Adjustable SA Sound Source as its generating method, the combination of drawbar effects are said to extend



considerably beyond the sonic possibilities of a standard organ. On-board effects include the essential overdrive and rotary speaker simulations.

Still on the performance kick, the *JX1* is a 24-voice polyphonic, 61-note, 64 preset synth with front panel sliders for altering sounds on the job. PCM sounds are TVF treated and these can be edited and stored in 32 user memories. Patches can be layered and microtonal tunings can be created with backup via MIDI dump. In line with the aforementioned General MIDI format and Roland's own GS Standard which conforms to it, the *SC55 Sound Canvas* is a 16-part multitimbral sound module capable of making sense of data configured for other modules. The 315 sounds can be edited by TVA and TVF and the unit shares a wireless remote with its partner the *Sound Brush* sequencer which can playback sequences on standard MIDI file format.

The *SBX1000* SMPTE-based MIDI Cueing Box combines a 100,000-note, 16-track sequencer with a 30,000 MIDI event, ¼ frame accurate cue sheet. Four devices can be hooked up via GPI connectors and data is stored

to an integral 3½ inch drive.

The highly acclaimed *S770* (now with version 2.0 software) is available in the cheaper guise of the *S750* with eight outputs and no hard disk but its 2 Mbyte of RAM can be expanded to 18 Mbyte and supplemented via SCSI.

Roland has enjoyed a good reputation for producing high quality, cost-effective outboard and the tradition looks to continue with the *RSP550* stereo multi-effects unit. Sampling at 48 kHz, separate ADCs and DACs are used for each channel and notable features include 160 memory locations from 39 effects algorithms, eight way multitap delay, tempo delay and real-time MIDI control of parameters.

For the guitarist, the popular Boss *ME5* multi-effects unit has been enhanced to the *BE5M* while the *FC50* MIDI foot controller not only addresses 128 patches but also allows connection of two footswitches and two expression pedals for real-time MIDI control.

UK: Roland, Fleet, Hampshire GU13 8UY. Tel: 0252 816181.

USA: Roland Corp, Los Angeles, CA 90040. Tel: (213) 685 5141.



Expanding an EIII

Emu Systems is to introduce a rackmount expansion unit for the *EIII* keyboard in the second half of this year. Communicating over SCSI. The *EIII* Expander adds 32 Mbyte of RAM, has digital I/Os, 48 kHz sample rate and eight polyphonic outputs served by 24 mono or 16 stereo voices. ADCs are autocalibrated with 64 times oversampling. The Expander uses EMU's H-chip—VLSI digital filter—for 32 dynamic digital filters with resonance and total compatibility with existing hardware,

data format and sound libraries. A 200 Mbyte hard disk drive is optional. Sound effects libraries for the *EIII* now include Northstar Productions' *The Hollywood Edge* on CD-ROM or magneto optical and In Vision Interactive's *Lightware SFX Series* on five CD-ROMs plus a 'best of' collection on 45 Mbyte removable cart.

EMU Systems, 1600 Green Hills Road, PO Box 660015, Scotts Valley, California 95067-0015. Tel: (408) 438-1921.

Opcode software

Originally intended to control music and audio hardware for developers. Opcode has now released *MAX* as a real-time graphic programming environment that allows complex applications to be built up by linking modules together. It can be used in MIDI, music, video, digital audio, animation and multimedia systems. *Vision* has been updated to version 1.3 which now supports more MIDI channels, allows punch in and out on the fly in Play or Record and supports 29.97 non-drop frame SMPTE. The package also sports Opcode's Open MIDI System local area network which permits enhanced interaction with other systems. *Studio Vision* includes all these updates plus the ability to work with Digidesign's four-channel playback version of *Sound Tools*

when it arrives.

Opcode has also released *The Book of MIDI* on interactive Hypercard stack which takes users of all levels through the most commonly asked questions and answers them in an entertaining and highly graphical way.

On the hardware side, the *MIDI Translator* is a cheap MIDI interface for the Mac with one in and three outs which plugs into the printer or modem port.

Opcode Systems, 3641 Haven Drive, Suite A, Menlo Park, CA 94025-1010. Tel: (415) 369-8131. UK: MCMXCIX, 708A Abbey Road, Tudor Estate, London NW10 7UW. Tel: 081-963 0663.

Studio Sound's Music News is compiled by Zenon Schoepe

On Tour

● **AUDIOLEASE** await the arrival of May with great expectations, when their new A2 2-box system has its first tour, on EMF's UK university dates. Steve Sunderland said the production cabinet lineup now includes a 2x15" horn loaded sub bass (replacing the prototype 2x18" reflex design 'for extra punch'). The mid/high cabinet comprises 2x12", a single 2" and four 'bullets'—using JBL drivers throughout. Eight of each box will be deployed for EMF,

who played universities and similar 2-3,000 seater venues. EMF, said Sunderland, are due back in the UK for larger shows later in the year, possibly headlining a 'package tour' aimed at capitalising on the current popularity of Indie/dance music.

● **BRITANNIA ROW**, among a busy schedule, are taking their Turbosound *Flashlight* system into indoor venues for the first time this Spring on two tours. First was Cliff Richard's March theatre tour, using 12 pairs; while from April the Pet Shop Boys use a larger rig for indoor

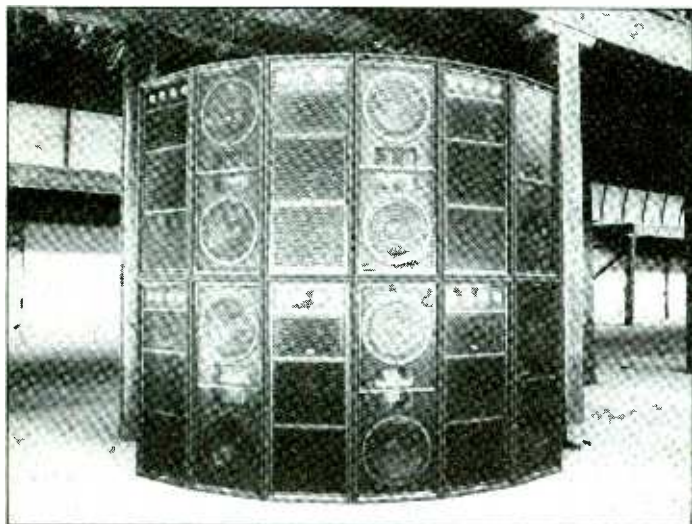

Audiolease A2 two-box system lineup

News round-up

● **SAFE-T 91** is the banner of an International Conference on Safety in Live Entertainment. This is surely a long-overdue meeting of minds and the dates of June 18th and 19th (at the Cavendish Conference Centre in Central London) should find a slot in everyone's diaries. Expert papers and discussion topics include Health & Safety regulations, pyrotechnics, causes of fire, RCDs, crowd control, auditorium seating and stage machinery.

● **SYNC FACILITIES**, of Otley, West Yorkshire, has announced an intriguing-sounding large-scale surround sound PA processor.

Their Sync Surround System, designed and built in-house, has been chosen for a high-profile launch to 3,000 people of British Aerospace's latest aircraft in a hangar at Glasgow's Prestwick Airport. Sync Facilities say perfect surround-sound reproduction is crucial to the event, and their concept offered the ability

to cover a large venue "where conventional systems have a 'hole in the middle' effect as in normal stereo".

Music and effects are ideally recorded and mixed via the 20-input encoder, they state; the surround sound information being encoded onto 6 channels of data for storage on tape or hard disk. The decoder accepts up to 4 coded sources and drives 18 separate power amplifier channels plus auxiliary stereo and mono broadcast feeds. The Sync Surround System is aimed at large events—and is for hire only.

● **TANNOY-AUDIX** has announced the ultimate Yuppie accessory—an SPL meter which fits in your *Filofax*. The Design Aid (obtainable free by writing to Tannoy-Audix) is, their press release states, a 'sound system design calculator' for anyone specifying voice alarm and PA systems, which calculates the SPL of any loudspeaker at any wattage tapping and any distance. Our own *Filofax* awaits its free sample to confirm the ingenuity of this invention.

arenas in the UK and Europe. The shows, said Mike Lowe, involve a 'very theatrical' set, much choreography and an immense array of MIDI sequencers, samplers and effects. Laurence Dunnett's Backroom Rentals is supplying the PSU expertise to ensure this digital pack of cards behaves itself.

Demonstrating international co-operation, top MSI engineer Paul Giansante joins Brit Row soon for a two-year stint. Other acts out include The La's, Jimmy Somerville, Gloria Estefan in arenas and James Last. Last but hardly least is David Lee Roth whose March and April dates involve 84 *TMS-3s*, which, said Mike Lowe, will be dwarfed by a backline of 100 Marshall cabinets—"It's probably the first tour I've done since the early '70s where the backline is bigger than the PA." Regrettably David decline to let us witness his hardware in action, presumably fearing negative comment. In Studio Sound? Heaven forbid. The annual Roskilde fest is confirmed, but Lowe confirmed a general shortage of major tours this summer—dating from pre-war and pre-recession days—although he added 'next year looks much better'. Dire Straits' rescheduled world tour will now begin at the end of August.

● **CANEGREEN** Tasco had a system with Deep Purple in the US in March and a C&W Festival at Wembley which then proceeds to two more European venues. But the biggest news is the official launch of their *Radio Station* personal monitor system. Elaine Page is using it for her Albert Hall nights and UK dates, and five sets go out with the Pet Shop Boys. Designed by Canegreen's Chris Lindop and Yan Stile, distributed worldwide by Personal Radio Systems UK Ltd at the same address and built in the UK, the system has been revamped after on-the-road trials and is now available at a list price of around £3,740 (approx. \$7,100). That buys you a base station transmitter with transformer balanced inputs, a belt-pack receiver with level control and a discreet in-ear monitor with either a 'standard ear' mould or (on request) a personally-sculpted variant for owners of oddly-shaped auditory organs. Any number of receivers can receive one mix; separate mixes naturally require additional transmitters. Chris Lindop said Aha, Sinead O'Connor, Anita Baker, Luther Vandross, Cliff Richard and Gloria Estefan are already confirmed users of *Radio Station*.

● **CLAIR BROTHERS'** Stan Horine said the company's European activities "are really slow right now". While transatlantic traffic will inevitably take time to recover from Gulf War uncertainties, Clairs nevertheless have Sting—playing stadia and indoor arenas—and Paul Simon heading across the pond, along with Kenny Rogers. A world tour by Yes is also scheduled. Meanwhile, their installations arm (handled in the UK by Elliott Bros) has scored a hit in Mexico City's Olympic Stadium with a large *S4* system on a long term lease.

● **SSE's** Chris Beale said his *MT-4* order books are full—with an exotic lineup of contracts. They have *AC/DC* in the UK and Europe from March to May—in conjunction with dB Sound—using 160 kW of *MT-4*, a *TAC SR9000* (mixed by Robbie McGrath) on front and a Ramsa onstage mixed by Paul Owen. *UB40* are using 60 kW, an *SR9000* and a *Scorpion* for monitors in the UK and Europe. *MC Hammer* plays arenas with a 100 kW system, a *PM3000* on front and a Ramsa onstage in April and May; *White Lion's* May and June dates will involve about 40 kW. Less run-of-the-mill is Nigel Benn's fight at the NEC on April 3rd—and the *WWF Wrestling 'Rampage'* tour with some 20 kW of PA. ("A boring job for the engineer," Beale confirmed, "there's just a CD player to plug in. But it's worth it to watch the punters fighting each other harder than the guys in the ring.") They also have the Newark Festival on May 18th with *UB40* due to headline a supporting cast including the *Isley Brothers*, *Courtney Pine* and others. Rapid changeovers on rolling risers will be the order of the day, with a 'huge amount' of *MT-4* plus two *SR9000s* and two *Scorpions*. SSE are also providing custom PA flying systems for the new ICC complex in Birmingham. Watch this space for an in-depth look at this sophisticated multi-hall venue.

● **WIGWAM** supplied Nexo speakers, Soundcraft and TAC consoles and Martin/Nexo monitor systems for tours by Shakin' Stevens and The Wedding Present—and a Meyer/Soundcraft/Midas rig for The Charlatans. Hire Director Chris Hill confirmed they also provided the sound for the 30th Year Celebrations of top TV soap *Coronation Street*.

Studio Sound's Live Sound news page is compiled by Mike Lethby

You don't have to be wild about Harry to be bowled over by new generation ScreenSound.

You don't have to run a digital video environment to make full use of ScreenSound's powerful new capabilities. Following an intense period of R&D, ScreenSound is now fully equipped to perform as the essential digital audio command centre for film and video.

As the name suggests, ScreenSound is all about editing audio, visually. Music, dialogue and effects can be edited, polished and laid back to film or video with sub-frame accuracy. Meanwhile, all this is achieved without incurring the generation losses that have always afflicted analogue audio. It couldn't be easier to use, thanks to a highly intuitive user interface that brings operator and system closer together. Simple, gestural movements of the cordless pen on ScreenSound's tablet provide control over all functions. No fiddly keystrokes, no mousey manoeuvres. At HHB we like to say that if you can hold a pen, you can explore ScreenSound's creative possibilities.

With SSL's new 'SoundNet' technology, archiving and uploading are instant procedures. You can even share and copy work between multiple ScreenSound command centres or play back as many as 56 channels of digital or analogue audio. Audio tracks appear on screen as "reels" of tape that can be edited, timeslipped, and crossfaded. Gain and pan position can be automated against timecode while an 'audio scrub' facility permits accurate manipulation of edit points. Thanks to powerful search and sort routines, ScreenSound helps you maintain an

accurate record of sound clips held within the system, while a WORM optical disc subsystem can provide massive off-line storage. With the 'SoundNet' option you can obtain instant on-line access to as much as 48 hours of audio. Naturally, a unique degree of operational speed and production efficiency are principal system benefits: ScreenSound can control up to sixteen VTRs, videodisc

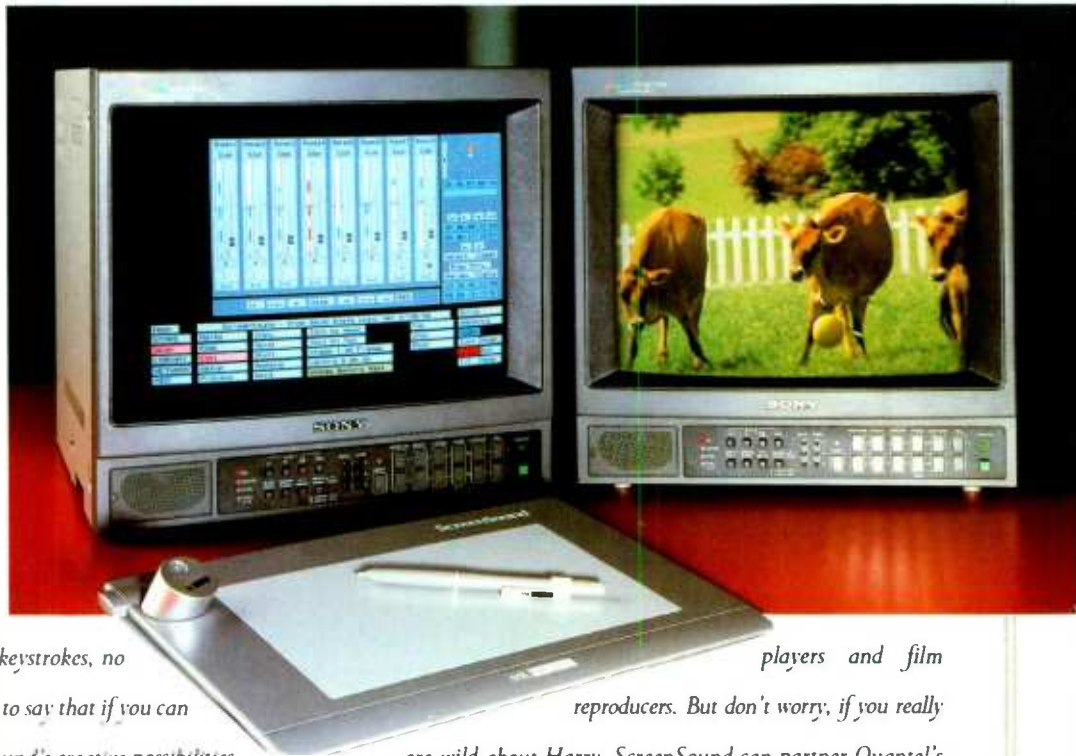

players and film reproducers. But don't worry, if you really are wild about Harry, ScreenSound can partner Quantel's system to provide operators with unparalleled levels of control.

Of course, ScreenSound comes from Solid State Logic, one of the world's most respected pro-audio manufacturers. But in the UK, new generation ScreenSound can be found only at HHB. And since HHB is widely recognised as Britain's leading source for digital audio technology, you also access the best expertise and the finest service in the business. So contact us now for a demonstration or to receive more information on ScreenSound's expanding facilities.

SSL DIGITAL

Fred says, if it's worth recording it's worth

FRIDA

FRIDA combines the well established editing facilities of FRED with its own fully comprehensive tape recording facilities ensuring the highest studio standards - wherever the action is.

Unique family features include:

- lightweight
- portability
- modular design
- ease of operation
- sensible pricing

and FRIDA is available in TC versions and models covering all working situations.

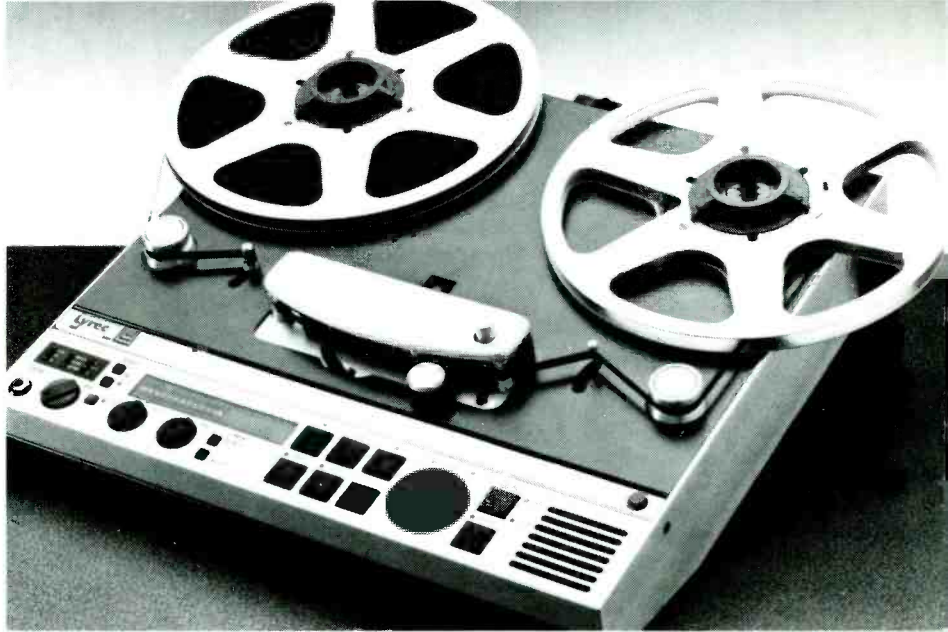

Table-top



Lyrec Manufacturing A/S
Box 123 (Mileparken 22), 2740 Skovlunde Denmark
Tel +45 44 532522 Fax +45 44 53 53 35

European Distributors

	Tel	Fax
Austria:	+43 22 36/26123	+43 22 36/83223
Belgium:	+32 11 415278	+32 11 491662
Finland:	+358 0 5661644	+358 0 5666582
France:	+33 1 42815047	+33 1 42858247
Greece:	+30 1 6475659	+30 1 3639234
Italy:	+39 2 817839	+39 2 8136032
Netherlands:	+31 20 141749	+31 20 140065
Norway:	+47 2 797730	+47 2 796154
Switzerland:	+41 18400144	+41 18410726
U.K.:	+44 84427 8866	+44 84427 8810
W. Germany:	+49 6171 4026	+49 6171 4401

Console

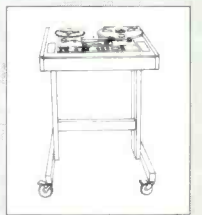

Rack-mounted

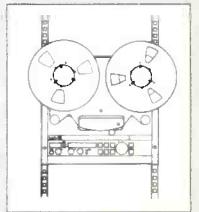

Portable

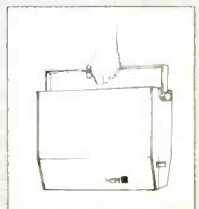

CRESCENDO AUDIO MIXING SYSTEM

David Miles Huber looks at a digitally-controlled analogue mixing console

Over the years, we have come to judge a newly introduced console by the number of inputs it offers, by its automation capabilities or by other standard factors. It's a rare occasion when a professional console is released that is so new in design philosophy that we must judge it by a new set of standards. One such audio mixing system is the *Crescendo* audio mixing console from Euphonix of Palo Alto, California.

The *Crescendo* is a digitally-controlled analogue console that offers dynamic and snapshot automation over all audio mixing functions (including faders, sends, EQ, routing—even headphone and talkback). An unusual feature is its digital signal routing and operating structure,

within a package that is offered at a reasonable price. Current system prices range from US\$127,000 (£65,000) for the 5624 (56 inputs/24 track buses) to US\$214,000 (£110,000) for the 9624 (96 inputs).

The system has three major components: a mix controller, an audio mainframe and a host computer system. The mix controller surface is compact, measuring 54×30 inches/135.5×77 cm, and is really a digital remote controller surface that does not internally pass audio signals at all: it communicates signal level, EQ and routing-related data to an audio mainframe through the use of a 2 Mbaud parallel data cable link.

The audio mainframe tower consists of a local power supply and a series of frame slots, into

which the master and audio boards are plugged. Each audio board contains the necessary DCAs (Digitally-Controlled Amplifiers), DCE (Digitally-Controlled Equalisers), switching circuits and audio connections for each of the *Crescendo's* I/O strips. The data cable can be used to connect the two components over a length of up to 100 ft/30 metres, which would allow the mainframe to be placed in an isolated central machine or tape room. In addition, the mainframe may be tied (via multiconnector cables) to an optional 480 point TT (bantam) patchbay.

An RS-232 port is offered for integrating a standalone IBM 386 or compatible computer into the system. Although not required for basic console operations, a *Mac*-like graphics interface (known as *MixView*) is offered that allows for dynamic and snapshot automation of 'all' console settings, on-screen alphanumeric or help menu readouts and a screen interface that enables any of the console's individual EQ settings and adjustments to be graphically displayed on the computer monitor.

Operating concepts

Throughout the years, the basic layout of the modular I/O console strip has come to be accepted as a design convention. Upon sitting down at a traditional board, we have come to expect the audio signal path to flow logically from the mixline preamps to the EQ, effects, monitor and other sections along the strip's signal path. In effect, most I/O strips are designed to control and/or process a single source along a defined

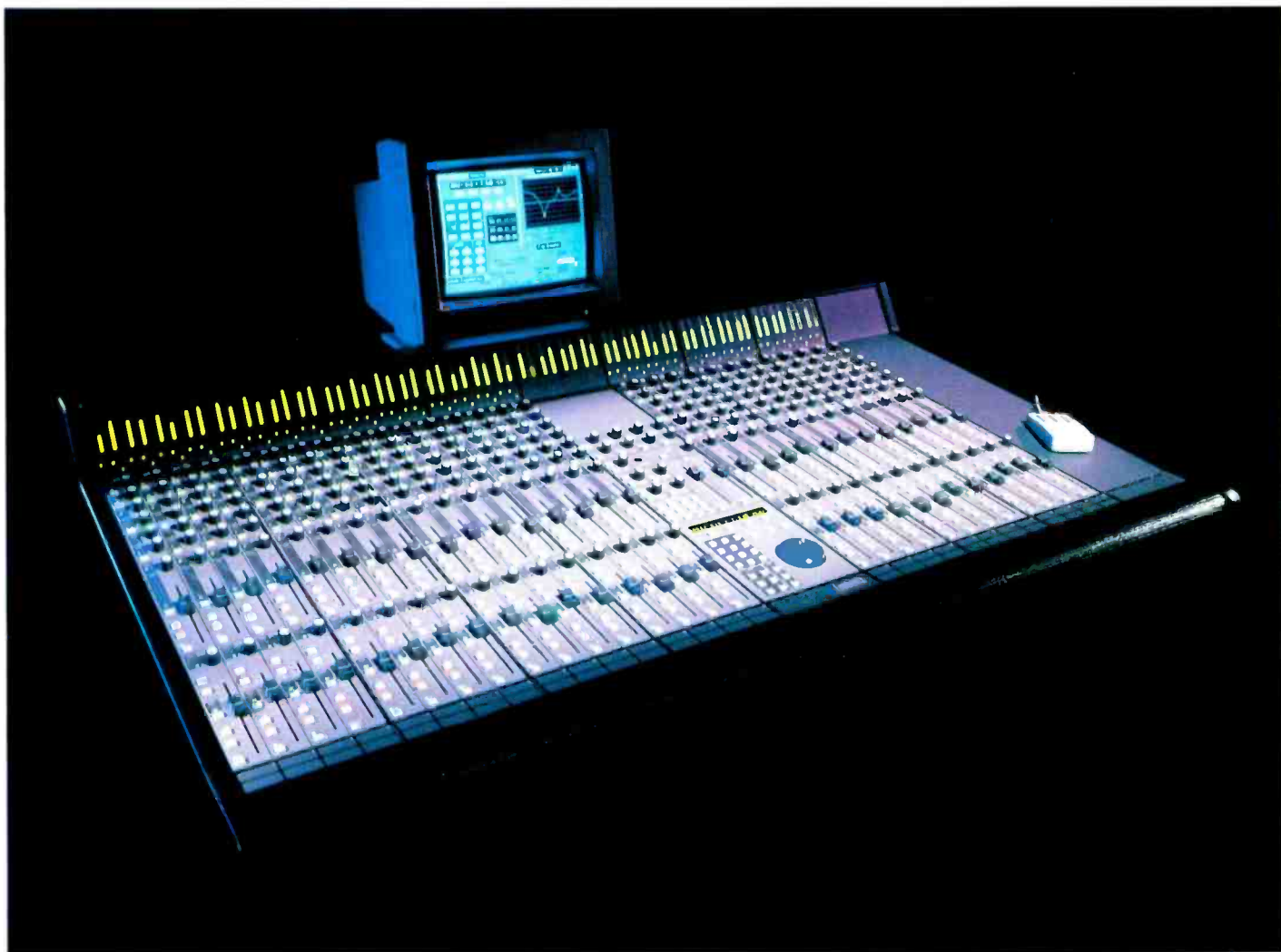

audio path, while enabling it to be routed to one or more destinations. *Crescendo* offers a novel variation to this, which might take a bit of getting used to, but once the basic concepts are understood, this console offers a flexible and logical operating structure.

Each of the *Crescendo*'s input strips can be broken down into a number of 'signal blocks' (familiar to us as mic/line preamps, auxiliary sends, channel faders, etc). However, the major difference lies in the fact that 'each' of the input strip's two auxiliary send blocks, upper fader blocks and lower fader blocks can be individually programmed to accept any (or all) of six possible inputs per strip (two mic and four lines). 'Each' of these blocks can likewise be assigned to a wide number of destinations (for example, to a tape track, auxiliary send or mixing bus destination), in either a mono, stereo panned or true stereo configuration. As an example, it would be a simple matter for a strip's upper faders and aux sends to derive their sources from a single

microphone, while the lower fader derives its source from a multitrack tape return (Line 4). It is also equally possible for auxiliary sends A and B to derive their inputs from a mono tape return, while aux sends C and D, and the upper fader derive their sources from the strip's two mic preamps in a linked stereo configuration. Its operating concept is totally non-traditional in form and function. You can easily mix and match sources and destinations to best fit the situation at hand.

These assignments can be made through the use of a BLOCK ATTENTION KEY (at the bottom of each signal block) and the associated assignment panel (within the master control section). By referring to the input strip and master section drawings, we can begin to understand the way in which a signal block can be programmed.

Example 1: Let's begin by assigning a multitrack tape track to an input strip's auxiliary sends 1 and 2. This is done by first pressing the desired BLOCK ATTENTION KEY (in this case, let's

choose an upper A/B aux send block). At the master section, we can then choose our source (L4=multitrack tape) and then our assigned destination (A-1 and A-2) and it's done. Having done this, lights behind L4, A1 and A2 will appear to indicate the block's routing status clearly. This particular tape track can be assigned to any number of odd/even auxiliary pairs in either of two ways: as a split mono source or as a panned source between the two buses. During the latter, the lower trim pot B will vary the signal level; while the upper A pot acts as a pan position pot.

Example 2: Using an 'upper fader' block as an example, it is equally possible for us to assign both the input strip's two mic preamps (M1 and M2) to any combination of two stereo output or 24 tape track buses. In addition to combining the signal into a single mono or stereo panned path, it is possible to software link a true stereo signal path so that it can be controlled from a single fader or rotary pot.

Your days as an Octopus are numbered

If you work with an unautomated desk, you've probably longed for the day when affordable automated mixing makes the nightmare of manual mixing a thing of the past. Thanks to Optifile 3D that day has arrived.

Optifile 3D is a very cost-effective pro SMPTE system that's fittable to any console. Its stunning array of mixing applications makes it the first choice for many console manufacturers.

Contact The Home Service today for the new brochure and discover how easily you can have Optifile 3D fitted to your desk.



OPTIFILE

NOW
WITH TOTAL
MACHINE CONTROL



Australia: Greater Union Village Technology - (02) 550 5488 **Belgium:** EML - (011) 348339 **Brazil:** Labor - (11) 318339
France: AD Systeme - (1) 42 53 31 18 **Hong Kong:** Audio Consultants Co Ltd - (852) 351 36 28 **Italy:** Audio Palomita - (02) 251 07 21
Malaysia: Meteor Sound & Lighting Systems - (03) 291 65 59 **New Zealand:** Protel - (04) 854 874 **Norway:** Audioton A S - (02) 35 20 96
Switzerland: Decibel SA - (021) 921 75 93 **Sweden:** Soundtrade AB - (08) 730 04 00 **Spain:** Twin Cam Audio - (03) 675 50 11
Singapore: Swee Lee Co. - 336 7886 **Taiwan:** Linfair Engineering - (2) 521 45 6 **Venezuela:** Acoustifab - (02) 987 48 45
W.Germany: Mega Audio - (067) 21 26 36

Manufactured by AD Systems. International representation: The Home Service, Unit 2, 10 William Road, London NW1 3EN. Tel: 071 388 0339

Controller surface layout

The mix controller comprises a mainframe that can be fitted with two types of modules: the I/O section and the master section module. Each I/O section is made up of a group of four input strips, while the master section contains all outputs/send masters, assignment/parameter controls and talkback/slate blocks.

I/O module

Each input strip offers two mic/line preamplifiers, which can be operated as two, independent mono sources or software-linked for stereo operation. Whenever a mic is chosen as a source, a gain trim control is active over a -4 dB to +60 dB range. At high-gain settings, an attenuation pad is automatically inserted into the circuit to reduce the possibility of input overload. Other software-settable features (which can be selected for either mic or any of four available line inputs) include individual phantom power, phase reverse and a 100 Hz highpass filter.

Four auxiliary sends (configured as two dual-send auxiliary blocks) have been designed into each input strip, however, any of these four sends can be assigned to any or all of the console's eight buses (in a pre- or post-fader and/or EQ configuration). As with many of *Crescendo*'s modules, each of these dual-send blocks can be software-linked in a mono panned or true stereo configuration. In either of these modes, each block's lower control knob will serve as a stereo send level, while the upper knob serves as a pan or a balance control.

In addition to the above effects sends, each input strip is fitted with three internal effects send/return loops. These insert loops are created through the use of three send blocks, which are located at the top of each strip and respectively send to Lines 1 to 3 (L1 to L3). By assigning a mic or line source to any of these inserts, it is possible to patch a signal patch through to an external effects device. The device's return signal will then return on its assigned source channel (L1 to L3), after which whenever any signal block is assigned to an appropriate insert line input, that signal will be processed.

Each input strip is also fitted with two, long-throw, programmable faders, which are simply

· PERFECT SOUND · PURE VISION ·

PERFORMANCE
CRAFTSMANSHIP
RELIABILITY

T

he Sennheiser name has been associated with high quality yet affordable audio products for nearly half a century. In order to fully service and support the ever-growing customer base, Sennheiser now announce the opening of their UK offices in High Wycombe.

Staffed by dedicated professionals and demonstrating the company's total commitment to the UK market, Sennheiser UK is the number to call for sales enquiries, product information and technical support.

Details of our complete range of innovative audio equipment including Studio, Vocalist and O.B. microphones, headphones, acoustic systems and the new range of M.K.H. Studio Condenser Microphones featured here, are available from Sennheiser.

For further information call Sennheiser UK on (0628) 850811.

 **SENNHEISER**

Sennheiser UK Ltd. · B2 Knaves Beech Business Centre · Loudwater
High Wycombe · Buckinghamshire HP10 9QY · Tel. 0628 850811
Fax: 0628 850958

OUR MONITORS

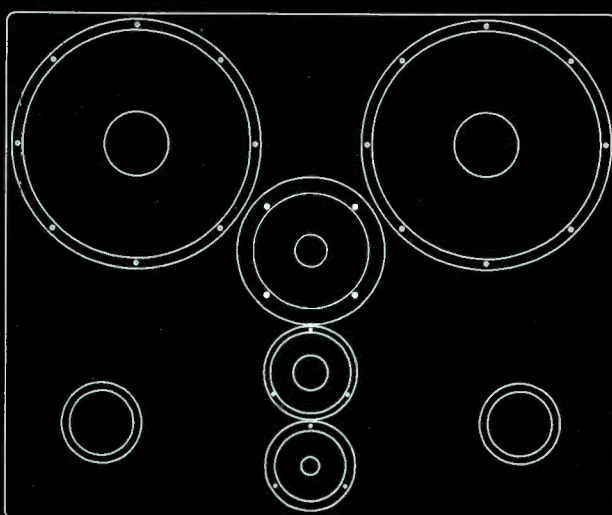
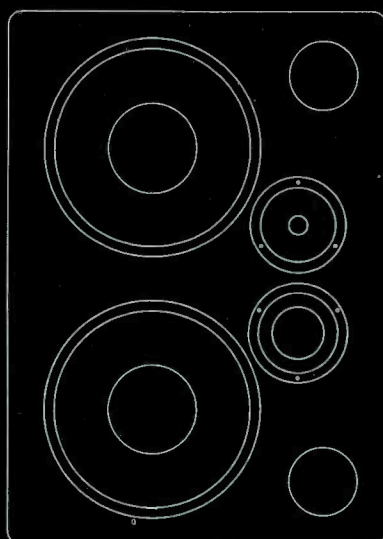
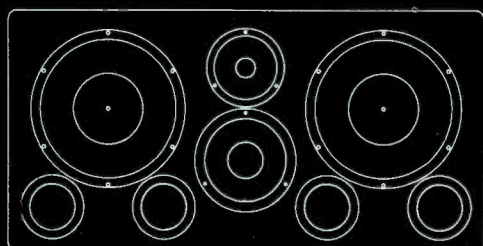
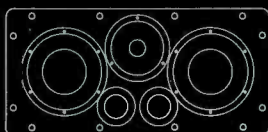

can't speak for themselves...

"We recorded and mixed the Beautiful South's new album on these little M1 nearfield monitors. They really are outrageously accurate, ridiculously loud, and the record's No. 1!"

Mike Hedges
Record Producer

"One of the reasons that people come here is the monitoring. I recall that Polydor called me up to congratulate me once. They had just had 3 separate projects from here, with 3 different engineers, going to 3 different cutting rooms. Every one was cut flat. It was the first time ever, apparently! Do I like my M2s? I couldn't live without them!"

Rod Gammons
Berwick Street Studios

"I use M2s in my own studio and on location. Working with artists like George Michael, Hall and Oates and Living in a Box I need a reference point which is absolute."

Chris Porter
Engineer and Producer

"Our dubbing engineers feel that we have the best audio Post Production facilities in the Network. We use Dynaudio Acoustics M3 systems throughout, and they play a key role in this claim."

Graham Lee
TVS Southampton

"The DA-M4 is simply the best monitoring system that money can buy. It's the first setup I've had where the console doesn't get stacked up with different monitors. People like them so much, they ask me to swap apartments with them! Seriously, though, out of 10 album projects since May, only one has had to be remixed. That's impressive."

Freddy Hansson
Sweet Silence Studios, Copenhagen

dynaudioacoustics

The Studio
13-16 Embankment Gardens
London SW3 4LW
England
Telephone 071-352 8100
Telefax 071-351 0396

Mix controller
 Height: 7.15 in
 Width: 53.35 in
 Depth: 30.35 in
 Armrest height: 29.00 in
 Overall height w/stand: 34.00 in

Technical specifications
 Bandwidth: 15 Hz-30 kHz±.2 dB
 Noise: -84 dBu (24 faders up)
 Distortion: <.01% (THD+N), <.01% (IMD SMPTE)
 Crosstalk: -84 dB (any two signals)
 Headroom: 24 dB
 Dynamic range: >110 dBu

Audio mainframe
 Height: 50.70 in
 Width: 17.40 in
 Depth: 19.00 in

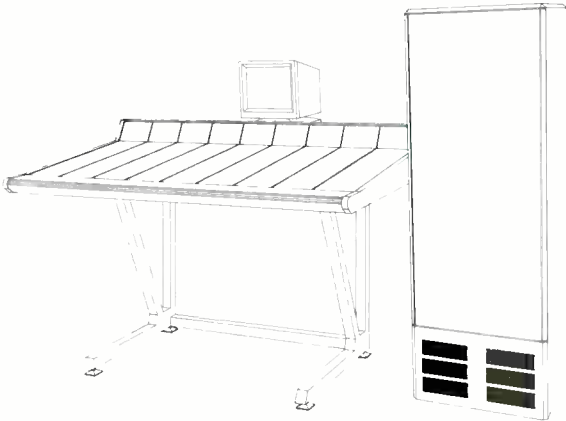

Basic Crescendo specifications (above). Channel I/Os (right)

designated upper fader and lower fader. Both of these can take their signal source from either of the input strip's mic/line preamps or line inputs and can be assigned to a direct output or the console's two main output buses (in a mono or stereo configuration). In addition, the source or output of either of these faders sections can be soloed in place using the PFL or AFL buttons; while an ON key is used to add or remove this fader's output from its assigned mix buses.

The two fader blocks are basically identical, with the exception that the upper fader has the added advantage of being able to route its mono or stereo signal source to any (or all) of the console's 24 track buses. As a result, the upper fader is often used for setting levels to tape, while the lower fader is commonly used for creating a monitor mix during tracking or as a full-function fader during mixdown.

Each I/O strip is fitted with two 19-segment LED bargraph meters, that can be individually or globally programmed to display channel inputs/outputs, multitrack buses or automated fader movements. Various meter ranges can also be user-programmed (allowing various headroom ranges to be monitored), while offering both vu and peak ballistics.

Master module

The master output section includes the main assignment and parameter controls, in addition to control over the console's auxiliary, monitoring and main output buses.

Crescendo's auxiliary bus master controls can be configured in any paired configuration, ranging between eight mono sends and four stereo-linked pairs. Three, independent monitor sends are offered for feeding any stereo control room, studio or headphone amplifier combination. Sources for each of these feeds can be derived from a programmable 'monitor set' section that includes auxiliary sends 1-2, 3-4, 5-6, 7-8; two external stereo line sources and the console's two main stereo output buses. An additional headphone block may be used, which derives its source from any or all of the three monitor sends.

Two, long-throw master faders are included for controlling the output levels of both of the two main stereo mix buses, while a programmable test oscillator and built-in talkback mic can be assigned to any of the auxiliary or mix buses or to an output jack on the audio mainframe or patchbay.

Equalisation

This console deals with equalisation in such a non-traditional manner, that this subject bears a closer examination on its own. Each of Crescendo's I/O strips offers two, programmable 4-band equalisers that can be linked together for stereo operation or assigned to two mono sources. Each section comprises four bands: LF shelving, low-mid parametric, mid-high parametric and HF shelving, and can be activated by pressing either of the EQ attention keys (S1 or S2), which are located within the lower fader block.

Upon pressing either of these keys, the status of frequency, level and bandwidth will appear within the master section's alphanumeric display, while a special MixView feature will graphically display each EQ setting upon the computer monitor. Through the use of the console's keypad, alpha dial and on-screen graphic help menus, the user can easily change EQ parameters with a visual resolution of ¼ dB.

Automation

Crescendo allows for 'all' system/EQ settings, assignments and routings to be saved to or recalled from disk, either dynamically (in realtime to SMPTE/EBU timecode) or as a single snapshot setting. Each of its I/O strips is capable of storing up to 99 individual snapshots, while up to 10 console-wide settings can be instantly recalled at any point within a mix (often a handy tool for making quick scene changes in a complex mix).

Many of the automation features follow standard automation technology by being referenced either to an internal or external timecode source, while fader position displays include the use of null lights for rotary knob and fader controls. Mix updating of any fader or knob is accomplished by simply moving the control to its new desired position. Automated EQ settings, on the other hand, create a novel and fun effect by visually adjusting to their proper settings on the computer screen in realtime.

In closing, this console represents a departure from traditional console design by taking full advantage of digitally-controlled analogue technology. Due to its fresh approach to signal routing and automation, this system would make a unique centerpiece for any music and audio-for-video production facility that is receptive to new concepts in mixing technology. □

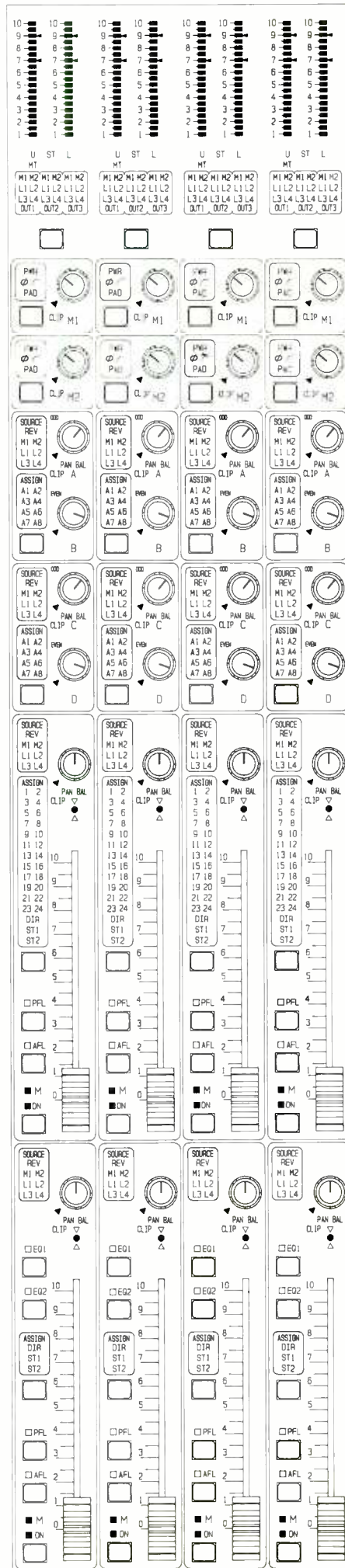

A MEGA NEW STUDIO CONSOLE

(IN EVERY AREA BUT THE PRICE)

THE WORD MEGAS—FROM WHICH THE MODERN WORD 'MEGA' IS DERIVED—MEANS, LITERALLY, 'GREAT'.

AND 'GREAT' IS EXACTLY WHAT OUR NEW MEGAS RANGE OF CONSOLES HAVE BEEN DESIGNED TO BE.

MEGAS IS THE PRODUCT OF BOTH ADVANCED AUDIO DESIGN TECHNOLOGY AND PRACTICAL THOUGHT; COMBINING UP-TO-DATE COMPONENTS WITH MODERN MANUFACTURING METHODS.

THE RESULT IS A RANGE OF LOW COST CONSOLES THAT PROVIDE AN IMPECCABLE DEGREE OF AUDIO QUALITY TOGETHER WITH UNMATCHED STANDARD FACILITIES AND FEATURES.

FOR EXAMPLE, THE MEGAS STUDIO RECORDING CONSOLE IS FITTED WITH MIDI CONTROLLED MUTING AS STANDARD, AND CAN EASILY BE INTERFACED WITH A SEQUENCER TO PROVIDE AUTOMATED MUTES.

THE STUDIO CAN BE SPECIFIED IN EITHER 16 OR

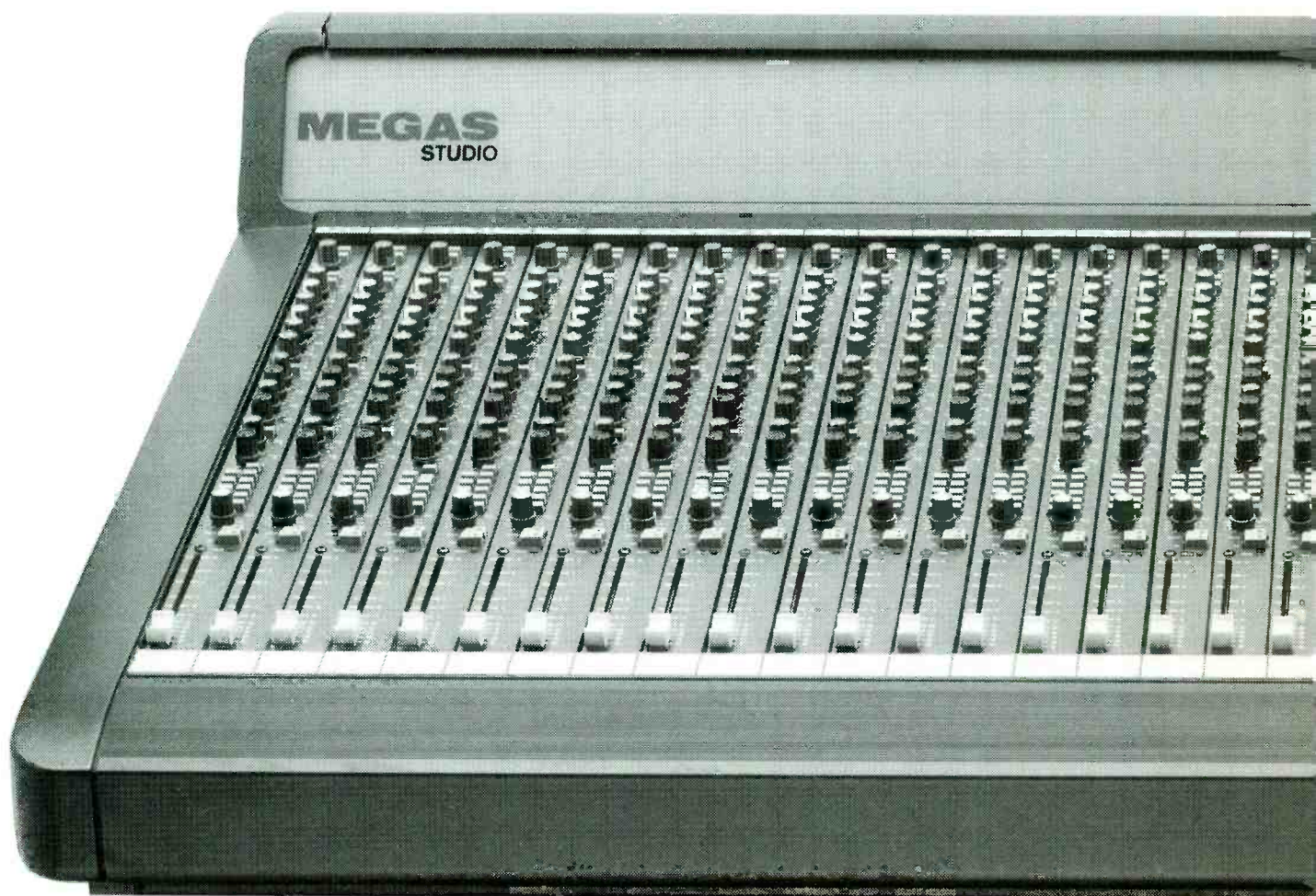

24 GROUP BUSS FORMATS. FOUR DIFFERENT FRAME SIZES CAN ACCOMMODATE A COMBINATION OF MONO OR STEREO INPUT MODULES PLUS UP TO TWELVE DUAL GROUP MODULES, A COMPREHENSIVE MASTER MODULE AND AN INTERNAL PATCHBAY. IN FACT, IT'S EXACTLY THE MIXER THAT YOU NEED IT TO BE.

WE'VE PAID SPECIAL ATTENTION TO AREAS YOU'LL NOTICE VERY QUICKLY.

SUCH AS OUR NEW EQUALISER DESIGN THAT NOT ONLY PROVIDES VERSATILE AND TRANSPARENT CONTROL OF THE AUDIO SIGNAL BUT ALSO SOUNDS, WE THINK YOU'LL AGREE, AS SWEET AS THOSE ON

CONSOLES COSTING MANY TIMES MORE.

AND A REMARKABLE NEW SWITCHING TYPE POWER SUPPLY UNIT THAT OPERATES AT LOW TEMPERATURES FOR HIGHER EFFICIENCY AND FAR GREATER RELIABILITY. EVEN THE HEADPHONE SOCKET HAS BEEN POSITIONED TO BE EASY TO REACH AND YET OUT OF THE WAY.

IN SHORT, THE MEGAS STUDIO IS THE PERFECT SOLUTION FOR THE TWO GREAT PROBLEMS IN LIFE; CREATIVE NECESSITY AND ECONOMIC REALITY.

MEGAS
STUDIO

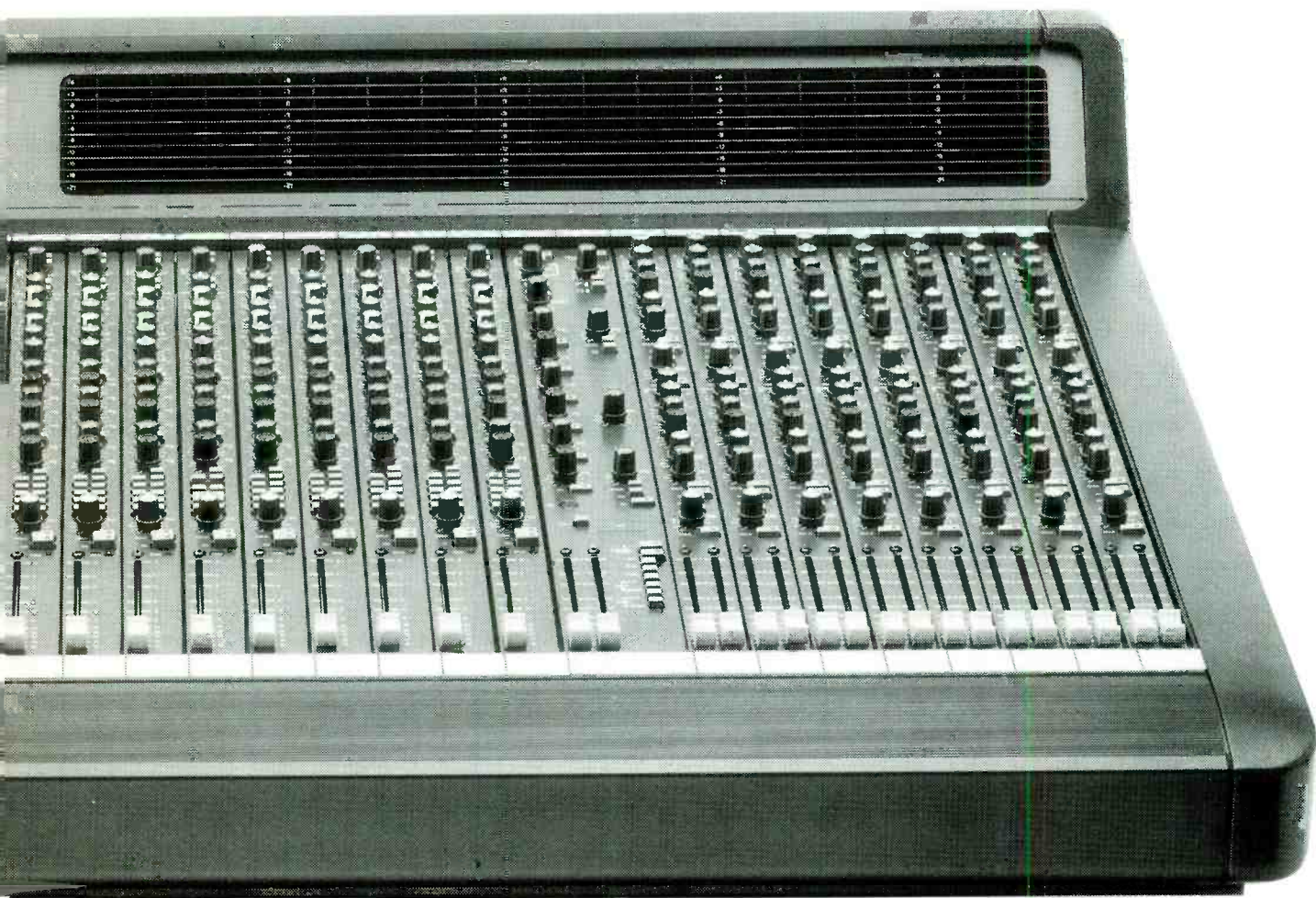

TECHNICAL SPECIFICATIONS: NOISE -127.5db , CROSSTALK $>90\text{db}$, CHANNEL MUTING $>90\text{db}$, INTERCHANNEL $>80\text{db}$.

ADAPTIVE DIGITAL FILTERING

An effective device for filtering out unwanted background noises is described by Francis Rumsey

The power of digital signal processing (DSP) is the factor most likely to influence audio product development over the next 10 years. A striking example of this power is displayed in a product from Californian company Adaptive Digital Systems, which has the ability to filter out complex signals from wanted signals in realtime, constantly adapting the filter characteristic to match the nature of the unwanted signal. This technology has only recently been declassified in the US from the list of 'things we don't talk about' and its potential is truly amazing.

What is it?

A digital filter (from the audio engineer's point-of-view) is a device that, by means of delay and

mathematical manipulation of digitised signals, can perform operations such as equalisation and various other effects in the digital domain. The complexity of the filter is governed by the number of 'taps' involved, that is the number of stages of delay and coefficient multiplication the signal is subject to, and thus a filter with many taps can be given a much more detailed characteristic than one with few taps. A multitap filter could introduce sharp notches into the frequency spectrum at a number of discrete frequencies, thus removing a signal with energy at those frequencies.

Most real audio signals are not static, they are changing and even if they are nominally static may drift slightly in speed or relative phase when compared with a static reference. Thus a filter tuned to remove an unwanted signal might be correct one moment and not the next. The

simplest example would be the removal of an unwanted tone from a recording. The tone is a fairly predictable entity and provided its frequency and phase were to remain constant, then a notch at the right frequency might be adequate to remove it. But what would happen in the case of a more complicated unwanted signal such as timecode crosstalk or, to go further, perhaps speech crosstalk from another channel or the noise of a nearby motorway on the pickup of an outside broadcast microphone? In such cases the nature of the unwanted signal would be much more difficult to predict and in order to filter it out the characteristic of the filter would have to be controlled to change so as to match the characteristic of the signal. And further, to remove the noise without also removing most of the useful signal as well would be a tall order.

This is where the adaptive digital filter comes in, since an adaptive digital filter is designed to adjust its characteristics to the nature of the unwanted signal, constantly changing its coefficients and updating the positions and depths, phases and bandwidths of the various notches. By doing this, provided the filter has enough taps, it is possible to adapt the filter to remove virtually any changing signal from the wanted signal, including noises and speech but it is at its most effective when provided with a reference signal containing the unwanted component. It then looks for correlations between the reference and the unwanted component in the main signal, adapting the filter characteristic so as to remove the appropriate elements. It does this continuously, in realtime, updating its correlation process many thousands of times a second, and each update requires a large number of calculations. This is now possible to achieve without a room full of supercomputers, thanks to low-cost DSP chips such as the Motorola 56000 and its offspring, capable of many Million Instructions Per Second (MIPS).

A real product

The Adaptive Digital Systems product, distributed in the UK by SSE, is currently a 7.5 kHz bandwidth system designed to handle one channel of audio plus a reference but by the time this article has been published there will also be a broadcast-orientated version capable of 15 kHz bandwidth, and accepting two audio channels plus two references or one audio channel and three references. It involves some frighteningly powerful processing, using no less than 17 DSP chips, each capable of 13.5 MIPS. The current model has 4,000 taps and is based on linear-phase FIR filters. It can operate with a reference signal, in which case it is extremely effective at removing all sorts of noises from a wanted programme, or without a reference, in which case it must search for repetitive elements in the signal's time domain (representing say a tone or a hum) and allow the user to freeze the autocorrelation process at a point where the adaptive filter has 'homed-in' on the unwanted signal before it starts to remove wanted portions of the signal as well.

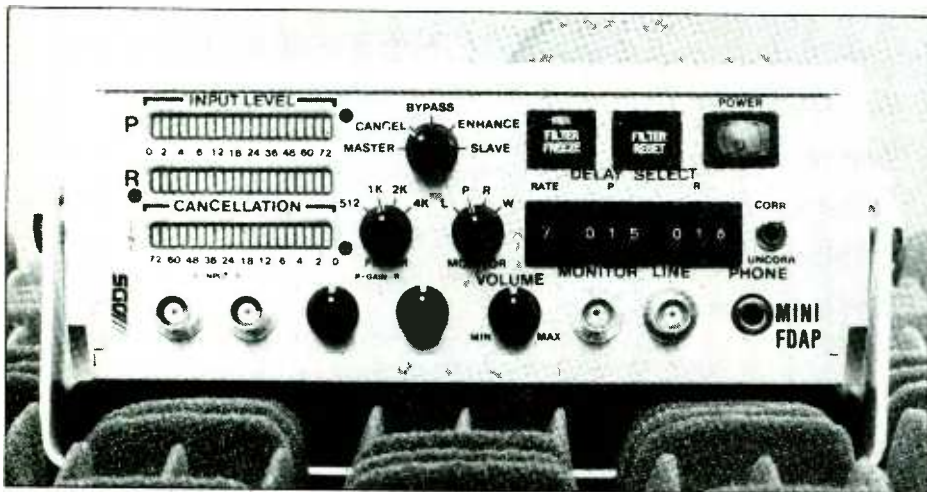

PPM5

20 PIN DUAL IN LINE HYBRID

Consumption 3mA.
Fully meets BS5428-9

SURREY ELECTRONICS LTD.
THE FORGE,
LUCKS GREEN,
SURREY GU6 7BG
Tel: 0483 275997
Fax: 0483 276477

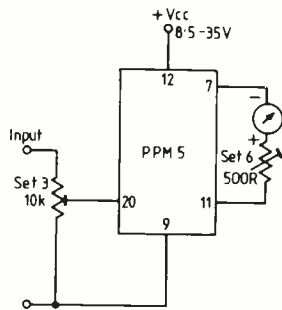

APRS STAND 001

Demonstrations showed that it was capable of removing such complex interference as cockpit noise and pilot communications superimposed on a wanted signal, when provided with a reference input containing the noise. It was also able to remove high-level buzzes and hums to varying degrees without a reference input, by slowing down the rate at which the filter adapted and allowing the user to freeze the filter characteristic at the point where it had sucked out as much of the buzz as possible without sucking out wanted components. It is possible to listen to both the 'correlated' and 'uncorrelated' outputs, in order to freeze the filter by listening to what has been sucked out, rather than what is left. Cancellation can be to depths of 70 to 80 dB when a reference signal is available.

The rate at which the filter adapts can be varied and at the fastest rate can become unstable but will follow very fast changes in the signal. It takes longer to correlate on high frequency signals than on LF signals, since these involve more rapidly-changing elements and more processing time. Furthermore, the delay between the reference and the principal signal may be varied to allow for better cancellation in certain operational circumstances where the unwanted component is slightly delayed (such as in broadcast comms circuits or for the cancellation of echoes).

Applications

There are 1,001 applications that may be imagined for such a device in sound recording and broadcasting, not to mention the value of such systems in surveillance operations and communications. In music recording it would be possible to remove serious crosstalk between tracks of a tape by taking as a reference the track responsible for the unwanted signal and processing the output from the track onto which the crosstalk had taken place; or perhaps one could remove unwanted spill from one channel to another by taking as a reference the mic output of the source of the spill against which to process the channel it was spilling onto.

In broadcast environments the filter could be used for removing traffic noise from outside broadcast pickup, by feeding the reference input with a microphone picking up surrounding traffic noise while the principal signal would contain the intended source plus the traffic noise. This would be invaluable when trying to pick up usable sound in difficult locations.

Other applications can be envisaged such as the removal of delayed foldback of his own voice to a commentator after having passed via a digital communications link leaving only the programme without the commentary to avoid confusion. Timecode crosstalk could be cancelled, as could thyristor dimmer interference and other such complex signals which are normally difficult to remove. Echoes resulting from satellite links could be cancelled using the delay facility.

Detailed tests have yet to be performed by potential users on high quality audio signals such

as music, since the broadcast version is only now due to be released for assessment in this country, and thus one cannot say for certain what subtle effects the filtering of complex interference will have on the sound of the remaining material but equally it should be said that the removal of interference is probably more important than the minor side effects of that removal on the remaining signal. The extent of side effects depends principally on how much the filter is being asked to do, and the more complicated and unpredictable the noise to be removed the more likelihood there would be of affecting the

programme as well, since the filter takes a finite time to adapt to the nature of the interference. Initial tests using the 7.5 kHz version show that impulsive noises, such as hammering, are much more difficult to filter without affecting the programme than more predictable noises, as one might expect.

The cost of such a device might be expected to be extremely high, but happily the prices begin at around £1 (\$2.00) per kHz of bandwidth. □

Adaptive Digital Systems, Irvine, CA, USA.
Europe: SSE Marketing, London. Tel: 071-387 1262. Fax: 071-388 0339.

DASS 100 keeps digital audio signals in the digital domain and is essential for transferring between different pieces of professional audio and video equipment.

DIGITAL AUDIO RESEARCH



DIGITAL AUDIO RESEARCH LIMITED

2 SILVERGLADE BUSINESS PARK · LEATHERHEAD ROAD
 CHESSINGTON · SURREY KT9 2QL · ENGLAND
 TELEPHONE (0372) 742848 · FAX (0372) 743532

AMEK Classic – the worldwide standard in broadcast audio consoles

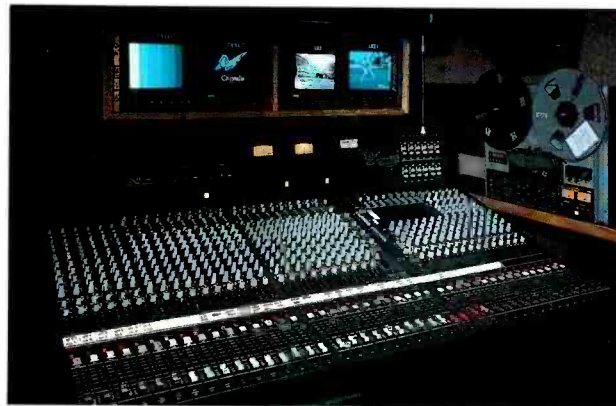

Chrysalis Television is among the UK's leading independent production companies. When building mobiles 3 & 4, they had special requirements for the audio consoles. This is what Steve Riley, Director, has to say: "We looked long and hard for a sound console that offered as many facilities as possible in a compact, reliable, robust and well-priced unit. All of these were met by the AMEK

'CLASSIC'. After nearly three years of service we know that we made the right choice. The 'CLASSIC' is an excellent desk."

Chrysalis are not alone in their choice. Major broadcast producers worldwide have chosen the CLASSIC, often in multiple installations. Flexibility, versatility, performance and reliability are the keynote of this leading audio system.



Head Office, Factory and Sales: AMEK Systems and Controls Ltd., New Islington Mill, Regent Trading Estate, Oldfield Road, Salford M5 4SX, England. Telephone: 061-834 6747. Telex: 668127. Fax: 061- 834 0593.

AMEK/TAC US Operations: 10815 Burbank Blvd. North Hollywood, CA 91601.
Telephone: 818/508 9788. Fax: 818/508 8619.

Users worldwide include:

- ▶ ABC, New York
- ▶ ANAND, Bombay
- ▶ BBC
- ▶ CENTRAL TV
- ▶ FILMS DU ROND POINT, Paris
- ▶ GRANADA TV
- ▶ HTV
- ▶ KRATKY FILM, Prague
- ▶ LIMEHOUSE
- ▶ MAINOS TV, Finland.
- ▶ NIHON KOGAKUIN, Tokyo
- ▶ NORDISK FILM, Copenhagen
- ▶ MOLINARE
- ▶ PARIS STUDIOS BILLANCOURT
- ▶ PARIS CONSERVATOIRE
- ▶ GREAT HALL OF THE PEOPLE, Beijing
- ▶ POINT 12, Paris
- ▶ RTM, Kuala Lumpur
- ▶ SKY TV
- ▶ STUDIO L'EQUIPE, Brussels
- ▶ TV NZ, Auckland
- ▶ TV2, Denmark
- ▶ TURNER BROADCASTING SYSTEMS, Atlanta
- ▶ WFO FILM, Warsaw

Economic conditions are currently less than favourable in central London and several facilities have recently decided that high overheads and slow business spells the end of sound recording in Soho.

Not so producer Mark St John, who has named his new music recording studio after its Soho address, 145 Wardour Street. He believes the area's historic connections with the music business still make Soho the place to be. "Soho is a more rock and roll place than East Ham or Chiswick" he says.

It is also one of the most expensive locations in London and St John acknowledges that it is easy to dismiss the capital investment a studio represents as 'economic suicide', when nearby properties are turned over to short term office accommodation, high end retail and other quick turnover enterprises.

But 30-odd years of rock'n'roll history gives a place a certain 'vibe' says St John, who cites Studio 2 at Abbey Road and the large room at Olympic pre-refit, as examples. Although 145 Wardour Street has now been open a few months, it had been a library music and jingles studio for many years.

Despite a complete refit, it has a certain 'lived in' quality, which has been cultivated with soft furnishings, patterned material and carefully considered lighting. There is no natural light as control room and studio floor are in the basement of the building, so a flexible lighting system has been fitted which can be adjusted to suit the time of day. "There is plenty of light because, when it is day outside, I want to be able to feel it actually is day. I spend most of my life in studios and they never seem to have enough light," St John explains.

In addition, it was decided that the studio should "definitely be somewhere with an identity of its own". There is no doubt that 145 has achieved this objective. Whether standing in the pink reception area on the ground floor, with its jukebox and Fifties plastic bar, or sitting within the curious hybrid of Asian and Victoriana that is the control room, there is little chance of the visitor mistaking the surroundings for any other studio.

The decor is a reaction to the 'hi-tech and hessian' approach that many facilities adopt. Patterned fabric was chosen for the control room so that it would 'feel like a proper room'.

Design and construction was undertaken in-house by maintenance engineer Dennis King and chief engineer Dave Garland. King's career started at the IBC in 1947, while Garland has worked with St John for many years and trained as a 'real engineer' in the days when 'MIDI' was something to do with the length of ladies skirts.

"We all have enough years in the job to know the difference between a good room and a bad room, without spending £1.5 million to get someone to fit a motorised revolving polystyrene paddle on the side of the wall." In St John's somewhat idiosyncratic analysis, "some of the finest rooms in the country" predate modern acoustic analysers. "That isn't to say that we weren't careful about it but it was based more on common sense than uncommon nonsense."

Common sense also dictated that expensive studio space should be used efficiently. The medium sized control room provides a comfortable working space and has a sofa at the rear of the room, while the live room at around 70 m² is large enough for the majority of applications in contemporary music. The space beneath the stairs houses two small booths. One of these houses a bass rig and the other a hot rodded Leslie

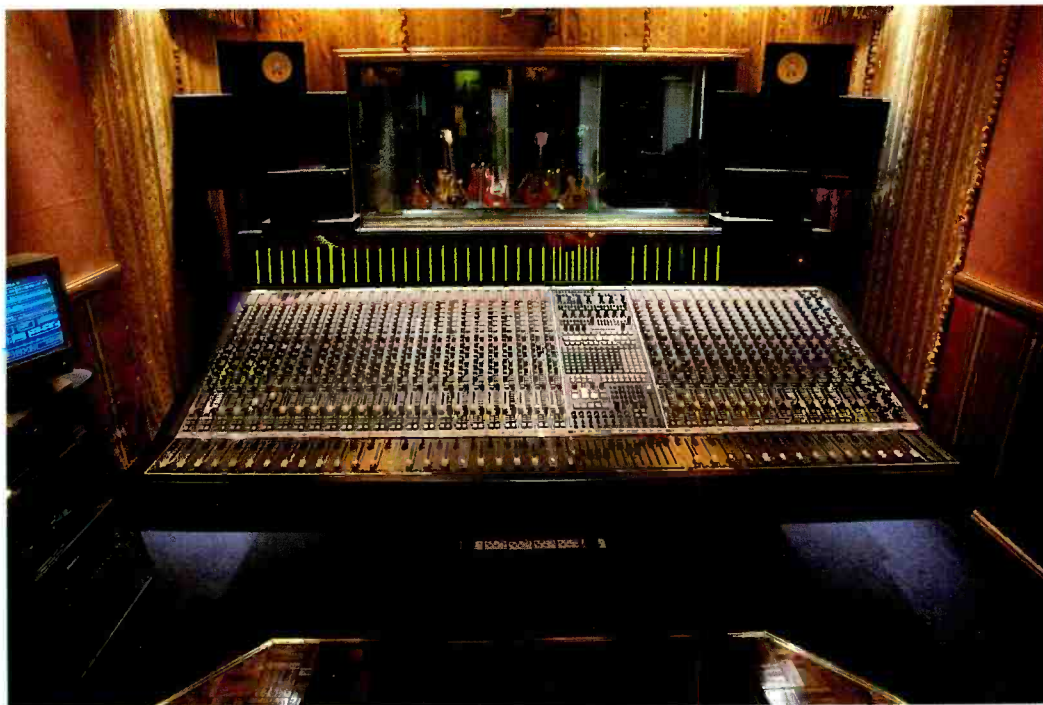

145 WARDOUR ST

London's newest rock'n'roll studio is bucking all the trends. Simon Croft reports

cabinet. Two floors up, in St John's office, Steve Winwood's old Hammond organ and a pair of JBL monitors can be found. Most of the rooms in the buildings are tie-lined.

Vintage kit is something of a 145 speciality. The place is stacked with vintage and unusual guitars, including Bill Wyman's Burns bass, a 1957 Fender *Stratocaster* and plenty of less common brands like Silvertone. Similarly, the combined microphone collections of King, Garland and St John add up to around 100 units, including *U87s*, *C28s*, *KM84s*, *STC* ribbons and a Calrec *Soundfield*, with the early type matrix box.

In conjunction with the medium live studio, Garland and St John find they can get exactly what they want from a drum kit, a big sound but plenty of control. The studio is currently experimenting with a set of prototype King-built mic preamps but otherwise, sources go straight into the Trident *Vector* console, a desk which has totally lived up to the studio's high expectations.

"This is the fourth Trident I've had and it's the third time that I've had one of the new breed," St John explains. Aside from positive past experiences, St John was attracted by the promise of excellent sonic performance, particularly the equalisation, and a comprehensive automation/machine control system.

Equally important for a studio that intended to attract US clients was the standing Trident has in America. St John reckons that "probably 80 percent" of records in the US top 100 are tracked on Trident consoles. In contrast, some consoles the studio considered were rejected on the basis that they were virtually unknown in the US. As part of publishing house Golden Songs and record label Golden Records, 145 Wardour Street gets some of its work from in-house projects. But around 50% comes from outside, so the reaction of potential clients to the facility was very important.

St John says the decision has already proven successful, with the studio achieving a high level of US clients despite the strength of sterling over the dollar potentially blunting the studio's competitive edge.

"A good 40% of the work we have had in here has been US-based," he claims. Customers include Rick Browdy (Poison's producer), who was due to do a couple of days on backing tracks with The Wild Hearts and apparently spent a complete week mixing.

"That really hammered the automation side because Dave had to sync up all sorts of disparate formats in order to provide usable front of house masters and cues," St John observes.

At the other end of the spectrum, the studio also undertakes more MIDI-based work, such as commercials and sound-to-picture, for which it keeps equipment like an Akai 950 sampler with library and Steinberg Pro-24/Cubase. Even the grand piano has a MIDI out, although St John's lip curls slightly as he mentions it.

The Trident automation is well equipped to deal with live and MIDI-based sessions. On the utilities menu, along with the ability to back up on 5.25 or 3.5 inch disks, there are neat touches like a tempo and offset calculator.

The offline menu has beat map, for logging tempo changes and the location of choruses and so on, when a MIDI sequencer is locked to the Trident computer.

Providing the location of cue points (in terms of beats and bars or timecode) is known beforehand, cue list management can be performed offline on any IBM PC compatible or a remote terminal linked to the Trident computer, even while it is still handling an online session.

Suffice to say, sophisticated autolocate with user definable pre-roll is also included, along with automated drop-in facility. One modification made at Garland's request was that manual drop-ins are automatically logged, so that in and out points made on the fly can be repeated if desired. At the other extreme, the automation will run quite happily without seeing timecode from tape, if sequencer-only mixing is required.

Garland was especially impressed that he suggested the drop-in modification to Trident software writer Mike King at 10.30 one evening and arrived the next morning to find it had been implemented!

According to St John, it is the "great relationship" 145 has with Trident that persuades him to hold back on fader



Parametric Equalisation

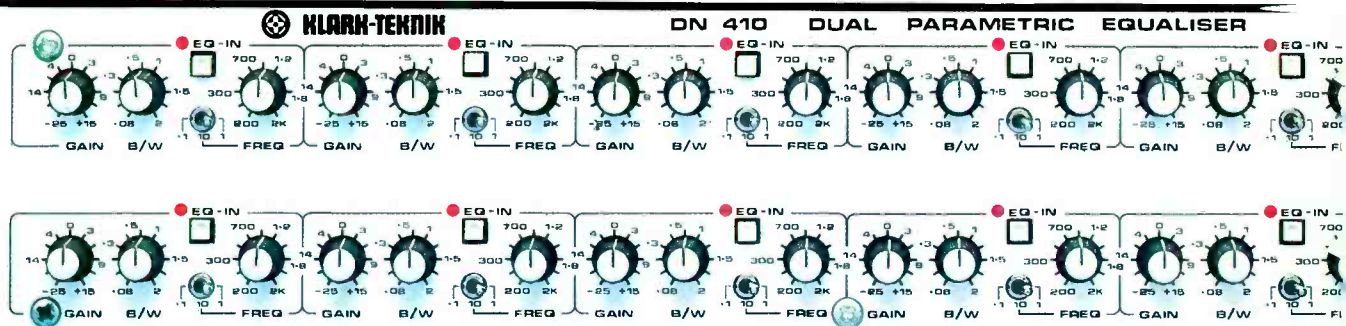

Klark-Teknik Research Limited Klark Industrial Park, Walter Nash Road, Kidderminster, Worcestershire DY11 7JJ, England. Tel: (0562) 741515 Telex: 339821 KLARTK G Fax No: (0562) 745371



automation. At present, a number of third party systems are available but St John would prefer to wait for the system Trident itself is developing.

On the subject of mixing, it is worth mentioning the monitoring situation. Like many medium sized contemporary studios, 145 uses free standing main monitors, usually a pair of Westlakes. But it has also been evaluating a pair of Genelecs and may also try ATC. This is not simply indecision. The studio keeps a range of monitors in order to meet client preferences and the selection includes small Tannoys, ARs and NS10s.

Outboard selection is similarly generous, with dynamic devices from the valve, transistor and IC generations. Alongside classics like the Urei 1176 are the rarer Pye compressors and the downright obscure Eventide *Omnipressor*. On the other side of the rack, there is a choice of long delay AMSs, reverbs including *RMX-16*, *224* and even an EMT gold foil plate.

Out in the machine room, the Otari *MTR-90* 24-track competes for space with 1/2 inch and 1/4 inch MCI half tracks, as well as Sony and Tascam DAT recorders.

On the floor above, there is a tape editing and real-time multi-machine cassette copying facility, which manages to co-exist with the outer entrance and catering and shower area. With its tape editing facilities and its odd bits of Fifties kitsch, there is something slightly old fashioned about 145 Wardour Street, albeit in the same mutated way that pop music brings back old ideas in new forms.

"In my view, the particular value of this place is that unlike a lot of new studios it has not been born out of a home studio development," says St John. "It has been born from a long term view of the degree of expertise necessary to make high quality recordings, without too much concern over what is the gimmick of the moment.

"It is about recording as a discrete element which allows people working together on a piece of music to capture a great performance. Through the profile of the publishing, record label and studio activities, I want to see Sun Records and Tamla Motown come to Wardour Street."

145 Wardour Street
London, W1. Tel: 071-734 1011.

....DN410 – The Universal Equaliser

Unprecedented control – with ten *universal* parametric filters, each capable of performing the full range of notch filter and broadband, functions *anywhere* 20Hz to 20kHz.

Outstanding audio quality – carefully designed for minimal distortion and lowest noise, the DN410 re-affirms Klark-Teknik's reputation for sonic excellence.

Professional features – with low and high cut filters, dual/mono mode select, fail-safe bypass and a choice of termination standards, the DN410 is thoroughly engineered – to suit your application.

Klark-Teknik reliability – designed-in from initial concept, the Series 400 parametrics feature quality assurance in the best traditions of Klark-Teknik.



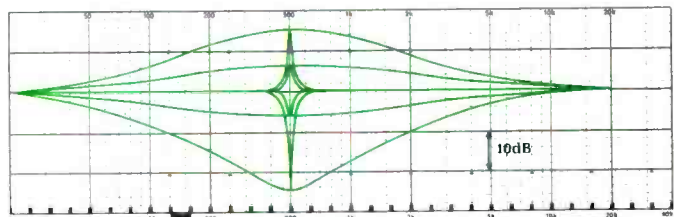

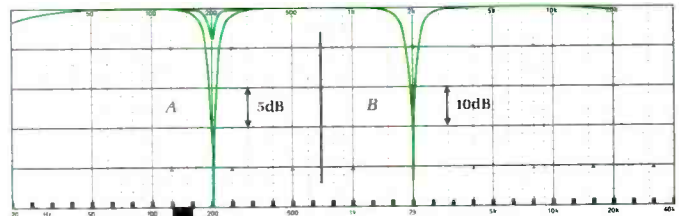

 Parametric



 Notching
A. Single filter
B. Two filters



The DN410...Specifications

	Frequency response (20Hz-20kHz)	±0.5dB
	Distortion @ +4dBm	<0.01% @ 1kHz
	Equivalent input noise (20Hz-20kHz unweighted)	<-90dBm
	Channel separation	>75dB @ 1kHz
	Filter bandwidth	Variable from 1/2 to 2 octaves
	Maximum boost/cut	+15 to -25dB
	Maximum output level	+22dBm

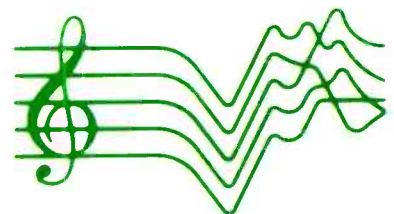

EQUALISATION

KLARK TEKNIK

The first name with sound system designers

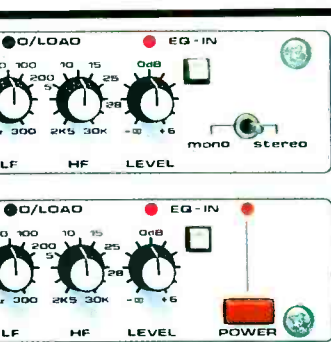

Klark-Teknik Electronics Inc. 200 Sea Lane, Farmingdale NY11735. Tel: 516 249 3660 Fax: 516 420 1863

Klark-Teknik (Singapore) Pte Ltd. 7500A Beach Road, 05-305 The Plaza, Singapore 0719. Tel: 293 9736 Fax: 293 9738

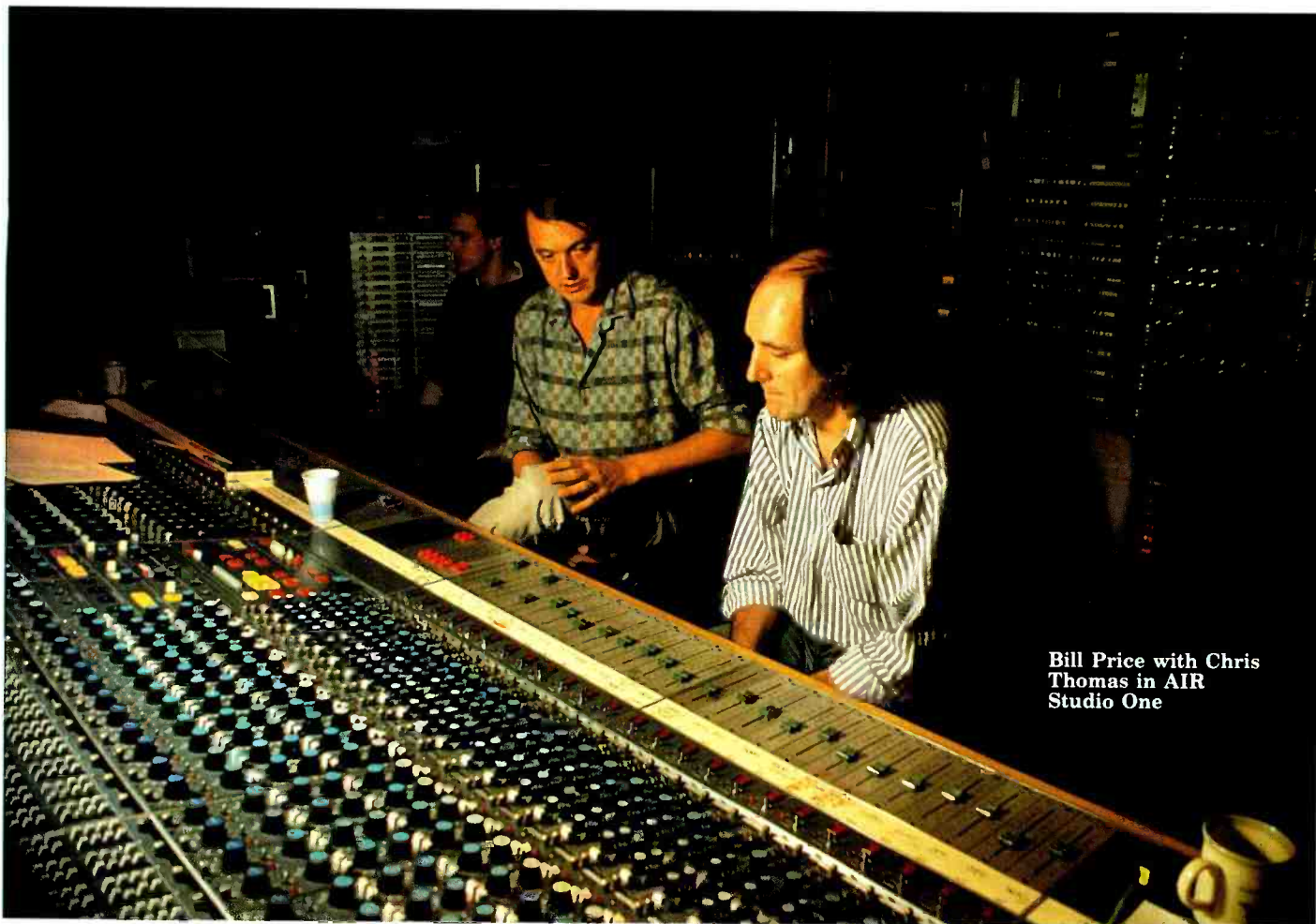

Bill Price with Chris Thomas in AIR Studio One

BILL PRICE / 2

Bill Price has engineered and produced most styles of popular music during his career. Here he continues his conversation with Ralph Denyer

During the period 1970 to '75 when Bill Price was chief engineer at Air Studios he engineered a substantial percentage of Chris Thomas's productions and they have subsequently worked together on many albums. Price has also worked there with other top producers, such as George Martin and Mutt Lange, as well as many clients, including Pink Floyd, ELO, Stevie Wonder and Paul McCartney.

By 1975 Air was well established as one of Europe's foremost recording complexes and changes were on the horizon for Price, as he explains: "I saw through the period when Air became part of the Chrysalis Group and almost simultaneously Chrysalis purchased Wessex Studios. They wanted me to move from being chief engineer at Air to being studio manager at Wessex, which I was very keen on doing. So I moved across, redesigned it, re-equipped the studio to a certain extent, and put it back on the market, which all went very successfully.

"In their wisdom Chrysalis made me managing director and put me on the board of Wessex Sound Ltd. That meant that finally with the

studio on the road, so to speak, I could then go back to devoting more of my time to my career as an engineer and subsequently as a producer. I put in a manager to look after the day-to-day running of the studio, which initially I did for the first couple of years but that wasn't something I was prepared to do on a long term basis. So I still retain overall control as managing director. My main responsibility at Wessex now is to ensure there are no difficulties being experienced by specific clients, to attempt to plan for the future and to ensure the equipment is kept up to spec, making sure the maintenance is carried out well and that sort of thing."

Joyce Moore, previously a studio manager at Wessex, now manages Bill's production and freelance engineering activities. Currently about half of his time in the studio is devoted to mixing and remix projects, and half to projects that he records, mixes and co-produces with the artist.

"Joyce sends me the cassettes and I put all the songs I like in one pile and all the ones I don't in another pile and hopefully I only get involved in working with the music I like. In my earlier days

I spent a lot of my time working on music I found totally loathsome. But I must admit I don't find that too much of a problem. I can keep myself perfectly happy by just sitting listening to a hi-hat on a session. You can get quite a lot of pleasure from a hi-hat even if you don't like the song."

Two bands whose demo tapes recently ended up in the pile Price most definitely liked were RIPLA and Nymph. "At the moment I've been working with RIPLA, which stands for 'Rest In Peace Los Angeles'. They're an English band signed to EMI who have yet to have a release and we're working on an album at Wessex and Air. I don't like to describe them in terms of other bands. They're very rocky, slightly Stones-ey, with a very big sounding lead singer so they're very exciting. Although they play very stagey rock'n'roll they're children of the 'Portastudio' generation. They've made demos that are astounding actually. They sound like live recordings of a huge rock band whereas it's just them and a *Portastudio* in their living room. It's quite an interesting merging of the modern technology bands use nowadays and absolutely straight rock music as opposed to dance music or the music normally recorded with that equipment.

"The situation with Nymph, whom I've been recording in Los Angeles, is the exact opposite. I don't usually record in America but they're an American band signed to Geffen Records and it wasn't practical for them to come to London. They're a fairly heavy rock band with a girl singer and they're quite popular in Los Angeles. This is their first album. I think they had a 3-track indie release about a year ago. I've been recording them at Ocean Way Studios in Hollywood, which is very interesting because I don't think there is any equipment there built



after 1979. It's all quite old; antique desks and Ampex ATR 124 machines. The place is bristling with old equipment and they've got the biggest collection of valve Neumann mics I've ever seen in my life. They've got a cupboard full of '50s 47s, 48s, 49s, 67s, 251s and the lot!"

Price says that before a production deal is set up he is careful to ensure that he has the appropriate skills for the project. "To be a full producer nowadays I think one needs not only to be a competent musician but one needs to be competent at executing original musical ideas in the style of the artist you're attempting to record. I don't consider myself 100% producer because I'm not capable of doing that. So if I co-produce with a band, I make sure they don't have any musical grey areas which are preventing them achieving what they want. There are situations when you get people that 60% of what they've got to offer is brilliant but they are incapable of getting really close musically to what they should be doing.

"And it is a jolly good idea if they have a fifth or sixth member who is their producer who can write some lyrics, play keyboards or arrange their vocal harmonies for them, and that's the full job of a producer. Now quite a few bands don't want that. Possibly a problem is that some producers who are capable of doing that will leap in with both feet and do it with people who don't want it done to their music. Hence the sort of bands I've often worked with have sometimes suffered that experience and certainly don't need or want somebody to do that to their music. Then I can fit the bill.

"So if somebody wants me to be involved with a production, I have to make sure that they are not looking for a producer who can write, arrange and play keyboards or something in order to fill a gap that is missing in their musical vocabulary. Obviously anybody can sit in a control room and say if something is in time or in tune. That's not a particularly difficult point. But what one has to do is think of musical ideas and hope the band one's working with is capable of executing them, which obviously if none of the band are, a lot of producers do themselves."

With such a wealth of experience, Bill's knowledge of the technical side of recording is phenomenal. Yet he always emphasises the primary importance of the engineer and producer not allowing their quest for optimum technical results to interfere with the artist's performance.

"I've been involved in recording for more than

25 years and I've tried lots of ways of doing things. The only advice I ever give to young engineers is there isn't really a best way of doing things because you've got to treat different singers, bands and makes of guitars differently and you just have to have an armoury of techniques so that you can choose the appropriate weapon for a particular problem.

"For instance if I am recording a singer I have never recorded before what I'll normally do is arrange maybe between three and five microphones in front of their face and hopefully, if I have got enough tracks, I'll record a run through of the song with each mic on a separate track."

"And sometimes I come up with the most peculiar selection of vocal mic, not because I've got a particular preference for that mic, it's just that I've just tried it and it sounds good on that singer's voice. I would consider it absolutely unforgivable to have someone sing for 2 hours before you've chosen the right microphone. Even if they haven't physically lost their voice they're not going to be capable of singing the song with any enthusiasm any more. If you can make use of the first one or two run-throughs of a song, then you can get an idea of how you should record that singer. If someone is singing their heart out you should be recording it.

"It helps if you are working on slave tapes or 32- or 48-track digital. Then you might have half-a-dozen tracks free so you can range up all the different microphones. Sure enough, a U47 often does sound good on a lot of people's vocals. But for instance, all the Johnny Rotten vocals I've ever recorded on Sex Pistols' records were done using an SM58 because that happened to get across Johnny's sort of spitting style the best whereas a U47 or something of that nature would just have been destroyed by what he was doing. It would sound like he was singing through a sock. So actually I would give him a stage microphone and let him wave it around and record that."

Price recalled an engineer who was very impressed with the vocal sound he achieved with Chrissie Hynde on some Pretenders recordings being quite astounded to hear a Neumann U87 had been used. "He said he thought U87s sounded horrible on vocals. Nine times out of 10 they do but in this case it really suited Chrissie's voice. The same thing with Pete Townshend. It was some time ago but I think I used a KM89 on Pete's voice, which is not a very often used

FOR SOUND ADVICE, LISTEN TO US...

With many years of sound experience behind us, we can help you devise the best equipment mix for your production, whatever or wherever it may be.

Our rental stock is both extensive and reliable, as is the knowledge and skill of our production managers and engineers.

To hear more, call us on (081) 575 5555, or fax (081) 575 0105.

**THEATRE
PROJECTS**

Theatre Projects Services Ltd
20-22 Fairway Drive
Greenford
Middlesex UB6 8PW

A MEMBER OF THE LIGHTING AND SOUND
DIVISION OF SAMUELSON GROUP PLC

M.S. AUDIO

EUROPE'S LEADING SPECIALIST IN USED PRO-AUDIO EQUIPMENT

NEW YEAR BARGAINS AT M.S. AUDIO

LYREC 532, 24 track. Auto/remote. This machine has undergone a full major overhaul in the last 6 months costing £4000.00 including new Lyrec heads. **Bargain Price: £5,750.00**

LYREC 532, 24 track. 16 memory autolocator. 6500 hours. Private use only. Excellent condition. **Bargain Price: £5,000.00**

SOUNDCRAFT 760 MKIII 16 track 2" Remote. Very low hours. Immaculate. **Bargain Price: £4,000.00**

TASCAM MSR24 1" 24 track. Genuine Ex Demo. **Bargain Price: £4,995.00**

KLARK TEKNIK DN780 reverb. **Bargain Price: £995.00**

LEXICON 200 Immaculate. **Bargain Price: £1,150.00**

SCAMP equipment including racks/ S01, S03, S04. £300. S100 modules. **Phone for Bargain Prices.**

TASCAM MS16 1" 16 track in console with N/R. autolocator and stand. Private use only. **Bargain Price: £3,000.00**

BARGAIN AMPLIFIERS: Harrison Xi1000 new. **£650.00**, Harrison Xi300 new. **£400.00**, Citronic PFX 450 ex-demo. **£475.00**, Citronic PFX 900 ex-demo. **£590.00**.

**RING NOW
ON
(0932)
872672/874768
FOR MONTHLY
MAILSHOT**



NORTH LODGE, STONEHILL ROAD, OTTERSHAW, SURREY KT16 0AQ.
TEL: 0932 872672. INTERNATIONAL + 44 932 872672
FAX: 44 (0) 932 874364

MASTERING MACHINES

* Please telephone for complete list of mastering machines including:
OTARI MX55, 1/4" with CTC 15/30 ips. As new. **£2,750.00**
STUDER A80-VU, 1/4" 15/30 ips. Very low hours. **£2,250.00**
SONY DIC1000ES, Dat. Ex Demo. 2 machines available. **£875.00 each**

OUTBOARD EQUIPMENT

Our comprehensive selection of outboard equipment includes:

LEXICON 480L, Version 3 software. **£4,995.00**
LEXICON 224 with remote. **£2,250.00**
LEXICON PCM70. **£1,050.00**
AMS RMX16. **£2,150.00**
ROLAND SDE2000. **£275.00**
YAMAHA Q2031 GRAPHIC. **£275.00**
URSA MAJOR 551-282 Space Station. **£300.00**

MIXING CONSOLES

SSL 4056E, 48 channel. G Series computer. Patchbay/Producers desk. Excellent condition. **£P.O.A.**
SSL 4048E, 48 channel. G Series computer. Patchbay/producers desk. Immaculate. **£95,000.00**
SSL 6048E, 48 channel. G Series computer. Total recall. Patchbay/producers desk. Immaculate. **£P.O.A.**
SSL 4040E, 40 channel. G Series computer. Total recall. Patchbay/producers desk. Immaculate. **£P.O.A.**
NEVE V3, 60 frame. 60 channel. Nevecam 96 automation. V.G.C. **£P.O.A.**
NEVE 8108, 48 channel. Nevecam 96 automation. Available immediately. **£P.O.A.**

* Please telephone for selection of small and broadcast Neve consoles *

TRIDENT DI-AN, 40 frame. 40 channel. Reflex automation. Currently on demonstration at M.S. Audio. **£69,000.00**

TRIDENT Series 80C, 32 frame. 32 channel. Optifile 11 HD automation. **£23,500.00**

AMEK MOZART, 56 frame. 48 channel. Supertrue automation. Immaculate. **£48,000.00**

AMEK G2520, 40 frame. 40 channel. Mastermix 1 automation. V.G.C. **£45,000.00**

SOUNDTRACS ERIC, 56 frame. 56 channel. 40 channels of Tracmix automation. Immaculate. **£42,000.00**

SOUNDCRAFT 1S24, 48 frame. 48 channel. with automation. V.G.C. **£P.O.A.**

DDA AMR24, 36 frame. 36 channel. Immaculate condition. **£25,500.00**

DDA AMR44, 44 frame. 44 channel. Immaculate condition. **£40,000.00**

MCI 600 SERIES, 36 frame. 32 channel. Patchbay. Complete recent refurbishment. Absolutely immaculate. **£114,000.00**

24/32 TRACK MACHINES

STUDER A827, with auto/remote. New machine. Cancelled order. **£23,500.00**

STUDER A820, with auto/remote. Private use. Under 1000 hours. **£P.O.A.**

STUDER A800 MKIII, with auto/remote. Low hours. Excellent condition. **£22,000.00**

STUDER A80 MKIII, with auto/remote. Low hours. Ex. cond. **£12,950.00**

OTARI MTR90 MKII, with autolocator. Low hours. V.G.C. **£15,950.00**

MITSUBISHI X850, Low hours with remote. 2 machines available immediately. Excellent condition. **From £55,000.00**

SONY 3324, with 3310 remote. Excellent condition. **£P.O.A.**

OTARI DTR900, 32 track digital. Auto/remote. Excellent condition. **£P.O.A.**

* Please telephone for additional list of multitrack machines *

VIEWING BY APPOINTMENT ONLY ALL PRICES SUBJECT TO VAT

**ALWAYS
A
GREAT
DEAL
ON
OFFER.**

**IF YOU DON'T SEE
WHAT YOU WANT
PLEASE RING
MIKE OR JENNY**

ONLY BLACK & WHITE CAN DO JUSTICE TO A COLOURLESS MONITOR...

We could have shown you the MONITOR ONE REFERENCE in glorious colour. We could have written reams about the fact that many consider it to be the most accurate and impressive mid/near-field monitor speaker they have heard. Instead, we decided you'd probably prefer to judge them for yourself, so call your local distributor to arrange an audition and hear the truth in black & white.

MONITOR TECHNOLOGY

P.O. Box 1102, Nedergade 35 C
DK-5100 Odense C, Denmark
Phone: +45 6613 9981 / +45 6614 5958
Fax: +45 6614 9181

DISTRIBUTION: Denmark/Norway/Sweden: Monitor Technology, +45 6613 9981/+45 6614 5958 France: Coach Audio Sales, +33 8777 0000 / England: Raper & Wayman Ltd., +44 81 800 8288 Germany: Coach Audio Sales, +49 6894 4717/4727 Holland/Belgium: Ampco Audio Products BV., +31 30 433 134 Rep. of Ireland: Control Techniques Ireland Ltd., +353 1966 866 Switzerland: Gotham AG., +41 1840 0144 Italy: Professional Equipment SRL., +39 2891 0241 Japan: Heavy Moon Inc., +81 33 797 6765 Singapore/Malaysia: Swee Lee Company, +65 336 2307/+65 336 0752.



microphone.

"Often the old U47 valve Neumann is hard to beat for a vocal. There's something about them and I don't know what it is. And young people who come across them seem to find the same thing. I don't really know what it is. But it's a good idea to have two because nowadays they all sound very different. Because of the incredibly high impedance circuitry involved, dirt, grime, nicotine staining and old age can change the performance quite dramatically. So it's a good idea to have two and see which one sounds best or which one doesn't crackle.

"One of the refreshing things about these discussions of equipment is that you hear the most wonderful sounding recordings made by people on awful equipment, in disgusting studios, in front rooms and under the strangest circumstances.

"The amount that you're just able to use your ears is much more important than the brand of desk or the brand of microphone you're using or something of that nature. If you are actually listening, your ears will filter out problems. If something doesn't sound good through a desk you'll find a way of getting round it because every desk has its good and bad points."

In fact Price feels that the only equipment that can throw a major spanner in the works is bad monitoring. Even then he feels that in many cases problems can be compensated for.

"If you're working in a studio where the monitors are definitely lacking in bass you can to a certain extent fix that if you mix in another studio or something. But sometimes bad monitoring erodes your judgement so much that you don't make the right judgements any more. If you think that it is bad monitoring while you are using it, then I think you are pretty much doomed. It has to be monitoring you can trust. If you trust the monitoring and are subsequently proved to be wrong then you normally can untangle the problem by applying the inverse of what the monitoring caused you to do.

"My definite opinion is that you can do it on anything. I've heard the most fantastic sounding *Portastudio* demos. And when they're mixed down to DAT they're indistinguishable from some masters because the noise reduction on some *Portastudios* is quite good. It's purely down to the imagination of the people that turn the knobs rather than the quality of the equipment. There are certain limitations. Recording vocals to any fidelity in a home studio situation can be a bit tricky and they can normally be improved in a good quality studio.

"When you finally get to a session and you've got a band or artist, the equipment you've got in front of you is the equipment you've got in front of you and there's not a lot you can do about that barring cancelling the session. I mean, you can't go by the numbers that are written on the equipment. You really do just have to use your ears and use the equipment to the best of its ability."

Price has worked extensively with Pete Townshend, initially with Chris Thomas producing on his *Empty Glass*, *All The Best Cowboys Have Chinese Eyes* and *White City* albums, and subsequently with Townshend producing on *Iron Man* and *Scoop*.

"Pete has been one of my heroes for many years. He plays a pretty mean rhythm guitar. He's just about the most rhythmic guitar player I've ever heard. He's a great songwriter. His lyrics are virtually literature; they're quite stunning. So he's got this incredibly aggressive guitar style mixed with this incredibly emotional



almost faltering sort of tender voice. It's like the man who doesn't sing very often and only sings when he's driven to, emotionally. You know, the old cliché of the soldier in the trenches; in the middle of death and destruction this great macho soldier starts singing in a beautiful tender voice across the battlefield. He's just amazing. He says he doesn't particularly like the sound of his own voice.

"Working with Pete is always an elucidation. He tells a good story does Mr Townshend. And of course he's an absolute mine of information on the technical aspects of recording and we can talk for hours about obsolete pieces of equipment that we've come across that he knows intimately. Sometimes on Pete's sessions it is difficult to get him to stop talking! He can recant non-stop. But it's always very interesting and he comes up with some genuinely stunningly effective hare-brained ideas."

On the *White City* album Townshend decided that he wanted to program a Fairlight to play Townshend-style rhythm guitar, and he laboriously sampled notes separately and built them up into chords.

"This was a time-consuming exercise but it ended up producing the most strange and eerie sounds that ended up on *White City Fighting*. One of Pete's ideas—which sounds like a hare-brained idea but which worked beautifully for us on a number of occasions—was using one of his early Roland polyphonic synthesisers, which I seem to remember had 16 voices modified with individual outputs. It sounds a pretty crude thing to do but at this fairly live studio at Eel Pie, he had 16 *Little David* loudspeakers all hanging from the ceiling in a fairly random arrangement around one end of the studio. Each speaker was powered by one of the separate Roland synth outputs. Then the final element was human. These loudspeakers are all joined together by pieces of string so that one person could stand on a ladder and sway them to and fro, hopefully vaguely in time with the music. We would then record them with a stereo microphone placed a suitable distance away. A totally hare-brained idea. It sounds wonderful!"

Townshend's idea was that the technique would simulate some of the random elements normally created by string players all playing together in a studio but all swaying in slightly different

directions.

"It gives an immediate warmth to a synthesised string sound. I don't know if it's worth anyone trying. It works terribly well in Pete's studio with Pete's synthesiser. I won't lay claim to having tried it anywhere else."

Whereas Townshend would happily spend half a day recording a synth string pad, Price says Elton John is a man with a totally different approach in the studio: "It's marvellous working with Elton. He's a very demanding person to work with in the sense that he's not one of these people who enjoys faffing around in the studio trying things over and over again. He's amazingly prolific songwriter. He writes songs incredibly quickly and he performs things very quickly. He comes into the studio and does his best in a very small number of takes; it's a very good idea to record first run-through with Elton because quite often it could be the best. I'm a great admirer of his talent, particularly his piano playing. Sometimes you listen to just Elton singing and playing the piano in the studio and you think: 'How can the record be any better than that?' He plays such a wild left hand he almost makes a bass guitar redundant. He's a wonderful pianist and a nice person to work for. He's very amenable. If things go wrong or something, obviously he's patient but he has the attitude: 'Well, tell me when you're ready for me—whenever—and then I'll do it.'"

For many years Price has had the reputation of being 'the recording engineer's engineer'. Though he had already produced the Racing Cars' *Downtown Tonight* album, which was released in 1976, it was the appearance of the strange credit 'Produced by Chris Thomas or Bill Price' on the sleeve of *Never Mind The Bollocks Here's The Sex Pistols* in 1977 that really brought his name to the fore as a producer. And there lies an interesting little tale.

Malcolm McLaren hired Chris Thomas to produce some singles by the Sex Pistols. Chris asked Bill to engineer and into Wessex they all went. The first single *Anarchy In The UK* was a hit and McLaren wanted an album by a certain date. Thomas had other commitments and could only spend so much time on the project. McLaren asked Price to produce some tracks to supplement the singles that Thomas had produced with himself engineering. He found that he was also being asked to produce tracks of some of the same songs Thomas had produced as singles, again engineered by Price! Thomas came back in to produce some more tracks—with Price engineering! Price was asked to make up three of four album master tapes with totally different total running times and combinations of tracks. A skilfully arranged smoke screen of confusion meant that just prior to pressing, neither of the two really knew whose productions were actually going to be used on the album. Therefore a clever manipulator might be able to avoid paying at least some production royalties! They decided to present a united front. Hence the credit.

Thomas had been to see the Pistols live and could see that the challenge was to recreate something of the excitement and hysteria of their live club dates. "On the demos I heard," Price explains, "they sounded like a very tame rock band playing out of time with each other." Bill went back to Thomas and told him that what he'd read about the group in the papers was really exciting but what he heard on the demos was really tame stuff. "They'd been recorded in a normal pop way so it sounded almost faintly ridiculous."

Part of McLaren's media manipulation included the basic premise that the band could not play

their instruments. Price says the reality of the situation was slightly different: "Steve Jones walked into the studio ready equipped with a stunning rhythm guitar style which was quite unlike anyone else. He could play like that faultlessly for 12 hours, absolutely perfect tempo, rhythmically incredibly exciting and really fast. Johnny Rotten might have just walked off the street but he had a fantastically original way of performing. He didn't put the songs across as a great musician but the way he delivered the lyrics—which incidentally were damn good lyrics in most cases—was very emotional. The timing problem that I mentioned was basically because Paul Cook was not a very good drummer when we started the album. There are very few bad timing situations that Chris will tolerate. We had to do a lot of work to make sure Paul was playing in time."

Price recalls being regularly first in the studios in the morning but then, a few days into the sessions, arriving to find Cook already practising, thrashing away at the kit and pouring with sweat, knowing he was under pressure and determined to get it right. "Obviously Chris has lots of techniques to help people who have got

timing problems. By the time we finished the album Paul was a very good drummer.

"There was something very exciting about the band but we knew it was easy to make them sound dull and boring on tape, so for that reason we had to think of a few things to do and that was the job Chris gave me. Chris had lots of suggestions and ideas. I'm not suggesting that I should take all the credit for it but this is the way I work. You have to think of, musically, the best way of attacking any particular band. You have to hear a bit of their music and have to start off with some sort of idea in your mind of how you want the finished product to sound and keep pushing in that direction. I remember Chris saying something like: 'I want the drums to sound like the guy's smashing dustbin lids and I want the guitar to slice your head off.'

"First of all we used the big room at Wessex which has a beautiful ambience—a natural club-like ambience—it's not one of these rooms that have been artificially treated to make it livelier than it should be. It's basically the meeting hall attached to a church and it's had virtually no acoustic treatment so it has the natural ambience that you would find at a small gig. It is about 5

metres high by 15 metres long and 10 metres wide and has a minimum reverberation time of about 0.3 or 0.4 seconds. At lower frequencies the reverberation time rises to about 0.75 seconds, which is something that, if you were designing a studio, you would ensure was flat. You wouldn't allow quite such a big LF rise in the reverberation time. So the room lends itself to a lot of techniques that you might wish to use in order to capture the sound of a band playing live or on stage.

"So rather than screening the members of the Sex Pistols off very tightly, we would give them the whole room to play in, recording the ambience of the room in different ways, probably leaning more towards having them play one at a time rather than all playing at once very tightly separated from each other. That's the general way we went about it. So we used ambience, gates and things and just tried to find a way of capturing the excitement the band put out when they played live. I mean, Chris pretty much explained it in that one sentence I quoted you. He had the right idea and we just had to sit down in the studio and develop the right technique for that band." □

Comments on equipment

As MD of Wessex Studios, obviously Bill's equipment preferences tend to be reflected there. Thus both rooms are equipped with SSL consoles and Mitsubishi X850 32-track machines. Here are some of his comments about major items of equipment.

"I still remain a great believer in SSL consoles, which seem to be fairly ubiquitous. No desk is perfect and you can criticise elements of any one. Once you know the areas that are not perfect you can make allowances in the way you work. But the SSL automation has always been very good and very easy to use to do anything you want. You don't have to stop and think, which saves a lot of time. People have written reams about the equalisers and all I can say about any variant of the SSL equaliser—because there have been at least five variants to my knowledge including the current G series—is that it is a very effective equaliser. So it is quite easy to make a really horrible sound with them but I don't know if it is necessarily very fair to blame the equaliser for that because you can get a good or bad sound using them. On some other desks the EQ is a lot less vicious and to a certain extent less effective, so the possibilities of making a really dreadful sound with them are limited whereas the SSL really does what it says on the front panel with a vengeance, so if you are doing the wrong thing it sounds horrible. In my experience that only happens when you are doing something nasty to the sound in the first place.

"Some other equalisers don't have such a high Q or as much boost and things like that which some people say is more musical; that an engineer can apply an equaliser musically or unmusically. That's down to his own taste really. I must say that I have never had any problems with the SSL equaliser musically, although creatively you can bugger things up very nicely with it; you don't have to try hard either. The latest Neve equalisers are excellent as well.

"The Mitsubishi is a superb sounding digital multitrack machine. When we purchased the Mitsubishi for Wessex it definitely sounded far superior to the Sony 24-track. Subsequent to that I've worked on the later Sony 24-track and 48-track 1 inch digital machine, which is superb. And I think that whatever it was that I disliked about the Sony multitrack digital machines when I first heard them, I think there must have been something genuinely not right about them, because Sony seem to have improved their machines. The things I felt about them when they first came out no longer apply.

"I've worked a lot on Dolby SR and that seems to sound jolly good as well. I don't have any particular anti-digital feelings and I've got no particular worries about Dolby SR although it doesn't quite achieve everything that digital multitrack does. It depends on what you want. One of the big bonus points digital has brought to me is being able to mix things down without degrading the sound. Obviously Dolby SR gets round the noise problem but it doesn't get round the progressive transient loss that lots of mixing down on analogue produces. Not that

noise level is one of the major worries nowadays in rock music. Even non-Dolby tapes on the latest 24-track tapes have a pretty respectable noise level for something that is moving about 1 dB either side of 0 vu once it is mixed. Plus the fact that it is guitars and synthesisers that produce most of the hiss you hear anyway. The best guitar and synthesiser sounds always seem to be the noisiest ones.

"I do occasionally find a few problems when I record on a digital multitrack and then mix digitally. My patent theory is that one's accumulating too many transients. If I'm mixing an analogue multitrack onto DAT, I can't really tell a hell of a difference between the DAT and analogue ½ inch because currently I mix on both formats and check out which seems to sound better. I've been doing this for a couple of years since the DAT machines came out and if I've recorded analogue 24-track, 48-track, Dolby A, Dolby SR or whatever, I have found that there is very little difference between the two. But if I'm mixing a Mitsubishi multitrack I normally prefer the ½ inch analogue; the sound is more efficient than the DAT. I think this may be because you are beginning to accumulate a lot of maybe inaudible transients and maybe the ½ inch machine lops a few off and allows a higher cutting or higher transfer level without adding fast attack time compression to the overall mix.

Although I've never used it, I see that Sony have brought out a digital compressor, which is possibly aimed at that sort of thing, but I've found that a piece of ½ inch tape seems to get rid of those transients or whatever it is. You seem to get a bit more punch out of the ½ inch. Compared to a DAT copy it seems to sound better and have a lower peak level so you could believe that a cutting engineer could get a bit more on to a CD or black vinyl when he cuts it. I could be wrong here because I've never looked at it technically.

"If it's a master from an analogue multitrack recording I usually tell the record company to use either the DAT or ½ inch analogue; whichever one they manage not to lose by the time they get to the cutting room, although they quite often manage to lose both. Record companies haven't changed."

Finally, Price speaks about mastering ½ inch analogue on vintage Ampex ATR100 machines because of the attractive quality they often seem to add to a recording.

"At Wessex we have rehabilitated one of the first Ampex ATR100 machines brought into this country and it is still working marvellously. And they are superb sounding machines. They have a slightly flattering bass end; it's a slight inaccuracy in the bass end I find quite pleasant. It's purely that, depending on how you line the machine up, they tend to be up in the 40 to 80 Hz region and slightly down in the 100 to 200 Hz region in overall response, which is slightly flattering on most occasions. We've also got modified Studer A80 machines, which are good, and the current Studer sounds very good as well. But there are some people who are particularly addicted to the sound of the Ampex ATR100. It's quite noticeable. It's only a frequency inaccuracy of ±1% to 1½ dB at the very most. It gets rid of a bit of 'pudd' and adds a bit of 'purr'. They're very quiet machines and they've got very good headroom."

Whilst everyone tried to copy the SM58, guess what Shure did?

Went one better.

The SM58 has been a world standard for many years and try as they may, competitors have not yet been able to replicate its performance and reliability.

Now, from the engineering team that brought you the SM58, Shure announce a new improved version – the BETA 58.

Whilst sharing the same low frequency warmth and guts, the Beta's unique supercardioid construction produces an even more open and natural sound. And as you'd expect from Shure, the mike is tough enough to withstand any amount of punishment it's likely to get, both on and off stage.

All this doesn't mean that the SM58 is being discontinued. In fact quite the reverse. It will carry on as a central part of the Shure range – and at a reduced price too.

So, if you are one of the envious competitors trying to replicate the performance of our world standard SM58, there's only one place left to go.

Back to the drawing board.

SHURE

HW International Ltd. 3-5 Eden Grove,
London, N7 8EQ. Tel: 071-607 2717

THE TRUTH ABOUT SCMS

Francis Rumsey

If you wish to cut costs and make use of consumer DAT machines you need to be aware of the significance of SCMS, the Serial Copy Management System. There is considerable confusion over what is possible with an SCMS-equipped machine, over what can be copied and how many times; furthermore, when SCMS machines are used in conjunction with older non-SCMS machines some unusual situations arise, as they also may when SCMS tapes are replayed in non-SCMS machines. The following is a guide through the minefield.

How SCMS works

Within the PCM area in the recorded DAT track is a block of information describing the vital statistics of the audio data. It includes such things as emphasis status and sampling rate but the part we are interested in is the two bits known as 'ID6', which control Copy Protection (CP). Prior to SCMS, ID6 could be set either to 00 (no CP) or to 10 (CP). A tape with ID6 set to 10 could not be copied digitally, since the recorder would note the assertion of the CP flag in the data copied over a digital interface. A tape with ID6 set to 00 would have been copyable. In non-SCMS machines it was not possible to make a digital copy at all at 44.1 kHz, and so the above only applied to 48 kHz recordings, unless the machine had been 'professionalised'.

In SCMS machines, ID6 has three possible states: the two given above, and a third, 11, which signifies that only one further digital copy may be made. An SCMS DAT recorder copying such a recording automatically sets the ID6 of that copy to 10, thus preventing further copies. In order to understand how this works it is necessary to introduce SPDIF category codes, since the SCMS process relies on the use of a new category code describing the source device to allow or prevent copies of copy-protected material.

SPDIF is the Sony-Philips digital interface found on consumer equipment, terminated in phono connectors, sometimes labelled 'co-axial' or 'digital in' and 'digital out'. Sources identify themselves over SPDIF as one of a number of possible categories, such as CD, General, PCM adaptor, DAT, etc. SCMS works by using the single CP bit in the digital interface format in conjunction with two DAT category codes: one called simply DAT (code 11000000) and one called DAT-P (code 11000001). If a recorder sees a DAT-P source it will allow a copy no matter what the status of the CP bit, whereas if it sees a straightforward DAT source it will only allow a copy if the source is not copy protected. An SCMS DAT machine looks at the ID6 bits recorded on the tape it is playing to determine how it should set the combination of category code and CP bit on the digital interface.

If the ID6 on the source tape is 00 (copies allowed) it will set the category to DAT and the CP bit to allow copies. An SCMS machine receiving that signal would set the recorded ID6 of the copy to 00 since there would be no reason to prevent further copies, and any number of serial digital copies might be made. If the ID6 on

SCMS limitations

This information applies only to copies made over SPDIF—copies made over the professional AES/EBU should be free of these limitations.

- 1 Digital copies from CD**
The CD category code (10000000), when recognised by an SCMS DAT machine, will result in a copy whose ID6 is set to 10 (copies not allowed).
- 2 Digital copies from other digital sources**
Copies made from sources having the so-called General category code (00000000) will have their ID6 set to 11, whatever the CP status, allowing one further copy only. Sources asserting this code are likely to be such things as A/D converters and some older DAT machines. It acknowledges that the source of the material is unclear and might be copyright or might not.
- 3 Digital copies to SCMS DAT machines from pre-SCMS machines**
Pre-SCMS machines may either use the General category or the DAT category, depending on when they were made and by whom. There is no easy way of telling, except by analysing the SPDIF data or contacting the manufacturer (who may not know either!). They will not normally be able to recognise the difference between a recorded ID6 of 11 and an ID6 of 10, because prior to SCMS the machine only had to look at one bit to detect CP status. Therefore such a machine will normally interpret both codes as indicating that the recording is copy protected (not even allowing one copy), and set the CP flag on the digital output.
Whether or not the receiver will record the data depends on whether the category is General or DAT. If it is General then see 2 above. If it is DAT, then not even one copy will be allowed.
The only case in which unlimited copies will be allowed is when the source tape has an ID6 of 00, which is likely to be the case with many pre-SCMS tapes.
- 4 Digital copies of recordings made from analogue inputs**
Unfortunately, SCMS DAT machines will set the ID6 of analogue-sourced recordings to 11, thus allowing only one digital copy. This is a nuisance when the source is a perfectly legitimate non-copyright signal, which could be one of your own private recordings.
- 5 Digital copies of pre-recorded DAT tapes**
The ID6 of pre-recorded tapes is set to 11, thus allowing one further copy if using an SCMS machine. If using a pre-SCMS replay machine, the 11 will be interpreted as 10 (see 3 above) and the CP bit will be asserted on the interface. A copy will only be possible if the category of the source machine is General and not if it is DAT.
- 6 Recording non copy-protected material on SCMS machines**
There is no way to record completely unprotected material on an SCMS machine, except by feeding it with a digital source having a category code other than General and a recorded ID6 of 00. This might be feasible if you have an early DAT machine. Even material recorded via the SCMS machine's analogue inputs will not be copyable past a single generation.
- 7 Digital copying from SCMS machines to pre-SCMS machines**
Such copies will only be possible at 48 kHz (or 32 kHz if you have such a tape). 44.1 kHz recordings will be blocked on unmodified machines. Source tapes with ID6 set to either 11 or 10 will cause the CP status to be asserted on the digital interface and, since pre-SCMS machines tend to ignore the category code, the copy will not be allowed at all. Source tapes with ID6 set to 00 may be copied.
- 8 Manual setting of ID6 status**
Consumer machines will not allow you to set the ID6 status of tapes but some recent professional machines will allow this. The Sony PCM-7000 series machines allow the user to set the status of ID6 bits on a recording to any combination.

the source tape is 10 (copies not allowed), the source machine will set the category to DAT and the CP bit to prevent copies, thus the recorder will not be able to copy that tape. If the ID6 on the source tape is 11 (one copy allowed), the machine will set the category to DAT-P and the CP bit to prevent copies, thus a receiver would be

able to record the signal (since DAT-P allows copies no matter what the CP status) but would know that it was copying CP material. The ID6 of the copy would then automatically be set to 10 to prevent further copies.

We could all stop there if that were all there was to SCMS but there is more (see panel above).

Just when you thought you'd heard it all..

DPR-901 DYNAMIC EQUALISER



From beyond the limits of convention comes a totally new approach to creative signal processing.

Four parametric bands of frequency—selective compression or expansion, each with the choice to operate below - threshold on quieter phrases only.

Enabling level dependent equalisation, dynamic loudness contouring, mix enhancement, noise reduction, excitation, broadcast limiting, transfer sweetening, softening, hardening, de-essing, de-effing, de-ditching and de-popping...

.....and just about anything else you'd care to try.

BSS Audio Ltd

Unit 5, Merlin Centre,
Acrewood Way,
St. Albans, Herts
AL4 0JY.

Phone: (0727) 45242

Fax: (0727) 45277

Telex: 265612 BSS G



an EdgeTech company
LONDON • NEW YORK • TOKYO

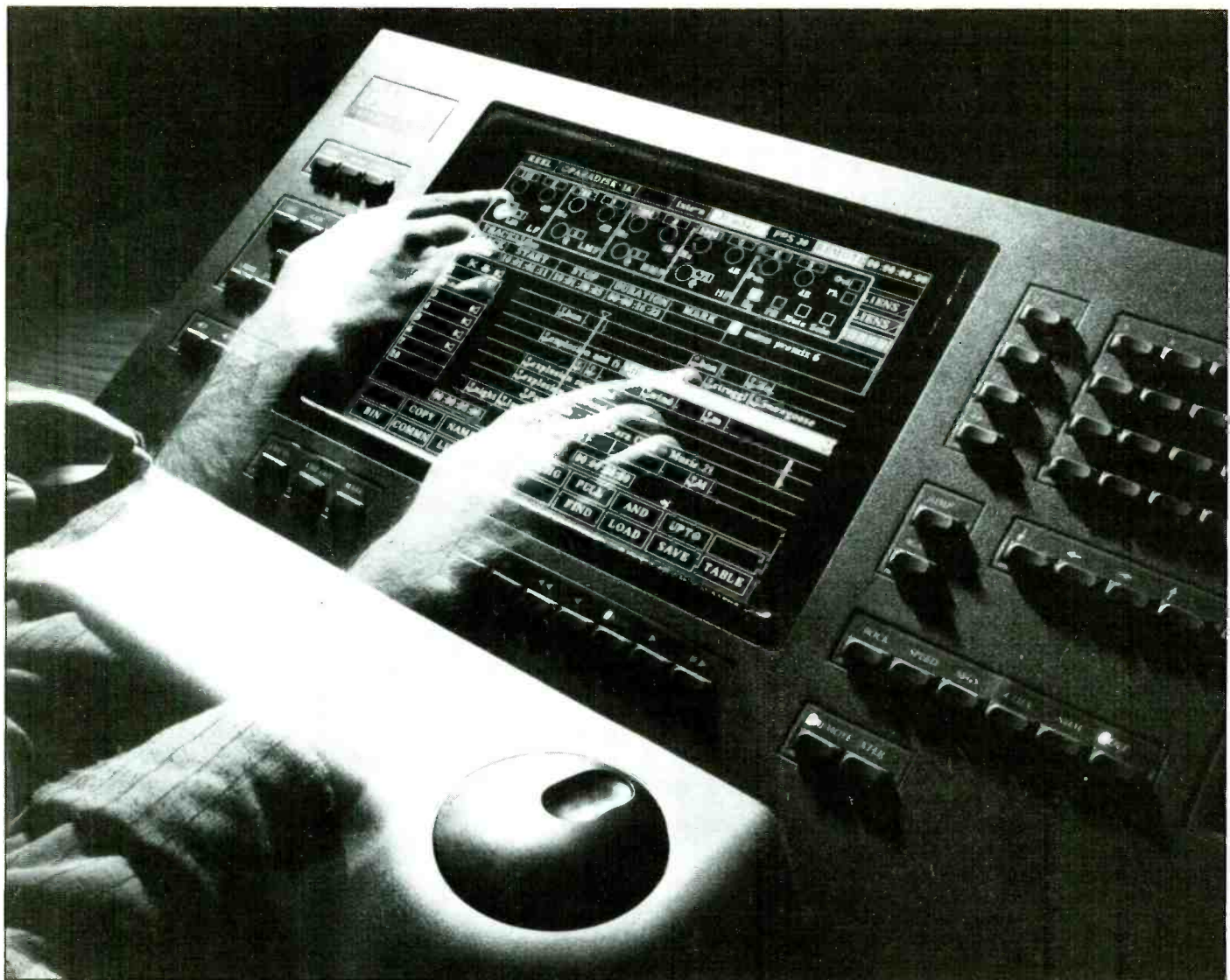

SOUNDSTATION DSP

Patrick Stapley assesses the new DSP function for DAR's SoundStation II

DAR have been working on a digital signal processing facility for *SoundStation II* for a considerable length of time and at last year's concurrent AES and IBC shows, *DSP* was finally announced. The new facility is designed to operate with 16-channel *SoundStations*, where it forms the 'platform' for a host of new features including a 'Channel Strip' providing EQ, gain and panning.

Simplistically viewed, *SoundStation DSP* provides 16 channels, rather like a multitrack tape machine, onto which stored digital audio can be positioned, edited and time slipped to produce a composite programme. These pieces of audio are called 'segments', and their *DSP* manipulation is referred to as 'segment based processing'. What this does is attach signal processing information to a segment, so whenever that segment is

accessed, irrespective of it having been copied, backed-up or moved, it will retain this information and reset parameters accordingly. The beauty of this is, for example, that a segment can be stored onto optical disk, reloaded at a later stage and automatically recall its original processing. As a segment can be as short as four samples, it's easy to see how the system can provide powerful sectional automation as parameters change from segment to segment; although at present there is no facility for true realtime dynamic automation.

Like other *SoundStation* functions the channel strip facilities can be controlled via the touch sensitive screen and the rotary controls. The display has been designed in a traditional manner, mimicking the rotary controls and buttons on a mixing console. These are laid out horizontally, comprising four identical EQ sections

and a section containing EQ in/out button, pan/balance control, pre-EQ gain control, PFL, mute and overload indicator. Each EQ section has separate controls and readouts for frequency, cut/boost and Q—these are selected by touching the appropriate control, which immediately becomes highlighted, and adjusted by turning the Vernier wheel at the base of the *SoundStation* console. Because of its familiar appearance, the system is very intuitive and anyone who's used to operating a mixer will feel at home in a few minutes. It's interesting to note that although the operation and functionality of the system appear to be very straightforward, the processing required to achieve this is in fact highly involved and complex (see Fig 1).

The four parallel EQ sections (LF, LMF, HMF and HF) share the same frequency range of 14.14 Hz to 21.8 kHz in quartertone steps, cut/boost of ± 31.5 dB in 0.5 dB steps, and Q of 0.0225 to 30 in semitone steps. The filters have been designed from traditional second order analogue curves but the sections differ in that LF and HF are shelving filters and the LMF and HMF are peak filters. The shelving filter has a

HE SAID,  *"You can write almost anything you want about this machine and put my name under it."* SO WE DID.

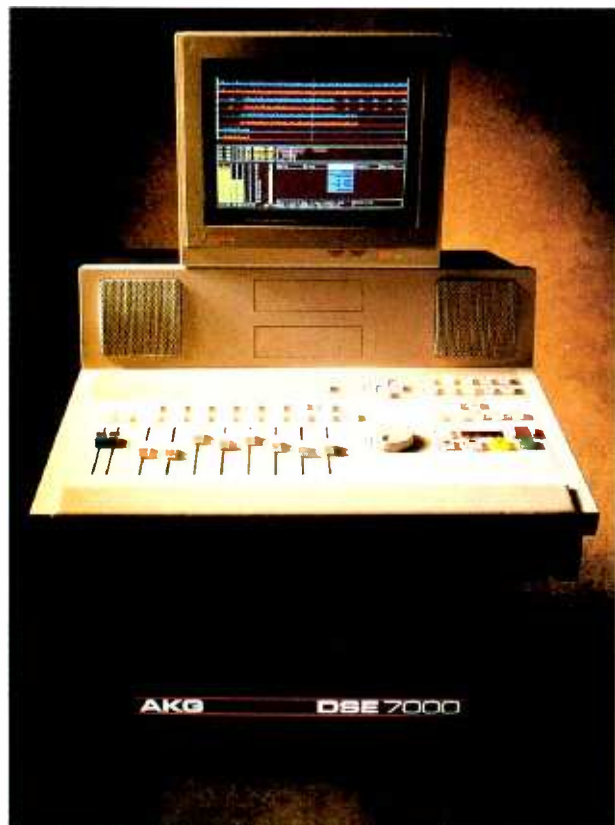

THE DIGITAL SOUND EDITOR. STATIONS FROM BOSTON TO SAN DIEGO ARE MAKING IT THE HOTTEST BOX IN RADIO.

Dan McCoy was the first production director in radio to use the DSE 7000, and he saw it revolutionize the way production is done at

WZOU-FM,  one of the top stations in Boston. A spot that used to take an hour to produce now takes 20 minutes. Without tape.

Without razors. Without a single dB of generation loss. Even agency dubs now go right to the

DSE for levels, sound enhancement 

and tags; then onto carts. Creativity has exploded, too. With the DSE's instant UNDO feature, the fear of trying new things is gone. You simply try another take, assemble a different edit, or test a new effect. If you don't like the results, UNDO it instantly. No wonder WZOU has

designed their production facility around the DSE.  And no wonder Dan McCoy calls

this machine "the most impressive thing that's ever happened to radio." His words, not ours.



DSE 7000 • THE NEW SPEED OF SOUND

TM



AKG AKUSTISCHE U. KINO-GERÄTE GESELLSCHAFT M.B.H.
Brunhildengasse 1, P.O.B. 584, A-1150 Vienna/AUSTRIA
Tel.: (1) 95 65 17-0*, Telex 131839 akgac a, Fax: (1) 95 65 17-245

AKG ACOUSTICS, LTD.,
Vienna Court, Lammas Road, Godalming, Surrey GU7 1JG/GREAT BRITAIN
Tel.: (483)425702., Fax: (483)428967. Telex: 859013 akgmic g

Why are ES.Lock systems so FAST?

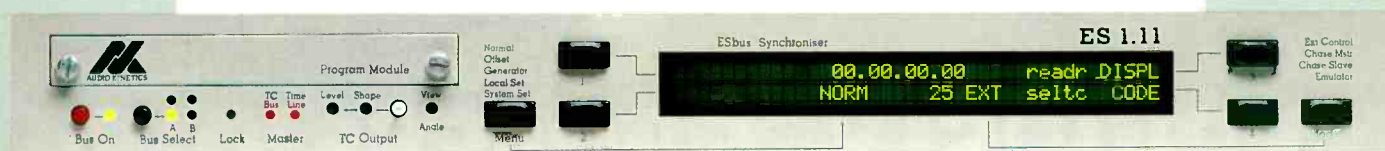

24 Bit-Servo Control
+
The AK DAK 010 Gate Array
+
16 Man Years of Software



**Software Revision 3.0 now available with
more Control Options**

SSL E and G Series Computers
NEVE Flying Faders Computers
GML Computers

PENTA - 5 Machine ES.Lock Controller
ECLIPSE - 8 or 16 Machine ES.Lock Controller

Audio Kinetics UK Ltd, Kinetic Centre, Theobald Street, Borehamwood, Herts, England WD6 4PJ.
Tel: 081-953-8118. Fax: 081-953-1118.

ES.Lock 1.11 and ES.Lock Controllers are installed in 22 countries worldwide: **Australia**, Maser, 2-958-6700. **Austria**, Grothusen, 22-297-2529. **Belgium**, Heynen, 1152-5757. **Canada**, Sonotechnique, 514-739-3368. **Denmark**, Interstage, 31-620026. **Eastern Europe**, Sondor (Switzerland), 1-391-3122. **Finland**, Studiotec, 0-592055. **France**, Audio Kinetics, UK-81-953-8118. **Germany**, STK, 40-690-1044. **Holland**, Heynen, 8851-96111. **Ireland**, Audio Kinetics, UK-81-953-8118. **Italy**, Audio International, 2-253-90121. **Japan**, General Traders, 3-293-2274. **New Zealand**, Maser - Auckland 9-479-7889. **Norway**, Siv. Ing. Benum, 2-135-460. **Singapore**, Team 108, 748-9333. **Spain**, Telco, 1-231-7840. **Sweden**, Proab, 760-19863. **Switzerland**, Studio World, 56-271233. **Taiwan**, Acesonic, 271-68896. **USA**, 21st Century, 213-463-4718.

Audio 'Bites' overheard circa 1991—Persian Gulf style.
 "Well, Dan . . . we think the Scud missiles will not be a problem here in Dhahran due to the distance from the Iraqi forces!"

"This is Eagle Leader . . . Strike Eagle 3 and 4 intercept the two incoming Fulcrums at heading 187 . . . UDF authorised."

"As you can hear, Chet, it sounds like a Fourth of July celebration back home. We can't see a thing in the sky above the city except for an occasional flash of light but we have a feeling in the pit of our stomachs like something with big jet engines has been here and gone . . . probably the Stealth . . . let me put the microphone by the open window so you and everyone back home can hear the ack-ack."

"We appreciate your interest in the Tomahawks but let me call the US Navy representative to the microphone. Captain, isn't it true that all we can tell the world's press gathered here, is that the Cruise missiles were launched from one of the battleships positioned adjacent to the war zone?"

"Cobra 7 to Cobra Ops . . . We have several bogie tanks at Delta Four Delta . . . request Big Ugly . . . That's affirmative Cobra 7 . . . Warthogs launched . . . Excuse me, Cobra 7, this is Big Ugly 1. Just because the A-10 has been described as looking like the front window of a secondhand auto parts store is no reason to have no respect . . . those 'rab' tanks will certainly get respect sooner than later."

"Sadaam Hussein is a most benevolent man. He does not wish this war with the great Satan. But, since it has been forced upon him, he will be the very spirit of the desert scorpion and unleash the forces of Islamic destruction that will scorch each grain of the very sand of the desert under the feet of the imperialist forces."

(In Arabic) "Iraqi troops—lay down your arms and surrender. The coalition wishes you no harm and you will be treated with the utmost courtesy. You will be fed, you will be given warm, clean clothes and a hot shower, medical attention, you will have plenty to drink and you will have a comfortable place to sleep . . . if only you will surrender."

"As the President speaks to the world, virtually every television and radio network on the planet is connected like a gigantic grid to convey his message. Now from the Green Room of the White House . . ."

"All I can tell you as the briefer is that last night there was a net gain of 117 EPW's in the KTO—63 Line-Crossers and 54 Collateral Action Transfers. The ICRC has been notified and will assist ASAP. The GCC has been especially careful to see that all EPW's are processed by twenty-four hundred hours Zulu for each day's new numbers. And we must confirm that none of the EPW's were in a MOPP mode."

"A prominent British psychiatry consultant commented today that the omnipresent, incessant, invasive coverage of the war in the Gulf had created US and EC civilian cases of 'shell shock' which he had dubbed as 'combat news media fatigue'. The results, he postulated, were

Martin Polon

Audio goes to war. Comment from our US columnist

increasing symptoms of sleeplessness, irritability, hypertension, systemic stress and an inability to complete tasks—all very similar to battle stress syndromes."

"This is CNN . . . Live . . . From Baghdad . . . Tel Aviv . . . Dhahran . . . Kuwait City!"

"This is London . . . The war in the Gulf is over. A cease fire . . ."

The point of all of these audio squibs is to illustrate via a somewhat hypothetical collection of various and sundry, just how audio has been used in and about the war in the Persian Gulf. As the American-led coalition jostled with Sadaam Insane and his battalion of Colonels' Ibn So Badd, the audio industry contributed services and channelled information to the world's peoples for better or worse, as one can judge from the above. Indeed, it can be clearly said that no one will ever forget the enormity of the geopolitical situation and the impact it has had on so many diverse lives all over our planet. Neither will anyone forget the mad rush to cover the conflict, as the various broadcasting medias fought a battle for news and technology supremacy and access not so different from the armed tug-of-war going on across the lines in front of them.

But, despite the self-serving and obviating nature of much of the military story in the Gulf . . . some bordering near manipulation, according to some media observers, the military has emerged a clear winner in terms of the success of audio and video systems, hardware, and satellite linkages. So has the broadcast audio community. The current technology base of military and civilian audio gear has proven to be equal to the wear and tear of desert warfare. Not so obvious, however, is the way in which audio equipment and practices will be improved by war-time experiences with state-of-the-art technology. The chase across the desert, has led the audio technology industry into some new developments and some major improvements for older ones, that could become part and parcel of broadcast audio, studio audio and remote audio origination and recording systems later in this decade.

In fact, the progress that has been made in the last ten years really became evident via the quality and quantity of the audio that was fed from the remote location of the war to the world's populations centres. Aside from the current uses of state-of-the-art audio, the advances in audio technology proven during the war will have perhaps an even greater impact on the business of audio in the future. So will those technologies or practices that did not fare so well. Here then are

the Gulf War winners and losers.

Portable Video Recorders : The extraordinary success and stunning imagery of US and Royal Air Force 'gun camera' VTRs and of associated electronic systems, will validate the viability of much smaller packages for originating and recording audio and video information. Size reduction is and always has been perhaps the number one pass-through of military research and development to the civilian electronics marketplace.

Digital Audio : The extraordinary quality of audio reproduction heard from the Gulf War validates the broadcaster investment in satellite communications, elaborate transmission line treatment and above all in the digital and near-digital systems used to record audio on video tapes and via digital audio recorders. Such innovations as the DAT system, Dolby SR, PCM audio tracks on VTR systems, etc., have all proven both their worth, their robustness and the quality provided. Said one network audio type, "this is the first event of this magnitude and remoteness to be covered by television in an aural sense that doesn't sound like the reporter is standing at the East portal of the Holland Tunnel talking into a paper towel roll."

DAT : The digital audio tape recording (DAT), has proven to be as versatile and reliable a tool in the hands of the broadcast news community as its predecessor analogue recorders were. The exchange of tape from one unit to another has not been the 'bugaboo' that some quarters of the audio community predicted it might be. The incredible pressures of both news deadlines and a war zone have simply served to prove the real worth of DAT units in the field as well as in the news studios back home. In a professional sense, the message is that the "DAT is here to stay."

Satellite Linkages : Equally successful has been the reliability, quality and accessibility of satellite coverage of a remote and difficult news event. Curiously, the success of civilian satellite systems mirrors the incredible effectiveness and dependability the military has found for its satellite C3 systems—communications, command and control. It is interesting to note, that the warnings on Scud missile launchings were processed via a remote sensing satellite to military computers in Colorado and then back by military communications satellites to the Persian Gulf—no mean task in a matter of seconds. Similarly, broadcast news coverage was winged instantaneously by satellites from Saudi Arabia to a worldwide collection of broadcasters via a network of civilian satellites and re-transmission centres. The success held by satellites will increase the already dramatic level of broadcast usage in the Western World and will also accelerate the trend in remote studio satellite linkages for recording purposes.

Test and Maintenance : Built-in, automated test and diagnostic technology has proven its value to the reliable performance of complex avionics, shipboard systems and land-based electronics. The validation of built-in software with automated microprocessor-controlled test hardware and routines, leads to an obvious

extension to expensive professional audio gear. This technology has already begun to be used on current generation professional digital video tape recorders, but the concept will be applied much more generally to pro audio products in the future. The ability to completely routine a complex unit in 180 seconds every day before use, will make studio operations virtually failure-free. In addition, the built-in test gear will allow pin pointing a problem without having to take the equipment in 'extreme jeopardy' out of the studio or out of the facility. It also makes repair by 'the

number' that much more feasible. Diagnostic systems allow studios to carry replacement modules, which will be identified for swapping out by the diagnostic system.

DSP : One of the secrets of the high quality, high intelligibility communications between the various units and personnel of the GCC (Gulf Coalition Countries), has been the extensive use of digital signal processors in the telecommunications and radio systems. The in-service success of such systems virtually guarantees the widespread manufacture of

affordable digital signal processing chips and architecture for audio signal processing applications. Many components, currently operating in the analogue domain for equalisation, filtering, signal compression and signal expansion will utilise DSP devices with greater affordability. Digital products found formerly only in the rarified world of high priced professional audio hardware will move down to the semi-professional/project studio marketplace as well.

Acoustic Signatures : The success of military systems to find, isolate, identify and attack specific vehicles and aircraft based on their acoustical signature, will bring future benefits to the civilian audio marketplace. The potential for future editing systems based on the 'signature' technology under microprocessor control is very exciting. Coupled with virtual memory systems, the combination will be able to find a specific note or beat as fast as today's word processors can bring up a selected word or phrase.

Telephone Dial-Up Systems : The use of dial-up transmission of audio over the commercial telephone network versus dedicated private lines clearly resulted in a 'win' for the private line mode. The dedicated lines used by broadcast media remained operative through most bombings, Scud missile attacks, etc., and even survived through the obvious disconnection of other news media telephone linkups on the commercial network. It even seems likely that some of the staying power of the several broadcasters using the private service, was the inability of the local PTT administrations to find the private linkages to disconnect them.

Connectors : The presence of wind-driven sand created an adverse environment that threatened much of the audio hardware used in the Gulf. Certain audio connectors fared better than others, but it became instantly apparent to anyone in the Kuwaiti Theatre of Operation (KTO) that the military had chosen well with their shallow self-wiping sealed connections systems. Many of the commercial grade connectors on the broadcast audio and video equipment used in the Gulf, were interfered with by the sand. Although evacuation of the particles was one acceptable solution to the malady, ongoing operation in any kind of blowing sand remained difficult for some kinds of connectors, especially multi-pin hi-fi grade units. A surprising dilemma was found in the headphone jacks found on most equipment. The jacks became a portal for the entry of sand—through the open centre hole. Units with semi-sealed phone jacks fared better than the open frame units, but the admission of sand to any machine with moving parts could and sometimes did cause a catastrophic failure. Many users simply left a pair of headphones plugged in to permanently seal the portal. Duct or air conditioning tape was frequently used to seal mated connectors on microphone extension cables.

Microphones : The Gulf environment certainly worked as a test centre for microphones. The military's insistence on ruggedness and reliability was justified by a very high degree of servicibility for voice origination. Having finally left the era of 'juice cans and string' fidelity with the carbon

Saki vs. Otari 24-track Replacement Heads: You'll Like the Difference.

Otari's own MTR-90 record and playback heads are excellent. Proven Permalloy cores and shields. Clean response with low crosstalk. Troublefree.

Just like Ours.

In fact, we guarantee to deliver the same mechanical and performance specs to your 100% satisfaction, or your money back.

So why change to Saki when replacement time comes? Because our Made in U.S.A. heads are priced significantly less than Otari, and we offer immediate delivery from stock.

Ours vs. theirs—the difference is worth a closer look.

Call us now for all the details.



SAKI MAGNETICS, INC.

26600 Agoura Road, Calabasas, California 91302

Phone: (818) 880-4054 Telex 244546 Fax (818) 880-6242



Ours.



Theirs.

microphones that served so long and so well, the military validated the quality of 1990's audio products. So did the broadcasters reporting on the war, but with varying degrees of success. Most radio and TV units in the Gulf found having multiple microphones to be a real plus, as impact and sand took a toll on occasion. In addition, the by-now-famous trait of military units to 'scrounge' or 'borrow' under command' various and sundry, seemed to include such behaviour by many users of small audio paraphernalia.

Portable Audio Products : As important to the morale of the troops as letters from home, was the successful supply of tens of thousands of portable units to the troops of the coalition. 'Walk' type tape players, AM/FM radios, small short wave receivers and even portable compact disc players/amplifier-speaker systems were placed into the hands of the men and women who needed them. Coupled with the supply of thousands of pieces of recorded music on cassette and CD and the rapid deployment of local broadcast and music origination capability by the AFRTS (Armed Forces and Television Service) and the BFBS (British Forces Broadcasting Service), not to mention the unintentional entertainment of Iraq's own Baghdad Betty—the forces were able to survive the boredom of the five month 'Sitzkrieg'.

Short Wave Radio: Last, but certainly not least, was the unequivocal realisation of the impact of short wave broadcasting by the civilian populace of the Middle East, the European countries with forces in the Gulf, the United Kingdom and all of North America. In the United States, the demand for short wave radios was just short of staggering. People were going into stores and buying units regardless of price or features. Ham radio stores were selling expensive semi-professional and professional receivers to home listeners who demanded the very best. Japanese and other Asian makers of the multi-band receivers were literally besieged by dealers all over the world who demanded more products to replace depleted stocks. Troops of all forces on both sides were reported to frequently know more—more quickly—about the war through their personal short wave units. If it has been said the CNN (Cable News Network) won the television 'war of words', it must also be said that the extraordinary denizens of Bush House of the Strand in London—the BBC World Service—captured the 'hearts and minds' of those on the planet who demanded the very best in information. Whether through short wave transmission to the world or via satellite rebroadcast to various national broadcasters, the 'Beeb' got the word out. In the United States and Canada, 'Auntie' was heard on public radio FM stations, commercial-less rebroadcast on AM stations and as audio on cable TV channels.

Much of the enhanced electronic equipment used by the Coalition and the media has been supplied to the Persian Gulf by some of the same suppliers that service the world's audio recording and broadcast equipment marketplace. Other suppliers invariably 'port' their military-grade technology onto chips for civilian application products. All of this suggests that the

normal flow of evolution in high technology will indeed see lower prices for today's sophisticated electronic devices. Certainly, the digital audio communications capability that upon its introduction to military applications in an earlier cold war era, was priced at the \$50,000 level, has descended to the under \$2,000 level in the 1990's, in the Gulf. For better or worse, war since the late nineteenth century has always ultimately brought a positive bonus of technological progress in the civilian sector. This has occurred in medicine, communications, electronic

development, transportation and weather forecasting—to name a few. Whether it is because of the impact of a crisis mentality with virtually unlimited funding or because of the ability to test new and prototype products and ideas under 'stress' conditions or all of the above . . . this war promises to be as pivotal to audio technology as previous conflicts have been. It does seem rather unfortunate that wars carry the greatest success factor for the advancement of things technical. It seems rather a shame societally, that we cannot do this some other way!□

Something for everyone!

Digital Processors

- Audio Design ProDat 1A
- Interface to DTA2000 Report Writer
- ProDat 1B (computer controlled R/DAT)
- ProBox 1 (AES/SP interface)
- ProBox 3 (SDIFF2/AES send/return)
- LevelModfier AES Digital Fader
- Sony ESD1000 32-bit Processor
- Sony PCM2500 (external synch modification plus DTA2000 interface)
- RTW Digital Meters (AES and SDIFF2 lines)

Digital Recording Systems

- Digi-4 16 bit Four Channel Recorder
- SoundMaestro Digital Editor
- Digidesign Sound Tools
- Computer Concepts'

- Digital Commercial System (DCS)
- Gotham Recordable CD system

Ambisonic Surround Sound

- Professional Multi-speaker Decoders
- Transcoder Encoder
- PanRotate Surround mixing

Analogue Processors

- F601 SuperDynamic Broadcast Limiter
- Complex 2 Production Dynamics
- PanScan Stereo Effects
- SPL Pro-SX2 Psychoacoustic Exciter
- SPL Optimiser Equaliser
- ProPak pro-consumer Interface
- RTW Analogue Lightmeters



Unit 3, Horseshoe Park
Pangbourne RG8 7JW UK
Tel: 0734-844545 Fax: 0734-842604



GOOD NEWS

A-DAM, recently voted best recording device of 1990, has already brought affordable digital multi-track capability to over 700 studios and musicians worldwide. But when you stop to consider the powerful features that Akai have packed into the A-DAM system, it's small wonder that everybody's buying it. Fast rewind and search time... programmable auto-locator... compatibility with other digital formats... all this, plus the superiority of digital recording using 8mm cassettes that you can buy locally at a fraction of the cost of reel to reel tape. A-DAM is fast, reliable



AKAI
DIGITAL

FOR INFORMATION CONTACT:
AKAI (U.K.) LTD, HASLEMERE HEATHROW ESTATE,
SILVER JUBILEE WAY, PARKWAY, HOUSLOW, MIDDLESEX TW4 6NQ
TEL: 081-897 6388 FAX: 081-759 8268

WHERE INNOVATION TRIUMPHS



SPREADS FAST

and versatile too. You can copy part/whole tracks, make back-up tapes, slip tracks in time, set digital crossfades and store as many as 100 cue points – even the most sophisticated functions are supremely easy to use. The DL1200 locator can be used to control up to three DR1200 recorders for synchronised 12/24/36 track operation. A-DAM also makes the ideal partner for the DD1000 digital recorder/editor. Digital technology has brought about a revolution in audio recording... and the good news is, with A-DAM, you can afford to be part of it.



A-DAM

AKAI DIGITAL AUDIO MULTI-TRACK FORMAT RECORDING SYSTEM



TEC
TECHNICAL EXCELLENCE & CREATIVITY
1990
WINNER

I have previously mentioned Mini Disc, the 3.5 inch erasable disc which Sony has been secretly developing as a new recording format. Plans are vague, perhaps deliberately so, to muddy the waters for Philips Digital Compact Cassette. MD would be formatted in different ways to record computer data, video pictures and either professional or domestic quality sound. The original idea was for the domestic version to use heavy data compression as a way of getting long playing times from small discs. Quality would be lower than for CD.

Demonstrations of MD technology were given to the record companies jointly by Sony and Philips, a year ago, but Philips has since concentrated on DCC as a long term replacement for the analogue compact cassette. Sony has been trying to decide whether to back DCC or offer MD as a replacement for the analogue cassette.

Now Sony has released technical details of a radical new technology which could squeeze longer playing times from smaller discs without compromising quality.

MD relies on magneto-optical recording. The basic MO technology is of course not new. An MO disc has a coating of rare earth alloy. During recording the disc is bathed in a magnetic field and scanned by a finely focused laser beam. This causes local heating which reduces the coercivity of the coating so that it switches magnetic state in the bathing field. Varying either the power of the beam or the strength of the magnetic field creates a coded pattern of magnetic spots on the disc. These will change the polarisation of a readout laser beam. The reflected changes are detected by a sensor similar to (but more sensitive than) the sensor in a compact disc player.

Sony's new system is called thermal eclipse reading, and catch-named IRISTER. It increases the storage capacity of an optical disc by a factor of six.

With short wavelength blue lasers, instead of the conventional long wavelength infra-red lasers, recording density can be increased by a factor of 20.

The aim of IRISTER is to make the effective size of the light spot smaller, and so cram more recorded bits of information on the disc surface.

The first step is to make the disc coating sensitive only to the central core of the beam where the light is most tightly concentrated and the most heat is generated. So a relatively thick beam creates small spots.

The second stage is more difficult. The system must read the small spots with a similarly thick pencil beam. This is where engineers have previously been left waiting for blue lasers.

Sony beats the system by making only the central core of the laser beam capable of read-out.

The disc surface has two layers, a lower layer with high magnetic coercivity (high resistance to magnetic change) and an upper layer with a low coercivity (low resistance to magnetic change). During recording both layers are magnetically addressed in tiny spots. But prior to read-out a steady readout laser beam erases the recorded signals in the upper layer. This field is not strong enough to affect the recording in the high

Barry Fox

Sony's 3.5 inch Irister MOD challenge. Disks for film sound. Sticky tape developments

coercivity layer underneath.

During read-out the laser beam is focused on the low coercivity top layer where there are no magnetic signals remaining. But the heat from the beam makes the top layer pick up magnetic information from the lower layer. Again the core of the beam is hottest so signals are only transferred up from the lower layer in tiny spots. So the beam reads tiny spots with its narrow core. It behaves as if it were more finely focused than optical theory allows with an infra-red laser and small lens.

Unlike CD, but like tape, MD would let domestic users make and erase their own recordings. Because MO discs are not playable on existing CD players (the reflection characteristics are different), there is good reason not to adopt the standard sizing of conventional CDs for any future domestic disc recording system.

The record industry has not yet shown much enthusiasm for MD. They prefer DCC because shops can stock them in the same racks as today's cassettes. They also do not want anything smaller because they will have to put it in a large package to prevent shoplifting. From experience with CDs, especially in the USA, they know that an increasing number of customers object to the idea of cutting down more rain forests to produce throwaway packaging.

Sony says that Irister is "the kind of accomplishment that can be realised only once in a decade". Such claims are two a penny in the consumer electronics industry, but in this case Sony is probably right.

It is unclear yet whether the latest form of Mini Disc uses either high density recording or data compression or both. Perhaps Sony is not sure either.

As a general reminder, increasing recording density (eg by the use of Irister or blue lasers) physically squeezes more digital bit spots on the disc. Using data compression (eg PASC as for DCC, MUSICAM or ASPEC for Digital Audio Broadcasting) makes better use of those bit spots.

With today's standard CD technology, the 3 inch CD single can hold around 20 minutes of 16 bit linear code. Let's say that a conventional 3.5 inch

MO disc could hold up to half an hour. On the face of things the use of Irister would let the 3.5 inch disc hold six times that amount i.e. three hours. But formatting makes recordable discs less efficient at storage than pressed discs and any attempt to raise the CD standard from 16 bit to 20 bit would lose another 25%. So Mini Disc might provide about 90 minutes of 20 bit linear recording time. With PASC, recording time could be extended by a factor of four, to six hours per disc. The unanswered question is how long it would take Sony to make Irister commercially available at consumer prices. My bet is, longer than it will take Philips to get DCC on the market.

French company Tacc et Cinelume has announced LC Concept, a new approach to digital sound for the cinema.

Time code is recorded optically on a film print, alongside the traditional optical track. This code is read by an extra head on the projector and locks playback from a separate optical disc into sync with the film. The disc is of magneto-optical type, so re-usable, and data compression or a large disc gives two-and-a-half hours recording time.

This is an extension of an earlier idea to lock soundtrack CDs to a movie projector.

The practical difficulty is coping with damaged film, where frames are missing, and with change-overs between projectors running sequential reels. The timecode has to keep pulling the sound and picture back into sync. This takes time, and has to be concealed by a rapid cross fade to the conventional optical track. If the film has been on the floor of the projection room a few times, there is likely to be a whole lot of cross fading going on.

I still remember someone telling me how they had watched the 3-D film *House of Wax*, which used left and right eye reels on separate projectors, in Ireland. The two reels had both been damaged, but in different places. So the left and right eye images moved in and out of sync, tearing the viewer's brain apart.

However clever the latest disc system may be, it must surely be a non-starter if Dolby Labs can justify its claim to putting both analogue and digital optical tracks on the same 35 mm print.

In anticipation of the *Studio Sound* article on what has now become known as the 'sticky tape syndrome' (December 1990) Ampex and the APRS arranged a briefing meeting in London. It is perhaps a pity that the meeting took place literally a couple of days before the feature was published. But full marks to Ampex for frankness. We now know a lot more about the likely extent of the problem.

At the meeting, Gus Dudgeon typified those who are now asking why nobody warned them. Dudgeon produced most of Elton John's best known recordings and was recently involved in producing a CD compilation of EJ's hits. He had to collect master tapes from a wide variety of record company, production company and archive sources. When he put on one master it started squealing. By bad luck, the recorder had

stationary guides. By the time he realised what was happening, the tape had shed oxide and was ruined.

Dudgeon showed the damage to a tape operator in the studio. "Is it an Ampex tape?" asked the tape op. "Well, that explains it then."

"It is only by sheer luck that someone else had made a digital copy of the tape made 6 years ago," says Dudgeon, "otherwise we would have had no master tape to work from."

"If I had been warned about the problem, I would have known what to expect. I only learned what was happening when I later read the article in *New Scientist*. After that I found eight or nine more tapes from 1979 to '82 that were affected. Ampex saved them by baking."

Other engineers told of similar experiences, dating back to the discovery in 1983 that some tapes (of various brands) recorded by Bob Marley in Jamaica were sticky.

To recap very briefly, sticky tape syndrome is caused by hydrolysis (chemical breakdown from the effect of water, usually from the air) of the polyurethane binder used to bond the magnetic oxide coating to the polyester base film.

"We now realise we should have been more open," says Steve Smith of Ampex in California, "but we did not want to cry fire in a crowded theatre."

Representatives of Ampex's three main competitors 3M, Agfa and BASF, also attended the London meeting. 3M and Agfa admit to encountering the problem but mainly in the US. BASF still believe their tapes are safe. BASF had previously confirmed to me that even today the company does not use polyurethane binder for its professional audio tapes. Ampex believe they have suffered most only because they supply more tape

to studios than all the other manufacturers put together.

Ampex now admit that they passed off first reports of stickiness in the early '80s as the result of improper storage. Then, in 1987, the National Film Board of Australia panicked when they found that some of their 200,000 reels of tape were exuding an unpleasant oil, which gummed up recorders and stopped them running. But members of the APRS and Producers' Guild complained that they knew nothing of the risk until they read about it in *New Scientist* in September, 1990.

Ampex began using polyurethane in 1972 and until 1984, when they installed new analytical equipment, were unable to check accurately the quality of supplies from chemical companies. Polyurethane acts like a sponge to absorb water from the atmosphere, and some varieties are more likely then to undergo hydrolysis, which breaks long chain molecules down into viscous liquids. After 1984, Ampex insisted on more stable varieties. The company warns that all tape companies used similar chemicals. But this seems at odds with BASF's claim not to have used polyurethane during the risk period.

Tests show that hydrolysis is very slow at 20°C and a relative humidity of 20% or 25%. But record companies rarely store their tapes in such heavily conditioned rooms. And studios do not like dry air because it causes static electricity build-up. An RH of 40 to 45% is a safe compromise. In warmer rooms and natural humidities, hydrolysis is much quicker.

Ampex warn that once a tape has been exposed to damp, it absorbs water and hydrolysis begins, regardless of where it is then stored. They have stopped exporting tape by sea and fly it instead.

Ampex discovered, in late 1987, that baking sticky tape (at 55°C and 10 to 15% RH for a day) temporarily reformed the binder. Engineers then have a month to make a safety copy onto a new tape. So far Ampex have been able to recover recordings from all affected tapes. But recovery is not possible if the oxide coating has been damaged by attempts at playing a sticky tape on a clogged recorder.

"Probably we haven't been as open as we should have been," acknowledges Steve Smith. "We have been waiting for people to call us, then we bake their tapes free of charge."

Ampex have been working for 2 years on binders made from polycarbonate instead of polyurethane. "These appear to be very stable," says Robert Perry of the company's tape laboratory in California, "but the raw material is not yet available in quantity and it will be much more expensive."

"We have yet to find any case where restoration doesn't work," says Smith. "In fact we are surprised the process works as well as it does. We say our tape will last 10 years but if properly stored it will probably last 20 or 30 years. But the lawyers limit the warranty I can give to 1 year."

Despite this reassuring talk, I know that some producers and engineers left the meeting with a nagging worry. They know their tapes are being stored by record companies in rooms and underground archives, which they fear are not air-conditioned and are likely to be very damp. Who has the time to go round those vaults, pulling sample reels off the shelves and playing them? And is the opportunity to restore really open-ended—can it be relied upon to work every time in the future?

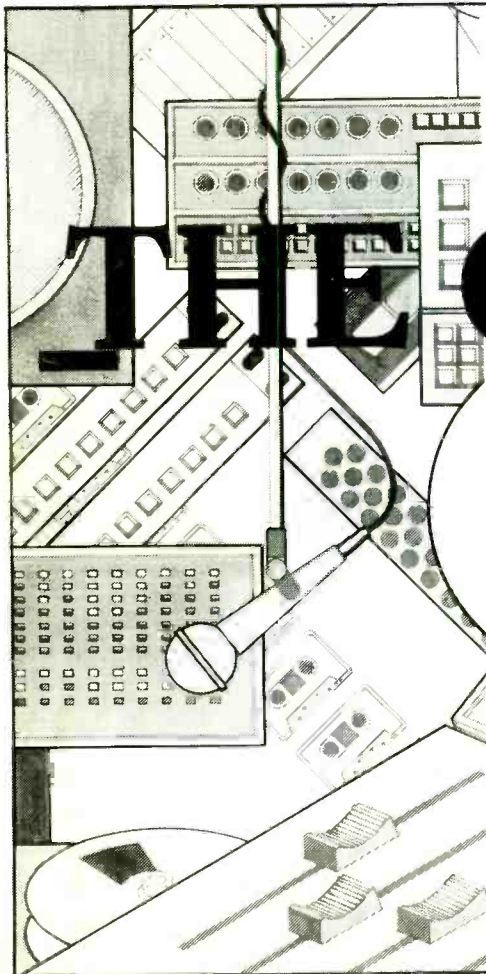

APRS 91 ... The ONE Show for the pro audio industry. APRS 91 is the showcase of the world's products and systems for recording, broadcasting, post-production and sound reinforcement.

It makes APRS 91 The ONE Show for YOU.

THE ONE SHOW

The annual, international APRS shows have long been uniquely important for exciting new product launches and all the latest in pro audio equipment and services. Year on year, we push out to fresh frontiers in technology and new markets.

Exclusively for professional visitors, APRS 91 is The ONE Show, for what will soon be the one market of Europe.

Don't miss APRS 91 – the event of the year.

For free entrance, you must pre-register (£5 admission if you register at the door).

Pre-registration now available from:
APRS 91 Office, 2 Windsor Square,
Silver Street, Reading RG1 2TH, England.
Tel: (0734) 756218. Fax: (0734) 756216.

**5th-7th JUNE 1991
OLYMPIA 2, LONDON**



A few important words about the new A-T 40 Series:



Tony Bongiovi
Power Station

"The 4051 is a great mike, especially for rock. It sounds fat and you can bang away at it with a lot of level without a pad...for a rock studio like the Power Station that's important. When you put it on horns it has a nice clean sound and it holds the dynamics well...it's just an excellent sounding mike."

AT4049
Omnidirectional
Capacitor

AT4051
Cardioid
Capacitor

AT4053
Hypercardioid
Capacitor

David Cook
Dreamland Studios

"...real nice top end and a warm bottom end...very versatile. I didn't have to pile on a lot of EQ to capture the air in the studio...very present, very natural sounding mikes."

Milan Bogdon
Masterfonics

"The S/N ratio is superior to some of the other mikes we used. They're bright and clean so we don't have to push the EQ. Superb mike...great for vocals, overheads, snare, toms, electric and acoustic guitar...it seems to work well wherever we put it."

Jeff Baxter
Producer/Artist

"If I'm not getting what I want from another microphone...I've been putting up the 4051 and it nearly always does the job."

Mack Emerman
Criteria Studio

"The response is very flat...it holds the natural tonal qualities even at high sound pressure levels."

Now it's your turn!

Compare the new Audio-Technica 40 Series against the very best in your studio. Contact your A-T pro sound dealer today.

Please send technical data
 Arrange 'no obligation' demonstration

Name: _____
Company: _____
Address: _____

Postcode: _____
Tel: _____ Fax: _____

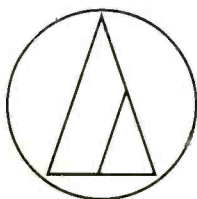

PRO-AUDIO DIVISION

audio-technica®

□ INNOVATION □ PRECISION □ INTEGRITY

Technica House, Lockwood Close, LEEDS LS11 5UU
SALES: (0532) 771441 FAX: (0532) 704836

SCOTLAND
LOUIS GRACE ELECTRICAL
(041) 632 4633

IRELAND:
G.F.D. COMMUNICATIONS
(0001) 713455

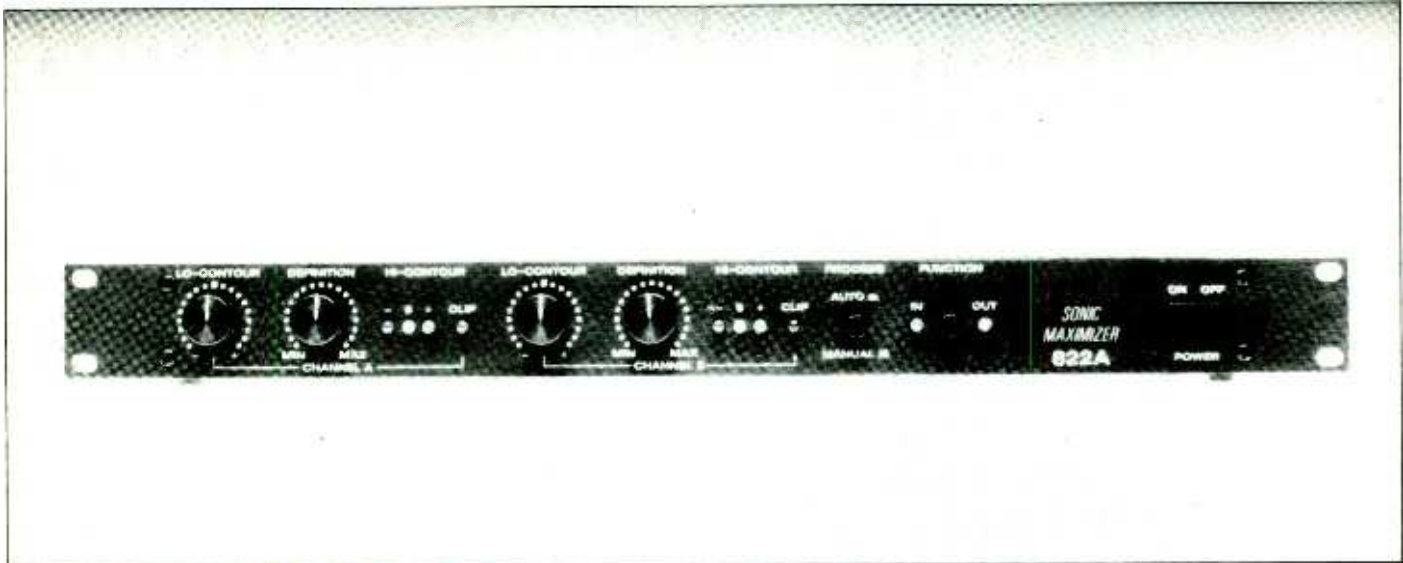

BBE 822A

Dave Foister studies enhancement and reports on the reality

I'm sure I'm not the only one to have joked about the *Better Knob* on my console: the client says: "Can you make X sound better" and the engineer replies "Certainly, I'll just turn up the *Better Knob*." The joke of course is the idea of a universal panacea, one standard process capable of improving any sound source whatever might be wrong with it. Recording people deal in specifics, in careful precise control of sound, in tailoring equipment and treatment to produce a clear required result. So how can it be that there is a market for devices which not only claim to be a *Better Knob*, but remain vague about what precisely they set out to do and how they do it?

One curious aspect of the enhancers/exciter market is that while most of the products make similar claims about increasing clarity, adding life, and restoring subtleties lost elsewhere in the signal path, they all seem to have different ideas about what problems need correction, what process to use to achieve it, and how much to tell us about what's going on inside. Some use controlled distortion to add supposedly missing harmonics, which many regard as a rather peculiar idea after all the care taken to eliminate distortion elsewhere. The BBE 822A does not work in this way. Many, in an apparent attempt to tantalise, remain deliberately reticent about what they do to a signal, and I feel sure that for many engineers this merely arouses suspicion that the process is some sort of con. Few of us like the idea of taking someone else's opinions on trust to the extent of routing our entire work through their little black box. Again, the BBE does not fall into this category, being

comparatively straightforward about what it does. The principal problem addressed by the 822A is the fact that whatever we do, the end result comes out of loudspeakers, which as BBE point out "have difficulty dealing with the electronic signals supplied by an amplifier." The manual goes on to say, in effect, that because these problems have proved unsolvable nobody has really bothered to try. It points out that phase integrity between frequency bands is lost when a signal passes through a speaker, HF being delayed so much that fundamentals can reach the ear ahead of the harmonic components. This, apparently, "is technically called 'envelope distortion'." BBE's research when developing the 822 centred on correcting for these phase shifts, and they make the bold claim that "while there are differences among various speaker designs in the magnitude of their needs for correction, the overall pattern of correction needed is remarkably consistent." Just as well really. The procedure employed is simple. The signal is divided into 3 bands, low to 150 Hz, mid from there to 1200 Hz, and high above that. The low band is delayed about 2.5 ms and the mid-range about 0.5 ms, with no delay on the highs. This certainly ties in with the preamble about loudspeakers, but the unit goes further, making 'dynamic amplitude corrections in both positive and negative directions' to the high band based on the relative harmonic content levels of the high and mid groups. In other words, the tonal balance is continuously being altered, which would seem to have little to do with the time domain problems the unit sets out to overcome. In addition the front panel offers what seem to be

gain controls for the high and low bands; Lo Contour provides boost and cut of the low group while Definition appears to boost the highs. The manual is uncharacteristically hazy and contradictory about this; first it says the control regulates the amount of amplitude compensation while later it says it increases the amplitude of the HF band relative to the mid band 'providing an improved spectral balance between the high and mid bands.' There is also an Auto switch whose function is far from clear, although Auto mode is considered normal operation. This is said to provide 'dynamic response to the HF band in relation to the mid band' allowing it to either compress or expand the high band, as opposed to manual mode which gives a factory preset expansion ratio for the high band. The Lo Contour and Definition controls are active in both modes.

As well as the obligatory Clip LED, the front panel features a group of three indicators showing what the HF band processor is doing. The central amber LED shows when no amplitude compensation is being applied: the manual says this means "the programme spectral content is correct". A green LED shows the HF is being boosted while a red one indicates HF reduction, and again the manual manages to imply that this is being done to correct failings rather than to provide a pleasing enhancement.

As with any piece of kit, the most important consideration is what it sounds like, and here of necessity any comments must be entirely subjective. If this were, say, a compressor, the reader would know what to expect and I could report on how well its various parameters matched those expectations. By its nature the 822A is a sound, a treatment, and I can only attempt to convey my impressions of that sound.

Let me say straight away therefore that I like it, to the extent that I have used it one way or another on virtually every session I've done while it has been in my possession, although I remain sceptical about some of the ideas in the manual. My main reservation concerns the phase compensation process, which is always active even

Bob Ludwig

RECOMMENDS

DOLBY SR



Randall Wallace

**“With Dolby SR,
I can master CD’s that
are second to none.”**

Award-winning mastering engineer Bob Ludwig knows what it takes to turn original recordings into best-selling albums. That’s why he likes to work from analog masters that are recorded with Dolby SR.

“Dolby SR masters are transparent, free of hiss, hum, and print-through. That’s just what I need to master state-of-the art CD’s.

“In fact, Dolby SR’s high resolution can actually reveal the limitations of the compact disc. With Dolby SR, ‘AAD’ on the label is an asset, not a drawback.”

Bob Ludwig, Vice President and Chief Engineer of Masterdisk Corporation, has mastered hundreds of gold and platinum albums. Bob and Masterdisk have earned numerous honors, including seven Mix TEC Awards.

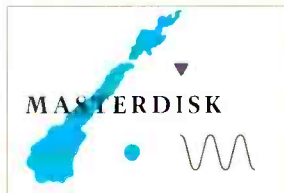

For more information on Dolby SR, contact your Dolby professional products dealer.

Dolby SR: now 50,000 tracks worldwide.

DD Dolby®

Dolby Laboratories Inc. • 100 Potrero Avenue San Francisco, CA 94103-4813 • Telephone 415-558-0200 • Telex 34409 • Facsimile 415-963-1373
346 Cuspm Road London SW9 9AP • Telephone 071-720-1111 • Telex 919109 • Facsimile 071-720-4118
Dolby and the double D symbol are trademarks of Dolby Laboratories Licensing Corporation. © 1990 Dolby Laboratories S9091Q1

USER REVIEW

with the front panel controls set flat. Frankly with it set like this I could not detect any significant audible difference as I switched the unit in and out. Adjustment of the controls, however, proved much more rewarding. It was readily apparent that what was going on was more than simple EQ, and all the claims about enhanced clarity and life began to ring true.

As with most devices in this broad category, restraint is vital. It is easy at first to go over the top with the effect, which can make things sound harsh and thin. This is particularly true when processing the entire mix, where a small amount of the Definition control is all that is required to inject significant sparkle and vividness. Individual instruments can benefit greatly, acquiring greater prominence in a mix without harsh EQ or excessive levels. I found this to work well, for instance, on vocals, piano, guitar, horns and drum overheads. The cynical might suggest that its effectiveness has more to do with the unusually broad-band nature of the equalisation than anything else, but I'll give it the benefit of the doubt. In fact I have yet to find anything which cannot be made to spring into life with judicious use of the unit, while the process used manages to avoid the phony, harsh edginess sometimes associated with other types of enhancer.

Some of the changes in the 822A compared with the earlier 822 can be slightly limiting. While the 822 comprised two quite separate processors, the newer model has a single in/out switch and the auto function is likewise shared between the two channels. This last is less significant than it might be since the auto switch makes little discernible difference to the effect, but it seems curious that the unit should be treated as a stereo device in this way when it is clearly likely to be used as two discrete processors in a mix. Besides this, there is presumably no attempt to link the two dynamic processes for true stereo use, although I was not aware of any image shifting as a result nor of any problems in mono. For stereo use, the uncalibrated controls are awkward to match accurately despite their clickstops; counting the little dots round the knobs is less than ideal. It should be pointed out that this process cannot be used on one half of a stereo signal since the delays involved produce quite predictably unpleasant effects.

Other applications suggested by BBE include the standard enhancer uses such as copying, broadcast and PA use. Certainly it has a place in cassette transfers, where it can inject a useful bite and sparkle, but this kind of application places it squarely in the enhancer pigeonhole and perhaps belies the unit's declared raison d'être. On the other hand, it works wonders in making small speakers sound much bigger and fuller.

If much of this review seems questioning, this has more to do with the way the unit is presented than what it does. In my opinion, the BBE 822A is an extremely useful enhancement device, eminently controllable and pleasingly free from unexpected side-effects and with a multitude of worthwhile applications, which has the misfortune to be saddled with some unnecessarily broad claims. I recommend you should try it, and, if you like what it does, use it. I did, and I do. □

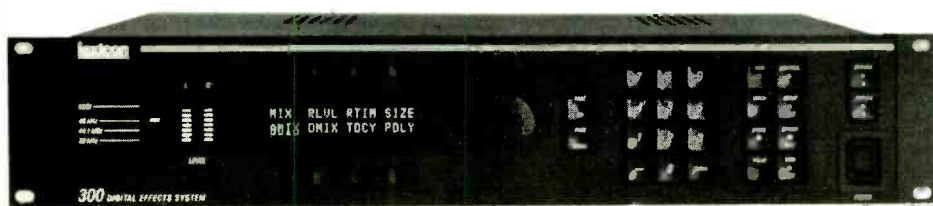

Lexicon 300

Lexicon's latest mid range effects processor examined by Patrick Stapley

The 300 fits into the Lexicon hierarchy mid way between the 480XL and PCM70, both in terms of facilities and price; it offers a number of features that will be familiar to current Lexicon users, as well as some fresh and innovative ones. This 2U, rack mount unit could be viewed as a replacement for the Lexicon 200, which proved particularly popular with broadcast and AV facilities: indeed the 300, with its Timecode and Stereo Adjust modes, appears aimed at a far wider market than purely multitrack music studios.

Inputs/outputs

The analogue I/Os are via electronically balanced XLRs (2 in/2 out), and the input is switchable 0 dB/+16 dB. There are two digital formats available via three types of connector—AES/EBU input is on XLR, and SPDIF input is via RCA phono or fibre-optic connector; the user specified output format is supplied to all three connectors. MIDI In, Out and Thru sockets are provided, timecode input is via XLR and there is a DE9 communications port for future enhancements.

To save the user time in reconfiguring I/O status, the unit includes eight setup presets containing common I/O configurations which can be edited, and stored in 64 setup registers. These setup presets will reset the type of input connector, and the format of the digital output (an analogue output is always present)—for example the input could be selected to Optical and the output to AES/EBU, or XLR In/SPDIF Out etc. In addition, setups contain the status of Emphasis, Copy Prohibit, Meter Source, and the Internal Sampling Rate (48 or 44.1 kHz) when the input is analogue—when the input is digital, the internal sampling rate will automatically lock to the incoming clock. Loading a Setup Preset/Register will also load one of the units stored sounds, and unless previously edited, this will default to the first effect preset—(P1) Large Hall.

Left and right analogue I/O levels are separately adjustable from front panel soft controls, and have a range of -10 to +10 dB in 0.1 dB steps, which of course follows the Input Gain Switch at the back of the unit. Any adjustments will remain in the systems memory unless the unit is globally reset to its original

factory settings (0 dB I/O).

Both the A/D and D/A converters incorporate oversampling by 64x and 8x respectively. Without going into masses of detailed figures, the general spec of the unit is very impressive, and the signal-to-noise of the analogue output at 100 dBm minimum, makes the unit noticeably quiet, if not the quietest of all Lexicon's reverb/effect units.

Front Panel

The front panel can broadly speaking be divided into six sections. Starting from the left there are four indicators which light to show the internal sampling rate (48, 44.1 or 32 kHz) and the presence of MIDI data. Next to these are the nine segment bargraph meters consisting of six green, two amber and one red segment—as mentioned their source is switchable between analogue input, digital input and effect output. Next is the display window with two lines of 20 alphanumeric characters; arranged above and below this are a total of eight soft buttons, each of which selects the parameter displayed nearest to it. To the right of the display is a stepped rotary control or 'Soft Knob', which is used to adjust selected parameter values and to run through presets, registers, lists etc. Two buttons marked Page Up and Page Down select the different pages of parameters associated with the systems operational modes. A numeric keypad is provided for keying in Preset/Register numbers, and for entering time code values, but frustratingly it cannot be used for entering parameter values. Eight dedicated function buttons switch the unit into different modes of operation, these are—RUN which is used to select and load stored Setup Presets or Registers; SETUP EDIT used to create or modify the current setup including Effect Preset selection; CONTROL which accesses various global system functions, including the MIDI Table and the mass deletion of Setup and Effect Registers (there is no provision for deleting single Registers other than overwriting them with an unused Register); EFFECT EDIT allows the current Effect's parameters to be modified; MOD EDIT is used to assign MIDI patches; VALUE toggles and display between parameter ID and its current value; STORE commits modified Presets to the systems memory; and MACH at present is

unused. At the extreme right of the unit above the power switch are two Bypass buttons, A and B, which at the moment operate in unison—it's possible that these, along with the Mach button, have been provided for a future 'Dual' machine facility which, like the 480XL, will allow two effects programs to be run simultaneously.

Operation

Gaining familiarity with the 300 is by no means immediate; it's not a unit that one can play around with for five minutes and feel instantly at home with—although Lexicon do provide a 'Quick Reference Guide' sheet. Locating certain operative functions hidden behind function keys and pages of parameters is at times less than intuitive, and it can be confusing when the function keys recall the last selected page rather than defaulting to a 'top level' start page. For example, what should be a simple matter of selecting an effect preset, can become complicated by having to search for the correct page once the correct operational mode has been entered—it would perhaps have been better if an important, and regularly used function like this were defaulted to. Obviously there is the trade-off here, between the convenience of returning to a function where you left it, and quick easy access to commonly used system parameters. Having said this, the speed and ease of operation improves with familiarity, but I can foresee a certain degree of user impatience in the early stages.

The basic operational procedure is as follows—once the unit is powered up the display will default to Control Mode, Page 1 allowing the system's memory protection facility to be switched on or off (if the Store function is to be used to save user effects etc, memory protection should be disabled). Run Mode is then entered to select an appropriate Setup Preset; the unit will automatically default to the last Setup Preset used. Once selected the Preset is loaded by pressing the Enter Button on the keypad. The next step is to select Edit Setup Mode which allows the Preset, if required, to be modified as described earlier and, by selecting the Store Function Button, to be stored in a Setup Register for future use. Loading the Setup will also load an Effect Preset, but to access other Effect Presets the display must be showing the correct page. Effects Presets can then be viewed through by turning the Soft Knob, and loaded by pressing the Enter Button. The loaded Effect is edited by switching to Edit Effect Mode where various parameters can be accessed from different pages and adjusted; the result may be renamed, and stored in a specified Effect Register by accessing Store Mode.

Another operational criticism that should be mentioned, concerns the soft buttons positioned above and below the display. As described, a parameter for an effect preset is accessed by pressing the soft button that relates to it, causing the abbreviated parameter to be underlined. If the soft button is pressed a second time the display will briefly switch to show a more detailed description of the parameter along with its value—this is similar to the action of the Slider

In France, a mixer you've never heard of outsells the ones you have. Why?

Standard features of the dazzling



include :

- Integral console/tape machine automation
- Multi-function dynamics on every channel
- Powerful parametric equalisation
- Twin mix concept, 2 line inputs
- 2 stereo busses
- 14 automated sub groups
- Individual status control
- Reverse talkback
- 2 stereo fold backs
- 5 stereo echo returns
- Bargraph option
- Lo noise and hi dynamic range
- Sophisticated soloing system
- 32 track routing
- Stereo output compressor

When Jean-Pierre Lafont began designing mixers in 1973, he started building a strong reputation. Within a few years of launch, his Producer consoles had become the most successful of their price range in the country.

Thankfully, Lafont Audio Labs consoles are no longer France's best kept secret. The innovative **Twin Mix 800** makes its début to the rest of the world through the Home Service.

The mixer comes with an integral computer system for tape and console automation.

Sound it out for yourself and we are convinced you'll agree Jean-Pierre makes consoles par excellence.

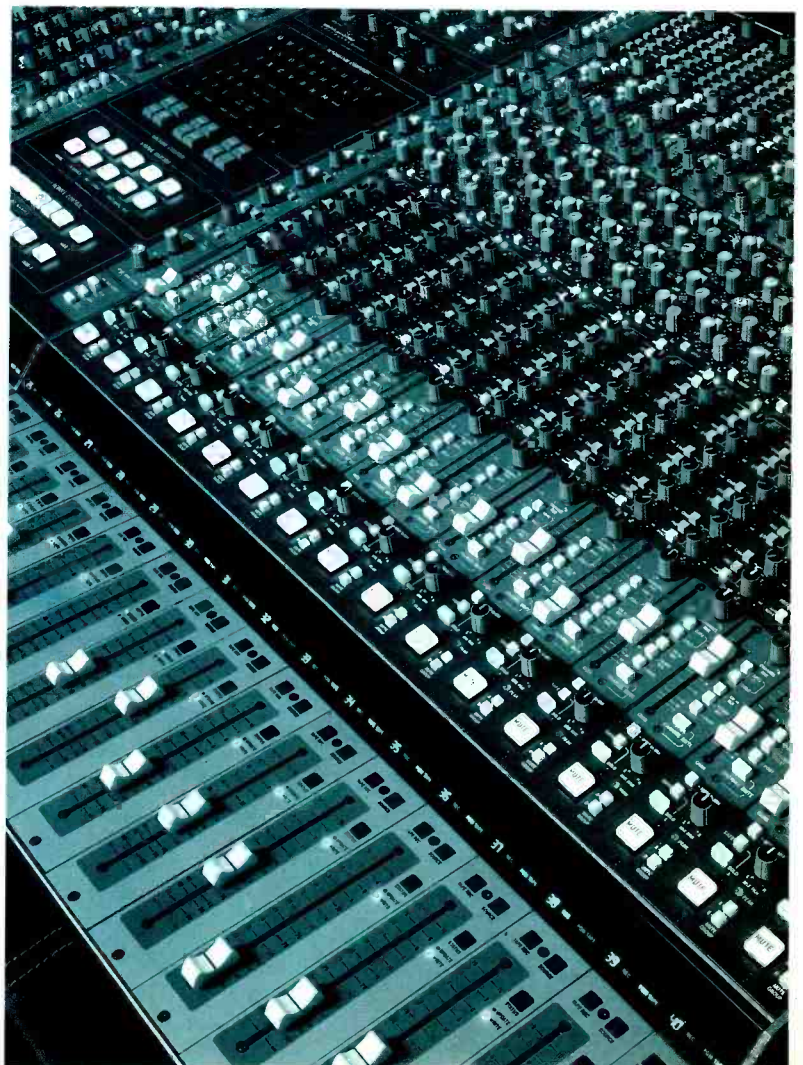

MANUFACTURED BY
LAFONT AUDIO LABS
INTERNATIONAL REPRESENTATION :
THE HOME SERVICE
UNIT 2, 10 WILLIAM ROAD, LONDON
NW1 3EN
TEL : 071 388 1820. FAX : 071 388 0339

Display Buttons on the 480s LARC controller. The problem is that, unlike the 480, what also happens is that the parameter value is incremented each time this function is used—what appears to be, and perhaps should be, an inert check function actually edits the Preset. This is especially worrying when the parameter control is a toggle, where it could easily cause a great deal of confusion to an unsuspecting user. The same problem exists with MIDI Patch parameters.

There is also a small but irritating, intermittent problem connected with the operation of the Soft Knob—when stepping through certain functions, like presets, an incremental or decremental step occasionally fails to register on the display, which results in the subsequent step causing the display to skip a position. It's possible this was an isolated fault on the review unit only, as other units weren't checked.

Algorithms, Presets And Parameters

The 300 contains four algorithms—Reverb, Ambience, Pitch Shift and Stereo Adjust. The 75 Effect Presets are divided into 38 Reverb, 21 Ambience, 9 Pitch and 7 Stereo. The Reverb Presets have 27 adjustable parameters, the Ambience have 12, Pitch 15 and Stereo 25.

The Reverb parameters are arranged in four pages. Many of the parameters will be familiar to Lexicon users such as Size (4-39.4M), Spread (0-70), and Shape (0-256) which collectively create the overall size of the reverberant space. As with the 480, Size adjustment causes both the Mid Reverb Time (0.03-64.2 s) and Spread to alter in a linear fashion; this relationship can be broken using the Link parameter, allowing unnatural reverb effects to be created. The algorithm has a maximum Predelay of 1 s arranged in 2 ms steps, and four separately adjustable Pre-Echo Taps. Pre-Echoes 1 and 2 have a maximum delay of 1 s, whilst 3 and 4 go up to 2.8 s and include Feedback (-93 to +93%); odd and even numbered taps are split between left and right channels. The apparent density of these early reflections is affected by the Diffusion parameter which determines the initial build up of echo density over time. Treble Decay (500 Hz-21.2 kHz) sets the frequency above which sounds, except for the Pre-Echoes, decay at a progressively faster rate. Bass Reverb Time (0.2x-4.0x) acts as a multiplier of the Mid RT value, and the Bass/Mid crossover point can be set anywhere between 100 Hz and 26.5 kHz). A 6 dB/octave low-pass filter shares the same range as the crossover, rolling off all frequencies above its selected frequency. Two parameters that were previously found in the 480's 'Effects' algorithm have been incorporated here, these are—Spin (0-48) and Wander (0 μ s-37 ms): they work together to synthesise the random changes in timbre that are present in natural reverberation, and help introduce a further element of realism to the sound.

Spin and Wander have also been included in the 300's Ambience Algorithm, as have Size, Pre-Delay (up to 99.9 ms in 1 ms steps), Diffusion and Roll-off (500 Hz-21.2 kHz). The Reverb Time (0.24 s-32.44 s) is not split between mid and low frequencies in this algorithm, and the link between RT and Size is fixed. Pre-delay is positioned before Diffusion, and there is the facility to separately delay the dry output (up to 99.9 ms), which can then be blended into the overall output using the mix control. Between the Reverb and Ambience algorithms an enormous

variety of sounds can be produced ranging from a 'Ballroom' to a 'Basement', a 'Drum Cave' to a 'Powder Room', a 'Gothic Hall' to a 'Full Closet'!

The Stereo Pitch Shift algorithm operates either in stereo with linked parameter control, or as two separate mono signal paths, depending on which Mode (stereo or mono) is selected. Left and right signal paths are identical, first entering a Delay Line (0-510 ms), then a Pitch Shifter (-2 to +1 octaves) followed by Feedback (0-99%) to the input of the delay line, and output. There are three parameters that control pitch—Glide, Pitch Interval, and Fine Pitch. Glide is used for dynamic adjustments to pitch such as repairing an out-of-tune vocal, or to create a smooth glissando effect—its operation can be either manual or implemented via MIDI. Pitch Interval provides coarse pitch control which will increment/decrement in exact musical intervals—ie Minor 2nd, Major 2nd, Minor 3rd etc—providing Fine Pitch remains set at 0 cents. There is a display for each of these parameters which shows the pitch percentage value, the musical interval, and the number of cents of fine adjustment. These parameters are duplicated for left and right channels, but in Stereo Mode the left control adjusts both channels simultaneously, although this link is unfortunately not echoed on the display. A Sync parameter, is used in stereo operation to keep both channels in constant synchronisation during processing, so avoiding any phase discrepancies. Apart from the more obvious pitch Presets like 'Octave Down', 'Chipmunks' and 'Going South' (a regenerating glissando effect), there are also more subtle Presets like 'Vocal Chorus', and a good flanging preset, 'Pole Flange'.

The Stereo Adjust algorithm has essentially been designed for digital mastering, but with the inclusion of a 5 s stereo delay line it becomes more versatile. The parameters include a Stereo Fader (off, -72 dB to +12 dB), Balance (L+78 to R+75 dB), and separate stereo and individual channel 6 dB/octave shelving EQ (-18 dB to +6 dB @ 100 Hz-26.5 kHz). De-Emphasis can be switched on/off; there is the facility to add on 11 μ s delay to the left input to compensate for the inherent right channel delay caused by F1 processing, and inputs can be stereo reversed and/or phase inverted. An alternative parameter to Balance is Rotate, instead of simply adjusting channel gain between left and right channels, a phase inversion technique is used. The Rotate function produces some interesting effects when used in conjunction with programme recorded on figure of eight microphones or coincident pairs—where it appears to cause the mics to rotate.

Spatial EQ is another interesting parameter that determines the low frequency content in the Sum and Difference channels; at one extreme it totally removes bass from the mono component of the sound whilst boosting it in the stereo—used with care, this parameter can produce some subtle spatial effects as well as altering the apparent depth of the sound. Delay is positioned at the end of the algorithms signal path, where it can be added to the overall stereo signal and/or the individual channels—the maximum value for each side is 5 s. In addition, a Fine Delay (0-500 samples) is also available for each channel—a sample at 44.1 is equivalent to 22.676 μ s. Feedback (-99 to +99) is provided both for the overall delay on each channel, and for the Fine delay on each channel—being fed back to the input stage of the algorithm.

Time Code

The 300 has the facility to change Effect Presets/Registers at user programmed timecode positions. Up to 50 Events can be stored, each of which will load an effect at a specific time code address, thus allowing automated program change during mixdown. Any of the usual time code formats will automatically be identified, and displayed on an 8 digit readout, accessed in Control mode. An Event is created by 'Snapping' timecode in real time, or by entering it manually via the keypad; once timecode value exists an Effect Preset is assigned to it. Events may be edited, copied and deleted.

Although the facility brings little new to MIDI users—the unit also offers MIDI Program Change—it does provide a new dimension for users working without MIDI but operating with timecode: for example it could be used to automate digital mastering. To work 100% successfully, the 300 requires gaps in the audio to allow for the changeover time between effects—this is especially relevant when changing from one algorithm to another, which can take over a second; loading between Presets/Registers sharing the same algorithm is almost instantaneous.

MIDI

Lexicon continue their strong commitment to MIDI by offering a comprehensive array of features which fall into four main categories—*Dynamic MIDI* patches, which allow real time control of up to five parameters simultaneously; Program Change, for changing Effects Presets or Registers; Automation via System Exclusive or Non-Registered parameter messages, allowing real-time data to be stored and replayed from a MIDI sequencer; and MIDI Dump, for copying Registers, Events, The Current Setup and the MIDI table to a MIDI device accepting System Exclusive, including other Lexicon 300s.

The five *Dynamic MIDI* patches connect virtually any MIDI controller to any parameter in the 300, via Source and Destination selection in Mod Edit Mode. Like the 480, the scale of the controller is variable between -200 and +200%; a setting of 100% causes the controller to operate over its full scale. A Threshold setting is also available that sets a point below which the controller will not affect the parameter. MIDI Patch data can be stored along with the rest of an edited Preset in the Effect Registers.

The MIDI Table, affects Program Change messages in three ways; OFF will cause the 300 to ignore all incoming messages; FIX will cause incoming Program Change numbers to switch Effect Presets in a set manner; MAP allows any Preset or Register to be assigned to any Program Change number.

Conclusion

On the minus side, the system can be operationally awkward and contains a few confusing elements. On the plus side, there is no doubt that the quality of the 300 is excellent—the construction of its algorithms, the range of parameters, and the sound of its presets are all impressive. The facilities it offers for configuring setups and operating MIDI are comprehensive; and the unit generally manages to cram in a lot of features. It will be interesting to see how the unit is received, and the type of facilities that buy it; it will also be fascinating to see how a mid price unit fares in today's economic climate. □



Alesis QuadraVerb Plus

Two effects units from Alesis, at either end of their range, have had recent upgrades. Patrick Stapley reviews the improvements

The *QuadraVerb*, Alesis' top of the range digital effects processor, has recently undergone a software upgrade, transforming it into the *QuadraVerb Plus*. This has added a number of new facilities to the unit through an inexpensive EPROM change. To enlighten those of you who are unfamiliar with *QuadraVerb*, I'll give a brief outline, and then detail the new software.

The 1U, 19" rackmountable unit has analogue stereo I/Os (¼" Jacks), MIDI connectors and is powered via an external 9V AC transformer. The front panel contains a level indicator, I/O rotary controls, a backlit LCD and 16 function buttons. *QuadraVerb* gets its name from the unit's ability to run up to four effects simultaneously; these effects—Reverb, Delay, Pitch and EQ—are arranged into different 'Configurations' which provide the structure for a program. The four effects are each sub-divided into several effect types, for example—REVERB=Plate, Room, Chamber, Hall and Reverse; PITCH=Chorus, Flange, Pitch Detune, Phase Shifter, and Leslie—these are then further broken down into their respective parameters. Within a Configuration there are a number of switchable signal paths, source mixing, and individual level controls for each effect output enabling them to be switched off entirely if desired. Up to 100 programs may be stored in RAM including the 90 factory programs which, although overwriteable, can be reinstated at any time from ROM. Programs will dump/load via MIDI; Program Change is transposable using the MIDI Table, and up to eight parameters can be controlled simultaneously from selectable MIDI controllers. The 16 bit unit is capable of producing some extremely complex effects, and its 42 kHz sampling rate provides a 16 Hz-20 kHz ±1 dB bandwidth.

QuadraVerb Plus offers three new effects—Sampling, Ring Modulator, and Resonator—each form a new Configuration, making a total of eight altogether; the Ring Modulator and Resonator configurations both include Delay and Reverb. Additionally the '5 Band EQ→Pitch→Delay' Configuration now has the choice of a Multi Tap Delay, and an Auto Panner/Tremolo Modulator

which also appears in the 'EQ→Pitch→Delay→Reverb' Configuration. The original features and operation of *QuadraVerb* remain identical, the only difference is that the last ten factory programs have been replaced with programs incorporating these new features.

The maximum sampling time is 1.5 s, and samples are captured either in Audio Trigger mode, which starts recording at a threshold of -18 dB, or manually by pressing the Bypass button. Sample playback is also activated by an audio trigger (unfortunately this was faulty on the unit we were supplied with) or manually by the EQ button, but a third method exists using MIDI. Two types of MIDI trigger are available; the first (MIDI One Shot) causes the whole sample to playback, the second (MIDI Gated) plays the sample only as long as the key remains depressed. A sample will follow keyboard pitch over a maximum two octave range (1 up, 1 down), and the keyboard base note is assignable. The start and end points of the sample are adjustable in 10 ms steps, and a Looping facility is provided for continuous play. The parameters for the Sampling configuration are accessed from the Delay button.

Ring Modulation is an effect that will be familiar to anyone who remembers Dr Who's Daleks. The effect works by stripping a sound of its fundamental content leaving behind just the harmonics; *QuadraVerb Plus* takes this harmonic portion and splits it by implementing an equal up and down pitch shift. The shift is adjustable in Hertz (1-300 Hz), so that if a shift of 100 Hz is applied to a harmonic of 1 kHz, the resultant outputs will be 900 Hz and 1100 Hz. The ratio between the two pitched signals is adjustable, both in terms of what is sent to the mix output of the configuration, and the other two component effects—Delay and Reverb.

The Resonator Configuration (Resonator→Delay→Reverb), provides five chromatically tunable resonators, each with a five octave range. They will follow MIDI notes, and like the Sampling Configuration, they can operate in a Gated mode causing an input to be connected only for the note's duration. The decay time of the resonators is globally controlled, and this, of

course, may also be modulated by a MIDI source. both the Ring Modulator and Resonator parameters are accessed by hitting the EQ button once the respective Configuration has been selected.

With the addition of Multi Tap Delay, *QuadraVerb Plus* now offers four types of delay; the original delays being—Mono, Stereo, and Ping Pong. Multi Tap Delay is only available in the '5 Band EQ→Pitch→Delay' Configuration, where it provides up to eight taps having a maximum cumulative delay time of 1500 ms. As before, the input to the Multi Tap Delay is a mix between pre/post EQ and the pitch shifted output. Each tap is separately controllable using the following parameters—Delay, Volume, Panning, and Feedback. There is also a Master Feedback control that adjusts all the taps globally, although the individual feedback displays don't follow this change.

Auto Panning or Tremolo Modulation is available across the direct EQ output in the 'EQ→Pitch→Delay→Reverb' and '5 Band EQ→Pitch→Delay' Configurations. Either effect is accessed from the Mix button, where parameters for Speed and Depth can be adjusted. The effects suffer from digital noise, but I am told that 'new de-bugged' software (Version 2.4) has cured the problem.

One slightly irritating feature about *QuadraVerb* is the fact that the direct signal is mixed together with the effect signal in the majority of factory presets; if the unit is patched with auxiliary sends and returns, the user has to continually turn down the direct output for each program. However this can be remedied by storing each preset after this modification removing the inconvenience for the future.

Alesis plan to release a further unit, the *QuadraVerb GT*, later in the year. This unit has all the *QuadraVerb Plus* facilities, as well as guitar based processing which includes an analogue pre-amp section, a guitar amp and cabinet simulator, variable compression, and a noise gate.

MicroVerb III

Microverb is the cheapest digital effects processor from Alesis and it offers a surprising number of static presets. The new unit has been expanded both in its capabilities and size (19"×1.75"×4")—*Microverb II* was a ½rd rack mount unit. Like *QuadraVerb*, it has stereo I/Os on ¼" jacks and is powered by a 9V AC transformer—it does not have any MIDI facilities. A Defeat jack socket at the back of the unit allows any SPST-type footswitch to be connected

RECORDING
ARCHITECTURE

1987 1991

Studio Designers and Acoustic Consultants

Clients April 90 – April 91 include:

Magmasters	LONDON	Crazysound	GUADELOUPE
The Mill	COOKHAM	CTS	LONDON
EMI/SBK	LONDON	Boogie Park	HAMBURG
Manfred Mann	LONDON	Trevor Morais	MARBELLA
University of Wales	CARDIFF	Giesing Team	MUNICH
Werner	COPENHAGEN	Castle Hill	CLWYD
Ground Control	LOS ANGELES	Loco	GWENT
Exit	LISBON	I.C.L.	NEW YORK/BOSTON
Select Sound	KNEBWORTH	Ian Anderson	BUCKS
Soundings	NEWCASTLE	Rushes	LONDON
Bernard Sumner	CHESHIRE	Slaughterhouse	YORKS
Sade	LONDON	Blue Chip	STAFFORD
Mute Records	LONDON	Tape to Tape	LONDON
Ace Records	LONDON	Lansdowne	LONDON
Konk Studios	LONDON	The Waterboys	GALWAY
Forwardbeat	MANCHESTER	Neneh Cherry	LONDON
Daniel Miller	LONDON	British Aerospace	PLYMOUTH
Orinoco	LONDON	Blue Room	YORKS

THE BLACK BOX

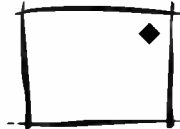

A C O U S T I C
C O N D I T I O N I N G
S Y S T E M

Completed installations include:

Ian Anderson	BUCKS	Bernard Sumner	CHESHIRE
Neneh Cherry	LONDON	The Waterboys	GALWAY
Sade	LONDON	Paul Carrack,	HERTS
Double Trouble	LONDON	Tape to Tape	LONDON
Billy Ocean	LONDON	Giesing Team	MUNICH
Parklands	HANTS	CTS 2	LONDON

Recording Architecture are registered with The Design Council
and listed as consultants under the DTI Design Initiative.



21-23 Greenwich Market, London SE10 9HZ.

Phone 081-858 6883

Fax 081-305 0601



PROGRAM KNOB							
	1	2	3	4	5	6	7
SMALL ROOMS	DEFEAT	BRIGHT AMBIENT	BRIGHT AMBIENT	BRIGHT AMBIENT	BRIGHT 0.5s	BRIGHT 0.5s	BRIGHT 0.5s
MEDIUM ROOMS	BRIGHT 1.2s	BRIGHT 1.2s	WARM 1.2s	WARM 1.2s	WARM 1.2s	WARM 1.2s	BRIGHT 1.2s
LARGE ROOMS	WARM 1.8s	WARM 1.8s	WARM 1.8s	BRIGHT 1.8s	BRIGHT 2.0s	WARM 2.0s	BRIGHT 2.0s
MEDIUM HALLS	BRIGHT 1.5s	WARM 1.5s	WARM 1.7s	BRIGHT 1.7s	WARM 2.0s	DARK 2.0s	BRIGHT 2.0s
LARGE HALLS	BRIGHT 3.5s	WARM 3.5s	WARM 4.0s	BRIGHT 4.0s	WARM 4.0s	WARM 4.5s	WARM 5.0s
CHAMBERS	WARM 0.8s	WARM 1.0s	BRIGHT 1.0s	WARM 1.0s	WARM 1.0s	WARM 1.2s	BRIGHT 1.2s
PLATES	BRIGHT 0.5s SOFT ATTACK	BRIGHT 0.5s HARD ATTACK	WARM 0.8s SOFT ATTACK	WARM 0.8s HARD ATTACK	WARM 1.0s SOFT ATTACK	DARK 1.0s SOFT ATTACK	BRIGHT 1.0s SOFT ATTACK
GATES	BRIGHT 100ms	BRIGHT 150ms	DARK 150ms	BRIGHT 150ms SOFT ATTACK	BRIGHT 165ms	BRIGHT 200ms	METALLIC 175ms
REVERSE	125ms	125ms REGEN	165ms	165ms REGEN	200ms	200ms REGEN	250ms
SHORT DELAYS	20ms 1/16 trip.@250 BPM	25ms 1/16 trip.@200 BPM	30ms 1/16 trip.@167 BPM	35ms 1/16 trip.@143 BPM	40ms 1/16 trip.@125 BPM	45ms 1/16 trip.@111 BPM	50ms 1/16 trip.@100 BPM
MEDIUM DELAYS	100ms 1/16 @ 150 BPM	110ms 1/16 @ 136 BPM	125ms 1/16 @ 120 BPM	135ms 1/16 @ 111 BPM	150ms 1/16 @ 100 BPM	160ms 1/16 @ 94 BPM	175ms 1/16 @ 86 BPM

Extract from manual's program chart showing positions 1-7 of Program knob

as a bypass switch. The front panel has Input, Mix and Output rotary controls, with a single tri-colour LED acting as an input level indicator. Basic EQ is provided pre-effect by Low and High pots operating at ± 10 dB at 100 Hz and 4 kHz. Two continuously rotating stepped controls are responsible for preset selection: one selects the program type whilst the other steps through 16 permutations, resulting in a total of 256 presets. The very first preset functions as a bypass setting.

Microverb II contained 16 programs based around Small, Medium, Large and Gated reverbs; the choice in *Microverb III* has been extended to

include delay and effects programs. The 16 program types are—Rooms (Small, Medium and Large), Halls (Medium and Large), Chambers, Plates, Gated Reverbs, Reverse Reverbs, Delays (Short, Medium and Long), Regenerating Delays (Short and Long), Multitap Delays, and Effects. The reverb presets seem to cover most applications, although being picky, there is not much in the way of long pre-delay. The delay presets range from 20 ms to 500 ms and the Program Chart, supplied with the unit, usefully indicates their individual BPM values. Multitap delays vary from simple two and three tap arrangements making good use of stereo, to some

quite involved regenerating presets. The effects programs also use stereo to its full advantage producing some interesting spatial sounds.

The algorithms used in this 16 bit unit are all new; the frequency response is quoted as 20 Hz-15 kHz ± 2 dB, and the sampling rate is 31.25 kHz. The audio quality is high considering the unit's price, but care should be taken to achieve optimum signal to noise. If one takes into account the number of presets, the ease of operation and its rack mountability, *Microverb III* should appeal to a large spectrum of users. There is no doubt that it offers remarkable value for money. □

Standards Are Wonderful... Aren't They?

Standards are wonderful — that's why we have so many of them. The proliferation of different formats in digital audio inevitably leads to problems in transferring audio within the digital domain. And solutions don't come easy... except when they come in the form of Audio Digital Technology's multi-purpose



FC1 digital audio problem solver.

The cost-effective FC1 features two independent stereo signal paths for processing digital audio data, and basic functions include format conversion (AES/EBU, SPDIF, SDIF-2), the stripping of emphasis, phase inversion, coincident time correction and channel reverse. Real time digital mixing and channel crossfading are also possible with the optional remote control. So, if you're serious about digital audio and care about quality, contact ADT now.

- Two independent stereo signal paths
- 24-bit internal architecture
- AES/EBU, SPDIF and SDIF-2 in and out
- The stripping of emphasis and associated flags
- Truncation and digital dither
- Coincident time correction (CTC)
- Manual override of status bits on output
- Digital mixing and crossfading
- Internal 1kHz oscillator
- Channel reverse
- 1Hz, 20Hz and 100Hz high-pass filters
- Phase inversion
- Real-time fader control

adt AUDIO-DIGITAL-TECHNOLOGY

The Coach House, Manor Road, Teddington TW11 8BG
Telephone 081-977 4546. Facsimile 081-943 1545.

RELIABLE PLAYERS

SCOTT PAGE ON QSC.

"Powerful sounds and dynamic images are what make a live performance great.

On world tours with Supertramp,

Toto, and Pink Floyd there are no second chances on the bandstand.

I depend on my equipment

to work every night."

QSC Power Amplifiers... as reliable as the players who use them.



QSC

A U D I O

QSC Audio Products, Inc.
1926 Placentia Ave., Costa Mesa, CA 92627
714-645-2540

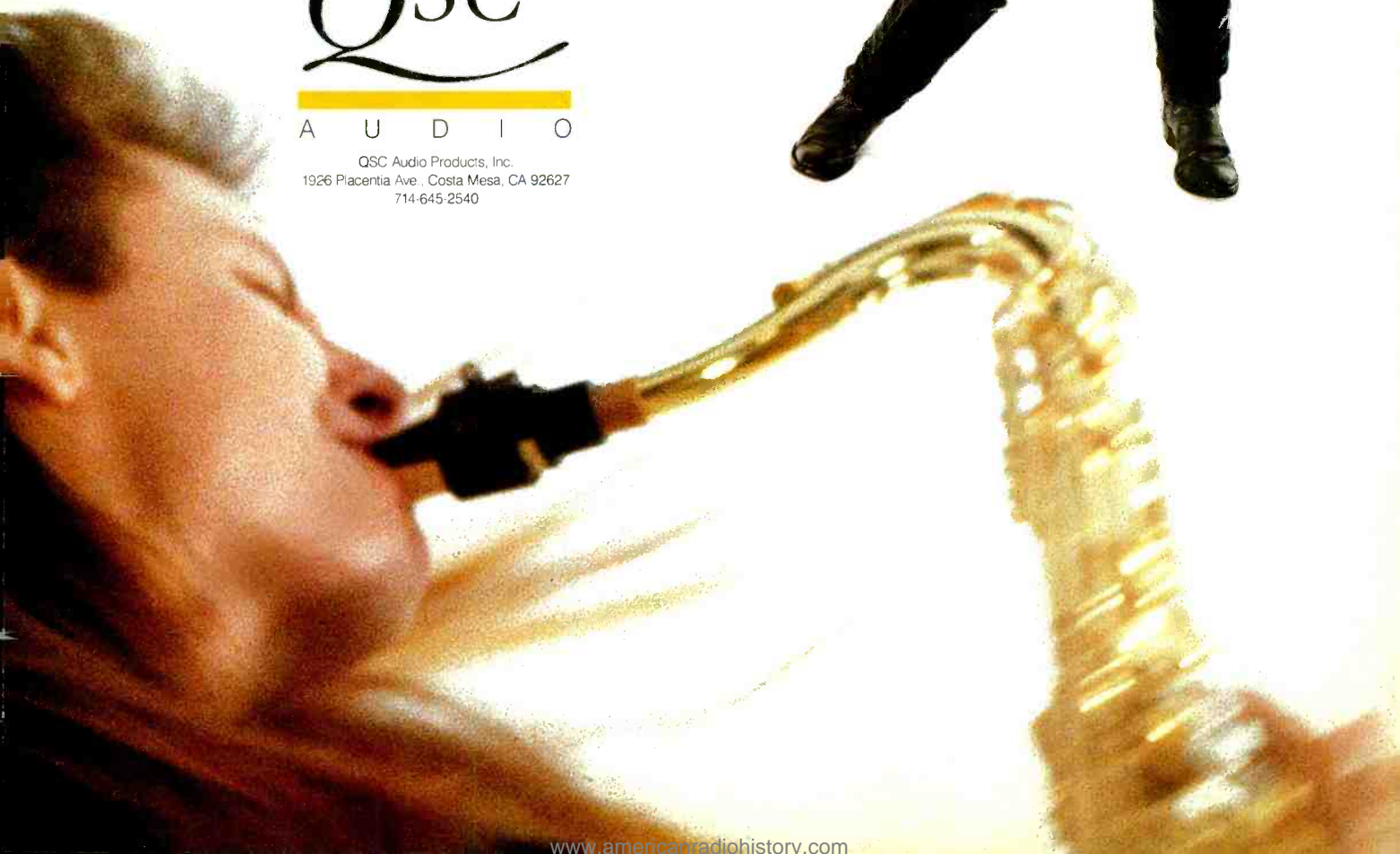



Zoom 9010

Patrick Stapley becomes familiar with a multi-effects processor

The Zoom 9010 is only the second product from this Japanese company who are also known for their R&D work for Korg. The first product, the Zoom 9002, was a comprehensive guitar effects processor, designed to attach to the musicians guitar strap. The 9010 is a rack mountable, 16-bit effects processor with a 44.1 kHz sampling rate, which by virtue of its four I/Os and ability to radically restructure internal architecture, can function in a number of different ways. With a very competitive retail price, the unit represents an attempt to crossover from the 'music shop' into the recording studio.

Connections And Controls

The front panel of this 1 U unit has a light grey textured finish; the controls consist of three groups of four buttons, and a stepped rotary dial. The central part of the unit contains a memory card slot to the right of which is the display section including a backlit LCD (24x2) with adjustable contrast. There is also a high impedance input with a dedicated level control (designed for direct connection of guitars, synths etc) which mixes into input 1. Positioned above one of the four button groups, used in setting up

input levels, are four dual coloured LEDs which act as basic input level indicators—a more comprehensive level display is available from the LCD.

The unit's four balanced inputs and four unbalanced outputs are via 1/4 in jacks; level switches (+4 dB/-20 dB) for both inputs and outputs are shared between pairs, ie—1 and 2, 3 and 4. MIDI In and Out sockets are provided, with the Out being switchable to Thru from the front panel. A remote terminal will connect a future remote controller, and two jack sockets are provided for footswitch or pedal connections.

Operation

There are two major elements that are fundamental to the operation and understanding of the system—Effect Modules and Routing Groups. The various effects within the unit are organised into four types of Effect Module (A, B, C and D) which each have a characteristic I/O configuration—there are 15 type A effects which have a mono I/O configuration; 13 type B effects with a mono input and stereo output; 10 type C effects with stereo I/O; and just two type D effects, Reverb and Multi Chorus, with selectable input and stereo output. Apart from various Reverb and Chorus effects, the unit offers Flanging, Phasing, Pitch Shift, Delay,

Equalisation, Excitement, Gating, Compression, Limiting, Tremelo, Amp Simulation, Distortion, and Wah-Wah. Many of these effects appear in more than one type of module, and generally speaking the more I/Os a module has, the more elaborate the effect becomes; the two Module D effects, for instance, each use the full processing power of the unit.

The Routing Groups restructure the system's architecture into four configurations; each of these groups arrange signal flow through one or a combination of effects belonging to one or a combination of Effect Modules. For example, Group 1 which is the simplest configuration, behaves like a conventional effects unit, taking one Module D effect which it connects between I/Os 1 and 2; Group 4 on the other hand, connects in series six Module A effects followed by a single Module B effect. As well as having control over the effect type and its parameters, the routing parameters within a configuration are also adjustable.

This should begin to give you an insight into the comprehensive and complex nature of the unit; it requires a considerable depth of understanding before it can be successfully operated, and I fear some users, who are looking for quick and easy effects, may be put off; those with more patience and time to experiment will find it a powerful piece of equipment.

The 9010 contains 60 factory presets and room for 60 nameable user programs; in addition presets can be saved to and loaded from RAM cards. Presets, or Patches as they are referred to, are tied to their respective Routing Groups, and are only accessible once that group has been selected. When the unit is powered up, it returns to the last selected Group and Preset; to access other presets in the same routing Group, the Edit Dial is used to step through the choices on the display—a preset is then loaded by hitting the Execute button. The Dial will operate at two speeds depending on how fast it's turned. To select a different Routing Group, the Group Change Mode must first be entered by repeatedly pressing the Mode button, which steps through six operating modes. Once this mode is accessed the required group is then selected using the dial and loaded as before by hitting the Execute button. The current preset and group number are always individually displayed in the centre of the unit.

The loaded preset can be edited in three different ways—firstly the effect/effects that make up the preset may be changed to any effect belonging to the same Effect Module, or individually bypassed; secondly the effect parameters can be modified; and thirdly the

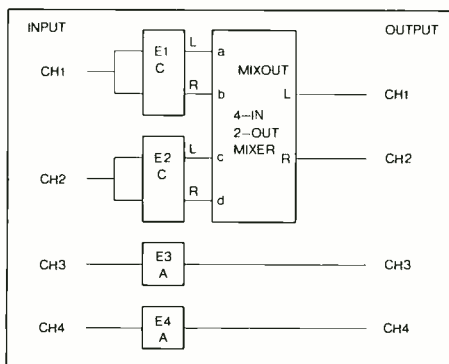

Fig 1. Routing group 3

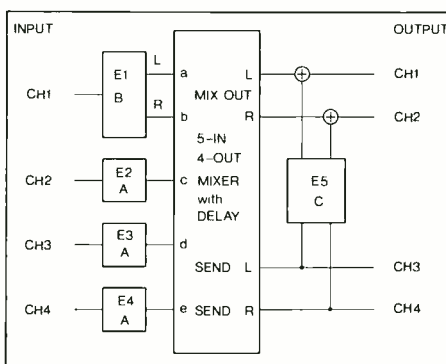

Fig 2. Routing group 2

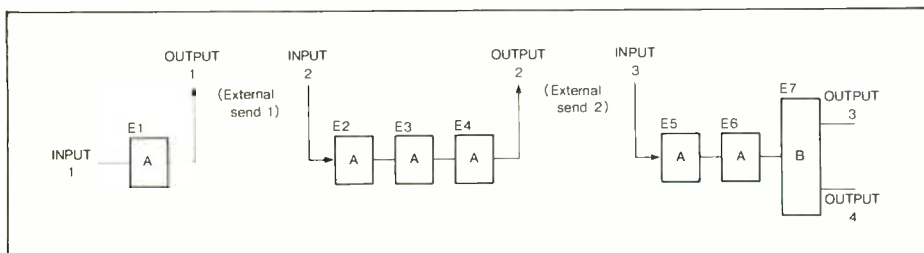

Fig 3. Routing group 4

routing parameters are adjustable. All of these operations are carried out using the dial and the Dial button which moves the display cursor between different levels of control. To aid multi-effect preset editing, the Quick button behaves like a solo by disabling all the effect outputs other than the one selected; it also restricts parameter selection to just the isolated effect. Effects may be copied either within a preset or between presets belonging to the same group; they can also swap position within a preset.

One of the more involved Routing Groups is Group 3 (Fig 1). This consists of two type C effects (stereo I/O configuration) which feed into a 4-in/2-out mixer, and two type A effects (mono I/O). The inputs of each C effect are paralleled; they are connected from inputs 1 and 2, and their mixed output is via outputs 1 and 2; the I/Os for the A effects is on 3 and 4. Depending on routing assignment the two C effects can be made to function in one of three ways—two separate effects receiving a mono input and outputting a mixed stereo output; one effect with stereo inputs and outputs; or two discrete mono effects. The last of these configurations, combined with the two A effects, turns the 9010 into four independent, mono effects units.

Routing Group 2 is perhaps the most complicated of the four (Fig 2). The four input channels feed one type B effect (mono in/stereo out), and three type A effects. These are then output into a 5-in/4-out mixer, which controls the level and pan position of each effect in regard to two stereo outputs—Mix Out on outputs 1 and 2, and Send Out on outputs 3 and 4. To make things more interesting a type C effect receives its inputs from the Send path and returns its outputs to the Mix Output. If you think this is sounding complicated, just wait! The mixer also includes built-in delay which can be added to each of the four input effects at both the Mix and Send output stages (eight in all). In addition there is another independently controllable delay which is pan dependent—this adds delay to the left or right component of each effect signal and can be used to produce stereo effects from mono sources using the Haas Effect. Both types of delay are additive and provide 0-99 ms in 0.1 ms steps for each stage.

With this level of complexity, one finds oneself continually referring to the manual, which at times is less helpful than it should be. As there is no room in the LCD for any graphic representation of the signal path, like for example the Roland 880 multi effect processor, it might be an idea to include a laminated reference card with diagrams of the more complex routing, which

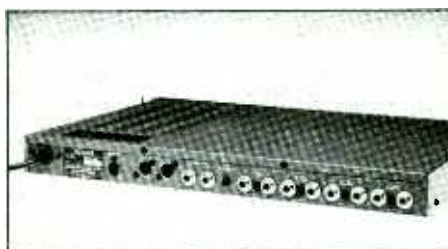

could be kept with the unit. This would also be useful for some of the more complex effects, like type C Echo and Pitch Shift, which incorporate a network of adjustable delays and taps.

The fourth Routing Group, as described earlier, strings together a total of seven effects in series, with a mono input (input 1) and stereo output (outputs 3 and 4). It also allows additional external effect processing to be incorporated via two movable insert points. Outputs 1/2 and inputs 3/4 are used to connect external equipment which is then inserted, using the routing parameters, before any of the effects (Fig 3). Most of the Group 4 presets are guitar effects such as distorted, chorus, and wah-wah sounds. For example, Distorted Lead Guitar 1, is made up from the following effects—1) Equaliser (-4 dB at 160 Hz and -12 dB at 1.2 kHz); 2) Equaliser (+5 dB at 900 Hz and +12 dB at 1 kHz); 3) Amp Simulator set to a Compact Enclosure with a further 12 dB reduction at 2.2 k; 4) Compressor; 5) Distortion; 6) Noise Gate; and 7) Reverb with a 3.5 s RT. Some of the distorted/overload presets are so lively that a little desk noise is all that's required to produce heavy feedback—it's quite surprising to lift faders on what one imagines to be a quiet return, and hear something resembling a guitar pinned against a Marshall stack. The Group 4 presets are quite impressive, producing a good range of convincing and useful sounds; effects like auto-wah, which changes frequency in relation to input level, can also be controlled in the more traditional way by a foot pedal connected to the back of the unit. Of course parameters such as this can also be modulated via MIDI.

I have to admit that I was more impressed with the effect based presets than the reverb presets. It's not always easy to be totally objective about the quality of reverb, after all it's a very subjective area in which people's opinion will differ depending on taste and application. What I would say though, is there is a lack of contrast between many of the reverb presets causing an underlying similarity to the sounds—it's a bit like eating at a restaurant and tasting the same sauces in many of the dishes.

One slight drawback regarding parameter changes is that the unit appears quite slow in registering modifications: for example each time a gain control is adjusted for an EQ, or the RT time is changed on a reverb, the output signal is momentarily disabled as the parameter is altered—this is less than intuitive when trying to 'tune' a sound. The 9010 can also be slow loading presets, taking up to 4s between some programs.

I should also make one final criticism concerning the arrangement of the Direct and Effect signals. The effects in 9010 have been designed to operate in an Insert capacity, ie they mix together a proportion of the direct sound with the effected sound; if the unit is patched from auxiliary sends, then the direct signal has to be laboriously turned down for each effect—there is no master wet/dry control. This is also a problem with other units that offer multi-effect configurations like *QuadraVerb*, and a solution is to store modified presets, however the default condition of the individual effects will remain set.

MIDI

As with most professional effects processors today, the 9010 has full MIDI implementation. This includes facilities such as assignable MIDI Program Change; real time Parameter Modulation with up to two controllers per effect and individual MIDI channels for each effect; System Exclusive bulk data dump/load; and switchable response the NRPN data. MIDI Program Change is restricted to presets belonging to the current Routing Group, so for example if Group 1 is selected, it's impossible to load presets from any of the other groups. Although the manual states that programs from Preset, User and Card Banks will respond to MIDI program Change, only the User Bank functioned on the unit we tested. Omni Mode has been omitted from MIDI Channel selection.

Future enhancements to the 9010 include an optional remote control unit, and additional Routing Groups and Presets which will be supplied on ROM memory cards. There is also the possibility that further effects will be introduced.

Conclusion

With equipment reviews like this, one always asks the question—would I actually use the unit in the future? The answer with the 9010 is a tentative yes; it would certainly be a main contender as a guitar effects processor, and if a complex multi-module effect needed to be created, it would also be high on the list. However, it would not be my first choice as a reverb unit and if I found myself working under pressure, I would probably use something different. The 9010 is most definitely a piece of equipment that demands a great deal of time and patience before its full potential can be realised; it will undoubtedly receive a lot of criticism for being over complicated. The unit does offer some unique features, along with the ability to produce some startling effects, and I can imagine it scoring highly with musicians—it may be via this route that it first arrives in the recording studio. □

CLASSIFIEDS

Advertisements for this section must be pre-paid. The rate is £1+VAT per word, minimum £20.00+VAT. Box Nos. £10.00+VAT. VAT (UK only) \$ rate \$2.00 per word, minimum \$40.00, Box No. \$20.00 extra. Semi-display rates on application. Copy and remittance for advertisements in JULY '91 issue must reach these offices by 24th MAY addressed to: The Advertisement Manager, Studio Sound, Link House, Dingwall Avenue, Croydon CR9 2TA. Cheques made payable to Link House Publications (Croydon) Ltd. Note: Advertisement copy must be clearly printed in block capitals or typewritten.

Replies to Box Nos. should be addressed to the Advertisement Manager, Studio Sound, Link House, Dingwall Avenue, Croydon CR9 2TA, and the Box No. quoted on the outside of the envelope. The district after Box No. indicates its locality. **SEX DISCRIMINATION ACT 1975:** No job advertisement which indicates or can reasonably be understood as indicating an intention to discriminate on grounds of sex (e.g. by inviting applications only from males or only from females) may be accepted, unless (1) the job is for the purpose of a private householder or (2) it is in a business employing less than six persons or (3) it is otherwise excepted from the requirements of the Sex Discrimination Act. A statement must be made at the time the advertisement is placed saying which of the exceptions in the Act is considered to apply.

The attention of advertisers is drawn to "The Business Advertisements (Disclosure) Order 1977", which requires that, from 1st January 1978, all advertisements by persons who seek to sell goods in the course of business must make that fact clear. From the above date consumers therefore should know whether an advertisement relates to a sale by a trader or a private seller.

SERVICES

CASSETTE DUPLICATING:
GAUSS Loop-Bin / TELEX In-Cassette
High Quality Blanks / Label Printing
OPEN REEL DUPLICATING
(ANY SPEED - ALSO TO BROADCAST SPEC.)
SPEECH RECORDING
(VOICE-OVERS; LANGUAGES; AUDIO-VISUALS)
SPEECH-PLUS RECORDINGS LTD.
UNIT 32, NO. 19, PAGES WALK, LONDON SE1 4SB. TEL: 071-231 0961

THE COMPLETE SERVICE.....

DIRECT

- Record Pressings
- Cassette Duplication
- Compact Discs
- Post Mastering
- P.Q. Encoding
- Print & Reprographics
- Video Duplication
- Competitive Prices
- Free Quotations

*Make it with us
We make the hits*

SRT

MARKET LEADERS

☎ 081-446 3218 LONDON
☎ 0480 61880 CAMBRIDGE

SITUATIONS VACANT

Sales/Product Manager Mixing Consoles

Our clients are leaders in the field of design and manufacture of advanced technology equipment for the pro-audio, broadcast, film and video post production markets.

They are now looking to recruit an experienced product specialist to assume responsibility for increased commercial development of the Company's range of mixing consoles in the UK, Europe and the Far East.

Reporting to the European Sales Director, you will need to have a complete technical understanding of mixing consoles and the ability to explore comparative details on performance benefits and features with competitive products.

A key factor will be to maximise sales through commercial advantages including leasing and other financial incentives.

Applicants should have good audio product knowledge and be familiar with the workings of a broadcast studio. Good communication skills in differing commercial environments involving customer contact are essential. Considerable overseas travel is involved.

Salary and commission are negotiable and a company car will be provided.

Apply in strict confidence to Mike Jones,



BROADCAST PROFESSIONALS

Broadcast Professionals, Unit 9B, Intec 2, Wade Road,
Basingstoke, Hants RG24 0NE. Tel. (0256) 470704.

MASSED NAKAMICHI'S IN LONDON!
ULTIMATE QUALITY REAL TIME CASSETTES
UNBELIEVABLE RATES * DAT TO DAT COPYING
AND EDITING * BLANKS WOUND
* COMPUTER PRINTED LABELS
AURAL CASSETTES 081-460 7435

FOR SALE

PRIVATE SALE

- 1 x 12 Ch Alice Mixer
- 1 x 8 Ch Alice Mixer
- 5 x Mono Quad Amps
- 1 x 16U Eq rack

Plus: Mics, Uher, LS, Power supplies and other equipment.

PHONE

GERRY 081-420 1279

SERVICES

COMPACT DISCS
95p each
PLUS MASTERING MIN. 1,000
Selecta Sound
Telephone (04024) 53424



FOR SALE

- 1 OTARI MTR 10
- 2 MCI JH 110
- 1 MCI JH 16/24
- 1 SOUNDCRAFT 1624
- 1 STUDER A80 VUMK2
- 1 OTARI MX 5050
- 3 EGALISEURS ALTEC

STUDIO GAM BELGIQUE

TEL: 32 80 67 99 20
FAX: 32 80 67 93 75

jbs records

MUSIC-SPEECH-DATA
REAL-TIME/HIGHER-SPEED Quality Cassette
Duplication and Blanks from 1,100. Computer printed
Labels. Solo, 1/4 Teel, Sony Betamax or R-DAT recording
Fast Security Delivery service.
FILTERBOND LTD, jbs records div, FREEPOST
19 SADLERS WAY, HERTFORD, SG14 2BR 0992-500101

MEET YOUR NEED

FOR 5", 7" and 10 1/2" white tape boxes: 5" and 7" tape spools
Leader and splicing tape; Ampex mastering tape (all lengths and sizes)
Phone us on **0372 460135** for full details and prices

MEDIATAPE LIMITED

PO Box 120C, Esher, Surrey KT10 9JS

SELECTA

SOUND

REAL TIME AND LOOP BIN
DUPLICATION
EXACT LENGTH CASSETTES
STUDIO SUPPLIES
COMPACT DISKS (FROM 95p)
TEL 04024 53424
FAX 04024 55565

THE COMPLETE SERVICE. Disc cutting, pressings, duplicated cassettes and blanks. Bin Masters. Location Recording. Free Brochure. Tam Studio, 13a Hamilton Way, London N3 1AN. Tel: 081-346 0033. (X)

DISC CUTTING EQUIPMENT and systems bought, sold, installed and manufactured by TAM/ENGLAND, 13a Hamilton Way, London N3 1AN. Telephone: 081-346 0033.

LOCKWOOD, TANNOY, etc. New and used equipment bought, sold, serviced. Authorised Tannoy specialist. Lockwood Audio, Tel: 0923 210254 Fax: 0923 240558.

QUALITY CASSETTE MASTERING AND COPYING, any quantity, Video duplication PAL/NTSC/SECAM transfers, 24 hour, seven days a week service. G.W.B.B. Audiovision, 42 Lancaster Gate, London W2 2NA. Tel: 071-723 5190.

KNIGHT PIANO 2 years old £1,200, records well, 16-8-2 mixer £500, 19 in rack stereo chorus £150, comp limp N gate stereo £150. Mobile 0831 402167 or 0705 752947.

CLEAROUT TIME! — Offers for Ampex 1/2 in., 4-track: 2x Revox B77: A&D compressor and limiter/equaliser: Hitachi oscilloscope hydrovane air compressor: etc. — Information from 0372 460135.

TAPE HEAD RE-LAPPING/RE PROFILING to a good as new standard. Same day turn round. Head Technology, 11 Britannia Way, Stanwell, Staines, Middx. Tel: 0784 256046.

FASCAM/SENN/BEYER, trade counter, Erricks VCD, Brighouse 722121. (X)



THE CASSETTE DUPLICATING SPECIALISTS
Real time & high speed loop bin duplication, printing & packaging. Blanks wound to length
TEL: 061-973 1884

BINDERS OFFER

Keep your copies of **STUDIO SOUND** magazine in smart black binders (each hold 12 copies) with title in silver letters on the spine. Price **£5.50** each (\$25 US) inc. VAT and P&P. Send your order (overseas customers must send international money

orders) to:
Binders

78 Whalley Road
Wilpshire, Blackburn
Lancs. BB1 2LS

State clearly your name, address and
STUDIO SOUND magazine

DO YOU USE TELEPHONE LINES?

CONNECT YOUR EQUIPMENT TO THE TELEPHONE SYSTEM without the cost and delay of type approval.

ACHIEVE THIS BY USING OUR Approved transmit, receive and hybrid systems for use on P.S.N. (normal dial system), Private circuits, or Music Programme circuits.

THE LEGAL ECONOMICAL SOLUTION for broadcast signals — Security alarm signalling — Linking of remote factory sites for P.A. — intercom etc.

Call **0268 793381** or Fax **0268 565759** FOR FULL DETAILS

PARTRIDGE ELECTRONICS

A. C. PARTRIDGE LTD.

UNIT D
318 HIGH ROAD
BENFLEET
ESSEX SS7 5HB



TAPELINE
Blank & Duplicated
Cassettes

New Tapematic Loop Bin
Duplication & Loading
High Spec Professional Bin
Mastering

- * 120x Real Time Duplication
- * Ferric & Chrome Cassette supplies
- * Printing & Packaging, cases & accessories.

FOR HIGH PERFORMANCE CASSETTES
CALL 061-344 5438

Tapeline, Unit 2, York Works, York Street
Audenshaw, Manchester M34 5HD

**HIGH SPEED HIGH QUALITY LOOP-BIN
DUPLICATING BY SRL TAPE SERVICES**

REEL REEL	DOLBY A	QUALITY CASSETTES
	NAB	
	IEC	
F1 PCM DIGITAL		QUALITY CASSETTES
— IN . . . OUT —		
AUDIO CASSETTE	DOLBY C	QUALITY CASSETTES
	DOLBY B	

THE BETTER THE MASTER, THE BETTER THE COPY!
HOW MANY WOULD YOU LIKE! 100-5000
081 383 4444 081 888 5665 PHONE FOR PRICE CHECK

EAST MIDLANDS AUDIO STUDER-REVOX NEW AND USED SALES SERVICE — SPARES

APPROVED CONVERSIONS
A807-A807 VU: POA

MACHINES CURRENTLY IN STOCK

STUDER C37 7 1/2, 15 IPS STEREO VALUE	£1,000.00
STUDER C37 7 1/2, 15 IPS STEREO TRANSISTOR	£800.00
STUDER A62 7 1/2, 15 IPS STEREO, TROLLEY	£750.00
STUDER B62 7 1/2, 15 IPS STEREO, TROLLEY	£1,000.00
STUDER B67 THREE SPEED TROLLEY	£1,650.00
STUDER A80 STEREO RC MK LI VU, 15 IPS	£2,200.00
STUDER A80 16 TRACK MK ONE, 15/30 IPS	£4,600.00

ALL MACHINES FITTED WITH NEW PARTS AS REQUIRED

REVOX PR99 MK TWO TROLLEY 7 1/2, 15 IPS	£1,200.00
REVOX PR99 MK THREE 7 1/2, 15 IPS NEW	£1,850.00
REVOX B77 MK TWO, HS IFC OR NAB NEW	£1,300.00
REVOX C270 TWO TRACK, HS MX DEM	£2,200.00
REVOX C279 TIME MIXER FX DEM	£1,400.00
REVOX C270 TIME CODE HS	£3,050.00
REVOX A77 MK THREE HS, NEW HEADS	£140.00
ALL +VAT	

TEL 0246 275479
FAX 0246 550421

FOR SALE



Studio House Audio

NEW AND 2ND HAND LIST

MIXING CONSOLES

AMEK MOZART 50 inputEPOA
AMEK 3500 52 input as new£40,000
AMEK ANGELA 28 input£7,000
DDA AMR 24 36 input£25,000
TAC 24/B£2,500
TAC MAGNUM 24 input LG frame£11,000
Trident TSM 40£16,000
Soundtracs MRX 24/B/16£2,950
Soundtracs 16/B/16£1,350
Soundtracs CM4400 28 p/b£5,000
Soundtracs MR 24£2,500
Soundtracs PC Midi 24£2,950
Soundcraft TS24 32 automation£12,000
Soundcraft 2400 16/16£4,000
AHB Sigma 44/24 patchbay£12,000
AHB Sabre 24/16/16£5,000
Tascam M700 40 inputnew £25,000
Tascam M520 20/8/16£2,400
Tascam M3 8/4/8£395
Tascam M3500 32/8/24new £4,500
Studiomaster I 20/16/16 p/b£1,000
Studiomaster Tracmix 24new £2,850
Midas (custom) 24/8/16 p/b£3,000

Studer A 812 consolenew! £3,250
Ampex ATR 100 2T 1/4" mint£2,250
Studer B67 30 ips console£1,500
Tascam 52 NB£1,200
Sony PCM 701£400
Tascam 122£250
Akai GX912£325

FX

AMS RMX16£2,000
AMS 1580S 6.5 Harm DG£2,250
Lexicon PCM 70£1,100
Lexicon SME card for 480L£200
TC 2290 32 sec£1,500
Yamaha Rev 7£400
Dolby 330, 361, Cat 22, K9, SR etcEPOA
BEL 2400, BD80s, BC series NREPOA
Akai S1100£2,750
Akai S1000£1,950
Akai S900£700
Aphex Compellor£600
UREI 117Bnew £800
Symetrix 511Anew £400
White 4400 pair room equalisers£595
SA PPE 2400 midi parametric£600
Drawmer DS 201£225
Drawmer DL 221£275

Loads of other 'toys' please phone!

MONITORING

ATC SCM 250 pair£2,500
JBL L250£1,500
JBL 4401 pair with stands£250
JBL 4333 pair£950
Yamaha NS10M pair£195
Omniphonics S100 amp£400
Omniphonics S50 amp£250
JBL 5234 elec crossover£250
Whites 4400 eq/3 way crossover£1,200
Harrison X800£500
Studiomaster 1000£400
Yamaha amps (various)EPOA

MICROPHONES

Neumann 47, 56, 84, 86, 87, 89, 170EPOA
AKG 414, 460, 12A, 28A, 224, 451, 112, 202, 190, 12 etcEPOA
Sennheiser 405, 441, 421, 416EPOA
EV RE20, PL92A, ND757, ND408EPOA
Shure 57, 58, 91, 54B, 54, 17EPOA
Beyer 69, 88, 201 + DT100 HP'sEPOA
Mic stands galore, booms from£20

EXPORT PRICES

(UK Customers please add VAT)

EXPORT A SPECIALTY

RECORDERS

AMS Audiofile (version B)£24,000
Otari MTR 90 II£13,500
Otari MX 80£15,500
Studer A80 III N£12,000
Studer A80 II W£6,995
3M M79£3,950
Soundcraft SCM 760 III£8,000
Soundcraft SCM 760 II£4,950
Saturn 24£13,500
Akai Adam 24 channel complete£21,000
Fostex G24SEPOA
Fostex G16£3,500
Fostex E16 + 4050£2,750
Fostex B16£1,700
Tascam MSR24S£6,500
Tascam MSR24£5,000
Tascam MS16 complete£4,100
Tascam 85-16B dbx£2,500
Soundcraft SCM 761 16T£2,000
Tascam 38£895
Fostex M80£695
Fostex R8new £1,250
Tascam 238new £750

MASTERING

Akai DD1000 opticalEPOA
Denon DTR 2000£695
Sony DTC 1000ES£950
Tascam DA30£1,150

WANTED FOR CASH COMPLETE STUDIOS

0663 764244
STUDIO HOUSE AUDIO
High Lane Village, Nr. Stockport SK6 8AA
Fax: 0663 762328

STUDIO SOUND
AND BROADCAST ENGINEERING

CIRCULATION DETAILS

STUDIO SOUND is available without charge to key personnel actively engaged in sound recording in any part of the world. Copies must be individually requested. Non-qualifying readers will be notified in writing and invited to take out a subscription (see below for details)

NEW READER ENQUIRIES: Link House Publications plc, Link House, Dingwall Avenue, Croydon CR9 2TA, UK. Tel: 081-686 2599

EXISTING READER ENQUIRIES:

Circulation Dept, Studio Sound, Link House Magazines Ltd, Central House, 27 Park Street, Croydon CR0 1YD, UK

Changes of address should be notified in writing to this address and the label containing the old address and reference number should be enclosed to ensure accuracy

SUBSCRIPTION ENQUIRIES: Subscription Dept, Studio Sound, Link House Magazines Ltd, 120-126 Lavender Avenue, Mitcham, Surrey CR4 3HP, UK

The cost of an annual subscription to **Studio Sound** is: UK: £24.00

Overseas surface mail: £30.50/US\$52

Overseas air mail: £52.50/US\$89

USA airspeeded delivery \$70

The publishers reserve the right to refuse applications considered inappropriate and restrict the number of free copies sent to any one company or organisation

ADVERTISERS' INDEX

AD Systems28
AKAI56/57
AKG49
AMEK7, 36
AMS Industries8/9
APRS59
Audio Design55
Audio Digital Technology68
Audio Kinetics52
Audio Marketing Group18
Audio PrecisionIBC
Audio Technica60
Bruel & Kjaer6
BSS47
Coach Audio Sales16
Denis The Fox16
Digital Audio Research35
Dolby Laboratories62
Dynaudio Acoustics30
Focusrite Audio EngineeringIFC
HW International45
HHB Communications13, 25
Klarck Teknik38/39
Lafont Audio64
Larking Audio6, 14/15
Lyrec Manufacturing26
MS Audio42
Monitor Technology42
QSC Audio Products69
RTW19
Recording Architecture67
Renkus-Heinz10
Saki Magnetics54
Samuelson Lighting & Sound41
Seem Audio6
Sennheiser29
Solid State Logic4
Sony20/21
Soundcraft ElectronicsOBC
Soundtracs32/33
Surrey Electronics34
Teac50/51
Tony Larking Professional Services22

We maintain a Double Standard

The Audio Precision product line now includes two different standard-setting products.

The automated System One - the industry standard for lab bench and factory test station.

- Graphic results on PC screen, copies to printers and plotters.
- GO/NO-GO testing, automated procedures.
- State-of-the-art performance and speed.
- Complete analog and digital domain testing.
- 2 to 192 channels.

The new self-contained Portable One - for service bench and field.

- Compact and affordable.
- An easy-to-use test set for applications not requiring automation.
- Comprehensive capability, high performance.
- Robust polycarbonate purpose-designed case.
- Full stereo capability.

System One and Portable One - two test sets designed for different jobs, each with the quality and performance that you have come to expect from Audio Precision.

System One



Audio precision

P.O. Box 2209, Beaverton, OR 97075-307C
503/627-0832 1-800/221-7350
FAX: 503/641-8906, TELEX: 283957 AUDIC UR

Portable One



INTERNATIONAL DISTRIBUTORS Australia: IRT (02) 439 3744 Austria, Eastern Europe: ELSINCO elektron GmbH 222 812 17 51 Belgium: Trans European Music NV, +02/466.50.10
Canada: GERR Electro Acoustics Ltd., (416) 868.0526 China, Hong Kong: ACE (HK) (852) 424-0387 Denmark: AudioNord Danmark/nph 86 57 13 1 Finland: Genelec OY, 77 13311 France:
ETS Mesureur (1) 45 83 65 41 Germany: RTW GmbH 221 70 91 30 Holland: Trens European Music, +03408 70717 Israel: Dan-El Technologies Ltd 3-5-4 1466 Italy: Medea S.r.l. 2 4840 1760
Japan: TOYO Corporation 3 (5688) 6800 Korea: Myoung Corporation 2 784 9942 New Zealand: Audio & Video Wholesalers, Ltd. 71 73 414 Norway: Lydcorsult (09) 19 03 61
Portugal: Acutron ELA 1 941 40 87 Singapore & Malaysia: TME Systems PTE Ltd 298 2608 Spain: Teico Electronics, S.A. 231 7840 Sweden: Tal & Ton AB 31 80 36 20 Switzerland:
Dr. W.A. Gunther AG, 01/910 41 41 Taiwan: Litz Technologies Ltd 2 753 3176 U.K.: SSE Marketing Ltd 71 387 1262

Status symbols.



SOUNDCRAFT ELECTRONICS LTD., UNIT 2, BOREHAMWOOD INDUSTRIAL PARK, ROWLEY LANE, BOREHAMWOOD, HERTS, W16 9JZ, ENGLAND
TEL: 081 207 5050 TLX: 23198 S CRAFT G FAX: 081 207 0194 H A Harman International Company

🔍 To be precise, the 3200 has 3,205. 3,205 illuminated switches which confirm the status of every facility at a glance. On up to 100 fader-controlled inputs and 20 auxiliary sends. 🟩

Fully balanced 32 bus routing, global multitrack A/B switching and a noise gate on every channel. Information clearly displayed. Making complex mixes faster.

🟦 And with outstanding ergonomics and sound quality, the 3200 is desirable to work with. And own.

To see the most informative console ever, call Jon Ridel at Soundcraft on 081-207 5050. 🟥

Soundcraft
3200