

# STUDIO SOUND

Special Advertising Section

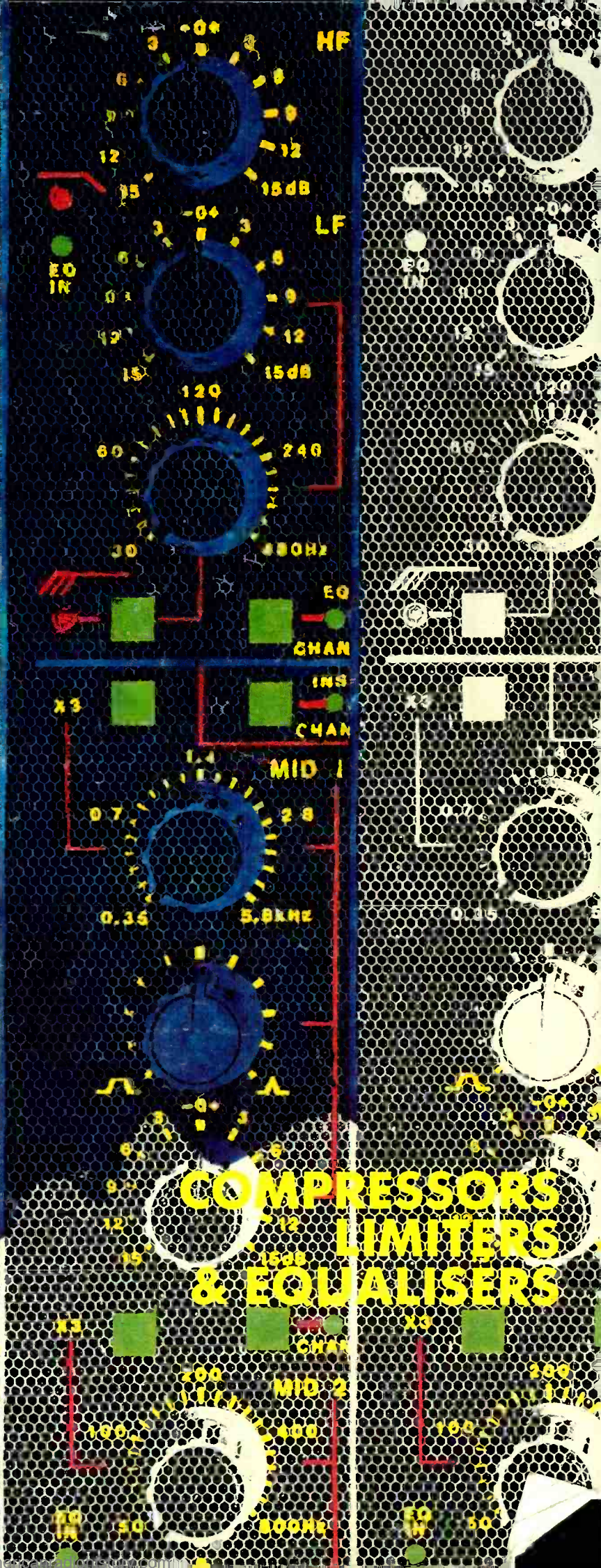

## COMPRESSORS LIMITERS & EQUALISERS

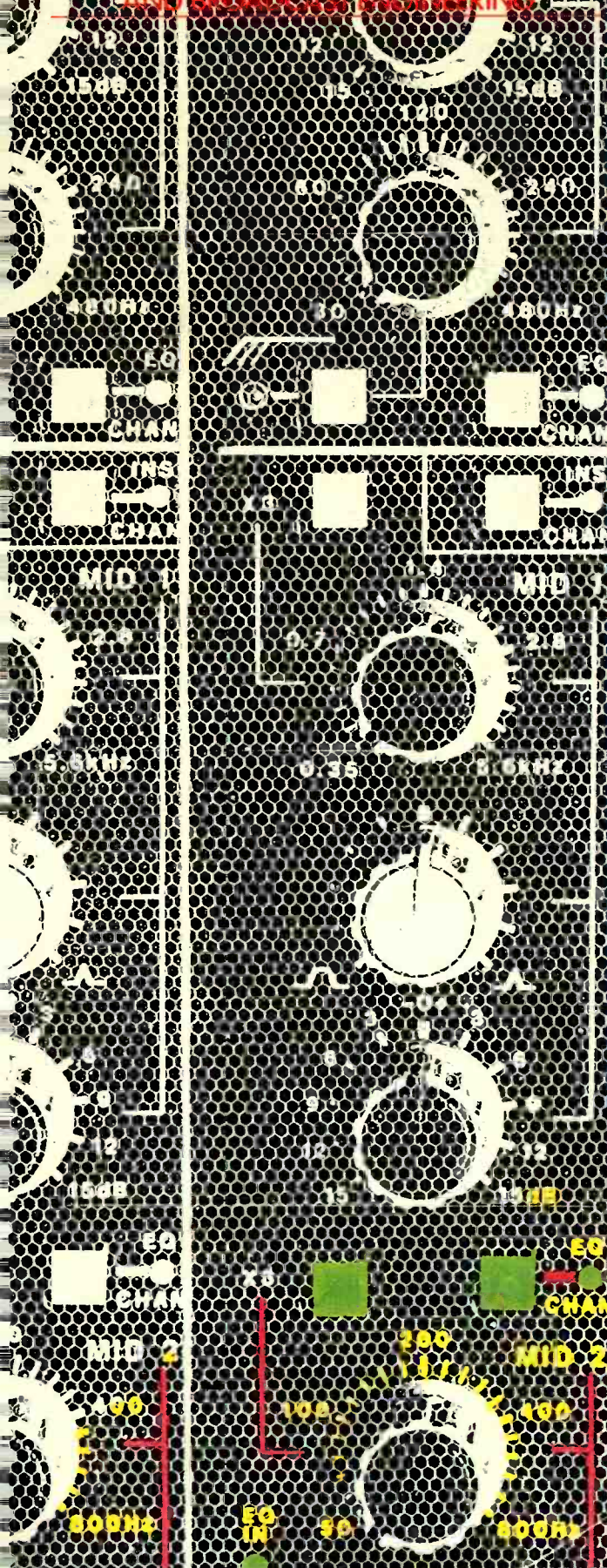

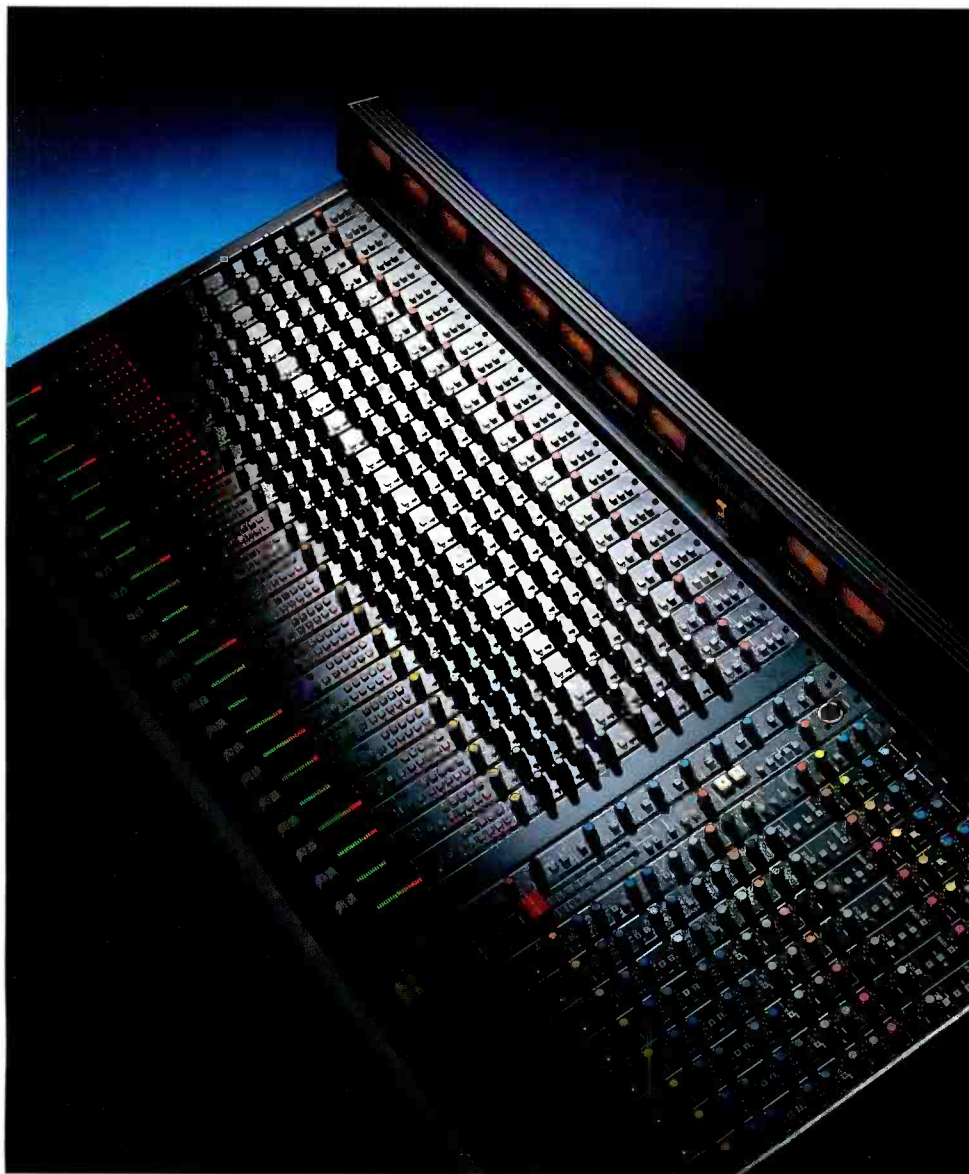

# Series 8000. Now status isn't reserved for the few.

The Soundcraft Series 8000 has set new standards in live mixing technology.

As you'll appreciate the minute you hear it, its electronics are a major advance.

That's why it's rapidly becoming the world's best selling live console.

Yet despite all its innovations, it's certainly not out of reach.

Because with the 'PA' input module, you'll be surprised how easily the Series 8000 will fit your budget.

#### LIVE MIXING WITH A NEW EDGE.

The Series 8000's technology makes ordinary desks look decidedly overpriced.

The 8-bus design includes sophisticated ground-compensated summing

and a grounding system that's hum and interference proof.

'PA' input control facilities range from 8 Aux sends to a 4-band EQ with sweepable mids. (With the 'House' input module, there's a 4-band parametric EQ and dedicated 8-way routing matrix).

You also get an active 2-way talkback interface for a Soundcraft Series 500 monitor console.

And the option of adding 8 effects returns channels with 3-band sweepable mid EQ or an 8 x 8 Output Matrix with parametric EQ.

Just a few of the advanced features we provided at your request.

#### A LIFE ASSURANCE POLICY.

A clear and familiar layout remains our trademark.

Inside, there's an immensely durable, custom made extruded aluminium frame, lighter yet more rigid than a steel chassis and proven worldwide through thousands of miles on the road.

Add to that our advanced electronics, the use of flexible connections and a stringent, 3-stage quality control program, and you get reliability when you need it most.

The Series 8000 is simply the finest all-round investment in live mixing.

Especially now that it can expand your sound, without expanding your budget.



**Soundcraft**  
**8000**

# STUDIO SOUND

AND BROADCAST ENGINEERING



**Problems with European DBS**

<b>Editorial:</b>	Keith Spencer-Allen presents his views on various topical subjects	<b>5</b>
<b>News:</b>	Events, news, moves and comment from inside and outside the industry	<b>8</b>
<b>Contracts:</b>	Equipment orders, deliveries and installations in the UK and around the world	<b>15</b>
<b>US News:</b>	Information on staff changes, equipment installations, etc in and around the USA	<b>15</b>
<b>Products:</b>	Information on new products, developments, upgrades and software updates	<b>16</b>
<b>Music News:</b>	Products updates and developments from another side of the business	<b>26</b>
<b>Digital Broadcasting:</b>	Sam Wise reports on a seminar held at the Hamburg AES Convention on the general acceptance of digital broadcasting	<b>29</b>
<b>Equalisers—The Proximity Effect:</b>	Ted Fletcher questions the use of equalisers in the past, present and future	<b>32</b>
<b>Compressors, Limiters &amp; Equalisers:</b>	A list of manufacturers, agents and products introduced over the last 18 months	<b>38</b>
<b>Satellite Broadcasting—A Lost Opportunity?</b>	Barry Fox reports on the latest situation in the satellite broadcasting war	<b>42</b>
<b>Perspective:</b>	US columnist Martin Polon with the story of the downfall of someone who bought equipment through dubious deals	<b>46</b>
<b>Broxmead:</b>	Janet Angus visits a dedicated film/video/television soundtrack recording workshop. Based in Surrey, UK	<b>53</b>
<b>VCA's Investigated:</b>	Ben Duncan describes three approaches to the design and manufacture of VCA's	<b>58</b>
<b>Practical Hard Disk:</b>	In the second part of their article, Yasmin Hashmi and Stella Plumbridge discuss the importance of the various facilities offered	<b>65</b>
<b>Business:</b>	Barry Fox comments on the changing scene in TV transmission.	<b>70</b>
<b>Roland R-880 and GC-8:</b>	An operational report from Patrick Stapley on this digital reverb unit and its graphic controller	<b>72</b>



**SONY**

Broadcast, Recording Studio and  
Video Post Production Professionals

Sony Broadcast  
& Communications

European Headquarters:  
Basingstoke  
Hampshire  
United Kingdom

*Dear Reader*

**Re: New analogue multi-track**

Sony are proud to announce the introduction of a new 24 track analogue audio tape recorder as a replacement for the JH-24, which over the years has become something of an industry standard.

The new machine, the APR-24, is eminently suitable for recording studios and audio/video post production. It has been designed to meet the widest range of audio recording requirements, in particular the fast and accurate synchronisation of audio with video.

Featuring comprehensive microprocessor control of both transport and audio electronics, along with versatile remote control facilities for ease of use, the APR-24 represents a major step forward in the world of cost effective analogue recording.

The APR-24 has an internal synchroniser, which being part of the machine's software, gives substantial advantages in terms of cost, space and ease of interconnection for external machine control. It also features a built-in all format timecode generator, giving versatile tape striping without the need for a separate timecode generator. In addition a multi-function metering system is included plus triggered edit synchronisation as an alternative to controlling drop-ins from an external synchroniser or studio computer.

State-of-the-art audio circuits and components ensure superb sound quality and microprocessor assisted alignment provides the user with accurate and repeatable control over machine line-up.

All these features, coupled with Sony's unrivalled reputation for quality and reliability, mean that the APR-24 is the solution to your audio problems. Don't delay - Contact your nearest Sony centre to find out more. You'll not be disappointed.

*Sincerely*  
SONY

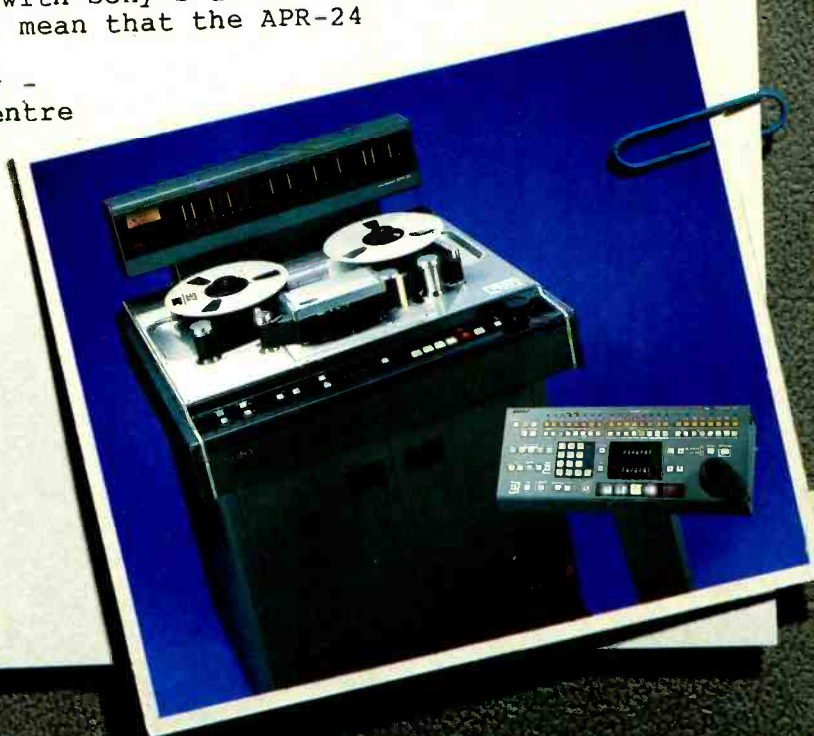



# STUDIO SOUND

AND BROADCAST ENGINEERING

July 1989  
Volume 31 Number 7  
ISSN 0144 5944

## EDITORIAL

**Editor:** Keith Spencer-Allen  
**Assistant Editor:** Julian Mitchell  
**Co-ordinating Editor:** Ann Horan  
**Secretary:** Elaine Sweeney  
**Consultant:** Sam Wise  
**Columnists:** Barry Fox, Martin Polon (US)  
**Regular Contributors:**

Janet Angus	David Hastilow
James Betteridge	Mike Lethby
Mike Collins	David Mellor
Ben Duncan	Terry Nelson
Dave Foister	Francis Rumsey
Neil Grant	Patrick Stapley
Yasmin Hashmi	

## ADVERTISEMENTS

**Advertisement Manager:** Steve Grice  
**Display Sales:** Shane Duffy  
**Classified Sales:** Peter Moylan  
**Secretary:** Dawn Boulwood

## CIRCULATION

**Circulation and Development Manager:**  
Colin Enderson  
**Controlled Circulation Manager:**  
Sally White  
**Enquiries:** See classified advertisement

**Director:** Doug Shuard  
**Associate Publisher:** Steve Haysom

## EDITORIAL & ADVERTISING OFFICES

Link House, Dingwall Avenue, Croydon CR9 2TA,  
UK  
Tel: 01-886 2599  
Telex: 947709  
E-mail: 78:DGS1071  
IMC: STUDIO SOUND UK/US  
Fax: 01-760 0973

## AMERICAN OFFICE

**Publishing Services Manager:** Fred Vega  
Studio Sound, 2 Park Avenue, 18th Floor,  
New York, NY 10016, USA  
Tel: (212) 779-1212  
Fax: (212) 213-3484

## JAPAN & FAR EAST AGENT

**Contact:** Mikto Tsuchiya  
Media Sales Japan Inc, Tamuracho Bldg 3 3 14,  
Shimbashi, Minato-Ku, Tokyo, Japan  
Tel: (03) 504-1925  
Telex: J25666  
Fax: (03) 595-1709

© Link House Publications plc 1989 all  
rights reserved

Printed in England by Lawrence-Allen Ltd,  
Gloucester Street, Weston-super-Mare, Avon  
BS23 1TB



A LINK HOUSE  
PUBLICATION

Studio Sound and Broadcast Engineering  
incorporates Sound International and Beat  
Instrumental

Studio Sound is published on the second Friday of  
the month preceding the cover date. The  
magazine is available on a rigidly controlled  
requested basis, only to qualified personnel (see  
classified advertisement for terms)

ABC

MEMBER OF THE AUDIT  
BUREAU OF CIRCULATIONS

Total average net circulation of 19,564 per issue  
during 1988.  
UK: 5,675. Overseas: 13,889.  
(ABC audited)

Cover: With thanks to DDA and the DCM

## Various topics

We have three short topics this month but there is an element continuity between them. Firstly we return to the topic of May—trade exhibitions. There was a fair degree of synchronous thinking taking place within the UK industry about the time that piece was being written. This culminated in a meeting in late May of a large number of UK-based companies who regularly exhibit at pro-audio trade shows. One outcome was the formation of the Pro-Audio Exhibitors' Group with an elected committee and a clear mandate to present the views of the companies present to exhibition organisers.

The votes were almost unanimous and there were a remarkable number of decisions taken on subjects such as preferred exhibition locations, timing, frequency and policy. More details will follow in next month's issue but it can only be beneficial that there is a unified voice—both for the exhibiting companies (who will hopefully join this exhibitors' group) and also for exhibition organisers who will have a single representative body to consult on all exhibition matters.

Initially this is a UK organisation due to the logistics of starting up but there was considerable interest in becoming fully international or liaising with similar groups worldwide. Let's hope that this can all bring a sense of reason to the exhibition circuit (39 related events this year and rising), which anyone with the interests of the pro-audio at heart will surely welcome.

There is a completely different issue that might also have some bearing. A few weeks ago I was passed a copy of a speech given by Thomas Beckmen, the president of Roland US, to a dealer meeting in the US. What was particularly interesting was the way that Beckmen indicated that the rate of technology introductions was to slow down. The frantic amount of development and product over the last few years has laid down a solid foundation of technology and now was the time to build on that and exploit the potential rather than replace it with something else. He further warned dealers that they should diversify rather than look to continuation of the continuous flow of new products. Should these feelings be felt industry wide, not only would there seem to be a great deal of sense in Beckmen's words but it would give us all a chance to see all the facets of the equipment that we bought over the last year—maybe even have time to read the manual before the product is obsolete. This attitude does not preclude new products but reasons that they should meet a need rather than just the need for a new product.

One area, however, where I would like to see further development is that of new control surfaces and methods for pro-audio equipment. In the next issue we have the SSL *ScreenSound*, which uses a graphics type tablet to totally control the system and this is one of the products that has taken this approach furthest. But there is also the Real World *Audio Tablet* and the Digital Audio Research *SoundStation II* with their touch-type screens as well as the trackball/mouse-controlled systems. Reports say that those who persevere with such systems come to find the design approach quite natural. With the techniques now available to create practical user interfaces that involve a physical movement other than a QWERTY keyboard, nudge buttons or dedicated switches, it would seem sensible to familiarise yourself with the various approaches currently practical. As a magazine, we will be pursuing this topic whenever there is a new development.

Keith Spencer-Allen



# A STRONG TEAM

D&R DAYNER **D&R**



This compact in-line mixer is available in frame sizes up to 59 channels. Its floating subgroup system means extra flexibility at reduced board space. Total Control.

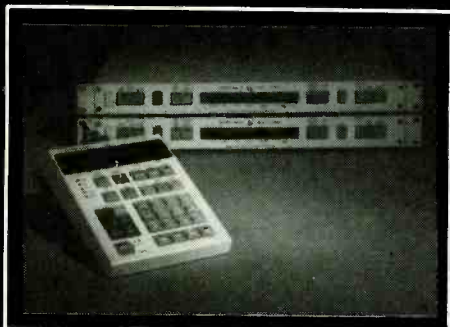

ADAMS SMITH ZETA THREE

The synchronizer for those who won't settle for anything less than professional. MIDI, remote capability and auto-locating make this a complete system at a very modest price. Total Timing.

*Write or  
call for  
info, dealers,  
distributors  
and...  
see us at  
APRS !!!*

**AXYS**

REPRO 1

A new name for a product line that combines craftsmanship with the latest thick-film technology. Audio perfection in a high-quality active monitor. Total Transparency.



**synton**<sup>®</sup>

Total Support

Synton International  
Computerweg 1  
3606 AV Maarssen  
Netherlands

03465-67424

Synton Germany  
Tersteegenstraße 29  
4130 Moers 1  
Germany

02841-16220

Synton UK  
Unit 12, North Fields Prospect  
Putney bridge road  
SW 18 London  
Great Britain

01-4398985

Synton Belgium  
57-59, Av. de Stalingrad  
1000 Brussels  
Belgium

02/5120574

Synton France  
110, Rue St. Denis  
75002 Paris  
France

01-40260555



# COMPANY ANNOUNCEMENT

## Change of Company Name

### The story so far!

- 1966 - MAGNETIC TAPE MECHANISMS LTD - Based in Richmond, Surrey - is formed for the manufacture of reel to reel tape recorders.
- 1969 - Company name changes to MAGNETIC TAPES LTD. Brand name CHILTON introduced, derived from name of factory, Chilton Works.
- 1971 - Product range expands to include the M Series of audio mixing desks. Beautifully finished in solid teak with black anodised control panels, they prove an early commercial success.
- 1976 - Owing to the demise of reel to reel due to the difficulty in obtaining specialised parts, a new range - the QM series of consoles - is introduced. The successful M series is replaced by the CM series modular broadcast/production desk.
- 1985 - Company purchases 6,000 sq. ft. factory in Ashford Middlesex.
- 1986 - January - move into new factory is completed. Company achieves full export order book for CM2-4 desks.  
Receives trial order from BBC Local Radio for seven QM3 24/8 consoles with modifications. This is based on reports on 2 standard QM3 24/8 consoles supplied to BBC Radio Leicester and to BBC Radio Merseyside.
- 1989 - Company name changes to CHILTON AUDIO LTD. Brand name CHILTON continues.

### For the record

No fewer than 36 QM3 consoles have now been supplied to BBC Local Radio for new O.B. vans and A stations.  
In other fields the CM2, with its excellent reliability, has demonstrated that it is ideal for the Community and Hospital Radio.

## CHILTON AUDIO LTD.

Chilton Works, 6-8 Wolsey Road, Ashford, Middlesex, TW15 2RB

Phone: 0784 247124

Fax: 0784 240159

For fuller details on the CM Series please contact Paul Reps.

## LET US INTRODUCE YOU TO A FRIEND

### THE OTARI MX80

*If you're considering upgrading to Otari, we'll be delighted to arrange a full demonstration, discuss the part exchange value of your existing equipment and even arrange finance if necessary.*

*Whether you're in the market for a complete studio package, or just the latest in signal processing — we'd like to talk to you.*

**KGM**  
studio specialists

18/42 Charlotte Street  
Wakelield  
West Yorkshire  
WF1 1UH England  
Telex: 556649  
Fax: 0924 290460  
Tel: 0924 371766





# ESP reincarnates Fairlight

The original founders of Fairlight Instruments, Kim Ryrie and Peter Vogel, have again joined forces along with several of their former key technical, R&D and user support personnel to form a new organisation. Electric Sound and Picture is the new company that has purchased Fairlight's assets including all trade marks, designs, software and patents as well as stock and work-in-progress.

Electric Sound and Picture has been formed in conjunction with a leading Australian professional audio and video group and will provide global support, production, ongoing development and servicing of the Fairlight lines of audio and video products.

Fairlight's distribution network in about 20 countries has also been taken over by Electric Sound and Picture. As the US subsidiary of Fairlight is no longer operational, the US market is now being serviced by Fairlight's original technical and user support personnel.

Kim Ryrie was managing director of Fairlight Instruments from 1975 to

1987, he resigned just prior to the company being taken over by venture capital group Advent-Western Pacific, which purchased Fairlight's controlling shares.

A plan to float the company, which would have raised needed capital for research and development as well as expansion of global sales and marketing, was not put in place due to the stock market crash of 1987. This inability to supply critical investment along with a wildly fluctuating dollar, extensive development of new technologies and problems in filling orders due to manufacturing delays, led to the company going into liquidation early this year.

Ironically the company was enjoying record levels of orders in its last months and was back in profit when the venture capital group withdrew funding. Electric Sound and Picture can be contacted at 30 Bay Street, Broadway, Sydney, NSW, Australia 2007. Tel: 212 6111. Fax: 281 5503.

## Sound Craft double-take

Those of you who read the contracts section in the May issue may have seemed surprised by one entry even though it was correct. A small explanation may, however, be in order. A recipient of a DDA Q series console was listed as Sound Craft, Japan. This is quite correct—they are

a Japanese facility that also happen to own two Soundcraft TS24 consoles, and now a DDA Q series. This facility should be distinguished from the Soundcraft-owned company, Soundcraft Japan for the obvious reason—there's a world of difference in a space and a comma.

## Exhibitions and conventions

**June 27th to 29th** 4th regional AES Convention, Tokyo, Japan.

**July 6th to 8th** Pro Audio Asia '89, Hong Kong Convention Centre.

Contact: North America Tel: (818) 709-6773; UK & Europe Tel: 0869 38040; Japan Fax: 235-5961.

**July 17th to 21st** Olympia 2, BKSTS Film, Video and Sound '89. Contact: Rebecca Moss. Tel: 01-370 8182.

**July 25th to 30th** British Music Fair, Olympia, London. Contact:

Music Industries Association. Tel: 0753 41963.

**September 10th to 13th** The Light & Sound Show '89, Olympia 2, London, UK. Contact: Clare O'Brien, O'Brien Associates Ltd, 10 Barley Mow Passage, Chiswick, London W4 4PH. Tel: 01-994 6477.

**September 18th to 21st** Media Visie '89, RAI International Exhibition Centre, Amsterdam. Contact: RAI. Tel: (0) 20-20-549 12 12.

## News from the AES

There has been a lot of talk recently about Pro-Audio exhibitions and as the major audio event in Europe the AES European Convention obviously features high in these discussions. Future Conventions have to be planned years in advance taking into account the various requirements of exhibitors, visitors and conference attendees. However, these requirements change over the years and it is about 10 years since we last carried out a survey among those in the industry. We are currently circulating a questionnaire to help us plan AES conventions for the '90s and if you would like to let us have your views, please contact Roger Furness, Vice-President, Europe Region at the address below, for your copy of the questionnaire.

Our next lecture will be on Tuesday, July 11th, when Matthew Richards and Nick Indermaur of Data Conversion Systems Ltd will talk on **Oversampling ADCs**. "Originally better known in telecommunications, high accuracy oversampling ADCs have been

getting a lot of attention over the last few years. We look briefly at their architecture and discuss the advantages in audio applications. After this we examine some areas in their design, including a digital anti-aliasing filter, which drops 110 dB in 8 kHz and has in-band alias rejection greater than 110 dB."

Other future AES events to note are the **4th Regional Convention** being held in Tokyo between June 27th and 29th, and the **87th Convention** to be held in New York between October 18th and 21st. (Please note alteration to dates.) Also you may like to note that the British Section will be running another conference on September 12th to 13th on the subject of **AES/EBU Interface** chaired by John Emmett of Thames Television.

For further details on any of the above or information on joining the AES, please contact: **Heather Lane, AES British Section, Lent Rise Road, Burnham, Slough SL1 7NY, UK. Tel: 0628 663725. Fax: 0628 667002.**

## Address changes

- **Sony's** UK sales and marketing company for broadcast, professional audio and video equipment is now called Sony Broadcast & Communication at Jays Close, Viabes, Basingstoke, Hants RG22 4SB, UK. Tel: 0256 55011. Fax: 0256 474585.
- **Smart Acoustics** have moved to 38-39 Westgate Chambers, Commercial Street, Newport, Gwent NP9 1JP, UK. Tel: 0633 252957. Fax:

0633 252958.

- **Ensoniq** (GB) have moved to Ensoniq House, Mirage Estate, Hodgson Way, Wickford, Essex SS11 8YL, UK. Tel: 0268 561177. Fax: 0268 561184.

- **gtc** UK's new address is Unit 40, Sheraton Business Centre, 26-28 Wadsworth Road, Perivale, Middx UB6 7JD, UK. Tel: 01-991 9152. Fax: 01-991 9391.

## Courses and seminars

**May 23rd to 24th** Sound reinforcement engineering conference. Contact AES (British Section). Tel: 06286 63725.

**June 13th** Studio Acoustics. Contact: AES (British Section). Tel: 06286 63725.

**July 11th** High resolution ADC. Contact: AES (British Section). Tel: 06286 63725.

**August 26th and 30th** Soundscape.

The University of East Anglia, Norwich, UK. Contact: Jane Thorp, UEA. Tel: 0603 592802.

**September 9th to 15th** International Conference for Studio Engineers, University of Surrey, Guildford, UK. Contact: APRS. Tel: 0923 772907. Fax: 0923 773079.

**September 12th to 13th** AES/EBU Interface. Contact: AES (British Section). Tel: 06286 63725.





M E T R O P O L I S

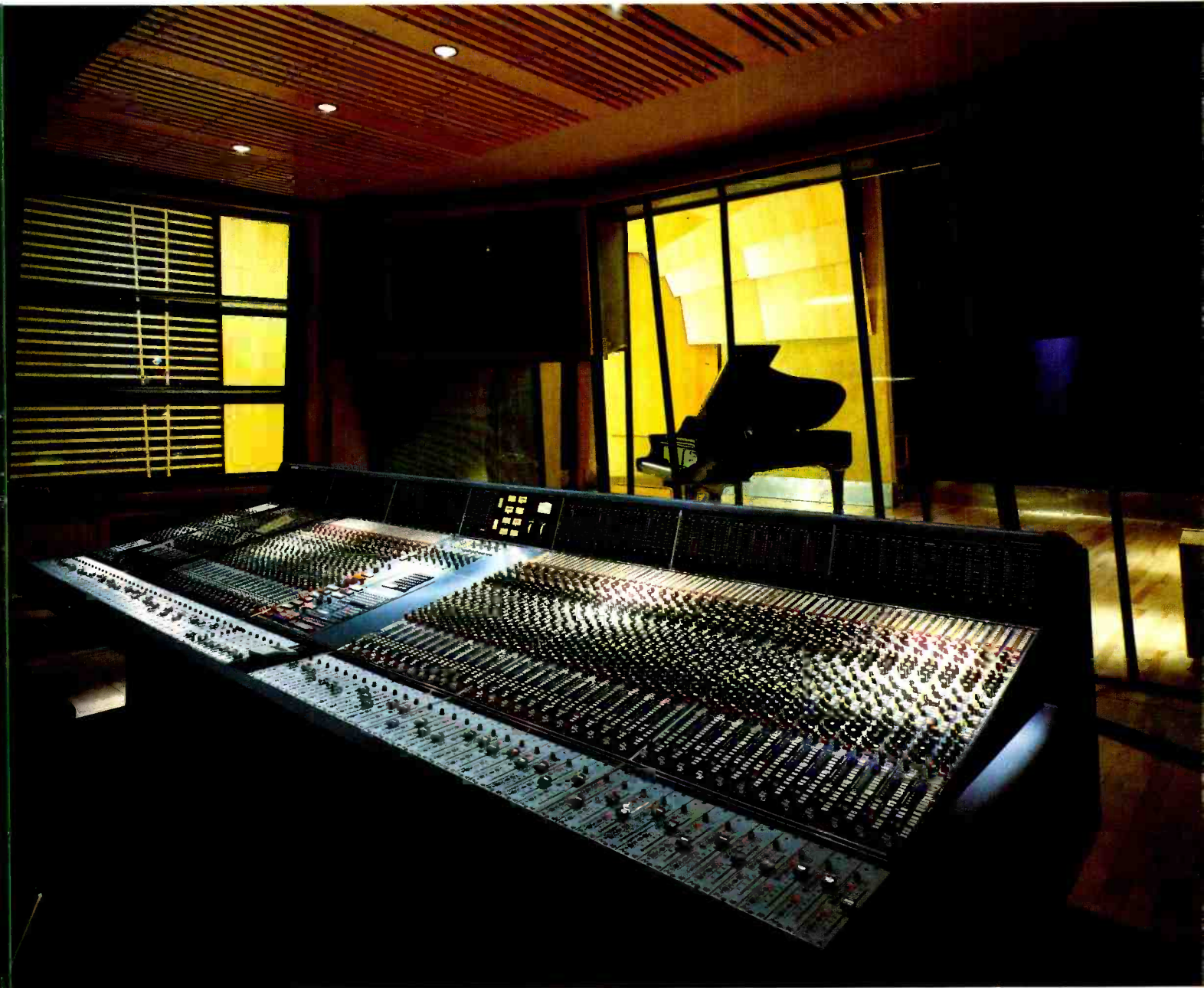

*The Neve VR Console with Flying Fader Automation in Studio A Metropolis London*





## People

- Klark-Teknik, Kidderminster, UK, have appointed Sophie Sellers as marketing co-ordinator.
- Courtney Nicholas has joined Acoustic Engineering Services of Byfleet, UK, to head their studio systems division.
- HHB Communications have appointed Brian Binding senior manager, to co-ordinate sales and marketing. Binding was the manager in the Radio Capital Projects Department at the BBC.

## Obituary

Milton T (Bill) Putnam founder of Universal Recording in Chicago, United and Western Recording in Hollywood, Coast Recorders in San Francisco and UREI (United Recording Electronics Industries), passed away on April 13th this year, aged 69.

Bill Putnam was involved in the recording industry for over 40 years, in all aspects of electronics, acoustics and amateur radio.

As a recording engineer he pioneered half-speed record mastering and was involved in many of the top ten record releases in the '40s, '50s and '60s.

Putnam wrote extensively for trade publications and conducted numerous seminars and classes. He was a fellow of the AES, and an officer of the Chicago Acoustical and Audio Group.

## In brief

- Court Acoustic Sales have, after falling into financial difficulties, been wholly bought by Brett & Christensen Ltd who are backed, among others, by a large pro-audio company. The Court range of graphic equalisers will continue to be manufactured, and the R&D department has been expanded with new products planned.
- ATC and Roger Queded have terminated their agreement that allows Queded to use ATC components in their designs.
- Steinberg's forthcoming MIDI DeskTop Recording system, which was to be marketed under the name CUBIT, has now, due to a legal complaint from ICL Computers, had

# Mitsubishi Pro-Audio moves to the UK

The Mitsubishi Pro-Audio Group is moving its headquarters to the UK and Neve North America will now be responsible for distributing the PCM line of products in the USA.

The relocation is seen as a direct result of Mitsubishi's UK and European sales expansion, which includes the setting up of a sales and technical service team in the UK and

an extensive distribution network throughout Europe.

To underline the relocation, Mitsubishi Pro-Audio will be moving from its present site in St Albans to larger premises at Mitsubishi Electric's newly built offices in Hatfield. Mitsubishi Pro-Audio Group, Travellers Lane, Hatfield, Herts AL10 8XB, UK.

## Quest Marketing seeks international trade

A new company has been formed to market and distribute pro-audio products in the US and Europe.

Quest Marketing aim to provide European manufacturers with a company experienced in US marketing and distribution. They plan to service the US dealer network and offer their experience to smaller US manufacturers wishing to

realise their world market potential.

Already Quest have been successful with an exclusive deal to distribute Drawmer products in the US.

Quest's marketing director is Scott Berdell, formerly general manager of dbx professional products division.

Quest Marketing, PO Box 20, Auburndale, MA 02166, USA. Tel: (617) 964-9466. Fax: (617) 969-7758.

its name changed to CUBASE.

- Studiomaster (UK) plc have acquired Ampro Electronics, which is now a wholly owned subsidiary, and has been renamed Amp Audio Systems Ltd.
- Ortofon A/S of Denmark have announced a re-organisation of their subsidiary company Ortofon (UK) Ltd. Ortofon will now co-operate with Hayden Labs on the distribution and administration of Ortofon products. Dermot Grace, while remaining general manager of Hayden's professional division, has also been appointed director and manager of Ortofon UK. Ortofon A/S have similar arrangements in other countries and have found the system works well.
- Adrian Kerridge and Johnny Pearson, sole owners of the

Lansdowne Group have bought the freehold to CTS Studios in Wembley from Arena Holdings.

● Wild Tracks, a London post-production house, have opened a second 24-track video sound dubbing studio installing a Betacam SP recorder player. Also featured is an Amek Angela desk, Studer multitrack and Studer synchronisation.

● We have been asked to point out that the new Beta 57 and 58 mics from Shure do not replace the long established SM57 and 58 upon which they were based. It is apparently Shure's intention that the SM series should continue for many years to come but with the bonus for future purchasers that there has been a reduction in their price.

## Agencies

● The Home Service have been appointed exclusive UK distributor for the IMS Dyaxis digital audio system. The Home Service, Unit Two, 10 William Road, London NW1 3EN, UK. Tel: 01-387 1262. Fax: 01-388 0339.

● Soundtracs have announced that German imports of their Eric and IL series consoles are to be handled exclusively by AudioMedia of Hamburg (tel: 069 37017-9) with sales of the IL series in the southern states handled by Music Shop in Munich (tel: 089 341111). Soundtracs' FM range of consoles is to be managed by Electro-Voice of Frankfurt (tel: 069 380100).

● Quad Electroacoustics, Huntingdon UK, now have five distributors for their professional products range, HHB Communications; Canford Audio; Michael Stevens & Partners; Studio Spares and Audio Systems Components.

● DAR have appointed SSE Marketing to distribute its SoundStation II digital audio production centre exclusively to broadcast and video facilities in the London area.

● MCMXCIX are now exclusive distributors of the PLI Infinity 45 removable SCSI hard disk unit. They are also exclusive distributors of the Reflective Arts CD ROM sound library for the Apple Macintosh.

● TSC (The Synthesizer Company) are now a London supplier of the Akai DR1200 digital multitrack, they've also been appointed authorised dealers for the E-Mu Emulator III.

● Cue Systems have been appointed by HW International to distribute the complete range of Carver professional power amplifiers in the UK.

● Milab Microphones, Sweden, have agreed for Klark-Teknik Research to undertake international marketing of their products. Sales and service is shared between Klark-Teknik, UK, for specified markets in Europe and overseas; Klark-Teknik Inc for the USA; and Milab from their offices in Sweden, for the rest of the world.



# AROUND THE WORLD IN 80 STUDIOS



From leading 48 track recording studios to producers' home facilities.

From national broadcast installations to premier music colleges.



From the Arctic Circle to the Antipodes.

The Saturn 824 Multitrack has an ever-growing list of users. In fact, it's now installed in 80 studios around the world.

And it reflects the progress we've made in taking analogue multitrack to a new standard.

From all those people, we hear the same response.

The Saturn 824 Multitrack is one of the most advanced machines of its kind in the world today.

With Auto Alignment, Total Remote, plus the unique COLT intelligent transport system and superb audio performance, it's now chosen by some of the most demanding studios.



To judge for yourself, ask for a personal demonstration.

Simply call the nearest Saturn distributor – wherever you are in the world.

**SATURN**  
RESEARCH  
SATURN RESEARCH LTD UNIT 3A 6-24 SOUTHGATE ROAD  
LONDON N1 3J1 ENGLAND TEL 01 923 1892 FAX 01 241 3644

**WORLDWIDE SUPPORT FROM SATURN RESEARCH**

UK: LARKING AUDIO 0469-492466 AUSTRALIA: JANDS ELECTRONICS PTY 08-516 3699 CANADA: SOUNDRAFT CANADA 514-685 1610 FRANCE: UDUCCO 48 97 81 60 GERMANY: AUDIO PROFESSIONAL HAMBURG 040-580961 HONG KONG: AUDIO CONSULTANTS 852-3-3513628 ISRAEL: SONTRONICS 972-3-449233 ITALY: AUDIO EQUIPMENT Srl 039-2000312 NORWAY: LYDROMMET 02 37 0918 SPAIN: LEXON 903-4804 SWEDEN: TAL & TON AB 031-80 3690 SWITZERLAND: AUDIO SYSTEMS PAS AG 01-391 5050



# What do successful albums have in common?

Billboard. <b>TOP POP ALBUMS</b> ™ 1988 YEAR END			
	ARTIST	ALBUM	PRODUCED ON SSL
1	George Michael	Faith	
2	Soundtrack	Dirty Dancing	✓
3	Def Leppard	Hysteria	✓
4	INXS	Kick	✓
5	Michael Jackson	Bad	✓
6	Guns 'N' Roses	Appetite For Destruction	
7	Debbie Gibson	Out Of The Blue	✓
8	Richard Marx	Richard Marx	✓
9	Tiffany	Tiffany	
10	Aerosmith	Permanent Vacation	✓
11	Terence Trent D'Arby	Introducing The Hardline	✓
12	Whitney Houston	Whitney	✓
13	Gloria Estefan	Let It Loose	✓
14	John Cougar Mellencamp	The Lonesome Jubilee	✓
15	Rick Astley	Whenever You Need Somebody	
16	Bruce Springsteen	Tunnel Of Love	✓
17	Belinda Carlisle	Heaven On Earth	✓
18	Soundtrack	More Dirty Dancing	✓
19	Whitesnake	Whitesnake	✓
20	Robert Plant	Now And Zen	✓
21	Tracy Chapman	Tracy Chapman	✓
22	Keith Sweet	Make It Last Forever	
23	Poison	Open Up And Say . . . Ahh!	
24	Sting	Nothing Like The Sun	✓
25	Pink Floyd	A Momentary Lapse Of Reason	✓

1988 chart data supplied by Billboard/Music & Media. Albums indicated were wholly or partly produced using SSL consoles

## Solid State Logic

MASTER STUDIO SYSTEMS

Begbroke, Oxford, England OX5 1RU (0865) 842300

Paris (1) 34 60 46 66 • Milan (2) 612 17 20 • New York (212) 315 1111 • Los Angeles (213) 463 4444 • Tokyo (81) 3 320 1101



# APT subsidiary for SSL

Solid State Logic have formed a subsidiary to develop and market a new digital compression system. APT, Audio Processing Technology, will apply techniques pioneered by Dr Stephen Smyth of Queens University, Belfast. Development and sub-assembly functions are also located in Northern Ireland.

APT's first product, *apt-X100*, was introduced at NAB in Las Vegas. It's a system that compresses 16 bit PCM samples to four bits per sample,

without a subjective loss of sound quality. The technique seems suitable for use in a variety of low capacity, high quality, audio transmission and storage applications.

APT have announced the appointment of Charlie Day as product manager for the *apt-X100* system. Day was formerly managing director of Fairlight (UK). APT's sales, marketing and manufacturing operations are based at SSL's headquarters near Oxford.

# Letter: Roland E-660 in operation

Dear Sir, As an owner of the Roland *E-660*, there are some problems with the unit that I would like to point out.

Unlike most professional digital products, the Roland unit uses a single A/D converter instead of two (as the *FI* and consumer *DAT* recorders). This is shameful because the supposed feature of being able to output (in the digital domain) a mix of the original digital plus an analogue signal from the Roland A/D converters is lost.

Phase stability is one of the unique advantages of digital audio. The use of a single converter 'swapping' between left and right creates a phase shift in the audio that results in a 2 or 3 dB dip at 15 kHz when combined to mono. Again, this happens when one uses the digital outputs. Reproducing the audio through the *E-660*'s own single D/A of course 'corrects' the time difference but one would assume that the digital outputs would be of most use to the buyer of the unit because, as the review points out, there are many better equalisers than this when used totally in the analogue world.

The unit defaults to 'digital mix

ON 100%' and 'analogue mix ON 100%'. Unless the user turns OFF the analogue mix to 0% they will be degrading the digital-to-digital sound of the equaliser needlessly.

While the unit is inexpensive as these things go, the user interface, having to interrogate a screen to see where the four bands are set is decidedly most unprofessional in my opinion.

As the unit chops off the sound while being switched from ON to BY-PASS or from one setting to another, its use as a realtime mastering instrument should be a bit limited.

Finally, and worst, if you are hooked-up in the digital domain and switch the unit on, be careful not to blow your speakers, or your career, as the unit outputs full 16 bit digital output for several seconds until it gets warmed up, there is no provision for muting the screech during this warm-up, again, most unprofessional!

For a cheap, pretty good sounding unit there is nothing I know about like it, but please observe the caveats I have mentioned.

Yours faithfully, Bob Ludwig, Masterdisk Corp, USA.

# Studio Service

## REPAIRS

Engineers Martin Leigh and Adrian Bowlas are a "Service" in house or call out. State of the Art test equipment, friendly, efficient repairs.

## CONSULTANCY SERVICE

We have over 15 years of experience in designing, building, installing and equipping recording studios in Universities, Schools, Colleges, people's homes as well as Commercial situations and Radio stations. We offer you by appointment, the opportunity to discuss your ideas.

## equipment wanted equipment wanted equipment

### SELLING SERVICE

Simply — we collect the equipment you have surplus and sell it for you. We are flexible on sales commission rates. And last but not least we will always pay instant cash for good condition equipment.

**INSTANT CASH**

## equipment wanted equipment wanted equipment

### NEW AND SECONDHAND EQUIPMENT

We have an extensive selection of New and Secondhand equipment available as well as knowing where to obtain the items you require. Don't hesitate to ring us, you never know we may have just what you're looking for. We pay cash for good Secondhand equipment. Studio clearances are our Speciality.

**EXPORT A SPECIALITY**

## famous laundry list famous laundry list famous

SSL 4000 G Comp 60F 48	P O A	FOSTEX A8	£795
SSL 4000 E G Comp. 40F	£118,000	MC1-JH110 8T	£2,200
NEVE B128-32	£47,000	FOSTEX E22 New	£2,250
HARRISON MR4 with MM	£35,000	FOSTEX M80 New	£1,100
TRIDENT TSM 40	£24,500	FOSTEX R8 new	£1,230
SOUNDCRAFT TS24 28 24	£15,000	TASCAM 34	£795
TRIDENT 75 28 24 Patchbay	£8,950	TASCAM 246 New	£695
SOUNDCRAFT 2400	£6,950	FOSTEX 260	£495
SOUNDCRAFT 3B 32 24	£7,950	SONY PCM 2500 New	£2,295
SOUNDCRAFT 800B monitor 40	£6,500	SONY DTC 1000 ES New	£1,130
SOUNDCRAFT 200 16 4 2	£1,495	SONY PCM 701 Yr warranty	£650
SOUNDCRAFT 200B 8 4 2 new	£1,295	SONY PCM 501	£325
SOUNDTRACS CP8800 32	£16,950	AMS SDMX	£4,995
SOUNDTRACS CM4400 32	£9,950	AMS 1580S	£2,995
SOUNDTRACS 18 16 18	£1,495	AMS 1580S	£3,500
SOUNDTRACS MRX 32	£4,500	AMS RMX16	£2,995
SOUNDTRACS PC Midl 24 16 16 2	£4,100	LEXICON PCM 70 3 01	£950
TAC Scorpion 24 16	£3,995	KURZWEIL 250	£5,000
TAC MATCHLESS 26 8 24	£7,950	FAIRLIGHT IIX	£3,950
ALLEN HEATH Sigma 32 new	£9,950	MELLOTRON	£995
ALLEN HEATH CMC 32	£2,995	PROPHET 2002	£895
ALLEN HEATH Sys 8 24	£1,395	AKAI MPC 60	£1,995
TEAC M2A 6 4	£150	KLARK TEKNIK DN780	£1,150
STUDIO MASTER II 24 16 2	£3,500	KLARK TEKNIK DN60	£1,295
CADAC 28 24	£13,500	TC 2290 32 sec New	£2,000
MC JH800 12 4 2	£3,200	WHITE 4400	£695
STUDIOMASTER "new" (all models)	Ebest	YAMAHA DMP7	£1,795
STUDIOMASTER 16 8 2	£695	YAMAHA Rev 7 new	£650
TASCAM M30	£395	YAMAHA SPX90 II	£395
SECK 18 8 2	£995	DRAWMER DS201	£250
RAM RM 10	£450	VU S22 New	£295
MITSUBISHI X850 32T	£76,000	VU E2X New	£395
STUDER A820 24T	£33,500	AKAI S900	£795
AMS AUDIOFILE	£45,000	YAMAHA DX7	£500
3M 32T	£25,000	ROLAND D50	£795
3M M79 with CM50	£7,995	BEL BD 80 8S	£395
LYREC 532 24T	£8,500	ELECTROSPACE GATE	£295
LYREC 532 24T	£7,200	ELECTROSPACE PRESSER	£295
SATURN 824 New from	£25,000	REBIS RAK with gates & comps	P.O.A.
OTARI MTR 90 II	£20,000	ATARI 1040 +SC1224 New	£395
OTARI MTR 90 II	£18,500	APHEX C	£195
STUDER A80 II	£14,500	AKG D12E	£120
TASCAM ATR 80	£18,950	AKG C451 CK1	£195
SOUNDCRAFT SCM 760 Mk II	£6,500	AKG C567	£95
TASCAM MS 16 with AQ85	£5,995	AKG C452 EB CK1	£175
TASCAM 85-16B dbx console	£3,995	AKG C28 Comb	£350
AKAI MG140 + ML14	£2,200	STC 4038	£250
TASCAM 38	£1,000	SENNHEISER MD421	£140
FOSTEX E16	£2,950	SHURE SM85	£195
FOSTEX B16	£2,200	SCHOEPS CMT S 501U	£995
OTARI MX70 1 6T	£8,000	JBL 4350 mc X-over	£1,995
TEAC A-3440	£595	JBL L250	£1,750
STUDER ABOVEU 1/2" 15 30	£4,750	TANNOY 15" CLASSICS	£795
REVOX B77II	£795	ATC SCM 250 pair	£2,995
TASCAM 32-2B	£595	YAMAHA PC2602M new	£695
TASCAM Porta-One	£250	BGW 7500	£495
ACES 24T Hi-spec	£4,950	NEUMANN U87	£650
GRAFF HSCD2 Duplicator	£995	UREI 813B	£1,950
OTARI MTR10	£2,750	QUAD amps s/h	P.O.A.
STUDER B67	£1,500	Shroff Racks	Evarious
REVOX B710 II New	£595	ENG OUTFIT JVC KY 310E kit	£195
REVOX A700	£595	JVC PR4800 HB U.M JVC TM 41 EK mon	£5,850
REVOX PR99 II	£1,295	All flight cased	£5,850
TASCAM 22 2	£350	24 SR 28 48 cards at each	£425
TASCAM 38B Mixer/Recorder	£1,550	DOLBY S - VARIOUS - PHONE	
REVOX PR99 M3 brand new	£1,295		
AMPEX MM1100 2" 16T	£3,995		
REVOX A77 HS	£250		

EXPORT PRICES  
(UK customers please add VAT)

Full description and details available on all the above equipment instantly by fax or next day by mail or verbally by phone, please call and ask for Alan Cheetham.



**PHONE NOW!**  
**0663**  
**64244**

High Lane Village,  
Nr. Stockport, SK6 8AA.  
Fax: 0663 62328



# SABER SERIES

*building on success*



- FOUR BAND EQ. SWEEP MIDS
- SIX AUX. SEND BUSES
- FULL MIDI MUTING
- FADER REVERSE ON ALL MONITORS
- EQ ON ALL MONITORS
- SOLO IN PLACE AND PFL
- MUTES ON AUX SENDS
- FULL SIXTEEN BUS
- 4 EFFECTS RETURNS, 2 WITH EQ
- CONNECTIONS FOR 2 TAPE DECKS
- CONNECTIONS FOR 3 SETS SPKRS
- 3 FREQUENCY OSCILLATOR
- 2 WAY TALKBACK
- PATCHBAY - AVAILABLE
- STEREO MODULE - AVAILABLE
- 3 INPUTS PER CHANNEL
- STAND INCLUDED

## **UK**

69 Ship Street  
Brighton BN1 1AE  
Tel: 0273 23346  
Fax: 0273 821767  
Telex: 878235 MBIAHB G

## **USA**

5 Connair Road  
Orange  
Connecticut 06477  
Tel: (203) 795 3594  
Fax: (203) 795 6814

**ALLEN  
&  
HEATH**



## Contracts

- **AMS** have supplied Square One Studio, Bury, Lancashire with an *AudioFile* digital recording system. AMS have also received an order from BBC for a 140-channel virtual console system for their colour mobile central control room. The console will be the largest so far supplied by AMS and is believed to be the largest console in the world installed in an OB vehicle.
- **TAC** have announced advanced orders of the *Bullet* mixing console from 36 countries around the world.

- The first **Mitsubishi X-880** 32-track digital recorders have been sold in the USA and Canada, to the Conway Studios in LA and the Spot Shop Studios in Vancouver.
- **Elliott Bros** have won the contract for the supply, assembly and insulation of **NTP** routing equipment and control systems in BBC Broadcasting House, Belfast, Northern Ireland.
- Recent **Amek Angela** console sales include Axis Studio, Sheffield, UK; Audiotone, France; and Studio 55, Sweden.
- The BBC World Service have bought an 8-channel **DAR**

*SoundStation II* in order to investigate the use of digital audio production systems in the preparation of current affairs programmes.

- **Soundcraft** console sales in Australia and New Zealand through Jands include a series 8000 to Mega Entertainment in Perth; a series 500 16-channel console and three series 200SR 8-channel consoles for the AOTEA Centre in Auckland, New Zealand; and a series 200SR for the new Bond University on Queensland's Gold coast.
- **Smart Acoustics** have been awarded a £100,000 contract to design, supply and commission the

entire sound system at the New Clubhouse in the Eden Beach Hotel complex, Malta.

- Recent **Soundtracs IL** console sales include Grapevine Studios, Adelaide, Australia; Golden Sunshine Studios, Austria; Side Studios, Munich, West Germany; and Echo House Studio, Roppongi, Japan.
- **Raindirk Symphony** console sales recently made through The Home Service include a 48 series mixer to Elcamion Studios in Barcelona, Spain; Broxmead Studios in Sussex, UK; Audio Media Studios, Munich, West Germany; and Ronnie Scott's Jazz Club in London, UK.

## US news

### Personnel

- **AMS/Calrec** have announced the appointment of Jim Stern as national sales manager. In addition Tom Irby of Omni Technology has been appointed **AMS AudioFile** representative for the southern region encompassing Tennessee, Alabama, Mississippi, North & South Carolina, Arkansas and Oklahoma.
- **Larry Lamoray** has been appointed director of marketing for **Fidelipac Corporation**. Lamoray's background includes 10 years with MCI.
- **Robert N Vendeland** has been appointed general manager for the West Coast office of the audio/video systems division of **Peirce-Phelps**, in Philadelphia, PA.
- **Steven Strassberg** has been appointed eastern division manager at **New England Digital**. Strassberg had been regional sales manager, eastern division at Adams-Smith.
- **Frank McMullen** has been appointed director of manufacturing at **Altec Lansing**.

- **University Sound**, a Mark IV Industries company, have announced the appointment of Robert W Sandell as company president. Sandell had been vice-president of marketing and sales at Kurzweil Music Systems.
- **Linda Murray** has been appointed general manager of **IDB's** new transportable division. Murray moves from director of operations.

Technology Consultants in Nashville, TN, as representatives for its **AudioFrame** digital audio workstation in the South Eastern United States.

### Installations

- **Acme Audio & Recording** have taken delivery of Chicago's first **PCM-1630**-based CD mastering facilities. Acme's control room now houses **Sony** equipment **DMR 4000**, **DTA 2000**, **PCM-501ES** and a **PCM-2500 R-DAT** machine.
- **Pro-audio** rental company, The Toy Specialists, have taken delivery of one of the first **AMS AudioFile** systems available in the US, and their second **Mitsubishi X-850** 32-track digital multitrack.
- **WaveFrame** have delivered an **AudioFrame** digital audio workstation to Master Sound Astoria in New York City.
- **Steve Lawson Productions** have upgraded their post-production facility by installing **New England**

**Digital's Post-Pro** system.

- **FM Acoustics** have installed an **FM 600A/ULI** precision power amplifier at American Helix Technology, Lancaster, PA, who specialise in custom CD manufacture and CD project management.
- **Solid State Logic** have announced 21 recent orders for their mixing consoles, including Power Station, New York; Century III Teleproductions, Orlando, FL; Phase One Recording, Toronto; and NBC Television, Burbank, CA.

### Agencies

- The US sales and service subsidiary of **Solid State Logic** are to act as North American distributors for **Sondor**, the Swiss manufacturer of magnetic film recorders and reproducers.
- **Samson Technologies** of Hicksville, NY, the exclusive US distributor for **Soundtracs** mixing consoles, have announced **Everything Audio** of Burbank, CA, as an area dealer.
- **WaveFrame Corporation** have announced the appointment of

### Address changes

- **Peirce-Phelps**, Philadelphia, PA, have moved their Washington DC regional office from Rockville, MD, to Gaithersburg, MD.
- **Sound Ideas** have moved to 105 West Beaver Creek Road, Unit 4, Richmond Hill, Ontario L4B 1C6, Canada. Tel: (416) 886-5000 US toll free (800) 387-3030. Fax: (416) 886-6000.

**CONDUIT STREET W1**

**YAMAHA MUSIC PULSE**

10% OFF EVERYTHING

OXFORD ST  
OXFORD CIRCUS  
ST MARLBOROUGH ST  
REAR ST  
CONDUIT ST  
WEST END ST

YAMAHA MUSIC PULSE, 58-60 CONDUIT STREET, LONDON W1. FAX: 4393239

OPENING TIMES:  
MON-FRI 9.30 AM-6 PM (LATE NIGHT)  
THURS TILL 8 PM, SAT 9.30 AM-5 PM.

A DIVISION OF KEMBLE MUSIC LTD

**ANNOUNCING THE PULSE HIGH-TECH-HIGH-SPEC-SO-WHAT-THE-HECK-SALE!**

**1st JULY-29th JULY 1989**

**RING PULSE NOW 01-734 5184**





## Digitec digital converters

French company Digitec SA have extended their range of digital audio equipment with the addition of two new digital converters. The *DS-C2* is a 1U 19 inch rackmount design and is available as an A/D or D/A converter. The *DS-C2 AD* will convert a stereo or two mono analogue input signals to two AES/EBU digital format outputs. The other unit, the *DS-C2 DA* is the equivalent digital AES/EBU to analogue converter. The *DS-C2* will operate at 32, 44.1 or

48 kHz sampling frequency and there is provision for internal clock or an external source. The front panel of the unit also shows the channel status data and the user data of the AES/EBU input signal and this may be altered locally or remotely via an RS 232 link.

**Digitec SA, 57 Boulevard de la Republique, BP 51, 78401 Chatou Cedex, France. Tel: (1) 30 71 48 71. UK: PRECO, 21 Summerstown, London NW17 0BQ. Tel: 01-946 8774.**

## Studer 990 mixing console

Studer have launched the *990* digitally-controlled mixing console. The console is in two basic versions, the in-line—which is suited to multitrack recording studios and post-production—and a simpler version without multitrack routing and monitoring for broadcast applications, etc.

The digital control of all routing and switching functions allows for a lot of flexibility in console setups and all routing can be controlled from a central keyboard. Both the channel and monitor faders are VCA-controlled, which increases the possibilities for automated mixing. The console is supplied in a automation-ready version and Studer motorised channel faders are optional.

The main principle behind the *990* series console is its integration into a centrally-controlled studio system via ESbus or similar networking system.

The desk control allows for the storage and recall of all switching and routing functions, 'snapshot' automation of all VCA levels, storage of knob positions for graphic recall and management such as cue lists, track lists, etc. For simplification,

two different central control panels are provided for desk control, ie the Snapshot Unit and the Master Graphic Control Unit.

The basic facilities of the in-line *990* are routing to 32 multitrack buses (expandable to 48/64) and eight audio subgroups, comprehensive channel input and output facilities, 4-band EQ with variable highpass filter, two insert points (pre/post EQ), 16 auxiliary buses addressed via four mono and two stereo sends, four stereo programme buses, 83 mm 'small VCA fader' with extensive routing and 104 mm VCA channel fader. The input level to the channel is controlled by MDACs.

An optional dynamics module with compressor/gate functions for each channel is also available together with remotely-controlled microphone preamplifiers for situations where long cable runs are required.

A system of VCA free-grouping is used where any channel fader can be designated as master and the programme master faders are stereo (mono/stereo operation) with optional limiters with link functions.

The console is supplied with comprehensive monitoring and

## Audiolab metal tape degausser

Audiolab Electronics Inc have introduced the model *TD-5* metal particle tape degausser: designed to handle bulk erasure of high coercivity tape cassettes such as DAT, 8 mm, Beta SP, MII and D1 and D2, as well as in open-reel formats of up to 16 inches in

diameter and 2 inches in width. Audiolab quote a current draw of 10 A and describe the unit as cool running.

**Audiolab Electronics Inc, 5831 Rosebud Lane, Building C, Sacramento, CA 95841, USA. Tel: (916) 348-0200.**

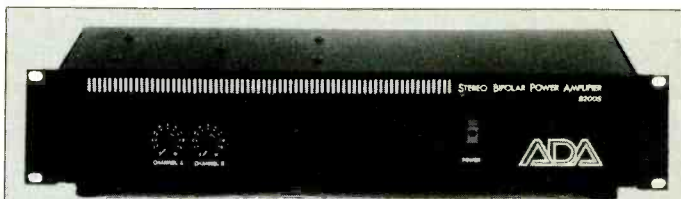

ADA have introduced a stereo rackmount power amplifier, the *B200S* rated at 100 W into 8  $\Omega$ , 250 W into 4  $\Omega$ . The design incorporates bipolar transistors in a design requiring no forced cooling. There is a fail-safe thermal regulation system used on each channel that automatically maintains proper bias at all operating temperatures. Fuse protection is provided on outputs and transistors. Inputs and outputs are on 1/4 inch jack sockets at the rear.

**ADA Signal Processors Inc, 7303-D Edgewater Drive, Oakland, CA 94621, USA. Tel: (415) 632-1323.**

**UK: Klondyke Trading Co, Unit 3B, 8 Cowley Road, Nuffield Industrial Estate, Poole, Dorset BH17 7UJ. Tel: 0202 670299. Fax: 0202 827999.**

## Quantec QRS/XL software

Quantec have announced that the *Macintosh* software for the *QRS/XL* digital effects processor is now available in Europe. This consists of *XLC (MacPlus and SE)* and *XLC2 (Mac II)*.

The new software allows the user to modify and create his own programs in the *XL* and is presented in a very logical, easy to use manner—complete with full graphics support.

Features of the *XLC* include the possibility to compare previous and new settings, the creation of libraries of effect types (eg plates, delays, halls) together with archives for program storage and transfer, and clear, high resolution graphics. **Quantec Tonstudioteknik GmbH, Clemensstrasse, 8 Munchen 40, West Germany. Tel: 89 33.30.34. Fax: 89 39.31.61.**

**UK: gtc Ltd, Unit 40, Sheraton Business Centre, 26-28 Wadsworth Road, Perivale, Middx UB6 7JD. Tel: 01-991 9152. Fax: 01-991 9391.**

**USA: Marshall Electronic, PO Box 438, Brooklandville, MD 21022. Tel: (301) 484-2220.**

communications facilities, as well as a variety of test and line-up routines. Metering consists of 100-segment bargraphs with two per channel (peak/vu) plus the bus and other function meters. The channel meters indicate multitrack routing and meter signal source as well as multifunction indications.

The largest frame configuration is 80 input channels, eight audio groups and four stereo masters and the optional dynamics section fits into a top panel installed over the meter bridge. The bantam jack patchbay can be installed at either end of the console and there is additional 19 inch rack space beneath it. All connectors to and from the console are *XLR* and multipins with the power supply and computer being installed in an external rack.

**Studer International AG, Althardstrasse 10, 8105 Regensdorf, Switzerland. Tel: (1) 840.29.60.**

**UK: FWO Bauch Ltd, 49 Theobald Street, Borehamwood, Herts WD6 4RZ. Tel: 01-953 0091.**

**USA: Studer Revox America Inc, 1425 Elm Hill Pike, Nashville, TN 37210. Tel: (615) 254-5651.**



# G

D A T A B A S E

F I L E

"Very high power triamped active monitoring system. 144dbSPL very low distortion and colouration."

S Y S T E M : 1 0 3 5 A



S T A T E M E N T : O L Y M P I C S T U D I O S

"We tried these out for four weeks and the response from our customers was so encouraging, we bought three pairs."



# GENELEC

D I S T R I B U T I O N

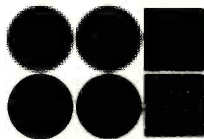

SSE MARKETING  
UNIT 2  
10 WILLIAM ROAD  
LONDON NW1 3EN  
TEL 01-387 1262



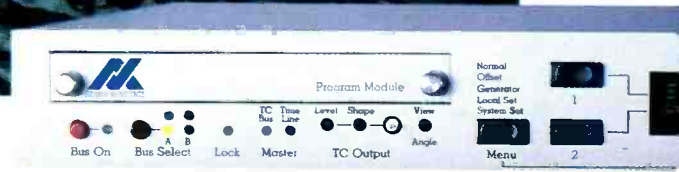

# *Why we decided to link our products as fast as we possible*

*Video and audio technology are at last coming together. At HHB their relationship is even closer. They're well and truly synchronised.*

*Take a look at the latest and most advanced audio products in our re-styled demonstration facility.*

*Sony's new analogue recorders may carry advanced video post-production features, but linked with Dolby SR, both the APR-24 and the APR-5003V set fresh standards in the recording studio. Digital Audio? We've always believed it should combine performance with practicality. That's why we offer DAT and Akai's brilliant pint-sized system alongside CD Mastering and DASH hardware.*

*Now you can take a look at the latest and best in video at HHB. A selection of*





# o-audio operation with video ossibly could.

*Betacam-SP components for the world's most popular broadcast system. Highly versatile 'Type IX' SP U-matics – high-band recorders with time-code options – totally compatible with both high and low-band equipment. And if you're keen on digits, HHB is already gearing up for D2 composite DVTR.*

*Blending the latest audio with the best video requires superb synchronisation. Naturally, we have the perfect solution. There's simply no faster way to lay back audio to video than the Audio Kinetics ES 1.11.*

*We're already known as Europe's leading pro-audio centre. Now we're backing video hardware with the same after-sales excellence and expert advice. The best of both worlds, only at HHB.*



# SyncController

## SMPTE - Based Studio Synchronization System

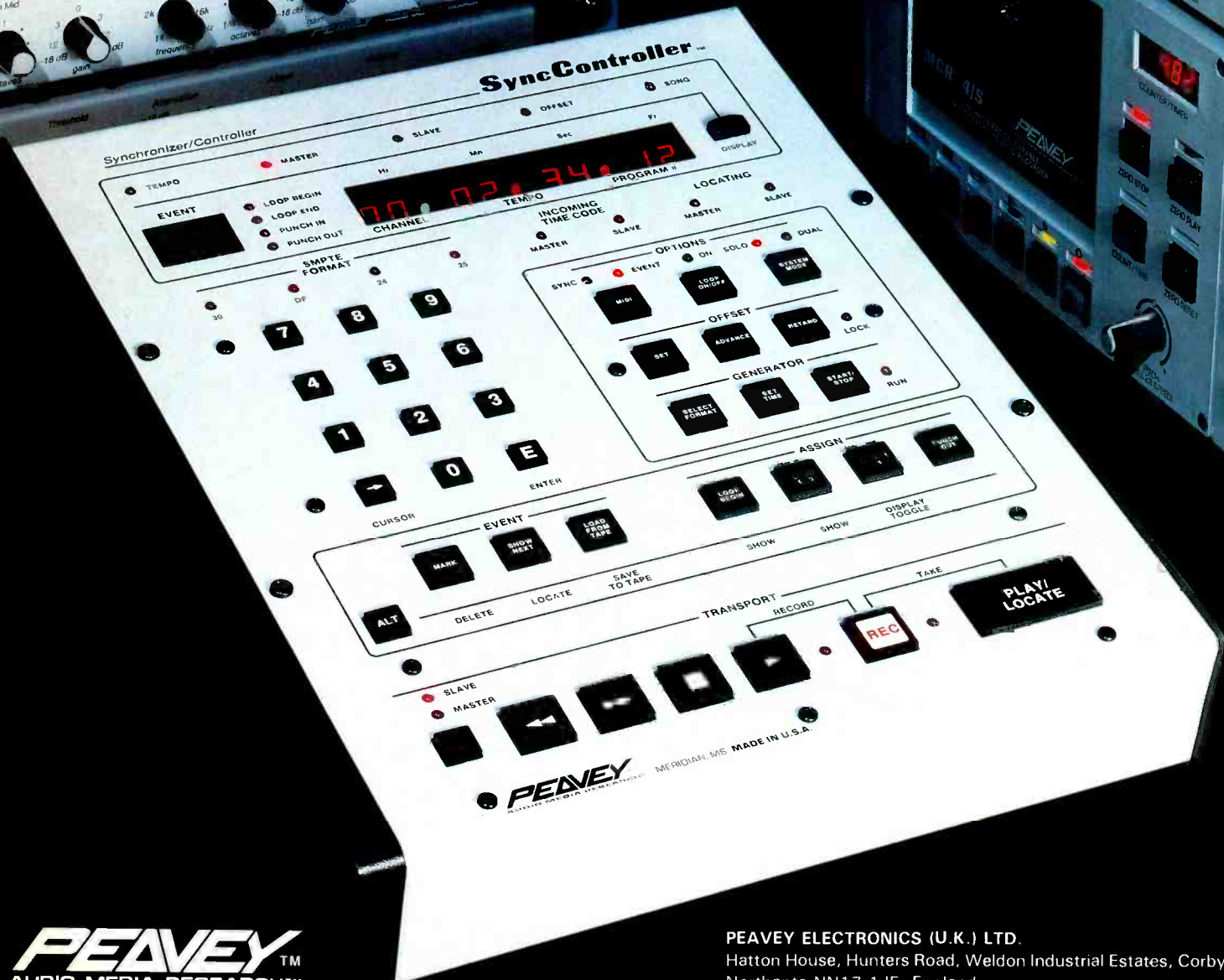
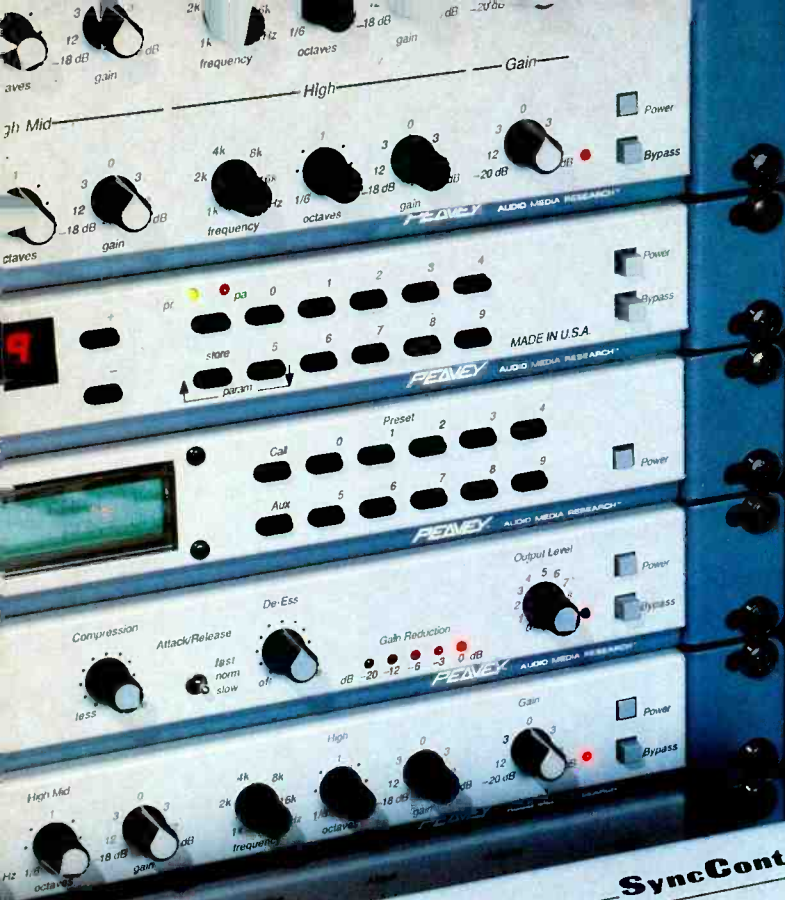

**PEAVEY**<sup>TM</sup>  
AUDIO MEDIA RESEARCH<sup>TM</sup>

A DIVISION OF PEAVEY ELECTRONICS CORPORATION

711 A Street/Meridian, MS 39302-2898/(601) 483-5372/Telex: 504115/Fax: 484-4278

PEAVEY ELECTRONICS (U.K.) LTD.  
Hatton House, Hunters Road, Weldon Industrial Estates, Corby,  
Northants NN17 1JE, England  
Telephone: (0536) 205520 Fax No. (0536) 69029



## Crown SASS-P PZM mic

Crown have released the SASS-P stereo PZM microphone and the SASS-B stereo boundary mount for two Bruel & Kjaer 4006 microphones fitted with the UA 0777 nose cones.

The SASS-P is designed to give highly localised stereo imaging for loudspeaker reproduction for such applications as classical recording, film and television sound or location recording where the soundfield must match the physical spacing of the sound sources rather than provide a stereo 'wash'.

The microphone features two capsules with human head-sized spacing, with the acceptance angle of each capsule being 125° through the vertical to horizontal planes. The microphone is also mono compatible.

The frequency response is effectively uniform from 20 Hz to 18 kHz and there is little or no off-axis colouration.

The SASS-P can be phantom powered or by two 9 V batteries. There are separate balanced low impedance outputs for left and right and the unit also incorporates a 100 Hz rumble filter.

Standard accessories are three windshields (including one in chromakey blue, which makes the microphone disappear when it is on camera), auxiliary foam wind protectors, hand grip and thread adapters for microphone stands. An optional Steadicam mount is also available.

The SASS-B boundary mount has similar specifications to the SASS-P but is recommended for applications requiring extremely low noise.

**Crown International Inc, 1718 W Mishawaka Road, Elkhart, IN 46517, USA. Tel: (219) 294-8000.**  
**UK: HHB Communications, 73-75 Scrubs Lane, London NW10 6QU. Tel: 01-960 2144.**

**UK: Shuttlesound Ltd, Unit 15, Osiers Estate, Osiers Road, London NW18 1EJ. Tel: 01-871 0966.**

## WaveFrame AudioFrame disk recording module

The WaveFrame Corporation have announced the development of hard disk recording for the AudioFrame Digital Audio Production System. Disk recording modules are either 4- or 8-channel plug-in units that

## Klotz Oak-Link

Developed by the Studiotechnique division of Klotz, Oak-Link is a digital data transmission system using fibre-optic connection between Oak-Link stations. Input signals may be digital or analogue and the stations may be up to 2,000 metres apart with the single fibre-optic cable carrying a maximum of 64 channels of audio.

Klotz see the system as being a possible replacement for bulky multicores with advantages including freedom from losses and interference, improved audio quality, more compact cable dimensions, and with signals in this form it is possible to easily patch, split and route signals at an Oak-Link station. These latter functions can be achieved by the use of a light pen and a series of dedicated screen displays or via cursor keys and a numerics keypad.

Oak-Link uses its own integral 16-bit oversampling A/D and D/A for analogue interfaces with AES/EBU and SDIF digital format converters completed so far. The system will therefore be of use as a format converter. The maximum word length accommodated is 24 bits at up to 48 kHz sampling but with the provision for external clock control of



48 or 44.1 kHz. MIDI signals can be used to reconfigure the system automatically and the system can also be used to send lighting signals.

Oak-Link is fully modular with the configuration of each station being variable as well as the size and extent of the overall network being expandable.

**Klotz & Co Elektronik,**

**Gronsdorferstrasse 14, 8013 Haar, West Germany. Tel: 089 461 0000. Fax: 089 461 00052.**

**UK: Klotz (UK) Ltd, CAPP House, 96 South End, Croydon, Surrey CR9 3SD. Tel: 01-681 0726. Fax: 01-681 4069.**

**USA: Apogee Electronics Corp, 1517 20th Street, Santa Monica, CA 90404. Tel: (213) 828-1930.**

## Audioscope modular analyser

Audioscope have recently introduced the model 9000 programmable audio analyser designed for a wide range of audio applications. The unit comprises a 3U rack mount frame with a large front panel key pad and an external colour monitor. The device is fully menu driven. Optional modules will be available to plug into the mainframe to offer expanded facilities. There is also an optional infra-red keyboard for remote operation.

Initial system features include 1/3-octave spectrum analysis, pink and white noise generation, an oscillator, PPM/vu metering, automation level indicator with future provision for

frequency curve plotter and RT analyser. There is provision to connect a printer to record all graphics and spectra, as well as a RS232 port for the connection to an external computer for further data processing or disk storage. Other developments include the possibility of external equalisation control. **Audioscope, Via Guilio Cesare Cordara 32, 00179 Roma, Italy. Tel: (06) 780 6979.**

**UK: Michael Stevens & Partners, Invicta Works, Elliott Road, Bromley, Kent BR2 9NT. Tel: 01-460 7299.**

**USA: Apogee Electronics Corp, 1517 20th Street, Santa Monica, CA 90404. Tel: (213) 828-1930.**

## Audio Logic room equaliser

The SC 131 from Audio Logic is a single-band equaliser offering 31 bands of cut only room EQ up to -10 or -20 dB. There are two bypass modes—the unit is removed from the signal path when the power is removed and there is also an active bypass that allows the switching out of the EQ section whilst still retaining the gain amplifier in the signal path. There are variable high and lowpass filters that can be individually switched in/out and a LED level indicator. Connections are XLR-type, barrier strip and 1/4 inch jacks.

**Dod Electronics Corp, 5639 Smith Riley Drive, Salt Lake City, UT 84107, USA. Tel: (801) 268-8400. Fax: (801) 262-4966.**

**International: Dod International, 10 Cindy Drive, Nashua NH 03062, USA. Tel: (603) 888-5230. Fax: (603) 888-6750.**

**UK: John Hornby Skewes, Salem House, Garforth, Leeds LS25 1PX. Tel: 0532 865381.**

occupy a single slot in the AudioFrame. The facility can be expanded to 32 channels and the system is described as switchable to either 16 or 24 bit modes. The 4-channel module DRM4 will be

available in the late summer. **WaveFrame Corporation, 2511 55th Street, Boulder, CO 80301, USA. Tel: (303) 447-2351.**  
**UK: Syco Systems, Kimberley Road, London NW6 7SF. Tel: 01-625 6070.**

## ARSONIC Sigma 1.2

ARSONIC are a German company manufacturing signal processing products and mic and power amplifiers. It is only recently that their products have become more widely available outside Germany. One of the first units to have wide distribution is the *Sigma 1.2* microprocessor-based Level Control Unit. This is an 'intelligent masterfader automation system' that independently levels out programme material by analysing the signal and 'initialising' it at the first pass. Accurate peak/transient detection, maximum S/N and no loss of dynamic range is achieved at the second pass without the use of limiting or compression. The unit apparently completes this operation by reference to the stored programme

information from the first pass and adjust the VCAs accordingly. It is also possible to program fade ins and outs of up to 60 seconds. Up to 100 memories are available for the storage of parameter data. The system also incorporates Dynafex noise reduction as a programmable function. The unit is two channel and the channels may be linked for stereo operation.

**ARSONIC, Nurnbergerstrasse 28, Postfach 100118, D-8580 Beyreuth BRD, West Germany. Tel: 0921 57711.**

**UK: Radius, PO Box 3, Basingstoke, Hants RG24 9QA. Tel: 0256 477222.**  
**USA: ARSONIC US, 146 Paoli Pike, Malvern PA 19355. Tel: (215) 647-9426.**

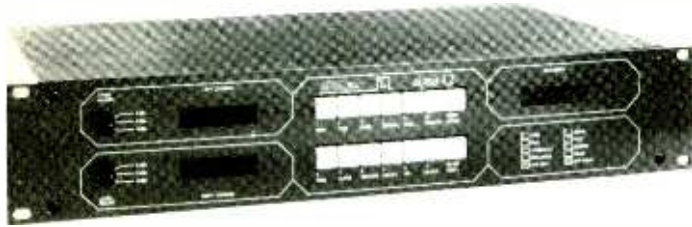

## Drawmer noise filter and distrib amp

Drawmer have released the *DF320* Universal Noise Filter and the *LA12* line distribution amplifier.

The dual-channel *DF320* is a single-ended noise reduction system, with each channel divided into a dynamic filter section and a comprehensive expander. The filter section senses the highest frequency of the programme material and opens itself to that frequency. Operation can be manual or auto; manual is used to set the initial threshold and auto then tracks the incoming signal as required.

Other features include balanced inputs and outputs, individual LED displays for input level—expander gain reduction—filter frequency, overall bypass switching as well as section in/outs and switchable 50 Hz 'rumble' filters.

Applications range from cleaning up old recordings for remastering to problem solving such as noisy electronic instruments and guitar

amplifiers.

The *LA12* line distribution amplifier has a stereo input with level and pan controls and 12 stereo outputs, each with its own level control. All input connectors are RCA/phono. An auxiliary stereo output, which follows the input level control, is also provided for use as an additional feed or for stacking units.

The *LA12* is housed in a 1U chassis and has a maximum input gain of +10 dB. Output gain is variable from -40 dB to +10 dB. Other features include very low distortion and noise, with a bandwidth from 5 Hz to 25 kHz (-1 dB).

**Drawmer Distribution Ltd, Charlotte Street Business Centre, Charlotte Street, Wakefield, West Yorkshire, WF1 1UH. UK. Tel: 0924 378669. Fax: 0924 290460.**

**USA: Quest Marketing, PO Box 20, Auburndale, MA 02166. Tel: (617) 964-9466. Fax: (617) 969-7758.**

## NAB notes

Whether it is the nature of the attendees at an NAB Convention or the fact that audio still occupies a very lowly place in the overall context of the show that makes audio equipment manufacturers feel far more confident about showing equipment in development quite openly, this year's convention was notable for almost all the major new products being shown in prototype although some will apparently be available before the end of the year.

The Digital Products division of AGK USA were showing the *DSE 7000*. We covered this RAM-based editing system briefly in the May issue and the pre-production prototype shown at NAB remained true to the given description. There was considerable relief that RAM prices have begun to decrease enabling the *DSE* to be a cost effective device for manipulation of up to eight tracks of audio of short duration. The demonstrated software allowed basic audio editing, time slip and manipulation for such requirements as commercials. It appeared to be quite straightforward and relatively intuitive to the unfamiliar user. Future plans include further software development as well as the possibility of DSP functions such as reverb and dynamics although there is nothing definite at this stage. One feature not mentioned so far is the provision of an uninterruptable power supply to allow downloading of the RAM-held information data into a medium such as hard disk or DAT before the power dies.

➤ Panasonic were showing what many have been waiting for—a DAT editing system. On demonstration were a pair of rackmount pro-type units with all the features that we have come to expect on pro-DAT. There being no information in written form, precise descriptions will have to wait but the SMPTE timecode implementation apparently follows the NHK derived proposed timecode format. Editing is possible with just two machines running together with editing between them at preset timecode points. A further part of the system was a separate edit controller that appeared to have been derived from a video editor. This allowed precise location of editing points within a buffer memory—as we have come to expect with other forms of digital editing from tape. On the prototype editor I understand that there are many things to be changed such as the replacement of the position location nudge buttons with a jog-wheel and so on. It is apparently possible that we will see this as a more finished product later in the year. Panasonic

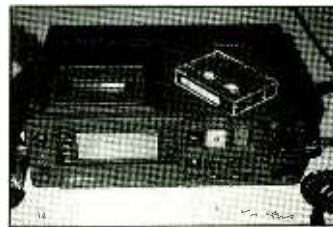

Panasonic DAT prototype

were also showing a very early prototype of a portable DAT also using SMPTE timecode as the rackmount units and offering truly portable recording facilities such as choice of phantom powering voltages, etc. Rather larger than the current Technics portable but still very compact it looks a particularly interesting project. None of the Panasonic machines shown had names allocated as yet.

On the subject of portable recording, Nagra were showing what looked like a concept rather more than even an early prototype. In a casing about the same size as a Nagra IV was a reel-to-reel deck but with a rotary head assembly. Tape was ¼ inch and the recording format described as DAN (Digital Audio Nagra), which I understand to contain six tracks of which four are available for digital audio. Apart from other brief information on possible format specifications, there was little else available.

Valley Audio were showing what they described as a pre-production prototype of the multiband digital dynamics unit. This device has fully adjustable dynamics parameters in each band (eight bands in all) and is already in Beta test sites with the broadcast software. A different software set will slightly later be made available for mastering applications and may be available by the time that this is published.

Sanken were showing two early prototypes of very small microphones, one of which is being designed as the world's smallest lavalier with the intention of meeting the demands of audio for high definition TV where they feel that standard-sized lavalier mics will become a problem to hide.

Sony were showing a prototype digital mixer—the *APX 177* although





---

# Audio & Video Jackfields Make the Right Connection

Plasmec manufacture the Mosses & Mitchell range of Audio and Video Jackfields and Sockets, widely acknowledged to be the finest in the world.

Designed and made in the UK, all Mosses & Mitchell products are built using the very latest engineering technology – and then subjected to the most stringent quality controls to ensure the ultimate performance.

That's why companies of the calibre of British Telecom, the B.B.C., L.W.T., Soundcraft and Neve continually specify Mosses & Mitchell Jackfields and Sockets or approach us to design and manufacture custom-made products to exact specifications.

Contact us now for a copy of our new brochure, featuring the full range of Audio Jack Sockets and Audio and Video Jackfields, including compact and pre-wired versions.

Plasmec Systems Ltd.  
Mosses and Mitchell Division  
Weydon Lane, Farnham, Surrey GU9 8QL  
England  
Tel: 0252 721236 Fax: 0252 712718

**Mosses and Mitchell**  
**PLASMEC**

---



## Soundtracs SPA 4800/3200

Soundtracs have launched the SPA 4800/3200 live sound console aimed at front rank touring sound reinforcement companies and high quality installations.

Available in 48- and 32-channel versions, the SPA series consoles can be linked together via the summing-VCA—master mute buses for a total of 96 input channels.

Special attention has been paid to low noise and crosstalk with all mixing buses being balanced, together with electronically-balanced inputs and outputs. Transformer balancing is available as an option. High headroom is obtained with the internal operating level set at -2 dBu, with line inputs and outputs set at +4 dBu.

Features of the SPA series include eight audio subgroups and dual stereo output buses, eight VCA groups, eight mute groups, eight auxiliary buses together with a direct output send with level control for each channel and 8x8 matrix from the audio subgroups.

The input channels are fitted with

the EQ section from the ERIC studio console and a 20-segment input meter is fitted beside the channel fader with the source user-selectable from four different points.

The subgroup module features a stereo return with HF/LF equaliser, level and pan, together with matrix and auxiliary master controls. A reverse switch function flips the auxiliary and subgroup buses, which then configures the console for onstage monitor mixing.

The console is fitted with comprehensive monitoring and talkback facilities and the frame is constructed from mild steel and aluminium extrusion for minimum weight with maximum solidity. Easy servicing has also been taken into consideration.

A dual power supply with auto-switchover is also provided. **Soundtracs plc, 91 Ewell Road, Surbiton, Surrey KT6 6AH, UK. Tel: 01-399 3392. Fax: 01-399 6821. USA: Samson Products Corp, 124 Fulton Avenue, Hempstead, NY 11550. Tel: (516) 489-2203.**

## Ampex DAT storage

Ampex have introduced a DAT cassette storage system called *DATpak*. This includes a 2-cassette storage tray, a documentation storage area for track sheets, recording information and duplication instructions, and a professional labelling system with check-off boxes, track sheets and cassette labels. This storage system has been developed to accompany the Ampex 467 DAT,

which is available in lengths of 45, 60, 90, 120 minutes running time. **Ampex Corporation, Magnetic Tape Division, 401 Broadway, MS 22-02, Redwood City, CA 94063-3199, USA: Tel: (415) 367-3888.**

**UK: Ampex Great Britain Ltd, Acre Road, Reading RG2 0QR. Tel: 0734 875200.**

## Publison DAB 3 audio system

The Publison DAB 3 digital audio system has a capacity of 1 to 16 hours of digital audio and is expandable in 1 hr increments. The system can be ordered with two or four tracks and 2-track models can easily be updated to four.

The system uses 16 bit linear A/D conversion with storage to hard disks. The unit also incorporates an 8 mm video cassette for saving or loading sounds to and from disk (six hours).

The DAB 3 uses high quality colour graphics and some of the facilities available include:

Waveform editing—where the sound(s) to be edited are represented

visually, for accurate in/out points;

Chaining lists—which allows the creation and modification of chains of sounds. Crossfade is adjustable for each fade point;

SMPTE/EBU synchronisation—where sounds can be triggered off as events when required;

Time compression/expansion—which allows separate adjustment of the pitch ratio and speed ratio, thus enabling audio to be inserted accurately into fixed time constraints. **Publison Audio Professional, 18 Avenue de la Republique, 93170 Bagnolet, France. Tel: (1) 43 60 84 64. Fax: (1) 43 60 80 31.**

## NAB notes

most audio people probably missed it. It was being demonstrated as part of the Sony composite video digital editing suite and was totally geared for this type of function. Looking more like a video switcher, the APX is designed for mounting within a console and is totally dominated by the routing buttons (giving the switched appearance). There were 12 input channels with mute, assign and a moving fader. The channel facilities were selected by assign buttons giving access to 4-band EQ, full dynamics and delay (in frames not milliseconds). All mix and setup data is recorded on a 3½ inch floppy and the console can fully reset itself. Exactly what form this product will be in when it makes a full appearance remains to be seen but it is indicative of how seriously the larger video product range manufacturers are taking digital audio, although of course Sony have a considerable advantage over other manufacturers here as they are heavily into audio anyway. In this respect, the barriers between audio and video are being dismantled and nothing hits harder than the announcement that the new HDVS (High Definition) digital VTR also records eight channels of 48 kHz

PCM audio!

General topics of interest at the NAB were High Definition TV systems and despite the lack of agreed standards there was a feeling that this is the way forward. From the audio point of view, in the production domain this was generally being linked with digital audio and also Dolby Surround with several idealised consumer demonstrations of what we could be listening to (and seeing). The fusion of audio and video is greater than ever.

If I had to pick the item that impressed me most I am afraid that I have to look to video and the Sony booth. The DME-9000 System G is a graphics processor capable of creating a 3D image out of a standard video display. It is possible to assign height or depth information by mapping over the image on the screen. The image may then be rotated around an axis and then turned into another shape such as a bottle. Difficult to explain—astounding to watch.

I left the NAB Convention wondering if, when digital audio first started appearing in a serious way at the start of the decade, we had referred to it as High Definition Audio we would now be on more equal terms with the video boys. It would have been less painful knocking on each others doors.

Keith Spencer-Allen



Prototype digital audio mixer from Sony

## Tascam TSR-8

Tascam have announced a new ½ inch 8-track recorder, the TSR-8. It runs at 15 in/s with built-in dbx Type I noise reduction and has been designed to also meet the needs of video post-production applications and is fully controllable by a synchroniser such as the Tascam Midiizer. Features include drop in/out

with rehearsal and review modes, gapless drop in/out, spot erase, microprocessor 3-point autolocator, bargraph level meters with peak hold, and an optional remote control. **UK: Teac (UK) Ltd, 5 Marlin House, The Croxley Centre, Watford, Herts WD1 8YA. Tel: 0923 225235. Fax: 0923 36290. USA: Teac Corporation of America, 7733 Telegraph Road, Montebello, CA 90640. Tel: (213) 726-0303.**



# IT'S THE LITTLE THINGS ABOUT THE IL SERIES THAT YOU'LL APPRECIATE.

Take a close look at the Soundtracs IL Production console. An outstanding console that's achieving acclaim amongst commercial recording studios around the World. Designed to meet a production climate that's radically changing with engineering that matches efficiency with vision.

More important, though, listen to the way it sounds. This 32 bus console offers very low noise, minimal crosstalk and a degree of sonic transparency that sets new standards.

Combine these attributes with a sensitive yet effective equaliser section to create one of the sweetest sounds to be found anywhere, perfect for high quality track laying.

And while our crystal clear layout is free of gimmickry, we've included a number of unique features and sophisticated circuit designs which, together with Soundtracs Tracmix fader automation, provides versatility to set your creativity free.

Little things in themselves. But in the Soundtracs IL, add up to a rather special production console.



SOUNDTRACS PLC, 91 EWELL ROAD, SURBITON, SURREY  
KT6 6AH ENGLAND. TELEPHONE: (01) 399 3392/390 8101.  
FAX: (01) 399 6821. TELEX: 8951073 STRACS G

#### SPECIFICATIONS:

- 48 OR 36 CHANNELS □ 104 OR 80 INPUTS ON REMIX
- INTERCHANNEL CROSSTALK BETTER THAN -88dB @ 1kHz
- MIX NOISE 32 INPUT ROUTED BETTER THAN -82dB.

#### EXCLUSIVE UK DISTRIBUTOR:

**LARKING  
AUDIO**

LARKING AUDIO, 15 CAM SQUARE, HITCHIN,  
HERTS SG4 0TZ. TELEPHONE: 0462 422466.  
FAX: 0462 421171. TELEX: 825488 DONLAR G.

## Ensoniq EPS-M performance sampler module

This is a rackmount version of the *EPS* keyboard. It was designed for use with any MIDI keyboard, guitar, percussion or wind controller. All the features of the *EPS* keyboard are included, plus 1 Megaword (1.7 Mbytes) of RAM (four times that of the keyboard version), a fully-functioning SCSI port (to allow connection to hard disks for extra sound storage, or direct connection to a *Macintosh* computer for editing purposes) and eight programmable polyphonic solo outputs. The on-board 8-track sequencer will record up to 80,000 notes and features an automated MIDI mixdown facility for individual tracks within a song.

The *EPS-M* is particularly suited to alternative MIDI controllers, such as MIDI guitars. It supports Poly, Omni, Mono A and Mono B modes. With 20 voices and up to eight simultaneous MIDI channels in, the *EPS-M* is capable of supporting several external controllers at once. Direct Memory Access permits sounds to play while additional sounds are loading.

The 16 bit linear sampler features 40 selectable sample rates of up to 52.1 kHz, with sampling times from 19.8 seconds to more than 2.5 minutes. There is an 'expert system' for auto-looping and there is a wide variety of digital signal-processing commands including sample copy,

truncate, mix, merge, splice, fade in and out, volume smoothing and six different crossfade loops.

A flexible audio output scheme includes stereo outputs plus eight programmable polyphonic solo outputs. A dynamic voice allocation system makes all 20 voices available to each output when using the 31.2 kHz playback rate. The number of voices available varies according to the playback sampling rate in use and reduces to 16 voices at 39 kHz playback rate and 12 voices at 52 kHz playback rate.

**Comment:** If viewed as a 'MIDI workstation', the *EPS-M* is competition for similar products such as the Korg *M1*, Yamaha *V50*, Roland *W30*, which include on-board sequencers. As a 16 bit sampler, it is obvious competition for the Akai *S950/S1000* samplers, lying between these in price. The *EPS-M* has a generous amount of on-board memory and an SCSI port is included for hard disk connection.

**Ensoniq Europe bv, Domplein 1, 3512 JC Utrecht, The Netherlands. Tel: 31-30-314 225.**

**UK:** Ensoniq UK, Ensoniq House, Mirage Estate, Hodgson Way, Wickford, Essex SS11 8YC. Tel: 0268 561177.

**USA:** Ensoniq Corp, 155 Great Valley Parkway, Malvern, PA 19355. Tel: (215) 647-3930.

## Op-Code Systems MIDI/SMPTE interface

Op-Code Systems have recently released a new MIDI interface for the *Macintosh* computer. The *Studio 3* is a 1U rackmount box with two independent MIDI ins and six independent MIDI outs. It can read and write all forms of SMPTE timecode, and outputs MIDI Time Code (MTC) directly to the computer. It also jam-syncs for regenerating code, and sends 'direct time lock' as an alternate sync code. The *Studio 3* also has Thru patching for playing through to synthesisers, printing or using a modem or other peripheral while keeping all MIDI cables attached. Other features include an internal power supply and an audio input for converting audio signals

into MIDI notes, which allows syncing to a live drummer or to a click or drum sound on tape. When used with Op-Code's new Vision MIDI sequencer, a unique feature called Soft Shoes allows remote control of most of the sequencer functions from a MIDI keyboard.

**Comment:** The *Studio 3* includes all the essential features to make it the ideal choice for use in a professional studio setup. Particularly nice features are the inclusion of the internal power supply and the Jam-Sync facility.

**Op-Code Systems, 1024 Hamilton Court, Menlo Park, CA 94025, USA. Tel: (425) 321-8977.**

## Poke low-cost patch editors for Yamaha synths

These editors run on most IBM-compatible computers with the Roland *MPU401* or compatible MIDI interface and work with most 4-operator Yamaha FM synthesisers. These include the *DX11*, *TX81Z*, *DX21*, *DX27* and the *DX100*. The main purpose is to provide 'friendlier' on-screen editing when creating new synthesiser sounds. The software also allows the edited voices to be saved and retrieved to and from the computer's disk, thus avoiding the hassle involved when using cassette interfaces with the synthesisers.

The programs all feature a simple-to-use menu-driven user interface, with context-sensitive help windows. The manual is clear, well-written and comprehensive. A performer editor is included for the *DX11* and *TX81Z* performance modes and there is a voice randomiser facility to produce new voices.

**Comment:** These programs are intended primarily as voice editors, and consequently should not be regarded as competition for other fully-fledged editors, which often feature more comprehensive Performance editing and Librarian features. However, they are extremely well-designed by a professional software writer who is also a musician and they are very competitively-priced. Particularly useful features are a variety of on-screen help facilities and screen layouts for the *DX11/TX81Z* editors, which are closely compatible with the programming sheets in the instrument's manuals. This latter feature is very useful if you wish to print out the parameters of patches you have developed.

**Poke Ltd, 54 Cambridge Road, St Albans, Herts AL1 5LD, UK.**

## Square Dance Audio MidiDrummer

This is a specialised drum programmer that will run on all *ST*-type Atari computers, in hi-res mono or medium-res colour. It can be used with any MIDI device capable of producing drum sounds, whether a sampler, a synthesiser, a Roland *D110*, a Korg *M1* or any MIDI drum-machine.

Drum patterns can be tapped in from the Atari keyboard or via MIDI from pads or keyboard. Alternatively beats can be placed on an on-screen editing grid with the mouse. All these methods can be used at the same time if you like and the program provides editing facilities for velocity information.

Patterns can be chained together to form songs, and cut, copy and paste operations are provided for quick re-arrangement of patterns. *MidiDrummer* will read MIDI song position pointers, making it perfect for use with SMPTE tape synchronisers and supports the Midifile standard, so that finished

drum songs can be saved to disk in a form that will load into any sequencer program that supports this standard file format. (NB: Most computer-based MIDI sequencers do now support the Midifile format.)

**Comment:** This program will be well received by anyone who uses and likes the grid-editing system first used by Roland on their popular drum-machines. The screen typically shows one bar of the music split into four main beat divisions and the program allows you to enter 'hits' in a variety of ways, after which you will see a visual representation of the patterns for each of the drum sounds available on your machine. This allows for very quick and intuitive programming of your rhythms, after which you may transfer the patterns to a sequencer if you wish.

**Square Dance Audio, The Bakery, Boyer Street, Derby DE3 3TD, UK. Tel: 0332 385021.**



# More features, more power more flexibility

“ Last year I completed 1138 sessions that could not have happened without AMS AudioFile.

No other single piece of equipment has ever generated the client response of AudioFile and with Version 8 software we can now even go after business that we couldn't before. This client response means CRC are now looking to buy a fourth system.”

**Tim Butler, Chicago Recording Company, Chicago.**

“ To be fair to AMS I must have been AudioFile's biggest sceptic and it took me a long time to decide to purchase my first system. I now own three AudioFiles and for anyone who knows me, that more than speaks for itself.”

**Dennis Weinrich, Videosonics, London.**

“ Version 8 software has so rapidly broadened our user base to include many top recording artistes throughout Europe that it was inevitable we had to buy another AudioFile.”

**Andy Hilton, Hilton Sound, London.**

“ The AudioFile is a powerful device in any audio application, but its ultimate strength is that it gives us a total system approach. Engineering and facility service can be achieved like never before in terms of quality and budget for the client as well as the studio.”

**Jimmy Dolan, Streeterville, Chicago.**



“ We bought our first AudioFile in 87, added a second in 88 and have now just added our third. Of course we looked round at the competition each time before we bought, but each time decided there was still nothing faster or more flexible than AudioFile.”

**Steve Cook, Magmasters, London.**

“ As our knowledge and business has expanded, we've added our second AudioFile and we know our clients and ourselves are now ready for a totally digital post production suite.”

**Alek Goosse, Videaudio, Brussels.**

“ Barcud's experience in post production proves that it is possible to be successful with AudioFile outside Soho. Having one AudioFile convinced us of the need to obtain a second machine, because of the enormous amount of time saved in a dubb and the cost effectiveness of such a facility.”

**Hywel Wiliam, Barcud, Caernarvon.**

“ We went to NAB 87 to check out disc based systems and bought an AudioFile. At NAB 88 we ordered a second and at NAB 89 we just ordered our third. The power of the latest AudioFile upgrades makes me even more convinced that we have chosen the right system for our needs at Sync Sound.”

**Bill Marino, Sync Sound, New York.**

Satisfied

More customers



Music Recording Consoles



Hard Disc Editor



Digitally Assignable Consoles



DMX/RMX Digital Audio Processors



Calrec Standard and SoundField Microphones



Custom Broadcast Consoles



Digital Mixing Consoles

**AMS**  
**AUDIOFILE**

**AMS Industries plc**

AMS/Calrec. AMS Industries Park, Burnley, Lancs. BB11 5ES. Tel (0282) 57011 Telex 63108 AMS-G. Fax (0282) 39542  
AMS/Calrec, USA. 3827 Stone Way North, Seattle, WA98103 USA Tel (206) 633 1956. Fax (206) 547 6890

Demonstration systems available throughout the United States



The Queen's Award for Export Achievement to Edendeck Ltd 1984 85 and AMS Industries plc 1986. In July 1985 Edendeck Ltd became AMS Industries plc

OVER 200 SYSTEMS IN DAILY OPERATION  
NOW WITH TIMEFLEX



# SATURN

## R E S E A R C H

### Saturn 824. Principal Features:

- Automatic Audio Alignment
- 14" Spool Capacity
- High torque bi-directional spool motors producing wind speeds up to 600ips
- Unique Calculated Open Loop Tension System ensuring accurate and safe tape handling even in a power failure situation
- Remote station giving digitally controlled access to:
  - Full Transport Control
  - Multi-function, 10 memory Autolocator
  - Programmable Macro function keys, storing 32 key sequences including Autolocate
  - Full control over monitor status with automatic monitor switching and solo function
  - Remote metering
- Remote and Local Tape Management panels, allowing complete digital selection of tape parameters, featuring:
  - 3 Tape speed selections
  - 3 Equalisation curve settings
  - 4 Tape type alignment memories
  - +/- 50% Variable pitch control
  - Multi-function oscillator with 16 frequency settings
  - LCD Status display
- Auto Cycle 'on the fly'
- Frequency response +/- 1db @ 27khz
- Frequency matched Sync and Replay heads
- Automatic 'find last play' function
- Gapless punch in/out with Timing Defeat facility
- Reverse Play facility

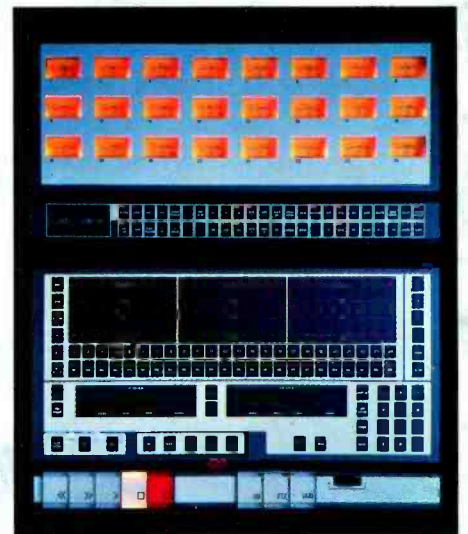

The Saturn 824 is a masterful piece of precision engineering. Suitable for major recording establishments and broadcast facilities it has standard features such as Auto Alignment and a Calculated Open Loop Tension system to name but two.

Built by people who are solely dedicated to making sophisticated Multi Track machines, The Saturn 824 comes with reliability built in, backed up by a comprehensive 2 Year Warranty.

This kind of machinery with these kinds of features normally commands a price. - But in this case not the price you think.

**LARKING**  
**AUDIO**

Sole UK Dealer

LARKING AUDIO 15 CAM SQUARE WILBURY WAY HITCHIN HERTFORDSHIRE SG4 0TZ TEL: 0462 422466 FAX: 0462 421171 TELEX: 825488 DONLAR G



**GS** Why do we want digital audio broadcasting? Isn't current FM good enough?

**NG** We want additional dynamic range and improved geographic coverage. Besides, I don't like compression and limiting effects on audio material.

**RS** In Germany, the manufacturing industry already has receivers ready for use with satellite broadcasting or for cable, but not for cars, there is no suitable aerial.

**GP** CD provides only archive recording, digital broadcast will provide live performance at CD quality. But radio listeners are mainly in cars. A 1 GHz satellite service could cover large service areas and be received in cars.

Terrestrial digital broadcast would allow regional programmes with car reception.

**ST** In cars digital would minimise multi-path distortion, but the expanded dynamic range would cause new problems.

**DP** In Denmark, we are a small, flat country with perfect pickup of three FM programmes and one AM programme on long wave. Coverage is not a problem in Denmark. Our worst quality problem is the studio to transmitter link. This will be upgraded to digital soon. For digital broadcast to be accepted, we must offer some additional benefits.

**AK** Improved transmission on FM is necessary, the existing situation is not good. We have 60 transmitters now in Paris operating every 400 kHz with a large interference problem. Of the four existing satellite channels, two are TV, the other two could be stereo audio. For mobile use we could use 1 GHz by satellite, or terrestrial but we have no frequencies.

**GP** Which, *D2-MAC* or *DSR*? We could have five radio with five TV programmes. Existing *D2-MAC* receivers can cope with that. But, *DSR* has better error correction, better resolution and works with a lower RF signal-to-noise ratio.

Frequencies in the 1 GHz band will be a problem in the short term. The committee meets again in 1992, but is unlikely to make a decision then. For the terrestrial service, it is a little better, perhaps a gap in the existing bands can be used and the *DSR* Eureka Project is examining this. Over the next four to five years we hope to have some answers regarding frequencies for mobile use. With digital or analogue transmission, reduced dynamic range may be required in certain environments.

**NG** 14 bit or 14 bit companded to 10 bit (*D2-MAC* resolution)? Either sounds better than conventional FM. I am very happy with the results. The transmission quality reveals the quality problem on the studio to transmitter links.

**RS** The consumer acceptance of CD

# DIGITAL BROADCASTING AND ITS ACCEPTANCE BY THE AVERAGE LISTENER

## Sam Wise reports on a panel discussion held at the 86th AES Convention in Hamburg

leads to the likelihood of a desire for better FM performance. *DSR* is better for quality and for station ID and programme selection information. More benefit for the customers. To get retailers to sell it, we must make sure that the consumer wants it. We did a recent market report in Germany on what customers want when purchasing hi-fi separates and stacks. Quality came first at 91%, with reliability and ease of use next at 72%. Which parts of a hi-fi system get regular usage? Our survey showed the tuner is used most at 85%, CD 82%, cassette 73%, record deck 64% and reel-to-reel 28%. I think *R-DAT* will start to sell when digital audio broadcast starts, it will be the only way to record the available quality. **DP** Is 85% tuner use for quality listening? Or is most of it for news, and background music?

**RS** I remind you that quality controls 91% of the buy decision.

**Aud 1** In the US this would be totally different. Volume sales of cassette are a lot higher than CD in most of the world. How can this usage be true?

**RS** This survey is for hi-fi, not for cars or portable equipment.

**Aud 1** But more hi-fi cassette recorders are sold than CD players. This doesn't agree with your survey. And people in the US don't listen to radio much.

**Aud 2** In figures published last week in California, cassette sales are now 50%, CD is 35% and records 15%. I disagree about radio, it is widely listened to in the US.

**Aud 1** Not in San Francisco, there

are 40 stations all interfering with each other.

**ST** Regarding cassette sales, there will be a lot more replacements due to damage than with CDs.

**Aud 3** I think price has a much higher actual effect on the buy decision. Look at all the rattling loudspeakers with cardboard backs.

**ST** The concept of sound quality is elusive. For example in surveys about newspaper readership, the *New York Times* appears to have about four times its actual sales.

People think that the quality paper to buy would be *The Times*, but they don't then actually buy it. People perceive their choice differently to what it actually is.

**RS** Price importance varies with the national market, here in Germany it is not such a problem. Let's look at the multichannel

systems just for the 5% to 10%. In designing digital radio, let's keep the customer in view. *D2-MAC* and CD Video will combine the TV and hi-fi so let's move the hi-fi across the room next to the TV. The next step may be multichannel audio but a long way in the future. Sooner may be big screen TV, which will require better sound within five years.

**NG** The concept of surround sound is fine, but have you listened to most people's stereo balance? There could be a case for more channels in TV audio but most likely placed in the front area or for multi-lingual use. I don't think surround sound is likely to succeed.

**RS** I was explaining household problems, not suggesting market direction. Experience with previous 4-channel was a total flop. We still have stocks, but only for historic interest.

**Dolby Rep** Dolby in cinema provides focus for dialogue behind the screen in large rooms plus surround sound speakers. For realistic sound we need a centre speaker. The *Surround* speakers provide a soundfield, atmosphere, ambience, realism. There are reasons why quad has failed but these don't apply to Dolby surround. Speaker position is not critical. Two million Dolby decoders have been sold. Current sales are 250,000 per quarter. That is not a market of just freaks. Customers use these decoders to playback Dolby *Stereo* video film releases. The BBC has broadcast in Dolby

---

In Denmark, we are a small, flat country with perfect pickup of three FM and one AM programme... for digital broadcast to be accepted, we must offer some additional benefits

---

opportunity. Here is a typical German living room. It has a door, a window and some chairs. The TV sits opposite the chairs and the hi-fi usually next to them. For 4-channel, the speakers are behind the chairs and the wire has to cross the door and the wife. Remember CD4 and SQ? Multichannel for TV or hi-fi has a limitation in the normal household. Hi-fi freaks will want it but we cannot design

*Stereo* and I believe it was used on the last two Superbowls in the US. **NG** The BBC are not in collusion with Dolby but we do broadcast some Dolby films with *Nicom* capability. But how many *Surround* users are still married?

**GP** Dolby *Stereo* is not a true multichannel system like we are talking about. The broadcasting system can degrade the Dolby signal to an unacceptable level due to crosstalk. Perhaps Dolby or others could be adjusted to suit real multichannel, the broadcasters could offer this and the Dolby decode matrix would be avoided. A centre screen loudspeaker gives a better result at any listening position so would not cause domestic problems. But the production of Dolby *Stereo* for cinema is well controlled, not so with TV.

**NG** As a broadcaster, I am concerned with how we source these

### The panelists:

**AK:** A Keller, director of R&D for major French Radio Station  
**DP:** D Popescu, Capital Projects, Danish Broadcasting  
**NG:** N Gilchrist, BBC, Kingswood Warren;  
**ST:** S Temmer, engineering co-ordinator for NY City Mayor's office  
**GP:** G Plenge, Institute for

Rundfunk Technik  
**RS:** R Sturm, product director of Deutsche Electronic Gruppe (German products of Thomson)  
**GS:** G Steinke, senior advisor of director general, RFZ Deutsche Post (Chairman)  
**AUD:** Audience participants, 1 to 6

signals. I am told that we can easily produce a centre channel. But what about rear loudspeakers, how do we source these?

**GP** With quadraphony we had no trouble with miking and mixing. It makes little difference to a mix engineer, all he needs is a surround monitoring system. I don't think either 2- or 4-channel mixing is a great problem.

**NG** I am concerned with live

stage. This will not change. We use a main stereo mic, perhaps two, plus panpotted spot mics—but this can be done for more than two loudspeakers. In quadraphony, we were surprised to find that side or rear localised sounds made no sense but now we know, they will not be used. Dolby stereo has no problem.

**Aud 5** I don't like forests of mics for orchestra but aren't we talking about more channels in front?

---

**21% of new TVs sold in the US are stereo capable (but) most buyers don't even know they have it. It says 'stereo where available', mostly it isn't**

---

programmes and getting things right first time. Our CIPHER Suite (audio sweetening) is costing a lot already. But I am not an operational person, so I will not pursue the argument.

**ST** The problem is miking. It will be ping-pong, not ambience in the multichannel. I don't believe this can work in the broadcast studio. We still have trouble with stereo on TV.

**Aud 4** I agree, it will be difficult to give any realistic rear signal.

**GP** There are no problems with L, C, R distribution. Regarding surround, with an orchestra we start with a normal stereophonic

**AK** Why not an artificial head? Fifteen years ago we got perfect reproduction playing back through a compensating circuit into loudspeakers.

**GP** Yes, an artificial head can reproduce a natural sound but this is contrary to the job of tonmeisters. (1) Tonmeisters want to do their own interpretation and this is against the artificial head concept. They have to have something to work at. (2) The development in artificial head devices was not ready at the right time but now they are available. With the new devices from AKG and others, perhaps we will have a

renaissance.

**ST** In the US it will never happen. **Dolby** 21% of new TVs sold in the US are stereo capable.

**ST** Most buyers don't even know they have it. It says 'stereo where available,' mostly it isn't so they don't use it.

**Aud 6** We are talking about high quality channels and more of them. Ambisonics is wonderful, but critical on loudspeaker quality and positioning. Will customers actually be able to accomplish this?

**ST** Quad was limited by money. Part of the problem was that the customer spent the same money on four lousy speakers as he would have spent on two mediocre ones.

**GS** Let's draw a conclusion; can we help the customer with our ideas?

**AK** We can today have digital broadcasting for fixed reception at 12 GHz and TV with *Nicam*. In future we should push for frequencies usable with mobile receivers with both terrestrial and satellite transmission. Provision should be made for dynamic range control. We need more research on TV stereo; this is not under control yet.

**DP** In Denmark we are spending a lot of money to put much of our programme material onto digital for archiving. We plan to improve the studio to transmitter links. In Switzerland they are preparing for

digital links to transmitters.

**NG** There is an element of risk in predicting the consumer response. I predicted that CD would not catch on and I was wrong. My mind has opened to further possibilities this evening but there is risk involved.

**ST** I was the last person to buy a TV, I was waiting for it all to blow over. The consumer is usually manipulated into buying by his friends, neighbours or inexpensive Eastern offerings. If we can get rid of multipath, that alone would make it worthwhile. Let us not answer problems that aren't there. Quality improvements will not be noticed in the typically non-ideal listening conditions. Remember, car makers sell the most audio.

**GP** Quality in car radios is very poor. The new service gives two benefits: digital locking and RF without multipath. Such a service will also offer high quality to the home. Today's problems in TV sound production will change when big screens become available. This will lead to more than two channels and may impact radio.

**RS** The consumer must be in the centre of our decisions, we must make things very easy for him. CD succeeded when many said it wouldn't. A good price:quality ratio means sales. But broadcasters must make good programmes to encourage consumer sales. □

# ARSONIC

## INNOVATIVE STUDIOTECHNOLOGIE

### Enough?

Almost any old power amp will churn out compressed music all day long ... until a hefty peak comes along. It'll be then that the protection circuitry decides that that peak will never reach the speakers. Sure - you don't want your amp' to blow up, right? Well, then you'll have to put up with chopped off peaks, crackling, distortion and other side effects.

The ARSONIC Sigma 8.2 Nearfield Monitor Amplifier is no ordinary beast. It's unique protection circuitry will save your amp but nevertheless leaves the peaks untouched ... and, it's super low negative feedback enables superior dynamics and imaging, not dissimilar to an old tube amp'.

ARSONIC ... made to a standard, not a price!

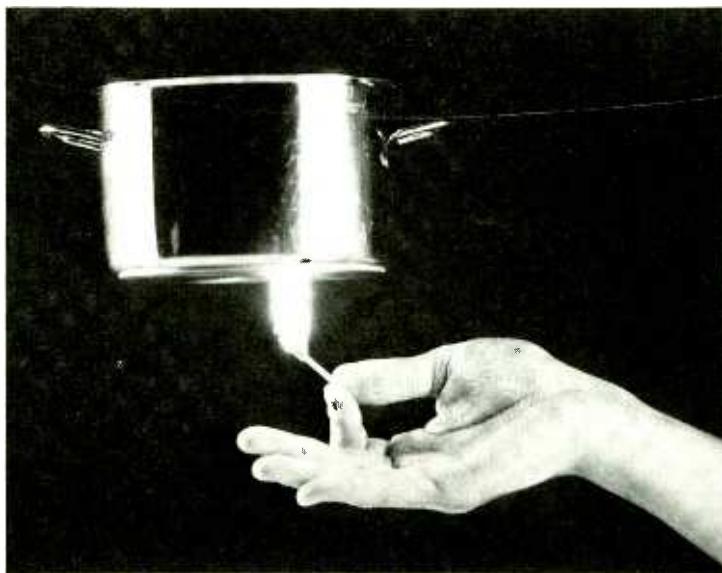

Kingdom:

Switzerland:  
Teleport AG  
Hermetschloosstr. 75  
CH-8010 Zürich  
Tel. 01/4322355

Norway:  
Creative Software AS  
Tvetenveien 55  
0666 Oslo 6  
Tel. 02/641430

Italy:  
Music Sound Technology  
Via 10 Maggio 5  
20040 Cavenago Brianza (MI)  
Tel. 02/95019812

Germany:  
Adam Hall GmbH  
Gewerbegebiet Süd  
6390 Usingen 1  
Tel. 06081/16031

France:  
MPI  
17, Rue Duperré  
75009 Paris  
Tel. 1/42820636

Austria:  
For Music  
Aiserstr. 9  
A-1080 Wien  
Tel. 0222/434440

U.S.A.:  
ARSONIC U.S.  
146 Paoli Pike  
Malvern, PA 19355  
Tel. 215/6479426

Sound, July 1989



# INSTANT SIGNAL PROCESSING



Orban's new digitally-controlled 787A Programmable Mic Processor integrates an unprecedented combination of vital signal processing functions into one powerful, compact package. It delivers fully programmable **mic- or line-level** processing with access to 99 memory registers through MIDI or RS-232 interfaces, or a console-mounted remote control. All you do is add the talent.

The 787A offers a space-saving, elegant solution to many annoying problems (voice deficiencies, poor room acoustics, noise, sibilance, wandering levels) in the broadcast control room, TV newsroom, or in commercial production, video post, audio-for-video, and film scoring facilities. The 787A gives you an important competitive edge by enabling you to repeat the same optimum sound every day for every voice, quickly and efficiently.

The 787A is complete audio processing arsenal in a box—a flexible parametric EQ, a smooth compressor, noise and compressor gates, and a handy de-esser. The 787A can be operated in mono or dual-channel/stereo (with the addition of a second-channel slave). An optional Jensen transformer mic preamp with 48V phantom power adds further flexibility.

Orban's 787A Programmable Mic Processor will help you remember tomorrow the way your talent sounded yesterday.

**Orban** a division of AKG Acoustics, Inc.,  
645 Bryant Street,  
San Francisco, CA 94107 USA  
(415) 957-1067 Telex: 17-1480  
FAX: (415) 957-1070

# orban

equaliser has always been the bane of recording engineers and the saviour

of incompetent producers.

Only comparatively recently has its importance dropped from absolute prime to only slightly below that of time-related peripherals (reverb and delay line).

Unarguably, more time has been wasted and studio money made by arguments about EQ settings than any other single aspect of sound recording. Similarly, in the choice of equipment for a studio, it has always occupied prime position as the yardstick by which a mixer is judged—the relative ‘sweetness’ of the EQ under different conditions or an opportunity to expound on a subject where everybody and nobody is an expert.

Since its invention and development in the 1930s as a device to correct for inadequacies in a sound channel or path, the equaliser has been used increasingly as a crutch to change and enhance an audio signal, to supposedly ‘improve’ the balance by altering the frequency amplitude relationships (the relative loudness of various frequencies) on any individual part or selection of a recording.

Whole generations of recording engineers have come and gone using the ‘equaliser’ as a tool to manipulate sound but with little or no knowledge of its real effect, and consequently with varying degrees of success and very much by trial and error.

I am questioning the whole validity of the use of ‘equalisers’ as anything except effect producers to introduce intentional unreality and am suggesting that the whole industry would be better served by the introduction of a new device founded on modern experimental physics rather than the theories of the past.

## Equalising out the talkies problems

To understand the argument against the equaliser it is essential to look back at the reasons it came into being in the first place. The introduction of sound recording technology capable of providing sound in synchronisation with motion pictures brought problems of monumental proportions to the early sound engineers, not least being the difficulties in achieving a realistic effect of speech where close microphone techniques were not possible (post-synchronising followed shortly afterwards but was not the full answer for all film directors). Technically the problem was that a distant microphone produced a distant sound. Obvious! But is it? Clever technicians of the day reasoned that the problem was in two parts. Part one is that ‘distant’ sounds are usually affected by reflection and reverberation of the environment, this was reasonably well solved by the application of acoustic treatment—necessary to ‘blimp’ the cameras anyway. Secondly, as sound of higher frequencies is absorbed by the air much more readily than the lower

# EQUALISERS THE PROXIMITY EFFECT

---

After a three-year break, Ted Fletcher returns to questioning the validity of the use of equalisers

---

frequencies then the reason for ‘distant’ sound (apart from the reverberation) is that it is distorted by the non-linearity of the ‘frequency response’. The answer at the time was to devise electrical circuitry to increase the absorption of the lower frequencies to match (or equalise) as nearly as possible the natural absorption of the air in the studio. This ‘equalisation’ had to be variable in effect as microphones had to be used at varying distances. The results were good and the basic problem seemed to be overcome and so the equaliser became a regular tool for the film sound man. Not too much later, the record industry found that it had applications there too; and so the rot began.

Given the state of knowledge about acoustics and the physics of sound at the time, the assumptions made and the steps taken were entirely understandable; however, what is less understandable and not really forgivable is the continued acceptance of what is basically a flawed argument and the failure to spot that ‘there is something not quite right’ in all this. I am as much to blame as anyone in this respect, although I must claim to have questioned the subject in my rantings about psycho-acoustics a few years back (*Studio Sound* various issues during 1983/84/85). And this brings us neatly to the crux of the argument: that the reasoning behind the original equaliser was only partly right; and then only in the less important aspect of the problem.

---

Since its invention and development in the 1930s as a device to correct for inadequacies in a sound channel or path, the equaliser has been used increasingly as a crutch to change and enhance an audio signal... I am questioning the whole validity of the use of ‘equalisers’ as anything except effects producers to introduce intentional unreality and am suggesting that the whole industry would be better served by the introduction of a new device

---

Sound travelling in free air has a velocity of approx 750 miles an hour. We all know that, we should also know that the velocity varies with temperature, pressure, humidity and frequency. So back in Hollywood on those old sound stages when the actors mumbled their lines and the sound engineers cursed quietly and tweaked their equalisers, the voices actually reached those great bulbous microphones unevenly; the low frequencies arriving first, the higher frequencies slightly attenuated by absorption but also delayed by the physics of the velocity of sound in air, so exhibiting a significant phase lag proportional to frequency. True that much of the effect of the phase inaccuracy was masked by inadequacy in microphone, amplifiers and recording media but nevertheless the effect was there and could not be totally overcome by equalising the frequency response.

But luck was on the side of the technicians. The circuit elements required to produce the ‘absorption’ effect of the lower frequencies also produced a corresponding phase shift—in the right direction, a phase lead at high frequencies. This helped to correct the situation and to produce accidentally a result that was closer to the ideal than anyone realised. The phase shifting effect got carried on into the recording industry because even with more sophisticated ‘equalisers’ with multifrequency lifts and cuts, phase shift is an integral part of the frequency distortion process.

## Descent into the pit of misunderstanding

Throughout the golden era of large analogue mixing consoles the equaliser became more empirically ‘refined’ towards musicality until in these latter days virtually all commercial consoles possess the sweetness of sound sought after by all the earlier designers and only achieved by exhaustive trial and error.

This continued development and refinement did a good job of wallpapering over the theoretical flaw, it succeeded in producing a universal false sense of security in the minds of designer, manufacturer and user alike. The high degree of sophistication levelled at the ‘problem’ has made a virtue out of complexity and constructed a complete armoury of names, theories, methods and techniques, all to achieve effect that we have been conditioned not to recognise accurately and even less to understand.

Then almost overnight (it seems like) the digital ‘revolution’ arrives and a radical new technology is applied to audio recording and reproduction. The experts in the new technology assure us that there is absolutely no problem, the conversion of sound into the digital domain is



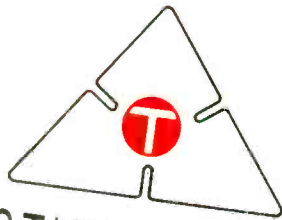

STUDIO M25

"A great place to jam"

Trident Audio Developments  
announces the opening of its in-house  
mixdown facility featuring the new

**Di - An Intelligent Console  
with AUTOMate II™ software.**

Accredited producers, A&R personnel  
artists, engineers, studio owners and  
managers in music, film and video  
production are invited to book  
complimentary time.

By appointment only. (0)932-224665  
Shepperton England

# PARAMETRIC PERFECTION



Orban's 642B Parametric Equalizer/Notch Filter offers unmatched versatility, superb specs, and highly musical equalization in a new generation of our famous and widely-used 622 series. The 642B represents Orban's continuing dedication to the art of creating the "most musical" parametric equalizers through the use of carefully designed, series-connected "constant Q" sections which minimize ringing and stridency.

The 642B's superiority over conventional parametric equalizers is particularly apparent at the extremes of its boost/cut parameter and at narrower bandwidths on difficult program material. In situations like these, the 642B's performance provides consistently satisfying results without complications or unpleasant surprises.

	Band 1	Band 2	Band 3	Band 4
<b>Model 642B</b> (Same in both channels.)	25-500Hz	80-1.6kHz	315-6.3kHz	1-20kHz

#### Special Application Versions

<b>Model 642B/SP</b>	80-1.6kHz	80-1.6kHz	315-6.3kHz	315-6.3kHz
(Same in both channels. Limited frequency range for speech processing, forensic work, notch filtering/feedback suppression, and similar applications.)				
<b>Model 642B/SPX</b> Frequency ranges of 642B in channel A; 642B/SP in channel B (For combined full-frequency range broadband shaping and restricted-range narrowband notching.)				

Features include:

- Dual 4-band or mono 8-band configuration selectable by the front-panel Cascade switch
- Each band can be tuned over a 20:1 frequency range; tuning ranges of bands overlap significantly to maximize versatility; +16dB boost/-40dB cut in each band; "Q" variable from about 0.29-5.0
- Vernier frequency control to facilitate fast, precise tuning of sharp notches
- Frequency-selectable 18dB/octave high-pass filter and 12dB/octave proprietary "Automatic Sliding Besselworth"™ low-pass filter to provide full flexibility with maximum musicality
- Noise and distortion specs significantly better than 16-bit digital

Call or write today to discover more about Orban's new, ultra-quiet, 642B Parametric Equalizer/ Notch Filter— a new generation of parametric excellence from the leader in parametric EQ.

**Orban** a division of AKG Acoustics, Inc.,  
645 Bryant St., San Francisco, CA 94107  
(415) 957-1067 Telex: 17-1480 FAX: (415) 957-1070

## LISTEN TO THE DIFFERENCE.



simplistic, it is merely a question of sampling fast and accurately enough—and, by the way, all our problems concerning audio manipulation in dynamics, mixing and equalisation can be handled by merely developing the right software.

So the digital engineers went ahead and produced their machines, demonstrated the (admitted and very real) advantages of digital audio and encroached further and further into the equipment market with digital goodies.

Early on there were the inevitable voices of dissent—the hi-fi buffs who can recognise the colour of the conductor's shirt when listening to a cherished album—but in among them were small voices of sanity that quickly multiplied. Suddenly we had a gigantic dilemma thrust upon us, Laws of Performance that we all thought were inviolate were questioned by those necessary accessories—the customers. Some digital sound consoles that are 'guaranteed' to perform as well or better than their analogue counterparts apparently sounded foul; although they check out perfectly well. Could there be yet another factor to that elusive 'quality' tag (other than the ever-present lunatic fringe masquerading under the pseudo-science of fidelity)?

Much has been done to improve the elusive 'quality' of digitally processed sound including considerable attention to processing cycle times, to such an extent that it is certain the degradation of quality has been eliminated from the digital recording path for all but the most pedantic and imaginative critics. But what of the audio editing suite where previously recorded material is 'equalised' for CD mastering? Here we have the ultimate proof of the Grand Deception of the equaliser. In the digital domain there is no longer the restraint on phase relationship that there is in analogue design, frequencies can be amplified or attenuated with little regard to their place in time, indeed, truly phase-shiftless amplitude/frequency distortion has become a reality; only to demonstrate how truly unmusical and awful it can be. Suddenly the accidental advantages of uninformed analogue circuit design are exposed to the glare of the ears of the world and we have to face the fact that 'something has been wrong for quite some time!'

## Baxandall

It would take a strong and determined bigot to argue against the 'Baxandall' being as smooth and musical an equaliser as is possible to achieve. Mr Peter Baxandall (long may his name be revered) first postulated the loss-free active feedback tone control circuit that became the industry standard for 'tone controls' on the more expensive record players and hi-fi systems. The circuit had a host of advantages: simple with a minimum of components, it has a reassuringly

---

**Ask yourself the questions: why have an equaliser in a channel? What is it really used for? But why does the EQ have to be used? Is it because the sound from the microphone is always wrong and needs bending into shape? Possibly, and yet everyone uses their best microphones for the human voice...**

---

predictable performance and functions to adjust for inadequacy over a wide range of different environments. Electronically it works entirely by cancellation and addition due to phase shifting. It has a maximum rate of 'lift and cut' of 6 dB/octave; a performance not too dissimilar to the sharpest changes that occur in nature, and in its standard and most used form, has a smooth phase/amplitude transition between areas of operation, ie, between treble and bass. Even with my present battleaxe raised high I cannot condemn the circuit out of hand, it has stood the test of time and many engineers and musicians (even ones with excellent ears!) have been entirely satisfied with it. But for what?

## Why an equaliser at all?

Ask yourself the questions; why have an equaliser in a channel? What is it really used for? The

beginning of the paragraph; pulling forward or pushing back. Without realising it the recording engineer is using the equaliser for the purpose its ancestors were intended for, to compensate for distance, or more accurately, to provide artificial distance information. At the same time as twisting the phase and achieving the effect, he is distorting the frequency response with the by-product of the device, very often using complex combinations of various frequencies to minimise the unpleasant effects of the distortions while retaining the feeling of the phase shifts; all without knowing it! The engineer has been using a tool for the wrong purpose and achieving results by empirical means; what could he do with the right tool for the right job and the information to use it!

## Proximity device

If we could turn back the clock and give some modern knowledge to those early sound recordists,

they could have created phase shifters that mimic the behaviour of sound at varying distances in both response and phase together; an artificial proximity device to fool all the people all the time. I doubt if it would have changed the course of recording history but it might have taught us all enough to reduce the criminal waste of time and effort expended over the years in recording studios fighting for the impossible and having to put up with the marginally acceptable.

The digital revolution has its unexpected blessings, it has forced attention on to the basic components of sound and human hearing. Without the horrors of phase-shiftless manipulation we may still have been crediting the relative performances of various filters and circuits to witchcraft.

I hear stirrings in the industry and hopefully we shall be greeted by a new generation of digital processors able to accommodate the proximity effect, in the meantime, I shall be applying the old analogue grey cells to the problem, hidebound by my prejudice that digital mixers won't be any good for absolutely ages and there are a few more electronic generations of superiority in analogue yet! □

*Ted Fletcher was formerly managing director of mixing console manufacturers Alice (Stancoil Ltd). He retired for health reasons in 1986.*

## Technical note

Part of the foundation for the argument against equalisers rests on the premise that the velocity of sound in air varies with frequency.

The velocity of sound in air is usually quoted as 1,125 ft/second at NTP (normal temperature and pressure). Due to the modulus of elasticity of air, there is a pronounced hysteresis effect that affects the time delay which sets the absolute velocity. While the hysteresis is constant for a given set of parameters, if the number of wave fronts per unit time is increased, then the transition time through the hysteresis cycle will also increase, reducing the velocity of sound at the higher frequency. This law is, however, extremely complex and non-linear due to adiabatic effects in air introducing large scale changes in transfer characteristics with relatively small changes in humidity, temperature, pressure and even intensity of sound — even the air is non-linear!

To be more certain that this argument is correct I made an attempt at measuring the effect; it is extremely difficult to achieve sensible results with makeshift apparatus, the elimination of variables, particularly temperature, is exceedingly boring.

Using a tiny loudspeaker enclosure, a power amplifier, a calibrated oscillator, a cheap capacitor microphone, an oscilloscope and a steel rule, mostly held together with plastic insulating tape and with wires twisted together, I managed to achieve the following consistent measurements of the velocity of sound at about 1000 millibars, 14°C:

1 kHz—1246 ft/s

2 kHz—1118 ft/s

4 kHz—1092 ft/s

Readings taken at other frequencies were not satisfactory due to external factors: traffic and long distances with LF, birdsong and standing waves with HF. (Don't waste time trying to do this sort of experiment indoors without anechoic conditions.)

It would be most interesting to hear from any research establishment that has the apparatus capable of more accurate measurement over a wider range; while I am certain that my figures are not wildly out they cannot be taken as gospel.

*Please address any correspondence to Ted Fletcher, c/o Studio Sound, Link House, Dingwall Avenue, Croydon CR9 2TA, UK.*



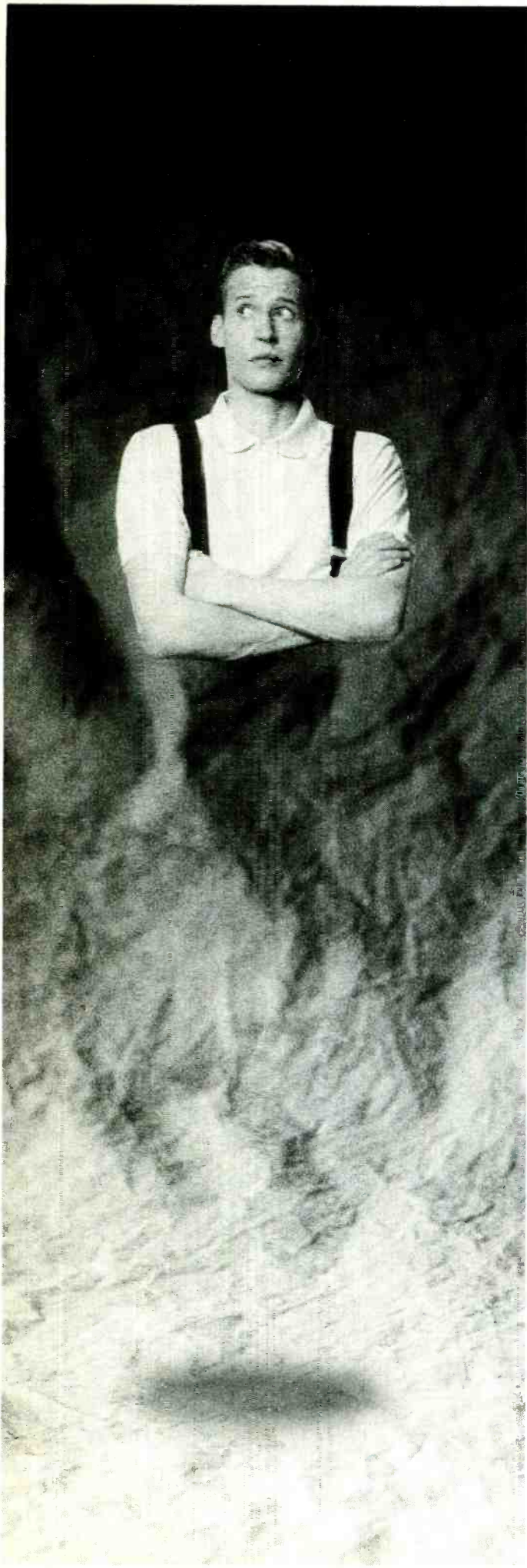

B.S.S. AUDIO LTD, UNIT 5, MERLIN CENTRE, ACREWOOD WAY, ST ALBANS, HERTS. 0727 45242 Fax: 0727 45277 UK DEALERS Autograph, HBB, Stirling, Music Lab, SSE, Roadstar, LMC, Wigwam, Marquee WCRD WORLD WIDE AGENTS Australia ATT Audio, Melbourne Regiscene Paris (01) 4396-5050 Greece Son Studios Athens (01) 363-3572 Holland TE M Breda (76) 812872 Hong Kong Tom Lee Music Co Hong Kong (3) 722-1098 Indonesia Pt. Awinindo Merien Prima Jakarta (021) 323025 Israel MOR Oslo (02) 11 4085 Portugal Dosa Calus Oporto (02) 384255 Singapore Lingtec Pte Ltd Singapore (03) 747-1951 Eire Audio Engineering Dublin (1) 686292 Spain Lexon Barcelona (03) 203 4804 Sweden Intersenic Stockholm (08) 744-5850



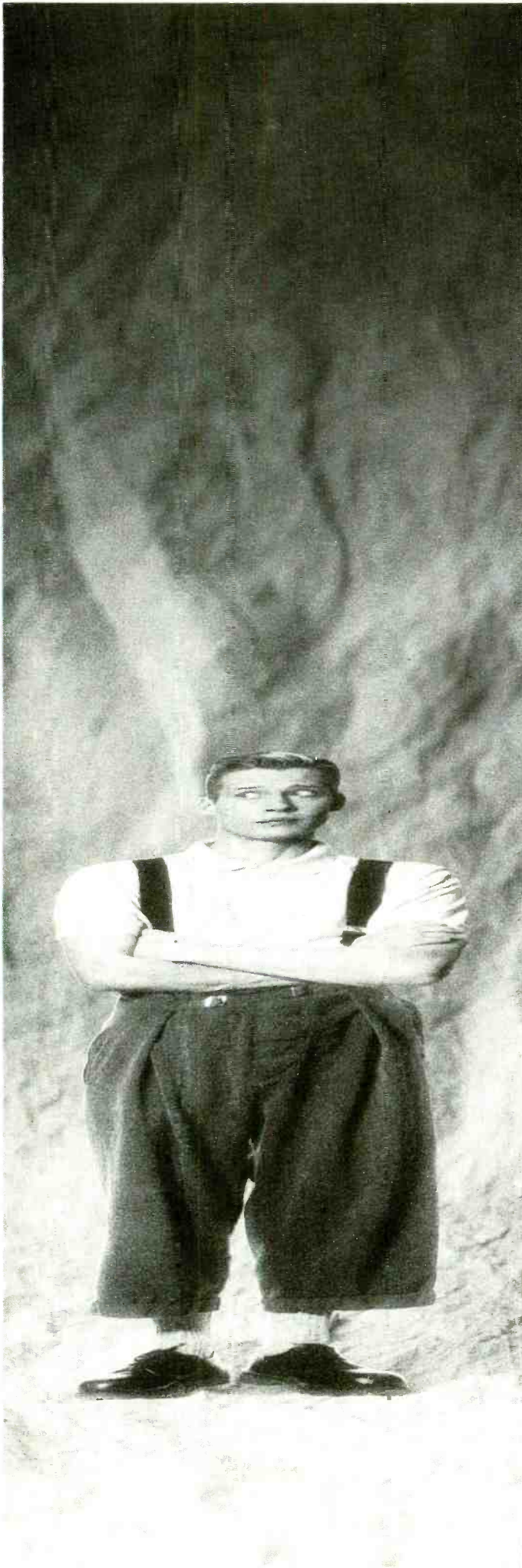

# AT LAST. SIGNAL PROCESSING THAT ISN'T GATED, DIVIDED OR LIMITED BY CONVENTION.

BSS equipment does much more than just process signals. Everyday tasks are merely the starting point from which we've explored signal dynamics. And some startling ideas have resulted.

The **DPR-502** is our new 'intelligent' 2-channel MIDI noise gate. Besides providing unusually accurate and responsive control functions, it expands on the expected with some rather exceptional features.

Like switchable Auto Dynamic Enhancement (ADE™) which subtly enhances leading edge transient information. And Key Level Metering – a unique, simultaneous peak and average LED array which displays the signal level in relation to the 'gate open' threshold.

With bi-directional MIDI, the DPR-502 generates and receives MIDI data including input velocity – making it possible to replace recorded sounds with dynamically-matched samples.

The **MSR-604** is a highly versatile Active Signal Distribution system. Each of its four channels supplies low-noise balanced and buffered feeds to two mixing positions and two other facilities, such as broadcast and mobile recording.

With phantom power and remotely-switchable gain, the MSR-604 completely overcomes the problem of supplying multiple feeds from a single source.

The **DPR-402** combines compression and de-essing with peak limiting. It gives the control and flexibility of multifaceted dynamics processing, without the usual compromises in signal clarity and user complexity.

Its unique double side chain architecture (with a parallel VCA control path) brings real audible benefits. And with internal high

and low pass filters inserted in the control chain, you have unprecedented problem-solving power.

You'll find all BSS Signal Processing is a step beyond conventional designs.

Because convention is something we'd certainly never allow ourselves to be limited by.



(03) 379 1511 - Austria Audiosales Modling (2236) 26123 - Belgium T.E.M. Dilbeek (02) 565-1823 - Canada Contact Dist. Ontario (416) 287-1144 - Denmark SG Sounds Taastrup (02) 998877 - Finland MS Audiotron Laitilanti (90) 0566-4644 - France Productions Tel Aviv (03) 454-003 - Italy Audio Link Parma (0521) 598723-4 - Japan Edg-Tech (Japan) Ltd (03) 295-4734 - Korea Young Nak So Ri Sa Co Seoul (01) 267-8987 - New Zealand Maser Auckland (09) 444-358314 - Norway Iyd Rommel Switzerland WA Guenther Zurich (01) 391-3939 - Thailand Mahajak Dev Co Bangkok (02) 2517-417 - Turkey Nefan Istanbul (01) 160-4514 - U.S.A. E.D.C. New York (914) 567 4400 - West Germany Audio Vertrieb Quickborn (04106) 69999

an **EdgeTech** company  
LONDON • NEW YORK • TOKYO

# COMPRESSORS LIMITERS & EQUALISERS

Products introduced over the last 18 months, from information available

## Alesis

*MEQ-230* with 60 bands of  $\frac{1}{3}$ -octave graphic equalisation in 1U of rack space.

Alesis, 3630 Holdrege Avenue, Los Angeles, CA 90016, USA. Tel: (213) 467-8000. Fax: (213) 836-9192.

UK: Sound Technology plc. Tel: 0462 480000. Fax: 0462 480800.

## Altec Lansing

$\frac{1}{3}$ -octave equalisers *1750A* (cut only) and *1753A* (cut and boost). Both include 28 ISO-centre bands, variable 18 dB/octave high and lowpass filters and a 20 dB gain control.

Altec Lansing, PO Box 26105, Oklahoma City, OK 73126-0105, USA. Tel: (405) 324-5311.

UK: Shuttlesound Ltd. Tel: 01-871 0966.

## API

*525b* passive compressor/limiter that uses a motorised pot for gain reduction instead of VCAs. *5502* 2-channel, 19 inch rackmount equaliser with four frequency bands. *5502D* version is dedicated for disc mastering. *API 550b* features the same circuitry design as the *550A* but miniaturisation of components has enabled a fourth band to be added.

API Audio Products Inc, 7953 Twist Lane, Springfield, VA 22153, USA. Tel: (703) 455-8188. Fax: (703) 455-4240.

UK: Syco Systems. Tel: 01-625 6070.

## ART

Two 'high definition' graphic equalisers, 31-band  $\frac{1}{3}$ -octave and 15-band  $\frac{1}{3}$ -octave both incorporating 60 mm faders, switchable subsonic and ultrasonic filters.

Applied Research and Technology, 215 Tremont Street, Rochester, NY 14608, USA. Tel: (716) 436-2720.

UK: Harman Audio (UK). Tel: 0753 76911. Fax: 0753 35306.

## Ashly Audio

*GQ* series available in three different versions. The *GQ215* features two channels of 15-band

$\frac{1}{3}$ -octave EQ and switchable highpass filter.

*GQ131* single-channel 31-band with tunable highpass filter, *GQ231* 2-channel 31-band also with tunable highpass filter. Also *CG-85* gated limiter/compressor.

Ashly Audio Inc, 100 Fernwood Avenue, Rochester, NY 14621, USA. Tel: (716) 544-5191.

UK: Sound Technology plc. Tel: 0462 480000. Fax: 0462 480800.

## Audio Developments

*ADO66-12 Flex-EQ*, a 2-channel, 2-band fully parametric equaliser with a link switch that allows the two channels to provide 4-band equalisation.

Audio Developments, Hall Lane, Walsall Wood, West Midlands WS9 9AU, UK. Tel: 0543 375351.

USA: Audio Developments, Santa Monica, CA.

## Audio Logic

*SC131* is a cut-only graphic equaliser with 31 ISO centres featuring variable high and lowpass filters.

Audio Logic, Dod Electronics Corp, 5639 South Riley Lane, Salt Lake City, UT 84107, USA. Tel: (801) 268-8400. Fax: (801) 262-4966.

International distribution: Dod International. Tel: (603) 888-5230. Fax: (603) 888-6750.

UK: John Hornby Skewes & Co. Tel: 0532 865381.

## Audiomatica

Computerised system for the control of parametric EQ.

Audiomatica, Via Faentina 250, 50133 Florence, Italy. Tel: (55) 575 221.

## Cadac

*RME100* rack of equaliser modules offers phantom-powered microphone inputs, phase reverse, mic/line switching. The EQ is fully parametric in four overlapping bands giving control from 31 Hz to 18 kHz.

Cadac, Clive Green and Co Ltd, 1 New Street, Luton, Beds LU1 5DX, UK. Tel: 0582 404202.

UK & Worldwide distribution: Autograph Sales. Tel: 01-267 6677/485 3749.

## CEM

*DPE* programmable equaliser is a 1U rack package containing single- or dual-channel 4-band parametric. Parameters can be stored in 100 memory locations.

CEM Electronica SRL, Strada Statale Ticinese N5, 28040 Varallo Pombia (Novara), Italy.

International distribution: Gotham AG, Switzerland. Tel: (1) 840.01.44.

## Citronic

*SPX7-21* dual 15-band  $\frac{1}{3}$ -octave graphic equaliser in a 1U package. Overall level control is provided on each channel, together with high- and lowpass filters, a bypass switch and peak indicators.

Citronic Ltd, Bowerhill, Melksham, Wilts SN12 6UB, UK. Tel: 0225 705600. Fax: 0225 709639.

## Circuit Design Technology

*CGM-2 Champ* is a stereo unit providing compression, limiting, gating and expansion using Dynex circuitry. The *MC-8 Multicomp* provides eight independent channels of compressor/limiter/noise gates in a 1U package. Circuit Design Technology, 26801 Richmond Road, Bedford Heights, OH 44146, USA. Tel: (216) 292-0491.

## Drawmer

*E101* passive coil equaliser. *M500* dynamics processor with seven basic processes comprising De-essing, gating, expansion, compression, limiting, panning and fading in stereo where required or as two discrete channels.

Drawmer Distribution, Charlotte Street Business Centre, Charlotte Street, Wakefield, West Yorks WF1 1UH, UK. Tel: 0924 378669.

USA: Quest Marketing. Tel: (617) 964-9466. Fax: (617) 969-7758.

## Furman

*PQ-4* 4-band parametric equaliser.

Furman Sound Inc, 30 Rich Street, Greenbae, CA 94904, USA. Tel: (415) 927-1225.

UK: Shuttlesound Ltd. Tel: 01-871 0966.

## HH Electronics

*EQ215P* and *EQ215S* rackmount 2-channel 15-band  $\frac{1}{3}$ -octave equalisers. *P* version is designed for installations tight on space is 1U high while the *S* uses 60 mm sliders to give the same degree of control in 2U. Both units feature 18 dB of gain control, peak LED indication and a subsonic filter.

HH Electronics, 9 Clifton Road, Off St Peters Road, Huntingdon, Cambs PE18 7DW, UK.

Tel: 0480 432227. Fax: 0480 411375.

## Ivo Lola Ribar

*LA 3201* graphic equaliser.

Ivo Lola Ribar, Bulvar Revolucije 84, YU-11250 Belgrade, Yugoslavia. Tel: (11) 43 51 22. Fax: (11) 43 14 94.



# *hurry up . . .*



# *. . . and slow down.*

Making the connections between the console automation system, MIDI equipment and tape machine synchronisers can be a nightmare and usually impossible. Leaving the comfort of your chair to alter parameters on synchronisers and tape machines is distracting and often time wasting for the client. As an engineer you may be fast between the machines but *motionworker* makes you faster.

*motionworker* is the solution to solving these problems. We've taken the time to observe these impracticalities and inefficiencies and designed a system that clears up those

ragged edges. *motionworker* will work with Timeline, Audio Kinetics and Adams Smith machine synchronisers and integrates full control to the SSL Master Studio Computer™. Information such as 'record drop-in's and 'offsets' can be manipulated and stored on the 'Reel Disc' via commands from the central console keyboard.

*motionworker's* 'virtual tape machine' can be driven directly from MIDI timecode to run the automation system.

*motionworker's* status panel reports current machine status and offers extended facilities such as 'transport solo'.

#### **Integrates:**

- SSL Master Studio Computer™
- Timeline 'Lynx' Synchroniser Modules
- Audio Kinetics ES 1.11 Synchroniser Modules
- MIDI Timecode - Reads/Generates



#### **Manages:**

- Timecode Routing
- Machine Sync/Repro Switching
- Machine Event Outputs
- Console Tape Remotes



## **motionworker**

ADVANCED SYSTEM CONTROL

motionworks, 7 Distons Lane, Chipping Norton, Oxon OX7 5NY England · Telephone: (0608) 3737 · Facsimile: (0608) 3530

SSL Master Studio Computer is a trademark of Solid State Logic Ltd

[www.americanradiohistory.com](http://www.americanradiohistory.com)

## JBL/UREI

7110 compressor limiter.

JBL Professional, 8500 Balboa Boulevard, Northridge, CA 91329, USA. Tel: (818) 893-8411.

UK: Harman Audio. Tel: 0753 76911. Fax: 0753 35306.

## Klark-Teknik

DN500 dual-channel compressor/limiter/expander for dual-channel mono or stereo operation. Series 300 range of graphic equalisers and series 400 range of parametric equalisers.

Klark-Teknik, Klark-Teknik Industrial Park, Walter Nash Road Kidderminster, Wores DY11 7HJ, UK. Tel: 0562 741515. Fax: 0562 745371.

USA: Klark-Teknik Electronics Inc. Tel: (516) 249-3660. Fax: (516) 420-1863.

## Orban

Parametric equaliser/notch filter that has been developed from the 622 series. The 624B features dual 4-band or mono 8-band configurations. Also 764B programmable equaliser providing 99 memory positions for complete recall of all parameters.

Orban Associates Inc, 645 Bryant Street, San Francisco, CA 94107, USA. Tel: (415) 957-1070. UK: SSE Marketing. Tel: 01-387 1262.

## Peavey

AEQ 2800 automated 28-band equaliser. Peavey Electronics Corp, 711 A Street, Meridian, MS 39301, USA. Tel: (601) 483-3565. UK: Peavey Electronics (UK) Ltd. Tel: 0536 205520.

## Rane

GE30 graphic equaliser is a constant Q, 30-band, 1/3-octave unit. Also DC24 Dynamic Controller a multifunction dynamics processor incorporating two channels of compression, limiting, expansion and noise gating, all available simultaneously.

Rane Corp, 10802 47th Avenue West, Everett, WA 98204. Tel: (206) 355-6000. Fax: (206) 347-7757.

UK: Music Lab Sales. Tel: 01-388 5392.

## Roland

E-660 digital parametric equaliser. USA: Roland Corp US. Tel: (213) 685-5141. UK: Roland UK. Tel: 01-847 5665.

## SECA

SE13 graphic equaliser 13-band stereo or 26-band single-channel.

Aces UK Ltd, Featherbed Lane, Shrewsbury, Shrops SY1 4NJ, UK. Tel: 0743 66671. USA: Power Studio. Tel: (216) 238-9426.

## Summit Audio

EQP-200 dual programme equaliser provides two channels in a 2U rack package. Separate boost and cut controls and switchable frequencies for high and low frequency attenuate points.

Summit Audio Inc, PO Box 1678, Los Gatos, CA 95031, USA. Tel: (408) 395-2448. Fax: (408) 395-1403.

UK: Autograph Sales Ltd. Tel: 01-267 6677.

## Stage Accompany

PPE 2400 programmable equaliser with four parametric overlapping bands each being a peaking boost or cut.

Stage Accompany, Anodeweg 4, 1627 LJ Hoorn, The Netherlands. Tel: (0) 2290-12542. UK: Stage Accompany (UK) Ltd. Tel: 0353 2278.

## tc Electronic

1128 28-band equaliser and spectrum analyser. tc Electronic, Grimhøjvej 3, DK-8220

Brabrand, Denmark. Tel: 06-26 2800. Fax: 06-26 2928.

UK: tc UK. Tel: 0691 658550.

## Valley International

Micro FX compressor from the small budget effects range with threshold, ratio, release and gain controls. They've also introduced a stereo digital compressor/expander offering a wide range of level control characteristics from mild compression to zero attack time peak limiting.

Valley International Inc, PO Box 40306, 2817 Erica Place, Nashville, TN 37204-3111, USA. Tel: (615) 383-4737. Fax: (615) 269-5441.

UK: Stirling Audio plc. Tel: 01-624 6000. Fax: 01-372 6370.

## Yamaha

DEQ7 2-channel digital equaliser with MIDI. UK: Yamaha-Kemble (UK) Ltd. Tel: 0908 71771. USA: Yamaha International Corp. Tel: (714) 522-9105.

### THE NEW LOOK SOLID BOND STUDIOS

GARDEN ENTRANCE  
STANHOPE HOUSE  
STANHOPE PLACE, LONDON W2.  
TELEPHONE: 01-402 6121/2

**CONTROL ROOM:** 48 channel solid state logic 4040E console with total recall  
two sony 24 track 3324 digital multitracks  
studer A80 24 track with dolby or DBX noise reduction available  
sony PCM 701 digital mixdown system  
2 x 1/4" studer A80's  
monitors: nell gram, boxer monitoring, yamaha NS10's,  
AR-AV18S, + tannoy little red's

**OUTBOARD GEAR:** drawmer dual gate  
8 polygram noise gates  
klark teknik dual graphic  
AMS DMX 15-80S digital delay  
AMS flanger/phaser  
KORG digital delay  
2 x eventide delay/harmonisers  
yamaha R1000 reverb  
klark teknik spectrum analyser  
AIWA cassette deck  
lexicon 480L digital fx processor  
2 x DBX-160X compressor-limiters  
AKAI ASQ10 MIDI sequencer  
orban sibilance controller  
6 polygram limiters  
audio and design panacan  
AMS keyboard interface  
AMS RMX 16 digital reverb  
MXR pitch shift doubler  
2 x eventide flangers  
roland SRE-555 chorus  
technics turntable  
2 x yamaha SPX90S multi effect processors  
roland SBX80 SMPTE sync box  
AKAI S1000 stereo digital sampler  
comprehensive range of keyboard + drum machines  
2 x EMT 140 valve reverb plates  
2 x EMT 140 transistor reverb plates

**STUDIO:** 48' X 20' recording area with marble and wood live end and drum booth  
large selection of microphones including:  
neumann, AKG, shure, calrec, sennheiser, tandy PZM's,  
old ribbon and valve mics,  
tannoy monitors

**COPY ROOM:** 12 x sony FX1010 cassette decks  
nave 8 into 2 console  
ampex ATR100 1/4 inch stereo 30 ips tape machine with 1/2 inch 4 track  
head block available  
2 x 1/4 inch 15.7 1/2 ips studer tape machines  
dolby noise reduction  
MIC MIX SUPER C reverb  
drawmer compression  
revox turntable  
monitors: tannoy HPD's, tannoy little red's, KEF LS5's

**CLIENTS** jaybean - bananarama - dee c. lee - blaze - the style council - curtis mayfield - juan Atkins - chris porter  
detroit spinners - dr. robert - the smiths - martin warr - black britain - valentine brothers - to name but a few

for more details log nkol - 01 402 6121





---

# STATE OF THE ART

---

We have extended our MKH studio microphone range:

MKH 50 (supercardioid)

- \* Low natural noise – only 13 dBA
- \* Exceptionally low distortion
- \* Well balanced frequency response even with lateral sound incidence

MKH 60 (short directional tube)

- \* Low inherent noise – only 10 dBA
- \* Sensitivity 40 mV/Pa (13 mV/Pa)
- \* Switch-over filter
- \* Lightweight
- \* The ideal microphone for medium range recording distances

MKH 70 (long directional tube)

- \* Low natural noise – only 10 dBA
- \* Optimum directional properties
- \* Sensitivity 40 mV/Pa (13 mV/Pa)
- \* Switch-over filter
- \* Lightweight
- \* Practical accessories

By far the best microphones we have ever produced. CD and outside recording – with these microphones you are at the forefront of modern technological standards.

Ask now for your test sample! Sennheiser electronic KG, D-3002 Wedemark, Department MSW, Telefax 0 51 30/6312, Federal Republic of Germany.

 **SENNHEISER**

WHY I RELY ON RAINDIRK'S  
SYMPHONY 48 SERIES



BY WILL SHAPLAND,  
CHIEF ENGINEER,  
MANOR MOBILE

*"We had a dilemma, how do we get 144 mic lines in a restricted space and retain the flexibility of a large mixer – the Symphony 48 Series."*

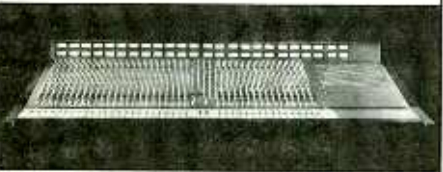

Born out of a stringent background in broadcasting, the Symphony 48 Series from Raindirk Audio was built to satisfy the following demands "low crosstalk, musical e.q. and very low noise levels.

Stereo mixing noise 32 channels routed -94dBu. For more information on the Raindirk contact the appropriate dealer below.



THE HOME SERVICE  
UNIT TWO,  
10 WILLIAM ROAD  
LONDON NW1 3EN

TEL: 01 387 1262  
FAX: 01 388 0339

YOU CAN RELY ON RAINDIRK

# SATELLITE BROADCASTING A LOST OPPORTUNITY?

## Barry Fox calls for rationalisation in the UK satellite broadcasting war and discusses the need for standardisation

The history of consumer electronics is littered with disasters. New ideas that never took off because they were too complicated or had been dreamed up at boardroom meetings where everyone present got carried away with their own enthusiasm and never stopped to think whether the public would ever want to buy the end product.

Lack of standardisation has always been the kiss of death. Broadcasters and studios need to exchange software. The public wants to buy software. Fragmentation limits choice, curbs mass-production and puts up the price.

We have seen it with professional noise reduction and digital studio recording technology, pre-MIDI music synthesisers, home computers, floppy discs, surround sound, video disc, the 7 inch EP versus the 12 inch LP, the 8-track cartridge versus the Philips audio cassette and VHS versus Beta.

The market abhors confusion as rabidly as nature abhors a vacuum. There is always a winner in the end. If more than one horse survives it's because they end up running on a different course. The 7 inch disc became the single. VHS became the domestic video standard, with 8 mm the vehicle for personal video.

It's not a new problem. I recently came across a reprint (by the Country Music Foundation Press of Nashville, TN, USA) of the Proceedings of the Convention of Local Phonograph Companies that neatly sums up why the satellite industry is in such a mess.

A hundred years ago there were two quite different and incompatible wax cylinder recorders; Thomas Edison's phonograph and the rival graphophone, developed by Alexander Graham Bell and Charles Sumner Tainter. The machines infringed each other's patents. This spoiled the market for everyone. In 1889 the trade formed an association of Phonograph Companies. The next year they all met in Chicago. A Mr Chadbourne, from Minnesota, gave an impassioned speech.

"Just so sure as you show both machines at the same time, you will lose a customer," he warned. "They will take neither machine, saying 'Well, I guess this thing is a little fresh yet, we will wait a little while.' Have but one machine and that a good one, and the public will be satisfied. You had better take these machines and pile them up on a 10 acre lot to get rid of them and have one good machine."

How true. Imagine what would have happened if the standards for telephones, FM stereo radio and 625 line TV had not been cast in concrete.

For a while it looked as if the world was learning from past mistakes. There was pre-launch standardisation on the compact disc format and the result was a spectacular success.

Direct Broadcasting by Satellite (DBS) looked as if it might become an equally exciting new

market for Europe, with digital stereo sound, higher quality pictures and a wider choice of TV channels, with radio riding piggyback on top. It makes far more sense to beam programmes down from space than dig up city roads. Cable is a 19th century technology, DBS belongs to the 21st.

But no. A clear picture is now emerging from the satellite soothsayers' crystal balls. It is not a pretty sight. At best satellite broadcasting will be a far slower burn than the backers expected; at worst it will go down in history as the biggest marketing disaster of all time. A lot of people are going to lose far more money than they ever dreamed possible.

The sad absurdity is that much of what will now follow could have been avoided—if competitors in the field had co-operated to educate the public and make the tricky new technology as easily accessible as humanly possible. Instead they have warred in public and made the technology so complicated and confused that it is a potential turn-off to all but the most dedicated viewer.

Ferguson recently created a stir by publishing the results of independent market research, which shows that the satellite market is developing far more slowly than expected, with most people adopting a wait and see attitude.

The report is significant, not so much for what it says but for who is saying it. Ferguson is one of the four companies selected by British Satellite Broadcasting (BSB—the company franchised by the IBA to provide a UK service) to make set-top receivers. And Ferguson is also (like all four) hedging bets by making reception equipment for programmes already coming from the rival Astra satellite, too. What is more, Ferguson is owned by Thomson of France, the company that developed, and is supplying, the equipment needed to receive the Sky movie channels from Astra when they start scrambling. The plan was to spread the cost of decoding hardware between two channels, one from Sky and one from Disney.

Amid all the absurd hype for satellite, which has long smelled as rotten as stinking fish to independent and informed observers, Ferguson's realism comes as a breath of fresh air. The bald, inescapable truth is that the once exciting chance of providing a viable alternative to ITV and Channel 4 has been squandered by a lethal mix of naivety, stupidity, technical ignorance and bare-faced lying.

The only surprise would be if Ferguson's research had produced more encouraging results.

Simplicity sells; confusion kills. And the one thing clear about the satellite market is that it is absurdly muddled. This has turned off the press, trade and public like a switch.

When Sky started broadcasting on February 5th, there were virtually no dish and receiver systems available to buy or rent. This was not in



**AKG**  
ACOUSTICS

# ADVANCED MICROPHONE TECHNOLOGY

The C747 comb. is one of a new generation of miniaturised microphones developed by AKG for professional recording purposes.

Although only the size of a pen overall, the C747's tuned acoustic tube, in front of the transducer, provides uniform frequency response and high sensitivity and its hypercardioid polar pattern makes it an ideal microphone for spot recording of individual instruments.

In the studio, its compact design allows easy and varied adjustments for any recording situation. On stage the C747 is virtually invisible to the audience. As with all AKG miniaturised microphones, for the C747 small is beautiful, for the engineer, the performer and the audience.

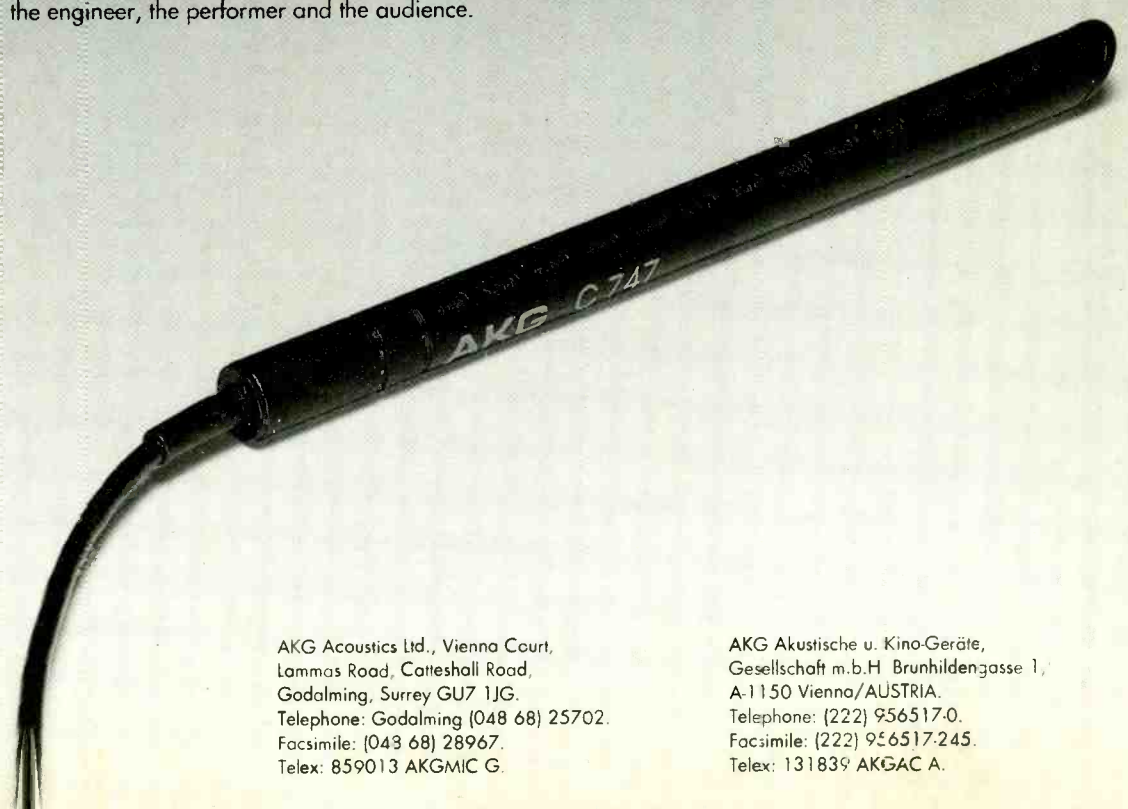

AKG Acoustics Ltd., Vienna Court,  
Lammas Road, Cotteshall Road,  
Godalming, Surrey GU7 1JG.  
Telephone: Godalming (048 68) 25702.  
Facsimile: (043 68) 28967.  
Telex: 859013 AKGMIC G.

AKG Akustische u. Kino-Geräte,  
Gesellschaft m.b.H. Brunhildengasse 1,  
A-1150 Vienna/AUSTRIA.  
Telephone: (222) 956517-0.  
Facsimile: (222) 956517-245.  
Telex: 131839 AKGAC A.



# Half-rack. All Symetrix.

## The SX200 Series



**SX201**  
Parametric Equalizer/Preamplifier



**SX202**  
Dual Microphone Preamplifier



**SX203**  
Telephone Interface



**SX204**  
Four Channel Headphone Amplifier

The Symetrix reputation for *reliability, versatility and ease of operation* continues in the SX200 Series. Backed by *fourteen years* of signal processing experience, Symetrix offers this solid approach to the half-rack format. Watch in '89 for the introduction of new SX200 Series products, which include the SX205 PRECISION AUDIO METER and the SX206 MULTI-DYNAMICS PROCESSOR.

**In the UK:**  
SOUND TECHNOLOGY plc  
6 Letchworth Business Centre  
Avenue One, Letchworth  
Herts SG6 2HR  
Telephone: 0462 480000  
Fax: 0462 480800

**International Representation**  
E & E INSTRUMENTS INTERNATIONAL  
PO Box 1313  
Laguna Beach, CA 92652  
Telephone (714) 494-0231  
Fax (714) 494-2594  
Telex 182291 E and E

# Symetrix

Signal processing at its best

the least surprising. The rocket that in December launched the Astra satellite, from which Sky broadcasts, could have exploded—rockets have a nasty habit of doing that. Inevitably it took until late January for the satellite to reach its final position in space and prove that it worked. Satellites have a nasty habit of failing in orbit. Ask the Germans who are already the proud possessors of a multimillion dollar dud. Astra had no back-up rocket or satellite, so no manufacturer in his right mind would start mass producing receivers until he was sure that there was something to receive.

So the Sky launch hype—with the Murdoch press listing satellite programmes with equal prominence to BBC, ITV and Channel 4—created a dish famine. In April, Sky announced that the famine was over and more than 200,000 kits would reach the shops by the end of May. TV advertising would tell the public what they could buy. In fact, even by April, warehouses and shop stock rooms were bulging with unsold dishes. In May, Murdoch's newspaper promised to *give away* 10,000 dish systems in a massive publicity campaign.

By April BSB had started a spoiler advertising campaign designed to stop people buying Astra equipment, with the promise of far better things in September. For who knows what reason (and even engineers inside the IBA, which franchised the service, don't understand it) BSB built a pizza-style advertising campaign on an aerial that is small, flat and square instead of small, round and dished. A full eight months after BSB unveiled the pizza 'squarial', without actually explaining that it was only a wood and plastic dummy, the company had still been unable to demonstrate a working prototype to the trade and press. By the end of April, there were not even any firm deals to manufacture the squarial, which BSB was promising for sale in September.

So far, flat plate aerials have been more difficult and more expensive to make than dishes but, as if on a kamikaze mission, BSB still cling to the promise of a full reception system for £250. The shape of the aerial is technically irrelevant to BSB's service but the company has now so tightly locked itself into this irrelevancy that it will suffer appalling loss of face if—as seems increasingly likely—the squarial fails to materialise in time. At the end of May, BSB began to acknowledge what the electronics industry had long warned—a launch delay until spring 1990 will be necessary.

Arguably the only real value of the Sky and BSB advertising campaigns has been to divert attention from far more important practical issues. These can be quite simply stated.

BSB's satellite will hang at a completely different place in the sky from Astra and use a completely different transmission system from the Sky Astra channels. In all, viewers will need two different aerials and *four* black boxes, requiring subscriptions of around £30 a month to keep them all working.

The details are tortuous but to cut a long and truly absurd story short, Astra, at 19° E, broadcasts Sky Channel, MTV and the W H Smith programmes, currently all in PAL without scrambling. A *first* set-top box or receiver is needed to tune between these channels, and convert the FM PAL signals from the satellite into the AM PAL a terrestrial set expects.

Later this year, under pressure from the film studios, Sky will start scrambling its movie channel using the Videocrypt system (previously called Palcrypt) developed by Thomson of France. This means a *second* box.



The Videocrypt descrambler only works when fed a smartcard (credit card with built-in computer) which signifies advance payment of £12 a month for two channels. The costings have been knocked off course because Disney has pulled out, leaving only one film channel to carry the cost of decoding hardware.

Unless the Luxembourg owners of the Astra satellite can deter them, the brains running WH Smith will switch from PAL to the quite different D-MAC transmission system later this year. At the same time they will adopt the quite different Eurocrypt scrambling system. This means a *third* box and between £5 and £10 a month more on subscriptions.

D-MAC, bear in mind, is not the same as D2-MAC, the system adopted by Continental Europe. The digital data rate, used for sound and encryption control, is halved on D2-MAC. You need a multistandard chip set to cope with both.

If all goes according to plan, BSB launches its satellite into orbit at 31° W in August. BSB was scheduled to start broadcasting in September, using D-MAG but with yet another scrambling system—Eurocypher—developed by General Instruments from the US system Videocypher. This means a *fourth* box and a subscription of £10 a month.

Compare this with the £66 per annum price of a UK TV licence and the simplicity of using a conventional TV set and video recorder. No amount of advertorial puff in newspapers owned by Sky boss Rupert Murdoch, and no amount of advertising hype by BSB for the squarial, can disguise the fact that satellite broadcasting in Britain is a dog's dinner.

The owners of the Astra satellite have long hoped to launch a generic advertising campaign, to create awareness for the wide range of

programmes available from one satellite—16 channels, at least 10 of them English-language—with the future option of two or three satellites in the same orbit offering up to 48 channels. But the illogical mish-mash of transmission and scrambling standards has so far blocked this logical and potentially valuable weapon.

BSB's slogan 'it's smart to be square' and Sky's brainwashing in the Murdoch press can only temporarily divert attention from more harsh realities. Whether flat and square, or round and dished, a satellite aerial still has to be erected on an outside wall or roof, or in a garden large enough to have direct line of sight (without even trees in the way) on the satellite hanging low in the sky over the Equator. Whereas an ordinary TV aerial can pull in pictures even when pointing in roughly the direction of the transmitter, a satellite dish or plate must be aligned with accuracy of around 1° on the invisible transmitter in space. Slight misalignment will mean 'rainfade', a mysterious drop in picture quality on wet days. Any obstruction along the line of sight, even leaves of a tree, will prevent reception.

It would be interesting to know how many people believe that the squarial will sit on top of a TV set. BSB has never said this. But sometimes the spaces between words say more.

Despite misleading advertisements about 'first run movies' on the satellite channels (which the ASA looks likely to sit on) most of the films booked for satellite transmission will already have been seen in the cinema and made available on home video, at least a year earlier.

DIY dish fixing is a No-No, unless you are an electronics hobbyist and either have a big garden or are a spare time roofer. Trying to align and then secure any aerial on a high ladder or sloping roof is a very dangerous game. Dishes need extra

wires to carry current that switches the 'polarity' of the dish, because Astra transmits eight channels with one polarisation and eight with another. There is no standard electrical interface, so mix-and-match between dishes and electronics is impractical.

Then there's the law to contend with. The government has ditched its scheme for a £10 dish licence, because it cost more than £10 to process each piece of paper. But the Department of the Environment's planning regulations put a limit of one dish (of less than 90 cm) per building. Absurdly, the Home Office has a completely contradictory law (Cable and Broadcasting Act, 1984), which its Cable Authority is duty-bound to enforce. This makes it a criminal offence for two or more flats to share a dish without licensing themselves as a cable station.

None of this bodes well for BSB, who must start selling aerials a year or more after 'first on the block' gadget buffs have had the chance to satisfy their curiosity with an Astra/Sky dish.

Without doubt some dish systems are easier to fit than others. I speak from miserable personal experience when I say that the expensive Grundig system is a user-hostile jigsaw puzzle, although the pictures are very good when you get them. The Amstrad system, I am told, is far easier to tame. But in this field the word 'easy' is purely relative. To generate sales predictions by comparing satellite reception with plugging in a video recorder is just plain stupid.

The next time someone shoots off statistics about satellite audiences, ask them two simple questions. Have they ever been up a ladder and got their hands dirty actually trying to install a system, and have they ever tried explaining to a member of the public what equipment will be needed to receive all the available programmes. □

## LENGTH AFTER LENGTH. CASSETTE AFTER CASSETTE. ON THIS YOU CAN RELY.



NOW OFFERING BOTH TYPE I AND TYPE II CASSETTES IN SEVEN LENGTHS—FROM 5 TO 90 MINUTES.

AmpeX Recording Media Corporation • Acre Road • Reading, Berkshire • RG2 0QR • England



**B**obby was very excited. He had come to the big city for the AES show and to buy new equipment for his studio. He had finally made it to the big time. Back home, the three major studios in town had laughed at him when he started. His band had been hot and the potential of a record contract had made the prospect of a home studio seem like a good one. Far better than spending the money working in someone else's facility. In fact, it was not too long before the studio eclipsed the band. Only one record had been released and that was a major flop. But the 'facility' had grown and moved out of his basement and into a former auto parts store. Now he was ready to buy a new multitrack recorder and some signal processing peripherals. The big time, indeed.

He had first seen the man on the floor at the AES exhibits. He was tall and sallow. A yellow complexion with almost waxy components rather highlighted by the black wool pants, plain white shirt and a short black leather tie. He seemed to be escorting people off the floor. It was the last day of the convention when the man moved in on Bobby.

"You're Bobby Sanford, aren't you?" the ominous stranger asked. Bobby nodded. "I looked you up in a studio directory," he continued. "The Facility. Cute name for a studio. I understand you are quite the powerhouse in your home town?" Bobby smiled and nodded. Suddenly the man walked away. Bobby thought little of the contact. He finished his perusal of the show and devoted his last two days in the city to talking to professional equipment dealers. He was standing at the window of 'Jet Sounds' looking at multitrack tape machines in the window when somebody touched his shoulder.

It was tall, black and yellow again. The man opened the contact. "I see you're looking for some hardware." Bobby nodded. "I might be able to help. How many tracks do you really want?"

Bobby signalled eight with his fingers. Bobby really wanted 48 digital tracks but what he wanted and what he could afford were two different things. Eight analogue tracks it would have to be.

"In fact," said the man, "I can help you double your money. Would 16 tracks interest you?—wait a minute. Maybe I can even help put you behind the wheel of a 24-track supercharged thoroughbred."

Now the man was interesting to Bobby. He seemed handsome and dynamic where just a few minutes ago his strange interlocutor had appeared as a dark visage.

Bobby had continued with the flow of the man's attempt to consummate some audio commerce. In truth, thought Bobby later, the whole thing had gone very smoothly. The trip up to the man's hotel room in one of the best digs in town had been followed by a drink from room service and a bowl of big succulent pink cocktail shrimps to dip in spicy red sauce. Bobby had succumbed to the prices offered on name branded merchandise. He had settled for a 16-track and an 8-track machine, with external signal processing thrown in for all the units. He had received four times the value for his money.

Delivery had been rather bizarre, though. On

## Martin Polon

### A warning about the dangers of buying studio equipment offered through the back door. Comment from our US columnist

the loading dock of a 'legitimate' trucking company, the transfer of the hardware was made. The strange 'dealer' delivered from a step van, with two assistants who clearly had strong interest in motorcycle gangs—judging by their emblazoned leather jackets. The units were not in marked boxes either. They had been crated by a packaging company with no identification on the crates. Money changed hands, in cash. That had bothered Bobby and taken up another day as his bank back home worked with a local institution in the city. The warranty procedure had been odd as well. The man had insisted that Bobby not 'under any circumstances' contact the manufacturer for service. Instead, the man gave Bobby the name and number for a well-respected freelance repair technician in a neighbouring large city to 'The Facility'. The equipment was trucked home and Bobby felt fat and sassy.

Four months later, Bobby's new secretary was approached by one of the studio engineers. The new 16-track had a noisy motor. Bobby was on vacation in Hawaii. She did not want to bother him with such a minor matter. Instead, she called the manufacturer. After answering some questions, which included the serial number for the unit in question, a service call was arranged. Imagine Bobby's state of mind when he returned to his business to find two FBI men waiting for him. The long and the short of the matter was that the equipment was stolen and it was clear that Bobby was not going to come up with the long end. Bobby felt like changing his name to Booby.

**W**ell, loyal readers, can you imagine anyone being that naive. That sort of thing couldn't happen to anyone in the Western World, could it? Or could it? Unfortunately, it can and does happen and with a regularity that amazes law enforcement officials. The notes and advertisements about stolen studio and touring equipment in professional audio journals are just the tip of the proverbial iceberg, according to informed sources. Somewhere between 3% and 5% of all professional sound equipment changing hands does so on the illicit market, according to some observers. Others feel the number might even be higher. One expert opted, "Many times a

studio will not advertise the loss of major equipment since it is exactly those units that are drawing in clientele. Far better to lick your wounds in silence while the police and the manufacturer try to find the purloined gear and the insurance replaces your losses."

It is curious that notices and advertisements are not ranked by law enforcement experts as being the most effective way of recovering stolen gear. That category goes to the warranty department of most manufacturers who maintain a list of who owns what. The FBI or Scotland Yard are just a phone call away. Registration of legitimate resale of audio equipment is solicited by some equipment makers to keep their 'lists' up to date. Unfortunately, not all equipment makers are as scrupulous as they should be and handle the warranty information carelessly. Good marketing practice requires the warranty information to be accurate and for the most part that keeps the industry 'honest' in tracking warranty information. And of course, the 'victim' must be sure to register that theft and the serial numbers of the purloined units.

P T Barnum was quoted as saying that there was a sucker born every minute. Unfortunately, that is the good reason that ads and notices to editors and others do not always snag equipment thieves. The lure of a good deal to a studio operator who could otherwise not compete fully in his or her market is frequently too strong an inducement to turn down. Even with printed notice in hand, buyers will forge ahead. There is an old saying that you get what you pay for. That has never been more true in the illicit purchase of audio equipment. One ends up buying a product that cannot be updated or retrofitted or repaired by the unit's maker or by factory-authorized warranty stations. Accessories cannot be purchased from authorised dealers, especially where they have to be fitted to the unit directly. Nevertheless, there is no shortage of buyers and it is rumoured that there are some theft rings that will literally steal to order.

The problem of equipment theft begins with inadequate security in studio facilities. Many studios today have plant investments greater than the cash reserves on deposit in a small bank. Yet the security measures taken by the studio are frequently less rigid than that taken by a neighbourhood dry cleaner. A retired policeman now consulting in security thought, "Many studios do not even go to square one. That is to use an engraving or etching tool and put your national tax number on all your units. Every business has a tax number and it is uniquely yours. One advantage of such engraving is that it allows a studio to recover a unit if there is any confusion about ownership with the receiver of the stolen property. Sometimes a studio will buy a piece of equipment and the serial number will be put on inadequately at the factory as with inked numbers, marking numbers on plastic parts or via a metal plate that is riveted on. Such markings can be obliterated or removed. Not so with etched markings in metal.

"Secondly," continued the gumshoe, "the 'safe' facility should have state-of-the-art protective technology such as microwave sensing or infra-red alarm systems. These should connect to a 24 hr



# Drawmer

*Ingenuity*

## UNNERVING CAPABILITY



# M500

## DYNAMICS PROCESSOR — ALL YOU'LL EVER NEED

DRAWMER DISTRIBUTION CHARLOTTE ST. BUSINESS CENTRE CHARLOTTE ST. WAKEFIELD W. YORKSHIRE ENGLAND

TEL 0924 378669 TELEX 556649 FAX 0924 290460

## MINUTE FOR MINUTE. PAK FOR PAK. ON THIS YOU CAN RELY.

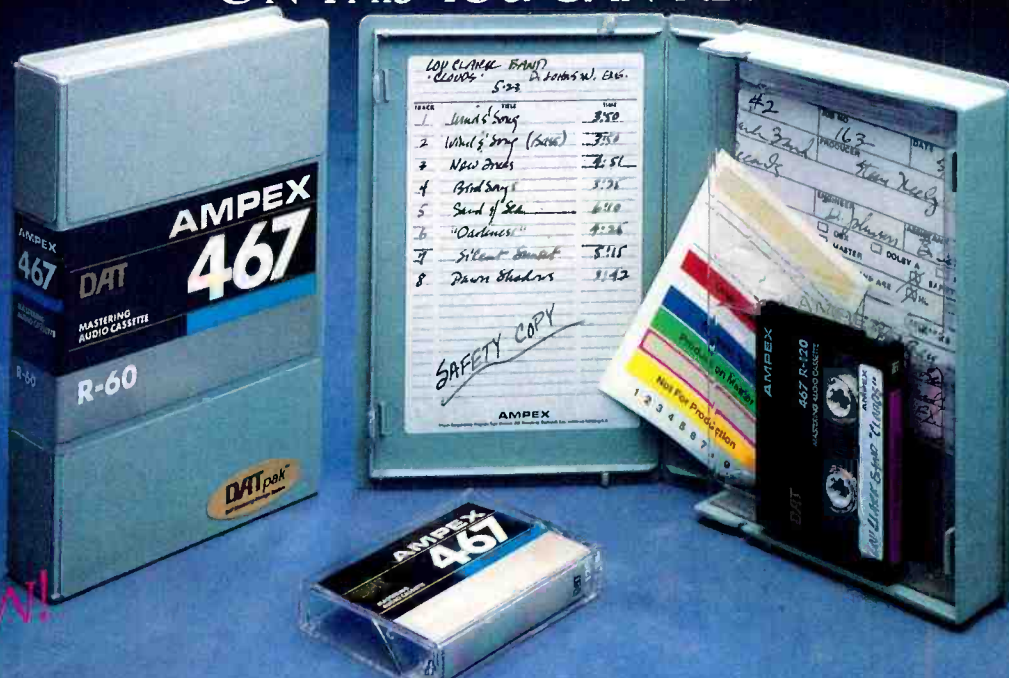

**NEW!**

Now safer storage and easier labeling with DATpak™ — AMPEX'S UNIQUE STORAGE SYSTEM  
AmpeX Recording Media Corporation • Acre Road • Reading, Berkshire • RG2 0QR • England

# Media

Our range of BPO audio jackfields are of the highest quality and economically priced, from £155.



Featuring high quality 5-point palladium contact gauge B jacks, the jackfield occupies just 2U, of rack space. Standard versions are 2 or 3 row in 20, 24 and 26 ways, and are now available with connectorised option, supplied fully wired and normalised.

Please contact us today for information on our range of video, audio and combined patch-panels and other systems equipment.

## 'It's in the name'

Media Products Limited  
14 The Markham Centre  
Station Road  
Theale  
Berks RG7 4PE

Phone (0734) 303800  
Telex 858893 FLETEL G  
Fax (0734) 323121 (G2/3)



If you use Stevens & Billington's 7-point service plan:

1. Samples normally supplied in 7 days.
2. Individually designed to your exact needs.
3. Precision quality for high performance.
4. Quick reliable deliveries.
5. 'Mumetal' shielding cans for excellent 'hum' rejection.
6. Flexible call-off arrangement to suit you.
7. Competitive prices.

'Phone 082571 2568 now - Get your sample next week

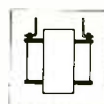

STEVENS &  
BILLINGTON  
LIMITED

Orchard House,  
Orchard Close,  
Fairwarp, Uckfield,  
East Sussex,  
TN22 3BW.

Specialists in miniature transformers



Orban's 245F Stereo Synthesizer is an inexpensive, effective means of creating compelling psuedo-stereo from any mono source—whether in production or live performance. Features include:

- Patented frequency-splitting, comb filter technique that renders dramatic spatial enhancement from any mono source.
- Perfect summing to mono to avoid phase cancellation problems.
- Powerful tool for track expansion on multi-track tape machines, or for stereo EFX on stage.
- Like all Orban products, the 245F is built to work the same hours that you do, and employs a unique and proprietary design to bring you a product worth listening to. Call us. We will be happy to provide you with the name of one of the top quality dealers carrying Orban products, worldwide.

Orban a division of AKG Acoustics, Inc.

645 Bryant St., San Francisco, California 94107 USA (415) 957-1067 Telex 17-1480 FAX (415) 957-1070

orban



response service that sends out armed representatives to check out the premises. Acoustic sensors that allow the protection service to monitor noise in the studio acts to back up the main system and can help to establish illicit entry or not. The rule of thumb is redundancy. Use two kinds of sensing systems in addition to contact switches on all doors and windows. All alarms are sent to a central service with complex continuity tones standing on the telephone lines to prevent lines from being severed. Really expensive components can have their own protection with aircraft cable 'bridles' having actual signal-bearing wires within. Any attempt to steal a 48-track digital tape recorder valued around a cool \$¼ million would be met with shrieking alarms during regular studio hours. You'd be surprised how much equipment is taken from a studio during the regular business hours. Night-time problems sometimes require dogs or on-site armed guards."

One thing about studio owners that quite amazes outside observers is that those who have never been hit spend far less or nothing on security as opposed to those who are victimised and can spend quite a bit. However, security systems frequently cost less than \$25,000 to install and often it is possible to protect a small facility for half of that sum. It is fascinating to see a studio with equipment worth \$3 million refusing to spend any money on an alarm system because it is not 'economical'. Frequently, the insurance company mandates such coverage under the general category of 'if you want insurance you do things our way!'

Some observers of the process blame the insurance industry for the current problem: "Insurers have been much too casual in the past about paying off from thefts," stated one studio owner. "That allows the studio owner who is a lousy businessman and many of them are, to avoid strengthening the premises or putting in adequate alarm systems." The owner critical of the industry continued, "now we are seeing insurance inspectors requiring solid steel doors with locking bars and concrete filled steel pipes outside the doors to prevent someone from driving a truck right through a wooden studio door and emptying the place at 3 o'clock in the morning."

Some owners feel that complete access for potential thieves is either built-in with the staff or else purchasable by the hour. This is not to say that studio owners must be paranoid about all the groups that rent their facilities. But it does say that there is some wisdom to know a little bit about the people who rent their studios. Also, there are certain cues that 'sing' for closer inspection. The one hour rental is certainly one of them, especially if no deposit crosses palms prior to the supposed 'session'. It only takes an hour to 'case' the entire studio operation. The all night 'four walls' session can also be a problem, especially when members of the 'band' take the one house engineer on duty out for a good meal at 3.30 am. Alarms are left off during a night session. A crew with an 18-wheeler can empty a facility in the time it takes a house engineer to finish a good steak dinner.

Another 'inside' problem is with the studio staff. No one wants to think that one's employees are not all the moral equivalent of Prince Charles. But life is hard and then you die. Some employees are not Rebecca of Sunnybrook Farm and this may be exaggerated by the extremely low rates of pay that characterise studio employment—especially for new staff. Owners will sometimes trust \$3 million worth of technology to an employee earning a minimum wage. Every so often a studio experiences the dilemma of an 'inside job'. Doors left unlocked at closing, alarms switched off, taking a night-time session that turns out to be with the 'movers', etc. The right kind of alarms will help to prevent some of that. Alarms through a service that do not switch on at the appropriate time, will bring an armed response unit to the front door quite promptly. Better pay will also help to guarantee staff loyalty. But it is clear that employees may be as valuable in a studio for their work habits and trustworthy behaviour as for technical skills.

Rentals are another area of potential casualty for the studio and/or equipment owner. Said one studio/rental operator, "it would be nice if equipment could be rented on a driver's licence like in the old days. Today, the 'stings' get to be so exotic that if we don't know who we are renting to intimately, we ask for a deposit equal to our cost on the rental item. Needless to say, we do not accept any cheques unless they are bank cashier's cheques or money orders. We verify those on the spot. For larger and more expensive units, we ask for an open-ended credit card like an American Express or a Gold Master Card or Visa. We usually like the card three days prior to the rental so we can be sure it is not stolen. If the credit rating on the card will carry substantial freight, we will normally go with the rental. Actually, we require a signed contract on every transaction since we want to be able to charge for damages or losses against the deposit or credit charge immediately. Other than that, a contract is worthless.

"Even if the party who has acquired your item illegally through a rental is still at his old stand, doing business with your property, it is usually seen by the police as a civil disagreement since there is the signed paperwork of commerce—contract, charges, etc. Your remedy is a civil suit, assuming you can hold your breath for three to five years in most big cities. Also, you have lost your equipment but you have to pay a lawyer as much as one third of the value of the property upon reclaiming it. In the US, one can claim grievance up to \$2 to \$3,000 in the Small Claims Court in various states without the need of counsel. Small items can be claimed more promptly in these courts but the point is not to depend on contracts to recover rental equipment.

For those attempting to buy bargains that are too good to be true, the risk can take several forms. Legally the receiver of stolen property is at the mercy of the whims of the law enforcement agency involved. It is very difficult to sustain the argument that you didn't know the multitrack tape recorder you took delivery of in a back alley was anything else but brand new and the dealer legitimate. The act of

transporting the equipment across state lines is what makes the whole thing a Federal offence punishable by the FBI. So the studio owner-buyer becomes the patsy for a whole range of nasty prosecutions that could include some heavy Federal time in prison. Within the EEC, the arrival of Europhoria in 1992 promises to create the same kind of scenario for illicit transport since elaborate phoney paperwork will no longer be necessary to cross national boundaries. And that kind of risky business could bring in Interpol and several national police agencies with very little in the way of a sense of humour.

Our erstwhile hero above was lucky in some ways in actually receiving what he bought. The problem with 'stings' has left many bargain

### The problem with 'stings' has left many bargain buyers holding the 'box' literally. Our buyer has just added a 17-year-old cast iron restaurant stove to his studio's equipment collection

buyers holding the 'box' quite literally. It is not unusual for a buyer (known to the trade as the 'mark') to see the equipment he has purchased actually boxed. He might even ride in the front seat of the 'delivery service' van. Unfortunately, several gentlemen will be playing cards in one of the larger boxes in the back. They will switch the packaging of the purchased tape recorder. The weight on the phoney package will be just right. Our buyer ('mark') has just added a 17-year-old cast iron restaurant stove to his studio's equipment collection rather than the 24-track tape machine he thought he was buying. When the buyer goes back to find the 'salesman' who had deceived him, he will find so little that 10<sup>3</sup> will look like a positive number. One veteran big city detective figured a certain 24-track recorder was 'sold' and 'sold' again at least as many times as it had tracks. Frequently such equipment is not stolen. The operators of the sting know that their chances in court are greatly improved if the charges are for bunco and/or fraud rather than grand theft and receiving stolen property. If the price is too good to be true, it probably is!

Now it is clear that this sort of thing shouldn't be happening at all. If everybody in the recording business refused to buy unsavoury deals on professional audio equipment, there would be no market for the theft and swindling of such equipment. There is no excuse for anyone knowingly buying stolen property. The hotlines provided by SPARS in the US and the assistance given to burgled studios by APRS in the UK should in theory prevent anyone from buying stolen property out of ignorance. The same can be said for the various warnings printed in the trade journals. Until studios stop trying to 'step up in class' by stepping down to buy their equipment in the muck, this problem will not go away. □

# RTW Peak Programme Meter



**PPM 1109 stereo**  
Analog + Digital  
Audio Peakmeter

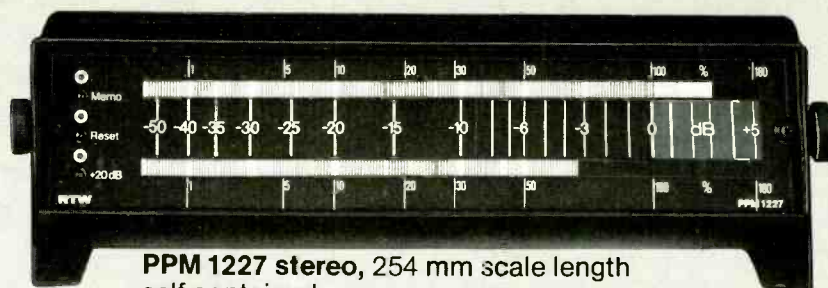

**PPM 1227 stereo**, 254 mm scale length  
self contained

**Model 1206**  
self contained

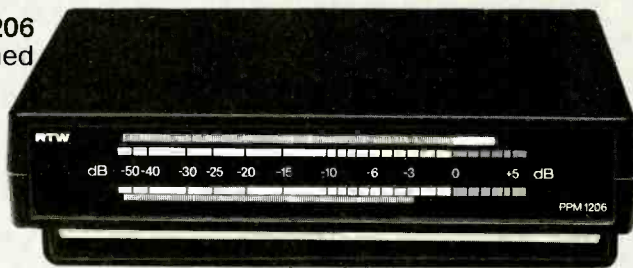

Peak programme meters  
for monitoring the peak level  
in analog and digital audio



**PPM 1118**  
2-Channel  
Module

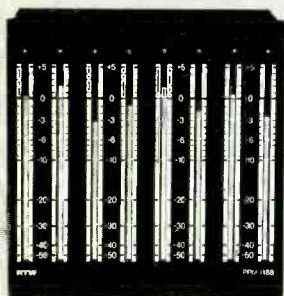

**PPM 1188**  
8-Channel  
Module

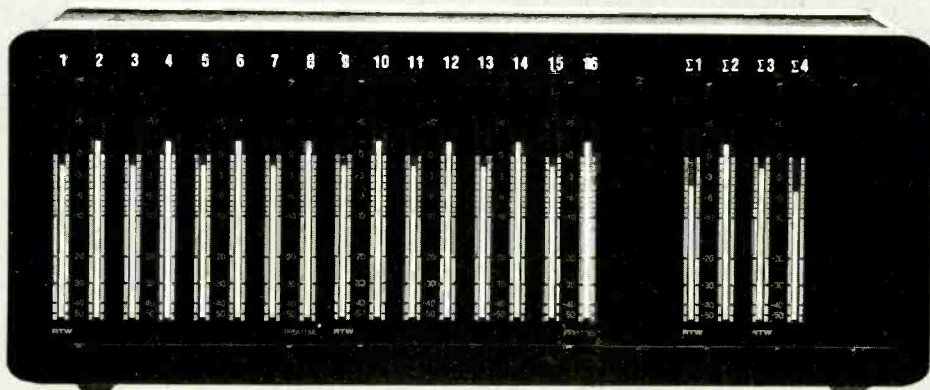

**Multi-Channel Unit 16-4 and 24-4**

# RTW Correlator

Compatibility meter  
displays the phase correlation  
of stereo recordings

**Correlator Model 1170**

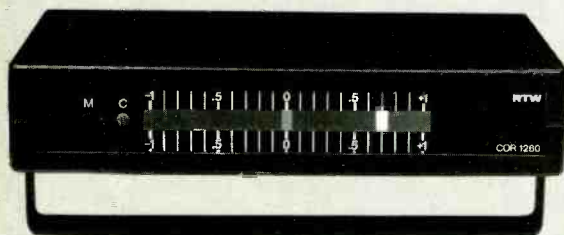

**Correlator Model 1260**  
self contained

**Correlator Model 1160**



# RTW

**RADIO-TECHNISCHE WERKSTÄTTEN GMBH**

Telephone (2 21) 70913-0 · Tx 8885 217 · Fax (2 21) 70913-32  
Elbeallee 19 · Post Box 7106 54 · D-5000 Köln 71 · W.-Germany

**Austria:** ACOUSTA ELEKTRONIK, Tel. (662) 84 61 64 · **Australia:** SYNTEC PTY, Tel. (2) 4 06 47 00 · **Belgium/Netherlands:** P.A.C., Tel. NL: (40) 4244 55 · **Denmark:** S.C. SOUND APS, Tel. (2) 99 88 77 · **Finland:** AV-POINT ICS AB, Tel. (0) 5 65 36 33  
**France:** SCV-AUDIO, Tel. (1) 48 63 22 11 · **Great Britain:** AUDIO & DESIGN LTD., Tel. (73 57) 45 45 · **Italy:** ROBOTECNICA S.R.L., Tel. (2) 242 81 47 · **Japan:** ELECTORY CO. LTD., Tel. (3) 9 50 62 66 · **Norway:** SIV. ING. BENUM AS, Tel. (2) 14 54 60  
**Switzerland:** AUDIO BAUER AG, Tel. (1) 4 32 32 30 · **Switzerland:** PROFAX AG, Tel. (1) 4 93 22 44 · **South Africa:** ELTRON LTD., Tel. (11) 7 87 03 55 · **Spain/Portugal:** SINGLETON PROD., Tel. E: (3) 2 37 70 60 · **Sweden:** AV MEDIA AB., Tel. (755) 6 54 98  
**USA:** ESL ELECTRONIC SYSTEMS LAB., Tel. (3 05) 7 91 15 01



# What's new at Studiospares besides two more computers, 5 more staff and the 89 Catalogue ?

Harrison MOS FET Amplifiers have long enjoyed a reputation for the ultimate in sonic performance. We now stock the 150watt, 300watt, 600watt, 1000watt.

Tannoy have just released three new models. The NFM8, TP1 and DC1000. These and all existing models.

We can now clear customers and company cheques up to £1000 within 1 minute of receipt.

Rockwool Sound Insulation provides an economic solution to the control of studio acoustics, particularly sound leakage between studios.

The Fostex R.DAT Recorder works like a stereo centre channel time code recorder. The rotating heads have four heads, two record and 2 replay.

Studiospares have introduced their own Credit/Charge card which provides customers with an appropriate credit line.

Studiospares has in the past mainly concentrated on studio accessories.

We are now open from 8am to 8pm every Thursday evening to aid those customers who are unable to make a visit.

During the last six months the level of business at Rochester Place has expanded enormously. The Computer installation was expected to take us into 1990 before we outgrew the system. With so many new accounts opening daily we required additional terminals, better stock movement analysis, more hard disc memory etc.. The new installation can handle 20 terminals, 70 thousand customer accounts, 50 thousand part numbers and three printers.

The inclusion of Fostex and Tascam Multi Track Recorders plus Seck Mixers will spearhead our thrust into the equipment market.

Seck Mixers provide a level of fidelity and performance usually associated with products costing considerably more. The 12x8 includes a revised version.

The Fostex R8 provides true multi track recorder facilities within the budget of a studio. The microprocessor controlled

The Quadra-verb, Multi-verb, Pro-verb increase Studiospares range of effects units.

*Save time - phone*  
**STUDIO SPARES**  
*first*

61-63 Rochester Place, Camden Town, London NW1 9JU.  
 ORDERS: 01-482 1692                      ADMIN: 01-485 4908  
 FAX: 01-485 4168                          TELEX: 838705 TAPE UK G

Please send free 56 page catalogue

Please send account application form

NAME \_\_\_\_\_

ADDRESS \_\_\_\_\_

\_\_\_\_\_

\_\_\_\_\_

\_\_\_\_\_

\_\_\_\_\_





- the specialist.... with the know-how

# The combined...

## COMPRESSOR EXPANDER

## LIMITER

## NOISEGATE



original size 40 · 190 mm

### NTP has it!

Type 179-160 the combined unit with an excellent performance and intelligent features like:

Compression or expansion can be changed during operation by means of only one knob, while maintaining a constant output level.....  
The same applies for ratio.....

The variable hold level avoids pumping effects.....

Includes programme dependant automatic recovery delay.....



Also available in dual channel 19" version

For further information and full technical specifications:

### NTP ELEKTRONIK A/S

Theklavej 44 · DK-2400 Copenhagen NV · Denmark · Telephone +45-1 10 12 22  
Telex . 16378 ntp dk · Telegramme: Electrolab



**B**roxmead Studios can be found in a beautifully converted part of Broxmead Court, a grand Victorian country house set deep in the Sussex countryside. Surrounded by acres of park gardens and paddocks it offers an ideal creative environment. The facility was developed by film composer/synthesist Derek Austin and is a dedicated film/video/television soundtrack recording workshop in rural surroundings—as far as Austin is aware, the first such facility in such an environment.

“While I would not claim that Broxmead is of the very highest state-of-the-art, after 20 years of session work in most of the world’s top studios, I am a firm believer that a lot of the recording industry is plagued by ‘techno-hype’,” explains Austin, “and that digital multitracks and expensive consoles, etc, are very nice but overkill in the majority of applications.”

A recent feature film he worked on was recorded in someone’s front room with an Otari MTR90 multitrack and Soundcraft 6000 desk.

“At the same time I do believe that there is such a thing as a minimum professional standard that must be maintained, while providing a client with a cost-effective package.”

Austin’s film credits include titles like *Return to Oz* (David Shire), *Cherry 2000*, *Robo-Cop*, *No Man’s Land* (Basil Polidouris), *Rambo—First Blood* (Jerry Goldsmith), *The Empire Strikes Back* (John Williams) and *Lace I and II* (Tony Britten). Television and advertising jingles as well as album sessions have taken him all over the world. Broxmead aims to allow the ‘conventional’ composer to work with synthesised scores for film and television without having to worry about the complexities of a large MIDI rig. Austin has long felt the need for a studio where the music doesn’t suffer from an excess of button-pushing, as he puts it, and where a visiting composer would not feel alienated by current synthesiser technology.

Austin’s working relationship with engineer Bob Butterworth is of many years standing, as a result of which he became involved in the Broxmead project. A top freelance audio engineer, Butterworth’s credits include *Robo-Cop*, *The Believers*, *Drowning by Numbers*, *Biggles* and *Dream Demon*. He has also worked on numerous commercial recordings from Art Garfunkel to the Sex Pistols. His 20 years experience working at CTS Wembley, Lansdowne and Abbey Road Studios was drawn upon

# BROXMEAD

## Janet Angus reports from a facility concentrating on soundtrack work in the heart of the Sussex countryside

for control room ergonomics at the design stage. Studio manager Mike Hazell was previously with Trilion Video, CTS and Lansdowne Studios.

Equipment choice was a joint decision and appears to have been unanimous. Centrepiece of the 14 × 23 ft control room is a heavily customised 40-input, 32-bus, in-line Raindirk *Symphony* recording console. This is designed to handle full Dolby cinema mixes, up to 8-stripe, at the flick of a switch, with eight auxiliary sends. The custom patchbay has all inputs/outputs hardwired and the SMPTE has its own dedicated patchbay.

“The Raindirk is very good value; there isn’t a desk to touch it in terms of quietness—noise is virtually non-existent,” says Austin. “Raindirk were happy to accommodate the heavy customising I wanted, unlike certain other manufacturers who didn’t want to know. Being in-line, the console can handle a large number of extra (synth) inputs on mixdown.”

The *Symphony* features 32 channels of *OptiFile* automation, which, Butterworth explains, offers value for money: “Not only price, but it was the most versatile system available at the time, being hard disk based.”

Being Dolby *Surround*-ready means that when the Dolby unit arrives at the beginning of a session it simply plugs in and with a 1-button operation the console configures to the left, right, centre and surround channels of Dolby *Surround*.



Photos: Paul W. Mattock

Broxmead’s rural setting





The control room also houses the keyboard systems

"There is a definite awareness of soundtrack audio quality—soundtracks have improved 500% in the last two years," says Butterworth. "A lot of films are recorded with Dolby SR now and major films will be done in Dolby Stereo. Take into account the fact that more television companies are recording in stereo and you conclude that your console, room and monitoring must all be designed with Dolby Stereo as a priority. Apart from Lansdowne and CTS Studios, setting up Dolby Stereo always seems a lash up job. It isn't here."

In the separate machine room there is a brand new Sony/MCI JH24 multitrack—apparently the last one to be built, equipped with 24 tracks of Dolby SR. Austin wanted this machine for its 'legendary' sound and reliability plus the fact that much of his own work is with American clients.

"The Americans adore MCIs and I must admit I agree with them. Drum sounds are just wonderful. The machine looks a bit utilitarian I suppose but it is a good reliable workhorse. And again it is bringing the whole facility into the right price bracket."

Mastering is on a new Sony APR 5003 ¼ inch with centre-track timecode plus Dolby 363/A/SR. Additional mastering facilities are offered by the Sony DTC1000 DAT and F1 systems.

"DAT may be a smaller more convenient format but it is still unproven," says Butterworth. "Given my way we would always work Dolby SR and analogue tape, having nothing to do with digits. It just sounds better. Digital may be perfectly clean but the sound is not what you put on to the tape. The pure sound of analogue tape with SR can't be beaten in my opinion. But having said that, obviously you have to provide all the major formats for those clients who prefer them." When mixing to film an 8-track or 4-track machine is hired in to accommodate the needs of the Dolby Stereo format.

Video playback is by Sony 5850 U-matic controlled by an Adams-Smith Zeta 3 synchroniser and Audio Kinetics Gearbox. Sony Trinitron monitors are set up in the control room, keyboard rig, live room and office; the video signal being

distributed by an M&W distribution amplifier.

Studio main monitors are ATC SCM 100As, mounted in a nearfield position. Both Butterworth and Austin have worked extensively with the ATCs installed at Lansdowne and CTS.

"They are much bigger versions there, obviously, but we trust the ATC systems," says Austin. "Plus, the fact that they are self-powered made them suitable for this room. We have added a sub bass driver just to give the system a little bit more." Yamaha NS10s and Visonik Little Davids are also provided.

The massive keyboard rig, arranged along the length of the back wall, is provided with its own NS10 nearfield monitors with independent level control for programming. There is also a TV monitor for programming direct to TV and film. The system is based on an Atari Mega 4 computer with C-Lab, Dr T and Steinberg software. A C-Lab Unitor reads SMPTE directly into the Atari, acting as a master tempo map. All tempo changes are saved to disk along with all other MIDI information. By syncing to video the C-Lab enables composition and recording to be executed live into the final format without going near a tape machine on the way.

The keyboard/synth rig will always house at least one of each of the following: Prophet T8 with 3.8 MIDI update (polyphonic aftertouch, full MIDI control of slave synths); Roland JX10 and D50 (hundreds of unique sounds created with the Atari Librarian by Dr T); Korg MI; Akai S1000 16 bit stereo sampler with large unique library and 4 Mbyte update giving 23.5 seconds stereo sampling at 20 Hz to 20 kHz; Emulator II; one E-mu Proteus; Yamaha TX81Z; Alesis HR16; Yamaha DX7; Mini-Moog (1967) heavily mod'ed to make it stay in tune; Roland MC500 and MSQ700 sequencers; a set of Roland Octapads.

SMPTE/MIDI synchronisation is provided by Bokse SM9, which has apparently never crashed, and a Bokse MH2 Humaniser, which enables live musicians to drive sequencers, or it can read timecode, or off-tape click track, in turn providing a MIDI sync.



# It's Time To Rack Up Another Hit.



It's hard to follow a great act. Expectations run high. The performance must be flawless. When we decided to carry the legacies of our LA-2A, LA-4 and 1176LN into the next generation, we knew exactly what we were getting into.

Our new 7110 Limiter/Compressor incorporates the characteristics of its predecessors, is the natural addition to a legendary line and has all the potential to become a major hit in its own right. The 7110 combines both peak and average limiting action, producing smooth, predictable RMS style performance like the LA-2A and LA-4 with the precise automatic peak control of the 1176LN.

The 7110, with our exclusive program dependent Smart-Slope™, gives you adjustable compression curves from 1.5:1 through infinity:1. You set



*The 7110 combines the smooth predictable RMS style performance of the LA-4 with the precise automatic peak control of the 1176LN.*

threshold, attack, release time and output level – the 7110 automatically rides the gain with split second response.

To make set-up as simple as possible, we've included an Automatic Preset function. Punch the button on the front panel – the 7110 automatically defaults to program dependent attack and release times, and presets the peak threshold and ratio to consistently used settings. Perhaps the best news of all, the 7110 produces crystal clean sound and is virtually transparent.

Just another limiter/compressor? We don't believe so. After you've heard it for yourself, we think you'll agree. Stop by your local JBL/UREI dealer and give it a listen. And, get ready to rack up another hit.



JBL Professional  
8500 Balboa Boulevard, Northridge, CA 91329  
© 1988 - JBL Incorporated A Harman International Company

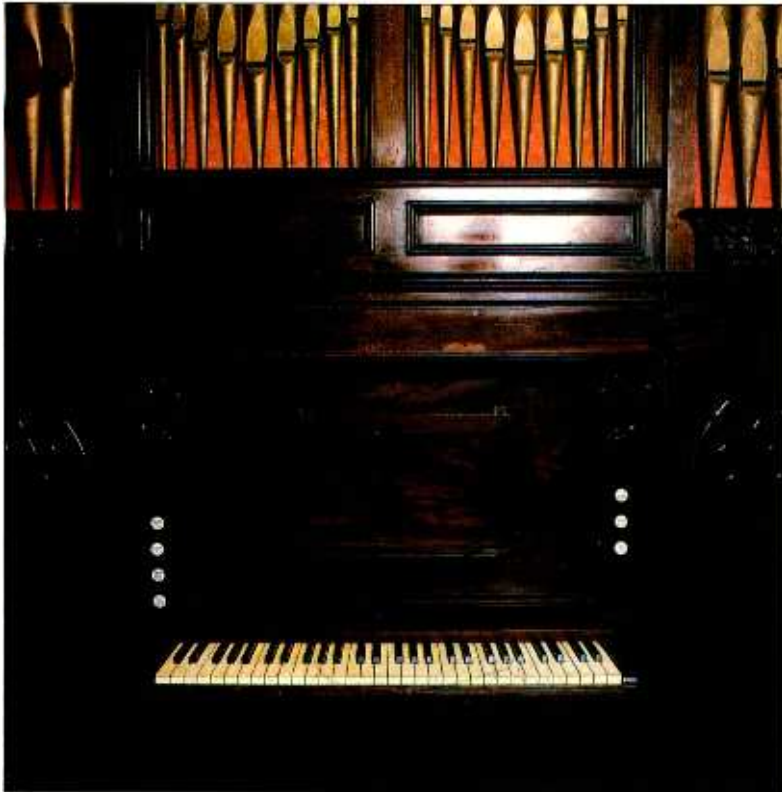

An 18th century pipe organ resides in the house

"We have retained a lot of classic early instruments including the Moog which is 22 years old," explains Austin. "It ranges right up to the Akai *S1000* with various classic machines on the way. We can offer a vast collection of sounds, samplers, analogue/digital synthesisers, for all of them. Very few factory presets are used; I don't think you can achieve any individuality that way. The whole system is like a giant piano roll. You can sit at the keyboard and write to picture in C-Lab and then cut it around in there to fine fit it.

"Alternatively someone could do a lot of work at home on an Atari or even with a Roland *MC500* and just come in here to use the desk. That way we are keeping the cost to the client down. There is always someone on hand to advise because all this equipment can get out of hand."

The outboard equipment complement features 10 reverb sources including an EMT *140* plate, K-T *DN780*, Yamaha *SPX90*, Lexicon *PCM70* and *PCM60*, *SRV-2000*, Alesis *Midiverb* and *Midifex*. In the grounds there is a 40 ft deep well, which gives a 4.5 second decay. One thing about a studio like this is that there are so many features in the building and the grounds that can be used to create unusual acoustic environments. A full complement of microphones from Neumann, Beyer, Shure, AKG and Sennheiser is provided. The control room rack also has a bank of six Drawmer *DS201* dual gates and compressors.

Down a Victorian spiral staircase there is a small live room beneath the control room. Formerly the 'coal hole' it has been converted into a very attractive recording area where the sun streams in through its several windows. It has round cream-coloured brick walls with beige curtains hanging between the windows and brown carpet on the floor. In here there is a 7 ft Steinway grand piano recently refurbished with new hammers. This area can be used for vocal and instrumental overdubs or even a small live group. Sixteen mic lines are built in as are MIDI sockets to and from the control room to allow for live drummers playing MIDI kits. The performance can be held in computer, allowing complete control of sounds on mixdown, while using the 24-track for real cymbals, acoustic drums, etc. Video tie lines to the studio and camera for control room CCTV are provided for communication.

Privileged clients are allowed into the house itself to use the 18th century pipe organ in the lounge. This instrument used to be resident in the assembly hall at a grammar school nearby, on loan from Austin while he had nowhere to keep it. So he is delighted to have it back in the home. What's more if you really want to go mad on the organ sounds Broxmead's adjoining

neighbour has a full blown 3-manual church organ, which can also be used.

The control room aims to offer a mini cinema-like environment. Spacious, with accommodation for at least five people to work together comfortably, it is of an *LEDE*-type design by Nick Ryan and is flat to 30 Hz. Daylight streams in through large windows at the front and back of the room with views over the surrounding gardens and paddocks.

The *Robo-Cop* sessions were the catalyst for Broxmead. Recorded at Abbey Road, Austin's vast keyboard rig was set up in Studio Three while the Sinfonia of London was installed in Studio One and the entire soundtrack went down in one, in sync. Austin looked at the amount of investment involved in keyboard hire and two Abbey Road studios, and decided there had to be a market for a dedicated studio.

"I wanted to provide a country studio for film. I know the industry is very much based in the West End of London but I believe that overseas clients will find this facility attractive. Our main attraction will be that we are good at what we do and with this facility we have got it together. There is nowhere in London that can do exactly what we do with no extra synth or video hire charges at our price. By making the 45-minute drive down from London people can record all our synths and with full 24-track you can mix and add up to 62 extra live tracks of synths."



The live room is reached via a spiral staircase and houses a 7 ft Steinway Grand piano

Because of the difficulty in attracting the film industry out of the city Austin was determined to make the price irresistible; £550 per 12-hour day (\$800 approx exc engineer).

"There are two types of client in this business," says Austin, "one who won't travel south of the River Thames and the other who can't wait to get out of town. Those are the ones we are here for.

"Composers are demanding more and more out of synthesisers—not just twiddly bits here and there. We are finding that the UK's top synthesists are becoming an attraction in their own right and sometimes directly are pulling overseas clients to the UK. These clients still require orchestras (on the 24-track) but are demanding a lot more of the synth elements in their scores and that's why we're here."

Although Broxmead is ostensibly a dedicated music-to-picture facility, they are not averse to the odd music session. Two of the first bookings were in fact album projects and the studio is well equipped to provide for rock musicians' needs.

Food, accommodation, liquid refreshment are all in plentiful supply in the nearby village of Cuckfield. Every type of accommodation from the majestic Ockenden Manor to £12 per night pub bed and breakfast is available and food can be delivered into the studio if a session is pressed for time.

Horse riding, croquet and tennis are among the recreations and although you would think yourself deep in the countryside, the A23/M23 motorway is only a mile away. □

Broxmead Studios, Broxmead Court, Broxmead Lane, Cuckfield, Sussex RH17 5JH, UK. Tel: 0444 415822/413180.



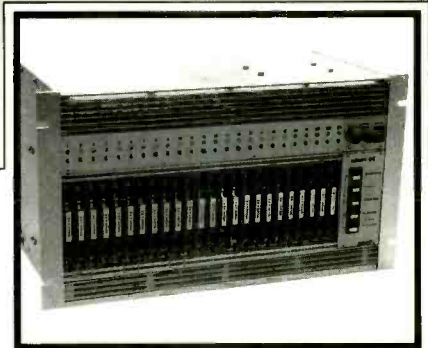
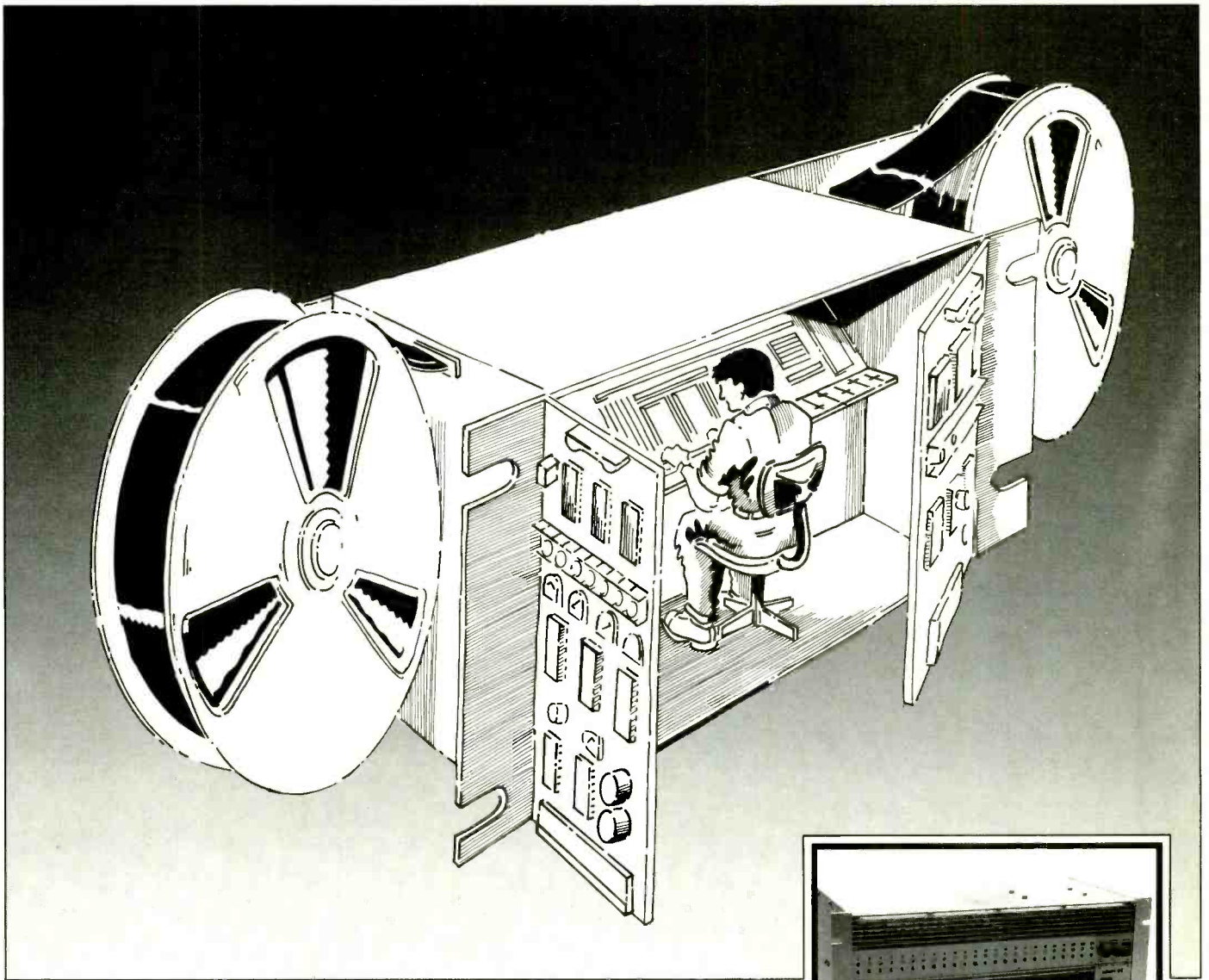

24-channel E413 c4 multitrack

## The Best of both Worlds

Whether you are recording your hits on analogue or digital machines, telcom c4 offers you the best from a big noise in noise reduction.

This processing method requires no line-up procedures and provides a dynamic range of up to 118 dB.

It improves analogue recorders to 18-bit comparable performance with natural sound and low tape noise.

Digital recorders such as DASH, PD, R-DAT etc are improved to 20-bit comparable performance for more recording headroom and less quantisation noise.

Here are the latest additions to our DIAMOND EXCHANGE CARDS to fit a wide variety of machines:

telcom c4-300/350 SR  
telcom c4-AC27 for BVH 2000/2500

Contact us and find out whether there is a CARD for your machine. In the UK: phone Tom Belshaw on 012261226

I would like to learn more about telcom!

Address

UK: PRO-BRITRO LTD,  
35 Britannia Row, London N1 8QH  
ANT Nachrichtentechnik GmbH  
Lindener Str. 15, D-3340 Wolfenbüttel  
Phone (05331) 83-364, Telex 95651 ant wf

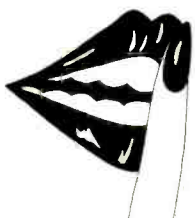

*PSSshhh*

telcom c4  
Silence by Design

**ANT**  
Telecommunications

# VCA'S INVESTIGATED PART TWO

Continuing Ben Duncan's series, Part Two describes the approaches adopted by three designers and manufacturers of audio VCA ICs and modules

The first widely successful audio VCA using transistors was pioneered and patented between 1970 and 1973 by David Blackmer, co-founder of dbx. In the basic log-antilog VCA (Fig 10, Part One, *Studio Sound*, June 1989), operation is limited to one polarity of input signal. In an earlier patent for an audio VCA by Embley (1970), single-ended (unipolar) operation was made workable by suitable biasing. Eight years later, competing VCA pioneer Paul Buff, patented a scheme using full wave rectification at the input to facilitate the required four quadrant operation from a 2-transistor core. But dbx's model 202 was the first VCA to contain a core comprising symmetrical pairs of npn and pnp log-antilog transistors for bi-polar or 'balanced' operation (Fig 1).

## dbx

The 202's biasing is Class A-B, meaning it's defined by the instantaneous signal level. As in power amplifiers, the minimum standing current is set by a  $V_{BE}$  multiplier. In the days when the conformity of npn IC fabricated transistors left a lot to be desired (fabricated pnps not even being mentionable in polite company!), the use of discrete devices in the dbx 202's core was a foregone conclusion for close matching. To this end, dbx developed ovens that could hold over 100 transistors under isothermal conditions, while simultaneously measuring and providing identification of those with matching  $V_{BE}$  voltages. On the other hand, isothermal conditions in the 202 were limited to improving thermal conductivity between the transistor cases through a thermally conductive ceramic block, interfaced with a silicone coating. If they occurred, 'vertical' temperature differentials between the npn and pnp core transistors (Q1, Q2 in Fig 1) would create an offset voltage (due to  $V_{BE}$ 's temperature dependence), leading to a thump when modulated by gain changes. In other words, the 202's feedthrough isolation might suffer if it were carelessly sited near parts radiating significant heat. At the same time, Class A-B operation means that feedthrough is inherently low, as the DC (bias) current in the cell, hence % changes created by  $V_{BE}$  mismatch, are both orders of magnitude smaller than in log-antilog VCAs operating in Class A.

Then again, with Class A-B operation, the core

transistors' temperatures could be internally unbalanced horizontally (between Q1+3 and Q2+4, the loggers and antiloggers respectively) if the VCA's DC input blocking were leaky (leaving it open to DC offset) while being set to attenuate high level programme. Highly asymmetric, high level programme (eg percussion) could arguably have similar consequences: harmonic distortion. According to dbx, thermal inertia residing in the silicon substrate and the metal packaged transistors used in the core of the 202, means distortion would only rise appreciably at the lowest audible frequencies. And while the distortion would be predominantly odd order, dbx consider that it's overshadowed in practice, by other error mechanisms.

Late in 1978, dbx introduced model 202C, a refinement of the 202. Additional circuitry was used to sense when any of the core transistors were approaching currents that would cause log errors, and generated a correction signal to compensate for the error<sup>1</sup>. This doubled the number of matched npn+pnp devices required, to eight. Further, the correction had to be adjusted to suit the transistors in individual cores, making the 202C more expensive and difficult to manufacture. The benefits were a reduction in distortion of 10 dB or more for a given operating current and S/N ratio. Alternatively, the interplay

between THD and S/N ratio meant that designers could choose to reduce the operating current, improving S/N ratio for a given THD. Either way, dbx claim the clean dynamic range is extended from around 110 dB (202) to 116 dB or more.

In 1980, dbx responded to demands by customers for a Class A VCA, with the 2001. The primary benefit of Class A operation is lower and more consistent distortion in comparison to Class A-B operation. dbx claim a typical midband THD of around 0.001% for the 2001, contrast 0.03% for the 202 and 0.01% for the 202C. The disadvantages cited include lower dynamic range, because the sum of  $V_n$  and  $I_n$  in the core increases in proportion to the square root of current. So in the Class A-B condition, an xdB increase in signal level causes an x/2 dB increase in noise. Bias in the Class A core needs to be set as large as the highest anticipated signal current. If this is 200 times higher (+46 dB), noise is then theoretically 22 dB higher under no-signal conditions. However, loss in dynamic range is mitigated by the necessarily high headroom of Class A operation, the 2001 returning a DNR that was only 10 and 16 dB short of the 202 and 202C respectively. dbx also point out their Class A VCA has degraded feedthrough isolation (typically -66 dB) and greater susceptibility to thermal gradients (typically caused by adjacent hot components). The extent to which these specifications are inevitable consequences of Class A operation *per se* should become clearer later.

The next stage was monolithic construction. Packaged as an IC, temperature gradients across the core could be reduced by closing up the spacing between the core devices by two or more orders of magnitude and by layout that takes account of thermal isobars within the dice. Models 2151, 2150A and 2155 arrived in 1981—in the familiar SIL package. The series of numbers disguises a single, selected IC, 2151 being the number stamped on the cream of the batch, with 2155 being salable to the makers of budget audio systems; and 2150A being the intermediate grade. After four years of development in conjunction with an IC manufacturer, dbx had arrived with a process capable of putting decent pnp transistors on a monolithic substrate in common with matched npns. The monolithic log-antilog core was finally born. The 2100 series ICs even included log conformance correction circuitry (as in the 202C) to help the core devices along.

When operating in Class A-B, the dbx topology

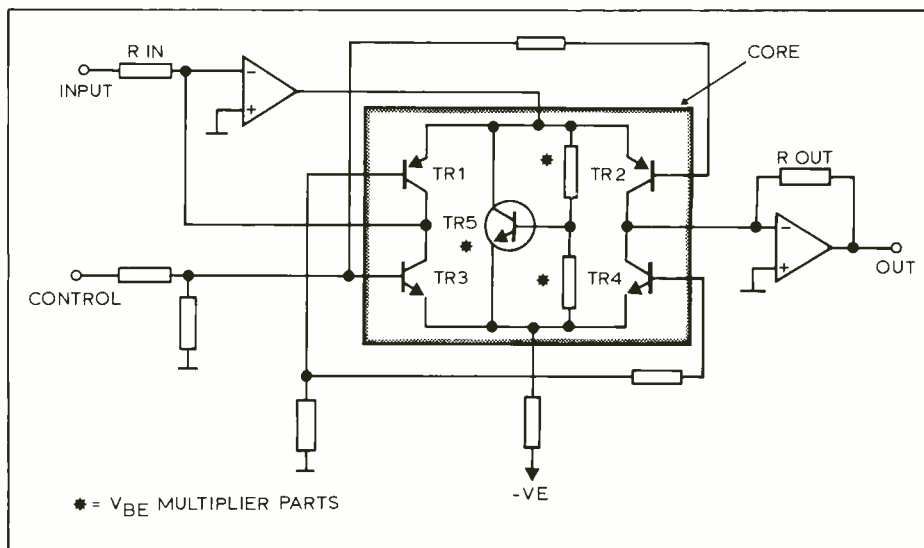

Fig 1: dbx Class A-B log-antilog VCA (excludes log conformance correction circuitry)



has a number of snags. First, at high signal levels, each half of the core is biased off with every polarity reversal. During this transition, the signal current approaches nil. With the remaining Class A-B bias current being as small as possible, the availability of current is restricted at the very point where transconductance is diminishing fast. Avoiding outright crossover distortion at high frequencies while keeping the bias current low relies on the core's input half being partnered with a wide-bandwidth, fast slewing op-amp. At the same time, the logging transistors' gain has to be degenerated, otherwise the poor phase margin and consequent risk of instability restricts the extent to which op-amp speed and open-loop gain can be used to 'kiss it better'.

SNR in Class A-B antilog VCAs is not quite what it seems. When signal levels are small, the standing bias current sets a respectably low noise floor. But then signal levels directly modulate the core current, so noise follows the signal. In real operating conditions, with programme near zero-level, dbx calculate the noise floor rises by 20 dB, though 30 dB has been measured<sup>2</sup> (our own measurements of modulation noise will be included next month). Generally, the noise should be masked by signal, but noise modulation is readily measurable (with suitable filtering or DC stimulation) and is held to be audible under suitable conditions by some sound engineers, as well as by other VCA makers. One explanation for the disparity may lie in the sensitivity of the control ports of dbx's VCAs. If the circuit and PCB designers are careless, excess noise present in the control path is liable to modulate and amplify the residual noise entering the VCA's audio input.

## Valley International

Valley International's VCAs are an independent development of dbx's original, symmetrical log-antilog VCA. It began in 1980 with the *EGC-101* (Electronic Gain Control), made by Allison Research, Valley's predecessor. The *TA-101* and *TA-104* arrived in 1982. (Until 1987, Valley International were known as Valley People.)

Unlike other makers' VCAs, Valley's VCA modules contain just the core transistors needed to implement their patented design: *TA-104* and *101* are respectively no more than supermatched quad and octal Transistor Arrays (hence TA). It's not as penny-pinching as it sounds. Space saving, cost and manufacturing convenience aside, the core transistors are arguably the only element in log-antilog configuration that unreservedly benefits from some kind of integrated construction.

Looking at **Fig 3**, the shaded area outlines the contents of Valley's prime VCA array, the *TA-101*, surrounded by the recommended support circuitry. Initial comprehension should come a little easier by studying the 'half circuit' in **Fig 2**, which has been simplified by surgically removing the negative half of the core—meaning it can only pass a unidirectional signal.

Like dbx, Valley's patented Class A VCA scheme is built around a symmetrical core, composed of pairs of pnp and npn transistors. Designer Paul Buff enumerates the residual base-emitter resistance of the core transistors as a source of non-linearity. The resulting THD is proportional to signal current. The symmetry of the pnp-npn core acts to cancel the majority of the 2nd harmonic. While yielding low THD figures,

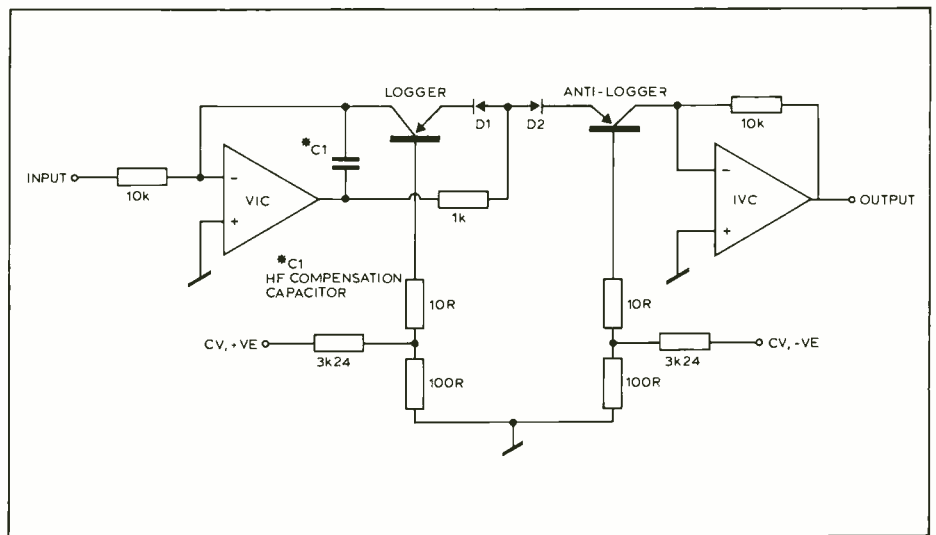

**Fig 2: Valley Class A log-antilog VCA core. Simplified half-circuit showing pnp log and antilog transistors only**

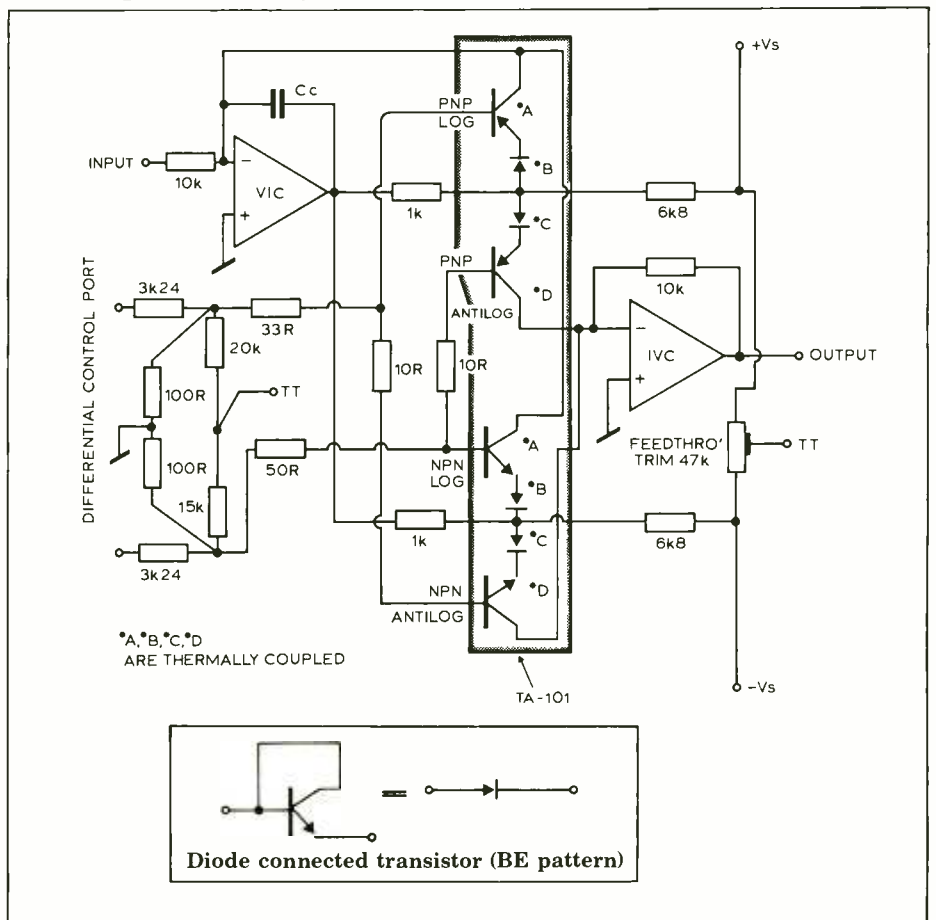

**Fig 3: Valley Class A log-antilog VCA—the full circuit**

cancellation leaves the 3rd and higher odd-order harmonics produced by Class A-B operation to dominate, together with associated intermodulation products. Nasty. Because Valley's VCAs operate in Class A, distortion is almost exclusively even order, which can be largely nulled by balancing the core transistors. Significant odd order distortion products don't arise until the signal current tries to exceed the bias current, at clip. For the *TA-101*'s recommended bias current of 2 mA, current clipping implies peak input levels beyond 50 VRMS (+36 dBu), so the conditions for producing substantial odd-order distortion are rather hypothetical.

Previous attempts at operating log-antilog cells in Class A had come unstuck. The logging

transistor in the classic transdiode configuration (**Fig 8, Part One, *Studio Sound*, June 1989**) exhibits current gain, which is a nuisance. For a start, it makes the transdiode circuit, an otherwise excellent log amplifier topology, notoriously difficult to stabilise. With 30 to 40 dB of current gain present inside the feedback loop of the associated op-amp, VHF instability is likely even with a tame UGS chip like LF351. Second, the unwanted gain magnifies voltage and current noise ( $V_n$  and  $I_n$ ). This has a direct effect on audio S/N ratio, since current fluctuations in the core are recovered as signal voltage. Third, the gain in the core can magnify the bias current.

Valley's VCA patent specifies the use of diodes in series with the core devices, to reduce the excess gain. As a result, VHF stability can be

guaranteed with a simple lead compensation capacitor (C1 in Fig 2), which can be kept small in value, thereby preserving the op-amp's bandwidth and slewing capabilities. Precise electrical and thermal matching between each transistor and its associated diode is achieved by doubling the number of core transistors, then connecting the extra ones as diodes (Fig 3a). With the diode degeneration in place, the intrinsic scale factor of the Valley VCA's control port doubles, to 120 mV per decade  $I_c$ , or  $120/20=6$  mV per dB. Bias current is only apportioned equally between the two halves of the core (pnp+npn) when the control signal is 0 V and gain is unity. With increasing attenuation, the bias current is progressively channelled through the logging transistors, and for gain, bias current is directed likewise into the anti-logging transistors. In this way, the ratio of bias and signal currents in each transistor remains constant, as does the total bias current, irrespective of VCA gain.

$V_n$  is kept at bay by setting the bias current high and making the core devices' geometry as big as is feasible.  $I_n$  is minimised by employing low impedances at the core transistors' bases and emitter terminals. Designing for minimum noise at the outset is important, because with Class A operation, the noise voltage at the output is invariant, meaning that S/N ratio falls in proportion to increasing attenuation. At the same time, the Valley scheme should have none of the noise modulation effects that characterise log-antilog VCAs working in Class A-B.

One other trade-off potentially arising from Class A operation is excessive control feedthrough. It doesn't matter whether the VCA is a log-antilog or transconductance type. The same vertical and horizontal temperature gradients that can cause DC offsets and LF distortion in Class A-B VCAs result in a shifting DC residual at a Class A VCA's output. If DC blocking isn't a problem, and assuming the DC offset is small enough not to result in loss of headroom, it need only be considered a source of distortion if it's actually audible. So much depends in turn on the rate of change of the

control signal. With the original *ECG-101*, use as a fast acting muting element (one of the toughest tests of control feedthrough rejection) could result in a discernible 'thump'. In the *TA* series, improved thermal coupling reduces control-feedthrough by at least 20 dB. Again, the bottom line rests with the designer and how carefully the control circuitry is configured.

David Blackmer's patent 'Multiplier circuits' is not limited to a specific bias level (hence operating class), so it covers the schemes promoted by Valley. Although Valley, have argued quite reasonably that the *TA* series are not VCAs in themselves (they are just precision-matched transistor arrays), Valley cite Blackmer's patent alongside their own and pay royalties to dbx. At the time of writing, Valley are the only pro-audio VCA manufacturers licensed by dbx.

## SSM (Solid State Microtechnology)

SSM was founded in 1975. More than any of the other audio VCA manufacturers, SSM are exclusively into OEM monofab, in manufacturing a variety of audio 'function' chips for inclusion into electronic music and, more recently, pro-audio equipment. In recent years, former and long-serving President Dan Parks realised that amalgamation with a major semiconductor maker was the only way to go to satisfy the company's technological ambitions. In 1988, SSM was acquired by PMI (Precision Monolithics Inc), a major manufacturer of innovative, precision ICs. It's brought the benefit of advanced processes beyond the reach of a small company (in IC manufacture, anything under \$100 million is small).

Fig 4 displays the contents of SSM's 2014 (presently their most highly specified VCA chip) together with the main external parts needed to produce a standard VCA. Although substantially integrated, external op-amps (A1, A2) are desirable for decent drive capabilities. The

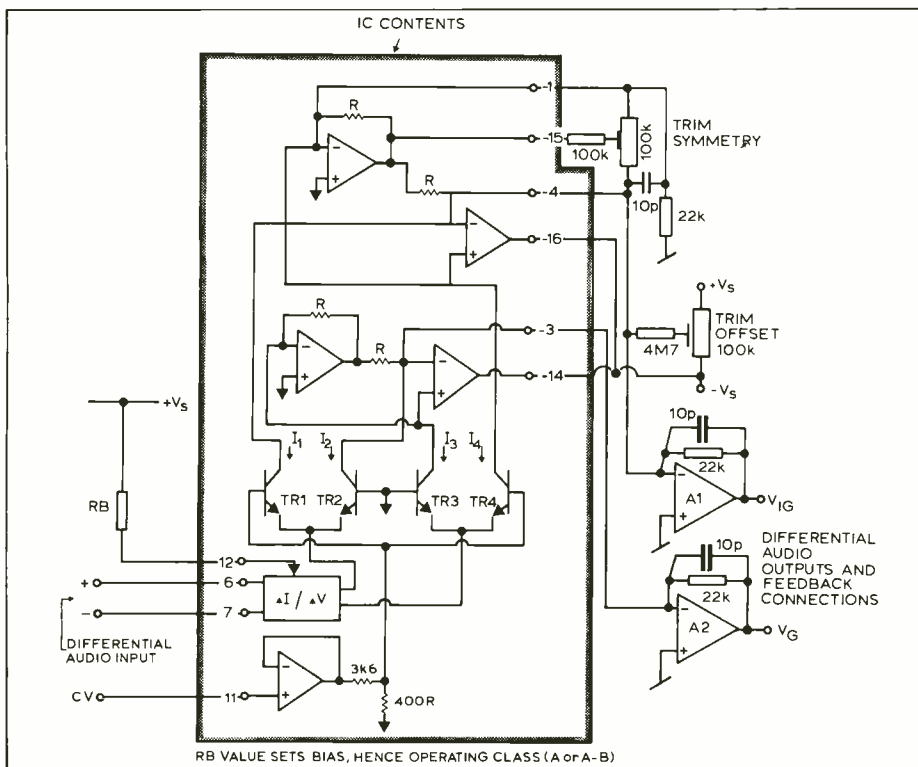

Fig 4: Inside the SSM 2014 advanced transconductance VCA

### WORLDWIDE AGENTS

- AUSTRALIA: A.T.T. AUDIO CONTROLS PTY LTD  
MELBOURNE (03) 379-1511
- AUSTRIA: AUDIOSALES  
MOEDLING (02236) 26123
- BELGIUM: T.E.M.  
ZELLIK (02) 466-5010
- CANADA: OMNIMEDIA CORP  
MONTREAL (514) 636-9971
- DENMARK: PER MEISTRUP PRODUCTIONS  
KARLSLUNDE (02) 151300
- FRANCE: REGISCENE  
PARIS (01) 4396-5050
- GREECE: ALPHA SOUND  
ATHENS (01) 363-8317
- HOLLAND: T.E.M.  
BREDA (076) 812872
- HONG KONG/CHINA: TOM LEE MUSIC CO  
HONK KONG (3) 730-1098
- INDONESIA: PT AUVINDO MERIEN PRIMA  
JAKARTA (01) 323029
- ISRAEL: BARKAI  
RAMAT-GAN (03) 735178
- ITALY: AUDIO LINK  
PARMA (0521) 598723/4
- JAPAN: EDGETECH (JAPAN) LTD  
TOKYO (03) 295-4731
- KOREA: YUNG NAK SO RI SA CO  
SEOUL (01) 267-9697
- NORWAY: NORDTEK EQUIPMENT  
OSLO (02) 231590
- PHILIPPINES: STAGE CRAFT INTERNATIONAL INC  
MANILA (02) 834-0539
- PORTUGAL: CASA CARUS ARTIGOS MUSAICAIS LTD  
OPORTO (02) 0384456
- SINGAPORE/MALAYSIA: SWEE LEE  
SINGAPORE (03) 336-2307
- SPAIN: LEXON  
BARCELONA (03) 203-4804
- SWEDEN: INTERSONIC  
STOCKHOLM (08) 744 5853
- SWITZERLAND: SINEC  
SCHÖNENWERD (64) 413747
- THAILAND: BANGKOK CINE/GRAPHIC CENTRE  
BANGKOK (02) 314-3570
- K.C.M. BANGKOK (02) 222-4712
- TURKEY: NEFAN  
ISTANBUL (01) 160-4514
- UK: FIRST AUDIO LTD  
BRIGHTON (0273) 693610
- U.S.A.: E.D.C.  
NEW YORK (914) 677-6478
- WEST GERMANY: ADAM HALL  
USINGEN (6081) 16031



The drive units at the heart of every new Turbosound enclosure are built by Precision Devices Ltd.

A company specifically established by our parent company, Edge Technology Group, to develop drive units with unsurpassed reliability and audio performance.

**DEVELOPING THE CONE AND COIL.**

Particular attention has been paid to designing each cone's profile and materials for its intended application.

The voice coils are wound with pure copper for long term strength and reliability, coated with high temperature enamel, onto an epoxy resin-impregnated woven fibreglass former.

The whole assembly is cured at high temperature to give it a completely rigid, integrated structure for greater strength and energy transmission abilities.

**AN ADVANCED MAGNET ASSEMBLY.**

The magnet assemblies are of the traditional iron and ceramic 'sandwich' type. The difference lies in our attention to detail and the quality of materials.

Top quality low-carbon steel is machined to very fine tolerances to maximise contact between plates. And as tight a magnetic gap as possible in turn gives greater magnetic power and increased cooling for the coil. (In our larger drivers, we also bolt the parts together for extra strength).

Finally, the loudspeakers' frame designs are based on the soundest of

engineering principles, with generous use of die-cast aluminium alloy to ensure their indestructibility on the road. In fact, our frames weigh twice as much as most other manufacturers'.

Guaranteeing that even under massive physical shock, the assembly won't suffer.

**ATTENTION TO DETAIL.**

All this attention to detail means that every step in the manufacturing chain is designed to enhance our enclosures' performance.

Finally, the components come together in a modular assembly process, with testing at every step, before being fitted into enclosures that have been built with equal precision.

The result is a finished product that produces accurate, natural sound simply through the precise matching of its components. Which means that, more than ever, there is no need for external electronic compensation.

So that's a breakdown of what Precision Devices will mean to you.

And what makes Turbosound enclosures so exceptionally reliable.



TURBOSOUND LIMITED, STAR ROAD, PARTRIDGE GREEN, WEST SUSSEX RH13 5EZ. TEL: (0403) 711447. TELEX: 878723 TURBO G. FAX: (0403) 710155. IMC: TURBO-UK.

# HOW DO PRECISION DEVICES MAKE OUR SPEAKERS SO RELIABLE? HERE'S A BREAKDOWN.

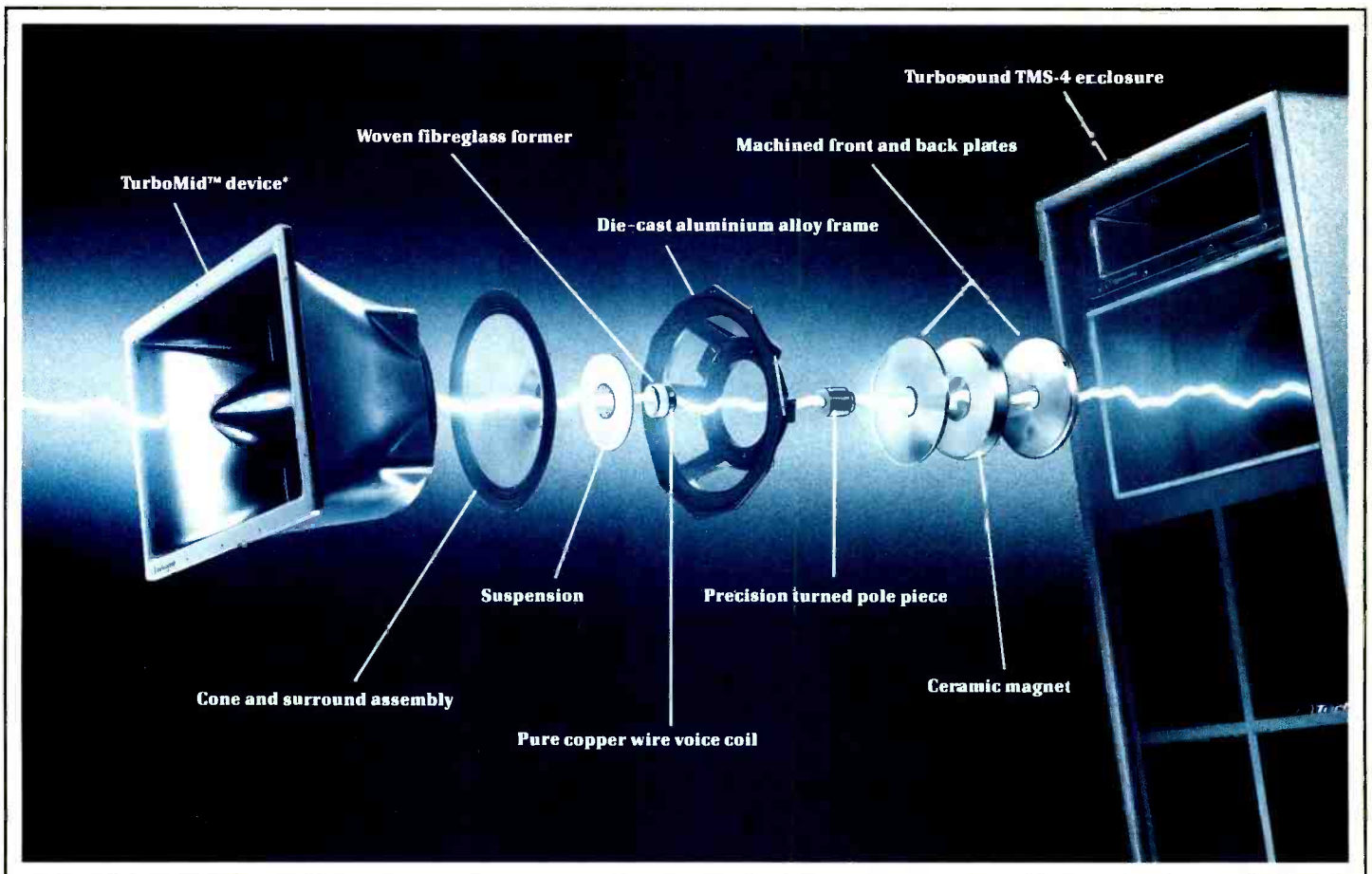

\*TURBOSOUND PATENT INFORMATION: Australia: 515, 535 Canada: 1,076,033 Japan: X113424/77 UK: 1,592,246 U.S.: RE 32,183 West Germany P274\*600/2 Other patents pending.

an **EdgeTech** company  
LONDON • NEW YORK • TOKYO

www.americanradiohistory.com

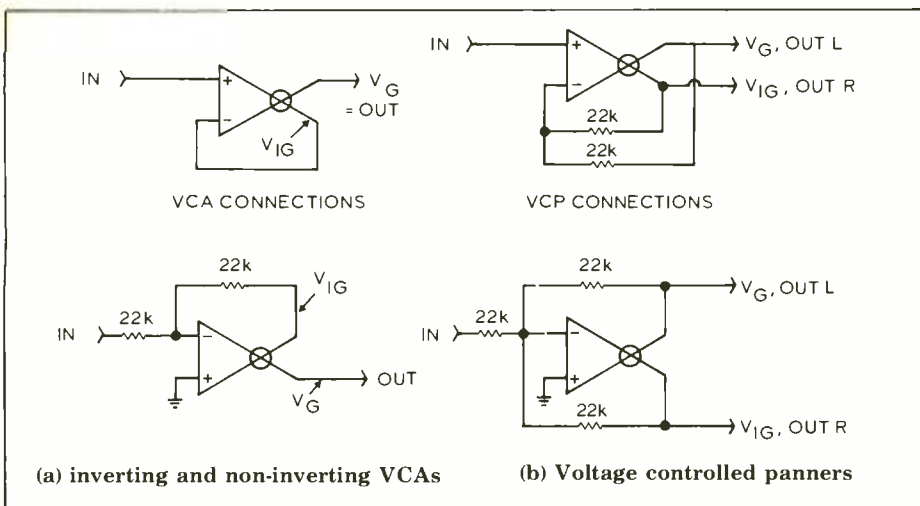

Fig 5: SSM 2014 circuit permutations

external parts count can be reduced by omitting A1+2 but then the on-board output amps (shown disabled in Fig 4 by tying their outputs 14 and 16, to -Vs) have limited output current. The problem is an intrinsic one, concerned with the management of heat, rather than a process limitation: the +20 dBu into 600 Ω line driving capability that is demanded by pro-audio designers has to be turned down for their own good! That's because any such output stage in the close confines of a monolithic VCA will almost certainly produce thermal gradients across the cell, unbalancing it. If such a VCA existed, there would be difficulties in deciding at which point to trim THD and feedthrough, as the device warmed up. At best, such a VCA might gain a reputation for only sounding its best after reaching thermal equilibrium, several hours after the console or processor has been switched on. Worse still, a 'heat-saving' Class A-B output stage would thermally modulate the cell to produce a THD rising steeply below 200 Hz.

Returning to SSM's 2014, the overall circuit is more complicated than any of the previous VCAs, because overall NFB is employed. This gives rise to several permutations: a choice of inverting and non-inverting VCAs (Fig 5a) and even VCPs (Fig 5b).

All SSM's VCAs are based on a marriage between the current-ratioing transconductance cell and log-antilog core. In his patents of 1981 and 1984, co-designer Douglas Frey has developed a topology that is suited to low cost monolithic production, meaning it has to beget good yields. To begin with, the cell can be implemented with just npn or pnp devices—or both. Restricting the cell to npn devices alone (as in 2014) saves the cost and design headaches involved in developing a usable pnp process that doesn't infringe existing patents. Second, when operating in Class A-B mode, matching between the cell's four devices is less critical than usual, for good results. In particular, Frey cites improvements in control feedthrough rejection over a previous transconductance type of VCA, where rejection depended on 'extreme matching'—something that is difficult for even the best IC makers to accomplish with high yields and hence low cost. Another perennial problem area, the need for isothermal conditions, is readily accomplished in the 2014, being a full-scale monofab.

The unique features of SSM's patented VCA technique extend to programmable operation: biasing can be Class A, A-B, or even Sliding-Bias Class A<sup>3,4</sup>. And in Class A-B mode, distortion cancellation circuitry comes into play, yielding a

THD residual that's close to Class A. For class selection, only one resistor value need be changed. In fact, for demanding applications, SSM recommend that level detection (an application circuit is supplied with their evaluation PCB) is arranged to switch from Class A-B over to A, at high signal levels. Class switching promises to overcome all the associated tradeoffs—with the caveat that attack and release time constants need careful attention<sup>4</sup>, depending on the nature of the programme. According to Ron Dow, SSM's founder and chief designer, provided the class change has a time constant above 10 ms, the main sonic effect of the changeover is a 16 dB change in the noise floor, which shouldn't be audible at the high programme levels where the class change occurs. SSM's model 2018 (due later this year) is scheduled to yield further process refinements leading to reductions in THD, noise and feedthrough. □

(Part Three will appear next month).

## Technical definitions and abbreviations

**Cell:** Active heart of a variable transconductance VCA  
**Core:** Active heart of a log-antilog VCA  
**DNR:** Dynamic range  
**H<sub>FE</sub>:** Current gain in a bipolar transistor  
**I<sub>C</sub>:** Collector current (in a bipolar transistor)  
**I<sub>C</sub>:** Current noise  
**Isothermal:** Areas of equal temperature  
**Monofab:** Monolithic fabrication, a true (not hybrid) IC  
**NFB:** Negative feedback  
**S/N ratio:** Signal to noise ratio  
**UGS:** Unity gain stable  
**V<sub>BE</sub>:** Base-emitter voltage of a bipolar transistor  
**VCP:** Voltage controlled panner  
**V<sub>n</sub>:** Voltage noise  
**ZOL:** Zero operating level, eg +4 dBu  
**I<sub>o</sub>, H<sub>o</sub>, V<sub>o</sub>:** The lower case letters indicate incremental (or 'small signal') changes in these quantities

### References

- 1 G Bergstrom, *Signal Correction Circuit for Electrical Control Systems*, US patent no 4,234,804 (1980)
- 2 P Buff, 'Specsmanship and the new generation of VCA', *RE/P*, pp.138-49, Oct 1982
- 3 B Duncan, 'Which Amplifier Technology?', *Studio Sound*, Dec 1988
- 4 R Bransbury, 'Automation and the VCA', *Studio Sound*, Aug 1985

## TASCAM European Distributors

Hi-Fi Stereo Center Kain  
Muenchner Bundesstrasse 42,  
5013 Salzburg,  
AUSTRIA.  
Tel: (0662) 37701

Beltronics  
Rue de la Celidee Straat 29,  
1080 Brussels,  
BELGIUM.  
Tel: (32) 2 424 0233

So and Hoyem A/S,  
Bulowsgarden,  
Bulowsvej 3,  
1870 Frederiksberg C,  
DENMARK.  
Tel: (01) 22 44 34

Studiovox Ky,  
Atomitie 5C,  
SF-00370 Helsinki,  
FINLAND.  
Tel: (80) 562 3411

Harman France,  
Peripole 243,  
33 Av. de Lattre de Tassigny,  
94127 Fontenay s/Bois Cedex,  
FRANCE.  
Tel: (01) 4876 1144

Elina SA,  
59/59A Tritis Septemvriou St.,  
Athens 103,  
GREECE.  
Tel: (01) 8220 037

Greenlands Radio Centre,  
PO Box 119,  
3900 Godthab,  
GREENLAND.  
Tel: 299 21347

GBC Italiana spa,  
TEAC Division,  
Viale Matteotti, 66,  
Cinisello Balsamo, Milan,  
ITALY.  
Tel: (02) 618 1801

Hljodriti — Hot Ice,  
PO Box 138,  
Hafnarfirdi,  
ICELAND.  
Tel: (01) 53776

AEG Nederland NV,  
Aletta Jacobslaan 7,  
1066 BP Amsterdam,  
NETHERLANDS.  
Tel: (020) 5105 473

Audiotron A/S,  
Seilduksgt, 25,  
PO Box 2068 Grunerlokka,  
0505 Oslo 6,  
NORWAY.  
Tel: (02) 352 096

Goncalves,  
Avenida 5 de Outubro, 53, 1,  
Lisboa 1,  
PORTUGAL.  
Tel: (01) 544029

Audio Profesional SA,  
Paseo Maragall 120,  
Entlo 3a,  
08027 Barcelona,  
SPAIN.  
Tel: (93) 349 7008

Erato Audio Video AB,  
Aegatan 115,  
116 24 Stockholm,  
SWEDEN.  
Tel: (08) 743 0750

Telion AG,  
Albisriederstrasse 232,  
8047 Zurich,  
SWITZERLAND.  
Tel: (01) 493 1515

Teac Deutschland GmbH  
Bahnstrasse 12,  
6200 Wiesbaden-Erbenheim,  
WEST GERMANY.  
Tel: (06121) 71580

**TASCAM**



# SOUNDS LIKE A VERY EXPENSIVE CONSOLE

The M-700 is TASCAM's new top of the range console. This sophisticated, automation ready, in-line console has been designed for the highest audio quality and engineered to fulfil the most demanding production tasks with ease – but without costing the earth. Before you check out the price however, check out these features:

40 channel, 32 group output in-line architecture

- Quad panning, 2 stereo and 8 mono Aux send busses per channel
- Two signal paths in each module
- 4-band equalization per module
- Variable HPF
- EQ section assignable to Channel or Monitor signal path
- FLIP switches locally swap channel microphone in/line in and monitor source/return signals (overridden in the master console mode)
- SUB switches on the channel modules allow the corresponding channel to be used as a sub-group master
- Post/pre EQ switchable insert points
- Switchable in-place or AFL/PFL solo modes with in-place solo defeat switches on the channel modules permit solo monitoring of multiple channels
- Master console mode switches (REC, FB, MIX) select eight channel input, monitor input, group input and meter input combinations
- Three group mute switches on the master section logically linked to channel module mute select switches
- Flexible control room/studio communication facilities
- Integral patch bay.

Now give us a call to arrange a demonstration and check out what is arguably the M-700's best feature – its price.

You'll make your accountants as happy as your engineers.

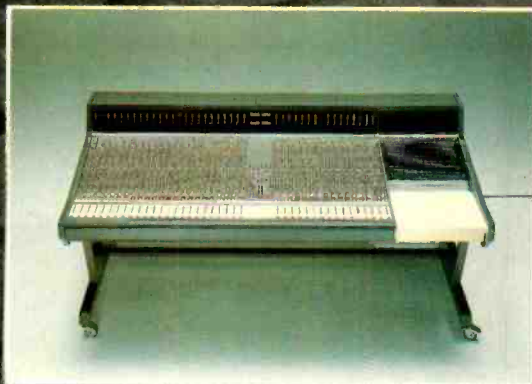

## TASCAM

5 Marlin House, The Croxley Centre, Watford, Herts. WD1 8YA  
Tel: 0923 225235 Fax: 0923 36290





# Opus in production

Uniquely, Opus was designed from the beginning to be an audio post production tool and its specialist features include:

- Recording or replaying of 8 channels simultaneously, on upto 99 tracks.
- Cut and splice editing on upto 8 tracks simultaneously.
- Loops of any duration.
- Alignment of audio segments or whole tracks from sub-frames to hours as required.
- Replacement of audio by other audio or by silence.
- Upto 8 hours storage.
- Integrated 12 channel digital mixer.

Too often, new technology offers nothing more than a different set of obstacles. Opus is a genuine breakthrough, setting new standards of efficiency, quality and creativity. The systems already in use are proving that statement everyday.

One Opus production session will do more than convince you!

STOP		Locate:	Reel:	External:
		00:59:00:00	00:59:02:27	00:00:00:00
Ch	Tk			
1	1	OG	DIALOG	
2	9	ANNOUNCE	ANNOUNCE	
3	12	MUSIC L	MUSIC L	
4	13	MUSIC R	MUSIC R	
5	14	FOOTSTEP		

Since deliveries of the Lexicon 'OPUS' audio post production system began earlier this year, many program makers in Europe and the U.S.A. are discovering the friendliness, the power and the creativity of OPUS.

## lexicon

USA: Lexicon Inc., 100 Beaver Street, Waltham MA 02154.

Italy: Grisby Music Professional Ltd., Via Delle Industria 4, 60022 Castelfidardo (Ancona).  
Tel: 39-71-781714. Fax: 39-71-7819048.

West Germany: Audio Export Georg Neumann & Co GmbH, 71 Heilbronn, Badstrasse 14, Postfach 1180.

Tel: (07131) 8 22 75. Fax: (07131) 6 87 90.

United Kingdom: F.W.O. Bauch Limited, 49 Theobald Street, Boreham Wood, Hertfordshire. Tel: 01-953 0091. Fax: 01-207 5970.

lexicon | OPUS



In the first part of this article (*Studio Sound*, June 1989) we covered the basics of hard disk recording. There are now 28 disk-based systems, either available or under development. It is unprecedented that any one form of recording should receive so much R&D effort in such a short space of time and the would-be user is faced with a somewhat bewildering choice. The second part of this article provides a guide to the points you should be considering if you are reviewing any of these systems.

A typical disk-based system is given in Fig 1. It will comprise the disk(s), a computer, audio inputs and outputs, a user interface, a backup (or archiving) system and, in some cases, a direct digital interface. The user interface will normally provide a screen, an alphanumeric keyboard and other buttons and controllers. Alphanumeric keyboards are mostly used for labelling. Cursor control on screen is normally via a mouse, cursor keys or by touching the screen itself.

The smallest systems are stereo editors. Stereo editors are mainly aimed at CD mastering, and

set aside for the system to complete these operations before the audio is output (ie non-realtime operation).

## Recording capacity

**Number of outputs:** There is one factor which fundamentally limits the number of tracks you can play simultaneously and that is the number of outputs (D/A converters) provided. Usually eight outputs means no more than eight tracks simultaneously; four outputs means no more than four tracks simultaneously. However, a system may have 12 outputs but can only play eight tracks at any one time—the extra four outputs only copy four that already exist.

The number of outputs a system can support is limited by how many disks are being used in the system. In general, one disk can provide a maximum of eight outputs simultaneously. Remember Fig 5 from part one showing a bucket filling a barrel? Well, there is a limit to the

increase the number of outputs it can support is by using more than one hard disk simultaneously.

Systems that use multiple disks are more likely to assign each disk a fixed number of tracks with each track having a fixed length. So for example, a system with two disks may have two tracks per disk making a total of four tracks. The thing to look for is whether a track has a fixed output or whether any track can be routed to any output. Consider the examples in Fig 2.

**Number of tracks:** This is often associated directly with the number of outputs a system has, but in some cases the number of tracks is different to the number of outputs. For example, a system may have 99 tracks but only eight outputs. This means that any eight of the 99 tracks may be played or recorded to simultaneously. However, it does not mean that the disk space is equally divided into 99 tracks (which would result in each track only being about 90 seconds long for an 800 Mbyte disk). The 99 tracks are actually sequencer tracks accessed in RAM-based memory (see 'Editing Functions')

# PRACTICAL HARD DISK PART TWO

The second part of this article by Yasmin Hashmi and Stella Plumbridge discusses the importance of facilities offered by the various disk-based recording systems currently available

speech and music editing for radio and TV broadcasts. Of the larger (multitrack) systems most have eight outputs but the number of tracks varies from 8 to 99 to 200 in two particular cases—there is a basic difference between tracks and outputs, which we will clarify shortly. Multitrack (or multi-output) machines are aimed at post-production for film, TV, music recording, video and anything that requires more than stereo editing, but can also be used in the areas given for stereo editors.

Before we proceed there is an expression that often appears when it comes to tapeless systems—it is 'realtime'. Its meaning depends on the context it is being used in—the main ones being digital signal processing and archiving (both these subjects will be dealt with later).

In the case of archiving, realtime means the duration of the recording at normal speed. In other words, if you have 30 minutes of audio on disk and the system takes 30 minutes to archive this, the system archives in realtime. If the system takes 60 minutes to archive it takes twice realtime: 15 minutes=half realtime. However, considerable confusion exists when it comes to archiving speeds due to the differing approaches used by manufacturers and this is explained further under 'Archiving'. It should be noted that the term 'twice realtime' is often used in place of 'twice as fast as realtime', ie what is actually meant is half realtime.

In the case of digital signal processing where complex mathematical operations on the audio may be involved, realtime means whether these operations take place 'live' as the audio is output (ie realtime operation) or whether some time is

number of different places the bucket can fill the barrel from in the time required. The demands on the hard disk can be even trickier if, for example, you are trying to record on to two tracks while playing the other six. One way to avoid pushing the system to its limits, and/or to possibly

and allow non-destructive variation in the playback sequence. All disk-based systems (with the exception of one) work this way although their implementations differ. It is up to the designers how they wish to present their track editing. Some elect to offer as many sequencer tracks as outputs (two tracks for a stereo editor, eight tracks for an 8-output multitrack). An advantage, however, of offering more sequencer tracks than the number of outputs is that a number of different arrangements of the same piece may be auditioned very quickly by switching from one group of tracks to another. **Number of inputs:** The number of inputs to a system may be different from the number of outputs. Hopefully, because of the explanation of random allocation in last month's edition, you

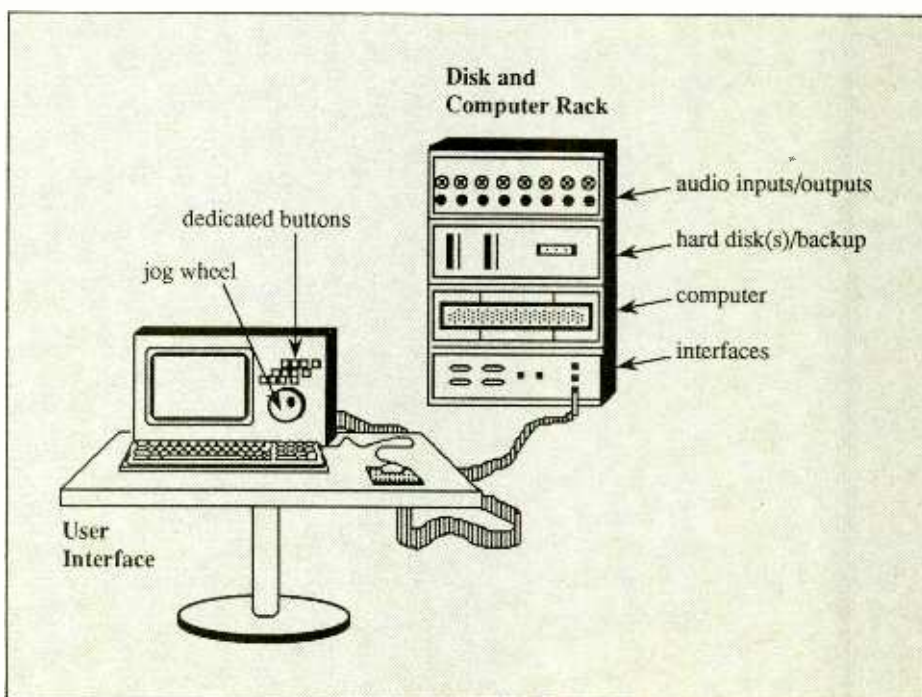

Fig 1: The components of a typical hard disk system

will see why. Just for clarity a simple analogy will suffice.

With tape you could record one track at a time if you wanted to but if you've already done this 12 times on a 16-track machine you will hear 12 tracks on replay. If you record a further track you will hear 13 tracks on playback. So it is not always necessary to have as many inputs as it is outputs. In the case of a live drum kit for example it is quite important to have enough inputs but for speech, sound effects or CD mastering one or two inputs (for stereo) may suffice—indeed a stereo editor may be all that you need.

**Recording time:** Often called track minutes, track hours, stereo track minutes, minutes per track, etc. As a rule of thumb, 1 Mbyte provides about 11 seconds of storage at 44.1 kHz, so the following serves as a guide to total recording times for a given disk size. An 80 Mbyte drive provides around 15 minutes; a 160 Mbyte drive provides around 30 minutes; an 800 Mbyte drive provides around 150 minutes.

A 160 Mbyte disk may therefore be described as 30 track minutes, 30 mono minutes, 15 stereo track minutes, 3.75 minutes per track (for an 8-track system) or any combination of time and tracks so long as the maxima for time and tracks are not exceeded.

Some systems use only one disk but allow random allocation of disk space so that the only limiting factor of how long a recording can be is how much time is left on disk. In cases like this any recording could be anywhere on disk and can be assigned to any output. Normally with systems such as this, adding another disk will only increase the recording time and will not allow the number of outputs to be increased.

The advantage of using multiple disks is that it is conceptually easier to increase the number of simultaneous tracks by adding more disks and outputs. There are of course systems that comprise multiple disks and allow the total random allocation of all disk space.

Although random allocation is useful for maximising the efficient use of disk space, it should be noted that it is not an automatic procedure when performing a continuous recording that may include silences. In other words the system will not automatically identify silences and omit to record them—the user must be familiar with the source material and must take the system out of record whenever a silence occurs. Some manufacturers are developing software that will do this automatically.

## Editing functions

In part one, we explained some of the theory behind what is possible with random access recording. How this is put into practice varies from system to system. What they all have in common, however, is the ability to record sound, edit it and play it out in any sequence. In addition to this, some systems allow digital mixing, time compression, harmonising and more specific software packages such as noise elimination processes for preparing old original recordings for CD.

Since there is no official agreement as to editing procedures or terminology, we shall explain in general how most disk-based editing works. Firstly source material is recorded into the system either with or without external timecode. The audio is then displayed as horizontal strips across the screen—the number of strips reflecting the number of tracks or outputs being used. Across

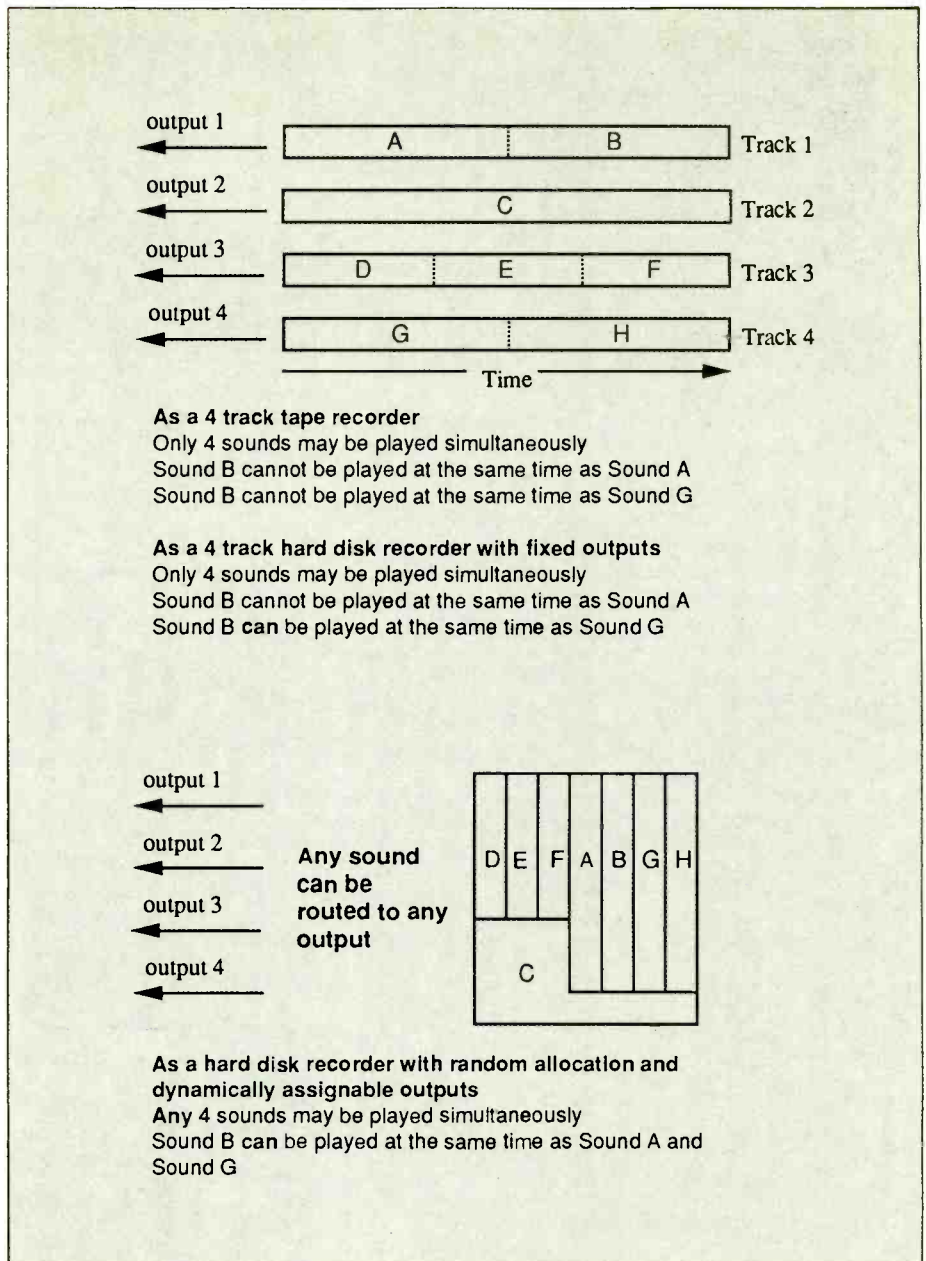

Fig 2: Track/output arrangements

the strips is a vertical marker that represents the play head. Then, using transport controls similar to those of tape machines, the user searches through the material to find the place(s) to be edited. Locating these places can be made easier by marking them as the recording is taking place or, if slaving to picture for example, by moving the picture to the desired point. To assist finding exactly the right point for editing, a rotary dial (jog wheel) can be used for reel-rocking the play head, which produces audio imitation of tape reel-rocking.

Once the precise edit point is located, it is marked by pressing a button. In this way, in and out points can be determined for sections of audio, which are either to be deleted or used for assembling a master track. Should the section be for master track assembly, it will be given a name and is now called (for our purposes) a Cue. Once the desired Cues have been marked out, they can be assembled in the order in which they should appear for playback. The way this is done can vary greatly for each system. Some systems use tape analogies where the Cues are assembled graphically on to horizontal strips representing the tracks or outputs, some provide edit decision

lists (EDLs) and some a combination of both. EDLs list the Cue names in the order of playback along with their playback times, durations and other useful information. It should be noted that whichever way the playback information is displayed/edited, the information telling the system which Cue is being played when, resides in RAM-based memory, which is separate from the disk. This RAM can be thought of as containing sequence information, which can be edited and saved onto floppy disk for archival. The sounds making the Cues would be archived on to tape.

Some examples of uses for disk-based systems are:

- Fitting sound effects/speech/music to picture or for radio using either library sounds or sounds already resident on disk
- Editing music for 12 inch mixes, copying verses and choruses, spinning in samples, etc
- Stereo mastering for CD/broadcast
- Editing out unwanted noise from old recordings
- Editing out unwanted mistakes in speech recordings
- Fast auditioning for post sync dialogue/radio ads
- Replacing cart machines



**Digital mixing:** This is also a relatively new event. Most systems must still transfer audio to external mixing consoles in the analogue domain. There are, however, a couple of manufacturers who are/will be offering integrated digital mixing within the system itself, and it is worth checking if such a system also offers mixing automation. A feature to note with these integrated digital mixers is that no audio actually passes through the mixing console. EQ, dynamics and level are imposed by the console faders/buttons on to the audio in realtime as it passes from disk to output. The MADI interface (see 'Compatibility') could provide direct transfer to an external digital desk that also supports MADI. Such desks are few and far between, however, so it is worth checking the manufacturer's development intentions before attempting to mix and match completely digital recording and mixing systems. Even if a manufacturer does not offer an integrated digital mixing console, it is worth checking if tracks can be digitally bounced internally. However, unlike non-destructive editing, this will actually create a new recording on disk comprising the bounced tracks and it is highly unlikely that the new recording can be unbounced.

**Digital signal processing:** Called DSP for short. Examples of DSP are digital mixing (as mentioned above), crossfades, time compression, harmonising, etc. Mixing (or level changing) involves multiplying binary numbers, which represent the audio by other binary numbers representing the amount of level. Bouncing audio means the addition of binary numbers representing the respective audio to be bounced together. Crossfades, time compression, etc, involve more complex mathematical operations and may, therefore, require some time in which to process the audio. It is for this reason that DSP does not always occur in realtime and may involve the computer doing calculations on the selected section of audio and writing a new file on to disk, which contains the calculated result. On playback the system will use random access to jump to the new file(s) as necessary. In all cases it is worth asking about the limits of these features,

for example how long a given feature can be, or how much of it you can have and whether the process occurs in realtime or not.

**Synchronisation:** for working to picture or locking to an external tape machine, it is important that a system should have a timecode interface and most systems do support timecode. The majority of systems actually slave to timecode, although one or two can be masters as well as regenerating different formats. Most systems that lock to timecode will record the external timing information along with the recorded audio so on reproduction the audio will be played in sync.

Firstly you should check that the system supports the format you work with and secondly whether the system actually checks the timecode as it is reading it. Some systems initially read the time value coming in and then continue only to check whether code is coming in at all. For example, if the time coming in suddenly jumps to half an hour later while the system is playing/recording, the system will be incorrectly slaving to half an hour before since it is not reading the actual time value—it only checks its existence. It is also worth investigating how the system reacts should there be a dropout in the incoming code.

## Archiving

Also called backup, This can be seen as the weak side of tapeless recording, although most manufacturers are exploring the possibilities of improving this area. The biggest problem is the time it takes to load audio from disk to tape and vice versa, which is often a little more than realtime, but beware that this expression does not mislead you. Multiple disk systems could theoretically diminish loading time by having a tape drive for each disk so that disks could load in parallel—indeed one manufacturer does this. If such a system is being used as a linear multitrack, parallel backup will appear to take realtime in as much as a five minute song will

take five minutes to load. But if the song is made up of eight tracks each five minutes long, the actual disk space used is  $8 \times 5 \text{ minutes} = 40 \text{ minutes}$ , so the system is loading 40 minutes of sound in five minutes, ie it is loading much faster than realtime. It should be noted, however, that with such a system loading will take the same time irrespective of how many tracks are used but describing loading times in terms of realtime is dependent on how many tracks are used. Consider the examples in Fig 3.

Most manufacturers, however, use just one tape drive for backup. Such systems, if used as a linear multitrack, will appear to increase their loading time (eg a five minute, 8-track song could take 40 minutes to load) but do in fact take realtime (since  $8 \times 5 \text{ minutes} = 40 \text{ minutes}$ ' worth of disk space takes 40 minutes to load). Another manufacturer uses automatic selective archiving, which means that the system will only load material that has changed, thus saving time by not downloading audio that already exists on tape, or uploading audio already on disk.

Whether archival times really cause a problem to the user depends on the type of work and the type of system. Sessions involving new clients every hour for example, will spend more time archiving than sessions that last all day and only need to archive once at the end of the day. Systems with large disk capacity don't fill up as quickly as small capacity ones, however, small capacity disks are quicker to archive (assuming all systems take the same time). It is worth checking whether the user can decide what audio on disk they want to archive, or whether the system archives all irrespectively.

Optical disks are often mentioned as being an alternative archival medium to tape but the technology for writing continuous mass storage of audio on to optical disk is still under development (this should not be confused with compact discs, which use a manufacturing process inappropriate to this discussion). Continuously reading audio from optical disk is not a problem (compact disc players for example) and some systems can store relatively short samples of audio on to optical disk. These systems, however, are usually RAM-based sequencers, not disk-based recorders. In addition, commercially available optical disks are the Write Once Read Many (WORM) type and are not erasable. These types of disks are most suitable for providing direct (on line) access to huge libraries of sound effects/musical sounds. As soon as erasable optical disks become available at reasonable cost, most manufacturers are likely to attempt to adapt/design their systems to archive on this medium. However, erasable disks are still not commercially available at the time of writing, so it seems we're stuck with tape for the moment.

## System assessment

By far the best way to assess a system is to see it working in a practical situation similar to the one in which you would be working, and try to see as many systems as you can. In reviewing tapeless systems it will soon become apparent that each has its own way of presenting information and on first impression this may be a key issue. Take note of how easy it is to perform operations, how familiar the terminology used is and whether the demonstrator is making sense or just blinding you with science (demonstrators can sometimes find it difficult to put themselves in your shoes). However, the fairest way to judge a system is to try it out yourself. If it is not possible to review the system on your own premises, take some of

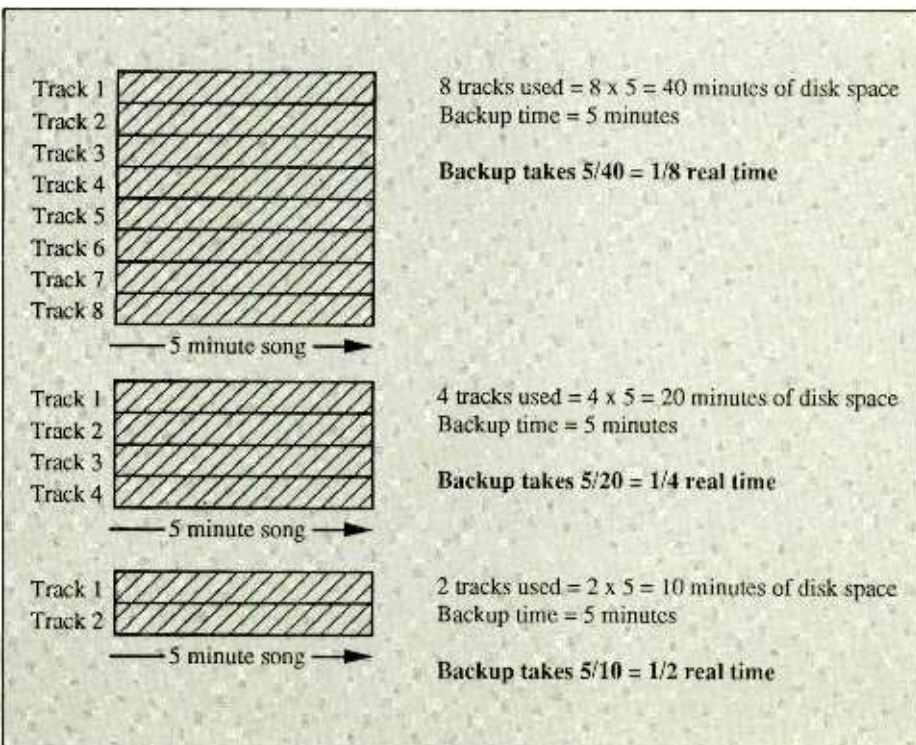

Fig 3: Archiving for a system with parallel backup



Recently a few dealers have complained about our second-hand and ex-demo list. It seems they are losing too many customers. Being the largest single supplier of 8 and 16 track equipment in Britain we've decided we can afford to give away a few secrets! We simply tell customers that if any new equipment you purchase breaks down in the first two months, we won't fix it. We will replace it! RESULT! Yet another customer who knows that Thatched Cottage can be relied on and a second-hand list full of the latest gear, factory repaired in mint condition, and with full guarantee. SIMPLE? We didn't become the biggest without being the best!

#### Some of our secondhand & ex-demonstration stock

Tascam 38, mint	£1,299
Dræwmer DL201 Gates	£255
Symetrix 511 Noise Reduction	£399
Midiverb 2 (Alesis)	£199
Aphex Compeller	£699
Soundcraft 16/4 (including compressors)	£799
Yamaha TX16W 16 voice sampler & full 30 disc factory library	£1,099
Fostex 4035 sync controller	£399
Tascam MS16 - as new	£4,500
Fostex 4050 SMPTE/autolocate/remote	£399
Yamaha DX7IID	£799
Yamaha WX7 Midi wind controller (NEW)	£249
Korg DRV3000 20K multi processor	£499
Kevox B77	£699
Fostex 4030 synchroniser	£999
A&H Sigma 24T consoles (several available)	£8,999
Fostex EB (10 inch spool) 8 track	£1,499
C Audio amp	£299
Hill 500 watt power amp	£499
Yamaha MLA7 mic line amp	£199
TC 2290 plus foot controller	£1,500
Neumann KM84 (x 2)	each £250
Fostex E16 demo	£2,750
Yamaha PF85 piano	£699
Bel BDE 2400 ES (£3,000 retail)	£599
Akai S1000	£1,999
Bel BD80S	£599
ART 4-way video monitor (rack)	£299
Yamaha KX88 mother keyboard	£899
Yamaha DMP7 automated mixing	£1,299
Apex type C	£1,199
Tascam MSR 16 (1 1/2 inch)	£3,499

Plus loads more - give us a ring!  
All prices exclude VAT

Soundcraft MkIII 24 track with full remote control, brand new, boxed, full guarantee, last one ever ..... £11,999 + VAT

#### CASIO DA2

The next generation of Casio portable DAT machines has finally arrived. Full size connectors, new design, more control and the same low price makes it well worth considering. Price £650 + VAT, including the rack kit (We also stock the Sony DTC 1000ES if you want the Studio Standard, including the conversion.)

Due to overwhelming demand, we have finally produced a Thatched Cottage Newsletter. As well as giving details on some VERY special offers, it contains a complete secondhand and demonstration list. (The list we advertise represents only a fraction of actual stock). There are also details of courses and classes we briefly introduce ourselves! Why not go on our mailing list and write or telephone for your copy? We also have a free 40 page colour magazine full of bargains, up to the minute product news and articles. Give us a call for your free copy.

#### SOUND IDEAS CD LIBRARY

6 discs with 3,500 samples - sound effects plus every instrument you can think of, call for details £299 + VAT

We have been appointed sole agents for the amazing Allen & Heath Sigma 24 track MIDI recording console. If you require any information or would like a comprehensive demonstration in our own 24 track studios, why not give us a call? - we think you'd be surprised!

#### YAMAHA SPX1000

Anyone who has heard about the ULTIMATE Yamaha multi-processor should give us a call for details - Don't Miss out!

#### ALLEN & HEATH SABER 16 & 24 TRACK CONSOLES

At this year's APRS, Allen & Heath launched a revolutionary new professional mixing console - The Sabre offering the quality of a Soundcraft and the durability of a TAC. It has comprehensive MIDI facilities as standard offered only as options by other manufacturers.

Demand has been so great, every month we sell the entire UK production run in advance!

If you're considering spending around £5000 on a high quality multi track console then you owe it to yourself to check this one out! Give us a call and we will send you full details and arrange a demonstration

#### SPECIAL OFFERS

Fostex E16 + remote SMPTE/autolocate £2,999 + VAT  
Atari 1040 + monitor + Steinberg Pro 24 Version III or C-Labs £675 + VAT

• EXPORT • FULL CREDIT FACILITIES AVAILABLE • MAIL ORDER •  
• LEASING ARRANGED •



Thatched  
Cottage Audio

Tel: Cambridge (0223) 207979 (3 lines)

Fax: (0223) 207952

Thatched Cottage Audio

North Road, Wendy, Nr. Royston, Herts.



your usual work with you to the demonstration facility. You may find the work easier and faster to achieve with better results—or even that the system opens up new areas of work. Whatever your assessment, a factor to keep in mind is who is actually going to be operating the system and if it is not only you, it would be a good idea to involve them as well.

#### Sampling rates/number of bits per sample:

Without going into the depths of digital theory, suffice it to say that each bit of a sample gives 6 dB of dynamic range. Therefore a 12 bit sample gives 72 dB, a 16 bit sample gives 96 dB and so on. It is generally accepted that 16 bit digitisation or over gives adequate dynamic range (16 bit operation also happens to be convenient for system designers—18 bit operation is a little more tricky). It is also accepted that sampling rates above 40 kHz provide adequate bandwidth (although 32 kHz is used for stereo FM broadcast). Sampling at 40 kHz allows editing accuracy of 1/40,000 second, at 50 kHz the accuracy is 1/50,000 second, etc. Oversampling is a term that appears every now and then. It is basically a technique to assist system designers to overcome limitations imposed by converters they use and involves internally increasing the sampling rate. That's as far as we are prepared to go on the subject because audio quality is subjective on the part of the listener—bits and sampling rate snobbery is often the domain of marketing folk.

The important issues are whether a system provides the bits and sampling rates you absolutely require. For compact disc for example, 16 bit 44.1 kHz sampling would be suitable, whereas 48 kHz sampling would be appropriate for DAT. In any case nearly all systems offer a choice of sampling rates although only one or two offer sample rate conversion (non realtime).

**Compatibility:** Unlike analogue multitrack, which can be transferred from one make of tape machine to another, disk-based systems all have their own archiving systems, which are not compatible with each other. In the past this has meant that the only way to transfer from one type of system to another was to record the analogue outputs on to multitrack tape and then to re-record from multitrack via analogue inputs on to the other system. This seemed to be defeating the object of maintaining the audio in the digital domain, so now most systems offer direct digital transfer of audio by means of AES/EBU and/or other standards of interfacing. This still means transferring on to tape (if the systems are not in close proximity) and in most cases transfer will take realtime. Also note that these interfaces can be offered as options—an 8-track system may only have one 2-channel interface as standard although the supplier may be able to provide more. For multichannel purposes the MADI format has been suggested and is offered by one or two manufacturers. MADI is still a relatively new format and allows the transfer of up to 56 channels of digital audio via a serial link.

**Upgradability:** The important thing to note with all computer-based systems is that they are capable of changing/improving the features they offer by software development. With software upgrades it is important to establish whether existing work will be compatible with the new software.

Although software mainly determines which editing features are available and how they are displayed, the basic physical capabilities of a system are determined by hardware. Disk sizes will limit recording time, the number of outputs will determine how many tracks can be played

simultaneously, etc. Most manufacturers have designed their systems so existing disks can be replaced by larger ones when they become commercially available and/or further disks can be added to the system to increase time or tracks. A number also claim that their hard disks can be replaced by erasable optical disks once these become commercially available. Whatever the manufacturer may offer, it is always a good idea to talk to existing owners if possible, to get an idea of how the system has developed—sales and marketing people tend to promote features before they become a reality. Also worth considering is that although software upgrades are usually inexpensive, hardware upgrades may not be—ask yourself if what is currently available will satisfy your requirements.

**Training:** To many this technology will be new, and no matter how much the system designers try to emulate conventional working methods with software, there is no point in pretending that a change of working practices won't be inevitable. Whatever the supplier says, the time it takes to become sufficiently fluent with a system's operation will vary for each person. If enough time is not invested in training, the full possibilities offered by a system may not be explored. Operators may revert to 'old ways' with the misguided idea that this is faster.

**Cost:** Taking a very rough average of current prices, an 8-track disk-based system would cost around £70,000 and a stereo editor around £20,000. Of course prices vary from system to system and can be subject to exchange rate fluctuations. Systems may be offered with or without backup, with integrated digital mixing, optional digital interfaces, additional disk drives, etc. So although one system may seem cheaper than another, on closer inspection their prices may end up at roughly the same should they be equally furnished (if possible).

Whether a system proves to be cost effective or not depends on a number of factors. Comparisons between disk-based systems and the tape machines they would replace are difficult because this would not be comparing like with like. Tape-based systems may be cheaper and offer more tracks—disk-based systems may offer editing and soundtrack assembly functions impossible with tape. Rather than pursuing the line that it must be one type of system or the other, many current owners of disk-based systems integrate their systems with existing equipment in ways that enhance the overall facilities on offer. As a result, many have found that they are able to increase their clientele, the range of work undertaken, their prices, their reputation and ultimately their overall profit.

However, not all prospective purchasers of such systems are in a position, financial or otherwise, to risk taking this relatively new technology on board—in many cases it has to be a choice between tape or disk. Obviously in commercial situations the demand for the product from your existing clients will be a major consideration. If there is currently little or no demand, why not wait a while—system prices may decrease. On the other hand, making it known that you have such a system may increase the demand for it.

Whichever way you look at it, comparing the number of tracks offered by a disk-based system with tape is missing the point, but comparing just what you get for your money isn't. □

Yasmin Hashmi and Stella Plumbridge are both independent consultants for SYPHA, which has recently published an extensive review on the hard disk recording market from the user's point of view. Contact SYPHA, 216a Gypsy Rd, London SE27 9RB, UK Tel: 01-761 1042.



# SOUNDSTATION II... Now with TIMEWARP™



## Digital Audio Disc Recorder and Production Centre

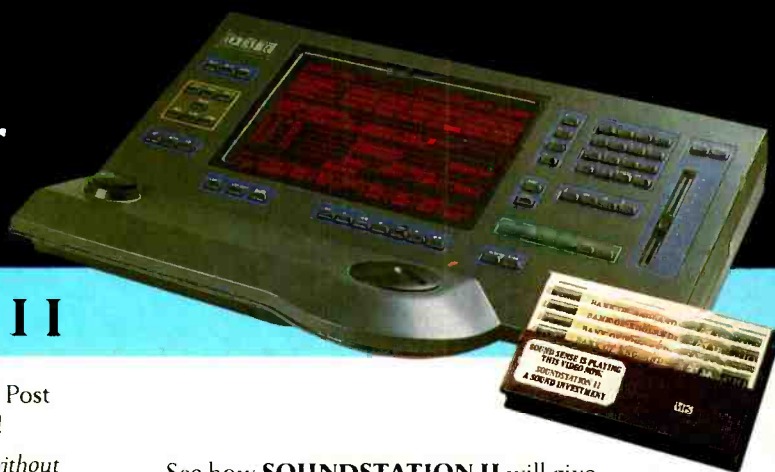

## SOUNDSTATION II

**SOUNDSTATION II**, the unique Digital Audio Editing and Post Production System from DAR, now offers Stereo TimeWarp!

Permitting superb quality time compression and expansion *without pitch change*, TimeWarp complements **SOUNDSTATION**'s vast repertoire of rapid and transparent editing capabilities. From simple spotting of sound effects to timecode, to complex dialogue and soundtrack editing, **SOUNDSTATION II** offers unparalleled power, speed and ease of use.

- Fast "tapelike" Recording and Editing
- All Editing on one Display - No Paging or Menus
- Instant Copy, Loop, Cut, Paste, Gain and Crossfade
- Scrolling Preview of Audio
- Digital and Analogue Inputs and Outputs
- 8 Track Hours in 9 Rack Units
- Affordable configurations for every application

See how **SOUNDSTATION II** will give your studio the competitive edge in - Video and Film Post Production - Multitrack Music - Dialogue Editing - CD Mastering. **Phone DAR for a free demonstration video tape now!**

U.K. Tel. No: (03727) 42848  
U.S.A. Tel. No: (213) 466 9151

DIGITAL AUDIO RESEARCH  
**DAR**

The satellite revolution is already turning out to be a damp squib. It was entirely predictable, once the industry segmented with a bizarre standards split between the two satellites serving Britain, BSB and Astra. (For the full gory details see page 42.) To cut the absurd story short, viewers would—at the last count—need two separate aerials and four set-top boxes, gobbling three different subscriptions totalling nearly £30 (\$50) a month, to receive all the English language programmes (around 15) promised by the end of this year.

Although bad news for anyone with money in satellite and a disappointment for those (self included) who saw satellite broadcasting as an exciting new step towards the 21st century, this extraordinary cock-up is good news for terrestrial broadcasters.

The BBC, ITV and Channel 4 all have an ace up their sleeve—*Nicam* stereo TV. ITV and Channel 4 will play it this autumn, just as the BSB satellite is scheduled to start broadcasting. Instead of installing a clumsy dish aerial and Christmas tree of expensive gadgetry on top of a TV set, anyone with spare cash will be encouraged to spend it on a new TV set or video recorder with *Nicam* facility.

The IBA has now gone on record and promised a “preliminary service” from Crystal Palace in London and Emley Moor in Yorkshire, starting in September. This will cover 30% of the population. By 1990 the IBA will have converted transmitters covering 75% of the population.

To re-cap, for *Nicam* the sound is sampled at 32 kHz, and encoded into 14 bit words, which are then artificially compressed to 10 bits. This code is transmitted at 6.552 MHz above the vision carrier. The system is called *Nicam 728* because it relies on the ‘near-instantaneous companding’ and the overall data rate is 728 kbit/s.

The BBC, who invented the system, started engineering tests in the early '80s and by 1984 had proved it workable. Regular *Nicam* test transmissions began in July 1986 from Crystal Palace. The IBA backed the system and in September 1986 the British Government approved it as a news standard. The BBC put out an announcement to reassure electronics firms who had been waiting for official approval before committing to the manufacture of receivers.

The electronics industry trade body BREMA (British Radio Electronic Equipment Manufacturers' Association) told members it welcomed the news. In August 1988 the BBC, IBA and BREMA gave all interested electronics companies a final specification.

Then—just when the companies started to produce chips and receivers—the BBC managers chickened out and started waffling about '1991'. But whereas the first round of waffle was about making a decision on *Nicam* in 1991, Director-General Michael Checkland has now changed his tune and promises a big-bang launch in 1991, with seven transmitters covering up to 70% of the population. Expect more fancy footwork if ITV and Channel 4 win publicity and audiences with their earlier start.

The BBC's sluggish start could prove a blessing in disguise. Problems of distributing the signal round Britain are still not solved.

Both the BBC and IBA will distribute the stereo sound to transmitters round Britain using the sound-in-syncs (SIS) system. This slots the digital

## Barry Fox

### There are hiccups in UK TV advances

sound signal into gaps in the video waveform, which are conveniently created by the regular pulses broadcast to synchronise the picture signal. The BBC developed SIS 20 years ago and it is widely used as a way of saving money by distributing both sound and picture signals on a single video link, either by wire or microwave link between transmitters

For mono SIS, the sound is sampled at 32 kHz, and converted to 14 bit code words, which are then compressed to 10 bit words to give a data rate of 338 kbit/s. This fits neatly into the 4.7  $\mu$ s sync pulse gaps.

Whereas there is plenty of room in the sync pulse gaps for a single channel of sound, it is a very tight squeeze to cram in two channels for stereo. The pulse slot is widened slightly and quaternary coding used; the signal changes through four steps instead of two. This creates a cleft stick problem.

If the digital signal is compressed, by reducing the number of bits transmitted per second, sound quality may be degraded. Also the signal processing circuitry has to have memory buffers that store the signal long enough for the processing to take place. This artificially delays the sound. If several processors are daisy-chained around the country, the cumulative delay will put the pictures viewers see out of sync with the sound they hear.

On the other hand, if the digital signal is not compressed, it is such a tight squeeze in the waveform gaps that any slight distortion of the signal will cause digital errors.

Whereas the BBC originates most of its programmes at a few studio centres, mainly in London, the ITV network is designed to combine programmes originated at numerous centres all over the country. So the IBA must provide sound-in-sync processing circuitry at almost every major transmitter site in Britain. So there is greater risk of both corrupting and delaying the stereo sound signal as it is distributed round the IBA network. Also the IBA's news facility, Independent Television News, wants to offer stereo sound with news reports sent by landline microwave link or satellite from remote locations.

So, at the end of last year, the IBA joined with ITN to do some practical tests, using prototype stereo sound-in-sync encoders and decoders made by broadcast equipment supplier, RE Instruments of Copenhagen. Ambitious plans to use 16 bit linear coding were dropped as impractical. The IBA will stick with 14/10 compansion.

Leaked copies of the report show that the results of these first tests were disappointing. IBA engineers at Winchester routed a picture and stereo sound signal round the country by British Telecom cable and across the Continent, by satellite. They deliberately sent the signal round long loops, to reduce its strength and introduce random distortion. Whereas the picture signal got through, the stereo sound failed.

Although the IBA plays down the results of these tests, saying it was “not too unhappy”, the

IBA's internal report is far more frank, referring to “three potentially serious problems”. One prototype decoder worked where the other did not, even though the IBA's engineers could not find any technical reason for the difference.

Mysteriously, the sound channel was most prone to failure when handling loud, high frequency tones. Most significant, the IBA found that the new stereo sound-in-sync equipment was “substantially less robust” than the mono versions currently in use. All the tests that failed with stereo sound, worked with mono sound.

The Danish supplier is now working on a second generation system, which is designed to cope with the problems the IBA's tests revealed. The IBA is still confident that the system will be up and running in time for its promised service launch in September. BBC engineers, while still smarting at the imposed delay until 1991, are taking advantage of the situation. They will wait and see how the IBA and ITN get on before finalising their own plans.

As we go to press in mid May we hear British Satellite Broadcasting is getting ready to announce a delay in its September launch plan. It was so entirely predictable—but confirmed only as a result of press pressure—that BSB's investors must surely ask what game the company has been playing. And what kind of fools it thinks they are.

If BSB folds, Britain kisses D-MAC goodbye as a new transmission system and with it the eight digital data and sound channels that can be used for direct digital radio broadcasting.

The admission on technical problems came while BSB was spending over £20 million on advertisements promising that its much publicised squarial—a flat square aerial still not demonstrated in working form—“will be proudly displayed on homes all over Britain from next September”. The company now acknowledges that it can offer only token supplies of reception equipment for September. There is good reason to believe that wise souls inside BSB have known that for months.

ITT Intermetall in West Germany has fallen behind schedule on the delivery of one of the vital D-MAC microchips. The missing chip is needed to interface the Eurocypher descrambling system, made by General Instruments of the US and on schedule, with the rest of the receiver circuits. Without chips, the four firms (Salora, Tatung, Philips and Ferguson) pledged to supply BSB's receivers cannot make them.

BSB now also admits that it has hit problems with the much publicised squarial. The moulded plastics design bought from British company Fortel has proved, as the electronics industry predicted, impractical to mass produce at low cost. A metal squarial developed by Marconi is bigger than the 30 cm promised by BSB. A 30 cm design, from STC, is currently favourite. That too is metal and will cost more than BSB hoped. By mid May no manufacturing contracts had been placed, making the delivery of anything more than a token few products for sale by September impossible.

The IBA developed MAC, and the IBA franchised BSB. I tried to warn the IBA policy-makers months ago that things were going wrong but got only a waffling response. □



# For Hot Licks And A Great Mix Do It With The Stylyx



Stylyx 31 console with optional meter bridge.

**G**et the sounds down right with a new D&R STYLYX console. Nothing in its class is sweeter to the ear or easier on the eye than this hot new split format console.

STYLYX sets the tone: The slick meterbridge and smart grey-on-black chassis are sheer elegance, and a contemporary colour scheme allows quick identification of all controls.

An extremely compact design allows up to 40 inputs. And beneath those good looks, features like smooth sounding 4 band EQ., super versatile aux section, true stereo input modules, and flexible dual channel subgroup modules make the STYLYX a perfect fit for broadcast production, video post production, as well as high quality sound reinforcement environments.

Eight and sixteen track recording studio's also benefit from STYLYX' digital quality specs, balanced inputs and outputs, custom configurations and one year warranty.

Call your **Local D&R dealer** for more information or call us.

**D&R STYLYX SERIES  
BEYOND COMPARISON**

#### HEAD OFFICE

Synton International B.V.  
Computerweg 1  
3606 AV Maarssen  
Netherlands  
Tel: 03465-69664  
Fax: 03465-73330

#### B.R.D. OFFICE

Synton Germany GmbH  
Tersteegenstrasse 29  
4130 Moers 1  
Germany  
Tel: 02841-16220  
Fax: 02841-16638

#### U.K. OFFICE

Synton UK Ltd  
Unit 12 Northfield Prospect  
Putney Bridge Road  
SW18 London, United Kingdom  
Tel: 1-8770787  
Fax: 1-8748602

#### FRENCH OFFICE

Synton France SARL  
110 Rue St. Denis  
75002 Paris  
France  
Tel: 1-40260555  
Fax: 1-40289753



**AUSTRALIA**, AUDIO&RECORDING, 2019 Sydney, 36-38 Daphne St Botany phone: (02) 6669935. **AUSTRIA**, KÜNL & WURZER, A 4020 Linz, Waldeggstrasse 68, phone: 732668125. **BELGIUM**, ASE pvba, 2800 Mechelen, Kon. Astridlaan 216, phone: 15 421152. **CANADA**, J-MAR, M4H 1E9 Ontario, 6 Banigan Drive, Toronto, phone: 4164219080. **DENMARK**, P.S.S. 2200 Kobenhavn n, Aboulevarden 38, phone: (01) 390037. **FINLAND**, SAHKOLIKKEIDEN OY, 01301 Vantaa 30, P.O. Box 88 Sahkometsa, phone: 908381. **FRANCE**, METTLER AUDIO, 75009 Paris, 1-3-5 Blvd de Clichy, phone: 148782911. **HONGKONG**, JOLLY SOUND Ltd, Tower B, RM 1214-1215, Hunghom comm, centre 37-39, Ma Tau Wei Rd KLN H.K., phone: 36202025. **ICELAND**, SAMSTARF, P.O. box 1197, 121 Reykjavik, phone: 354153055. **ISLD. CANARIAS**, MUSIC ACCORD, S. Cruz de Tenerife Puerta Causeco 35, phone: 22-289506. **ITALY**, PROFESSIONAL EQUIPMENT SRL, 20142 Milano, Viale Famagosta 37, phone: 02-817839/02-8910241/2/3. **NORWAY**, VEDUM ELEKTRONIKK, N-1381 Heggedal, Aamotveien 2, phone: 2798990. **PORTUGAL**, JORSOM AUDIO VISUAL, 1000 Lisboa, Rue Eca de Queiroz 20-3 phone: 19562850. **SPAIN**, BOSE SA, 28027 Madrid, Aristoteles 3, phone: 4050611. **SWEDEN**, MONTEZUMA RECORDING, 10265 Stockholm, Kocksgatan 17, phone: 8436291. **SWITZERLAND**, ISLER AG, 8048 Zurich, Badenerstrasse 808-810, phone: 14321444. **VENEZUELA**, SOUND AND POWER, 1070 Caracas, P.O. box 76766, phone: 2223201.

# Roland R-880 and GC-8

## An operational report on a digital reverb and its graphic controller from Patrick Stapley

**R**oland have taken digital reverb a significant step forward, by introducing a system that, for the first time, allows the user to construct personalised algorithms from onboard controls. The *R-880* has been designed to operate at various levels of complexity, ranging from simple, no nonsense call up of presets to the more intricate and time consuming business of creating sounds from scratch. The basic system consists of two units—the *R-880* processor and the *GC-8* graphic controller, which accepts credit card sized program cards, and is capable of independently controlling up to 16 *R-880*s.

### Hardware

The rackmountable processor unit measures 483x91x421 mm/19x3½x16½ inches (whd), its front panel houses an overall analogue input level control, six bargraph meters, a MIDI channel step selector and display, and the power switch. At the back, analogue I/Os are either via balanced *XLR*s or unbalanced standard phone-type jacks, and digital I/Os are either on coaxial SP DIF connectors or 20 bit optical connectors. The system provides two inputs and four outputs, which, as will be seen, can be configured in various ways. MIDI I/Os and RRC (Roland Remote Control) I/Os are provided to allow a series of *R-880*s to be connected.

The remote control unit, with its purple LCD and textured black casing, can, broadly speaking, be divided into three areas of control: menu/function selection, cursor control and editing. Menus and their associated functions are selected using the five function keys along with the UP/DOWN and SHIFT keys, situated in a column to the right of the LCD. Cursor control is governed by the UP/DOWN/LEFT/RIGHT keys found at the top right hand side of the unit, and editing is controlled either from the numerical keypad, if appropriate, or from the five continuously rotating soft knobs under the LCD. The display measures 135x35 mm/5¼x1½ inches and has adjustable contrast controlled from a screw pot at

the back of the unit. Also at the back, is a slot for the memory cards; MIDI I/O and Thru connectors; the RRC connector to the processor unit, which also powers the remote; a 9 VAC adaptor socket to power the unit when it's used independently; and an on/off switch. The remote measures 333x176x51 mm/13x7x2 inches and is designed to sit close to the engineer. Of the two units I looked at, both suffered from two small problems—they produced an irritating mid frequency tone from the internal transformer and lacked one of four rubber feet making them unsteady during operation.

### Operation

The first thing to do is load the system program by inserting a system card. The display will then ask you if you want to set the clock: the *R-880* will add the time and date to user-saved presets to aid in identification but to do this the clock and calendar have to be set up every time the system is switched on—it seems a pity that this could not have been designed as a non-volatile function. Once the clock is dealt with, the system returns to the preset number and mode it was last set to.

When the *R-880* is delivered it comes with 46 factory presets distributed equally between the internal RAM memory and the ROM system card. User presets can be saved to additional 16 k or 32 k RAM cards and, depending on the complexity of the presets, each card will hold an average of 40 or 80 respectively. The memory cards are the same type that Roland's *D-50* synthesiser uses, and they require initialising before use with the *R-880*, which is a straightforward and quick operation. Memory cards have a life expectancy of about five years and the

graphic controller alerts the user when the internal batteries are getting dangerously low.

The right hand side of the graphic display contains a menu box with five choices—Algorithm, Parameter, Mixer, Function and Memory. These are accessed from the five function keys, so to access Memory, I press function key 5. The menu box will now change to display a sub menu—Read, Copy, Name (IDs in English and Japanese), Write, Next (indicates there are more functions on another page and accesses them), Delete, Initialise and Backup (for copying the entire contents of one memory card to another; the internal memory can only be copied a preset at a time). So to simply call up a preset, the system must be switched to Read, and the internal or card memory selected. A preset can then be chosen either by scrolling through the display with the cursor, or inputting its number from the keypad. Whichever method is used, the preset is finally loaded with the ENTER key—the *R-880* is quite slow in loading presets, taking on average three seconds.

Once a preset has been loaded it can be modified, either by editing its parameters or by altering the algorithm itself. The parameters available will depend on the nature of the algorithm—obviously if a reverb algorithm has been constructed without delay, adjusting the delay settings will have no effect. The easiest way to describe how the system works, is to imagine the algorithm as a collection of effects units that can be patched together in all kinds of ways, rather like the elaborate patching that used to go on in the days before multi-effects processors. These effects units come in pairs and comprise different types of reverb, EQ, dynamics, delay, chorus and early reflection. All have full parameter control and can be joined together directly or via 2 in/1 out level mixers (10 in total). When the Algorithm menu is called up it is possible to see an algorithm map of the preset showing all the component parts of the sound and the signal flow.

There are three displays associated with the algorithm menu. The main display gives soft knob control over the I/O status between 1-2, 1-4, 2-2, or 2-4, making it possible to split a preset into two discrete algorithms with mono inputs and stereo outputs. The two reverb units, or 'Main Units' as Roland refer to them, are independently switchable between Reverb, Plate or Non-Linear characteristics, and can also be switched into a Sync mode whereby they will share the same characteristic and have shared parameter control (this also improves the overall

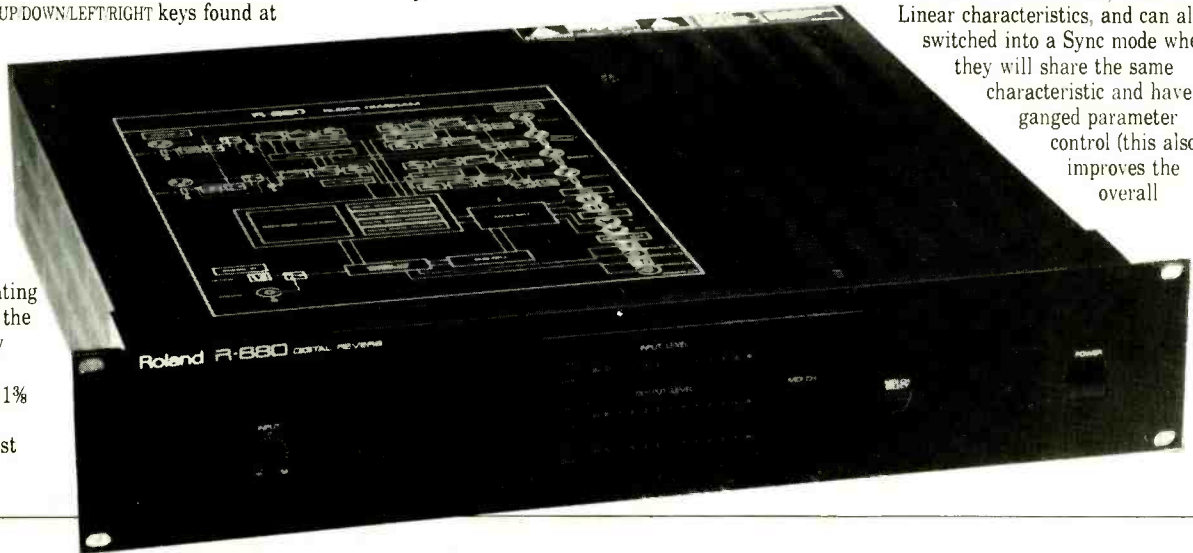



# Apollo has Landed

If the sound you generate from your audio mixer doesn't burst into life, your problems are over.

The Aries Apollo has arrived.

This brand new mixer is the latest in a long line of high performance equipment produced by Goutam Electronics for the modern recording studio.

And when it comes to sheer audio power, Apollo is, quite simply, shattering. We think it's the best on the market – listen to Apollo and you'll agree.

- Low noise, mic and line input
- 48 V PHANTOM POWER
- -20dB PAD
- Tape return (recording console only) for 1 to 16 line input ready for remix.
- 4 Band EQ
- HI/LOW sweepable MIDS
- 8 AUX
- MASTER MUTE which can be assignable to the channels or groups.



*Aries*

For full specification and prices contact:  
Aries Goutam Electronics Products Ltd,  
Unit 3B, 6-2<sup>c</sup> Southgate Road  
London N1 3JW.  
TELEPHONE: 01 249 5306  
FAX: 01 249 0252





quality of the reverb). Units set to Reverb or Plate have further choices: they are switchable between Stack (produces rich, thick sounding reverb) or Tap (more diffused sounds with longer decay times) and can have a gate connected across their outputs—the control input for each gate is selectable either pre- or post- the reverb.

The Move display shows a rectangular area and a selection of labelled boxes: the boxes represent the effects units and level mixers, and any that appear within the rectangle make up the structure of the algorithm; those outside the rectangle are available for incorporation. By using the CURSOR and ENTER keys, the boxes can be grabbed and moved, removed or introduced into the rectangular area. There is also a master Clear command that literally clears all the boxes out of the rectangle so that an algorithm can be built up from scratch.

The third display, Join, is concerned with creating and displaying the signal flow from the inputs through all the boxes to the outputs. It shows the number of I/O terminals on each box and like the previous display uses the CURSOR and ENTER keys to make or break connections. The rule for making connections is that only one is permitted for each input terminal but output terminals can have as many as are physically possible. Silly connections like joining inputs to inputs will be ignored but feedback loops can be set up and as a general precaution the outputs are automatically turned off when an algorithm has been edited and must be reset.

The inputs, outputs and mixers all have controllable levels from 0 to +100 (unity gain) and 0 to -100 (inverted phase). They are controlled from the Mixer displays either by soft

knob or keypad control. As mentioned the mixers are 2 in/1 out, and during dynamic processing the mixers themselves are being dynamically-controlled, so in the case of a gate, two mixers are required to attenuate the stereo output of each reverb. When gates are added to an algorithm the system will automatically insert or re-arrange the mixers to fit the existing configuration. A further point worth noting, is that gates and compressors share the same units and consequently a unit can only operate as one or the other.

When building up a sound there is a hierarchical arrangement both in the displays and the operational procedure. If, for example, I have constructed an algorithm but feel that it could be improved by changing a Stack reverb to a Tap reverb, I run the risk of losing all the Move, Join and Mixer editing I've just programmed, unless I write the algorithm as it stands into memory and re-edit from there. The reason for this is that the Main Algorithm display, which controls Stack/Tap selection, is the starting point for algorithm editing and any changes made here take precedence over the other displays, resetting them to their original values. Similarly some of the Parameter displays are arranged in a tiered fashion offering different levels of control, so that adjustment of a broad-based display will automatically recalculate the settings of a more detailed one. This arrangement means that the system can be operated at different levels of complexity but it does require a degree of caution and consequently the R-880 always double checks with the user warning him that he is about to embark on destructive editing. There is also a Help display that shows which bank of parameters have been edited and are therefore at

risk. The secret with the system seems to be to paint a broad picture first and then fill in the details.

The Parameter menu lists the effects units and accesses the various graphic displays for each. The displays on the whole are well executed and operationally self-explanatory, with the exception of the Dynamics display, which was somewhat confusing and poorly explained in the manual.

Reverb, on the other hand, was more intelligible being divided into five displays. The main display has control over five parameters: Type, which selects Hall, Room or Garage (Tap reverbs only); Size, with a range from 0.2 to 80 m; Reverb Time 0.1 to 99.9 s; Early Reflection level from 0 to 100; and a Brightness 0 to 100. The next display sets the Predelay time between 0 and 800 ms, controls the frequency and attenuation of high and low frequency Damping, and controls Density. The third display allows a Sub Reverb to be added to the Main Reverb with control over Level and Predelay. The remaining two displays deal with Early Reflections, giving access to four Patterns, Predelay, and Density as well as controlling the level and delay of the 20 ER taps either individually, or in four adjustable segments.

The Plate parameters are similar, although there are no Size or Early Reflection controls; they are split into four types differing mainly in terms of EQ and the addition of predelay. Non Linear reverb is organised into two displays: the main display controls predelay, gate time (0 to 1200 ms) and reverb time from -9.9 to +9.9 s where minus values invert the decay producing backwards effects and three types of form which effect output panning; the second gives the user greater control over the shape of the reverb, allowing it to be treated in segments giving rise to some interesting attack and decay contours. The graphic display (level against time) gives a clear picture of the resultant reverb.

The three band equalisers have a range of 20 Hz to 20 kHz, and each band is divided into 48 frequencies with 12 dB of cut or boost. The low and high bands are selectable between peak and shelving but the mid frequency band is peak only; a variable Q is provided for peak EQ. The two control displays offer basic or comprehensive adjustment, and a graph of the EQ curve provides the user with a quick overall check of what has been set up.

The two delay units have a maximum value of 400 ms controlled in 1 ms steps; they have positive and negative feedback and adjustable output levels that can be inverted. The display shows the delay and any feedback repeats as vertical bars on a level/time graph. An A-B check between the source and delayed signals showed no degradation apart from slight digital colouration.

The Chorus units are displayed as two sinewaves with independently controllable rate and depth. They have up to 40 ms of predelay adjustable in 0.1 ms steps, and their phase relationship to each other can be shifted through 0 to 360° (360° represents one complete cycle).

As mentioned the Dynamics displays were not as immediate as the others and were insufficiently backed up by the manual. I think there is a tendency to expect dynamic processing to be accompanied by dynamic indication and as a

## STEREO STABILIZER 5



- Rack mounting frequency shifter for howl reduction in public address and sound reinforcement
- Mono version, box types and 5 Hz fixed shift boards Mark 5 also available

**SURREY ELECTRONICS, The Forge, Lucks Green, Cranleigh, Surrey GU6 7BG.**  
Tel. 0483 275997



# Sound sense

The 4104b microphone



The workhorse of the outside broadcast world. BBC designed and recommended and used throughout the world for all broadcasts where there is a high degree of background noise. Even in a video editing suite for voice overs the 4104b is unsurpassed.

Bi-directional 60 HZ to 12,000 HZ F.R.  
300Ω - 70db ref. IV, +12db 8PL SPL

Sole distributors  
**Rispoli Ltd**  
The Paddocks  
Frith Lane  
Mill Hill, London N.W. 7.  
Tel: 01-346 9271  
Fax: 01-346 3932

# STUDIO SOUND

AND BROADCAST ENGINEERING

## CIRCULATION DETAILS

STUDIO SOUND is available without charge to directors, managers, executives and key personnel actively engaged in sound recording in any part of the world. Copies must be individually requested. Non-qualifying readers will be notified in writing and invited to take out a subscription (see below for details)

**NEW READER ENQUIRIES:** Link House Publications plc, Link House, Dingwall Avenue, Croydon CR9 2TA, UK. Tel: 01-686 2599

**EXISTING READER ENQUIRIES:** Circulation Dept, Studio Sound, Link House Magazines Ltd, Central House, 27 Park Street, Croydon CRO 1YD, UK

Changes of address should be notified in writing to this address and the label containing the old address and reference number should be enclosed to ensure accuracy

**SUBSCRIPTION ENQUIRIES:** Subscription Dept, Studio Sound, Link House Magazines Ltd, 120-126 Lavender Avenue, Mitcham, Surrey CR4 3HP, UK

The cost of an annual subscription to **Studio Sound** is:  
UK: £24.00

Overseas surface mail: £30.50/US\$52

Overseas air mail: £52.50/US\$89

USA airspeeded delivery \$70

The publishers reserve the right to refuse applications considered inappropriate and restrict the number of free copies sent to any one company or organisation

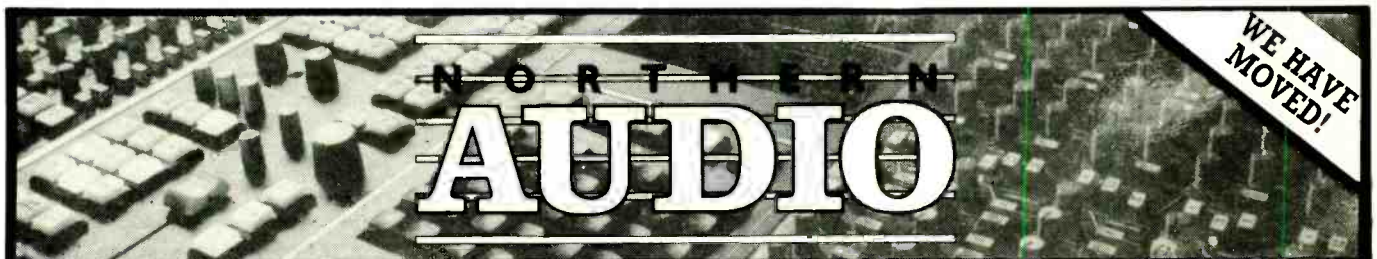

### SECOND HAND CONSOLES

1. Amek 2520 40 frame 36 fitted with patchbay Bargraph meters, Mastermix automation, 18 months old in fine condition	£40,000.00
2. Neve 'V' 3 48 frame with 48 mono channels fitted patchbay right format 1-24 monitor 25-48 patchbay. New console available immediately	£136,813.00
3. SSL 4000e 56 frame 56 fitted with V/U meters, left hand patch. Total recall with G series computer, 6 years old in good condition	£105,000.00
4. SSL 4000e 48 frame 40 mono channels fitted 'E' series computer, 8 channels wired for stereo modules. Total recall, Plasma metering, G-series E/Q Patchbay to the left. 5 years old in good order	£85,000.00
5. SSL 4000e 64 frame 48 mono channels fitted with Bargraphs metering. Total recall. Patchbay right and producer desk. 2½ years old in first class order available July 89	£120,000.00
6. Soundcraft TS24 48 input with patch and stand and patchbay. 2 years old in fine condition	£24,500.00
7. MCI 556 'C' with Spectra-View 56 mono channels fitted patchbay, JH 50 automation, available June/July 89	£38,500.00
8. Neve 8128 32 input console with penthouse and LED bargraph meters in fine condition, 5 years old, available immediately	£33,000.00
9. Trident Series 80B 30 input with 56 E/Q returns patchbay with pine end checks, 4 years old in good condition	£16,500.00
10. Trident TSM 40 input 24 monitors with updated patchbay. 9 years old but in superb order, available immediately	£20,000.00
12. Amek 2500 36 frame 32 fitted extended patch Plasma display 2 channel analyser, Optimix automation, 3 years old. Available April 1989, in good condition	£22,500.00
13. Mitsubishi 8000 42 input with Automation, 18 months old available within 6-8 weeks of order	£52,500.00
14. Soundcraft 6000 Ex Demo 36/24 patch and stand PSU	£9,500.00
15. Soundcraft 200b 32 frame 30 fitted with PSU as new	£2,750.00
16. Soundcraft 2400 32 input with bargraphs, 4 years old	£10,000.00
17. Soundcraft 6000 28 frame 24/24 fitted PSU no patch	£7,900.00
18. Soundcraft 8000 PA desk 40 input 32 fitted, 4 stereo PSU	£9,750.00
19. Soundtracks CP 6800 32 input console 18 months, fine order	£15,500.00

WE ARE CONSTANTLY ON THE LOOKOUT FOR USED EQUIPMENT...

### NOTICE

We also act for studios as selling agents, let us handle the hassle of getting rid of unwanted items, it does not matter where you are in the world, why not drop us a line listing your equipment or ring us on the numbers below for the best rates. We assure you of our best attention and service plus the utmost confidentiality at all times

### SECOND HAND TAPE MACHINES

1. Soundcraft Saturn 24 track with full remote Ex Demo	£20,500.00
2. Lyrec 533 24 track with autolocator, 12 months old (as new)	£16,500.00
3. 2 Lyrec 533 24 tracks with Q-lock and interface cards	£40,000.00
4. 4 MCI JH24 24 tracks Autolocate Ex-Demos, 200 hours each	£15,500.00
5. Mitsubishi X86 Digital Master machine	£8,250.00
6. Studer A820 with auto and 24 S/R Cards, 325 hours, 18 months	£44,000.00
7. Otari MTR 90Mk1 24 track with Auto and 16 track block	£11,500.00
8. Tascam MS16 16 track with dbx units and stand (new)	£5,950.00
9. 3M DMS System 32 tracks 1 editor 1 4-track and spare 4-track cables and connectors in good condition	£27,500.00
10. 3M DMS 32 track recorder with remote (lots spares)	£27,500.00
11. Studer B67 in as new condition	£2,250.00

AMS Audio File 2 in 8 out. Completely updated with F1 card, 120 minutes memory, Version 8 Rock and Roll edit. 18 months old, in superb order, not used

£34,500.00

### SECOND HAND EFFECTS

Focusrite ISA 118HD mono modules with PSU, 2 in stock	each	£3,500.00
Aphex Aural exciter 'B'		£250.00
White 4000 E/Q units, 2 in stock		£450.00
Klien Hummel Stereo parametric		£625.00
dbx 160x units two in stock	each	£239.00
Postec 4030 with 4035 controller cables as new		£1,350.00
Dolby M24H rack 24 cat 22 cards		£4,250.00
Dyna Mres Comp/limiter		£395.00
Eventide 949 Harmonizer		£750.00
Lindsay 7607 ½-octave analyser		offers
Roland SDE 2000 Digital delay		£275.00
Orban 536a Stereo De-esser new		£470.00
Sony F1 Processor		£555.00
MDB window recorder, 16 bit		£595.00
48 way stereo patch fully wired with stereo jacks		£225.00
Urei 529 room equalisers, 2 units	each	£575.00
30u high free standing effect racks		£200.00
Neve E/Q units 1051 3 band		£625.00
Klark Teknik DN22 Graphics stereo unit 10 band		£175.00

FOR A COMPLETE STOCK LIST WRITE OR RING TONY BAYLEY ON

0565-830005

GREYLANDS STUDIOS, MERESIDE ROAD, MERE, KNUTSFORD, CHESHIRE WA16 6QQ. TELEFAX: 0565-830405. TELEX: 666597 NAUDIOG

result a static display is somewhat alien, especially when it omits a numerical scale. As one becomes more familiar with the system, however, so the displays make more sense. As far as the gates were concerned the operation was straightforward enough, there being only Threshold, Attack and Release to adjust, and quite honestly this is a matter of tuning by ear rather than by display.

The Compressor units were not so elementary and each contained three adjustable thresholds with separate, selectable ratios; in addition there was a Limiter with its own threshold and overall program Attack and Release controls. The ratio is adjustable in 0.1 steps between 0.3 to 8.00, with 1.00 representing a ratio of 1:1. Ratios lower than 1.00 produce compression and higher ratios seem

to result in expansion. The threshold levels for each section have a direct relationship as follows: Threshold 3 must be set lower than the Limit Threshold; Threshold 2 must be lower than Threshold 3; and so on. The end result is that a dynamic slope can be 'sculpted' (including soft-knee characteristics) that would be impossible to create using a conventional device.

## Sounds

As can be seen the *R-880* is well-equipped to manufacture a large range of sounds. The factory presets cater well for more natural sounding reverbs like Large Hall, Small Room, Perc Ambience, etc, but there are not many that demonstrate its ability to create effects. This is

perhaps intentional, as it could be argued that standard sounds are more useful as factory presets than a collection of effects programs that might only have a limited application. It is also possible that the future may see the release of new factory sounds and Roland UK have been busy developing a library of their own presets, with exotic names like Ice Pipe and Heavy Breathing, which they will be pleased to offer to users. I believe the real power of the system lies not with calling up factory presets but with the creation of personalised sounds.

Considering the degree of control given to the user, the system is not over-complicated but equally one won't be constructing elaborate algorithms within five minutes. To get results you really need to sit down and devote some time to it but it's a worthwhile exercise as, in the end, sounds can be built to suit exacting requirements.

The overall sound of the system is good both from the point of view of quality and spec, in particular the low noise floor. The frequency response is 20 Hz to 20 kHz (+0.2/-3 dB), and the AD/DA are 16 and 18 bit linear respectively.

## External matters

The Function menu is responsible for calling up the MIDI and Digital Interface displays. There are two MIDI displays, one deals with assigning program change numbers to the presets for external control and the other displays the attached *R-880* units, showing their MIDI channel numbers, and connects/disconnects them with the Graphic Controller to provide individual or collective control. There is no provision made for patching external MIDI controllers, which is perhaps something for future consideration.

The Digital Interface display gives various information including the digital format (PCM, DAT or CD); the sampling rate (48 or 44.1 kHz), which automatically changes to match the source; and the status of the EMPHASIS switch.

Emphasis will be switched on/off automatically to suit the incoming digital signal but is user-switchable when there is no digital input.

The Graphic Controller can be used independently of the *R-880* main processor, by connecting up a suitable external power supply to its 9 V adaptor. This enables the lightweight unit to be taken away and programmed, without audio, away from the control room.

## Conclusion

I think the *R-880* is well worth exploring, it offers new levels of control to the creative user in an operationally coherent manner. There are a few minor areas that could see improvement but it is early days for the system, which, being totally software based and without dedicated controls, is expandable in all kinds of ways. With the added advantage of a reasonable price tag, this should put the *R-880* on a par with other top quality digital reverb units. □

UK: Roland UK Ltd, Amalgamated Drive, West Cross Centre, Brentford, Middx TW8 9EZ.  
USA: RolandCorp US, 7200 Dominion Circle, Los Angeles, CA 90040-3647.

# AUDIO DESIGN New Wave Technology DIGITAL PROBOXES™



### ProBox 1™

Domestic SP to be converted to EBU, and EBU to be transferred to a SP domestic format. The unit also provides for a word-clock output which can act as a house master-synch, or enables locked operation with other equipment. A further important feature is that it will allow the transfer of CD digital code, to be read in EBU/SP format. 'Good lock' and emphasis indicators. Sampling frequencies: 48, 44.1 and 32 kHz.

### ProBox 2™

ProBox 2 provides a full interface between the FI format and EBU (both send and return). It is necessary to fit a small interface board to the FI format processor (PCM701 or 501) to provide a digital input/output. CD digital code can be converted to AES/SP as in Pro-Box 1 and 'Good Lock' and emphasis indicators are provided.

### ProBox 3™

ProBox 3 provides a full send and return interface between Siffit 2 and EBU with slaving capability, having separate word-clock IN and OUT. The system is in a 1U rackmount case.

### Level ModeDefier™

This unit provides all the functions available in ProBox1 (the ModeDefier function), plus a dithered real-time fader for use on EBU/SP lines. A studio law fader offers gain scales switchable between unity and a +12dB range; channel balance has a +6dB range; phase and channels can be reversed. The unit is a 1U rackmount format with a slim-line fader control box that can be extended by 15 meters from the processor unit.

### Error Status Report Writer™

This is a small computer system which interlinks with PRODAT series of R/DAT recorders. It will provide a full hard copy of various combinations of error correction flags against time. Intended for quality assurance of master tapes.

AUDIO DESIGN  
New Wave Technology

U.K. Broadcast and Export Sales  
Unit 3, Horseshoe Park, Pangbourne  
Berks. RG8 7JW U.K. Tel. 07357 4545  
Fax: 07357 2604



# Amek APC 1000 at Sunset Sound

## Al Schmitt – Engineer

"A very comfortable, musical console with a great control surface.  
Among the finest consoles I've ever worked on."

(5-Time Grammy Winner, Best Engineered Recording: *Hatari* - 1962,  
*George Benson*/*"Breezin'"* - 1976, *Steely Dan*/*"AJA"* - 1977 & *"FM"* - 1978, *Toto*/*"Toto IV"* - 1982)



## Paul Camarata – President, Sunset Sound

"The AMEK APC-1000 console offers our clients greatly enhanced creative capabilities to meet the demanding requirements of increasingly complex record, jingle, and film sessions at our studio. Its outstanding sonic qualities, superior recall and reset functions, compact construction, and GML automation system satisfies our most discriminating customer. We are very pleased to have added it to our collection of consoles. I am sure it feels right at home!"

## Don Murray – Engineer

"An unbeatable combination – 64 channels of Amek & GML! So much in such a compact package!"  
(3-time Grammy nominees: 1985, 1986, 1987; GRP Records, Hiroshima, Elton John, Yes, The Jacksons, Dave Grusini)

## Bob Schaper – Engineer

"Clean and quick! A musical tool with great flexibility."  
(Melissa Manchester, Ringo Starr, Bryan Adams, "La Bamba", "Karate Kid")

## Bobby Brooks – Engineer

"This is the console for the '90's. Definitely the one for my clients who need a lot of inputs. I love it! I think Amek's got it goin' on!"  
(Stevie Wonder, Jody Watley, Teena Marie, Rick James, Temptations, Pebbles)



Head Office, Factory and Sales: AMEK Systems and Controls Ltd., New Islington Mill, Regent Trading Estate, Oldfield Road, Salford M5 4SX, England.  
Telephone: 061-834 6747. Telex: 668127 Fax: 061-834 0593.

AMEK/TAC US Operations: 10815 Burbank Blvd, North Hollywood CA 91601. Telephone: 818/508 9788. Fax: 818/508 8619.

# CLASSIFIEDS

Advertisements for this section must be pre-paid. The rate is 70p + VAT per word, minimum £17.00 + VAT. Box Nos. £6.00 + VAT. VAT (UK only) \$ rate \$2.00 per word, minimum \$50.00, Box No. \$10.00 extra. Semi-display rates on application. Copy and remittance for advertisements in AUGUST issue must reach these offices by 22nd JUNE addressed to: The Advertisement Manager, Studio Sound, Link House, Dingwall Avenue, Croydon CR9 2TA. Cheques made payable to Link House Publications (Croydon) Ltd. Note: Advertisement copy must be clearly printed in block capitals or typewritten.

Replies to Box Nos. should be addressed to the Advertisement Manager, Studio Sound, Link House, Dingwall Avenue, Croydon CR9 2TA, and the Box No. quoted on the outside of the envelope. The district after Box No. indicates its locality. **SEX DISCRIMINATION ACT 1975:** No job advertisement which indicates or can reasonably be understood as indicating an intention to discriminate on grounds of sex (e.g. by inviting applications only from males or only from females) may be accepted, unless (1) the job is for the purpose of a private householder or (2) it is in a business employing less than six persons or (3) it is otherwise excepted from the requirements of the Sex Discrimination Act. A statement must be made at the time the advertisement is placed saying which of the exceptions in the Act is considered to apply.

The attention of advertisers is drawn to "The Business Advertisements (Disclosure) Order 1977", which requires that, from 1st January 1978, all advertisements by persons who seek to sell goods in the course of business must make that fact clear. From the above date consumers therefore should know whether an advertisement relates to a sale by a trader or a private seller.

## SERVICES

**CASSETTE DUPLICATING:**  
**GAUSS Loop-Bin / TELEX In-Cassette**  
 High Quality Blanks / Label Printing  
**OPEN REEL DUPLICATING**  
 (ANY SPEED - ALSO TO BROADCAST SPEC.)  
**SPEECH RECORDING**  
 (VOICE-OVERS; LANGUAGES; AUDIO-VISUALS)  
**SPEECH-PLUS RECORDINGS LTD.**

UNIT 32, NO. 19, PAGES WALK, LONDON SE1 4SB. TEL: 01-231 0961

## THE COMPLETE SERVICE.....

### D.I.R.E.C.T.

- Record Pressings
- Cassette Duplication
- Compact Discs
- Post Mastering
- P.Q. Encoding
- Print & Reprographics
- Video Duplication
- Competitive Prices
- Free Quotations

*Make it with us  
 We make the hits*

**SRT**

MARKET LEADERS

☎ 01 446 3218 LONDON

☎ 0480 61 880 CAMBRIDGE

### TAPELINE

Blank & Duplicated Cassettes

- Real time cassette duplication
- From 1/4" reel, PCM Beta digital, DAT or cassette masters
- Custom Wound Ferric or Chrome Cassettes
- Labels & Inlays • Shrinkwrapping

Telephone (anytime)

061-336 5438

High Quality, Low Cost, Express Service

53-55 CORPORATION ROAD, AUDENSHAW, MANCHESTER M34 5LY



### HIGH QUALITY REAL TIME CASSETTE DUPLICATING

From 1/4" reel, cassette or PCM F1 digital masters

Telephone: 0268 794386

### AA Tape Winders 0268 765010

For rapid supply of exact length  
 Audio Cassette + Tape Duplication



### THE CASSETTE DUPLICATING SPECIALISTS

Real time & high speed loop bin duplication, printing & packaging. Blanks wound to length

TEL: 061-973 1884

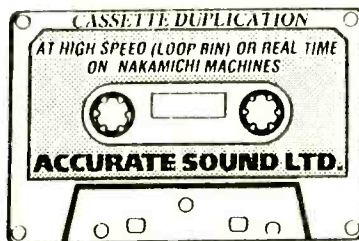

TEL: LEICS (0533)

602064 QUENIBOROUGH IND. EST.,  
 MELTON RD, QUENIBOROUGH, LEICS

**RAINHILL TAPE SPECIALISTS**

HIGH QUALITY

HIGH SPEED DUPLICATION (LYREC LOOP BIN)  
 REAL TIME DUPLICATION (NAKAMICHI)  
 PRECISION WOUND CASSETTES (FERRIC AND CHROME)  
 POST-PRODUCTION SUITE  
 FULL PRINTING SERVICE

Music House  
 369 Warrington Road  
 Rainhill, Prescott  
 Merseyside L35 8LD  
 051-430 9001

APRS

HIGH SPEED HIGH QUALITY LOOP-BIN DUPLICATING BY SRL TAPE SERVICES

REEL-REEL [DOLBY A, NAB, IEC]  
 F1 PCM DIGITAL [DOLBY B, DOLBY C, DOLBY B]  
 AUDIO CASSETTE [DOLBY C, DOLBY B]

IN...OUT

QUALITY CASSETTES  
 QUALITY CASSETTES  
 QUALITY CASSETTES

THE BETTER THE MASTER, THE BETTER THE COPY!  
 HOW MANY WOULD YOU LIKE? 100 5000  
 01-868 5555 01-866 5555 PHONE FOR PRICE CHECK

### THE COMPLETE SERVICE includes:

BLANK CASSETTES (C1 - C100 incl. Chrome)  
 HIGH-SPEED LOOP-BIN CASSETTE COPYING  
 OPEN-REEL COPYING  
 CASSETTE LABELS & INLAY CARDS  
 EMPTY TAPE SPOOLS & TAPE BOXES  
 LEADER TAPE & SPLICING TAPE  
 AMPLEX MAGNETIC TAPE

and is available from -  
 MEDIATAPE LIMITED

Unit 32, Bookham Industrial Park, Church Road,  
 Bookham, Surrey KT23 3ET \* Tel: (0372) 54899

**SELECTA** REAL TIME AND LOOP BIN DUPLICATION  
 EXACT LENGTH CASSETTES  
 STUDIO SUPPLIES 04024 53424

**SOUND** WHERE THE CHOICE IS YOURS

jbs records  
**MUSIC-SPEECH-DATA**  
 REAL-TIME/HIGHER-SPEED Quality Cassette  
 Duplication and Blanks from 1-1000. Computer printed  
 Labels. Solo, 1/4" reel, Sony Betamax recording.  
 Fast Security Delivery service.  
 FILTERBOND LTD., jbs records div., FREEPOST  
 19 SADLERS WAY, HERTFORD, SG14 2BR. 0992-500101.

**SAMPET SOUND**  
 CASSETTE AND OPEN REEL  
 REAL TIME DUPLICATION  
 TAPE LENGTHS AS REQUIRED  
**ANDOVER (0264) 65252**



THE BRITISH LIBRARY NATIONAL SOUND ARCHIVE  
**RECORDING TECHNICIAN**

The National Sound Archive is the national collection of all kinds of recorded sound. The collections include material on carriers ranging from wax cylinders to digital audio tape with a subject coverage including various musical traditions, literature and the spoken word and wildlife sounds. Listening and Transcription Services are provided for public access to the collections.

Applications are invited for the post of Recording Technician (Museum Technician II) in the Conservation and Technical Section.

You will be responsible for the production and documentation of optimum quality copies from the collections (working in digital and analogue modes as appropriate) for publication, lectures and for general transcription work. The Archive places particular emphasis on the restoration and preservation of impaired or damaged recordings and you would play a major role in this area of work. You will also be expected to supervise the work of the Museum Technician III in respect of the recording of broadcast material off-air and on external recording assignments.

You will be expected to share in the work of external recording assignments and recording NSA evening lectures which will involve additional working outside normal hours.

Applicants should have experience of operating professional recording equipment, but further training will be provided by the Library if required. Some understanding of, or an interest in, music would be helpful for carrying out the duties.

The possession of a current UK driving licence would be an advantage.

Salary Range (currently under review) £10,159-£11,366, inclusive of London Weighting. Annual leave 22 days plus 10½ public and privilege days.

For further information please contact Mr. P. Copeland 01-589 6603.

For an application form and further details please phone 01-323 7137 or write to Personnel (Recruitment) Central Administration, The British Library, 2 Sheraton Street, London W1V 4BH. Applications to be returned by 13 June 1989.

The British Library is an Equal Opportunity Employer.

**SALES PROFESSIONALS**

**Pro-Audio to £28K**

It is an exciting time in the pro-audio and broadcast market with significant business expansion resulting in increased career opportunities within the sales function. I am interested in talking to experienced sales professionals who are keen to progress. Vacancies currently exist in a broad number of areas and at varying levels:

- ★ Sales Manager/Area Manager/ Engineer/Representative.
- ★ Mixing Consoles/Tape Machines/ Direct to Disk/Amplifiers/PA.
- ★ Sound Recording Market/Network Broadcast/Post Production.



Discuss your next career move in strict confidence with Mike Jones at Professional & Technical Appointments, Unit 9b, Intec 2, Wade Road, Basingstoke, Hants. Telephone: (0256) 470704.

**MAYFAIR RECORDING STUDIOS**



**Wanted**

**Assistant/Trainee Maintenance Engineer for our 3 studio complex**

SUCCESSFUL APPLICANT WILL HAVE  
GOOD COMMONSENSE, WITH AN ELECTRONICS BACKGROUND.  
STUDIO EXPERIENCE NOT ESSENTIAL

*Salary dependent on experience*

PLEASE WRITE WITH CV TO:

**Peter Suthers, Mayfair Studios, 11A Sharpleshall St, London NW1**

**SELECTION OF PRIVATE RADIO STUDIO EQUIPMENT**, mixers, record decks, speakers, tape machines. Suitable for hospital radio or community radio projects also multitrack machine and deck. Contact David Liscombe 0792 771579.

**1 PAIR OF ELECTROVOICE** Century 100A Studio monitors £450. Phone 01-968 3602.

**DISC CUTTING EQUIPMENT** and systems bought, sold, installed and manufactured by TAM/ENGLAND, 13a Hamilton Way, London N3 1AN. Telephone: 01-346 0033.

**STUDER B67 MK1** portable version with new VU panel, butterfly heads, superb condition £2,400. Tel 0246 275479.

**TASCAM/SENN/BEYER**, trade counter. Erricks VCD, Brighouse 722121. (X)

**THE COMPLETE SERVICE.** Disc cutting, pressings, duplicated cassettes and blanks. Bin Masters. Location Recording. Free Brochure. Tam Studio, 13a Hamilton Way, London N3 1AN. Tel: 01-346 0033. (X)

**ESTABLISHED 16 TRACK STUDIO** for sale. Liverpool City Centre over 4,000 sqft. Offers invited contact the studio manager 051 708 5090.

**LOCKWOOD, TANNOY, etc.**, new and used equipment always available and wanted. Lockwood Audio Sales 01-866 0671. (X)

**VINTAGE NEUMANN U87** valve mic, perfect working order. Complete with power supply, connecting lead and stand. Offers invited. Tel: (0895) 440843 evenings.

**WANTED** — 8 or 16 track recorder damaged beyond economic repair, insurance write-off!! Anything considered. Tel: 091 297 0815 after 8pm.

**WANTED REDUNDANT STUDIO EQUIPMENT.** Valve amplifiers, drive units, turntables, 301/SME's, old cassette/tape recorders. Anything gathering dust in the corner. 0903 883535.

**FOR SALE**

**ATARI MTR 90**

2 inch 24-track with remote—Ex SSL demo use

Offers around **£9,500**

Phone: Colin Bateman, SSL, 0865 842300

**SSL DIGITAL**

**Solid State Logic**

**Field Service Engineers**

As a member of the SSL Field Service team, you will install and maintain SSL systems in leading audio facilities throughout the UK, with occasional travel abroad. This position requires some knowledge of audio production methods, practical experience with audio electronics and a knack for rapid trouble-shooting. Some understanding of computer technology is important together with a keen interest in the music industry. Additional training will be provided.

Rewards and career opportunities are in line with those of a major international Company.

Please contact Gill Bartle or Sue Forrest on:

**0865 842300**

for an application form or send your cv to:

**Solid State Logic  
Begbroke, Oxford OX5 1RU**

SERVICES

BE IN WHEN YOU'RE OUT

**PORTA~PHONE**

FOR THE BEST SERVICE IN THE BUSINESS

**MOBILE COMMUNICATION SYSTEMS**

Motorola, NEC, Panasonic, Roamer car & portable phones supplied, installed and guaranteed!! Plus full back-up services Faxes and Office Communications

**0836 330051**



**AMPSOUND**  
153a Victoria Street, St Albans  
0727 50075

8.16.24 Track  
new and second  
hand equipment

Please phone  
for price list  
and availability

Microphones, Mixers, Amplifiers,  
Computers, Software, Etc.

Monitors, Effects, Recorders, Cable.

**FOR SALE**

AUDIO PRECISION SYSTEM ONE TEST SET, 2 CHANNELS LATEST MODEL AND SOFTWARE WITH IMD AND FILTER OPTIONS  
**£4500**

IBM AT WITH 20M HARD DISK VGA GRAPHICS AND NEC MULTISYNC 11  
**£950**

**WANTED**

SONY 1610/1630 AND OTHER CD MASTERING EQUIPMENT  
CALL JIM DOWLER  
**01-977 4546**  
**FAX 01-943 1545**

SITUATIONS VACANT

**oxford digital**

Oxford Digital is a small independent Research & Development company specialising in the design of professional audio equipment. We are located in new premises four miles from the City of Oxford.

**HARDWARE & SOFTWARE DESIGN ENGINEERS in DIGITAL AUDIO**

We are looking for self-motivated engineers who will be responsible for a variety of design projects. Applicants should have the ability to work with the minimum of supervision, and some knowledge of professional digital audio equipment would be an advantage. Successful candidates will probably have a degree followed by 2-5 years experience in:-

- C & UNIX
- Digital Audio
- Real Time Software
- Digital Signal Processing
- Software Control of Devices
- Design of Microprocessor Systems
- Design of High Speed Digital Systems

Generous salaries will be offered together with the opportunity to use the most modern hardware & software CAD tools in a friendly atmosphere.

Please send a CV to Emma MacLachlan at Oxford Digital Ltd., or telephone 0865 883772 during office hours. Ref. SS-01

Oasis Park, Eynsham, Oxford OX8 1TP.

**WOULD YOU BUY A CAR WITHOUT A TEST DRIVE? THEN WHY BUY A MIXER WITHOUT A TEST DRIVE?**

Thinking about a new project - from a small Mixer to a large studio complex - come and talk over ideas with the people who offer manufacturing and user experience at our new premises:

**Unit D, 318 High Road, Benfleet, Essex SS7 5HB**

**TO TAKE THAT TEST DRIVE - PHONE 0268-793381**

(Weekend Committee visits welcome by prior arrangement)



**PARTRIDGE ELECTRONICS**

A. C. PARTRIDGE LTD.

Head Office: 56 Fleet Road, Benfleet, Essex SS7 5JN  
Telephone 0268-793256

**- TURNER -**  
STEREO POWER AMPLIFIERS

**- TURNER -**  
STEREO POWER AMPLIFIERS

**- TURNER -**  
STEREO POWER AMPLIFIERS

**- TURNER -**  
STEREO POWER AMPLIFIERS

**- TURNER -**  
STEREO POWER AMPLIFIERS

**- TURNER -**  
STEREO POWER AMPLIFIERS

**- TURNER -**  
STEREO POWER AMPLIFIERS

**- TURNER -**  
STEREO POWER AMPLIFIERS

**- TURNER -**  
STEREO POWER AMPLIFIERS

STEREO POWER AMPLIFIERS  
Manufacturers and suppliers:  
**TURNER ELECTRONIC INDUSTRIES**  
PO BOX 49  
ETCHINGHAM  
E. SUSSEX TN19 7NZ  
TELEPHONE 0435 882581



## STUDIO CONTACT FILE

CALL PETER MOYLAN ON 01- 686 2599 Ext 489 TO BE INCLUDED IN OUR STUDIO SECTION

# RIZOUND

**RIZOUND MULTITRACK  
RECORDING**  
46 Belvoir Road,  
Bristol BS6 5DT.  
Tel: 0272 248487.  
Contact: Steve Risley.

The ultimate flexible,  
all-inclusive package,  
4 self-contained, fully  
residential DDA & SSL  
studios under one roof.

**MARCUS  
RECORDING 01-385 3366  
STUDIOS**

17/21 WYFOLD ROAD, LONDON SW6

**Are you getting the  
mix you deserve?**



*"It's the only tape I've been able to cut  
completely flat in 18 months."*

—Jacko of Tape One

Contact David Headley Jones  
8 Berwick Street, London W1V 3RG  
Tel: 01-734 5750/01-287 0630

# AXIS

C-Mix automation.  
Lexicon 480L.  
1,200 sq.ft. recording area.  
Otari MTR 12—2-track.

Phone Tim Strickland on  
**0742 750283**  
for further details



**PARSIFAL**

Telephone 01-994 7711-4445



Recording Studios Ltd.

**STUDIO ONE**  
24 Track Recording Facility

**STUDIO TWO**  
24 Track Mix-down Suite

PROGRAMMING/SONG WRITING SUITE  
Atari + Steinberg Software  
12 Track Recording Facility

PHONE FREVOR ON 061-797 2908  
For Rates

### YEW TREE FARM 24 TRACK

**Control Room:** 23' x 16' with natural daylight  
3M M79 24 Track 2" tape machine with Audio Kinetics  
Soundtracs 32 input CM4400 with  
CMS2 Computer Automation Desk  
Steinberg Pro 24 Track Midi Sequencer Atari 1040 ST  
Trackman Midi Sequencer  
Sony PCM Digital Master Revox B77 Revox A77  
Proton cassette deck  
Monitors J B L Altec Aurotones Mosslet or Quad

**Studio:** converted stone barn with natural daylight  
30' x 16' 15' high  
Live Area 16' x 12' 15' high  
Sonor Acoustic Drum kit Simmons SDS7 Electronic kit  
Fender Ampig Bass Rig Musicman AC30 Combos  
Hammond Organ with Leslie Cabinet  
Fender, Gibson, Dan Armstrong Guitars  
Microphones by Neumann AKG Shure, Sennheiser  
Rest Room Colour T.V. Kitchen shower, accommodation  
**Yew Tree Farmhouse, Sutton-cum-Beckingham.**  
Nr. Newark Nottinghamshire.  
Tel: 063684582

# BTW

Situated in North London near Bowes  
Park, BR Station and Bounds Green  
Underground, Piccadilly Line.

ACCOMMODATES TEN OUTBOARD  
EQUIPMENT PRESSINGS, TAPE COPYING,  
MUSIC PUBLISHING & PRODUCTION,  
RECORDED MUSIC LIBRARY FOR AV  
PRODUCTIONS, RADIO AND TV JINGLES &  
FILM MUSIC, AT MCPS RATES.

24 HOUR ANSWERING SERVICE  
CONTACT JOHN BORTHWICK ON  
**01-888 6655**



A fully residential music production  
facility. Clients include: All About Eve,  
Bad Co., Breathe, Fastway, OMD, Saxon,  
Simple Minds, Wet Wet Wet.

*An exciting and flexible recording  
environment — excellent value — brochure  
available.*

BOOKINGS/FURTHER DETAILS:  
**CHAPEL, SOUTH THORESBY, LINCS.**  
TEL: 05216 305



**24-track recording,  
Neve/ICI**

PINK MUSEUM  
1 HESKETH STREET  
LIVERPOOL  
TEL: 051-727 557

## SSE MARKETING LTD.

Sales/Admin/Support/Development Manager

Opportunity for a bright energetic person to work as part of a small team to further develop our sales and marketing strategy for 1992.

The successful applicant will be required to develop our dealer network, nationally & internationally, along with reassessing our existing business methods.

Applicants will need a proven knowledge of the UK and European broadcast and pro-audio industries along with a track record in sales administration.

Salary 15K +

PLEASE REPLY TO KATIE TOMPKINS

**Tel: 01-387 1262**

## FREELANCE SALES PEOPLE

Studio electronics by ARSONIC, LAKE PEOPLE and portable sound control booths from SOUNDFORMS are already highly successful products but, until now, have not been available in the UK.

We need Freelance Sales Professionals with established contacts throughout the Music, Recording and Video industry to help quickly establish these and other brands, much of which is without competition.

We have a full programme of media coverage and are able to offer good commission rates. If you regard yourself as the person we want, contact us now without delay. Applies to all areas including Eire.

PLEASE WRITE IN STRICTEST CONFIDENCE TO:

**Radius International Ltd**  
**PO Box 3**  
**Basingstoke RG24 9QA**

## James Owen & Co.

- PLANT MACHINERY & CHATTELS
- COMMERCIAL PROPERTY
- VALUERS & AUCTIONEERS

- Tel: 01-485 6791
- Fax: 01-482 0963

Offices & Auction Rooms  
Linton House  
39/51 Highgate Road  
LONDON  
NW5 1RT

By Order of the Liquidator I. D. Holland Esq, FCA, of Messrs  
Casson Beckman & Partners

RE: HOLLYWOOD STUDIOS LIMITED

The contents of a Professional Recording Studio comprising:

"Harrison" 'MR-4' mixing desk with master mix automation,  
"Yamaha" Baby Grand Piano

*Effects including:*

"Alban" D'Esser, "Aphex" aural exciter, "Bokse" 'TS-4' active timebase splitter, "Bokse" 'MP-6' patch bay, "Bokse" 'US-8' universal synchroniser, "Bokse" 'MH-2' midi humaniser, Two "Quark" long range midi 2's, "Pascan" auto panner, "Yamaha" 'REV7' reverb, "Quark" '999' midi line, "Beyer" headphones, "Nad" amplifier, "Otari" 'MTR12' AR98's speakers, "Yamaha" 'DX9', "Quark" patch bay, Q-play, "H&H" 'V800' amplifier, "NS10" speakers, Audio Screens, Midifex, Mirage Ensonique, Sound Booth, Fixtures, etc... etc...

FOR FURTHER DETAILS CONTACT R. GERAGHTY

**JAMES OWEN & COMPANY**

**Tel: 01-485 6791**

## SUCCESSFUL APPLICANT RENEGES!

Competent Technical  
Engineer  
*still required*

FOR EXPANDING  
STUDIOS

**Contact Steve**  
**734 9901**



# MORE CONTROL



JBL Control 10

There's the sound: big, forward, solid - the classic JBL voicing of the Control 1 and Control 5 now made even more revealing through the latest driver and enclosure technology.

The Control 10 is a compact three-way monitor featuring the latest generation 25 mm pure titanium dome tweeter combined with powerful 300 mm and 125 mm cone drivers, all critically matched for broad dispersion and high power handling. Its enclosure is molded from high impact styrene, extensively cross-braced and damped for minimal cabinet resonances.

There's the sheer versatility:

rugged and portable, the Control 10 adapts to a wide range of monitoring applications. It's easily wall or stand mountable with accessory hardware. It's small enough to place at the mixing desk. And because it's magnetically shielded, the Control 10 won't interfere with video monitors or desk metering.

The corners are rounded and trimmed with rubber stripping to protect supporting furniture. The anthracite gray finish is scratch resistant, and a wire mesh grille guards the drivers from accidental damage. There's even a convenient carrying handle.

Control 10 loudspeakers are ideal utility systems, durable enough to serve in small sound reinforcement and discotheque as well as monitoring applications.

The Control 10 - the latest in the JBL Control Series. It gives you more control.



**AUSTRIA:** Hi-Fi Stereo Center, Munchner Bundesstrasse 42, 5013 Salzburg **BELGIUM:** Beltronics NV SA, Rue de la Célèbre straat 29, B-1080 Brussels **DENMARK:** AudioNord, Danmark A/S, Vester Alle 7, 8000 Aarhus C  
**UNITED KINGDOM:** Harman (Audio) UK Ltd, Unit B, Mill Street, Slough, Berks, SL2 5DD **FINLAND:** Studiovox KY, Atomitie 5C, 00370 Helsinki **FRANCE:** Harman France SA, Perpète 243, 33 avenue du Maréchal de Lattre de Tassigny 94127 Fontenay s/Bois Cedex **GREECE:** Lync Hi-Fi, 7 Stournara St, 10683 Athens **HOLLAND:** AEG Nederland NV, Aleetta Jerooblaan 7, 1066 BP Amsterdam **ICELAND:** Steini Danielsson, Skulagata 61, PO Box 5066A, 125 Reykjavik **ISRAEL:** Sikru Trade International Ltd, 19 Ehad Haam St, 66541 Tel Aviv **ITALY:** Linear Italiana SPA, Via Arbe 50, 20125 Milano **NORWAY:** Erling Nebby A/S, Ryenbergtun 70, Oslo 6 **PORTUGAL:** Valerim do Carvalho Ci SARL, Rua Nova do Almada 95-99, 1200 Lisboa **SPAIN:** EAR PRO, Sant Gervasi de Cassoles 17, 08022 Barcelona **SWEDEN:** Septran Electronic AB, Box 4048, S-421 04 Vastra Frolunda **SWITZERLAND:** Musica AG, Ramistrasse 42, 8024 Zurich **WEST GERMANY:** Harman Deutschland GmbH, Hunderstrasse 1, 7100 Heilbronn



# REALISE YOUR ASPIRATIONS

## STUDER'S COST-EFFECTIVE A827

### A827 Multitrack

Aspiring to a Studer multitrack recorder may seem like a distant dream to some people.

The A827 is the solution.

The new Studer A827 has the ultra fast proven A820 tape transport with 14" reel capacity. There are 3 tape speeds with integrated varispeed controller, an optional internal synchronizer/resolver and switchable Dolby HX PRO. It comes complete with phase compensated audio electronics, NAB/CCIR/AES EQ switching, 2 alignments/speed, amorphous heads for improved response and long life and an RS232/RS422 port for full audio and transport control.

And if you should so desire, there are also comprehensive interfacing possibilities and a very impressive range of peripherals.

Your aspirations realised with Studer's cost-effective solution.

**BAUCH**  
*Solutions*

### STUDER REVOX

STUDER INTERNATIONAL AG Regensdorf Telephone (411) 8402960  
STUDER REVOX AMERICA INC Nashville Telephone (615) 254-5651  
STUDER REVOX A R L Paris Telephone 533 5858  
STUDER REVOX CANADA LTD Toronto Telephone (416) 423-2831

F. W. O. Bauch Limited  
49 Theobald Street, Boreham Wood, Herts, WD6 4RZ  
Tel: 01-953 0091 Fax: 01-207 5970