

September 1988

\$5.00 £2.00

A LINK HOUSE PUBLICATION

# STUDIO SOUND

AND BROADCAST ENGINEERING

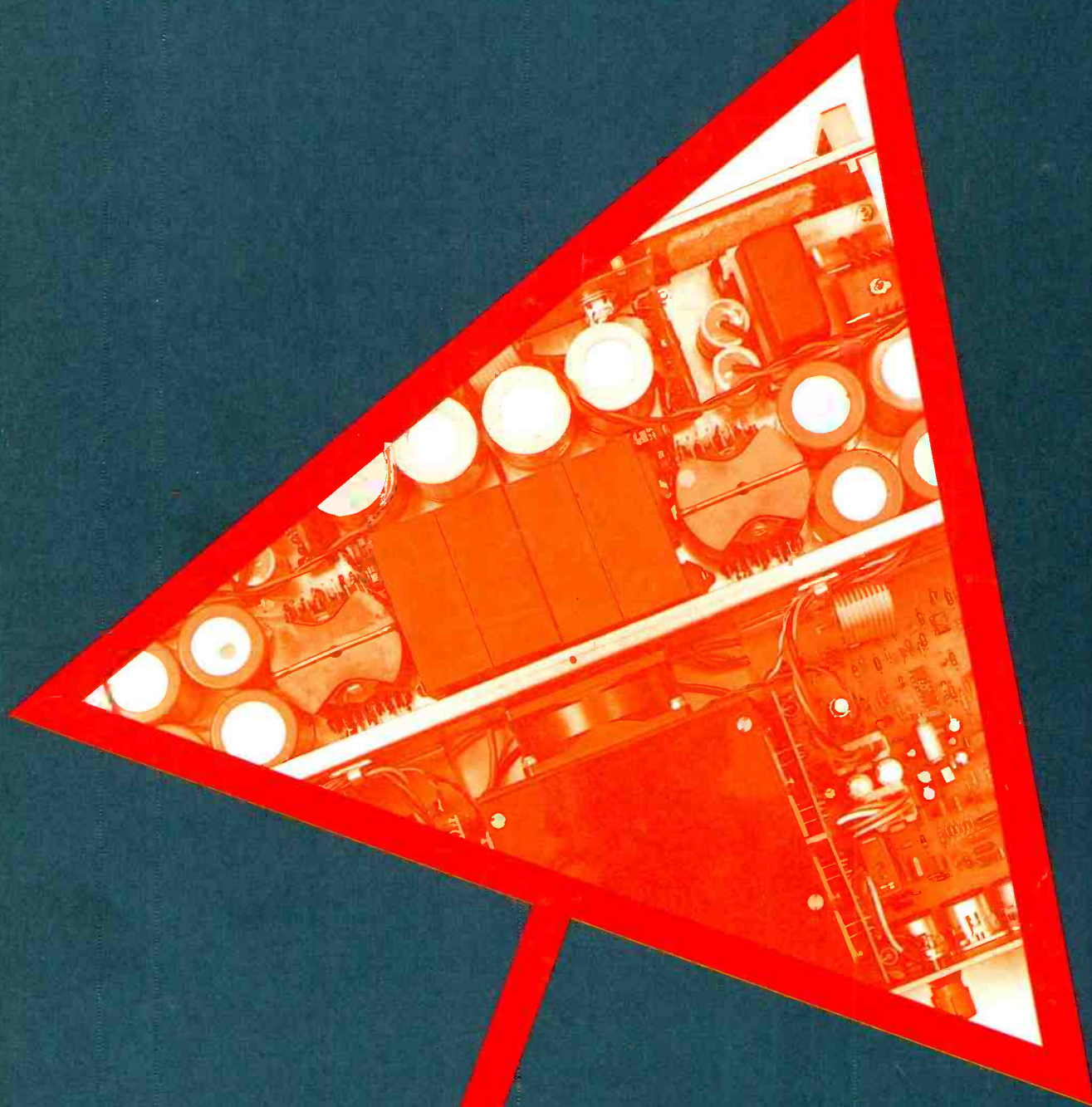

## LOUDSPEAKERS & POWER AMPLIFIERS





# Series 8000. Now status isn't reserved for the few.

The Soundcraft Series 8000 has set new standards in live mixing technology.

As you'll appreciate the minute you hear it, its electronics are a major advance.

That's why it's rapidly becoming the world's best selling live console.

Yet despite all its innovations, it's certainly not out of reach.

Because with the 'PA' input module, you'll be surprised how easily the Series 8000 will fit your budget.

## LIVE MIXING WITH A NEW EDGE.

The Series 8000's technology makes ordinary desks look decidedly overpriced.

The 8-bus design includes sophisticated ground-compensated summing

and a grounding system that's hum and interference proof.

'PA' input control facilities range from 8 Aux sends to a 4-band EQ with sweepable mids. (With the 'House' input module, there's a 4-band parametric EQ and dedicated 8-way routing matrix).

You also get an active 2-way talkback interface for a Soundcraft Series 500 monitor console.

And the option of adding 8 effects returns channels with 3-band sweepable mid EQ or an 8 x 8 Output Matrix with parametric EQ.

Just a few of the advanced features we provided at your request.

## A LIFE ASSURANCE POLICY.

A clear and familiar layout remains our trademark.

Inside, there's an immensely durable, custom made extruded aluminium frame, lighter yet more rigid than a steel chassis and proven worldwide through thousands of miles on the road.

Add to that our advanced electronics, the use of flexible connections and a stringent, 3-stage quality control program, and you get reliability when you need it most.

The Series 8000 is simply the finest all-round investment in live mixing.

Especially now that it can expand your sound, without expanding your budget.



**Soundcraft**  
**8000**

# STUDIO SOUND

AND BROADCAST ENGINEERING

## CONTENTS

- 5 Editorial:** Keith Spencer-Allen calls for a halt to pre-emptive marketing of new technology
- 14 General news:** IBC Technical Papers... Exhibitions and conventions... News from the AES... Agencies... Fame by Court... Courses and seminars... The Gateway School of Music and Recording Technology... People... Contracts... First US DAT manufacturer... Ampex Digital Reference Tape... SSL in a spin... Music Works US link... A-V copyright clearance... Disctronics goes public... MIDI equipment applications at APRS... Stolen equipment... Synclavier training centre... Software update... Address changes... Literature received... Training... BASF sponsor engineers award... In brief
- 26 US news:** Star Case new products... NED wins award... PMI purchases Telemation/Phoenix... Sear Sound moves... People... Contracts... News in brief
- 28 Product news:** SSMT dynamics processor... BSS power amplifier... Crest Audio 7001... Digitec digital matrix... Sony PCM-3324 update... Orban mic processor... Fairlight Rev 5.4 software... Ross LAB series headphones... Musicomp digital standards converters... Reference compact discs... Groove control from SW Davies... Rane Flex series
- 41 Power amplifiers:** A guide to amplifier manufacturers and equipment available
- 49 Northstar:** David Mathew visits Northstar Recording in Portland, Oregon, where they also have an extensive sample library
- 54 NTS mobile:** Janet Angus visits Portsmouth where this mobile recording unit was on location
- 58 Equipment construction standards:** David Mellor and Richard Salzedo discuss the pros and cons of equipment design
- 63 Direct-to-Disk:** Yasmin Hashmi describes the Direct-to-Disk digital audio workstation
- 69 Monitoring:** A look at developments in the field of studio monitors over the last year
- 77 Perspective:** US columnist Martin Polon on DAT Old Black Magic
- 81 Business:** Launch of CD-V and ACTT reply. Barry Fox reports
- 82 Review:** Terry Nelson presents a user report on the DPE programmable equaliser from CEM of Italy
- 87 Review:** Martin Colloms reviews the D2A digital decoder from Audio Systems Components

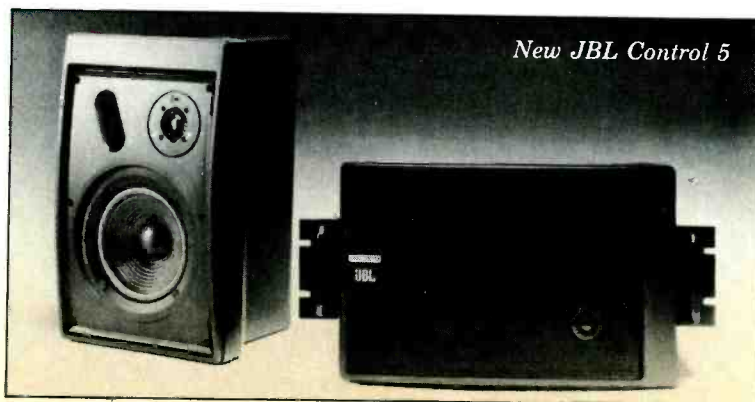



# Sooner Or Later You'll Need A Dayner!

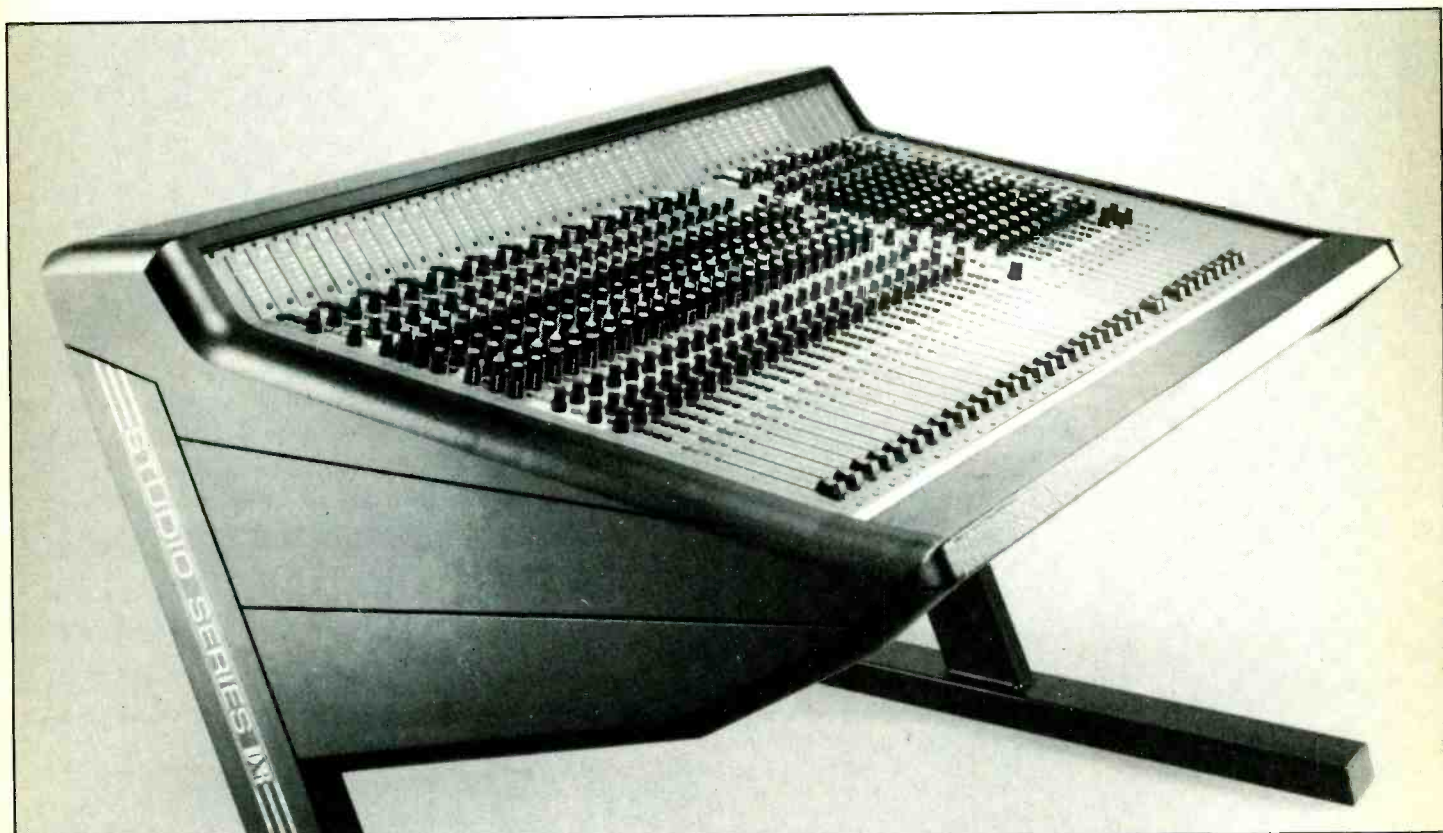

Dayner 42 studio console and desktop version.

D&R's Dayner series offers more inputs in less space than any other console. Up to 56 input modules (112 mix inputs) in less than six feet. Ideal for space-limited control rooms and MIDI oriented studios.

Yet despite its compactness, the Dayner is long on features. Split EQ, Floating

Subgroup System (FSS), 8 aux send buses and digital quality specs are just a few.

Whether you have 8, 16, 24, or 32 tracks and the most elaborate MIDI set up, the Dayner is all the recording mixer you'll need for years to come.

If you prefer the traditional split format, the innovative in-line format or both, your Dayner can be custom configured to fit your particular needs in just minutes.

Don't you deserve the best now rather than later?

Contact the D&R sales/service distributor in your area for a little free consultation or call us.

**DAYNER SERIES  
BEYOND COMPARISON**

#### HEADOFFICE

D&R Electronica b.v.  
Rijnkade 15B  
1382 GS WEESP  
THE NETHERLANDS  
Phone (-) 31 2940 18014  
Tlx 18503 dr nl  
Fax (-) 31 2940 16987

#### U.S.A. OFFICE.

D&R USA  
1720 Chip 'N Dale Drive  
Arlington, TX 76012  
U.S.A.  
Phone (817) 548 1677  
Fax (817) 277 6066

#### U.K. OFFICE.

D&R (UK) LTD  
5 Fulmer Drive  
Gerrards Cross  
Bucks, SL9 7HH U.K.  
Phone (0753) 884 319  
Fax (0753) 889 133

#### B.R.D. OFFICE.

D&R Electronica GmbH  
Steinkaulstrasse 21  
D 5100 Aachen  
Tel 0130-810078  
Tlx 0031-18503 dr nl  
Fax 0031-2940-16987



AUSTRALIA, AUDIO&RECORDING, 2019 Sydney, 36-38 Daphne St Botany phone: (02) 6669935. AUSTRIA, KÜNL & WÜRZER, A 4020 Linz, Waldeggstrasse 68, phone: 732668125. BELGIUM, ASE nvba, 2800 Mechelen, Kon. Astridlaan 216, phone: 15 421152. CANADA, J-MAR, M4H 1E9 Ontario, 6 Banigan Drive, Toronto, phone: 416-4219080. DENMARK, P.S.S. 2200 København n, Boulevarden 38, phone: (01) 390037. FINLAND, SAHKOLIKKEIDEN OY, 01301 Vantaa 30, P.O. Box 88 Sahkometsa, phone: 908381. FRANCE, METTLER AUDIO, 75009 Paris, 1-3-5 Blvd de Clichy, phone: 148782911. HONGKONG, JOLLY SOUND Ltd, Tower B, RM 1214-1215, Hungghom comm, centre 37-39, Ma Tau Wei Rd KLN H.K., phone: 36202025. ICELAND, SAMSTARF, P.O. box 1197, 121 Reykjavik, phone: 354153055. ISLD, CANARIAS, MUSIC ACCORD, S. Cruz de Tenerife Puerta Causeco 35, phone: 22-289506. ITALY, PROFESSIONAL EQUIPMENT SRL, 20142 Milano, Viale Famagosta 37, phone: 02-817839/02-8910241/2/3. NORWAY, VEDUM ELEKTRONIKK, N-1381 Heggedal, Aamotveien 2, phone: 2798990. PORTUGAL, JORSOM AUDIO VISUAL, 1000 Lisboa, Rue Eca de Queiroz 20-3 phone: 19562850. SPAIN, BOSE SA, 28027 Madrid, Aristoteles 3, phone: 4050611. SWEDEN, MONTEZUMA RECORDING, 10265 Stockholm, Kocksgatan 17, phone: 8436291. SWITZERLAND, ISLER AG, 8048 Zurich, Badenerstrasse 808-810, phone: 14321444. VENEZUELA, SOUND AND POWER, 1070 Caracas, P.O. box 76766, phone: 2223201.



# STUDIO SOUND

AND BROADCAST ENGINEERING

September 1988  
Volume 30 Number 9  
ISSN 0144 5944

## EDITORIAL

**Editor:** Keith Spencer-Allen  
**Production Editor:** Ann Horan  
**Production Assistant:** Carrie Love  
**US Commentator:** Martin Polon  
**Secretary:** Elaine Sweeney

## ADVERTISEMENTS

**Sales Manager:** David Reynolds  
**Display Sales:** Andrew Knox  
**Copy Controller:** Sue Chambers  
**Advertisement Production:** Chris Baillie  
**Executive Ad Manager:** Steve Haysom

## USA Advertising/Commercial Manager:

Robert J. Sinnott, 2 Park Avenue,  
18th Floor, New York, NY 10016.  
Tel: (212) 779-1212

## Japan and Far East Agent:

Media Sales  
Japan Inc, Tamuracho Bldg 3 3 14,  
Shimbashi, Minato-Ku, Tokyo, Japan  
Tel: (03) 504-1925. Telex: J25666.  
Fax: (03) 595-1709. Contact: Mikto Tsuchiya.

**Director:** Douglas G Shuard

## CIRCULATION

**Circulation Manager:** Sally White

**Editorial and advertising offices:** Link House,  
Dingwall Avenue, Croydon CR9 2TA, UK  
Tel: 01-686 2599  
International tel: +44 1 686 2599  
Telex: 947709  
E-mail: 78:DGS1071  
IMC: STUDIOSOUND-UK/US  
Fax: 01-760 0973

## CIRCULATION ENQUIRIES

Controlled circulation: Controlled Circulation  
Dept, Studio Sound, Link House Magazines Ltd,  
Central House, 27 Park Street, Croydon CRO  
1YD, UK

Paid subscriptions: Subscription Dept, Studio  
Sound, Link House Magazines Ltd, 120-126  
Lavender Avenue, Mitcham, Surrey CR4 3HP,  
UK

2nd class postage paid New York, NY: Postmaster  
please send address corrections to Studio Sound  
c/o Expeditors of the Printed Word Ltd, 515  
Madison Avenue, New York, NY 10022, USA

© Link House Publications plc 1988 all rights  
reserved

Printed in England



A LINK HOUSE  
PUBLICATION

Studio Sound and Broadcast Engineering  
incorporates Sound International and Beat  
Instrumental

Studio Sound is published on the second Friday  
of the month preceding the cover date. The  
magazine is available on a rigidly controlled  
requested basis, only to qualified personnel (see  
back page for terms)

Annual subscriptions are available for non-  
qualifying personnel or where more than two  
copies are required in a studio or small  
organisation as follows:

UK £24.00. Overseas surface mail: £30.50/\$52.

Overseas airmail: £52.50/\$89.

USA Airspeeded: \$70



MEMBER OF THE AUDIT  
BUREAU OF CIRCULATIONS

Total average net circulation of 16,666 per issue  
during 1987. UK: 6,073. Overseas: 10,593.  
(ABC audited)

# EDITORIAL

**T**he phrase 'new technology' always seems to me to be one of those dull catch-all expressions that writers and speakers like to hide behind, particularly when they are not sure what they mean themselves. New Technology can mean whatever you

want it to mean. New Technology will do whatever you want it to do—perhaps the most accurate definition of new technology you will find!

New technology, however, has a serious handicap from the end-user's viewpoint that did not affect old technology to anything like the same extent, and that is user knowledge. The end-user generally has to rely heavily on manufacturers for their information on equipment and developments at the front end of technology largely because the developments are almost all being made by employees of these manufacturers. There is no background pool of accumulated knowledge in the public domain as there is with analogue audio. This means that potential customers are very dependent on what manufacturers and their representatives will give in the way of information to make purchasing decisions.

The role of the pro-audio press within this is somewhat mixed. We are also quite dependent on manufacturers for information although we also have good access to purely academic correspondents but rarely in a way that would give worthwhile information to a non-technical customer. Also in these high-tech areas there has been a tendency to see the press purely as a marketing tool by generally keeping them unaware of the dialogue between the user and the manufacturer—and then the press just being expected to publicise the end result. We have our ways of getting information but in certain product areas we do remain reliant on the manufacturer and his replies to our questions.

So how do the manufacturers measure up to their new-found responsibility as a supplier of information? Well, the answer is that it varies quite considerably. The purpose of this piece is to draw attention to what we see as opportunistic marketing practices that really have no place within the aforementioned situation. With equipment increasingly under software control there must be considerable pressure on a salesman to say that his products will do everything asked of them—at least, they will tomorrow. How is the customer to evaluate this information when many of the competing companies will be making similar claims? There also appears to be a reluctance to publicise new software releases when they allow a product to fulfil a function that most thought it was capable of a year ago (unless you were one of the unlucky people who found out that it didn't after actually buying it).

The integration of software into the understanding of the end-user is really far greater than some manufacturers appear to give credit for. We have all learnt that 'it's only software' is a phrase that strikes where it hurts most. Telling the truth about a product's capabilities at a current moment will actually gain respect for that company—perhaps not immediately, I agree, as it may put it at a slight disadvantage until the customer has asked the same questions of the competing and apparently more sophisticated machines. When accurate information is hard to acquire a source of the truth is doubly valuable. I look forward to the time when a new software release is given the publicity that a new product does; because surely that is largely what it is if it gives a piece of hardware the ability to complete an identifiable new set of operations. When we reach this stage it will be far easier for customers to evaluate the systems available to find the one that suits them most.

A lesser area of concern is the situation where sales are announced as definite although this may be far from the case. I can think of at least half a dozen cases where we have been informed of the sale of a piece of new equipment only to find that the announcement was based on the flimsiest of evidence and did not actually materialise—largely because the customer was misled about the timing, costing or abilities of the equipment.

Unfortunately all this adds to the customer becoming confused and unsure of what to believe. This in turn makes him more sceptical of the advantages or benefits of a complete field of technology. If we ally this to the previously mentioned fact that the customer is required to look to manufacturers for his basic information on new technology we can see that he is being doubly affected by a misleading manufacturer's claims or statements.

I don't wish to appear to be unduly hard on companies active in these fields, many of whom are very good if asked the right questions, but when the nature of professional equipment is changing we need to have a maturity of marketing that reflects the cost and the seriousness of the product. Let's hope that rising technologies attract equally elevated marketing principles.

Keith Spencer-Allen

Cover inset: Rauch DVT-300S power amplifier



nd) • Lucasfilm • Marantz • Harris Broadcasting • Grundaig • Grundig • Grundig Systems • Ga  
 ett Broadcasting • Home Box Office • Kimball Electronics • Fox Broadcasting • JVC (Japan)  
 delipac • Ensoniq • Madrigal Audio • Electro-Voice • Meyer Sound Labs • Dukane • Harma  
 lectronics • dbx • National Public Radio • Hill Audio Ltd (England) • Image Video (Canada) • Danis  
 roadcasting • High Fidelity Magazine • Crutchfield • Ford Motor Co • Clarion • Len Feldman (Aud  
 agazine) • Clair Bros. Sound • Swiss Broadcasting • Logitek • Cello Ltd • MA/Comm • CBS-TV  
 nited Nations • Denon (Japan) • Carvin • National Bureau of Standards • Symetrix • Canno  
 lms • Grass Valley Group • Calrec (England) • BTS (Bosch-Philips) • Genelec OY (Finland) • Broa  
 ast Electronics • Datatek • British Broadcasting Corp • Continental Electronics • Bose • Fende  
 unn Division • BGW Systems • Consumers Union • TAC (England) • Benchmark Media Systems  
 ela Audio (Holland) • Barcus Berry Electronics • Audiotronics • Lexicon • Audiotone • Dolby Labor  
 ries • Audio-Technica U.S. • Matsushita (Japan) • Audio Technologies • UREI Division of JBL  
 akamichi (Japan) • Universal Studios • Moseley Associates • Jensen Transformer • KEF (Eng  
 nd) •

# THANKS!

ony Broadcast • TVB (Hong Kong) • Ramsa/Panasonic • Modulation Sciences • Rane • AK  
 coustics (Austria) • Rauch Precision (England) • Boeing • Sonosax (Switzerland) • Rauland Borg  
 ony (Czechoslovakia) • RCA Consumer Electronics • NBC-TV • RTBF (Belgium) • Sunkyong Magne  
 cs (Korea) • RTS Div Compact Video • SAJE (France) • NTP (Denmark) • Samsung (Korea) • OF  
 Austrian Bdcstng) • SCV Audio (France) • Capitol Records • Sescom • Oxmoor • SGS Microele  
 ronica (Italy) • Philip Drake (England) • Showco • Plantronics • Siemens (Germany) • Air Studic  
 London) • SONO Magazine (France) • ADS • Sony (Germany) • Neve Electronics (England) • Soun  
 raft (England) • Philips (Germany) • Studer-Revox (Germany) • Burr Brown Corp • Precision Mon  
 thics • Suddescher Rundfunk (Germany) • Tandberg (Norway) • U.S. Military Academy • Sony Pl  
 oducts (ex-MCI) • Viennatone (Austria) • RCF (Italy) • Voice of America • Warner Brothers • Swe  
 sh TV • Waveframe • Sharp (Japan) • Westinghouse Broadcasting • Shuttlesound Ltd. (England)  
 Wheatstone/Audioarts • Solid State Logic(England) • Willi Studer(Switzerland) • Norddeusch  
 undfunk(Germany) • Studer-Revox America • Yamaha (Japan) • Boeing • Starkey • Ensoniq  
 GW Systems • 3M/ITC • Daimler-Benz (Germany) • Stereo Review • Georg Neumann (Germany)  
 Counterpoint • Apogee Electronics • General Instruments • Sony (Japan) • Analog Devices • Son  
 France) • Mitsubishi • Altec Lansing • CBS Records • ACS Communications • Beltone • W  
 Studer (Germany) • Acoustic Research • Storer Cable • ABC-TV • NEC (Japan) • Otari (England)  
 Pacific Recorders & Engineering • Bogen • Sydney Opera House (Australia) • Allen Organ • Phil  
 Research (England) • Simpson (Australia) • Lullat Music (France) • Plantronics • Cello Ltd (En  
 and)

To these audio industry leaders (and hundreds of others) who have purchased the recognized standard in audio testing, Audio Precision System One.

Before you buy any audio test system, shouldn't you learn what our users

already know? For full information, call Audio Precision at 1-800-231-7350 (from outside the U.S., call (503) 627-0832) or write to Audio Precision, P.O. Box 2209, Beaverton, OR 97075

## System One

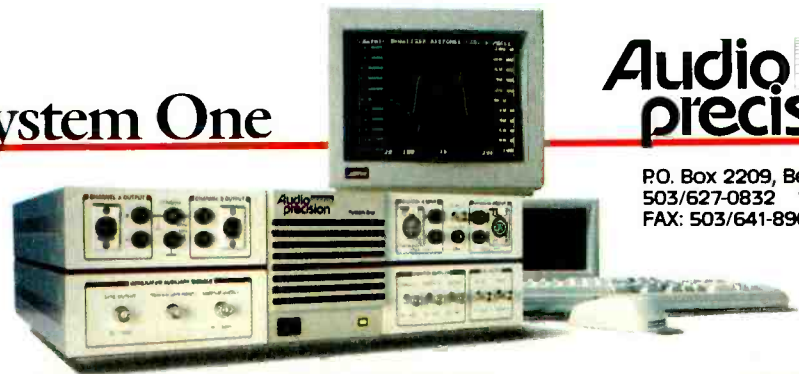

## Audio precision

P.O. Box 2209, Beaverton, OR 97075  
 503/627-0832 1-800/231-7350  
 FAX: 503/641-8906, TELEX: 283957 AUDIO UR

**INTERNATIONAL DISTRIBUTORS** Australia: J.N.S. Electronic Industries 3 439 1430, Austria, Eastern Europe: ELSINCO elektron GmbH, Vienna 222 87 17 51, Benelux: Trans European Music NV, Zellik, Belgium (02) 466 50 10, Canada: Glentronix Ltd. (416) 475-8494, China, Mainland: Harvest Company, Hong Kong 5-782253, Denmark: SLT 1 71 33 44, Finland: Intlo OY 358-0755 7711, France: ETS Mesureur (1) 45 83 66 41, Germany, West: RTW GmbH 221 70 91 30, Hong Kong: TRP Consumer Electronics, Ltd. 5650 517, Israel: Koliner Ltd. 326 3298, Italy: Medea S.r.l. 2 445 38 28, Japan: TOYO Corporation 3 279 0771, Korea: Myoung Corporation 7849942, New Zealand: Audio & Video Wholesalers, Ltd. 71 73 414, Norway: Lydcnconsult 35 40 67, Portugal: Acutron ELA, Singapore & Malaysia: TME Systems PTE Ltd., Singapore. 286 4608, Spain: Telco Electronics, S.A. 231 7840, Sweden: Tal & Ton AB 31 80 36 20, Switzerland: Technad SA 21 35 35 01, Taiwan: Litz Technologies Ltd. 7036280, U.K.: Scenic Sounds Equipment Marketing Ltd. 1 387 1262



# No One Takes The Rigors Of The Road As Seriously As BGW.



It's true. Next to BGW Grand Touring Amplifiers, other so-called touring amps are just "tourists." Our Grand Touring Amps deliver the power, performance and features you need on the road. And they're built to keep on doing the job under conditions that send other amps packing.

Take our new heavy-duty model **GTB**. You won't find this combination of road-ready features in a Crown Macro-Tech, a QSC Series III, or ANY other power amp (except our own flagship model **GTA**).

- One-piece welded steel chassis withstands rough rides and load-outs.
- Forced-air cooled, massive extruded aluminum heat sinks provide continuous operation in hot, crowded racks.
- Two ohm capability allows BGW amps to drive more speakers with fewer amps — saving money and rack space.
- Magnetic circuit breaker/front panel power switch affords instant overload protection. (You have to pull a Crown out of the rack to change a 20¢ fuse!)
- DC Crowbar speaker protection — a BGW first since 1971 — provides positive protection for expensive speakers, without relays.
- Modular construction means fast, easy field service.
- 100% discrete circuitry (no IC's) with low feedback delivers superb sonic performance.

- Active balanced inputs with looping XLR-type connectors provide greater than 70 dB common mode rejection — some of our competitors don't even spec this crucial parameter. Optional transformer-isolated inputs offer absolute isolation.
- Switchable subsonic filters protect low frequency drivers from excursion limit damage.
- Crossover capability — two BGW cross-over cards can be mounted in our touring amps, safe from abuse.
- Large LED indicators maintain readability across the stage.

A touring amp with all these essentials, plus legendary BGW reliability and sonic integrity, will make our competition nervous — especially since the GTB costs no more than their "comparable" amps. Too bad for them. But peace of mind for you, when you go with BGW Grand Touring Amplifiers.

You know a professional tour is no place for "tourists." (And neither is a fixed-location amp rack, right?) So call BGW Systems toll free at **1-800-468-AMPS** (in USA and Canada) to arrange a demo of our new "workhorse" model **GTB** or the "2.4 Horsepower" model **GTA**.



BGW SYSTEMS INC.  
13130 SOUTH YUKON AVE.  
HAWTHORNE, CA 90250  
Tel: 213-973-8090  
Fax: 213-676-6713

**ENGINEERED TO BE THE BEST**

BGW Products Are Distributed In The UK By:  
**PRO-BRITRO LTD, 35 BRITANNIA ROW, LONDON N1 8QH ★ TEL: 01-226 1226**  
**DISTRIBUTION OPPORTUNITIES ARE AVAILABLE**  
In Selected Countries. Contact BGW Systems. Telephone: 213-973 8090 Fax: 213-676 6713

# PROCOM INTERCOM WITH SINGLE-BUTTON SELECTION



Patents pending

DILESS ProCom is a new kind of full-duplex intercom, with convenient single-button selection. Every kind of connection is possible: station-to-station, station-to-all, all-to-all, or any combination, up to 11 simultaneous calls. You hear no unnecessary messages – only those which concern you directly.

No line can be busy, so your message will always reach the other party.

Stations are connected with standard three-core microphone cables. ProCom is also compatible with other systems currently in use, so you can upgrade your existing system by adding a central unit and keypads.

For further information, contact your local dealer, or

## DILESS

DILESS Ltd.  
Melkonkatu 16 A, SF-00210 HELSINKI, FINLAND  
Phone: +358-0-679 271. Facsimile: +358-0-671 910  
Telex: 100 1825/Arnn: DILESS

REPROSTUDIO LUOMANEN & RAUNIO OY  
ELIMÄNKATU 12 E, 00510 HELSINKI 51, ☎ 730 255

# ABACUS ELECTRICS

*For exacting engineers, a precise instrument, the **ARTA 80** third-octave audio analyser.*

- Incorporates precision pink-noise generator.
- Ultra-bright LEDs for clear display and battery power saving.
- Thirty non-volatile memories. View any memory simultaneously with "live" display.
- RS232 serial port for down-loading memory data to a personal computer.

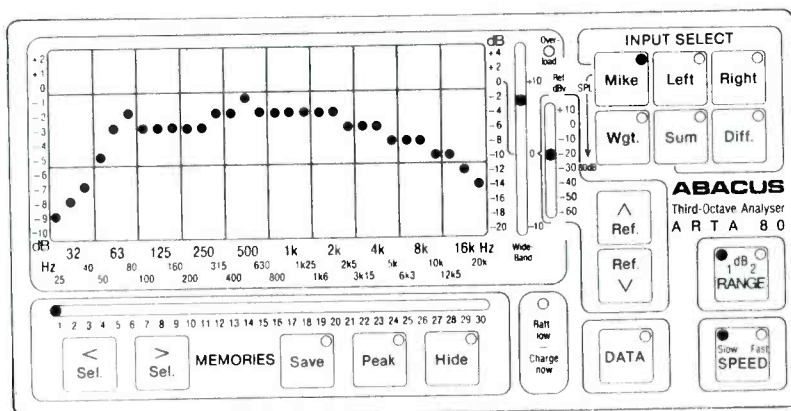

Battery portable – size 24 x 16 x 8 cms. weighs only 1.5 kg.

Microphone plus two line inputs.

Parallel printer port for plotting spectrum graphs directly on dot-matrix printers.

12dB or 24dB display range, fast or slow response.

## ABACUS ELECTRICS

10 Barley Mow Passage, Chiswick, London, W4 4PH, U.K.  
Telephone (01) 994 6477 Telex 8811418 SPACES G



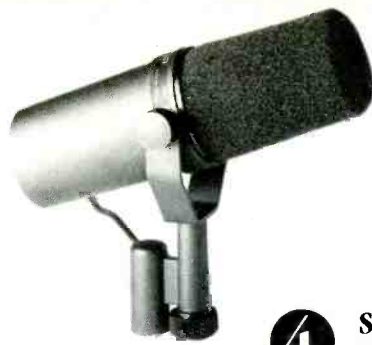

**1 SM48 Dynamic**  
 Perfect for vocalists on the way up. Many of the outstanding performance features, similar appearance, and ruggedness of the world-standard SM58, at a most affordable price. Delivers the famous Shure sound, and features the uniform cardioid polar pattern and distinctively enhanced upper mid-range of the SM58. Rugged, reliable and dependable.



**2 SM85 Condenser**  
 The SM85 is ideal for the most demanding live applications as well as broadcasting and studio requirements. It exhibits remarkably low distortion (right up to overload point) over the entire audio spectrum, considerably less than other more expensive condensers. Controlled low frequency roll-off, tailored mid-range and clean, scintillating high frequencies set this mic in a class of its own.

**So you thought Shure only made one vocal mic**

**4 SM7 Dynamic**  
 The SM7 is among the finest studio professional dynamic microphones in use today. It features a wide range, very smooth frequency response with graphic response-tailoring switches to allow the choice of four different mic response curves. It has an accurate, symmetrical cardioid pick-up pattern, uniform with frequency and provides maximum rejection of unwanted background noise.



**5 SM87 Condenser**  
 The SM87 is a studio-quality supercardioid condenser with Shure's legendary road mic ruggedness. New cartridge element and highly directional polar pattern enable the SM87 to reject unwanted sounds and produce high gain before feedback. Its vocal-contoured response provides tremendous flexibility at the mixing board and a warm, smooth, naturally rich sound. High SPL levels are handled effortlessly.

**3 SM96 Condenser**  
 This vocalist's microphone has features usually found in much more expensive condenser units. Smooth response has a controlled low-end roll-off to correct for proximity effect, and a slight presence rise to enhance vocals. Efficient 3-leg capsule suspension system minimizes handling noise. Optimized output level to control overloading. Steel-shielded against hum and RF pickup. Operates off phantom power, plus the convenience of automatic battery switchover.



**6 869 Condenser**  
 An economically priced electret condenser mic, the 869 is an outstanding performer for general sound reinforcement and music applications. The 869's controlled upper mid-range presence rise and low frequency roll-off give optimal clarity and crispness to voices. It's as rugged and reliable as you'd expect from Shure and can be phantom powered or uses a 1.5 volt AA battery.

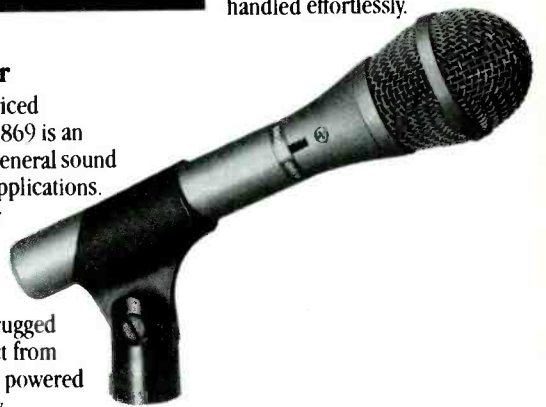

**SHURE®**

HW International, 3-5 Eden Grove, London N7 8EQ. Tel: 01-607 2717

# RTW Peak Programme Meter



**PPM 1109 stereo**  
Analog + Digital  
Audio Peakmeter

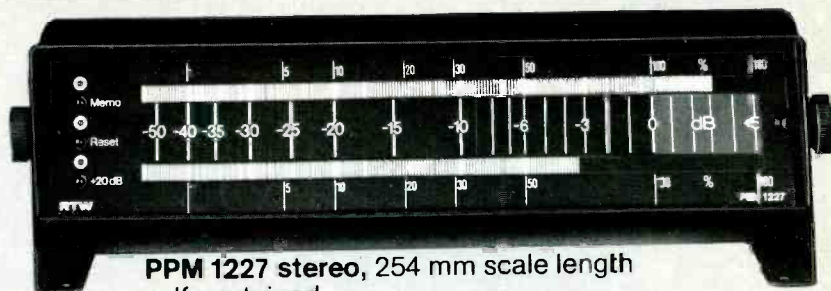

**PPM 1227 stereo**, 254 mm scale length  
self contained

**Model 1206**  
self contained

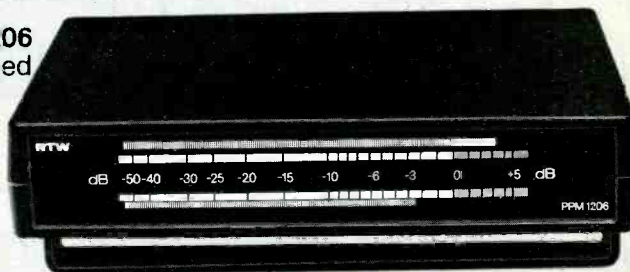

Peak programme meters  
for monitoring the peak level  
in analog and digital audio



**PPM 1118**  
2-Channel  
Module

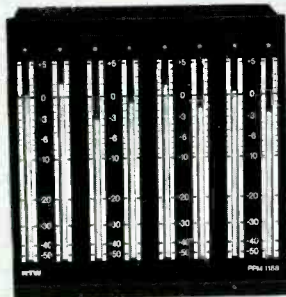

**PPM 1188**  
8-Channel  
Module

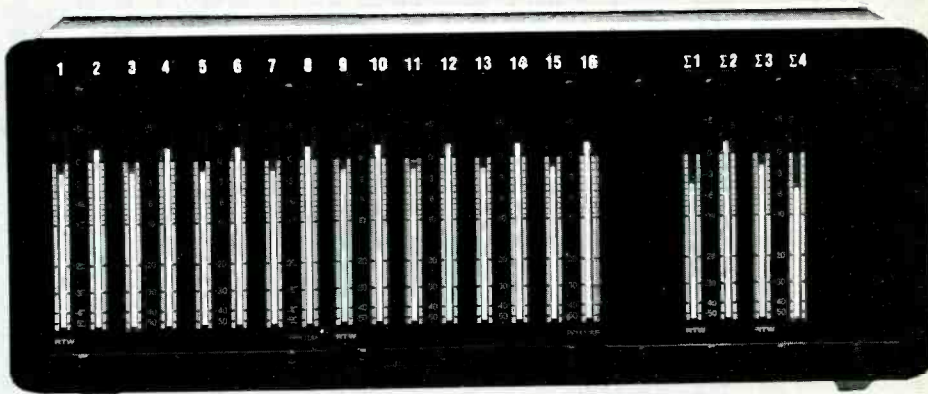

**Multi-Channel Unit 16-4 and 24-4**

# RTW Correlator

Compatibility meter  
displays the phase correlation  
of stereo recordings

**Correlator Model 1170**



**Correlator Model 1160**

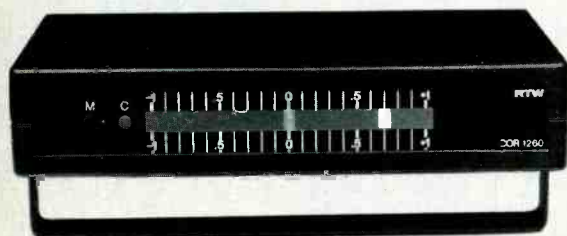
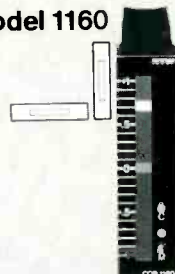

**Correlator Model 1260**  
self contained

# RTW

**RADIO-TECHNISCHE WERKSTÄTTEN GMBH**

Telephone (2 21) 70913-0 · Tx 8 885 217 · Fax (2 21) 70913-32  
Elbeallee 19 · Post Box 7106 54 · D-5000 Köln 71 · W.-Germany

**Austria:** ACOUSTA ELEKTRONIK, Tel. (662) 84 61 64 · **Australia:** SYNTEC PTY, Tel. (2) 4 06 47 00 · **Belgium/Netherlands:** P.A.C., Tel. NL: (40) 42 44 55 · **Denmark:** S.C. SOUND APS, Tel. (2) 99 88 77 · **Finland:** AV-POINT ICS AB, Tel. (0) 5 65 36 33  
**France:** SCV-AUDIO, Tel. (1) 48 63 22 11 · **Great Britain:** AUDIO & DESIGN LTD., Tel. (73 57) 45 45 · **Italy:** ROBOTECNICA S.R.L., Tel. (2) 242 81 47 · **Japan:** ELECTORY CO. LTD., Tel. (3) 9 50 62 66 · **Norway:** SIV. ING. BENUM AS, Tel. (2) 14 54 60  
**Switzerland:** AUDIO BAUER AG, Tel. (1) 4 32 32 30 · **Switzerland:** PROFAX AG, Tel. (1) 4 93 22 44 · **South Africa:** ELTRON LTD., Tel. (11) 7 87 03 55 · **Spain/Portugal:** SINGLETON PROD., Tel. E: (3) 2 37 70 60 · **Sweden:** AV MEDIA AB., Tel. (7 55) 6 54 98  
**USA:** ESL ELECTRONIC SYSTEMS LAB., Tel. (3 05) 7 91 15 01



# ASONA

## for Complete Cassette Production

The WINDER 2015 is designed for universal installation. Completely self-contained; may be plugged in wherever needed. No compressed air or external vacuum required. Compact size; easily transported with integrated carrying handles.

**Winder 2015**

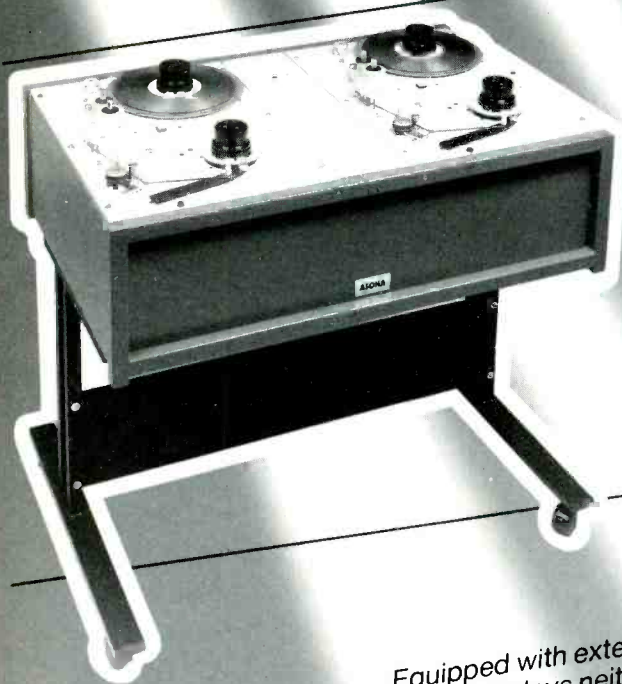

The newly developed ASONA 301 Twin Slave Unit is equipped with an advanced studio type transport mechanism with electronic control of the capstan and reel motor. For use with Asona high speed Loop-Bin for a duplication ratio 1 : 32.

**Twin-Slave 301**

Equipped with extended range duplicating electronics. Employs neither compressed air nor vacuum and requires only single-phase mains power. Low maintenance requirements, low personell costs. Robust construction – rational design – economical price.

**Loop-Bin MK 2**

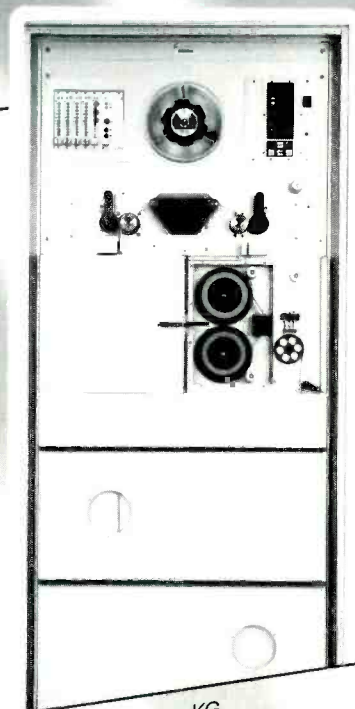

# ASONA

**We can tailor a cassette production system to your needs.  
Write or call for a proposal.**

ASONA is manufactured in West Germany by ASONA AUDIO-TECHNIK GmbH & Co. KG,  
Bahnhofstraße 60, D-7634 Kippenheim, Tel.: (0) 7825-1068, Telex: 754325 auvis d

**CUSTOM  
WOUND**

• JAPANESE TAPE • 5 SCREW SHELLS •

# CASSETTES

**MASTERCHROME**  
High Bias.  
Mastering and  
Critical Applications

**MASTERFERRIC**  
Normal Bias.  
Mastering and  
Critical Applications

**STUDIOFERRIC**  
Normal Bias.  
Duplication and  
General Purpose

	50+	250+	1000+	50+	250+	1000+	50+	250+	1000+
<b>C10</b>	36p	35p	34p	33p	31p	30p	26p	24p	22p
<b>C30</b>	46p	45p	44p	38p	35p	34p	31p	29p	26p
<b>C45</b>	52p	51p	50p	42p	40p	39p	33p	31p	28p
<b>C60</b>	66p	65p	64p	54p	53p	52p	38p	36p	34p
<b>C90</b>	90p	88p	86p	74p	72p	70p	48p	42p	40p

All lengths available from C1 to C95

	50+	250+	1000+	50+	250+	1000+	
<b>Library (Standard) Cases</b>	7p	6½p	6p	Library (Clear) Cases	8p	7½p	7p



**LONDON SALES: Battersea Wharf,  
Queenstown Road, London SW8 4NP  
Tel: 01-627 3760**

**NATIONAL SALES: PO Box 19,  
Stratford-on-Avon, Warwickshire CV37 6SA  
Tel: (0789) 68579**

## PROFESSIONAL SERIES— FULLY PACKAGED

	10-99	100-249	250-999	1000+
<b>C7</b>	34p	32p	30p	28p
<b>C10</b>	35p	33p	31p	29p
<b>C15</b>	36p	34p	32p	30p
<b>C20</b>	38p	37p	36p	34p
<b>C30</b>	44p	40p	38p	36p
<b>C45</b>	46p	42p	40p	38p
<b>C60</b>	52p	46p	44p	42p
<b>C90</b>	60p	56p	52p	48p
<b>C120</b>	76p	72p	70p	68p

All Prices Exclude VAT. P&P Free on Orders over £80 ex VAT. Small Orders P&P £4.00

## WARNING!

From Professor Mad

*These cassettes could  
seriously damage  
your pre-conceived  
notions.  
Sample  
them at  
your  
peril.*

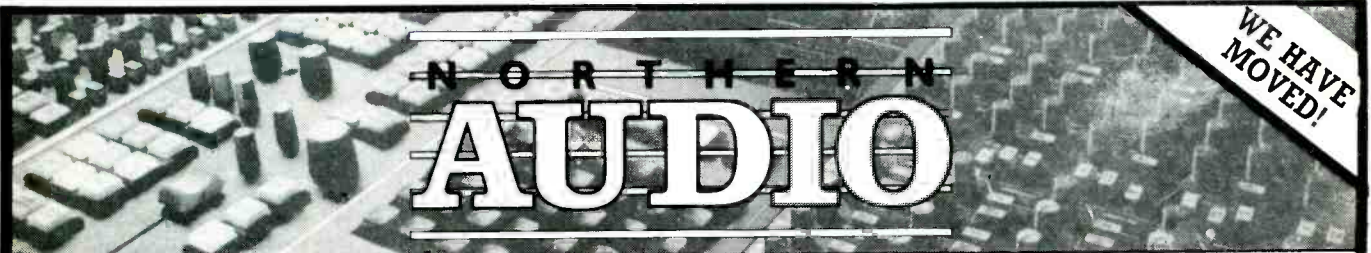

### SECOND HAND CONSOLES

1 SSL 4000e 40 frame 32 fitted with bargraphs. Total recall patch to the right no Prod desk. 4 years old	£65,000.00
2 SSL 6000e 40 frame 32 fitted with bargraphs, total recall patchbay	£75,000.00
3 Neve Custom console 36/4/24 with direct outputs completely refurbished as new	£35,000.00
4 Neve 8128 32 input console, 4 years old, no Auto	£39,500.00
5 MCI 636 36 input with JH50 Automation all the last MCI updates in superb order	£23,500.00
6 Soundtracs CM4400 28/8/16	£7,500.00
7 TAC Matchless, 2yrs old, 26/24, good condition	£8,000.00
8 Raindirk Concord 28 input patch and stand	£5,500.00
9 Soundcraft 2400 28 input, 4 years old	£10,500.00
10 Soundcraft 800b 16 input	£2,500.00
11 TAC Matchless 32 input with patch and stand	£9,500.00
12 TAC Scorpion 28/12/24/2	£6,500.00

### SECOND HAND TAPE MACHINES

1 Otari MTR 90 Mk2 with autolocator	£18,500.00
2 Studer A800 Mk3 auto and remote, 2 years	£28,000.00
3 Soundcraft 762 Mk2 24 track with 9 memory	£10,500.00
4 Soundcraft 760 Mk1 24 track standard remote	£5,950.00
5 Otari 5050 Mk2 4 track (age not known)	£500.00
6 Sony 3324 with autolocator, 18 months old	£48,000.00
7 Soundcraft Mk3 24 track with 9 memory remote	£9,500.00
8 Soundcraft Mk1 16 track remote	Offers
9 Revox B77 Mk2 high speed	£550.00
10 Studer A80 ¼" master	£1,950.00
11 Studer A800 Mk3 16 track with remote	£16,000.00

### SECOND HAND KEYBOARDS

Bechstein 9ft grand piano in rosewood	£7,500.00
Bosendorfer concert grand	£27,000.00
Fairlight III 16 voice full spec, 18 months old	£29,500.00

### SECOND HAND REVERBS

AMS 1580 Delay 13.2 a 1, 6 blocks and declutch	£3,900.00
AMS Audiofile 2in 8 out 1 hours hard disc memory	£30,000.00
Quantec room simulator	£3,500.00
SRC Friendchip SMPTE time clock	£995.00
MDB Window recorder 16 bit computer, 1 year old	£995.00
Bel Digital BDE 2400, 24 secs delay (two pieces)	£1,250.00
Dolby 372 battery operated stereo system (mobile)	£1,850.00
Dolby 362 Stereo system 2 units	(each) £425.00
Dolby SP system 24 track Dolby "A"	(each) £7,500.00
Dolby 360 system	(each) £350.00
Lexicon 224X with lark	£4,000.00
Lexicon 200	£1,850.00
Tymeline Synchroniser two modules with manuals	£2,500.00
AMS RMX 16 reverb unit	£3,000.00
AMS RMX 16 reverb unit	£2,500.00
AMS DMX 1580s with 13 seconds and 1.6 sec and locks	£4,500.00
UREI 1176 Comp/Lim, 3 units	(each) £475.00
UREI 813 monitors, 4 units	(each) £275.00
JBL 4430 monitors	(pair) £1,250.00
JBL 4313 monitors	(pair) £595.00
Neumann U87i, 4 units	(each) £650.00
Neumann U47iFET, 4 units	(each) £800.00
AKG 414 EB, 2 units	(each) £395.00
AKG 451 with CK1 Capsules, 4 units	(each) £95.00
AKG D12, 2 units	(each) £95.00
Sony C48, 1 unit, offers	£375.00
DBX 162 Comp/Lim, 1 unit	£395.00
Drawmer DL221, 2 units	(each) £225.00
Drawmer DL201, 4 units	(each) £175.00
TC Electronics, effects	£995.00
Nemesis Q4D, parametric E/Q, new ex demo	£495.00
Teac Q4D noise reduction units, 4 in stock	(each) £135.00
Yamaha rev 7	£750.00
DBX 160x ex demo	£165.00

WE ARE CONSTANTLY ON THE LOOKOUT FOR USED EQUIPMENT...  
NOTICE

We also act for studios as selling agents. Let us handle the hassle of getting rid of unwanted items. It does not matter where you are in the world. Why not drop us a line listing your equipment or ring us on the numbers below for the best rates. We assure you of our best attention and service plus the utmost confidentiality at all times.

FOR A COMPLETE STOCK LIST WRITE OR  
RING TONY BAYLEY ON  
**0565-830005**

GREYLANDS STUDIOS, MERESIDE ROAD, MERE, KNUTSFORD, CHESHIRE WA16 6QQ. TELEFAX: 0565-830405. TELEX: 666597 NAUDIOG



# KINDLY NOTE

Studio Spares are moving  
to 61/63 Rochester Place,  
Camden Town, London NW1 9JU,  
on Monday 22nd August 1988.

The move provides customers  
with free on-premises parking  
and Studio Spares with  
6,500 square feet of new  
warehouse space.

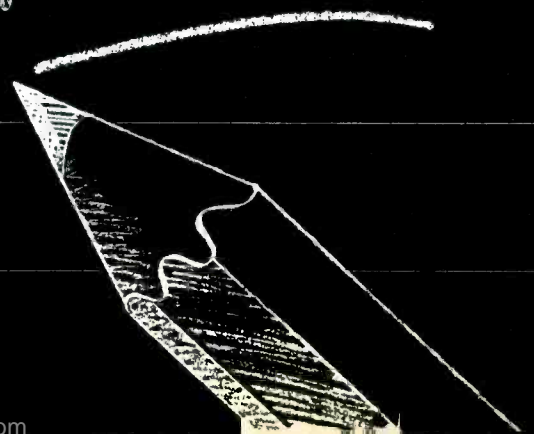

# NEWS

## IBC Technical Papers

The Technical Programme Committee of the International Broadcasting Convention has selected 100 papers for presentation by experts from 11 countries at IBC '88, to be held in Brighton from September 23rd to 27th. The papers cover in depth the various technical developments in sound and television broadcasting and allied fields, and include high

definition television, direct broadcast satellite and cable systems, recording, studio and OB equipment, cameras, transmitters, receivers, measurement techniques and new services. The opening session will include speakers outlining the impact of evolving technology on future broadcast activity.

## Exhibitions and conventions

**September 3rd to 6th** Annual Festival Of New Age and Synthesiser Music, St John's, Smith Square, London SW1. Tickets at £5 to £10 are available from the box office on 01-222 1061.

**September 8th to 12th** 22nd SIM-HI-FI-IVES, Milan Fair Pavilions, Milan, Italy.

**September 11th to 24th** Light & Sound Show, Olympia, London, UK. Contact: Tony Andrew, Secretary, Professional Lighting and Sound Association. Tel: 0323 410335. Fax: 0323 646905.

**September 23rd to 27th** International Broadcasting Convention '88, Metropole Conference and Exhibition Centre, Brighton, UK.

**September 29th to October 3rd** International Broadcasting and Telecommunications Show, South Pavilion, Milan Trade Fair, Italy.

**September 29th to October 3rd** MITAS '88 Show of Technology Equipment and Services for Entertainment (including discotheques, ballrooms, theatres, cinemas, congress centres and organisations), South Pavilion of the Milan Trade Fair, Italy.

**September 29th to October 3rd** MeM—Mediterranean Market (International Market of Audio/Video programmes and Services), South Pavilion of the Milan Trade Fair, Italy.

**September 30th to October 9th** BBC Radio Show, Earls Court, London, UK.

**October 5th to 11th** Photokina, Cologne, West Germany. Contact KölnMesse, Messe- und Ausstellungs-GmbH. Tel: (221) 821-1. Fax: (221)

821-2574.

**October 11th to 13th** Sound Broadcasting Equipment Show, Albany Hotel, Birmingham, UK. Admission by invitation. Contact: Point Promotions. Tel: 0734 583086.

**November 3rd to 6th** 85th AES Convention, Los Angeles Convention Center and Los Angeles Hilton, Los Angeles, CA, USA.

1989

**January 21st to 25th** MIDEM, Palais des Festivals, Cannes, France. Contact: Peter Rhodes, International Exhibition Organisation Ltd, 4th Floor, 9 Stafford Street, London W1X 3PE, UK. Tel: 01-499 2317.

**February 21st to 22nd** Sound '89, Heathrow Penta Hotel, London, UK. Contact: Sound & Communications Industries Federation, Slough, Berks. Tel: 06286 67633. Fax: 06286 65882.

**March 7th to 10th** 86th AES Convention, Congress Centre, Hamburg (CCH), AM Dammtor, D-2000 Hamburg, West Germany.

**April 28th to May 2nd** NAB, Las Vegas, USA.

**June 7th to 9th** APRS 89, Olympia 2, London, UK. Contact: APRS Secretariat. Tel: 0923 772907.

**June 17th to 23rd** ITS Montreux, Switzerland.

**October 3rd to 9th** World Broadcasting Symposium, Geneva, Switzerland.

**October 4th to 7th** Broadcast 89, Frankfurt, West Germany.

1990

**March 30th to April 3rd** NAB, Atlanta, USA.

## News from the AES

The summer is traditionally our holiday period and meetings start again in September. The first will be our **Lecture Visit to Solid State Logic** at their factory near Oxford on Tuesday, September 13th. There will be a lecture on their new digital console and a tour of their facilities. This event is for members only, please apply to the Secretariat for further details.

Next will be the **British Section Annual Dinner**, which will be held on October 13th at the Queen Elizabeth II Conference Centre.

Subjects to be covered later this year and early next will include Loudspeaker Cluster Design, BBC Radio Data Transmission, Uses of Fourier Transforms, Acoustic Modelling, Mixing Consoles, Design of Pipe Organs, Studio Acoustics and

Analogue/Digital Converters. Details and dates will appear in due course.

The other major event in the calendar is the **85th AES Convention in Los Angeles** between November 3rd to 6th.

The AES publishes many books on audio-related topics as well as Convention Preprints, Standards etc which provide a wealth of technical information. Also two of our members have written books: John Borwick *Loudspeaker and Headphone Handbook* and John Watkinson *The Art of Digital Audio*.

For further details on any of the above or information on joining the AES, please contact: **Heather Lane, AES British Section, Lent Rise Road, Burnham, Slough SL1 7NY, UK. Tel: 06286 63725.**

## Agencies

● Selectron (UK) Ltd has taken over sole distribution of Whirlwind leads, cable systems and spares. Apart from offering an increased product range of cables, the company will also be manufacturing complete custom multicore systems. Selectron, Selectron House, Springhead Enterprise Park, Gravesend, Kent. Tel: 0474 60521.

● Australian distributor **Rebel Audio** has been appointed to represent the following manufacturers in that area: Astatic, Audio/Digital, Bel Electronics, Community Light & Sound, DOD, Digitech, Audio Logic, Greystone, Micro Audio, Nemesis, Pro Co, Schoeps, Sescor, Tantek and White

Instruments.

● **Allen & Heath** have appointed Thatched Cottage Audio of Wendy, near Royston, Herts, as agents for *Sigma* consoles. Apart from selling pro-audio equipment, Thatched Cottage also runs various educational courses at their own studios, one of which has a *Sigma* installed.

● **Coach Audio Sales** have been appointed exclusive dealers for **AMS/Calrec** products in West Germany and Luxembourg. The company has also opened new branches in France (c/o Alain Vanzella, Tel: 0877 70000) and Spain (c/o Andreas Kalcker, Tel: 064 410429).

## Fane by Court

Fane Acoustics has entered into an agreement with acoustic systems design consultant Stephen Court to produce a new range of professional enclosures and monitors, to be marketed under the banner of 'Fane by Stephen Court'.

The new products will be aimed at clubs, theatres and other venues that

require specialist installations of all sizes. Court will also continue to operate independently in the design, manufacture and installation of recording studio monitors.

Fane Acoustics Ltd, 286 Bradford Road, Batley, W Yorks WF17 5PW, UK. Tel: 0924 476431.

## Courses and seminars

**September 3rd to 9th** APRS Engineers' Training Course, University of Surrey, Guildford, UK. Contact: APRS Secretariat, Rickmansworth, Herts. Tel: 0923 772907. Fax: 0923 773079.

**September 6th to 8th** 'TEF Basics and applications to transducers and room acoustics', Hotel Mercure, Braunschweig, West Germany. Contact: Werner Keller, ANT Wolfenbüttel. Tel: 05331/83-366.

**September 20th to 22nd** Digital Processing of Signals in

Communications, Institution of Electronic and Radio Engineers, Loughborough University of Technology, UK.

**November 3rd to 6th** Reproduced Sound 4, Hydro Hotel, Windermere. Contact: Institute of Acoustics, 25 Chambers Street, Edinburgh EH1 1HU, UK.

**November 22nd to 24th** Digital Information Exchange, Private Suite, London Zoo. Contact: DIE, PO Box 46, London SW6 7BU. Tel: 01-381 1991.



# G

FILE

D A T A B A S E

## SYSTEM: S30

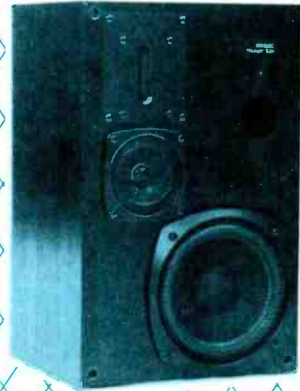

Compact tri-amp active monitor. 105db SPL per pair. 43Hz to 20KHz response. Fully integrated and protected. Standard and Nearfield versions available for small control rooms, mobiles and console mounted applications.

## STATEMENT: BATTERY STUDIOS



For our new CD editing suite we needed detail without fatigue. The GENELECS did this so well that we bought an additional pair for our transfer room.

## SYSTEM: 1024B



Large tri-amp active monitor. 115db SPL per pair, 32Hz to 20KHz response. Completely integrated system for precise monitoring in medium sized control rooms.

## STATEMENT: TAPE ONE



We first heard these speakers at Masterworks in New York and we really had to try them out. Scenic Sounds put them in, the engineers loved them so thirty-six hours later, we bought them.

## D I S T R I B U T I O N

GENELEC



SCENIC SOUNDS EQUIPMENT  
MARKETING LIMITED  
Unit 2 10 William Road  
London NW1 3EN  
Tel 01-387 1262

# NEWS

## The Gateway School of Music and Recording Technology

Training in the audio industry is a subject that tends to polarise people into the 'fors' and the 'against's'. A cynic might say that those who have themselves undergone formal training will automatically be included among the 'fors', those that haven't are likely to be 'against'.

Most people will agree, however, that if they ever have to go into hospital, they hope the doctor who treats them will have undergone a thorough course of study and is not learning 'on the job'. The same might be said of the civil engineer who designs tunnels and bridges. In these two situations, a competent practitioner—of medicine or engineering—will have undergone not only an intensive period of formal study but also lengthy periods of supervised experience in the real world of work.

Audio engineering is becoming an increasingly complex field. Although no-one's life has ever depended on getting the level on tape correct (has it?), it is essential that an engineer has a firm grasp of the principles involved. The learning process can be slow. The function of training in an ideal world should be to short-circuit this process. A tool to be used in the quest to increase the quality of the end product.

Well known in the field of audio training is the Gateway School of Music and Recording Technology. It was started back in 1977 by Dave Ward and Lise Monck as a 4-track studio, developing over the years into a 16- and then a 24-track studio. The name 'Gateway' comes from the studio's original location in Balham, London—'The Gateway to the South'. About five years ago, Gateway started to run courses on studio equipment and techniques. They had found that many people in the audio industry just don't have time to keep up with new developments.

Gateway's aim was to shorten the learning curve.

As has been reported recently in *Studio Sound*, Gateway have now relocated and have embarked on a co-operation with Kingston Polytechnic in Surrey. An interesting juxtaposition of public and private education.

The background to this development is that Kingston Polytechnic recently built a new music studio, an adventurous octagonal building with acoustic design by Sandy Brown. Then Kingston's Senior Music Technician, Andy Smith, had the bright idea of getting together with Gateway to take advantage of their recording and music technology experience. This marriage was advantageous to both sides—Gateway's lease on their old premises was about to run out and

Kingston Polytechnic were able to finish and equip their new studio.

Negotiations took place between Gateway and Kingston Polytechnic's Head of Music, Edward Ho, and the Polytechnic's directorate, during the 1987 summer vacation. These negotiations culminated in Gateway equipping a 24-track control room in the new studio and moving in lock, stock and barrel, ready for action in October that year. Kingston Polytechnic use the studio for four days during the week, Gateway have it at weekends and in the Polytechnic's vacations. Gateway provide music technology instruction for Kingston Polytechnic's music students and have a suite of rooms in the Music Department, which they can use for their own courses.

Since Gateway have several years' experience in training for the audio industry, one might expect their educational ideas and courses to be well developed.

Dave Ward describes some of Gateway's courses: "All our courses presuppose no knowledge of sound recording at all, we start right from scratch. They are all very much production based.

"We run three different types of courses—the first is a one week intensive course and we tend to have a lot of people from retailers and the manufacturing side of industry. It's orientated towards what's happening in sound recording. We have another course, which is a month long, where we can go into much greater depth and get more hands-on experience. Both these courses are full time. Another course is one year part time where students come for one weekend a month and one evening a week."

These are courses that cover sound engineering in general, obviously the depth Gateway goes into depends on the length of the course. There are other courses that are more specialist, for instance the MIDI Sampling and the Servicing weekend courses.

What sort of people come to Gateway and what topics do the basic courses cover?

"Our courses are not structured

towards training people for non-existent jobs, they are more orientated towards industry training. Some people are sponsored by industry, some by a local authority. Some are self-sponsored.

"Our one week course covers soundwave theory, the basic programme chain, concepts of multitrack recording, equalisation, compression, noise gates, working with reverb. The month-long courses cover these areas but in greater depth and with more practical experience in the different fields.

"We have a follow-up to the week-long course, which we call the advanced course. We bring in a musician or a group of musicians. They have a track prepared and we take people from a pre-production meeting all the way through the recording and mixing of the track. We sit back and take the role of producers."

Gateway are fortunate in having the support of manufacturers. In the schoolroom there is a Fostex *E16* and a new Soundtracs *MRX* console, which was given to Gateway by the manufacturer. In the new studio there is a Soundcraft *Saturn* multitrack, which Gateway bought, and a Soundcraft *TS12* which Soundcraft provided. In return for this, Gateway are providing training for Soundcraft staff—a true symbiosis. Brüel and Kjaer have also lent microphones to the school.

In addition to the studio courses, there is a new PA course supported by Electro-Voice and Shuttlesound. The climax of the course is when the participants do the PA for a band in the student's union building.

It should go without saying that a school is only as good as its teachers. Dave Ward looks for the professional engineer who has a desire to help others by passing on his knowledge.

"All our teachers are experienced engineers who have decided that they want to teach and can communicate. Then we train them in our teaching methods. You can't teach sound recording just from theory. The teachers need to feed in all the problems they have had in the studio, the good times, the bad times, experiences and anecdotes. All that is just as important as the theory itself, particularly when the teaching is creatively based. We use lots of imagination in our teaching methods."

Gateway's courses run throughout the year and include, as well as the basic multitrack courses, such course titles as 'Composing for Radio/TV Commercials', 'Synchronisation and Music to Picture' and 'Fairlight'. The next one year part time course will commence in September '88.

**The Gateway School of Recording and Music Technology, The School of Music, Kingston Hill Centre, Surrey KT2 7LB. Tel: 01-549 0014. David Mellor**



Gateway's Soundcraft TS12 in the new studio



## FM ACOUSTICS

introduces the

**- FM 214 PRECISION  
BALANCED LINE DRIVER**

**- FM 216 PRECISION  
LINE LEVEL INTERFACE**

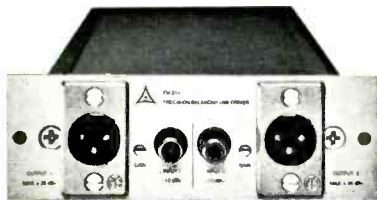

They resolve any level and impedance problem between -10 dBv semi-professional and consumer equipment, audio sections of video recorders, CD players and professional balanced equipment working at +4 dBv, +6 dBv, +8 dBv and similar levels.

FM ACOUSTICS LTD  
Tiefenhofstr. 17 CH-8820  
Wadenswil/Switzerland  
Telephone: 01-780 64 44  
Telex: 875414 FMAC



US OFFICE:  
FM ACOUSTICS USA  
P.O. Box 854, Benicia  
CA 94510  
Tel: (707) 745 4444  
Telex: 550161

PRECISION AUDIO ELECTRONICS  
FROM SWITZERLAND

# HARDWARE HOUSE



**10 YEARS EXPERIENCE  
IN LIVE PERFORMANCE SOUND**

- Equipment Rental and Sales •
- Specialist Radio Mic Applications •
- Sound Design and Engineering •

Share our experience · Contact us on:

**01-986 6111**

West Works Chalgrove Road  
London E9 6PB  
Telex 265871 Attn. DGS 2220  
E-Mail Hardware-UK

A member of the Association of  
Professional Entertainment Hire  
Companies

Distributor for  
The Hackney  
Cab speaker  
system



Dealer for AKG, Amcron, Beyer,  
Courtryman, Electrovoice, JBL,  
Samson, Sennheiser, Shure, Yamaha

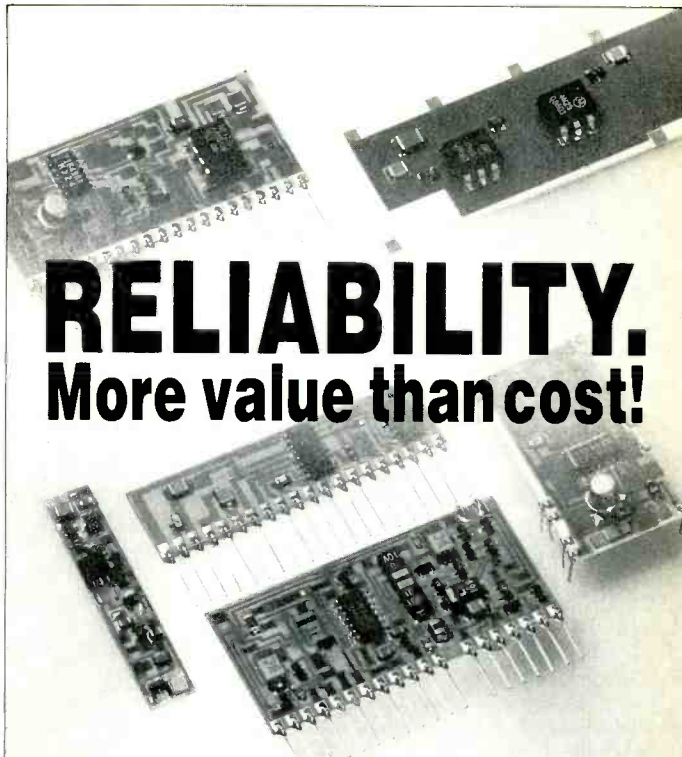

# RELIABILITY. More value than cost!

## CITEC HYBRID CIRCUITS

In the broadcasting industry, reliability has a greater value than cost. What offers that user reliability so vital in high-performance equipment? Hybrid circuits from Citec.

Citec's hybrid circuits offer you

- Consistency between circuits – one unit will function exactly as another.
- Close component matching within the circuit – so each element performs at its optimum.
- Packaging densities and levels of performance not achievable by other methods – the product of circuit miniaturisation, low levels of signal distortion and the excellent high frequency performance of thick film substrates.

The result? Equipment which performs just as it should, every time you turn it on.

Want to know more about applying thick film hybrid techniques to your circuit designs? Then contact Roy Page on 0793 487301 or write to him at:

BICC-Citec Limited,  
Westmead,  
Swindon,  
Wiltshire SN5 7YT.



Telephone: 0793-487301  
Telex: 449112 Citec G  
Fax: 0793-610217

# Contracts

● **Windmill Munro Design** are undertaking a full turnkey project for the new Telegaël Teo facilities house in Galway, Ireland, involving the management, building, systems design and installation of two edit suites, a television studio, an EFP unit and sound dubbing suite based on the AMS *AudioFile*. The company is also contracted to design a BBC edit suite in Belfast and has recently completed a sound dubbing suite for TVS in Southampton.

● **Sunset Sound, Hollywood, USA**, have installed an **Amek APC1000** with microprocessor-controlled Recall and Dynamic Reset, and GML moving fader automation. The console is part of the redesign of Studio Two.

● Orders for **Soundtracs'** new *In Line* console have been confirmed by Aosis Studios of London, Pace Studios of Milton Keynes, CGD Records of Milan, Italy, and keyboard player Paul Fishman. Recent clients of other models have included *CP6800s* to Bali Studio, Hong Kong; Saint Felix-Gossier, Guadeloupe, West Indies; and six French studios. *CM4400s* to Studio de la Madeleine, Paris; Parasol Music, Neuilly; Audio Video Luci, Rome. A *CP6800 40/24* to Music Delli of New York. The company have also supplied two *16/4/2 FME* consoles to Dire Straits keyboard players Alan Clark and Guy Fletcher for on-stage mixing.

● **Trident Audio Developments** have been contracted to supply a 56-channel audio post-production console to Videasonics of London. The console, known as the Trident *VP*, will be fitted with a centre section containing an AMS *AudioFile*. Videasonics have also recently completed a new audio pre-production suite for music videos, featuring a **Neve** console, **Studer** recorders, a **Sony** 1 inch video deck and **Cypher** digital synchronisers.

● **Soundcraft** have supplied four series *8000s* (40-, 32-, 24- and 16-channel) and two 24-channel series *500* monitor consoles for what they say is the largest PA rig to enter Eastern Europe. The contract was put together by Audiovision Trade on behalf of United Entertainment Enterprises of Warsaw, Poland. The

rig was used in June for a concert in Moscow, USSR, and will go to Poland for the 25th International SOPOT Song Festival during August.

● **PME Audio**, German distributor for **Master Blaster**, is to supply 40 enclosures to Munchen-Gladbach based PA hire company, Action Service.

● **Rainhill Tape Specialists**, Merseyside, UK, have taken delivery of a **Lyrec P-2000** high speed tape duplication system. This is part of a considerable expansion programme at the cassette duplication plant.

● **Ian P Kinloch & Co** have been awarded a contract to supply the BBC with two outside broadcast vehicles for use in Leeds and Newcastle. The vehicles will be the first in a line of new lightweight 2-camera units equipped with Ikegami cameras and Audio Developments *AD062* multmixers.

● **Sondor**, Switzerland, have been contracted to supply *14 OMA S* perfotape units to Mosfilm of Moscow, serving two video post-production suites and a voiceover studio. Two 16 mm EBU recorder/players have also been supplied to Radio Bremen and the Deutsche Welle, Cologne.

● **Audio Kinetics** have announced orders for two 16-channel *MasterMix* systems for installation in the Canadian Broadcasting Company's *Neve 5104* consoles at their Montreal facilities. Other contracts include 64 channels of *AK2* faders for Universal Studios, *Westar* console; three *MasterMix* systems for Soundcraft *TS24* consoles in New Zealand, Norway and Japan; a *Q.Lock 4.10* 3-machine *Alpha* system for the China Motion Picture Studios; plus *Q.Locks* to film dubbing companies *Dovi* and *QT-Lever* in Spain (supplied by Telco of Madrid), to Swedish Educational Broadcast (supplied by Ercotron), and to De Wolfe for Angell Studios in London.

● **Coach Audio Sales**, Germany, have supplied **SSL** consoles to Gam Studios in Belgium, Touch Down Music in Munich and Studio Harry Son in Paris. Other installations include sales of *Neve*, *MCI* and *Tascam* equipment to various customers in Europe.

# NEWS

## People

● **Graham Paddon** has joined **Autograph Sales** in London to be responsible for UK sales.

● **Cameron Communications** have appointed **Ian Vickerage** managing director. Vickerage comes from the computer industry, most recently with Computervision and Insignia Solutions. Alan Cameron becomes chairman.

● **Peter Jamieson** has succeeded **Rob Dickens** as Chairman of the **British Phonographic Industry**, stating his main objective during his two-year term as "motivating and mobilising the BPI membership committee to

ensure both government and public awareness of the complex issues facing the industry". Jamieson has previously worked for EMI for 19 years, and is currently chairman of RCA Ariola/BMG Records.

● **Nigel Read** has joined the audio post-production department at **Videasonics**, London, where apart from regular programme dubbing he will also head a new department specialising in music and effects for foreign language versions. He was previously chief dubbing mixer at BBC Enterprises.

## STUDIO ACOUSTICS by TUBETRAP™



Pete Townshend, The Who, The Boathouse, Eel Pie Studios

The QSF Digital Sampling Room

- QSF™ QUICK SOUND FIELD SYSTEMS
- PRE FAB, MODULAR SOUND TRAPS
- FULL BAND-WIDTH ABSORPTION
- BUILT-IN, ADJUSTABLE DIFFUSION
- FACTORY BASED DESIGN SERVICE
- ALL PRODUCTS SHIP UPS IN DAYS

1-800-ASC-TUBE, 1-503-343-9727, FAX: 343-9245

**ASC** ACOUSTIC SCIENCES CORPORATION  
 P.O. Box 1189  
 Eugene, OR  
 USA 97440

APPLIED ACOUSTICS-RESEARCH, DESIGN & DEVELOPMENT

(LICENSED MFG. ALSO IN CANADA AND ITALY, DEALER INQUIRIES WELCOME)

## First US DAT manufacturer

Shape Inc, manufacturers of audio and video cassettes, compact discs and computer products, have announced the first UK production line for Digital Audio Tape (DAT) cassettes based at their Biddeford, Maine plant. Their CD plant will be responsible for the winding, duplicating and packaging of cassettes, while their Gage Molding

subsidiary will manufacture shells and boxes. A projected total capacity of five million by December is regarded by Paul Gelardi, President of Shape Optimedia, as complementing the company's line of CD products.

Shape Inc, PO Box 366, Biddeford, ME 04005, USA. Tel: (207) 282-6155.



INSTANT SIGNAL  
PROCESSING—  
JUST ADD TALENT.



Orban's new digitally-controlled 787A Programmable Mic Processor integrates an unprecedented combination of vital signal processing functions into one powerful, compact package. It delivers fully programmable **mic- or line-level** processing with access to 99 memory registers through MIDI or RS-232 interfaces, or a console-mounted remote control. All you do is add the talent.

The 787A offers a space-saving, elegant solution to many annoying problems (voice or instrumental deficiencies, poor room acoustics, noise, sibilance, wandering levels) in multi-track and MIDI recording studios, commercial production, video post, audio-for-video, and film scoring facilities. The 787A increases production efficiency through consistently repeatable processing. Less time need be spent tweaking separate processors, so more attention can be devoted to capturing top creative performances as they happen.

The 787A is complete audio processing arsenal in a box—a flexible parametric EQ, a smooth compressor, noise and compressor gates, and a handy de-esser. The 787A can be operated in mono or dual-channel/stereo (with the addition of a second-channel slave). An optional Jensen transformer mic preamp with 48V phantom power adds further flexibility.

Orban's 787A Programmable Mic Processor will help you remember tomorrow the way your talent sounded yesterday.



**Orban Associates Inc.,**

645 Bryant Street, San Francisco, CA 94107 USA  
(415) 957-1067 Telex: 17-1480 FAX: (415) 957-1070



# ***DAT. Whoever said it woul***

*With portable recorders now available, the DAT format can fulfil its promise as the digital two-track standard for any professional audio application.*

*Europe's leading pro-audio centre now stocks the full range of Sony DAT recording technology. Not only is HHB the leading independent distributor for Sony Broadcast professional audio products, but the company has been officially appointed the first independent pro-audio distributor of Sony's 'consumer' DAT*

*recorders, the DTC 1000ES and the remarkable carry-anywhere device, the TCD-D10. This guarantees full service support and Sony spares back-up.*

*The stunning and compact TCD-D10 is supplied with a full range of accessories including carrying case, power unit, battery, battery charger and stereo microphone. The recorder even offers remote control recording functions. The DTC 1000ES is already an HHB best-seller, providing superb digital quality at a highly competitive*







# *d never get off the ground?*

*price. For DAT performance with professional facilities, the Sony PCM 2500 carries a full range of digital inputs and outputs,*

*including SDIF 2 and AES/EBU for recording at sampling rates of 44.1kHz as well as 48kHz.*

*For fully professional recording on the move,*

*the PCM 2000 heralds a new digital era – at a stroke. Sturdy design and built-in time code*

*facilities are backed by two times oversampling in record and twin A to D and D to A conversion.*

*Put simply, the PCM 2000 sets new standards in digital recording performance. Period.*

*Of course, you don't have to take our*

*word for it. Why not pay a visit to the Scrubs Lane demonstration facility*

*and meet 'The Sony DAT Family' in person.*

*Alternatively, call 01-960 2144 and ask for our new brochure. With the extra*

*benefit of large stocks*

*of DAT tape at new low prices, the HHB DAT experience is something you cannot afford to miss.*

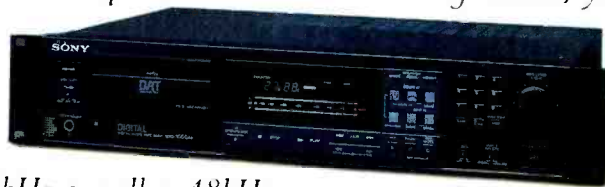

# NEWS

## Ampex Digital Reference Tape

Following extensive evaluations by DASH and PD-format hardware manufacturers including Sony, Studer, Mitsubishi and Otari, Ampex Digital Mastering Audio Tape has been selected by the International Electrotechnical Commission (IEC) as a worldwide primary reference tape for digital open-reel recorders.

The IEC Digital Audio Primary Reference Tape is a reel of unrecorded tape with established, highly consistent physical and electromagnetic properties that is

used to calibrate a machine's record and playback characteristics. The tape is available in 1/4, 1/2 and 1 inch widths suitable for all open-reel digital recorders. Reel flange labels display electrical test data, while each reel box contains information on the use of the tape. In addition every reel flange, box and shipper will contain the designation *IEC Primary Reference Tape No 8000, Digital Audio*. The tape is available from any Ampex tape sales office.

## SSL in a spin

Metropolis Audio in Melbourne, Australia, have come up with a novel control room construction to satisfy the different requirements of pop music clients and those involved in film and video sweetening.

The former usually like their monitoring fairly close, whereas film engineers want their 3-channel (left-centre-right) monitoring at a distance. In order to satisfy the needs of all customers, Metropolis have put the mixing console on a rotating platform in their new Studio Three control room and the two types of monitoring at either end of the room. An SSL 6000E series desk is set in the middle of the 48 m<sup>2</sup> floor area and engineers and producers can not only face each monitoring system but also, at the halfway mark, look directly into the bluestone and timber overdub booth that runs

alongside the control room.

Three video monitors at the back or front of the control room cater for vision from U-matic, domestic or 1 inch video machines, while at the other end is a screen whose vision source comes from a projector mounted in the ceiling. Off to one side are another two monitors, which display tape synchroniser information and vision output from the SSL, while any vision source can be directed to any monitor. The studio floor also accommodates an extensive array of keyboards and sequencers, which are wired up via two columns that fold out of the floor and carry 48 direct feeds, AC mains and MIDI connectors.

Metropolis Audio Pty Ltd, 180 Bank Street, PO Box 296, South Melbourne 3205, Victoria, Australia. Tel: (613) 686-2111.

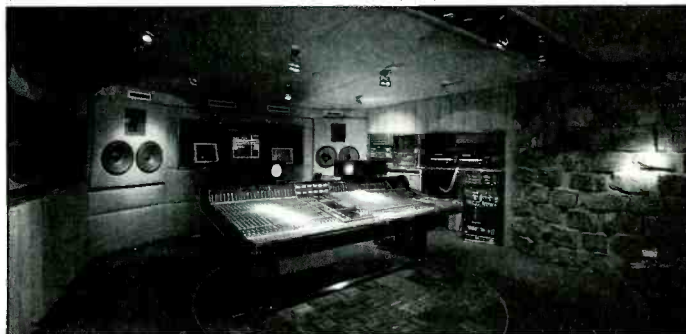

(90) 722599 \* France: Lazare Electronic (01) 40100900 \* Greece: Hellas Sound (01) 8831311 \* Holland: Audio-Electronics (020) 990480 \* Italy: FBT (071) 9841421 \* Norway: Norsk A/S Philips (02) 680200 \* Spain: Lexon (03) 2034804 \* Sweden: Handic (08) 7358020

## THE ULTIMATE MACHINE FOR DRIVERS.

The new generation of Renkus-Heinz Smart Processors boasts features that deliver unsurpassed levels of performance from the entire line of Smart Speaker Systems.<sup>™</sup>

The Smart Processor shows its true character when sound pressure levels are extreme. Spectrum Power Transfer<sup>™</sup> noiselessly eliminates excessive driver excursion and heat build up. And the Sense Fail<sup>™</sup> detection circuitry protects the system even if sense lines are interrupted.

An L.E.D. matrix on the front panel provides complete system status at-a-glance, revealing just how smoothly this machine goes through its paces.

Interchangeable front-loading modules make it possible to drive any of the full line of Smart Speaker Systems with one Smart Processor, maintaining precise time correction and equalization.

And Renkus-Heinz offers you the largest line of processor-driven systems available. For any application. From small clubs to large concert arrays.

Smart Processor. Smart Speaker System. Only from Renkus-Heinz. Call for the ultimate test drive.

**rh RENKUS-HEINZ**  
PROFESSIONAL SOUND PRODUCTS

17191 Armstrong Ave., Irvine, CA 92714  
(714) 250-0166 • Telex 705568 • FAX (714) 250-1035



European Distributors: Austria: Austrian Philips Industry (0222) 601010 \* Belgium: Sound Equipment Distribution (SEDI) (02) 5200827 \* Denmark: Mr. Music (01) 375589 \* Finland: Koma

\* West Germany: Barnh. Stuttgart (0711) 823341, Musik-Wellingtons Dormund (0231) 171921, Musikhaus Thomann Treppendorf (09546) 281, Sound & Drumand Berlin (030) 8843030



## A-V copyright clearance

The Mechanical Copyright Protection Society, which represents over 10,000 UK publishers and composers, is offering a free service to audio-visual producers for clearing the recording of copyright music and negotiating the fees involved.

With the exception of library music, there are no set fees for music used in audio-visual productions. The MCPS team of licence negotiators can

arrange clearance for the vast bulk of copyright music available in the UK, for which royalties are payable by law.

A free booklet entitled *Mechanical Copyright and Non-Theatrical Audio-Visual Presentations* is available from MCPS, Elgar House, 41 Streattham High Road, London SW16 1ER, UK. Tel: 01-769 4400.

# NEWS

## Music Works US link

Jo Julian, owner of The Music Works studio complex in North London, has become co-owner of New York studio The Loft in conjunction with American engineer Alan Hemberger. The studio is currently being redesigned by Windmill Munro Associates, the company's first US project, and will house a 44-channel Westar console and Mitsubishi digital recorders.

The trans-Atlantic link has come about as a result of Julian's

production work for Polygram International's new Theta instrumental label. "I spent six weeks recording an album by violinist Scarlet Rivera in New York and mixed it back in London, the type of work which I undertake at regular intervals during the year. As a result, I began to see the potential of running The Loft as a sister studio to The Music Works, enabling us to offer facilities on an international basis."

## Disctronics goes public

Disctronics Ltd, the world's third largest manufacturer of compact discs, is to become a listed public company, and will be moving its head office from Melbourne, Australia, to New York, USA. Present owners Quatro Ltd and Pro-Image Studios Ltd will retain majority ownership after an envisaged A\$25 million is raised from institutional investors, underwritten by Ord Minnett Ltd.

Roger Richmond-Smith, chief executive of Disctronics, explained the listing as an opportunity to

expand growth of the company in the areas of CD-Video and optical storage products such as CD-ROM, as well as the expansion of manufacturing plants acquired within the past year at Southwater, UK, Huntsville, Alabama and Anaheim, California. The company also has integrated sales and marketing offices in London, New York, Los Angeles and Sydney, and plans to maintain its estimated 10% share of the world CD market, currently around 65 million discs per annum, exceeded only by Philips and Sony.

## MIDI equipment applications at APRS

MIDI is becoming more widely accepted as a control system for desks, effects and units other than musical instruments, however, many stands at the recent APRS show also included synthesisers, computers and compositional software in an attempt to make these products more accessible to the studio engineer.

**Adams-Smith:** The *Zeta Three* is an inexpensive machine synchroniser with built-in software for many makes of video and audio recorder plus MIDI output with Song Position Pointers. New for the APRS was the *Zeta Remote* which is an editor-autolocator for the unit featuring 100 memories. **Akai Digital:** Akai were featuring the *S1000* sampler, which supersedes the *S900* (although this will remain in the catalogue for a time). Sixteen bit sampling, 16 voices, timestretching to retain the same sample playback speed at different pitches, stereo sampling and *S900* disk compatibility make the *S1000* a certain success when it's introduced later this year. **Allen & Heath:** Were showing large production consoles such as *Sigma* and the new *Saber* along with the processor controlled *CMC* mixers which have an optional interface for MIDI patch changing. **Audio & Design:** *SoundMaestro* is an Atari *ST*-based 2- or 4-track digital recorder with MIDI facilities and applications for jingles, newsgathering, editing and spin-in against timecode. **Audio Digital**

**Technology:** A very wide range of IBM *PC*-compatible music software including products from Voyetra (the *Sequencer Plus* package), editors for most popular synths from the Bacchus range, the unusual *Cakewalk* compositional system from Twelve Tone Music, and many others. ADT recommend Amstrad *PC* clones or Compaq models for added sturdiness; they are also handling the IBM *Music Feature Card* which gives a *PC* 356 FM-generated voices with software including educational packages. On the hardware side, ADT showed the *Event* from Real Time Logic, a powerful UK-built SMPTE/MIDI converter, and a prototype EB Technology MIDI Analysis rackmount intended for MIDI designers and engineers. **Cue Systems:** Agents for the MIDI-compatible ART equalisers who have also developed their own realtime spectrum analyser that can

automatically control suitable MIDI-equipped equalisers. Also shown; *CUEDOS*, a desk operating system capable of controlling desks such as the MIDI-equipped Yamaha *DMP7* in realtime. **Drawmer:** The usual range of sound processors including the Drawmer *MIDMAN* MIDI management system, which handles routing and signal processing for complex MIDI setups. **Evenlode Soundworks:** A vast range of software, mainly for the Atari *ST*, from the Steinberg range. The *Pro-24* sequencer has recently been updated to *Version III* with new *Drum Composer* and *Score* pages, and the *Desk Top Mixing* (DTM) software, which includes the company's own complete system, *MIMIX*, as well as a version for the Yamaha *DMP7* and Amek/TAC mixers, was on show. The full range of Digidesign editors for synthesisers and samplers was on show, as were *Macintosh* packages such as *Q-Sheet* for film composers, the *Sound Accelerator* and a *Universal Sound Designer* software package, which makes samples from all major designs intercompatible. Evenlode are also agents for Passac MIDI guitars. Saro Software, Palmtree Instruments (makers of the MIDI *Airdrums*), and Clavia (makers of the samples *D-Drum* system).

**Hinton Instruments:** Without a stand at the show, Hinton nevertheless managed to create a lot of interest in their *MIDIX*, *MIDIZ* and *MIDI RECALL* units. A custom rack can contain almost any combination of these units, which act as routing matrices, long range MIDI transmitters and software-based processor parameter save/restore devices respectively. Virgin Studios have taken seven racks to use in conjunction with their Lexicon *480L PCM 70* and Yamaha *REV5/SPX90* effects. Custom racks can be constructed to handle any combination of MIDI merging, processing and storage. **Kelsey Acoustics:** Effects processors including the ADA range with the programmable *MQ-1* stereo equaliser, *MPI* tube preamp, and *Pitchtraq* pitch changer, all with optional MIDI control footswitches. **Korg:** The instrumental highlight of the show, the *M1* keyboard combines a two Megaword 16 bit sample memory, a multitrack sequencer, velocity and pressure sensitive keyboard, ROM card loading and a sensible 'workstation' approach to composition. The standalone *Q1* sequencer was also on display showing MIDI and SMPTE interfacing, and the *S1* adds



# Synclavier training centre

New England Digital has established an official training school for the *Synclavier* and *Direct-To-Disk* digital audio systems at the Full Sail Center for Recording Arts, Florida. NED president Bradley J Naples announced that a comprehensive curriculum covering all aspects of the systems' operations will ensure that present and future operators "will receive the very best training and education. With systems now installed at over 500 facilities worldwide, the opportunities for full-time operators are growing tremendously."

The Full Sail Center has been established as a leading educational establishment for the recording and related industries for over nine years,

with facilities including an SSL console and a 48-track mobile unit. Founder and president Jon Phelps commented that "with the industry's increased attention on digital and computer technology, our affiliation with NED will enable our students to be on the cutting edge".

The NED courses, which run over two-week periods, are directed by Richard Head, owner of Song Bird Digital in Nashville, and cover all aspects from beginners and advanced *Synclavier* and *Direct-To-Disk* system operation. For information contact Joan Daubresse, Full Sail Center, 658 Douglas Avenue, Altamonte Springs, FL 32714, USA. (407) 788-2450.

# NEWS

## Stolen equipment

Central Manchester College (CMC) have suffered the theft of over 40 items of equipment and instruments valued at over £25,000. Items stolen in the burglary, which took place on the weekend of June 3rd from the College's East Manchester Studio, include equipment by Fostex, Yamaha, Roland, Akai, Atari, Simmons, Drawmer, Revox and other manufacturers.

A full list of all models and their serial numbers is available from course tutor Vince Wilkinson, who would appreciate any information concerning their disappearance to be directed to the college or the police. Central Manchester College, East Manchester Centre, Taylor Street, Gorton, Manchester M18 8DF, UK. Tel: 061-223 1628.

## Software update

MCM Distribution have been appointed the official UK distributors for the Alchemy software package, which allows central storage of sound samples on a *Macintosh* computer and distribution via MIDI and

SMPTe to a variety of samplers following creation and on-screen editing. MCM Distribution, 9 Hatton Street, London NW8 8PR. Tel: 01-724 4104.

## MIDI equipment applications at APRS

sampling and drum machine facilities. MIDI-compatible signal processors include the *DRV3000* reverb with infra-red remote, and the rackmount *DSM1* version of the *DSSI* sampler/synthesiser together with the new *DRM1* ROM card-based drum module with trigger-to-MIDI conversion and the *P3 Piano* and *Symphony* Sound modules were on show. Yamaha recently bought an interest in the company, and these new Korg products are likely to make a major impact in 1988. **Rebis Audio:** Audio processors including the dual-channel *RA701* MIDI gate, which is capable of replacing drum and other sounds with new MIDI-controlled sounds accessed using any programmable MIDI note number and channel. **Roland UK:** The Roland range of LA synthesis instruments now comprises the *D50* keyboard and *D550* module, the *D110* multitimbral module, the *D10* keyboard version and the *D20*, which has an integral sequencer. Samplers include the *S-330* and *S-550* modules and the *S-50* keyboard, shown with the new *SYS-553* sequencer software and *HD-5/80* hard disk interface. Also on show were sequencers including the updated 100,000 note *MC500 MkII* with *Turbo Software* and drum machines including the *TR626* with *SBX-80* SMPTe synchroniser. A new

range of professional processors includes the *R880*, a digital reverb with four interactive processors in one unit and remote control, and the *E660*, a 2-channel 4-band or single-channel 8-band digital parametric equaliser, both with MIDI compatibility, coaxial and optical input/output and 16/28 bit processing. **Sound Technology:** Showing *Notator*, an expansion of the C-Lab *Creator* sequencer for the Atari *ST*, which adds powerful score writing options. Also on show were the *X-Alyser* (*DX* editor) and *Explorer* (*MT-32* editor) packages; the popular budget digital reverbs, drum machine and MIDI sequencer from Alesis; the Oberheim *Matrix 1000P* preset analogue rackmount synth; and the *DPX-1* sample disk player with hard disk and multiple output options. **Syco Systems:** Syco were concentrating on the *AudioFrame* from WaveFrame Corp. The system will eventually be capable of synthesis, recording and editing, signal processing, constant rate sampling, mixing and mastering. Syco are also handling the Technos *Axcel*, a 're-synthesiser' with realtime controls, and the *Emulator III*, *Dyaxis* is a new disk-based recorder for the *Macintosh*, which is MIDI-compatible and in some ways similar to the WaveFrame unit; and the new

Kurzweil *1000* range of pro-quality sampled sound modules includes the Professional, Horn, String and Guitar units. **Syndromic Music:** The Atari *ST* software specialists with products from Hybrid Arts, Drumware and others. Hybrid have now released *ADAP II*, a 16 bit stereo sampling/direct to hard disk recording system optimised for jingles, editing and mastering with up to 45 minute stereo capacity, SMPTe and AES/EBU digital transfer. Hybrid's software lines were represented by *SMPTETRACK* and *MIDITrack*, *EZ Score Plus* and others, and Drumware's editors included versions for all the Akai samplers plus *Genwave 12/16*, which handles *Emax*, *Prophet*, *SP-1200*, Oberheim *DPX* and Yamaha *TX16W* simultaneously. **Tascam:** Were showing the inexpensive *MTS-30* SMPTe/MIDI tape synchronisation unit with MIDI Song Position Pointers. **The Synthesiser Company:** A vast range of hardware and software including packages for the Atari *ST*, *Macintosh* and *Amiga*. Hardware included the *Lynx ST*-based 16 bit sampler from Commander Electronics, which leaves the *ST* free to run compositional software such as Steinberg *Pro-24 Version III*; the Simmons *SDX* now configured as a keyboard sampler as well as a drum sampler; the Fairlight *Series III*; the inexpensive *SRCat* SMPTe/MIDI synchroniser with 1/10,000 frame accuracy; and the Axxess *MIDI Mapper* for processing MIDI signals in a variety of ways. Software included the Dr T range of

interactive sequencers and editors for the *ST*; Opcode editors and sequencers for the *Mac*; Passport sequencers, editors and score packages on the *ST*, *Mac* and *PC*; Southworth and Mark Of The Unicorn *Mac* packages; and many others. The Soundquest editor range for the *Amiga* and *PC* is imminent and TSC's software distribution service, *MCMXCIX*, is adding new titles constantly. **Yamaha:** Apart from the industry standard range of *DX* synthesisers, Yamaha had a couple of unannounced items in the form of the *QX5FD* sequencer and the *C1* computer. The *QX5FD* is a version of the *QX5* with a built-in floppy disk; the *C1* is a lap-top IBM *PC*-compatible micro with a built-in gas plasma fold-down screen, built-in dual disk drive, optional hard disk, multiple MIDI ports and SMPTe. Voyetra Technologies have transferred their multitrack MIDI sequencer package to 3.5 inch disk for the machine and Bacchus have provided editors for the Yamaha *TX81Z* and *TX802* synthesisers. Also on show were the simplified *SPX50D* effects unit; the budget *R100* reverb; the *GEP50* guitar effects rackmount; and the digital input 'D' version of the MIDI-compatible *DMP7* programmable mixer with a wide range of analogue/digital and digital standards converters. Release dates and possible price for the *C1* are not yet clear, but the power and portability of the machine could well affect the booming *ST* and *Mac*-based MIDI sequencing market. □



# AUDIO JACKFIELDS & JACK SOCKETS

Mosses & Mitchell are the largest manufacturer of Audio Jacks and Jackfields in the UK. We are approved suppliers to the BBC, British Telecom, and many other major telecommunication companies throughout the world. We manufacture a complete range of Audio Jacks & Jackfields and offer a design and manufacturing service geared to meet your specific requirements. For further information and technical data on our products contact:

## MOSSSES & MITCHELL

Plasme Systems Limited  
Weydon Lane, Farnham, Surrey GU9 8QL  
Telephone: Farnham (0252) 721236  
Telex: 858820 Plasme G  
Fax: (0252) 712718

# Rogers LS3/5a

66,124 in use worldwide and still the industry's number one small monitor.

Distributed by

*Michael Stevens & Partners*

Invicta Works Elliott Road  
Bromley Kent BR2 9NT  
Tel: 01-460 7299 Fax: 01-460 0499  
Telex: 896979 TACS G

For more information on the complete Rogers range of speakers call us now.



## NEUTRIK

### Loudspeaker Connectors



Loudspeaker  
Line Plug



Airtight Loudspeaker  
Chassis Socket for  
Speaker Cabinets



Loudspeaker  
Chassis Socket



Coupling for  
Two Loudspeaker  
Line Connectors

### Nothing Breeds Success Like Success

Sole Agent UK

## Eardley Electronics Ltd

Eardley House, 182-184 Campden Hill Road, Kensington, W8 7AS  
Telephone: 01-221 0606/01-727 0711 Telex: 23894 Telefax: 01-727 9556

## NEWS

## Sear Sound moves

After 17 years on 46th Street, Sear Sound has moved to new and larger headquarters at 353 West 48th Street, 6th Floor, New York, NY 10036, which was the former home of The Hit Factory.

The control room is 18x22 ft and houses a Neve 8038 mixing console, Studer and Ampex multitracks and outboard equipment ranging from vacuum tube to digital. Synthesizers include a fully-equipped Kurzweil and a large modular Moog. Echo

systems include two EMT vacuum tube chambers as well as AKG and other assorted systems.

Monitoring is by UREI and JBL.

Studio A is 37x21 ft and houses two grand pianos and other keyboards. Studio B is a 16-track vacuum tube voiceover facility for commercials, demos, library music, etc. Studio C is a 35 mm 10-track film mixing facility with a Western Electric console and Westrex recorders.

## News in brief

● **The Master's Workshop Corporation** of Toronto, Canada, have received two Golden Reel awards from the motion picture sound editors of Hollywood, for work in the half-hour and TV mini-series categories. The soundtracks were edited and mixed using the company's own computerised and digital systems, the editing version of which is now being developed for marketing internationally under the name of Soundmaster International.

● **Conway Recording** have retrofitted Apogee filters to their three Mitsubishi X850s. George Massenburg has also fitted filters to his X850.

● **Ampex Golden Reel Awards** have been presented to The Beastie Boys for *Licensed to Ill* produced at Chung King House of Metal, New York, and Ray Stevens for *He Thinks He's Ray Stevens* produced at his own studio in Nashville.

## People

● **Altec Lansing** have appointed Tim Smith as national accounts manager. Smith comes from Vaughn Communications where he was regional manager.

● **The University Film and Video Association** recently announced the appointment of Fred Ginsburg, Audio Services Corp, as Industry Sustainer Liaison Chairman. The post was previously held by Lee Duncan. Ginsburg will serve as 'a communications bridge between dealers, manufacturers and industry

professionals'.

● **Fairlight Instruments** have announced the appointment of Mick Higgins as a technical sales representative based in Los Angeles, and of Daniel Bols as a technical support engineer based in New York.

● **Teledyne Acoustic Research** has appointed Burke Mathes as its new president, based at AR's Canton plant near Boston, USA. His 20 years experience in consumer electronics include chief executive positions with Curtis Mathes and Pacific Stereo.



Sony PCM-3324 is installed at New Age Sight & Sound

## Contracts

● **20th Century Fox Studios**, Hollywood have taken delivery of their second **Harrison 66-input PP-1** post-production console, for use in film and television productions

including *LA Law* and *Hooperman*.

● **New Age Sight & Sound Studio** in Atlanta, GA, USA, have purchased a **Sony PCM 3324** digital recorder for use in audio and video projects.



## Star Case new products

Star Cases of Munster, IN, have introduced *Case Legs*. A pair of Ultimate Support aluminium legs can be fitted to the lid of your rack case to convert it into a working surface. The lid latches to the side of the rack case. The 'legs' option can be fitted to most rack cases at the time of construction.

Also new from Star is the *Mini Brief*. This is smaller than a regular

briefcase with an inner cavity size of 12 $\frac{7}{8}$ x8 $\frac{3}{4}$ x2 $\frac{7}{16}$  inches and is lined with  $\frac{1}{2}$  in polyester foam. The exterior is glassfibre laminated on plywood with double aluminium angle extrusion and steel ball corners.

**Star Case Manufacturing Co Inc**, 648 Superior, Munster, IN 46321. Tel: 1-800-822-STAR or (219) 922-4440.

## NED wins award

New England digital, White River Junction, VT, has received a 1988 ITS Award for engineering achievement.

One of three awards made this

year, NED's is for the implementation of SMPTE timecode in the *Synclavier* digital audio system.

## PMI purchases Telemation/Phoenix

Production Masters Inc of Pittsburgh, PA, have purchased the Phoenix, AZ, division of Telemation Inc. The video and film production company will change its name to Production Masters Inc with immediate effect.

The newly renovated facility will be upgraded over the next several

months with the addition of audio services as well as an increase in 3-D computer animation and special visual effects capabilities via a link with the present Pittsburgh operation. Additional equipment will be installed in the edit suites of both facilities.



**The Ultimate Range  
of  
Professional Products**

**Hayden Laboratories Ltd**

**NAGRA KUDELSKI**

**≈ / ≈ SENNHEISER**

**DENON**

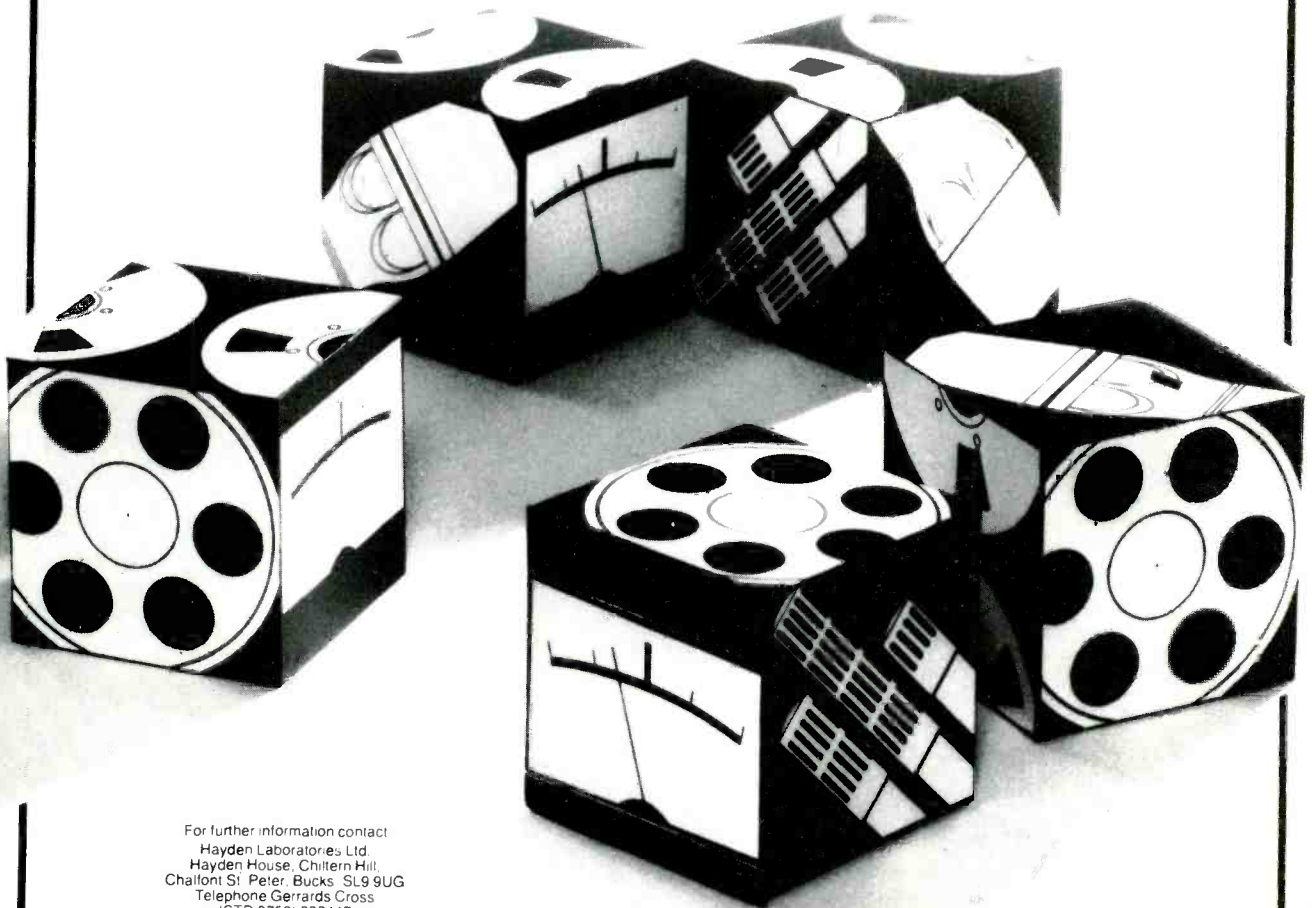

For further information contact  
Hayden Laboratories Ltd.  
Hayden House, Chiltern Hill,  
Chalfont St Peter, Bucks, SL9 9UG  
Telephone Gerrards Cross  
(STD 0753) 888447

# NEWS

## BASF sponsor engineers' award

Tape manufacturers BASF are sponsoring a new monthly award aimed at recognising the contribution of balance engineers to the quality of recordings. The Studio Master Award For Excellence will go to the engineer using BASF 911 tape who has produced the most outstanding recording of quality each month, with

similar awards to assistant engineers and the studio involved.

First SMAFE Award winner was Kenny McDonald of Park Lane Studios, Glasgow for his work on Wet Wet Wet's version of *With A Little Help From My Friends*. McDonald received his award during the APRS show in June.

## People

● Simon Shaw has joined FWO Bauch as manager of the Video Systems Division, which distributes a range of broadcast television equipment. He was previously an overseas manager for CMX editing systems.

● Bryan Fane, previously UK sales manager at Fane Acoustics, has been appointed head of the company's US subsidiary. His former position has been filled by Michael Wood and Kay Winterburn.

## In brief

● The Royal National Institute For The Blind's studios have become APRS members in order to ensure that their Talking Book service compares favourably with commercially recorded books. Their four recording suites, each comprising two studios and a control room, record about 600 unabridged books each year with 7,000 titles currently available in its library.

● The entire original music score for the recent UK Channel 4 series *The Storyteller* was recorded at Videosonics' Studio One, with all post-sync dialogue recorded using the company's ADR facilities.

● UK specialist case manufacturers Frontline Cases have introduced a PDQ service guaranteeing production of up to two rigidised aluminium cases within 14 days, with no extra cost to their regular prices.

● A new illustrated pocket guide for Emergency Resuscitation Treatment of Electric Shock Victims, with resuscitation

instructions approved by St John Ambulance, is available from Focal Displays Ltd, 12 Wandle Way, Mitcham, Surrey CR4 4NB, price 35p plus VAT.

● Oakleigh Products Ltd have changed their name to Oakleigh Cases Ltd. The company designs and manufactures transit cases to protect all types of equipment.

● Power amplifier manufacturer C Audio has been acquired by Hans Freytag's Executive Audio distribution company. C Audio MD Phil Hildrow and other staff members remain with the company, which is in the process of launching various new products over the next few months.

● SSL have just published their G Series Computer Operator's Manual intended for new users and those with experience of earlier SSL computer systems. The manual is split into main sections and runs to 198 pages in a ring binder with short form reference guide.

## SSMT dynamics processor

Solid State Micro Technology for Music have announced full production on the SSM2120 dynamic range processor. This is a monolithic device with a wide range of dynamics applications containing two independent VCAs and level detection sidechains in a 22-pin package. The manufacturers describe the chip as using patented class A VCAs offering a 102 dB dynamic range with less than 0.01% THD under most conditions and the level detectors having a 100 dB dynamic range with a log of absolute value outputs. Intended applications for the device include stereo compressor/

limiter, noise gating, automatic gain, control, ducking, de-essing circuits, companding, single-ended noise reduction and fader automation systems.

Another version of the device is available known as the SSM2122 dual VCA, which is the same as the SSM2120 but in a 16-pin package with only the VCAs pinned out. Solid Stage Micro Technology for Music Inc, 2076B Walsh Avenue, Santa Clara, CA 95050, USA. Tel: (408) 727-0917.

UK: Hartech Marketing Ltd, 7 West Pallant, Chichester, West Sussex PO19 1TD. Tel: 0243 773511.

## Address changes

● Turbosound have moved to larger premises for the second time in under two years to Star Road, Partridge Green, West Sussex RH13 5EZ, UK. Tel: 0403 711447.

● Musicable have moved to new premises at Park House, 20 Park Close, Pinxton, Notts NG16 6QQ, UK. Tel: 0773 861690.

● Vitavox Ltd wish to let anyone who does not have their present address know they are at 5 Elstree Way, Borehamwood, Herts WD6 1SF, UK. Tel: 01-953 4151.

● Larking Audio, previously named Don Larking Audio Sales, have moved to brand new premises at 15 Cam Square, Wilbury Way, Hitchin, Herts SG4 0TZ, UK. Tel: 0462 422466.

● Roland UK have moved to new premises at Amalgamated Drive, West Cross Centre, Brentford, Middx TW8 9EZ. Tel: 01-568 4578 (Music Sales); 01-847 5665 (Digital Group Sales); 01-568 1247 (General/Customer Services).

## Literature received

● *Sonics* is the name of a new illustrated thrice-yearly publication from Allen & Heath describing the company's product range and highlighting some of the projects on which their consoles have been used. Allen & Heath, 69 Ship Street, Brighton, Sussex BN1 1AE, UK. Tel: 0273 24928.

● *Video With A Difference* by Barrie Gibson and David Stewart is a 24-page booklet aimed at anyone who needs to know more about the pre-production and planning stages of making a video. It also explains the basics of the production process in straightforward terms. Normally

£2.95, it is available to readers free from Merrie Longbottom, Documentary Video Associates, 16 Fernhill Road, Farnborough, Hampshire GU14 9RX, UK. Tel: 0252 545505.

● Composite Video have published their new 1988 72-page catalogue of video, audio and computer production accessories and components. Unit 13, The Swan Centre, Rosemary Road, London SW17 0AR, UK. Tel: 01-879 3767.

● Canford Audio's latest catalogue is available from Crowther Road, Washington, Tyne & Wear NE38 0BW, UK. Tel: 091-415 0205.

## Training

● The University of Newcastle has established a new part time course in recording, with up to eight places available to unemployed people under the age of 25. *Working With Sound* commences on August 29th, and will run for an initial 17 weeks, offering practical and theoretical training in a comprehensive range of audio-related subjects, with instruction from main tutor Douglas Doherty and sessions by various specialist speakers. Contact Douglas Doherty, Working With Sound, Department Of Music, The University, Newcastle upon Tyne NE1 7RU. Tel: 091-232 8511.

● Network Studios of York have refurbished their 16-track facilities and have recently introduced an engineers' training course. This consists of one week's initial grounding followed by 30 8-hour sessions spread over a one year period on a time-share basis. The course costs £1,000, with credit terms available, and funds may be available to students from the Government's Enterprise Scheme. Network Studios, 46 Auster Road, N York Trading Estate, Clifton, York YO3 8XA, UK. Tel: 0904 691761.





# audio-technica®

□ INNOVATION □ PRECISION □ INTEGRITY

## Since 1962.

For more than twenty five years we've been at the sharp end of miniature transducer technology in sound reproduction. Famous throughout the world for our patented high quality pick-up cartridges, we've been steadily pushing back the barriers of micro-engineering and electronic circuitry. The result is now a range of audio products tailored to meet the critical demands of specific broadcast, studio and sound re-inforcement applications. Update your technical file soon on the innovative A-T range.



### Audio Technica Ltd.

Technica House, Lockwood Close, LEEDS LS11 5UU.  
Te: (0532) 771441. Fax: (0532) 704836

Please send more information on the Audio Technica range. SS/9/88

NAME .....

JOB TITLE .....

COMPANY .....

ADDRESS .....

TEL: ..... Fax: .....

INDUSTRY SECTOR  BROADCAST  RECORDING STUDIO  PA  MUSIC  HI-FI





# NEWS



## BSS power amplifier

BSS Audio launched a power amplifier during the APRS exhibition, something of a departure from their existing product lines. The *EPC-780* is a compact 2U rackmount unit with a weight of 20 kg and a rating of 1000 WRMS/channel into 4 Ω. The internal design is fully modular and features include 'intelligent' start-up routine and fault diagnostics, signal level temperature

and fault indication, calibrated input sensitivity controls, remote control of mute and level and transformer balanced inputs as standard.

**BSS Audio Ltd, Unit 5, Merlin Centre, Acrewood Way, St Albans, Herts AL4 0JY, UK. Tel: 0727 45242.**

**USA: EDC, 611 Broadway, New York, NY 10012. Tel: (212) 460-9940.**



## Crest Audio 7001

Crest Audio have introduced a 2U rack version of the *8001* power amplifier to be known as the *7001*. It is a fully modular unit weighing 49 lb. It is rated at 550 W/channel into 4 Ω and 810 W/channel into 4 Ω. Crest claim that the *7001* is capable of swinging 83 VRMS/channel with peak power of 3,200 W/channel being available into 2 Ω. Other features

include Instantaneous Gain Modulation, impedance sensing, Auto-Ramp signal control and an RMS clip limiter.

**Crest Audio, 150 Florence Avenue, Hawthorne, NJ 07506, USA. Tel: (201) 423-1300.**

**UK: Electromusic, 89-97 St John Street, London EC1M 4AB. Tel: 01-253 9410/9079.**

## Digitec digital matrix

Digitec has launched an asynchronous digital switching matrix with AES/EBU interfaces, which the manufacturer claims to be the only one of its type in the world. This is a 1U 19 in rackmount unit that switches 16 inputs to 16 outputs with extension possibilities up to 64x64. Control is through parallel buses and the matrix provides a

monitoring output and a memory with battery back-up. The manufacturers see possible applications where CDs, R-DATs and digital VTRs are in applications such as mastering, copying and post-production.

**Digitec SA, 57 Boulevard de la République, BP 51, 78401 Chatou Cedex, France. Tel: 1 30 71 48 71.**

## Sony PCM-3324 update

Sony have launched a new version of the *PCM-3324* digital multitrack—to be known as the *PCM-3324A*—with improvements in sound quality, enhanced error correction and VLSI technology. There are new filters in the A/D and D/A stages as well as 2x oversampling in both record and playback. Error correction has also been increased to five digital words rather than just three without affecting compatibility with other DASH machines. The large scale adoption of VLSI technology has allowed a reduction in the number of circuit boards from 45 to 28, which assists in a 25% power consumption reduction from 2 kVA to 1.5 kVA as well as making the machine lighter at 176 kg. For ease of transportation the wheels have been increased in size and big handles have been added.

On the service side the time indicator now provides an LCD log display of time spent in record, hours spent switched on, the time the transport has been in operation and the frequency with which the transport brakes have been applied. Additional features on the electronic side include two selectable channels of digital I/Os, both for *PCM-1610/30* and standard AES/EBU systems, allowing direct digital transfers to 2-channel devices or may be used for selective track bouncing when cross-connected. The MADI format interface is not fitted as standard but can be retrofitted once the standard has been fully ratified. For film and video applications the *PCM-3324A* now has a built-in video clock board and is supported by all the software updates implemented over the last year for the *3324*.

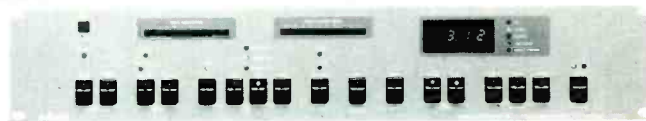

## Orban mic processor

Orban Associates have announced the model *787A* Programmable Mic Processor designed for mic and line level applications. The unit features a 3-band constant Q parametric equaliser, a compressor with adjustable release time, de-esser, noise gate and/or compressor gate, effect send and return sockets all in a 2U rack space. It has the ability to store complete set-ups in 99 memories. The settings may be recalled through keystroke sequences. There are bargraph displays for gain reduction and peak level outputs and a numeric display to show current setting of a parameter. There is also the possibility of using a security code to lock out programming controls.

The *787A* has a line level input as standard, mic preamp with Jensen transformer and 48 V phantom powering as optional. There is provision for program stepping by external contact closure as well as optional MIDI or RS-232 interfaces, and a console-mounted Basic Remote Control accessory with numeric display. There is also a version designated *787A/SL* for use as a second channel slave for dual mono or stereo applications.

**Orban Associates Inc, 645 Bryant Street, San Francisco, CA 94107, USA. Tel: (415) 957-1067.**

**UK: Scenic Sounds Equipment Ltd, Unit 2, 12 William Road, London NW1 3EN. Tel: 01-387 1262.**

## Fairlight Rev 5.4 software

Fairlight have a new software release for the *Series III, Revision 5.4*. The features include MIDI sync and song pointer with simultaneous SMPTE read and generation; improved sequencer timing with vertical performance now better than MIDI spec; mono hard disk recorder with non-destructive editing and SMPTE sync; a cue list sequencer; enhancement of the icon function key interface; multi-instrument record on RS page; facility to list up to five hard disks or directories together; many new features on RS page including randomise, constant value setting and count-in; sample monitoring at the sample rate specified; time scale along the waveforms on WE page; and the

acceleration of some page changing.

On the hardware side Fairlight have now released the WORM optical disk that can be used with the *Rev 5.4* software. The drive comes with the complete *Series III* library on one side of the optical disk. Also the large 380 ESDI hard disks are now available offering faster access times with 50 minutes of audio storage each.

**Fairlight Instrument Pty Ltd, Rushcutters Bay, NSW, Australia. Tel: (02) 331 6333.**

**UK: Stirling Audio Systems Ltd, Kimberley Road, London NW6. Tel: 01-624 6000.**

**USA: Fairlight Instruments Inc, 2945 Westwood Boulevard, Los Angeles, CA 90064. Tel: (213) 470-6280.**



# SOUNDTRACS IN LINE



BARRY BLUE AND LEE WITH SOUNDTRACS IN-LINE CONSOLE.

**BARRY BLUE** – THERES A NAME TO CONJURE WITH. WHY IS A TOP PRODUCER AND RECORDING ARTIST LIKE BARRY BLUE ONE OF THE FIRST TO BUY A SOUNDTRACS IN-LINE CONSOLE FOR HIS HIGHLY SUCCESSFUL AOSIS STUDIOS?

“We were looking for an In-Line console anyway – the width of the control room dictates it really – but this console, in terms of noise is very, very quiet; secondly it is very flexible and has a very pleasing sound. Thirdly it is easy to use and well designed; and fourthly, it looks the part.”

**BARRY BLUE'S** SUCCESSES STRETCH FROM THE LATE SIXTIES WITH ACTS SUCH AS URIAH HEEP, THE MESSAGE AND THE RAM JAM BAND TO PRODUCTION CREDITS WITH THE HONEYCOMBES, DANA, HEATWAVE, BANANARAMA, HOWARD JOHNSON, FIVE STAR, AND MOST RECENTLY AMAZULU, AS WELL AS MAJOR WRITING HITS SUCH AS PERHAPS HIS MOST WELL KNOWN SINGLE DANCING ON A SATURDAY NIGHT. HE IS CURRENTLY IN A POSITION TO JUDGE WHAT IS REQUIRED OF TODAY'S MIXING CONSOLE.

“It is everything you could ask for; simply a very well

designed desk which is straightforward to use. Everything seems to be there. Every other desk we looked at seemed to have something missing. It has been very well put together and thought out. We are in no doubt that it is going to be a very popular desk, so we have no qualms about being one of the first. Everybody who has used it so far will be coming back.”

“We were simply looking for a flexible, quiet, well designed In-Line mixer and the Soundtracs is just the job. We have been selling studio time on it from the day it was installed.”

#### Noise

Equivalent input noise (gain 60dB ref 200 Ohm) –127.5dBv  
Mix noise (32 channels routed) –82dBv

**Distortion** (channel input through to mix output)  
Line 100Hz<0.006% 1kHz<0.008% 10kHz<0.02%

#### Signal Cross talk

Between any two groups  
1kHz<–82dBv 10kHz<–78dBv  
Microphone/line  
1kHz<–85dBv 10kHz<–75dBv  
Monitor  
1kHz<–88dBv 10kHz<–85dBv  
Between any two channel line inputs  
1kHz<–88dBv 10kHz<–85dBv

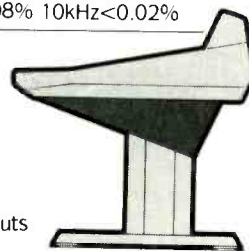

**SOUNDTRACS**  
**IL4832**  
**IL3632**

SOUNDTRACS PLC 91 EWELL ROAD SURBITON SURREY KT6 6AH ENGLAND TEL: (01) 399 3392 TELEX: 895 1073/STRACS/G FAX: (01) 399 682 1

UK SALES: LARKING AUDIO 0462 422466

www.americanradiohistory.com

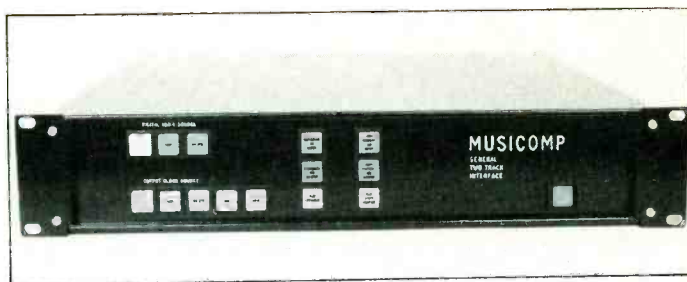

# NEWS *Musicomp digital standards converters*

## Ross LAB series headphones

British manufacturer of headphones, Ross, have introduced a professional range of headphones called the LAB series. The RE-2720 and the RE-2730 are designed for heavy duty applications within language labs, etc, and are described as virtually unbreakable, heat resistant and tamperproof (which might have some appeal in pro-audio circles). Both units are wired mono with a closed acoustic design, impedance of 600  $\Omega$  and a 20 kHz frequency bandwidth. The model RE-2730 has each of its drive units connected to a Ross-designed sound limiter that restricts listening levels to below 92 dB.

The RE-2760 stereo unit has been designed for pro-audio applications and is described as being of a tough and robust construction and using 50 mm mylar dome drive units with samarium cobalt magnets and low mass diaphragms in a closed acoustic design. Quoted specification includes frequency response of 18 Hz to 22 kHz; sensitivity at 1 kHz of 110 dB/mW; impedance of 600  $\Omega$  and weight of 180 g.

Ross Electronics, Silver Road, White City Industrial Park, Wood Lane, London W12 7SG, UK. Tel: 01-740 5252.

UK company Musicomp have produced two digital audio standards converters for a wide range of digital conversion applications. The *General Two Track Interface GTI 0206* converts between all the major standards in use for CD, DAT, AES/EBU, SDIF, 2-track PD, digital desks and has parallel ports for keyboards and unusual standards with operation at 44.1 and 48 kHz sampling. Emphasis and Copy flags may be flipped while transferring. The *Multitrack Converter MIS 3248* will transfer up to 32 tracks of digital audio between all current PD and DASH multitracks. A master clock of 44.1 or 48 kHz is selectable as is Emphasis on/off. Connectors are compatible with the formats. Both converters are 2U 19 in rackmount and will run on 240 or 110 V.

A third unit, the *Multitrack Patch Box MPS 3202* is a unit allowing patching of up to 32 tracks of digital audio. It can be used with both DASH and PD format multitracks with bypass switches available on each channel. There is also circuitry included to convert from multitrack to 2-track SDIF outputs. Patch leads are supplied with the unit, which is also 2U rackmount.

Musicomp also manufacture an SSL/Sony *PCM-3324* interface that allows SL 4000 and 6000 series track remotes to control the digital multitrack and removes the need for the RM3310. Wiring for the transport controls is available. All these units are already in use with studio and hire companies internationally. Musicomp, 3 Petley Road, London W6 9SU, UK. Tel: 01-386 8019.

# Digital Reverberation





# Reference CDs

A US West Coast company by the name of Digital Intelligence Systems Corporation (DISC) have announced a compact disc reference service for companies requiring a single CD for technical and artistic evaluation prior to mastering. This disc provides a means of evaluating programme material and cue point selection as well as review opportunities prior to commitment to mastering and replication. DISC describe their service as low cost and fast

turnaround and applicable equally well to CD-ROM or any situation where storage of data is needed on a single CD. DISC is also a manufacturer of CD mastering systems, CD stamper players and analysis equipment.

**Digital Intelligence Systems Corporation, 201-C West Dyer Road, Santa Ana, CA 92707, USA. Tel: (714) 549-5034. Telex: 910 2503788 DISC UQ.**

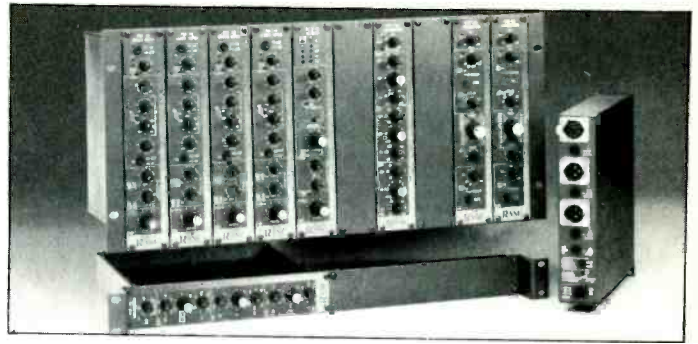

# Rane Flex series

Rane Corporation have announced the *Flex* series modular signal processors. Each module is a self-contained processor packaged in the proposed HR (Half-Rack) format allowing the modules to be mounted vertically or horizontally using a minimum of 19 in rack space. Each processor requires an external low voltage supply and will be equipped with 3-pin, ¼ in and DIN connectors to interface with professional equipment. The initial group of processors to be released this year will include a variety of mixing functions, splitters, crossovers, equalisers, filters, compressors, limiters, programme meters, headphone amplifiers, output transformers and power supplies.

The first *Flex* unit in production is the *FAC 28*, an 8th order Linkwitz-

Riley active crossover which Rane describe as the first commercially available unit of its design. It offers 48 dB/octave slopes and uses 28 binary code switching that allows selection of 24 discrete crossover points. This is a 2-way module with 3-pin and ¼ in balanced inputs and outputs with patch points and mono low frequency capability. There is also built-in variable constant-directivity horn equalisation and adjustable phase alignment capability.

**Rane Corporation, 10802 47th Avenue West, Everett, WA 98204-3400, USA. Tel: (206) 355-6000.**

**UK: Music Lab Sales, 72-74 Eversholt Street, London NW1 1BY. Tel: 01-388 5392.**

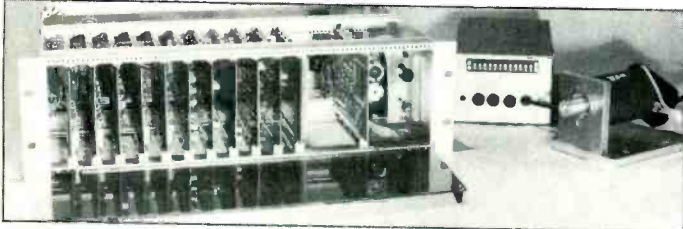

# SWD Groove Control

SW Davies Ltd have introduced a retrofit disc cutting groove control system designed to upgrade the performance of most makes of disc mastering lathes. The *GC 821* takes 4 to 6 hours to install and this includes the fitting of a new Swiss-made pitch motor. Operationally the system divides the disc surface into 16 segments and assists the engineer in achieving greater level and/or

playing time on the disc. The manufacturer claims that peak recognition circuits avoid the random groove crashing that has been found with earlier systems. Systems are already in use at Porky's Mastering, London; TAM, London; Dureco and Holland Cutting (Netherlands). **SW Davies Ltd, 5-7 Buck Street, London NW1 8NJ, UK. Tel: 01-485 8559.**

# ...that fits all pictures

**Immediate results** - with an extensive factory loaded program library, including classic Hall, Chamber, Room and Plate reverb simulations; exclusive "ALIVE" super enhancement, gated sounds and effects with digital quality.

**Outstanding audio quality** - through the application of high speed DSP technology, 16 bit converters and 32 bit arithmetic processing.

**Operational confidence** - with realtime control and simultaneous display of all program parameters.

**No extra costs** - full function remote control unit, tape-save and MIDI supplied as standard.

Proven performance makes the DN780 one of the leading digital systems currently available. At £1650\* it represents unsurpassed value for money.



**DN780 Reverberation qualities are truly recognised in the audio industry by:**

- BBC Radio/TV
- Central Independent Television
- Sony Broadcast Limited
- Video London Sound Studios
- John Wood Sound Studios
- Lansdowne Recording Studios
- DN780 users in the UK and internationally

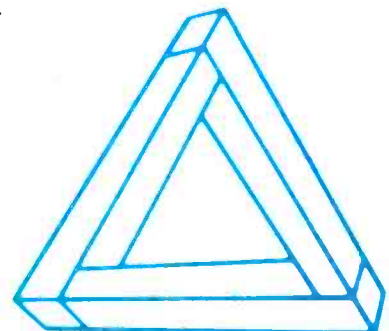

D I G I T A L A U D I O

**KLARK TEKNIK**

The first name with sound system designers

KLARK-TEKNIK Plc  
 Klark Industrial Park, Walter Nash Road, Kidderminster,  
 Worcestershire DY11 7JU, England.  
 Tel: (0562) 741515 Telex: 339821 KLARK G Fax No: (0562) 745371

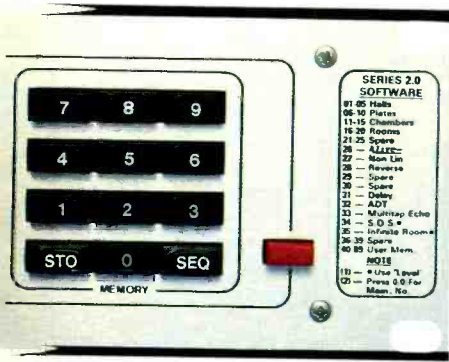

\* Applicable in the United Kingdom only. Exclusive of Value Added Tax.

IF YOU'RE IN TW  
ABOUT AUDIO EQ  
CONSULT A





# O MINDS QUIPMENT, THIRD.

At Stirling Audio it's always been our business to provide the best advice possible.

Matched with the most up-to-date information from the industry.

Now, our Kilburn centre provides the custom-designed space and facilities to make that service even better.

So when you look around, we'll open your eyes with the latest equipment: Otari tape machines, Timeline synchronisation, Lexicon signal processing, and the Fairlight system, all working in a large, comfortable demo room.

Together with a fully equipped, acoustically treated DDA Control Room which gives you the chance to appraise studio products in a real environment.



The best way to try the facilities is to bring a tape and try them for yourself. While you're doing that, we can discuss your requirements and pinpoint the best solution.

Whether you're buying a microphone or a complete studio system, you'll get our undivided attention for as long as you need it. We'll even help you organise the finances.

The new Stirling Audio Centre in Kilburn.

Really, it's a whole new way of buying audio.

Stirling Audio, Kimberley Road, Kilburn, London NW6. Tel: 01 624 6000.



 **Stirling**

# The UA8000 with TASC an unbeatable mix.



Odyssey Studios, London W1 showing 64-channel UA8000 with TASC (The AMS Studio Computer).

When Abba built Polar Studios in Stockholm, they thought they had taken quite a gamble by not making the usual choice of automated console. But word soon got around about the business they were attracting with the Calrec UA 8000.

When plans were being put together to build a 'no expense spared' studio complex in Denmark, members of the PUK team went to Sweden and spent time at Polar.

After exploring and listening to the Calrec console at Polar they knew a UA 8000 had to be the centre piece of their new studio.

When EMI Abbey Road heard rumours about the audio performance of the UA 8000, they did some in house tests. They were sufficiently impressed to send important members of their team to PUK Studios in Denmark. Just as history has been made at Abbey Road before, it is now being made on a Calrec UA 8000 with TASC (The AMS Studio Computer).

When MasterMix of Nashville decided to spend whatever it took to offer their clients the very best automated mix facility in America, they commissioned a survey and did some tests. On these results they sent their studio manager and chief engineer to spend some time at EMI Abbey Road. It didn't take them long to know they had found what they were looking for – and the competition didn't come close.

There are very few world class studios, Polar, PUK, EMI Abbey Road and MasterMix are amongst the few.

Take up our offer to have a closer look and find out why AMS and Calrec make the unbeatable mix.

## The UA8000 with TASC - one of the AMS family.



Hard Disc Editor



Digitally Assignable Consoles



DMX/RMX Digital Audio Processors



Calrec Standard and Soundfield Microphones



Custom Broadcast Consoles



AMS Industries plc

AMS/Calrec: AMS Industries Park, Burnley, Lancs BB11 5ES Tel (0282) 57011 Telex 63108 AMS-G Fax (0282) 39542  
AMS/Calrec, USA: 3827 Stone Way North, Seattle, WA98103 USA Tel (206) 633 1956 Fax (206) 547 6890



The Queen's Award for Export Achievement to Edendeck Ltd 1984/85 and AMS Industries plc 1986. In July 1985 Edendeck Ltd became AMS Industries plc.



ANNOUNCING THE

# Producers Handbook

1988

**THE GUIDE TO WHO'S WHO IN THE RECORDING INDUSTRY**

**A guide to producers, engineers, remixers and programmers working in the UK and Europe, with contact details, background information and recording credits.**

★ An invaluable source of reference for A & R executives, record/publishing and production companies, musicians, studios and anyone requiring the services or information about today's music technologists.



Please return the completed order form enclosing full remittance or giving your credit card number to

The Producer's Handbook, Pro Sound News (Europe)  
Link House · Dingwall Avenue · Croydon · Surrey CR9 2TA · England  
Telephone: 01-688 3161 · Telex: 997709 · Fax: 01-760 0973

SS/9/88

I enclose a cheque for £15 made payable to  
Link House Magazines Ltd.

Please bill my credit card:  
AmEx Diners Visa Access/Master Card

No.

Expires

Signature

Date

Deliver copies to:

Name:

Company (if applicable):

Address:

Post Code:

Country:

# ***PRECO FOR AUDIOPAK***

## **NAB BROADCAST CARTRIDGES AA3 and AA4**

Despite rumours to the contrary Audiopak (Capitol Magnetics) AA3 and AA4 NAB Broadcast Cartridges are still being manufactured and are readily available.

We have large stocks of all lengths plus Lub Tape and spares. All at very competitive prices.

Same day delivery in London. 24 hours UK and Eire.

*When you can buy AUDIOPAK, why settle for less?*

## **THE PROFESSIONAL RECORDING EQUIPMENT CO. LTD.**

21 Summerstown, London SW17 0BQ

**Tel:** 01-946 8774

**Fax:** 01-944 1326

**Telex:** 8954667 VBS TLX REF PRE.

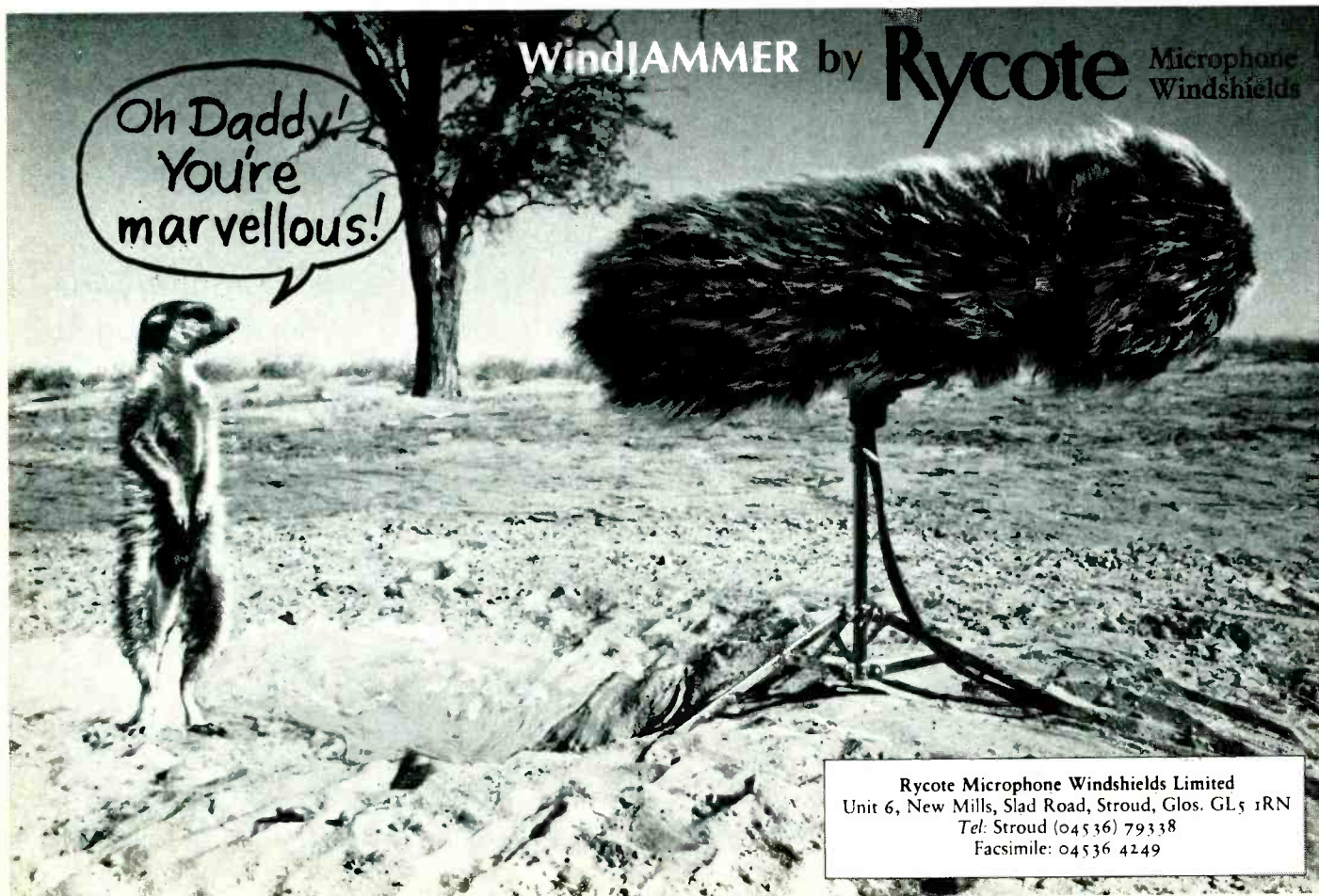

**WindJAMMER** by **Rycote** Microphone Windshields

Oh Daddy!  
You're  
marvellous!

Rycote Microphone Windshields Limited  
Unit 6, New Mills, Slad Road, Stroud, Glos. GL5 1RN  
Tel: Stroud (04536) 79338  
Facsimile: 04536 4249





# Our greatest hits

There's only one way to build a great reputation. And that's to do it consistently, hit after hit.

We set the analog standard with Ampex Grand Master® 456. We pioneered a new digital standard with Ampex 467 digital mastering tape. And we developed Ampex 406 for outstanding performance in a wide range of analog mastering applications.

When it comes to analog and digital mastering tapes, nobody offers a wider selection.

More great performers record their hits on Ampex tape than any other tape in the world. While opinion may vary on what it takes to make a hit, there's no argument on what it takes to master one.

## AMPEX

Ampex Magnetic Tape Division, Acre Road, Reading, Berkshire RG2 0QR, England (0734) 875200

# It's Time To Rack Up Another Hit.



It's hard to follow a great act. Expectations run high. The performance must be flawless. When we decided to carry the legacies of our LA-2A, LA-4 and 1176LN into the next generation, we knew exactly what we were getting into.

Our new 7110 Limiter/Compressor incorporates the characteristics of its predecessors, is the natural addition to a legendary line and has all the potential to become a major hit in its own right. The 7110 combines both peak and average limiting action, producing smooth, predictable RMS style performance like the LA-2A and LA-4 with the precise automatic peak control of the 1176LN.

The 7110, with our exclusive program dependent Smart-Slope™, gives you adjustable compression curves from 1.5:1 through infinity:1. You set

threshold, attack, release time and output level – the 7110 automatically rides the gain with split second response.

To make set-up as simple as possible, we've included an Automatic Preset function. Punch the button on the front panel – the 7110 automatically defaults to program dependent attack and release times, and presets the peak threshold and ratio to consistently used settings. Perhaps the best news of all, the

7110 produces crystal clean sound and is virtually transparent.

Just another limiter/compressor? We don't believe so. After you've heard it for yourself, we think you'll agree. Stop by your local JBL/UREI dealer and give it a listen. And, get ready to rack up another hit.



*The 7110 combines the smooth predictable RMS style performance of the LA-4 with the precise automatic peak control of the 1176LN.*



**UREI  
ELECTRONIC  
PRODUCTS**

JBL Professional  
8500 Balboa Boulevard, Northridge, CA 91329  
© 1988 - JBL Incorporated A Harman International Company



# POWER AMPLIFIERS

*We have updated our list of amplifier manufacturers and agents, together with a brief description of their products, from information available to us at the time of writing*

This survey of power amplifiers is intended to include units designed for professional use primarily in the areas of recording studio monitoring systems. It also includes some units for use in live sound although we have omitted units for commercial sound installation where identifiable. Because the definition of what comprises a power amplifier suitable for these applications is open to a degree of interpretation, there may be some omissions. Further, the number of manufacturers active in this field is so large and internationally based that there are almost certainly names that have not been included.

All power amplifiers are 2-channel with all wattages quoted in RMS watts unless otherwise stated.

## Altec Lansing

Altec Lansing Corp, PO Box 26105, Oklahoma City, OK 73126-0105, USA. Tel: (405) 324-5311.  
UK: Shuttlesound, Unit 15, Osiers Estate, Osiers Road, London SW18 1EJ. Tel: 01-871 0966.  
1268: 60 W/ch, 8  $\Omega$ ; 200 W bridged, 8  $\Omega$ .  
1269: 120 W/ch, 8  $\Omega$ ; 400 W bridged, 8  $\Omega$ .  
1270B: 220 W/ch, 8  $\Omega$ ; 800 W bridged, 8  $\Omega$ .

## AMR

Audio Media Research, PO Box 1230, Meridian, MS 39301, USA. Tel: (601) 483-5372.  
PMA-200: 100 W/ch, 8  $\Omega$ .  
PMA-70+: 35 W/ch, 8  $\Omega$ . Half rack width.

## BGW

BGW Systems Inc, 13130 S Yukon Avenue, Hawthorne, CA 90250, USA. Tel: (213) 973-8090.  
UK: Pro-Britro, 35 Britannia Row, London N1 8QH. Tel: 01-226 1226.  
250D & E: 100 W/ch, 8  $\Omega$ ; 300 W bridged, 8  $\Omega$ . Difference between models in metering.  
750D & E: 250 W/ch, 8  $\Omega$ ; 800 W bridged, 8  $\Omega$ .  
GTA: 600 W/ch, 4  $\Omega$ ; 1800 W bridged, 4  $\Omega$ .  
GTB: 275 W/ch, 8  $\Omega$ ; 400 W/ch, 4  $\Omega$ ; 800 W one ch driving 2  $\Omega$  load.  
620B: 200 W/ch, 8  $\Omega$ .  
2125: single ch 100 W, 8  $\Omega$ .  
7500: single ch 300 W, 4  $\Omega$ .  
7500T: 300 W/ch, 4  $\Omega$ .  
6500: single ch 100 W, 8  $\Omega$ .  
85: 35 W/ch, 8  $\Omega$ ; 90 W bridged, 8  $\Omega$  (broadcast use).  
150: 50 W/ch, 8  $\Omega$ ; 150 W bridged, 8  $\Omega$  (broadcast use).  
SPA-1: amplifier system to power sub bass in

sound reinforcement systems. Incorporates crossover and EQ. 250 W/ch, 8  $\Omega$ ; 1200 W bridged, 4  $\Omega$ .

SPA-3: 3-way amp system with crossover and EQ. 250 W/ch, 8  $\Omega$ ; 1200 W bridged, 4  $\Omega$ .

## Bose

Bose Corporation, 100 Mountain Road, Framingham, MA 01701, USA. Tel: (617) 879-7330.

UK: Bose UK Ltd, Trinity Trading Estate, Sittingbourne, Kent ME10 2PD. Tel: 0795 75341.  
1800 series II: 280 W/ch, 8  $\Omega$ ; 425 W/ch, 4  $\Omega$ .

## Boulder

Boulder Amplifiers, 3101 3rd Street, Boulder, CO 80302, USA. Tel: (303) 449-8220.  
UK contact: Syco Systems Ltd, 20 Conduit Place, London W2. Tel: 01-724 2451.  
500: 150 W/ch, 8  $\Omega$ ; 250 W/ch, 4  $\Omega$ ; 500 W bridged, 8  $\Omega$ .

## BSS

BSS Ltd, Unit 5, Merlin Centre, Acrewood Way, St Albans, Herts AL4 0JY, UK. Tel: 0727 45242. Fax: 0727 45277.  
USA: EDC, 611 Broadway, New York, NY 10012. Tel: (212) 460-9940.  
EPC-780: 1000 W/ch, 4  $\Omega$ .

## Bryston

Bryston Ltd, 57 Westmore Drive, Rexdale, Ontario, Canada M9V 3Y6. Tel: (416) 746-1800.  
UK: Roksan Engineering Ltd, The Turnmill, 63

Clerkenwell Road, London EC1R 5BH. Tel: 01-251 1021.

USA: Brystonvermont, RFD 4, Berlin, Montpelier, VT 05602. Tel: (802) 223-6159.

2B: 50 W/ch, 8  $\Omega$ ; 200 W bridged, 8  $\Omega$ .

3B: 100 W/ch, 8  $\Omega$ ; 400 W bridged, 8  $\Omega$ .

4B: 250 W/ch, 8  $\Omega$ ; 800 W bridged, 8  $\Omega$ .

6B: single ch 500 W, 8  $\Omega$ ; 800 W, 1  $\Omega$ .

## Carlsbro

Carlsbro Electronics Ltd, Cross Drive, Kirkby-in-Ashfield, Notts NG17 7LD, UK. Tel: 0623 753902.

CP 250: 125 W/ch, 4  $\Omega$ ; 250 W bridged, 4  $\Omega$ .

CP 600: 300 W/ch, 4  $\Omega$ ; 600 W bridged, 4  $\Omega$ .

CP 1000: 500 W/ch, 4  $\Omega$ ; 1000 W bridged, 4  $\Omega$ .

S600: 300 W/ch, 4  $\Omega$ ; 600 W/ch, 4  $\Omega$ .

S300: 150 W/ch, 4  $\Omega$ ; 300 W/ch, 4  $\Omega$ .

## Carver

Carver Corp, PO Box 1237, Lynnwood, WA 98046, USA.

UK: HW International Ltd, 3-5 Eden Grove, London N7 8EQ. Tel: 01-607 2717.

PM-1.5: 450 W/ch, 8  $\Omega$ ; 1500 W bridged, 8  $\Omega$ .

PM-175: 175 W/ch, 8  $\Omega$ ; 500 W bridged, 8  $\Omega$ .

PM-350: 350 W/ch, 8  $\Omega$ ; 900 W bridged, 8  $\Omega$ .

## C-Audio

C-Audio Ltd, Barnwell Road Business Park, Cambridge CB5 8UY, UK. Tel: 0223 211333.

Fax: 0223 410446.

SR 808: 850 W/ch, 4  $\Omega$ ; 1700 W, 8  $\Omega$  bridged; 2500 W, 4  $\Omega$  bridged.

SR 606: 600 W/ch, 4  $\Omega$ ; 1200 W, 8  $\Omega$  bridged; 1500 W, 4  $\Omega$  bridged.

SR 404: 400 W/ch, 4  $\Omega$ ; 800 W, 8  $\Omega$  bridged; 1100 W, 4  $\Omega$  bridged.

SR 202: 200 W/ch, 4  $\Omega$ ; 400 W, 8  $\Omega$  bridged.

## Citronic

Citronic Ltd, Halifax Road, Bowerhill, Melksham, Wilts SN12 6UB, UK. Tel: 0225 705600.

PPX 300: 100 W/ch, 8  $\Omega$ ; 300 W bridged, 4  $\Omega$ .

PPX 450: 140 W/ch, 8  $\Omega$ ; 450 W bridged, 4  $\Omega$ .

PPX 900: 280 W/ch, 8  $\Omega$ ; 900 W bridged, 4  $\Omega$ .



Carlsbro CP250, CP600 and CP1000 range of MOSFET amplifiers

# POWER AMPLIFIERS

PPX 1200: 400 W/ch, 8 Ω; 1200 W, 4 Ω.  
PPX 1600: 480 W/ch, 8 Ω; 1600 W, 8 Ω.

## Crest

Crest Audio, 150 Florence Avenue,  
Hawthorne, NJ 07506, USA. Tel: (201)  
423-1300.

UK: Electromusic, 89-97 St John Street, London  
EC1M 4AB. Tel: 01-253 9410. Fax: 01-608 3539.  
PL300: 220 W/ch, 8 Ω; 650 W bridged, 8 Ω.  
PL400: 290 W/ch, 8 Ω; 900 W bridged, 8 Ω.  
3001: 240 W/ch, 8 Ω; 1280 W bridged, 4 Ω.  
3000: as 3001 but with LED meters.  
4001: 325 W/ch, 8 Ω; 1500 W bridged, 4 Ω.  
4000: as 4001 but with LED meters.  
8001: 750 W/ch, 8 Ω; 1200 W/ch, 4 Ω; 2400 W  
bridged, 8 Ω and 3000 W bridged, 4 Ω.  
7001: 900 W/ch, 2 Ω; 715 W/ch, 4 Ω; 550 W/ch,  
8 Ω; 1600 W bridged, 4 Ω; 1510 W bridged, 8 Ω.

## Crown/Amcron

Crown International Inc, 1718 West  
Mishawaka Road, Elkhart, IN 46517, USA.  
Tel: (219) 294-5571.

UK: HHB Hire & Sales, 73-75 Scrubs Lane,  
London NW10 6QU. Tel: 01-960 2144.  
UK: Shuttlesound Ltd, Unit 15, Osiers Estate,  
Osiers Road, London SW18 1EJ. Tel: 01-871 0966.  
D-75: 40 W/ch, 8 Ω.  
D-150A series II: 96 W/ch, 8 Ω; 280 RMS bridged,  
8 Ω.  
DC-300A series II: 180 W/ch, 8 Ω; 600 W bridged,  
8 Ω.  
MT-600: 300 W/ch, 8 Ω; 510 W bridged, 8 Ω.  
MT-600LX: as MT-600 but with XLRs, display  
and custom front panel adaptable to user's  
connectors.  
MT-1200: 600 W/ch, 8 Ω; 790 W bridged into 8 Ω.  
MT-1200LX: as MT-1200 but with XLRs, display  
and custom front panel adaptable to user's  
connectors.  
Power Base-1: 200 W/ch, 8 Ω; 400 W bridged, 8  
or 16 Ω.  
PSA-2X: 220 W/ch, 8 Ω; 1200 W RMS bridged,  
4 Ω.  
DO-2000: single ch 600 W, 8 Ω.

## d&b audiotechnik

d&b audiotechnik, Steinstrasse 40, D-7054

Korb, West Germany. Tel: (07151) 3 10 18.  
UK: Michael Stevens & Partners, Invicta Works,  
Elliott Road, Bromley, Kent BR2 9NT. Tel: 01-460  
7299.  
AMP: 220 W/ch, 8 Ω; 800 W bridged, 8 Ω.

## Dynamic Precision

Norwegian Audio Designs A/S, Jerikoveien  
10, 1067 Oslo 10, Norway. Tel: 2 32 20 40.  
UK: Phase Audio UK Ltd, 80 St Mary's Road,  
Market Harborough, Leicester LE16 7DX. Tel:  
0858 31717.  
No. 1: 250 W/ch, 8 Ω; 1300 W, 4 Ω bridged.

## FM Acoustics

FM Acoustics Ltd, Tiefenhofstrasse, CH-8820  
Wädenswil, Switzerland. Tel: 01-780 64 44.  
Fax: 01-780 04 88.

FM300A: 100 W/ch, 8 Ω; 150 W/ch, 4 Ω; 180 W/ch,  
2 Ω.  
FM600A: 250 W/ch, 8 Ω; 350 W/ch, 4 Ω; 400 W/ch,  
2 Ω.  
FM800A: 400 W/ch, 8 Ω; 600 W/ch, 4 Ω; 850 W/ch,  
2 Ω.  
FM801: 420 W/ch, 8 Ω; 750 W/ch, 4 Ω; 1000 W/ch,  
2 Ω.  
FM1000: 450 W/ch, 8 Ω; 750 W/ch, 4 Ω; 1300  
W/ch, 2 Ω; 1800 W/ch, 1 Ω.

## Hafler

David Hafler Company, 5910 Crescent  
Boulevard, Pennsauken, NJ 08109, USA. Tel:  
(609) 662-6355.

UK: HW International Ltd, 3-5 Eden Grove,  
London N7 8EQ. Tel: 01-607 2717.  
P125: 62 W/ch, 8 Ω; 125 W, 16 Ω bridged.  
P225: 105 W/ch, 8 Ω; 350 W, 8 Ω bridged.  
P505: 255 W/ch, 8 Ω; 800 W, 8 Ω bridged.  
P500: 255 W/ch, 8 Ω; 800 W, 8 Ω bridged.  
XL280: 145 W/ch, 8 Ω; 400 W, 8 Ω bridged.

## HH Electronics

HH Electronics Ltd, 9 Clifton Road, Off St  
Peter's Road, Huntingdon, Cambs PE17 7DW,  
UK. Tel: 0480 432227.

USA: TMJ Inc, 17191 Armstrong Avenue, Irvine,  
CA 92714. Tel: (714) 250-1937.

VX 150: 80 W/ch, 4 Ω; 160 W, 8 Ω bridged.  
VX 200: 105 W/ch, 4 Ω; 210 W, 8 Ω bridged.  
VX 300: 155 W/ch, 4 Ω; 310 W, 8 Ω bridged.  
VX 450: 230 W/ch, 4 Ω; 460 W, 8 Ω bridged.  
VX 600: 310 W/ch, 4 Ω; 620 W, 8 Ω bridged.  
VX 900: 470 W/ch, 4 Ω; 940 W, 8 Ω bridged.  
VX 1200: 610 W/ch, 4 Ω; 1220 W, 8 Ω bridged.  
V800: 400 W/ch, 4 Ω; 800 W, 8 Ω bridged.  
M900: 400 W/ch, 4 Ω; 800 W, 8 Ω bridged.  
V150L: 150 W, 4 Ω mono; 100 W, 100 V line.  
AM8/12: 75 W, 4 Ω mono; 30 W, 15 Ω mono.  
AM8/17: 50 W, 4/8 Ω mono.

## Hiletron

Teksam Srl, Via 1 Maggio, 47, 20021  
Baranzate, Milan, Italy.  
3076: single ch 100 W, 8 Ω.

## Hill

Hill Audio Ltd, Hollingbourne House,  
Hollingbourne, Maidstone, Kent ME17 0QJ,  
UK. Tel: 062 780 555.

USA: Hill Audio Inc, 5002B N Royal Atlanta  
Drive, Tucker, GA 30084. Tel: (404) 934-1851.  
DX300: 200 W/ch, 8 Ω.  
DX800: 250 W/ch, 8 Ω; 800 W, 8 Ω bridged.  
DX1500: 300 W/ch, 8 Ω; 1500 W, 4 Ω bridged.  
DX1000: 375 W/ch, 8 Ω; 1200 W, 8 Ω bridged.  
DX2000: 400 W/ch, 8 Ω; 2000 W, 4 Ω bridged.  
DX3000: 550 W/ch, 8 Ω; 3000 W, 4 Ω bridged.  
DX1000A: 500 W/ch, 8 Ω; 1600 W, 8 Ω bridged.

## HIT

Harrison Information Technology Ltd, Unit 3,  
Button End, Harston, Cambs CB2 5NX, UK.  
Tel: 0223 871711.

UK: Elliott Brothers (Audio Systems) Ltd, Osney  
Mead, Oxford OX2 0ER. Tel: 0865 249259.  
Xi150: 75 W/ch, 4 Ω.  
Xi300: 150 W/ch, 4 Ω.  
Xi600: 170 W/ch, 8 Ω; 600 W bridged, 8 Ω.  
Xi1000: 300 W/ch, 8 Ω; 1000 W bridged, 8 Ω.  
Xi1200: 350 W/ch, 8 Ω; 1200 W bridged, 8 Ω.  
Xi1600: 450 W/ch, 8 Ω; 1000 W/ch, 2 Ω; 1600 W  
bridged, 8 Ω.  
P900: 270 W/ch, 8 Ω; 900 W bridged, 8 Ω.  
DSA300: 150 W/ch, 4 Ω; 300 W bridged, 8 Ω.  
DSA500: 250 W/ch, 4 Ω; 500 W bridged, 8 Ω.  
DSA800: 400 W/ch, 4 Ω; 800 W bridged, 8 Ω.  
DSA1200: 600 W/ch, 4 Ω; 1200 W bridged, 8 Ω.

## Industrial Research

Industrial Research Products Inc, 321 Bond  
Street, Elk Grove Village, IL 60007, USA. Tel:  
(312) 439-3600.

UK: Knowles Electronic Ltd, Victoria Road,  
Burgess Hill, Sussex RH15 9LP. Tel: 04446 5432.  
DH 4020: 100 W/ch, 8 Ω; 300 W, 8 Ω bridged.

## JBL/UREI

JBL Professional, 8500 Balboa Boulevard,  
Northridge, CA 91329, USA. Tel: (818)  
893-8411.

UK: Harman (Audio) UK Ltd, Mill Street, Slough  
SL2 5DD. Tel: 0753 76911.  
6210: single ch 40 W, 8 Ω. Mounts on JBL 4400



Crest Audio 8001



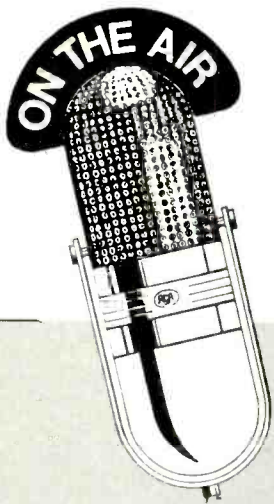

# ON AIR WITH eela audio

EELA AUDIO BROADCAST MIXERS SPECIALLY DESIGNED TO SATISFY THE REQUIREMENTS OF "DJ-SELF-OP" BROADCASTING. ALL THE MIXERS ILLUSTRATED USE THE LATEST TECHNOLOGY ie VCA LEVEL CONTROL, VOLTAGE SENSING FOR MUTES, START, PFL, COUCH, OVERALL LIMITING etc. MODULAR CONSTRUCTION, ALLOWS THE USER TO POSITION MODULES TO SUIT HIS PREFERRED MODE OF OPERATION.

## PROFESSIONAL BROADCAST EQUIPMENT

### SRM

HAS BEEN DESIGNED FOR THE SMALLER COMMUNITY OR STATIONS EQUIPPED WITH ALL THE NECESSARY FUNCTIONS, TO ENABLE THE STATION TO GO ON AIR, WITH THE MINIMUM COST, AND TIME, AND WITHOUT THE DRAWBACKS OF GENERAL PURPOSE MIXERS. IT COMES AS A STANDARD MIXER WITH THE OPTION OF TWO SPARE MODULES OF YOUR CHOICE.

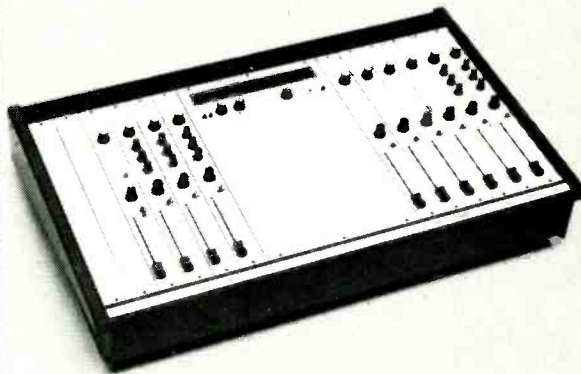

### SBM

TWO FRAMES ARE AVAILABLE FOR THIS MIXER, ONE TO ACCEPT A MAXIMUM OF 12 INPUTS, AND THE OTHER 16. AS IS COMMON WITH THE OTHER MIXERS, THE TELEPHONE CHANNELS COME EQUIPPED WITH BUILT IN TELEPHONE HYBRIDS.

### S90

A FURTHER DEVELOPMENT OF THE SBM. THIS MIXER HAS MANY OF THE SRM OPTIONS AS STANDARD FUNCTIONS, IN ADDITION THE STEREO CHANNELS ARE EACH EQUIPPED WITH A "D" CONNECTOR, WHICH IS WIRED WITH ALL THE FUNCTIONS TO INTERFACE WITH THE SOURCE ie START, INPUTS AND OUTPUTS, MUTES, +/- 18 VOLTS TO POWER PRE-AMPS etc. SPACE IS PROVIDED ABOVE THE METER BRIDGE TO HOUSE CLOCKS, TIMERS, AND ANY OF THE NEW EELA 800 SERIES MODULES.



EELA AUDIO  
Hondsruglaan 83a  
5628 DB Eindhoven

Tel. 040-424455  
Telex: 59281 bolle nl.  
Fax: 40-428925

Dealer: UNITED KINGDOM  
Tel: 0992-468674  
Contact—Bill Dyer

Dyer Audio Systems  
13 Holesworth,  
Hoddesdon,  
Hertfordshire  
EN11 9PT

# POWER AMPLIFIERS

series studio monitors.

6211: as 6210 but with mic inputs.  
6215: 35 W/ch, 8  $\Omega$ ; 90 W bridged, 8  $\Omega$ .  
6230: 75 W/ch, 8  $\Omega$ ; 300 W bridged, 8  $\Omega$ .  
6260: 150 W/ch, 8  $\Omega$ ; 600 W bridged, 8  $\Omega$ .  
6290: 300 W/ch, 8  $\Omega$ ; 1200 W bridged, 8  $\Omega$ .

## Lab Gruppen

Lab Gruppen AB, Lilla Verkstadsgatan 7,  
S-434 Kungsbacka, Sweden. Tel: 300-168 23.  
SS1300: 650 W/ch, 4  $\Omega$ ; 325 W/ch, 8  $\Omega$ ; 800 W/ch,  
2  $\Omega$ .

## Lenco

Lenco, 300 North Maryland Street, PO Box  
348, Jackson, MO 63755, USA. Tel: (314)  
243-3147.  
PPA-100: 100 W/ch, 8  $\Omega$ .

## Meyer

Meyer Sound Laboratories Inc, 2832 San  
Pablo Avenue, Berkeley, CA 94702, USA. Tel:  
(415) 485-1166.  
UK: Autograph Sales Ltd, 2 Spring Place, London  
NW5 3BA. Tel: 01-267 6677.  
MS-1000: 300 W/ch, 8  $\Omega$ ; 1000 W bridged, 4  $\Omega$ .

## Otis

Otis Communications Ltd, Thriplow House,  
Thriplow, Cambs, UK.  
International: Emberman Ltd, The Innovation  
Centre, Cambridge Science Park, Cambs, UK. Tel:  
076 382 465.  
Power Station: single ch 125 W, 4  $\Omega$ .

## Peavey

Peavey Electronics Corp, 711 A Street,  
Meridian, MS 39301, USA. Tel: (601) 483-3565.  
UK: Peavey Electronics (UK) Ltd, Hatton House,  
Hunters Road, Weldon North Industrial Estate,  
Corby, Northants NN17 1JE. Tel: 0536 205520.  
CS-800: 400 W/ch, 4  $\Omega$ ; 800 W bridged, 8  $\Omega$ .  
CS-900: 450 W/ch, 4  $\Omega$ ; 900 W bridged, 8  $\Omega$ .  
CS-1200: 600 W/ch, 4  $\Omega$ ; 1200 W bridged, 9  $\Omega$ .  
M-2600 MkV: single ch 130 W, 4  $\Omega$ .  
M-3000 MkV: single ch 210 W, 4  $\Omega$ .  
M-4000: 200 W/ch, 4  $\Omega$ .

M-7000: 350 W/ch, 4  $\Omega$ .  
DECA-424: 200 W/ch, 4  $\Omega$ .  
DECA-528: 250 W/ch, 4  $\Omega$ .  
DECA-724: 350 W/ch, 4  $\Omega$ .  
DECA-1200: 600 W/ch, 4  $\Omega$ .

## Quad

Quad Electroacoustics Ltd, Huntingdon,  
Cams PE18 7DB, UK. Tel: 0480 52561.  
USA: Tovil Distributors of America Inc, 14120-K  
Sullyfield Circle, Chantilly, VA 22021. Tel: (703)  
631-8618.  
520F: 100 W/ch, 8  $\Omega$ .  
510: single ch 135 W, impedance from 2 to 75  $\Omega$ .  
405-2: 100 W/ch, loads from 4 to 16  $\Omega$ .  
606: 180 W/ch, 8  $\Omega$ .  
306: 70 W/ch, 8  $\Omega$ .

## QSC

QSC Audio Products Inc, 1926 Placentia  
Avenue, Costa Mesa, CA 92627, USA. Tel: (714)  
645-2540.  
UK: Music Lab Sales, 72-74 Eversholt Street,  
London NW1 1BY. Tel: 01-388 5392.  
1080: 35 W/ch, 8  $\Omega$ ; 100 W bridged, 8  $\Omega$ .  
1200: 100 W/ch, 8  $\Omega$ ; 300 W bridged, 8  $\Omega$ .  
1400: 200 W/ch, 8  $\Omega$ ; 600 W bridged, 8  $\Omega$ .  
1700: 325 W/ch, 8  $\Omega$ ; 1000 W bridged, 8  $\Omega$ .  
3200: 110 W/ch, 8  $\Omega$ ; 280 W bridged, 8  $\Omega$ .  
3350: 200 W/ch, 8  $\Omega$ ; 600 W bridged, 8  $\Omega$ .  
3500: 300 W/ch, 8  $\Omega$ ; 900 W bridged, 8  $\Omega$ .  
3800: 375 W/ch, 8  $\Omega$ ; 1200 W bridged, 8  $\Omega$ .  
MX1500: 330 W/ch, 8  $\Omega$ ; 1000 W bridged, 8  $\Omega$ .

## Ramsa

UK: Panasonic UK Ltd, 300 Bath Road, Slough,  
Berks SL1 6JB. Tel: 0753 34522.  
USA: Panasonic Professional Audio Division,  
Matsushita Corp of America, 1 Panasonic Way,  
Secaucus, NJ 07094. Tel: (201) 348-7000.  
WP-9110E: 150 W/ch, 4  $\Omega$ ; 100 W/ch, 8  $\Omega$ ; 300  
W/ch bridged, 8  $\Omega$ .  
WP-9220E: 300 W/ch, 4  $\Omega$ ; 200 W/ch, 8  $\Omega$ ; 600 W  
bridged, 8  $\Omega$ .

## Rauch

Rauch Precision Engineering Ltd, Blackhill  
Industrial Estate, Snitterfield, Stratford-upon-  
Avon, Warwicks CV37 0PT, UK.

Tel: 0789 731133. Fax: 0789 731075.  
DVT25S: 120 W/ch, 4  $\Omega$ .  
DVT50S: 225 W/ch, 4  $\Omega$ , 440 W bridged, 8  $\Omega$ .  
DVT250S: 550 W/ch, 4  $\Omega$ , 1080 W bridged, 8  $\Omega$ .  
DVT300S: 600 W/ch, 4  $\Omega$ ; 1500 W bridged, 4  $\Omega$ .  
DVT500S: 1000 W/ch, 4  $\Omega$ .  
PB 44: 500 W/ch, 4  $\Omega$ , 990 W bridged, 8  $\Omega$ .

## Reflexion Arts

Reflexion Arts, Atlantis Buildings, High  
Street, Bruton, Somerset BA10 0AE. Tel: 0749  
812260.  
4180/700: 3U unit containing four 180 W/ch amps  
with pair 2-way crossovers.

## SAE

Scientific Audio Electronics Inc, PO Box  
60271, Terminal Annexe, Los Angeles, CA  
90060, USA.  
UK: Presence Audio, The Old Posthouse,  
Plummers Plain, Horsham, Sussex RH13 6NU.  
Tel: 0403 76777.  
A202: 100 W/ch, 8  $\Omega$ .  
A502: 200 W/ch, 8  $\Omega$ ; 600 W bridged.

## SECA

Aces (UK) Ltd, Featherbed Lane, Shrewsbury,  
Shrops SY1 4NJ, UK. Tel: 0743 66671.  
USA: Power Studio, 13453 Hollo Oval,  
Strongsville, Cleveland, OH 44136. Tel: (216)  
238-9426.  
USA: The Rock Studio, 430 Kansas Street,  
Norman, OK 73069. Tel: (405) 329-8431.  
SL30: 170 W/ch, 4  $\Omega$ ; 120 W/ch, 8  $\Omega$ ; 295 W  
bridged, 8  $\Omega$ .  
SL57: 285 W/ch, 4  $\Omega$ ; 180 W/ch, 8  $\Omega$ ; 490 W  
bridged, 8  $\Omega$ .  
SL96: 480 W/ch, 4  $\Omega$ ; 250 W/ch, 8  $\Omega$ .

## Studer

Studer International AG, Althardstrasse 10,  
CH-8105, Regensdorf, Switzerland. Tel: 411  
840 29 60.  
UK: FWO Bauch Ltd, 49 Theobald Street,  
Borehamwood, Herts WD6 4RZ. Tel: 01-953 0091.  
USA: Studer Revox America Inc, 1425 Elm Hill  
Pike, Nashville, TN 37210. Tel: (615) 254-5651.  
A68: 175 W/ch, 4  $\Omega$ ; 350 W bridged, 8  $\Omega$ .

## Studiomaster

Recording Studio Design Ltd, Studiomaster

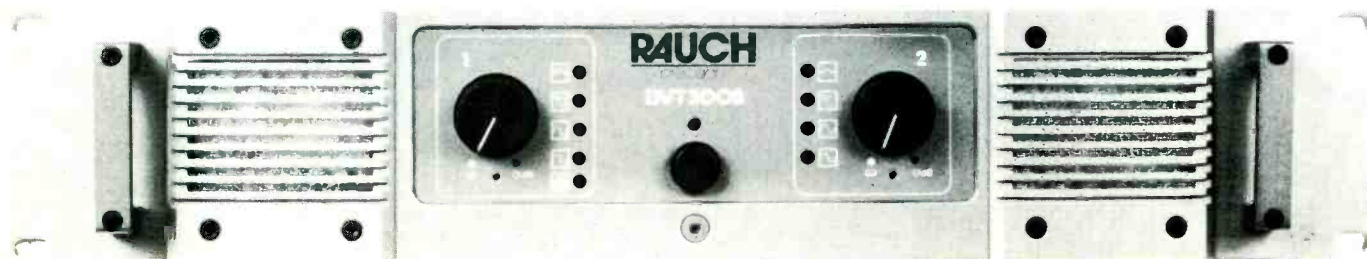

Rauch DVT 300S



# Greene Street First in New York



The first AMEK APC 1000 installed in New York is at Greene Street. This is what they and their clients have to say:

"In the ten years since Greene Street's been in operation, equipment choices were made based on sonic quality, then on ease of operation, and finally, on client awareness. We're the first with the Amek APC 1000, and initial reaction, especially in a city where SSL has proliferated, is sceptical... that is, until the producer/engineer actually works with the desk. Then all pre-conceived notions fly out of the control room door and as you can see by reactions from some of the early users, the Amek APC 1000 sets tomorrow's standard today." Steve Loeb (President, Greene Street Recording and Producer - Love Bug Starski, Riot, Carol Lynn Townes)

"Great flexibility, sweet sound, no compromise." Arif Mardin

"Yo, the dopest sh\*t." Russell Simmons (President, Def Jam Records & Producer of Run/DMC, Orin "Juice" Jones, Beastie Boys)

"After a night on APC 1000 all I could say was SS-what?" T-Bone Wolk (Co-producer, Hall & Oates, Bananarama, Carly Simon, Daryl Hall)

"Nothing sounds like it, nothing works like it, and why would anyone want to use anything else?" John Robie (Producer - Boy George, UB40, Chaka Khan, New Order)

"The only serious alternative." Joe Mardin (Producer - Chaka Khan, New Man, Kenny Loggins)

"I waited two years for the APC - after two weeks I couldn't imagine working on any other console." Rod Hui (Producer - Shannon)

Kurtis Blow, Riot, "Breakin" Soundtrack. Engineered - Philip Glass, Bonnie Tyler, Run/DMC, James Brown, Bee Gees)

All quotes supplied by GREENE STREET STUDIOS unsolicited by AMEK

APC 1000

GML  
GEORGE MASSENBURG LABS

Greene Street Recording Inc.,  
112 Greene Street, New York, NY 10012.  
Telephone: (212) 226 4278.

AMEK

EMPHASIS ON ENGINEERING



Head Office, Factory and Sales: AMEK Systems and Controls Limited, New Islington Mill, Regent Trading Estate, Oldfield Road, Salford M5 4SX, England. Telephone: 061-834 6747. Telex: 668127 AMEK G. Fax: 061-834-0593.

AMEK/TAC US Operations: 10815 Burbank Blvd, North Hollywood, CA 91601. Telephone: 818/508 9788. Telex: 662526 AMEK USA. Fax: 818/508 8619.



# AKG

ACOUSTICS

UNMARRED SOUND + TECHNOLOGY FOR YEARS TO COME

## THE C414 B-ULS



ADV 355/1/E



Digital recording techniques call for  
high quality microphones and audio  
processors.  
We supply the microphones.  
Get more information from your dealer or directly from



# POWER AMPLIFIERS



Tannoy SR 840 power MOS:FET

House, Faircharm Trading Estate, Chaul End Lane, Luton, Beds LU4 8EZ, UK. Tel: 0582 570370. Fax: 0582 570242.

USA: Studiomaster Inc, 1340-G Dynamics Street, Anaheim, CA 92806. Tel: (714) 524-2227. Fax: (714) 524-5096.

Mosfet 1000: 450 W/ch, 4  $\Omega$ .  
Mosfet 500: 250 W/ch, 4  $\Omega$ .  
Stellar Fet 1: 100 W/ch, 4  $\Omega$ .

## Tannoy

Tannoy Ltd, The Bilton Centre, Coronation Road, Cressex Industrial Estate, High Wycombe, Bucks HP12 3SB, UK. Tel: 0494 450606.

North America: Tannoy North America Inc, 300 Gage Avenue, Unit 1, Kitchener, Ontario N2M 2C8, Canada. Tel: (519) 745-1158.

SR840: 250 W/ch, 8  $\Omega$ ; 1220 W bridged, 4  $\Omega$ .

## TOA

TOA Electric Co Ltd, Kobe, Japan.

UK: TOA Electronics Ltd, Hutton Industrial Estate, Tallon Road, Brentwood, Essex CM13 1TG. Tel: 0277 233882.

USA: TOA Electronics Inc, 480 Carlton Court, South San Francisco, CA 94080. Tel: (415) 588-2538.

P-300D: 300 W/ch, 8  $\Omega$ .  
P-300M: single ch 300 W, 8  $\Omega$ .  
P-150D: 150 W/ch, 8  $\Omega$ .  
P-150M: single ch 150 W, 8  $\Omega$ .  
P-75D: 75 W/ch, 8  $\Omega$ .

## Turner

Turner Electronic Industries Ltd, PO Box 49, Etchingam, East Sussex TN19 7NZ, UK. Tel: 0435 882581.

B502: 340 W/ch, 4  $\Omega$ ; 190 W/ch, 8  $\Omega$ .  
B302: 150 W/ch, 4  $\Omega$ ; 100 W/ch, 8  $\Omega$ .

## Yamaha

Yamaha Corporation, PO Box 1, Hamamatsu, Japan.

UK: Yamaha-Kemble Music (UK) Ltd, Mount Avenue, Bletchley, Milton Keynes MK1 1JE. Tel: 0908 71771.

USA: Yamaha International, PO Box 6600, Buena Park, CA 90620. Tel: (714) 522-9011.

P2040: 20 W, 4-way, 8  $\Omega$ ; 40 W, 2-way, 8  $\Omega$ .  
P2075: 75 W/ch, 4  $\Omega$ .

P2150: 150 W/ch, 4  $\Omega$ .  
P2250: 350 W/ch, 4  $\Omega$ .  
PC1602: 160 W/ch, 8  $\Omega$ ; 480 W bridged, 8  $\Omega$ .  
PC2602: 260 W/ch, 8  $\Omega$ ; 800 W bridged, 8  $\Omega$ .  
PC2602M: as PC2602 with meter.  
PC5002M: 500 W/ch, 8  $\Omega$ ; 1500 W bridged, 8  $\Omega$ .  
PD2500: 250 W/ch, 8  $\Omega$ ; 500 W, 2  $\Omega$ ; 1 kW bridged, 4  $\Omega$ .

## YBA

YBA Company, Phlox Electronics, F-91440 Bures-sur-Yvette, France. Tel: (1) 6 446 4204.

UK: Presence Audio, The Old Posthouse, Plummers Plain, Horsham, Sussex RH13 6NU. Tel: 0403 76777.

YBA1: 85 W/ch, 8  $\Omega$ .  
YBA2: 70 W/ch, 8  $\Omega$ .  
YBA3: 50 W/ch, 8  $\Omega$ .

If you want to  
hear just how low  
on noise the *new*

**s y m p h o n y** LN IS,

IN LINE MIXER

hold this advert  
next to your ear.

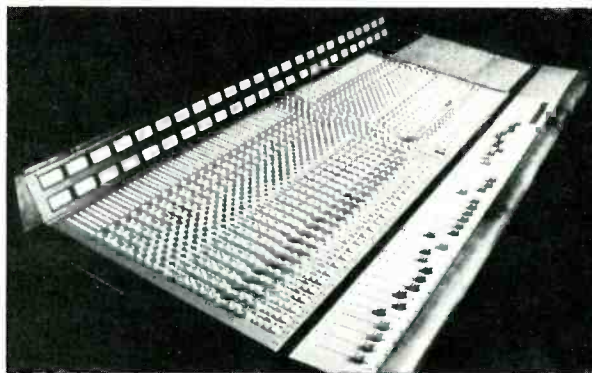

The Raindirk Symphony mixer is extremely low on noise and crosstalk. It has been rumoured that it's actually better than some mixers that are twice the price. Call us for a brochure.

For example: Stereo mixing noise 32 channels routed -90dBvu. Mute attenuation, crosstalk and breakthrough are better than -100db @ 20Khz. 32 groups & 2 stereo groups. 28/60 channels.

UNIT TWO, 10 WILLIAM ROAD, LONDON NW1 3EN.  
TELEPHONE: 01 387 1262 FAX: 01 388 0339.

YOU WON'T BELIEVE YOUR EARS



# The difference between hearing most of the music and all of it.



It's a vital difference. Especially if you're an engineer, musician, vocalist, composer, producer or broadcaster.

#### **BBE Makes The Difference**

And the difference is heard around the world. In leading recording studios, at major live concerts, and by audiences of top-rated radio stations.

#### **What's The BBE Difference?**

We make an exclusive line of audio processors. For all audio uses. Professional. Personal. Industrial. Wherever sound is involved, so are we.

Our technology restores the proper harmonic structure of sound by compensating for amplitude and phase distortion.

#### **What's The Result?**

You won't believe it. You literally will hear nothing like it. That's because instead of hearing most of the music, you'll hear all of it.

#### **How Is It Done?**

Well, we began 10 years and 42 patent claim awards ago. But simply, the BBE SYSTEM:

- Divides the audio spectrum into three bandwidths
- Applies specific phase corrections to each band
- Makes dynamic high-frequency amplitude compensations as required

#### **What Do The Experts Say About BBE?**

"The most hearable advance in audio technology since high fidelity itself."— *Music Connection Magazine*

"The effect is shattering!"— *Music Technology Magazine*

"I can't imagine working on another album without BBE."— *Steve Levine, producer of The Beach Boys, Culture Club, Denice Williams, and BPI Producer of the Year*

"The difference in (BBE) processed audio and non-processed audio is like the difference between high-fidelity speakers with and without pillows placed in front of them."— *Radio World Magazine*

"For my own personal system, it was the answer to problems I had been trying to solve with a graphic equalizer. The system has never sounded so good."— *Mix Magazine*

"You're in aural heaven."— *Music & Sound Output Magazine*

#### **Full Warranty**

All BBE products are backed by a full year's warranty on all parts and labor.

#### **Where Can You Hear The BBE Difference?**

For the name of the BBE professional sound dealer nearest you call toll free 1-800-233-8346. In California 1-800-558-3963.

Then stop by. You'll love what you hear. All of it.

## **BBE**

**Sound Inc.**

5500 Bolsa Avenue

Suite 245

Huntington Beach, CA 92649

(714) 897-6766



In 1981 Scott James Hybl had never touched a sampling keyboard. The spring of that year saw Hybl and partner Curt Cunningham proudly open the cellar door to Northstar Recording, dug into the Mount Scott suburbs of Portland, OR. Their instrument list included nothing more electronic than a Carvin double-neck guitar. Yet today composers, synthesists and sound editors throughout the US and Europe keep Hybl's name in their files under 'S' for 'Samples, Digital'.

The Northstar studio is small but nicely designed to serve as a

of 650 ft<sup>2</sup>; the triple ceiling is high and the underground isolation is amazing.

The door to the drum booth is actually a hinged wall, increasing the main floor area by almost one-third when the booth is not in use. Pianos, guitars, amplifiers and synthesisers crowd the perimeter. Drums? Choose from Ludwig traps, Tama *Techstars*, a Wendel *Junior* or Alesis, two *Drumulators* or simply an *Emulator II* connected to a CD-ROM library.

Plenty of outboard equipment has been squeezed into the control room. Two *Macintoshes* with hard disks wait to be assigned their MIDI-crunching tasks. There are synthesisers, samplers, sequencers, and racks of outboard gear from Aphex, Eventide, Lexicon, DeltaLab, UREL, and Burwen. The package is completed by the requisite German microphones and headphones. A Sontec preamp and a new Sanken stereo mic give final assurance that Northstar is serious about recording.

Things were simpler when Hybl carried those first buckets of dirt up the basement stairs, though: "We didn't even have synthesiser one when we started," said Hybl, "everything was all acoustic. There weren't any effects boxes... well, no, we did buy one Lexicon *Prime Time* digital delay. That was our special effect."

Northstar Recording is busy today, a successful studio averaging seven hours of booked time every day of the year. Free Rain's artist roster is growing and many outside producers crowd the schedule. But as the studio grew the irresistible sweep of new technology caught Hybl up and set Northstar on a course neither of the founders had imagined.

# NORTHSTAR

*David Mathew visits a US studio with an extensive interest in sampling*

recording base for Hybl's Free Rain Records and to rent a few hours here and there to the Oregon music community. The original Sound Workshop *Series 30* and the Tascam *Model 85* 1 inch 16-track are still in service, offering a great sounding and affordable home to clients like commercial music producer Rob Farley, or Quarterflash's Brian David Willis. An hour-meter on the 16-track takes care of the billing: the client is only charged while the tape is moving.

There is no question that Northstar is a 'basement studio'. It's located in the basement of Hybl's home. But the 800 yds<sup>3</sup> of earth removed pail-by-pail to lower the floor should put the room in a different class.

Hybl can laugh about it now; the calluses have disappeared. "Remember *Close Encounters of the Third Kind*, where Richard Dreyfuss was piling all the dirt in his house? Well, in our case the dirt was outside but nobody could figure out what was going on. The neighbours would drive by and the mountain would keep growing and growing but there was no visible hole!"

The finished studio is roomy and comfortable with a total area



"The very first sampler that I got," said Hybl, "was the 'E-II' (E-mu Systems *Emulator II*). I bought it to finish off an album project, and then it just went crazy because I got into it so much. I wanted to capture everything.

"I'd take my kids someplace like McDonald's and we'd drink a Coke or something, and the next thing you know, they'd be going, 'Listen to this, Dad, listen to this straw sound as I'm sucking up through it, isn't that bizarre?' And I'd start thinking about how I could stretch that over octaves.

"We were creating our own disks and trading disks here in town," continued Hybl, "and we decided to send one of our

engineers, Mark Schulman, to a trading party in Los Angeles. In that infant state, it was just fun to be able to trade.

"Mark went down to this show and ended up not trading our disks. Everybody else was just going mad, and here's Mark, bringing all of our disks back, untraded. He realised, we've got something here, we've got a good number of disks, almost as many as the factory.

"So we thought about it for a while, and decided to form Northstar Productions to sell the disks. We advertised in music and recording magazines and immediately got response. People were really excited about it."

Northstar sold disks outright and offered to trade on a three-for-one basis for new disks to broaden the library.

"But some musicians didn't want to do that," said Hybl. "A lot of people were getting ripped off and they didn't want to let their sounds out. We wanted to keep everything square, so we said 'if we'll pay a royalty for it, then it makes sense. You

# NORTHSTAR

## SAMPLING HINTS AND TIPS

### *Set input levels*

First set the input levels. A sampler is a PCM digital recorder with similar operation and requirements. Set the level as high as possible without clipping the preamp or converter. Digital word length, which helps determine dynamic range, will range from 8 bits to 16 bits, depending upon the design of the sampler.

### *Set sample rate*

Some samplers offer only one rate, typically 44.1 kHz for a full 20 Hz to 20 kHz bandwidth. Others have several sample frequencies, or even infinitely variable sample rates.

The highest sampling rates provide the broadest bandwidth and the truest reproduction. Sounds sampled at higher rates can also be shifted further down in pitch before the sample frequency becomes audible in the output.

Lower sample rates conserve storage. With low frequency acoustic sounds and many synthesised sounds, a low sample rate can produce results indistinguishable from full bandwidth samples. In some machines this memory saving can be accomplished later by digitally converting a full bandwidth sample to a lower rate, comparing the original to the converted version all the while. A low piano note may require only a bandwidth of 5 kHz to 10 kHz but it may need 3 seconds to capture the development of the tone.

Percussive sounds on the other hand may require full bandwidth to capture the quick transients but need only a very short window of time.

### *Select sample length*

Select the sample length, the duration of this time-window, next. The sample length can be set to the maximum memory in the machine but often it is more convenient to set a repeated short length to provide for consistent note-to-note samples. Also, the shorter the sample, the less memory used.

A sample can be played back at different pitches, but too much 'stretch' in either direction destroys the illusion of a real acoustic instrument. In many cases, a sample may only be shifted up a few musical steps before a new sample at a higher pitch must be used. If you are sampling an acoustic instrument with a broad range, you must plan to use a number of samples across the range, and the performance and recording of each sampled note must be consistent. Where the notes and their pitch-shifted counterparts will actually lie on the playback keyboard is determined by presets (below).

### *Truncate and loop*

Truncating is simply cutting off the beginning or end of the sample; looping is digital editing of the sample into a long (even endless) loop for sustained sound on playback. Truncating and looping each improve the usability of the sample by giving it a precise, uncluttered start, a clean ending and a smooth, natural range of durations. Both processes also help conserve memory: only those portions of sound essential to the attack of the note and the components needed for the sustained loop need

be kept. The rest of the sample can be discarded, freeing more storage.

Truncating 10 ms of 'dead air' before a note may seem picky but if the note is a sharp conga slap later used in an auto-corrected sequencer playing a fast pattern, 10 ms delay on each stroke makes for a sloppy track.

Loops can be formed by hard-cut digital edits, by cuts to relatively pure tones generated to simulate the original sound, or by digital crossfades between sections of the original sample. The 'crossfade loop' technique seems generally to yield the best results in the least time.

### *Fine tuning*

Next perform a gain analysis on the sample. Still working in the digital domain, adjust the level of the sound to make the best use of the machine's signal-to-noise ratio, and to provide consistency in playback.

Digitally tune the sample, if necessary, by sample rate conversion until it is in perfect concert pitch.

### *Set the presets*

The presets determine how this sample will actually be manipulated during playback. A great number of parameters can be set in a sampling machine, often including truncation points, loop points, playback sampling rate (pitch), panning, VCA level, VCA envelope generator settings, VCF frequency, VCF envelope generator settings, the combining of different samples, assignment of keyboard position, assignment of key velocity control, and so on. These presets can be undone or adjusted upon playback but can also be saved on the disk with the sample. This allows a powerful variety of sounds and effects and control, with a minimum of actual PCM sample information, which is the real memory hog.

With some machines it is possible to form more than one loop within a sample, capturing characteristics of the sound at later points, perhaps looping to the actual decay of the note, and so on. But creating each loop can be tedious work, and most samplers form only one, letting the preset-controlled VCA and VCF envelope generators define the sloping sustain and final close of the note.

Many sampling keyboards incorporate degrees of velocity control in their keys. This can also be programmed by presets and could for example switch from sample 'A' to sample 'B' at a given velocity, or could control the VCF or the VCA or both. In the latter case, for example, a piano sample played softly would be muted and quiet; played strongly, the VCF would open and the VCA would increase its gain and a much brighter tone would be produced. (This is a good reason to sample on the bright side. The high end can always be filtered out but it can't be recreated in a dull recording.) A current sampling keyboard might incorporate 128 different levels of velocity control that can be routed to any of the preset functions. In conjunction with an electronic release pedal, velocity control makes for a very expressive instrument.

Hundreds of presets can be stored and a preset can be copied from one sample to a different location, then modified further. Even your playing style can be accommodated. Entire families of presets can be developed requiring, for example, harder strokes overall; or alternatively providing a very light touch.





# C:SOUND<sup>®</sup> Graphic Audio Editing

First Time.

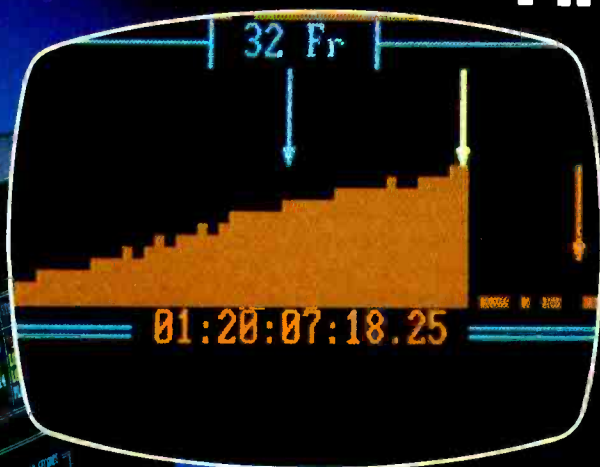

Every Time.

## The 2600 A/V Audio-for-Video Editor

**Imagine** spotting effects to 0.1-frame accuracy. Perfectly. The first time. Every time. In half the time.

**Imagine** ADR and Foley on the first try.

**Imagine** conforming 100-plus edits of original audio from a video EDL by pressing a single key.

**Imagine** all this—and more—with just one addition to your conventional analog or digital studio hardware.

The ADAMS-SMITH 2600 A/V Audio-for-Video Editor.

**It boggles the imagination.**



**ADAMS • SMITH U.K. LTD.**

Barnwell House, Room 9, Barnwell Drive, Cambridge CB5 8UJ England  
Tel: 0223-410104 FAX: 0223-215293 TELEX: 851-817847

created that sound; it's yours'. That generated a lot of interest all over."

One of the reasons for the success of the Northstar sample library is its size and diversity, which can largely be attributed to their royalty system. The list of authors is long and includes top musicians from across the country, like session player Jason Miles, synthesist Craig Anderton and recording artist Kerry Livgren of Kansas.

Also, Hybl has always insisted that Northstar's disks be sonically compelling, easy to use and full to the limits of the available memory. The spectacular quality of the samples has

# NORTHSTAR

satisfied a worldwide clientele of world-class artists.

Making a sample seems like a pretty straightforward procedure. You put a dog in front of the microphone, have him bark, you play him back as a chord.

But to make a great sample, you first need to make a great recording. Excellent instruments and players, the best mics and preamps, and careful placement are all important. That's just the beginning; and many musicians deep in production have found that they simply cannot take the time to create all of their own samples too.

"It's not so much the hardware you have," said Hybl, "as it is the care that you put into making the effect.

"It takes upwards of 10 hours to put a really good disk together. If you're going to do it right, by the time you label the voices, tune them, filter them, loop them, create interesting and usable presets, you've often lost your focus on what you were trying to do in the first place. That's why people call me for custom disks.

"John Ashenbrenner does the music for the soap opera *Days of Our Lives*," Hybl went on. "He needed a bagpipe for a programme, and he called me up and said 'Can you throw one together?' So I hired a piper and made a whole disk for John. It was a lot of fun but it was a lot of work. I wish there were more people out there doing that, 'cause a lot of times I'll need a sound but I know how much work it is to create it, and I don't know who to call!

"You'd think bagpipes would be very simple. But there are a lot of little nuances that need to be captured; there are trills, there are different types of trills. Now, the *Emulator II* has the capability to do velocity switching, I can hit a key soft and I can get it to play soft. If I hit it harder there is a point at which the sample becomes a different sample. It might be a trill. Or it might be a sample of the piper blowing into the instrument in a different manner.

"But most people don't do that. All they want to do is get the single note. And that never works. It never sounds realistic."

A problem in sampling a bagpipe is the bag itself: "The player has to pick up the bag," explained Hybl, "and then come down on it. You don't want all that noise in there; you want to be able to play from the point of the beginning of the note. So we had to just tear his whole bagpipe apart, to end up with the airbag in position to get that initial attack.

"That's really frustrating for some people we sample, because they think they are actually going to play something but we just rip instruments into pieces when they get in here."

Although a single sample could theoretically be played back at any pitch, the timbre and vibrato will change with the frequency, and the sound loses its character. A careful samplist will record a new sample from the instrument at least twice within each octave.

"Generally I go at (musical intervals of) either thirds or fourths. You could go fifths if you needed to. . . but after that much stretch it can sound like Mickey Mouse—or Darth Vader."

The 'E-11' format imposes a limit of 17.5 seconds of audio per disk. A well-thought-out disk might have several samples of two or three voices within an instrument, 'Quiet Bagpipe', 'Loud Bagpipe' and 'Trills', for example. These samples have to be brief to fit on the disk.

A technique called 'looping' is applied to lengthen the notes. At a point after the attack of the note, the sample is digitally spliced back upon itself to maintain a tone as long as the key is

depressed. Finding the correct points to make an audibly flawless loop is a painstaking procedure, and must be performed for each individual sample on the disk. Fortunately, the information for each loop can also be recorded on the disk, preserving for other users the results of hours of tedious looping. Software programs such as *SoundDesigner* and *Alchemy* are a great aid in looping samples but a lot of it is still listening and then listening again.

Northstar's disks are full of presets, with as many as 90 on a single floppy. Each preset is a pre-programmed treatment of a sample, a set of instructions to the sampler to modify the playing of the sound in some way: slowed down, sped up or muted, for example.

"Listening to our library would take about 48 hours straight through," said Hybl, "just putting in disks, going next preset, next preset, one after the other. It's frustrating with all the volume. So that's why eventually we went to a CD-ROM with Optical Media International. The amount of storage is phenomenal. On the disk there are 436 banks (a bank is the equivalent of a floppy) and it has more presets than any disk I've seen."



The *Northstar Gold* CD-ROM has a reflective surface of 24 ct gold, as opposed to the aluminium surface commonly used. The gold has none of the dropout-causing pinholes, which can be easily seen by holding an ordinary aluminium-surfaced compact disc up to a light. Also, the gold will not oxidise over long periods of time, as is projected for the aluminium surface. (A contentious statement!—ed.)

The disk is played on a Sony CD-ROM computer drive, specially modified by Optical Media to recover the data in the proper format for an *Emulator*. The drive and a disk come to about \$3,000 but it beats buying 500 pre-recorded floppies at \$10 to \$20 each, let alone carting them around and drumming your fingers on the desk while they load into memory.

Hybl is currently mulling over an expansion at Northstar—more tracks and a bigger console. And the sampling?

"We're going to add some more formats," said Hybl. "Right now we've got 'E-11', *Emax*, Ensoniq *Mirage* and *EPS*, and Roland *S-50* disks. We're looking into doing the Akai *S-1000*, burning chips for the Korg *M1* format, and as soon as we get the *Emulator III* in, we're starting a whole new library for it from scratch. Everything will be 16 bit stereo, and all the location sounds will be recorded on a portable DAT recorder."

Hybl remains firm in his resolve, though, to carry no more buckets of dirt up the stairs. □

Northstar Recording/Northstar Productions, 13716 SE Ramona, Portland, OR 97236, USA. Tel: (503) 760-7777.



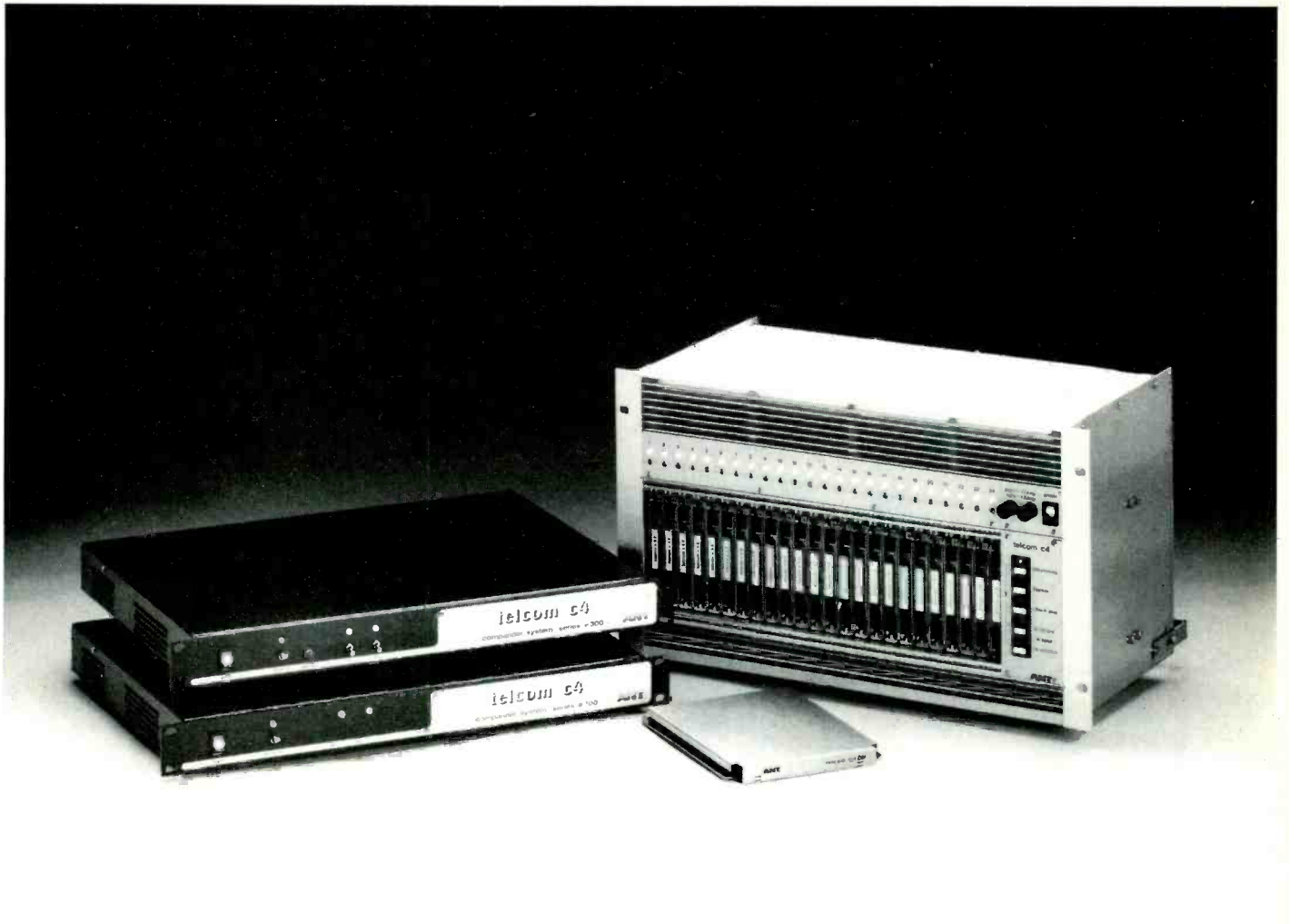

## telcom c4, the user-friendly NR system. Just switch it on and forget about it.

Yes, it's as easy as that. There's no wasting time with lining up. Not even for tape exchanges. With the telcom c4, you can really just switch it on and forget about it.

Not only that. It will prevent decoding faults and clean up recordings, even when misaligned.

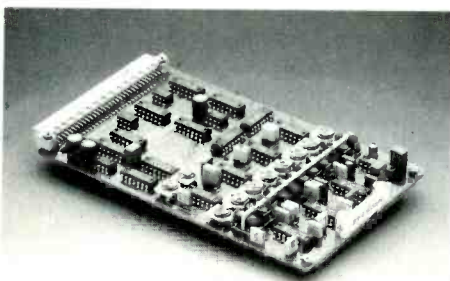

The new c4 E card uses the latest SMD technology

With a dynamic range up to 118dB, telcom c4 offers you a quality of sound which is unsurpassed. Second to none.

Simply ask for a test demonstration - and you won't believe your ears. An analog recording can outperform a 16-bit digital recording. You don't believe it? Then check it out.

With telcom c4, you can be certain of success. You'll get

the sound you always wanted - the sound that makes hit records.

I would like to learn more about telcom:

Name \_\_\_\_\_

Company \_\_\_\_\_

Street \_\_\_\_\_

City \_\_\_\_\_

SS/9/88

# telcom c4 the sound idea

ANT Nachrichtentechnik GmbH  
Lindener Str. 15, D-3340 Wolfenbüttel  
Phone (05331) 83-0, Telex 95651 ant wf



Telecommunications

**O**wners of recording studios will be the first to assure you that if you are in it for the money you've picked the wrong business. The days when recording studios paid huge dividends were short lived and are long gone. The same applies to mobile recording units, if not more so.

The National Transcription Service is a relative newcomer to the field whose philosophy and concept is unique in the industry. Run by a diverse collection of personnel from all walks of life, it has come into being as essentially a charitable concern. The people involved all work on a voluntary basis and their aim is to build up a tape library of recorded local events—not only music but drama, documentaries, etc.—anything that can incorporate a local flavour as well as achieving some sort of longevity.

David Hurlock, one of the founding members of the team explained. "The whole purpose is to build a tape library for

professional outfit that will now strive to fill these gaps. The personnel involved each have their own motives. Hurlock was inspired in 1979 after a long stay in Chichester Hospital (West Sussex's county town), after which he felt a need to give something in return for the care he had received.

As a dealer in secondhand recording equipment, tape services and lighting, and a live sound operator, he has perhaps most experience of the recording industry of the NTS team. They are Ralph Harvey (formerly sleeve note writer for EMI Records); Dennis Hall (retired Plessey's employee, responsible for wiring); Ray Betts, master builder and 'Mr Fixit' who turns his hand to any metal or wood repairs; Sally Peer (involved with hospital radio); Duncan Marshall (hospital radio, local radio, TVS, etc); Roderick Henley (retired Lloyds Bank management who brought financial expertise to the project—unfortunately temporarily retired from NTS due to illness); and Sally Strong who "holds us all in check. When we're getting carried away with our plans, she brings us all back down to earth and forces us to be realistic!"

"We all work on a voluntary basis but it is coming to the point where people keep asking us to record them and we are beginning to think commercially. We should charge around £350 a day and then that would pay for one of us full time."

Back in 1984 after Hurlock's stay in Chichester Hospital he recorded the Southern Chamber Orchestra using some of his second hand equipment stock for the hospital. In 1985 he spent two weeks at Chichester Festival recording various events for broadcast at the hospital.

"I had some STC 4038 ribbon microphones and a stereo Longden desk, which came out of a hall in London, was sold to someone in the Midlands and then came to me when it was scrapped. I had bought some telecine equipment and the desk was thrown in. It was useless for studio work so I couldn't sell it. It was very noisy but had a good tone. I had two Studer A62s and I put the whole lot into a Luton van. When I had finished I was left with a pile of cables and that old desk, which has subsequently been scrapped."

As the idea of NTS developed sponsors were gradually found. In early 1987 Hurlock heard a rumour that the BBC was retiring one of its transcriptions vans and negotiated to buy it, hopefully complete with mixing desk. In the event it arrived minus the console, which had been hurriedly removed leaving cables cut under the floor, mains cables were snipped off and left too short to rewire, monitor speaker fascia plates were missing, etc.

"Yes I frowned a lot too! But we did get it at a very reasonable price. Even the track lighting had gone and yet they left things like the patchbay, complete with Varelco connectors, the air conditioning, and there is a socket in the wall that is wired via a thermostat so that you can leave a heater plugged in and it will automatically switch on during a cold night to keep the van and equipment warm for when you want to start work the next day."

# NTS MOBILE

*The NTS is a charitable mobile recording unit manned by volunteers that aims to make extra facilities available to hospital radio. Janet Angus visited them on location in Portsmouth*

hospital radio to use. That is no mean task because as we all well know radio gobbles up tape very quickly; it takes much longer to produce two hours worth of documentary, or whatever, than it takes to broadcast.

"Hospital radio relies very heavily on using records and because younger people tend to have a lot of time to spare, for example after school, it also relies on school children a lot of the time to run it. The trouble is that the majority of hospitals get a lot of people who are 60 years old plus. The things they relate to are music from the 1940s and '50s, not today's pop music which is what the young people operating the stations relate to. Nine times out of ten, people in hospital do want to make programmes, documentaries, etc, but they just don't have the facilities or resources."

By seeking sponsorship, NTS have managed to put together a very





# Why did Rockfield choose the Neve V Series?

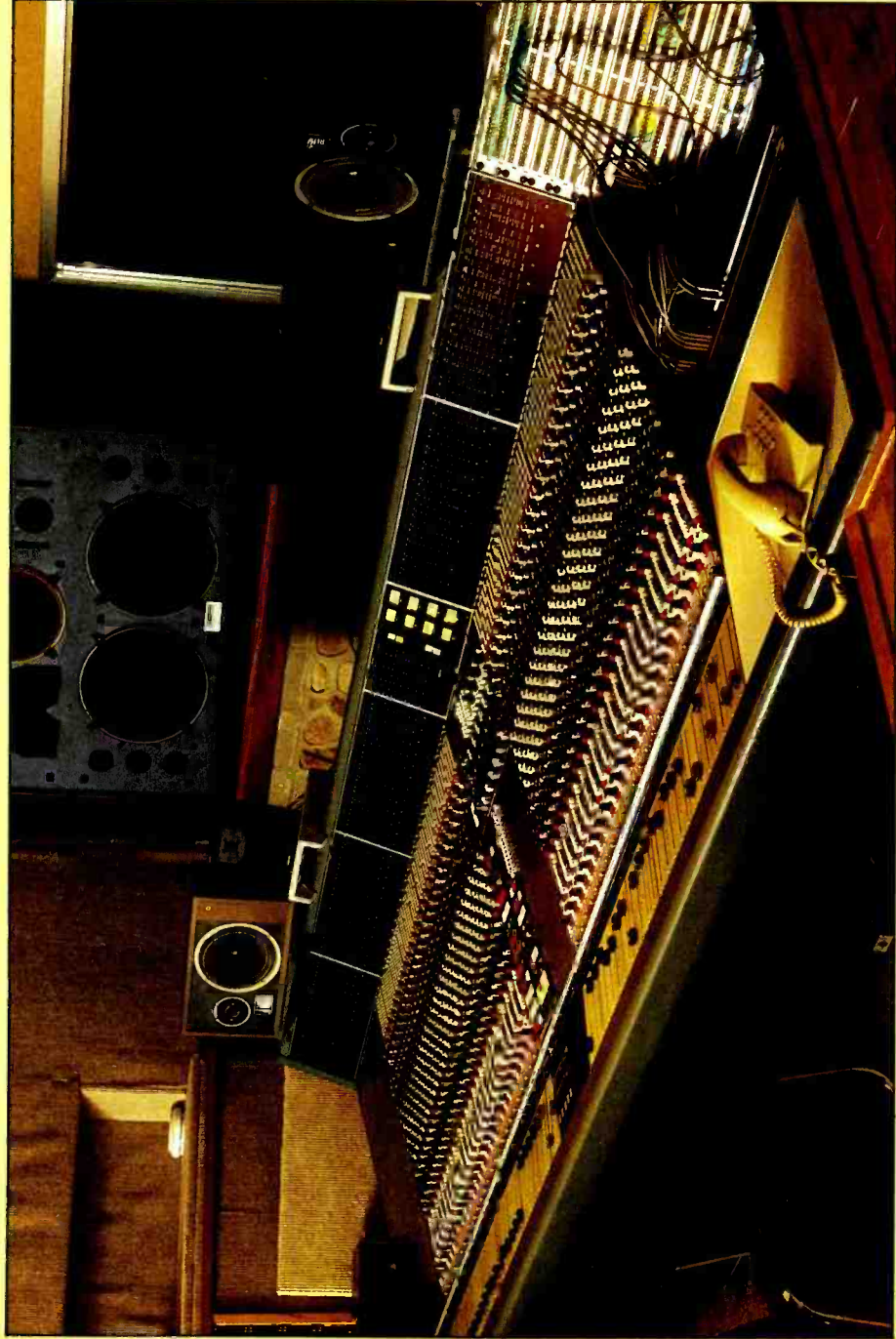

“Having questioned many producers and given careful thought ourselves, the Neve V Series was chosen primarily because of Neve’s reputation for producing fine musically sounding consoles coupled with the fact that the facilities incorporated in the V Series are more than adequate for our needs.”

“Furthermore with a Neve as opposed to certain other consoles we did not find a single producer who would not be happy to use it.”

Kingsley Ward  
Owner Rockfield Studios

## Neve V Series

# When only the best is good enough



NEVE ELECTRONICS INTERNATIONAL LIMITED, MELBOURN, ROYSTON, HERTS SG8 6AU, ENGLAND  
TELEPHONE: ROYSTON (0763) 60776. TELEX: 81381. CABLES: NEVE CAMBRIDGE. FACSIMILE: (0763) 61886

# An improvement on the MTR 90 Mk2? Who on earth could have managed that?



Many an envious glance has been cast in the direction of an MTR-90 Mk.2.

No wonder. With its pinch-rollerless transport, its user-friendly control and its faultless reliability, the MTR-90 Mk.2 has been known as the king of 2-inch multitrack.

But now, it shares its crown with a newcomer. A machine with all its advantages, plus faster wind and rewind, auto alignment on record and repro and frame-accurate mini-locator.

A machine that offers even better audio quality than the MTR-90 Mk.2, but retains all its vital portability.

A machine that even features an optional inboard Dolby\* Rack, ready to accept your choice of SR cards or Otari's unique, switchable A/SR combination cards. As well as a host of detail features aimed at helping the skilled engineer to do a better, faster job.

The name of this marvel is the MTR-100A. And if you're still in the dark as to its maker, wonder no more.

Because there's only one machine that can top an Otari. Another Otari.



## MTR-100A. The master of masters.

\*Dolby and the DD are trademarks of the Dolby Laboratories Licensing Corporation.

**For more information, phone or write:**

Otari Electric (UK) Limited, 22 Church Street, Slough, SL1 1PT, Berkshire. Telephone: (0753) 822381. Telefax: (0753) 823707

Otari Corporation of America, 378 Vintage Park Drive, Foster City, CA 94404. Telephone: (415) 341 5900. Telefax: (415) 341 7200

Otari Electric Co Ltd, 4-29-18 Minami-Ogikubo, Suginami-ku, Tokyo 167. Telephone: (03) 333-9631. Telefax: (03) 331-5802

Otari Singapore Pte Ltd, 625 Aljunied Road, 07-05 Aljunied Ind. Complex, Singapore 1438. Telephone: 743 7711. Telefax: (743) 6430

Otari Electric Deutschland GmbH, Rudolf Diesel Strasse 12, D-4005 Meerbusch 2, West Germany. Telephone: 010 49/2159/50-861-862 or -863. Telefax: 010 49 2159 1778



Citicorp Citibank came up with the money to buy the van and most of its equipment on the basis that it would be used for charitable work and that NTS would also do commercial work to enable it to pay its own way. "People like to give money to build something; it's always easy to get money to create something they can physically look at but you can't get them to give money to record things."

The van arrived in traditional green and grey BBC hue. Dulux Paints were persuaded to donate the paint for Sparshatts (custom truck builders whose clients include the BBC) to paint it blue and white with the NTS and its various sponsors' logos.

Wiring was not NTS's only problem. For some unknown reason the truck had been fitted with an exhaust pipe designed for a tipper truck and so the exhaust fumes were being drawn up inside.

"It was full of black diesel fumes and the walls and ceilings were plastered. It was crazy, every time the BBC chaps arrived anywhere they had to dismantle the desk and clean it! We ran

So you've dragged all your cables out in a mess and then they turn the outside lights off. We've put lights on the side and back of the lorry as well as over the spare wheel and we carry two large batteries that power these as well as the fluorescent strips inside."

Two automatically switching phantom power supplies are carried in case of failure. There is a video—a monitor in the lorry but "unfortunately the only thing we haven't got at the moment is a camera! We should be able to get hold of one but in fact a lot of theatres have their own, which we can hook up to."

Two Alpage (new Alpine) AL-300 cassette machines (ex-Stones Mobile) complete the equipment list. Back at Hurlock's base there is a Wollensak mono x5 cassette copying machine. The cassettes are duplicated in mono as hospital radio is broadcast mono.

Hurlock has elected to use Agfa 468 multitrack tape as he finds it less likely to have printhrough problems on old tapes.

"In my experience Ampex 456 gives a lot of printhrough on old tape and also there seems to be white dust, which comes off it on to the tape guides and is extremely difficult to clean. With Agfa 468 I have never had those problems. It also winds very easily on any machine—nice and smooth with very little printhrough. Also the writing on the tape is very useful for editing! You can see very quickly and easily if the tape has moved before you put the razor blade on it."

One of the hurdles to building up a tape library has been persuading the Musicians' Union to allow their members to be recorded for charity, but Hurlock is confident that the situation will be resolved. Although NTS is currently concentrating on the West Sussex area, they will move on somewhere else when they have compiled a good stock of programmes.

"We record things like classical concerts given by local orchestras, programmes about West Sussex—things which have quite a wide appeal. Events in Chichester will be of interest to people in Worthing and Portsmouth hospitals as well as Chichester."

There is an organisation called the NAHBO (National Association of Hospital Broadcast Organisations) which offers a library of about 97 titles, which any hospital is entitled to use. All they have to do is send in an appropriate cassette and stamped addressed envelope. "But it has never been that successful. For a start 97 titles is not very much, you soon exhaust that lot. The other reason is that people so frequently send in the wrong length cassette. They want a 1-hour

# NTS MOBILE

it for about a month until we decided we couldn't go on with it. We replaced all the hessian inside and cleaned the woodwork, which was black and shampooed the carpet goodness knows how many times."

The finished product is now fitted with a Neve 8066 20-channel (16-track monitoring) mixer and a pair of Rogers LS37 monitors.

"We are recording mostly live or classical music and quite often we can get away with using only four channels. A lot of people go around with a Nagra and a pair of headphones; that's not really the way to do it, is it?

And sitting in a room at the hall or church, no matter how well you know the equipment, is also not as good as sitting in a room where you know the acoustics."

The Neve came out of the BBC Radiophonic Workshop and the three B62s also came from the BBC. There is a Studer A80 8-track recorder and full complement of Dolby A-type noise reduction.

Apart from the dynamics section on the mixer there is an Alesis *Microverb*, which tends to be left on the same setting, as well as custom BBC compressors and noise gates, which are in fact seldom needed.

"We have access to a second A80 should we need it. Being a BBC vehicle we've got things like volt meters and ameters and a Lyons voltage stabiliser, which means that we can go down to as little as 204 V and still get 240. Our multicore cables are the same as the BBC's—seven mic pairs on each one, giving a total of 56. We've got all the usual microphone splitters, etc."

On the van's exterior there is a simple but essential extra: "One thing which always happens when you are recording a concert, the event finishes, the people have gone and you are still upstairs packing up your cables when they throw you out.



programme so they send in a C60 instead of a C120, which will have to be turned over half way through; what are they going to do when they are broadcasting while they turn the tape over? Or else they will send the wrong stamp or even forget the stamp altogether.

"What we intend to do is put our recordings on to C120 tapes which we will provide and bulk duplicate. Then they will be offered to hospital radio stations for £1.10 which will include everything—postage and packing, cue list and all the paperwork, etc.

"All we need now is more people to use us—both commercially and for the hospital work. We have to rely on word of mouth but I think that's the best way." □



# EQUIPMENT CONSTRUCTION STANDARDS

account of both voltage and current output). An alternative might be to state on the front panel at what level of input the amp will clip (with a specified load) and a gain control calibrated in decibels. I can't believe that engineers don't want to know how hard they can drive their amps, so why can't it be done?

**DM:** Unity gain is an interesting concept, which I fear might be forsaken if we don't shout loud enough. I've always thought it was essential to be able to set a piece of equipment (such as a digital delay or a tape recorder) so that, whatever level goes in, that same level comes out. It saves an awful lot of fiddling about and you know where

you stand. To achieve a unity gain setting then two things are required: an input level control and an output level control, preferably screwdriver operated presets so that all level balancing operations will be done at the console. A lot of equipment, especially in the lower price bracket, is coming on to the market without output level controls. I hope this trend will not progress up the professional scale.

On the subject of level, what do the letters VU stand for? Two answers are acceptable: Volume Unit or Virtually Useless. I don't claim to have invented the second description but isn't it true? I know that many engineers have developed considerable skill in interpreting the readings of this type of meter but my feeling is that there is enough already for the sound engineer to do without having this extra doubt. VU meters with a peak-reading LED are a definite improvement.

**RS:** Of course. VU meters do have some uses. Firstly to indicate a presence of signal. Secondly for lining up with tone. The one thing they won't do is indicate the peak level of a typical

programme signal. For that you need a Peak Programme Meter—or a bargraph with PPM characteristics—which will tell you when you are approaching clipping level. The VU meter reads average level, which isn't really the issue.

## Transformers

**DM:** The disadvantage of transformers is size, weight and cost, in no particular order. Add to that doubts about the frequency response and resonance problems. When you consider that an audio signal might pass through a dozen or more transformers from cradle to grave, then this may be something to worry about.

**RS:** The big plus that you do get from the transformer is that you can plug anything into anything and rarely have any interface problem.

**DM:** Electronically balanced output stages are another matter. In my experience, they come in two sorts. In type A, the manufacturer's instructions say, 'when connecting to an unbalanced input, leave pin three disconnected'. In type B it is, 'when connecting to an unbalanced input, link pin three to pin one'. In both cases, the manual often goes on to describe the misfortunes that might befall you if you should ignore its advice. To be fair, type B is exactly the same procedure as you would follow for a transformer. What would make me happiest would be if manufacturers printed diagrams of how unbalancing connections should be made, on the rear panel of the equipment as well as in the book.

## Performance

**DM:** The audio performance of semi-professional equipment may approach that of fully fledged pro gear. But in some situations, even the most highly specified equipment may impose restrictions. For instance, no matter where loudspeakers are situated in a theatre, ideally no member of the audience should be aware of electronically generated noise.

**RS:** Assuming that power amplifiers, with signal to noise ratios of 100 dB plus, are capable of a sufficiently wide dynamic range. I have been aware of excessive noise coming from speakers, even when the desk's output faders are closed.

**DM:** Where do you think it comes from?

**RS:** Active crossovers, delay units, graphic equalisers and the like. With most theatre systems using multiple speakers each with its own EQ and delay setting, processing equipment is invariably placed between the desk and the power amplifier. The best achievable signal to noise ratio of the entire system will be defined by the worst of these—beyond the control of the output faders.

**DM:** That would also apply to things like frequency response and distortion. The worst performing element of the system would be the limiting factor.

Also, in the case of truly professional gear, there has to be a 'professional headroom'. This means that even when the equipment is not working at its best, or in its optimum environment—temperature and humidity, etc—then the level of performance should still be adequate. It should not throw fits of temperament at reasonable amounts of abuse, dusty working environments, poor mains, shorted outputs, etc.

**RS:** There's a lot more we could discuss about headroom, perhaps we should leave that for another time... □

**Rebis MULTIGATE**

# THE MULTIGATE

FOUR FREQUENCY CONSCIOUS GATES  
 FAST RESPONSE, DEPENDABLE PERFORMANCE  
 ENGINEERED FOR MINIMAL SET UP TIME  
 UNIQUE SYNC FACILITY FOR TIGHT HARMONIES  
 ADVANCED LOW NOISE VCA DESIGN

# ESSENTIAL EQUIPMENT

RA702  
POWER

For full information/demonstration contact:

**Rebis Audio Ltd.** Kinver Street, Stourbridge West Midlands DY8 5AB, ENGLAND. Telephone: (0384) 71865. Telex: 335494. Fax: (0384) 265907

Australia: John Barry Group, Artamon N.S.W. 02 439 6955. Austria: Bauer Sound, Himberg 02235-89298. Belgium: S.E.D., Bruxelles 522 70 64. Canada: Heintz Electronics Inc., Ontario 727-1951. Denmark: Kinovox A/S, Lyngby 02 18 76 17. Finland: Studiotec, Espoo 592055. France: High Fidelity Services, Paris 285 0040. Germany: Thum & Mahr Audio, Langenfeld 2173-7806-0. Hong Kong & China: Audio Consultants Co. Ltd., Kowloon 3-7125251. Japan: Soundcraft Japan Ltd., Tokyo 3416201. Netherlands: Special Audio Products B.V., Amsterdam 140035. New Zealand: Maser Broadcast Systems Ltd., Auckland 4797889. Singapore, Malaysia & Indonesia: Bell & Order, Singapore 7438081. South Africa: Tru-Fi Electronics, Johannesburg 786 7177. Sweden: Tai & Ton, Gothenburg 803620. Switzerland: E.M.M. Studio, Basel, 061 54 20 45. U.S.A.: Rebis U.S. Atlanta, Georgia 404 633 6626.



# SSL G SERIES

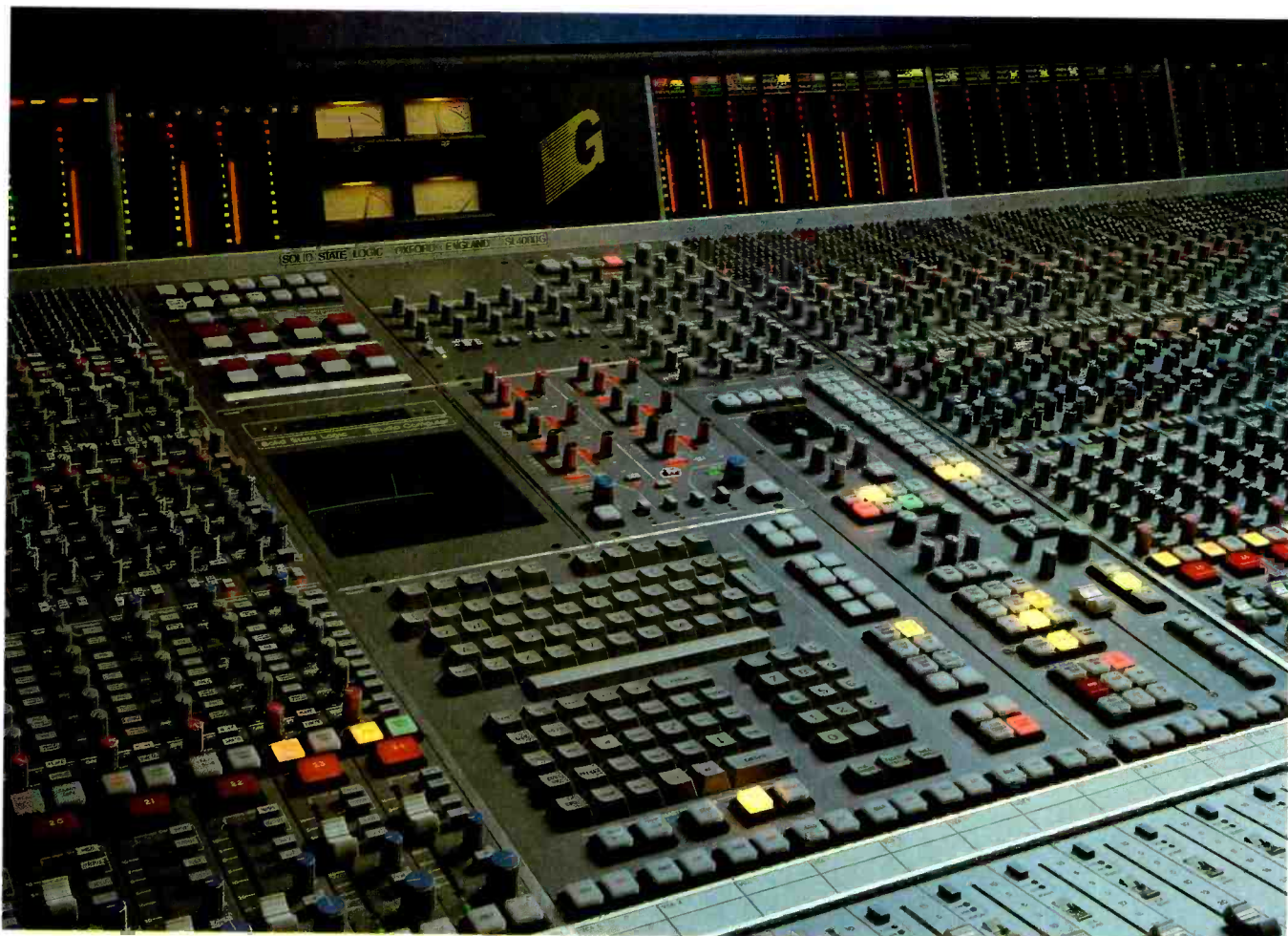

## For Tracking And Mixing

A production becomes a classic when the sound of the console matches an inspired performance, and the mixing system is true to the talent of the producer and engineer.

With G Series, every stage between the microphone and the recorder sounds rich and full. The Total Recall Computer instantly stores all eq and mic settings,

monitor mixes and routing – from the first track you lay to the last mix you create.

Today, there is more pressure than ever to produce a finished mix – fast! The tracking data compiled on an SSL means fast, effective mixing on an SSL.

If you want to produce classics — give us a call.



## Solid State Logic

Oxford · Paris · Milan · New York · Los Angeles

Begbroke, Oxford, England OX5 1RU · (08675) 4353  
1 rue Michael Faraday, 78180 Montigny le Bretonneux, France · (1) 34 60 46 66  
Via Cesare Cantù 1, 20092 Cinisello Balsamo, Milan · (2) 612 62 81  
320 West 46th Street, New York, NY 10036 · (212) 315-1111  
6255 Sunset Boulevard, Los Angeles, California 90028 · (213) 463-4444

SSL Representatives: Acustilab, Venezuela (58) 2-987-4845 Audio Consultants Co Ltd, Hong Kong (852) 3-7125251 Siv Ing Benum A/S, Norway (47) 2-145460 Cinax, Eastern Cameroon (41) 24-71-1600 EMT, West Germany (49) 7825-1011 Dr W. A. Gunther, Switzerland (41) 1-391-3939 Savana Comunicações Ltda, Brazil (55) 21-274-5009 Studer Revox Japan Ltd, (81) 3-320-1101 Syntec International PTY Ltd, Australia (61) 2-406-4700 TEF, Turkey (90) 41-380296 Trans European Music, Belgium (32) 2-569-1823

US TOLL-FREE NUMBER 800 343 0101

# The best of all worlds All over the world

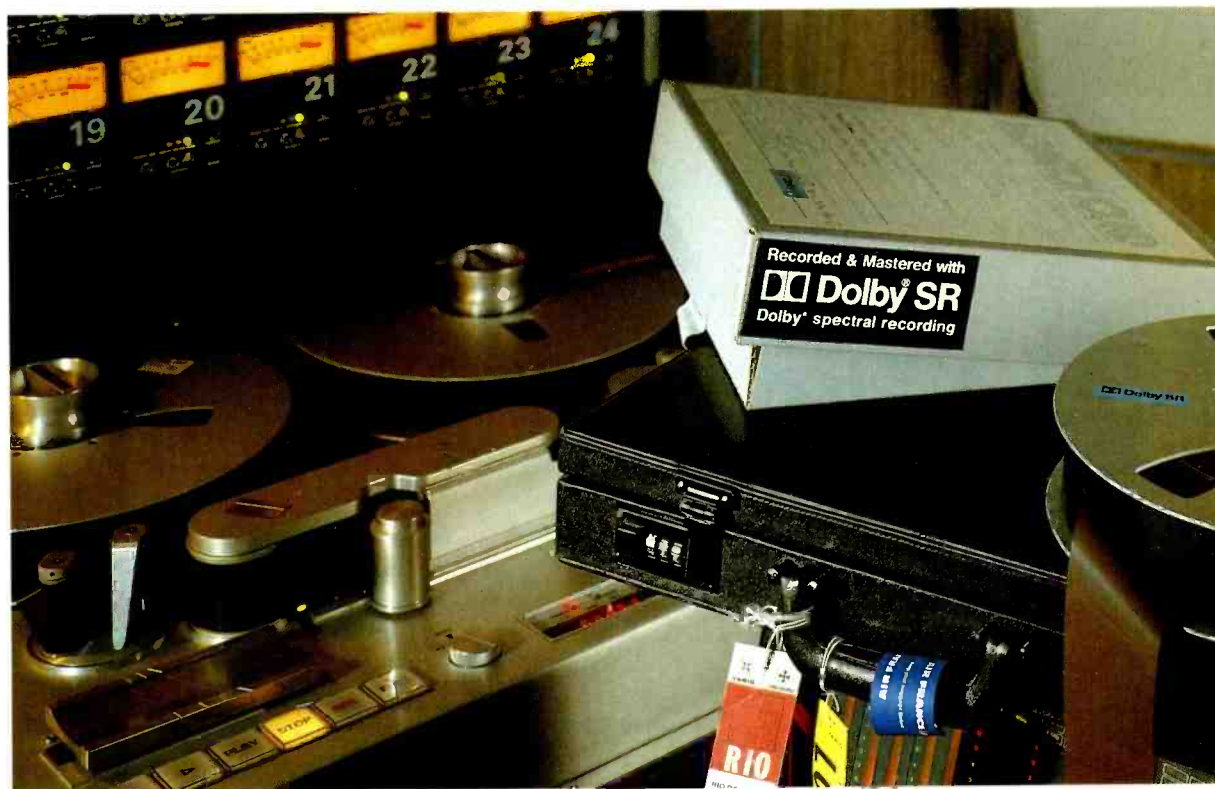

You need the best possible recording quality; you also need the freedom to record and mixdown wherever you want.

All over the world you'll find 2" 24 track analogue recorders; over 400 of these are already equipped with Dolby SR. Thousands of other studios can upgrade simply by plugging SR modules into existing Dolby A frames.



There is now also a choice between external Dolby SR units and the new generation of auto-align recorders from Otari or Studer, with built-in Dolby SR.

Dolby Laboratories Inc, 346 Clapham Road, London SW9 9AP, Tel: 01-720 1111, Tlx: 919109, Fax: 01-720 4118  
100 Potrero Avenue, San Francisco, California 94103-4813, Tel: 415-558 0200, Tlx: 34409, Fax: 415-863 1373

## **Dolby SR**

Dolby and the Double-D symbol are trademarks of Dolby Laboratories Licensing Corporation.

L88/043



# DIRECT-TO-DISK

*Yasmin Hashmi describes the salient features of the NED Direct-to-Disk System*

**T**here are now a wide range of hard disk editing systems on offer to the audio industry.

Although hard disk editing seems to be a relatively new concept, its development has not been sudden. In fact New England Digital (NED) started recording directly to hard disk over six years ago. This article shows how hard disk recording/editing has progressed from a sophisticated monosampling option to a 32-track standalone *Direct-to-Disk* system currently offered by NED.

## *The past*

The first hard disk system was called the Sample-to-Disk option for the *Synclavier* system. At that

time the *Synclavier* allowed polyphonic replay of synthetic sounds, in conjunction with a monosample. The monosample was directly recorded on to disk, and directly triggered from disk via the *Synclavier* keyboard or sequencer. The type of hard disk used was an IMI Winchester, usually of 10 or 20 Mbytes capacity, and recording was, by default, at 50 kHz with 16 bit dynamic range. Editing was non real time and achieved directly on disk. The software not only included normal top and tailing of samples, but also filtering, resynthesis and a number of sophisticated analysis programs.

By 1985, the *Synclavier* incorporated multiple D/A converters and relatively large amounts of RAM, so that monosamples could be called from Winchester into RAM and played with polyphony. By 1986 software had been developed to allow stereo sampling and editing directly in RAM, with

a sample rate of up to 100 kHz/channel. This improved sound fidelity and accuracy of editing, but the length of sample was limited by the amount of RAM in the *Synclavier* (then a maximum of 32 Mbytes—around five minutes mono at 50 kHz).

Whilst RAM editing software was being developed, NED were also developing the *Direct-to-Disk* system, ie a unit which would be able to record and play directly to/from disk with polyphony. Their goal was to provide a 'tapeless studio' comprising the *Synclavier* working transparently with a hard disk multitrack. The *Synclavier* would provide the synthesising/sampling/sequencing side with the *Direct-to-Disk* accommodating recordings which were too long for the amount of RAM available in the *Synclavier*.

In the past, manufacturers had always come across the problem of controlling continuous streams of data when trying to record sound on to hard disk. In the business computer world Winchesters were already in full use for random access storage purposes, but in these cases files were relatively short (a text file is usually a fraction of the size of a sound file). With the monosampling option NED had already overcome the problem of continuous data recording/retrieving, but to today's standards, the disks then used were small with a maximum capacity of around three minutes. If the *Direct-to-Disk* was to replace the tape multitrack much larger Winchesters would have to be used.

However, it wasn't a simple case of transferring the monosample technology across when using a large Winchester. To begin with there was polyphony to consider. Recording and playing several tracks to a single disk would certainly warrant a much larger buffer memory between disk and output converter. A Winchester disk is actually made of several platters stacked above



*The Direct-to-Disk system in operation on a vocal session*

# DIRECT-TO-DISK

each other and each platter has an associated play/record head. But only one head can be active at any one time so if a Winchester is trying to play two tracks, for example, it has to retrieve information from two different places at the same time. Since it cannot do this, it has to load chunks of each track into buffer RAM in rapid succession, and it is from here that the tracks can then be played simultaneously. In the case of recording and playing simultaneously, one can imagine that even more control of the heads and data flow would be required, and that this would require complex software development.

Additionally, consistent with NED's ideology of providing a fully integrated system, the problem of archiving these large amounts of data once the disk is full, would have to be solved. The system would also have to be fully compatible with the existing *Synclavier* and operationally in sympathy with it.

NED foresaw problems with using a single disk for recording multiple tracks due to the physical limitations this involved. In practice, NED like to design their systems with ample hardware headroom, thus allowing the system to develop with software without having to constantly

upgrade hardware. In 1986 they launched the 8-track *Direct-to-Disk* system with eight 80 Mbyte SCSI Winchesters, one for each track. Each disk had an associated output converter with a 1 Mbyte buffer. As standard, the 8-track system came with four inputs, each assignable to any disk, and all four capable of recording simultaneously up to 100 kHz (the same converters as used for the *Synclavier's* sample to RAM mentioned earlier). Each track had a maximum capacity of around 13 minutes mono at 50 kHz (or 6.5 minutes mono at 100 kHz). For archival purposes, each disk had an associated high speed tape drive, so an 8-disk system would have eight tape drives loaded in parallel, thus greatly reducing archiving times. The whole system was housed in a computer tower the same size as a *Synclavier* computer tower.

Since the *Direct-to-Disk* had no sequencer or terminal interface of its own, it had to be connected to the *Synclavier* in order to share its computer and terminal. All operations were therefore achieved via the *Synclavier* keyboard and terminal, and this type of *Direct-to-Disk* is called a 'slave' system. It was also available in 4- and 16-track configurations (with four and 16 disks respectively) and allowed simple recording and playback, with lock to the *Synclavier's* sequencer, which in turn could be locked to timecode. So, for example, if the *Synclavier's* sequencer continuously looped between two points, the *Direct-to-Disk* would follow suit. This is particularly useful if a performer wishes to make multiple attempts at a defined section without having to stop and rewind after each pass.

## The present

The 80 Mbyte Winchesters have now been superseded by 320 Mbyte Winchesters, which play/record two tracks per disk. For example, a 4x320 Mbyte disk system can be used as a 4-track system with 50 minutes per track, or as an 8-track system with 25 minutes per track, ie each disk can provide up to two tracks. Systems with 2, 4, 6, 8 and 16 disks are available, so the largest *Direct-to-Disk* system would be a 32-track. With higher capacity disks in use, the back-up system now incorporates higher capacity tapes, and is also much faster in loading time (around 1/5 real time).

NED realised the need to build a system which would function independently of a *Synclavier*, since not all potential customers would necessarily want to buy two systems. The solution was a relatively simple one. They built a system similar to the slave, but included a *Synclavier* computer and terminal interface. The 320 Mbyte Winchesters with their backup tape drives were housed in a separate unit (about a third of the size of a tower), and these units could hold a maximum of four disks. A simple connection was made between this unit and the tower and this allowed the system to be easily upgraded. A four-disk system can become an eight-disk system simply by connecting another four-disk unit and adding more outputs to the computer tower. The terminal and mouse are directly connected to the tower and in this form, the system is called the standalone *Direct-to-Disk* (Fig 1).

Although the standalone and slave systems differ physically, their operational software is exactly the same. The benefit of *Synclavier* owners purchasing a slave system is that it's cheaper than a standalone. Both standalone and slave can read and display all standard timecodes and MIDI, and also display in feet and frames, minutes and seconds, and measures and beats.

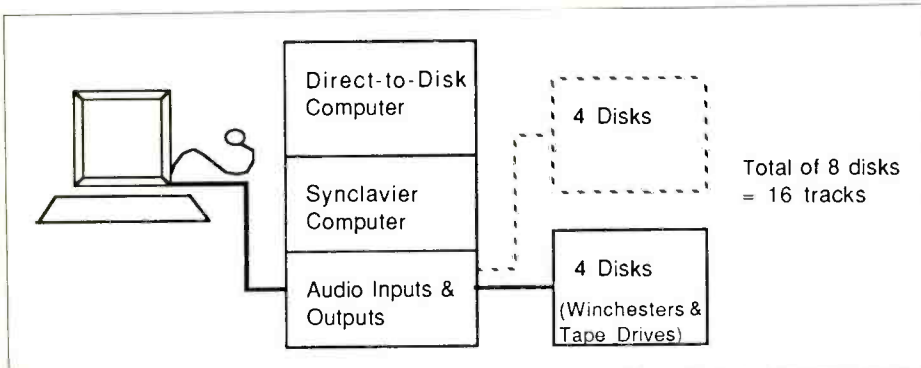

Fig 1

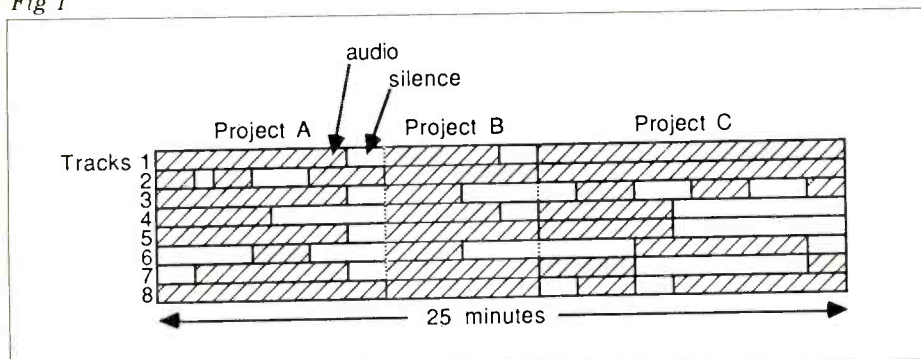

Fig 2

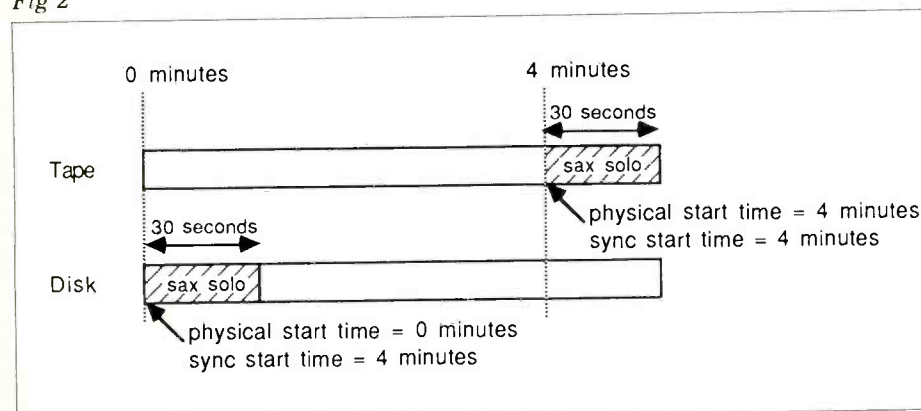

Fig 3



# New PCM-2000. You can take it anywhere.



# You can put it anywhere.

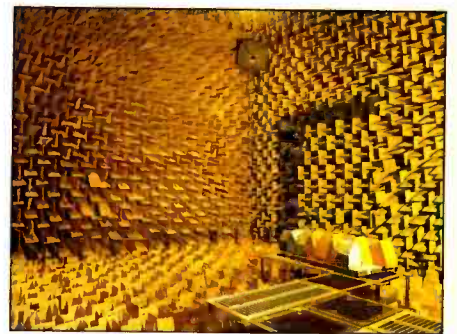

Small, Reliable, Long Recording Time.  
Essential requirements for a portable professional tape recorder.

For the first time the advantages of digital recording are presented in a package that meets all these requirements. For the first time a digital product has been designed to stand up to the rough handling of location use. No more consumer compromises.

The applications in broadcast, film and location recording are obvious, but already the DAT format is used extensively in a number of industrial, scientific, and institutional roles.

If you need the finest sound quality, the PCM-2000 offers it to you. It also offers other key features not found on any other portable DAT recorder.

- Linear Time Code recording.
- Selectable automatic track finding or CTL tracking.
- Supports 48khz, 44.1khz and 44.056khz recording.
- Balanced line or MIC inputs with phantom power.
- AES/EBU digital I/O.
- 1.5 hours battery life with NP-1A battery.
- Subcode recording and erasing capability.
- 2X oversampling A/D and D/A converters with digital filtering.

## SONY®

Sony Broadcast Ltd., Belgrave House, Basing View, Basingstoke, Hampshire RG21 2LA, United Kingdom. Telephone (0256) 55 0 11, Telex 85 84 24.



For further information on this product or to be contacted by the Sony organisation in your country complete this coupon and send to:  
Bryan Freer, Marketing Services, Sony Broadcast Ltd., Belgrave House, Basing View, Basingstoke RG21 2LA.

SS/09/88

Name: \_\_\_\_\_

Position: \_\_\_\_\_

Company: \_\_\_\_\_

Address: \_\_\_\_\_

Tel. No: \_\_\_\_\_



YAMAHA YAMAHA YAMAHA YAMAHA YAMAHA YAMAHA YAMAHA

# YAMAHA HIFI

Dolby Surround for True Theatre Entertainment

Complete Digital Control of the Sound Field in Your Hands

A Hundred Years of Musical Experience

The Amazing Yamaha DSP-1!!!!!!!!!!!!!!!!!!!!!!!!!!!!!!  
 (As featured on page 74 of 'Studio Sound' July '88)

The DSP-1 simulates the distinct acoustic patterns of reverberation, echo, presence, and ambience measured in actual performing environments — from the intimate jazz club to the symphonic concert hall to the open air pavilion — to recreate the spatial realism of the live listening experience.

And in so doing, transforms any listening room into a dynamic, remarkably "live" sound field that brings music back to what it's really all about — an emotional experience that's felt with body and soul as well as heard. And once experienced, there's no going back. The DSP-1 also decodes Dolby Surround Sound.



YAMAHA YAMAHA YAMAHA YAMAHA YAMAHA YAMAHA

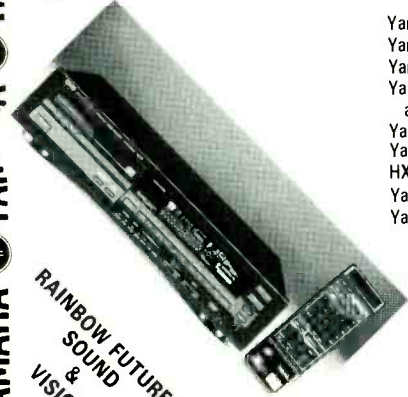

RAINBOW FUTURES & SOUND VISION

Yamaha Digital sound field processor DSP-1	£565.21
Yamaha 4 channel power amplifier M-35	£173.88
Yamaha compact disc player CDX-510	£199.97
Yamaha audio/video 100W 4-channel amp with surround and remote AVC-30	£286.93
Yamaha AM/FM quartz lock tuner TX-300	£95.61
Yamaha 3 head, 3 motor, Dolby B/C	
HX pro remote cassette deck KX800	£286.93
Yamaha NS-10, nearfield monitors NS10	£178.23
Yamaha NS-1000, 200W input power NS1000	£782.62



ALL PRICES EXCLUDE V.A.T.

SOUND AND VISION FROM RAINBOW FUTURES LTD.  
 LANCE HOUSE · 41 MARKET PLACE · DRIFFIELD  
 EAST YORKSHIRE YO25 7AN  
 TELEPHONE: (0377) 47191/47311/47822 · TELEX: 52168 LANCES G  
 Directors: J. R. Webster (Managing) R. D. Sinton (Company Secretary)  
 ALSO AVAILABLE YAMAHA MUSICAL INSTRUMENTS &  
 PRO-AUDIO, SATELLITE TV, CAR & PORTABLE PHONES

YAMAHA YAMAHA YAMAHA YAMAHA YAMAHA YAMAHA YAMAHA

Drawmer  
*Ingenuity*

## UNNERVING CAPABILITY



# M500

DYNAMICS PROCESSOR — ALL YOU'LL EVER NEED

DRAWMER DISTRIBUTION CHARLOTTE ST. BUSINESS CENTRE CHARLOTTE ST. WAKEFIELD W. YORKSHIRE ENGLAND

TEL. 0924 378669 TELEX 558649 FAX 0924 290461



# DIRECT-TO-DISK

They will even read one type of timecode whilst displaying in another.

The *Direct-to-Disk* software has been greatly enhanced to provide extremely easy recording, editing and sequencing. The disks are user-sectioned into projects (or songs) and recording can be straightforward linear multitrack recording from beginning to end of song, with punch-ins, looping and so forth (Fig 2).

However, there are other ways of recording, which take full advantage of the random access hard disk recording provides. With tape recording, the tape moves past a fixed head so recording is linear, and winding a tape from beginning to end can take a few minutes. Conversely it is the head which moves on a Winchester, and with incredible speed. So moving the head from beginning to end of a disk takes a fraction of a second. This means that a recording can be placed anywhere on the disk, so long as the head knows where to find it.

On tape, a recorded track often consists of passages of audio with silences in between. For example, a 30 second sax solo four minutes into a song will be preceded by four minutes of silence. On disk however the sax solo could be recorded at the beginning of the track (or anywhere else for that matter), but on replay it will still be played back at four minutes. This is because the recording will have been made against timecode (or the internal sequencer) and the *Direct-to-Disk* will attach the external timecode to the start of the recording. This means that timing is not dependent on physical location (Fig 3).

This has several other uses. If the same sax solo is required three times in the track, rather than making three copies and wasting time and space, the same recording is simply told to play at three different times. This is done via the internal sequencer. Another use is in post-production, for example, where an actor records multiple takes of a post-sync dialogue against timecode. The takes would be recorded one after the other on a single track, but each take would have the same start time (Fig 4).

With an 8-track system there is a polyphony of eight. So a recording can be made on any track, in any position and can be played through any output at any time, as long as no more than eight sounds are trying to play simultaneously. In other words, the *Direct-to-Disk* treats its recordings in the same way as the *Synclavier* treats its samples, but instead of having samples sitting anywhere in RAM and being played in any sequence, recordings sit anywhere on disk.

In order to edit recordings an on-screen edit table is provided. This is simple to use and is accessed using a mouse. Jumping from beginning to end or anywhere else in the recording is achieved by clicking the mouse at beginning or end and so forth on a horizontal bar display (Fig 5).

This display represents the contents of the tracks selected for editing. To select a certain phrase one simply has to mark the start and end

points of the phrase and give it a name. This can be achieved 'on the fly', with precise locating possible by audio rock 'n' rolling with the mouse. The timing of start and end (or in and out) points are always displayed and are updated as the points are moved by the mouse. Once begin and end points have been established, an appropriate name is given to the section, and it is saved as a 'cue'. As each cue is made, it is saved into a 'cue directory' which displays all cues in alphabetical order. These cues can be auditioned by clicking the mouse on the cue names. The true random access of the system becomes evident when doing this, as cues from opposite ends of the disk can be heard playing simultaneously. It must be noted that when making cues, the original recorded information is not altered or copied in any way. All that actually happens is that timing and name information is added so when sequencing, the heads know exactly where to go in advance. This means that the buffers can be constantly preloaded with the audio ahead of time, and therefore there are truly no delays.

There are a number of ways in which cues can be sequenced. They can be dragged from the cue directory into a track on the sequencer display, and placed at any point on any of the sequencer's 200 polyphonic tracks. Another method is by chaining cues. In this case cues play in the order selected, when one cue finishes the next will play. Cues can also be placed in real time 'on the fly' or in sync time. This is particularly useful with the multiple takes mentioned before. Each successive take will automatically appear in the cue directory. All that is left to do is to audition the takes, select the preferred take in sync mode, and it will automatically be placed in the

sequencer with the original sync time intact. In addition to defining cues and sequencing them, the software offers features such as cut, paste, delete, fill, time compression/expansion and transfer of *Direct-to-Disk* cues to *Synclavier* RAM for treatment as samples.

## The future

As far as digital interfacing is concerned, there are a number of reasons why NED have not yet provided any. One of them being that a preferred standard has not yet been decided upon. NED claim however that you can order a *Direct-to-Disk* system with your preference of either AES/EBU, Sony or Mitsubishi formats, although no mention has been made of any system having been delivered with a digital interface to date. Those of you who have followed the development of the *Synclavier*, will have noted that NED offered MIDI as an option much later than most other manufacturers, their reason being unwillingness to compromise the system's performance. When MIDI was finally available it was not as comprehensive as some other systems, although it worked with high precision and very effectively. One could therefore imagine that NED will follow suit when they finally introduce their digital interface. NED are now introducing the *Mac II* graphics workstation to replace their current Pericom terminal. This includes a 19 inch colour monitor which currently only emulates the Pericom, but by the end of the year, windowing and enhanced editing displays should be available. Also under development is a digital mixing control surface which should allow volume, panning and possibly equalisation control.

## Conclusion

The technology involved in hard disk editing systems has been well tried and tested by NED, with many *Direct-to-Disk* systems operating in commercial facilities. However, until the digital mixing system is available the audio must return to the analogue domain for mastering and mixing purposes and NED are still some distance from a truly tapeless studio. □

**Author's note:** Thanks to Stella Plumbridge of WKT Ltd for help with this article.

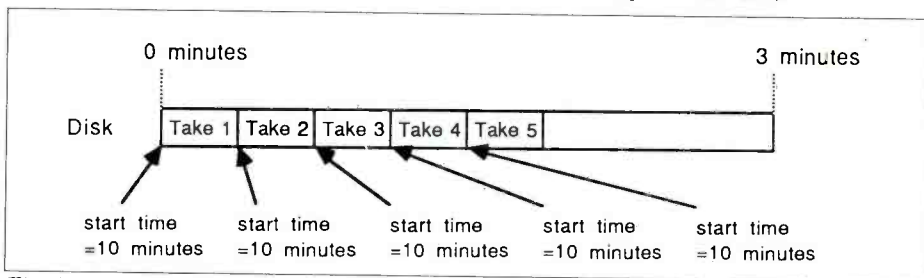

Fig 4

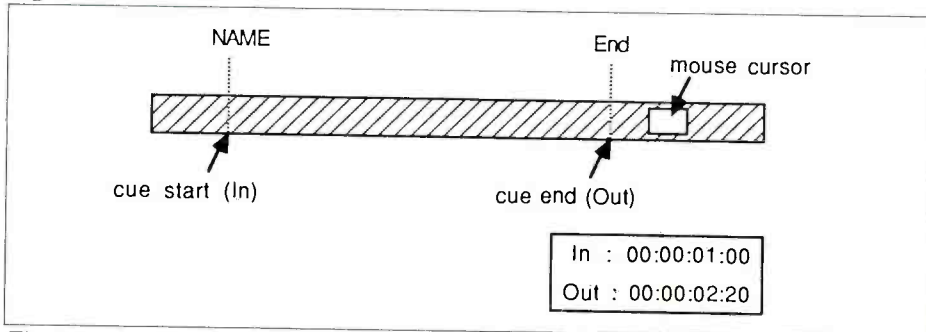
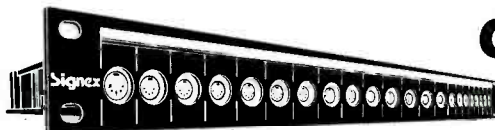

Fig 5

## NEW SOLUTIONS FROM SIGNEX

These two new connector panels employ the same proven construction methods which have made the ISOPATCH so popular and versatile. They are hand-bult to an exacting standard with all sockets mounted on a single PCB, providing not only reliability, but excellent panel rigidity and strength. Socket designation on the 1U front panels is simple to mark and can be easily changed using the slide-in ident strips provided.



### CPM22

MIDI PANEL

This panel offers a single row of 22 MIDI sockets which can be configured as required for MIDI IN/THRU/OUT connections. Primarily intended for MIDI connections between keyboards, expanders and outboard equipment, the CPM22 can be wired to MIDI splitters, mergers, etc., to form a complete patching system. Available with DIN or solder rear connections.

### CPX16

XLR PANEL

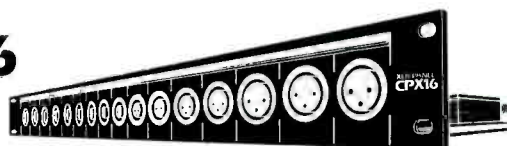

Designed for input/output connection of balanced microphone lines and other signals, the CPX16 is fitted with 16 male or female XLR connectors. Rear connections are directly soldered or via 1/4" stereo jacks. Tip can be wired to either pin 2 or 3 by bridging programming pads on the PCB.

# Signex

PRO AUDIO PRODUCTS

For further details contact:

MANUFACTURE AND UK SALES: ISOTRACK, PO Box 18, POOLE, BH14 8EA. ☎ (0202) 747191  
OVERSEAS SALES: KELSEY ACOUSTICS LTD., 28 Powis Terrace, LONDON, W11 1JH. ☎ 01-727-1046

## THE OPTO-SWITCHER



The OP-1 is a small rugged box that allows optically-isolated, interference-free switching of mains devices from an input of 5-50vDC. The maximum mains load is 6 Amps. XLR and IEC sockets allow easy connection.

OP-1

£55 + VAT

TOTALSYSTEMS

41 Windermere Avenue  
Basingstoke, Hants RG22 5JH, UK

Phone: 0256-468555

Telex: 858893 FLETEL G

Fax: 0252-620729



## MICROCOMPUTER CONTROLLED AUDIO SYSTEM

The MCA MULTIMIX combination makes it possible to create easily multichannel sound images — such as static and moving effects covering the stage and audience area.

The computerized output MIX-MATRIX (VCA) offers a large amount of possibilities for creating multi-layered effect fields, independently moving from corner to corner, rotating, spiralling and operating in mixed combinations.

Up to 1000 cues can be built with the MCA and stored on a diskette. The concept is similar to the one in sophisticated lighting consoles.

### MULTIMIX



ADVANCED THEATRE SOUND

THE MCA SYSTEM OFFERS SEVERAL SIGNIFICANT ADVANTAGES WHEN COMPARED TO TRADITIONAL METHODS OF THEATRE SOUND EFFECT PLAYBACK. THE POSSIBILITY OF A HUMAN ERROR IS REDUCED TO A MINIMUM, BECAUSE THE MCA PROCESSOR PERFORMS MOST OF THE EVER REPEATING ROUTINE TASKS. THE SOUND ENGINEER GAINS MORE TIME FOR CONCENTRATING ON THE CREATIVE ASPECTS OF THE SOUND EFFECT. ALSO, SOUND EFFECTS WHICH PREVIOUSLY WERE TOO COMPLICATED FOR ONE ENGINEER TO RUN IN REAL TIME, ARE NOW POSSIBLE WITH THE MCA SYSTEM.

### THEATRE SYSTEM PLAN

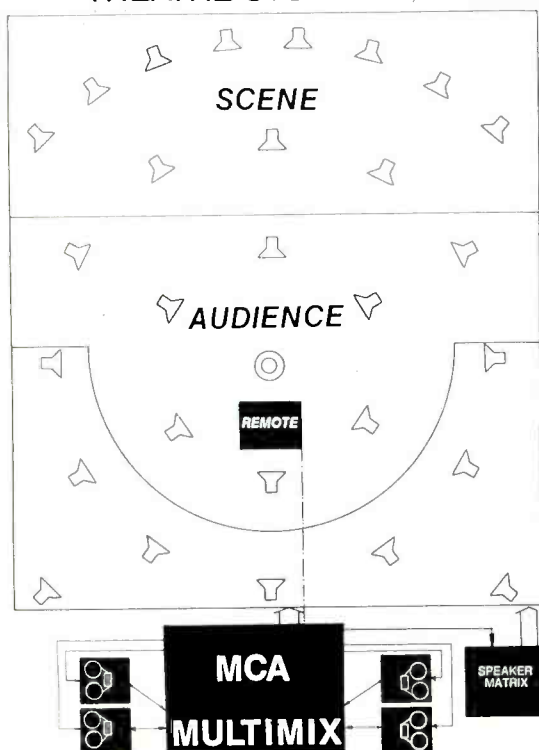

MS-AUDIOTRON  
LAILILANTIE 10  
00420 HELSINKI

TELEX 125 778 ms sf  
TEL. +358-0-566 4644  
FAX 566 6582



# MONITORING

*A summary of trends in the field of monitoring loudspeakers together with a description of some of the products introduced over the last year*



Acoustic Energy AE1

There has not been any clearly identifiable trend in monitors over the last 12 months. We still have designers and manufacturers who are following

horn or soft dome-type approaches, there are those that search for increasing power and sophistication in smaller boxes, there is an increasing number of hi-fi-type manufacturers moving into pro-audio and there is an interest in active speaker systems.

The need for larger, more powerful monitors has continued. In the UK we have seen large monitor systems coming from studio designers who are quite correctly designing from the premise that it is not possible to view a large monitor system and a control room response as unconnected entities. There may be an element of marketing involved here but at least it means that they are personally able to keep a few of the possible design variables more fully under their control. It also appears that studio designers are a driving force in specifying higher and higher amplification ratings. This is not to overcome the absorptive effect of an over-dead control room—as was the problem in the late '70s—but the concept of effortlessness. A monitoring system that is not under strain generally has a clarity and quality of sound that is not found in systems of lesser rating. To this end we hear of systems with amplification ratings of over 5000 W per side. While in the hands of the responsible such systems are admirable, we should fear the possible effects of unrestrained use.

Sub-woofer low frequency extension systems are also beginning to make an appearance. There is, however, a fine line here between being able to hear what is happening in those lower octaves and enhancing what you hear. The former gives you more control and better knowledge of what is happening in the VLF range while the latter is more suited for record company listening sessions.



Klark Acoustic Jade 1



## 1/3 OCTAVE AUDIO ANALYZER

- THE STUDIO; to check room response and monitor the mix.
  - LIVE SOUND; to eliminate feedback and easily set room EQ.
  - SOUND CONTRACTING; to analyze rooms, set EQ and SPL levels, eliminate feedback, verify system performance.
- FEATURES INCLUDE: built-in rechargeable batteries; built-in microphone, aux line input, SPL in A or C weight, Decay settings.  
 FILTERS: 30 bands on ISO centers to ANSI Class II double tuned specifications.  
**SUGGESTED RETAIL \$599.95**

## GOLD LINE LOFT

P.O. Box 115 • West Redding, CT. 06896 • (203) 938-2588  
 Fax-(203) 938-8740



## GREAT SOUNDING CROSSOVERS/LIMITERS

LINKWITZ-RILEY filters. • Calibrated level controls • Electronically balanced ins and outs • DC control on all pots • Subsonic filters • Extra gain without extra noise • LED headroom indicators • High slew rate circuitry for digital sources • Transient muting to suppress spikes. LOFT's advanced technology assures superb, uncompromising sound.  
**RETAIL \$299.95 to \$629.95**

### DISTRIBUTORS

- AUSTRIA: Musichaus, Vienna
- CANADA: Audionova, Dorval, Quebec
- DENMARK: Studio-Lydeclinic ATS, Vanlose
- FINLAND: Studiotec, Helsinki
- FRANCE: Publison, Paris
- GREECE: Hellas Sound, Athens
- HONG KONG: Jolly Sound
- ITALY: Grisby Music, Ancona
- JAPAN: Kawamura, Tokyo
- SPAIN: Letusa, Alcoron, Madrid
- SWEDEN: Creative Audio, Djursholm
- SWITZERLAND: Gotham, Regensdorf
- UNITED KINGDOM: Marquee, London
- WEST GERMANY: Alphonon, Kelkheim-TS



# The Gold Standard.



Tannoy has been setting standards in the audio industry for the past 60 years and has now created a new standard for audio monitoring from speakers to power amplifiers. The Gold Standard – for alchemy in sound.

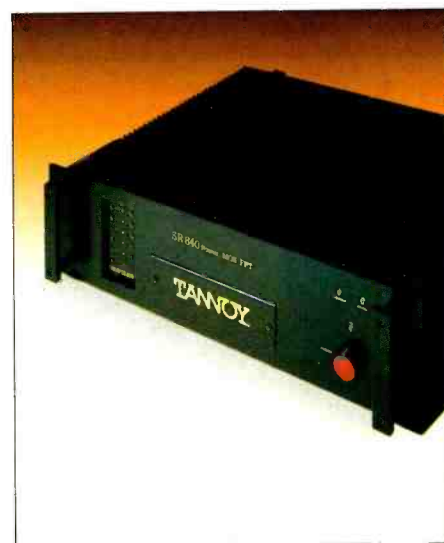

**TANNOY**  
The Name for Loudspeakers

Tannoy Ltd, The Bilton Centre, Coronation Road, Cressex Industrial Estate  
High Wycombe, Bucks HP12 3SB, UK. Tel: 0494 37431.



# MONITORING

The compact disc has made that frequency area usable but I am not sure that we have decided how much it should be used.

Nearfield monitoring is still very popular. It is, however, odd that studios with very expensive acoustic designs are working in the nearfield as much as those with a lesser acoustic. Nearfield monitors, however, have developed in several different ways. We have seen systems grow quite considerably in size to such an extent that there are now so-called nearfield monitors that are as large as those we used to use as main monitors. An interesting development we have seen incorporated in some facilities currently under construction is nearfield monitors that sink into the floor when they are not required and rise at the touch of a button. This is probably the only way that it is possible to stop such systems interfering with serious use of the main monitoring systems.

The use of active speaker systems, ie monitors where the amplifiers and crossovers are integral to the cabinet, is beginning to grow. There is something very convenient in a single package and they are generally very compact. You are, however, tied to the amplification package that the manufacturer decides to use and there is also the problem of getting mains powering to the units although these are relatively minor problems. Without a doubt, there has never been more choice of speaker systems on offer than now and it looks like more manufacturers are about to enter the field.

## Acoustic Energy AE1

The AE1 is a full-range compact 2-way nearfield monitor with a 5 inch bass driver and a 1 inch HF unit. Both these units use metal diaphragms and edge wound ribbon voicecoils. AE say that the triple layer construction of the diaphragm on the bass driver gives very low distortion characteristics and this is coupled with the ability of the diaphragm to dissipate heat and therefore maintain a more constant impedance load with a quoted 200 W programme. The cabinet is manufactured from MDF lined with a high density non-resonant material that aids LF response. Quoted frequency response is 35 Hz to 30 kHz. A slightly larger unit known as the AE2 is nearly completed and this has two 5 inch LF drivers and a rated power handling of 400 W.

## AKG LSM 75A

The LSM 75A is an active 2-way compact speaker with a rating of 75 W. The LF unit is the same 5.5 inch unit as that used in the existing LSM50 reference monitor and this is used with a ¾ inch dome HF unit. The unit has a balanced input and a sensitivity that AKG claims will enable it to be used with low output level equipment. Cabinet construction is of a medium density particle board.

## Alexander metal cabinets

A little known British speaker manufacturer,

Alexander had their products shown at the APRS by Presence Audio for pro applications. The most unique aspect of these speakers is the fact that they have metal cabinets, which does not appear to impair their performance. The 514 is described as being the size of a house brick and is used on end. The 566 is a reflex ported design and is twice the height, ie very slim. An even larger design will be available soon designated the Aurora. Their robustness should see some suitable pro-audio applications.

And while on the subject of unusual speaker designs, Presence Audio also distribute a range of sloping front speakers manufactured in the US by Spica which have particular nearfield applications when turned on their side as even being quite

large speakers they fit securely on the console. The TC-50 has been improved recently with a change in the drivers, greater internal bracing and new crossover ports. These are also now available in black.

## JBL Control Five

Although not recommended by JBL as an accurate monitor the Control Five is a larger version of the Control One introduced a couple of years ago and it has found a number of useful applications in pro-audio. It has a quoted power rating of 175 W, a response of 75 Hz to 20 kHz  $\pm 3$  dB and with a usable output down to 50 Hz. The driver system is 2-way with a 25 mm titanium driver and a 165 mm LF driver.

## Manta MS 1.10

The Canadian Manta Electronics Group, a Canadian pro-audio and video dealership has



Move your Fairlight™ CMI up to first chair with The Master Sampler Collection™ of fully-engineered virtual instruments for professional sound producers. Unlike a "sound library" of raw notes that you must sample, trim, loop, filter, transpose, ... every virtual instrument in The Master Sampler Collection is ready to load and perform.

The Master Sampler Collection provides producers with the highest fidelity and sonic realism that digital sampling computers can produce.

Along with the collection, you receive ScoreKeeper™ which organizes the entire collection of virtual instruments. ScoreKeeper allows you to listen to each waveform on an Apple Macintosh™. After you have selected virtual instruments and prepared a score, ScoreKeeper takes your decisions to the Fairlight and minimizes wait time by handling all the loads from disk to RAM.

Don't play second fiddle! The Master Sampler Collection moves you up to concertmaster.



## SOUND GENESIS

Sound Genesis Corporation

7808 Creekrige Center • Minneapolis, MN 55435

(612) 944-8528

Fairlight is a trademark of Fairlight Instruments, Pty. Ltd. Macintosh is a trademark licensed to Apple Computer Inc., Master Sampler Collection and ScoreKeeper are trademarks of Sound Genesis Corp.

**THE AUDIO ENGINEER DIPLOMA**  
15 SCHOOLS WORLDWIDE

*audi. Engineer*  
SAE DIPLOMA - FIRST

*all theoretical and practical requirements of the School of Audio Engineering approved by the Institute of Engineers*

*Diploma*

*in this*  
*Department*

Head instructor \_\_\_\_\_  
Director \_\_\_\_\_

**SAE**  
School of Audio Engineering

**We have spent the last 12 months training your next studio employee in our 24 track studios.**

15 schools worldwide, major schools in:

<b>London</b> 16 Chillingworth Rd London N7 9QJ Tel: 01-609 2653	<b>Los Angeles</b> 3000 S. Robertson L.A. 90034 Tel: 213-559 0973	<b>Sydney</b> 69-72 Wentworth Ave Sydney NSW 2010 Tel: 02-221 3711	<b>Munich</b> Weissenburger Str 19 Munich 90 Tel: 089-48 7145	<b>Vienna</b> Mayerhofgasse 6 Vienna A-1040 Tel: 222-65 2716
---	--	---	--	---

Proudly associated with: WEBER ARTS - AKG - EMT - NEVE - Audio Consoles

# Your Guarantee

NO GUESSES  
NO GIMMICKRY

The circulation of this publication is independently audited to the professional standards administered by the Audit Bureau of Circulations



The Hallmark of Audited Circulation

**WORTH ITS WEIGHT IN GOLD**

*The* **GOLD BOOK**

**ONE TO ONE**  
THE INTERNATIONAL MAGAZINE FOR MASTERING, PRESSING & DUPLICATING

Traditionally the industry has been serviced by a network of local suppliers but now with changing consumer demand and the introduction of new technologies, sources for products and services often extend well beyond national barriers.

With the GOLD BOOK you will be able to quickly identify who's providing what services in which sector of the market, in which geographical areas.

Equally you will be able to see at a glance what products are available - be it a major piece of equipment or a small 'throw-away' item.

With thousands of listings covering the many areas of Mastering, Pressing and Duplicating.

The GOLD BOOK will be sectionalised into three main headings: VINYL - MAGNETIC - OPTICAL

The GOLD BOOK will be published in an A5 format, so it will never be far away from your side.

If you're involved in the many areas of Mastering, Pressing and Duplicating and you want a book just for you - look no further than the order form.

Professional Publications Group, Link House Magazines Ltd, Dingwall Avenue, Croydon CR9 2TA, United Kingdom.

Cover price £30 (UK) \$50 (USA)

Please send me ..... copies of the GOLD BOOK.  
£31: (UK) £32: Europe \$57: USA Airmail  
£35: World Airmail includes postage and packaging.

I enclose a cheque/postal order/International money order payable to **Link House Magazines** for the amount \_\_\_\_\_

Or debit my credit card

☐ Credit card holders can order by simply ringing 01-686 2599 ext 163, quoting credit card No \_\_\_\_\_

Credit card No

Signed \_\_\_\_\_  
Name \_\_\_\_\_  
Address \_\_\_\_\_  
\_\_\_\_\_

Please return the completed order form enclosing full remittance (including delivery) or giving your credit card number to **Professional Publications Group, Link House Magazines Ltd, Dingwall Avenue, Croydon, CR9 2TA, United Kingdom.**

Please allow 28 days delivery in Britain, extra overseas depending on country and delivery method



# MONITORING

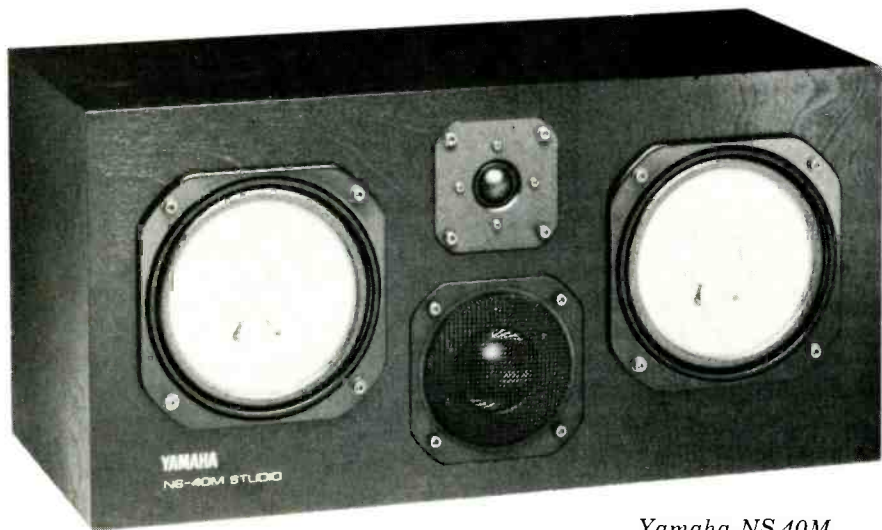

Yamaha NS-40M

developed a monitor system for small and medium-sized studios. The *MS 1.10* is a 3-way system with a passive crossover network. An interesting aspect of the cabinet design is the shape, ie a horizontally-angled front that enables the system to fit into corners more easily. MEG describe the design as being phase coherent, with a good off-axis response and wide horizontal stereo imaging.

## Stage Accompany Master Series

The *Master* series is a range of studio monitor systems that differ in size and power handling. Designated *Master 4544*, *4547* and *4549*, they all feature an MF/HF driver developed by Stage Accompany known as the *Compact Driver*. This uses a flat rectangular diaphragm whose operation gives a flat frequency response beyond 30 kHz and a good transient response. It also has a very high power handling capacity of 60 WRMS continuous and 1000 W peak (for 200 ms) and is used to cover frequencies from 1 kHz to 30 kHz. The *Master* series is intended for use with an active crossover although the two smaller units are supplied with internal passive crossovers as well. The *4544* is the smallest model and is suited for nearfield use. It is a 2-way system with 8520 compact driver and a 1203 12 inch LF driver in a vented enclosure. The *4547* is a 2-way medium-sized monitor with an 8525 *Compact Driver* and a 15 inch LF driver in a vented enclosure. The *4549* is a large 3-way system with a 8525 *Compact Driver*, a 15 inch (type 1502) driver covering 100 Hz to 1 kHz and mounted in a separate chamber within the cabinet, for the LF, two 1503 15 inch drivers are used in a vented enclosure operating down to 30 Hz. The cabinets have been designed to eliminate acoustic and panel resonances. The standard finish is natural but colours are available to match clients' decor.

## Tannoy AV PRO

Tannoy have shown a prototype of a new small reference monitor, the *AV PRO*. This is a 15 inch

tall cabinet constructed around heavy internal bracing. The mid/bass driver uses an improved construction technique for the cone apex configuration along with a new roll surround material ensuring linearity and robustness. The HF uses a duralumin diaphragm and skirt with separate silicone-based suspension, which Tannoy say gives the piston rigidity associated with titanium but without HF break-up modes in the pass band. The coil is ferrofluid cooled. An important feature of the design is the lack of stray magnetic field claimed as less than 1 milli tesla at any point outside the cabinet making it suitable for use close to video equipment.

## Yamaha NS-40M

An addition to the *NS* nearfield range of monitors and the bigger brother of the *NS-10*. This is a 3-way system incorporating dual 7 inch woofers, a 2.4 inch soft dome mid-range driver and a 1.2 inch soft dome tweeter. Frequency response of 50 Hz to 20 kHz is quoted with a rating of 100 W programme. Sensitivity is 90 dB/W at 1 m.

## Brief notes

WMD have introduced a 'portable' active nearfield system designed by Andy Munro in conjunction with producer Mike Hedges. The *3K* System is a free standing design. . . Wellard have a new active monitor, the *Major Monitor*, which is a big brother to the *Middle Monitor*. It has a cabinet size of 90 litres and uses two 10 inch LF units and a flat plane HF driver. . . Klein+Hummel have recently added three new active monitors to their range—the *O 92*, which is a reference monitor designed for German radio use; and the *O 96* and *O 98*, which are medium-sized professional music recording monitors. . . Klark Acoustic have introduced a MkII version of the *Jade 1* active monitor and have shown an early version of the *Jade 2* high powered nearfield active monitor. . . Genelec have added a high-powered active monitor for studio main monitor use. It is known as the *1035* and is significantly more powerful than the previous largest *1025*. □

Recently a few dealers have complained about our second-hand and ex-demo list — it seems they are losing too many customers. Being the largest single supplier of 8- and 16-track equipment in Britain we've decided we can afford to give away a few secrets! We simply tell customers that if any new equipment you purchase breaks down in the first two months, we won't fix it. We will replace it! RESULT — Yet another customer who knows that Thatched Cottage can be relied on, and a secondhand list full of the latest gear, factory repaired in mint condition, and with full guarantee. SIMPLE? We didn't become the biggest without being the best.

### Some of our secondhand & ex-demonstration stock

Yamaha DX7II D	£1,050
Roland D550	£850
Tascam 38, mint	£1,299
Yamaha 2031 graphics	£299
Kurzweil 1000 horn Expander	£1,099
Sony PCM 601 digital mastering (new)	£750
Slapback scintillator (exciter) (new)	£125
Yamaha 31 band graphic eq. (2 only)	£160 each
Drawmer DS221 compressor/limiter	£275
24 channels Bel Noise Reduction	£1,000
Drawmer DS201 Gates	£255
Symetrix 511 Noise Reduction	£399
Aphex Dominator	£699
Digitech 1900 delay 2 seconds full bandwidth	£165
Seck 18/6/2	£1,100
Yamaha RX5	£599
Midverb 2 (Alesis)	£225
Neumann UB7 ex demo (2 available)	£750
Casio FZ1 Sampler	£899
Yamaha Rev 5	£899
Aphex Compeller	£699
Lexicon PCM 70	£1,299
Active D.I. boxes	£35 + VAT
12U Rack trolley stand	£99
Tannoy active crossover (4 little golds/reds)	£299
Symetrix 522 comp/lim, EXP, Gate, Ducker	£250

Plus loads more — give us a ring!  
All prices exclude VAT

### THIS MONTH'S BEST BUYS!!!

Yamaha TX16W new amazing super sampler (including free 30 disc library).  
Tascam MS16 multitrack (including free noise reduction).  
Yamaha DX11 multitimbral synth.  
Tascam 238 8-track cassette.  
Yamaha SPX50D multiprocessor.  
Casio R-DAT and rack kit.

### CASIO DAT MACHINE

It's finally happened! Casio have brought out a fully professional DAT machine at their usual silly price — for the machine and power supply and battery pack (Yes — it's portable as well!) only **£686 + VAT**. Get your orders in quickly, strictly first come first served. (We even throw in a free tape!)

Due to overwhelming demand, we have finally produced a Thatched Cottage Newsletter. As well as giving details on some VERY special offers, it contains a complete secondhand and demonstration list. (The list we advertise represents only a fraction of actual stock). There are also details of courses and classes we briefly introduce ourselves! Why not go on our mailing list and write or telephone for your copy?

Due to our bulk buying policy we have the amazing BEL 2400 BDE, 99 window, 24 sec, 18K bandwidth delay/sampler available at only **£799 + VAT** (Give us a ring for more Details) (RRP £3,000)

We have just been appointed sole agents for the amazing Allen & Heath Sigma 24 track MIDI recording console. If you require any information or would like a comprehensive demonstration in our own 24 track studios, why not give us a call? — we think you'd be surprised!

Yamaha TX16W supersampler, 16 voices, full stereo, astounding memory. We are one of a strictly limited Yamaha dealer network capable of demonstrating this product. For more details give us a ring! Full Library.

### PRODUCER'S MASTERCLASS

From March we have been holding a series of one day masterclasses, featuring some of the world's leading producers. Each seminar will consist of a comprehensive question and answer session and a practical demonstration of production techniques in our own 24-track Studio. In order to allow maximum flexibility classes will take place at weekends and will be limited to the first 15 applicants. Those taking part will include: Hugh Padgham, Rupert Hine, Stephan Hague. For anyone interested in producing, these classes will present a unique opportunity. Tickets are £50.00 plus VAT each and are available from Thatched Cottage. For further details of dates and timetables, phone Paul Tingen on 01-249 1876, or contact Thatched Cottage. Book early to avoid disappointment.

### ATARI — CHEAP COMPUTERS

As many of you have no doubt discovered, Atari of late have developed an interesting method of quality control — it's called the end user! Because we have to replace dufo units (to ensure minimum disruption to the customer), we have large stocks of nearly new Atari 1040 computers plus monitors. Until the mountain has subsided we are offering these (with full guarantee) for only **£450 + VAT** if purchased with software.

For a limited period we are offering Tascam MS16 track with FREE 16 Track dbx noise reduction **£5,500 + VAT**

• EXPORT • FULL CREDIT FACILITIES AVAILABLE • MAIL ORDER •



Thatched  
Cottage Audio

Tel: Cambridge (0223) 207979 (3 lines)  
Thatched Cottage Audio  
North Road, Wendy, Nr. Royston, Herts.





# STUDIO SYSTEMS FROM 4 TO 48 TRACK

## SALES AND SERVICING

Professional audio equipment and home studio recording equipment supplied and serviced at the most competitive rates. We have the experience, knowledge and enthusiasm to provide you with the right choice of equipment — and at the right price. Advice is free of charge and so is coffee and tea!

## NEW PACKAGE DEALS

### 8 TRACK

Tascam 38  
Soundtracs T Series 16:8:2  
Wiring Loom  
Package Price: **£3,250**

### 16 TRACK

Tascam MS-16+DBX  
Soundtracs MRX 24:8:16  
Wiring Loom  
Package Price: **£10,450**

### 24 TRACK

2 x Akai MG-14D's + ML.14  
Autolocator Studiomaster  
Series II 24:16:24  
Adams Smith Zeta 3  
Synchroniser  
Package Price: **£11,500**

### 12 TRACK

Akai MG 14D  
Soundtracs Midi PC 16:16:2  
Wiring Loom + 10 Free Tapes  
Package Price: **£6,450**

All Package Deals include Wiring Loom, Take Up Spool, Reel of Ampex Tape and Mixer Stand, and of course, 12 months parts and labour warranty.

We are situated above the famous Strawberry Recording Studios and have our own demonstration studio with all the latest outboard gear — if you wish to come and see us please telephone first. We will be happy to show you around.

## NEW EQUIPMENT AVAILABLE

ALLEN & HEATH SIGMA — all formats available — Please telephone for separate list and colour brochure.

BEL BDE2600 inc. Twin Disc Drive and Remote 13 sec. Stereo ..... £3,295  
26 sec. Mono Delay/Sampler ..... £3,295  
BEL B080S 6.5 sec. Stereo/13 sec. Mono Delay/Sampler ..... £850  
ALESIS Midiverb II Stereo, 16 bit, 99 Programme ..... £260  
ALESIS Microverb II Stereo, 16 bit, 16 Programme 15KHz ..... £173  
ALESIS Microenhancer ..... £108  
ALESIS Micro Gate ..... £108  
ALESIS Micro Limiter ..... £108  
ALESIS MMT-8 Midi Sequencer ..... £260  
ALESIS HR-16 16 bit Digital Drum Machine ..... £385  
ALESIS S-15Q 2x15 Band Graphic ..... £156  
ALESIS S-31Q 31 Band Graphic ..... £156  
APHEX Aural Exciter Type C ..... £250  
APHEX Compeller ..... £1,075  
YAMAHA NS-10M Loudspeakers ..... £178  
TASCAM 32 1/2" Two Track Recorder ..... £855  
TASCAM 34B 4 Track 1/4" Recorder ..... £1,430  
TASCAM 42NB 2 Track 1/4" Commercial Series ..... £2,090  
TASCAM 480B 8 Track 1/2" Commercial Series ..... £2,995  
TASCAM MS-16 16 Track 1" ..... Reduced Price £5,500  
TOA NR-8 B Track Cassette Recorder Available Now ..... £1,120  
TASCAM ATR-80-24 24 Track Recorder ..... £26,000  
REVOX B77 MkII Ex-Demo - New ..... £985  
REVOX C270 High Spec 2tk ..... POA  
KLARK TEKNIK DN780 Digital Reverb Inc. Remote Control ..... £1,650  
KLARK TEKNIK DN360 2 x 30 Band Graphic Equaliser ..... £995  
KLARK TEKNIK Jade One MkII Powered Monitors ..... Pair £1,175  
SOUNDTRACS Midi PC 16:16:2 ..... £4,045

SOUNDTRACS MRX 24:8 ..... £5,200  
ALLEN & HEATH CMC 24 — New ..... £3,100  
ALLEN & HEATH CMC 32 — New ..... £4,150  
AKAI MG-14D 12 Track Recorder ..... £3,042  
AKAI S-900 Multi-Sampler ..... £1,650  
AKAI MPC-60 Phenomenal Songriter/Production Centre ..... £2,595  
ATARI/STEINBERG PACKAGE  
1040ST Monitor Pro 24 ..... POA  
XRI Systems XR-300 SMPTE/Midi Synchroniser ..... Excellent Value £226  
STEINBERG Time Lock SMPTE/Midi Sync ..... £339  
J.L. COOPER PPS-1 Chase Lock/Sync Box ..... 169  
J.L. COOPER MSB 8x8 Prog Midi Matrix ..... £399

T.C. ELECTRONIC  
2290 with 8 secs. and latest Sampling Software Option ..... £2,595  
1210 Spatial Expander ..... £736  
1128 Programmable Graphic ..... £1,250  
2240 Stereo 4 Band Parametric ..... £576  
SONY DTC-1000ES DAT Recorder ..... £1,130  
LUXMAN KD117 DAT Recorder ..... £1,095

At no extra charge we will make the small mod. which enables the Sony DTC-1000 to record at 44.1kHz both analogue and digital (£20 for existing users)

MICROPHONES BY SENNHEISER, BEYER ELECTRO-VOICE, NEUMANN, AKG, TOA  
Please send for our separate Mic. Price List  
TANNOY SGM 10B ..... Pair £575  
TANNOY SGM 12 Little Gold Monitors ..... Pair £540  
TANNOY SGM 12X ..... Pair £795  
TANNOY SGM 1000 ..... Pair £1,695  
Full Range of HH Vx Series Amplifiers Available.  
HARRISON DSA and Xi Series Amplifiers  
HARRISON GP Series Graphics  
Send for Information

## SECONDHAND EQUIPMENT AVAILABLE

SOUNDCRAFT SCM 761 Mk3 1" 16TK with Remote & Bell N.R. 2Yrs Old ..... £5,895  
AHB CMC 24 Mk1 1 Yr Old - As New ..... £1,595  
TEAC 32-2 As New ..... £395  
YAMAHA P2100 2 x 100W Power Amp - Mint ..... £250  
REVOX B77 MkII only 5 months ..... £975  
SOUNDCRAFT SCM 761 Mk3 1" 16 Track with remote 2 Yrs. Old ..... £5,895  
DOLBY SP24 — 4 Years Old ..... £5,495  
SOUNDCRAFT SCM 762 MkIII 16TK Pre-wired 24 with Remote 2 Years Old — Mint ..... Offers around £6,950  
FOSTEX Synchroniser System comprising: 2 x 4030 Sync Units 1 x 4035 Sync Controller

1 x 87103 Machine I/F ..... Bargain £2,950  
4 x Interfaces (Various) ..... £495  
AKG C414 B-ULS 1 Year Old ..... Each £250  
BEL B Chan N.R. 2 Available ..... £750  
PANASONIC AG 6200 Industrial VHS Recorder ..... £2,449  
AKAI MG 14D 6 Months Old Boxed, As New ..... £1,295  
TASCAM 42 NB - Pro 2TK 2 Yrs Old ..... £495  
FOSTEX 4010 SMPTE GENERATOR/TRIGGER ..... £175  
STEINBERG Prophet 2000 Soundworks ..... £399  
STEINBERG Mirage Soundworks

All Prices Subject to VAT.

### BROKERAGE

We can act as agents to sell your equipment on commission. We collect, or you deliver to our premises and then we advertise and mail out to studios throughout the country. As soon as the equipment is sold we send you a cheque less our commission.

Please contact Tim Eastwood should you wish to use this service.

AMPEX AUDIO and FUJI DAT Cassettes available at super-low prices. • MAIL ORDER • BULK DISCOUNT • SEND FOR OUR TAPE PRICE LIST.

EXPORT SERVICE: We can quote a delivered price anywhere in the world within minutes.

Please contact Tim Eastwood or Will Logan with any query you may have. Our price list will be sent at your request by First Class post.

**AXIS**  
audio  
SYSTEMS

AXIS AUDIO SYSTEMS, 3 Waterloo Road, Stockport SK1 3BD.  
Telephone: 061-474 7529. Telex: 265671 MONREF G 78:DGS 2764. Esi Street AXIS - UK.  
Fax: 061 474 7619

# Media

Our range of BPO audio jackfields are of the highest quality and economically priced, from £155.

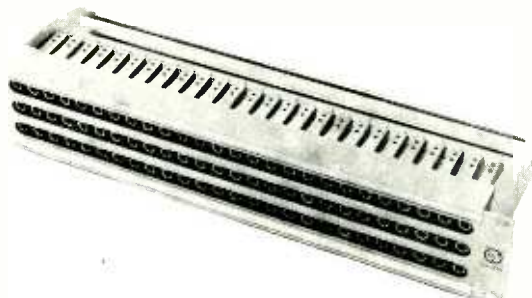

Featuring high quality 5-point palladium contact gauge B jacks, the jackfield occupies just 2U, of rack space. Standard versions are 2 or 3 row in 20, 24 and 26 ways, and are now available with connectorised option, supplied fully wired and normalised. Please contact us today for information on our range of video, audio and combined patch-panels and other systems equipment.

## 'It's in the name'

Media Products Limited  
Unit 4,  
Chiltern Enterprise Centre,  
Station Road, Theale,  
Reading, Berks., RG7 4AA  
United Kingdom.

Phone (0734) 303800  
Telex 858893 FLETEL G  
Fax (0734) 323121 (G2/3)

# SONOSAX

## Hi-tech sound mixers

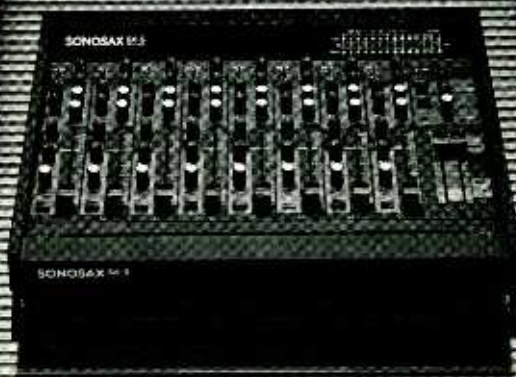

SONOSAX SA 1025 St Sulpice  
Switzerland  
Tel. 021 35 35.01/02 Telex. 26 325 sx ch



# C ONCERT, CLUB OR CONFERENCE. ONE SYSTEM TRANSFORMS THEM ALL.

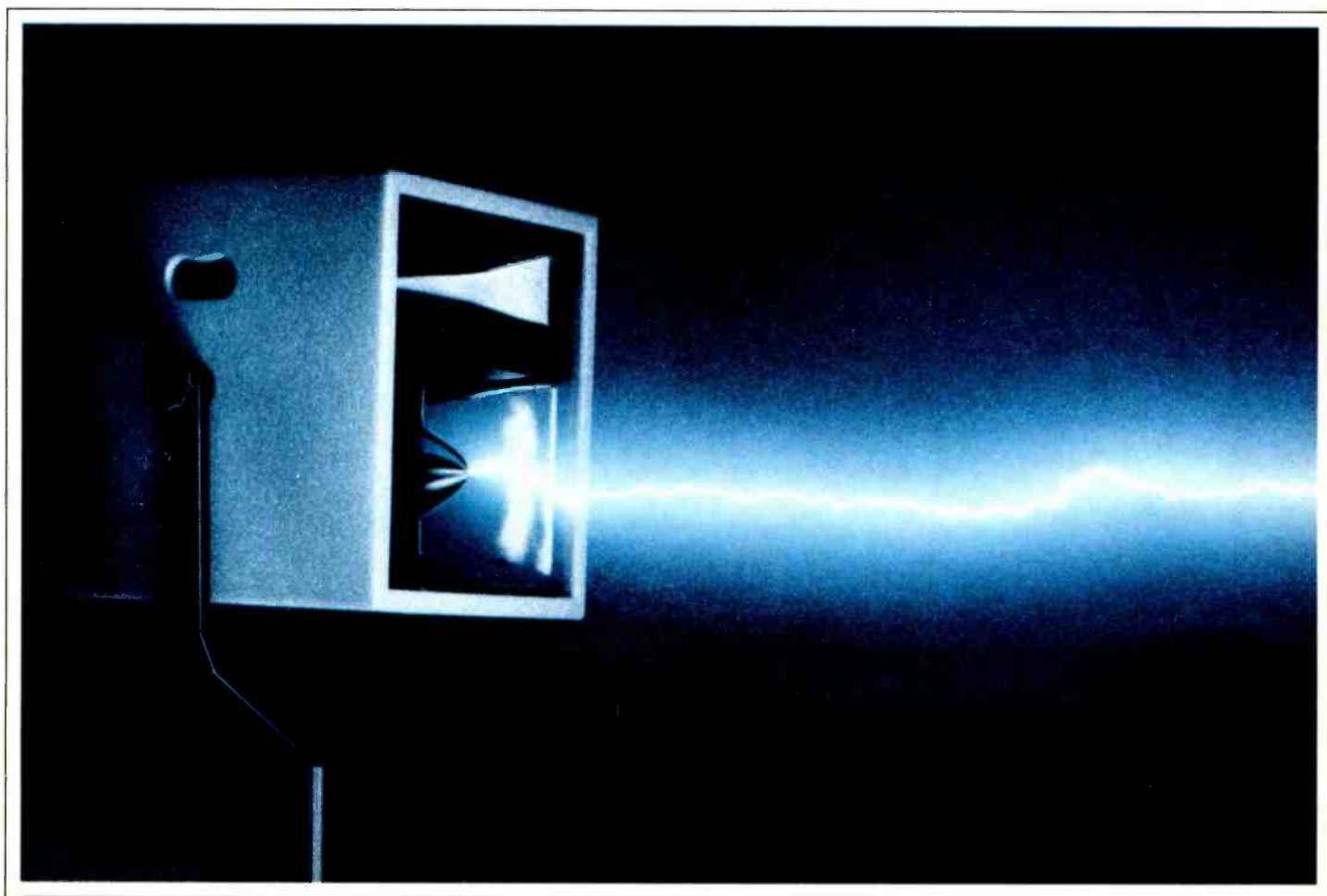

The Turbosound TSE Series is a very different proposition to ordinary speaker systems.

Yet its unique qualities aren't exclusive to the biggest halls or the largest budgets.

Because our modular concept makes it equally effective whether you're specifying two speakers or twenty.

#### DESIGNED LIKE NO OTHERS.

TSE Series speakers are phase-coherent, so they perform equally well in small numbers and larger 'cluster' systems.

While in any configuration, the enclosures' controlled dispersion allows you to direct the sound exactly where you want it.

Producing a startlingly crisp sound anywhere from a small club or conference suite to the largest auditorium.

#### WORLD CLASS SOUND QUALITY.

The TSE Series is best known for its unique clarity and dynamics, as clients from New York's Carnegie Hall to many of the UK's top nightclubs will confirm.

It's designed around our patented TurboMid™ and TurboBass™ devices, which deliver undistorted sound at all frequencies and levels.

As well as keeping the crucial 'vocal' midrange free of crossover points – making it clearer than anything you've heard before.

So despite its high acoustic efficiency, its dynamics, clarity and freedom from 'listener fatigue' are unrivalled.

#### A HIGHLY PRACTICAL SYSTEM.

Excitement isn't at the expense of practicality.

Since no external 'black boxes' are needed, it'll prove totally reliable.

While the combination of light weight and compactness mean straightforward siting and installation.

Perhaps you should judge the remarkable TSE Series for yourself.

Call us for a personal demonstration – and details of our installation service.

**Turbosound**   
ONCE HEARD NEVER FORGOTTEN

TURBOSOUND LIMITED, STAR ROAD, PARTRIDGE GREEN, WEST SUSSEX RH13 5EZ. TEL: (0403) 711447.  
TELEX: 878723 TURBO G. FAX: (0403) 710155. IMC: TURBO-UK. E.D.C. 611 BROADWAY NEW YORK  
NY 10012. TEL: (212) 460-9940. FAX: (212) 460-9947. IMC: TURBO-US.



an  company  
LONDON • NEW YORK • TOKYO

www.americanradiohistory.com

# Simple Intelligence



## Let's assume that results are what's important, not which tools you use.

Audio production is at least as much art as science; there will always be those who ascribe a magical aura to certain pieces of equipment. But if your client list is built on quality and consistency rather than techno-voodoo, the DCM 232 in-line console with CAT automation can give you more of both.

## You need more console, not more headaches.

You're working for more demanding clients, on bigger projects, with tighter deadlines. You need greater flexibility, expanded features, enhanced performance. What you don't need is a "mega-star" console—or the jumbo mortgage that goes along with it.

DDA's AMR 24 has already set new standards of audio performance and versatility in the "classic" split configuration. Now the in-line DCM 232 combines the accuracy of digital-quality audio, the flexibility of digital control and the capacity to handle a pair of synchronized digital 32 tracks.

## CAT Central Automation

### Terminal: engineered to speed your work flow.

The DCM 232's Central Automation Terminal controls one of the most ingenious automation systems ever to shorten a mixing session. Along with the precise fader and muting control you'd expect, the CAT system includes advanced functions like *Channel Copy* that lets you duplicate a channel's signal flow as many times as you need to. The computer will recall a "snapshot" of most console switch settings manually or via SMPTE code.

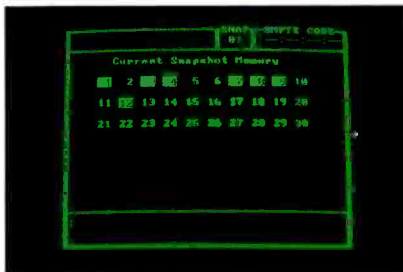

With all of its convenience functions, this CAT won't leave footprints all over your tracks. The DCM 232 maintains an overall dynamic range of 100 dB with at least 22 dB headroom at each stage, thanks to exacting calculation of every circuit component.

## A console investment that instantly doubles your returns.

Each of the DCM 232's channels, including the four band EQ section, can be split during mix-down. So a 56 channel frame can handle as many as 112 inputs from samplers, synths and digital storage media. You'll probably run out of control room space before the DCM 232 runs out of inputs.

The advantages of the DCM 232 in-line console with CAT automation are explained more fully in our brochure.

To get a copy, write on your letterhead to the appropriate address below.



Unit #1, Inwood Business Pk., Whitton Rd.  
Hounslow, Middlesex. UK TW3 2EB  
01 570 7161



Klark-Teknik Electronics Inc., 30B Banfi Plaza North  
Farmingdale, NY 11735 (516) 249-3660



# MARTIN POLON'S PERSPECTIVE

**H**i. Hi out there in Home Television Retail clubland. This television programme is your guide to the best in retail values, and I am your announcer—Mark Point. Tonight we have our usual Saturday night electronics specials. Stay with us on this channel for tonight's sensational electronic values as we finish up with our previous jewellery selections. How about the outstanding nugget watch finished in 24 carat gold nuggets, that Barbara was just telling you about. And how about that Barbara. Sorry about that, Barb. And how about that fabulous circle of ½ carat diamonds set in a ring on the solid gold bezel of the watch. The gold-plated band is covered with authentic gold nuggets. And the watch itself has tiny sapphires at noon, three o'clock, six o'clock and nine o'clock. And the price. A watch like this in a retail jewellery store would cost well over \$3,000. So what do you think the Home Television Retail price will be? Not \$3,000, not \$2,000, not even \$1,000.

Here at HTR our prices are designed for you, our television customers. It is the result of our extraordinary buying power that allows us to offer top quality merchandise from major manufacturers at bargain prices. Our buyers scour the globe looking to make deals that will allow us to offer the best for less ahead of the rest. This extraordinary nugget and diamond watch is going for \$179.95. That's right. Not \$1,000 but \$179.95. And just to show you how much we at HTR care about you, our customers out there in TV land, we are going to add a vital accessory to this HTR Special Deal!!! We will give you absolutely free with this watch a Doberman puppy. You will not be able to wear this great watch in public in most of urban North America without having someone try and take it from you. But imagine how positive you will feel as you walk down the street proudly displaying your fine new nugget, diamond and sapphire watch while your vicious man-eating 110 lb Doberman struts at your side. We only have 16,000 of these beauties so please get on the toll free phone to us now. Batteries are included with the watch. No food is provided for the puppy but frequent strolls at night with the watch should keep the dog well-fed with high quality protein.

And now we open our electronics edition of Home Television Retail with the ultimate consumer audio device, the DAT—the digital audio tape recorder. We have been able to scoop these state-of-the-art units from all of the major audio manufacturers; companies whose names you will instantly recognise. These units were held off the marketplace while these companies fought for

the right to sell their products without interference or modification of the product. These units all have 90 dB signal-to-noise ratios, no wow or flutter, virtually no distortion of any kind. They are equipped with analogue audio, digital audio and optical inputs and outputs. Most sample at 48 kHz but some have several sampling rates. These units were to be introduced at the \$2,000 price point but here they are at HTR for only \$150? No, honk the horn and take it down to \$125? No, honk again and take that price down to \$109. That's right. \$109 is the correct price. You can't afford not to buy at least one, two or three of these beautiful digital technology machines at that price. I can see the phones lighting up as this special really grabs our audience. For all you first time HTR customers these fabulous digital units will cost you only \$99 with your 'first-timer' \$10 discount.

Look at the fine finishes on these great units. Some are brushed silver, others are gold plated and several are finished in cadmium plating covered with a stunning matte black surface. According to testimony by record industry leaders these units will turn your home into 'a professional recording studio'. All for \$109. And all you HTR gals out there can purchase metallic lamé blouse and evening skirt ensembles in the matching finish of your DAT to colour co-ordinate with your living room/recording centre. Barbara will be telling us more about that in a moment. And as a special accessory, we will include a booklet entitled, 'What to do until your attorney comes when you are sued for owning a DAT'. This is an HTR real deal.

Please be sure to stay with us because after the DAT, I have some other sensational products from the wonderful world of consumer electronics. Would you believe a listening microwave oven? It's the ideal companion for those of you who bought our talking refrigerator last month. Out would come your frozen *entrée* and the refrigerator would tell the microwave what setting to use. Unbelievable. Only here on HTR. How about a Long Wave—AM Medium Wave—AM Short Wave and FM Stereo Vibro-Massage chair? And a combination microwave oven—19 inch television set so all you HTR couch potatoes can make up snacks without ever having to leave the comfort of your television set or living room? Stay with us as we will have all of these fine, fine products coming right up. And remember at ten o'clock, Bruce Edith will be back with a whole range of brushed polyester business suits for you really 'big' gals in tonight's segment of our regular feature 'Skirting the Issue'. Remember to stay tuned to Home Television Retail—HTR. It rhymes with, 'Where The Bargains Are'.

**I**s this the fate that awaits the recording digital audio tape recorder? It is enough to make my blood run cold to presume that DAT recorders could be 'dumped' by the marketplace and left to be seconded off in the home television sales arena; the Bermuda Triangle of unwanted products and ideas. Would a 'Daily Variety' headline sometime in the near future possibly read, 'DAT Is A Crock—Sales In Hock—Ends Up On TV Auction Block'. Or might the DAT theme song be 'DAT Old Black Magic That You Knew So Well. Icy Fingers Go Down Your Spine, As The Battle Against Digital Piracy Claims Your Brain For The Fourteenth Time'.

Well, we have returned for the fourteenth time to discuss the further adventures of digital audio tape or DAT. What's that you say? You thought that the good guys in the white hats had slain the evil Copycode monster in the corridors of power in that place the ancients call Washington? And that DAT had been saved for all time—ready to pass on from generation to generation. It's true that Copycode was split asunder. However, the nearly unstoppable forces of DAT destruction pulled themselves up from the floor of Congress, did a quick two-step and flashed a pearly smile exiting left. The attack on digital taping continues again but with different weapons. What is so interesting here is that in reality the coalition of record companies and recording artists that is hell bent on stopping digital recording in any format has succeeded in so slowing DAT that its ultimate evolution seems in doubt as newer technologies threaten to eclipse its progress.

What was stopped in the halls of the US Congress or more precisely on the floors of the National Bureau of Standards testing laboratories was the Copycode system; not the concept of retarding the introduction of digital audio tape recording (DAT) at all costs. While it is true that many members of Congress were a trifle offended by the disparity between the promises of Copycode protection made by the record industry and the actual results of the Government testing lab that invalidated the copy protection system, everyone involved with the issues still recognises the need for some form of protection for intellectual property.

**I**t has been unfortunate that the record lobby has so overstated its case in terms of each of the relevant issues surrounding home copying or 'theft', that finding a middle ground is a difficult task. Nonetheless, it would appear from current and past research by objective observers that some percentage of record revenue is lost through home copying and that the relative perfection of digital will in all probability enhance the desire to copy in the home; no matter which digital format is used. But few equipment makers or audio industry professionals are willing to grant that reality due to the harsh and antagonistic stance that the record companies have taken with home digital recording. The record companies have accepted publicly the demise of the Copycode system because they promised Congress that they would so do if their system failed to make the grade. Privately, they continue to question the need for such an anti-copying system to be so 'pure' that recorded music is left untouched. There is still the belief among many record company executives that the majority of the popular music consumers lack significant perceptive comprehension of what they listen to or

## MARTIN POLON'S PERSPECTIVE

ingest to discern the use of such a system.

Having failed with the nearly two year campaign to stall DAT via the Congress, the Record Industry Association of America (RIAA) has turned to the threat of extensive and expensive litigation to further stall US introduction of DAT. By utilising the threat of six- or seven-figure civil court action in the California court system against DAT makers and possibly even against DAT dealers, the RIAA has paralysed the further introduction of DAT products. Consumer electronic equipment makers have shied away from what could be a time consuming and expensive process of legal contests. No major introductions of DAT took place during the summer of 1988 at the Chicago Consumer Electronics Show. That makes the sixth consecutive Winter or Summer show where equipment makers have bowed to record industry pressures concerning DAT. The US Electronics Industry Association (EIA) has raised a six-figure 'DAT Defense Fund', but that has not been sufficient to motivate equipment makers to jump the gun.

**A** record company attorney on the West Coast of the US opted, without identification, that "this is the perfect ploy to continue the process of delaying introduction of DAT. As most legal experts agree, there is no real underlying legal justification for any such lawsuits but since it takes between three to five years for cases to wend their way through the California system, a manufacturer and potentially his entire dealer network would have their hands tied up by the pending action. A restraining order could be obtained to prevent any DAT sales until the case could be resolved. Just before the case reached a hearing date, three to five years hence, the case could be dropped with very little cost or liability to the plaintiff. Bottom line, no risk for the record industry and a sticky mess for the DAT builders. The equipment manufacturer cannot afford to have a large inventory of DAT machines tied up injunctively for several years until the units are obsolete and worthless. Further, the dealers could hold the manufacturer liable for their trouble in such a situation and—*abracadabra*—more law suits. Of course, the fact that California has more lawyers, more law suits and a truly convoluted court system helps matters to no end."

The announcement of the possibility of 1989-1990 delivery for recording optical disc machines compatible with the compact disc format by Tandy Corporation in the US and Thomson in France is acknowledged by almost everyone in the industry as jumping the gun on a not-quite-ready technological format. But the fact that the gun could be jumped at all by two unconnected companies who have quantified similar technology indicates just how near the impending introduction of a recording optical disc really is. There are numerous other companies who have been working on recording optical disc systems for some time, some of which are formatised to the CD. Included are virtually every major electronics

maker in Japan, NV Philips and most if not all major computer system manufacturers. Although these companies have refrained from making specific statements about their progress in the search for a successful recording disc format, informed sources at these companies indicate that a successful product is no more than several years away—worst case. The problem for DAT is that at a time when the DAT technology is being successfully held in limbo by the actions of the RIAA, other competitive digital recording systems are continuing to move forwards and into the marketplace.

The promise of a recording CD is especially challenging to the DAT concept since it holds the familiarity of the CD system for the consumer. It also promises to retail at the \$500 price point initially, as compared to the DAT recorders, \$1,200 to \$2,000 initial price point. Blank recording media for the optical recorder promises to be half the price of that for the DAT. Such an introduction would place recording DAT manufacturers in an awful quandary with products that could prove difficult if not impossible to sell against recording optical disc systems. The combination of threatened legal action and competitive optical disc recording technology seems to have created a situation where the risk of introducing recording DAT machines to the audio marketplace, has become a substantial one for the world's electronics manufacturers.

**Y**et the real market for DAT could be in the play-only mode where the potential of DAT in automotive and portable usage would override any other considerations. None of the current technology audio delivery systems in use today achieve complete mastery over the forces of gravity and motion that define the use of portable audio equipment. Despite the efforts of numerous manufacturers, car-borne CD has not been especially successful and is certainly not price competitive. Portable CD units have achieved some success but their size and short battery life, not to mention susceptibility to any kind of motion, have limited both their performance and user acceptance. The portable use of the so-called Philips cassette, whether in an automotive situation or as part of a 'walk person' system has reached the limits of analogue recording and transport motion as a component of the signal. DAT could deliver digital perfection in playback-only units for the personal portable and automotive audio marketplaces. It would not be wishful thinking to presume that in excess of 50 million units could be sold in North America alone over a period of several years, and that 100 million units worldwide would be equally feasible.

For that reason, the major record companies/equipment makers such as Philips and Sony are behaving with a split personality towards DAT. Though these entities have record divisions that loathe the very thought of DAT recording, they also have executives who salivate at the thought of pre-recorded DAT software sales and DAT player hardware sales. In fact, the potential of pre-recorded DAT software to virtually double 'record' sales provides a severe case of puzzlement to record industry observers. Despite a solid basis for the record companies, publicly stated concerns about digital copying and an equally well founded private fear of DAT undermining the current highly profitable CD retail prices, no-one in the financial or business community who follows record industry activity can see anything but

significant financial gain as a new format increases the overall volume of software sales by quantum amounts.

Can the record companies and their companion artists continue to threaten and abort all new digital recording technologies that emerge? The answer lies in the motivations for the technological roadblocks thrown in the path of DAT. If the reality of the marketplace is not being accepted by the foes of DAT, then the issue has clearly reached the point of emotion. The problem with that is the fact that an aging 'Baby Boom' population in the Western World does not bode well for future software and hardware sales increases in audio entertainment products unless all segments of the audio and record industry work together. Emotional responses are not going to achieve that level of co-operation. Secondly, any future assaults on emerging digital recording technologies will bring the record industry up against a different kind of foe from the current round of sparring with the audio industry.

In the process of fighting the audio industry, the \$4 billion-strong record industry has picked on someone its own size. If recording optical disc is targeted, then the record industry will need much larger guns. The recording optical disc will have its major application as a computer data storage and retrieval device. The US computer industry has sales in excess of the \$200 billion mark and worldwide the computer industry is capable of generating sales figures in excess of \$400 billion per year. It would be safe to say that the world computer industry might spend more in legal fees than the US record industry takes in as revenue annually. That will produce a confrontation more like a children's fairy tale—something about an elephant and an ant. An important point for the record industry to remember is that in real life, the elephant wins and it takes an electron microscope to find the ant.

None of this means that professional DATs will not continue to grow within the studio and portable recording marketplace. The DAT recorder has created a new and well-received category of 2-track digital recording for the studio environment. Especially for remote recording, the DAT machines promises to enhance the capability and flexibility of recording operators. Small studios will be able to acquire digital capability at a price considerably more affordable than that of open reel digital. And the eventual release of enhanced DAT recorders can only increase the viability of a format that could replace *FI* for location recording and could even become the new standard for CD mastering. Data recording versions of DAT are also scheduled to reach the marketplace, as a consequence of the Sony/Hewlett-Packard effort for backup computer storage.

**T**he final question seems to be one of where do we go from here? It may well be, like the image of an old lover who is best seen from the romantic shroudings of our collective memories, that DAT should be allowed to fade naturally—at least as a home recording medium. But DAT may well show enough strength to overcome its current difficulties and seize the home and professional audio market. One thing is certain, the current roadblocks to DAT should be removed and a programme of industry reconciliation and future planning should be embarked upon by the major players in the record industry and in audio manufacturing. The current status quo of a digital recording 'no man's land' benefits no-one.□



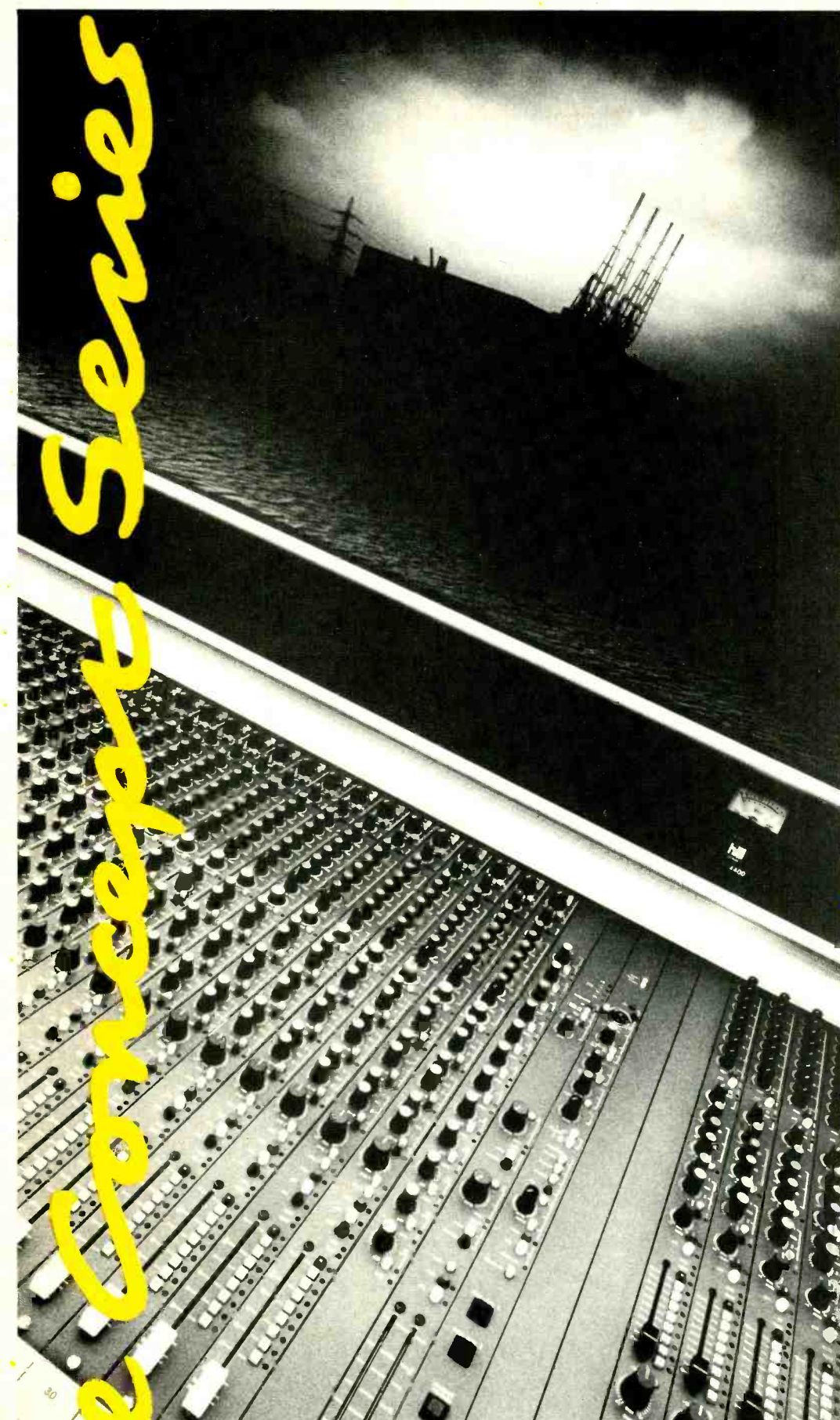

## The Concept Series *limited only by your imagination*

Only your imagination will limit the potential of the creative new Concept series of modular consoles from Hill Audio.

Available in any size from 16:8:2 to 56:24:48:2, the range more than matches the quality of existing studio consoles whilst they are tough enough for touring applications.

Popular all over the world with recording and film studios, dance companies and theatres, as well as with PA companies, the key to the consoles' success is its flexibility.

Choice of: metering, type of Eq, front end circuitry, patchbay facilities, VCA grouping and automation as well as a wide variety of input and subgroup modules mean that you get a tailor-made console. All for the price of an off-the-peg model.

Truly you are limited only by your imagination.

Hill Audio Ltd., Hollingbourne House, Hollingbourne, Kent ME17 1QJ England.  
Telephone: (062 780) 555 Telex: 966641 HILL Fax: (062 780) 550.

Hill Audio Inc., 5002B N. Royal Atlanta Dr. Tucker, GA 30084 USA.  
Telephone: (404) 934 1851 Telex: 293827 HLAD Fax: (404) 934 1840.



# SOUND MAESTRO

Doing for Music Editing . . . what  
Word Processing did for Office Efficiency  
Stereo Digital Recording and fast,  
accurate editing

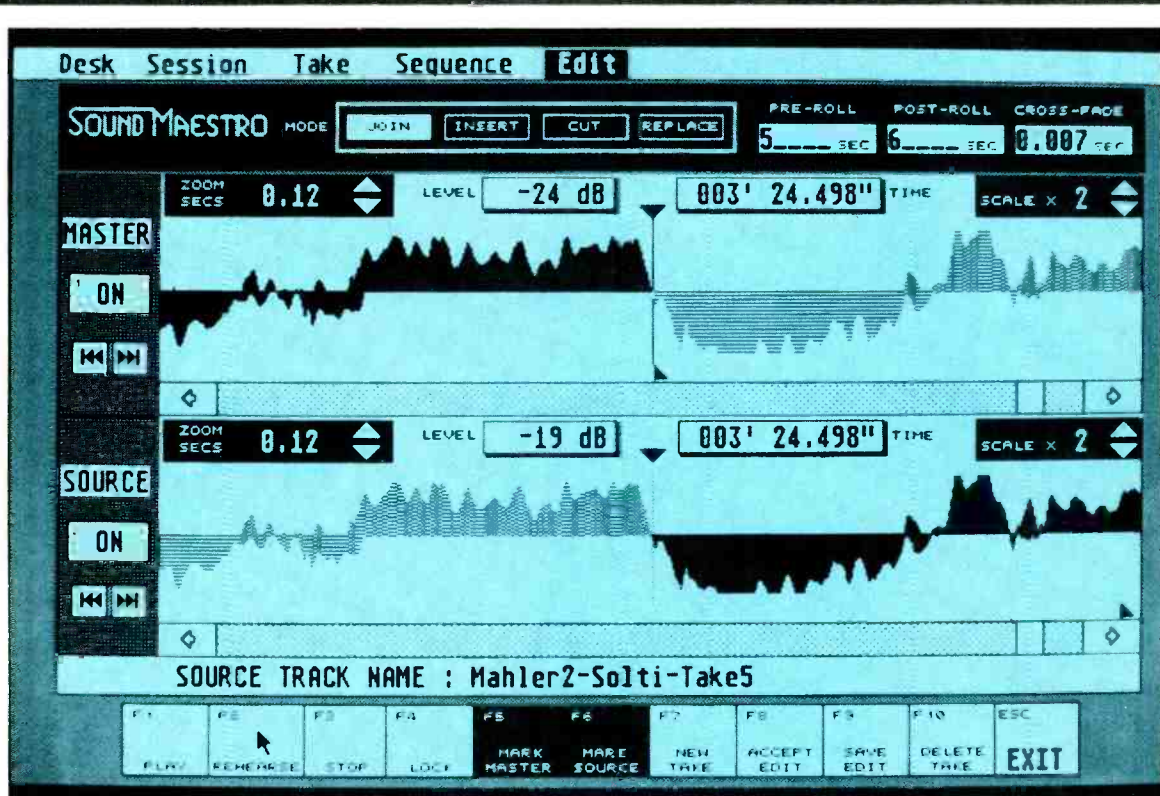

At last – see what you are doing!

- 12 minutes to 8 hours stereo recording on hard disk
- Friendly Software makes the whole process so easy!
- Non-destructive editing
- Rock 'n' Roll editing facility
- Sony PCM 1630 and EBU interfaces
- Spin-in against timecode
- CD event listing and sub-coding
- 4 times oversampling monitor
- All industry sampling standards.

**AUDIO DESIGN**

New Wave Technology

U.K. Broadcast and Export Sales:  
Unit 3, Horseshoe Park, Pangbourne  
Berks. RG8 7JW U.K. Tel: 07357 4545  
Fax: 07357 2604 Telex: 848722 ADR UK

UK Studio distribution

**AUDIO RENTS**

01-586 7587



# BARRY FOX'S BUSINESS

When audio journalists hit town, they always make for the nearest record shop. We all have our own favourites. In Japan I usually go to one on the top floor of an electronics emporium in the Akihabara.

Last September I was browsing through vinyl LPs there. This spring there was not a trace of vinyl left in the shop. No LPs, no vinyl singles and no VHD video discs. All the racks are now given over to optical discs; CDs, Pioneer *Laserdisc* video discs, a very few 5 inch CD-V pop clip discs (pressed I note in Japan, not Blackburn) and the new CD-3, 3 inch single.

The CD-3 singles come in a neat oblong package, like a book marker, to curb shop lifting and make browsing easier. You snap off a piece of plastic to reduce the size and fold the cardboard sleeve down into a 3 inch square. Price is ¥1,000, between £3 and £4, which is carefully chosen.

As one Japanese father put it to me: "That's ¥300 more than for a vinyl single, and expensive for just two titles. But it's still cheap enough for the youth market. Whereas my children have to ask me if they can buy a full length CD at around ¥3,000, they come and show me CD-3 singles that they have bought with their pocket money."

He added that this helped explain why the 5 inch CD Video clip disc is not taking off. Shortage of software and muddles over launch plans have let Sony steal the publicity thunder with CD-3—which firms like Nimbus will press for 45p leaving room for a shop price reductions. The youth market isn't interested in more than one gimmick at the same time.

In Japan CD-V looks likely to revert to its successful origin—8 inch and 12 inch video discs with digital soundtracks. The 5 inch clip may just fade away.

In Europe things are not that simple. There has never been a successful market for 12 inch (or 8 inch) video discs. The CD-V launch was intended to create an all-round market for all sizes of disc. The PDO factory at Blackburn has stopped pressing video discs with analogue soundtracks, arguing that this is yesterday's technology and to sell it risks confusing the market for tomorrow's technology, 5 inch, 8 inch and 12 inch CD-V discs with digital soundtracks.

The big question, is when will tomorrow come?

The press—and here I carefully quote other journalists—has now taken to describing the non-launch of CD-V as a 'shambles' and predicting that even if Philips and Polygram are ready for the latest launch date, now set for September 1988, there will be far too little software to kick the format into gear. The audio and video industry would sympathise with Philips, and PDO, if kept abreast of the technical problems

that they have faced on mastering discs from virtually un-sync'able NTSC sound and vision tapes, and producing hardware that will keep the beam from a solid state laser on track over so many different disc sizes, running at speeds ranging from 200 RPM to 2,250 RPM. But no effort has been made to explain what went wrong and why, and how it is being corrected.

Likewise, Philips engineers have played clever tricks to squeeze longer playing time on the disc, by re-structuring the speed change format, to align the sync bursts, but typifying the whole nonsense of CD-V the press has only found out about this by accident.

Philips and their UK PR people just haven't communicated with the outside world. They have left reviewers waiting for non-existent machines, dealers unable to satisfy interested customers and journalists with egg on their faces after stimulating interest by writing about product launches that never happened.

After unveiling CD-V all round the world during 1987, Philips promised Combi players would go on sale 'in selected outlets in London from November and nationwide from January'. This promise was of course not kept but worse still it was never corrected. In the early part of this year, questions on CD Video were answered by Philips' PR representatives Burson-Marsteller with the promise of a briefing to be held on March 15th, with representatives of PDO, Philips Electronics and Polygram present to clear the air on CD-V. There was even encouraging talk of the briefing being held at the PDO plant in Blackburn. Subsequently this idea fell by the wayside, with cock and bull talk about people not wanting to go to Blackburn. "Tell me who these people are," I asked, because everyone I know would have jumped at the chance. I am still waiting for an answer.

At the last minute, the briefing was canned, with another cock and bull story that because Philips' president Cor Van der Klugt had announced that the official European launch of CD-V would be in September 1988, a briefing was redundant. First the briefing was 'postponed' then it was 'cancelled'.

There followed silence, broken only by Burson-Marsteller complaining to editors about what I subsequently wrote about the launch delay.

Trapped by a previous promise, Philips found itself committed to exhibiting at the consumer electronics trade shows, which are held in London in May. This exposition was scheduled to coincide with a trial roll out of CD-V, with a few players on sale in selected shops. But neither players nor discs were ready. Polygram failed even to come up with an announcement on disc titles and the CD-V players made at the Philips factory in Hasselt, Belgium, were still delivering pictures nowhere near as good as the industry has grown

to expect from *Laservision*.

Talking with staff from Philips UK, I felt every sympathy for their predicament. They can no longer believe what they are told by their colleagues across the water. So they have dug their heels in and will only launch CD-V in September if it is well and truly ready.

The CD-V launch has, as one hi-fi magazine put it, become like 'the longest running farce since *No Sex Please, We're British*'. The real sadness is that many of the problems could have been avoided if Philips, or their PR representatives had provided outgoing information to smooth things over. But no. The press, trade and public have been left to ferret out information or guess.

For the May trade shows Burson-Marsteller put together a status report, dated 16th May, which clarified the current position on CD-V. But like me, the editor of one video magazine found out about the status report only by accident and had to ask for a copy. 'We only gave the report to journalists who came to the Philips exhibition on press day (Monday 16th May) and asked about CD-V,' B-M explained.

Other journalists, who went to the show on the three other open days, or couldn't get to the show at all, stood a good chance of hearing nothing. So here, for the record and for the benefit of those in the industry who were unlucky enough not to be at the right place at the right time, is Philips formal statement on CD-V:

*Philips CD-V—latest news 16 May 1988*

*The formal launch of Philips CD Video is still scheduled to take place in September 1988 in the following countries:*

*UK; France; Germany; Holland; Switzerland.*

*Philips UK's intention of releasing limited product to start to stock trade outlets and commence sales to consumers in late May/early June has been delayed until the September Pan-European launch.*

*The reason for this further delay is due to tracking problems experienced with the playing of the 5 inch CD-V single. These tracking problems have occurred when the machine reached a certain operating temperature.*

*Another difficulty experienced in the development of the CD-V Multiformalt player was the interference of Digital Audio and Analogue Video—one signal influencing the other.*

*Philips UK understands that the above problems have been resolved and final testing is underway prior to starting production to facilitate the September launch.*

*Philips UK are in on-going discussions with Polygram UK to ensure that CD-V software will be available from software outlets complementary to Philips hardware outlets.*

*Philips UK understands that the production of software has started and that quantities of CD-V discs in all formats will be available for the September launch.*

For the record: in the May issue (page 54) I replied to a reader's letter about the ACTT dispute at

TVam, noting that neither Alan Sapper nor his union had ever thought to contact either myself or *Studio Sound*. This seemed especially odd as the technician generously described *Studio Sound* as 'own magazine'. Either Mr Sapper and his colleagues don't read *Studio Sound*, or they don't think it is worth communicating with us, because the May comment produced no reaction until I wrote a personal letter to him enclosing a copy of the SS text. Technicians may like to know this.

# REVIEW

## Terry Nelson takes a look at a programmable equaliser, the DPE from CEM of Italy

Introduced last year, the CEM DPE joins the fairly select club of programmable equalisers now available on the market, at the same time emphasising an increasing Italian presence in the international pro-audio world. CEM are one of the foremost manufacturers of computerised control systems in Italy and though it may seem strange that they should put out an audio product, the result is well worth looking at.

The name *Digital Parametric Equaliser* is in fact a misnomer—digitally controlled equaliser would have been more correct as the audio circuitry is analogue. The word 'digital' is bandied about in the consumer market with cheerful unconcern but pro-audio products should be correct in their terminology.

The CEM DPE is a 1U rack package containing a single- or dual-channel 4-band parametric equaliser whose parameters can be stored in 100 memory locations (0 to 99). The unit also features MIDI control with MIDI in/out and 'thru' connectors. The DPE is also fitted with a composite video output on a BNC connector for displaying the settings numerically or graphically on an external monitor. This latter feature is available in two options: the computing power needed for the display causes the control circuitry to be disabled for six seconds (ie the equaliser still functions but you cannot change parameters) and this is in the standard version. An optional dedicated video processor board is available for permanent video display and shows changes in settings in realtime.

The front panel is neat with a plastic fascia in white and light grey with pad switches and windows for the displays.

From left to right the controls are as follows: input section with down/up buttons for input gain, digital display from 0 to 99 and a 10-LED bargraph vu meter; equaliser section with down/up buttons and numerical displays for gain, frequency and Q-factor; band selection with three vertical rows of four LEDs indicating CLIP, B and BYP, and two pad switches marked BYP and B; output section as input section; keypad with a lower row of pads labelled PROGRAM down/up, V, R, II, and an upper row labelled P, S, I, with a numerical display from 0 to 99 for the memory locations; and two vertical pads for power on and off.

The review version was 2-channel and fitted with the optional video board and the unit was interfaced with professional and non-professional systems without difficulty. The equaliser is fitted with an IEC mains socket and XLR input and output connectors for the active balanced inputs and outputs.

### Controls

The DPE powers up to its previous status or last used memory position so you can continue where you left off. The operation mode is determined by the keypad: the switches marked I and II are for the individual channels and each contain a red LED. The equaliser can operate in stereo, in which case both LEDs will be illuminated and the equaliser settings identical for each channel, or in 2-channel mono. In mono mode pressing either I or II will cause the LED to light and the parameters for that channel will be displayed.

Stereo to mono operation is very simple as pressing either of the channel buttons selects that

channel and the unit takes on dual-channel status. To return to stereo the button R has to be used. This is a multifunction button and in this case returning to stereo requires that the R button be held down and followed by the II button.

The equaliser has three input gain ranges, 12 dB, 18 dB, 24 dB, with each range divided into 100 increments and adjusted by the down/up nudge buttons. The unit defaults to the 12 dB range and the other two are selected by pressing the R button and one of the down/up buttons. The 18 dB range is indicated by a point after the numeric display—eg '35.'—and the 24 dB range by a point between the figures—eg '3.5'.

Each frequency band is adjusted one at a time, the band being selected by the B switch. The appropriate LED illuminates in the B column indicating the band selected and each band can be switched in or out of circuit by the BYPass switch, again with the appropriate status LEDs illuminating. Each band is also provided with a clip LED, which is self-explanatory. The gain, frequency and Q-factor displays change for the band selected. The gain for each band is adjustable from -19.5 dB to +19.5 dB in 0.5 dB steps and the Q from 0.3 to 30.

The four frequency bands are overlapping with the first band from 20 to 600 Hz and adjustable in 3 Hz increments, the second from 60 Hz to 2 kHz in 8 Hz increments, the third from 200 Hz to 8 kHz in 35 Hz increments and the fourth from 600 Hz to 20 kHz in 80 Hz increments. (Note: the last frequency is always at an odd interval to reach a round number!)

The output level is adjusted as per the input level but with a fixed gain range (approx 40 dB).

The DPE has 100 memory locations and these are selected by the down/up buttons in the keypad section. Loading a program takes about 1 second and no audible muting is heard during changes with programme material.

The remaining buttons are those marked S, V and P.

The S button is dual function and when pressed by itself acts as a system in/out switch; the 'out' status is indicated by the selected LED in the band column flashing. When used in conjunction with the R button, programs can be stored. Pressing R and S will cause the word COPY to appear in the frequency display section and pressing R and S again will store the program into the memory location displayed.

Programs can easily be moved around or copied from locations. The program mode is selected with R and S, the desired memory number is selected with the down/up buttons and the program stored by pressing R and S again.

It is also possible to modify a program without losing it. When a program is loaded it is put into

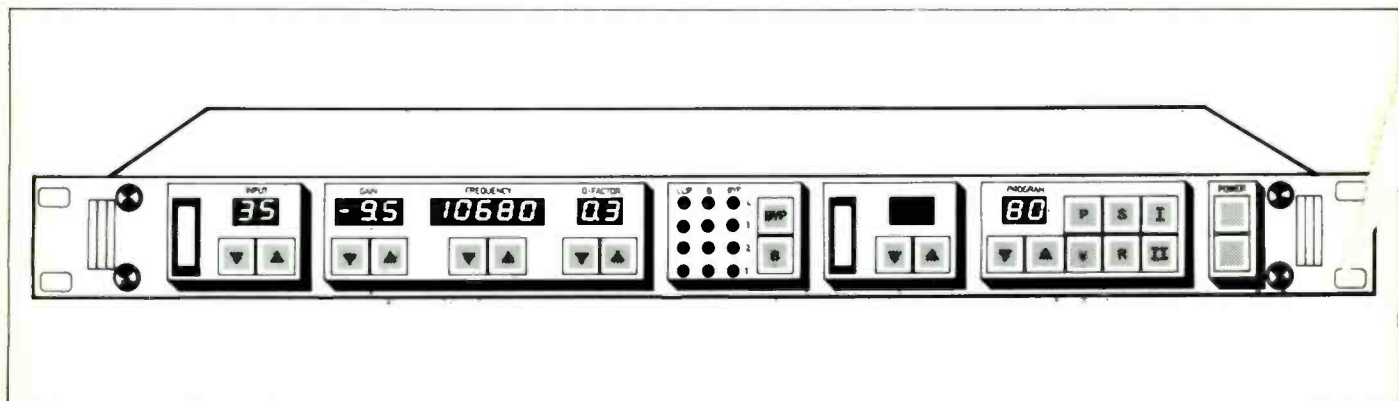





# REVIEW

what CEM call a 'work memory'. The moment it is modified in any way (input/out gain, frequency, etc) the program number begins to flash to indicate that the program has been modified and that it is not in memory. The updated program can then be stored as required.

A useful feature is that each memory location is stereo or dual channel. This means that in mono mode each channel can be programmed into the same memory location, thus allowing parallel processing of two independent signals.

The P and V buttons concern the video output of the equaliser. Pressing V selects the video output for a unit not equipped with the extra video processor and the P button enables the 100 memory locations to be scrolled through in 10 pages.

## Operation

The *DPE* provided a wide range of effects from 'subtle' equalisation to 'brute force'. The circuitry is such that the bands are in parallel and then remixed, meaning that extreme amounts of boost and cut are not possible. However, some very interesting effects could be created by positioning two frequencies very close together and finding the right balance of gain or attenuation. The parallel filter design means that the output from the mixer has a phase shift of 180° and I found that an almost infinite notch could be created by putting the centre frequency of the notch at maximum attenuation with a Q of 30 and combining it with the nearest frequency—also at a Q of 30—but with, for example, -2 dB of attenuation. Combining more or less immediately lessened the effect due to phase-related phenomena.

The 'sound' of the equalisation was also very pleasant with a nice sheen on the trebles and an overall lack of 'aggressiveness'.

The separate input and output gain facility is very handy and despite blocking the input/output meters completely, no distortion was heard in normal use (meaning good headroom or smooth clipping). The unit was quiet and no hum or noise was noticed.

Digital control can mean clicks and with no programme going through the unit, clicks caused by changing settings quickly are just noticeable. However, these are unnoticeable with signal present.

Though, in general, no problems with surrounding equipment was observed, there was one instance when the control signals bleed through into adjacent equipment in a rack. Unfortunately, time and circumstances did not permit a thorough investigation into the situation

but it is possible that poor system earthing aggravated the effect.

Construction of the CEM *DPE* is quite solid—it has a steel chassis—but I would have preferred to see a nut and bolt assembly attaching the top cover and not self-tapping screws. The electronics are mounted on a main motherboard with a piggyback board for the second channel in stereo units and the quality of components, layout, wiring, etc, is to a high standard. The computer ancestry is also evident by the IEC mains socket with built-in filter. The *XLR* sockets are wired with pin 3 hot and as these are connected with shielded wire, changing the wiring to pin 2 hot would be easy (the sockets are bolted, not riveted).

Now the 'why didn't they do this' department. First it would have been nice to have the choice of shelving and bell filters on the high and low frequency bands—or even HP and LP filters with parametric mids. Being able to frequency shape with processing in the middle provides a lot of flexibility and surely this function would not have been difficult to implement?

The other thing is nudge buttons. Computer designers need to concentrate more on the human interface—knobs, may be less aesthetic but they do get you there faster and save a lot of nervous energy.

Although the question 'why should anyone want a programmable equaliser?' has been raised recently in these pages, in a studio situation they do permit the storage of tried and tested settings that can be called up to 'save the day' when a client just can't seem to get it right. Used in conjunction with MIDI it means EQ settings can be programmed in for different parts of a mix. Live sound is also an area where it is useful to have presets that can be called up—even if you are going to tweak them from the rehearsal setting during the performance—as a basis to work from. As with everything else, if you have it you will (hopefully) find a lot of uses for it.

## Summary

The CEM *DPE* offers all that one would expect from a high quality parametric equaliser with the added flexibility of 100 memories. The video output was found to be more than a gimmick and very useful although the optional processor for realtime working is strongly recommended. The only point to be pondered is whether you can put up with nudge buttons or not. □

**CEM Elettronica srl, Strada Statale Ticinese N5, 28040 Varallo Pombia (Novara), Italy.**  
**International distribution:** Gotham AG, Althardstrasse 238, CH-8105 Regensdorf, Postfach 122, Switzerland.

## TASCAM European Distributors

Hi-Fi Stereo Centre,  
Muencher Bundesstrasse 42,  
5013 Salzburg,  
AUSTRIA.  
Tel: (0662) 37701

Beltronics  
Rue de la Celidee 29,  
1080 Brussels,  
BELGIUM.  
Tel: (32) 2 424 0233

So and Hoyem A/S,  
Bulowsgarden,  
Bulowsvej 3,  
1870 Frederiksberg C,  
DENMARK.  
Tel: (01) 22 44 34

Studiovox Ky,  
Atomitie 5C,  
SF-00370 Helsinki,  
FINLAND.  
Tel: (80) 562 3411

Harman France;  
Peripole 243,  
33 Av. de Lattre de Tassigny,  
94127 Fontenay s/Bois Cedex,  
FRANCE.  
Tel: (01) 4876 1144

Elina SA,  
59/59A Tritis Septemvriou St.,  
Athens 103,  
GREECE.  
Tel: (01) 8220 037

Greenlands Radio Centre,  
PO Box 119,  
3900 Godthab,  
GREENLAND.  
Tel: 299 21347

AEG Nederland NV,  
Aletta Jacobslaan 7,  
1066 BP Amsterdam,  
NETHERLANDS.  
Tel: (020) 5105 473

GBC Italiana spa,  
TEAC Division,  
Viale Matteotti, 66,  
Cinisello Balsamo, Milan,  
ITALY.  
Tel: (02) 618 1801

Hljodriti — Hot Ice,  
PO Box 138,  
Hafnarfirdi,  
ICELAND.  
Tel: (01) 53776

Audiotron A/S,  
Seilduksgt, 25,  
PO Box 2068 Grunerlokka,  
0505 Oslo 6,  
NORWAY.  
Tel: (02) 352 096

Goncalves,  
Avenida 5 de Outubro, 53, 1,  
Lisboa 1,  
PORTUGAL.  
Tel: (01) 544029

Audio Profesional SA,  
Paseo Maragall 120,  
Entlo 3a,  
08027 Barcelona,  
SPAIN.  
Tel: (93) 349 7008

Erato Audio Video AB,  
Aeogatan 115,  
116 24 Stockholm,  
SWEDEN.  
Tel: (08) 743 0750

Telion AG,  
Albisriederstrasse 232,  
8047 Zurich,  
SWITZERLAND.  
Tel: (01) 493 1515

Harman Deutschland GmbH,  
Huenderstrasse 1,  
7100 Heilbronn,  
WEST GERMANY.  
Tel: (07131) 480202

## TASCAM



# THE ATR80-24



**Don't just note  
check out**

**the good looks,  
the features!**

The ATR80-24 is more than just a pretty face.

Yet with all the features you would expect of a Professional 24 track recorder/reproducer, it is easy to overlook one of the most essential: the quality of the heads.

The fact is that we don't trust anyone else to make them for us. So for the last 30 years, we have designed and manufactured our own record/sync, reproduce and erase heads.

This resulted in TASCAM being the first multitrack manufacturer to achieve full playback frequency response in sync mode.

SYNC EQUALS REPRO – means no quality loss during track bouncing or overdubbing.

- \* High density permalloy record/sync and repro heads with contourless configuration for hard wearing heads and optimum tape to head contact.
- \* Erase head with overlapping tracks and glassbonded gaps for erasure precision.
- \* Non magnetic ceramic capstan with high torque motor.
- \* Smooth transport, controlled by three 8 bit D to A converters, even in varispeed.

- \* 14 inch reel capacity and a wind speed of 375 ips.
- \* Interface for external noise reduction system.
- \* Optional serial interface for external control.
- \* Sophisticated remote includes rotary shuttle, rehearsal and "sync lock" function enabling simple use of reference codes, such as timecode.

**Run in to the '90s with an ATR80!**

For a demonstration or more detailed information, contact your nearest TASCAM Professional dealer or TEAC UK Limited.

TEAC UK LTD, 5 Marlin House, The Croxley Centre,  
Watford Herts WD1 8YA

**TASCAM**  
PROFESSIONAL

Tel: 0923 225235. Fax: 0923 36290.  
Contact: Martin Capp – Sales Manager



**Roland**



**System·house**

# for the discerning professional!

Two state-of-the-art Digital Audio processors for which **Roland System Houses** have retail exclusivity. Both employ 16 and 18 bit technology for the highest achievable sound quality, are fully MIDI compatible and feature Digital co-axial and optical input/output connectors (AES/EBU format).



The **E-660** is a 2-channel/4 band or 1-channel/8 band Digital Parametric Equaliser. Frequency response curves are displayed on a large-scale LCD, and a pre-delay function and separate per-band delay times can create complex EQ-based delay effects.



The **R-880** Digital Reverb contains four separate digital signal processors to provide four independent or a wide variety of interactive reverbs in addition to chorus effects, delay, 3-band parametric EQ and compression.



The **GC-8** Graphic Controller remotely controls the operational functions of up to sixteen R-880 units.

For full specifications and details of the Roland System House network contact:

**D I G I T A L**  
**A U D I O**  
**D I V I S I O N**

**Roland (UK) Ltd**

Amalgamated Drive, West Cross Centre, Brentford, Middlesex TW8 9EZ.  
Tel: 01-568 4578 Fax: 01-847 1528 Telex: 934470 Roland G



# REVIEW

## A technical report by Martin Colloms on the ASC D2A digital decoder

This neat little box takes the AES/EBU digital signal source and economically delivers stereo audio on balanced lines up to +13.5 dBm (MSB). Automatic phase lock is assured over a range greater than 30 kHz to 50 kHz encompassing the present standard frequencies of 32, 44.1 and 48 kHz. In addition to the audio output the digital input is also available as a bypass output via buffer.

It is 1U, and can be rackmounted (half width) with optional 'ears'. The review sample came in a well-finished two-tone grey. No user controls are present on the front panel, which simply sports a neat horizontal row of LED indicators and two presets. The LEDs show respectively power on, the status group—mute, emphasis, copy prohibit—and the sampling frequency group—32, 44.1 or 48 kHz. Finally on the right-hand side we have two screwdriver presets for individual fine control of output level for left and right channels. These are adjustable from -10 dBA to +13.5 dB at full modulation. The rear panel lineup comprises the balanced audio outputs with the pin convention clearly marked, 1-0V, 2-plus, and 3-minus. Digital I/O is also via XLRs, female in and male out. Mains input is via a 3-pin IEC, the socket fitted with an integral 250 mA slo-blow fuse. An internal strap provides for 110/120 V operation.

The digital output will accept any level from 250 mV to 5 V Pk to Pk and delivers a standard 5 V Pk to peak. (See Fig 1.)

5 V PK to peak. (See Fig 1.)

Its applications include the interfacing of domestic CD and DAT players to professional audio line standards and, where appropriate, the upgrade of existing players to a higher audio standard. It can also be used for general stereo audio distribution since the coded signal is robust requiring only one cable. It can also be used as a general purpose D/A converter for decoding digital audio data computer test signals, etc. A facility ASC might well consider is a fibre optic input terminal for digital data. If a standard can be agreed then this will ultimately be the preferred method of data transfer.

### Design and construction

Inside, the unit is built on a single PCB with a neat layout, the whole powered via a small toroidal transformer. The Sony CX2053 data acquisition chip is used with the high level implementation for signal track and phase lock, a nice feature. Digital I/O is properly buffered using the appropriate logic. The separated, multiplexed data is fed to the decoding system, which uses the Philips chip set comprising an SAA7220 FIR oversampling digital filter, 96th order, followed by a TDA1541 ('A' grade selection) dual 16 bit D/A converter.

<sup>†</sup> These proved to invert absolute phase on test.

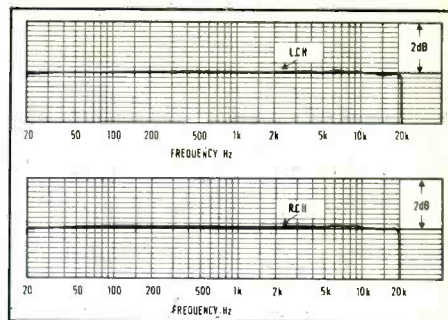
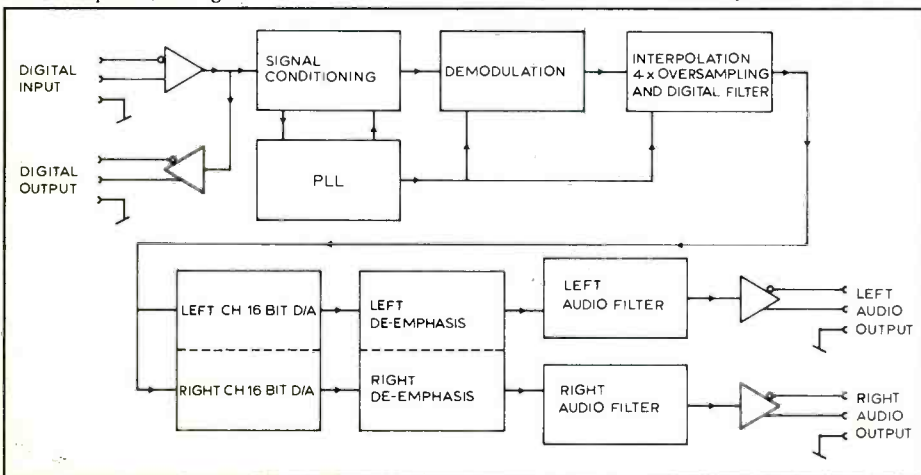

FIG 1 DIGITAL OUTPUT

In unselected consumer form, this chip set has a reputation for missing bits out to 16 bit but the selected chips used here should deliver a decent standard. Following D/A conversion, the output current is converted into a voltage, this stage combined with the first integration of the sampling pulses.

Given that the replay resampling rate is  $4 \times 44.1$  kHz the digital filter has taken care of most of the obvious spurs—all that is required is a linear phase, third order Bessel filter to reduce spurs to respectable levels. ASC use additional ultrasonic filtering to improve the spurious responses. Thus the output is linear phase, absolute phase correct, and with dual D/A converters, the two channels have no differential phase shift. De-emphasis and muting is accomplished by relays while the balanced output is transformerless, using op amps in bi-phase mode.

The construction is of professional quality with good accessibility for servicing with the ICs mounted on plug-in sockets for easy substitution.

### Sound quality

Knowing this to be a contentious area, I shall tread carefully. The audio output is quite superior to the run-of-the-mill domestic CD players currently available. It was clearly greatly superior to earlier generations of non-oversampled players such as the Sony CDP101 and the early Philips models that used this chip set.

As regards professional digital tape units, the standard beats PCM-F1, 1600, 1610, 701, 501, etc. It did not supplant some of the more costly domestic interfaces such as the Marantz CDA94, Denon DAP 5500 or the Accuphase DP81, all of which sport balanced outputs but offer domestic output levels and use phono jacks for the digital input. It is fair to say that the D2A performance exceeds that of current professional encoders.

### Laboratory

The frequency response for left and right channels was very similar, the right showing a mild 0.18 dB lift in the 5 to 10 kHz region. Taken overall, both channels met fine  $\pm 0.2$  dB limits from 20 Hz to 20 kHz (spec  $\pm 0.1$  dB). The 96th order digital filter still has a trace of ripple at high frequencies, which has been banished from the new 283rd order designs such as those from Yamaha and others.

Channel balance held to  $\pm 0.05$  dB 20 Hz to 20 kHz, while interchannel phase shift was  $0^\circ$  over that range. The de-emphasis curve was accurate to 0.1 dB.

Channel separation reached a maximum of 93 dB at 1 kHz, and a similar 92 dB at 20 Hz, but showed some differential degradation by 20 kHz, R on L dipping to 62 dB while L on R held at 79 dB. Poorer than the absolute potential of the

# REVIEW

medium—typically 100 dB or more—the channel separation was still more than satisfactory.

It was in the key area of linearity and distortion that the ASC D2A excelled. At full modulation the MSB 1 kHz distortion (first nine harmonics) approached 100 dB down or 0.0012%. At 20 Hz the figure was -86 dB, while at 20 kHz the highest beat products below 20 kHz were no higher than -87 dB—a fine result.

Proving a higher than 16-bit replay resolution, the 1 kHz distortion (incoherent noise excluded) at -10 dB modulation was -100 dB. The test procedure also involves the application of 1 kHz tones in stages to examine distortion variations and the encoded tracks on the usual sources are computer generated without dither. The unit turned out textbook results for pure distortion of -48 dB at a -60 dB encode level (Fig 2), and

-25 dB for a -80 dB encode level. Fig 3 shows the clean wideband output up to 100 kHz for a -20 dB 1 kHz tone. Barely any distortion was visible at the graph noise floor, this 106 dB below MSB in this representation.

At this point, I brought into service the new CBS test source, which incorporates encode dither and I made new distortion spectrograms at -70 dB modulation, one with dither (Fig 4)

and one without (Fig 5). The analysed upper frequency noise floor lies at typically -135 dB on MSB. Dither appeared to level up the audio band noise floor to the -110 dB line with apparently a slight reduction in distortion. It was interesting to see that on these graphs, the dither reduced the 88 kHz sideband group indicating a significant linearising effect. Verification was provided by the narrow band spectrum analysis. Here dither improved the -70 dB modulation level distortion from -37 dB to -49 dB and the -80 dB distortion from -25 dB to -47 dB.

I usually examine the recovery of low level tones and Fig 6 offers a pretty neat sinewave at -90 dB achieved with encode dither. The fundamental level was recovered pretty accurately at -92 dB left and -91.5 dB right. Encouraged by this exceptional display of linearity I pressed on to the -100 dB encode level and again got a pretty decent representation (Fig 7). Encode dither was clearly demonstrated to linearise the encode and decode process. Fig 8 shows the corresponding record for this -100 dB tone with a remarkable absence of digital spuriae over the 0 Hz to 2 kHz measurement bandwidth.

High level, high frequency intermodulation tests were also made, 19/20 kHz mixed 1:1 at full level, which resulted in an excellent -101 dB of difference tone distortion. At -10 dB modulation this test also gave -96 dB which was another excellent result. The corresponding spectrogram, Fig 9, only showed one spurious response above the audible range at approximately 24 kHz this the first beat with the sampling rate. (44.1 kHz minus 19/20 kHz=24 kHz).

In general, spurious responses were well suppressed in this unit (Fig 5) so typically -103 dB, and were rather better than domestic Philips-type CD players.

Fig 10 shows the impulse response, the result typical of a linear phase FIR filter. Note the phase inversion. The rear panel instruction was followed for unbalanced use but unfortunately the phase labelling was inverted. As instructed: 'wire Pin 1 to 3', '+ on 2', actually inverts. For the auditioning the phase was corrected, however.

FIG 2 DISTORTION SPECTRUM FOR -60dB NON-DITHERED ENCODE MODULATION

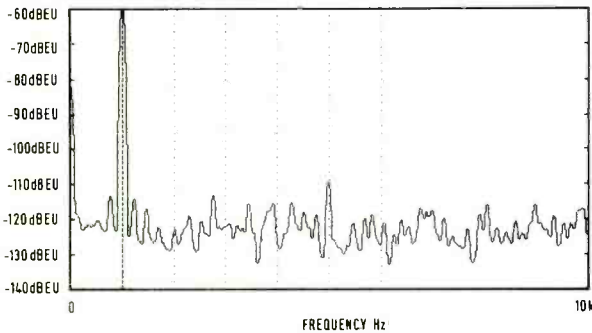

FIG 3 FULL SPECTRUM ANALYSIS INCLUDING SPURIAE FOR A 1kHz TONE ENCODED AT -20dB, NOISE/DISTORTION FLOOR UP TO 20kHz (TWO HORIZONTAL DIVISIONS) LIES AT -80dB OR BETTER

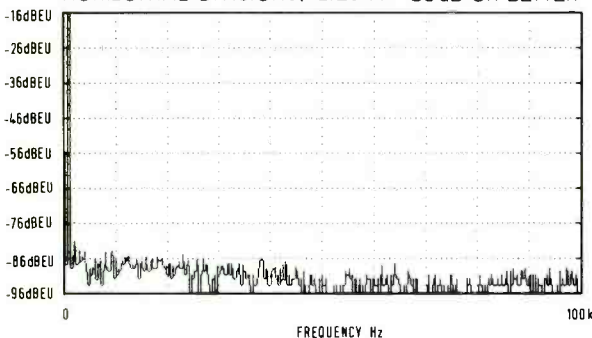

FIG 4 FULL SPECTRUM FOR -70dB DITHERED TONE, DITHER FLOOR AT -110dB REF MSB

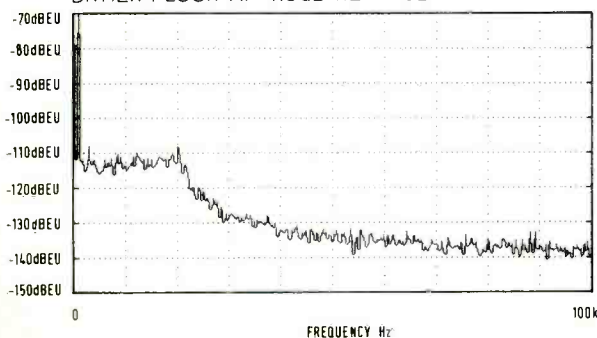

FIG 5 FULL SPECTRUM WITHOUT ENCODE DITHER

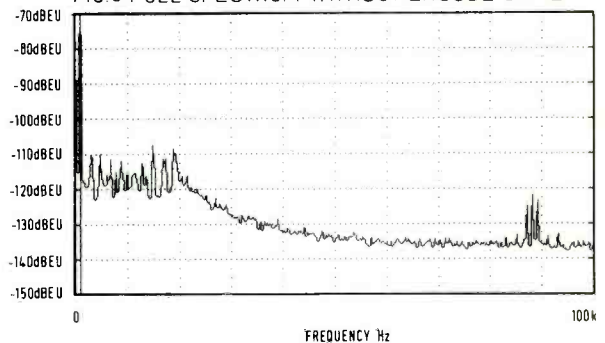
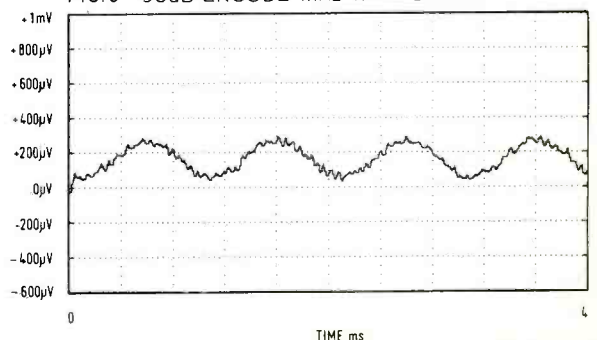

FIG 6 -90dB ENCODE 1kHz WITH DITHER





## The Performer's Choice

# NEMESIS FBS 1000

The FBS 1000 is a sophisticated FOLDBACK SYSTEM, giving musicians a high degree of control over their personal monitoring, which allows the balance engineer more freedom and time to devote to the mix.

The high technical specification and well engineered construction combine to make the FBS 1000 the logical choice in either studio or mobile situations.

The standard product is available in 4 formats.  
4 or 8 channels;  
mono or stereo.

To find out more about the most comprehensive monitoring system please contact:



### Nemesis Electronics Ltd

Cornwallis House, Howard Chase, Basildon, Essex SS14 3BB, Great Britain  
Tel 0268 286668 Tlx 995092 Fax 0268 286088

The Company for Sound Sense

## LET US INTRODUCE YOU TO A FRIEND

### THE OTARI MX80

*If you're considering upgrading to Otari, we'll be delighted to arrange a full demonstration, discuss the part exchange value of your existing equipment and even arrange finance if necessary.*

*Whether you're in the market for a complete studio package, or just the latest in signal processing — we'd like to talk to you.*

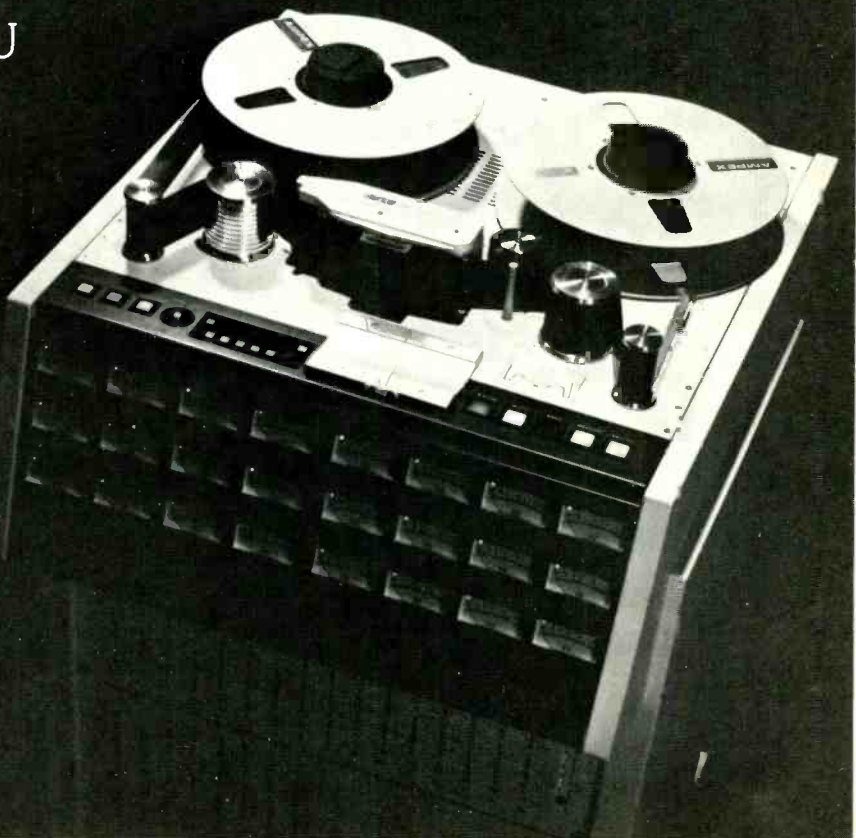

**KGM**  
studio specialists

18/42 Charlotte Street  
Wakefield  
West Yorkshire  
WF1 1UH England  
Telex: 55664C  
Fax: 0924 29046C  
Tel: 0924 371766

# REVIEW

At full modulation the *D2A* produced up to 4.14 V, +14.5 dBm level, adjustable from a low source impedance of 47  $\Omega$ . (The standard output for domestic CD players and R-DAT is 2 V or +8.2 dBm.) No load matching problems should

occur. Full line levels of up to +23 dBm cannot be obtained but few setups will need this. The S/N ratios were very good. For example, the unweighted full bandwidth result without pre-emphasis was 110 dB of MSB. In fact even CCIR

weighting (1 kHz ref ARM) the worst case result was 108 dB and 109.5 dB was obtained A-weighted RMS.

The term 'dynamic range' has not been fully agreed for digital replay and one definition is based on a -60 dB modulation level measurement of the distortion and noise in a 20 Hz to 20 kHz bandwidth and relating that figure to MSB 0 dB reference. By this method, the ASC *D2A* achieves the excellent result of 105 dB. Driven to peak level with white noise no sign of clipping or slew limiting was observed, such defects are more common than might be anticipated.

It was noted that the resolution and linearity improved by 0.5 bit as the machine warmed up from cold (30 minutes). When conditioned the resolution figure was very close to 16 bits, with only mild shape curvature, this proven by the fine amplitude decoding down to -90 dB.

## Conclusion

The *D2A* is a well-designed and well-engineered D/A converter equipped with the proper professional interfaces. Using one of the best

FIG.7 -100dB ENCODE WITH DITHER, A QUITE RESPECTABLE RECOVERED SINEWAVE

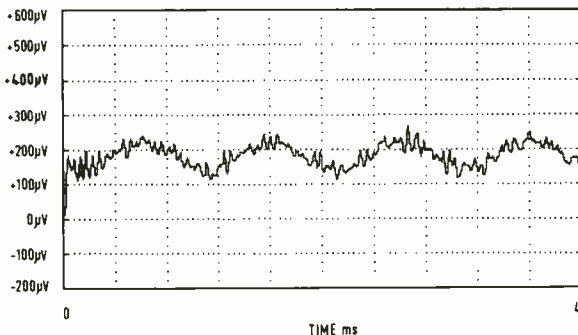

FIG.8 ZOOM ANALYSIS OF -100dB TONE, 1kHz SHOWING SPECTRAL PURITY 0Hz TO 2kHz SPAN

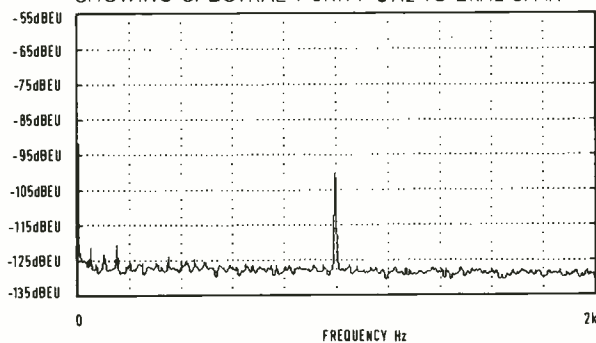

FIG.9 TWO-TONE HF INTERMODULATION 19/20 KHZ MIXED 1:1. NOTE VERY LOW LEVEL OF AUDIBLE DIFFERENCE PRODUCTS, UPPER PRODUCT IS AT 24 kHz, A BEAT WITH 44.1kHz CD CLOCK RATE

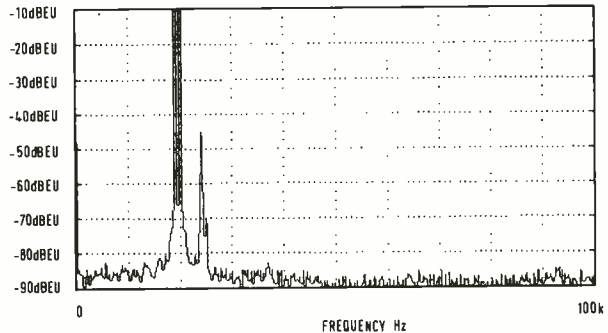
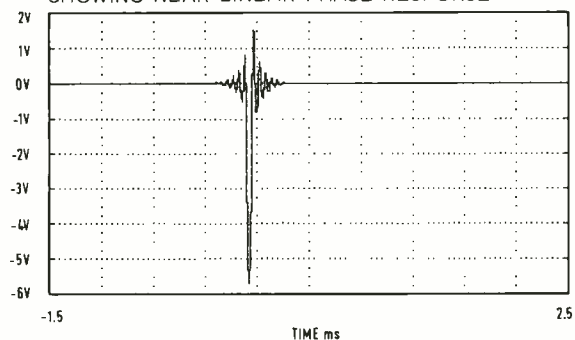

FIG.10 IMPULSE RESPONSE (TAKEN FROM INVERTED CONNECTION AT OUTPUT CANNON) SHOWING NEAR LINEAR PHASE RESPONSE



## STEREO VARIABLE EMPHASIS LIMITER 3



- As a protective limiter for live recording and broadcasting.
- For dynamic range reduction in professional to semi-pro format transfers.
- Incorporates independent flat limiters and variable emphasis limiters.
- Manufactured using BBC design information.

**SURREY ELECTRONICS LTD**  
**THE FORGE, CRANLEIGH, SURREY GU6 7BG**  
**TEL: 0483-275997**

consumer technologies for CD replay, and thus benefiting from the huge research investments made, the ASC implementation of the Philips '4x dual 16 bit system' has resulted in a very good performance. The lab results closely approached the state-of-the-art and also showed a fine standard of filtering of unwanted spurious.

Its decode performance exceeded that for encode for nearly all pro recorders, and most pro decode circuits, as well. A large number of CD players will benefit directly from its use, while the ASC *D2A* will also interface them to studio lines. Many buyers will be interested on the grounds of improved sound quality alone.

As it stands it is competitively priced, and succeeds admirably in its design aims. □  
**Audio Systems Components, 4a King Street, Mortimer, Berks RG7 3RS, UK.**  
**USA: Klark-Teknik Electronics Inc, 30B Banfi Plaza North, Farmingdale, NY 11735.**



# Sony 701 Digital Interface

A small retrofit board allowing a digital output conforming to the AES/EBU protocol, enabling digital transfer to Sony 2500 and other R-DAT machines. Additional cards will soon be available for transfer to the Sony 1610/1630 format.

701 retrofit .....£250 fitted

Distribution by

**Audio Digital Technology Ltd.**  
6 Manor Road, Teddington  
Middlesex TW11 8BG

TEL: 01-977 4546

FAX: 01-943 1545

**EXPORT ENQUIRIES WELCOME**

STUDIO & BROADCAST

QUALITY PRINTED CIRCUIT BOARDS

## PTH-Multilayer-Conventional

Delivery within 2/3 weeks for  
production batches or sooner on  
our fast prototype service.

For free quotation please telephone Angela on

**Reading (0734) 596435**

OR

**Fax (0734) 393516**

**PRINTBOARD PCB**  
LIMITED

PRINTED CIRCUIT MANUFACTURERS

64 Portman Road, Battle Farm Trading Estate, Reading, Berkshire, RG3 1ET  
Telephone: Reading (0734) 596435/6  
Telex: 848439 Fax: (0734) 393516

## PPX AMPLIFIERS

# CITRONIC

**A SIGN  
OF  
QUALITY**



Technically superior and totally dependable high  
quality power amplifiers.

**PPX, better performance.**





I am delighted with Mitsubishi's new X-850 Multitrack. Not only does it give first class sound quality, its 32 Digital Tracks offer an excellent range of options.

Steve Winwood

Steve Winwood rolls with it...



**MITSUBISHI PRO AUDIO GROUP**

Unit 13, Alban Park, Hatfield Road,  
St. Albans, Hertfordshire AL4 0JJ. Tel: 0727 40584



# PROFESSIONAL VIDEO

INTERNATIONAL YEARBOOK 1987/88

TENTH EDITION PUBLISHED BY  
**BROADCAST-SYSTEMS-ENGINEERING**

## 10 YEARS SERVING THE PROFESSIONAL BROADCAST INDUSTRY

### A must for your bookshelf!

For 1987 the Professional Video International Year Book is published in the popular A4 magazine format. With its successful editorial coverage of equipment and services covering the international broadcast industry with 1,000's of listings by manufacturers, brand-names and in many cases their UK and Overseas distributors, plus a summarised text of product lines.

All this invaluable information is classified under sections, ranging from aerials antennae and masts to video cassette storage and cases, therefore ensuring that looking for the equipment you need can be found in our comprehensive easy to use publication.

Published in association with Broadcast Systems Engineering the international magazine for the broadcast industry.

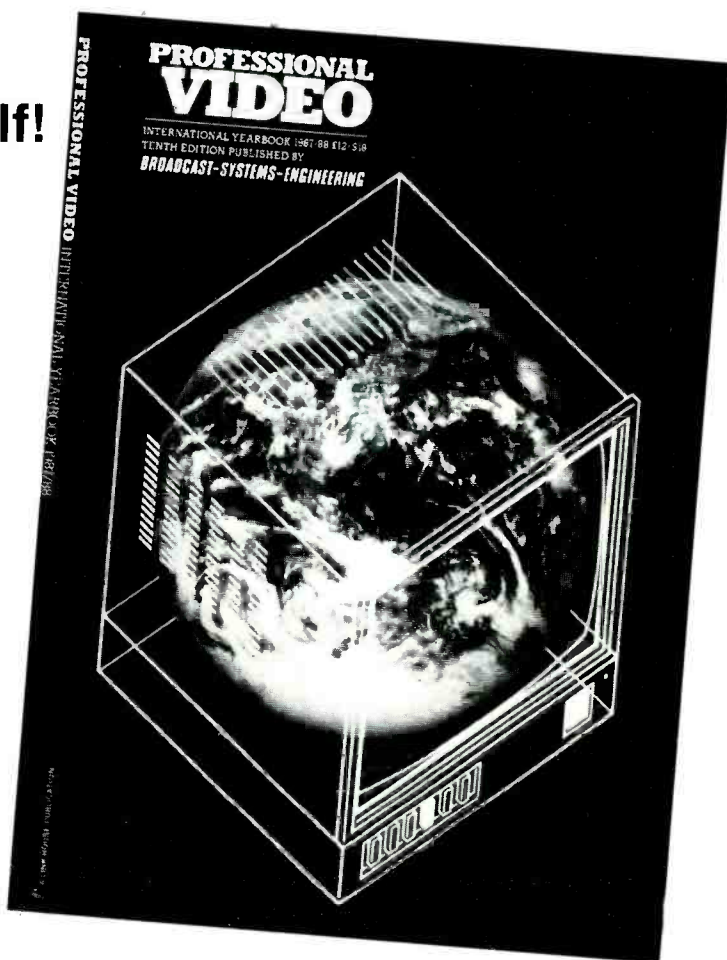

Professional Publications Group, Link House Magazines Ltd, Dingwall Avenue, Croydon CR9 2TA, United Kingdom.

Please send me ..... copies of  
**Pro Video International Year Book 87/88.**

£14.00 (UK) £16.00 Europe \$27 USA Airmail  
£19.00 World Airmail. *Includes Postage and Packing.*

I enclose a cheque/postal order/international money order  
payable to **Link House Magazines** for the amount \_\_\_\_\_

Or debit my credit card



Credit card No.

Credit card holders can order by simply ringing 01-686 2599  
ext 550, quoting credit card No.

Signed \_\_\_\_\_

Name \_\_\_\_\_

Address \_\_\_\_\_

\_\_\_\_\_

(please print)

Please return the completed order form enclosing full  
remittance (including delivery) or giving your credit  
card number to **Professional Publications Group,  
Link House Magazines Ltd, Dingwall Avenue,  
Croydon, CR9 2TA, United Kingdom.**

Please allow 28 days delivery in Britain, extra overseas depending on  
country and delivery method.

SS/9/88

# Drum up more business

**At MIDEM '89**

**Music's International Marketplace.**

Palais des Festivals, Cannes. Jan 21-25 1989

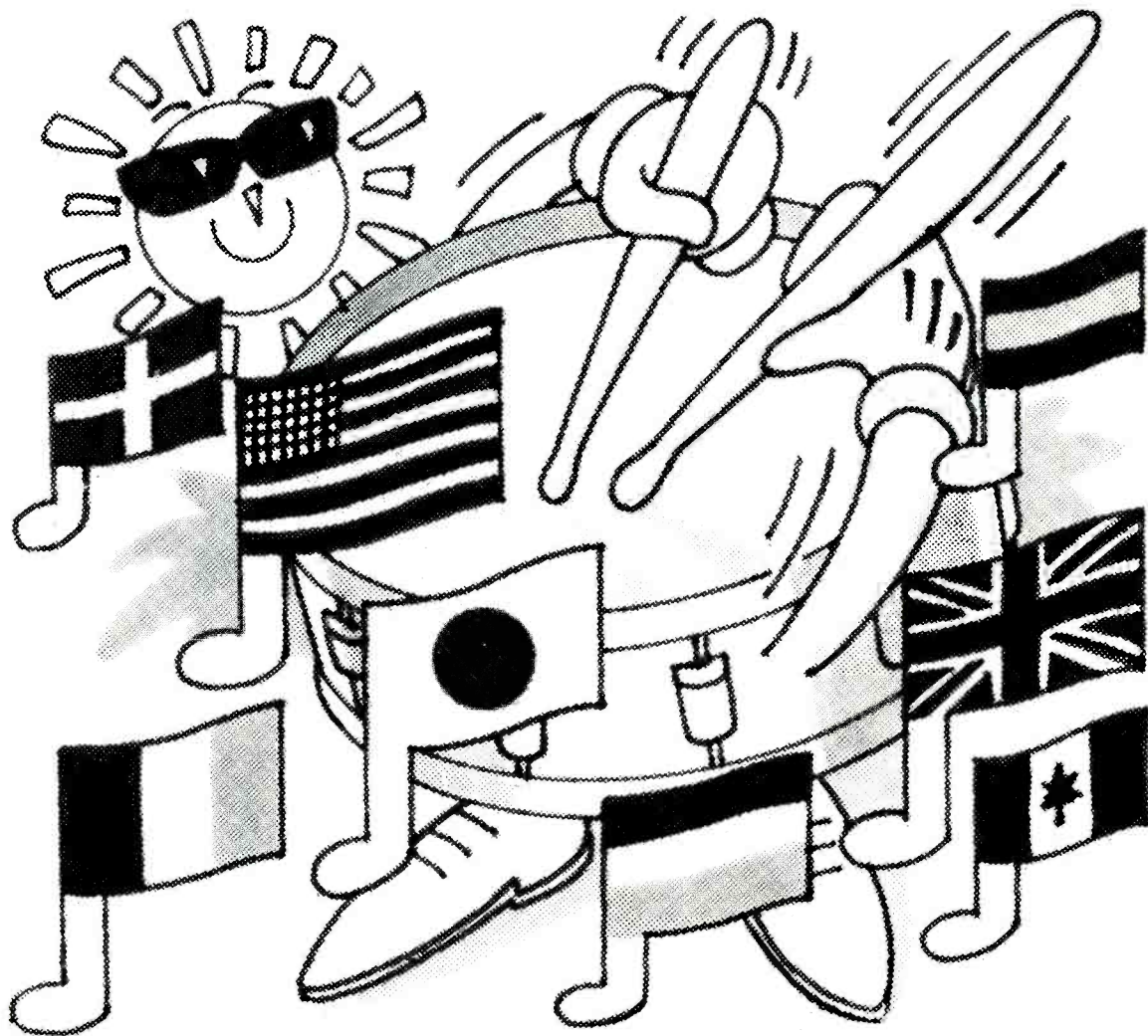

All the Big names will be exhibiting at MIDEM '89. So will many of the smaller companies who play such a vital role in the world's music industry. Why not join them? As an Exhibitor, you're not just part of MIDEM you are the show, ranking with the biggest names, and with all the business pull of the music industry's greatest international marketplace.

**LIAISE.** MIDEM is where global deals are struck that build company prosperity. It's where you'll find all the top producers, record companies, publishers and independents from over 50 countries.

**LOOK.** MIDEM is the place for viewing or screening the latest video promos. It's where you'll find out all about Compact Video Discs and be updated on state-of-the-art studio equipment and hardware. Nowhere else comes close for promoting records, catalogues, artistes and studio equipment.

**LISTEN.** And where else can you attend the famous MIDEM concerts or see so many top bands performing live? Or attend the MIDEM RADIO — the fifth great International Radio Programme Market?

The rest of the world always has a special welcome for MIDEM's British Exhibitors (and that includes the 700+ international press and TV journalists).

**LEARN.** Ring Peter Rhodes right now on LONDON 01-499 2317. He'll tell you all you need to know about exhibiting at MIDEM '89. Almost everything is done for you — including fully-equipped and furnished stands with phone and hi-fi equipment. British companies exhibiting at MIDEM also qualify for a BOTB subsidy resulting in a considerable saving providing your stand is booked by November 5th. All in all you will be surprised by how little it costs to exhibit at MIDEM '89.

## MIDEM'89

I like the sound of MIDEM '89. Please rush me details.

Name \_\_\_\_\_

S/S06/88

Company \_\_\_\_\_

Title \_\_\_\_\_

Address \_\_\_\_\_

Phone \_\_\_\_\_

International Exhibition Organisation Ltd., 4th Floor, 9 Stafford Street, London W1X 3PE. Tel: 01-499 2317. Telex: 25230.  
For USA: Perard Associates Inc., 38 West 32nd Street, Suite 1512, New York, NY1001, USA. Tel: (212) 967-7600.

D



# CLASSIFIEDS

Advertisements for this section must be pre-paid. The rate is 70p+VAT per word, minimum £17.00+VAT. Box Nos. £6.00+VAT. VAT (UK only) \$ rate \$2.00 per word, minimum \$50.00, Box No. \$10.00 extra. Semi-display rates on application. Copy and remittance for advertisements in NOVEMBER issue must reach these offices by 9th SEPTEMBER addressed to: The Advertisement Manager, Studio Sound, Link House, Dingwall Avenue, Croydon CR9 2TA. Cheques made payable to Link House Publications (Croydon) Ltd. Note: Advertisement copy must be clearly printed in block capitals or typewritten.

Replies to Box Nos. should be addressed to the Advertisement Manager, Studio Sound, Link House, Dingwall Avenue, Croydon CR9 2TA, and the Box No. quoted on the outside of the envelope. The district after Box No. indicates its locality. **SEX DISCRIMINATION ACT 1975:** No job advertisement which indicates or can reasonably be understood as indicating an intention to discriminate on grounds of sex (e.g. by inviting applications only from males or only from females) may be accepted, unless (1) the job is for the purpose of a private householder or (2) it is in a business employing less than six persons or (3) it is otherwise excepted from the requirements of the Sex Discrimination Act. A statement must be made at the time the advertisement is placed saying which of the exceptions in the Act is considered to apply.

The attention of advertisers is drawn to "The Business Advertisements (Disclosure) Order 1977", which requires that, from 1st January 1978, all advertisements by persons who seek to sell goods in the course of business must make that fact clear. From the above date consumers therefore should know whether an advertisement relates to a sale by a trader or a private seller.

## SERVICES

*Check It Out...*

**DIRECT FROM OUR MODERN U.K. PRESSING PLANT**

- CUTTING · PRESSING
- TEST PRESSING
- LABELS · SLEEVES
- CASSETTES
- ARTWORK
- COMPETITIVE PRICES

**MARKET LEADERS**

**SRT**

**01-446 3218**

**CASSETTE DUPLICATING:**  
**GAUSS Loop-Bin / TELEX In-Cassette**  
**High Quality Blanks / Label Printing**  
**OPEN REEL DUPLICATING**  
 (ANY SPEED - ALSO TO BROADCAST SPEC.)  
**SPEECH RECORDING**  
 (VOICE - OVERS; LANGUAGES; AUDIO - VISUALS)  
**SPEECH-PLUS RECORDINGS LTD.**  
 UNIT 32, NO. 19, PAGES WALK, LONDON SE1 4SB. TEL: 01-231 0961

**R-DAT HIRE**

**RAPER & WAYMAN**  
 THE SOUND AUTHORITY

34 Danbury Street London - N1 8JU 01-226 7215 Fax 01-354 4765

**REAL RECORDINGS**

THE CASSETTE DUPLICATING SPECIALISTS

Real time & high speed loop bin duplication, printing & packaging. Blanks wound to length

TEL: 061-973 1884

**pcb design**  
**cad and manual**  
**sparkes designs**  
 0296 25801

*Audio Exp*

**HIGH SPEED HIGH QUALITY LOOP-BIN DUPLICATING BY SRL TAPE SERVICES**

REEL-REEL: DOLBY A, NAB, LIEC  
 F1 PCM DIGITAL

AUDIO CASSETTE: DOLBY C, DOLBY B

QUALITY CASSETTES

QUALITY CASSETTES

QUALITY CASSETTES

**IN...OUT**

THE BETTER THE MASTER, THE BETTER THE COPY!  
 HOW MANY WOULD YOU LIKE? 100-5000  
 01-868 5555 01-866 5555 PHONE FOR PRICE CHECK

**REAL-TIME CASSETTE DUPLICATING**  
**C1 - C120 BLANK CASSETTES**  
**LABEL & INLAY PRINTING**  
**FAST, PROFESSIONAL SERVICE**  
**PHONE 025 125-4253 NOW!**

**keynote**  
**CASSETTES**

AMPEX VISA

**STUDIO · WORLD**

Fully re-furbished Multitracks  
 always available + Desks, Monitor  
 Systems, Outboard, etc

PHONE FOR FULL LIST

**Call (0727) 58977**  
**153a Victoria Street, St Albans**

**RAINHILL TAPE SPECIALISTS**

High Speed and real time high quality duplication

Printed inlays and side labels

AMPEX Distributors  
 Studio Accessories  
 Full mastering suite

Music House  
 369 Warrington Road  
 Rainhill, Prescot  
 Merseyside L35 8LD  
 051-430 9001

APRS

**SOUNDS GOOD**  
**CASSETTE DUPLICATING**

Stereo, Mono, Dolby, "On Body"  
 Printing, Editing and Mastering  
 Fast service on small quantities

**READING 0734 302600**

**TAPELINE**

Blank & Duplicated Cassettes

- Real time cassette duplication
- From 1/4" reel, PCM Beta digital, DAT or cassette masters
- Custom Wound Ferric or Chrome Cassettes
- Labels & Inlays • Shrinkwrapping

Telephone (anytime)  
**061-336 5438**

High Quality, Low Cost, Express Service

53-55 CORPORATION ROAD, AUDENSHAW, MANCHESTER M34 5LJ

**THE COMPLETE SERVICE**  
**includes:**

BLANK CASSETTES (C1 - C100 incl. Chrome)  
 HIGH-SPEED LOOP-BIN CASSETTE COPYING  
 OPEN-REEL COPYING  
 CASSETTE LABELS & INLAY CARDS  
 EMPTY TAPE SPOOLS & TAPE BOXES  
 LEADER TAPE & SPLICING TAPE  
 AMPEX MAGNETIC TAPE

**and is available from -**  
**MEDIATAPE LIMITED**

The Courtyard, 152-154 Ewell Road, Surbiton, Surrey KT6 6HE England 01-399 2476 7

# CLASSIFIEDS

## SERVICES

### CASSETTE DUPLICATORS

The established specialists in the supply and servicing of cassette duplicators, and accessories.

BULK CUSTOM-WOUND CASSETTES  
**GRAFF SONY TELEX WOLLENSAK**  
**SOUND CASSETTE SERVICES LTD**  
 Bodon Street, Chard, Somerset TA20 2DD

SCS

0460-67237

SCS

jbs records

### MUSIC-SPEECH-DATA

REAL-TIME/HIGHER-SPEED Quality Cassette Duplication and Blanks from 1-1000. Computer printed Labels. Solo, 1/4 real, Sony Betamax recording. Fast Security Delivery service.  
 FILTERBOND LTD., jbs records div., FREEPOST  
 19 SADLERS WAY, HERTFORD, SG14 2BR. 0992-500101.

REAL TIME CASSETTE DUPLICATION in Yorkshire, from 1/4", PCM-F1, or cassette, quality service. C.P.S., The Westfield Centre, Westfield Lane, S Elmsall, WF9 2PU. (0977) 45141 ex 222.

### SELECTA

REAL TIME AND LOOP BIN DUPLICATION  
 EXACT LENGTH CASSETTES  
 STUDIO SUPPLIES 04024-53424



### SOUND

WHERE THE CHOICE IS YOURS

### TAPE HEADS

**REPLACEMENT..**  
 OF ALL TYPES OF  
 MAGNETIC RECORDING HEADS

**REFURBISHMENT..**  
 OF WORN HEADS  
 TO AS GOOD AS NEW STANDARD



CALL US NOW ON:-  
 01 864 1577  
 01 864 1601

BRANCH  
 APPLEBY  
 LIMITED

STONEFIELD WAY  
 RUISLIP, MIDDLESEX HA4 0YL

### DIGITAL EDITING

Accurate editing from your F1, DAT or other format masters using the ADR Sound Maestro 90 minute capacity system. £25 per hour

QUALITY LOCATION AND STUDIO RECORDING FACILITIES AVAILABLE.

### ★ RECORDING ASSOCIATES ★

34 Ryhill Way, Lower Earley, Reading RG6 4AZ.  
 Tel. (0734) 866142

• WHATEVER IT IS LET US FIX IT 24 HOURS  
 (at a price you can afford)  
**WING ENTERPRISES (maintenance)**  
 0277-362833  
 or page 01-587 3973 no. 0252 anytime

### AA Tape Winders 0268 765010

For rapid supply of exact length  
 Audio Cassette + Tape Duplicating

QUALITY CASSETTE MASTERING AND COPYING, any quantity. Video duplication PAL/NTSC/SECAM transfers. 24 hour, seven days a week service. G.W.B.B. Audiovision, 42 Lancaster Gate, London W2 2NA. Tel: 01-723 5190.

THE COMPLETE SERVICE. Disc cutting, pressings, duplicated cassettes and blanks. Bin Masters. Location Recording. Free Brochure. Tam Studio, 13a Hamilton Way, London N3 1AN. Tel: 01-346 0033. (X)

## EDUCATION

### SOUND RECORDING & PRODUCTION TRAINING

#### ADVANCED SOUND RECORDING & PRODUCTION

One year full-time DIPLOMA Course in Modern 24-track studio and 32/48-track digital studio

Digital audio concepts: DASH & PD formats; analogue/digital recording, processing, mixing & editing; automation & synchronisation: MIDI & SMPTE timecode; computerised sound mixing consoles; analogue/digital sound synthesis & sampling; working with various bands & individual artists; music writing, song & orchestral arrangements, radio jingles & commercials; TV/film sound tracks; local radio operation; introduction to pop promo production; business practice in music industry.

3-month intensive or 6-month part-time CERTIFICATE courses in

#### ANALOGUE SOUND RECORDING & PRODUCTION

Modern 24-track sound recording & production; introduction to digital audio; analogue/digital sound synthesisers & sampling keyboards; studio work with bands & individual artists; music for TV & film; song arrangements for record release.

#### DIGITAL SOUND RECORDING & PRODUCTION TECHNOLOGY

Digital sound recording; DASH & PD formats; digital multi-track operation; SONY PCM-3324 & MITSUBISHI X-850; rotary heads digital recording; tapeless recording; AUDIOFILE & SYNCLAVIER; digital synthesis/sampling incl. FAIRLIGHT digital audio processing, mixing, electronic & manual editing; computerised sound mixing consoles; automation & assignable consoles; MIDI & SMPTE timecode; their practical application in creative music production; MIDI controlling, networking, triggering & sequencing; ATR/VTR synchronisation.

#### CREATIVE MUSIC RECORDING & PRODUCTION TECHNIQUES

Music notation & song/music writing; rock, funk, jazz, soul, reggae. TV/film theme & background music, song & orchestral arrangement techniques; arrangements for strings, brass section, woodwind, etc. creative use of instruments & microphones; working with artists & artists; recording vocals & choirs; local radio operation.

Also courses in Programming FAIRLIGHT SERIES III

Many former students are now employed in TV/video and audio industries

#### MEDIA PRODUCTION SERVICES

BON MARCHE Building, Ferndale Road, London SW9 8EJ  
 Tel: 01-274 4000 x.328 or 01-737 7152 ★ Telex: 8955126 BRIENT G

### SITUATIONS WANTED

YOUNG SOUND RECORDING ENGINEER seeks position in Recording Studio/Industry. MIDI programming experience. Available end August. Contact Ian Jory 061 2281830/2283072.

### WANTED

WANTED NEVE EQUIPMENT of all types. We buy and sell valve microphones, outboard gear and consoles. Dan Alexander Audio, 2944 San Pablo, Berkeley CA, USA 94702. (415) 644 2362/Telex (650) 291 8567 MCI.

OLD STUDIO/THEATRE equipment by Westrex/Western Electric, vintage Tannoy speakers, EMT turntables. Shipping no problem. Contact, Charlie Dripps, 4331 Maxson Road, El Monte CA 91732, USA. Fax (818) 444-6863.

### FOR SALE PRIVATE

SSL 6000E 40 frame, 32 channels total recall £79,000. Otari MTR90 Mk1 24 track £11,000. Otari 50/50B 2 track £550. A.M.S. 15805 1.6 sec stereo new £3,500. 01-671 3731.

TRIDENT TSM Mixer 32 ch. 24 groups privately owned little used offers in excess of £20,000. Call 0737 551213.

MIXING DESK: ACES SECA 60 channel inline, GPO patchbay, P&G's. £10,000. Also ACES MT24HS Multitrack £7,000. Both 1 yr old, VGC. Telephone Brighton (0273) 561900.

'TANNOY' 15 'GOLDS'. Completely refurbished in 'Lancaster' cabinets £500. Tel: 0270 68448 (Cheshire).

STUDER MK2 16TR, Headblock. Never used, £1500. EMT 140ST Plate £1200. Tel: 0932 562611 Ext 2267.

### FOR SALE TRADE

### FOR SALE

AMEK BC02 Broadcast desk: 8 mono plus 4 stereo channels into 4 groups. Talkback, oscillator and good monitoring facilities. Perfect £3,000.

SOUNDCRAFT 1624 with 24 track playback strip. About 8 years old, but still in daily use and kept in good shape. £3,000.

JBL 4343 BIG monitors. Perfect £175 each.

URIE 409 monitors. 4 available £300 each? Offers.

SONY 2630 U-matic machine. PAL - PAL/NTSC playback £175.

SONY 2830 U-matic machine. PAL - PAL/NTSC playback £100.

Convergence Corporation ECS 1B off-line editing computer, with monitor and two SONY V02850P U-matic machines. Suit community or educational use (for which we will give 25% discount). £350.

SONIFEX Micro HS200R Broadcast cart machine record/playback two extra cues. 4 years old but completely unused; absolutely as new and certainly the best model made worldwide. Cost £1,700 - we will sell for £500. We'll give discount to hospital or community radio stations.

Call 01-891 1266 for details

## CLASSIFIEDS





# TASCAM 238

**HAS ARRIVED!**

JUST ONE OF MANY EXCITING  
NEW PRODUCTS COMING INTO  
STOCK THIS MONTH.

MAKE SURE YOU ARE ON OUR  
DATABASE TO BE CERTAIN OF YOUR  
COPY OF OUR NEXT FULL PRICE LIST.

**A SMALL SELECTION OF OUR NEW, S/H AND EX-DEMO  
STOCK - RING FOR FULL LIST**

DRAWMER M500 dynamics processor	£695
DRAWMER Midiman MIDI management system	£295
DRAWMER DS201 gate	£295
DRAWMER LX20 expander/compressor	£225
DRAWMER DL221 compressor/limiter	£345
DRAWMER DL231 comp/lim/expander	£475
DRAWMER Passive EQ	£395
DRAWMER DL221 compressor/limiter s/h	£295
REVOX C279 62 broadcast mixer	£1397
STUDIOMASTER IDP 1 dynamics processor, ex demo	£420
ART Proverb digital reverb - Ex-demo	£230
REBIS RA 203 comp/lim s/h	£65
REBIS other modules available from	£50
SOUNDTECH series A stereo broadcast desk from	£1500
BROADCAST electronics stereo rec./replay cart machine s/h	Phone
AKG D130 mic	£75
UHER 4000 report monitor	£755
QUAD 306 2 x 70W	£277
TECHNICS SL1200 MkII direct drive turntable	£275
ALESIS Microverb II	£155
ALESIS Microlimiter	£100
ALESIS Microgate	£100
APHEX type C	£230
STEINBERG SMP24 MIDI/SMPTE processor	£899
STEINBERG PRO24 V3/ATARI 1040 package - Hurry while stocks last	£715
BEL BD80S - immaclulate	£795
NEUTRIK XLR's in stock	Phone
MICS Large range of new & secondhand	Phone for Quote
CABLES & Wiring looms made to order	
YAMAHA OX1 sequencer with flightcase	
YAMAHA RX11 drum machine - 2 available	
SYMETRIX 525 dual gated compressor/limiter - ex-demo	£250
SYMETRIX 544 quad gate	£295
DOD RB30 graphic eq 2 x 15 band	£395
TC 2230 sampler 8 seconds, ex demo	£225
BOSS RCL10 comp/lim/gate/exp s/h	£1820
BOSS RRV10 dig reverb s/h	£85
BOSS RPS 10d slaypitch shifter s/h	£130
BOSS BMR5 micro rack + RPW7 power supply, s/h	£130
<b>BARGAIN OF THE MONTH</b>	£75
JVC XL V45g infra red remote CD player s/h	
TEAC X300 14" stereo machine mint, boxed, s/h	£165
TEAC E3 demagnetiser, new	£30
TC 11 40.4 band parametric eq	£290
RAUCH DV725 2 x 75W monitor amp, ex display	£325
TANNOY LITTLE GOLDS, new	PAIR £725
JBL Control 1 - new and secondhand from	PAIR £330
JBL 431 2 AKB as new - ex demo	£95
BEYER DT100	£625
BEYER 201	£59
AKG C414 B-U.L.S.	£59
AKG D12E	£110
AKG D190	£560
AKG D112	£150
YAMAHA TX816 8-channel midi expander s/h	£65
AHB impulse one drum machine/smpite processor s/h	£85
A.D.R. Gemini compact comp/lim s/h	£1950
SENNHEISER 421	Phone
YAMAHA REV5, new	£180
<b>PACKAGE DEALS AVAILABLE ON ALL ITEMS IN STOCK</b>	£120
NOMAD Bassman in stock now	£995
STUDER B67 1/4" 33-4 7 1/2 ips in trolley, s/h	£399
STUDIO MASTER 16: 8: 2 with full wiring loom & 140 hole PO Jackfield.	£2100
ALESIS Midverb II - new low price	£1200
NOMAD AXXEMAN - ex display	£255
TASCAM PORTA 05	£245
NOMAD P2M MIDI trigger - Ex-demo	£240
YAMAHA NS10M Studio - special offer	£99
TASCAM MS16 16 track - now in stock	£205
TASCAM MS16 inc dbx - now in stock	£205
TEAC V770 3 head cassette - console package	£5500
TEAC V770 3 head cassette - console package	£8250
ALESIS HR16 drum machine	£210
QUAD 405 MkII, 2 x 100W	£355
TEAC V210C Cassette - only a few left at old price	£245
TASCAM PE-40 Quad Parametric - ex demo	£67
Ex-BBC PO type Jackfield 20 holes per row	£326
Any item can be reserved by phone for up to 3 days pending receipt of cheque	£20

- Sales, installation, maintenance, mail order & export.
- Custom Wound Cassettes - BASF chrome & ferric, selection of shells, very competitive prices, ring for list.
- Hire Dept - New list available - for details phone & ask for Mat.
- Tape & Sundries - Agfa & Ampex, blades, splice, chinagraph & spools always in stock.



**SEYMOUR HOUSE, 382 CHESTER RD.,  
MANCHESTER M16 9EA  
061-873 7770**

# INDEX TO ADVERTISERS

A.M.S. Industries Plc	36
Abacus Electronics	8
Acoustic Sciences Corp	18
Adams-Smith	51
AKG	46
Amek Ltd	45
Ampex	39
ANT Nachrichtentechnik	53
Asona	11
Audio & Design	80
Audio Digital Technology Ltd	91
Audio Precision	6
Audio Technica	29
Axis Audio Systems	74
Barcus Berry Electronics Inc	48
BGW Systems	7
BICC-CITEC	17
Boomerang Sounds	98
Cassette Duplicators	83
Citronic Ltd	91
D&R Electronica	4
DDA	76
Diless	8
Dolby Laboratories Inc	62
Drawmer Distribution Ltd	66
Eardley Electronics	25
Ela Audio	43
FM Acoustics	17
FWO Bauch Ltd	OBC
Goldline	69
H W International (Shure)	9
Hardware House	17
Hayden Laboratories Ltd	27
HHB Hire & Sales	20, 21
Hill Audio Ltd	79
Home Service Ltd, The	47
Isotrack	68
JBL	40, IBC
KGM Studio Supplies	89
Klark Teknik Plc	32, 33
Media Products Ltd	74
Michael Stevens & Partners	25, 83
Midem	94
Mitsubishi Pro Audio Group	92
Mosses & Mitchell Ltd	25
MS Audiotron	68
Nemesis Electronics Ltd	89
Neve Electronics Labs Ltd	55
Northern Audio	12
Orban	19
Otari	56
Pangbourne Musical Dist.	12
Preco	38
Printabord (PCB) Ltd	91
Rebis Audio	60
Renkus-Heinz	22
Roland U.K. Ltd	86
RTW	10
Rycote Microphone Windshields	38
Scenic Sounds Equipment	15
School of Audio Engineering	72
Slaughterhouse Studios	66
Solid State Logic	61
Sonosax SA	74
Sony Broadcast Ltd	65
Soundcraft Electronics	IFC
Sound Genesis	71
Soundtracs PLC	31
Stirling ITA	34, 35
Studio Spares	13
Surrey Electronics	90
Symetrix	83
Tannoy	70
Teac UK Ltd	84, 85
Thatched Cottage Audio	73
Total Systems	68
Turbosound	75

*Studio Sound* is available without charge to qualified readers: these are directors, managers, executives and key personnel actively engaged in sound recording in any part of the world. The Publisher reserves the right to refuse applications considered inappropriate and restrict the number of free copies sent to any one company or organisation. Non-qualifying readers can buy *Studio Sound* at an annual subscription of £18.00. All enquiries to: Subscription Department, Link House Magazines, 120-126 Lavender Avenue, Mitcham, Surrey CR4 3HP. Published by the proprietors Link House Magazines Limited, Link House, Dingwall Avenue, Croydon CR9 2TA and printed by Lawrence-Allen Ltd., Gloucester Street, Weston-super-Mare, Avon BS23 1TB.



# It Takes More Than A Little Neodymium To Change The Face Of Driver Technology.



Hailed as the catalyst for a new generation of high performance compression drivers, the rare earth compound neodymium showed up in our R&D lab shortly after it was first formulated. But its extremely high cost and sensitivity to heat had to be overcome before neodymium could live up to its full potential.

The availability of this highly magnetic, extremely lightweight material coincided perfectly with our development of the Coherent Wave™ phasing plug.

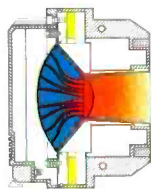

*JBL's 2450J Neodymium Compression Driver with Coherent Wave™ phasing plug provides in-phase combining of sound waves for extended high frequency performance. JBL's patented diamond surround titanium diaphragm with new embossed dome greatly reduces distortion and damage at high SPL.*

This new design, a phasing plug with annular apertures of constant path length, uniformly directs sound through to the throat providing in-phase combining of sound waves for extended high frequency performance. This new technology is combined with our patented diamond surround titanium diaphragm, incorporating a new embossed dome, to reduce the possibility of distortion or damage at high SPL.

## 2450J

The 2450's smaller size translates to tighter spacing of horn arc arrays, more even and precise coverage and greatly reduced requirements for delay. Plus, the 2450 nets out at a mere 4.8 kg (10.5 lb). The benefits of this dramatic weight reduction include lower shipping costs to the site or on the road and significantly less load bearing requirements for both structures and rigging. With built-in mounting points, the 2450 will take much less time to install.

Yes, it took more than a little neodymium to change the face of driver technology. But we're confident you will find the breakthrough results were certainly well worth the wait and the effort.



JBL Professional  
8500 Balboa Boulevard, Northridge, CA 91329

© 1988 - JBL Incorporated A Harman International Company

# Pure ingenuity



Much of what we see today was shaped by tools. And by ingenuity. When the two come together, the result is often a universal, all-in-one device.

Now Studer presents the multi-purpose tool for audio: powerful, compact, and affordable. Constructed on a rugged die-cast aluminum chassis, this remarkably fast machine features servo controlled spooling motors, a brushless DC capstan motor, a shuttle controller, and one-hand cueing. All tape deck and audio functions are microprocessor controlled, including digitally controlled, phase-compensated audio electronics and audio alignment through D/A converters. Among other features, the A807 provides switchable NAB/CCIR equalization, phantom-powered microphone inputs, monitor speaker, parallel remote control, serial RS232 port, and vari-speed.

**Studer A807** – professional ingenuity in the 19" rack format.



## STUDER INTERNATIONAL AG

Althardstrasse 10, CH-8105 Regensdorf

### Sales Offices:

**Australia**, North Sydney 4064700. **Austria**, Vienna 4733 09 / 4734 65. **Belgium**, Hasselt (011) 229664. **Canada**, Toronto (416) 423-2831. **Denmark**, Gentofte 451652340. **Finland**, Helsinki 80/742133. **France**, Paris (1) 45 33 58 58. **Germany**, Lüdingen 07654-8030. **Great Britain**, London/Herts. 01-9530091. **Hong Kong** 5-441-310 / 5-412-050. **Italy**, Milano (02) 25390121. **Japan**, Tokyo 03-320-1101. **Netherlands**, Gennep 08851-96300. **Norway**, Oslo (02) 356110. **Singapore** 2507222/3. **Spain**, Madrid 2317840. **Sweden**, Solna 08/7340750. **USA**, Nashville (615) 254-5651. **Worldwide**: Studer International AG, Regensdorf, Switzerland, +41 840 2960.