

# studio sound

August 1979 60p

AND BROADCAST ENGINEERING



Mobile Recording

# MIDAS 1979 maintaining a standard

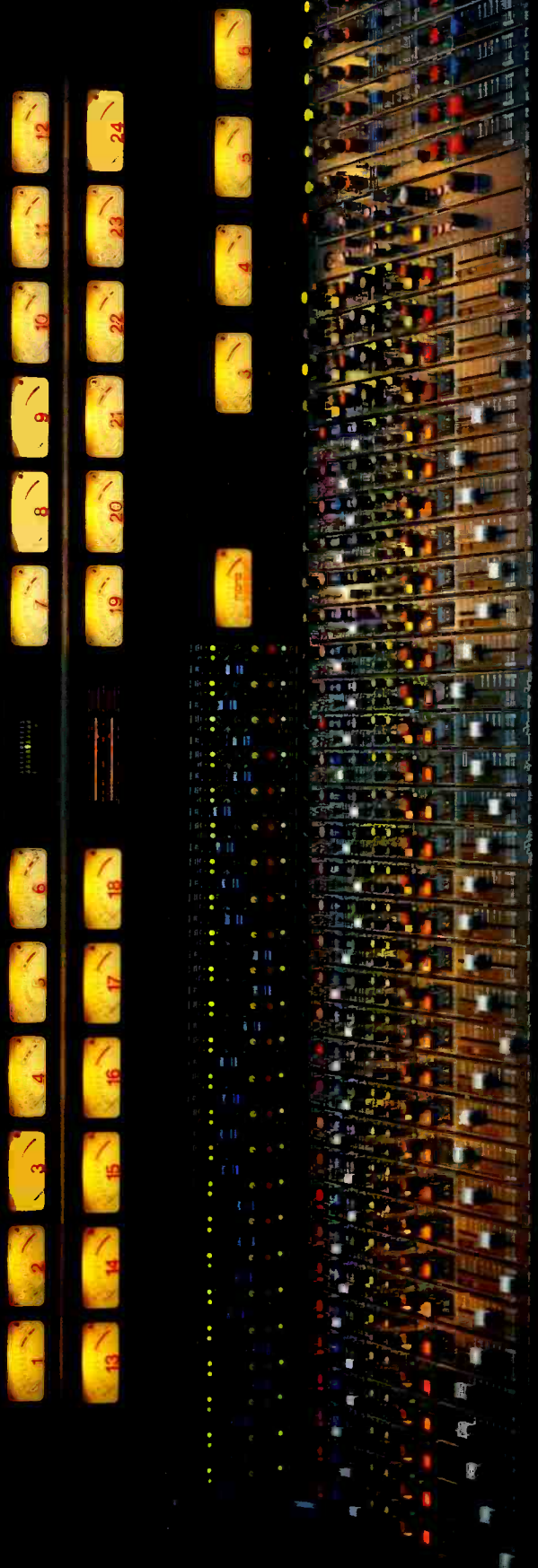

30 into 6-24 Sound Recording Console as  
supplied to Eurosound Studios, Holland  
for highest quality mobile recording  
their third MIDAS console to date.

How could MIDAS experience benefit you?

MIDAS AUDIO SYSTEMS LTD. DRAVID SOLARI, 54-56 STRATHMORE STREET, EUSTON, LONDON N1 1JL, UK. Tel: 01-388-7060 01-387-7679  
MIDAS AUDIO CORPORATION, BOB STELGROVE, 730 MAIN STREET, NIAGARA FALLS, NEW YORK, 14301, U.S.A. Tel: 716-282-4100  
MIDAS CANADA, FRANK PIMISKERN, GERR ELECTRO-ACOUSTICS, 365 ADELGADE ST. EAST, TORONTO M5B 4R9, ONTARIO, CANADA. Tel: 416-866-0528

**EDITOR**  
ANGUS ROBERTSON

**ASSISTANT EDITOR**  
NOEL BELL

**PRODUCTION EDITOR**  
DRUSILLA DALRYMPLE

**CONSULTANT**  
HUGH FORD

**EDITOR'S  
PERSONAL ASSISTANT**  
WENDY SMEETH

**ASSISTANT  
ADVERTISEMENT MANAGER**  
PHIL GUY

**ADVERTISEMENT SECRETARY**  
MARION MOISER

**PUBLISHER**  
DOUGLAS G. SHUARD

**Editorial and Advertising Offices:**

**LINK HOUSE, DINGWALL AVENUE,  
CROYDON CR9 2TA, GREAT BRITAIN**  
Phone: 01-686 2599  
International: +44 1 686 2599  
Telex: 947709  
Telegrams: Aviculture Croydon

© Link House Publications Ltd 1979

All rights reserved.

*STUDIO SOUND is published on the second Friday of the preceding month.*

**SUBSCRIPTIONS**

*STUDIO SOUND is available on a rigidly controlled requested basis only to qualified personnel (see back page for terms of control), or for an annual cost of £9.50 to non-qualifying readers or where more than two copies are required in a studio or small organisation.*

*EUROPE Subscription cost £9.50  
UNITED STATES Surface mail subscription \$25, airmail subscription \$45  
OVERSEAS Surface mail subscription £12.50, airmail subscription £22.50.*

*All subscription and circulation enquiries to:  
Subscription Dept, Link House Publications Ltd, Robert Rogers House, New Orchard, Poole, Dorset BH15 1LL, Great Britain.  
Phone: 02013 71171.  
Telex: 417109.*

**BACK COPIES**

*A limited number of back copies are available, 60p each*

**BINDERS**

*Loose-leaf binders for annual volumes of STUDIO SOUND are available from Modern Bookbinders, Chadwick Street, Blackburn, Lancashire. Price is £2 (UK and overseas). Please quote the volume number or date when ordering.*



MEMBER OF THE AUDIT  
BUREAU OF CIRCULATIONS

*Total average net circulation of 13,366 per issue during 1978. UK: 6,257. Overseas: 7,109.*



**A LINK HOUSE GROUP  
MAGAZINE**

# studio sound

## AND BROADCAST ENGINEERING

NEWS	20
STUDIO DIARY	including Ferber Studios 28
AUDITORIUM ACOUSTICS FOR ROCK CONCERTS	Ken Dibble 36
AES 63rd CONVENTION, LOS ANGELES—A REPORT	Angus Robertson 44
BUSINESS	52
TAPE RECORDER SPEED MEASUREMENT	Arthur Garratt 56
MOBILE MADNESS	Barry Ainsworth 60
SURVEY: MOBILE RECORDING TRUCKS	62
REVIEWS: Hugh Ford	
_____URSA MAJOR SPACE STATION SST-282	70
_____NEUTRIK AUDIOTRACER	76

In the tape recording business, there are basically two different types of company—those that manufacture recording equipment and those making the recording medium: audio tape. It was always obvious that there would be some overlap between the two business aspects and most audio tape manufacturers have, at some stage, actually manufactured tape recorders—some more successfully than others. But of the many audio tape manufacturers that come to mind, four are particularly interesting: Ampex, Matsushita (Technics), 3M and Sony. Each of these companies is actively engaged in the development of digital multitrack tape recorders and this raises a variety of interesting questions since none of the exclusive tape recorder manufacturing companies has yet to show signs of development reaching marketing capability.

● Perhaps it is simply that the profits in tape recorder manufacture are insufficient to maintain expensive development teams and laboratories for digital design, while the tape companies are making substantial profits thus allowing this investment?

● Perhaps the tape companies have been looking in their crystal balls and see the impending end of audio tape as a recording medium? While current digital recorders obviously use magnetic tape, various other mediums are under development that 'might' eventually provide greater flexibility—such as the diode laser disc recorder mentioned last month, or bubble memories and such innovative devices. So it makes sense to diversify company effort?

● It provides a potential stepping board for the two Japanese companies to breach the current stranglehold on professional recording equipment held by European and American companies such as Studer, Lyrec, MCI, Ampex, 3M—although Otari is making valiant efforts going up market with its latest analogue 24-track.

● Some say 3M has a vested interest in marketing its digital multitrack since it uses three times as much tape as most ordinary multitracks! And of course 3M makes that tape.

Another thought comes to mind—it is always the tape manufacturers that take European hifi journalists (not *Studio Sound*) on overseas binges, to West Germany and Japan. Very few other companies have been known to offer this form of freebie.

Perhaps this situation comes about because there is no central 'research department' in the recording business. Much research was carried out in film studio development departments in the early days of film, although most studios no longer undertake research, so today this tends to come out of production budgets when unusual requirements arise (such as the special effects in *Star Wars* or sound in Francis Coppola's *Apocalypse Now*—to be discussed in these pages shortly). Broadcasting is much more of a closed shop affair, with very few companies having effective virtual monopolies of various countries, geographic areas or territories, giving long term financial security and allowing investment in research. In Britain for instance, despite very restricted funds, the BBC Research and Development Departments consistently break new ground—they were first with digital audio in everyday use some 10 years ago with sound-in-synchs for TV sound transmission, and provided considerable assistance to 3M on their multitrack development. But unfortunately the broadcasting companies don't have a long term interest in digital multitracks, and so we are back to the tape companies . . .

While wandering around the Los Angeles Hilton Hotel last month for AES, I was accosted several times each day with offers of money for my shirt—a *Studio Sound Sweatshirt* that is. So we are now making these available to readers in addition to the T-shirts we have been offering. The Sweatshirts are available in either red or black, and are long sleeve, round neck. An order form may be found at the back of the magazine.

# Out of bounds

A power amplifier has to produce an adequate output voltage. This voltage has to be able to change at a sufficiently high rate to trace accurately any possible programme waveform. It has to be able to do all this independently of the current drawn by the loudspeaker.

These are the three dimensional limits of a power amplifier, usually referred to as voltage clipping level, slew rate and output current limit.

If an amplifier is operated so that none of these limits is exceeded, and is otherwise competently designed, then the amplifier will not degrade the programme. (If the programme were auditioned at the input or the output of such an amplifier there would be no audible change).

QUAD amplifiers are such amplifiers.

For further details on the full range of QUAD products write to:

The Acoustical Manufacturing Co. Ltd.,  
Huntingdon, Cambs. PE18 7DB. Telephone (0480) 52561

**QUAD**  
**for the closest approach  
to the original sound**

QUAD is a registered trade mark.

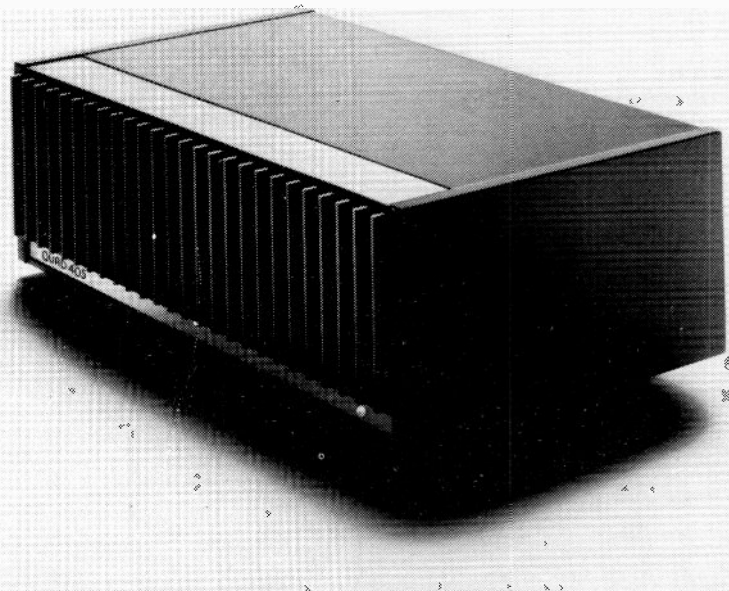

# AKG

ACOUSTICS



## Studio condenser microphone C414EB

The twin-diaphragm system enables the selection of four different microphone polar patterns. Pre-attenuation before the output stage is incorporated to permit the increase of undistorted maximum

sound pressure level by 10 or 20 dB for close-up recordings. The incorporated bass-cut circuitry will reduce the risk of distortion at low frequencies. This feature is especially useful to combat wind noise and stage floor vibrations. The slope of the bass-cut filter is more than 12 dB/octave, the cut-off frequency may be set to 75 or 150 Hz. The all metal housing adds to the rejection of r.f. interference when the microphone is used close to

transmitter stations or in conjunction with wireless microphones or other communication equipment. A recessed switch on the front enables the user to select any one of four different polar patterns to adjust for different recording situations. Four different types of microphones are thus combined in only one C414EB. The chosen polar patterns are almost frequency independent to guarantee the same sound character for all angles of incidence.



AKG Acoustics Ltd.  
191, The Vale, London W 3 7 QS  
TF: 1-749 2042,  
TX: 28938 akgmic g

Response Curve

d

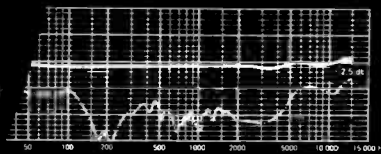

Super-cardioid

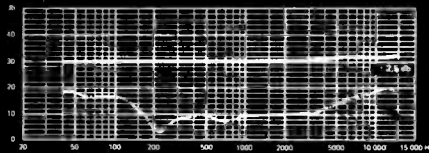
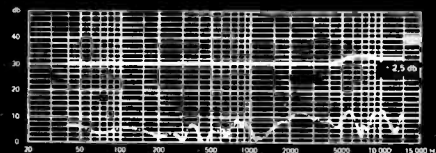
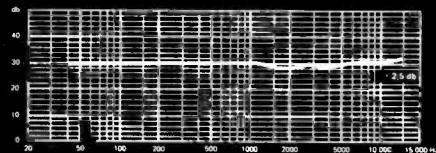

Figure-eight



Omni-directional



ADV 256/E

Send this coupon for information about AKG products

- STEREOHEADPHONES  
 MAGNETIC CARTRIDGES

Name \_\_\_\_\_

Street \_\_\_\_\_

Town \_\_\_\_\_

Postcode \_\_\_\_\_ AUG

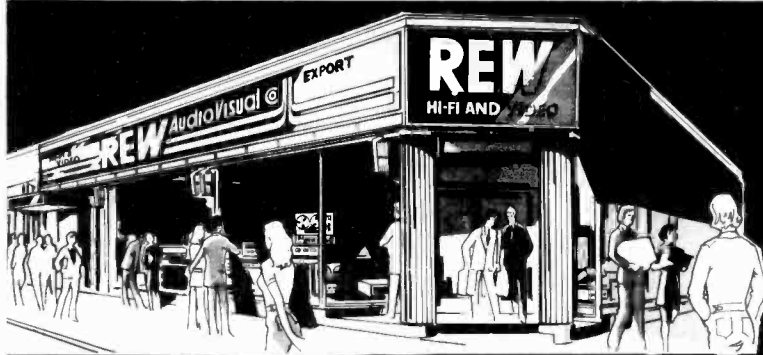

# REW Professional Audio

## Now Bigger And Better Than Ever!

Entire 2000 Sq  
AT 114-116



**EQUALIZERS**  
**SOUNDCRAFTS**  
Graphic EQ's.  
**SAE** Parametric EQ's.  
**JVC** SEA 10 (2 x 5 Band),  
SEA20 (2 x 7 Band)  
**TECHNICS** SH9010 (2 x 5  
Band), SH9090 (1 x 10 Band)  
**MXR** (1 x 5 Band), (1 x 10  
Band), (2 x 10 Band)  
**MM-Pace** (2 x Band), SR271  
(1 x 27 Band)

**WOLLENSAK**  
**WOLLENSAK/West**  
End Distributors

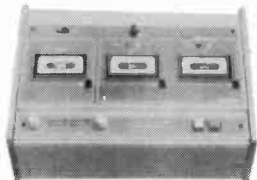

High Speed Duplicators.  
£1498.90 + VAT. New 2772A/V  
gives 2 stereo musicassettes in  
under 4 minutes. Call in for a  
demonstration.

### UHER PORTABLE RECORDERS

As used by most  
Broadcasting Companies.  
All models in stock plus every  
accessory available.

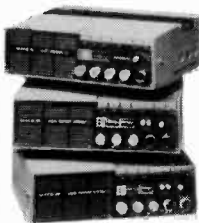

Very low  
prices, e.g.  
4000IC £225  
+ VAT.  
+ SONY +  
NAKAMICHI  
+ JVC +  
TECHNICS +  
TEAC.  
Portables all  
Off the Shelf.

### REVOX

Incredible stocks at  
ridiculous prices!



A77, B77, A700 Off the Shelf.  
High speed, low speed, vari-  
pitch + all accessories!  
Ring us now for the lowest price.

### TAPE AT TRADE PRICES

Any quantity—  
same price  $\frac{1}{4}$ "  
tape, 10 $\frac{1}{2}$ " reels.

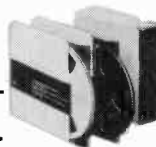

AGFA PEM368 Metal ..... £10.06  
AGFA PEM368 Plastic ..... £7.79  
SCOTCH 207 Metal ..... £9.81  
SCOTCH 207 Plastic ..... £8.03  
MAXELL UD180 Metal ..... £8.89  
TDK AUDUA LB3600 Met £11.40  
TDK AUDUA L3600M Met £9.50  
SONY SLH-11-1100BL Met £10.00  
SONY SLH-740B Metal ..... £6.89  
REVOX 601 Metal ..... £11.80  
REVOX 601 Plastic ..... £10.00  
All above prices exclusive of VAT.  
Also large stocks of 7" & 5" reels.

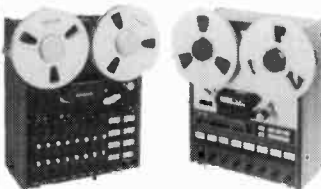

### 8 TRACKS $\frac{1}{2}$ " or 1"

Both Tascam and Brenell  
Recorders in stock for immediate  
delivery.  
Plus complete range of 8 Track  
ancillaries.

### MICS-OVER 500 ALWAYS IN STOCK!



**AKG** We carry every model  
inc. capacitors  
**BEYER** Most dynamic + ribbons.  
**CALREC** 600 Range.  
**SENNHEISER** Large stocks.  
**SONY** All models.  
**NAKAMICHI** All models.  
**E.V.** Selected range.  
**SHURE** Very large range.  
**NEUMANN** All popular  
models.  
+ Cables, Transformers, Stands,  
Connectors & Clips, Windshields,  
etc.

### CANNON XLR'S

ANY QUANTITY—SAME PRICE

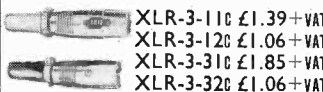

### AMPLIFIERS

**HH** S500D, TPA, All stage  
amplifiers.  
**SAE** From 2 x 50 watts to  
2 x 400 watts RMS.  
**QUAD** 405, 303, 50E usually  
in stock.  
**JPS** A fantastic range of budget  
studio amps.  
**AMCRON** DC 300A, D150A,  
D60. Trade prices.

## SPECIAL OFFER

**AMCRON D150A**  
£311 + VAT FEW ONLY

### TEAC A3340S



4-channel recorder.  
Symul-sinc. 10 $\frac{1}{2}$ " reels,  
7 $\frac{1}{2}$  + 15 ips.  
**NOW BACK IN STOCK**  
Price on application.

### MIXERS

The widest range under one  
roof!

From £35-£2500.  
Mixers in stock:  
**SOUNDCRAFT** 16/2, 12/2,  
12/4 Series II.  
**HH** 16/2, 12/2.  
**MM** All models.

### TEAC-TASCAM Models

1, 2, 3, 5 + Accessories.  
**CANARY** 10/2, 10/4.  
**HILL** 16/2, 10/2.  
**SONY** MX8, MX510, MX650.  
**Plus ALLEN & HEATH,  
JVC, UHER, EAGLE, etc.**

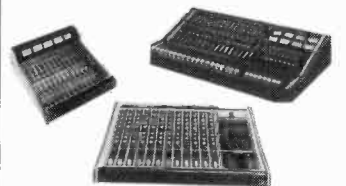

Plus Echoe's, Phasers, Flangers,  
Limiters, Noise Reducers,  
Expanders, Mix-Downs, Mic  
Stands, Cable Drums, Disco  
Gear, Chassis Speakers, Studio  
Monitors, Headphones, Demags,  
Splicers, etc.

**REW** PRO-AUDIO & DISCO: 114-116 Charing Cross Road, WC2 01-836 2372 7851  
Also separate floor of Hi-Fi and Video Phone 01-240 3386/7  
TAX-FREE EXPORT & EXPRESS MAIL ORDER: REW House, 10-12 High Street,  
Colliers Wood, SW19. 01-540 9684 ● Also at 230 Tottenham Court Road, W.1.

# The Professional Everything Store

**100**  
 Ft. Basement Area  
 CHARING CROSS ROAD

**Lowest Prices  
 Largest Stocks. All  
 Studio & Stage Equipment**

**EXCLUSIVE FROM REW**

**SAE** A superb range of studio electronics from the U.S.A.



**POWER AMPLIFIERS  
 ← PARAMETRIC EQUALIZERS**

Prices exclude VAT

- 2800 Parametric equalizer 2 x 4 Bands ..... £408.00
- 1800 Parametric equalizer 2 x 2 Bands ..... £239.00
- 4000 Electronic crossover, stereo, variable frequency ... £155.00
- 4100 Digital time delay, stereo ..... £354.00
- 2200 Power amplifier 2 x 100 watts ..... £346.00
- 2400L Power amplifier 2 x 200 watts ..... £578.00
- 2500 Power amplifier 2 x 300 watts ..... £755.00
- 2600 Power amplifier 2 x 400 watts ..... £887.00
- 5000 Impulse noise reduction unit..... £176.00

**SOUNDCRAFTSMEN**

America's Largest Manufacturer of Graphic Equalizers



**GRAPHIC EQUALIZERS**

- 2204 2 x 10 Bands ..... £199.00
- 2205 2 x 10 Bands,  
 rack mount ..... £226.00
- 2209 2 x 10 Bands,  
 rack mount,  
 600 ohm balanced  
 in/out XLR ..... £319.00

**NEW CLASS H  
 POWER AMPLIFIER**

MA5002 2 x 250  
 watts, meters ..... £399.00  
 Prices exclude VAT

**HH DIGITAL  
 MULTI ECHO**

Studio quality at an economic price. Facilities include A.D.T., echo and reverb. Fully electronic (no tapes or discs) giving exceptionally low noise.

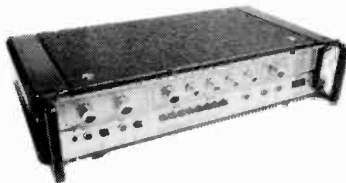

**Open 9.30 am — 6 pm — 6 days a week  
 just walk in — 95% of advertised  
 gear available off the shelf**

Payment by: Cash,  
 Barclaycard, Access,  
 American Express, Diners,  
 HP (Instant credit possible)

**THE LOW PRICE HOT  
 LINE 01-836 2372**

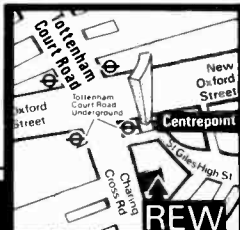

**NEAREST TUBE STATION  
 TOTTENHAM COURT ROAD UNDERGROUND**

**POWER AMPLIFICATION  
 BY MUSTANG**



Our SS.100 and SS.50 are economical amplifiers with outputs of up to 175 and 100 Watts RMS into 4-16 ohms, typical THD figures being 0.1%, slewing rate > 10v/μs, noise > 90dB down, zero level input, and full electronic protection. Considering these points with their proven reliability and robust construction, plug in output transistors and driver board, optional balanced input and 100V line output, and virtually ex stock despatches we reckon we take some beating! Contact us now for the full technical specifications.

Manufacturers of mixers, integrated mixer amplifiers and slave amplifiers, studio power amplifiers, transformers, lighting control equipment and cabinets for the home and export markets. Contact us for full illustrated technical brochures.

**MUSTANG  
 COMMUNICATIONS**

**Nelson Street, Scarborough,  
 North Yorkshire YO12 7SZ  
 England  
 Telephone 0723-63298**

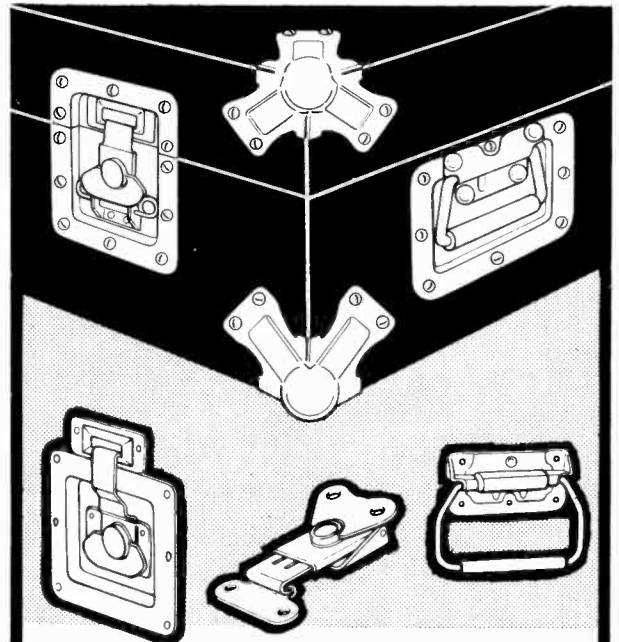

Protex quick-release latches, handles, corner pieces and fasteners are used by some of the world's leading manufacturers because they are just right for the job.

**protex FASTENERS LTD.**

Arrow Road, Redditch, Worcs. Tel: Redditch 63231

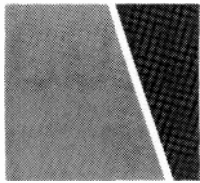

# fact: the SC39 Series meets all the unique demands of professional cartridge users

- Broadcasting
- Recording
- Disco
- Transcription and other professional uses

**The Professional Challenge:** Undistorted playback, even of the toughest-to-track, "hottest" recordings.

**The SC39 Solution:** The Shure-designed shank structure and bearing assembly gives trackability up to and beyond the theoretical cutting velocities of today's recordings. Frequency response is essentially flat across the audio spectrum, optimized for professional applications.

**The Professional Challenge:** Day-in, day-out rigours of slip-cuing, backcuing, and the inevitable stylus abuse that comes with the job.

**The SC39 Solution:** The internal support wire and special elastomer bearing ensure stable and accurate backcuing without groove jumping. This, plus the following exclusive features, protect the SC39 from accidental stylus damage.

## SIDE-GUARD Stylus Deflector

A unique lateral deflection assembly prevents the most common stylus damage by withdrawing the entire stylus shank and tip safely into the stylus housing before it can be bent.

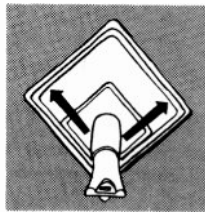

## FLIP-DOWN Locking Stylus Guard

The exclusive lever-operated, locking stylus guard gives the stylus tip positive protection when not in use. With the flip of a lever, it snaps out of the way, and positions a highly visible cuing aid.

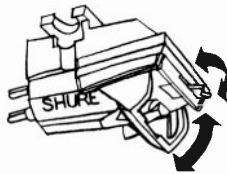

**The Professional Challenge:** Prolonged record (and lacquer master) playability without objectionable noise buildup.

**The SC39 Solution:** A unique Shure MĀSAR™ stylus tip is designed to minimize noise and cue-burn on records. Tests on lacquer masters show that the noise level on a record played repeatedly with an unworn Shure MĀSAR tip is significantly below that of a similar disc played with an unworn conventional stylus. The SC39 also reduces noise buildup on 45 rpm records made from reprocessed or substandard vinyl.



**The Professional Challenge:** A multiplicity of different applications, which no one cartridge can satisfy.

**The SC39 Solution:** The SC39 Series consists of the following three cartridges, for every professional and high fidelity application:

Cartridge	Stylus tip	Tracking force	Applications
SC39ED	Biradial (Elliptical)	3/4—1-1/2 grams	High fidelity, or where light tracking forces are a consideration. Transcription, recording lab, playback of lacquer masters, high quality broadcast.
SC39EJ	Biradial (Elliptical)	1-1/2—3 grams	Where heavier tracking forces are required. AM broadcast, disco.
SC39B	Spherical		

## The SC39 Series Professional Pick-up Cartridges



Shure Electronics Limited, Eccleston Road,  
Maidstone ME15 6AU, Telephone: (0622) 59881



# SAVE MONEY SAVE TIME

## WHAT IS OPTIONAL FOR THE OTHERS IS FOR US A MATTER OF COURSE

- \* From 16 to 52 in/out channels
- \* 24 channel busses including panning
- \* 4 band parametric equalizer
- \* Continuously variable Hipass filter
- \* Up to 28 sends as standard
- \* 3 different channel mute grouping
- \* Momentary short travel mute switches
- \* All solo facilities including «Solo in place» either in monitor or in remix mode
- \* 3 master status logically reversible on each channel
- \* 28 light meters either vu or PPM and phasemeter as standard
- \* 28 Iso frequency third octave analyzer
- \* PLUS 30, RS64 automation with separate mute and level encoding using one 6502 microprocessor per channel
- \* High quality and high performance components
- \* Tough, reliable and attractively designed

# PLUS 30

42, rue Pierre Nicole  
75005 PARIS - Tél. 634.01.36  
FRANCE

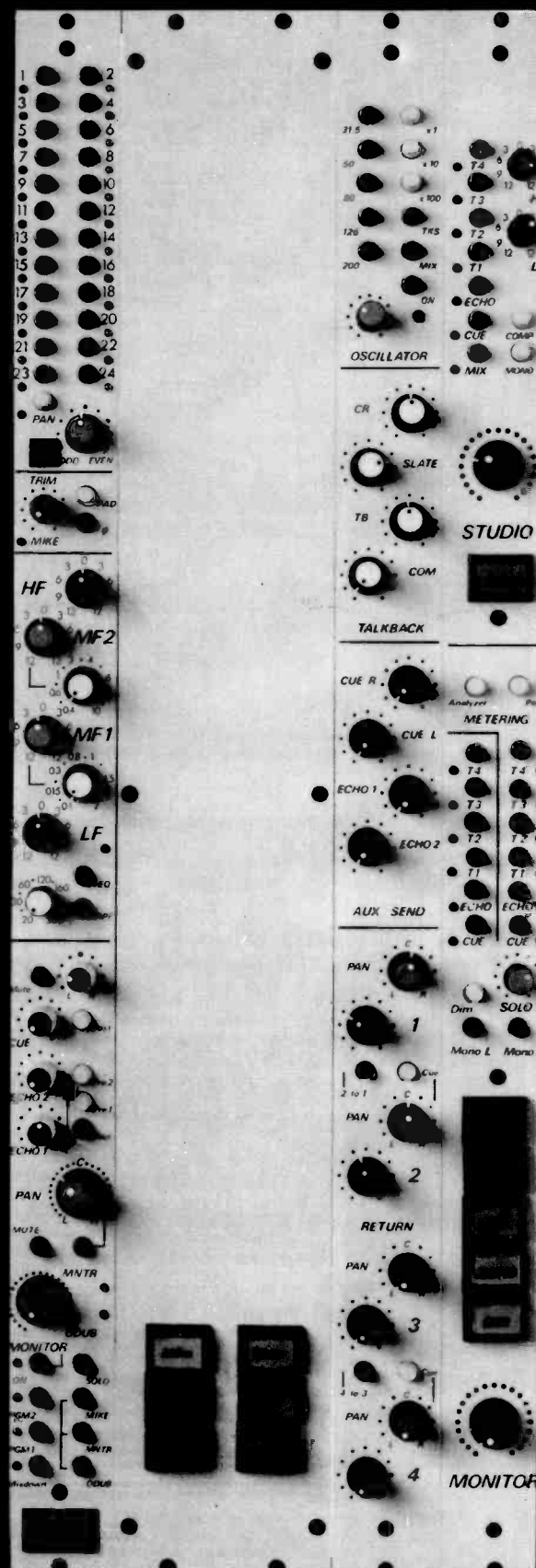

# What do you want in a console? You tell us.



That's the great advantage of Hill's new 'K' Series: you specify your own requirements from a surprisingly wide range of standard modules and we'll build it for you in custom configuration to professional performance specification, at a standard price!

For the price you'd normally pay for standard equipment (a 32/24 need cost no more than £8000), you've virtually your own custom-built console.

The Hill 'K' Series:  
sound value.

**Malcolm Hill  
Associates**  
Hollingbourne, Kent  
Telephone Hollingbourne  
(062 780) 555/6/7

London Sales Office:  
6 Lillie Yard SW6 1UP  
Telephone (01) 381 3446  
Studio Sales: 15 Greenfield Close  
Stapleford, Cambs. Tel. (02204) 2060

## Our Package Deal is as good as a Holiday

We won't exactly pack your suitcase or wave you off at the airport, but the effect's the same.

Once you've given us your script, or master, you can forget about it. Go play golf. Or, to be more realistic, get back to all the other jobs which claim your attention. Only this time without the interruptions you usually suffer when you're nursing your latest baby along the production line.

We'll do more than record or duplicate it. We'll label, check, package and deliver it too. Your distributor gets it on time, so he's happy. We're pleased because we've completed another good job. You've got the result you wanted, painlessly, and you're delighted.

With all these smiling faces around, you could forget you're still at work.

Contact James Scarlett or Peter Fanshawe.



**James Yorke Limited**

Oak House Northleach Gloucestershire Tel: 045 16 509

We have a lot to live up to . . . and we do.



"We've £150,000 worth of recording gear working 24 hours a day — all fed from the OTARI MX5050B. On a cost effectiveness basis alone the MX5050B is unbeatable, but when taking into account sheer professionalism and performance, it is unequalled by recorders three times the price."

*Mike McLoughlin, Chief Engineer, Independent Tape Duplicators, Aylesbury.*



The Otari MX5050B costs little more than modified domestic recorders. That little extra buys so much more.

1. Proper editing facilities with calibrated splicing block.
2. Four heads provide 2 or 4 track replay.
3. Bias and EQ adjustable from front panel.
4. Switchable NAB and IEC EQ.
5. XLR Connectors.
6. +28 dBm 600 ohm balanced output.
7. Direct drive capstan servo with varispeed.
8. Variable or preset output level.
9. 70 dB (weighted) signal/noise ratio.
10. Sel sync on each channel.

# OTARI from ITA

1-7 Harewood Avenue, Marylebone Road, London NW1. Tel: 01-724 2497. Telex: 21879.

# NEW from *Alice* the 12.48

**12** Balanced mic inputs, with separate line and re-mix inputs and direct post-fader outputs.

**4** Output groups, with multiple connectors for 8-track and stereo tape machines.

**8** Track monitoring with individual A/B, gain, pan, foldback and monitor echo.

*plus* channel and group inserts  
stereo A/B  
talkback,  
oscillator and  
many other features.

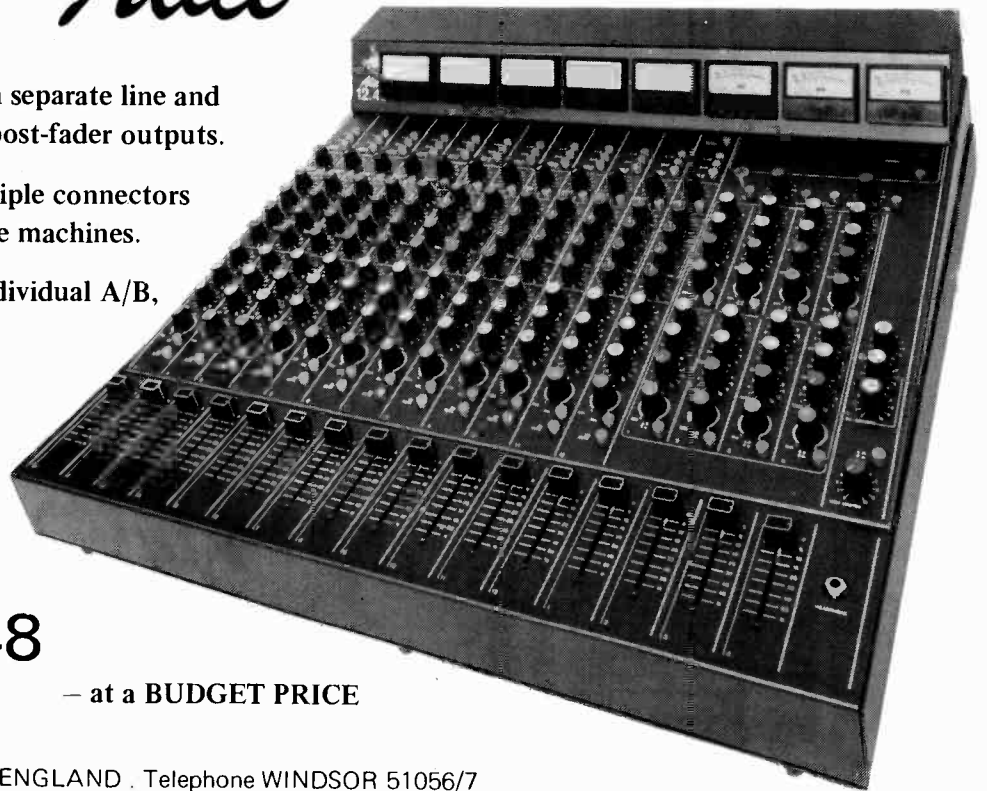

## *Alice* 12.48

BROADCAST QUALITY — at a BUDGET PRICE

*Alice* (STANCOIL LTD)

ALEXANDRA ROAD . WINDSOR . ENGLAND . Telephone WINDSOR 51056/7

# Just add a studio...

The Sescom range of mike splitters and combiners, incorporating a new generation of transformers, is capable of taking higher input levels and passing phantom power to the mikes.

### Microphone splitters and combiners

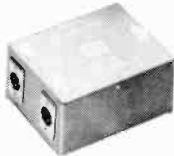

### In-line transformers and accessories

The Sescom series of audio transformers, filters and related devices are designed to be simply fitted in the line between two units.

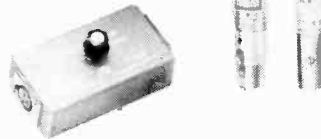

### Cable tester



This strong, die-cast unit is designed for use in the field, when reliability is essential. Simply plug in your XLR 3-pin male to female cable, or 3-core jack to jack, and the three red lights will enable you to quickly pin-point breaks or shorts in any part of the plugs.

### Direct injection boxes

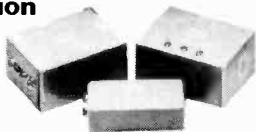

The Sescom range of DI boxes is probably the most used by recording studios and PA companies throughout America and the UK. Featuring professional quality with rugged construction, they are designed to be used with any modern electronic instrument, and all models have low-impedance balanced output.

### Sescom leads...others follow



Sescom twin core microphone extension cords, available in 5, 25, 25 (thin), and 100 foot lengths, are made from high quality rubber type cable with XLR 3-pin audio connectors. Shown is the 25T thin belden lead.

### Audio modules

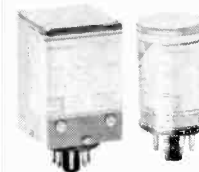

Sescom audio modules are designed for easy fitting and servicing, operating from a single power supply and shielded to prevent hum pick-up. All these units plug into standard 8 or 11-pin plugs.

Make ends meet with  
**SESCOM**  
Quality Engineered Sound Products

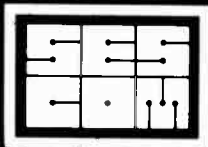

Distributed by  
**Atlantex**  
16 High Street, Graveley, Hertfordshire  
Tel. 0438 50113



Ask for the latest Sescom catalogue now, or ring our hotline 0438 50113 quoting your Access or Barclaycard number for immediate despatch.

Following the world's most successful  
four channel recorder isn't easy.  
Unless it's the new A3440 by TEAC.

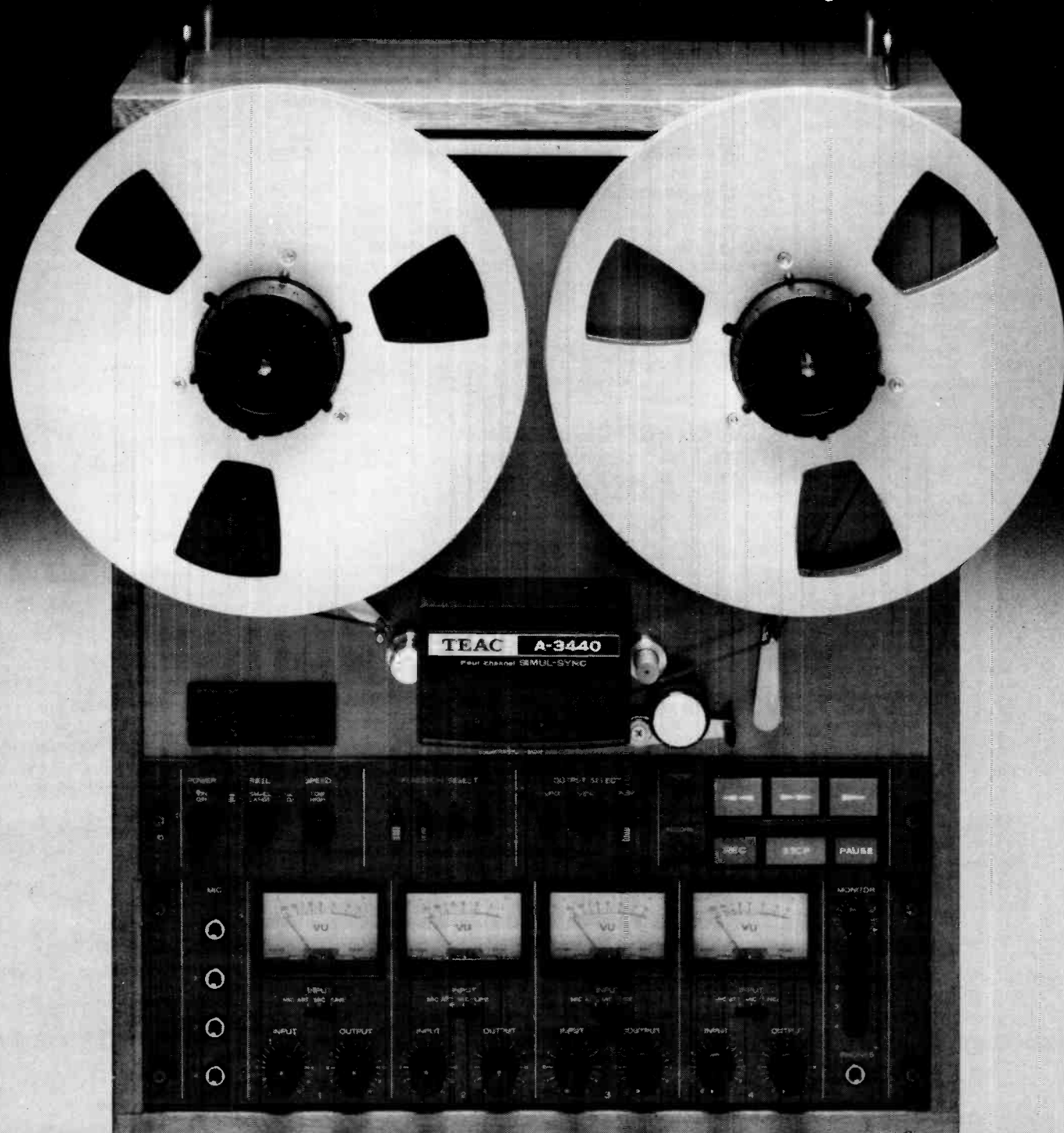

**TEAC from ITA**

1-7 Harewood Avenue, Marylebone Road, London NW1. Tel: 01-724 2497. Telex: 21879.

# Our business is helping you with yours

Considering or upgrading a multitrack system?  
We offer a select range of studio equipment, backed with advice, demonstration and service. Turnkey sell, install, lease or hire.

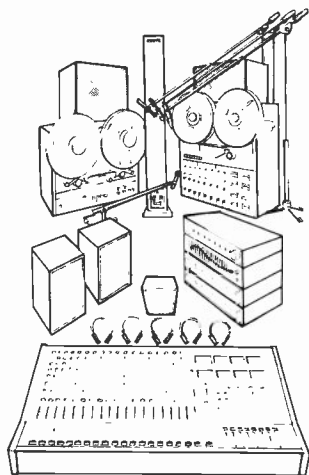

## SYSTEMS

As our name implies, at TURNKEY we specialise in systems.

From the simplest four channel setup to large eight or sixteen track installations, we can tailor a package to fit your exact needs.

This can include acoustics advice, wiring, consoles, training and so on.

Ask for our 'Quotation Sheet' or call Andrew Stirling now, on 01-440 9221 and discuss your requirements first hand.



## MONITORING

QUAD is a remarkable company that has stayed in the forefront of monitor amplifiers for over a decade. Their current series, the 303 and 405 are available for medium and high power use.

JBL and TANNOY share the market for studio monitors worldwide. We demonstrate and supply matched systems for budget and big-time monitoring. The renowned AURATONE mini-mighty speaker cubes, are also in stock.



## SIGNAL PROCESSORS

The choice is immense. We cannot sell them all so we pick and choose the best.

Take MXR for example. This American based company has grown from making effects for guitars to studio equipment for professionals. Their digital

## MICROPHONES

As with speaker systems, the choice of microphones is very much one of personal preference and we stock a range to satisfy most requirements. Our current favourites are the new CSE range by AKG. This is a system (in similar lines to the revolutionary C451 range some years ago) of interchangeable bodies and capsules. As electret technology is used, the prices are correspondingly low.

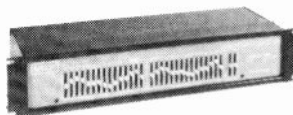

delay and graphics are second to none.

Roland of synthesiser fame, have introduced their 'Studio Series' of rack-mount units, including a phaser/flanger with extensive control facilities.

We also have the budget ACCESSIT range.

## ACCESSORIES

As well as supplying standard plugs, tapes etc., We have developed an exclusive range of 'hard to find' studio accessories.

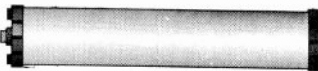

Take for example our 'Great British Spring' - a high quality stereo reverb developed for the budget conscious studio.

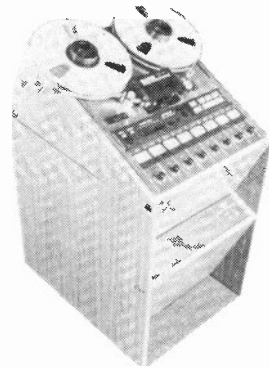

We also have . . . mike boxes . . . track sheets . . . preamplifiers . . . direct boxes . . . rolling consoles . . . and much more.

Full details in our 'TURNKEY by mail' catalogue.

## MIXERS

Our exclusive 1478 is a freebie with all four track recorders. Treble, bass, pan and level on four channels.

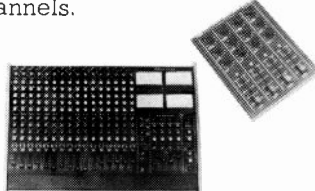

The RSD, 16 by 4, offers great value for money in budget multitrack mixers. Packed with features and our own mods for 8 track.

SOUNDCRAFT is well known for its' state of the art performance. We have extensive experience of the Series Two, 16 by 8.

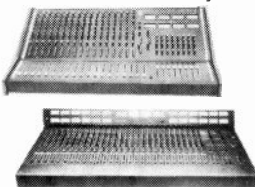

SYNCON by A&H is a major breakthrough in the design of big consoles for 16 and 24 track. We offer fast delivery and installation.

## TAPE RECORDERS

REVOX lead in the field of 2 track mastering. The new B77 includes all the features that were hot-rodged to the A77.

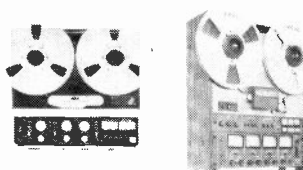

TEAC's new 3440 is the updated version of the 3440S. Now with varispeed, logic switching, monitoring and motion sensing.

The TASCAM 80-8 is the most reliable half inch, 8 track recorder available. We also supply dBx and a studio console optionally.

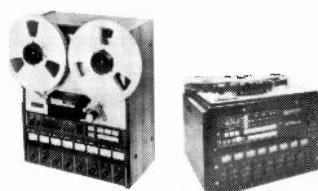

The 8 track, one inch from SOUNDCRAFT MAGNETICS is a sophisticated workhorse with unique remote control facilities.

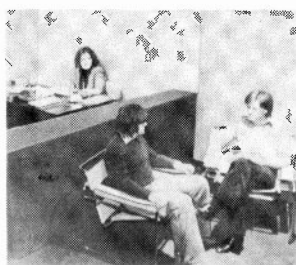

Write or call for a free copy of the 'Turnkey Book', the 'Turnkey by mail' catalogue and TEAC's 'Are you ready for Multitrack' book.

You are welcome to come and visit our extensive demonstration showroom at any time during normal office hours.

**8 East Barnet Road,  
New Barnet,  
Herts EN4 8RW**  
**Supply & Installation  
of Recording Equipment**  
**Telephone 01-440 9221**  
**Telex: 25769**

**turnkey**

# We satisfied their requirements. We can satisfy yours.

C.E.G.B.  
University of Cambridge  
Dept. of the Environment  
Rols Royce  
BBC  
ITN  
Decca  
EMI  
Royal Courts of Justice  
London Weekend TV  
Capital Radio

ATV  
Rediffusion Reditune  
Pye TVT  
Ministry of Defence  
TEK Cairo  
Israeli Ministry of Defence  
Radio Swansea  
Piccadilly Radio  
The Who  
Queen  
British Rail

Kodak  
Wiggins Teape  
Molins Sound  
Precision Tapes  
Gayana Broadcasting  
Disk Jams Music  
Sound Developments  
Roundhouse  
Olympic Studios  
Impera College  
Institute of  
Oceanographic Science

British Gas  
Central Office of Information  
J.K. Universities  
Island Records  
Marconi  
Metro Radio  
National Coal Board  
NBC News  
Audio International  
ICA  
Royal College of Music  
etc etc



## REVOX from ITA

1-7 Harewood Avenue, Marylebone Road, London NW1. Tel C1-724 2497. Telax: 2-879.

# More than the best connections...

Cables, cords, jackfields, connectors, switches, adaptors, components, tools, faders, DI boxes, intercoms, headsets, service aids, microphone-stands, goosenecks, cable drums, racks & cabinets, level indicators, a portable Dolby 'A'-type noise-reduction unit, and more.

112-PAGE 1979 CATALOGUE, FREE  
ON REQUEST

FUTURE FILM DEVELOPMENTS  
36/38 Lexington St, London, W1R 3HR  
Tel: 01-437 1892/3 Telex: 21624 ALOFFD G  
Cables: Allotrope - London W1

## Analyse-Equalise- Eliminate

Formula Sound help you eliminate your sound problems with the S19GA by combining the functions of an analyser and equaliser. This easy to operate unit is approximately half the cost of a conventional analyser and fits into a rack space of only 5¼"

The S19GA is a half octave stereo 19 band graphic equaliser/analyser with dual L.E.D. display. By using half octave filters twice the control of standard octave devices is achieved.

**For the Studio** the S19GA enables the engineer to adjust his monitoring equalisation with confidence, knowing that the balance he hears is what's on tape.

**For the Concert Hall** - the S19GA is an invaluable aid to compensate for poor hall acoustics.

**Sound reinforcement** - switching the S19GA analyser display to visually monitor programme lets you pinpoint and tune out acoustic feedback.

**For the serious audiophile** - the S19GA offers professional analyser facilities at a realistic price for domestic use.

**Full professional specification** - Maximum level +20dBV. Equivalent input noise -90dBV. Total distortion less than .01%.

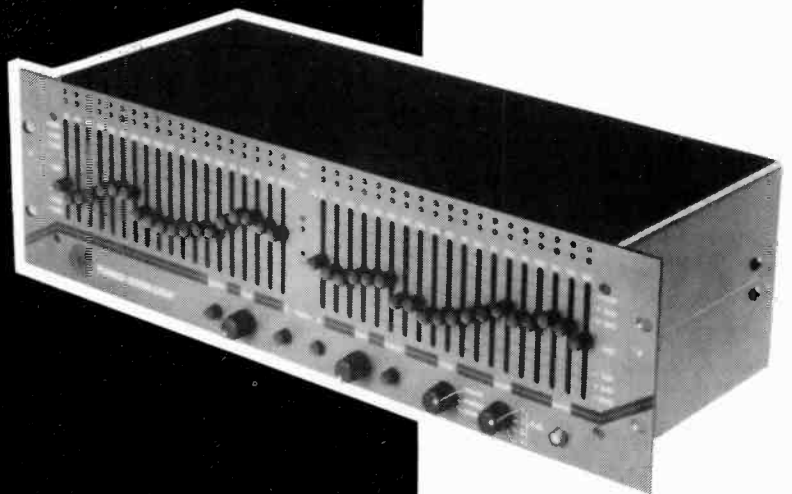

More information from



**FORMULA  
SOUND LIMITED**

3 Waterloo Road,  
Stockport SK1 3BD.  
Telephone: 061-480 3781.  
Telex: 669249.



# ITAM 806.

## A new standard in compact multitrack recorders.

NEW compact cabinet, with optional console base.

NEW tape heads, giving outstanding cross-talk characteristics.

THREE VERSIONS

8 channel, half inch tape

4 channel, half inch tape

4 channel, quarter inch tape

Built-in wide ranging varispeed ( $\pm 100\%$ ).

Modular electronics.

Logging versions available (down to 15/16 ips)



## ITAM from ITA

1-7 Harewood Avenue, Marylebone Road, London NW1. Tel: 01-724 2497. Telex: 2-379.

FRANCE: Son Professionnel, 2 Rue des Tanneuses, 92210 Saint Cloud (Paris) Tel: 602 68 5

**QM2 Series**  
**24 Inputs**  
**8 Out 16 Track Monitor**

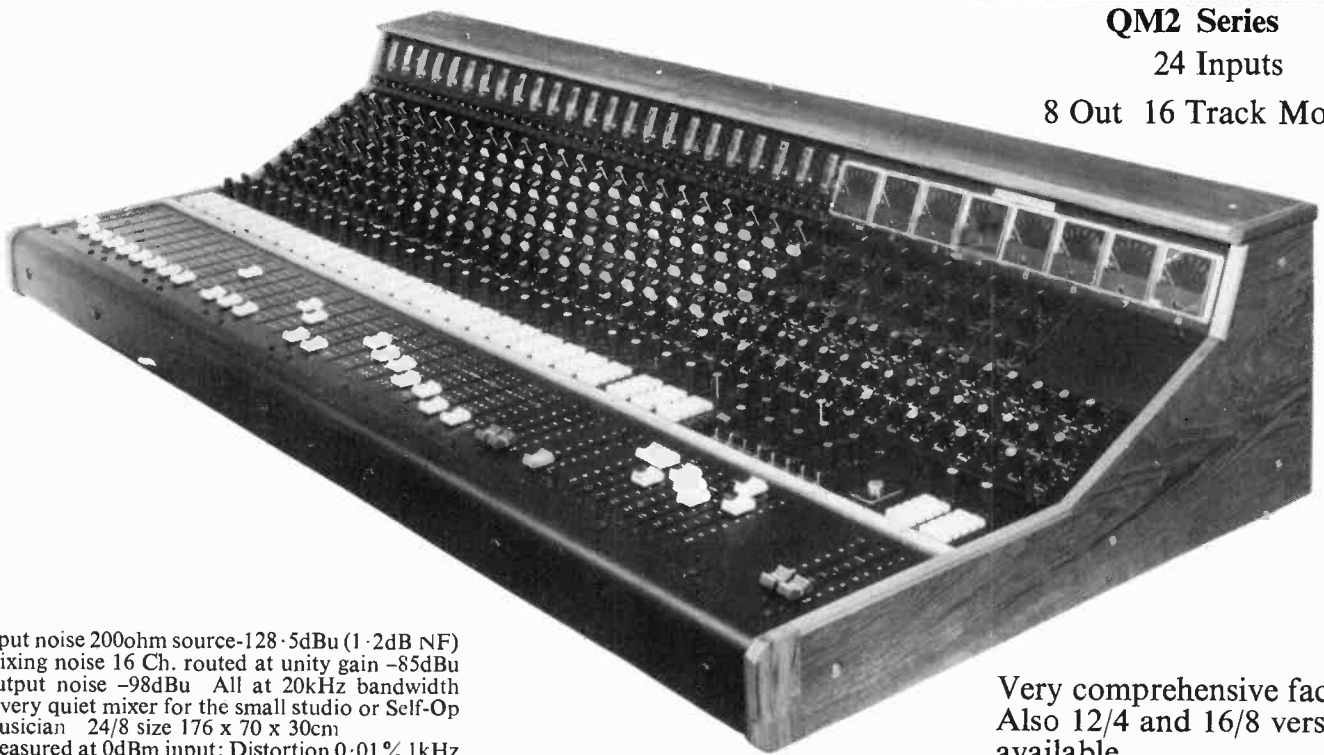

Input noise 200ohm source-128 -5dBu (1 -2dB NF)  
 \*Mixing noise 16 Ch. routed at unity gain -85dBu  
 Output noise -98dBu All at 20kHz bandwidth  
 A very quiet mixer for the small studio or Self-Op  
 Musician 24/8 size 176 x 70 x 30cm  
 \*Measured at 0dBm input: Distortion 0.01% 1kHz

Very comprehensive facilities  
 Also 12/4 and 16/8 versions  
 available

**CHILTON MAGNETIC TAPES LTD.**

**Chilton Works, Garden Road,  
 Richmond, Surrey, U.K.  
 Tel: 01-876-7957**

**A microprocessor-controlled  
 audio analysis system.**

- 1/3 octave band real-time analyzer
- Precision sound level meter (Type 1, IEC 179)
- Peak, impulse, fast and slow responses
- Automatic spectrum plots
- System weight 4.5 lbs.

*The new family of Ivie acoustic and audio analysis equipment is the most advanced measurement system in the world, yet is so light and compact you can place a complete acoustics laboratory under an airline seat.*

*Now you can accurately measure sound pressure levels and perform real-time, third-octave band analysis simultaneously. Measure RT<sub>60</sub>, delay, decay, and program an infinite number of time/amplitude variables for gated time measurements. The newest computerized Ivie analyzer is a versatile, compact, acoustics laboratory that is completely independent of power cords. Plot amplitude vs. time, amplitude vs. frequency, etc., with precision accuracy, and generate "hard copy" automatically into any standard X-Y recording device.*

*Ivie has a complete family of audio analysis products and accessories designed for your particular application. Our products are sold and serviced worldwide.*

*Write for product catalogs containing specifications and applications information.*



Ivie Electronics Inc.  
 500 West 1200 South  
 Orem, Utah 84057 USA  
 Telephone (801) 224-1800  
 TELEX or TWX 910-971-5884

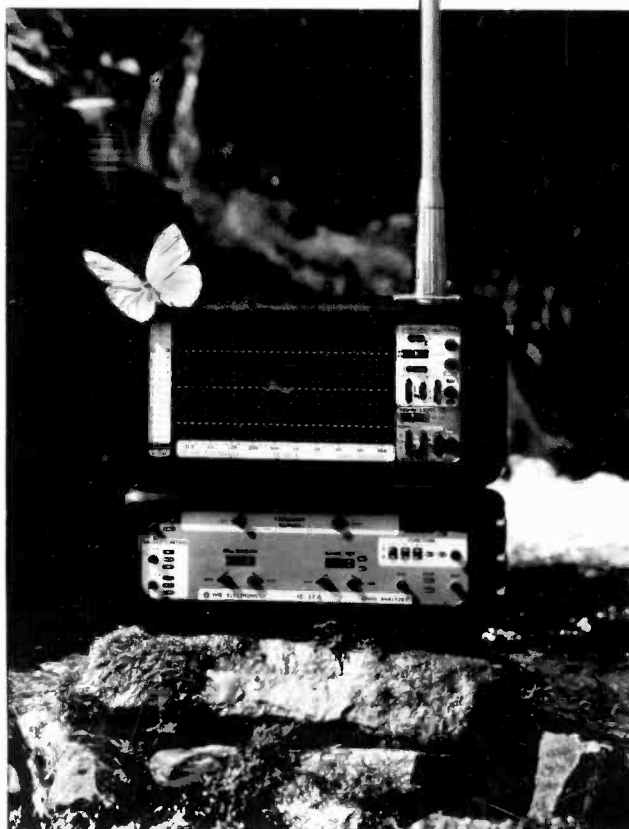

# A JBL MONITOR KNOWS ITS PLACE.

A studio monitor is only a tool. It is not supposed to enhance, add to, subtract from, or in any way modify sound.

That's your job.

What a studio monitor is supposed to do is tell you precisely what's on tape. Because you have to know everything that's there. And everything that isn't. Before it's too late.

That's why JBL monitors are in thousands

of recording and broadcast studios around the world. In fact, according to a national survey by Billboard Magazine, JBL's are in more recording studios than any other brand.

A JBL monitor plays what it's told. Nothing more. Nothing less. If that sounds good to you, contact your nearest JBL Professional Products Studio Equipment Supplier.

And put a JBL monitor in your place.

The 4301: Our newest 2-way monitor. Compact and efficient, for small broadcast control rooms and home studios.

The 4311: The most popular monitor going. A compact, full-range 3-way.

The 4315: An ultra-shallow 4-way, for maximum sound in minimum space.

JBL studio monitors come in three other models, too. All fully compatible for accurate cross referencing.



GET IT ALL.



James B. Lansing Sound, Inc. / Professional Division, 8500 Balboa Boulevard, Northridge, California, U.S.A.

## Sennheiser UPM 550

Further to our review of the Sennheiser universal level meter *UPM 550* in our October 1978 issue, Sennheiser has informed us of the availability of a number of additional plug-in filters. In all an additional 11 filters are available including a noise weighting filter to DIN 45405 (1967). Any combination of two of these extra filters mounted on the mother printed circuit board *B 17-0* can be inserted in the free space in the meter's cabinet. Also available is

a plug-in frequency deviation meter with two ranges (0 to 10kHz and 0 to 100kHz) for the measurement of infra red transmitters. Additionally, an extension card is available to facilitate servicing, together with a balanced input transformer for audio frequencies.

Sennheiser Electronic, D - 3002, Wedemark 2, West Germany. Phone: 05130 8011.

UK: Hayden Laboratories Ltd, Hayden House, Churchfield Road, Chalfont St Peter, Bucks SL9 9EW. Phone: 02813 88447.

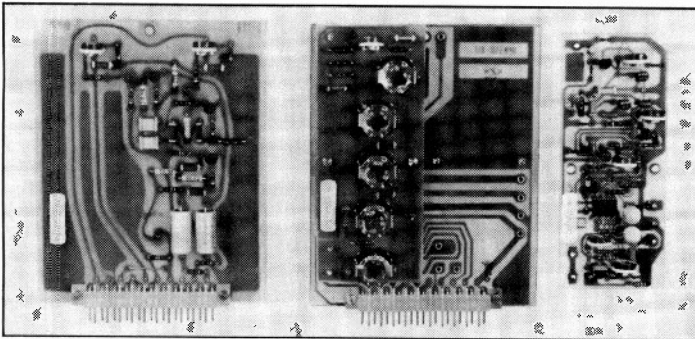

## New Redifon BT1000 Series MF broadcast transmitters

An entirely new range of solid state broadcast transmitters has been launched by Redifon Telecommunications Ltd, part of the Rediffusion group of companies. Based on the triple-bay *BT1000* 1kW MF transmitter developed for

the BBC, who needed to re-equip its MF transmitters for the November 1978 radio frequency changes, the new ranges are modular 2-bay designs for unattended station usage. Basis of the range is the *BT1002* 1kW MF transmitter, which can also be doubled up to provide a 2kW version, while other models are the *BT500* (500W) and the *BT250* (250W). The *BT1002* is intended for continuous unattended operation with reliable service based on the fault tolerant concept of two independent systems parallel combined and housed in a single cabinet. This comprises eight output modules in the *BT1002* with each of the bays having its own independent power supplies and signal processing stages.

Remote status analysis facilities using LED displays and remote control of power output are available, while a central VDU can be used to monitor an entire network of transmitters including the condition of each module. The modulators are DC-coupled and have a linear phase characteristic so that asymmetrical modulation and other special types of modulation can be applied. This also simplifies modulation synchronisation of adjacent transmitters. The transmitter has a high RF power conversion efficiency of 60% which compared with the typical figure of 34% for a conventional valved transmitter gives significant savings in running costs. This high conversion factor also means that



## Dynacord appoints UK distributor

Beyer Dynamic (GB) Ltd has been appointed sole British importer for the Dynacord range of products in the UK. At a recent press launch held at Gus Dudgeon's Moonlight Studio in Buckinghamshire, Beyer announced its appointment and demonstrated a number of units from the present Dynacord range. Of particular interest to the studio market were the Dynacord 'Stage Studio Series' comprising the *DRS78* digital reverberation system; the *TAM19* time axis

manipulation unit; and the *SRS56* analogue stereo reverberation system.

While designed primarily for on-stage use where studio recording effects are required, the units are also suitable for studios. The *DRS78* digital echo and reverberation system uses 12-bit coding with a memory store of 100k-bit capacity and microprocessor based processing. Maximum reverb delay is 10s while echo and reverb delay is adjustable over the range 0-320ms which may be selected, preset, stored in the memory, and recalled. Frequency range of the unit is 20Hz-20kHz on the original signal and 20Hz-8kHz for the effects processing mode. All functions of the unit such as switching echo/reverb, volume reverb, volume echo, and selection of the three preset echo delays may be controlled remotely.

The *TAM19* time axis manipulation system is a stereo effects unit which offers flanging, phasing, pitch shifting, double tracking, ambience enhancement, and chorus facilities. Consisting of two low noise delay lines which can be varied simultaneously or reciprocally by internal or external control, the signals are mixed by an effects matrix prior to being mixed with the direct signal. Control of the signals is by three control voltage generators which can be mixed with each other. The unit additionally has a control voltage output which can be used to drive a second *TAM19* to produce triple channel and multichannel effects. The *SRS56* analogue stereo reverberation system generates stereo time delay reverb signals in the range 30ms-560ms in the delay mode and 30ms-20s in the reverb mode. In addition the unit also provides a number of other effects such as pitch shifting, and double and triple tracking, etc.

Dynacord Electronic GmbH, PO Box 68, D-8440 Straubing, West Germany.

UK: Beyer Dynamic (GB) Ltd, 1 Clair Road, Haywards Heath, Sussex RH10 3DP.

Phone: 0444 51003.

there is less wild heat to dissipate since there is no need for cooling fans in temperate climates, thereby allowing additional savings in cooling and ventilation plus silent operation of the transmitters. A further saving comes from the elimination of the need for a station voltage stabiliser since the *BT1000 Series* has a power output stability within 0.2dB for a variation of 10% mains supply voltage (maximum output fluctuation of 30W in 1kW). The system offers large safety margins as in the event of the failure of any of the modules the transmitter will continue working with only a small reduction in power. Additionally a half section of the transmitter may be taken out of service or modules can be replaced while the transmitter is operating and without interrupting transmission.

Frequency range of the system is 520kHz to 1610kHz and installation is simply a matter of wheeling the transmitter into position and plugging it in. It can also be powered up without the usual pre-commissioning routines so cutting installation costs. A number of options are available including an oscilloscope monitor module providing a trapezoidal modulation display. To date 55 *BT1000 Series* transmitters have been ordered by the BBC and IBA.

Redifon Telecommunications Ltd, Broomhill Road, Wandsworth, London SW18 4JQ, UK. Phone: 01-874 7281.

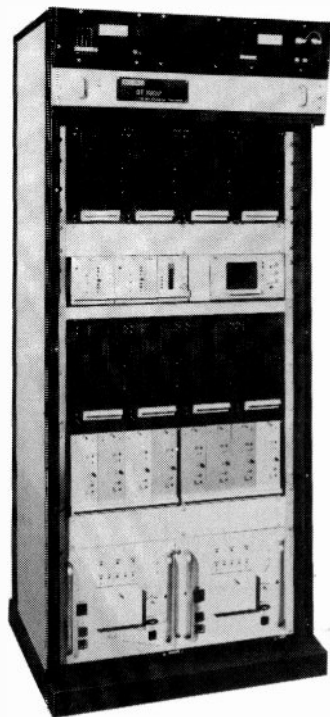



**STUDER B67**  
**Professional Tape Recorder**  
Respected STUDER quality at attractive prices.

# Performance — we guarantee it...

tomorrow's generation with features you requested,  
available today



# STUDER INTERNATIONAL AG

CH-8105 Regensdorf, Phone (01) 840 29 60, Telex 58489

STUDER REVOX AMERICA INC., Nashville, Phone (615) 329-9576, Telex 55-4453

STUDER REVOX CANADA LTD., Toronto, Phone (416) 423-2831, Telex 06-23310

STUDER FRANCE S. à r.l., Paris, Phone 533 58 58, Telex 24-744

F.W.O. BAUCH LTD., Boreham Wood, U.K., Phone (01) 953-0091, Telex 27502

### Inovonics Model 377

Inovonics has introduced the *Model 377* dual channel tape playback pre-amp specifically designed for radio automation service. The unit will interface with a wide variety of tape heads and transports, and is pin-compatible with Ampex and Schafer equipment. The *Model 377* is claimed to feature high stability, low noise and wide range response; and is fully RFI-proofed and offers balanced outputs capable of +24dBm. Front panel of the unit includes multi-turn gain and equalisation adjustments,  $\pm 5$ dB level trim controls and VU meters for each channel. Price of the *Model 377* is \$395. Inovonics Inc, 503-B Vandell Way, Campbell, Ca 95008, USA. Phone: (408) 374-8300.

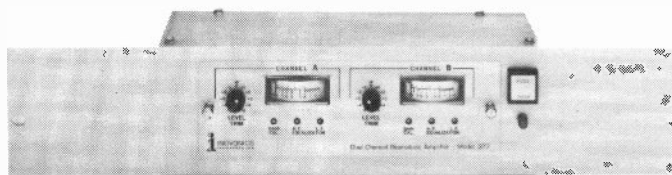

*Inovonics 377*

NE 6th Avenue which it is planned will accommodate the company's machine shop and sheet metal plant operations. The company currently employs 375 people and the acquisition of the new building coupled with heavy production demands from the recording industry will entail the creation of some 100 new jobs immediately, and about 350 more jobs by mid-1980. 'Jeep' Harned, president of MCI, commented: "All things equal, we plan to double our production in the 12 months ahead. The new building gives us the room to grow comfortably and employ more people."

### MCI expansion

MCI Inc has purchased a new site for its manufacturing activities in Fort Lauderdale, Florida for \$4.25 million, comprising 23.5 acres at 1400 West Commercial Boulevard including a 156,000ft<sup>2</sup> building. The building currently serves as corporate headquarters for the STP Corporation and MCI moved its progressive assembly operation into 30,000ft<sup>2</sup> of the building in May. STP is to remain in the rest of the building until February 1, 1980, at which time MCI will move its corporate headquarters and the remainder of its production and research operations into the building—MCI currently operates from five North Broward locations. MCI will retain its present worldwide headquarters building at 4007

*Custom Audio Electronics' gooseneck lamp*



### Memorex moves

Memorex UK Limited has moved its headquarters to Staines as part of the company's current expansion programme. The company's new address is Memorex House, 96-104 Church Street, Staines, Middlesex TW18 4XU. Phone: 0784 51488. Telex: 935013.

### Gooseneck lamps

Gooseneck lamps would on first thought be an unusual product to include in our pages. However, in situations where normal or dimmed lighting would be an anachronism they can be extremely useful for illuminating control panels and work spaces in dimly-lit areas. A new gooseneck lamp from Custom Audio Electronics which is slim and stylish is therefore of more than passing interest. The CAE lamps are available in a black finish in 6, 12 and 16in lengths, complete with bayonet type bulb and a 360° swivel base. The lamps are durable and easily detached from their base connector for storage. Various mounting brackets, power supplies and dimmer controls are available allowing the lamps to be fitted to new or existing equipment. In addition to ready-made units Custom Audio Electronics also offers a kit comprising lamp, base, dimmer, power supply, cable and mounting hardware. Custom Audio Electronics, 2828 Stommel Road, Ypsilanti, Michigan, 48107, USA. Phone: (313) 482-6568.

### Orange County PEQ module

A new fully parametric equaliser module, the *PEQ*, has been introduced by Orange County. The new module is a 4-band parametric with centre frequencies variable from 20Hz-20kHz in five octave (32:1) overlapping ranges. Each section may be tuned over a 40dB control range and bandwidth is variable from 0.15-3.00 octaves.

*Orange County PEQ parametric equaliser module*

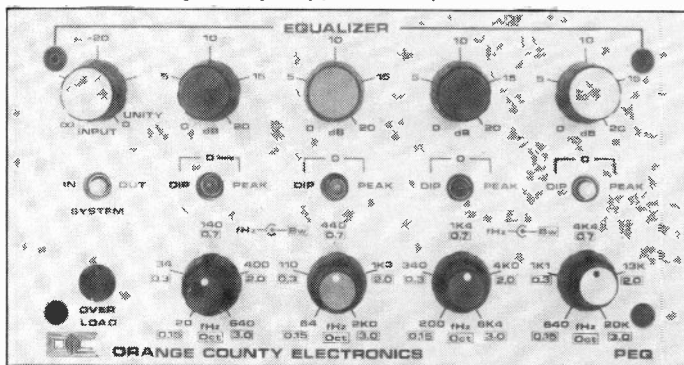

### Lindsay Electronics

PA and lighting company Highlife Productions has announced that it is to market two new products from Gloucestershire based Lindsay Electronics, which is best known for the installation of Mike Oldfield's 24-track studio and is currently building a computerised live concert console for Mike. The new products are the *Model 7634*  $\frac{1}{3}$ -octave audio spectrum analyser and the *Model 7607*  $\frac{1}{3}$ -octave graphic equaliser. The spectrum analyser has 27  $\frac{1}{3}$ -octave ISO bands covering the range 40Hz-16kHz; switchable flat or A-weighted broad band filter; slow, VU or PPM time constants; 28 x 11 LED display with 10dB or 20dB display ranges; a display shift facility which increases dynamic range to 40dB; and over-range indication on each channel. Other features include balanced and floating mic/line inputs; direct dB SPL mic input display; internal calibration facility, a gain range of 70dB; overload limit indicators for input and gain; an internal noise generator; sync and video outputs; and two independent memories with hold, accumulate and erase functions.

The *Model 7607* graphic equaliser has 27  $\frac{1}{3}$ -octave ISO bands covering the range 40Hz-16kHz with  $\pm 12$ dB gain for each band;

All the controls are non-interacting allowing the bandwidth to be varied without changing level. Specifications are—signal-to-noise ratio 110dB with all sections at 20dB boost; THD 0.05% at 18dBm output; and output capability +30dB (10k load) or +24dB (600 $\Omega$  load). Standard balanced or unbalanced operation is available and an overload indicator warns of excessive levels at any stage. The module may be used as either a mono or stereo parametric equaliser and can also be utilised as part of the Orange County *V5-1* stressor thereby offering additional signal processing capability. Orange County Electronics, 1125 Empress Street, Winnipeg, Manitoba R3E 3H1, Canada. Phone: (204) 775-8151.

an input gain range of -22dB to +7dB; a unity gain bypass circuit; and an output limit indicator. Maximum output level is +22dBm, and inputs/outputs are transformer coupled (balanced and floating). Highlife Productions, 2 Heathfield Terrace, Chiswick, London W4 4JE, UK. Phone: 01-995 6472.

### Fraser-Peacock

Fraser-Peacock Associates Limited has changed its phone number to 01-947 7551. The company's address remains the same—94 High Street, Wimbledon Village, London SW19, UK.

### Protech Audio Corp

Protech Audio Corporation, a newly incorporated electronics manufacturing company, has concluded an agreement with Robins Industries for the purchase of its Broadcast & Sound Equipment product line. This line was originally marketed by Fairchild Sound Equipment Corp, which was acquired by Robins in 1971. Protech Audio Corporation, PO Box 638, Lake Ronkonkoma, NY 11779, USA. Phone: (516) 473-5979.

The DELTALAB DL1 offers 160 mS digital delay with a no compromise 20Hz~15KHz bandwidth and 85dB dynamic range even at maximum delay

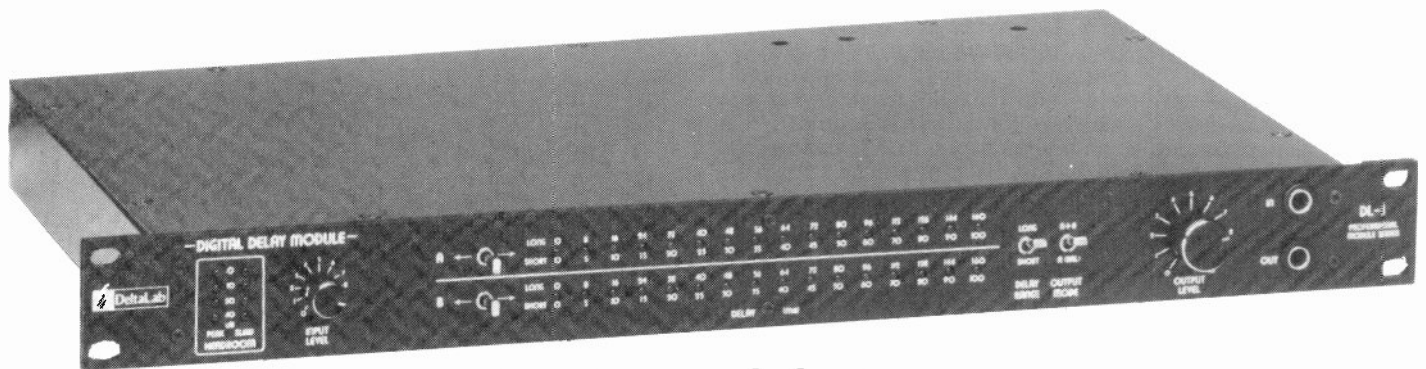

# NOW THE DL2 'ACOUSTICOMPUTER' OPENS UP A WHOLE NEW AREA - TIME DOMAIN MANIPULATION

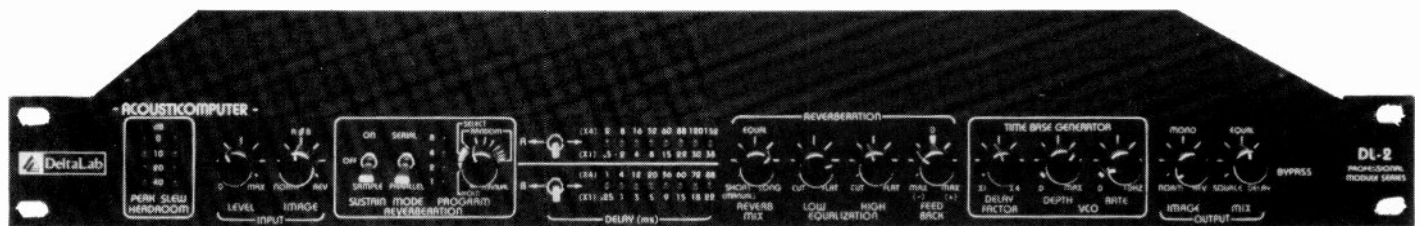

It is a stereo unit of equally impressive performance but in addition offers:-

- ★ Supplementary 2 second delay modules
- ★ 16 Synthesised room acoustics
- ★ Continuous repeat, doubling, vibrato etc.,
  - ★ Internal time base VCO
  - ★ Positive and negative flanging
  - ★ Equalisation controls

UK Distributors



Scenic Sounds Equipment  
97-99 Dean Street, London W1V 5RA

Telephone : 01-734 2812/3/4/5  
Telex : 27 939 Scenic G

## Matsushita Electric announces evaporated film tape

A microcassette employing an evaporated metal film tape known as 'Angrom' is to be test marketed in Japan from August this year. While it is known that several manufacturers have been working on metal film tapes, this is the world's first to be announced.

The extremely thin coating of only  $0.2\mu\text{m}$  together with a polyester base film of  $6\mu\text{m}$  permits a 3-hour microcassette recording at a tape speed of only 1.2cm/s (in dictating machines). The cobalt-type coating is deposited by a vacuum deposition technique, which means that 100% of the coating is active magnetic material, compared with the typical 30% in the case of conventional tapes which results from the binder and other components of the coating.

Although the mechanical properties of this type of tape present severe problems, owing to the easily damaged thin coating and smoothness—which can introduce winding problems, the electromagnetic properties are of great interest. In spite of the thin coating the retentivity is quoted as 12,000 gauss with a coercivity of 550 oersteds, the sensitivity at low frequencies is similar to conventional microcassette tapes but increasing to +5dB at 2kHz at 1.2cm/s.

An interesting feature of very thin metal film tapes is that the

frequency response of the record/replay process is not sensitive to bias. The bias/sensitivity curves for conventional tapes are something like those shown in fig 1 where particularly short wavelength output is sensitive to bias adjustment, with a resulting frequency response error if the bias is incorrect. Thin metal tapes have characteristics like those shown in fig 2 where the bias/sensitivity curves at short wavelengths are close to those at long wavelengths such that the frequency response of the record/replay process is insensitive to bias. Another advantageous feature is the ease with which the tape can be erased. This is demonstrated in fig 3 which sketches the erasure versus erase current for a conventional gamma ferric oxide tape of  $3\mu\text{m}$  coating thickness, a metal powder tape of  $1.5\mu\text{m}$  coating thickness and the new evaporated metal film tape of  $0.2\mu\text{m}$  coating thickness.

While very thin metal tapes are a breakthrough in audio recording, they really come into their own in the fields of video recording and digital recording where the pulse-crowding effects limit the recorded density with conventional tapes, due to the high coating thickness. Obviously the mechanical problems are more severe in these applications than with a cassette at 1.2cm/s and the thought of a high speed video head being pushed into a  $0.2\mu\text{m}$  coating is to say the least frightening. **Hugh Ford**

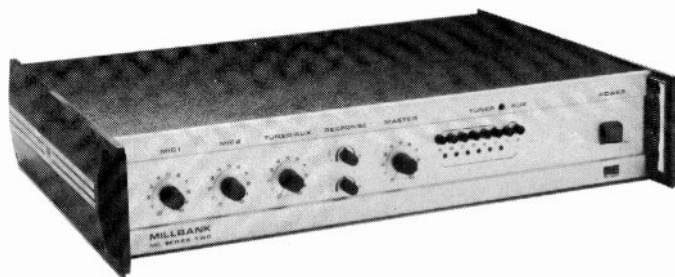

## Millbank Electronics

At a recent press conference Millbank Electronics Group Limited introduced a number of new products including updated versions of the *MIL Series* and *PAC-System* audio systems, all of which are compatible with previous units. The *MIL Series* amplifier has undergone a complete redesign and is now available as a lower priced second generation of models, but to the same basic format as the original models. The models available include 3-input, 5-input, and 3-input with FM or AM tuner and feature a redesigned pre-amplifier with bass, treble and master gain controls. Both the *MIL Series Two* and *PAC-System* now use toroidal transformers giving a minimum 20% increase in power output, together with new power amplifier designs incorporating a new protection circuit to obviate freak output load conditions. *PAC-System* power amplifier mainframes in the 40-250W power range also now incorporate an input pre-amplifier and combined printed circuit guide for simpler mainframe insertion. In addition the *PAC-System* has had three new input pre-amplifiers added to the range including the *IPA410* radio mic receiver designed for use with EDC hand-held or pocket transmitters. Millbank informs us that over £100,000 of orders have been received in advance of the initial production of the new models, and that some 70% of production will be exported.

Other news from Millbank is that a new company, Millbank Electronics Groupe Europe SA, is being set up with headquarters in Avenue Louise, Brussels, to handle supply and distribution to EEC mainland European countries. In addition future plans include the construction of a new factory close to the company's present premises, land for which is currently being purchased. The company also hopes to double turnover to £3 million over the next 18 months mainly through greater export market penetration. Millbank Electronics Group Limited, Uckfield, Sussex TN22 1PS, UK. Phone: 0825 4166.

## Nilesco Europe

Community Light and Sound of Philadelphia has announced the appointment of Amsterdam-based Nilesco Europe as the sole European distributor and importer for its range of fibreglass loudspeaker horns and enclosures designed for high level sound reinforcement use. Heading the European operation will be Nilesco's Peter Christensen. Nilesco Europe, Herenstraat 1A, PO Box 11686, Amsterdam, Holland. Phone: 020 258420.

## Schoeps UK agency

Due to an oversight by the editorial team the review of the Schoeps *CMTS 501U* mic in our June issue appeared with the incorrect UK agent. This should have read as the mic survey . . . UK Agent: Scenic Sounds Equipment, 97-99 Dean Street, London W1V 5RA. Phone: 01-734 2812. Telex: 27939. Our apologies to all concerned.

## Susan Blue DI boxes

Sun Recording Services has introduced a new range of *Susan Blue* direct injection boxes. The range consists of three DI boxes: a passive unit with a variable input impedance of  $100\text{k}\Omega$  and  $10\text{k}\Omega$ , switchable attenuation of -10dB, -20dB, -40dB and balanced  $200\Omega$  output; an active unit with an FET amplifier input stage, dual  $10\text{M}\Omega$  input, switchable 0dB, -15dB, -30dB attenuation and balanced  $200\Omega$  and low imp unbalanced output; and a transformerless unit with dual  $10\text{M}\Omega$  input, switchable 0dB, -15dB, -30dB attenuation and balanced  $200\Omega$  and low Z unbalanced output. All the units feature on/off/auto earth lift switches and distortion is better than 0.05% at all frequencies. The active and transformerless units may be powered either by standard mic phantom powering or from an internal battery. Prices of the units are: passive £41.36, active £52.73, and transformerless £42.75. Sun Recording Services Ltd, 34-36 Crown Street, Reading, Berks RG1 2SN, UK. Phone: 0734 595647.

FIG.1 BIAS SENSITIVITY CURVES FOR CONVENTIONAL TAPE

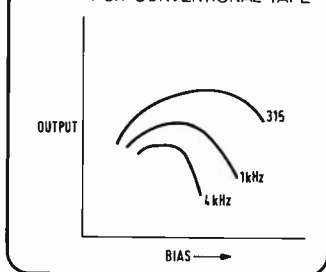

FIG.2 BIAS SENSITIVITY CURVES FOR FILM TAPE

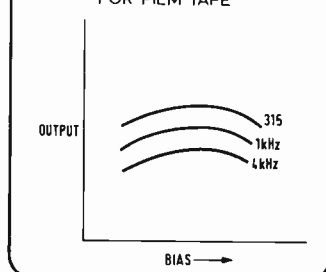
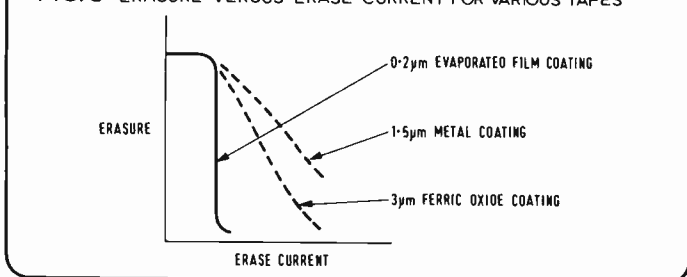

FIG.3 ERASURE VERSUS ERASE CURRENT FOR VARIOUS TAPES





# The Technology Must Serve The Music

This one thought is reflected in every facet of Solid State Logic's Master Recording Consoles. From the beginning, we wanted to offer the artists in our industry a truly exceptional instrument which would not limit their expression in any way. After years of quiet and deliberate work, we have created an unprecedented marriage of hardware, firmware and software with advantages and potentials years ahead of any other studio system.

**SSL's ULTRALOCATOR**, for example, brings automation to recording as well as mixing. The multi-track transport is directed to unlimited cue points which may be requested by songtitle, verse or other words, as well as sequential numbers and timecodes. All session data, such as track assignments and comments on takes, can be stored on floppy disc for video display or hardcopy printout. The proprietary SUPERDUE system enables unerringly accurate programmable drop-ins with tandem multi-track, monitor, and foldback switching.

**SSL's SOFTWARE ASSISTED MIXING (SAM)** is easily the most useful and easy to use mixing automation ever. SAM automatically selects the appropriate fader status, displays VCA levels on a built-in video screen, stores unlimited mixes, and enables extensive off-line manipulation of those mixes. Best of all, SAM is software based, which means he easily learns lots of new tricks to keep you ahead of the pack.

**SSL's SIGNAL PROCESSING** includes a full-feature compressor/limiter/expander/gate in each module. Front panel "Link" buttons enable an unlimited number of strapped stereo or quad units to be freely configured across the board. The module's four band parametric equaliser has continuously variable Q in each of the overlapping mid-bands, selectable peaking or shelving in the high and low bands, and separate variable HP and LP filters. Pushbutton switching enables the equaliser to be placed at the channel input, the channel output, in the dynamics unit sidechain, or in the monitor mixer. The dynamics unit can also be switched to the monitor mixer.

**SSL** has developed these and many other innovations to free the production team from the tedious, purely mechanical aspects of multi-track work, so that they may apply their full skills and judgment towards perfecting the artist's performance. If that sounds like music to your ears, contact us for additional notes. Or visit us at the Brussels or Los Angeles AES shows.

**Solid State Logic**  
—at the leading edge of recording technology

## Solid State Logic

Stonesfield • Oxford, England  
099 389 324 • TLX 837400

Milan, Michigan • USA  
313 663-6444 • TLX 230504

### Sales and Distribution

#### North America

Washington Musicworks Inc.  
3421 M Street N.W.  
Washington, DC 20007  
Doug Dickey  
East Coast (202) 333-1500  
West Coast (213) 464-8034  
TLX 440519

#### UK

Solid State Logic  
Stonesfield  
Oxford, England  
Colin Sanders  
099 389 324  
TLX 837400

#### Italy

AEG Telefunken  
Viale Brianza 20  
20092 Cinisello Balsamo  
A. Savasi  
Milan 61798  
TLX 31473

#### Germany

B.F.E.  
65 Mainz 23  
Postfach 81  
West Germany  
Jeff Nieckau  
Mainz 42430  
TLX 4187300

### Pentagon duplicators

Chicago-based Pentagon Industries has introduced two new high speed cassette copiers with automated functions. The new units, *Model C-100* (mono) and *Model C-400* (stereo), copy cassettes at 30in/s, both sides being recorded simultaneously. The units have an erase feature allowing reuse of cassettes and feature automatic rewind of both master and copy so that cassette copies come off the machines ready to play. In addition adjustable bias and production rewind are standard for greater flexibility and a 'short copy' warning light eliminates the embarrassment of missed programming.

Pentagon Industries Inc, 4751 North Olcott, Chicago, Illinois 60656, USA. Phone: (312) 867-9200.

### High quality A/D and D/A converters

Design consultant Tim Orr, best known as designer of the *EMS Vocoder*, has designed and is selling under licence high quality A/D and D/A converters. The units were originally designed for an all digital sound processing system for the IRCAM Centre in the Pompidou Centre in Paris, to which 18 units have already been delivered. The units have a maximum sampling rate of 50kHz; audio inputs and outputs of +14dBm maximum (600Ω balanced); switchable filters operating at 16kHz, 12-4kHz and 4kHz; a dynamic range of greater than 90dB; and an overall performance (signal-to-noise/distortion/unwanted products) greater than 80dB, 84dB maximum. The data input/output is 16-bit optically isolated with MUX capability; connection is by 40-way ribbon cable (clock connection by 75Ω BNC, optically isolated); and data is held in LS TTL latches.

Tim Orr, Design Consultant, 55 Drive Mansions, Fulham Road, London SW6, UK. Phone: 01-731 2077.

### EMI digital single

EMI has released its first digital recording; a 12in 45rpm single entitled 'Love don't live here anymore' from Dick Morrissey and Jim Mullen. The single was recorded in April at EMI's Abbey Road using EMI digital tape machines. These utilise an instrumentation transport from EMI subsidiary SE Laboratories combined with electronics designed by EMI's Central Research Labora-

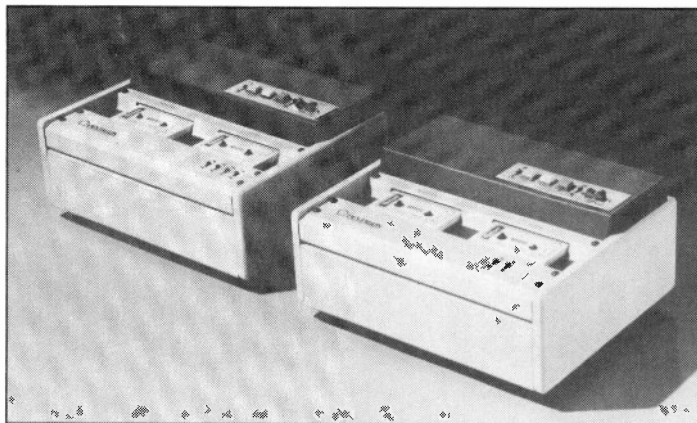

Pentagon C-400 (left) C-100 (right) automatic cassette copiers

tories at Hayes. Two stereo machines were used for the recording and the EMI system uses 15-bit coding (including error correction) giving 90dB dynamic range. The recording session was also recorded as a stereo direct cut session, as 2-track analogue, and as 24-track with *Necam* mixdown, the comparative results apparently vindicating the decision to go digital. We understand EMI is still working on its digital system, especially the editing side, and that it will be some time before a final system standard is adopted. In addition EMI informs us that it has several classical digital recordings in the can but that it will not be issuing any product until digital standardisation is accomplished.

### APRS digital teach-in

The Association of Professional Recording Studios seems dedicated to the task of bridging the educational gap for the staffs of its 123 member studios, 61 members (manufacturing) and 50 affiliates etc. One of the ways it goes about promoting its published aim 'to strive constantly to improve the standards of professional sound recording' is to organise training courses. The annual one-week Recording Engineer's course at Surrey University this September 15-22 will be the sixth in the series and there have been other courses for non-technical studio staff, and one on Management and Computers.

From Friday evening, April 27 to Sunday, April 29, the APRS ran the first of a new-style course on Digital Electronics for Studio Staff at the Euro Crest Hotel, Maidenhead. They had limited the number of attendees to 24, to give everyone a fair crack of the whip, and so had to disappoint many people who applied too late. The 24 included

engineers from Air Studios, Decca, Neve, RCA, Sarm, Advision, Strawberry, Polygram (Holland) and elsewhere.

The first lecturer was Alan Mornington-West who had the difficult job of introducing the basic A/D theory without really knowing if his audience were already mathematical geniuses or needed to take off their shoes to count higher than 10 (though the APRS stipulated that applicants must have at least 'O' Level maths and physics). However the lecturer had done everyone a favour by producing a folder of preprinted notes with definitions of all the difficult terms like bit, clock and op amp, with lots of binary, octal, hexadecimal and binary coded decimal examples. He also covered the basic Boolean algebra with its associated gates, logic circuits and the dreaded (but not so frightening really) truth tables, as well as some of the ICs and other devices that can be bought off the shelf.

Richard Helyer then took over and uncovered the mysteries of microprocessors, outlining the evolution of more complex (and better) ICs and techniques through RTL, using resistors and transistors, DTL, adding diodes, TTL, ECL, MOS, CMOS... He too had prepared very helpful and detailed notes and diagrams. Besides building up block diagrams of microprocessors and explaining the advantages of 4-bit, 8-bit and 16-bit registers, he described and compared all the current data storage methods — open-reel tapes, cartridges and cassettes, hard and floppy magnetic discs, optical discs, solid state memories, ROM, RAM, PROM, EPROM and bubble memory.

Turning from basic computer and digital matters to the world of audio, he then outlined the building bricks for A/D converters and vice-versa, digital filtering etc. As an

evening workshop he had also brought along a desk-top computer to demonstrate the ease and speed with which it could be operated.

The third lecturer was Guy McNally of BBC Research Department who naturally waded straight into the main stream of interest for most of the course attendees, namely the currently available formats for digitising sound in tape mastering recorders, as well as the BBC's experience in designing a digital mixing console. He described the desirable parameters for sound digitising hardware and used tape recordings to demonstrate the audible effects of different bit rates and quantising levels. Finally there was a discussion on quality versus cost in the different digital media, and the 24 engineers set off home agreeing that they now felt better able to face the impending micro-processor revolution than they had just three days previously.

John Borwick

### People

●Quad-Eight has appointed Don Hudson as its new vice-president of operations.

●Mike Bennett has joined Alice (Stancoil) Ltd as a member of the management team responsible for Local Radio planning, installation and commissioning. Previously he was with the Quality Control section of the IBA...

### Ampex Professional cassettes

Ampex International recently introduced a new range of audio cassettes. The new range called the *Professional* series are high performance, low noise/high output cassettes designed particularly for the professional, industrial and educational markets. Features of the cassettes are 5-screw shell assembly, precision torqued for improved azimuth control, welded viewing windows, and precision moulded roller guides operating on lubricated, stainless steel pins. The cassettes also have a poly-olefin, graphite-impregnated shell liner to minimise tape friction and static build up. Available in standard play lengths the cassettes may be purchased as individually packaged cassettes in hinged plastic boxes, or are available in bulk packages with separate labels and without the hinged box.

Ampex International, Acre Road, Reading, Berks, UK. Phone: 0734 864121.

# Master-Room REVERBERATION Units

A complete range of superbly natural sounding reverberation devices equally suitable for fixed or portable operation.

Master-Room models are in reliable daily use with broadcasters, film dubbing facilities, multi-track music recording studios and P.A. companies.

◁ Master-Room Model MR III fixed decay time stereo output reverberation unit, U.K. list price £982.00

For full details contact:



**Scenic Sounds Equipment,**  
97-99 Dean Street,  
London W1V 5RA  
Telephone: 01-734 2812

Belgium  
**S.E.D.,**  
Rue Bara Straat 146,  
1070 Bruxelles  
Tel: Bruxelles 552 7064

Denmark  
**Lake Audio APS,**  
Artillerivej 40,  
DK-2300 Copenhagen S  
Tel: Copenhagen 570 600

Belgium  
**A.R.C. SPRL,**  
Rue Th. Decuyper 134,  
1200 Bruxelles  
Tel: Bruxelles 771 3063

Holland  
**Pieter Bollen Geluidstechnik,**  
Hastelweg 6,  
Eindhoven  
Tel: Eindhoven 512 777

France  
**3M France SA, Mincom Div.,**  
Boulevard de l'Oise,  
95000 Cergy  
Tel: Paris 749 0275

Norway  
**Siv Ing Benum AS,**  
Skovvn 22,  
Oslo 2  
Tel: Oslo 565 753

Sweden  
**Tal & Ton Musik & Electronic AB,**  
Kungsgatan 5,  
411-19 Gothenburg  
Tel: Gothenburg 130 216

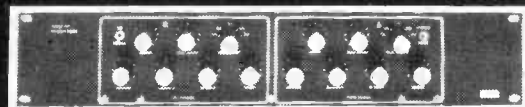

△ Master-Room Model CSR23 EQ, two independent channel variable decay time reverberation unit with comprehensive reverb return equalisation, U.K. list price £1,435.00 (sound columns not shown)

## Amber 4400A: top studio performer.

**AMBER 4400A MULTIPURPOSE AUDIO TEST SET.** Designed for an industry where time is money, and maintaining top performance is essential. It saves you time by integrating virtually every test and measurement function you could need. It cuts setup time, and assures quality equal to or exceeding competitive equipment, but at a fraction of the cost.

With your oscilloscope, the Amber 4400A can plot the frequency response of a tape recorder or monitor system; measure the weighted noise of a console; plot the phase response of an equalizer or check the transient behaviour of a speaker; tune your room or measure the RT<sub>60</sub> of your studio. Optional interface lets you make hard copy plots with any XY recorder.

The Amber 4400A combines versatility with quality. It integrates sine, function, sweep, tone burst and noise generator; autoranging digital dBm meter and frequency counter; multimode filter; spectrum analyser; frequency response and phase response plotter.

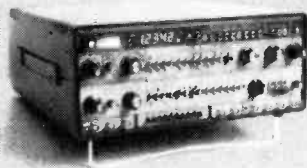

The Amber 4400A lets you make sure your product is always at its best.



UK Distributors  
**Scenic Sounds Equipment**  
97-99 Dean Street, London W1V 5RA  
Telephone: 01-734 2812

Amber Electro Design Ltd.  
4810 Jean Talon West  
Montreal Canada H4P 2N5  
Telephone (514) 735 4105

**amber**

# studio diary

## Ridge Farm, Dorking

While most recording studios today are purpose built either from the ground up, or on a room-within-a-room basis, there are still a few studios being opened in which an existing structure has been adapted to produce a studio that still retains some of the building's charm. Ridge Farm, near Dorking in the south of England, has adapted a period Elizabethan barn, complete with wooden beams, into a full 24-track recording studio with excellent acoustics. The barn was initially used a couple of years ago as a rehearsal room, but its acoustics started attracting bands who wanted to make albums using mobile units. With a demand thus created, July 1978 saw the introduction of more permanent facilities utilising the isolation booth as a control room, but it was soon realised that further enhancement was necessary and so winter saw a totally new control room installed at Ridge Farm.

The large barn was divided at one end into two levels, the control room being elevated on a 10in thick reinforced concrete raft thus providing an excellent view of the studio without generating a feeling of disassociation. Sunk beneath the new control room is an area with variable acoustic ceiling and floor, and attached is a recently completed sitting room with kitchen and bathroom facilities—total studio working floor area is 1,200 square feet. The control room is fully floating on rubber pads to isolate it from the main structure and was designed and constructed by Frank and Billy Andrews in a style complementary to the timber

framing of the barn. Interior acoustics were designed by Keith Slaughter, and the control room is 17ft x 11½ft with bass traps positioned in the rear wall sitting diagonally across the corners—the ceiling is designed as a sound focus with an inverted pyramid ceiling centering over the console, while serious consideration has been given to the texture and tactile qualities within the room making imaginative use of natural materials. The final atmosphere is of comfort and warmth, and even includes an exterior window.

Equipment is basically an MCI package comprising *JH-400 Series 28-channel console* with MCI *JH-24 multitrack* and ¼in transports. Monitoring is by JBL 4341 or Lockwood *Red* speakers driven by Crown amplifiers. Effects include EMT 240 gold foil reverb, Eventide digital delay, *Flanger* and *Harmonizer*, and Urei limiters with microphones from Neumann, Beyer, AKG, Electro-Voice and Schoeps. Also resident in the studio is a Steinway Grand. Accommodation can easily be arranged for up to 12 people with first class food to individual taste. Located in extensive grounds, Ridge Farm also offers extensive recreational facilities including tennis, swimming, sauna, riding and so on, as well as organised visits to the local real ale public house. Resident engineer is Mike Dunne, and recent work has included the Pop Group for Radar Records, Bad Company, Roxy Music, National Health, Tim Blake, Magazine, and Wilco Johnson.

Ridge Farm, Capel, Nr Dorking, Surrey. Phone: 0306711202/711571.



## Zipper Mobile

A new addition to the mobile recording studio fold is the Zipper Mobile Recording Studio owned by Jeffrey Zipper. The new mobile consists of a custom-built van equipped with a 16-track Soundcraft console, Cadey 16-track tape deck, AKG reverb and mics, JBL monitors, and Dolby noise reduction. The mobile is extremely compact and functional and has economical recording in mind. Typical hire rate for a full 10-hour day is £76. Jeffrey Zipper has working experience of a number of studios, together with live sound mixing experience in various venues from small clubs to large theatres. Zipper Mobile Recording Studio, 15 Langland Gardens, London NW3 6QE. Phone: 01-435 3076.

## Suntreader Studios, Vermont

Nestled in the sylvan seclusion of Vermont's Green Mountains, Suntreader is separated from New York's urban sprawl by a short commuter flight. The peaceful setting, comfortable facilities and conscientious staff offer a striking contrast to the fevered pace of the United States' Northeast. In an art currently obscured by gadgetry and tricks, Suntreader's success has been founded on one simple unassuming goal: help the artists do their best. Platinum albums and a host of significant album credits, received during the studio's brief 4-year history, are visible proof that musicians record superior work at Suntreader.

A residence is maintained by the studio for visiting artists and additional homes are available within a short distance if required. Excellent food and an extensive wine cellar are examples of the concern given to visitors' comfort. The forested mountains in the summer and the snow covered slopes in the winter are only two of the numerous recreations available nearby.

The 870sq ft studio has a distinctly live sound free from echoes. Staff designed baffles allow isolation of instruments with an effectiveness previously unachievable in a live environment. The control room simulates a real world listening environment rather than following the current trend of unrealistically refined acoustics. Observation areas permit visitors to view on-going work without entering the control room.

Thirty-six inputs are featured on

Ridge Farm from L to R: aerial view of exterior, the studio, studio showing rest area and window to control room, and control room itself

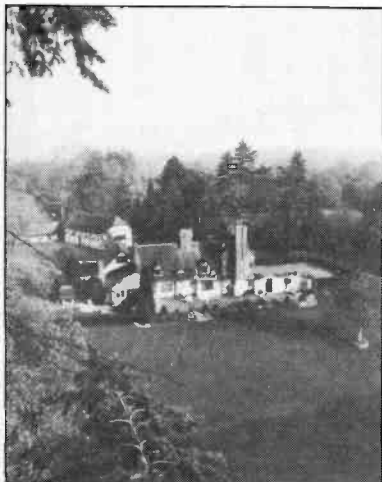

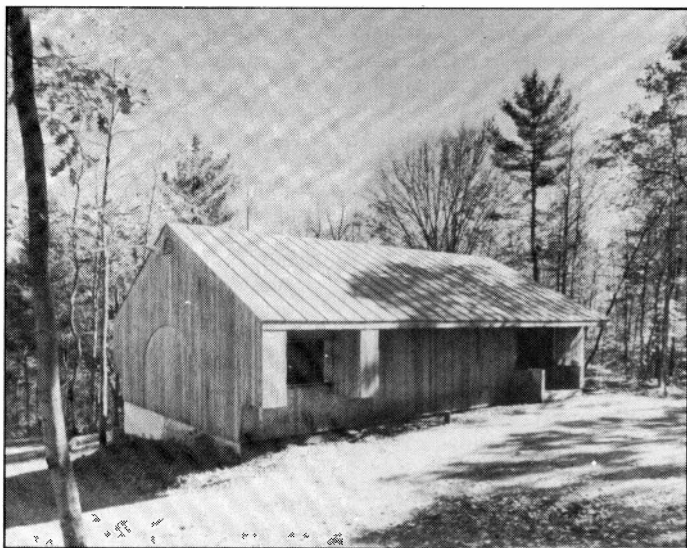

Suntreader exterior

the heavily modified API console. Tape recorders and accessories in use are a Studer A80 24-track with autolocator, a Studer A80 2-track, a 3M M79 2-track and 4-track, various Revox, and Dolby noise reduction. Staff designed loudspeakers employ Altec and JBL drivers tri-amplified from passive low level crossovers. A second and third pair of monitors may be selected by the user from an available assortment. Among the selection of outboard equipment are Neve, Urei and dbx compressors, Urei graphic equalisers, Urei and Sontec parametric equalisers, Lexicon DDLs, RM and Kexep noise gates, Eventide Flanger, Phaser, Omnipressor, Harmonizer and DDLs, AKG and EMT reverbs. Neumann, Studer, Sennheiser, AKG, Electrovoice and Shure are included in the selection of 40 microphones. Keyboards at the studio are a Steinway Concert Grand Piano, a Hammond B3 organ and a Baldwin electric piano.

The newly completed office and laboratory building is allowing Suntreader to expand its already extensive programme of in-house design and modification of equipment. Purchased equipment is routinely tested and modified to improve performance and simplify system operation. Custom designs are built when users desire effects or instruments which are unavailable from stock. Ongoing or recently completed projects have resulted in a quieter, more transparent console sound, simplified noise reduction alignment, precision punch-in timing, simplified

patching and monitor switching and improved cue system convenience. Upcoming studio modifications promise to optimise sight contact and circulation between the studio, control and isolation rooms and a reverberation chamber of revolutionary design is to be constructed. Equipment currently on order includes a Studer A800 24-track, additional Studer 2-tracks and the Ambience Vacuum Tube Console. Designs are in progress for Suntreader Lodge, which will add eight bedrooms, rehearsal and recreational facilities to the studio's capabilities.

Suntreader Studios encourage long term bookings in order to best serve the recording artists. Enquiries to Jerice Bergstrom, studio manager, Suntreader Studios, Sharon, Vermont 05065, USA. Phone (802) 763-7714.

## Fantasia—multitracked ?

It is not, readers will presumably have noticed, our usual custom to report on recording sessions that took place 40 years ago. But when Leopold Stokowski spent seven weeks with the Philadelphia Symphony Orchestra on a stage in the Philadelphia Academy of Music in April and May 1939, there was no *Studio Sound*, and no *Studio Diary* column to report what went on. But what went on was, for the period, quite exceptional. Stokowski was working with Walt Disney and music critic Deems Taylor to produce a soundtrack for the film *Fantasia*. Disney had become dissatisfied with the quality of film sound recording and is quoted in contemporary magazines as saying: "We know that music emerging from one speaker from behind the screen sounds thin, tinkly and strairy". So for two years the Disney Studios engineers' worked with RCA engineers to devise a sound reproduction system that would live up to the animation planned for *Fantasia*. In all, a thousand Disney assistants worked on the visual and audio interpretation of the seven classic compositions which form the basis of *Fantasia*.

What Disney wanted was what is now routine in a multitrack studio. But at that time even tape recorders were unknown. Multitrack was science fiction. There was no practical system of stereo reproduction by loudspeakers. As early as 1933 Bell Labs had demonstrated a multi-loudspeaker system for reproducing stereo sound but this relied on numerous hardwire

Scene from *The Sorcerer's Apprentice* sequence, *Fantasia*



Copyright Walt Disney Productions

channels to recreate the wavefront picked up by a matching array of mics. Meanwhile Alan Blumlein was working on exactly the same problems in EMI at Hayes but it is doubtful that Disney even knew Blumlein's name. In 1937 Stokowski had worked with RCA engineers to produce a multichannel recording for a film *One Hundred Men and a Girl* but although the sound was recorded in multitrack fashion, using optical recorders, it was mixed into a single channel for release and reproduction. What Disney and RCA now planned was a multitrack recording with multitrack release and reproduction. They also planned to extend the dynamic range of around 35dB which was then available from an optical sound film track, to 70dB—a range comparable with the natural characteristic of a symphony orchestra. Because there was no multitrack equipment available 'off the shelf' the Disney and RCA engineers set about modifying existing equipment for the recording process and designing suitable reproduction equipment from scratch.

They ganged together nine separate optical recorders using synchronous mains supply lock with sync pulses at the beginning of each take. In all, 33 microphones were used to cover the orchestra and six of the available nine channels were delegated to cover the sections' such as violin, cello, basses, woodwinds and so on. The seventh channel was used to record a mono mix of all six and the eighth channel recorded a distant pickup of the entire orchestra. The ninth channel was designated as a metronome or click track for use by the animators. The nine recorders were installed in the basement of the Philadelphia Academy of Music building. In all, nearly half a million feet of soundtrack film was recorded in 42 working days and processed by Disney's Hollywood labs.

Although the individual optical recorders were able to capture a good dynamic range with flat frequency response (a wide optical track on clean film is a delightfully linear recording medium) cinemas could not possibly be expected to gang a string of separate full width optical playback machines together in the projection box. And of course any reduction in track width would mean a degradation of signal-to-noise ratio. Disney plan-

ned to mix the eight audio tracks down into three (left, centre and right) for stereo release. But even with these three tracks on a separate film designated solely for sound and running in synchronism with the picture film, the signal-to-noise ratio of the reduced track width was still inadequate. So while the eight audio tracks were mixed down into left, centre and right, a separate control-tone track was recorded alongside the three audio tracks. This tone track was used to control variable gain amplifiers for the three audio tracks in gain riding fashion. In this way the dynamic range of each audio track could be expanded by 20dB.

Thus the released print for cinema projection took the form of two films, a picture film print plus a sound film print, the sound film print carrying four parallel optical tracks across its full picture width and thus no picture information. In fact the picture film print also carried sound information because the mono track was optically recorded down the film edge in conventional manner. This was regarded as a safety track, for use if the complex system used in the cinema to reproduce the separate audio track failed. The whole process was christened *Fantasound*.

The cinema installation was very exotic and very expensive. When *Fantasia* was premiered in 1940 there was just one cinema, the Broadway in New York, fully equipped as Disney intended. A total of 90 speakers, 39 behind the stage and 54 spread around the auditorium, were installed along with ganged picture and sound film projectors. The total cost of installation, even in 1940, was \$85,000. The object of spreading speakers round the auditorium was to reproduce sound sections of the track in true surround-sound fashion. To achieve this using just three tracks, the soundtrack film edge was notched to operate a mechanical switch which routed selected sounds to the side and rear speakers. For instance, church bells came from the rear and the Ave Maria chorus was routed to progress from the rear to the front of the cinema and link up with the solo voice behind the screen. Contemporary reports testify to the fine results, although judged by today's state of the art there was obviously room for improvement. For instance, because a multitrack printer did not exist, the four parallel tracks on the sound film had to be printed in succession by a step printer. One track was recorded during a first pass of the

film negative, then the optical head was racked over to record the second during a second pass and so on. This produced phasing effect and there was also some evidence of a rather clumsy noise gate in action. You can often hear such gates in operation when new prints of Forties films are screened on TV. It was particularly noticeable a while back on *Citizen Kane*.

Disney planned to equip at least a dozen cinemas to show *Fantasia* with full surround-sound and there was a road show with no less than 35 packing cases of Fantasound equipment moving round the country with film prints. But Pearl Harbour put a stop to all that. Once America was at war with Japan there was no time, money or enthusiasm for spectacular cinema sound. One can only guess at what might have happened had America not become involved in the war and Fantasound had taken off. Producer Walter Wanger had in fact already shut up his studios to await the availability of the Fantasound system for his own productions. Warner Brothers were working with RCA to modify their own Vitasound system to provide a souped down version of Fantasound.

The original optical tracks, recorded on nitrate film, lay around for years and deteriorated. In the Fifties when, first Cinerama, and then Cinemascope with magnetic sound tracks, became available the cinema looked again at stereo sound. Disney Studios collected together as many of the original release prints as possible and re-recorded them piecemeal to produce the best possible transfer onto magnetic film. *Fantasia* was re-issued with all tracks and has now been re-released again. Audio engineers thus do now have an opportunity to gain a reasonable impression of how Stokowski sounded in multitrack 40 years ago. They may also be interested to know that the sound panning heard on the track probably represents the first use ever of panpots. RCA and Disney worked with the Cinema Engineering Co, to develop a combination of potentiometers to shift the sound between channels during the mix down.

I am grateful to Disney Studios for making available to me contemporary documents and notes which have enabled me to put together this reconstruction of what happened during what must surely have been the world's first ever multitrack recording. Incidentally, it has been suggested that the release of *Fantasia* involved the re-

recording of tracks by Stokowski. This is categorically denied by Disney. They guarantee that all the sound you hear on the track comes from prints and copies derived from the original recording sessions.

Adrian Hope

## Air Montserrat postscript

We have received further details on the Neve console which has been supplied to George Martin's Air Studios Montserrat in the West Indies (*Studio Sound* May 1979 p30). The specially designed Neve console is a 52+6 channel mixer which incorporates a number of customised features not previously available on any Neve desk. The Air Montserrat Neve console has a very wide audio bandwidth extending from 10Hz to 40kHz with minimal distortion, and has specially tailored roll-off characteristics and custom designed equalisers in each channel. Other channel facilities include eight auxiliary outputs on each channel which can be used in a foldback mode, while any four auxiliary outputs per channel can be used for echo effects during mixdown or overdub. Additionally stereo panpots are provided on outputs 7 and 8 on each channel. Another unusual feature of the console is the use of remote gain-controlled mic amplifiers designed to enhance hf performance by reducing cable length between mics and their associated amplifiers. The Neve console is not presently fitted with *Necam* automation but is capable of retrofitting whenever it is deemed necessary.

George Martin, John Burgess  
and Geoff Emerick with  
Rupert Neve and Les Lewis looking on



## MAFILM, Budapest

MAFILM, the Hungarian film and TV production organisation, has recently completed a new sound recording complex in Budapest. Situated in a purpose-built modern building, MAFILM boasts a music studio with a volume of 150,000 cubic ft designed to meet the highest standards. The studio was built for orchestral music recording and has movable acoustic elements for recordings requiring a fairly dry sound, ie light music. It was constructed on the room within a room principle for total acoustic isolation, is fully airconditioned and has comprehensive lighting and projection facilities.

The control room has an extremely large window offering an excellent field of view into the studio and is equipped with a Neumann 28/8 console providing facilities for mono; stereo; 3-track, and 3+1-track recording for cinemascope films; 4-track, quadraphonic recording; and 5+1-track recording for Todd AO films. Tape machines comprise an Ampex MM1000 8-track recorder and Ampex AG440B 2-track, with 1/3-track 16 and 35/17.5mm recorders. Monitor loudspeakers are Altec Lansing, while ancillary equipment includes Neve and PDM equalisers, filters and compressors; AKG BX20 reverb; and Dolby A Model 361 noise reduction. Microphones include Neumann and Altec.

With the opening of this new studio MAFILM has become one of the most up-to-date film and television sound production studios in Europe. It is interesting to note that the facilities are available to allcomers with quotations available on request.

MAFILM (Magyar Film Gyártó Vállalat), H-1145 Budapest, Lumbumba str 174, Hungary.

Phone: (36) 834-533. Telex: 226860.

32 ▶

# Travel light.



The Nagra E is a professional.  
Totally self-contained. Ready to travel  
anywhere, anytime.

The 'E' has all the proven  
characteristics of Nagra high performance  
quality and accuracy.

Add to these, simplicity of operation,  
a useful range of accessories, a smart  
leather carrying case (complete with  
microphone pocket) and you will see that  
your lightweight travelling companion  
is no lightweight recorder.

**NAGRA KUDELSKI**

**HAYDEN**

Exclusive UK Agent

Hayden Laboratories Limited,  
Hayden House, Churchfield Road,  
Chalfont St Peter, Bucks.  
Telephone: Gerrards Cross 86447.  
Telex: 849469.

## Ferber Studios, Paris

Ferber Studios, although based in the outskirts, east of Paris, is within pleasant surroundings. Originally the building was a factory but was reconstructed with floating slabs to provide excellent sound insulation. It opened for business in January 1973 and became famous for the equipment it offers: two 24-track studios and the first automated console; a 32/24 prototype from Automated Processes.

The studio is extremely busy so I was grateful to manager and servicing engineer, Jean-Pierre Lafont (previously servicing manager for 3M France), for allowing me to take up a morning of his time.

Jean-Pierre is accountable for all present electronic and acoustic improvements and is well known for his self-built automatic phaser, real-time analyser and complimiter, developed especially for Ferber; and is respected for pushing French equipment, as it is very difficult to sell. "Our engineers themselves are prejudiced towards American equipment," says Jean-Pierre.

The building houses two studios—A and B, and the equipment has been chosen mainly from 3M France—to simplify servicing. They have three 3M 24-track tape machines, one for each studio and one spare. On the ground floor is Studio A with its control room, a small lobby, and a restaurant.

René Ameline, co-owner and chief engineer, designed the layout and acoustics of Studio A, and with John Moseley chose the equipment—but the leads were laid by John and a group of Englishmen. This studio, with 1,935 sq ft of floor area, a very high ceiling and two booths, can accommodate 80 musicians. The control room is 322 sq ft which is very pleasantly uncramped—René likes control rooms that feel like flats rather than sound laboratories.

Studio A has a 32/24 Automated Processes console that looks really impressive, each input channel includes a noise gate, a limiter and VCA facilities. From the outset a lot of functions could be programmed: echo sends, quad panning, channel routing and track-to-track transfer. "This console," said Jean-Pierre, "was very expensive (around £110,000 in 1973) and automation was too complex. To prevent breakdowns we decided to simplify automation: now faders and channel routing can only be programmed." Some improvements have been made; leads were shortened by 6m and the console



Studio A

transformers were replaced by active transformers—so the frequency response is better and the sound very dry and fast.

To the left of the console is a lot of ancillary equipment: Eventide digital delay line, *Harmonizer*, *Flanger* and *Omnipressor*; two Urei graphic equalisers, two Urei 1176 LN limiters and a *Cooper Time Cube*; JP Lafont automatic phaser, Ferber realtime analyser and limiter; eight Automated Processes' limiters, Audio & Design *Compex* limiter *F760X* and equaliser *E900*; Orban Parasound sibilance controller and five Kepex.

On the right is a rack with 28 Dolby As, Sansui *QSD4* encoder and decoder and a *Revox A77*. Tape equipment includes the 3M 24-track that runs at 30in/s without Dolby and two 3M 4-track machines. "We shall replace little by little the Studer *A80 RC* 4-track," said Jean-Pierre. Loudspeakers are Eastlake bi-amplified

by H/H *S500D* and equalised by Altec graphic equalisers. "At the beginning," related Jean-Pierre, "there were six Lockwoods in each studio, then we had Altec and JBL. The Eastlake are really satisfying." Reverb is provided to the two studios by an EMT *140* plate, three AKG *BX20s* and a *MicMix Master Room*—there is also a natural echo chamber.

Studio B, in the basement, is suitable for rock bands and offers 806 sq ft, including a booth, while the control room is 322 sq ft. This studio has a standard 24/24 Automated Processes console, Eastlake loudspeakers, 3M 24-track and 4-track recorders, and simplified ancillary equipment. Microphones include: Neumann *U47* and *U87*, a number of *C451s* with *CK1*, *C12*, *C412*, *D224*, *D202* and Electrovoice *RE15* and *RE20*.

Both studios offer an impressive variety of percussion instruments, two Steinway *Grand* pianos, Ham-

mond *C3* organs with Leslies and EMS *Vocoder 2000*.

The studio personnel includes four resident engineers, a freelance, three assistants, two servicing engineers, and four servants!

It was nearly midday when René Ameline, looking really sleepy, joined us. René has had a lot of experience in the recording business and said that Jean-Pierre wanted to stop recording and devote his time fully to studio management, but clients keep asking for him and he can't refuse.

In the beginning times were very hard, the studio leaseings were heavy and the studio had to pay for itself and its staff. These problems have now disappeared, but Ferber remains extremely busy. "For six years René slept only five hours each night," related Jean-Pierre.

I asked René what he felt about the studio equipment and what plans he had. "The console in Studio A was not cheap but the advantage is that, six years later, it is still in fashion. We have now decided to rebuild Studio B's control room and to save time we have built the new control room in a cellar near the studio, and have numbered all the pieces, so it will hopefully take only one week to rebuild." Jean-Pierre added: "we have plans for a mixing room in one or two years and the basement, near Studio B, provides good possibilities for extension. Firstly, we will put our third 24-track machine in, then perhaps two 24-track recorders synchronised for 46-track mixing—this would enable Studio A's control room to be used for things other than mixing. We also want to develop our own equipment, and are working on digital techniques. The desk will be built here and will include 50 inputs, functions programming . . . and later we will replace Automated Processes' machine." "Digital will come in three or four years," said René.

Artists who have used the studio include: Emerson, Lake and Palmer, Frank Zappa, Ringo Starr and a lot of French musicians. There is a 'Ferber Sound' and the studio offers unusual facilities—faultless equipment, large and pleasant control rooms, and above all a highly qualified and very friendly staff. It was pleasant to talk with Jean-Pierre and René who are continually looking to improve their equipment, even going as far as to build it themselves.

Ferber Studios, 56 Rue du Capitaine Ferber, 75020 Paris, France. Phone: 361 31 01. Jean Marandet

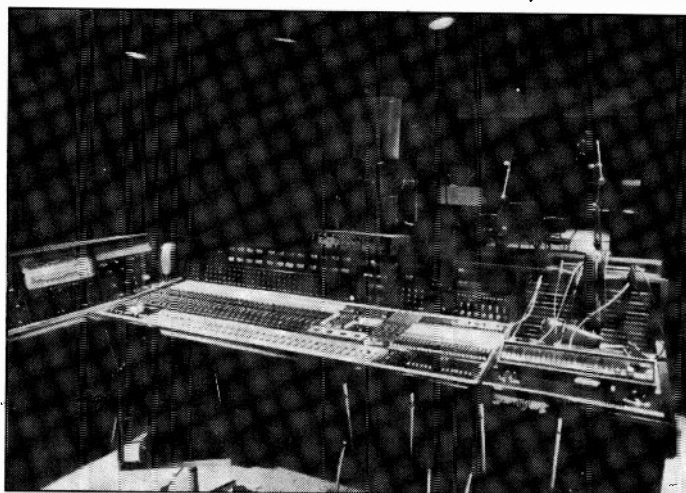

Control room A with Automated Processes 32/24



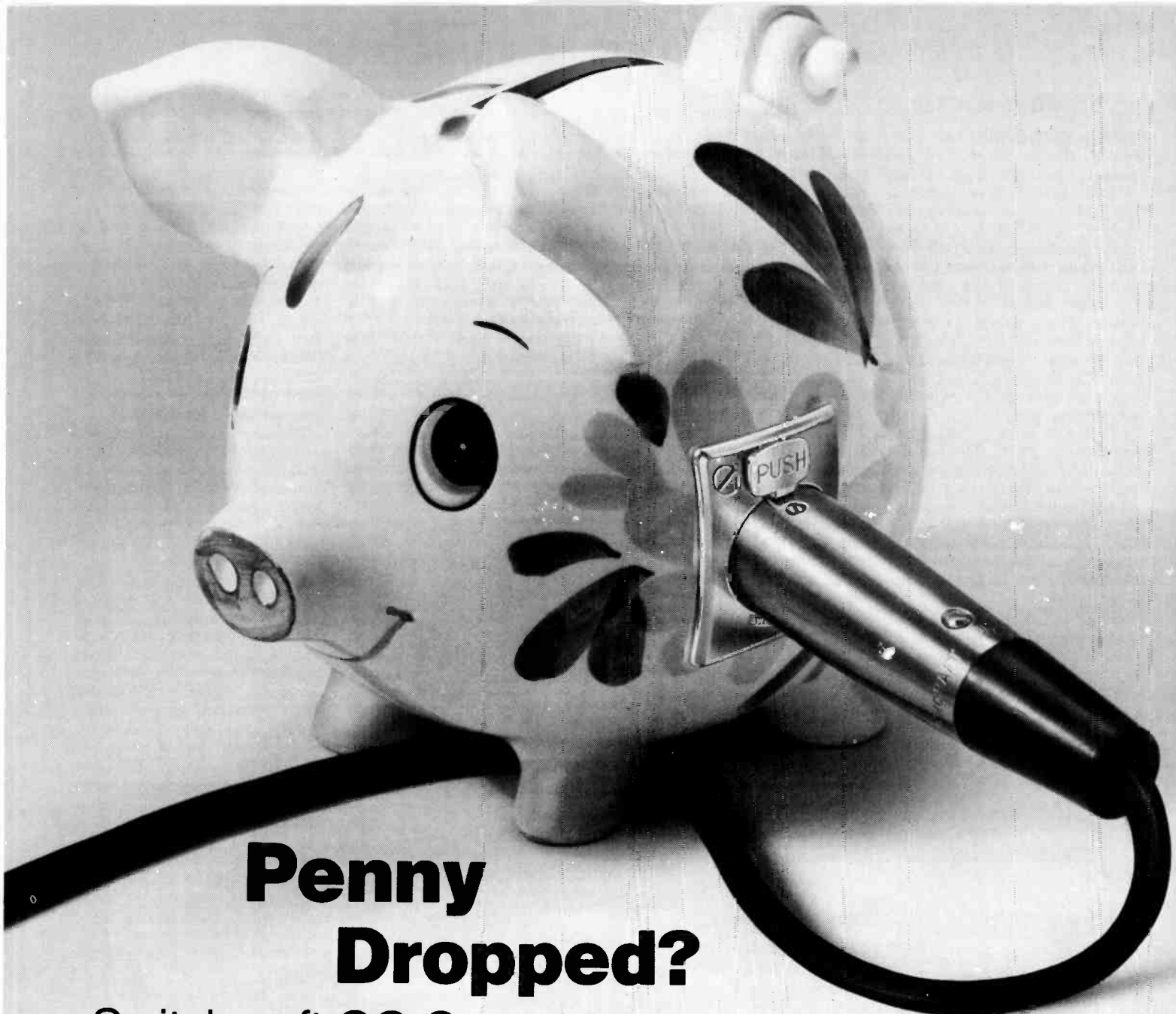

# Penny Dropped?

Switchcraft QG Connectors are money savers . . . .

Because we have introduced an attractive new quantity discount structure. Switchcraft are still the same high quality, with unique features such as captive design screws and shell ground terminals.

Two new additions to the range are –

## FAS-DISCONNECT

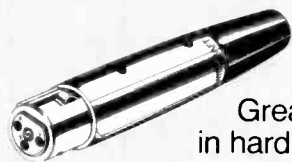

A new non-locking feature allowing immediate disconnection that requires only a 4 lb (1.8 kg) force.

Great for that fast equipment take-down in hard to reach, darkened areas. Stage hands never had it so good!

## REAR MOUNTED RECEPTACLES

The new Y series QG receptacles permit a complete sub assembly to be soldered, cleaned and tested prior to chassis mounting. Available with PC or solder terminals with lock or Fas-disconnect latching, the Y series offers real savings in production costs. Extra colour trim escutcheons provide functional panel trimming and colour coding.

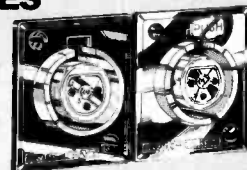

Switchcraft QG Connectors are just right for audio mixers, consoles, PA systems and in computer applications.

*The professionals choose Switchcraft QG and save the pennies!*



## F.W.O. Bauch Limited

49 Theobald Street, Boreham Wood, Hertfordshire WD6 4RZ  
Telephone 01-953 0091, Telex 27502

## Filmways/Heider remotes

Wally Heider Recording, now known as Filmways/Heider Recording, was one of the first in the field of mobile recording. For example, in 1967 the first rock and roll Pop festival, Monterey Pop, was recorded on 8-track by Wally himself. Those of you who saw the film *Monterey Pop* could witness Wally saving his microphones during The Who's destruction on stage. Since then, remote recording has changed greatly.

The obvious change is multitrack recording growing from 8-track to 24-track and beyond. Qualifying 'beyond'—in 1978, Bill Sargeant requested the Heider mobile units to record on double 24-track (48 tracks) for the filming of the stage play *Stop The World, I Want To Get Off*. This show's equipment requirements were immense—from 120 microphones to four 24-track tape machines.

Also in 1978, Heiders were contracted by the Merle Haggard office to record Merle while vacationing on Lake Shasta in Northern California. The equipment requirements for this remote ranged from mosquito repellent to a fully equipped recording truck that could be barged to the middle

of the lake to Merle's hideaway. The relaxed atmosphere of that recording session is becoming more evident in the overall direction that the mobile recording field has taken.

During last summer's concert season, their remote truck headed for the Hollywood Hills to record Chuck Mangione, accompanied by the 101-piece Los Angeles Philharmonic Orchestra, live at the Hollywood Bowl. On a complex project such as this, engineers Ray Thompson and Mic Gizowski utilised 124 microphones in order to reproduce the orchestra's full, rich sound on tape.

Over the past year, Heiders has recorded several other remote album projects. Among them was Bob Dylan's *Street Legal* on the CBS label. This project was in itself an unusual situation. Bob Dylan and his band were in rehearsal for an upcoming world tour. Because he and the band were comfortable at their rehearsal location, they decided to record their album there. They wanted to achieve a live sound but under a controlled situation. Heiders Mobile Unit 2 was set-up at the rehearsal location and engineer Biff Dawes managed to produce a

live feel, without the presence of an audience.

Communication between the stage (or in this case the indoor rehearsal location) and the truck, is the main obstacle in this type of recording situation. So that everyone involved knows what is going on at any given time during the recording, a video camera and PL communications system were set-up inside the rehearsal hall with the video monitor and communications system operational in the truck. Once the communications systems were set, Dylan began his 'rehearsal', and after six days the album was finished, complete with background vocals—no overdubs were necessary. All that was left was a final mix and mastering.

Another album that was recorded totally on location is the nearly completed Little Feat album which is currently being mixed in Mobile Unit 1. Having worked with the Heider mobile unit previously, engineer Ray Thompson and maintenance technician Billy Youdelman booked the truck for an on-location recording at the Little Feat Paramount Ranch rehearsal location. In this case, Little Feat was recorded live but under studio conditions, not as in

Dylan's case, a live album, but a studio album done where and when the artists wanted.

The truck was set-up for tracking and the recording began with Lowell George and Ray Thompson producing. On completion of the tracks, the truck was moved to a more convenient location for overdubbing and then the mix (now in progress) began. The Little Feat, Bob Dylan and Merle Haggard albums were all done where and when the artists specified. At present this seems to be the trend in mobile album recording.

The other side of mobile recording is television production. Large scale television specials such as the Academy Awards, the Grammy Awards, American Music Awards and the Academy of Country Music Awards shows, all require quality audio facilities and recording for broadcast. As an example, the 1978 Academy Awards show production included a 100-piece orchestra playing live and accompanying various artists as well as the usual award show activities. The audio requirements included 140 microphones, several mixing consoles, hundreds of miles of cable and eight days of set-up and preparation. **Jim Seiter**



MXR 2x15 Band Graphic Equaliser

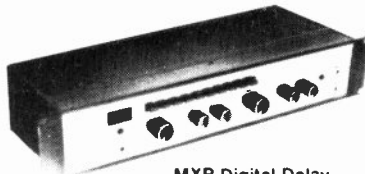

MXR Digital Delay



Revox B77

We are one of the leading equipment sales and installation companies, offering you a friendly and helpful service.

Every item we supply is tested and aligned in our own workshops, and after-sales service is always readily available.

We supply anything from an XLR to a complete 8-track studio installation, at competitive prices to clients that include recording and AV studios, government departments, schools, radio stations, theatres and PA companies in all parts of the world.

Our stocks include AKG, Allen & Heath, Beyer, Brenell, Ferrograph, JBL, MXR, Neal, Quad, Revox, Sescam, Shure, Sonifex, Studiomaster, Tannoy, Teac, and Uher.

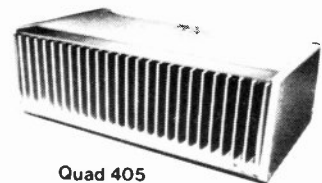

Quad 405

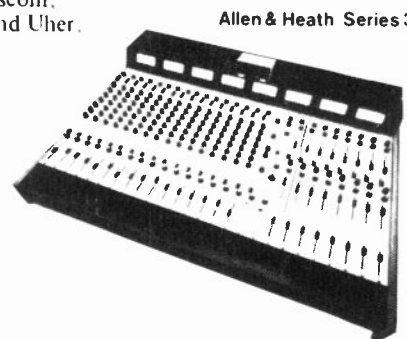

Allen & Heath Series 3

## STUDIO EQUIPMENT SERVICES

Studio Equipment Services Ltd.

The Studio Shop, Oxgate Farm  
Coles Green Road, London NW2 7EY  
Telephone: 01-452 1979

# Publison Audio Professional Manufacturing

## CATCH THE 'NEW' SOUND WITH THE 'NEW' AUDIO COMPUTER!...



### DHM 83 B

By means of complex digital manipulation of memorized sounds (memory capacity : 210 kilobit), this device allows many original effects :

**Dual delay**, with various combinations bandwidth – maximum delay (bandwidth up to 20 kHz. Delay up to 1200 mS. On request, up to 5000 mS).

**Echo**

**Pitch shifting**, from –2 to +1 octave. Sophisticated micro computer operates phase-coincidence of joining points, and eliminates "glitches". Minimum and maximum delays of pitch-shifting are adjustable.

**Automatic arpeggio**

**Reversed sound** : electronic equivalent of a magnetic tape running reversed. Reversed sound can be itself pitch-shifted.

**Memory latch** : memorized sound can repeat indefinitely. Start, length, reading sense and pitch-shifting of repeating sequency are adjustable. Numerous applications : rhythm with any natural sound, memory synthesizer, by means of associated keyboard, ETC !

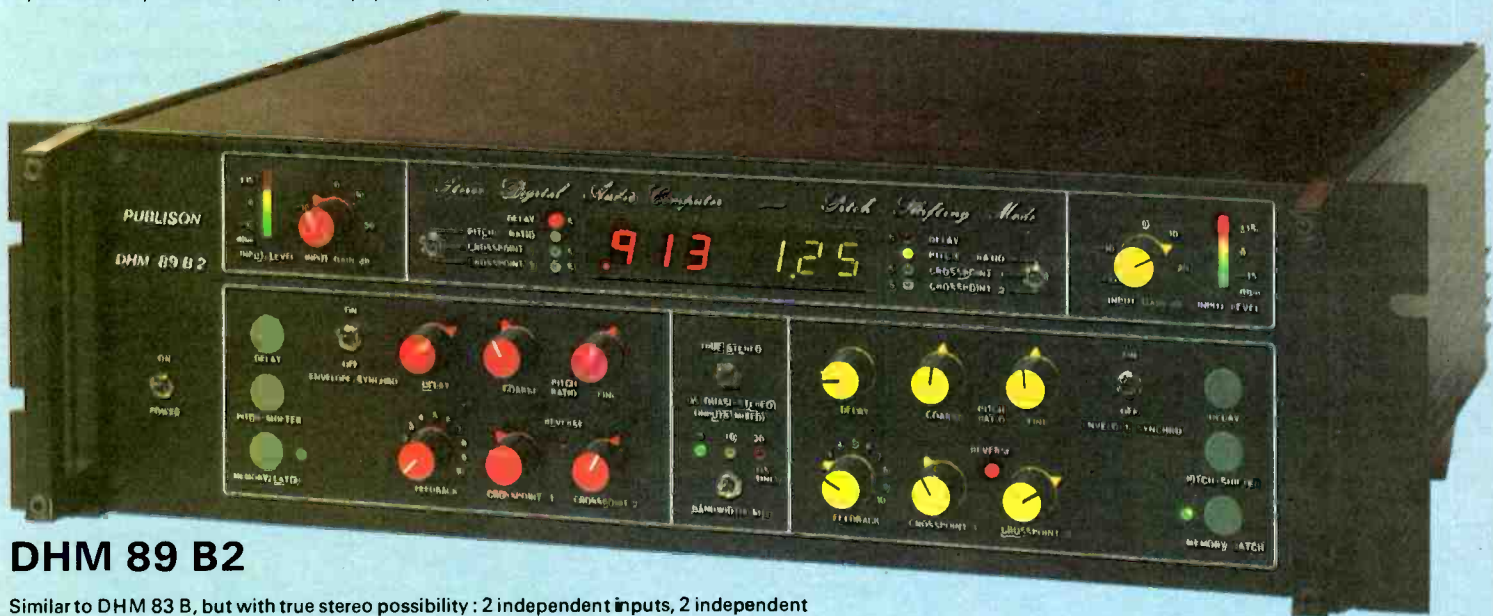

### DHM 89 B2

Similar to DHM 83 B, but with true stereo possibility : 2 independent inputs, 2 independent pitch ratio.

FOR FURTHER INFORMATION CONTACT PETER DEAN

## Publison Audio Professional

5-7-9 RUE CRESPIN DU GAST 75011 PARIS

TEL: (0-10-33-1-) 357 64 08

# Auditorium Acoustics for Rock Concerts

Ken Dibble

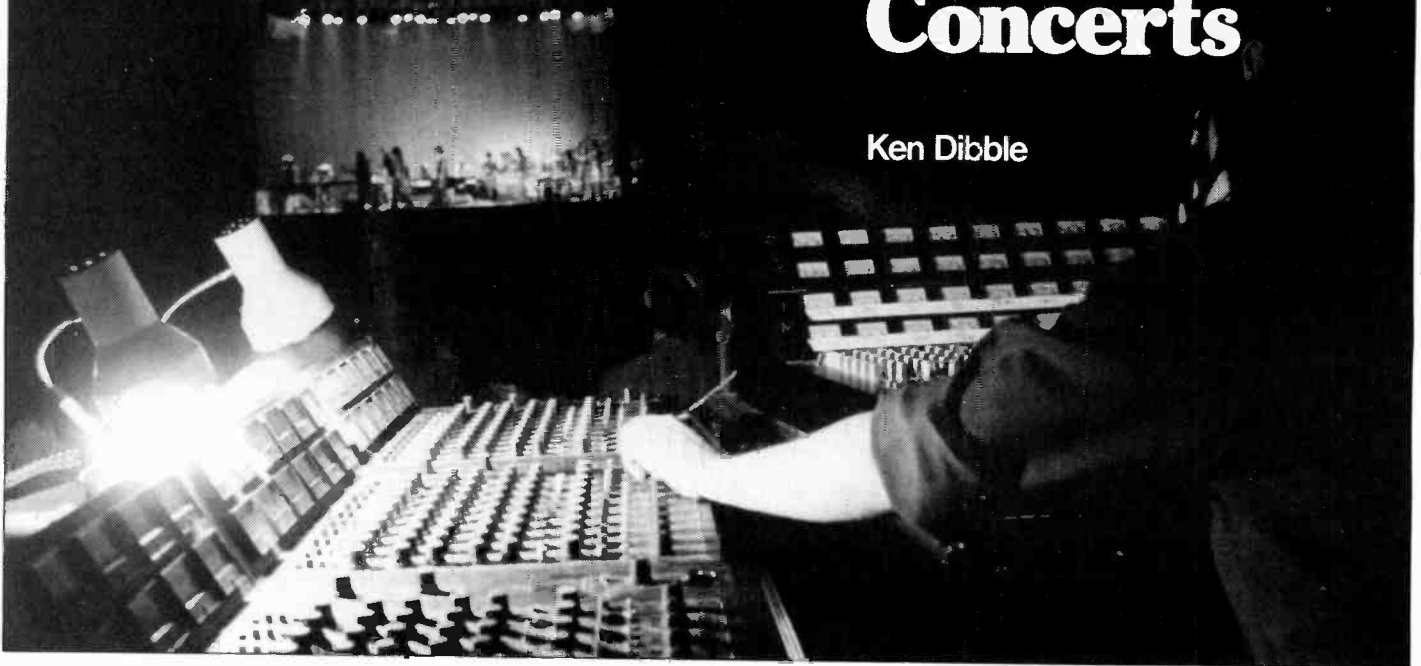

**T**HE National Exhibition Centre stands in 400 acres of landscaped parkland at the very hub of Britain's motorway and rail network, and is right alongside Edmdon Airport, Birmingham. It was officially opened in 1976 by Her Majesty the Queen and is the first purpose-built exhibition complex to have been constructed in Britain since the Crystal Palace was built in Hyde Park for the Great Exhibition of 1851. Besides providing six separate exhibition halls of varying sizes to accommodate practically any type of exhibition requirement, the complex also includes a central Piazza offering a whole range of back-up services: bars, restaurants, two first class hotels and a conference centre. British Rail's Birmingham International station runs right alongside the complex and is directly linked to it by a covered overhead walkway. In fact, every facility likely to be required for the staging of exhibitions and conferences on a national or international scale are available on the site, and this, coupled with its unrivalled accessi-

**Very few rock concerts are presented in purpose-built auditoriums, more often than not they take place in large stadiums, exhibition halls, and other acoustically bad locations. But Ken Dibble, a consultant in electro-acoustics, was approached to overcome the problems of presenting rock concerts in a new large exhibition centre in Britain.**



**Large pic:** Close-up on the mixing desks, stage in the distance. **Above:** Hall 5 with an amazing number of seats. **Below:** Mike Oldfield in concert, Hall 5, 1979.

bility by road, rail and air, unhindered by the bustle and congestion of the London venues, probably accounts for its almost immediate success—remembering that the complex is only just three years old.

Although the hall space available is heavily booked—often years in advance by exhibition organisers—there are inevitably periods when some of these halls remain empty. In an attempt to maximise the use of the facilities available, and to open up the NEC to other uses, the management have embarked on a policy of letting halls not required for exhibition use, for concerts, sporting events, and other types of entertainment. So far, the World Table Tennis Championships and the Birmingham International Showjumping, both televised nationally, have been staged and a Conservative Youth Rally was held in early June 1979. To add further to the variety, a Sikh Festival and a Veteran Car Rally was held in June, and at present a 4-week summer circus is under way. In December 1978, Rory



Gallagher played the first major rock concert to be staged at the NEC, and this was followed by Rod Stewart. Already booked for 1979 at the time were Johnny Cash, Mike Oldfield and Status Quo, but after the Gallagher and Stewart concerts, there was some doubt as to whether these would go ahead due to the difficulties experienced with the acoustic conditions within the halls. Following his concerts, Rod Stewart was interviewed for the BBC Television programme *Nationwide*, and complained bitterly about the poor acoustics and excessive echo. Therefore, if the NEC were to survive as a major rock venue, it became apparent that steps would have to be taken to effect some improvement. Rod Stewart's sound system had been provided by TFA-Electrosound who were therefore in the thick of it as far as understanding the problem, and it seemed natural that they should be brought into the discussions at the outset. Simon Woodroffe, assisted in the early stages by Bill Kelsey, represented Electrosound at the various meetings with the NEC management. Subsequently, the author was invited to join the team to advise on the specialist acoustic aspects and to identify the likely causes of the problems being experienced.

Although the Stewart and Gallagher concerts had been staged in Hall 3, it was anticipated that mostly, such events would be held in Hall 5. This is because Hall 5 has been specially constructed to provide a large open area free from structural support pillars, and by a clever arrangement it would be possible to provide an arena sufficiently large to accommodate a seated audience of 10,000 plus, without obstruction of sight lines. Whereas Stewart and Gallagher had played to a standing audience, it had been decided to purchase a demountable system of tiered seating which although likely to be used mainly in Hall 5, could be dismantled for storage and re-erected in any of the other five halls as and when required. In practice, however, the manual labour and time factors involved in erecting such a huge arena are such that the arena is likely to be left in-situ for several weeks at a time, and to be used for a number of events before it is dismantled. This factor of course completely ruled out any possibility of permanent acoustic treatment of the halls themselves, which would be the normal manner of dealing with a problem of this nature. Fig 1 gives some idea of the layout of the NEC.

Hall 5 is vast by any comparison. It is approximately 700ft in length, 400ft wide and 75ft high. The total floor area is therefore about

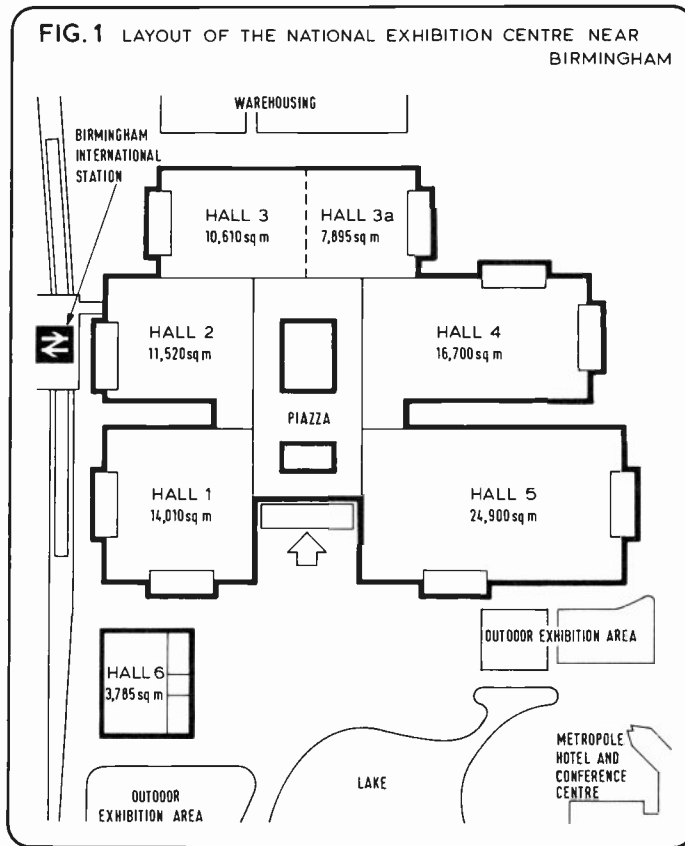

280,000 sq ft and its internal volume something in the order of 21,000,000 cubic ft. The floor has a surface treatment of 'Latexfelt' over concrete, and this is about the only surface treatment which offers any absorption to sound at all. The walls are solid block with glazing over the upper 6ft or so, and the roof consists of a complex matrix of steel trusses carrying a heavy corrugated steel roof, the trusses in turn being supported by a forest of steel pillars on a 96ft grid. Some idea of the construction is given in fig 2. The whole building is like a gigantic echo chamber, and the 'clang' of a heavy object dropped in the empty hall seems to resound for ever. Little wonder Rod Stewart was not happy with his sound!

Although the Hall 5 arena layout plan given in fig 3 shows that the arena itself occupies only one-third of the total floor area of the building, the surface area and volume of the entire hall must be taken into account when acoustics are considered — not just the area occupied by the arena. As a first step therefore—with time against us due to the Johnny Cash concert being just a few weeks away—the reverberation time and frequency response characteristics of the empty building were measured. These measurements were in fact made late at night, immediately prior to the erection of the arena which was to serve for the International Showjumping event, the Cash, Oldfield and Quo concerts and the summer circus, and it would be some 15 months before we could again get into Hall 5 to make tests on an empty hall! Fig 4 shows the rate of decay from a filtered wide-band pink noise source at 500Hz, and fig 5 shows the decay at 4kHz. The reverberation times calculated from these produce figures in the order of 12 to 14 seconds at 500Hz and 4 seconds at 4kHz. This high level of absorption at the higher frequencies is confirmed by the frequency response characteristic shown in fig 6, where a rapid fall-off at frequencies above 2kHz can be seen.

The reverberation time of a concert hall is one of the most important factors that will govern its suitability for music, and some idea of the orders of magnitude desirable in halls of various volumes and at various frequencies can be gained from the graphs shown in figs 7 and 8. A great deal of research has been carried out into this subject, the most notable work probably being that of L L Beranek.<sup>1</sup> However, it soon became obvious that within the limitations imposed by the fact that any acoustic treatment had,



**Above:** Fig. 2 shows some idea of construction.  
**Below:** Close-up on Mike Oldfield's shades.



# Auditorium Acoustics for Rock Concerts

due to necessity, to be removable and also of budget limitations, there was no way we were going to get the reverberation time down to the lower single figure region at the lower and mid frequencies as recommended by these curves, even allowing for the increased RT at

low frequencies permitted by the curve in fig 8. Therefore, a compromise had to be sought. Further calculation shows that there are already some 6,700 Sabins of absorption in the building and to even halve the reverberation time would necessitate the introduction

of a further similar amount of absorption. This would involve the treatment of thousands of square feet of surface area—again an impracticable proposition.

At first, it seemed that the suspension of specially designed absorbers from the roof might offer a solution, but the two major difficulties here were: firstly that the absorbers would interfere with the proper operation of the sprinkler valve system installed in all six halls, and secondly the difficulty of rigging such a system on a temporary basis in such a way that the severe weight restrictions on the roof trusses was complied with.

Of course, there is one very important contributing factor that we have not yet considered, and this is the acoustic absorption provided by the audience themselves when occupying the tiered seating stands that enclose the arena. This alone would provide some 2,500 Sabins of absorption and reduce the RT to about 9 seconds. Besides providing a sizable chunk of much needed absorption, it occurred to me that one of these fully occupied tiered seating stands would provide a useful degree of attenuation to

sound energy destined to excite the high levels of reverberant energy in the unused part of the hall behind the arena. The obvious solution therefore seemed to be to screen off the wide gap left between the top of these tiers and the underside of the roof structure, thereby enclosing the arena area. It would seem from the application of theory that if large baffles were designed with the desired absorption characteristics on the inside and were highly reflective on the outside, then these would contribute to the overall scheme of things in a number of ways:

- a The absorbing inside surface would provide almost another 35,000 sq ft of treated surface, which with suitable materials could provide a further 1,000 Sabins of absorption.
- b The reflective back would serve to contain the reverberant energy present in the unused part of the hall within that area, thereby reducing its interference effect on the direct sound from the loud-speaker system.
- c By suitable design, the baffles could be made to provide a high degree of attenuation to

FIG. 3 FLOOR PLAN OF NEC HALL 5 WITH TIERED SEATING AND STAGE

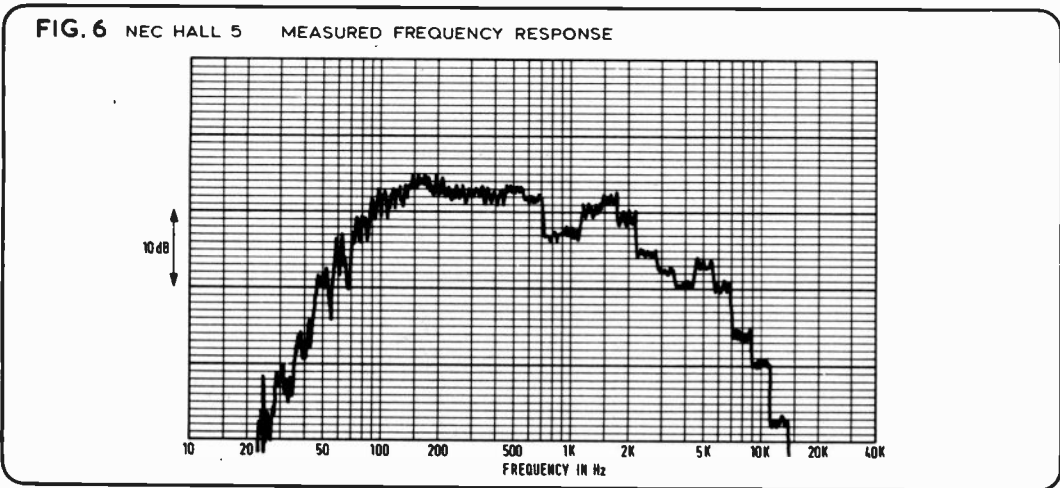
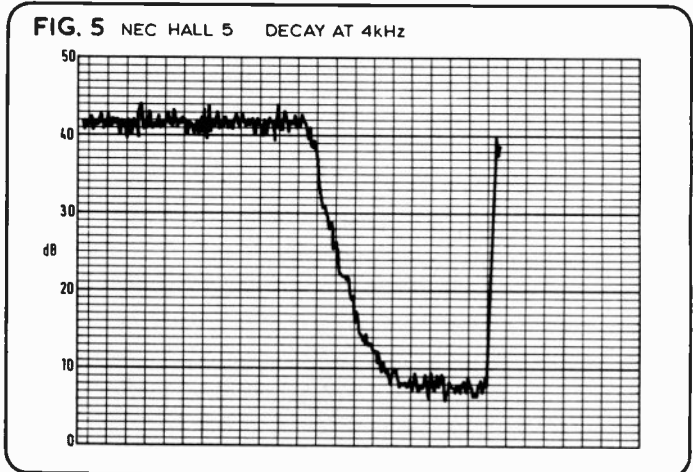
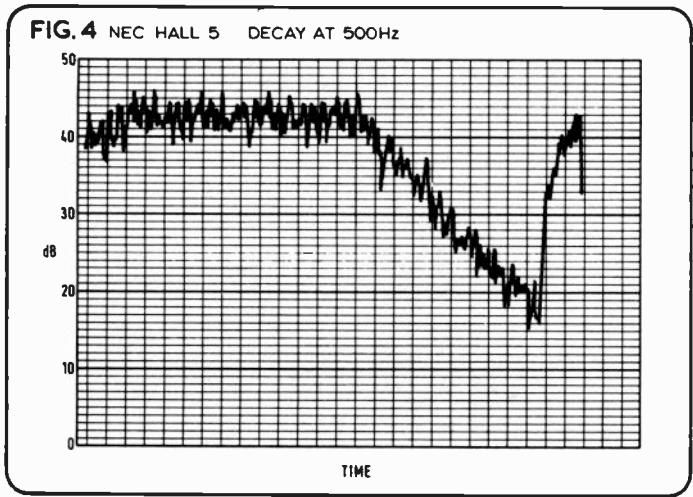
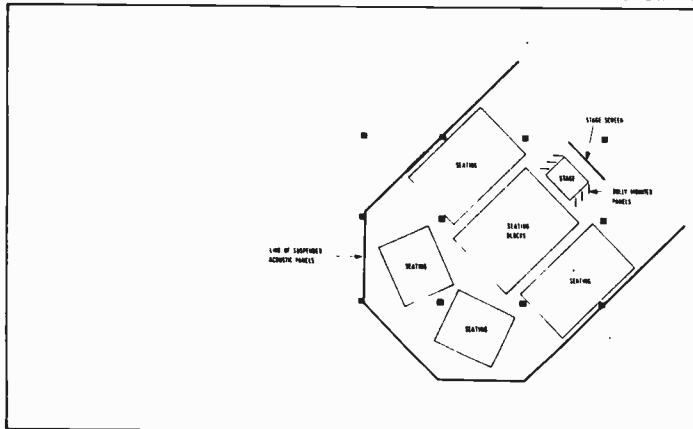

the spillage of direct sound from the arena to the unused parts of the hall, thereby reducing the excitation of reverberant energy in those areas.

- d Where the back of the seating stands are in close proximity to the walls, the baffles would provide a substantial reduction in reflections attributable to this cause, serving therefore much the same purpose as permanent treatment of the building.
- e Such a system would be infinitely flexible in that it would lend itself to any number of different configura-

**Imagination fuses two powerful illusions.**

**Experimentation leads to the  
discovery of new realities.**

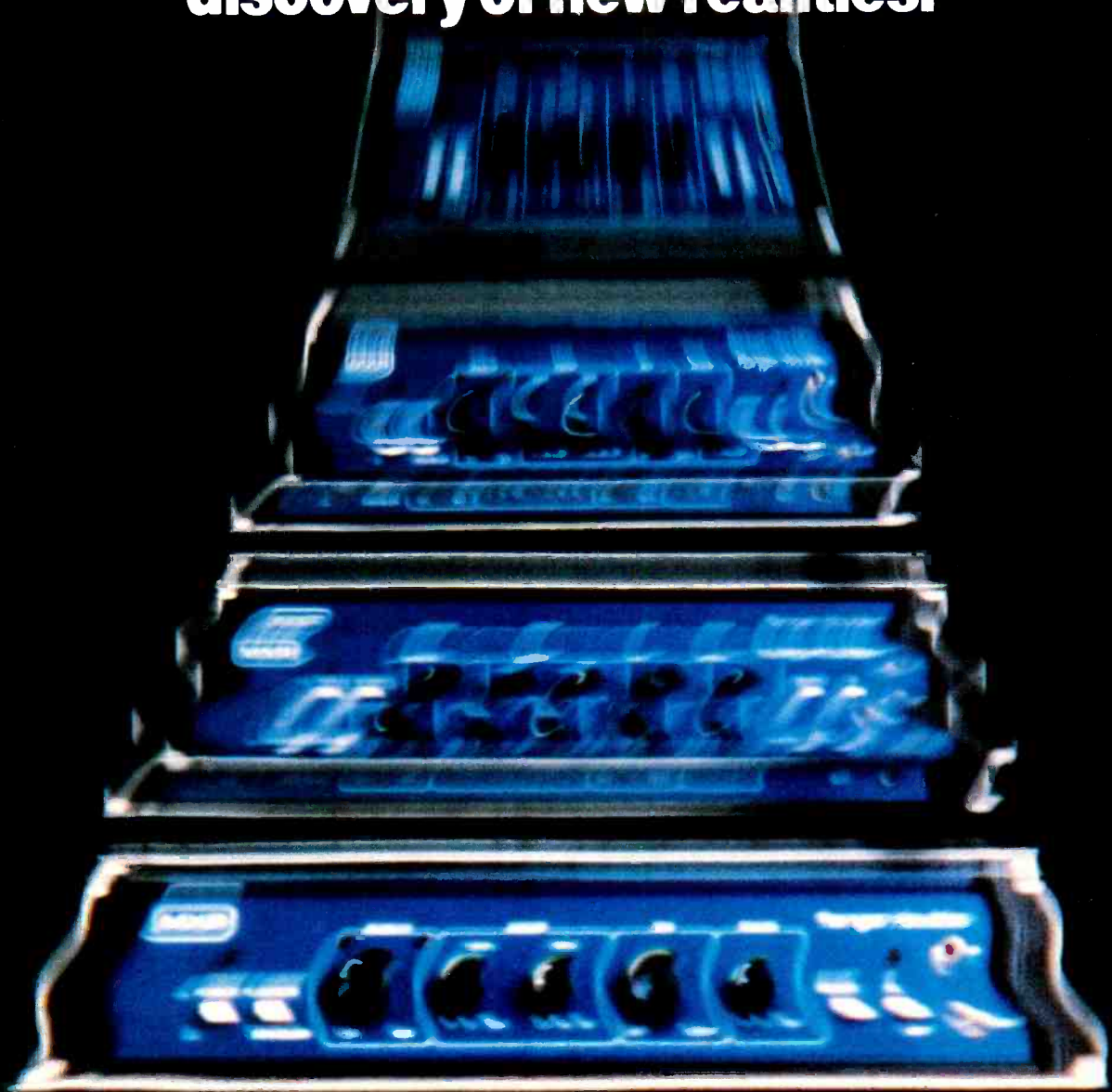

Introducing the MXR Flanger/Doubler.  
For more information see your MXR dealer or write us.

Atlantex Music Ltd., 16 High Street,  
Graveley, Herts., England, (0438) 50113



Professional  
Products Group

# Auditorium Acoustics for Rock Concerts

tions to suit practically any arena layout and can be expanded simply by the addition of further panels.

f Although by necessity such panels would be of heavy construction and large dimensions these could, with careful design of the rigging system, be suspended on catenary wires from the main structural pillars in such a way that the load bearing capability of the roof trusses was not interfered with at all.

Whilst acoustic performance must be the main factor in the design of such baffles, it had to be borne in mind that large numbers of these would be within reach of the audience and therefore prone to damage. Also, due to the size

suspended and that the weight was properly distributed, and hung only from the main roof support pillars. Another specialist, Jeremy Thoms, was brought in to design the rigging system and finally a proposal was put to the NEC management for approval.

The scheme proposed was in three stages:

- 1 The manufacture and supply of sufficient panels to completely enclose three sides of the arena to a depth of 16ft below the roof truss level. All rigging apparatus necessary to hang the panels along the line indicated in fig 3 was included. Also included were a small number of extra panels to be positioned behind the stage platform, and a further

of 16ft square panels across the roof of the arena area only.

It was estimated that working in conjunction with a capacity audience, scheme 1 would reduce the reverberation time to something in the order of eight seconds, scheme 2 to about  $7\frac{1}{2}$  seconds, and scheme 3 to about  $6\frac{1}{2}$  seconds. However, in the cases of schemes 1 and 2, the reverberation time does not tell the whole story, as the masking effects of the various panels in respect of audience seated in the upper rows of the tiered stands, and those in close to the large openings between these stands, would be expected to be considerably better than the reverberation time figures would indicate. These proposals were discussed at a meeting at the NEC on February 22, 1979, following which an order was placed for scheme 1 as an initial installation. The deadline was that the system must be instal-

led and in operation for the Johnny Cash concert on March 17, leaving just three weeks to obtain materials and manufacture a total of 94 specially designed baffle panels and the entire rigging gear. TFA-Electrosound delivered on March 12 after sending a van to Holland to collect the special acoustic materials and the NEC riggers had the system up by March 16. If all went well for the Cash show, there was every chance that the Oldfield and Quo concerts would go ahead.

It worked! It worked for Johnny Cash in March, it worked for Mike Oldfield and Status Quo in May. It looks as if rock concerts—along with other forms of entertainment—are to be an ongoing feature at the National Exhibition Centre. Obviously, an RT of around 8 seconds is far from ideal, but at least it can be lived with.

Reference (1) *Music, Acoustics and Architecture*. L L Beranek 1962. ■

FIG. 7 RECOMMENDED REVERBERATION TIMES AT 500Hz (FULL)

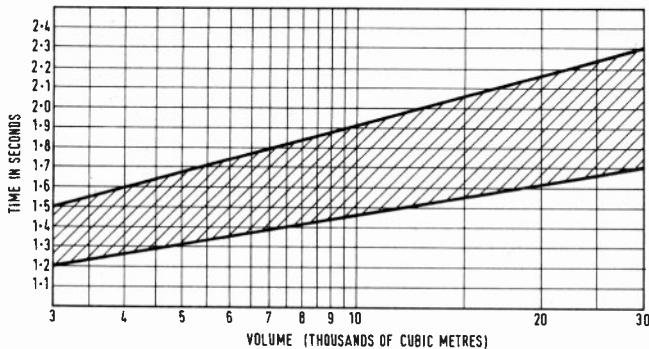

Mixing is from a central position, among the audience.



and weight, the panels would have to be handled by fork trucks and cranes and must be able to withstand some fairly rough handling. These requirements ruled out the use of the mineral fibre tiles as used for acoustic ceilings, and therefore imposed a considerable restriction on the choice of absorbing surfaces available. The design finally adopted is shown in fig 9. Another problem was that of rigging the panels (each weighing some 550lb), in such a way that the panels remained vertical when

number of panels mounted on dollies. These were to provide some acoustic screening of the stage itself to reduce the effect of reflected sound and reverberation on the function of the stage monitor loudspeaker system.

- 2 The supply of further panels to completely fill the major gaps left between the seating stands down to floor level.
- 3 The supply of further panels and associated rigging to fly a 'chequerboard' arrangement

FIG. 8 RECOMMENDED REVERBERATION TIME AS A FUNCTION OF FREQUENCY

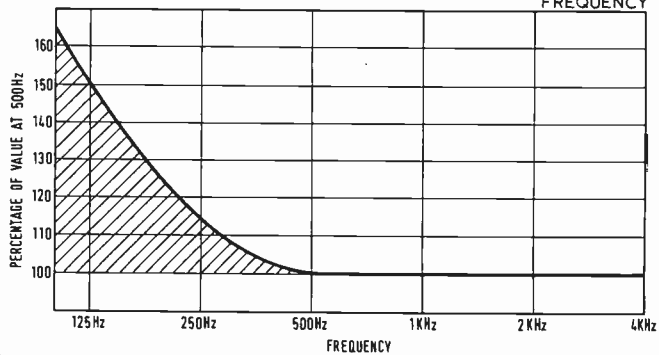
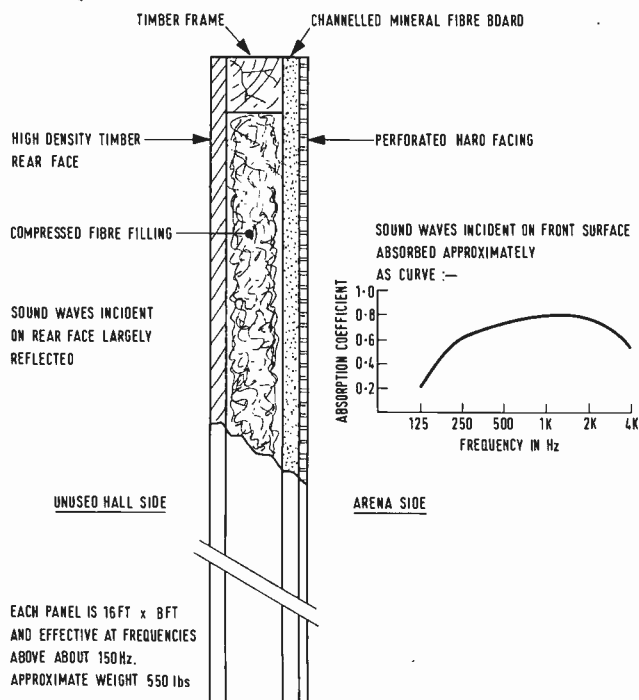

FIG. 9 CONSTRUCTION OF BAFFLE PANELS





*40 Channel Remix Console supplied recently  
to Olympic Sound Studios, London.*

**The Series III De Luxe range of mixing console  
represents a high quality versatile system. A fully  
detailed colour brochure, including price lists, is  
available direct from the factory or agents.**

**AGENTS:**  
Canada C.O.R.A. Inc.  
131 - 18eme Rue, 1046 Quebec P.O.,  
Canada Tel. 418-522-1397

Denmark Audiophil  
Howitzei, 49-1, 2000 Copenhagen,  
Denmark Tel. 134 1622

Netherlands Prietor Bollen, Geluidstechniek bv,  
& Belgium Hastelweg 6, Eindhoven,  
Holland. Tel. 40 51 2177/520662

South Africa Prosound,  
Elkhaim, Upper Level Pretoria Street,  
Hillbrow, Johannesburg 2001  
South Africa. Tel. 642-8721/1209

Spain Telco Sociedad Limitada, Gravina 27  
Madrid, Spain. Tel. 1 2317840

France Reditec,  
62,66 Rue Louis Ampere,  
93330 Neuilly/Marne, France  
Tel. 300 96 30

W. Germany Elnus GmbH,  
D1 Berlin 12,  
Henderstrabe 16,  
W. Germany, Tel. 030 312 2012

Acoustics Audio Import  
Curtiusstrabe 85,  
4300 Esson 1. Tel. 0201 7017 34

U.S.A. (Brochure Service Only)  
Keith Monks Audio (USA),  
652 Glenbrook Road,  
Glenbrook CT 06906  
Tel. (203) 348-4969

**Raindirk Limited** Downham Market Norfolk Tel. 03663-2165 Telex No. 817737

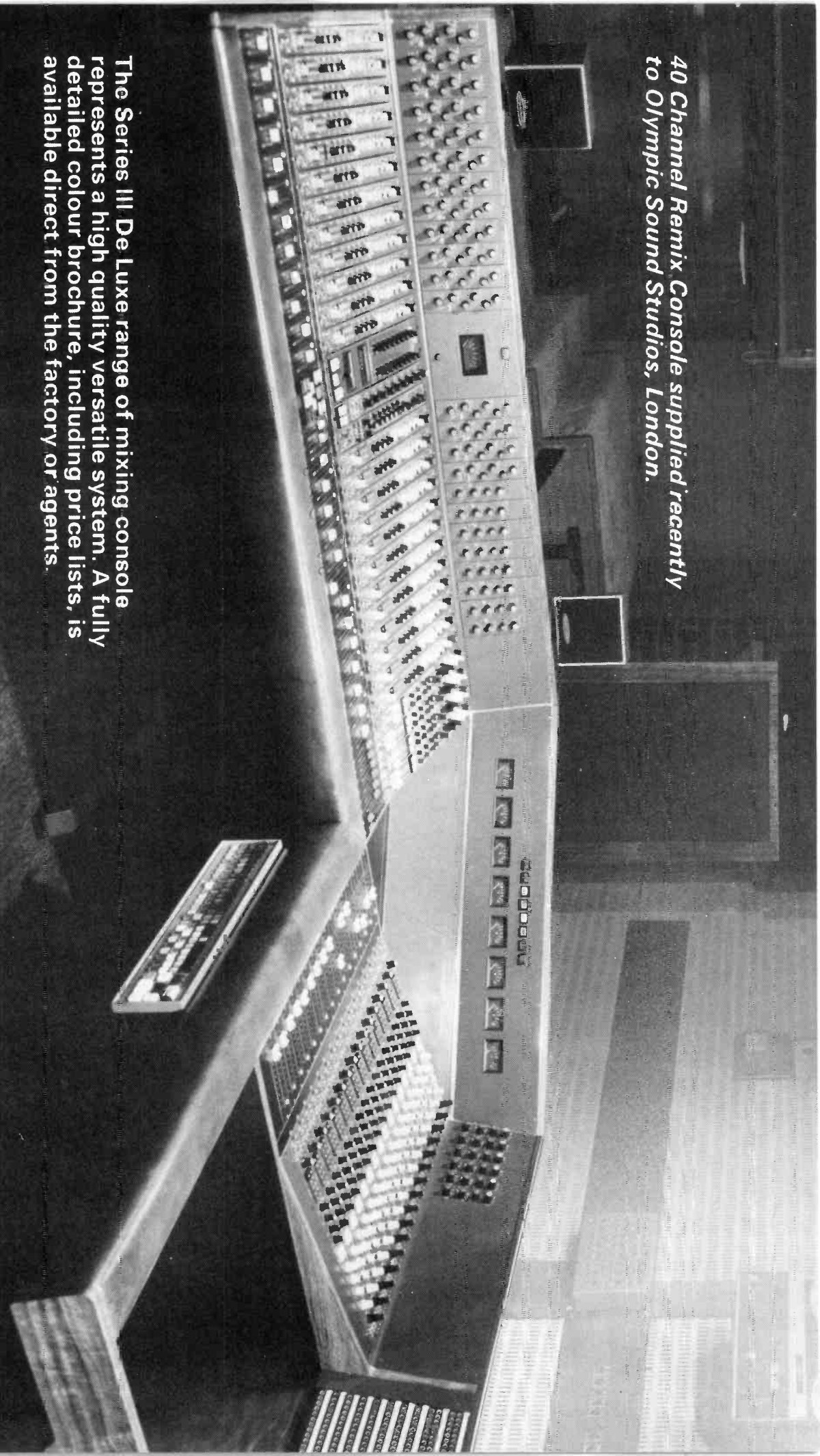

# THE ULTIMATE...



**MCI**<sup>®</sup>

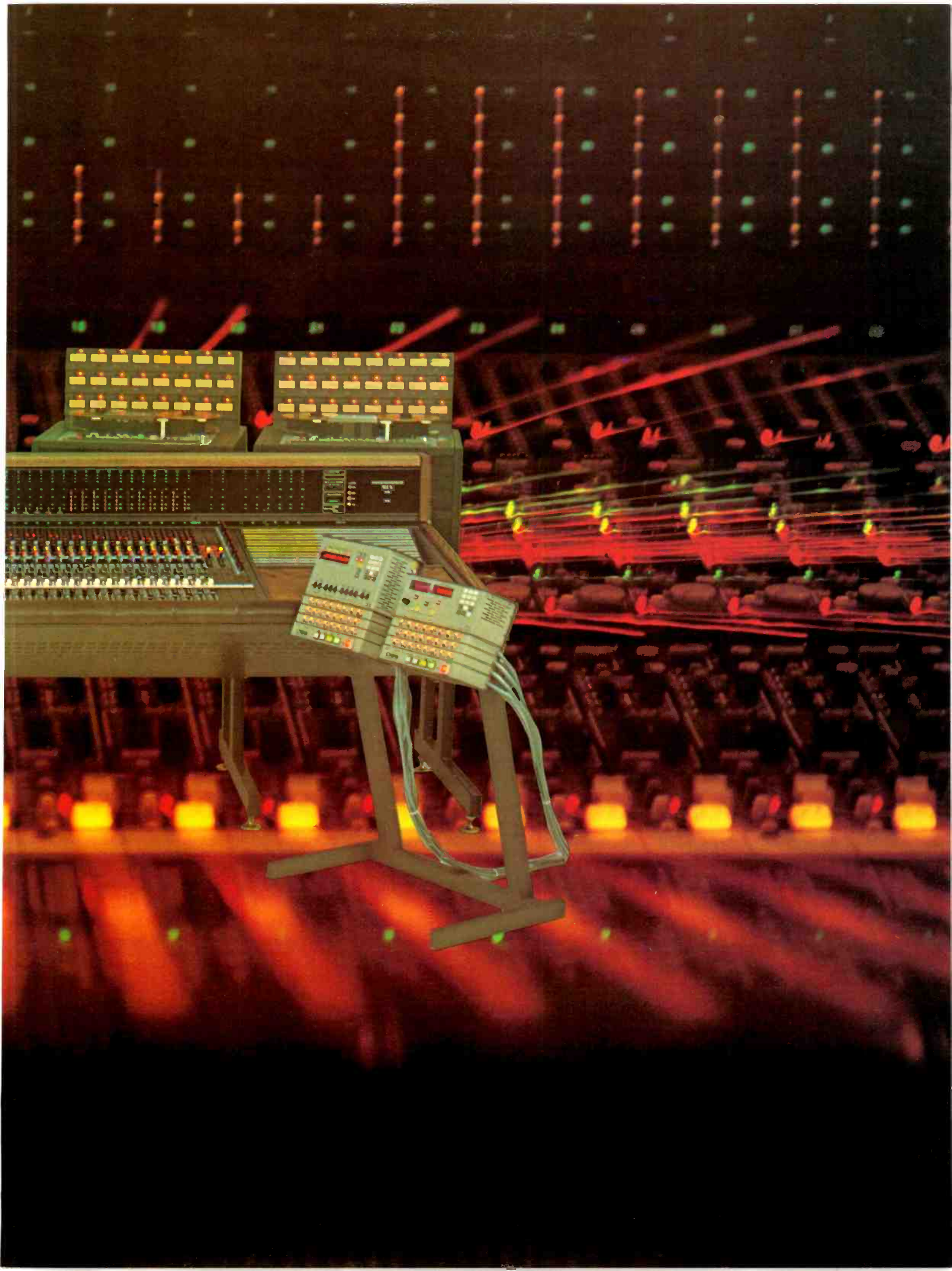

# AES 63rd Convention, Los Angeles—A Report

Angus Robertson

**S**TUDIO SOUND'S annual excursion to Los Angeles was certainly more successful than its previous trip to Brussels—and my camera worked this time! It was easily my most comfortable and relaxed transatlantic flight ever, thanks to Freddie Laker's *Skytrain*.

But back to the Convention. There were over 175 exhibitors, the largest show yet and a significant number from overseas exhibiting for the first time on the West Coast. While there were very few outstanding new products, many were shown for the first time in Los Angeles. There were a total of 71 papers presented in Los Angeles, of which 57 were distributed as preprints and one paper was repeated from the Brussels show. Although several other publications had hailed digital technology as being the centre of the Convention, there were only three papers presented on digital professional recording. One was from EMI in Britain providing a comparison between 16-bit and 12-bit linear, plus 2-bit floating coding systems (this same week EMI's Abbey Road Studios announced the production of a digital 12in single from Dick Morrissey and Jim Mullen, recorded using equipment developed by EMI Central Research Laboratory). The second paper was from Polygram Record Operations in Hannover proposing a 'codeword controlled' multistandard recorder design that would accommodate different recording systems but difficulty would still be caused by different mechanical formats, such as the number of recorded data tracks per audio channel. And a paper from the Sony Audio Technology Centre describing a digital recorder with multiple sampling rates. Perhaps

**The 63rd Convention of the Audio Engineering Society took place at the Los Angeles Hilton, from May 15 to 18.**

it is significant that two out of the three papers were concerned with essentially compromise solutions to the problems of digital recording....

Technics provided further information on the digital multitrack format first described at Brussels. Technics (Matsushita) is using thin film heads that allow very tight track packing, and in fact use four tracks on the tape for each recorded channel. The machine described was a 4-channel on  $\frac{1}{4}$ in tape using a 20-track head that allows four auxiliary tracks to be used for timecode, or audio cueing purposes. Because it would be impossible to manufacture conventional multitrack heads with  $140\mu\text{m}$  track pitch, a totally different technique is

used as shown in fig 1. The heads are manufactured photographically on a ferrite base, each voice coil has only one turn but utilising magnetic resistance effect techniques based on the fact that the electric resistance of the nickel-iron alloy ferromagnetic thin film components, changes according to the strength of the magnetic field—a 1mV output is typically obtained. Track pitch is  $240\mu\text{m}$  and the final head is shown in fig 2—the interconnections prove the most bulky. Technics uses 16-bit linear coding with a 50.4kHz sampling rate, and proposes to introduce 24 or 32-track recording on 1in tape.

Soundstream was promoting both its finished record products of which there are now about 26 original digital master albums, and providing replays direct from the Soundstream digital recorder. This used a conventional instrumentation digital recorder with an add on box to provide A/D conversion and

**Right: Fig. 1**  
comparison  
of conventional  
magnetic  
head and thin  
film magnetic.

**Below: Fig. 2**  
Technics 20-  
track head  
for  $\frac{1}{4}$ in tape  
with bulky  
connector

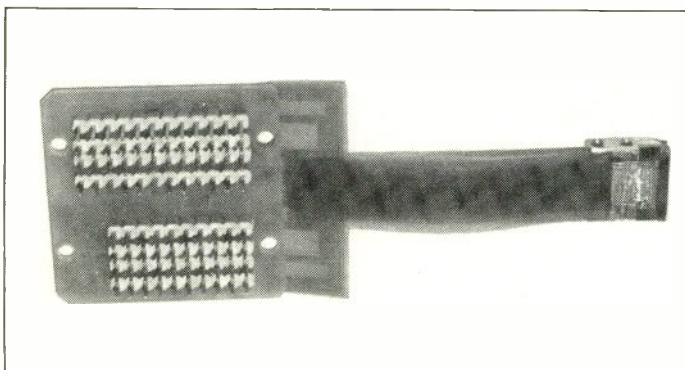
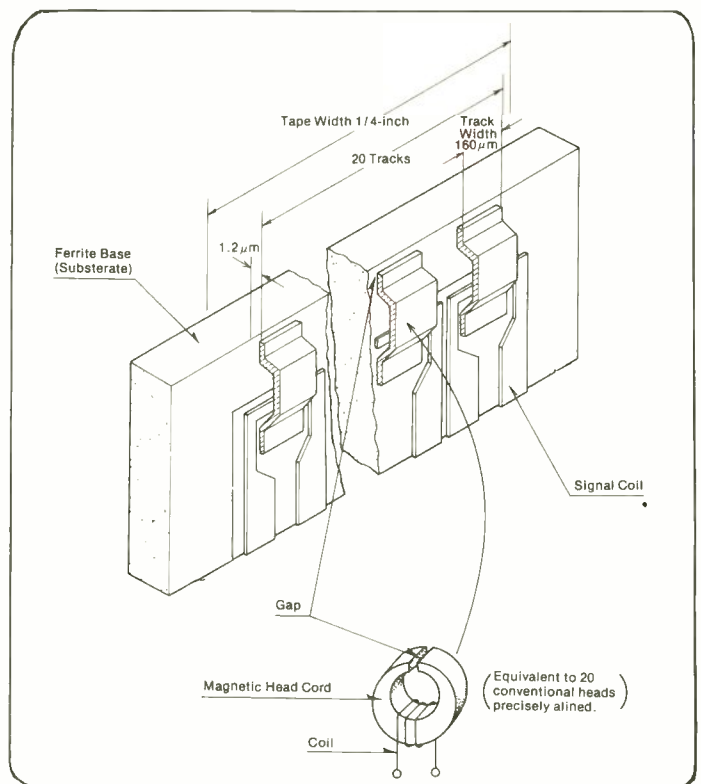

so on. Soundstream uses 16-bit linear coding which it claims gives a frequency response of 0-21kHz +0.5dB, -1dB, with 90dB S/N and 0.03% harmonic distortion. Tape speed is 35in/s. It is a 4-track unit, but not for sale and is either leased out, or provided on a royalty basis, typically 50¢ per disc.

With the news that Stevie Wonder has just purchased a Sony digital recorder system using *U-Matic* video cassette recorders, Sony was again demonstrating its range of digital recording and processing equipment at LA. Sony is basically working along two separate paths for digital audio—dedicated multi-channel digital systems that have been demonstrated but which are not commercially available, and video based digital systems that are here now and which are becoming readily accepted. In the latter market, Sony introduced and demonstrated the *DEC-1000* editing controller which allows electronic editing between a pair of *BVU-200A U-Matic* video cassette recorders, and this allows the edit point to be selected as easily as turning tape recorder spools, enables edits to be previewed and the edit point shifted, all without actually physically touching the tape. First, the edit point is found within a 6s range and the audio stored into a solid state memory which may thus be rapidly scanned for the exact edit point using a manual search dial with a range from 0 to 2x normal speed. A crossfade facility is available over seven selectable fade times ranging from 0.5µs to 100ms. The *DEC-1000* provides digital tape counters and has built-in SMPTE timecode readers and generator.

Sony showed the *PCM-3200* series digital multitrack recorder which is fixed head operating at 22½in/s and offering (eventually) from four to 48 tracks with extra SMPTE timecode track for editing. The *PCM-3200* series offers both analogue and digital inputs and outputs which will thus interface directly with the various digital accessories that Sony has also developed. These include the small *DMX-800* digital mixer and the *DRX-2000* digital reverberation unit. This can either be used with analogue or digital inputs and outputs, and uses a 16-bit word providing three selectable reverberation modes with various combinations of reverberation time (100ms to 9.9s), initial delay time (0 to 200ms), input level and frequency characteristics. Although the normal frequency response is 10Hz to 15kHz, this may be varied by digital filters to provide high or low cut—dynamic range is 95dB when used with digital inputs, 85dB when used with analogue.

Perhaps emphasising the problems encountered with different digital standards, Sony also introduced the *DSX-87* sampling rate converter which converts the sampling frequency of 44,056Hz used for Sony video based PCM systems to 50,350Hz as used in the *PCM3200* multitrack series, and vice versa. Internal or external clocks may be used for different sampling rates and the *DSX-87* includes a new linear phase finite impulse response filter with co-efficients accurately computed according to Remez exchange algorithms—the multiplier accumulator is a highly accurate 16x16-bit unit performing its calculations within nanoseconds.

Back in the analogue domain, Sony also introduced three small mixers—the *MX-5* passive 3-input mixer for mics or lines, *MX-7* which is similar but stereo, and the *MX670* battery powered active mixer with six input



Soundstream digital 4-track recorder using electronics package and standard instrumentation recorder.

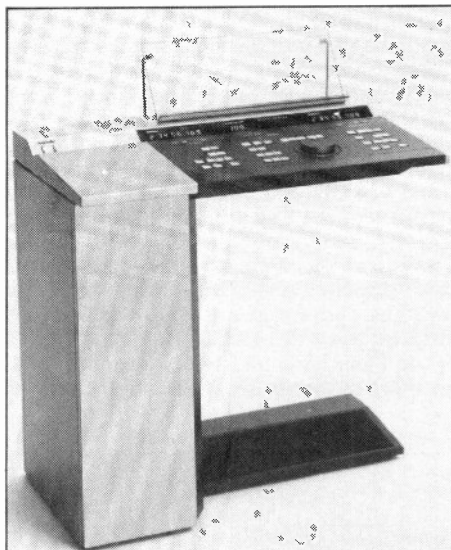

Sony *DEC-1000* digital editing controller—system for video-based digital audio.



Neve 8108 console with touch sensitive routing and monitoring in foreground.

channels including two for RIAA magnetic phono inputs.

MCI provided demonstrations of the 'Ultimate' recording system which comprises a *JH556C-56-LM* console with *JH-50* automation, two *JH-16* 24-track (or a *JH-32* 32-track and *JH-16* 24-track) synchronised with an *Autolock* and an *AutoLocator*. While the recording market is upward toward 24 or 32 tracks, MCI is expecting an upswing in sales of its *JH-110-8* for which a whole new market is being opened up by the availability of low cost timecode synchronisers enabling 8-track recorders to be used with video tape recorders in television in order to obtain higher quality sound and more versatile editing and sweetening.

Teac was demonstrating the successor to the *A-3340S* 4-track, the *A-3440* which uses a DC servo-controlled capstan motor, two eddy current induction motors, microswitch transport controls with full logic and remote control,

headphone monitor selection of any track combination, manual cueing which pre-empts the pinch roller and tape lifters, pitch control allowing ±5% variation of tape travel, independent mic/line selectors with switchable 20dB pad for high level mics, and expanded scale VU meters reading to +5VU for accurate reference when used with the optional dbx noise reduction system, for which an interface is provided. The function and output select switches have been re-arranged to simplify selection procedure—price is £888.

Audio Kinetics was demonstrating its *QLock 210* synchroniser which was initially shown in prototype form at Brussels, but was fully operational for Los Angeles. A number of minor modifications have been made as a result of 'customer feedback', and the *QLock* is available from 3M in Europe, and a new company, Quintek Distribution Inc in North Hollywood which will also become the North American distributor for Advanced Music Systems whose digital delay line was reviewed in *Studio Sound* last month.

El-Tech in Nashville manufactures a simple type of tape location system that sells for around \$400 and uses an 'electro-optically' triggered system. Basically it uses an optical sensor to count the spool revolutions, the sensor being thin so that it can normally be mounted under the spool flange. Digital read-out is in uncalibrated units, and a memory is provided which triggers a relay contact for remote stop. Very simple but rather basic.

Tape speed measurement has only recently progressed beyond stroboscopes, and now *Image Formations* in Burbank is offering a stand alone tape speed indicator that is switchable to read either inches per second, Hz or per cent (but not cm/s!). It is crystal controlled and the makers claim it can be interfaced to most tape machines in only 45 minutes.

While not strictly within *Studio Sound's* field, a paper was presented by Mr K Rey Smith of KRS Magnetics Inc describing a reversible 8-track endless loop cartridge called *REV 8*, which, it is claimed is already tooled up and ready for distribution this summer. Although a normal 8-track cartridge has only a single spool, from which tape is continually drawn from the centre, the *REV 8* uses a second spool above the first driven externally and may be used to take up rewind tape which is generally a maximum of about 3½ minutes. Very complex engineering solutions were necessary to accomplish this rewind technique which were fully explained in the paper.

#### Consoles

While we are not in the habit of making outlandish claims in respect of new products in this business, it must be said that the new Neve 8108 console range is a radical departure from the norm, both in facilities available, and the construction and design techniques. Even Neve considers it to be its greatest step forward in two decades of console development. The full details were presented as a paper entitled 'A fresh approach to audio console design' by a team from Neve Electronics International Ltd and it is only possible here to give an outline of the concept. The 8108 range is designed specially for 48-track recording and accepts up to 56 input channels of the in-line input/output type. Rather than using some 2,500 switches for routing, Neve has introduced solid state analogue crosspoints into a micro-

## AES REPORT

processor controlled routing matrix—an assignment panel with touch sensitive switches provides four stores and allows any combination of channels to be selected to each track. It provides a display of either, which channels are selected to which tracks, or which tracks are assigned from which channels. This assignment panel also provides routing for four aux and four cue busses selected on the same basis. Another complete design change means that the only transformers in the console are on the microphone inputs, all other inputs are electronically balanced, and there are virtually no transistors left, only audio integrated circuits with a low output impedance used for driving the new flexible ribbon cables for interconnecting modules—no more seating problems. Although a solid module front panel is used, printed circuit boards can be removed individually, all controls and pots being mounted directly on these boards eliminating more wiring. Even the front panel is different—laminated plastic with reverse printed instructions offering an attractive durable surface. Each channel module includes high and low-pass parametric filters, 4-band parametric equaliser, four mono and one panned stereo aux assignments, multitrack controls, primary and secondary faders (the primary being either VCA sub-grouping, NECAM automated or manual), mixdown controls and interrogation switches that when pressed illuminate high intensity LEDs to indicate assignments both on the central display and all appropriate channels. For those who can never decide upon PPM or VU metering, this console offers both simultaneously on adjacent 200 segment bargraph displays either of which might be extinguished as appropriate. Finally a comprehensive monitor and facilities panel, also, with touch sensitive switches and LED 'mimic' indicators showing which section of the monitoring facilities is in operation, allows quadrasonic monitoring and all normal functions. Neve will also continue manufacturing its existing range of consoles.

Harrison Systems has now added a film rerecording console to its range of studio consoles along with the *Alive* console which is also finding studio applications. An enormous console destined for Walt Disney studios was on display, and this was for four operators with 48 inputs—perhaps the most interesting aspect of this console is the number of automation facilities which means that a micro-processor has been built directly into each channel module. On each input, the following is automated: input pad (-20, -10, 0 or +10dB), B line phase reverse, two A/B patch points, in/out switching separately for each of the

Harrison film console with automated graphic equaliser in foreground

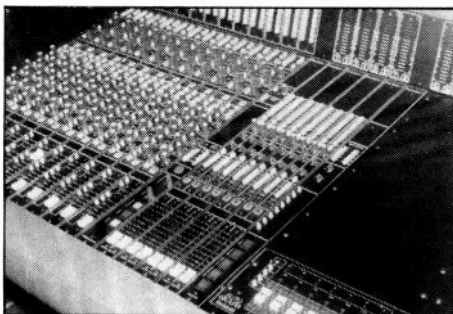

four parametric equaliser sections and high and lowpass parametric filters, channel mute, fader level and VCA group select with 7-segment LED readout display. This display may also be used for self diagnostic routines, troubleshooting and calibration, and many critical alignments may be made using it as a meter. Non-automated features include 2 or 3- (for centre) channel panning with true divergence control, four echo sends, solo in place with echo, unique 'cueing' feature, and electronic pre fade listen function under computer software control, which allows monitoring of a channel with the fader down or in mute, the signal being sent to the main monitors but not busses. It is hoped to publish further information about this console and Harrison's approach to film remixing in a future issue.

While not a familiar name, Neotek has been producing consoles for some seven years, at first transformerless custom PA consoles which users soon discovered had better performance than many recording consoles. Neotek thus found themselves in the recording console market and the experience has been distilled into the *Series I, II, III, IV* and *Theatre System* consoles. Basically, the *Series I* and *II* have separate monitoring with mechanical switching and are available in 4 and 8-buss formats, while the *Series III* and *IV* have in-line monitoring and logic controlled FET switching of console status and are available in

Neotek Series III console

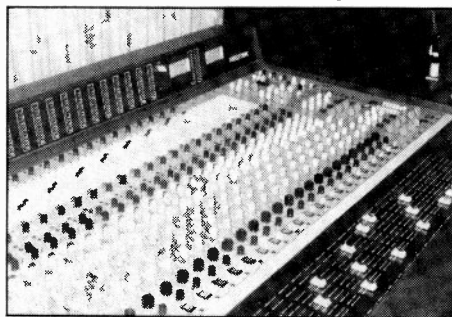

16-, 24- and 32-track versions for multitrack recording. The *Theatre System* is based on the *Series I* console. Basic features of the consoles are transformerless instrumentation amp mic preamp, state variable parametric equalisers, three peak LEDs in each channel, and a complete headphone solo system with built-in headphone amp. Pricing on the *Series I* and *II* varies between \$6,200 to \$15,350 with between 16 and 32 inputs, while the *Series III* ranges between \$15,000 and \$34,000 for 16 to 32 channels.

Solid State Logic was showing its *SL-4000 E* console in which each channel includes an instrument quality noise gate, keyable programme expander, full feature compressor/limiter, totally flexible true parametric equaliser and separate continuously variable high and lowpass filters. The whole console interfaces to the Solid State Logic *Studio Computer* which maintains reel information, track lists, songtitles and cuepoints, then uses this data to perform swift, intelligent autolocation, unerringly accurate programmable drop-ins and automatic cycling of overdub passages, in addition to automating the console.

Trident Audio Developments introduced a new console, the *Series 80*, which is basically a scaled down version of the established *TSM* console. Available with 16, 24 or 32 inputs

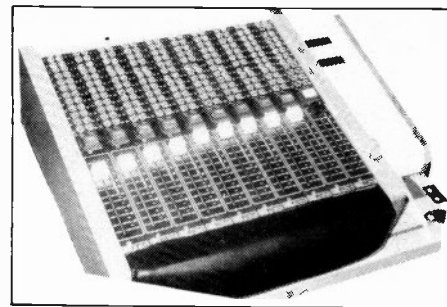

B & B Audio Grouper

and separate monitoring, the *Series 80* includes two parametric mid equalisation sections, three mono and one stereo sends, and solo, solid state switching, fully modular patchbay with 512 patchpoints, automation retrofitable, and only costing £20,000 for a 32/24 model.

B & B Audio (Apex Systems) introduced the *Model OAS-24 'Grouper'* which improves mixing flexibility and speed on standard consoles for both recording and PA, by providing one fader control of any combination of mixer input channels or outputs. The *Grouper* comprises a control unit with 10 faders and 24-track select switches per fader, nine being subgroups, and one an overall master, and a separate equipment rack which contains a B & B VCA for each track, the VCA being simply inserted in series with the mixer inputs or outputs or even patched into a channel. Thus nine subgroups can be simply arranged and either separately or simultaneously switched into operation by use of mute buttons. The *Grouper* brochure describes operation very clearly by reference to the music score of a typical disco number! B & B also introduced the *CX-1* compressor/expander (again utilising the B & B VCA) which provides 'over easy' or levelling characteristics similar to the *LA-2A* and a claimed 'tube' (valve for European engineers) type overload characteristic. Release time is variable from 50ms to 2.5s, threshold -20dBV to +20dBV, expansion from 0dB to 50dB maximum, with -75dBV to -10dB threshold. The *CX-1* includes a 10-segment bargraph display switchable to read compression or expansion, gain reduction, C+X gain reduction, and output level.

Shure introduced its *Promaster* modular sound system which comprises the *Model 700* portable mixing console with eight inputs, six with monitor, aux send, hi and lo eq, pan, input attenuation and rotary level control (labelled volume) and two simple aux only input channels. It also offers twin 10-band graphic equalisers and a complex patch panel. Shure has also introduced a new disco cartridge, the *SC39*, which tracks between 1½ and 3g and has a special stylus protection guard that prevents the stylus being moved sideways but upwards instead for protection.

### Effects

Eventide launched the new *Model H949 Harmonizer* which can change the pitch of an input signal by three octaves (one up, two down), has two outputs each with 400ms of delay, a frequency response of 15kHz and a signal-to-noise ratio of 96dB. Other features include flanging, repeat, random delay (for automatic double tracking) and an entirely new effect, 'reverse'. The micro pitch change function allows extremely precise, stable

# From today, anywhere with a power point can be a recording studio.



Up till now, if you were serious about making high quality, two-track simul-sync recordings, you had to resort to sophisticated reel-to-reel equipment.

Up till now.

Because we'd like to introduce you to the revolutionary TEAC A-108 Sync.

It's the world's first-ever two-track simul-sync cassette machine.

And it'll produce beautiful synchronised stereo recordings just like a multi-track reel-to-reel, only with all the simplicity and convenience of a cassette deck.

For the aspiring star, the A-108 Sync represents a unique opportunity to get recording experience without the horrific expense of a recording studio.

While to the fully-fledged professional it means a lot of studio time could be more profitably (and more comfortably) spent at home.

## What can the A-108 Sync do?

Take one look at the controls of our machine and you'll realise it's more a question of what it can't do.

For a start, head layout and circuitry has been so designed as to allow you to record left and right channels individually, one after the other, in perfectly synchronised stereo.

Let's take an example.

You lay down your lead track on the left channel. You rewind. Then, while listening to the lead track back through the cans, you can over-dub the bass track on the right channel.

Play back the result, and you'll find both channels have been recorded in perfect sync with each other.

Then, to get some idea of how the vocals would sound, the A-108 allows you to place your voice in the middle of the two-track recording.

You can even hear yourself simultaneously on the cans while using the music blend control to adjust the mix of the new track to exactly how you want it.

## We didn't stop there.

The A-108 Sync also boasts a mic/line mixing feature which lets you record your own voice or instrument on to your favourite record (so you can show them all how it should be done).

And once your recording session is over, you only have to flip the 'Cross-Feed' switch to blend left and right channels together to give that 'live' stereo feel to the final result.

As you'd expect, a machine like the A-108 Sync has all the advanced features normally found on TEAC cassette decks.

Features like the finely engineered and highly reliable transport system; the sophisticated Dolby circuitry; and independent bias and equalisation selectors.

Nor have we forgotten the memory re-wind facility built into the tape counter.

## Where we did stop.

There is, however, one feature of the A-108 Sync that's conspicuous by its absence: the hefty price tag.

Incredible though it may sound, you'll find the machine retailing at around £200.00 plus VAT.

The way we see it, that's a mighty small price to pay for indefinite studio time.

---

Please send me a free information pack on the revolutionary TEAC A-108 Sync cassette deck and its accessories.

Name

Address

Post Code

Harman UK, St. John's Road, Tylers Green,  
High Wycombe, Bucks HP10 8HR.  
Telephone: Penn (049 481) 5331.

**TEAC**

## AES REPORT

settings and high and low equalisation of feedback. The *H949 Harmonizer* has two different algorithms to handle the pitch change glitches, so the user can select whichever is optimum for the programme material. Price is \$2,400.

There are now many realtime analysers available on the market, and the more recent are using microprocessors and software, the basic ingredients of a home computer—and so now Eventide has gone a stage further and designed a *Real Time Analyser* board that installs directly inside a CBM *PET* 8K computer providing 31  $\frac{1}{3}$ -octave bands and displays them with their amplitude, on the *PET* screen. Because of the capabilities inherent in a 'computer', the system provides various facilities including store and recall of data which may be compared with past, future or other channel data, and peak hold providing indication whether any preset levels have been exceeded. In the log mode, display range is 36dB, while in linear mode resolution is 144 vertical elements, with top of the display adjustable over an approximately 48dB range with better than 1dB resolution at gain settings lower than 26dB. Price of the analyser board is \$595 and versions are available for the original 8K *PET*, the 16/24K *PET*, and soon for the Radio Shack *TRS80*, *Apple* and *S-100* buss. Eventide is also running a contest for the best *PET* program to recognise disco music by studying the rhythmic content and frequency distribution using the *PET* and Eventide *Real-Time Analyser*. Closing date is December 31, 1979 so there is plenty of time to enter, and first prize is a *Real Time Analyser* or an Eventide 24K *Big Mem* for a *PET* computer (yes they're in the computer business as well), with T-shirts for all who make a non-frivolous entry.

Marshall Electronic introduced the *Mini-modulator* which makes use of digital technology to control the analogue delay circuitry for time modulated signal processing thus overcoming the problems of complex control. So all effects are entirely analogue 'for that smoother Marshall analogue sound (and freedom from quantising error and extremely limited sweep range that plague all digital units)', but under digital control for the best of both worlds. Maximum delay with 7kHz filter is 250ms, and 125ms with 15kHz filter, dynamic range is 95dB, continuous sweep range over 70:1, stereo outputs, no tracking filters which add noise and distortion, and programmable LFO sweep instigation. All programming is done internally with the aid of a keypad.

Neutrik's American distributor Philips Audio Video Systems Corp was showing the new *AD4* analogue audio delay unit which is primarily designed for PA systems with a frequency response of 20Hz to 10kHz  $\pm 1.5$ dB and S/N of 66dB with 1% distortion. The unit has four outputs from the time delay with a delay adjustment range of 4:1 and maximum delay of 200ms. The system comprises a limiting input amplifier, an LED overload indicator, four bucket brigade delay modules each with associated clock circuitry, multipole lowpass filters and output amplifiers, and the last two delay stages have active noise filters to preserve dynamic range—price is \$795.

MXR must have a very dedicated design team because the company seems to be introducing new products each week, and indeed

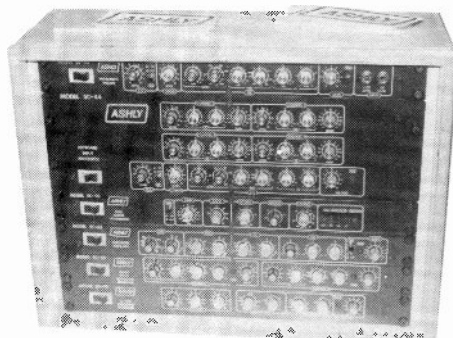

Ashly range of compressors, limiters, crossovers and parametrics.

have three new products: the *Flanger/Doubler* launched at AES, the *Dynamic Expander* seen two weeks later at CES, and finally the *Pitch Transposer* (Pitch/Bitch!), otherwise known as a harmoniser). The *Flanger/Doubler* (or Floubler for short) is an analogue device that uses bucket brigade devices for the shorter delay times appropriate for flanging applications, and a charge coupled device providing longer delays needed for convincing doubling effects. Flanging is created by superimposing a harmonically related series of peaks and notches on the sound spectrum of an instrument and this comb filtering imparts a musical tonality to drums and cymbals or enhances the sound of conventional musical instruments, while doubling allows a single instrument to simulate the sound of two (or two vocalists singing), in unison. Other effects available include vibrato and reverb, and maximum delay with doubling is 70ms—price is £450. The MXR *Dynamic Expander* is a consumer item (and thus its appearance at the Consumer Electronics Show) that can perform up to 8dB of upward expansion, and 21dB of downward expansion (reducing noise). Release time is variable, as is the amount of expansion. More information on the *Pitch Transposer* next month.

The MicMix *XL-305 Master-Room* reverberation chamber is claimed to be the first reverb 'to offer the natural sound performance of a live studio chamber or the qualities of a plate in a compact rack mount package. In addition to unprecedented smoothness and the complete absence of any undesirable effects or coloration (even on the sharpest of material), *XL-305* features exceptional stereo enhancement of the reverberant field, including full stereo imaging of a monaural signal.' The *XL-305* is contained in a 3 $\frac{1}{2}$ in high rack mount enclosure and is isolated from acoustic feedback and mechanical shock or vibration, and also offers a 4-band peak-dip equaliser section at 150Hz, 600Hz, 2.5kHz and 6kHz. Price is \$1,195.

EXR Corp showed its second *Exciter*, the *EX-2* which now has internal mix capability enabling the system to be used in-line at the final stages of mastering or copying, and features a claimed S/N of 90dB without noticeable triggering limiters or compressors. The 2-channel unit has four enhancement settings for various functions.

Ashly is a Rochester, New York company that manufactures a wide range of signal processing gear: the *SC-63* and *SC-66A* are parametric equalisers, the former single channel with three bands (\$369), the latter 2-channel each with four bands (\$599). Claimed bandwidth of each band is variable from 30 octaves to  $\frac{1}{16}$ th of an octave. A range of electronic crossovers includes the *SC-22* which is a stereo 2-way crossover (\$290), the *SC-70* 3-way with

two crossover frequency selectors (\$249), the *SC-77* similar to *SC-70* but stereo (\$429), and the *SC-80* 4-way with three crossover frequency selectors (\$349). The *SC-40* and *SC-44* are an instrument preamp (\$349) and keyboard input processor (\$499) respectively designed specifically for musicians to provide features such as separate level controls for stage and PA feeds, complex 3-band tunable equaliser, peak overload indicator, and five different outputs, while the *SC-44* also offers four mixable inputs each with high and low eq. Finally the *SC-50* and *SC-55* are peak limiters/compressors, mono and stereo respectively (\$299 and \$499) with  $\pm 30$ dB gain, 2:1 to infinity ratio, 200 $\mu$ s to 20ms attack, and 100ms to 2s release. Each has a 5-segment LED gain reduction indicator, the *SC-55* also having left or right 'action' indicators. Incidentally Ashly is now distributed in the UK by Atlantex Music Ltd.

Sontec Electronics from Maryland was showing a 2-channel dynamic range controller, the *DRC-202*, which is basically a complex compressor/limiter with threshold (20dB range), crest factor (variable from 0 to 20dB), ratio (1.5:1 to 50:1), gain (up to 20dB below threshold), attack and release.

Furman Sound Inc of San Rafael also has a range of signal processors: the *PQ-3* and *PQ-6* are 3-band mono and stereo parametric equalisers/preamplifiers variable from over four octaves to  $\frac{1}{3}$ -octave (\$275 and \$495), the *TX-2* tunable crossover/bandpass filter (\$225) which is 3-way with two crossover frequency selectors with push buttons for x1, x10 or x100 frequency ranging. Finally the *RV-1* is a reverb system with limiter and equalisation (\$250) which features a shock mounted dual 16in spring assembly with LED indication of limiting action.

### Microphones and radio mics

While I don't pretend to understand the theory, Synergetic Audio Concepts from Tustin in California was showing a range of *PMZ* Pressure Zone microphones in which a pressure response electret module is mounted facing a flat metal plate so that a pressure zone develops providing 'exceptional sensitivity and definition with a balance between direct and reverberation sound minus the usual microphone-caused coloration'. A range of seven different types are available with varying sizes of plates from 2 $\frac{1}{2}$ in square to 9in. Prices are \$300 per pair with battery or transformer phantom power supplies, or \$320 with dual op-amp phantom power.

Electro-Voice introduced the *RE18* and *DO56* shock mounted microphones which are variable super cardioid and omni directional dynamic microphones respectively.

While I always hope my equipment surveys are complete when published, when a new subject is covered, invariably one or two companies are initially overlooked. And so with Californian radio microphone manufacturer Nady Systems Inc (formerly Nasty Cordless Inc), who produce a stage system operating in the 88-108MHz broadcast band (actually legal in the USA when used with low power), that may be tuned to spare channels anywhere within the band. Nady Systems has now also introduced a range of fixed frequency systems, the *Nady VHF 600* and *700 True Diversity* which claims to offer 102dB S/N, 25Hz to 20kHz frequency response and 100dB image rejection in the receiver. The

50 ►





"The original A77 had set a standard by which I have judged other domestic and semi-professional recorders for many years. It is now clear that the new B77 sets a new standard not easily surpassed at its price"

Argus McKenzie (March 1978)

# REVOX

For the full story contact F.W.O. Bauch Ltd., 49 Theobald St., Boreham Wood, Herts. WD6 4RZ

## Informed opinion

Few products in the hi-fidelity world have received such favourable comments from knowledgeable experts as the Series III precision pick-up arm.

They are too numerous to quote here, so we have prepared a special presentation of them which we will gladly send on request. Please indicate whether or not you require details of the arm as well.

Write to Dept 1052

SME Limited · Steyning · Sussex · BN4 3GY · England

SME SERIES III

The best pick-up arm in the world



## AES REPORT

transmitter is available as a belt pack or self-contained with a Shure SM58 head, while either a straight receiver or diversity receiver system may be used depending upon circumstances.

### Discs and turntables

Ampex entered a new market with its *Mastering System* which is basically a system for disc mastering that allows electronic preview of the audio signal for groove spacing purposes when using a standard three head tape recorder (such as the 'ultimate' ATR-100 suggest Ampex), rather than a specially adapted model with fourth preview head. The *Mastering System* provides 80dB signal-to-noise, a bandwidth to 20kHz, and selectable delay times to five seconds in both channels. So in use the direct tape recorder signals are sent to the groove controller, and the delayed signals then become the recording audio.

Cybersonics Inc of Universal City was showing its *Disc Master 2002* which is rather more compact than most other lathes, being only 16in high and weighing approximately 250lb. The turntable is driven by a high torque motor with a hollow shaft for the vacuum, while the cutter carriage incorporates its own servo motor complete with digital encoder. The head mount is a dynamically balanced suspension system while the microscope is on a threadless lead screw positioned either manually or by a motor. All functions are under the control of 'Compu-Drive' and update to pitch and depth of cut can be made two to 18 times per turntable revolution. Price of the basic lathe system is \$47,700, while various cutter heads are available from \$5,000 to \$10,000. The Cybersonics lathe is distributed by Ortofon in Europe and by Feldon Audio in the UK.

Technics has added to its range of professional direct drive turntables with two new models in addition to the ubiquitous *SP10 MkII*. While the *SP10 MkII* starts in 400ms with exceptional torque, the *SP15* has reduced torque but still starts in 700ms, is 3-speed with a pitch control providing  $\pm 9.9\%$  variation (particularly useful for 78 discs recorded at the wrong speed) with digital display of actual speed, while the *SP25* is similar to the *SP15* but is only 2-speed with  $\pm 6\%$  pitch change range but without digital display. So while the *SP10 MkII* (£680) is still the 'only' turntable for live broadcasting, the *SP15* (£350 or \$700) would be very useful for smaller broadcasting and music studios while the *SP25* (£200 or \$400) should provide all the facilities that discos might require.

Pioneer was showing a new turntable system using innovative technology which was fully described in two papers at the Convention: A New Phonograph Motor with Stable Hanging Rotor, and Linear Motor Drive Tangential Tracking Tone Arm. The new motor has the thrust bearing placed near the top of the spindle producing a hanging rotor with a slotless and coreless motor resulting in very low wow and flutter of less than 0.003% Wrms. The tangential tracking arm is driven by a linear motor without any mechanical linkages and is transported to the tone arm without mechanical connections, so S/N is claimed at 78dB.

### Other goodies on show

Duncan Electronics was showing a wide



Pioneer turntable system with hanging rotor motor and linear motor drive tangential tracking tone arm

range of conductive plastic faders that are very widely used in the United States, but past currency differences have meant that they were not particularly competitive in the European marketplace, although this is now changing. The *Series 400* is available with either 2.75in or 4.25in travel and feature narrow width and low profile with single or dual channels (prices from about \$10 to \$20), while the *Series 300* is available in 2.6in, 4.1in and 4.6in strokes and are impervious to moisture and most solvents—they also offer optional switches and cost from \$30 to \$100.

Taber Manufacturing and Engineering Co was showing its *Taberaser* which is able to bulk erase all reel to reel magnetic tapes from 150mil to 2in widths, as well as all cartridges, cassettes and magnetic film stocks. Erase field is automatically diminished at the end of each 20-second cycle minimising residual noise caused by turn-off transients. Price is \$495, and Taber also has a wide range of reconditioned and replacement heads for most Ampex, MCI, Scully and 3M tape recorders, in most track formats and also Ampex and RCA video tape recorder head blocks.

Design Electronics of London attended its first American Convention and demonstrated the *Cuemix* foldback system, first seen at Brussels earlier this year. Basically, *Cuemix* uses a loop system with different carriers for each of the five channels, that may be individually mixed and balanced on the cordless, freestanding battery-operated unit, which has a 2W stereo headphone output.

Wireworks showed its range of snakes and stage boxes, and particularly the *Hardwired Microphone Multicables* which accept individual cables from mics on a stage box and are terminated in either XLR or  $\frac{1}{4}$ in jack plugs for connection directly to conventional mixer inputs—they are available in sizes from three to 50 pairs and are stocked in 50, 100, 200 and 250ft lengths.

Finally, Clear-Com of San Francisco manufactures a wide range of intercom systems ranging from console and rack mounting systems, to belt packs and was showing an 8-channel system which will interface with up to 200 remote stations, and provide three operating modes on each channel, 'out' for private communication between stations, 'cue' for general distribution to most stations but with no intercommunication, and 'party line' which does allow multiple conversations between operator and stations. Clear-com is distributed in Britain by Rank Strand Sound.

So that ties up Los Angeles for another year, but not audio exhibitions because APRS is only two weeks away at the time of writing, but then that will be history by the time you read this . . .

 Sync0 Sync0

Its all in sync we go... 

The joys of synchronisation are often dwarfed by complexities  
So we developed QLOCK 210 the locating  
synchroniser that can be  
understood fast!



IF YOU'RE CONSIDERING SYNCHRONISING TWO MACHINES, THE BASIC ESSENTIALS ARE:

1. A DUAL OUTPUT SMPTE TIME CODE GENERATOR
2. TWO READERS
3. A SYNCHRONISER
4. TWO MACHINE INTERFACES

WOULDN'T IT BE NICE IF THESE ESSENTIALS WERE IN ONE UNIT WITH A LIGHTWEIGHT REMOTE CONTROL.

OF COURSE THE OPERATION WOULD BE IMPROVED IF WE ADDED:

5. THE AUDIO KINETICS AUTOLOCATION PROGRAMS
6. A TAPE TRANSPORT REMOTE ASSIGNABLE TO MASTER OR SLAVE
7. AUTO RECORD DROP IN AND OUT MEMORIES
8. USER DEFINABLE PRE-ROLL
9. USER DEFINABLE INSTANT REPLAY

WOULDN'T IT BE INCREDIBLE IF WE INCLUDED:

10. TACH ONLY READ IN HIGH SPEED WIND ELIMINATING TAPE TO HEAD CONTACT AND THE NEED FOR EXPENSIVE WIDE BAND AMPLIFIERS
11. LEARNING LOCATION PROGRAMS WITH CYCLE ROUTINES ASSIGNABLE BETWEEN ANY 2 OF THE 10 LOCATE MEMORIES
12. RECORD DROP IN VISUAL AND AUDIBLE REHEARSAL

**YOU'VE GUESSED, QLOCK 210 HAS IT ALL. TOGETHER!**

SOLE UK DISTRIBUTORS, 3M UK LTD., P.O. BOX 1, BRACKNELL BERKS; TEL: 0344-58445

AUDIO KINETICS UK LTD., KINETIC HOUSE, VERULAM RD., ST ALBANS, HERTS. TEL: 0727 32191 TELEX 299951

### Mineral shortages?

AT FIRST sight the political upheavals in Iran and Zaire don't seem too relevant to the record and recording industry, but shock waves from unrest in those countries will soon be making themselves felt in the studio business. Iran was the second largest oil exporter in the world. When the country flipped, oil exports stopped and with them disappeared some 10% of the world's oil supply. Most important it is unlikely that Iran will ever again pump and export oil at anything approaching the previous rate. Current estimates are that the world oil market will stabilise with a permanent shortfall. In other words from now onwards, and for the foreseeable future, oil will always be in somewhat short supply. One inevitable result of an oil shortage is an increase in oil prices; another inevitable result is a shortage of plastic because plastic is an oil by-product. The last oil shortage, some six years ago now, was only just starting to bite by the time the crisis was averted. But it bit hard enough to give a foretaste of what could now be on the way on a more permanent basis. Pressing plants found it difficult to secure reliable supplies of high grade vinyl and some of the tape companies were starting to run into supply difficulties, both for tape and cassette housings. In fact virtually the whole of the record and recording industry relies for its viability on a reliable source of high grade plastics and it is anyone's guess how the cookie will now crumble.

I also have this fantasy of what would happen to Los Angeles, surely the centre of the studio recording business, if there were a real oil shortage and thus a real petrol famine. With virtually no public transport and a pretty dire taxicab system, the city relies entirely on private automobiles to function properly. Whereas in most cities in the world it would, at a pinch, be possible for musicians to get from home to the studio and from session to session by public transport or taxi cab, the whole of LA would quite literally grind to a halt if car travel became a luxury. The dream city could just turn into a science fiction nightmare.

Although less widely recognised, a shortage of cobalt caused by the unrest in Zaire is already creating very real headaches for some sectors of the audio industry. Zaire produces cobalt metal as a by-product of refining copper from the rash of mines there. During the 1978 wars in Zaire the copper-cobalt mines were abandoned, some flooded, and foreign technicians fled for their lives. As a result cobalt supplies dwindled and the price rocketed by several hundred per cent. There is in fact very good reason to believe that supplies might have dried up altogether if the governments in Europe and the USA, which rely very heavily on Zaire for their cobalt, had not released some national stockpile supplies. These were in strategic reserve for use in high temperature metals, eg for aircraft engines.

The audio industry needs cobalt for two reasons—as an additive to high energy ferric

recording tape and as a component for high energy loudspeaker magnets. The amount of cobalt needed to make high energy tape is relatively small but the amount needed for high energy loudspeaker magnets is very large. A cobalt shortage is thus potentially crippling to the loudspeaker industry, especially in two specialist sectors. TV set manufacturers have so far relied on loudspeakers with alnico magnets (formed from a mixture of cobalt, aluminium and nickel) because alnico magnets are contained within a pot and form a closed magnetic circuit with no stray fields. Any stray field in a TV set will sour the picture colour and is thus quite unacceptable. The construction of PA and heavy duty monitor loudspeakers has also become heavily dependent on cobalt. Alnico is a very efficient magnetic material, providing many more gauss per cubic centimetre or pound weight than the more conventional ceramic ferrite type of magnet. If you think that the alnico potted magnet of a heavy duty loudspeaker is big, bulky and heavy then you should see and feel the size and weight of a ceramic ferrite magnet of equivalent strength. Also the ceramic ferrite magnet of a heavy duty speaker has an open magnetic circuit and leaks very strong stray fields. These can erase tapes, cling to nearby metal objects and probably upset the navigational system of an aircraft freighting the speaker across the world.

There is currently considerable uncertainty both in Europe and the USA over the future of cobalt supplies and prices. No one seems really to know, or be prepared to admit, just how heavily the Western world depends on Zaire for its supplies and just how much cobalt Zaire is now supplying. Perhaps the most reliable estimate is that Zaire supplies 60% of the Western world, with the East looking to Australia for its cobalt. But most disturbing of all is the official admission that world production of cobalt, even under normal conditions, now falls far short of demand. The short fall has so far been made good by stockpiles accumulated in the past. But obviously this can't go on. So, far-sighted firms are already working hard to free themselves from the cobalt trap. JBL, for instance, whose loudspeakers are almost all powered by cobalt magnets, are already looking to alternative designs based both on ceramic ferrite and other magnetic alloys; for instance those using manganese and samarium. Although cobalt is still an essential part of these alloys, the proportion is around 10% less. But the new alloys are much harder to work, for instance much more fragile, and the problem of screening ceramic ferrite magnets to prevent the escape of stray fields into a studio environment is still on the drawing board. Engineers are also looking at the possibility of reverting to the old approach of using current powered coils, instead of permanent magnets. Studios with alnico-powered monitors would be well advised to hold on to them, recoiling or reconing rather than scrapping anything that gets damaged. It's not inconceivable that

one day cobalt-powered speakers might be as rare and expensive as valve amplifiers.

### Roll it, again

BY A CURIOUS coincidence, re-release of the 40-year old film *Fantasia* (with the astonishingly advanced film recording technique described in the August issue) coincided almost to the day with UK release of *The Wiz*, a modern re-make of the 40-year old *Wizard of Oz*. And both *The Wiz* and *The Wizard of Oz* are interesting on the ears.

It is not widely known that the original Judy Garland feature (along with *San Francisco*, a previous film climaxing with an earthquake scene) contained low frequencies on the soundtrack which in many respects predates *Sensurround*. For *Sensurround*, an effects generator produces high level sound of around 20Hz. Original prints of these earlier films had fairly dense optical tracks so that the projectionist tended to crank up the overall volume level. When the twister strikes Dorothy's home and when the earthquake strikes in the earlier San Francisco film, frequencies down to around 20Hz on the soundtrack boomed out. Enterprising cinemas bought in extra bass bins for the performance and the audience was rewarded with body shaking rumbles.

*The Wiz* contains no 20Hz rumbles, but a Dolby stereo soundtrack of the Quincy Jones score. This was recorded by Bruce Swedien, of Acousonic fame. For those asleep at the time when we first mentioned Acousonic, it's a multi-multitrack system. As many instruments and sections as possible are recorded in stereo and overdubs are handled on a work tape to leave the original tape with the master rhythm tracks unscathed by repeated travels past the multitrack head.

The British reviewing critics made little or no complimentary mention of *The Wiz* sound, which is hardly surprising because the British press show was an unmitigated disaster. *The Wiz* was screened to the public at the Dominion Cinema, Tottenham Court Road which, since the *Star Wars* run, has had available a sound system with greatly improved power handling capability. But *The Wiz* was press-shown at the Empire, Leicester Square which (except for *Superman* when special equipment was temporarily laid on) is badly under powered for modern 'play it loud' films. Even worse, one of the boards which control the sound changeover between projectors went faulty as the screening started and there was total loss of the centre channels. This produced the fascinating sound and spectacle of a 70mm 6-track film screened with backing tracks only and no centre screen solo voices. After a couple more false starts the rest of the film was screened using a single projector, with the house lights raised for reel changes every ten minutes or so. Any film that can survive that, which *The Wiz* did, can't be all bad.



Also in action with:  
Thames TV Euston,  
Radio Trent,  
Piccadilly Radio,  
Thames TV Teddington  
and the  
Town House Studios

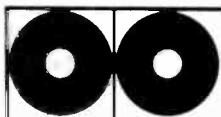

**PROLINE  
PROFESSIONAL**

**2000TC  
recorders**

## In action with the professionals— at Radio Clyde

Proline 2000TC recorders are now in action at Radio Clyde. Fitted with a control panel which was designed in collaboration with John Lumsden, Chief Engineer of Radio Clyde these machines suit the particular requirement of independent local radio.

The Proline 2000TC is a state of the art 6.25mm professional recorder designed for heavy duty operation.

Electronics have replaced mechanics wherever possible. All board switching is via solid state analogue switches. Together with modular construction which is used throughout the Proline 2000TC is an extremely reliable recorder which is easy to maintain.

The comprehensive specification also includes servo controlled DC spooling motors using a digital open loop servo (patent pending) to provide constant tape tension for all reel sizes. Twin servo controlled DC capstans with built in varispeed. TTL logic for fast foolproof operation with the facility to programme the logic and select various editing facilities depending upon the users requirements. Velocity controlled spooling for easy editing and position location. L.E.D. tape timer providing real time readout in minutes and seconds at both fixed speeds.



319 Trinity Road Wandsworth  
London SW18 3SL

Telephone 01-874 9054  
Cables Leemag London SW18  
Telex 923455 Wembley

## STILL THE BEST CARTRIDGE MACHINE

# Cuemaster

(WE STOCK ALL THE SPARES!)



## Granet

Communications Ltd.

39 BEECHCROFT MANOR, OATLANDS  
DRIVE, WEYBRIDGE, SURREY KT13 9NZ

Weybridge (0932) 47785

### Credit cards

I SUSPECT that many studio personnel use a credit card provided by the studio company to entertain business guests—certainly employees of firms selling studio equipment use cards. A familiar sight at every audio exhibition and convention is a company rep winning and dining prospective clients on a company credit card. But holders of company credit cards may not know the risks they are running. In short, under the terms of some company credit cards, the *individual* card holder is liable for charge incurred on the card if the company welves on payment or goes bust. This came to light recently when the holder of an American Express company credit card returned from a long trip in the USA on company business to find his employers going into voluntary liquidation.

There was a £1,900 bill outstanding on the card account and American Express wasted no time in threatening the individual holder of the card with legal action if he did not cough up the full amount. So that company rep's reward for a hard trek round the USA, selling company business, was a £1,900 bill. Too late, he checked the small print on the form he had signed to give his specimen signature. Sure enough the small print confirmed that he, as individual card holder, was liable along with the employer for charges incurred on the card. The employer was in liquidation so the employee, as well as being out of a job, had no choice but to settle the full amount in cash. It's a horror story and makes yet another good reason for always reading the small print before signing anything. Engineers and company reps should at best insist that business bills run up on company credit cards are chargeable *only* to the company, or at worst know the risk they run every time they settle a company account on the company card. Forewarned is at least forearmed.

### Mobile re-issues

CAN you imagine the public reaction if Leyland, Volkswagen or General Motors licensed a small independent company in their own country to produce exact replicas of their most popular models, but with one difference between the original and the replica—namely that the replica is fault-free on delivery? It would amount to a public admission by the car companies that they were unable to produce a fault-free product. Well this is exactly what is happening in the USA. The small Californian company Mobile Fidelity Sound Lab is being licensed by large record companies, including A & M, ABC, Warner, London and others to produce fault-free replicas of commercial disc releases. The replicas look like the originals, even the artwork on the sleeve is the same except for an identifying 'Mobile' label. But whereas the original commercial issue is cut with extra limiting, compression and eq and pressed by uncaring plants, the Mobile replicas are cut without any extra limiting, compression, or eq and are pressed with love and care by JVC of Japan.

Mobile license the original master tapes (not dupes) from the record companies and

send them to the JVC cutting centre in Hollywood where Stan Ricker remasters using a half-speed lathe developed for *CD4* cutting. Incidentally Ricker also cuts the Telarc Frederick Fennell Sound Stream digital disc, at half-speed. Those anxious to pour cold water on the Mobile and digital disc half-speed projects argue that JVC is now simply seeking justification for its special lathe now that *CD4* is dead. But those who have heard, and analysed, the Mobile and digital cuts will tell you otherwise. It is here worth remembering that many early disc releases were cut on half-speed lathes simply because the cutting heads then available couldn't cope with high power, high frequency content. As Mobile points out, half-speed cutting (with both the lathe and the tape running at half normal speed) reduces the power requirements of the cutting heads to a quarter the realtime level. Thanks to inverse square law, the 600W per channel amps for the JVC cutting heads perform like 2.4kW per channel amps, driving a lathe running at realtime.

Contrary to folk-lore, half-speed cutting does not in practice limit low bass.

For the Mobile cuts, Ricker eschews limiting, compression and equalisation of the horrid kind that makes voices sound so dramatic on limited bandwidth AM radio. While I was in the USA recently John Eargle of JBL showed me traces he had made which compared the spectral content of the John Klemmer LP *Touch* as originally issued and re-issued by Mobile. The commercial issue has a 6.5dB lift in the mid range over the Mobile 'flat' cut, but is 6.5dB down at both the top and bottom end. This 13dB discrepancy is more than a little audible, as is the overall cleanliness you can get from half-speed cutting. But cutting without limiting, compression or bass cut eq of course makes it difficult to cram the same amount of recording time on a single masterside. Ricker simply reduces the overall cutting level accordingly. If the discs were to be pressed in the usual grade of chocolate chip board favoured by so many record plants around the world, such a cut back of overall level could be disastrous. But Mobile sends the master metals to JVC in Japan who press with customary care and in the 'super vinyl' plastics they developed for *CD4*. So the pressings are delightfully flat, quiet and smooth on the ear. Mobile makes the interesting claim that 'super vinyl' has no 'memory' like conventional, softer, vinyl. A soft vinyl LP played several times during the same day will gradually deform and lose some of its high frequency content. The plastic memory then reforms and regains the high frequencies over a period of rest, lasting a day or so. But 'super vinyl' doesn't deform in the first place.

Advances in hardware technology over recent years have outstripped advances in programme quality. Much sound heard today outside the studio control room is programme-limited. Hence the boom in direct cut, digital and now Mobile re-issue recordings.

Mobile Fidelity Recordings are being imported by Lentek Audio, Edison Road Industrial Estate, St Ives, Cambs. Price is £15 per disc. Ed.

The 1980's are brought one step nearer by the introduction of the MTR-90. This new sophisticated design is based on accumulated technology and innovation which have been the hallmark of Otari for over 15 years.

The new-generation tape transport incorporates a pinch-roller-free direct drive capstan with phase-locked-loop dc-servo circuitry. Tape speeds are 15/30 ips with  $\pm 20\%$  stepless varispeed and a digital percentage readout. Features include full dc-servo on supply and take-up

motors for constant tape tension, automatic switching between input/sync/reproduce electronics with gapless punch-in/punch-out. And a sliding tape-speed controller, built-in digital timer, auto/manual motor-driven head shields plus 40-ohm balanced output, to name but a few. It comes with the latest electronics featuring a single plug-in card per channel.

The MTR-90 is also available in a 16-track frame, and a 16-track prewired for 24 which can be upgraded to a 24-track machine simply

and economically. For the full story, get in contact with your nearest Otari distributor.

# OTARI

Japan: Otari Electric Co., Ltd.,  
4-29-18 Minami Ogikubo, Suginami-ku, Tokyo 167,  
Phone: (03) 333-9631

U.S.A.: Otari Corporation,  
981 Industrial Road, San Carlos, California 94070,  
Phone: (415) 593-1648

## Announcing the new 24-track designed for 1980's. Otari MTR-90.



# Tape Recorder Speed Measurement

Arthur Garratt

There are several well established methods of checking the speed of a tape recorder, three well known techniques being (i) using a stroboscope, (ii) using a test tape of known frequency and comparing the recorder playback with a known frequency, and (iii) measuring the length of a piece of tape and timing how long this takes to run through the machine.

EACH of these methods can be employed, providing you have the necessary equipment available, to measure speeds with an error of the order of 1%. But all these present serious difficulties if you need to measure with an error of 0.1%, ie to another order of magnitude. Such errors are now the norm for professional equipment and even for the better so-called semi - professional machines. A speed error of 0.1% represents a drift of a stroboscope operating on 50Hz mains of one division every 10s which is difficult to measure accurately. If you use a test tape and compare this with a known frequency each of these should have an error of less than 0.1%—better, less than 0.05%, while using a measured length of tape 10m long at a speed of 19cm/s (7½ in/s) this has to be timed to an accuracy of 0.05s or better—impossible using an ordinary stopwatch.

## Using a frequency meter

Frequency counters which measure frequency and count events are now available at reasonable prices, less than £100. Such instruments embody quartz crystals and can measure frequencies to better than one part in 10<sup>5</sup>, an order of magnitude higher than is required for speed determination. The particular instrument I use is a Heathkit IM-4100 which measures frequencies or counts to a total of 99,999. It also measures periods but this is not required for speed determinations. Although the counting is limited to 99,999, simple inspection allows

this to be extended indefinitely by noting how many times the 'clock goes round' during an experiment. To measure speeds the only other equipment necessary is an audio-frequency generator with good short-term frequency stability and a ruler. The generator I use is a Heathkit Model IG-18 and this can easily be set to any desired frequency with an error of no greater than one part in a thousand and it will maintain this accuracy for long periods. This generator provides either sine or square wave on separate outputs—either can be used for measuring speeds.

The technique is simple. You employ tape with the best possible anti-stretch properties which means standard play, preferably acetate which breaks rather than stretches, a suitable length is joined at each end to leader tape using a 90° cut

and the length of this test tape is then measured as accurately as possible. I find a convenient length is about 5m and I lay the tape on the carpet alongside a 5m flexible ruler. The tape should be carefully straightened—ideally tension it with a spring balance to the same as that provided by the recorder, but this is a refinement. After measuring, the tape is spooled. For a complete check you should position it at various points along a length of similar unrecorded tape so that speeds may be checked at the beginning, middle and end of a spool.

Then connect the audio frequency generator to the record input, switch it on and leave it to stabilise for half an hour. The frequency counter is connected to the A output of the recorder (ie switched to 'source'), set in its frequency mode and the audio frequency generator adjusted to provide the frequency desired. If the generator has only switched positions or if it is a single fixed frequency oscillator, it may not be possible to set it to a round number—this is unimportant, merely meaning that you have to do a little arithmetic to determine the speed

error.

The recorder is then run in the record mode and the measured length of test tape recorded with tone. You then have a tape recorded at a precisely known frequency, the next step is to count the number of cycles recorded on it. This is done by rewinding and playing back once more with the frequency counter switched to count events, ie cycles. Then, assuming no tape slip, you can calculate the speed of the recorder from the obvious expression:

$$s = \frac{f \cdot l}{n}$$

where 's' is the speed of the recorder, 'f' is the frequency recorded, 'l' is the length of the test tape and 'n' the number of cycles counted.

In order to check that there are no triggering failures of the counter or failure of the tape to wrap the playback head, the test tape should be run through several times to ensure that the events counting is consistent. To guard against dropouts, the recording level should be reasonably high—I personally record at 8dB below peak. Needless to say you must take care to note how many times the clock has gone round if, the count exceeds the digits on the frequency counter. In the case of the Heathkit IM-4100 this is necessary if the test tape is longer than 190cm at a frequency of 10kHz and a speed of 19cm/s.

On the machines I normally use a Nagra 4.2 and a Ferrograph 7, I experience no tape slip within the accuracy limits of an error of 0.1%. This is checked by playing the recorded tape into the frequency counter switched to frequency determination and comparing the result with the original recording frequency.

One now has a test tape which has a known number of cycles recorded in a known length and this can be used on any other

TABLE 1  
RESULTS

Machine	Band	Length (cm)	Tape	Wave	'f'	'n'	's' (cm/s)
Nagra	1	95.4	Racal	sine	1000	4992	19.11
	2	95.3	Racal	square	1001	4992	19.08
						4991	
						4999	
3	902.6	Racal	square	1000	5000	19.08	
					5000		
					47303		
					47303		
4	502.1	Agfa	sine	10000	263248	19.07	
					263253		
					263254		
					263254		
Ferrograph	1	95.4	Racal	sine	1008	4992	19.260
	2	95.3	Racal	square	1007	4999	19.20
	3	902.6	Racal	square	1007	47305	19.21
	4	502.1	Agfa	sine	10073	263245	19.21

Tape: Racal Zonal RZ, Agfa PE31S.



# The most versatile digital reverb ever made...



## for one-third the cost of its rivals.

Ursa Major's new SPACE STATION is a true breakthrough in audio technology—a digital reverb so versatile that it can create virtually any pattern of direct sound, early reflections and reverberation, yet costs only a third of what you would pay for a single-function reverb system. This easy-to-use unit will take your dry tracks and put them into an endless variety of reverberant spaces, from tiny rooms to concert halls to parking garages to sci-fi locales. And the SPACE STATION can do even more. Multi-Tap Delay and built-in mixer give you totally new pure delay effects, while feedback of a single tap provides simultaneous echo or resonance effects.

**KEY SPECS:** Delay Mode: 80dB dynamic range, 0.1% T (N+D), 7kHz, 256ms delay, 16 programs of delay times for 8 Audition Taps; Reverb Mode: decay time 0 to 3.5s, EQ +0/-10dB at 20 Hz and 7kHz, two programs of reverb taps; Echo Mode: delay time 1 to 255ms, decay time 0 to 13s. Mono In/Stereo Out. LED Peak Level Indicator at 0, -6, -15 and -30dB. Manufactured in USA. URSA MAJOR, SPACE STATION and Multi-Tap Digital Delay are trademarks of Ursa Major, Inc.

### URSA MAJOR

Box 18  
Belmont, MA 02178  
USA (617) 489-0303

ENGLAND: FELDON AUDIO, London, (01) 580 4314 • BELGIUM: MAYBIES, Brussels, (02) 734 31 18 • GERMANY: THUM+MAHR AUDIO, Langenfeld, 02173-72928 • R. BARTH, Hamburg, (040) 2 29 88 83 • FRANCE: 3M, Cergy, (1) 031.61.61 • SPAIN: LLEWELLYN-JONES, Madrid, 637 07 52 • ITALY: AUDIO PROD. INT'L, Milan, 228.120 • HOLLAND: PIETER BOLLEN, Eindhoven, 040-520662 • SWITZERLAND: AUDIOCOM, Kerzers, 031 95 57 42 • AUSTRALIA: KLARION, So. Melbourne, 61 3801 • JAPAN: ELECTORI, Tokyo, (03) 950-6266 • CANADA: J-MAR, Toronto, (416) 421 9080 • NORWAY: PRO-TECHNIC, Oslo, (02) 46 05 54 • FINLAND: AUDIOTRON, Helsinki, 410 688 • DENMARK: AEG-TELEFUNKEN, Albertslund, 02 64 85 22.

## AN ACCURATELY MATCHED 8-TRACK STUDIO PACKAGE AT A PRICE YOU CAN'T AFFORD TO MISS ...

### ALLEN & HEATH BRENNELL MINI 8 STUDIO PACKAGE, COMPRISING:

MOD II CONSOLE 16 X 8  
HEAVY DUTY POWER SUPPLY  
BRENNELL MINI 8 1 INCH COMPATIBLE  
STUDIO RECORDER  
DIGITAL TAPE COUNTER  
ELECTRONIC VARISPEED UNIT  
PRO-LIMITER  
OUR ADVICE & TECHNICAL BACKUP  
ARE AT YOUR DISPOSAL  
FINANCE AVAILABLE

WRITE OR TELEPHONE FOR DETAILS TODAY



CATHEDRAL SOUND LTD.,  
FOURWAYS, MORRIS LANE,  
HALSALL, ORMSKIRK,  
LANCS. L39 8SX  
TEL. HALSALL (0704) 840328

## GALAXY

Direct DC  
Drive Servo



Full Servo  
Loop Speed  
Control

- ★ Instant Start
- ★ Variable Speed Control
- ★ Back Cue (no motor drag)
- ★ Direct Speed Read Out Led
- ★ Slip Cueing
- ★ Remote Start Stop

## LEE ENGINEERING LTD.

NAPIER HOUSE, BRIDGE STREET,  
WALTON-ON-THAMES,  
SURREY, ENGLAND KT12 1AP

TEL: WALTON-ON-THAMES 43124/5/6

TELEX: 928475

# Tape Recorder Speed Measurement

recorder at any playback speed to check its speed, using, of course, a frequency meter. Clearly the highest frequency which can be used based on the performance of the machine and the quality of the tape, in terms of dropouts, the higher the accuracy of the speed determination (see Table 1.)

Taking the results from Band 4 which was recorded at the highest frequency and is over 5m long and therefore should represent the highest accuracy, we find the following results:

Nagra 4-2, speed is 19.07cm/s correct speed is 19.05cm/s error 0.105% fast.

Specification is 'error not greater than 0.1%' therefore the machine is just outside specification.

Ferrograph 7 (mono), speed is 19.21cm/s error 0.84% fast.

Specification is 'error not greater than 1.0%' therefore the machine is within specification.

Note that the same test tapes were used for both machines, each recorded on the Nagra. The count of cycles agree very well suggesting that both machines are playing back satisfactorily, this being particularly significant at 10kHz where playback head contact might have been critical.

## Frequencies of test tapes

Once a machine has been calibrated it is simple, using the frequency counter in its frequency mode, to check the frequencies of test tapes. The following three examples have been checked in this way, in each case the frequency of the calibration band has been measured (see Table 2.)

These results show that ordinary calibration tapes are not sufficiently accurate in terms of frequency to be used to check recorder speeds to the required precision.

## Indicating dropouts

As frequency meters such as the Heathkit IM-4100 trigger fairly critically, you can use them to indicate dropouts. The technique is to choose a suitable recording

level as a standard. I go from my normal recording level of 8dB below peak to 28dB below for dropout tests. Using the Heathkit audio generator this is simple as, using sinewaves, you can switch the oscillator output in 10dB steps. It is important to ensure that the RF bias is correct for the tape in use. A tape of known length is then recorded at -28dB at a suitable frequency, say 10,000Hz. This is then played back into the frequency counter in the totalise mode with the counter arranged just to count. This can be done by adjusting the attenuator on the counter in conjunction with the output gain. From the tape length and frequency you know the number of cycles recorded and this figure is compared with the playback count,

the difference being an indication of dropout. To ensure that you are measuring true dropout and not failure to contact the playback head you should count several times, if possible using more than one playback machine.

Using this technique the following result was obtained on a full track recording using Agfa PE31S tape at 19cm/s (see Table 3).

This result should be regarded as an indication and not an absolute figure because of variations in the triggering voltage of the meter.

## Conclusions

The use of a relatively low cost frequency counter in association with an audio frequency generator of good short term frequency stability enables the speeds of tape recorders to be measured with high accuracy. Once a tape has been recorded and calibrated it can be used on other machines at different speeds to check the machine or to set it to run at the correct speed, this is valuable when setting up recorders such as the Uher Report 4000L.

This technique can also be used to check the frequencies of commercial test tapes and to obtain a useful measure of tape dropout, although it is not claimed that this measure is as accurate as the speed determination.

TABLE 2

Ampex type 01-31321-01 7½in/s NAB

quoted frequency 700Hz  
measured 698.3Hz

Agfa type DIN BESUGSBAND 19 S

quoted frequency 1000Hz  
measured 999.0Hz

EMI type SRT 17 (15in/s)

quoted frequency 1000Hz  
measured 1009Hz

TABLE 3

Recording level:

-8dB, frequency 10,000Hz, n = 26329

-24dB, frequency 10,000Hz, n = 26157  
representing a dropout of 0.58%.



## SERIES 4000 ACTIVE EQUALISER

### FEATURES:

- 27 1/3 octave bands on ISO centers from 40 Hz through 16 kHz.
- 10 dB boost or cut on continuous control. Equal Q in both boost and cut conditions.
- Variable high-pass filter from 20 Hz to 160 Hz with 12 dB/octave roll-off.
- Filter Q optimized for best summation with adjacent bands.

- Noise guaranteed to be -90 dBm or better.
- Sealed Mil-Spec pots.
- EQ IN/OUT switch on front panel

### PLUS OPTIONAL CROSSOVERS FOR BI-AMPING!

- Dual buffered outputs for bi-amp operation.
- Accessory socket to permit insertion of 12 dB/oct. or 18 dB/oct. low level crossover for bi-amp outputs.

# MONITOR EQUALISER!

ALSO:

## ANALYSERS

- MODEL 140 1/3 OCTAVE ANALYSER FOR ROOM EQ
- MODEL 142A SIGNAL MONITOR
- MODEL 150 OCTAVE BAND ANALYSER

White

instruments,  
incorporated

P.O. Box 698 AUSTIN TEXAS 78767  
PHONE AREA 512/892-0752

Scenic Sounds Equipment,  
97-99 Dean Street, London W1. Tel: 734 2812

Belgium  
S E D Rue Bara Straat 146  
1040 Bruxelles Tel: 522 7064  
A R C SPRL Rue Th Decuyper 134  
1200 Bruxelles Tel: 771 3063

France  
3M France SA Mincome Div  
Boulevard de l'oise  
95000 Cergy  
Tel: 749 0275

Denmark  
Lake Audio APS  
Artillerivej 40  
DK 2300 Copenhagen S  
Tel: 570 600

Holland  
Peter Bollen Geluidstechniek  
Hastelweg 6 Eindhoven  
Tel: 512 777

Sweden  
Tal & Ton Musik & Elektronik AB  
Kungsgatan 5  
411 15 Gårhagenburg  
Tel: 130 216  
Spain  
M. Llovelyn Jones  
AP Postal 8178  
Madrid 8 Spain  
Tel: 637 0752

# LASTING QUALITY

by Coles Electroacoustics Ltd.



With a background of lasting top quality Coles bring you two versions of a low priced cardioid. In use with the B.B.C. need we say more? of course we do but please write or telephone

Coles Electroacoustics Ltd., Pindar Road, Hoddesdon, Herts. EN11 0BZ Hod. 09924 66685  
or Hampstead High Fidelity, 63 Hampstead High Street, London. NW3 1QH 01-435 6377

# Mobile Madness

Barry Ainsworth (Mobile One)



**T**HE FIRST problem with a mobile is working out what equipment will be required, ie what type of recording session it will be. A situation where a session with a rock band were transformed, as if by magic, into a Big Band session would be less than amusing. The main problem being the amount of time taken to set up a rock band compared with a larger session. Sometimes clients can be surprisingly ill informed as to the number of musicians and instruments involved. In most cases this doesn't matter, as nearly all mobiles carry a large selection of microphones and stage equipment.

Next problem is where the recording will take place. It could be a concert hall, club, school hall or maybe an artist's home. Each situation is different and must be looked at in a different way.

Looking at a concert hall first. During its design, the acoustic architect will be trying to produce an environment that suits the natural balance of an orchestra, taking into account that a full orchestra will produce a very even natural sound, while the following day if the hall is used for a rock band it must rely on a PA balance engineer to produce an acceptable sound. It is certainly helpful to visit an unknown venue prior to recording as some concert halls have not managed to get their acoustic sums right, as most mobile engineers know to their cost. Some

**The phone rang and a voice said: "Hello, can you do a mobile on Saturday?"**

halls manage to produce a very strange echo which in most cases is acceptable as it adds to the overall sound of the final tapes, providing the engineer can compensate for the effect. If an audience reaction is required—and, surprisingly enough, this is not always wanted—the overall acoustics of the hall must be taken into account. The final placing of the audience mics relies on the acoustic transmission into the auditorium. I recall one hall (not too far away from London) that has the strange effect of producing a sound that can be picked up by the audience mics with almost equal level to that coming off the main mics positioned above the orchestra.

In London, as in most other regional areas, the local council is a force to be reckoned with. They can in fact help the smooth running of a recording session, but at the same time the local byelaws can be very difficult to contend with. The cardinal sin which cannot be abused is the cable routing, and this at times can mean an extra run of many yards. How exciting it can be when you are just a few yards short! Usually there is no other way around this problem but to conform. Some venues have permanent cable ducts laid just for this very reason. If as much as one cable is in the wrong place, it

could mean that until it has been resighted the concert can't take place. After spending a few hours crawling through and balancing on the most precarious bits of architectural embellishment, it's not very funny to be told by the local fire officer: "You can't run a cable there!". Lesson One—always make certain of the local byelaws *before* starting to lay cables—it could save time in the end. The theatre electrician is usually the best person to help with these problems and probably the most helpful person you will meet on a session. He is always worth remembering for a later date too, when on a subsequent visit you may need his help. He may also remember you—as the company that blew all the main fuses and tried to strap a cable to a 100-year-old plaster cherub, that just came off in your hand!

Lesson number Two—cables should be laid along or through spaces that are obviously capable of carrying the weight expected of them.

Lesson number Three—check your mains requirements very carefully. Some halls may be able to handle the current load capacity that you actually require. While it sometimes works, if you do happen to be working along the limit, you stand the risk of blowing the fuses at just the wrong moment—usually

just as the concert starts, and if you're very lucky you'll take the stage and maybe even the fire alarm system out with you. This means you get the grand prize and go into the stage electrician's black book for ever; this is not a book but is, I think, an engraving on his heart. The only way around this is to hope that on a return visit the electrician has a day off or has left, due to a nervous breakdown after the last visit. Another exciting encounter is inadvertently wiring the mobile gear to a handy socket that just happens to be live when the main house lights are on; when it comes to the session the house lights go down and so does your power. Have you tried to run a tape recorder on zero voltage when it should run on 240V? Once again the results are amazing, and can be guaranteed to keep the adrenalin flowing. This again is where the electrician is, as far as the mobile's concerned, next to God.

Most of the above thoughts also apply to theatres although there are a few exciting differences, not least being the variable lighting controls used to produce the stage effects. Usually it's possible to do a sound check before the actual concert, but just occasionally this may not include a lighting rehearsal. When it comes to the actual concert the lights are changing all the time, and so is that distinctive hum which can be likened to a badly suppressed motor bike—

that's the wonder of good old thyristor dimmer circuits. This can be the biggest problem encountered in a theatre. To clear it, may simply mean drawing your mains from a different supply, or moving the main mobile earth, or even rerouting the audio cables. If all else fails a quick prayer won't do any harm. However, this really is the last resort. A much easier solution is to move the mains input to a different mains phase. At this point, please check that you are on the same phase as the rest of the artist's sound equipment as 450V between his mic and guitar or amplifier could cause a nasty accident. The best way to avoid this is to use a voltmeter between any electrical gear on stage, and the shells of your microphones, and make certain that there is no potential difference. This can also be a good check for any earth leakages. Even a few volts difference would give hum problems, which could be easily removed before even a fader on the console was opened. The safest way is to make certain that all the stage sound gear plus the mobile gear goes down to the same mains input as well as the same mains earth point. At the very least if your gear goes off, so will the stage gear.

Another problem to watch out for on theatre stages is visual effects. It was pointed out to the drummer on a session in Europe where the final 'big finish' was to have been the artist kicking over his drum kit, followed by an explosion on the drum platform, just how much microphones cost and his finish was adjusted to preserve the mics for another day.

Scenery and curtain movement can also cause other problems—the acoustic separation can change. A well-remembered session some years ago, before the advent of video monitoring—we were about a quarter way into the show when the complete sound perspective changed and only later did we discover that a curtain had been lowered across the stage to reduce its size for a more intimate effect, but unknown to the producers this also caused a dramatic effect to the overall sound on the mobile.

If it's possible to watch the show before the recording takes place, it can pay dividends later when it comes to mixing the multitrack tapes.

Well that about takes care of the basic problems of a live session. I'm sure that there are many areas I haven't covered, but at least you should get the general idea that live recording is very different from a studio environment.

The next area that needs to be looked at is the actual recording of a live session. Again the most important area is knowing exactly

what is taking place, remembering that you usually have only one chance to get it right. This problem can be reduced as the use of 24-track recording equipment becomes more common, but it is still essential that the basic tapes are recorded accurately as well as having the essential quality of a live recording. This is something that is very hard

possible to adjust the sound more accurately to suit the recording, compared to the actual live sound.

The biggest problem an engineer will face on a live recording is the separation between the band and a voice, or the band and a string section. Both of these sound sources are low level, and yet must be boosted to appear over the top

Even a movement of a couple of yards can make all the difference.

One other method is to change the phase angle of the mics, by putting the problem mics 180° out of phase the separation can be improved, but be warned the sound *must* be checked as an overall entity, rather than just the strings alone, as phase cancellation can cause a legion of other problems, which may not be apparent until the final mix is finished and the record goes into the cutting room. The tell-tale sign is smoke coming from the cutting engineer's ears on close scrutiny of the cutting equipment's phase meter.

Another factor that must be taken into consideration with mobile recording is the amount of wear and tear that mobile mics have to stand up to. One day they may be used for a classical session, the next an open air rock session, and a mic that may have been used on a bass drum for days on end and then be expected to work on a more subtle sound such as a piano will have a restricted frequency range that has to be heard to be believed.

Microphones usually stand up to mobile use very well, although you'd never think so listening to the dealer's comments when a price is being fixed for your pride and joy that you wish to part exchange for a later design.

All in all, microphone technique on a mobile is far more critical than a fixed recording session. This, to me, is part of the enjoyment, where every situation is different, and each session has its own set of problems.

However, another area which can prove difficult is the audience. This in theory is easy, but in practice, far from it. The usual decision is how many mics and where to place them. If you're wrong then you could get the artist's mother and auntie coming over loud and clear, or at worst a single handclap that is far louder than the general audience sound. This spells disaster. I would choose a position that is well away from any seating, but occasionally this proves impossible. In such a situation the only way is to point the mic in another direction, perhaps up at the ceiling, and hope that the mic's pick-up pattern is what the makers say it is.

Right, now we have the equipment set up, the mics in place, and we're ready for the session to start. The set-up started at 09.00 hours, it's now 16.00 hours; still no lunch—remember *The Show Must Go On* (ha, ha). The artist has not turned up; he should have been here at 15.30. This gives you time to prove the mics work and that the tape recorders are recording something



Above and below: inside Mobile One from both ends

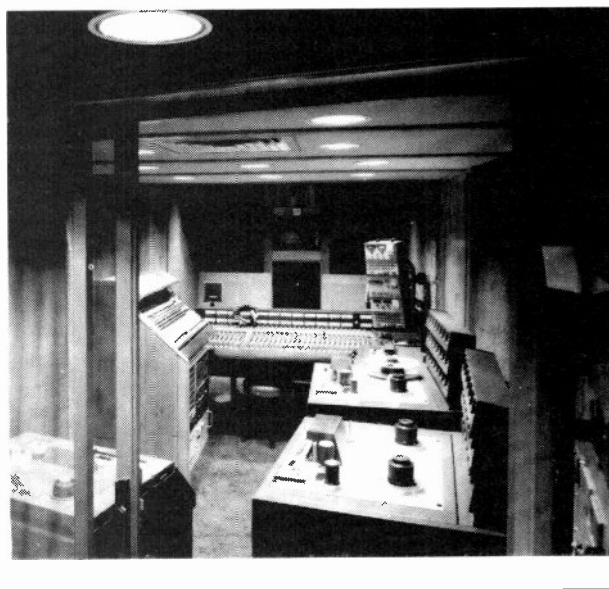

to define, the 'you are there' effect. The dividing line between a good recording and 'oh well it's live' sound is becoming increasingly narrower. Microphones are now far more complex, not only is their pickup field more controllable but their frequency response more selectable. This gives the engineer a more selective range in which to work. Direct injection also plays an important part in the final sound as generally a bass sound, for example, is more exciting in a live situation—loud and 'bassy' which can be difficult to control on the recording. Therefore, if the engineer has the facility to take a direct sound from the guitar it is usually

of a rhythm section, or rhythm section plus brass. One method is to mic-up each instrument in the strings, but this can give an uneven sound as well as taking up valuable mics and channels to the mobile desk. Usually the stage set designer can be relied upon to put the strings next to the drums with the bass guitar in front. The problems this can cause have to be heard to be believed. Again a direct line to the Almighty may help, but people in the music recording business tend to rely on more direct methods, like getting at the designer and persuading him or her to change the stage layout slightly. This may not be as drastic as it sounds.

# Survey: Mobile Recording Trucks

This month's survey of mobile recording units is not fully comprehensive as some mobiles failed to reply to our questionnaire. The survey is limited to 24-track facilities although we have included relevant 16-track facilities.

## ABBEY ROAD MOBILES (EMI)

**Bookings:** Abbey Road Studios (EMI), 3 Abbey Road, London NW8 9AY, UK.

**Phone:** 01-286 1161.

**Bookings to:** Vera Samwell.

**Vehicle or trailer type:** two Mercedes Benz vans.  
**Exterior dimensions:** 19.5ft long, 8ft. wide, 8.75ft high.

**Design and construction:** Abbey Road (EMI).

**Tape recorders:** Studer 24-track/16-track/8-tracks and 2-tracks.

**Consoles:** EMI 24/8 and 28/16 (may be linked together for 24-track).

**Monitoring:** JBL and Tannoy driven by Quad or Crown.

**Noise reduction:** Dolby.

**Microphones:** wide selection including Neumann, AKG, etc.

**Stage boxes, snakes, etc:** cables any length using multiways, plus several DI boxes.

**Communications gear:** headset system.

**Video gear:** Sony CCTV system.

**Hire charges:** on request.

**Availability:** Worldwide.

## ARTISAN RECORDERS

**Bookings:** Artisan Recorders, 5077 North East 13th Avenue, Fort Lauderdale, Florida 33334, USA.

**Phone:** (305) 491-3132.

**Bookings to:** Peter Yianilos.

**Vehicle or trailer type:** GMC motorcoach.

**Exterior dimensions:** 27ft long, 8ft wide.

**Interior dimensions:** 20ft long, 8ft wide.

**Designer:** Peter Yianilos.

**Construction and installation:** Peter Yianilos.

**Tape recorders:** two MCI 24-track, one MCI 2-track.

**Console:** MCI JH 416-24LM plus a 16x8 submix for 40 inputs to 24 busses.

**Monitoring:** Crown powering JBL 4311.

**Ancillary equipment:** Dolby noise reduction, Urei and Orban parametric eq, MXR digital delay, Eventide phaser and omnipressor, Kepex, Urei, Inovonics, Allison limiters, Orban reverb, etc.

**Microphones:** Neumann, AKG, Sennheiser, Electro-Voice, Sony, Schoeps, and Shure. At least 50 carried at all times.

**Stage boxes, snakes, etc:** 250ft cable run, 12 return lines, 48V phantom powering, 40 input lines

with 3-way Iso-ground outputs. All 52 lines cross-patchable.

**Communications gear:** Clear-com multi-station system.

**Video gear:** B/W monitoring system.

**Hire charges:** 24-track \$1600, 2-track \$500 per day (including engineer and crew). Travel 30¢ per mile.

**Availability:** on request.

## BLACK PETE

**Bookings:** Record Plant Studios, 321 West 44th Street, New York, NY 10036, USA.

**Phone:** (212) 581-6505.

**Bookings to:** David Hewitt.

**Vehicle or trailer type:** Peterbuilt tractor and custom trailer.

**Exterior dimensions:** 35ft long, 8ft wide.

**Interior dimensions:** 24ft long, 8ft wide, 9ft high.

**Designer:** David Hewitt.

**Construction and installation:** Record Plant.

**Tape recorders:** two Ampex MM1200 multitracks.

**Console:** API custom 44/44.

**Monitoring:** Westlake and Auratone.

**Ancillary equipment:** Urei, dbx, CBS custom limiters; virtually any device available on request including Dolby or dbx noise reduction.

**Microphones:** Shure, Sennheiser, AKG, and Neumann. Others available.

**Stage boxes, snakes, etc:** 48-input/96-output, Jensen transformers on Belden cable.

**Communications gear:** Chaos headsets and squawk box.

**Video gear:** Sony and Panasonic CCTV.

**Hire charges:** on request (rates include engineer and crew).

**Availability:** USA and Canada. Others on request.

## DIERKS RECORDING MOBILE

**Bookings:** Dierks-Studios, Hauptstrasse 33, D-5024 Pulheim 3, West Germany.

**Phone:** 02238 3333. Telex: 888 3241.

**Bookings to:** Mr Hook.

**Vehicle or trailer type:** Mercedes Daimler Benz L911.

**Exterior dimensions:** 25ft long, 8ft wide, 11ft high.

**Interior dimensions:** 18ft long, 7ft wide, 7ft high.

**Design:** Dierks-Studios.

**Construction and installation:** Dierks-Studios.

**Tape recorders:** Studer 16-track or Telefunken 16/24/32-track machines.

**Console:** 30/32 console with built-in limiters and noise gates.

**Monitoring:** Klein & Hummel and Auratone.

**Ancillary equipment:** Dolby noise reduction,

Kepex, AKG reverb, plus a wide selection of phasers, flangers, etc.

**Microphones:** selection of Neumann, AKG, Sennheiser, Shure, and Electro-Voice.

**Stage boxes, snakes, etc:** 600ft multicore cables, two 40-input stage boxes, etc.

**Communications gear:** headphone, loudspeaker and walkie-talkie facilities.

**Video gear:** Sony and Shibaden monitor system. VCR recording on request.

**Hire charges:** DM1,800 per day, DM1,500 per day (four days or more). Rates include two engineers. Travel DM500 per day.

**Availability:** Europe and the Middle East.

## FILMWAYS/HEIDER RECORDING

**Bookings:** Filmways/Heider Recording, 1604 North Cahuenga Boulevard, Hollywood, California 90028, USA.

**Phone:** (213) 466-5474.

**Bookings to:** Ms Marlee Dailey.

**Vehicle or trailer type:** five mobile units of various types and sizes.

### Mobile Unit One

**Dimensions:** 35ft long, 8ft wide.

**Tape recorders:** Ampex MM1200 24/16-track, 3M M79 24-track, 3M M56 16/8-track, Ampex 440 4/2-track, and ATR-100 stereo machine.

**Console:** API 40/24 with two AM-10 6x1 submixers.

**Monitoring:** Altec.

**Ancillary equipment:** various.

**Microphones:** wide selection.

**Communications gear:** telephone system.

**Video gear:** CCTV system.

**Hire charges:** on request.

**Availability:** on request.

### Mobile Unit Two

**Dimensions:** 29ft long, 8ft wide.

**Tape recorders:** Ampex MM1200 24/16-track, 3M M79 24-track, 3M M56 16/8-track, Ampex 440 4/2-track, and ATR-100 stereo machine.

**Console:** API 32/24 with two Neve 6x1 submixers.

**Monitoring:** Altec.

**Ancillary equipment:** various including Urei and dbx.

**Microphones:** wide selection.

**Communications gear:** telephone system.

**Video gear:** Sony CCTV.

**Hire charges:** on request.

**Availability:** on request.

### Mobile Unit Three

**Dimensions:** 21ft long, 8ft wide.

This truck can accommodate a Yamaha PM-2000



# TSM

# Creme de la Creme

When you're making the final mix of your latest album, you don't trust to luck with any detail.

Certainly, Kevin Godley and Lol Creme don't, which is why they chose a studio equipped with an automated Trident TSM console to make their final mix-down - Essex Studios with their 32-24-24 TSM.

The expertise they put into their music is matched by the response of the TSM's electronics, guaranteeing the ultimate technical performance from their own performance.

Contact Ken Bray or Steve Gunn at Trident and discover for yourself the 'creme de la creme' of mixing consoles.



**Trident Audio Developments Limited TRIDENT**  
Shepperton Studio Centre, Squires Bridge Road,  
Shepperton, Middlesex, England.  
Telephone: Chertsey (09328) 60241 Telex: 8813982

**America Area 1** Studio Maintenance Services, California. Tel: 213-877-3311 **America Area 2** Sound 80 Inc., Minneapolis. Tel: 612-721-6341 **America Area 3** Winteradio Companies, Parma, Ohio. Tel: 216-886-5536 **America Area 4** Empirical Audio, New York. Tel: 914-762-3089 **Australia** John Barry Group, Sydney. Tel: 61-2-439-6955  
**Belgium** Naybies, Brussels. Tel: 32-2-734-31-38 **Canada** La Salle Audio Products Ltd, Montreal. Tel: 513-342-2511 **France** Lazare Electronics, Paris. Tel: 33-1-878-62-10  
**Germany** Peter Struven, Hamburg. Tel: 49-40-801028 **Holland** Cadac Holland BV, Hilversum. Tel: 31-35-17722 **Italy** Audio Products International, Milan. Tel: 392-273-896  
**Japan** Continental Far East, Tokyo. Tel: 81-3-583-8451 **South Africa** Leephy (Pty) Ltd., Johannesburg 2092. Tel: 010-48-3821 **Spain** Neotecnica S.A.E., Madrid. Tel: 34-1-242-09-00

## SURVEY: MOBILE RECORDING TRUCKS

console, monitor loudspeakers and tape machines for smaller recording assignments. Alternatively it may be used as a utility tape truck in conjunction with Mobiles One and Two.

### Mobile Unit Four

**Dimensions:** 21ft long, 8ft wide.

This truck can accommodate a Yamaha PM-1000 console, monitor loudspeakers and tape machines. Functions are the same as Mobile Unit Three.

### Mobile Unit Five

**Dimensions:** 29ft long, 8ft wide.

This truck interfaces with Mobile Units One and Two to create an expanded control room for performances that require multiple consoles or large numbers of tape machines. Equipment is available for this truck to suit the requirements of any production including PA system storage.



**Left:**  
Filmways/Heider  
Mobile Unit 2  
at the Griffith  
Park Observatory,  
Los Angeles



**Right:**  
The  
Manor  
Mobile

## ISLAND MOBILE

**Bookings:** Basing Street Studios, 8-10 Basing Street, London W11 1ET, UK.

**Phone:** 01-229 1229.

**Bookings to:** Penny Hansen and Howard Kilgour.

**Vehicle or trailer type:** British Leyland Boxer.

**Dimensions:** 31ft long, 8ft wide.

**Tape recorders:** two 3M 24 tracks and two Studer B62 stereo machines.

**Console:** custom Helios 40/24.

**Monitoring:** JBL 4310 and 4311 driven by Amcron DC300A.

**Ancillary equipment:** Dolby noise reduction, EMT and Master Room reverb/delay, Kepex, Universal Audio limiters, etc.

**Microphones:** selection of Neumann, AKG, Beyer, etc.

**Stage boxes, snakes, etc.:** 500ft cable run, 40 mic lines plus foldback.

**Communications gear:** Clear-com system.

**Video Gear:** Closed circuit system.

**Hire Charges:** on request (includes engineers and crew).

**Availability:** Europe.

**Phone:** 08675 2128. Telex: 22542.

**Vehicle or trailer type:** Mobile 1—Fiat 684T with 30ft trailer, Mobile 2—Fiat 130NT with 20ft trailer.

**Exterior Dimensions:** Mobile 1—40ft long, 8ft wide. Mobile 2—34ft long, 8ft wide.

**Interior dimensions:** both mobiles 20ft long, 8ft wide, 8ft high.

**Designer:** Philip Newell.

**Construction and installation:** The Manor Mobile. **Tape recorders:** both mobiles have two Ampex MM1100 24/16/8-track machines plus two AG440 stereo machines.

**Consoles:** Mobile 1—Helios 40/24. Mobile 2—Neve 40/24.

**Monitoring:** Tannoy/Altec.

**Ancillary equipment:** various makes of equalisers reverb, delay, etc, plus Dolby noise reduction.

**Microphones:** AKG, Neumann, Schoeps, Sennheiser, Beyer, Calrec, and Pearl.

**Stage boxes, snakes, etc.:** various.

**Communications gear:** Clear-com and Polaron.

**Video gear:** Sony and Hitachi CCTV.

**Hire charges:** £600 per day (depends on nature of work and location). Rate includes a crew of two or three.

**Availability:** Worldwide.

**Design:** Mirasound.

**Construction and installation:** Mirasound.

**Tape recorders:** Mobile One—MCI JH16 24-track and Studer A80 2-track. Mobile Two—MCI JH16 24-track and two JH110 2-track machines.

**Consoles:** Mobile One—Midas 24/24. Mobile Two—Midas 28/24/8.

**Monitoring:** Mobile One—Tannoy. Mobile Two—JBL.

**Ancillary equipment:** various including AKG and EMT reverb, and dbx noise reduction (additionally Dolby in Mobile Two).

**Microphones:** Neumann, Schoeps, AKG, and Sennheiser.

**Stage boxes, snakes, etc.:** 350ft multicables and direct-line outputs for PA.

**Video gear:** Sony CCTV.

**Hire charges:** £500 per day (includes personnel). Travel extra.

**Availability:** Holland, Germany, Belgium, France, and the UK.

## LE MOBILE FILTROSON

**Bookings:** Filtroson Ltée, 4 Carré des Bois, Ste-Thérèse, Québec, J7E 2R3 Canada.

**Phone:** (514) 733-8166.

**Vehicle or trailer type:** Chevrolet truck.

**Exterior dimensions:** 25ft long, 8ft wide.

**Interior dimensions:** 22ft long, 8ft wide.

**Designer:** Guy Charbonneau. Acoustic design by Serge Melancon.

**Tape recorders:** Studer A800 24-track plus Studer 2 tracks.

**Console:** Neve 8058 32-input/24-track monitoring.

**Monitoring:** JBL 4311 and Auratone.

**Ancillary equipment:** Dolby noise reduction, EMT, Kepex limiters, compressors, Eventide delay, flanger, harmonizer, etc.

**Microphones:** Neumann, AKG, Sennheiser, Electro-Voice, Shure, Schoeps, Sony, and Beyer. Choice of over 80 mics.

**Stage boxes, snakes, etc.:** two special multicables taking up to 64 pairs of mic lines. Custom built mic splitter and Jensen transformers etc.

**Communications gear:** Clear-com system.

**Video gear:** Sony and Panasonic cameras and monitors.

**Hire Charges:** Live shows \$2200, Studio work \$1000.

**Availability:** Canada and the USA.

## MIRASOUND MOBILE STUDIOS

**Bookings:** Mirasound, Langstraat 51, Wijhe Netherlands.

**Phone:** (31) 05702-1826.

**Bookings to:** Mr G Voskuylen.

**Vehicle or trailer type:** Mobile One—Mercedes 408 van. Mobile Two—Mercedes 508 van.

**Exterior dimensions:** Mobile One—20ft long, 6.5ft wide. Mobile Two—23ft long, 6.5ft wide.

**Interior dimensions:** Mobile One—14ft long, 6ft wide. Mobile Two—20ft long, 6ft wide.

*Le Mobile Filtroson*

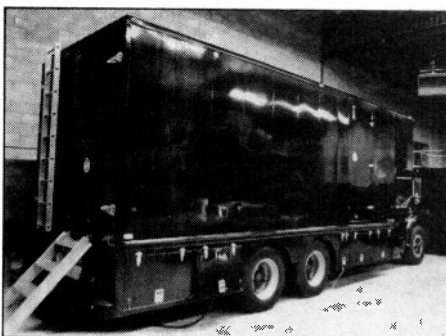

## MANOR MOBILE

**Bookings:** The Manor Mobile, Shipton-on-Cherwell, Oxon OX5 1JL, UK.

## MOBILE ONE

**Bookings:** Tape One Studios, 29/30 Windmill Street, Tottenham Court Road, London W1P 1HG, UK.

**Phone:** 01-580 3744. Telex: 298531.

**Bookings to:** Barry Ainsworth or Helen.

**Vehicle or trailer type:** Ford Transcontinental tractor and custom trailer.

**Exterior dimensions:** 46ft long, 8ft wide.

**Interior dimensions:** 18ft long, 7.5ft wide, 8ft high. Also includes a small overdund studio 7ft long.

**Designer:** Barry Ainsworth.

**Construction and installation:** bodywork—AC Penman, acoustics—Eastlake Audio, electronics—Brabury Electronics.

**Tape recorders:** two 24-track MCI multitracks and a MCI 2/4-track mixdown machine.

**Console:** MCI JH 400 Series 35/36 plus 16x4 Triad console, allowing up to 52 inputs.

**Monitoring:** Amcron powered Eastlake and Auratone.

**Ancillary equipment:** Audio & Design compressor, limiter, noise gate, etc, EMT digital echo, Dolby noise reduction, Eventide harmonizer, etc.

**Microphones:** AKG, Sennheiser, Neumann, and Beyer.

**Stage boxes, snakes, etc.:** up to 52 mic lines, plus 24 direct lines, and splitter/DI boxes.

**Communications gear:** PO radio telephone, six channel internal switchboard, etc.

**Video gear:** JVC colour monitor plus remote camera control.

**Hire charges:** £500 per day, £2,850 per week (rates include engineers and crew).

**Availability:** Worldwide including the USA.





# ELECTRONICS SALES LTD.

Telephone : Watford 47988

## FOR SALE

### NEW & SECONDHAND STUDIO EQUIPMENT

M.C.I. JH10 16-TRACK ... ..	£7000
M.C.I. JH114 24-TRACK and Autolocate	£17000
3M M56 16-TRACK ... ..	£8500
3M M23 8-TRACK ... ..	£3500
AMPEX MM1000 8-TRACK ... ..	£3750
AMPEX MM1000 8-TRACK ... ..	£4000
SCULLY 280 16-TRACK ... ..	£5500
SCULLY 280 8-TRACK ... ..	£3000
SCULLY 280 8-TRACK with Syncmaster	£3500
STUDER C37 STEREO ... ..	£700
STUDER J37 8-TRACK ... ..	£2200
STUDER A80 Mk II 8-TRACK 1400 hours	£7700
STUDER A80 Mk I 8-TRACK ... ..	£6500
STUDER A62 STEREO ... ..	£1000
AUDIO DEVELOPMENTS PICO MIXER 6-2	£650
AUDIO DEVELOPMENTS 007 MIXER 10-4	£1100
AMEK 2016 20-16 MIXER ... ..	£6500
TRIDENT 24-16-16 ... ..	£11500
CADAC 28-16-24 as new ... ..	£28000
SYNCON ALLEN AND HEATH 28-28 ...	£8500
DOLBY MI6 ... ..	£4750
DOLBY A360 x 2, pair ... ..	£590
KLARK TEKNIK DN27, new ... ..	£400
STATIK SA10 DUAL TEN GRAPHIC EQ.	£280
MXR 31 BAND GRAPHICS x 2, each ...	£300
EMT WOW AND FLUTTER METER ...	£400
FERROGRAPH TEST SET ... ..	£300
AUDIO AND DESIGN E500BS PROCESSOR	£500
AUDIO AND DESIGN E900-S SWEEP EQ.	£350
2 LEEVERS RICH 7-BAND GRAPHIC EQs.	£160
GELF AUTOPHASING UNIT ... ..	£280

ALL PRICES PLUS VAT

## The TRADEQ Spring Reverb

- 19" RACK MOUNTING
- XLR TYPE CONNECTORS
- INPUT LEVEL + BASS LIFT CONTROLS
- LIMITER ON INPUT
- PEAK READING LED
- VERY LOW NOISE
- THREE SPRING SYSTEM
- 12 MONTHS PARTS + LABOUR WARRANTY

PRICE £175.00 MONO

£275.00 STEREO

OVERSEAS AGENTS REQUIRED

## Webber TEST TAPES

¼" NAB OR CCIR ... ..	£18.00	7½ OR 15 IPS
½" NAB OR CCIR ... ..	£28.00	7½ OR 15 IPS
1" NAB OR CCIR ... ..	£92.00	7½ OR 15 IPS
2" NAB OR CCIR ... ..	£170.00	7½ OR 15 IPS
2" A.E.S. 30 IPS ... ..	£180.00	

ALL EX STOCK

ALL PRICES PLUS 8% VAT HOME MARKET  
AGENTS REQUIRED IN ALL COUNTRIES

## WE PAY CASH FOR STUDIO EQUIPMENT PART X WELCOME

### 149B ST. ALBANS ROAD, WATFORD, HERTS.

Tel. WATFORD 47988

Telex 262741

## SURVEY: MOBILE RECORDING TRUCKS

### OMEGA AUDIO

**Bookings:** Omega Audio, 2805 Clover Valley Drive, Garland, Texas 75041, USA.  
**Phone:** (214) 226-7179.  
**Vehicle or trailer type:** 1 ton Chevrolet van.  
**Dimensions:** 21ft long, 8ft wide.  
**Designer:** Paul Christensen.  
**Construction and installation:** Paul Christensen.  
**Tape recorders:** 24-track, 16-track, 8-track MCI machines plus an Otari 2-track.  
**Console:** Speck 30/24 with parametric eq on each input.  
**Monitoring:** JBL and Auratone.  
**Ancillary equipment:** dbx noise reduction and limiters, Orban eq, Deltalab digital delay, Kepex, Mic Mix reverb, etc.  
**Microphones:** Neumann, Beyer, Shure, Electro-Voice, AKG, Sony and MB. Approximately 50 mics available.  
**Stage boxes, snakes, etc:** 34 pair 200ft snake, 24 pair with transformer isolated splitter box. 75 assorted mic cables of various lengths.  
**Communications gear:** Clear-com headset system.  
**Video gear:** close circuit video monitor.  
**Hire charges:** 24-track \$1600, 16-track \$1200, 8-track \$850, and 2-track \$450 per day (includes two engineers). Weekly rate four times the daily rate. Travel 50¢ per mile plus expenses.  
**Availability:** USA, Mexico and Canada.

### MOBILES PUBLISON AUDIO PROFESSIONAL

**Bookings:** Publison Audio Professional, 5-11 Rue Crespin du Gast, F-75011, Paris, France.  
**Phone:** (33) 357-6408.  
**Vehicle or trailer type:** Saviem lorry.  
**Tape recorders:** two 3M M79 24-tracks and a Studer 4/2-track.  
**Console:** Audio Help 40/32.  
**Monitoring:** Gauss 11/54.  
**Ancillary equipment:** Dolby and dbx noise reduction, Publison limiter, compressor, digital delay, AKG reverb, Kepex, etc.  
**Microphones:** Neumann, AKG, Beyer, Sennheiser, multicaibles, folding screens.  
**Video gear:** National CCTV system.  
**Hire charges:** on request.  
**Availability:** on request.

### RECORD PLANT REMOTES

**Bookings:** Record Plant, 8456 West 3rd Street, Los Angeles, California 90048, USA.  
**Phone:** (213) 653-0240.  
**Bookings to:** John Rugis  
**Vehicles or trailer type:** three GMC vans.  
**Exterior dimensions:** trucks 1 and 2, 28ft long, 8ft wide; truck 3 33ft long, 8ft wide.  
**Interior dimensions:** all trucks 19ft long, 8ft wide, 7.5ft high.  
**Design:** Record Plant staff.  
**Construction and installation:** Record Plant.  
**Tape recorders:** two 3M M79 24-tracks in each truck.  
**Consoles:** truck 1—Audionics 32/24.  
truck 2—Automated Processes 44/24.  
truck 3—Automated Processes 44/32.  
**Monitoring:** JBL custom bi-amped and equalised.  
**Ancillary equipment:** Dolby, dbx noise reduction, plus Urei, Pultec, Lang, dbx, Eventide, AKG, EMT, Lexicon, ADR, White, etc.  
**Microphones:** Neumann, AKG, Sennheiser, Electro-Voice, Shure, Beyer, and Sony.  
**Stage boxes, snakes, etc:** 27 pair and 15 pair cables, splitter system, as many channels as required.  
**Communications gear:** RTS intercom.  
**Video gear:** Sony camera and colour monitors.  
**Hire charges:** negotiable (rates include engineer and crew).  
**Availability:** Worldwide—the mobile studios may be shipped in flight cases.

### REELSOUND RECORDING

**Bookings:** Reelsound Recording Co, Box 280, Manchaca, Texas 78652, USA.  
**Phone:** (512) 472-3325.  
**Bookings to:** Malcolm Harper Jr.  
**Vehicle or trailer type:** Bus.  
**Exterior dimensions:** 38ft long, 7.5ft wide.  
**Interior dimensions:** 18ft long, 7ft wide.  
**Designer:** Malcolm Harper.  
**Construction and installation:** Bob Reed and Malcolm Harper.  
**Tape recorders:** MCI 24-tracks and Ampex 2-tracks.  
**Console:** MCI 428-28LM.  
**Monitoring:** JBL 4313.  
**Ancillary equipment:** Allison Gainbrains, Kepex, Urei, AKG reverb.  
**Microphones:** Shure, Electro-Voice, Neumann, AKG, Sony, and RCA.  
**Stage boxes, snakes, etc:** two 16-input split boxes using Sescom transformers.  
**Communications gear:** Bell telephone type.  
**Video gear:** Sony Toshiba colour system.  
**Hire charges:** \$2050 per day (includes four man crew). Travel 55¢ per mile.  
**Availability:** North and South America.

### ROAD 80

**Bookings:** Sound 80, 2709 East 25th Street, Minneapolis, Minnesota 55406, USA.  
**Phone:** (612) 721-6341.  
**Bookings to:** Barb Crofoot.  
**Vehicle or trailer type:** GMC transmode motor-coach.  
**Dimensions:** 26ft long, 8ft wide.  
**Designer:** Robert A. Hansen, New York.  
**Tape recorders:** 2/8/24/46-track MCI; and 4/32-track 3M digital available.  
**Console:** Trident 48-input.  
**Monitoring:** Altec.  
**Ancillary equipment:** Dolby noise reduction Pandora/Trident limiters, AKG echo, Eventide, Marshall, etc.  
**Microphones:** Shure, Sennheiser, Sony, AKG and Neumann. Others available on request.  
**Stage boxes, snakes:** 200ft snake, splitterbox—48 split.  
**Communications gear:** privateline to stage.  
**Video gear:** VTR/video monitor.  
**Hire charges:** 24-track \$1500, 46-track \$2000 per day. Travel \$1 per mile.  
**Availability:** on request.

### ROADWAY RECORDERS

**Bookings:** Roadway Recorders, 51 Glendale Ave., Livingstone, New Jersey 07039, USA.  
**Phone:** (201) 325-2056.  
**Bookings to:** Kurt Fleischer.  
**Vehicle or trailer type:** Heavy duty van with 18ft rigid box.  
**Interior dimensions:** 16ft long, 7ft wide.

**Design and construction:** Kurt Fleischer and Rick Dior.  
**Tape recorders:** two MCI 24-track machines (16-track heads available).  
**Console:** Allen and Heath Syncon 28/28.  
**Monitoring:** Altec driven by Crown DC300.  
**Ancillary equipment:** various including Urei 1176 limiters and BTX SMPTE synchroniser. Dolby/dbx available by arrangement.  
**Microphones:** Neumann, AKG, Sennheiser, Electro-Voice, and Shure.  
**Stage boxes, snakes, etc:** 250ft snake with 27 mic lines.  
**Communications gear:** Clear-com system.  
**Video gear:** CCTV system.  
**Hire charges:** 24-track, \$1800 per day; 16-track, \$1400 per day.  
**Availability:** USA and Canada.

### ROLLING STONES MOBILE

**Bookings:** The Mobile Studio Ltd, 2 Munro Terrace, London SW10 0DL, UK.  
**Phone:** 01-352 0005. Telex: 914985.  
**Bookings to:** Ian Stuart or Ellen Trillas.  
**Vehicle or trailer type:** two axle rigid, BMC Laird.  
**Exterior dimensions:** 32ft long, 8ft wide.  
**Interior dimensions:** 22ft long, 8ft wide, 9ft high.  
**Designer:** Dick Swettenham and Sandy Brown Associates.  
**Construction and installation:** Bonnallack and Helios.  
**Tape recorders:** two 3M 24-track (14in spools), 3M 2-track, Revoxs.  
**Console:** Helios 32/24.  
**Monitoring:** Altec and Amcron/Quad.  
**Ancillary equipment:** Dolby noise reduction, Master Room echo, Pultec, Urei, Kepex, Lexicon digital delay, harmoniser etc.  
**Microphones:** Neumann, Shure, Beyer, Electro-Voice, AKG. At least 50 carried at all times.  
**Stage boxes, snakes, etc:** 54 mic lines with actively isolated splitter boxes.  
**Communications gear:** stage-to-console talk-back.  
**Video gear:** Sony CCTV.  
**Hire charges:** quoted for specific jobs.  
**Availability:** anywhere drivable, including USSR.

### RONNIE LANE'S MOBILE (LMS)

**Bookings:** The Mobile Studio Ltd, 2 Munro Terrace, London SW10 0DL, UK.  
**Phone:** 01-352 0005. Telex: 914985.  
**Bookings to:** Ian Stuart or Ellen Trillas.  
**Vehicle or trailer type:** air-conditioned Air-Stream caravan.  
**Designer:** Ron Nevison.  
**Construction and installation:** Ron Nevison and Helios.  
**Tape recorders:** Studer 16-track and B67 stereo machine, plus a number of Revoxs.  
**Console:** Helios 20/12.  
**Monitoring:** Tannoy driven by Amcron.  
**Ancillary equipment:** Dolby noise reduction, AKG reverb, Urei, Audio & Design, etc. 68 ▶

*Interior of the Rolling Stones mobile looking to the rear*  
Left: 3M Mincom M79 24-track and 2-track  
Right: recently installed third machine



# The amazing 32-track Telefunken 'magnetophon' 15A. A new dimension in studio recording technology.



Available in 8, 16, 24 and 32-track format.



## **AEG-TELEFUNKEN**

Tape Recorder Division,  
Postfach 2154,  
D-7750 Konstanz, West Germany.  
Telephone: (7551) 86-2460.  
Telex: 733233.

Hayden Laboratories Limited,  
Hayden House, Churchfield Road,  
Chalfont St. Peter, Bucks SL9 9EW.  
Telephone: Gerrards Cross 88477  
Telex: 849469.

**HAYDEN**

Exclusive UK Agent

# Mobile Madness

other than that earth loop hum you have suddenly started to pick up. The big decision here is do you blame the venue's earth or do you lay an earth stake? The safest way is to confirm your earth connection to the main electrical earth . . . yes, that's okay; quick panic—the sledge hammer to lay your own earth stake got left behind on the last gig. Suddenly all is revealed: the engineer setting up the tape recorder on the mobile had forgotten to switch off the low frequency oscillator after setting up the recorder. The next thing is to check the recording engineers' guide to unfair dismissal of assistant engineers rule book. Discretion being the better part of valour, say nothing; one day you'll get revenge. Wait till it rains when the cables have to be packed away, yes that's the answer, wait until it rains. Right, everything is working.

At this stage all that can be done is to set each mic to produce approximately the same ambient noise—at least it proves the system is complete and working. A bonus . . . there is somebody talking in the auditorium; that means it may be possible to check the audience mics. Until the audience arrives the sound is not at all representative of the final sound, but at least it

may give some ideas on perspective. I've often found that a number of audience mics are better than maybe just a stereo pair. Depending on the theatre or hall, its shape and size, up to 10 mics may be necessary. To decide on the number it is usually a good idea to talk to the booking office, to find the number of seats sold, the artist's management is generally the last to be given this information, and because these mics are invariably the most difficult to rig, it is essential to have this information as early as possible. The artist has arrived. Right here we go, fingers crossed, everything ready, right, let's go. Hopefully, half an hour later the sound is okay. There's been the usual discussion with regard to the general sound, and now it's down to the complicated bit of assembling an overall sound that the producer is happy with. This again can be a problem in a mobile situation. Not least, is once the audience is in, the basic sound can change—the theatre is full, therefore the sound becomes 'deader' than at the rehearsal. When setting up a balance this must be taken into consideration. Also the fact that in most cases the performers will give that little bit more during the show, and so

the best you can do is to get an approximation of the final sound. I have known situations where a limiter has been carefully set on the bass (for instance) to produce an even sound and on the actual session the limiter starts to work much harder and therefore change the general sound. All these problems must be considered carefully during the rehearsal period. Eventually everybody is happy: the artist and musicians go off to eat and to arrange their programme while the mobile crew sort out any last minute problems that became apparent during the rehearsal.

Right, everything is okay. The concert starts at 19.30, quick check the time, then lunch (belatedly). 19.00!!! No lunch. *The show must go on.* (What an over-used phrase.) Three minutes to curtain up. This is where a prayer is very useful. At this stage there is very little you can do, even if there is a problem. I remember one concert, where during the half hour before it was due to start two audience mics went missing—I suppose that is all part of the wonder of mobile recording. When an engineer went to check the mics, it was found that somebody had stolen the mic heads. Thank goodness this is very unusual. The houselights go down, the recorder is started, and we're off.

The recording system is running

two machines, so as one tape nears its end the next can be started, thus losing no part of the performance. In comparison with the panics before the recording, everything goes very smoothly. The final curtain comes down, the artists shoot out of the theatre before the musicians have finished playing and all that's left is the clearing up. The time is now 23.00 and still no lunch. The race is on. The question is how quickly can the equipment be stored away, and what time does the last Chinese restaurant close.

On such a session it is possible to use the same microphones as the house PA. To do this a split feed is taken after the microphones, but before the PA mixer. You would only supply mics when the PA engineers' and the recording engineers' ideas vary. This cuts down the amount of packing time as well as the number of mics seen on stage. Midnight; all packed away. Now down to the local Chinese restaurant and lunch. Only 12 hours late, at least we managed to get something. On occasions we're so late even the Chinese restaurants are closed. In this case breakfast is the next meal.

It is said that a recording engineer's life is glamorous. I hope I've managed to put it all in perspective, and that I haven't put too many people off.

## SURVEY: MOBILES

**Microphones:** Neumann, Shure, AKG, and Sony.  
**Communications gear:** stage-to-console talkback.  
**Video gear:** Sony CCTV.  
**Hire charges:** on request.  
**Availability:** on request.

### SABRE MOBILE

**Bookings:** Sabre Mobile Recording Studio, 55 Cliff Drive, Canford Cliffs, Poole, Dorset BH13 7JG, UK.  
**Phone:** 0202 708303.  
**Bookings to:** Dave le Neve-Foster.  
**Vehicle or trailer type:** British Leyland Terrier.  
**Exterior dimensions:** 22ft long, 7.5ft wide.  
**Interior dimensions:** 15ft long, 7ft wide, 7ft high.  
**Designer:** Dave le Neve-Foster.  
**Construction and installation:** Richard Hemming and Dave le Neve-Foster.  
**Tape recorders:** Ampex MM1100 16/8-track and Studer B62 stereo machine.  
**Console:** custom Alice ACM 18/8/16.  
**Monitoring:** JBL 4320 and Auratone driven by Amcron and Quad.  
**Ancillary equipment:** Dolby noise reduction, Master Room reverb, Mayer, Audio & Design, dbx, Rebis etc.  
**Microphones:** AKG, Calrec, Beyer, and Neumann.  
**Stage boxes, snakes, etc:** 330ft multicore cable, Sabre 18-channel stage box, DI boxes and mic splitters.  
**Communications gear:** Headphones and talkback.  
**Video gear:** Sanyo B/W CCTV system.  
**Hire charges:** £150-£300 per day. Rate includes two engineers.  
**Availability:** Europe.

**Vehicle or trailer type:** Bedford Luton.  
**Exterior dimensions:** 16ft long, 7ft wide.  
**Interior dimensions:** 10ft long, 6ft wide.  
**Design:** Kenneth Shearer & Associates.  
**Construction and installation:** Sutton Audio Ltd.  
**Tape recorders:** Studer 24-track and 4-track, plus Philips stereo machines.  
**Console:** Sutton Audio 20/8  
**Monitoring:** Tannoy/Lockwood driven by Quad.  
**Ancillary equipment:** Dolby noise reduction. Facilities for radio link transmission and PO line connection.  
**Microphones:** Neumann, AKG, and Calrec.  
**Communications gear:** full talkback and telephone facilities.  
**Video gear:** CCTV system.  
**Hire charges:** minimum £200 per day. Minimum £1,000 per week. Travel extra. Rates include two balance engineers.  
**Availability:** Worldwide.

### THE TRUCK

**Bookings:** The Truck Ltd, Comforts Place, Tandridge Lane, Tandridge, Nr. Lingfield, Surrey, UK.  
**Phone:** 034285 2133.  
**Bookings to:** Louis Austin.  
**Vehicle or trailer type:** Ford D1414 lorry.  
**Exterior dimensions:** 36ft long, 8ft wide.  
**Interior dimensions:** 24ft long, 8ft wide (plus 7ft rest room/kitchen at rear).  
**Designer:** Louis Austin.  
**Construction and installation:** Unitruck Ltd/SHE Audio.  
**Tape recorders:** MCI 24-track and two MCI 2-tracks, plus a Revox A700.  
**Console:** Rairdink Quantum 40+10/32 with MCI automation.  
**Monitoring:** JBL 4340 driven by bi-amped Crown DC300s. Also Auratones.  
**Ancillary equipment:** Dolby and dbx noise reduction, AMS digital delay, Eventide Harmonizer,

Marshall Time Modulator, Quad/Eight reverb, Roger Mayer and Scamp noise gates, Universal Audio, Audio & Design, etc, comp/limiters.  
**Microphones:** over 70 available including Neumann, AKG, Beyer, Calrec, Electro-Voice and Shure.  
**Stage boxes, snakes, etc:** 60 mic lines (active/passive), control stage box, 10 assorted DI boxes, 500ft cable run.  
**Video gear:** Philips CCTV system.  
**Hire charges:** on request.  
**Availability:** Europe.  
NB. The Truck mobile is still undergoing installation and will not become operable until Autumn 1979.

## LATE ENTRY

### FANTA MOBILE

**Bookings:** Fanta Professional Services, 1213 16th Avenue South, Nashville, TN 37212, USA.  
**Phone:** (615) 327-1731.  
**Bookings to:** Johnny Rosen.  
**Vehicle or trailer type:** semi-trailer.  
**Dimensions:** 40ft long, 8ft wide.  
**Designer:** Johnny Rosen.  
**Tape recorders:** two Ampex MM1200 24-track machines plus AG440 4/2-tracks.  
**Console:** Sphere Eclipse, 48 input.  
**Monitoring:** Electro-Voice Sentry III, Klipsch, Auratone and JBL.  
**Ancillary equipment:** Dolby or dbx noise reduction available on request, also Urei and dbx comp/limiters  
**Microphones:** Schoeps, Electro-Voice, Sennheiser, AKG and Shure.  
**Stage boxes, snakes, etc:** 54-pair cable snake and stage splitter.  
**Communications gear:** Clear-com system, plus private channel VHF walkie-talkies.  
**Video gear:** Ampex, Sony, Conrac system.  
**Hire charges:** \$3,000 per day, \$12,000 per week (rates include a crew of three). Travel \$1.50 per mile.  
**Availability:** USA, Canada, Central America, (Europe for long engagements only).

### SUTTON SOUND

**Bookings:** Sutton Sound Ltd, 80 Queensway, London W2 3RL, UK.  
**Phone:** 01-262 9066.



The days of amplifiers with one distinctive sound are gone. It is no longer enough just to amplify; today's musicians need amplification systems which are versatile enough to adapt to any instrument, any musical environment.

Similarly the perfect mixing system is one which extends the performer's capabilities without being obtrusive.

In a field where quality and reliability are often sacrificed in the race for more advanced specifications,



Yamaha stand alone in offering a comprehensive range of amplification and mixing units which combine advanced technology and traditional craftsmanship.

When you choose Yamaha, you can be sure that the only sounds you hear are the ones you want.



**YAMAHA**  
Craftsmen to the world's  
musicians since 1887.

*Kemble/Yamaha, Mount Avenue, Bletchley, Milton Keynes Telephone 0908 71771*

# reviews



## MANUFACTURER'S SPECIFICATION

**Input:** active differential input, 10k $\Omega$  high pin, 20k $\Omega$  low pin, XLR-3 connector. Sensitivity at 1kHz for 0dB LED is 0dBm minimum.

**Outputs:** single-ended from operational amplifier, source resistance 47 $\Omega$ , minimum load resistance for +18dBm is 600 $\Omega$ , XLR-3 connectors.

**SPECIFICATIONS FOR DELAY ONLY MODE** (measured from input to output, any single audition delay tap).

**Frequency response:** 20Hz to 7kHz, reference 1kHz at -3dB reference 0 LED - +1/-4dB, 20Hz to 6kHz, reference 1kHz at -3dB reference 0 LED  $\pm$ 1dB.

**Dynamic range:** 80dB minimum, 20Hz to 20kHz noise bandwidth.

**Total distortion and noise:** 0.1% typical, 0.2% maximum at 1kHz, just below 0dB LED threshold, including quantising noise.

**Pre-emphasis, de-emphasis:** none.

**Delay settings:** 16 programmes of eight delay tap times, preprogrammed to 1ms resolution over the range of 1ms to 225ms.

**Sampling rate:** 16kHz nominal.

## SPECIFICATIONS FOR REVERBERATION MODE

**Decay time:** zero to 3.5s maximum at 500Hz,  $\frac{1}{3}$ -octave noise, with HF and LF equalisation set flat, long reverberation programme and four decay programmes.

**Equalisation:** +0/-10dB shelving at 20Hz. +0dB/-10dB shelving at 7kHz.

## GENERAL SPECIFICATIONS

**Size:** standard 19in x 5 $\frac{1}{2}$ in x 9in (483 x 139 x 229mm) —rear protrusions for connectors excluded.

**Weight:** approx 4.5kg.

**Power:** 115/230V AC for international use. 30W nominal.

**Environment:** 10°C to 40°C operating, 0°C to 70°C storage; relative humidity up to 95% non-condensing

**Price:** £1,260, \$1995.

**Manufacturer:** Ursa Major, Box 18, Belmont, Mass 02178, USA.

**UK:** Feldon Audio Ltd, 127 Great Portland Street, London W1.

THE Ursa Major *Space Station* is a novel effects unit employing a digital delay line with random access memory and a maximum delay capacity of 255ms. Internal programmed selection of taps, provided every 1ms in the delay line, obtain the special effects. In addition to the above taps, by means of a programmable read-only memory, considerable manual control of the effects is provided (see fig 1). The electronically balanced input is fed to the input

level control, it splits and is fed to an adder where a feedback signal can be applied. It is also fed to a 'dry/mixed' potentiometer which allows the outputs to be derived from any mixture of the input 'dry' signal and the processed signal.

The input adder is followed by the HF and LF equalisers and then the A/D converter. After these are four digitally controlled LED level indicators showing maximum peak input level on a red indicator and -6dB, -15dB and -30dB below maximum on a yellow and two green indicators respectively. The signal in digital form is then fed to the delay line which has a number of taps.

In fig 1 at the bottom of the delay line are four pairs of two taps, each known as audition taps. Each pair of audition taps is programme-controlled to produce a stereo output which may be mixed with the 'dry' input signal to produce two outputs in the form of a pseudo stereo output, the four pairs being at progressively longer delays.

Referring again to fig 1, a number of taps above the delay line can be fed to an adder to produce a reverberation feedback signal which is derived by programme control of the selected delay times. Alternatively the feedback signal may be switched to the echo mode where the time delay of the feedback signal is manually controlled from zero to 255ms maximum. Either of these signals may be fed to the feedback level control and then to manual bass and treble equalisers as high and lowpass filters.

It follows that the output signals are a combination of the individual level settings of the four audition taps which may be mixed with the original 'dry' input signal in any desired proportion, these features controlling the 'sound' of the output, whilst the feedback permutations control the reverberant qualities of the output signal.\*

The *Space Station* is designed for mounting into a standard 19in rack and has XLR signal connectors and an IEC mains power connector at the rear. The base is covered with a printed circuit mother board which supports the power supplies and many other components. Two sub-boards plug into the mother board with a further board holding many of the front panel controls which are connected by a ribbon cable connector. Most components are clearly identified for servicing but neither of the fuses are identified in value or type and one is very difficult to get at, as it's underneath the front panel circuit board.

The general standard of layout and construction is excellent with good quality components being used and all of the integrated

72 ▶

\*You will note that no mention has been made of the D/A conversion and I'm afraid that I have no information on this aspect of the unit as only preliminary documentation was supplied.

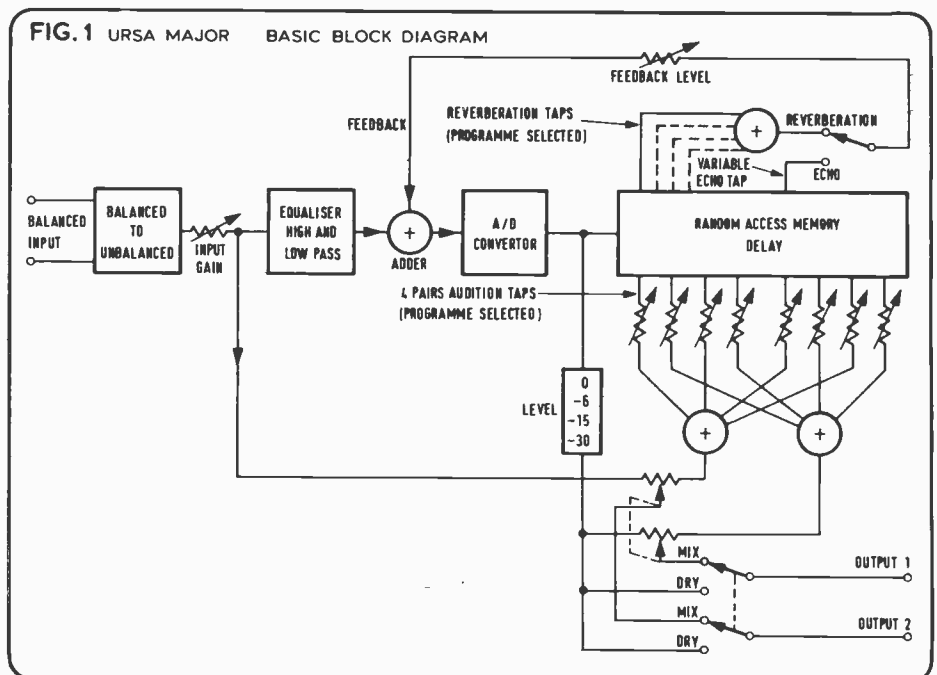

LONDON

PARIS

# MOBILE ONE

## First in Europe

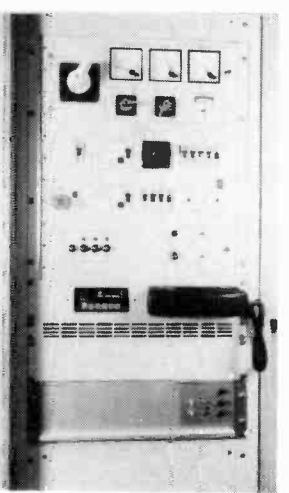
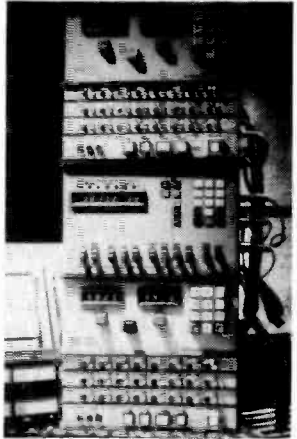
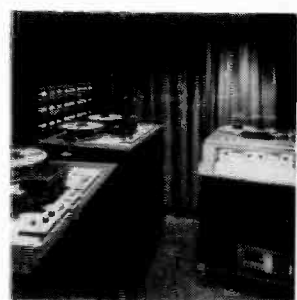

circuits being mounted into sockets to ease servicing.

The dark blue front panel layout is extremely clear. The controls are sensibly grouped, easily identified and include a basic block diagram.

Left of the front panel is the input level control with the peak level indicators below and the equalisation controls for the LF cut and the HF cut to the right. Further to the right is the direct/reverberation mixing potentiometer followed by the four level controls for the outputs of the four pairs of programme selected delay taps. Underneath these are the pushbuttons for selecting the operating programme of which more later.

At the right of the unit is the feedback level potentiometer and the echo delay time potentiometer which operates in conjunction with a red pushbutton: this pushbutton is pressed to set the delay after the delay has been set on the potentiometer thus providing an instant jump in echo delay time. If the button is held pressed the delay time may be constantly varied, but not always without undesirable effects.

Two locking pushbuttons allow selection of the 'dry' input signal alone, irrespective of the setting of the mixing potentiometer and also selection of either the reverberation mode using the added multiple delay taps or the echo mode where the tapping is controlled by the echo delay time setting.

In either mode the audition delay programmes function upon the four sets of audition delay tap outputs in the mix set by the four front panel level controls, 16 such programmes are selected by eight interlocked pushbutton switches. Each of these switches has a dual function depending on the setting of an adjacent locking pushbutton switch which selects the programmes indicated by legends, above or below the interlocking switches. In addition a separate button selects a long or medium reverberation programme, there being a subtle difference between the two.

Considering the top set of legends the first four pushbuttons are identified as 'Rooms 1, 2, 3 and 4' and are intended to simulate the reverberation characteristics of four different sized rooms in terms of early reflections. In these modes the longest audition delay programme taps are about 70ms for the smallest

room, and 255ms for the largest with the earlier taps providing appropriately shorter times. Subjectively these effects were found to be different from conventional reverberation units in particular the effects with the large rooms, which were very useful with judicious use of the feedback function. I was not, however, impressed with the simulated stereo output which was irritating with speech.

The next four top buttons comprise four different programmes of comb filters. Remembering that the *Space Station* has four audition delay taps and also that the two outputs have different delays, these comb effects are very comprehensive and very unusual effects can be obtained by combining the comb programmes together with the feedback.

Turning to the bottom set of legends, these are divided into two groups broadly identified as 'delay clusters' and 'space repeats'. There are three 'space repeat' programmes which provide two, three or four repeats of the input signal with the repeat sequence being set by the audition delay mixer controls. The use of the space repeat feature in conjunction with feedback can of course produce multiple repeats (or long distance echoes) continuing over several seconds—what may be described as science fiction outer space sounds.

The delay cluster modes have some highly original captions under the switches—'fatty', 'cloud', 'slap 1', 'slap 2' and 'echo'. All these fancy names result from the use of single repeats with the delay taps close together, the farthest apart being 'echo' which uses the full 250ms delay capability with as usual the eight delay taps available at the output, but delivering a cluster or outputs at similar delay times. The echo was most effective with a degree of feedback, the remaining four modes providing interesting effects on musical instruments either increasing or decreasing apparent loudness and presence.

The one remaining feature is the echo mode with its associated echo delay time manual setting. This provides a single repeat after the selected delay time when using the latest audition delay mixer taps, repeating at earlier times when using earlier taps. More interesting effects can be produced by combining this feature with space repeats and with feedback thus giving multiple decaying repeats.

74 ▶

**FIG. 2**  
URSA MAJOR  
FREQUENCY RESPONSE  
OF INDIRECT CHANNEL

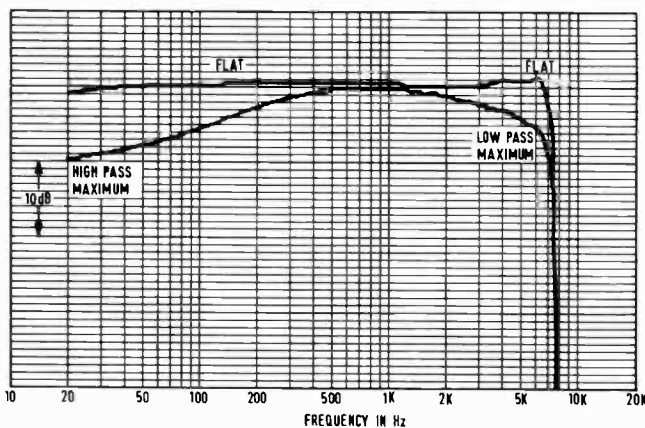

# Aphex Dealers

**APHEX SYSTEMS LTD.**

7801 Melrose Avenue,  
Los Angeles,  
California 90046  
Tel: (213) 655-1411  
TWX: 910-321-5762

**APHEX AUDIO SYSTEMS AUSTRALIA, PTY. LTD.**

(Sydney) Tel: 261381  
TLX: (790) AA24035

**APHEX BENELUX**

(Brussels) Tel: (02) 345.44.44  
TLX: (846) 26409 (TEMBEL B)

**APHEX BRAZIL**

(Rio de Janeiro) Tel: 205.35.66  
TLX: (391) 1121008 (XSPC BR)

**APHEX AUDIO SYSTEMS CANADA, LTD.**

(Toronto) Tel: (416) 363-8138  
TLX: 06225500 (OCTO TOR)

**APHEX CHICAGO LTD.**

Tel: (312) 642-8910

**APHEX DENMARK**

Tel: (01) 59 1200

**APHEX COLORADO, LTD.**

(Golden) Tel: (303) 278-2551

**APHEX FRANCE S.A.R.L.**

(Paris) Tel: (1) 500.57.87  
TLX: (842) 290846 (IPARIS)

**APHEX GERMANY, GmbH**

(Frankfurt) Tel: (0 64 42) 53.03  
TLX: (841) 184174 (INTRO D)

**APHEX HAWAII, LTD.**

(Honolulu) Tel: (808) 521-6793  
TLX: 7430148 (SOUND)

**APHEX ISRAEL**

(Tel Aviv) Tel: 232-143

**APHEX JAPAN, LTD.**

(Tokyo) Tel: 478 7641  
TLX: (781) 2224244 (NNR)

**APHEX MIDLANTIC**

(Washington D.C.)  
Tel: (202) 363-1223

**APHEX NEW ENGLAND**

(Boston) Tel: (617) 232-0404

**APHEX NEW YORK, LTD.**

(West Orange, New Jersey)  
Tel: (201) 736-3422/(212) 964-7444  
TWX: 710.994.5806 (APHEX LTD. WOGÉ)

**APHEX SCANDIA**

(Stockholm) Tel: 08-67.80.69

**APHEX SOUTH, INC.**

(Nashville) Tel: (615) 327-3075

**APHEX SYSTEMS (SUISSE) SA**

(Le Mont-Sur Lausanne)  
Tel: 021/33.33.55  
TLX: (845) 24107 (VOGUE CH)

**APHEX TEXAS, LTD.**

(Dallas) Tel: (214) 351-6772  
TLX: 732715 (APHEX DAL)

**APHEX AUDIO SYSTEMS UK, LTD.**

(London) Tel: 01-359 5275  
TLX: 268279 BRITRO G

**APHEX WEST**

(Los Angeles) Tel: (213) 655-1411  
TWX: 910.321.5762 (APHEX WEST LSA)





## Parametric Equaliser

A very versatile instrument for getting sounds just right. It's modular and directly retrofits APSI 550.

EQ is peak or shelf.  
Filter is high or low pass, tunable.  
Bandwidth is 20Hz to 20kHz.  
Reciprocal cut or boost on EQ.

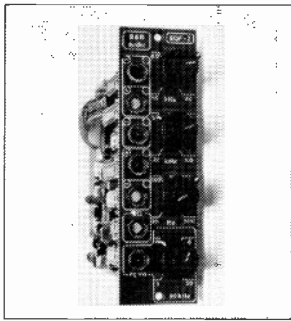

Input	High level	+ 30dBm (max) at 34KΩ
	Low level	+ 20dBm (max) at 11KΩ
Output	High level	+ 30dBm with - 93dBm noise
	Low level	+ 20dBm with - 103dBm noise
Frequency response	EQ & filters out	10Hz to 20kHz, ± 0.1dB
	EQ & filters in	20Hz to 20kHz, - 1dB
Distortion	Harmonic & IM	< 0.1%
Transient response	Slew rate	> 10V/μ sec.
Power		± 12V to ± 18V at 75mA

## Voltage Controlled Attenuator

The first high quality VCA in the professional audio market.

It's available in chip form for OEM, with full input and output facilities for direct fitting to any automated console with existing VCAs. However, we can design a VCA package to fit any other manufacture.

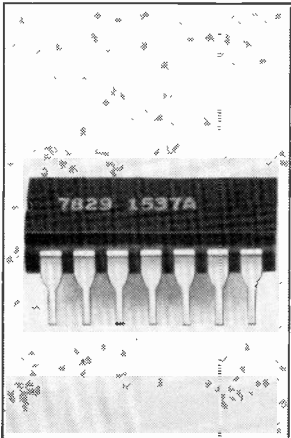

Band width		DC to 50MHz
THD	+ 10dBm input	0.004% (20Hz to 20kHz)
IMD	+ 14dBm input	0.03%
Noise	Unity gain	- 90dBV; ± 1dB
Modulation noise		6.5dB
Overshoot & ringing		None
Slew rate		> 10V/μ sec.
Input impedance		20KΩ
Input level		+ 20dBV
Gain		0dB
Attenuation		> 100dB; 20Hz to 20kHz
Control voltage		Can be scaled as needed
DC shift	Vs Attenuation	≤ 5mV
Power		Regulated ± 15V at + 25, -33mA

## Grouping and Automation System

With this system, you can now add semi-automation to your console at a fraction of the cost of a new one. Adaptable logic and extensive matrix grouping make up to ten 24-channel presets available.

And since the unit is portable, it can be moved from one studio to another in minutes, for the most efficient use of studio time.

It's expandable from 8 channels and it's just as useful for PA grouping as studio mixdown.

For MCI equipment, a compatible automation package is available.

Our own Voltage Controlled Attenuators (VCA) are used throughout, whose high quality assure minimal sound degradation.

Maximum output is + 24dBm.

The system comes in two parts - control console and VCA case.

The control console has group control modules, each containing grouping switches, mute switch and fader, and a master control module with master fader.

The VCA case is self powered and houses the appropriate number of VCA cards and all the input/output XLR connectors.

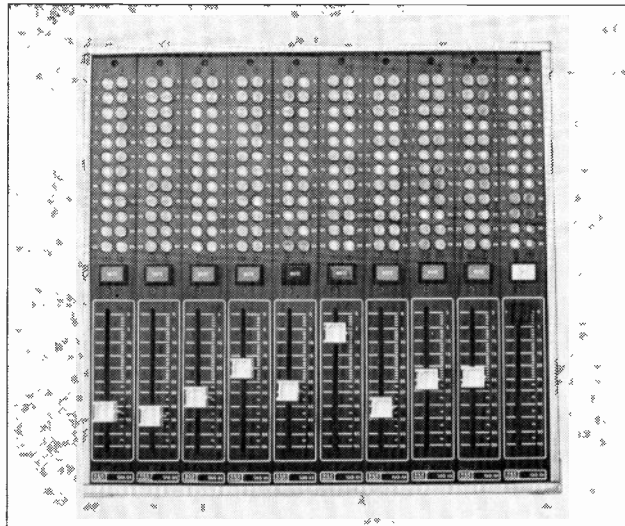

# Aphex

## The Aphex Aural Exciter

One of the most exciting signal processors to have been invented.

It brings sound to life and makes it louder, without any actual change in level.

It does it by introducing phase information in the form of a series of minute delays whose magnitude depends on frequency.

The formula by which the Aphex device selectively processes the audio signal has been arrived at after considerable research into the mechanisms of the ear. In particular as to how it receives complex phase information relating to the actual location of a sound source.

Aphex sounds amazing on most instruments, including the human voice.

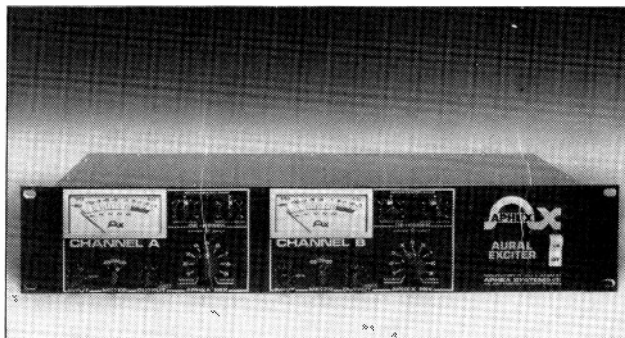

Aphex  
Audio Systems (UK) Ltd  
35 Britannia Row  
London N1 8QH  
Telephone: 01-359 5275  
Telex: 268279 Britro G.



If short echo times are selected with feedback, the unit becomes a notch filter, or rather a comb filter with flanging effects available by slight movement of the echo delay control with the 'set' button pressed. This button was found to be a rather irritating feature for two reasons, firstly the unit was inadvertently switched off by pressing the nearby power on/off switch, and secondly it was a 2-handed operation—it would be better if the switch and the potentiometer had been a single combined control.

**The technical aspects**

The electronically balanced input was found to have a 19.7kΩ impedance in one leg and a 10kΩ impedance in the other, with the impedance being 20kΩ in the balanced mode with a common mode rejection ratio of 50dB throughout the audio frequency range. The input impedance was constant with the input gain setting and the maximum input level +22dBm at any gain setting.

At maximum input gain, the red 0dB overload indicator became illuminated at an input level of 0dBm with the yellow -6dB indicator and the green -15dB indicators illuminating at precisely 6dB and 15dB below the red indicator and the -30dB indicator operating at -30.5dBm.

These indicators were found to sense the peak value of the input and to operate extremely fast thus providing an excellent level control for the digital delay which like most digital devices clips on overload.

The overall frequency response of the direct chain was found to be flat within 1dB from 20Hz to 20kHz, the frequency response of the indirect chain is shown in fig 2 with the two equalisation controls at the extreme positions. While the highpass control has an adequately large range it is felt that the lowpass control could do with a wider range in the 5kHz region. Clearly in audio terms the 7kHz bandwidth could be wider to provide more dramatic effects, but that is really of little consequence in an effects unit of this versatility.

As can be seen from fig 3 the second and third harmonic distortion products are virtually equal and at a very low level throughout the frequency range of the delay—furthermore the distortion depended little on the audio signal level.

Similarly as shown in fig 4 the twin tone intermodulation distortion to the CCIF method using tones separated by 70Hz was extremely low for a device of this kind.

Remembering that no pre-emphasis is used the frequency response is flat at all signal levels. The noise performance was also excellent with the following noise levels being measured in both outputs (Table 1).

**TABLE 1**

Band limited 22Hz to 22kHz rms	-82dBm
A-weighted rms	-81dBm
CCIR-weighted rms	-71dBm
CCIR-weighted quasi-peak	-65dBm

These noise performance figures should be related to the maximum output capability of greater than +18dBm from a 48Ω unbalanced source. Furthermore as no compression or other analogue noise reduction is employed, these are genuine dynamic or static performance

**FIG. 3**  
URSA MAJOR  
HARMONIC DISTORTION

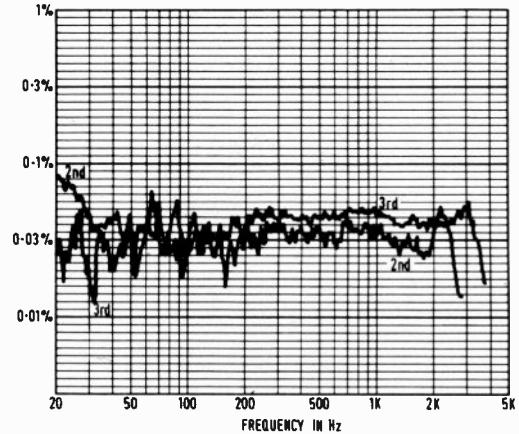

ance figures.

In the straight delay mode the tone burst performance was clean and free from distortion and investigations into the various delay and echo modes confirmed the manufacturer's claimed modes of operation.

**Summary**

The Ursa Major *Space Station* is probably the most versatile effects unit on the market giving not only normal reverberation, time delay effects and echo effects but also a large number of original effects peculiar to this unit.

Clearly the restricted bandwidth of the effects channel poses a certain restriction on the potential applications, but the versatility of the unit more than compensates for this while the noise and distortion performance are exceptionally good.

The lack of noise reduction and pre-emphasis in any form is also an important feature—however noise effects as opposed to noise breathing could be induced in exceptional circumstances.

An excellent front panel layout together with a good standard of engineering make the unit easy to use and service, on the assumption that

**FIG. 4** URSA MAJOR CCIF INTERMODULATION DISTORTION AT -6dB

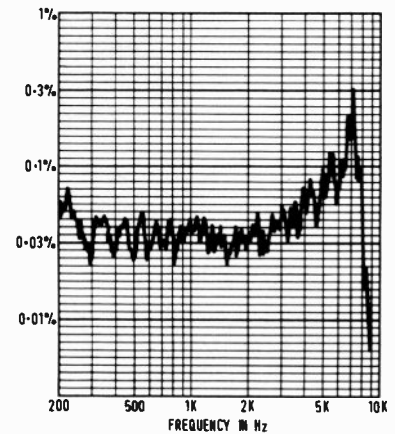

the manufacturer will produce a good replacement for the preliminary manual.

I strongly recommend a trial of the Ursa Major *Space Station*.

Hugh Ford

**agony**

I am on a PIONEER MISSION for our School to ACOUSTIC RESEARCH a quantity of speakers without SPENDING too much and hoping GOODMAN'S will CELESTION cheaply even if I have to RAM and HACKER down the price with a DUAL or WAR but not to be sold MORDAUNT-SHORT or sent off at a TANGENT as we ELAC funds. They must be KEFUL not to BOSE about the order, TANNoy it from the CASTLE, LEAK it to the RANKS, even ROTEL anyone or ALTEC the blame. Incidentally my home is next door to CHARTWELL and I enjoy a BOLIVAR whilst listening to the EAGLE, SWALLOW and NIGHTINGALE YAMAHAing above. ROGERS and out.

**PEAK PROGRAMME AND DEVIATION MONITORING**

**PPM2 DRIVE CIRCUIT WITH STANDARD PERFORMANCE UNDER LICENCE FROM THE BBC**

PPM2 is based on the ME12/9 but with an electronic floating input which withstands mains or static voltages on the signal lines. It meets all the specifications of IEC268-10A, draft BS5428, and fulfils the requirements of the BPO, IBA, EBU and broadcasting organisations of other countries. Ernest Turner meter movements 642, 643 and TWIN from stock. The TWIN is a flush-mounting type and flush-mounting adaptors and illumination kits are available for the 642 and 643. Stereo Disc Amplifier \* 10 Outlet Distribution Amplifier 2 \* Stabilizers \* Frequency Shifters for Howl Reduction

**Surrey Electronics** The Forge, Lucks Green, Cranleigh, Surrey GU6 7BG. Tel. 04866 5997

**PEAK DEVIATION METER**

For monitoring mono or stereo fm stations either off air or at the transmitter.



**CHART RECORDER**

By itself records on inkless paper scaled 1-7 and 0-100kHz to PPM standards left, right, sum, difference or peak of either and, with the above unit, charts Peak Deviation. The unit holds the true peak amplitude, applies this slowly to the stylus to avoid overshoots, holds to make a mark and then runs the stylus down slowly. This is arranged to give correct monitoring of transients as well as a good impression of dynamic range. Used in broadcasting for 24-hour records of levels or presence of programme at transmitters or on lines.

# No stranger...

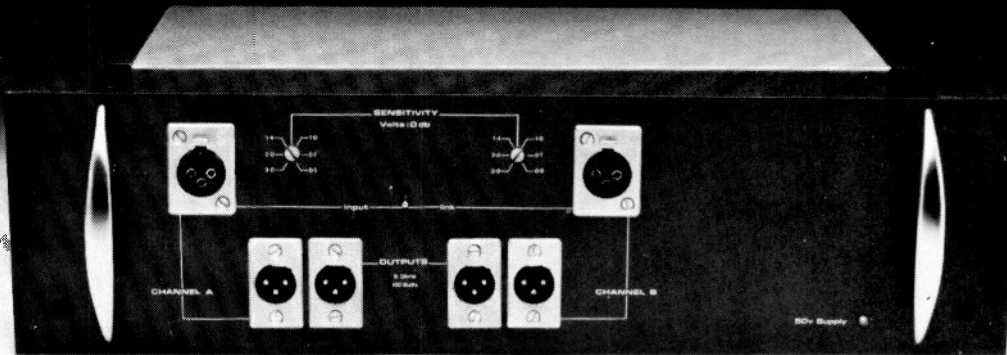

You may not have seen one quite like this before, but the major part of the product shown is not a stranger to professional audio — behind the disguise of a rack-mounting steel case, the XLR type connectors, the pre-set input level controls (variable from 0.5 to 3 Volts), and the channel input link switch, rests a familiar and particularly well respected power amplifier — the QUAD 405.

Professional conversion packages for QUAD 405's —  
available as a kit or ready assembled from

## **SOUND REINFORCEMENT SERVICES**

3 Melior Ct., Shepherds Hill, London, N6. Telephone for further details, 01 348 0212

# APRS

## **COURSE FOR STUDIO ENGINEERS**

THE 6th COURSE IN THE SERIES WILL BE HELD **SEPTEMBER 16-22, 1979**, AT **SURREY UNIVERSITY**

The purpose of the Course is to provide information on a wide range of technical subjects relating to recording operations and to provide a Forum for interactive discussion in the exchange of ideas and experience.

*Prospectus from*

**APRS Secretary**  
**E. L. Masek**  
**23 Chestnut Avenue**  
**Chorleywood, Herts, UK**  
**WD3 4HA**

# APRS

## **WEEKEND COURSE NOVEMBER 2 - 3 - 4** **DIGITAL TECHNIQUES**

**Repeat of course held April 1979**

This course is designed for senior technical and management staff who wish to inform themselves about the present and future use of digital techniques in sound recording mixing consoles and peripheral equipment.

*Prospectus from*

**APRS Secretary**  
**E. L. Masek**  
**23 Chestnut Avenue**  
**Chorleywood, Herts, UK**  
**WD3 4HA**

# reviews

## Neutrik Audiotracer

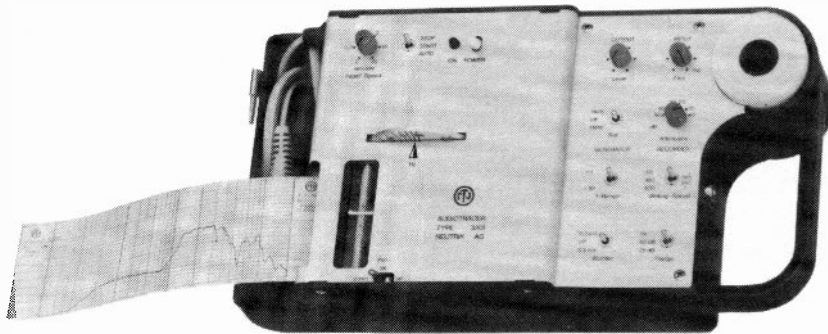

### MANUFACTURER'S SPECIFICATION GENERATOR

**Type:** voltage controlled oscillator with three decades, controlled by a precision potentiometer.  
**Range:** 20Hz to 20kHz, 0.2kHz to 200kHz, switchable.  
**Power output:** 3W rms into 4Ω maximum (20Hz to 20kHz).  
**Line output:** 1mV to 100mV, source impedance 50Ω, loaded with 50Ω.  
**Reference frequency:** 1kHz.  
**Linearity:** 40Hz to 50kHz  $\pm 0.2$ dB, 20Hz to 200kHz  $\pm 0.5$ dB.  
**Distortion:** 200Hz to 5kHz maximum 0.55%, 20Hz to 100kHz maximum 1% THD.  
**Stability:** better than 1.5% of set value.  
**Accuracy:** better than 5% (typically 3%).  
**Warble generator:** modulation frequency 5Hz, deviation 0.3 and 0.5 octave.  
**Voltage output:** DC 10mV to 10V negative, proportional to frequency 20Hz to 20kHz.

### RECORDER

**Type:** high speed inkless, galvanometer type.  
**Input sensitivity:** maximum 5mV for 50dB and linear, maximum 0.28mV for 25dB fsd.  
**Input attenuator:** five steps of 10dB ( $\pm 0.5$ dB).  
**Vernier control:** approximately 20dB.  
**Input impedance:** 20kΩ in parallel with 47pF.  
**Frequency response:** with attenuator at 0dB  $\pm 0.2$ dB 40Hz to 15kHz,  $\pm 0.5$ dB 20Hz to 20kHz. With attenuator at 10dB  $\pm 0.2$ dB 40Hz to 20kHz,  $\pm 0.5$ dB 20Hz to 50kHz. With attenuator at 30dB to 50dB  $\pm 0.2$ dB 40Hz to 50kHz,  $\pm 0.5$ dB 50Hz to 200kHz.  
**Indication error:** maximum  $\pm 1$ dB at both ends of scale, otherwise 1dB at 50dB fsd, other ranges equivalent.  
**Rectifier:** true rms, crest factor seven, time constant according to writing speed.  
**Temperature range:** 0 to 40°C, all specifications after half an hour warming up time.  
**Power:** 220/120V AC  $\pm 10\%$ , 50 to 60Hz, 20VA.  
**Dimensions:** 285x140x75mm.  
**Weight:** 2.24kg net.

### RECOMMENDED ACCESSORIES

Measuring microphone 3281: 12x18mm, condenser, 30Hz to 20kHz, 10mV/Pa, with individually calibrated response curve. Stand adaptor 3283:  $\frac{1}{4}$ -in for mic 3281. Artificial ear 3282: acoustic coupler according to IEC recommendation 318, for headphone measurements, to be used with mic 3281. Registration paper 3284: thermosensitive paper, frequency and dB scales, 53mm, 200 recordings.  
**Price:** £825. A accessory microphone £32.50, recording paper £2.30 per roll.  
**Manufacturer:** Neutrik AG, FL-9494 Schaan, Liechtenstein.  
**UK:** Eardley Electronics Ltd, 182/4 Campden Hill Road, London W8 7AS. Phone: 01-221 0606.

THE Neutrik 3201 Audiotracer, housed in a neat carrying case, comprises a small chart recorder and an oscillator which may be synchronised with the recorder. The case is made of shatter-proof moulded plastic with integral handle and removable hinged lid. There is enough space within for a spare roll of recording paper and the mains lead, but no room for a 13A UK plug and no cutout for the lead to protrude through when the lid is closed. Also the retention device for the recording paper is so good that removal was very fiddly.

Inputs and outputs are locking Tuchel sockets at the rear with a 4-pin socket providing AC and DC inputs plus polarisation voltage for the optional microphone and a 6-pin socket providing high and low level oscillator outputs, also a DC output proportional to oscillator frequency and a remote start facility.

The pin connections are clearly illustrated inside the lid of the case with instructions on changing the recording paper and a statement of the maximum sensitivities. Changing the paper is via a trapdoor in the bottom of the case, and was also found to be rather fiddly but this may become easier with practice. Each roll accommodates up to 200 recordings on thermosensitive paper which is calibrated from 20Hz to 20kHz in the horizontal direction and in 25 steps in the vertical direction. Scaling of the paper is either 1 or 2mm per dB and 15mm per octave using a writing area of 50mm by 150mm.

The legibility of the trace was excellent under common recording conditions with a clear blue trace on a white background, but at the highest pen and paper speeds the legibility was reduced though a readable trace obtained.

Layout of the panel and control identification is excellent with the basic controls and pen recorder at the left, the oscillator controls in vertical array are next and then the remaining recorder controls. Also at the left of the unit is the paper speed control which is continuously variable from 0 to 25mm/s with calibrations at 0.2, 1.3, 3, 14 and 25mm/s. Next to this is the paper movement switch which has three positions giving stop, start (continuous run) and 'auto'. In the latter position the paper runs for a full chart length and then stops automatically in the blank section of the frequency dial. It may then be restarted for another run by entering 'start' for a short time and reverting to 'auto'. Unfortunately when at the stopping point part of the previous recording is invisible and cannot be seen until the subsequent run has been initiated—the paper cannot be torn off at the stopping position—and it is not particularly easy to set level with any accuracy without running the paper.

Synchronisation of the paper and the oscillator is achieved by depressing and turning the vertical frequency dial which is connected to the paper drive by a friction clutch. Simply the frequency dial is set to correspond with the frequency at which the recording pen rests and synchronism is then retained. The frequency dial itself is calibrated in a 2, 3, 5, 7, 10-sequence over the three decades with intermediate markings at 4, 6, 8 and 9, the three decades being either 20Hz to 20kHz or 200Hz to 200kHz depending on the frequency range switch setting in the oscillator section. The remaining controls in the recorder section are a pen up/down switch, the mains power switch and a nearby red power indicator.

Turning to the four recorder controls on the right, these comprise two 3-position toggle switches which select the writing speed as either 50, 100 or 500mm/s the vertical range of which can be logarithmic 25dB or 50dB full scale or alternatively linear. 78 ▶

**FIG. 1**  
NEUTRIK  
OSCILLATOR FREQUENCY  
RESPONSE AT  
LOW LEVEL OUTPUT

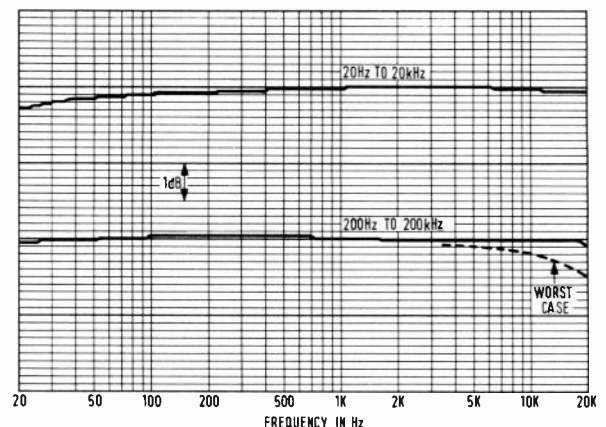

SQN SALES LTD present the new  
**SPR-1 UNIVERSAL SYNCHRONISER**  
 FOR ALL YOUR FILM SOUND TRANSFERS



- \* Handles 50Hz AND 60Hz Neopilot sync. pulses
- \* Resolves 10Hz, 25Hz and 30Hz Subaudio (SN) pulses
- \* Drives and slaves ALL modern portable reel-to-reel recorders
- \* Use with Nagra III/IV and our spool adaptors for ALL 6.25mm. AND 3.81mm (SN) sync. tapes.
- \* Locks to line frequency, built-in crystal or ext. ref.
- \* Unrivalled for versatility and economy

Send for fully descriptive colour brochure to:-

**SQN SALES LTD.**

2 HIGH ST., PORT ST. MARY, ISLE OF MAN

Telephone: 0624 - 83 4294

Telex: SQN Sales, c/o 629313 COMCAB G

New York Agent: John Messenger, Apt 2H, 300 W. 23rd St., N.Y. 10011 Telephone:(212) 6919567

AVAILABLE SOON - SQN - 3 Control Unit for Nagra SN recorders (3 mic inputs)

**MODULAR STAGE-LINK-SYSTEMS**



**CABLES**  
 FOIL SCREENED MULTI PAIR  
 AUDIO AND INSTRUMENTATION  
 CABLES 6-12-15-19-27-31 PAIR



**STAGE BOXES**  
 OPTIONS: XLR, 3 POLE, 2 POLE JACKS  
 Each fitted with Multi-pin Connector.  
 Up to 31 balanced inputs/outputs.

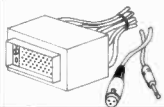

**ADAPTORS**  
 OPTIONS: XLR, 3 POLE, 2 POLE JACKS  
 Each fitted with Multi-pin Connector.  
 Up to 31 balanced outputs/inputs.

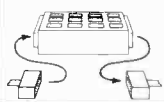

**SUB UNIT EXTENSION**  
 inputs/outputs.



**CABLE REELS**



20, VICTORIA ROAD, PHONE 01 449 3663  
 NEW BARNET,  
 HERTFORDSHIRE.  
 EN4 9PF TELEX 87515 WISCO G



**Professionals  
 speak very  
 highly of our  
 microphones and  
 monitors**



**In microphones and monitors  
 Electro-Voice leads all the way**

What Electro-Voice has to offer by way of microphones and monitors sounds really good. The numerous wireless, TV and recording studios using Electro-Voice microphones and monitors show it.

Where only the best is good enough, Electro-Voice is always there. Be it with studio- or soloist-, omnidirectional-, Single-D-cardioid-, variable-D-cardioid microphones or monitors speakers.

Why not send in the coupon and get detailed particulars? You will immediately realize that every Electro-Voice product is backed up by an outstanding technology, and why professionals always speak so highly of our microphones and monitors.

**COUPON**

Please forward detailed particulars on:  Electro-Voice microphones  Electro-Voice loudspeaker systems

Name \_\_\_\_\_

Address \_\_\_\_\_

Send to: Electro-Voice Division  
 Gulton Europe Ltd.  
 Maple Works  
 Old Shoreham Road  
 Hove BN3 7EY

Remaining controls are the fine and coarse input attenuators with the fine potentiometer control having a calibration position and about 20dB range; the coarse control is a 6-position rotary switch calibrated from 0dB to 50dB in 10dB steps. Whilst the recorder has an alternative DC input the attenuators do not affect this input which has constant sensitivity.

In addition to the frequency dial are four oscillator controls: two 3-position toggle switches, a 2-position toggle switch and an output level potentiometer which controls the level of both outputs. These are a low level output rated at up to 200mV and a power output rated at a maximum of 3W into 4Ω. The 2-position toggle switch selects the frequency range as either 20Hz to 20kHz or 200Hz to 200kHz with a 3-position toggle switch providing a reference frequency by placing it in a locked or spring-loaded position. The reference frequency although identified as 1kHz depends on the frequency range setting, ie 1kHz in the lower range and 10kHz in the higher. A rather irritating feature of the reference frequency system is that the output is only available in the active section of the frequency dial, such that level cannot be set in the normal resting position of the recording paper.

And finally, the remaining toggle switch which permits frequency modulation of the oscillator at 5Hz nominal with an option of either 1/8-octave or 1/4-octave modulation according to the switch setting.

**The oscillator section**

The frequency response of the oscillator at the low level output is shown in fig 1. For the two frequency ranges it shows that the output drops

0.5dB at 20Hz which could be a nuisance. Also, in the higher frequency range it was found that the frequency response depended upon the output level setting with a worst case drop of 0.8dB at 200kHz as shown. As far as the high level output is concerned this is only specified from 20Hz to 20kHz with the response identical to that at the low level output. Above 20kHz the output was usable up to 70kHz at high output levels with a rapid frequency roll-off depending on the output level.

At all frequencies the predominant harmonic distortion products were the second, third and fifth harmonics which are plotted in figs 2 and 3 for the two frequency ranges, it can be seen that the distinct null in the third harmonic occurs at different frequencies. Clearly the level of the harmonics is too high for many applications but perfectly adequate for frequency response measurement, measurement of rooms etc. The plotted results refer to the maximum output at the low level output, when working at maximum output into 8Ω, the distortion was about 10dB higher but sensitive to level and dropping with falling output level.

While the frequency response and distortion did not appear to drift I found that the output level at both outputs drifted from switch onto an undesirable amount as follows (Table 1).

**TABLE 1**

Time from switch on	Drift
10min	-0.30dB
20min	-0.48dB
30min	-0.60dB
40min	-0.67dB
50min	-0.74dB
60min	-0.79dB

80 ▶

**FIG. 2**

NEUTRIK  
OSCILLATOR HARMONIC  
DISTORTION AT LOW  
LEVEL OUTPUT  
FREQUENCY x1 RANGE

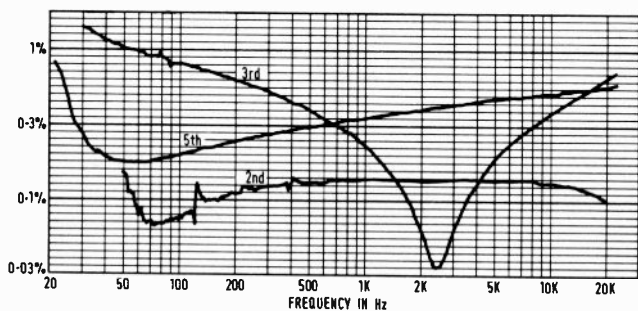

**FIG. 3**

NEUTRIK  
OSCILLATOR HARMONIC  
DISTORTION AT LOW  
LEVEL OUTPUT  
FREQUENCY x10 RANGE

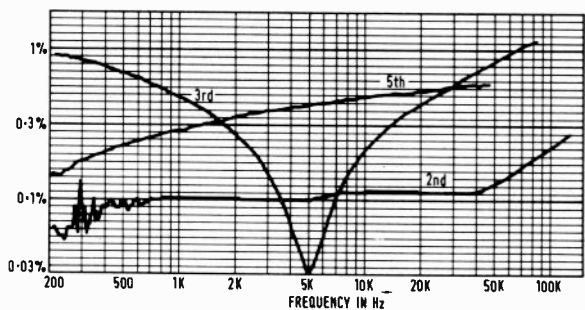

# audio & design recording worldwide

- Australia**  
Audio & Recording, Tel: 261 1383
- Austria**  
Peter Mueller, Tel: 229 9 444 233
- Belgium**  
ASC/SED, Brussels. Tel: 02 522 7064
- Brazil**  
Serion Ltd, Sao Paulo. Tel: 34 8725
- Canada**  
BCB Electronics Ltd., Ontario Tel: (065) 24478
- Caribbean**  
Dynamic Sounds Recording, Jamaica Tel: 933 9138
- Denmark**  
Audiophil, Copenhagen. Tel: (01) 341 622
- Eastern Europe**  
Denis Tyler Ltd., UK. Tel: (089 54) 43681
- France**  
3M France, Paris. Tel: (1) 031 6161
- West Germany**  
Elmus GmbH, Berlin. Tel: (030) 312 2012
- Greece**  
Audiolab Hellas, Tel: 822 5222
- Holland**  
Pieter Bollen, Eindhoven. Tel: (040) 512 777
- Italy**  
Roje Telcomunicazioni, Milan. Tel: 415 4141
- Japan**  
Nissho-Iwai Co. Ltd., Tel: (03) 544 8311
- Korea**  
Yushin Co. Ltd., Seoul. Tel: 69 3261
- New Zealand**  
General Video Co. Ltd., Tel: 872 574
- Norway**  
Siv. Ing. Benum & Co., Tel: (02) 56 57 53
- Spain**  
Fading, Madrid. Tel: 446 8325
- South Africa**  
Eltron (Pty) Ltd., Tel: 23 0018
- South East Asia**  
O'Connor's (Pty) Ltd., Singapore 5  
Tel: 637 944
- Sweden**  
KMH IjudAb, Tel: (08) 690 120
- Switzerland**  
Audiocom Tel: 031 955 742
- Tahiti**  
Oceanic Garage, Papeete.
- United States of America**  
Audio & Design Recording Inc.  
Nigel Branwell  
PO Box 902, Calif. 93933 Tel: (408) 372 9036
- UK and All Other Territories**  
**audio & design (recording) Ltd.**  
Reading, UK. Tel: (0734) 53411  
Telex: 847605 a/b TilleX G



## THE SCAMP®

PRICE: £3,710 (list)  
 WEIGHT: 7½ Kilo  
 DIMENSIONS: 19" x 8½" x 11"  
 No. OF MANUFACTURERS: 1  
 No. OF POWER CONNECTIONS: 1

## THE COMPETITION

PRICE: £5,250 at least  
 WEIGHT: TOO MUCH (around 70 kilo)  
 DIMENSIONS: 60" x 21" x 24" at least  
 No. OF MANUFACTURERS: at least 4  
 No. OF POWER CONNECTIONS: 9+

Compare the above two examples of how to tackle your aux. signal processing equipment needs. Compare the cost, size and weight. Think about the powering requirements. Consider the headaches associated with dealing with so many manufacturers versus getting everything from one source. Then, when you're certain, call **Audio & Design (Recording)** to discuss the **SCAMP** solution.

And if you're already committed to the competition call us anyway — it's never too late to become a SCAMP user.

**SCAMP** — conceived in the '70's...  
 ... for the '80's.



**audio & design (recording) Ltd.**

OXFORD ROAD, READING RG1 7LJ, BERKSHIRE, ENGLAND.  
 Tel: Reading (0734) 53411 Telex: 847 605 a/b Tillex G

audio & design recording inc. Nigel Branwell, PO Box 902, Marina, Calif. 93933  
 Tel: (408) 372 9036

The accuracy of the frequency setting, for both frequency ranges, in relation to the dial calibrations is shown in fig 4. From this it can be seen that at all frequencies the actual frequency is low—if the calibration had been taken at the right frequency the oscillator would have met its specification of within  $\pm 5\%$ . However, the accuracy of the reference frequency was excellent, to within 0.01% at 1kHz and 0.03% at 10kHz.

Because of the drift in oscillator output a defined statement about the maximum available output level cannot be made. However, the low level output gave in the order of 200mV from a source impedance of 54 $\Omega$  which is nice and low, while the high level output could give 3.5V into an open circuit from a source impedance of less than 1 $\Omega$ . After a warm up period the specification of 3W into 4 $\Omega$  could not be met. Although the output voltage range, of from a usable minimum of 1mV at the low level output to 3.5V at the high level output is adequate for many applications, an increased output of up to say +20dBm is desirable for measuring a good deal of professional equipment.

The accuracy of the DC output proportional to frequency followed the inaccuracies of the frequency calibration such that DC output was a far more accurate indication with the full range being -9.00mV to -10.13V from a source impedance of 150 $\Omega$ .

The final feature of the oscillator is the warble tone facility and this was found to approximate to the specified  $\frac{1}{2}$ -octave or  $\frac{1}{3}$ -octave and proved to be a useful feature for room measurements in conjunction with the optional microphone.

**The recorder**

The maximum input sensitivity for full scale deflection was 6.5mV on the linear and 50dB ranges and an extremely sensitive 300 $\mu$ V on the 25dB range, the former was somewhat adrift from the specified 5mV.

Checking the accuracy of the 0 to 50dB step attenuator showed that this was within the readability of the chart with the variable attenuator having a useful 22dB range. It follows that the maximum signal levels that can be handled are in the order of 20V in the linear and 50dB ranges, or 1V on the 25dB range.

As far as scale linearity is concerned the pen always plotted within 1dB of the correct level with respect to full scale deflection but as specified by the manufacturer the frequency response depended on the step attenuator setting. The variable attenuator setting did not affect frequency response.

At the zero attenuator setting (maximum gain) the response was within +0, -0.2dB up to 15kHz, falling to -1dB at 50kHz, and improving to +0, -0.2dB up to 20kHz at the -10dB setting where the -1dB point rose to 60kHz. At 20dB attenuation the response was +0, -0.2dB up to 50kHz with the -1dB point at 80kHz. With the remaining settings the response was effectively flat up to 20kHz but rose to around +1.5dB at 50kHz falling to -1dB at 200kHz—something not quite right here!

Checking the rectifier characteristic showed true rms up to a crest factor of eight with the alternative DC input having a sensitivity fixed

at +0.31V for full scale deflection. The input resistance of this input was 26,400 $\Omega$  and the impedance of the AC input effectively constant with attenuator setting at 21,400 $\Omega$  in parallel with 25.4pF—both sensible arrangements.

Measurement of the paper speed against the calibrations showed these to be quite adequately accurate, but measurement of the pen speeds showed that the rise and fall time differed significantly as shown in fig 5. Measurement of the 500mm/s speed could not be accurately made in view of the lack of available paper speed to make the measurement, but at a nominal 100mm/s the rise speed approximated 63mm/s and the fall 200mm/s. Similarly at a nominal 50mm/s the rise speed was about 63mm/s and the fall speed about 150mm/s.

**General**

The microphone polarisation voltage at the input socket was 14.7V from a source impedance of 10,900 $\Omega$  designed for use with the

optional Neutrik condenser microphone. Briefly checking the review microphone showed that it had a sensitivity of 10mV/Pa and a frequency response which was effectively flat up to 3kHz, rising to +1.5dB at 5kHz and rising slightly to +2dB at 15kHz—quite adequate for many applications.

**Summary**

This is a very useful instrument for many routine audio applications and is not expensive when compared with the alternatives. However, for accurate measurements it has a number of shortcomings and it is sad that in some instances does not meet its specification.

Generally it was easy to use but paper loading was fiddly and the end of chart stop, hiding part of the recording was a nuisance. However, if the manufacturer tidies up a number of points this will be an instrument of great potential.

Hugh Ford

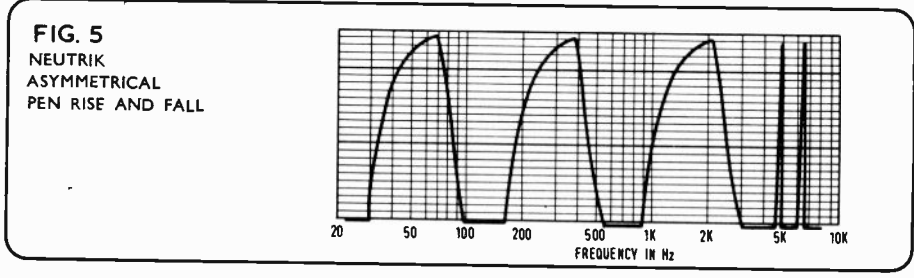
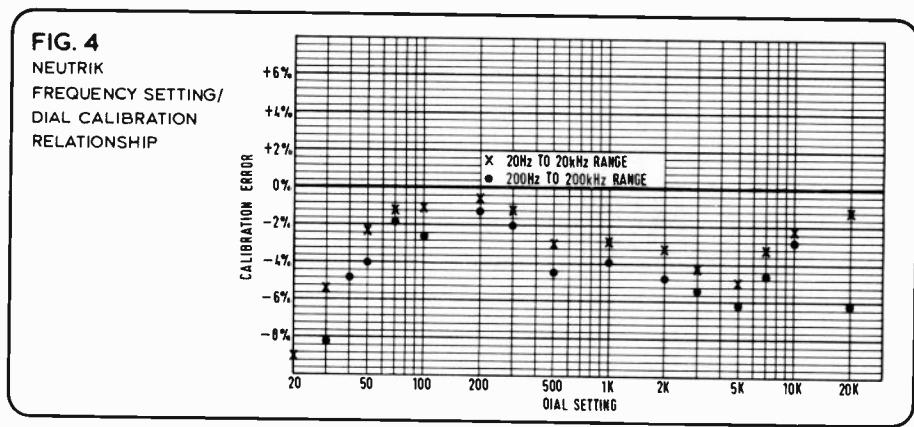

**STEREO DISC AMPLIFIER 3**

A reference amplifier for disc monitoring and transfer when replay signals of the highest quality are required.

Based on the Surrey Electronics Disc Amplifier 2 and manufactured under licence, two unbalanced outputs are provided enabling Line and DIN level inputs to be driven simultaneously. To facilitate cartridge matching, a wide range of switchable load capacitance and resistance values are provided, together with left and right 20 turn gain presets.

Noise measurements are often quoted with the disc input short circuit thus ignoring the noise contribution of the cartridge and the noise figure of the amplifier itself when loaded with the complex source impedances characteristic of magnetic cartridges.

Disc Amplifier 3 noise is specified with a simulated high inductance cartridge source. The CCIR noise weighting curve is also used as it gives a better correlation with the subjective annoyance of noise than other weighting or broadband measurement techniques.

High (Line) output: 1kHz at -44dBV.7 (5mV) set for 0dBV.7 output.	CCIR468-2 weighting and peak meter	CCIR/ARM Ref. 2kHz	20Hz-20kHz average reading meter
Short circuit input	-64dBV.7	-75dBV.7	-71dBV.7
Cartridge source 1H + 1k $\Omega$	-56dBV.7	-67dBV.7	-68dBV.7

Price: cash with order, UK postage and 12 $\frac{1}{2}$ % VAT inclusive £165

**DOMINUS P.O. BOX 1, CRANLEIGH, SURREY. Tel. 04866 6477**



**TRIDENT CONSOLE  
INSTALLED AT OUR LUTON  
SHOWROOM**

30 x 16 x 16 four years old £10,000

**NEW & USED EQUIPMENT**

HELIOS Console 26 x 24 x 24, five years old	
HELIOS Console 36 x 24 x 24 automated	P.O.A.
HELIOS Console 32 x 24 x 24	
NEVE CONSOLE BCM 10 x 2	£6,000
AUDIO DEVELOPMENTS 28 x 8 P.A. Console including compressor limiters, in flight case	£5,000
RAINDIRK 18 x 8 x 16 plus 2 master outputs, brand new available July	
TRIDENT A Range 32 x 24 x 24 one year old	
TRIDENT 28 x 12 x 24	£13,000
ALLEN & HEATH Mod 2 16 x 8 x 16	£1,800
ALLEN & HEATH Mod 2 10 x 8 x 16	£1,500
AUDIO DEVELOPMENTS Pico Mixer 6 x 2 with flight case and P.S.U.	£600
AMPEX MM 1000	£6,500
MCI JH10 24 track with 16 track head block	£17,500
AMPEX AG 350 4 track machine	£1,000
AMITY SCHROEDER 8 track 15/30 ips	£3,500
AMPEX MM 1000 8 track	£3,500
SCULLY 280 8 track	£3,000
AMPEX AG 440 stereo with Studer B62 elec's in trolley and with vari speed	£1,400
AMPEX AG440 stereo in console	£1,200
OTARI MX7000 stereo in console	£1,000
REVOX A700 immac	£950
TEAC 3340S	£650
OTARI MX 50/50 stereo	£450
BRENNELL Mini 8 track nine months old	£3,500
CROWN D60 amps	£130
CROWN DC150A amps	£275
QUAD 202 valve amps, per pair	£100
RADFORD STA 25 valve amps stereo	£150
PYE Stereo comp/lims	£350
DBX 160 comp/lims, per pair	£400
DBX noise reduction 16 tracks 216	£3,300
PPM Cards and meters Various	
CADAC Monitors with Audix amps, per pair	£800
LOCKWOOD Cabinets with 2 reds in each, per pair	£600
LOCKWOOD Major with golds	£500
TANNOY Ardens	£350
TANNOY Devons, per pair	£250
19 inch Jack Strips	
A & D E900RS sweep equalisers	£350
EVENTIDE Delay with two cards	£1,500
NEUMANN KM53 and KM54 with p.s.u. and leads, each	£130
MM 12 into 2 mixer	£150
KLARK TEKNIK DN22 2 x 11 graphic balanced	£350
SENNHEISER MKH 110 condenser mikes and p.s.u. (new)	£120
B.E.L. ELECTRONICS BF20 stereo flangers	£450
WASP Synths	£160
SESCOM Products	
TRIDENT Fleximix	P.O.A.
EMI TR90 mono tape recorders in trolleys	£250
Guaranteed once used Scotch 250 2" tape, reel	£25

ALL PRICES EXCLUSIVE OF V.A.T.

**Don Larking**  
Audio Sales

50 CHEAPSIDE, LUTON, BEDS.

Telephone: Luton 27195, 26693, 422387

Telex No. 825488

**THE PROFESSIONALS SHOP**



# AF Transformers 10 ranges - 95 standard types

Used and specified throughout the world for the highest professional applications including broadcasting, public address systems, recording consoles, mixing and filtering.

Other users will find that these ranges provide the answer where impedance matching is essential for data transmission, accurate measurement and instrumentation.

Audio transformers in the high voltage proof range are approved by the Post Office (Technical Guide No. 26) as permitted attachments to Post Office lines.

The high quality specifications of these comprehensive ranges are set out in our brochure — send for them now.



# Gardners

Def. Stan. 05-21 approved  
BS 9000 capability approval  
(BS 9720) in progress

Gardners Transformers Limited,  
Somerset Road,  
Christchurch,  
Dorset BH23 3PN, England.  
Tel: Christchurch 482284  
Telex: 41276

# AND NOW YOUR VERY OWN STUDIO SOUND T-SHIRT or SWEATSHIRT



**T-Shirts—Black—£2.50 or \$6 (inc p&p)**

**Sweatshirts (longsleeve)  
Red or Black—£5.50 or \$13 (inc p&p)**

Tick  **Black T-Shirt**       **S**  
 **Red Sweatshirt**       **M**  
 **Black Sweatshirt**       **L**  
 **XL**

I enclose cheque to the value of ..... Made Payable to:  
 Link House Magazines (Croydon) Ltd.

Send coupon and payment to: Studio Sound, Link House, Dingwall Avenue, Croydon CR9 2TA.

Send to:

NAME ..... (block capitals)

ADDRESS .....

Link House Magazines (Croydon) Ltd, Link House, Dingwall Avenue  
 Croydon CR9 2TA. Registered in England, No 1341560

# SOUND COMMUNICATION FOR REPLICATION

DEWSBURY, W. YORKS. TEL. 0924 451717

## Cassette and reel to reel

### PUBLISHERS ANNOUNCEMENT

Due to the recent budget increase in the V.A.T. rate, some prices in this issue may be subject to alteration.

We suggest all prices are checked with the advertisers before purchase.

(Applies to UK only)

### THE ACOUSTIC SCREENS from AK

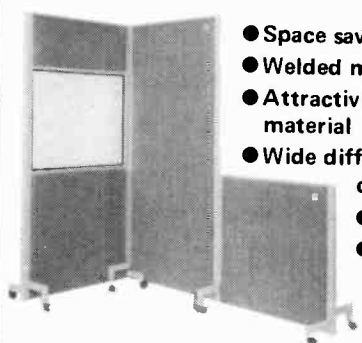

- Space saving corner interlock system
- Welded metal frames
- Attractive 'cigarette proof' covering material
- Wide differential non crushing castors
- Custom size option
- Roof sections to match

### SONAPANEL ACOUSTIC SYSTEM

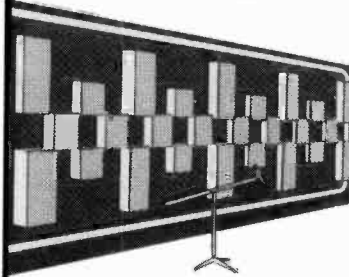

- Economic and flexible
- Individual layout scope
- Fast delivery
- Detachable fixture allows relocation or resale



AUDIO KINETICS (UK) LIMITED  
 Verulam Road, St Albans, Herts, AL3 4DH. Tel: 32191. Telex: 299951

# Classified Advertisements

Advertisements for this section must be pre-paid. The rate is **22p** per word, minimum **£4.40**. Box Nos. **60p** extra. Semi-display rates on application. Copy and remittance for advertisements in **SEPTEMBER 1979** issue must reach these offices by **12th JULY 1979** addressed to: The Advertisement Manager, **Studio Sound**, Link House, Dingwall Avenue, Croydon CR9 2TA.

**Note:** Advertisement copy must be clearly printed in block capitals or typewritten.

Replies to Box Nos. should be addressed to the Advertisement Manager, Studio Sound, Link House, Dingwall Avenue, Croydon CR9 2TA, and the Box No. quoted on the outside of the envelope. The district after Box No. indicates its locality. **SEX DISCRIMINATION ACT 1975:** No job advertisement which indicates or can reasonably be understood as indicating an intention to discriminate on grounds of sex (e.g. by inviting applications only from males or only from females) may be accepted, unless (1) the job is for the purpose of a private householder or (2) it is in a business employing less than six persons or (3) it is otherwise excepted from the requirements of the Sex Discrimination Act. A statement must be made at the time the advertisement is placed saying which of the exceptions in the Act is considered to apply.

The attention of advertisers is drawn to "The Business Advertisements (Disclosure) Order 1977", which requires that, from 1st January 1978, all advertisements by persons who seek to sell goods in the course of business must make that fact clear. From the above date, consumers therefore should know whether an advertisement relates to a sale by a trader or a private seller.

## SERVICES

★**Studio Design.** Complete acoustic design and measurement services for new studios and studio expansions. Monitor system equalisation service. Acoustic Technology Ltd., 58 The Avenue, Southampton SO1 2TA. Phone (0703) 37811. US Office: 320 Dresser Tower, 601 Jefferson, Houston, Texas 77002. Tel. 713/759-9768. X

## TAPE COPYING SERVICES

We specialise in short run cassette duplication.  
**NO JOB TOO SMALL**  
Fast turnaround, reliable service  
**LOW COST**  
**STEREO—MONO—PULSED**  
**01-723 6301 (Baker Street)**

## STUDIO FACILITIES

★**Disc Cutting Masters and Demos, Pressings, Cassettes, Mobile Recording Studio.** Free brochure. TAM Studio, 13a Hamilton Way, London N.3. Tel. 01-346 0033. K

★**Radio Production Studios for Commercials, Voice-Overs, A.V. Soundtracks, Audio Promotions.** D.I.Y. or complete service. Mark Stevens Productions Limited. 01-485 8087. L

## SHORT-RUN CASSETTE DUPLICATING

Fast service: cost of cassette included  
C32—49p each MINIMUM QUANTITY  
C60—62p each 10 COPIES  
C90—78p each (p. & p. extra)  
I — I / HI SPEED S.a.e. for FULL PRICE LIST to:  
**SIMON STABLE PROMOTIONS**  
46 West End, Launton, Oxon. Tel. 08692 2831

## COUNTY RECORDING SERVICE

From your tapes we cut master discs, demo discs, using our Scully lathe fitted with the latest ME/76 UK stereo disc-cutting system. Dolby 'A', Dolby 'B' and DBX Noise Reduction. Telephone Bracknell (0344) 54935.  
**London Road, Binfield, Bracknell, Berks, England**

## CASSETTE COPYING STEREO / MONO

From your master tape only first-class quality, any quantity supplied. Example 100 C90 cassettes 75p each, including library case.

**R.F.W. RECORDINGS SUPPLIES**  
50 BEDFONT LANE, FELTHAM, MIDDLESEX  
Tel. 01-890 6064

## IF YOU NEED...

Cassette Duplication Empty Tape Spools  
Blank Cassettes White Tape Boxes  
1/2" Tape 8T Cartridge Bodies  
Leader Tape Lubricated Tape  
Splicing Tape Head Cleaner Tape  
Why not ring us on 01-399 2476/7 and let us quote you for your next requirements.

**MEDIATAPE LIMITED, 29a Tolworth Park Road, Surbiton, Surrey.**  
01-399 2476/7

## CASSETTE COPYING IN THE MIDLANDS

Specialists in short run productions. Prices from 1p per minute, inc. cassette and library case. Label and inlay card printing, plus services and supplies for film, disc and AV productions.  
Write or phone for rate card to:

**AUDICORD RECORDS**  
10 The Chapel, Shilton Road, Barwell, Leics LE9 8HB. Tel. 0455-47298 (24 hr. answering service)

★**Teac-Tascam.** Sales, Service and Hire. The Playback Studio. 01-267 6752/3. H

★**Revox.** Sales, Service and Hire. The Playback Studio. 01-267 6752/3. H

## CASSETTE FAST-COPYING

Stereo or Mono. High Quality. Prompt Personal Service. Also bulk supplies of excellent virgin cassettes.

**SOUND CASSETTE SERVICES Ltd.**  
P.O. BOX 2, GERRARDS CROSS, BUCKS.  
Tel. 02813 84409

## HIGH SPEED CASSETTE COPYING IN MONO OR STEREO AT COMPETITIVE PRICES

Long or short runs.  
Blank cassettes supplied in bulk.  
A growing reputation for reliability.

**MORARD SOUND PRODUCTIONS**  
**THORNTON HEATH, SURREY**  
Telephone 01-689 7424

## DUPLICASSETTES

67 Compton Road, London N21  
Tel. 01-360 1200 01-903 0827

### CASSETTE DUPLICATION PRICE LIST

	20+	50+	100+	250+	500+	1000
C10	-45	-43	-41	-39	-36	-35
C20	-49	-47	-45	-43	-40	-39
C30	-53	-51	-49	-46	-42	-41
C40	-61	-59	-57	-54	-50	-48
C50	-70	-68	-66	-63	-58	-56
C60	-79	-77	-75	-71	-66	-64
C90	1 09	1 06	1 01	94	87	83

★**Vinyl pressings** from your tapes. Labels. S.A.E. for list. Deroy Records, P.O. Box 2, Morecambe, Lancs. X

★**Fanfare Records.** Tape-disc pressings, demo's, masters, any quantity. Studio/mobile Neumann disc cutter. S.A.E. brochure. 1 Broomfield Close, Rydes Hill, Guildford. Tel. 0483 61684. X

**SPR**

SPEECH RECORDING  
CASSETTE DUPLICATING  
OPEN-REEL DUPLICATING  
LANGUAGES/AUDIO-VISUAL

**SPEECH-PLUS RECORDINGS LTD**

32, PAGES WALK, SOUTHWARK, LONDON SE1 4SB.

01-231 0961/2

## WANTED

★**Wanted.** Revox and Teac Tape Recorders. Best prices paid. R.E.W. Professional Audio. 01-836 2372. X

★**Record Press** required, any model considered. Contact R. Adams, 34 Coventry Road, Brinklow, near Rugby. Ring 0788 832341. H

## FOR SALE—TRADE

★Add accurate level control to your mixer with the Cathedral LA3 comp/limiter module. Excellent performance at moderate cost. Build your own mixer with Cathedral low noise channel modules dispatched post free to any part of the world. Cathedral Sound Ltd., Fourways, Morris Lane, Halsall, Lancs L39. Tel. Halsall (0704) 840328. X

## BROADCAST CARTRIDGES

Large selection available ex stock. Competitive prices. Standard lengths.

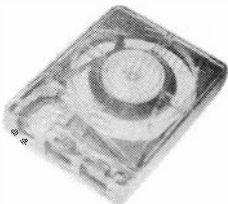

Custom winding. Lubricated tape. Also full range of tape cartridge storage systems.

**JOHN A. STEVEN**  
Professional Recording Equipment  
Brentwood (0277) 215485

★Bose 802 speakers with equalisation £475 per pair or £432 without equalisation. Amcron DC 300 £498 and D150A at £310. All prices plus VAT. Contact Geoff Yates, C.A.V.S. Ltd., 01-363 6125. A

★Soundcraft Studio console 24/16, 23 PPM's, P. & G. faders, sweep E.Q., 260 position patching (mint) \$19,500.00 U.S. Ampex MM-1100 16-track, 500 hours, like new, \$17,500.00 U.S. 3M M79 16-track, w/selectake, \$15,900.00 U.S. Ampex ATR-100 2-track, mint, \$6,800.00 U.S. Phone: 1-902-469-3243 (Canada). J

### UHER AT DISCOUNT

4000 Report IC	...	...	...	...	£215
4200 Report IC	...	...	...	...	£255
4400 Report IC	...	...	...	...	£259
CR210 Stereo and Case	...	...	...	...	£279
CR240 Dolby	...	...	...	...	£289
CR240 AV	...	...	...	...	£309

Prices are subject to VAT

D. Shaw, INTERPHOTO EQUIPMENT LIMITED  
11 Castle Street, High Wycombe, Bucks.  
Tel. 0494 41919

★Yorkshire. Erricks of Bradford. Tascam, JBL, Bose, AKG, Beyer, Calrec, Revox, Ferrograph Sales, Service, Exchanges, Leasing. 1st floor 8 Channel Studio Hire. Bradford (0274) 22972 (Roger). X

★Save up to 35% on cassettes! Buy direct from the manufacturer. Studio quality cassettes for high speed duplication, wound to any length, e.g. C40 from 16p. High Energy Cassettes, including library case, inlay card and labels, from £0.18 (C60), £0.27 (C90). (Using household name Japanese tape) Private Brand Cassettes—minimum order 100! Professional Tapes Ltd., Dept. 38, 329 Hunslet Road, Leeds LS10 1NJ. Tel. (0532) 706066. Telex 55293. CHACOM G PROTAPE. H

**WOLLENSAK**  
CASSETTE FAST COPIERS  
2770 mono & 2772 stereo, meticulously aligned.  
REDUCED PRICES  
**SOUND CASSETTE SERVICES Ltd.**  
P.O. Box 2, Gerrards Cross, Bucks. SL9 7PH  
Tel. 02813 84409

## USED STUDER CONSOLE FOR SALE

Model 189-080, Swiss-made like a fine watch. A steal at £10,000. Complete and in perfect condition.

Lincoln Stevenson, Pres. North American Leasing Co., 111 W. 57, NY 10019, U.S.A.  
Tel. 212/765-2005

## CADEC NO HASSLE NOISE REDUCTION SYSTEM

Gives 25dB of noise reduction with no side effects and no setting up procedure. Preproduction 4-track switchable code-decode unit from as little as £125 plus VAT. Will soon cost over £200. Buy direct now. Details of this professional quality system from:

**DB ELECTRONICS**  
2 Ash Street, Buxton, Derbyshire SK17 6LL  
Phone 0298 3756

STOP PRESS

## NOW AVAILABLE FROM FELDON AUDIO

We can supply single edged razor blades for your tape editing

Not usually obtainable in the UK

£5.00 per 100

While stocks last

(Plus VAT)

Feldon Audio Ltd.  
126 Great Portland St.  
London WIN 5PH  
Telephone 01-580 4314

## UHER

### THE BEST BUY THE LOWEST PRICES

S	4000IC	£201-00	42/4400IC	£246-50	S
A	CR210	£260-00	CR240	£276-00	E
L	SG561	£330-00	CR240AV	£293-00	R
E	5000	£254-50	CG340	£137-50	V
S	CG310	£83-00	CG330	£140-50	I
	EG750	£128-75	VG850	£137-50	C
	PS950	£100-00	Mini Line	£375-00	E

Prices nett cash with order VAT extra

**PHOTO ACOUSTICS LIMITED**  
255a St. Albans Road, WATFORD. Tel. 32006  
and Newport Pagnell (0908) 610625

## FOR SALE—PRIVATE

★Pair of Cerwin Vega full range monitors, 300 watts R.M.S. each. Five-drive units per speaker. Superb output. £580 o.n.o. Tel. 0254 72073. H

★Ampex AG 300 1/2 inch 4-track £750. Ampex AG 351 full track mono w/spares £400. Neumann SM2 stereo microphone £350. Prices ex. VAT. Telephone Tim Wheatley, Frensham (025-125) 4253. H

★Studer J 37 1in 4-track with large tape stock; 50m Belden 15x 2-core screened, with XLR stage box; dynamic and ribbon mics; four reels unused 1in NAB Racal 888; stands; jackfield; 150m armoured 2-core screened cable; no reasonable offers refused. Locks Heath 84146. H

★Pair IMF professional monitor Mk3 improved loudspeakers with IMF stands. Wood-effect laminate finish. £470. Please ring 588 4545 ext. 2515 office hours. H

★Telex 235 CS1 series reel to cassette copier, excellent condition, £1,750 o.n.o. (plus VAT). Telephone Bob Gittus (Chelmsford (0245) 83351). H

★JBL Monitors. 4301, 4311, 4315 etc. The Playback Studio. 01-267 6752/3. H

★Teac A3340S, A3440. In stock now. The Playback Studio. 01-267 6752/3. H

★Technics Hi Fi. Reel-Reel, Cassette Decks and Turntables. The Playback Studio. 01-267 6752/3. H

★The astounding new four track TEAC 3440 is available NOW from C.A.V.S. Ltd., anticipated list price £900 plus VAT. Our price £750.00 plus VAT. Phone Geoff Yates, 01-363 6125. H

## FOR SALE

Isle of Man registered recording company with 8-track operational Studio. Long lease.

£20,000

Write for details to:

P.O. Box 38, Douglas,  
Isle of Man

## SITUATIONS WANTED

★Young Sound Engineer, presently employed with Mobile, 8-track experienced, seeks post as Assistant/Trainee Engineer in a good studio. Willing to work hard. Mike Newbon, 01-363 9563 (after 6). J

★Experienced Recording and Maintenance Engineer (22) wishes to relocate in U.K. Seeks position in up-to-date 16/24 tk studio. Box No. 807 c/o Studio Sound. H

★Energetic 24-year-old seeks experience in Recording Studio in any major city as Junior Maintenance/Recording Engineer. 12 months ILR experience prior to returning to college. Working at present. Ring Dave on 051-523 4443. H

★English Recording Engineer (25) with 7 years studio experience (24 track) plus excellent references seeks employment. Box 809 c/o Studio Sound. H

## SITUATIONS VACANT

### RADIO NETWORK RF SYSTEMS ENGINEER

Six-station radio network in Minnesota seeks engineer strong in RF to help design, improve, build and maintain RF facilities. New stations, translators and microwave facilities in the works. Requires strong experience with state-of-the-art RF equipment and practice. FCC first class licence or ability to acquire. Electronics training and experience important. Resume, references, letter of interest and salary requirements to:

**Dan Rieder, Director of Network Engineering, Minnesota Public Radio Inc, 400 Sibley Street, St Paul MN 55101. AA/EOE.**

### RADIO NETWORK AUDIO SYSTEMS ENGINEER

Six-station radio network in Minnesota seeks engineer strong in audio to help design, improve, build, and maintain studio audio facilities. A new studio-office complex (with seven control rooms and studios) in the works. Requires strong experience with state-of-the-art FM audio equipment and practice. FCC first class licence or ability to acquire. Electronics training and experience imperative. Resume, references, letter of interest and salary requirements to:

**Dan Rieder, Director of Network Engineering, Minnesota Public Radio Inc, 400 Sibley Street, St Paul MN 55101. AA/EOE.**

## NT NATIONAL THEATRE

### SOUND ENGINEER

Applications are invited for the above position in the National Theatre's Sound Department. The successful candidate will be responsible to the Sound Manager for equipment design, manufacture and maintenance.

Applicants should have a full Electronic Engineer's qualification as well as some theatre background. Salary is negotiable.

Please apply in writing or telephone for an application form to **David Roberts, Head of Establishments, National Theatre, Upper Ground, South Bank, London SE1. Tel. 01-928 2033, Extension 376**

#### OLYMPIC STUDIOS ARE LOOKING FOR A SENIOR MAINTENANCE ENGINEER

The engineer we are looking for would have both academic and practical experience in the studio environment and capable of leading a small team of maintenance engineers.

Salary negotiable.  
For further details call 01-748 7961 or write to:  
**117 CHURCH ROAD, BARNES, SW13**



### TRAINEE ENGINEER

IF YOU ARE A KEEN YOUNG PERSON,  
WILLING TO LEARN THE RECORDING  
BUSINESS INSIDE OUT,  
CALL BILL FOSTER NOW! 01 580 0444

★Experienced Studio Engineer wanted for recently re-opened 24-track studio in London's West End. Call Mrs. Float at 01-930 7951 for interview. H

#### RED BUS RECORDING STUDIOS REQUIRE

Experienced Maintenance Engineer  
CONTACT  
**GEOFF CALVER 402 9111**

★Engineer required, must be experienced in 16-track recording. Ring 836 7608 (London). H

#### The Manor Mobile and the Manor Studio

Have a vacancy for a  
**MAINTENANCE ENGINEER**

Phone: Rhonda at the Manor 08675 2128



Trainee Disc Cutting/Tape Copying Engineer required for one of London's most successful independent Recording Studios.

Duties will be interesting and varied.

A great opportunity for a young man interested in a career within a company with a proven track record.

Applications in writing please to:

#### Derek Sticklen

Utopia Studios, Spencer Court, 7 Chalcot Road, London NW1

## ANNOUNCEMENTS

#### Richard Swettenham Associates

audio engineering consultants are now at  
147 STATION ROAD, HAMPTON, MIDDLESEX  
01-891 2697

01-979 4611

# CLASSIFIED ADVERTISEMENTS ORDER FORM

Please use this coupon for your private sales and wants. Rates 22p per word. Minimum £4.40. Box Nos. 55p extra. To: **Studio Sound, Classified Advertisements Dept., Link House, Dingwall Avenue, Croydon CR9 2TA.** Please publish the advertisement indicated below for ..... insertion/s under the heading .....

Name .....

Address .....

Cheque/P.O. enclosed £ ..

Is a Box No. required Yes/No. If no, please include remittance to cover name and address and/or Tel. No.

Please write in block capitals.

## INDEX TO DISPLAY ADVERTISERS

<b>A</b>	Acoustical Manufacturing .. .. . 4	<b>H</b>	Harrison .. .. . <i>IBC</i>	<b>P</b>	Plus 30 .. .. . 9
AKG .. .. . 5	Alice (Stancoil) Ltd. .. .. . 12	Hayden Laboratories .. .. . 31, 67	Hill, Malcolm .. .. . 10	Protex Fasteners .. .. . 7	Publison .. .. . 35
Aphex .. .. . 72, 73	APRS .. .. . 75	<b>I</b>	I.T.A. .. .. . 11, 13, 15, 17	<b>R</b>	Raindirk .. .. . 41
Atlantex Music .. .. . 12	Audio & Design (Recording) Ltd. 78, 79	Ivie Electronics .. .. . 18		R.E.W. .. .. . 6, 7	
Audio Kinetics .. .. . 51, 82				<b>S</b>	Scenic Sounds .. .. . 23, 27
<b>B</b>	Bauch, F. W. O. .. .. . 21, 33, 49	<b>J</b>	JBL .. .. . 19	Shure .. .. . 8	SME .. .. . 50
<b>C</b>	Cathedral Sounds .. .. . 57	<b>K</b>	Kemble/Yamaha .. .. . 69	Solid State Logic .. .. . 25	Sound Communications .. .. . 82
Coles Electronics .. .. . 59		Klark Teknik .. .. . <i>OBC</i>		Sound Reinforcement Services .. .. . 75	SQN Sales .. .. . 77
<b>D</b>	Dominus .. .. . 80	<b>L</b>	Larking, Don .. .. . 81	Studio Equipment Services .. .. . 34	Surrey Electronics .. .. . 74
<b>E</b>	Electro-Voice .. .. . 77	Lee Engineering .. .. . 57	Leevers-Rich .. .. . 53	<b>T</b>	Teac Professional .. .. . 47
<b>F</b>	Formula Sound .. .. . 16	<b>M</b>	Magnetic Tapes .. .. . 18	Trad Electronics .. .. . 65	Trident .. .. . 63
Future Film Developments .. .. . 16		MCI .. .. . 42, 43	Midas .. .. . <i>IFC</i>	Turnkey .. .. . 14	
<b>G</b>	Gardeners .. .. . 81	Mobile One .. .. . 71	Mustang Communications .. .. . 7	<b>U</b>	Ursa Major .. .. . 57
Graham, Steve .. .. . 77	Granet Communications .. .. . 54	MXR .. .. . 39	<b>O</b>	<b>W</b>	White Instruments .. .. . 58
		Otari .. .. . 55	<b>Y</b>	Yorke, James .. .. . 10	

STUDIO SOUND is available without charge to qualified readers: these are directors, managers, executives and key personnel actively engaged in sound recording, broadcasting and cinematograph industries in any part of the world. The Publisher reserves the right to refuse applications considered inappropriate and restrict the number of free copies sent to any one company or organisation. Non-qualifying readers can buy STUDIO SOUND at an annual subscription of £9.50. All enquiries to: Subscription Department, Link House, Robert Rogers House, New Orchard, Poole, Dorset BH15 1LU. Tel. Poole (02013) 71171. Published by Link House Magazines (Croydon) Limited on behalf of the proprietors Link House Publications Limited, Robert Rogers House, New Orchard, Poole, Dorset BH15 1LU and printed by Arthurs Press Ltd., Woodchester, Stroud, Glos. GL5 5PB.

# COME

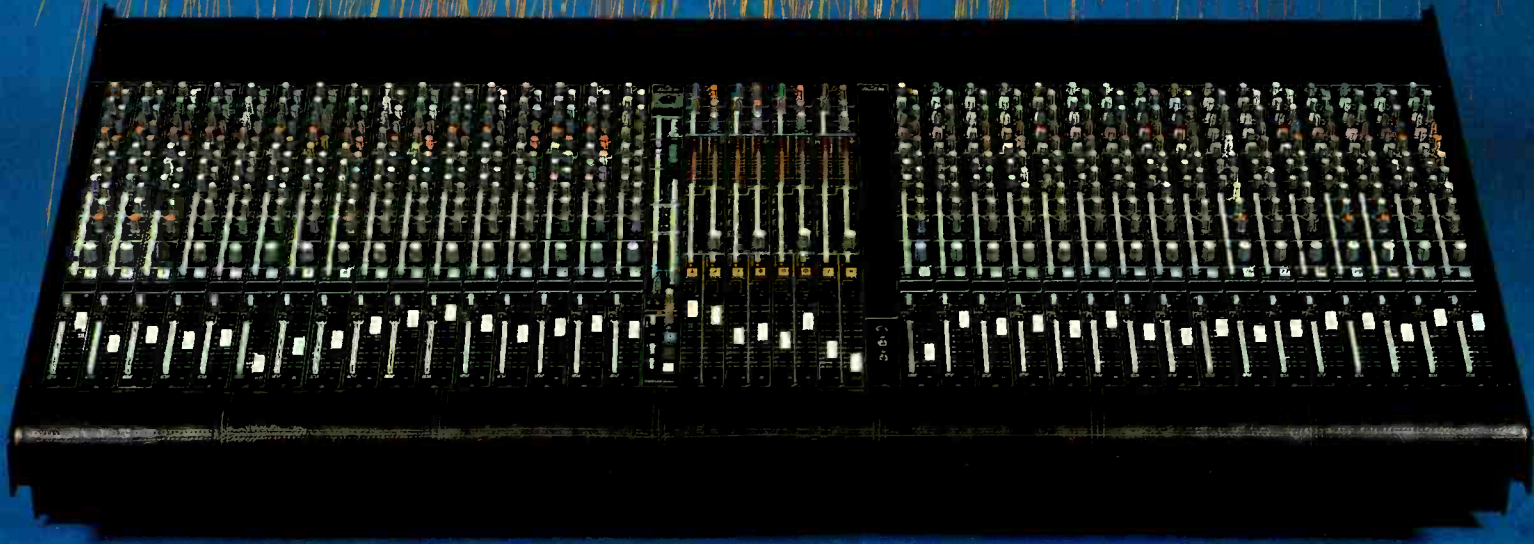

Now, a high performance studio quality Harrison console designed for LIVE PERFORMANCE. The Harrison NO COMPROMISE philosophy has been carried through every aspect in the design of the ALIVE console. Standard features:

- Harrison transformerless microphone preamplifiers.
- Automated VCA Faders with Groupers.
- 8 VCA matrix sub groups.
- 3 band parametric EQ with high-pass.
- Direct communications interface.
- 4 main stereo output pairs.
- 8 auxiliary send busses.
- 8 built-in 16 segment electronic LED VU meters.
- 32 or 24 channel mainframes and extender frames.
- 3 point overload LED indicator on each I/O module.
- Roac proof lightweight aircraft aluminum frame.

**Harrison** 

# You should know it's the best.

By now you should know that Klark-Teknik has the reputation for manufacturing the ultimate in signal processing products.

Each one represents the very best in its specific technology.

Our substantial research and development commitment ensures not only this but also maximum operational flexibility.

All our products undergo an exhaustive test procedure which involves visual checks, bench

alignment, burn-in period and, finally, performance verification using a music source.

Whoever you are, wherever you are, insist on the best.

Klark-Teknik.

As if you didn't know.



## KLARK-TEKNIK

For more information and 'Independent Technical Reviews' of our complete range, contact:  
Klark-Teknik Research Limited, Kidderminster DY11 7RE, Worcs., England. Tel: (0562) 741515/64027 Telex: 339821



### 1. DN70 digital time processor

The latest technology in digital conversion puts this delay line in a class of its own.

2. **DN71** A low cost, add-on sound effects generator to compliment the DN70.

### 3. DN34 analogue time processor

The most versatile delay-based sound effects unit on the market today.

4. **DN27 and DN22** The most respected graphic equalizers throughout the world.

Often copied, never equalled.

Worldwide Distributors: AUSTRALIA: Klarion Enterprises, S. Melbourne.  
BELGIUM: S.E.D. Sprl, Bruxelles. CANADA: Hammond Industrial Imports, Malton, Ontario.  
DENMARK: Teamsound, Graested. FRANCE: R.E.D., Studio Centre, Paris.  
GERMANY: Hausmann Concert Electronic, Berlin. HOLLAND: Pieter Bollen, Eindhoven.  
ITALY: Laboacustica Srl., Roma. JAPAN: Hibino Electro Sound, Tokyo.  
NORWAY: Siv. Ing. Bensum, Oslo. NEW ZEALAND: General Video, Wellington.  
SINGAPORE: Ultralinear International. SOUTH AFRICA: Colosseum Acoustics, Johannesburg.  
SPAIN: Mabel Sdad, Barcelona. SWITZERLAND: Dr. W.A. Gunter, Zurich.  
U.S.A.: Hammond Industries, Syosset, N.Y.