

# studio sound

May 1978 50p

AND BROADCAST ENGINEERING

NOISE REDUCTION



see us on stand 102/103 at the A.E.S. Exhibition Los Angeles



## UNIVERSALLY ACCEPTED WHERE RELIABILITY CANNOT BE COMPROMISED

The versatile p.r. system provides high quality signal processing electronics to cater for recording, live media and broadcast applications

The new 24 track console shown above incorporates in-line direct track monitoring with many innovative features.

MIDAS AUDIO SYSTEMS LTD., JEFF BYERS, 54-56 STAMOPE STREET, EUSTON, LONDON N1 3EX. Tel: 01-388-7060 01-387-7679

MIDAS EUROPE, LOUIS DE POTESTA, 23 AVENUE D'AVRIL, 1200 BRUSSELS, BELGIUM. Tel: 322-771-3063

MIDAS AUDIO CORPORATION, BOB SHELGOVE, 730 MAIN STREET, NIAGRA FALLS, NEW YORK 14301, U.S.A. Tel: 716-282-4100

MIDAS CANADA, FRANK PIMISKERN, GERR ELECTRO-ACOUSTICS, 365 ADELAIDE ST. EAST, TORONTO M5B 4R9, ONTARIO, CANADA. Tel: 416-368-2528

**MIDAS**



**EDITOR**  
RAY CARTER

**ASSISTANT EDITOR**  
MEL LAMBERT

**EDITORIAL PRODUCTION**  
DRUSILLA DALRYMPLE

**CONSULTANT**  
HUGH FORD

**SECRETARY**  
WENDY SMEETH

**ADVERTISEMENT CONTROLLER**  
DOUGLAS G. SHUARD

**ADVERTISEMENT MANAGER**  
MIKE STORMER →



**THE LINK HOUSE GROUP**

**Editorial and Advertising Offices:**

**LINK HOUSE, DINGWALL AVENUE,  
CROYDON CR9 2TA, ENGLAND**

**Telephone: 01-686 2599**

**Telex: 947709**

**Telegrams: Aviculture Croydon**

**© Link House Holdings Ltd 1978**

**All rights reserved.**

*STUDIO SOUND is published on the 17th of the preceding month unless that date falls on a Sunday, when it appears on the Saturday.*

#### **SUBSCRIPTIONS**

STUDIO SOUND is available at an annual subscription of £8.20. All enquiries to: Subscription Dept, Link House, 25 West Street, Poole, Dorset BH15 1LL. Poole (02013) 71171.

#### **OVERSEAS READERS**

For overseas readers, outside Europe,\* who require STUDIO SOUND within days of publication instead of weeks, we have the facility to send the magazine by Accelerated Surface Post (USA only) or Airmail.

The Accelerated Surface Post charge is \$10 per annum. The Airmail charge is £12 (sterling) per annum.

If you would like your copies of STUDIO SOUND sent by either of these methods, please write to the Editorial Office at Croydon.

On receipt of your remittance all subsequent issues of STUDIO SOUND will be sent to you by ASP/Airmail.

\*All copies to Europe are sent Airmail.

#### **BINDERS**

Loose-leaf binders for annual volumes of STUDIO SOUND are available from Modern Bookbinders, Chadwick Street, Blackburn, Lancashire. Price is £2 (UK and overseas). Please quote the volume number or date when ordering.



MEMBER OF THE AUDIT  
BUREAU OF CIRCULATIONS

Total average net circulation of 12111 per issue during 1977. UK: 6175, Overseas: 5936.

# studio sound

**AND BROADCAST ENGINEERING**

## Get it right

In our report of the last New York AES Convention we stated (hopefully) '... it appears that the large desks have reached a stage where manufacturers are taking a timely stock of the situation. Primarily the goal has been automation and this in itself warrants much user and manufacturer analysis'. Information received concerning the LA Convention this month seems to bear this out. But what *is* the situation?

Over the last decade the size of the recording industry has increased to such an extent that manufacturers are relying more and more on mass production techniques (hence the modular concept?) in order to keep prices down. Not all manufacturers, however, are using this philosophy to the same extent, which has led to a situation where the term custom-built has a sliding scale of meaning.

At one end is the manufacturer who will discuss the complete desk design with the studio engineer before building begins, and at the other end is the company who will explain to the engineer how the desk works, more or less after it is installed. But alongside this runs a reasonably parallel scale of decreasing cost; so if you want a truly custom-built desk, it'll cost you. This all seems very reasonable—you pay your money and you take your choice!

However, because of the relatively high costs involved in the purchase of any large desk, and the pressures on studios to have the most up-to-date and 'impressive' gear as a criterion (so often contrary to the *right* criterion—a good sound) this choice is not always made by the right person.

At present the situation is in no way one of total disregard for the engineer's (the user's) opinions but, as with all expanding industries, the insidious signs are there. So it's up to you, the engineer, not to be steam-rollered into ending up with gear that, even though it looks pretty and wasn't *too* expensive, won't do the job you want it to. In the long run it will probably work out as a bad investment.

## It's mutual

For several years now the main point of criticism of STUDIO SOUND has been that we don't cater sufficiently for the 'smaller studio'. This was a deliberate policy decision to ensure that STUDIO SOUND didn't dilute its efforts; but it left a large gap in our coverage of the recording field. We've now filled this space with a new publication—Sound International—which is aimed at 'musicians' on both sides of the glass. Between us our two magazines will cover the entire professional music scene. For more information on Sound International give us a call.

## contents

### FEATURES

SOUND ON STAGE—ENGINEER'S CONTROL  
Terry Nelson

34

AES 59th CONVENTION, HAMBURG—A PHOTO REPORT  
Mel Lambert

40

DOING IT FOR EFFECT . . . THE NOISE GATE  
Len Lewis

48

SURVEY: NOISE REDUCTION EQUIPMENT

54

### COLUMNS

NEWS

30

BUSINESS

52

WORK

64

### REVIEWS

DBX K9-22, DOLBY CAT 22, TELCOM c4D

NOISE REDUCTION SYSTEMS

Hugh Ford

72

**MAY 1978 VOLUME 20 NUMBER 5**



# The musical computer.

MXR have been working on a new type of audio delay line. The result is the MXR Digital Delay.

It works on memory banks. Just like an analog computer. The system is called "Digital Random Access Memory". And it's a great improvement on the old type of 'shift register' delay.

It's small. Completely self contained and has ordinary jack plug sockets so it can be used on stage. Or rack mounted for the studio.

The basic unit delays a sound by between 0.08 m.sec and 320 m.secs. But you can add plug-in memory boards to increase this to 1.28 secs.

You have precise control over the volume mix between the original and delayed sound. And over the amount of delay.

So you can produce a large range of effects. From the slightest hint of echo to hard reverb and A.D.T.

There are special circuits built in to give you flanging, frequency modulation and true vibrato. Pitch alteration, non deteriorating repeat hold and overdubbing effects.

And there's nothing on the market that can produce anything like the same results. Unless you want to pay at least £1,000 on top of the price of the MXR.

The Digital Delay is just part of the MXR Innovations range. Which also includes the Auto Phaser, the Auto Flanger and the Mini Limiter. Everything MXR makes is designed to keep noise

and distortion levels down to a minimum. And to sell at a very reasonable price. All the equipment is thoroughly tested before it leaves the workshop. And is backed up by the service professionals need.

MXR is distributed in the UK by Rose-Morris.

Find out more. Fill in the coupon.

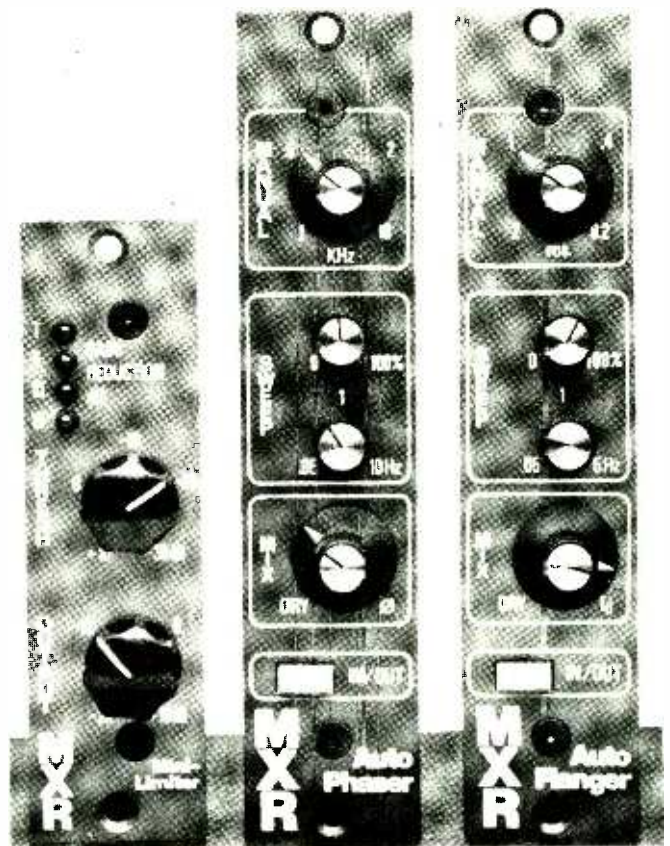

I am interested in knowing more about MXR.

Name \_\_\_\_\_

Address \_\_\_\_\_

Rose-Morris & Co Ltd., 32 Gordon House Road, London NW5 1NE, 01-267 5151.

**Rose-Morris**  
**MXR**



# The IE-30A Audio Analysis System from IVIE

- 1/3-octave Spectrum Analyzer
- Full-octave Spectrum Analyzer
- Precision Sound Level Meter
- True RMS AC Voltmeter
- RT<sub>60</sub> (Reverberation)\*
- THD (Harmonic Distortion)\*

For the first time, a real time analyzer and precision sound level meter have been combined into a portable audio analyzer "system" with features and accuracies rivaling the best laboratory instruments available.

The fully digital IE-30A comes standard with a precision laboratory microphone calibrated in dB-SPL and remoteable up to several hundred feet, a test probe with three precision attenuator settings for calibrated dB $\mu$ V measurements (true rms, average or peak), nickel cadmium batteries with charger, and a hard shell, foam lined travel case.

\*Using optional accessories



Other features include selectable detector responses, gated mode operation for measurement of reflections and time delay events, dual involatile memories that store or accumulate data that can be recalled to the IE-30A display up to weeks later.

The IE-30A was designed to accommodate an inexpensive new family of optional accessories. The IE-17A measures RT<sub>60</sub> (reverberation time) in 1/3-octave bands up to 99.99 seconds with 10 millisecond resolution. The IE-15A measures total harmonic distortion (THD) to less than .01%.

## SPEC BRIEFS

- 1/3 octave or full octave bands 30 filters on ISO centers 25Hz to 20KHz.
- Highly selective three pole-pair filters exceed ANSI S1.11-1966 Class III, B.S. 2475-1964, DIN 45652, and IEC255-1966
- 1/3 octave display weighted A, C or Flat.
- LED array 30 x 16 Resolutions of 1, 2 or 3 dB for display ranges up to 45dB.
- Precision SLM has *Fast, Slow, Impulse or Peak* responses with A, C or Flat filter weightings.
- 4 digit 0.1dB resolution readout with display hold mode.
- Meets requirements of:
  - ANSI S1.4-1971 TYPE S1A, S1C, BS 4197-1967
  - DIN 45633 B1.1, B1.2 (Impulse) IEC 179-1973
- 30 to 149 dB SPL re 20 $\mu$ N/M<sup>2</sup>.
- Microphone is omnidirectional condenser Type 1 (Precision), Flat 10Hz to 20KHz
- Signal outputs for recorders, oscilloscope displays and voice prints.



IVIE ELECTRONICS, INC  
500 West 1200 South  
Orem, Utah 84057 U.S.A  
(801) 224-1800  
TELEX or TWX 910-971-5884

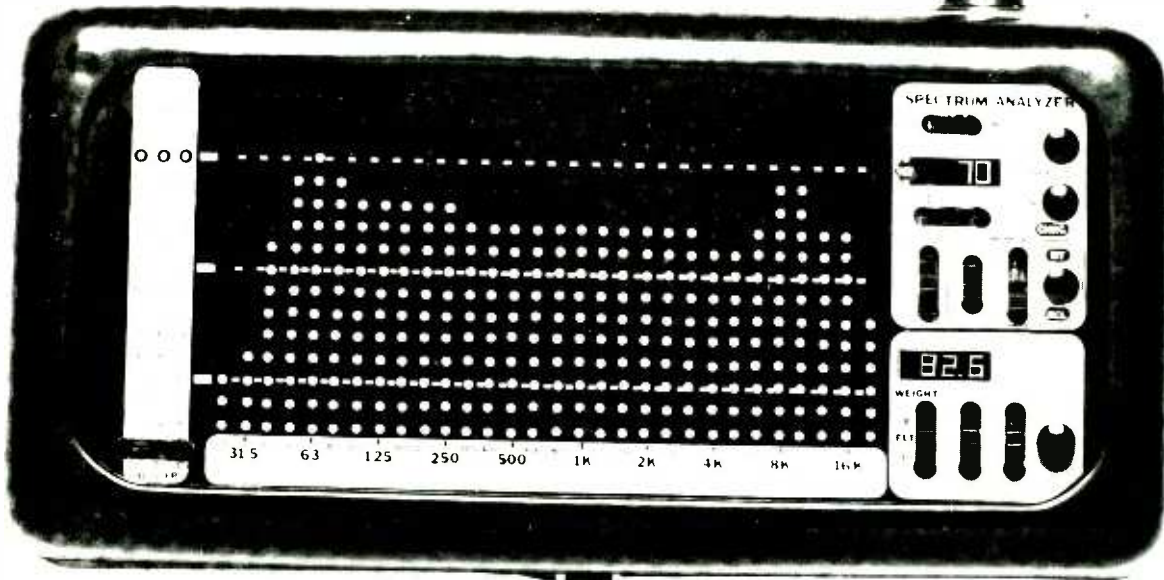

## Contact any of these Ivie Distributors for further information:

Australia, Melbourne  
KLARION ENTERPRISES  
Tel 61 3801

Belgium, Brussels  
S E D  
Tel 02-522 70 644

Finland, Helsinki  
MS AUDIOTRON  
Tel 410688

France, Paris  
REDITEC  
Tel 935 97 86

Italy, Milano  
ROJE TELECOMUNICAZIONI  
Tel 415 41 41/41 43

Italy, Roma  
ROJE TELECOMUNICAZIONI  
Tel. 480 029 - 465 630

Japan, Tokyo  
ELECTORI CO  
Tel (03) 950-6262

Malaysia, Indonesia, Singapore  
ELECTRONICS & ENGINEERING  
Tel 75873

Netherlands, Amsterdam  
SELETRONIC  
Tel. (02963) 4838.4966

Norway, Oslo  
MORGENSTIERNE & CO  
Tel (02) \*35 61 10

Spain, Madrid  
NEOTECNICA  
Tel 242-0900

Sweden, Stockholm  
ELFA  
Tel 80 730 07 00

Taiwan, Taipei  
ASIA ELECTRIC TRADING CO  
Tel 5925545-8

United Kingdom, London  
FWO BAUCH  
Tel 01-953 0091

Venezuela, Caracas  
ELECTRONICA GRAMCKO  
Tel 351419

# REW Professional

**We Will Beat Any Genuine Advertised Price**

## Europe's Largest Suppliers of Studio



### EQUALIZERS SOUNDCRAFTSMEN

Graphic EQ's.  
SAE Parametric EQ's.  
JVC SEA 10 (2 x 5 Band),  
SEA20 (2 x 7 Band)  
TECHNICS SH9010 (2 x 5 Band), SH9090 (1 x 10 Band)  
MXR (1 x 5 Band), (1 x 10 Band), (2 x 10 Band)  
MM-Pace (2 x Band), SR271 (1 x 27 Band)

### WOLLENSAK WOLLENSAK/West End Distributors

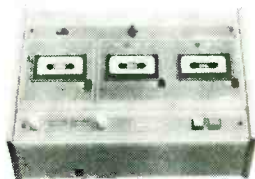

High Speed Duplicators.  
£1322+VAT. New 2772A/V gives 2 stereo musicassettes in under 4 minutes. Call in for a demonstration.

### UHER PORTABLE RECORDERS

As used by most Broadcasting Companies. All models in stock plus every accessory available.



Very low prices, e.g. 4000IC £225 +VAT.  
+SONY+  
NAKAMICHI  
+JVC+  
TECHNICS+  
TEAC.  
Portables all Off the Shelf.

### REVOX

Incredible stocks at ridiculous prices!



A77, B77, A700 Off the Shelf. High speed, low speed, vari-pitch + all accessories! Ring us now for the lowest price.

### TAPE AT TRADE PRICES

Any quantity—same price  $\frac{1}{4}$ " tape, 10 $\frac{1}{2}$ " reels.

AGFA PEM368 Metal ..... £10.06  
AGFA PEM368 Plastic ..... £7.79  
SCOTCH 207 Metal ..... £9.81  
SCOTCH 207 Plastic ..... £8.03  
MAXELL UD180 Metal ..... £8.89  
TDK AUDUA LB3600 Met £11.40  
TDK AUDUA L3600M Met £9.50  
SONY SLH-11-1100BL Met £10.00  
SONY SLH-740B Metal ..... £6.89  
REVOX 601 Metal ..... £11.80  
REVOX 601 Plastic ..... £10.00  
All above prices exclusive of VAT. Also large stocks of 7" & 5" reels.

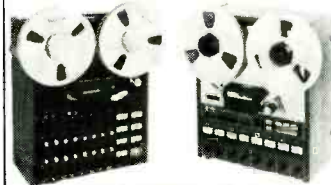

### 8 TRACKS $\frac{1}{2}$ " or 1"

Both Tascam and Brenell Recorders in stock for immediate delivery. Plus complete range of 8 Track ancillaries.

### MICS OVER 500 ALWAYS IN STOCK!



AKG We carry every model inc. capacitors  
BEYER Most dynamic+ribbons.  
CALREC 600 Range.  
SENNHEISER Large stocks.  
SONY All models.  
NAKAMICHI All models.  
E.V. Selected range.  
SHURE Very large range.  
NEUMANN All popular models.  
+ Cables, Transformers, Stands, Connectors & Clips, Windshields, etc.

### CANNON XLR'S ANY QUANTITY—SAME PRICE

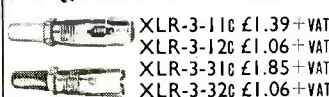

XLR-3-11C £1.39+VAT  
XLR-3-12C £1.06+VAT  
XLR-3-31C £1.85+VAT  
XLR-3-32C £1.06+VAT

### AMPLIFIERS

HH S500D, TPA, All stage amplifiers.  
SAE From 2 x 50 watts to 2 x 400 watts RMS.  
QUAD 405, 303, 50E usually in stock.  
JPS A fantastic range of budget studio amps.  
AMCRON DC 300A, D150A, D60. Trade prices.



### TEAC-TASCAM CENTRE

Britain's Largest Stockists.

All Models on demo in our studio

3340S 4 CH  
2340SX 4 CH  
3300SX2T 2 TR  
6100 2 TR  
7300 2T 2 TR  
TASCAM 80-8 8TR

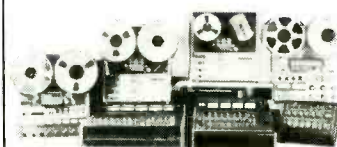

### MIXERS

The widest range under one roof!

From £35-£2500.  
Mixers in stock:  
SOUNDCRAFT 16/2, 12/2, 12/4 Series II.  
HH 16/2, 12/2.  
MM All models.

TEAC-TASCAM Models 1, 2, 3, 5 + Accessories.  
CANARY 10/2, 10/4.  
HILL 16/2, 10/2.  
SONY MX8, MX510, MX650.  
Plus ALLEN & HEATH, JVC, UHER, EAGLE, etc.



Plus Echo's, Phasers, Flangers, Limiters, Noise Reducers, Expanders, Mix-Downs, Mic Stands, Cable Drums, Disco Gear, Chassis Speakers, Studio Monitors, Headphones, Demags, Splicers, etc.

# REW

PRO-AUDIO & DISCO: 126 Charing Cross Road, WC2 01-836 2372  
VIDEO & HI-FI: 114-116 Charing Cross Road, WC2. Hi-Fi 01-240 3386 Video 01-240 3066  
TAX-FREE EXPORT & EXPRESS MAIL ORDER: REW House, 10-12 High Street, Colliers Wood, SW19. 01-540 9684 ● Also at 230 Tottenham Court Road, W.1.

# The Professional Everything Store



# Audio Established 1948

**Largest Stocks Lowest Prices!!**

## & Stage Equipment

### EXCLUSIVE FROM REW

**SAE** A superb range of studio electronics from the U.S.A.



#### POWER AMPLIFIERS ← PARAMETRIC EQUALIZERS

*Prices exclude VAT*

2800 Parametric equalizer 2 x 4 Bands .....	£408.00
1800 Parametric equalizer 2 x 2 Bands .....	£239.00
4000 Electronic crossover, stereo, variable frequency .....	£155.00
4100 Digital time delay, stereo .....	£354.00
2200 Power amplifier 2 x 100 watts .....	£346.00
2400L Power amplifier 2 x 200 watts .....	£578.00
2500 Power amplifier 2 x 300 watts .....	£755.00
2600 Power amplifier 2 x 400 watts .....	£887.00
5000 Impulse noise reduction unit .....	£176.00

### SOUNDCRAFTSMEN

America's Largest Manufacturer of Graphic Equalizers



#### GRAPHIC EQUALIZERS

2204 2 x 10 Bands .....	£199.00
2205 2 x 10 Bands, rack mount .....	£226.00
2209 2 x 10 Bands, rack mount, 600 ohm balanced in/out XLR .....	£319.00



#### NEW CLASS H POWER AMPLIFIER

MA5002 2 x 250  
watts, meters .....

£399.00  
*Prices exclude VAT*



#### DOKORDER

##### Pro 1/4" 4 Channel Recorders

1140. 15 + 7 1/2 ips, 10 1/2" reels. Full motion sensing logic. Auto rewind-play. Auto-sync switching. Front Panel variable bias. Peak LED's. Eye-level electronics. £698 + VAT.

**Open 9.30 am — 6 pm — 6 days a week**  
**Just walk in — 95% of advertised**  
**gear available off the shelf**

Payment by: Cash,  
Barclaycard, Access,  
American Express, Diners,  
HP (Instant credit possible)

**THE LOW PRICE HOT**  
**LINE 01-836 2372**

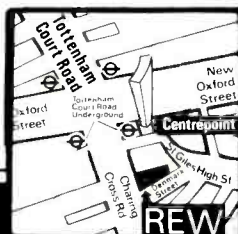

**NEAREST TUBE STATION**  
**TOTTENHAM COURT ROAD UNDERGROUND**

# Wollensak Duplicator copies music expertly and fast



The Wollensak 2772AV Stereo High Speed Desktop Duplicator. £1498.93 + 8% VAT

**Quality** The 3M Wollensak 2772AV Duplicator is a high speed cassette to cassette duplicator for fast stereo (or mono) copies — two stereo copies in under four minutes.

If you need to be technical: Crosstalk 45dB, frequency response 50-10,000 Hz ± 3dB, wow and flutter 0.15% rms max., speed accuracy ± 1%, s/n ratio within 3dB of master.

**Versatility** Because these copies have such professional quality, leading recording Studios like **Dick James Music** use them. They've a rapidly growing place in university or college music departments, local radio stations, and advertising agencies, too.

**Simplicity** This duplicator sits happily on any desk or table. Its colour-coded illuminated push buttons interlock to prevent accidental damage. Old programme material on copies is automatically erased. Automatic rewind, manual rewind switch, visual and aural monitoring facilities.

**From Fraser Peacock Associates — the audio visual specialists**

Use the coupon for more about this machine's ruggedly reliable quality. And remember the Fraser Peacock name for advice on conference presentations, film strips, recording sessions and a complete range of audio visual equipment for sale or hire.

Please tell me more about the Wollensak 2772AV Duplicator.

Name \_\_\_\_\_

Address \_\_\_\_\_  
\_\_\_\_\_  
\_\_\_\_\_

**fpa**

To Fraser Peacock Associates Ltd.  
94 High Street, Wimbledon Village, London SW19  
Telephone: 01-947 7551  
*3M and Wollensak are trademarks*



# JIGSAW "put it all together" with Fleximix... the master mixer



Jigsaw, a leading 8 track studio, chose the incredibly versatile **Trident Fleximix** for its outstanding performance.

Make a record of these **Fleximix** points:

- Fully Modular
- Total system flexibility – a module can be placed anywhere in the mainframe.

- Expandable at any time from mono to 24 track with no pre-wiring necessary.

- Maximum of 10 mixed output groups (8 sub-masters and 2 main left-right masters), plus monitoring facilities up to 24 tracks.

- Individual illuminated channel metering and L.E.D. column indicators to P.P.M. specification on sub-master groups.

- Complete patchfield facilities including direct channel outputs and pre-fade limiter insertion on input channels and output groups.

- Self-contained power supply system. Each mainframe contains a fully regulated and protected dual power supply which can be used to "slave" another mainframe in the event of failure.

- Now available with P. & G., conductive plastic faders.

For full details contact:  
Trident Audio  
Developments Ltd.,  
Sales Office,  
112-114 Wardour Street,  
London, W1V 3AW.  
Tel: 01-734 9901/6.  
Telex: Tridisc 27782

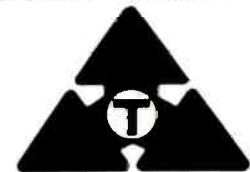

**TRIDENT**  
Crossing the  
frontiers of sound.

*Photograph shows Dave  
and Sue Williams at work  
in their Jigsaw studios  
Tel: 01-668 3457*



# NEW PRODUCTS BULLETIN

## ITA



**ORBAN  
PARASOUND from USA**

Dual channel multispring reverb unit. Each channel features four springs – far smoother than single spring systems. "Twang" and "boing" are virtually eliminated by incorporating a floating threshold limiter. Bass, mid-range EQ and bandwidth controls. The best compact reverb unit available.

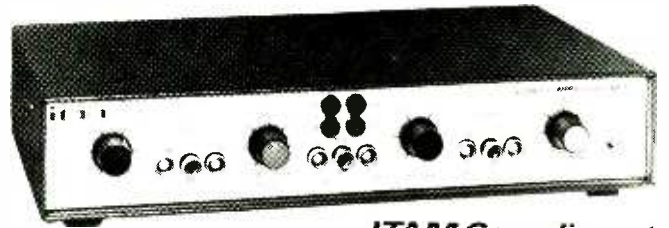

**ITAM Compliment**

New Stereo compressor limiter. Competitively priced. Free standing self-contained unit, accurate stereo tracking, stepped 1:1, 1:5, 3:1 plus limiting ratio at 20:1. Switchable attack time, variable release time, automatic release time. Input attenuation to accommodate large range of inputs. Pre-set adjustable output. Switched link for stereo tracking. Visual representation of compression.  
£247 + VAT

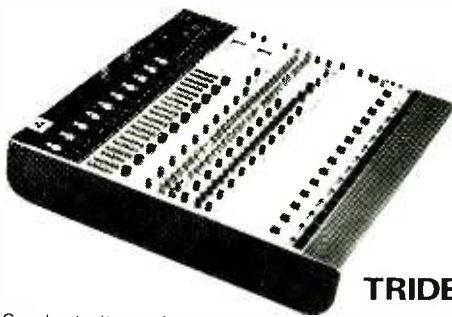

**TRIDENT Fleximix**

Can be built up from stereo through 4 channel to 8 channel groups with unlimited number of input channels. Well thought-out and superbly constructed to the highest standards. ITA always have Fleximix in stock for demonstrations and immediate delivery.

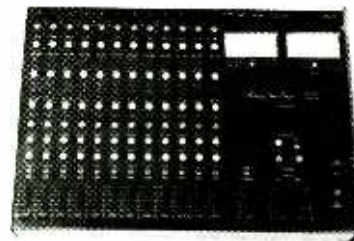

**RSD  
Studio Monitor  
12x12x2**

A really comprehensive budget-priced mixer. Twelve inputs, each with direct output, pre-fade monitor, multi-band EQ including 3 EQ and 2 sweep controls, balanced inputs, Cannon connectors. An ITA exclusive.  
£385 + VAT at 8%.  
Also available: 16 - 4 model £767 + VAT.

**OTARI  
DP4050 OCF  
IN CASSETTE  
DUPLICATOR**

Now with 3% + 7% master capability and Ferrite heads. Duplicates 6 cassettes each run at 8 times speed. Over 80 stereo C60 per hour. Unquestionably the finest in cassette copier available from the world's largest duplicator manufacturer.



**QUAD**

The new 405 power amplifier is now in stock. 100 watts per channel – simply the best, for £££'s less! Immediate Delivery!

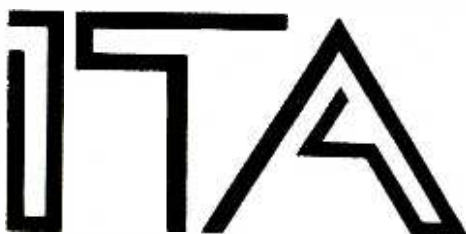

1-7 Harewood Avenue, Marylebone Road, London NW1.  
Tel: 01-724 2497 Telex: 21879

FRANCE: Son Professionnel, 29-31 Avenue André Morizet,  
92100 Boulogne (Paris). Tel: 605 3363

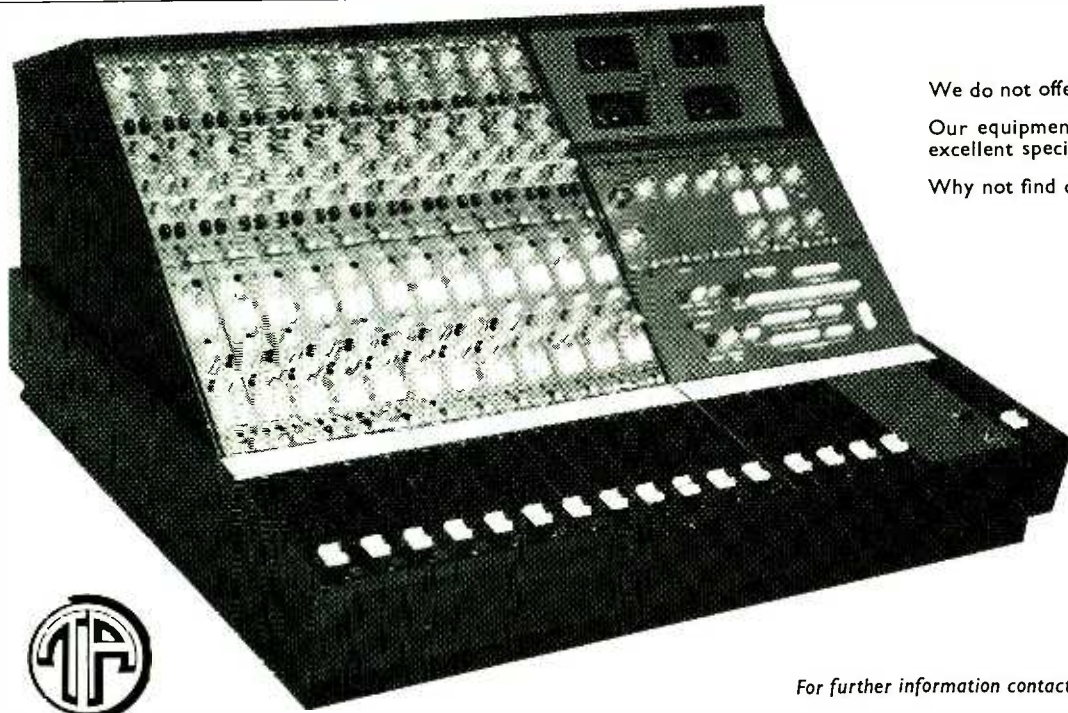

We do not offer any gimmicks.  
 Our equipment is designed to last with excellent specification at realistic prices.  
 Why not find out more about it?



**3M UK Ltd.,**  
 Witley Works,  
 Witley Gardens,  
 Southall, Middlesex.  
 Tel: 01-574-5929/6045

**Tweed Audio,**  
 Pinnaclehill Industrial Estate,  
 Kelso, Roxburghshire.  
 Tel: (05732) 2983  
 Telex: 727633

1640 Fifth Street,  
 Santa Monica,  
 California 90401  
 Tel: (213) 451-0688

*For further information contact nearest office.*

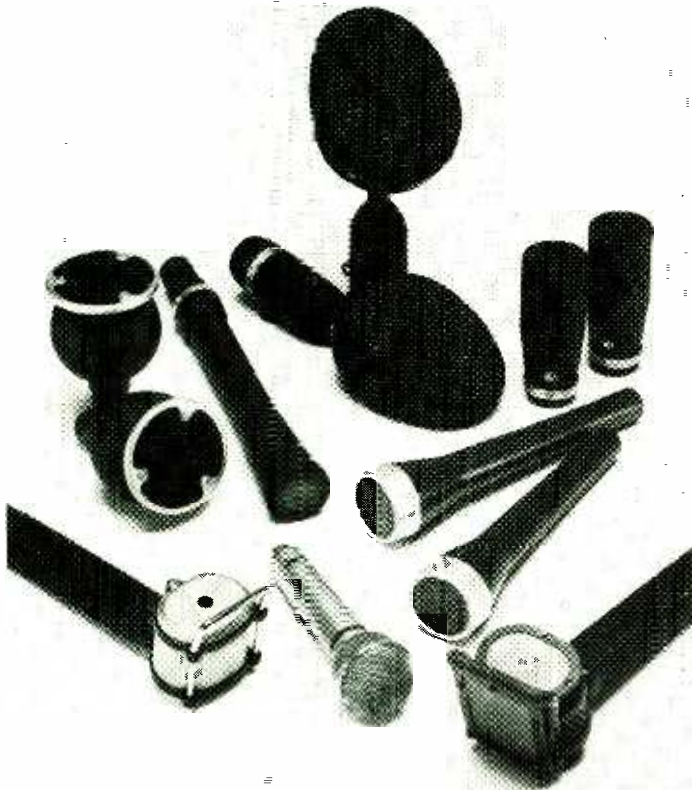

# BROADCASTING PERFECTION

Hampstead High Fidelity—professional equipment for professional people, and distributors for the complete range of COLES (formerly STC) microphones; a range of microphones covering the whole spectrum of inside and outside broadcast uses.

**ALL IN STOCK AT OUR LONDON SHOWROOM**

We also supply the Keith Monks range of microphone stands, booms and accessories.

**ALL IN STOCK AT OUR LONDON SHOWROOM**

Choose from our range of professional equipment, REVOX, YAMAHA, NAKAMICHI, HARMON KARDON, GALE, DAHLQUIST AND SENNHEISER

For the home market we carry in stock at our London Showrooms a comprehensive range of superb professional equipment.

**EXPORT IS OUR SPECIALITY. 24 HOUR SERVICE WORLD WIDE.**



**Hampstead High Fidelity Ltd**  
 63 Hampstead High Street  
 London NW3 1QH, England  
 Tel: 01-435 0999/6377

All microphones shown are used by the major TV and radio networks worldwide.



# Now-VARISPEED plus CRYSTAL CONTROL

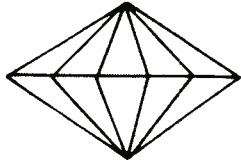

Industrial 3340SX available with  
VARISPEED + CRYSTAL CONTROL

# TEAC

NEW VERSIONS EXCLUSIVE TO ITA  
VARISPEED OPENS A NEW AREA FOR CREATIVE EFFECTS

Industrial 3300SX with  
VARISPEED + CRYSTAL CONTROL

Wide range VARISPEED provides 40% speed variation for effects. Crystal control guarantees capstan motor speed error less than 0.001% whilst mains locked versions depend on power line frequency up to 2% error.

DON'T ACCEPT LESS

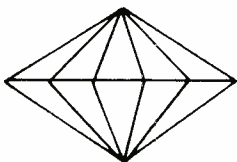

1-7 Harewood Avenue, Marylebone Road, London NW1.  
Tel: 01-724 2497 Telex: 21879

# ITA

# There is a Dolby noise reduction unit for every professional application

## Professional recording and transmission applications



### 360

The Dolby 360 is a basic single-channel A-type noise reduction unit for encoding or decoding. This unit is normally used in a fixed mode such as in disc cutting or landline sending or receiving; the operating mode is manually selected.



### 361

The Dolby 361 is similar to the 360, providing a single channel of A-type noise reduction, but with relay switching of operating mode and tape recorder connections. The changeover can be controlled automatically by the recorder.

## Motion picture industry



### 364

The Dolby 364 Cinema Noise Reduction Unit is intended primarily for use with Dolby A-type encoded optical sound-tracks. The 364 also includes a standard 'academy' filter for conventional tracks, and provision for playback of magnetic sound tracks with or without Dolby system encoding.



### E2

The Dolby E2 Cinema Equalizer is a companion unit to the 364, and has been specifically designed to solve the response equalization problems of cinemas. Used with the 364 and Dolbyized optical sound-tracks the E2 enables most cinemas to achieve modern sound reproduction standards without replacement of existing equipment.

## Professional encoders for consumer media



### 330

The Dolby 330 Tape Duplication Unit is a professional quality unit with B-type (consumer) noise reduction characteristics. The unit is used for encoding duplicating master tapes in the high-speed duplication of Dolbyized cassettes, cartridges, and open-reel tapes. The 330 is a two-channel unit.



### 334

The 334 FM Broadcast Unit allows broadcast stations to encode stereo FM broadcasts with the Dolby B-type characteristic. The unit also provides for a reduction of high frequency pre-emphasis to 25 microseconds, thus reducing the need for high frequency limiting, thus allowing a significant additional improvement in reception quality.

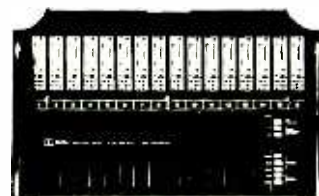

### M-Series

The Dolby M16H A-type unit is designed specifically for professional multi-track recording, and incorporates 16 channels of noise reduction in a compact chassis only 10 inches high. The similar M8H is an 8-track version, and the M8XH allows simple extension of the M16H for 24-track use.

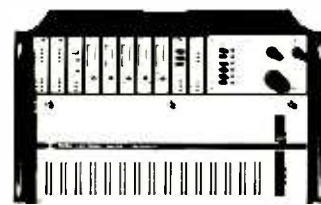

### CP100

The Dolby CP100 Cinema Processor is designed for the reproduction of all current and presently foreseeable film sound-track formats including conventional optical and magnetic tracks, Dolby encoded monaural optical tracks, Dolby encoded magnetic sound-tracks and the new stereo optical release prints. Up to three noise reduction modules can be incorporated. Typically, three channels of theatre equalization, as in the E2, will be incorporated, but facilities exist for five channels of equalization and the connection of an external quadraphonic decoder.



### Cat no. 35

The Dolby NRM Test set, Cat no. 35, permits rapid verification of performance of Cat no. 22 noise reduction modules without their removal or the need for additional test equipment.

## Noise reduction module



### Cat no. 22

The Dolby noise reduction module, Cat no. 22, is the basic functional unit employed in all A-type equipment. The Cat no. 22 is available as a spare or in quantity to OEM users for factory installation. A half-speed version of the module (Cat no. 40) is also available.

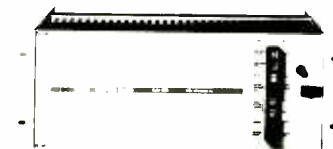

### CP50

The new Model CP50 is intended for the reproduction of all optical soundtrack formats: Dolby encoded and conventional, mono and stereo. The unit is designed to interface with an existing fader and magnetic stereo installation. A wide range of accessories is available.

## Noise weighting filter



### Cat. Nr. 98A

Noise weighting filter to CCIR/ARM characteristic (recommended by Dolby Laboratories). Filter is used with average responding meter (ordinary millivoltmeter) allowing noise measurements to be made on tape recorders, tapes, FM tuners, etc. with results which correlate closely with the subjective effect of the noise. Filter can be used for the testing of professional and consumer equipment.



**Dolby Laboratories Inc.**  
Dolby, Dolbyized and the double-D symbol are trade marks of Dolby Laboratories Inc.

731 Sansome Street, San Francisco, CA 94111  
Telephone (415) 392-0300, Telex 34409  
Cable: Dolbylabs

346 Clapham Road, London SW9 9AP  
Telephone 01-720 1111, Telex 919109  
Cable: Dolbylabs London





# NO COMPETITION

The superb 3.77 is the only choice in compact professional recorders.

## Who says?

Hundreds of satisfied professional users— Broadcast authorities, studios, record companies, universities etc etc.

## What makes it the best?

The 3.77 provides more performance and features for your £ than any other model. Like 3 speeds, flat metal facia with excellent editing facilities, 100% variable speed control, logic control with motion sensing, line-up oscillator.

## Is it reliable?

The 3.77 uses the famous REVOX A77 chassis— there are more A77 recorders in use in studios than any other recorder. The industry depends on it.

## How about delivery?

As quick as you can dial 01-724 2497/8.

3¾ + 7½ + 15 £575    7½ + 15 + 30 £610

An **ITA** Product.

1-7 Harewood Avenue, Marylebone Road, London NW1. Tel: 01-724 2497. Telex: 21879



# The CPR-16 Computer Programmed Reverberation

The Quad Eight CPR-16 represents a revolutionary breakthrough in the application of advanced computer technology for the professional audio marketplace.

Two years in development, the CPR-16 is the first product to embody advanced digital technology in a configuration which will allow an unprecedented degree of control over the reverberant field by signal processing.

It offers the user a flexibility beyond the now ordinary mechanical methods; every possible aspect of the reverberant field is capable of alteration by the engineer. Reverberation time can be changed from zero to twenty seconds in sixteen steps, even during operation, without signal degradation. High and low frequency damping rates can be controlled over a wide range which previously was only achieved by time-consuming and clumsy rearrangements of complex arrays of absorption plays in live chambers or rooms. The simulation of "room size"

can be modified with a single control which adds a variable delay before the first echo or reflection signal.

And, most importantly, the CPR-16 allows the prominence and density of resonant modes to be altered. Thus, the density and diffusion rate of echoes can be tailored to match any room, electromechanical device, or whim.

The CPR contains two individual reverb programs and one "open" program provision for future custom sound processing effects. Program 1 is analogous to a live acoustical chamber, and Program 2 creates a simulation of an artificial plate. Program 3 switching facility is pre-wired for a plug-in programming module and Program 4,

ECHO allows a "Tape-Echo" simulation that is unobtainable by present mechanical methods.

The CPR-16 incorporates control over every critical aspect of the reverberant field. If you have a special application which requires a previously unavailable sound processing effect, information on custom programs is available from the factory.

Write us or call for a detailed brochure on the revolutionary CPR-16. The age of affordable digital processing for audio has arrived. If you've been waiting for technology to catch up with your imagination, your time has come.

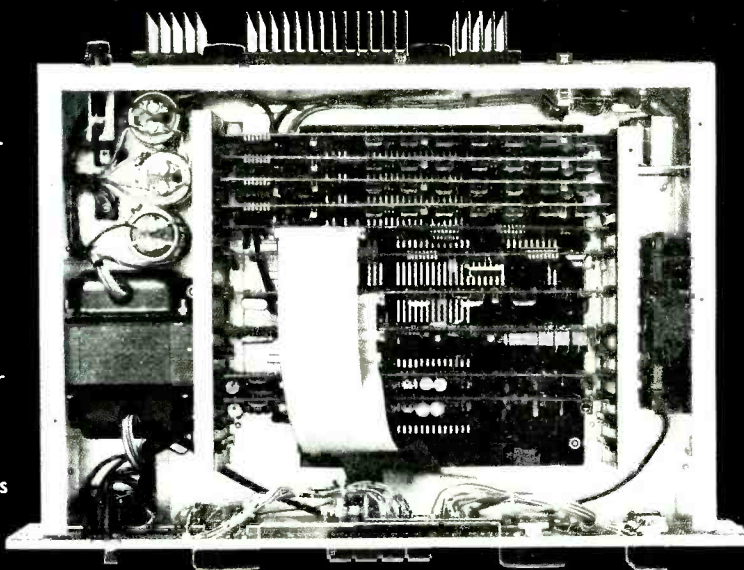

Quad/Eight Electronics • Quad/Eight International 11929 Vose St., No. Hollywood, Ca. 91605 • (213) 764-1516 • Telex: 662-446



# BGW AMPS PROS GET BEHIND



Over the past seven years BGW has turned a lot of professional heads around. We came out of nowhere to successfully challenge the stand-pat technology of the aging monarch of professional amplifiers. The most demanding buyers in the music business now rely on BGW: Studio owners. Recording engineers. Serious musicians. Everyone who makes his living from recorded or live sound. Performers and technicians alike have gotten behind BGW's legendary power, impeccable performance and workhorse reputation.

Here's what's made BGW the most imitated product in the pro sound business:

A full professional line starting with the MODEL 100: 30 watts per channel into 8

ohms, 20 Hz to 20 kHz, at less than 0.1% THD (80 watts mono);

The MODEL 250 C: 100 watts per channel into 8 ohms, 20 Hz to 20 kHz, at less than 0.1% THD (251 watts mono);

The new MODELS 750B and 750C: 225 watts per channel into 8 ohms, 20 Hz to 20 kHz, at less than 0.1% THD (720 watts mono).

For the true sound professional, quality isn't a luxury. It's a necessity and something we build into every BGW amp.

Contact our home office for complete technical specs. You'll understand why so many of your professional peers get behind BGW. And why the competition stays behind.



Get Behind Us!

BGW Systems, Inc., 13130 S. Yukon Ave., Hawthorne, CA 90250. Telex: 66-4494

In Canada: Omnimedia Corp., 9653 Cote de Liesse, Dorval, Quebec H9P 1A3

U.K., Webland International Ltd., 129 Walham Green Court Moore Park Rd., Unit F, London SW6 2TP.01 385-9478. Telex: 25570

International Inquiries please contact the factory.

# Master-Room Reverberation Units

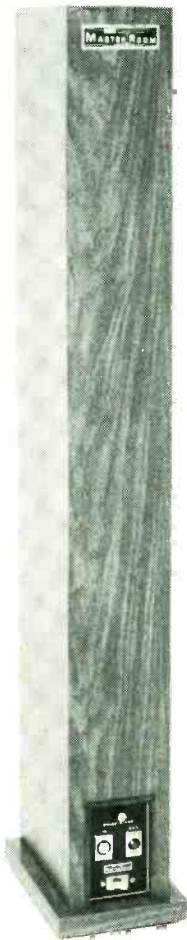

A complete range of superbly natural sounding reverberation devices equally suitable for fixed or portable operation. Master-Room models are in reliable daily use with broadcasters, film dubbing facilities, multi-track music recording studios and P.A. companies.

Illustrated:  
Master-Room Model MR111 fixed decay time stereo output reverberation unit

U.K. List £934



Sound columns not shown

Master-Room Model CSR23 EQ two independent channel variable decay time reverberation unit with comprehensive reverb return equalisation

U.K. List £1,384

For full details on the MICMIX Master-Room range contact:

**Scenic Sounds Equipment,  
97-99 Dean Street, London W1. Tel: 734 2812**

Belgium  
S.E.D., Rue Bara Straat 146,  
1070 Bruxelles. Tel: 522 7064

A.R.C. SPRL, Rue Th. Decuyper 134,  
1200 Bruxelles. Tel: 771 3063

Denmark  
Lake Audio APS,  
Artillerivej 40,  
DK-2300 Copenhagen S  
Tel: 570 600

France  
3M France SA, Mincom Div.,  
Boulevard de l'Oise,  
95000 Cergy  
Tel: 749 0275

Holland  
Pieter Bollen Geluidstechniek,  
Hastelweg 6, Eindhoven  
Tel: 512 777

Norway  
Siv Ing Benum AS, Skovvn 22,  
Oslo 2. Tel: 565 753

Sweden  
Tal & Ton Musik & Elektronik AB,  
Kungsgatan 5,  
411-19 Gothenburg  
Tel: 130 216

## CHILTON

If you are searching for a *Quality* mixer which has attention to *detail*, many *facilities* and NO hidden snags + *impressive* appearance, seek out the new CHILTON QM1 series.

The price is very competitive due to full in-house manufacture. 12-4 and 16-8 + Add-on Input modules.

Our very popular M10/2 and M16/2 are also available, from £670.

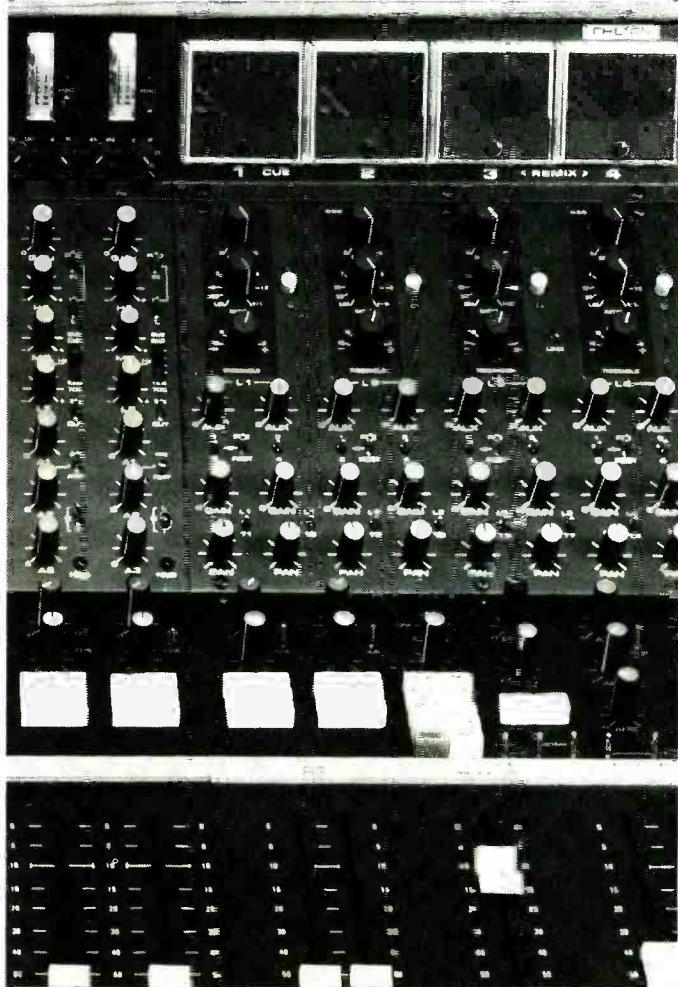

### MAGNETIC TAPES LTD.

Chilton Works, Garden Road  
RICHMOND, Surrey TW9 4NS

Telephone: 01-876-7957



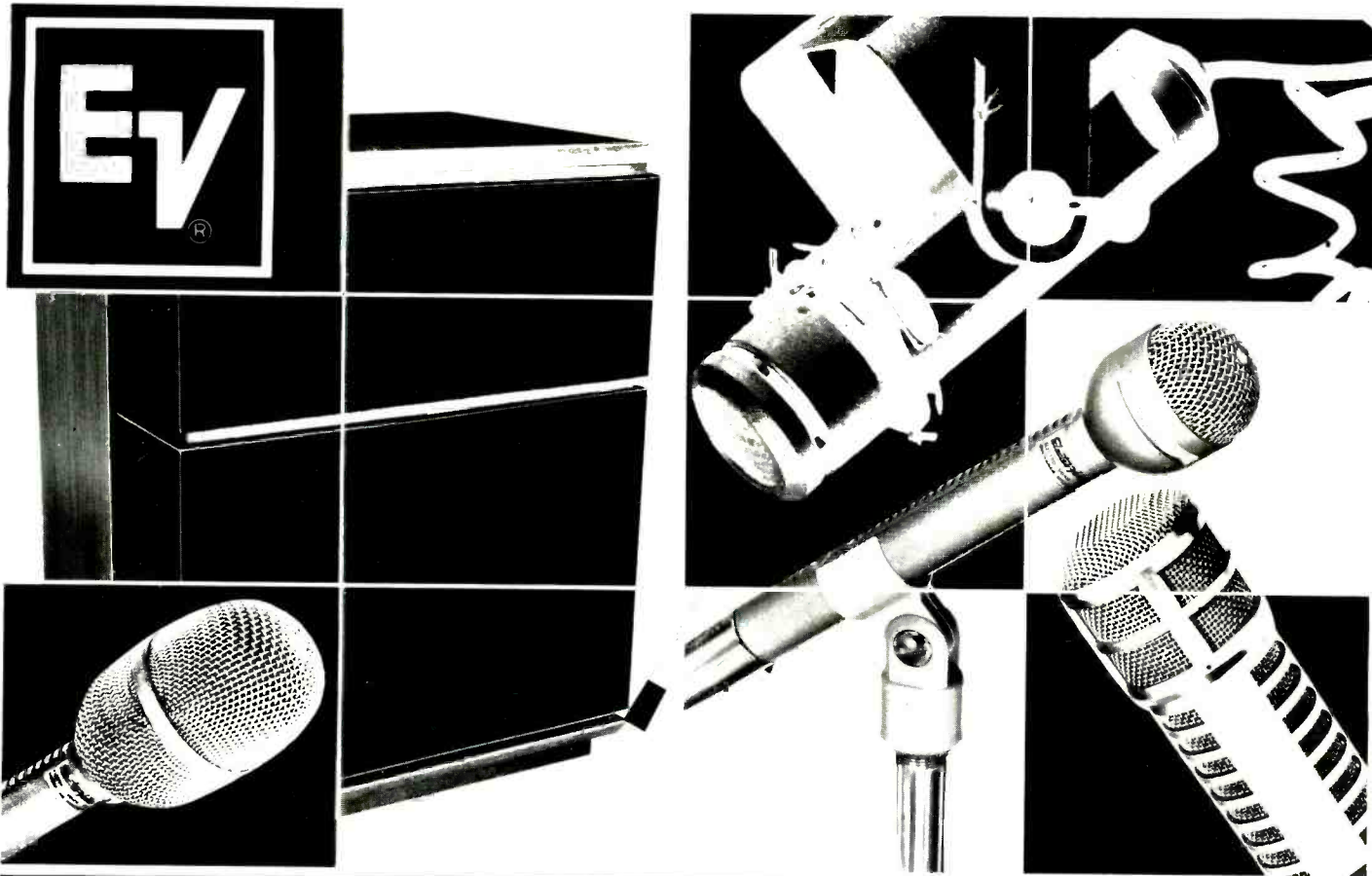

# Professionals speak very highly of our microphones and monitors

**EV** In microphones and monitors  
Electro-Voice leads all the way

What Electro-Voice has to offer by way of microphones and monitors sounds really good. The numerous wireless, TV and recording studios using Electro-Voice microphones and monitors show it.

Where only the best is good enough, Electro-Voice is always there. Be it with studio- or soloist-, omnidirectional-, Single-D-cardioid-, variable-D-cardioid microphones or monitors speakers.

Why not send in the coupon and get detailed particulars? You will immediately realize that every Electro-Voice product is backed up by an outstanding technology, and why professionals always speak so highly of our microphones and monitors.

**PRIMARY DISTRIBUTORS:**

<i>Theatrescene Limited</i>	<i>Satur Electrical</i>	<i>Sound &amp; General</i>
<i>12/13 Henrietta St.,</i>	<i>63 Livingstone Rd.,</i>	<i>59 Dury Street</i>
<i>London WC2.</i>	<i>Sheffield.</i>	<i>Dublin 2.</i>
<i>Tel: 01-240 2116</i>	<i>Tel: 07415 64585</i>	<i>Tel: 711222</i>

## COUPON

Please forward detailed particulars on:

- Electro-Voice microphones*
- Electro-Voice loudspeaker systems*

Name \_\_\_\_\_

Address \_\_\_\_\_  
 \_\_\_\_\_  
 \_\_\_\_\_

Send to: *Electro-Voice Division*  
*Gulton Europe Ltd.*  
*Maple Works*  
*Old Shoreham Road*  
*Hove BN3 7EY*

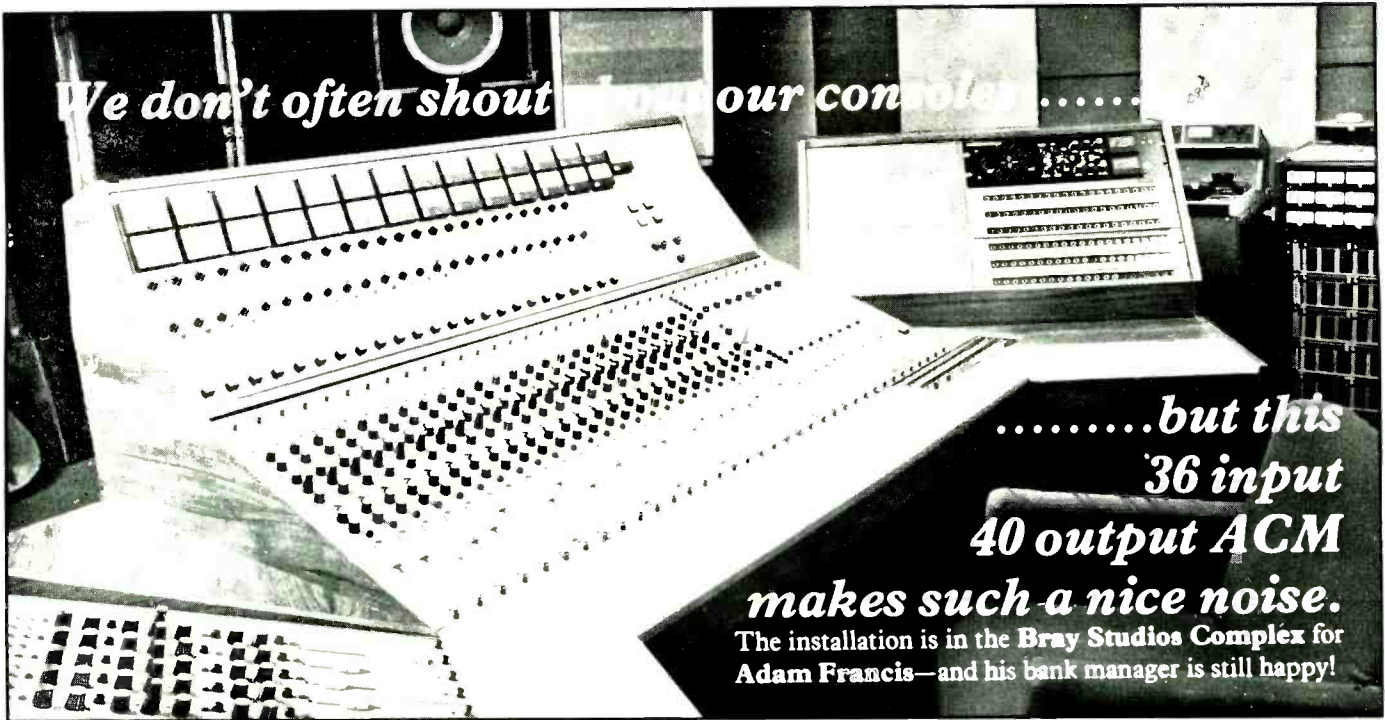

*Alice* (Stancoil Ltd.) makers of distinguished consoles

38 Alexandra Road, Windsor, England Tel: Windsor (075 35)51056 / 7 Telex: 849323 a/b Aegis G

# Studio Compressor-Limiter



A new product designed and developed with care by **Audio Developments – The quality and performance you expect.**

The ADO55 is for rack mounting. The controls on the attractive front panel are clearly laid out and colour-coded for greater simplicity. All the input and output connectors have XLR, DIN and PO Jacks fitted as standard.

The ADO55 Compressor is a dual channel compressor/limiter with a comprehensive range of useful facilities. The two identical systems may be linked for stereo operation.

## Specification

RATIOS 2 3 4 5 1 Lim (20:1)  
 RELEASE TIME Adjustable – 75mS 150mS 300mS 600mS 1.2 sec. 2.4 sec  
 ATTACK TIME Adjustable – 0.25mS 0.5mS 1mS 2mS 4mS 8mS  
 FREQUENCY RESPONSE 1dB 20Hz to 30kHz NO COMPRESSION  
 DISTORTION 0.1% at 1kHz to 10kHz NO COMPRESSION +8dB input  
 MAX. COMPRESSION 25dB  
 MAX. OUTPUT – 19dB at 1kHz + 12dB at 20Hz  
 MAX. INPUT Dependent on the MAX. OUTPUT and MAX. COMPRESSION  
 NOISE Wideband – 68dB Band Limited – 71dB

# Audio



Developments  
 Hall Lane, Walsall Wood  
 WALSALL, W. Midlands, WS9 9AU  
 Telephone: Brownhills 5351/2/3 (STD Code 05433)  
 Telex: 338212 Audio



# could you tell the difference...

If you are a highly trained professional engineer or a producer the answer would be yes, but with response, distortion, wow and flutter comparable to £10,000-plus machines, you would have to be a professional to tell.

If you require a compact, portable, PROFESSIONAL 8 track using 1 inch tape then let us tell you more.

Contact Andy Munro at:-

## Allen and Heath-Brenell

Pembroke House,  
Campsbourne Road,  
Hornsey,  
London, N8

Tel: 01-340 3291 Telex: 267727 BATGRP G

AGENTS: Studio Sound & Music, Frankfurt; Fading, Madrid; Son Professionnel, Paris; Audiomarketing, Stamford, USA; Texim, Milan; Sun Music, Denmark; Intersonic, Stockholm; Pieter Bollen, Holland; Saturn Audio, Canada.

## POWER AMPLIFICATION BY MUSTANG



Our SS.100 and SS.50 are economical amplifiers with outputs of up to 175 and 100 Watts RMS into 4-16 ohms, typical THD figures being 0.1%, slewing rate > 10v/μs, noise > 90dB down, zero level input, and full electronic protection.

Considering these points with their proven reliability and robust construction, plug in output transistors and driver board, optional balanced input and 100V line output, and virtually ex stock despatches we reckon we take some beating! Contact us now for the full technical specifications.

Manufacturers of mixers, integrated mixer amplifiers and slave amplifiers, studio power amplifiers, transformers, lighting control equipment and cabinets for the home and export markets. Contact us for full illustrated technical brochures.

## MUSTANG COMMUNICATIONS

Nelson Street, Scarborough,  
North Yorkshire YO12 7SZ  
England  
Telephone 0723-63298



## Gelf

## ELECTRONIC CROSSOVERS



2 to 5 ways fixed or switchable  
30db per decade roll off  
-80db noise  
0.05% thd.  
balanced 600 ohm or line

## Gelf

ELECTRONICS LTD.,  
UNIT 5 MOUNT AVENUE,  
BLETCHLEY, MILTON KEYNES, MK1. 1LS.  
Telephone Milton Keynes (0908) 77503/647262

supplying studios, schools, the  
broadcasting industry and  
governmental departments –  
carrying a full range of products  
Otari Revox Neal Quad JBL Phase  
Linear Tannoy Teac DBX  
AKG Shure Tascam Beyer and  
Turner Ferrograph Uher.

### Accessories:

XLR Mics Stands spools De Magnetisers  
Splicers Signal Processors Mixers.

## PRO-WORKSHOP AND MOBILE SERVICE FACILITIES

Buy and sell second hand Studio  
Equipment, collections/delivery

now at new premises

THE  
STUDIO  
SHOP  
Oxgate Farm  
Coles Green Rd  
London NW2 7EY  
Ring 01-452 1979

 **studio  
equipment  
services**  
LIMITED

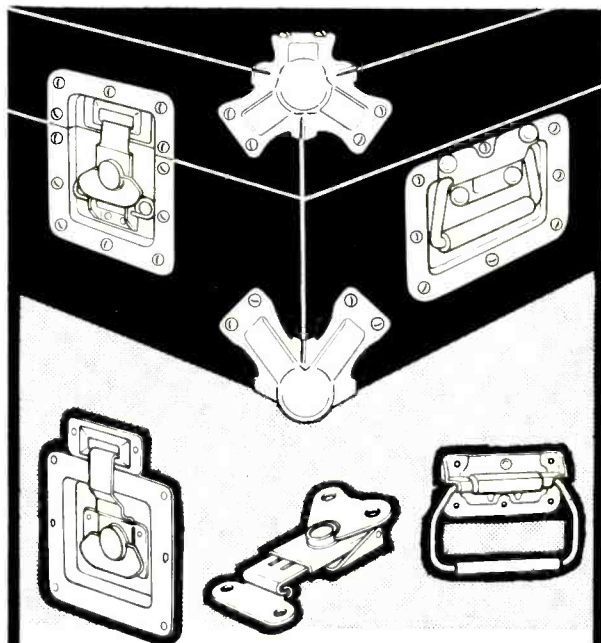

Protex quick-release latches, handles, corner pieces and fasteners are used by some of the world's leading manufacturers because they are just right for the job.

## protex FASTENERS LTD.

Arrow Road, Redditch, Worcs. Tel: Redditch 63231



# You always perform better with the right equipment

With Neal Ferrograph you get the right equipment for the job, and the best in its class. A good formula for success, of which you can be assured every time you choose from the fully - integrated range of specialist recording and ancillary equipment in the NEAL FERROGRAPH range.

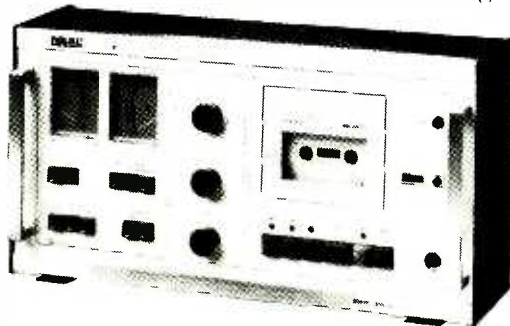

## The NEAL 302.

Incorporating a 3-motor mechanism, controlled by a full solid state logic system actuated by ultra light touch buttons, this is the machine used by top recording studios and broadcasting stations, for quality cassette copies and for in - cassette duplication masters.



## The Ferrograph Logic 7.

A transportable tape recorder of unrivalled facilities; taking all spool sizes up to 27 cm, and providing three speeds, plus positive action push buttons in association with logic circuits . . . for fast, safe tape handling under all conditions.

## Studio 8

A professional studio tape recorder logic controlled for superb tape handling characteristics, offering a choice of stereo, twin track and full or half track mono heads, PPM or VT meters, IEC (CCIR) or NAB equalisation, console or transportable models.

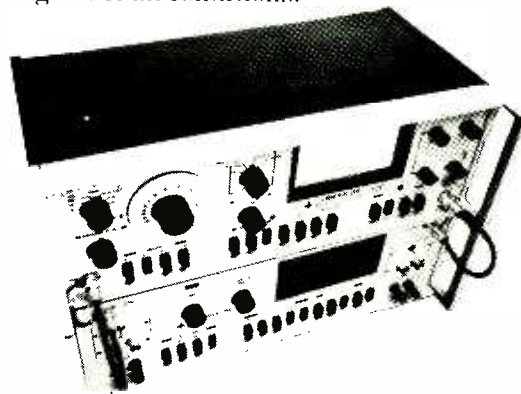
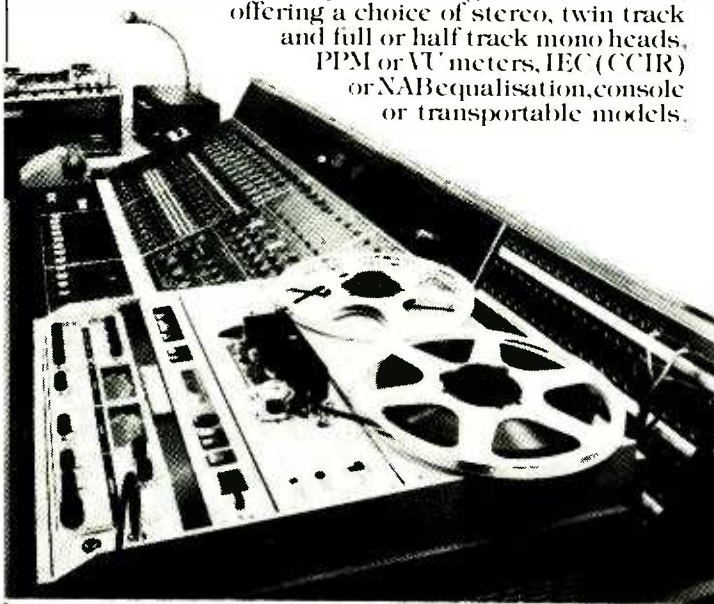

## The RTS 2.

Combines in one easy to use compact instrument the measurement of gain, noise, frequency response, input sensitivity, output power, distortion and the parameters relating to recording equipment, such as wow and flutter, crosstalk, drift and erasure. Its range of application can be extended even further by the addition of the Auxiliary Test Unit **ATU 1**.

**NEAL FERROGRAPH**  
TOTAL TAPE TECHNOLOGY

SIMONSIDE WORKS · SOUTH SHIELDS · TYNE & WEAR NE34 9NX Telephone: SOUTH SHIELDS (0632) 566321 Telex: 537227

**TRAD**

**ELECTRONICS SALES LTD.**

Telephone: Watford 47988  
Specialists in Service and Repair of T.R.D. recorders. All parts, motors, etc., available. Collection and delivery: London and Home Counties. Prices ex-Watford. Delivery extra.

**FOR SALE**

- 1 3M M79 16 track, like new ... **£11,000**
- 1 Scully 280 16 track Acorn Electronics ... **£5,000**
- 1 3M 400 Series 16 track ... **£5,500**
- 1 Ampex MM1100 24 track A/L+U/P ... **£16,000**
- 1 Ampex AG300 4 track Transistor Electronics ... **£650**
- 1 Ampex MM1100 16 track with auto locate ... **£9,750**
- 1 Raindirk 24-8-16 ... **£8,000**
- 1 MCI Custom desk 29-24 ... **£9,500**
- 1 MCI JH114 24TR+16HB+A/L ... **£17,500**
- 1 Spectrasonics 24-24 desk ... **£16,000**
- 1 MCIJH10 24 track ... **£11,000**
- 1 Crown DC300A amp ... **£425**
- 1 Klark Teknik C track ... **£2,000**
- 2AKG C12 valve mics complete and mint ... offers
- 1 Tascam 80-8, D x 8 remote ... **£2,600**
- 2 AKG C12A mics ... offers
- 1 Trident 40-24 desk ... **£17,000**
- 1 Neve 20-16 mixing desk ... **£15,000**
- 1 Sound Technics system 12 18 -18 ... **£3,500**
- 1 Nagra 4L Tr sync head, etc. ... **£1,200**
- 1 MCI JH 440 36 i/o, light metres, analyser, automated mixdown ... **£27,000**
- 2 Cadac Monitors+amps ... **£650**
- 2 Gramplan 6.36 Reverbs, each ... **£60**
- 1 pair Lockwood type cabs with Tannoy 15" reds ... **£300**
- 1 Orban 106 CX reverb as new ... **£275**

Now available new Webber, Laboratory standard test tapes.

1/4"	NAB	15ips	<b>£16</b>
1/2"	NAB	15ips	<b>£22</b>
1"	NAB	15ips	<b>£82</b>
2"	NAB	15ips	<b>£150</b>
2"	NAB	30ips	<b>£160</b>

CCIR and other speeds P.O.A.  
Manufactured in the United Kingdom  
Why pay more! In stock now.

**WANTED—ALL STUDIO EQUIPMENT**  
All prices are exclusive of VAT

**149B ST. ALBANS ROAD  
WATFORD, HERTS.**

Tel. WATFORD 47988 Telex 262741



**Sound International**

**SOUND INTERNATIONAL** forms a link between professional musicmakers and those recording sound. The focus is on news from both sides of the recording fence, providing musicians, studio engineers, and home recordists with a monthly point of reference on the music scene.

The magazine reports the international news of people and events and reviews the latest in recording equipment and musical instruments. Also scheduled are regular articles on technique and problem solving together with behind-the-scenes look at events in the big studios and concerts.

There is no doubt **SOUND INTERNATIONAL** is a lively forum in the world of music and recording. (Available May 1978)

I enclose cheque/International money order, made payable to The Link House Group (Subscriptions) to the value of.....

Name .....

Street .....

City .....

County/State .....

Country/Zip Code.....

**Annual Subscription Rates:** UK £8.20, Overseas \$25.00

To: Subscription Manager, Link House Holdings Ltd., Link House, 25 West Street, Poole, Dorset BH15 1LL. SS 5



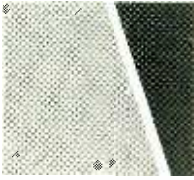

# fact: the 702 stage monitor cuts through!



**Made for you.** The 702 was designed from scratch after a careful analysis of on-stage performance requirements — Shure tested it **on stage**, and Shure refined it **on stage**. Here's what we found:

**You need . . .** Clear, clean sound from your stage monitor without extra bass, and with smooth, high-end dispersion. You must hear yourself . . . above the super-amplified instruments, above the brass.

You want a monitor that cuts through! We've solved the problems, so you hear YOU — no more and no less. Where innovation was necessary, our engineers rose to the challenge. For example, the 702's unique tweeter array with three tweeters mounted in a concave, cross-firing arrangement dramatically

increases high-end dispersion. This array eliminates high frequency beaming commonly found with single and double flush-mounted tweeters. This means more freedom of movement for you on stage.

**You also get . . .**

**Super Intelligibility.** Shaped response — boosted mid-range, controlled bass rolloff. Lets vocals cut through on stage.  
**Super Output.** 114 dB sound pressure level at four feet (1.2 m) with only 50 watts.

**Exceptionally Wide Dispersion.** 90° horizontal, 110° vertical dispersion for broad stage coverage.

**"Roadie" Proof.** 5/8" plywood, corner protectors, rubber feet. Built to last.

**Stage Versatility.** Close-up (30°) or long-throw (60°) set up positions. Great for both roomy and confined stage areas.

**Portability . . . Looks.** All these features in a fine-looking, low profile, and lightweight cabinet.



Unique wide angle concave tweeter array — cuts through on-stage volume, eliminates beaming on axis and muddy sound off axis.



It's compatible with voltage — or current — source amplifiers, and is highly efficient. Handles 50 watts continuous at 16 ohms. The Model 702 Monitor is a necessary part of your act. Put it up front and you'll like what you hear.

702 Frequency Response Curve — with enhanced mid range for outstanding intelligibility

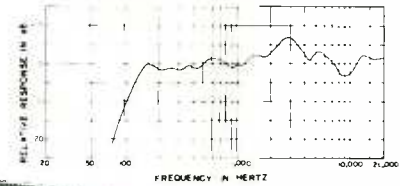

## Shure 702 Monitor Speaker



### Sound of the Professionals.

Shure Electronics Limited, Eccleston Road, Maidstone ME15 6AU—Telephone: Maidstone (0622) 59881

# AMEK M2000- the most purpose-built, versatile, beautiful feeling you can hear for your money..



#### Contact—

UK: Nick Franks and Graham Langley  
AMEK SYSTEMS AND CONTROLS LTD.  
Islington Mill, James St., Salford,  
Lancashire M3 5HN.  
Tel: 061-834 6747 Telex: 668127

Or—Australia:  
Con Psorakis  
AUDIO CONTROLS  
22 Finnis St.,  
North Adelaide.  
Tel: 08-267-4529  
Telex: 88729

Benelux:  
Luc Ardyns  
JUST BORN STUDIOS  
Terlindenstraat 76,  
1790 Hekelgem,  
Belgium.  
Tel: 053-70 50 03

France:  
Francis Linon,  
SOCIÉTÉ CYBORG,  
72 Ave. Lenine,  
Gentilly 94250.  
Tel: 161-657 0812  
161-366 1772

Germany:  
Manfred Brunwey  
RECORD STAR STUDIO,  
Bernstorffstrasse 123,  
D-2000 Hamburg 50.  
Tel: 40-439 7254

USA:  
Brian Cornfield,  
EVERYTHING AUDIO,  
7037 Laurel Canyon Blvd.,  
North Hollywood, Ca. 91605  
Tel: 213-982-6200  
Telex: 651485



# HH S500-D



## The Perfect Power Amplifier for Top Sound Systems....

Since its introduction, the HH S500-D has become established as one of the world's leading power amplifiers. Many prestigious organisations have confirmed the amplifier's unique performance and dependability under tough operating conditions.

The list of users is long and varied but here are a few of interest:

Installers — Scenic Sound Limited, in co-operation with Eastlake Studios (for world-wide recording studio use); Martin Audio Limited (P.A. systems builders); Harold Fielding Limited (Theatrical use); International Sound (Italy); Virgin Record Hire; Dolby Laboratories.

The London Palladium; The Grosvenor House Hotel, London (S500-Ds in the main ballroom); Colac P.A. Hire Co. (S500-Ds on Dr. Hook European tours); The Duane Family (Winners of the Variety Club of Great Britain Award 1977); E.M.I. Publicity Department; Supertramp (U.S.A. and European tours); The Rubettes; Colosseum II; Black Sabbath; Liverpool Express; Simon Townsend Band; Island Records; Gallagher and Lyle; Tangerine Dream; Five Hand Reel; Horslips; The Barron Knights; . . . . . the Admiralty Surface Weapons Establishment (for hush, hush use!)

### POWER CAPABILITY:

500W RMS	-2.5 ohms	900W RMS - 5 ohms Mono
320W + 320W RMS	-4 ohms Stereo	640W RMS - 8 ohms Mono
200W + 200W RMS	-8 ohms Stereo	400W RMS -16 ohms Mono

### TECHNOLOGY AND COST

Professionals are buying the S500-D for two reasons — firstly, the superb performance and advanced technology and secondly, the price which is lower than other less advanced amplifiers of similar power rating.

HH gives unbeatable performance — the best value for money.

### PERFECT POWER FOR YOUR SOUND SYSTEM

Please send me full information on the S500-D

NAME.....

ADDRESS.....

.....  
.....



H.H. Electronic  
Viking Way, Bar Hill, Cambridge CB3 8EL  
Telephone: Crafts Hill (0954) 81140  
Telex: 817515 HH ELEC G

# PICO mixer PLUS

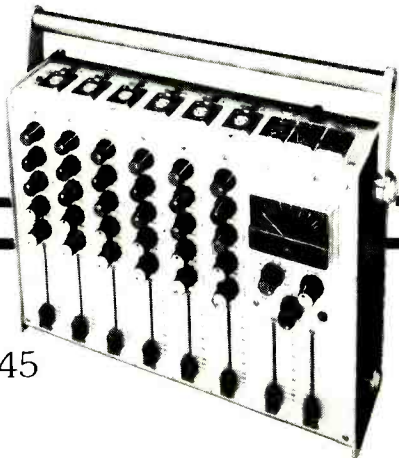

AD 045

Specially developed at the request of Thames Television and other T.V. and film production companies with Extra facilities not available on standard model.

- E Q Bypass switch.
- Phase-change switch.
- Tone Generator.
- Nickel Cadmium batteries to treble times between charges.
- Novel idea of priority p.p.m. (Two peak programme meters in space of one — reads higher of two outputs all the time with indication of left or right.)

## Audio

Developments

Hall Lane, Walsall Wood  
WALSALL, W. Midlands, WS9 9AU  
Telephone: Brownhills 5351/2/3 (STD Code 05433)  
Telex: 338212 Audio

## May we introduce ourselves...

We have been well established as an important domestic Hi Fi and Video supplier for some years and we have now finalised a formidable professional audio section designed to cater for studios and professional users like yourselves.

To give you some idea of the standard we set, look at the company we keep.

We are main agents for:

JBL (we are the only place to have 4343, 4315, 4301, 4380 monitors on dem and available, and a full stock of drive units).  
KEITH MONKS, complete range in stock.  
TEAC & TASCAM · AKG · QUAD · ALICE · REVOX · ALLEN & HEATH · NEAL · BRENNELL.

We also supply:

Bever · DBX · Amcron · Studer · Ruseo  
Master Room · SIS · EMI · EMT · Dolby · MCI · Shure · 3M · Sennheiser · B&W · Orban/Parasound · A&R · Klark · Teknik · Agfa to name but a few.

Pricing:

very, very competitive with (proper) professional discount structure.

Stock:

big and getting bigger for fast delivery times.

Delivery service, demonstration facilities, consultancy service, and account facilities.

As you can see, a large percentage of your equipment requirements (splicing tape to 24tk masters) can be obtained from one source at your normal pricing. We do the running around and paperwork, you just 'phone.

...give us a try, you have nothing to lose, — you could gain a lot!

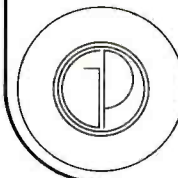

## GRAHAMS PROFESSIONAL

86-88 Pentonville Road, London N1.  
Tel: 01-837 4412 Ext. 66 Telex: 299446

# JP STELLAVOX

RECORDERS AND MIXERS  
IN USE ROUND THE WORLD



Since 1972, David Lewiston has used his Stellavox SP7 to produce for the Nonesuch Explorer Series, 17 stereo records of music from Mexico, Korea, China, Japan, Iran, India, the Himalayas, the Karakorams, Kashmir, Ladakh and Tibet.

HAVE YOU SEEN THE SP8 ?

SOLE UK AGENTS:—

## JOHN PAGE LIMITED

WESLEY HOUSE, 75, WESLEY AVENUE, LONDON, NW10.

☎ 01-961 4181

TELEX: 24224 REF 568



# Reliability in its most compact form the TELEFUNKEN 'magnetophon' 15A Multi-Track: the complete system

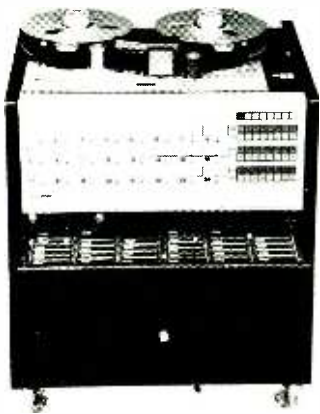

Unprecedented flexibility and operating ease. A system approach to all accessories: a micro-processor based autolocator with 9-position memory and stop timer, remote track selectors and a capstan speed controller with crystal precise digital speed read-out. The TELEFUNKEN M15A multi-track. All in all a totally new generation of master recorders from the inventors of modern tape recording. Up to 32 tracks on 2" tape! 12 1/2" reel diameter capacity. Versions with the TELEFUNKEN "telcom c4" noise reduction system (built-in for up to 24 tracks). Readily upgradable to higher track configurations. Crystal locked 7.5/15 or 15/30 ips tape speeds, NAB/CCIR/AES switchable equalization and clock-timed record/erase functions to permit gap-less, inaudible electronic splicing. It's the recorder for the engineer who wants to pay for performance - not for gadgets: the experienced professional.

Please send me the brochure on  
»magnetophon 15A  
Multi-Track-Systems«

Name \_\_\_\_\_

Address \_\_\_\_\_

Telephone \_\_\_\_\_

**GOTHAM**  
AUDIO CORPORATION

Hayden Laboratories Ltd.  
Curchfield Road  
Chalfont St. Peter, Bucks. SL9 9EW  
Gerrards Cross 88447 (STD 02813)  
U.K.

741 Washington Street  
New York, NY: (212) 741-7411  
1710 N. La Brea Ave.,  
Hollywood, CA: (213) 874-4444  
USA

AEG-TELEFUNKEN  
Magnetbandgeräte  
P.O. Box 2154  
D-7750 Konstanz  
W.-Germany



**professional tape recorders  
by AEG-TELEFUNKEN**

WAK 578 E

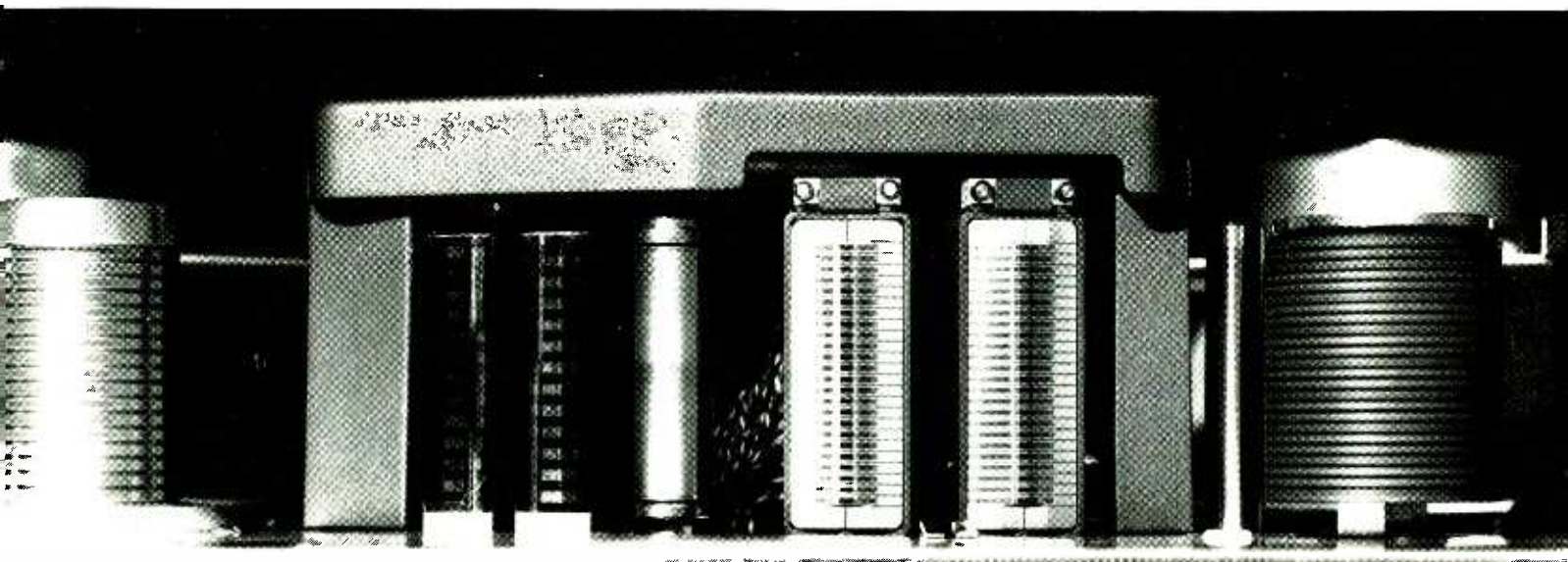

# MACINNES MIXER 18/4

At The AES Hamburg On Stand No. L-8

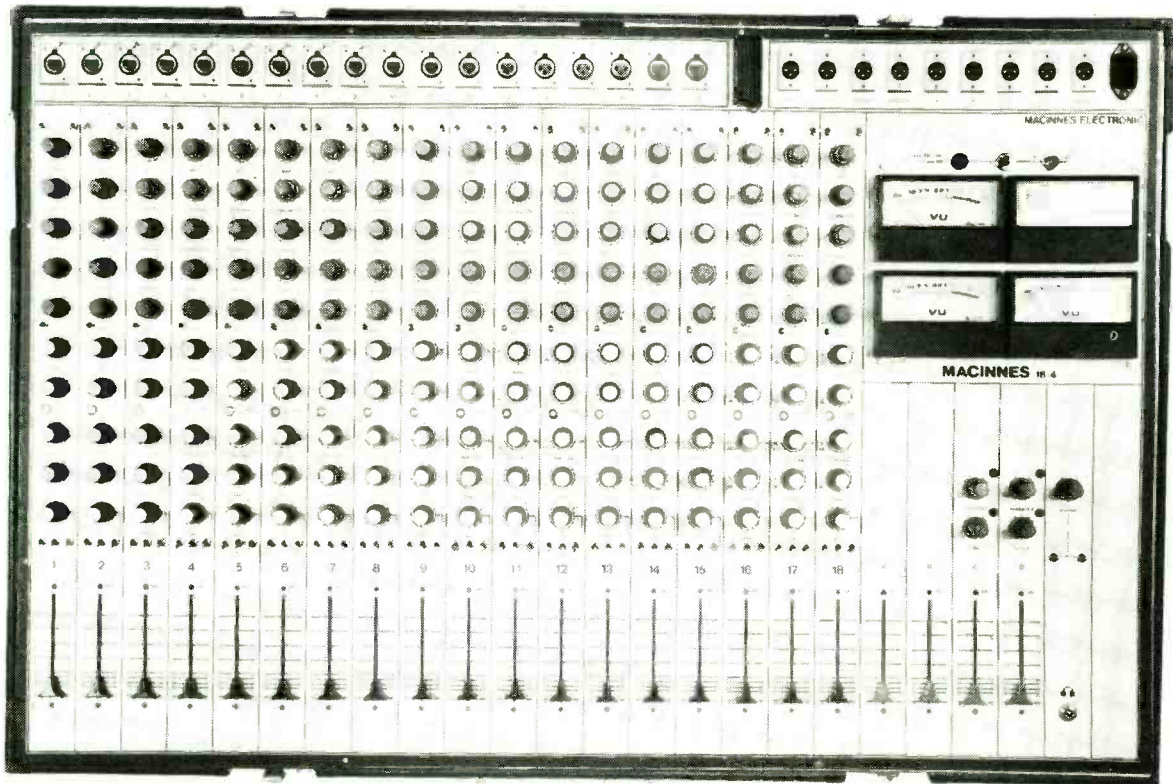

**THE MODERN PORTABLE MIXING  
CONSOLE FOR BANDS, THEATRES,  
MOBILE RECORDING AND CLUBS  
IS THE MACINNES 18/4!**

For Full Details Write or Phone:-

**MACINNES LABORATORIES LIMITED,  
MACINNES HOUSE,  
CARLTON PARK INDUSTRIAL ESTATE,  
SAXMUNDHAM, SUFFOLK IP17 2NL**

TEL:- (0728) 2262 2615

**MACINNES FRANCE,  
18 RUE BOTZARIS,  
75019 PARIS**

TEL:- 206 60 80 et 206 83 61.



# A REALLY PROFESSIONAL MICROPHONE

## THE EAGLE PRO M90 MICROPHONE

A tough cardioid mike for stage use.  
Voice or music. Indoors or out.  
A mike with really good feedback control and an amazing  
40 to 16000 Hz frequency response.  
Three layer windshield. XLR connector.  
Custom-built clip for stand use.  
A mike that will never let you down.



That's why the real professionals use it.

# EAGLE

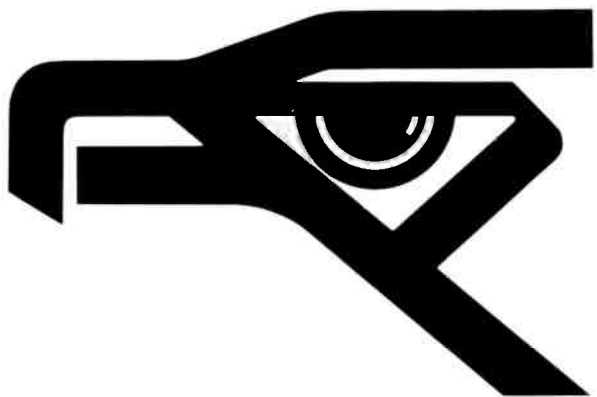

Please send me  
details of all the Eagle mikes,  
mixers, stands and other  
studio equipment.

Name \_\_\_\_\_

Address \_\_\_\_\_  
\_\_\_\_\_  
\_\_\_\_\_

Phone \_\_\_\_\_

## EAGLE INTERNATIONAL

Eagle International Precision Centre, Heather Park Drive.  
Wembley HA0 1SU, Middlesex. Tel: (01) 902 8832

SS1

# news

## A & D da

The new *SO8* distribution amplifier from the *Scamp* range features two inputs switchable to any or all of eight outputs. Each input is protected against over-voltage, and outputs are individually isolated from each other via line amps and are short-circuit protected. Thus a fault on one of the lines will not bring down the others. Furthermore, each output is switchable between balanced and unbalanced operation, and features ultra-low (<1 ohm) impedance for strapping cans or other monitoring facilities anywhere across the line without unduly affecting the signal.

A fine-adjust preset is provided on each input for adjusting the gain by  $\pm 4$  dB. Also a led 'optimum modulation indicator' with peak-sensing, slow-decay characteristics operates at +12 dBm to protect onboard equipment. Monitoring of inputs is by means of two jack sockets wired for use with mono or stereo cans.

The *SO8* is just 25 mm wide, allowing up to 17 units to be fitted in a standard 483 mm *Scamp* rack: a total of 34 inputs and 136 outputs.

Extract from manufacturer's specification:

**Frequency response:** +0, -1 dBm, 20-25k Hz.

**Noise:** less than -100 dB; ref +8 dBm.

**Distortion:** <0.008% at 1 kHz and

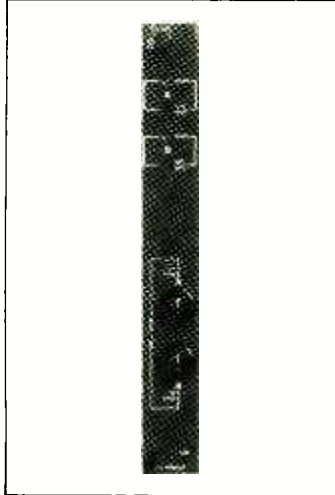

<0.1% at 24 kHz; ref +8 dBm.

**Crosstalk:** -95 dB at 20 Hz, -88 dB at 1 kHz, -68 dB at 10 kHz and -60 dB at 25 kHz (one input open-circuit, the other driven at +8 dBm).

**Clip level:** +24 dBm.

Audio & Design Recording Ltd, St Michael's, Shinfield Road, Reading RG2 9BE, UK.

Phone: Reading (0734) 53411. Telex: 847605.

US: Audio & Design Recording Inc, PO Box 23047, Honolulu, Hawaii 96822.

Phone: (808) 845 7226.

## Af test with self-diagnosis

A test set manufactured by Telecommunications Technology Inc for the measurement of level, frequency, noise and weighted noise is now available in the UK from Wandel and Goltermann. The unit is available in two versions: the battery-powered *1120* which weighs only 6.3 kg; and the mains-powered *1122* for rack-mounting.

An outstanding feature of both units is said to be the built-in microprocessor with on-board memory which, in addition to controlling measurement and transit function, also tests automatically all major instrument components. The results of such tests—which take only 12s—appear in word form on the front-panel alphanumeric display.

A low-distortion oscillator acts

as the signal source, which may either be tuned in two overlapping frequency bands (50-4k Hz and 1-20 kHz), or at predetermined frequencies by means of push buttons. Level, noise and frequency readings are monitored simultaneously on the dual digital display, all range measurements being fully automatic. Level is autoranging from -50 to +10.5 dBm; noise reading from -90 to +10 dBm; and frequency range 50-20k Hz. Once the impedance has been selected, any one of three weighting switches selects both the noise measurement mode and weighting network.

Wandel and Goltermann (UK) Ltd, 40-48 High Street, Acton, London W3.

Phone: (01) 992 6791.

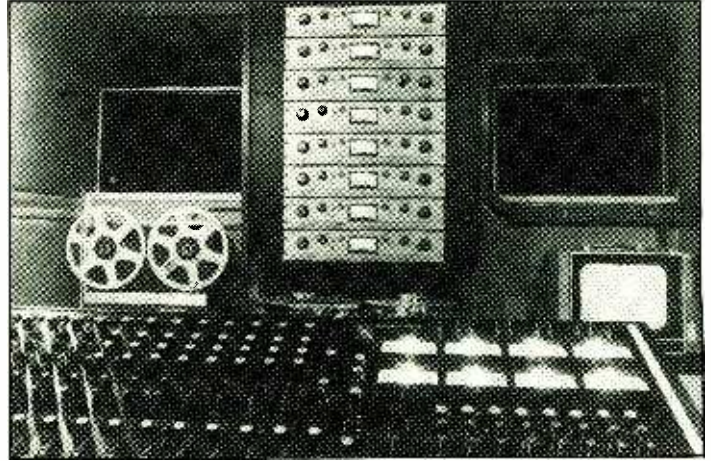

The *Mobile Sound Services' 8-track mobile* is equipped with a *Soundcraft 1618 Series Two desk*, *Scully 8-track on 25.4 cm tape machine* and *Tannoy Devon monitors*. The desk has sweep eq, P & G faders, balanced inputs and outputs and ppm metering. Noise reduction is handled by a M8H rack of *Dolby A*. Outboard equipment includes *Pye compressor-limiters*, *Orban Parasound reverb*, *Allen & Heath adt* and *HJH tape echo*. The mobile is available for hire at £9/hour or £85/day; rates are cheaper for longer hirings. Full details from *MSS Ltd, 33 The Parade, Claygate, Surrey KT10 0PB*. Phone: *Esher 67087* and (01) 734 3356.

## Lavalier mic

Electro-Voice now offers a lavalier tie-clasp microphone, *CO 90*, to full professional specification. It measures just 9.5 mm in diameter by 22 mm long, and comes complete with necktie mount, wind-shield, storage pouch and 180 cm of cable connecting to a belt pack of battery and transformer etc. The quoted frequency range is 40-15k Hz with an output level of -57 dB into a low impedance input. The microphone carries a 2-year guarantee.

Electro-Voice Inc, 600 Cecil Street, Buchanan, Mich 49107, USA.

Phone: (616) 695 6831.

Europe: Electro-Voice SA, Romerstrasse 3, 2560 Nidau, Switzerland. Phone: (032) 516833.

UK: Electro-Voice Division, Gulton Europe Ltd, The Hyde, Brighton BN2 4JU.

Phone: Brighton (0273) 66271.

Telex: 87172.

normal room eq, a graphic equaliser is inserted in the signal chain and adjusted for flattest overall response as shown by the tv bar graph.

The *Visu-Lizer*, pink noise source and microphone cost approximately £600, which doesn't include the equaliser. Naturally, AVAB makes an equaliser suitable for use with the room eq kit.

Tommy Jenving AB, Karl Johansg 98, 41451 Goteborg, Sweden. Phone: 031 124720.

## Cadac board

The board of directors now comprise the following: Adrian Kerridge Chairman; Clive Green Managing Director; Robin Bransbury Director of Engineering; Mike Blackburn Sales Director; and Ira D Gale who has joined the company as Finance and Marketing Director.

32 ►

## Room equalisation

The Swedish company AVAB offers a relatively low-cost room analysis kit which operates in conjunction with a domestic television set. The basis is a 10-octave band real time analyser which produces a bargraph when plugged into the set's aerial socket. It eliminates the need for a dedicated led display. Range is 49-130 dB spl in three calibrated steps.

A separate pink noise generator (supplied with the kit) provides the test signal for the speaker/amplifier combination. As per





# Budget DBX Noise Reduction for the Small Multi-Track Studio

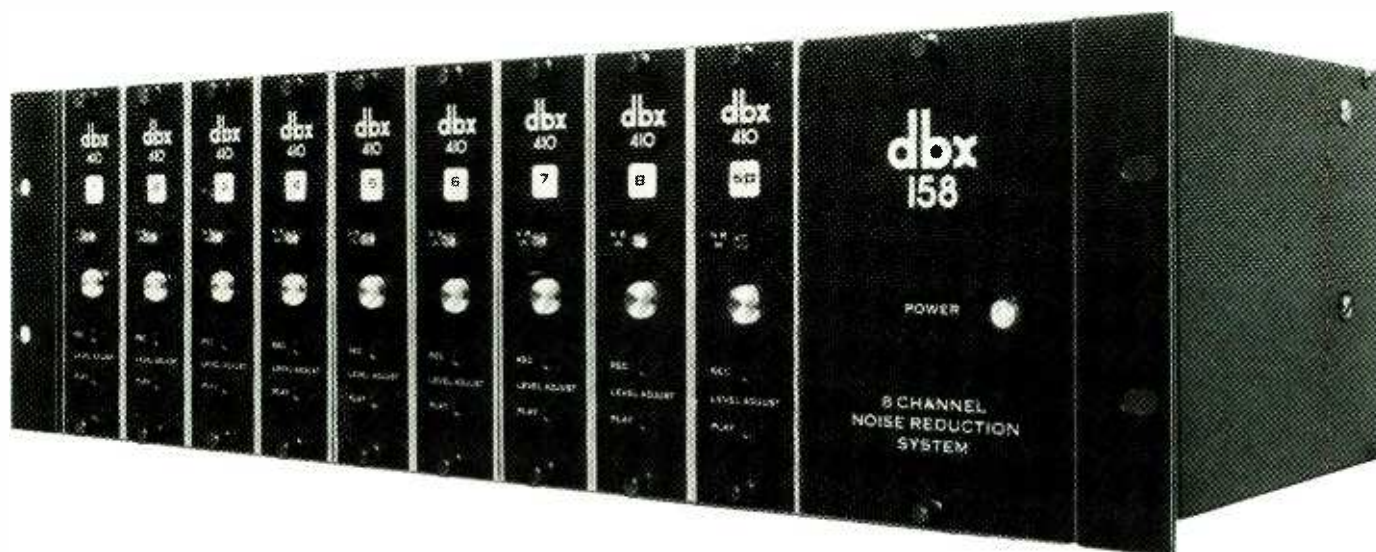

The dbx 158 is a semi-professional version of the well-established dbx professional series of noise reduction units. Recordings made with a dbx 158 may be decoded by any studio using dbx professional equipment.

At a U.K. List Price of **£1485**, the dbx 158 provides 8 tracks of *simultaneous* encode and decode noise reduction, obviating the need for mode switching of noise reduction system by operator or machine.

By reducing tape noise by more than 30db, it significantly increases the multiple overdub capability of any recorder – especially those using  $\frac{1}{2}$ " 8 track recording formats.

dbx's unique and patented circuitry does not require critical matching of encode (record) and decode (play) levels, therefore no reference tones or metering are necessary.

Phono and Molex multi-pin connections allow rapid interface to the unit and modular construction with inclusive spare module ensures minimum downtime in the event of breakdown.

- ★ **Unbeatable 30db noise reduction**
- ★ **Total compatability with dbx professional studio noise reduction equipment**
- ★ **Modular format**
- ★ **Simplicity of operation**

For full details on the dbx 158 or any dbx professional or semi-professional product, please contact



U.K. Distributors  
Scenic Sounds Equipment,  
97-99 Dean Street,  
London W1V 5RA  
Tel: 01-734 2812

Denmark  
Lake Audio APS,  
Artillerivej 40,  
DK-2300 Copenhagen S  
Tel: Copenhagen 570 600

France  
3M France SA, Mincom Div.,  
Boulevard de l'Oise,  
95000 Cergy  
Tel: Paris 749 0275

Holland  
Pieter Bollen Geluidstechnik,  
Hastelweg 6,  
Eindhoven  
Tel: Eindhoven 512 777

Norway  
Audio Trow,  
Tollbugt 7,  
Oslo 1  
Tel: Oslo 417 535

Sweden  
Tal & Ton Musik & Elektronik AB,  
Kungsgatan 5,  
411-19 Gothenburg  
Tel: Cothenburg 130 216

## NEWS

### Didn't they do well

Neve has announced a whole string of orders worth together around £½ million. The orders comprise mainly broadcast sound desks; £180 000 of equipment is destined for Eastern Europe.

The Rumanian tv organisation in Bucharest has ordered four 20-input channel 5305 sound mixing consoles for use in ob vans. Bulgarian Radio has contracted for three 24/16 8058 desks as well as a

couple of smaller mixers for tv use. A similar 8058 desk is to be installed in a Polish 16-track recording studio.

The company has also sold a few more consoles in the UK. HTV has placed an order for two 30-channel desks for its Bristol studios. One is to be used in a brand new film and dubbing theatre in conjunction with a 16-track machine, while the other goes to Studio 5 as part of a re-equipment programme. General sales manager Les Lewis states that HTV is now exclusively equipped with Neve consoles.

Neve 5305 console



### Institute of Broadcast Sound

The newest Institute in the broadcast sound business is run, in the main, by an enthusiastic gentleman named Ron Ferris from his Surrey home. The declared aims (as it says on the application form) are 'to promote the interchange of ideas and techniques associated with sound in broadcasting. To pursue the improvement of the Art and to encourage the maintenance of the highest professional standards. To liaise with other bodies in pursuit of these aims'.

The membership fees for Mr Ferris's Institute of Broadcast Sound are £10 per annum for a full member (registration fee £3 on top) sliding down to £5 for a student member (registration still £3). While this magazine would hate to put the kaibosh on an organisation for which there might be a need, the writing on the wall—or at least in the rather slim but closely written news letter—bodes ill.

News sheet no 2 reads as follows: 'As promised at the Inaugural General Meeting (sic) this second meeting will take place in our second city, Birmingham. . . . Our membership now numbers 140 and applications are still trickling in. A

standard poster for display notice boards will be shortly available (A4 size) but in the meantime, you could be recruiting members . . .' Slightly wistfully, news sheet no 3 reads: 'The Birmingham meeting which took place on December 2 was enjoyed by all those who attended it . . . The executive Committee were a little disappointed by the relatively small attendance of members.'

In a more admonishing tone, it continues: 'When the IBS was founded, the Executive Committee made the point to you all that the Institute would only flourish if you, the members, supported it. Based on the Birmingham meeting, this support is not as firm as it should be.'

Without wishing to be unkind, the birth pangs of the IBS seem rather painful. However, they would appear to be exacerbated by trying to cover the regions in one fell swoop. Whatever the actual need for the IBS, it should heed the proverb which decrees that it's a mistake to run before you can walk.

Potential members wanting more information should contact Ron Ferris at 65 Chertsey Road, Windlesham, Surrey GU20 6HE. Phone: 0276 75553.



The Raindirk Series III console recently installed at Olympic is equipped with 28 input channels, eight group outputs, two remix group outputs and 24-track monitoring. Each dual monitor module contains an echo return section that features a comprehensive equaliser and routing to all the group and monitor circuits. The eight group outputs may be submixed via panpots to the two master remix outputs. In addition, routing to these master remix outputs from each input channel is provided via a routing switch and panpots. The console is finished in Indian laurel veneer and sports a real leather padded armrest (for real leather padded arms maybe?). Tape machines include a 24-track 3M M79 and two Studer mastering machines. Dolby 360 modules handle the noise reduction. Up to 30 musicians can be accommodated in the studio, which measures 15 by 6m by 5.5m high. There is also a large isolation booth.

### SARM damaged by fire

Sound and Recording Mobiles of Osborn Street, London, suffered a serious fire on March 5. The studios, better known as SARM, were extensively damaged not by the fire itself, but by the quantities of water flooding the area by the time the fire was extinguished.

Directors John and Jill Sinclair were understandably shocked by the damage to their studio, now closed for the first time since it opened in July 1973 as the first 24-track studio in the UK.

'Luckily, only two master tapes were damaged, and our tape library wasn't affected,' said Jill, 'but it's been a horrifying experience. The fire didn't spread to the studio, but the smoke density was high—the firemen had to use breathing apparatus—so now almost everything smells of smoke. Although we've baled out most of the water, practically everything that was wet is still damp.' According to brother John the area most affected was the floor, ruining electrical and audio cable installations.

The circumstances surrounding the fire are still something of a mystery. Apparently the main door was left open, presumably by one of the tenants with which SARM share the building. Person or persons unknown, possibly children, then somehow started what was to

be a very expensive fire. An insurance claim has been filed.

'We had planned to completely update the studio in September,' said John, 'and we now hope to bring that programme forward.' Plans include replacing the Trident B desk with a new 40/32 TSM console, and installing two 24-track 3M machines, pulsed together for 46-track operation. Almost all the electrical installation will have to be replaced; also the audio routing, according to damage.

Damage to SARM's collection of ancillary and effects units, reputedly among the most comprehensive in the country, is thought to be negligible. However, in common with all equipment retained in the studio, it will be thoroughly tested before re-use. The refit operation is expected to be completed by late May or early June.

'As you can imagine', Jill told me, 'it's all a bit chaotic at the moment. We're currently channeling client's work to other studios, still using our resident engineer Gary Langen, so it's not the end of the world. Looking on the bright side, we'll have the twin advantages, when we reopen, of a top studio with an established clientele, but refitted with the best equipment currently available.'

Richard Dean





76 LYNTHURST GARDENS,  
LONDON N3. 01 349 1975-6

# Treat yourself!

MODEL 5



80/8

3340 S

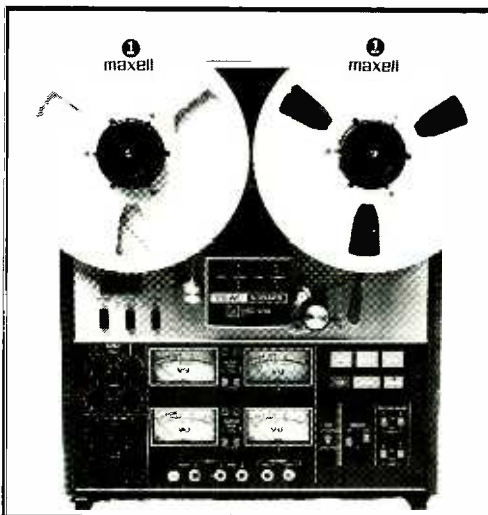

A77

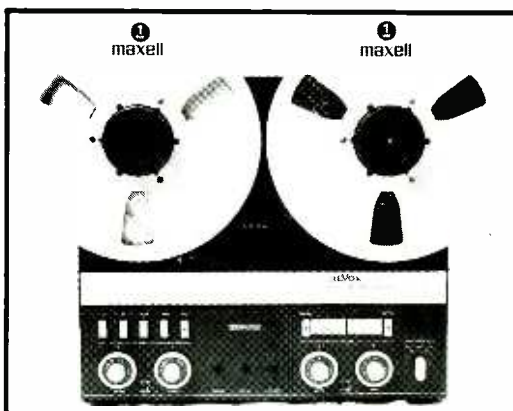

## TEAC MODEL 5

8 into 4. Separate control room and studio mixing facilities. Adaptable control at your fingertips.

## TEAC/TASCAM 80/8

Professional 8 track 1/2" format. Full line up facilities. Easy operation. Incredible value.

## TEAC 3340 S

Superb 4 channel multi-track recorder. Ideal for demos.

## REVOX A77

Ten years' proven reliability. Over 400 versions available.

## REVOX A700

Studio mastering machine.

A700

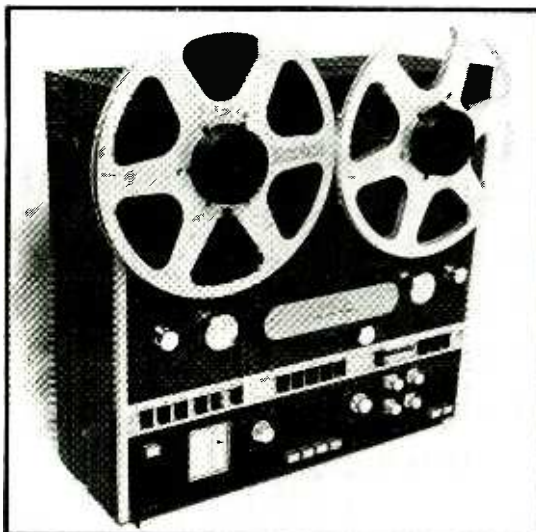

# Sound on stage~engineer's control

Terry Nelson

*The second part of this article deals with the engineer's role in achieving a good live sound. And it appears that even the problems and pitfalls are not yet well-defined. So the answers?*

**C**ONTINUING our discussion on pa it may be an idea to quickly run through the two principal types of installation: namely, sound reinforcement and the sound system.

## Sound reinforcement

As the name implies, this type of setup is used to enhance (or reinforce) existing conditions and may be considered in many cases as a blend between acoustic and electric instruments or sound sources. Obvious applications are theatres and small venues where the main amplification needs are microphones for vocals or speech, playback of prerecorded effects tapes and so on. In the case of a group having amplified instruments, reinforcement can be used to enhance solos or balance out instruments that may be weak in comparison to the others; examples being organ Leslies, percussion and acoustic instruments. Used with discretion, reinforcement is capable of very useful results, often better than those sometimes obtained by 'bunging everything through the pa and hoping for the best!'

## Sound system

This is the principal means of amplification of a group, orchestra or whatever. It is aimed at large venues, open-air concerts, stadiums, etc, and often resembles the setups discussed in the first part of this article published in last month's issue.

We may now start discussing the requirements and utilisation of a

sound system. Obviously, the first requirement is to amplify the artists for their own benefit and the audience's. And it is here that the decision can be taken as to whether a complete pa is necessary, or if reinforcement would be the better solution. Having taken the decision that a complete sound system is required, we need to accept the fact that from this moment the pa forms the other half of the musical entity—it is as important to the instruments as, say, the soundboard is to a piano, or the bell to a trumpet. 'You don't say!', I can hear. But I wonder how many of us really realise the implications of this most important consideration. Before following the well-trodden and familiar paths to amplification a clear and definite appraisal of the requirements is essential. These can be summarised under four main headings:

1. What are the musical and artistic objectives?
2. What sort of venue is envisaged?
3. What resultant sound is required?
4. How much *control* is desired by the musicians over the resultant sound?

It will be immediately evident that what is right for group A will almost certainly not be what is wanted for group B; whereas for group C it will be an amalgam of the requirements for A and B! From this situation we can extract two main courses of action (which in practice may also be a mixture of the two!):

a) A sound system where the ultimate control is in the hands of the engineer. Here the main mixer will be situated at a good vantage point in the audience area. The engineer will be able to hear what the public wants to hear (in theory, anyway) and can balance and tailor the sound to suit. As for the musicians themselves, they are left with the task of just making music and do not need to bother about technicalities.

However . . . the engineer *must* have a thorough knowledge of the programme material and all special effects required: for example, prerecorded tapes, electronic effects, etc. It is also essential that the engineer has a good experience of concert technique. The stage is not a studio and fast reactions to tricky situations are a must. It is not possible to do another take! Evidently, this is not to imply that studio engineers cannot be pa engineers, but rather to point out that only having studio experience is not enough.

b) A sound system where the main control is in the hands of the musicians. Here the musicians can balance and control the sound according to the 'feel' of the music, and not be at the mercy of an engineer who may be unfamiliar with the music or the musician's ideas and who, when in doubt, turns it all up or down as the case may be. Already hearing the rumbles of critical muttering upon this course of action, I would hasten to point out that the idea is not to do engineers out of a job! Obviously for any system they are indispensable: the setting up and design of a sound system requires





knowledge and experience, plus a willingness to reconcile artistic aims with what may at first appear technical impossibilities.

### Criteria for a system

Starting with the first proposition, namely that of engineer control, speaker towers on either side of the stage will be the most likely situation. Most desks have stereo capability and if the decision is taken to use the pa in stereo, it follows that good separation is a must if we are to have an image that means anything. It is also here that the problems start and standard studio practice falls down— isolation booths are just not practicable!

Take the microphones first. The great majority are floor-mounted with no shock isolation. This means pickup from the vibrations coming up the stand, so an initial remedy is to get those microphones 'off the stand' with good isolation mounts—either the ring or web variety. As the drummer is the man liable to need the most microphones, we can start our tour of the sound stage with him.

Most drummers like to be in the centre of the action with the bass player's equipment in close earshot. Which means really close miking—that overhead pair may be great for the guitar and bass but it doesn't add much for the drums. The microphones themselves will need to handle high spls—up to 130 dB—without folding up, and still sound good during the quiet passages. Plus being unidirectional. Physical robustness is also a must. On-stage mics get dropped, thrown, walked on and all types of abuse, so delicate condensers are definitely out! Good 'workhorse' microphones for stage use are units such as the Electro-Voice *RE20* and *RE15*—the *DO54* omni is also excellent for bass drums if you can place it well inside—or Shure *SM58* and *SM57*. The question of which microphone is an important one, and it is well worth the time and trouble to select and try out various models for the different jobs in hand; you might even try reading the manufacturer's specification to give yourself a start.

Now that we have our drum kit miked up, a phasing check is a good idea. Nothing is worse for drums than sloppy mic techniques giving rise to phase interference and other evils. As with all things, it may take a little longer at first but the payoff in sound will be well worth the investment. With a large kit this will mean a lot of microphones so, if the economics permit, a submixer may be a good idea. It will also mean less 'clutter' on the main desk plus subgroup volume control.

Moving on to the instrument amplifiers we very often arrive at a conflict of interests. A lot of rock musicians like to play loud (*too* loud some will say) and don't feel happy if they haven't got two Marshall stacks behind them. This is where a bit of common sense is needed. Nothing appeared more ridiculous to me than the sight last year of one microphone stuck in front of one speaker of Ted Nugent's multiple amp/speaker array. By way of interest, Ted uses four 'beefed up' Fender *Twin 100s* with EV speakers plus four extension cabinets: two 4 x 12 and two 2 x 15, all EV. That, ladies and gentlemen, is loud! It is also what is known as a big sound and one mic stuck in front of a stack like that will just not convey the same impression. Even at large venues, amplification of this kind will be loud enough on its own. And if not reinforce it when (and *only* when) needed through the pa. This is also a prime case for directs, but with the signal taken from the amp's speaker outputs. This way *all* the characteristics of the amplifier are retained and transmitted to the console—with no separation problems!

Mixing all the instrument amplifiers in this way can make no small contribution towards cleaning up the overall sound through the system, leaving the engineer with a lot less open microphones to worry about during silent passages etc, as well as solving phasing problems. The di boxes themselves are often cheaper than the mics. I have used a Courage box for about four years that only cost \$30 and works a treat. It is easily tucked away behind the cabinets (no more stands to knock over!) meaning fewer cables to trail across the stage. However, a musician may want his amp miked up . . . and no discussion. Well, chum, in that case why not think about a smaller amplifier? If your bag is overload characteristics etc, an amp like the Mesa Boogie is the one for you, or any medium amp using master volume controls in the circuitry. All nice and loud where you are, but not enough to worry the other musicians or tickle the fancies too much of all those microphones nearby.

Bass guitar amplification has always been a bit of a problem. Apart from custom-built jobs, it is only recently that there has been

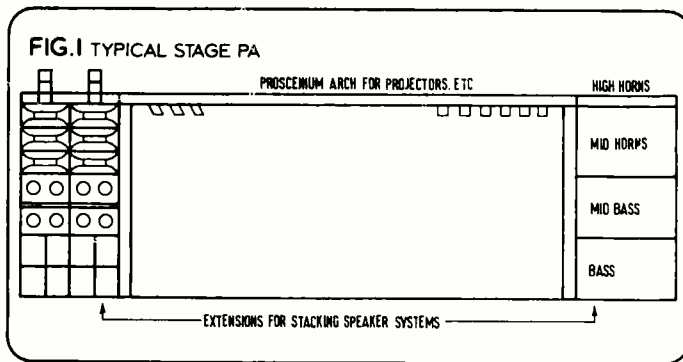

what I would call serious commercial equipment being built. Acoustic were perhaps one of the first to give the lead. Many bass amps use folded-horn cabinets, though a well designed reflex is still a very good proposition. We have also used a Vitavox *Bitone Major* cabinet as part of a bass system with outstanding results. (The player in question used two Electro-Voice *Eliminator* bins, *Bitone* cabinet with EV *FR150* re-entrant horn crossing over at 1100 Hz. This gave a tight, punchy full-range sound, with lots of 'guts' in the bass end without being soggy.) As with guitar, the use of direct boxes will give a far more positive result as far as mixing is concerned, keeping the sound tight and more pronounced.

The keyboardist has risen from being a pianist trying vainly to make himself heard, to the multikeyboard performer of today. As such he/she needs special attention. I feel the best approach is to feed all of the keyboards into an onstage submixer, enabling the artist to balance his instruments himself as required. For the money-conscious, people such as Acoustic and Peavey have brought out keyboard mixers or control centres designed specially for the job. Synthesists might also want to check out the new Moog *SynAmp* which features a whole host of goodies. It is most important that a keyboard mixer be designed and capable for the job—tarted-up mic mixers are just not on. The mixer should then feed the main consoles and the performer's own monitor system, which should be power amplifiers and speaker system capable of correctly reproducing the instruments. *Minimoogs* through guitar amplifiers can sound rather strange.

Even with modern phasers, flangers, etc, most organists feel that their Hammond without its Leslies is like fish without chips. And accepting this we have a problem on our hands. Miking up a Leslie to make it sound right is no mean feat. One solution is to put the cabinet(s) in at least a fairly soundproof room offstage with a *good* omnidirectional microphone and feed it through the pa and monitor; the sound is much more life-like than with top and bottom mics. The organist, however, says: 'No go. I like to see the rotors turning', or 'I want it onstage'. As with many things in life, this is a case of making a compromise—here we are back to the top and bottom mics again. Still, now armed with shock mounts and cardioid mics, place them at the back of the cabinet (the side facing backstage—he wants to see the horns, remember?) and try angling them so that the sound passes *across* and not into the microphone. (Where there is a high risk of spurious pickup it is probably better to 'stick 'em inside'.) In this way we can often reduce the characteristic swishing of the rotors; a little bit of experimentation can work wonders. This is especially exaggerated at chorale speed into a deep slow tremulant and any attempt to smooth it out is well worth it. Also, *please* take care when balancing the two microphones: it is all too easy for the treble horn to cover the bass, especially when the organ is in ensemble with other instruments. In passing it may be mentioned that, where possible, a mixture of onstage and offstage Leslies can also give pleasing effects. In this way a simulation of several organ chests is possible—try a ddl on the offstage cabinet.

The remaining microphones will be for acoustic instrument and vocal use. Stiffing the cries of 'Oh no, not *more* on mic technique!', I will content myself with a few observations. (You ought to know your mics anyway.) As we noted earlier, use the right mics for the job and even take time out to correct bad technique on the part of the musicians. For instance, tell the trumpeter politely but firmly to play a bit off-axis and not ram the mic inside the bell—explaining

## SOUND ON STAGE—ENGINEER'S CONTROL

the problems to the musicians will nearly always help things along and make for better sound. A 'them and us' attitude does nobody any good. Where possible, Barcus-Berrys or FRAPs are best for acoustic guitar in order to get a good clean sound at a high level. The same goes for piano, though you could also try the Countryman or Helpinstill pickups. Each one has its merits and vices so once again, try . . . I have already mentioned that the microphone needs to be robust, and for vocal use this really *is* a must. (Ever seen Roger Daltrey?) One of the strongest mics ever made must be the Electro-Voice *RE15*; you could play baseball with it and sing during the runs. Both EV and Shure make units specially designed for stage work, from both the performance and strength angle, and at reasonable prices. The Shure *545* and *SM58* are very popular and for those on a budget, check out the EV *671* model or *DS35*.

Enough has been written on the subject of mixing consoles that it would be superfluous to spend much time on it here. It is worth noting one or two points, however. Make sure the desk will do all you want it to, both now and in the fairly near future—or at least has provision for expansion in accordance with ideas. A concert engineer has enough on his hands without griping about the desk. I like a switchable pfl with meter on all of the inputs and groups. Then if the overload led has collapsed (or there isn't one) you can find out where that distortion is coming from, either when setting up or during performance. This facility obviously has a host of other uses that most engineers will recognise. Rather than make up a specification for a desk we will refer to features as they arise during this article. I could mention, however, that the desk be completely 'roadie proof'—yes, they do get dropped down flights of stairs or off the truck, and when the show is in five hours time you don't want to have to service your console.

Possibly the biggest source of problems of most pa setups is the speaker installation. In spite of all that has been written or said we still see untidy piles of bass and mid bins, radial horns side by side etc, etc (fig. 4). The components sit horizontally on top of one another (fig. 2) with the sound winging its way straight to the back of the hall. And coming straight back again! We should all know that the best way to arrange our tower is to build up and not out (fig. 3 and 5). In this way the bass bins form a nice *solid* airtight wall, effectively extending down the bass response, which is especially useful for outdoor use. (Manufacturers please note: no protruding handles please.) These are followed by the mid bins, if any, then the radial horns and tweeters; all with the drivers nicely in line. Where high stacking is not always possible, one solution is shown in fig. 5. Here, for example, 60° radial horns are stacked vertically and side by side but angled so that interference is kept at a minimum. Once again a little thought can save an awful lot of hassle. Manufacturers' specification are there for a purpose so why not read them and work out your system on paper before humping. In fig. 3a you may also notice that the horns are angled down to give selective coverage and make use of all that absorbent material present to kill those first reflections—in most cases the audience! Fig. 3b shows a variation on 3a where the stacks are divided in half, one section sat on the stage and the second suspended quite high up. This can be quite effective in arena-shaped halls (Yes used pretty much this setup for the Hallendstadion at Zurich) where the stage equipment effectively covers the central area, while the suspended array caters for the tiered seats. But it's all very well talking about high towers—how do you get it up there? For the T Nelson non-patent-applied-for solution see fig. 1. Having noticed a trend for touring groups to carry around their own proscenium arch for lighting and stage props, it seems to me that an extension on either side capable of handling pulleys and hoists should present no real problem. Access ladders can be built into the main vertical pillars.

At this point it may be a good idea to consider the question of stereo or mono. If a stereo effect is required, and we have been able to arrive at a good separation, why not? I have found that in general many sound engineers prefer to work in mono, leaving stereo capability for special effects and drums. Another point to consider is that in large auditoriums, people to the extreme left hear only the left stacks and vice versa. (And they have all paid for their tickets.) Angling and high stacking will compensate to a certain extent, but in the end the decision is best left to the engineer at each venue. 38

FIG. 2 'SLAPBACK ECHO' FROM LOW SPEAKER STACKING

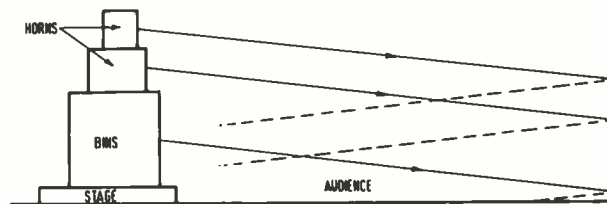

FIG. 3 HIGH STACKING AND ANGLING (AUDIENCE PROVIDES ABSORPTION)

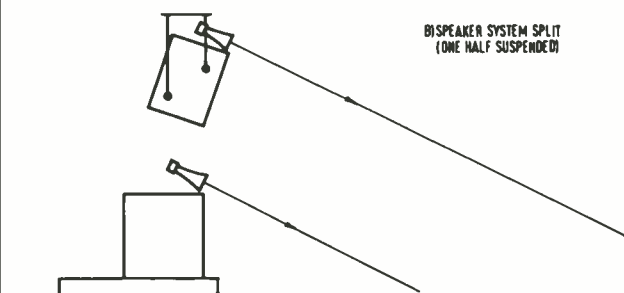
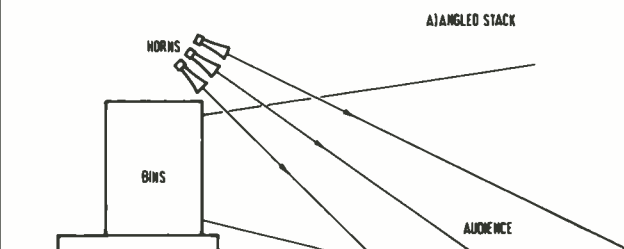

FIG. 4 STACKING SPEAKERS

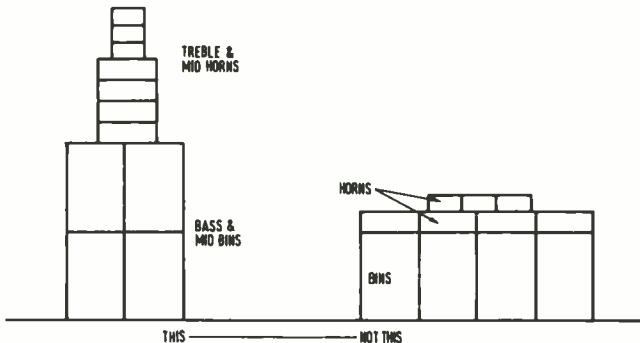
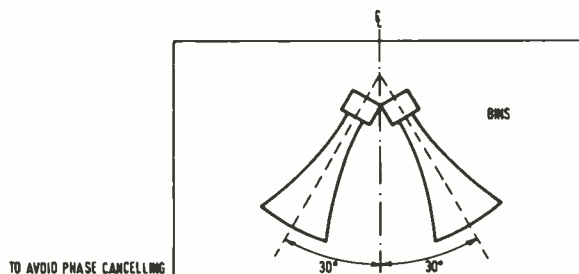
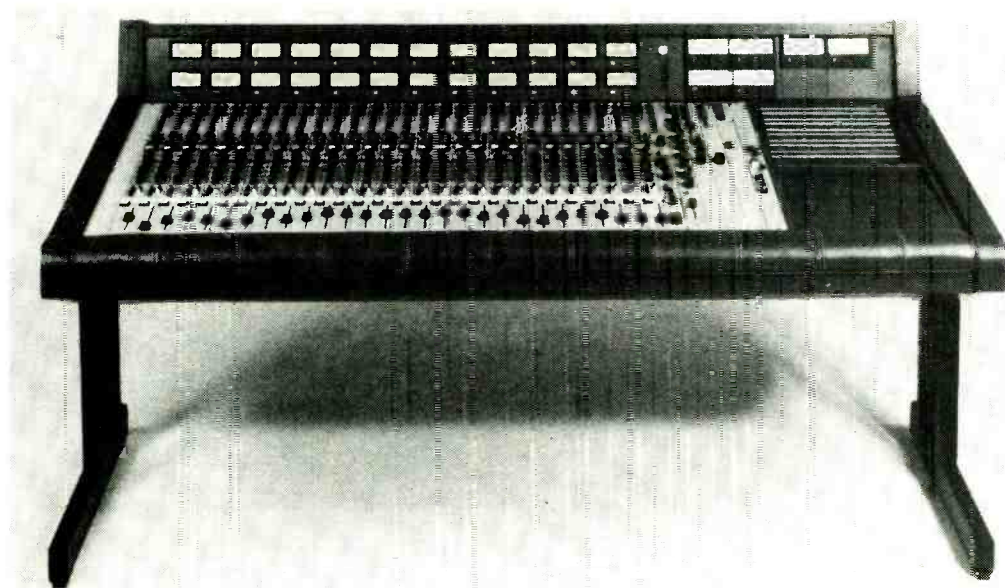

FIG. 5 STACKING RADIAL HORNS







**JH-400B-28-VU**

# THE CHAMPIONS

**A recent Billboard survey of studio equipment confirmed that MCI is now the Number One manufacturer of consoles in the U.S.A.**

**MCI JH-400 Series and MCI JH-500 Series are now the recognized standard of the industry.**

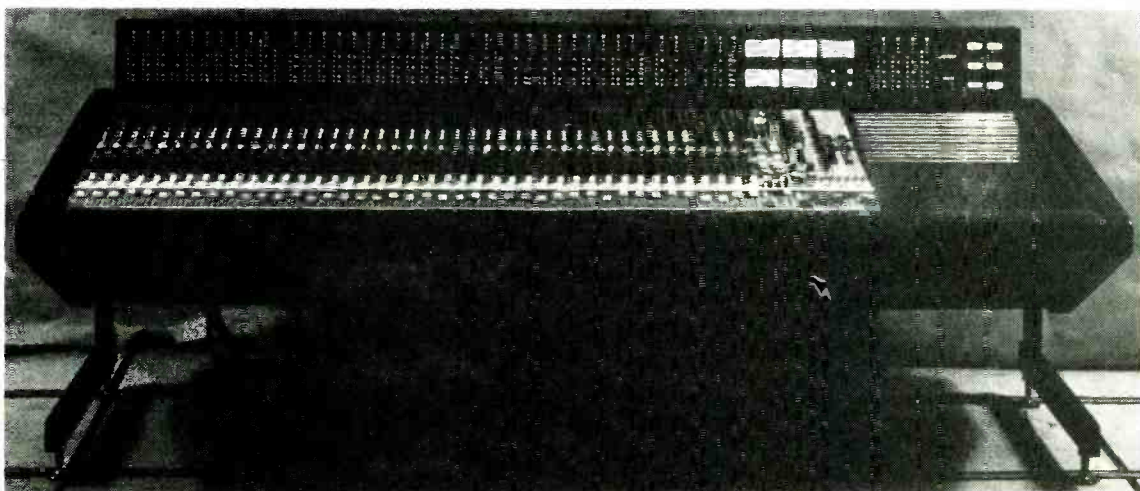

**JH-500-42-LM**



**MCI (PROFESSIONAL STUDIO EQUIPMENT) LTD.  
MCI House, 54-56 Stanhope Street,  
London NW1 3EX. Tel: 01-388 7867/8. Tx: 261116**

## SOUND ON STAGE—ENGINEER'S CONTROL

(In other words, when doing your sound check, have a toddle around the hall in order to hear what the punters are going to hear.) Before going on, I would just say a word on active crossovers. No one needs to extol the virtues of bi or tri or even quad-amping: we all know the tremendous difference it makes and why. However, make sure the crossover does the job with the *minimum* of phase shift—no point in correctly setting up your speakers if the crossover is going to louse it up!

Another general rule seems to be that, mono or stereo, all the signals go through all of the speaker system together, as if it were some giant hi-fi. This is fine if you are listening to a record, but a concert is a *live* performance. To digress for a moment, when listening to an orchestra or group without a pa you can hear each instrument separately and distinctly plus spatial placement. Buzz it through the pa and what happens? intermodulation distortion, phasing problems; you name it, you got it. Obviously the first thing to do is place your mics properly, check for phasing etc. Fine. Having done all that why not emphasise your good work by splitting the stacks. With at least four output groups on the desk you can route the vocals through 1 and 2 and each half of each stack, and the instruments through 3 and 4 and the remaining stacks. Yes, you've got it—separate amplifier systems for vocals and instruments. And did you notice the improved clarity and depth plus apparent increase in volume? Of course, you could go even further and separate the keyboards from the guitars and so on. Now we're getting towards that 'live' sound that I was hinting at: clean, defined, separated etc. By the way, this is not just daydreaming. I've tried it and does it work! With today's 8 and 16+ output consoles this kind of installation presents no real problem—costs you a bit in active crossovers, perhaps—and the potential is enormous. The moment the main stacks are separated down to sub-systems, each handling an individual instrument(s)—vocals, guitar, keyboards, brass etc.—'live' sound really starts becoming a reality. Don't worry about losing power—three instruments each through a good 100W amplifier will sound a lot louder and bigger than all three through one 300W unit. If by now you've got a nagging feeling that somehow all this seems familiar, but you just can't quite put your finger on it, may I suggest the pipe organ? In many ways I feel the analogy between a sound system and pipe organ is quite interesting; we have the manuals (musicians), stops (mixer), and pipe chests (speaker banks for each voice or instrument). And we all know the thrilling sound of a large organ with all the stops out—not forgetting its *dynamic range*. There is also another factor to consider—organs are designed to perform well in large environments, exactly the same criteria for our sound system.

### Monitor systems

One of the prerequisite conditions for a good performance is that the musicians must be able to hear exactly what is going on within the group. Most of us will support a fairly poor sound if the band is really cooking, but be let down by a poor performance, even if the sound is excellent. As has been already stated in previous articles in *STUDIO SOUND*, the idea is to put foldback where and when it is wanted. Where a monitor mixer is available, this means as many outputs as there are musicians. Or groups of musicians such as three brass or vocal groups. Although individual mixes are possible, nearly everyone has different ideas as to what makes a good monitor mix. The stage acoustics should be analysed for feedback-prone peaks and the system equalised—as should, ideally, keyboard monitor systems and even the other instruments. This can be done either by graphics or notch filters, depending upon the economics. The speakers themselves should be designed for the job, being not too large and with a tailored response for the bass and treble end. Too much bass just muddies everything and there's nothing worse than screeching high trebles.

There is a good case here for amp/speaker combination cabinets, complete with tone and volume controls. In the heat of the action it is useful to be able to tweak the volume up or down oneself, rather than have to catch the monitor engineer's attention. (I use a Quad 303J with an EVM bass unit and 8HD/1829 horn/driver in my own cabinet with very good results. I would suggest, however,

that when using mid-range horns for monitor systems to crossover between 1100 and 1500 Hz in order to reduce the 'honk' of being near the horn; an attenuator is also useful.) Where possible the cabinets should be placed in the nulls of the microphones to minimise pickup. One way to 'free up' the monitor signals, and one favoured by musicians, is for the instrument amplifiers to have an extension cabinet on the other side of the stage. The advantage is that it can fit in with the general line of cabinets facing front (and not back as perhaps with a monitor) and contributes to the sound. I have often used my monitor in this way and find it more agreeable to play with the sound coming from behind rather than split front and back.

The monitor system is really one area where everyone should chip in with their ideas and problems. Time should be spent finding the best speaker placement points and balance. Where no monitor mixer is available, the main console should have at least four foldback sends per input; it is gratifying to see that large desks have up to eight auxiliaries. (Perhaps as a result of pa?) I have always thought console manufacturers to have been a bit tardy on this point of multiple foldbacks and am glad to see this being rectified.

The other form of monitoring is foldback for the groups. There are quite a few musicians who like to balance themselves by second nature and who like to hear what is going out from the auditorium speakers. Foldback from groups is the answer, though this does need some care. It is also a good idea to have talkback switchable to either each foldback or all together. This way general instructions can be given or individual 'get your fingers out!' Some new desks, including the Soundcraft *Series 1.5*, feature interface with *ClearCom* or compatible intercom systems that are now widely used at concerts. This kind of facility is well worth having. On a final note, using stage backcloths of sound absorbent material (such as blankets) can work wonders for onstage reverberation.

### Studio equipment for pa

The increasing use of studio equipment in sound systems means that we are virtually obliged to take a mobile studio around with us; a brief look at what this entails may be useful. Space and portability is an important consideration and equipment of the *Scamp* or Allison variety comes in very handy. A good roadie-proof rack is the order of the day, complete with patchbay. Compressor-limiters are finding an increasing use for vocal work. The problem of noise from open mics or hiss and hum from amplifiers via direct inputs can be attacked with dynamic noise filters; drums, especially, can benefit from this form of treatment. Digital delay is useful, either for studio effects such as flanging or adt, or compensating for time delays where speakers are placed in the hall away from the stage area. Phasers, Flangers and other forms of time delay equipment all have their place for special effects, as do equalisers for signals needing special processing.

Hall equalisation is accomplished by  $\frac{1}{3}$ -octave analysers (real time is best) and graphics. It may also be noted for large halls and venue it is better to give a house curve with a 3 dB per octave rolloff (reverberant field equalisation) above 1 kHz—a flat response will nearly always be far too bright. This done, another pair of test equipment—your ears—can be used for the final adjustments. (Such as, perhaps, a little bit of presence for vocals and a bit of 10 kHz boost for the cymbals). If a lot of power amps are to be slaved together the final link in the chain will be the distribution amplifiers eliminating any loading effects.

It can be seen that the putting together of a sound system requires a lot of planning and hard work—and expense—but the results gained will be well worth it. Established groups promote record sales with good concerts, either to existing fans or to create new ones; new groups can certainly create a demand for records if their concert performances create a stir. Poor concerts do nobody any good, least of all the tour promoters and record companies. What of the future? The next likely step will be automation and for those with plenty of money the new Harrison *Auto-Set* system is worthy of interest. For complicated mix changes—or in a multigroup festival situation—this piece of equipment would be very useful to have.

I hope I have given you some food for thought in the interests of better sound and look forward to hearing the results! The third part of this article will deal with the second proposition for sound systems. It will look at the pa systems of some well-known groups and how they accord with their artistic objectives. ■



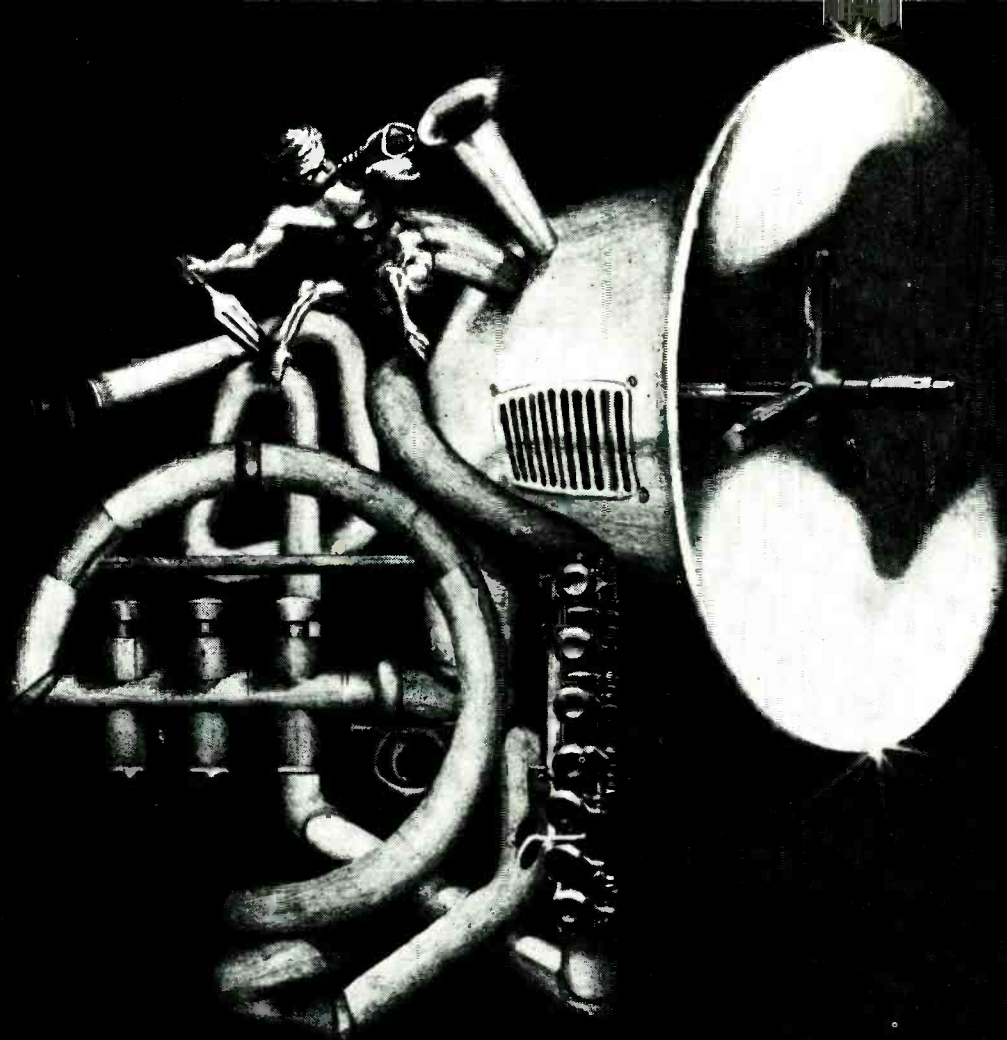

## We Capture ANY Sound!

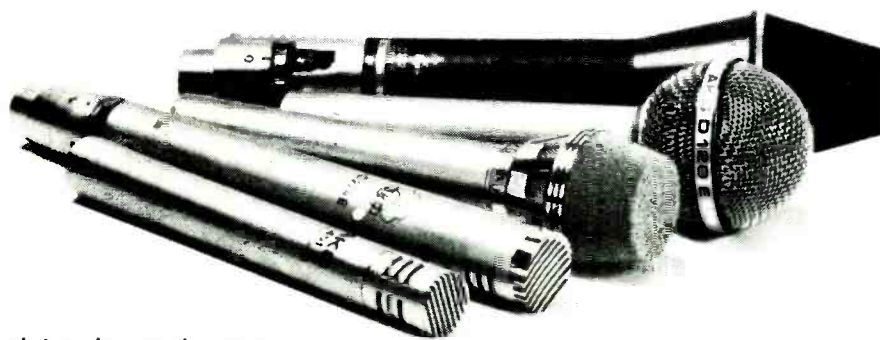

### AKG—the right microphone for every application

The cheering of the spectators at the Olympic Games. The roaring of a formula 1 racing car. The singing of the greatest singers in the world. The capturing of those precious moments in family life, on tape. Wherever crystal clear reproducing or recording is required you will find AKG, for every application there is a specially designed AKG microphone. However high your quality requirements may be — AKG can exceed them.



Please send me by return, informations about 

- sound reinforcement     studio microphones  
 musicians microphones     headphones

Name \_\_\_\_\_

Address \_\_\_\_\_

Country \_\_\_\_\_

Please recommend the best mic for my particular application

ADV 188/E

182/4 Campden Hill Road Kensington **AKG ACOUSTICS Ltd.** London W8 7AS Tel. 01-229-3695, 01-727-0788

# AES 59th Convention, Hamburg a photo report

Mel Lambert



A warm round of applause please for the organisers of the 59th AES Convention, which was held from February 28 to March 3 at the Plaza Hotel, Hamburg. Both the exhibition and technical sessions ran as smooth as clockwork, and a liberal supply of a most excellent German beer was on hand at all times. What more could you ask?

Without a doubt the star of the exhibition was the new Studer *A800* multitrack, which features micro-processor control of the transport functions and can handle 360 mm reels. Speed of operation is quite staggering; the machine will cycle from fast wind to play in well under a second, without passing through stop. (The transport monitors the tape's speed as it slows down and selects play at the appropriate point.)

An improved replay signal-to-noise ratio is claimed, mainly because the pre-amplifiers are now located under the headblock. The time needed for routine machine line-up and re-adjustment following a change of tape has been reduced by incorporating a master bias control for each speed, which adjusts all the tracks at the same time.

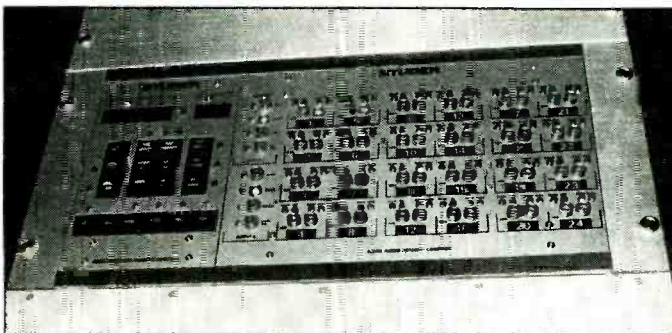

Individual remote control is provided for the deck and audio electronics. The two outputs per track can be switched for all tracks simultaneously between input/sync/repro/individual control on output 1, and input/repro/sync/line out on output 2. A master safe/ready switch controls all tracks (presently only 16 or 24 on 50.4 mm tape).

The remote control unit (bottom picture) duplicates the master switching between outputs 1 and 2, and controls the mode of individual tracks. Because of the *A800's* micro-processor control, it can be readily interfaced with the *TLS 2000* tape synchronisation system. An auto-locator is a standard feature, combined with a 66-150% varispeed.

However, you won't be able to buy one until early next year. Price? Nothing has been finalised yet, but we hear that it should be round about £30k for a 24-track version.

But the Studer *A800* wasn't the only interesting exhibit to be seen at Hamburg. The next four pages are devoted to a double-page spread of some nice-looking mixers, followed by a two-page 'pot pourri' of odds and ends that attracted our attention.

42 ►



# Broadcasting Helios

Télémetropole (known generally as Channel 10) is the largest French-language commercial broadcasting company in Canada. In common with Mainos TV, Finland, and Capital Radio, London, they have recently opened a studio for multitrack music recording and mixing, and for re-mixing of audio tracks for 'sweetening' of video tape sound. Each station operates a Helios console, custom built to it's own technical/ergonomic requirements.

A new Helios console is the outcome of an in-depth study of each client's requirements. The latest and best circuit designs and advanced production engineering methods are employed, to achieve the most cost-effective solution to the operational requirements. Only Helios specialise in custom building - only through the Helios approach can you be sure that all your requirements are fully met.

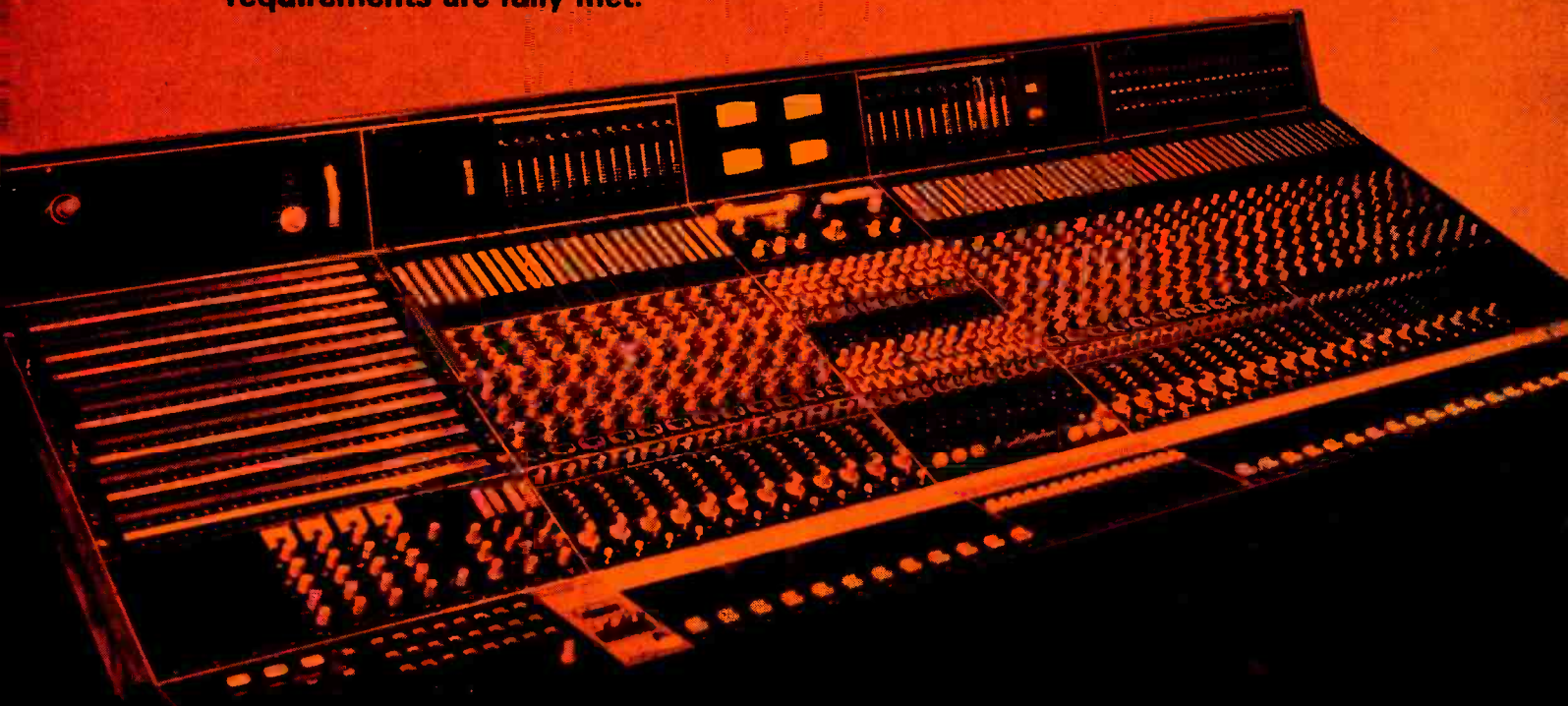

The Télémetropole console is shown in the background of this advertisement and has 32 input channels each with parametric equalisers, 16 output groups, 24 track monitoring, and many other features including a Helios-built noise reduction interface. For further details of this desk or any other information, please write or telephone to any of the addresses below detailing your requirements.

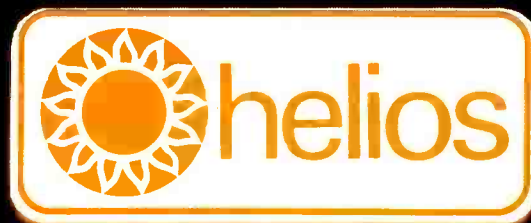

**Helios Electronics Ltd., Browells Lane, Feltham, Middlesex TW13 7ER, England.**

**Telephone No. 01-890 0087. Telex No. 8814265**

**INTERNATIONAL SALES AND SERVICE REPRESENTATIVES**

**U.S.A.**  
EVERYTHING AUDIO  
7037 Laurel Canyon Blvd.,  
North Hollywood, California 91605  
Telephone No. (213) 982-6200  
Telex No. 651485

**SCANDINAVIA**  
SIV.ING.BENUM A/S,  
Boks 2493,  
Sollvi, Oslo 2, Norway.  
Telephone No. (02)565753

**CANADA**  
RADIO SERVICE INC.  
2500 Bates Road,  
Montreal, Canada H3S 1A6,  
Telephone No. (514) 342-4503  
Telex No. 055-60070





## AES Report

1. A Midas 24-input console with six sub-group outputs and monitor channels. Direct outputs are provided on each channel for multitrack recording. Routing is by means of two thumbwheel switches in conjunction with a pan control. This particular desk is destined for a customer in Spain.

2. Neve brought along a custom-built 40-input quad-output disc-cutting console ordered for the new CBS-Sony recording complex in Tokyo. The desk is equipped with Necam automated mixdown. Inputs can be switched between mic and line level for direct-to-disc or multitrack-to-disc mixdown. The total value of the CBS-Sony deal, which also includes two consoles without Necam, is worth a reported £250k.

3. The Schlumberger PMA124 microprocessor-based 'premixer' can memorise up to 15 sets of routing and level information for 12 input and four output channels. Discrete changes between one particular mix and another are available at the touch of a key. Sequences can be set up and then recorded on

cassettes for use at a later date. The crt facilitates visual checking of the memorised data.

4. Surprise of the show, console-wise, was this new computer-assisted desk from Solid State Logic. Two floppy disc stores handle the fader automation. The desk on show, which is destined for Country Lane Studios, Munich, featured 32 'ordinary' vcas, eight subgrouping vcas and a master control. The desk is also equipped with a central crt that displays track details (title, duration etc) as well as labelling take numbers on the multitrack tape.

5. Allen and Heath were exhibiting for the first time in Europe the new Syncon 'synergetic' console. The model on show was of a 24/24/24 configuration with quad mixdown, and is destined for Decibel Studios, London. Free-subgrouping in the record and mixdown modes, without upsetting normal channel operation, is a feature of the Syncon's routing system.

6. MCI were demonstrating a JH-400 Series console fitted with the JH-50 automation package. Mixdown data from the vca channel faders is recorded on two tracks of a multitrack tape (one mix per

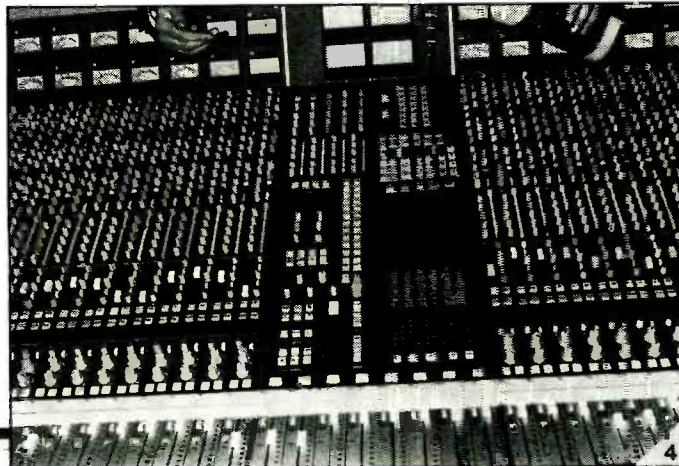



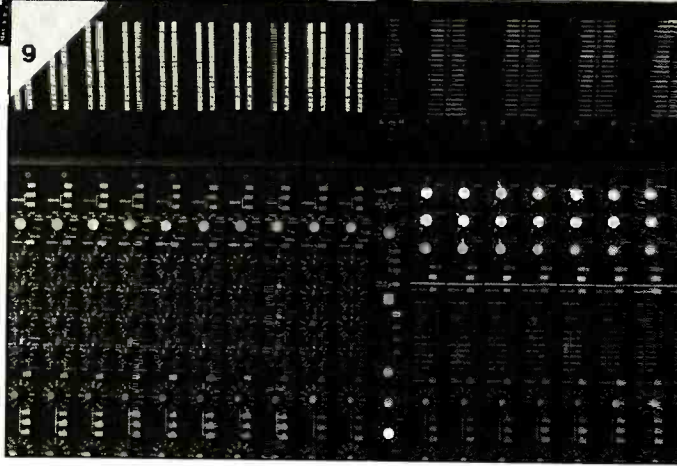
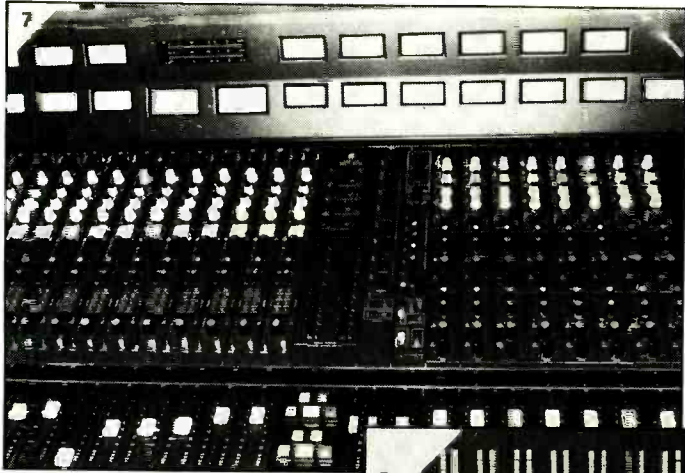

track). If you need to record more mixes, the company suggests that the multitrack be linked via the JH-45 synchroniser to one of the new JH-110A-8 eight-track machines. That way you can record seven more mix attempts (you need one track for the SMPTE code) and also have a spare 8-track on hand for other odd jobs.

7. The Series III desk on the Rainbird stand features 26 input channels with direct out on each, eight mix-down outputs and 24-track monitoring. Six auxiliary buses and eight effect returns, each with equalisation, are also provided.

8. Helios were showing a broadcast console designed for Mainos TV in Finland. A free-grouping facility allows any or all of the 30 input channels to be put under the control of another channel designated as submaster. The submasters in turn can be re-grouped onto two main outputs.

9. Scundcraft were showing a 24-input/16-output Series Three modular console, which is available with a maximum configuration of 32/16 with 24-track interface. Special facilities include auto-solo on inputs, groups and auxiliary sends, and optional 20-segment led metering.



The company tells us it is currently selling 80-odd mixers a month, worth a total of about £100k.

10. Trident were showing an odd-sized 24-input / 16-output / 16-monitor version from the very attractive TSM Series. The largest configuration available is 40/24/32. Half-width group output faders and tandem-banked monitor modules keep the overall size to 'reasonable' proportions.

11. Amek brought along a 28-input / 16-output / 28-monitor version of their M2000 Series. Four stereo subgroups are provided for routing during mixdown. We hear that the first of the new M3000 Series consoles has been ordered by Amazon Studios, Liverpool.

12. Macinnes were showing their new 18/4 portable mixer and its associated stage box. The two are linked with a new multiway cable manufactured by Macinnes. Cables with up to 35 individually-screened pairs can be supplied. The glass-fibre case is laminated with balsa wood for added strength without excessive weight, and has reinforced corners. A rubber seal is fitted between the two halves of the case to keep out moisture.

44 ▶



12



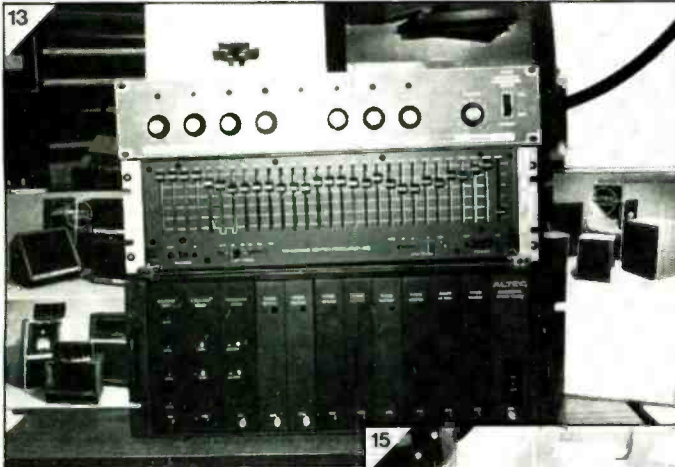

## AES Report

**13.** Among the products on the Altec stand, we came across the new 1650  $\frac{1}{3}$ -octave equaliser with variable-frequency high and lowpass filters. Also on show was a new modular 'incremental' power amplifier system. This contains up to eight 75W power amps that can be used independently, in a parallel or bridge mode, or in a combined parallel/bridged configuration.

**14.** The Teac Tascam 90-16 16-track, 25.4 mm tape machine features full logic interlock of transport controls plus motion sensing. The panel housing the output and function select buttons can be removed from the machine and mounted on a console. An optional dbx noise-reduction package within the cabinet automatically selects encode or decode according to track mode.

**15.** Calrec had laid on a very interesting demonstration of the new Soundfield microphone. It consisted of a B-format recording of an acoustic guitar and vocalist. Visitors to the stand could adjust controls on the playback 'decoder' and tilt the angle between the (virtual) 'coincident-pair', change the char-



acteristics of the microphone between omnidirectional, cardioid, hypercardioid and figure-of-eight and alter the stereo 'width' from mono through stereo to 'stereoplus'. Other modules in the decoder, still under development, will allow the same degree of control on quadrasonic material.

**16.** A 'brace' of new XT24 Interlocators on the AudioKinetics stand. The combined autolocator and remote control can be used with a 3M M79, Studer A80 or Ampex MM-1200 and 'learns' the behaviour of the transport over the whole tape—not just between two locations. Four memories are included, and the unit can be set to cycle once or recycle between these positions.

**17.** Sescom had a wide selection of its products on show, including the SB-1 stereo balance box, which contains two input transformers for balancing and impedance matching and two adjustable line amps with output transformers; the LS-1 line-level splitter box, which provides up to four balanced and isolated outputs from one unbalanced input; and the OB-1 stereo output balancer.

**18.** Brenell were showing the Mini-8 eight-track, 25.4 mm tape machine complete with the presently-available remote control unit

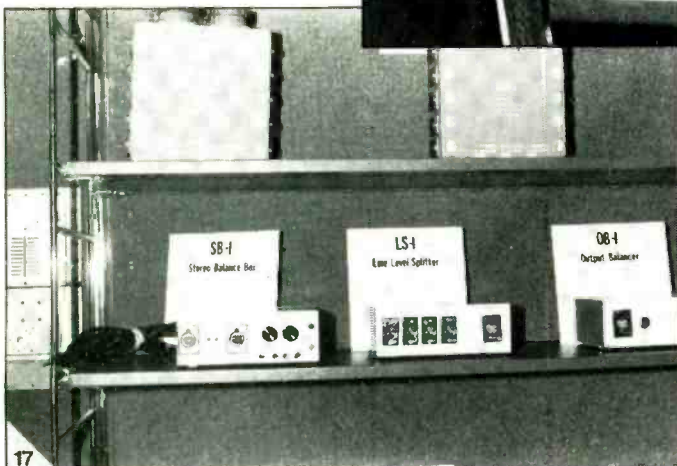



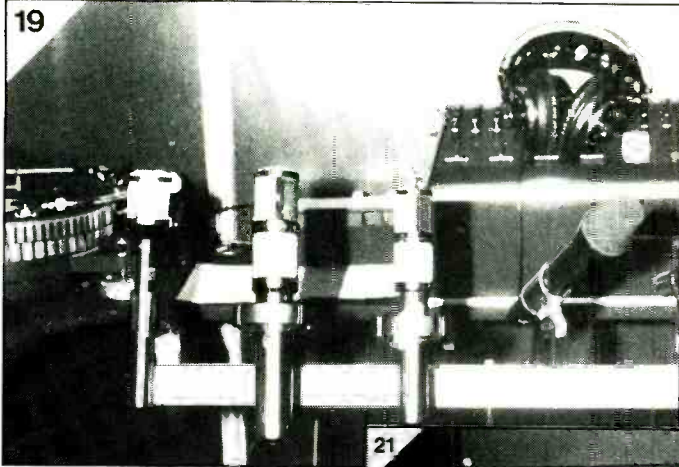

(left) and a prototype of an improved version (right).

19. AKG were showing four new microphones. From left to right: the CK4 capsule from the CMS range with fixed figure-of-eight polar response; the coincidence-pair C422, a remote-controllable successor to the C24 in solid-state form and with led indication of phase angles; the C34, a smaller brother to the C422 and based on capsules from the CMS range; and the D222, a successor to the well-known D202.

20. The keyboard and display unit of the new Harrison 864 Auto-Set, on show for the first time in Europe. Two distinct modes of operation are featured: fader automation via, for example, an Allison programmer, offering four mixes/track onto the multitrack tape; and the recording onto a data cart of up to 630 preset static mixes. The position of as many as 63 faders can be memorised on each static mix.

21. Klark-Teknik were exhibiting not one but two of the new DN70 digital time processors. It incorporates three separate delay lines (the range of which can be individually adjusted between 0 and 633 ms) plus a mix and regeneration controls. Individual outputs of the delay lines are provided, plus a

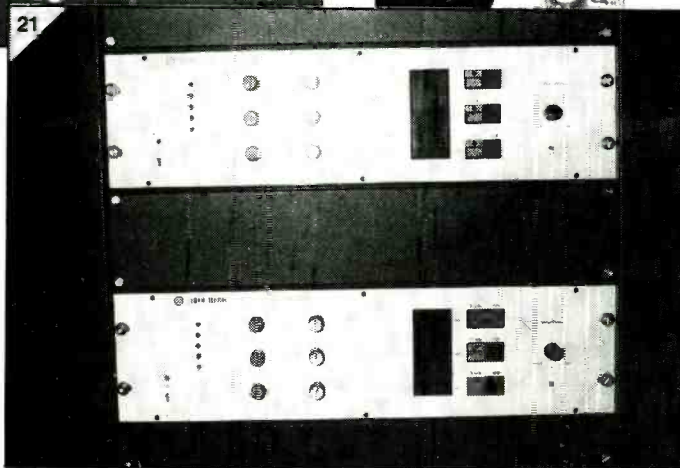

mixed output. A 50 kHz clocking speed is said to maintain frequency response up to 15 kHz.

22. Pride of place on the Audio Developments' stand was the new Pro Graphic programmable graphic equaliser. The unit will memorise 16 sets of equalisation comprising up to 14 dB cut and boost on 16 equally-spaced centres between 20 Hz and 20 kHz.

23. Ivie brought along their entire range of sound analysers. From left to right: the IE-15A distortion analyser accessory; the IE-10A octave band analyser and spl meter; and the IE-30A 1/3-octave or octave band analyser and spl meter. Above the IE-30A is the new IE-2CB pink and white noise generator.

24. The optional, more comprehensive remote control for the Lyrec TR532 24-track tape machine. Each track has individual controls for ready, safe, line, sync, replay and solo. Sixteen memories are included, and the transport can be made to shuttle between combinations of a memory location, the present tape position, or the keyboard setting. Lyrec were also showing a prototype of a new tape synchronisation system for use with SMPTE or Mag-Link coding. The system will comprise two independent subsystems for coarse and fine control.

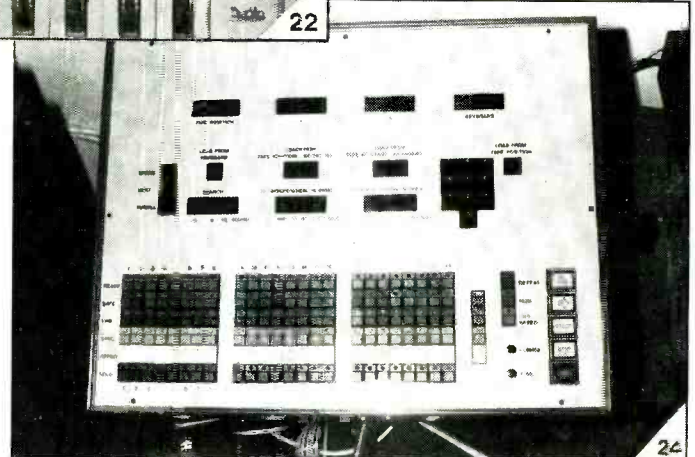
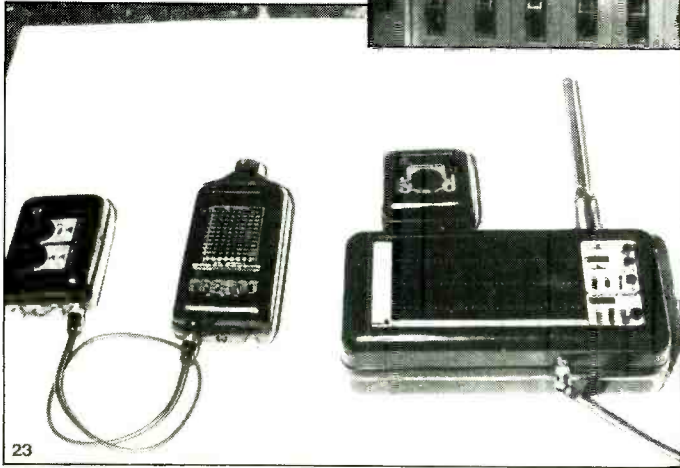

# 11th INTERNATIONAL EXHIBITION OF PROFESSIONAL RECORDING EQUIPMENT LONDON

**Dates of Exhibition.** Wed. June 21st — 10.00 hours to 18.00 hrs  
 Thurs. June 22nd — 9.00 „ „ 18.00 hrs  
 Fri. June 23rd — 9.00 „ „ 17.00 hrs

**CONNAUGHT ROOMS . GREAT QUEEN ST . KINGSWAY . LONDON WC2**

Amek  
 \*Allen & Heath/Brenell  
 \*Audio Kinetics  
 \*Agfa-Gevaert  
 \*Allotrope/Future Film  
 \*AKG  
 \*Audix  
 \*Audio & Design  
 \*Amity Shroeder  
 \*Ampex  
 Avcom  
 Acoustic Research  
 \*Audio Developments  
 \*Alice  
 Billboard Publications  
 "Beat Instrumental"  
 Broadcast Audio  
 \*Bauch  
 \*BASF  
 B & K Labs  
 Beyer Dynamics  
 \*Cadac  
 \*Calrec  
 \*Cetec  
 \*Dolby Labs  
 Eardley Electronics  
 \*EMI Tape  
 Electro-Voice  
 \*Formula Sound  
 \*Feldon  
 Harmon Audio

Hammond  
 \*Helios  
 \*Hayden Labs  
 \*H/H  
 ICM Cassette  
 \*ITA  
 "International Musician"  
 \*Jacques Levy  
 \*Jackson Recording  
 John Page  
 James Yorke  
 \*Klark-Teknik  
 \*Keith Monks  
 \*Lennard Developments  
 \*Leevers-Rich  
 Lee Engineering  
 Libra Electronics  
 Lyrec  
 \*Lockwood  
 "Music Week"  
 \*Mosses & Mitchell  
 \*MCI  
 Magnetic Tape  
 3M  
 \*Midas  
 Maglink  
 \*Macinnes Labs  
 National Panasonic  
 \*NEAL-Ferroglyph  
 \*Pyrat  
 Philip Drake

Penny & Giles  
 Professional Tape Marketing  
 \*Publison  
 Recortec  
 \*Rupert Neve  
 \*Rugby Automation  
 \*Racal-Zonal  
 Roger Squires  
 Rockwool  
 \*Raindirk  
 \*Radford  
 \*Solid State Logic  
 \*Soundex  
 \*Shure  
 "Studio Sound"  
 Surrey Electronics  
 Superscope  
 \*Soundcraft  
 Sifam  
 \*Scenic Sounds  
 Turnkey  
 Tannoy  
 \*Trident  
 Trad  
 Turner Elec. Indus.  
 \*Tweed Audio  
 Tandberg  
 \*Vitavox  
 Walter Luther  
 Webland

FREE TICKETS FROM

**APRS**

23 CHESTNUT AVENUE  
 CHORLEYWOOD HERTS  
 ENGLAND

EXHIBITORS AT TIME OF GOING TO PRESS

\*APRS MEMBERS



NOV. 77

# BESTOP

- |        |   |         |   |         |   |
|--------|---|---------|---|---------|---|
| 1(-)*  | <b>LOVE YOU LIVE</b><br>Rolling Stones - Rolling Stones | 17(33)* | <b>EVEN IN THE QUIETEST MOMENTS</b><br>Supertramp - A & M | 35(40)* | <b>DERRINGER LIVE</b><br>Rick Derringer - Bluesky |
| 2(1)   | <b>ON STAGE</b><br>Rainbow - Oyster                     |         | <b>BOSTON</b><br>Boston -                                 | 36(47)* | <b>OVERNIGHT</b>                                  |
| 3(3)   | <b>LIVE</b><br>Status Quo - Vertigo                     | 18(37)* |   |         |   |
| 4(12)* | <b>MADE IN EUROPE</b><br>Deep Purple - Purple           | 19(19)  |   |         |   |
| 5(5)   | <b>HOTEL</b>  |         |   |         |   |

*Bragging is not our business, but which other mobile studio records the top 4 albums in the European charts?*

*We feel we have the best.... with our 2x3m 24 track machines, Helios 32/24 desk, Maglink, Dolbys, Altec monitors, Lexicon Digital & 58 mike lines with Actively Isolated Splits....*

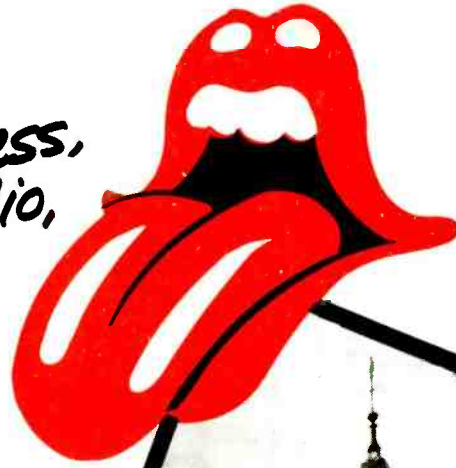

**The Rolling Stones Mobile Studio :-**  
 2 Munro Terrace, London SW10 0DL  
 Try calling Ian Stewart or Ellen on 01-352 0005

# Doing it for effect...the noise-gate

Len Lewis

*The modern day studio control room is likely to house any number of different pieces of auxiliary processing gear. Yet the noise-gate (or low level noise expander/gate—to give it its full name) is often sadly lacking in this, a field where it pre-dates just about all others. Although its uses are many, varied and quite unique the noise-gate is still frequently cast as poor relation to the latter day noise reduction systems which it fathered.*

**I**N 1926 a Russian born singer Asa Yoelson (Al Jolson) appeared in a short talking picture entitled 'April Showers', followed in 1927 by 'The Jazz Singer', the first feature film with synchronised speech as well as music and sound effects. The picture revolutionised the motion picture industry and, lucky for us, signalled the end of the 'silent' era.

The arrival of optical film track, which made the new development possible, immediately stimulated interest in developing techniques for making the best use of the strictly limited dynamic range available. One of the first such techniques was—the noise-gate! Optical film recording techniques involved the transcription of varying impulses of sound waves into varying impulses of light, photographed on a film strip. After development the film, when passed between a light source and photoelectric cell in the projector, was transformed back into the 'original' sound. The snag in the system was that with no signal present clear film passed over the cell complete with dust, marks, scratches et al and gave rise to crackles and pops in silent passages. To counter this, early Thirties' recording

cameras appeared on the scene with noise reducing shutters or 'gates' which mechanically closed over the light source or cell to give 'infinite' attenuation. The Noise-Gate was born and, together with compressors and limiters developed through thermionic valves to our current solid state devices.

## Operation

The object of a noise-gate is to discriminate between and further separate wanted signal from noise. As such it belongs to the 'low level' family of processors since it operates *below* a certain threshold. Since gates at rest are in the attenuated position, the open (or attack) time of the gate is defined as the time it takes to allow the signal through at unity gain; the close (or release) time is defined as the time it takes the gate to fully attenuate. The ratio of input to output gain at which this is effected is illustrated in **fig. 1**. The gate (with say, a 1:20 ratio) will attenuate its full range for a very small change in input level at the threshold point, whereas the expander slope

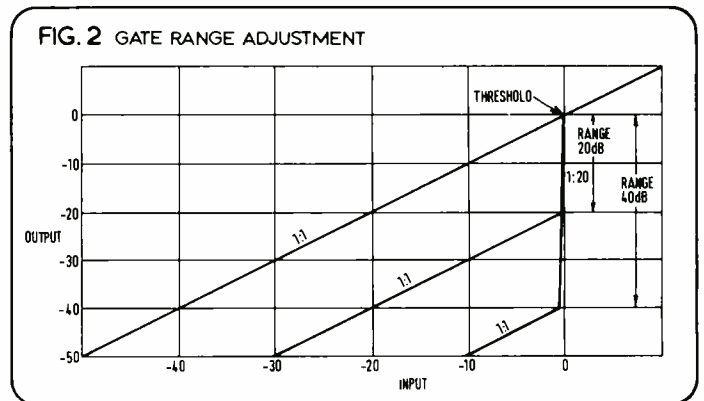
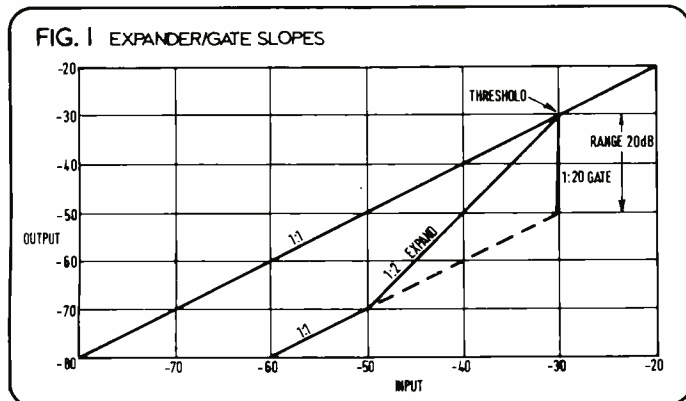



needs a greater input change to effect a comparable amount of attenuation.

The most common use for both systems is that of eliminating unwanted noise during pauses in programme material and, used in this manner, the threshold will normally be set just under the wanted signal level. The expander's slope, being 'softer', is less critical to set up and easier to use provided the signal-to-noise ratio is reasonable in the first place.

If one is to avoid actually expanding some of the low level signal, the noise must lie well below the wanted signal (eg with a 1:2 slope, 10 dB in order to get greater than 10 dB improvement). If it is only 5 dB below, the expander can only improve it by a further 5 dB whereupon it is held open by the noise itself. In that case the threshold can be lifted so that part of the lower level signal is expanded, but there is the danger of modulation effects and 'hunting' unless slower release times are used. This does, of course, rather defeat the idea of getting rid of the noise fast before the ear can detect it, but has its uses where the noise is so poor that it actually merges with wanted signal. In such cases, as with older recordings, the attenuation range can be reduced to about 8 dB maximum (to avoid great noise contrasts) and with slower attack and release parameters the lower part of the signal can be expanded.

The Gate is effectively an audio switch with an attenuation rate controlled by the release. In poor signal-to-noise circumstances it can be invaluable and more effective than the expander in achieving separation. Gates have, over the years, not achieved a very good reputation either because of slow open characteristics such that initial transients were lost or the fact that they are very prone to hunting characteristics. With modern designs and components, however, there need be little or no apparent transient loss and by arranging the threshold to have a hysteresis effect, such that the 'close' threshold is lower than the 'open' threshold, 'hunting' is largely obviated.

One other factor to emerge more recently, relatively speaking, is the 'keyed' or programmable gate. Here the control volts are applied externally to the signal being processed, viz the Allison *Keplex* expander and, more recently, the Audio & Design *F300* expander gate.

### Applications

In the studio set-up, probably the most common application of the gate is on drum kit miking. It is quite possible, especially in an isolation booth, to have 12 microphones on a drum set. In order to reduce cross talk and splash from cymbals and hi-hat on snare and bass the threshold is set high at 0 or +10 dBm with slow attack and fast release, adjusting the range of attenuation as desired (fig. 2). Faster attack characteristics will tighten-up the initial transients (of the bass drum, for example) to the extent that a sharp cut lowpass filter at 10 kHz would be desirable to filter out the unavoidable

FIG. 4 DYNAMIC REVERSAL

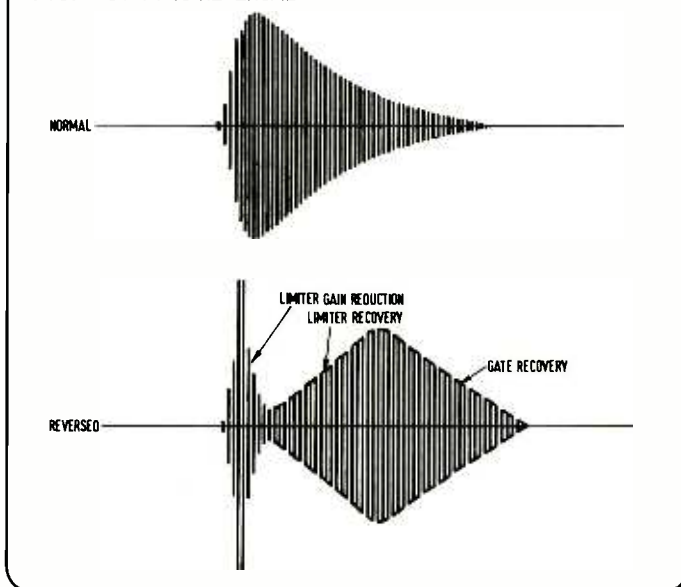

'click' generated by wide range attenuation as the gate opens. Mike Stavro, engineer at Air Studios in London, uses noise gates in this fashion to 'restore' vital initial transient information to a flabby bass drum and, coupled with a slow attacking limiter, recover some of the original 'square-wave like' shape. Fig. 3 shows how the bass drum waveform is modified by a very fast attacking gate with the slow attack limiter modifying its decay characteristic. He has also, by application of this technique, produced a very creditable 'synthesised' drum sound using a low frequency signal generator as the input source.

It is also often the case that an equalised version of the gated signal is used to drive the gate via the key or trigger input, thus operating on the essential information (as defined by eq) only.

John Mackswith, Studio Manager of Utopia Studios in London, also uses the gate coupled with a fast attack limiter to create a 'dynamic reversal' effect (see fig. 4). Here, in a simulated oscilloscope trace, we can see the initial transient, heavily overlimited by an extremely fast acting limiter with slow recovery, being eventually attenuated by a slow releasing gate. The effect is to give a 'backward' sounding snare or tom-tom. In situations where separation on the track is poor it would be undesirable to limit first because of the gain needed to over-limit. A gate is therefore utilised *before* the limiter to pre-condition the desired separation followed by 'dynamic reverse'. Where two tom-tom mics are in use this means four gates and two limiters on one track.

Modulation of one signal by another and then mixing the two is also an effect worthy of experimentation. On the recent *Consequences* album it was possible to have 'talking wind'. Fig. 5 shows how a continuous wind noise can be fed to a gate whose control volts are derived from a parallel feed of voice-track. The output of the gate, when mixed with the voice will then be modulated in sympathy. Similarly, another not so common use of the key input is to drive the gate from the sel-sync or advance head of a tape machine, feeding the direct signal through the gate and utilising a slow release time. This ensures that, since there is typically something like 100 ms between the two heads, the gate is opened in advance of the signal thus obviating any possible initial transient modification. Very handy on voice dubbing where signal to noise is poor, time is short and programme content unfamiliar. It is, of course, equally feasible to employ a delay line to delay the direct signal.

The value of the expander has been unexpectedly increased by the introduction of complementary noise reduction techniques since, by removing the masking effects of tape hiss, they increase the listeners awareness of source noise. To combat this, use of an expander on

FIG. 3 MODIFYING A BASS DRUM SIGNAL

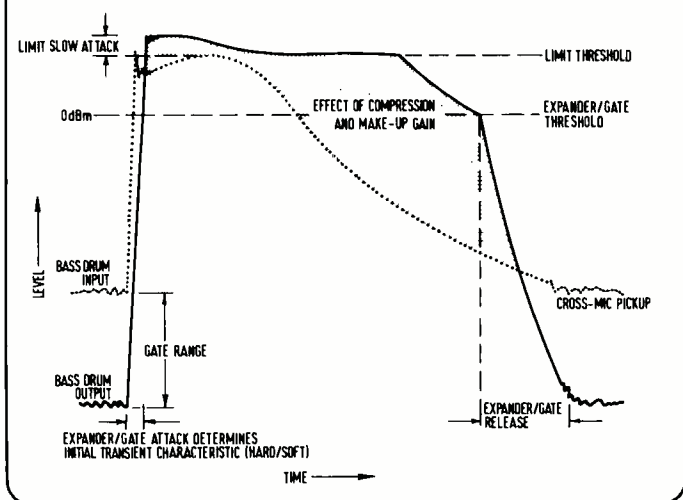

## DOING IT FOR EFFECT . . . THE NOISE GATE

each track during reduction will ensure that channels are only contributing to the mix in the presence of wanted signal. This can dramatically reduce cross-mic pick-up, additive tape hiss and other objectionable sounds generated by electronic instruments.

This approach is also likely to show benefits in live pa work where many spurious signals are at large, especially where a vocalist with a weak voice may require high gain on his mic, or a keyboards player has anything up to five (or more?) instruments to himself.

Some perhaps less obvious uses of expanders include increasing of the dynamic range of the signal itself, applied either to the high or low end of the signal (fig. 6). It will be less noticeable at high signal level relative to low signal since noise cannot then be modulated.

Small amounts of attenuation are necessary and the threshold should be set so high that the unit is just coming out of attenuation on peaks. This will be quite subtle and could be used to reprocess older classics or recover some of the dynamics of 'over-compressed' signals. Finally, fixed decay time of some reverberation devices or instruments can be shortened by a little judicious juggling of threshold and release parameters.

It must be stressed that the availability of expander/gates, like all signal processing gear, should not detract from efforts to obtain good mic separation and placement. As always, it is technique that distinguishes good sound engineers—the rest is only aids, and primarily for effect!

*This is the first in a series of articles from Len Lewis on studio ancillary equipment. In the near future he will be writing us an article on adt and flangers.*

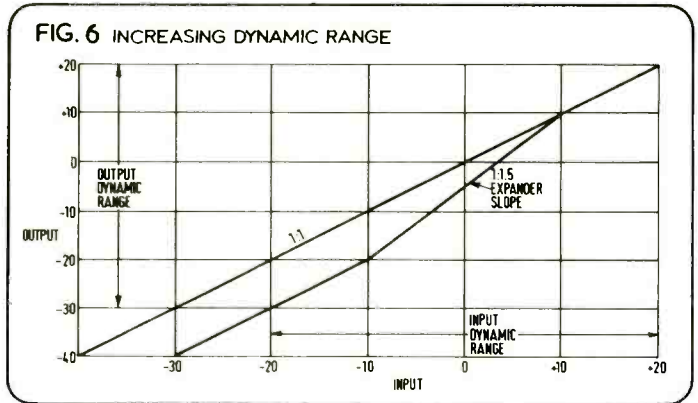
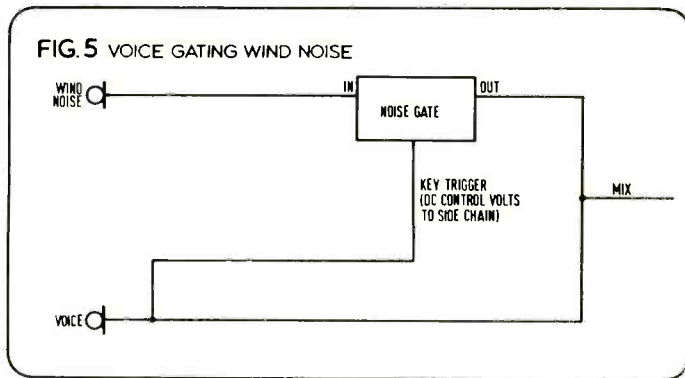

**MXT-1000  
AUDIO  
MIXING  
SYSTEM**

The new MXT-1000  
A unique system enabling  
your own requirements to  
be built from standard  
equipment

8 channel, 2 group MXT-  
1000—each channel fitted  
with compressor

**Manufacturers of  
sound systems  
and electronics**

**Station Road, Wenden  
Saffron Walden  
Essex CB11 4LG  
Saffron Walden  
(0799) 40888**

**audix**



 **Neve** supreme in sound

# unsurpassed in broadcast and recording consoles

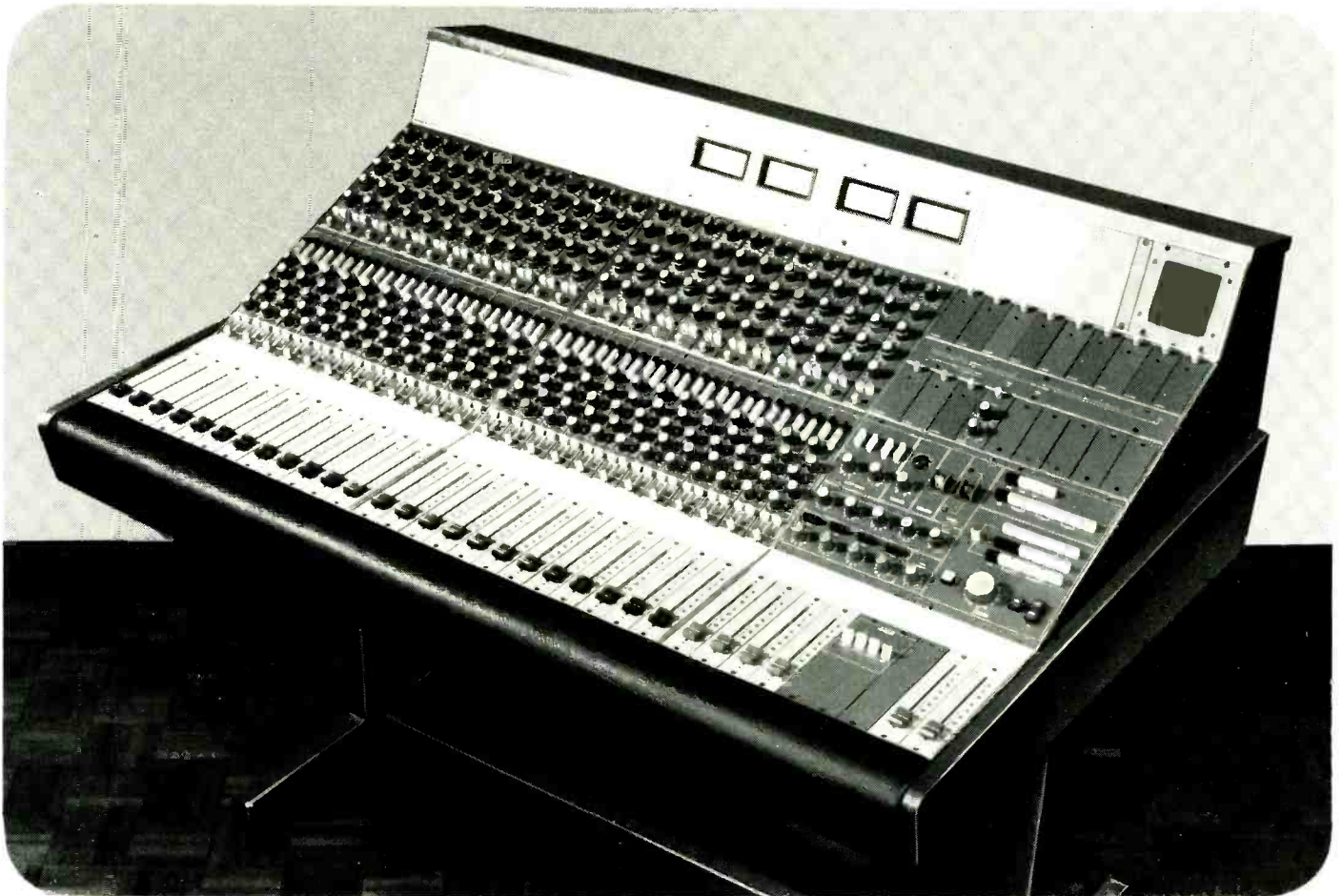

Neve's superb range of broadcast consoles includes the following standard models:-

The powerful 5315 Recording and Broadcast Console (shown above) featuring 12 or 24 input channels, 4 group outputs and 2 master outputs ideal for 4 group television production, 4 track recording or stereo broadcast production.

The versatile 5312 'Melbourn' All-purpose Console for recording or broadcast where 12 input channels, 2 group outputs and comprehensive monitoring are required.

The comprehensive 5402A Broadcast Console providing highly flexible radio broadcast facilities for disc jockeys or continuity applications.

The compact 8301 'Kelso' Transportable Console featuring 10 inputs, 2 main output groups, cue, speaker monitoring outputs and talkback facilities.

The portable 5422 'Suitcase' Mixing Console suitable for full professional use and powered either by re-chargeable batteries or from an optional mains supply/charger.

**Rupert Neve and Co. Ltd.**, Cambridge House, Melbourn, Royston, Herts. SG8 6AU England.  
Tel: Royston (0763) 60776. Telex 81381.  
Cables: NEVE Cambridge

**Rupert Neve Inc.**, Berkshire Industrial Park, Bethel, Ct. 06801 USA Tel: (203) 744 6230 Telex 969638

**Rupert Neve of Canada Ltd.**, 2721 Rena Road, Malton, Ontario Tel: 416 6776611. Telex: 21 06 983502

**Rupert Neve GmbH**, D-6100 Darmstadt, Bismarckstrasse, 114 W. Germany. Tel: 6151 87038 Telex 419581

# Neve

## Copy-write your broadcast!

RECENTLY a BBC producer inadvertently discovered a loop-hole in British copyright law that could affect all broadcasters. Not only is it a loop-hole in current law, it looks like being a loop-hole in the new copyright laws which are due to be enacted in the UK. Although by publicising the loop-hole we risk encouraging villains to use it, it seems more important in the long run to encourage the government to plug the gap by airing the issue.

The BBC spends a considerable amount of time and money on producing radio programmes based on interviews with famous pop-stars who are often living in the USA. One such programme was broadcast last year and widely acclaimed. And not too long afterwards a book appeared in which streams of the pop-star's words to the BBC appeared verbatim. The BBC approached the publisher who initially apologised, then took legal advice and withdrew the apology. Here's why.

The Copyright Act 1956, which currently governs copyright law in the UK, makes it an offence to record a broadcast without authorisation and then rebroadcast it or issue it as a disc or tape. The Act implicitly allows a radio broadcast to be recorded for private purposes and there is also provision for 'fair dealing' with excerpts, so that magazines and newspapers can safely quote passages of a copyright work in a critical review.

But by default, in other words through not specifically forbidding it, the Act appears to leave a publisher free to record and transcribe a broadcast, and then publish its content. This is what happened in the case of the pop-star's personal tale of his life story. There is room for legal argument on all this, and one hard-to-swallow suggestion is that the pirate is safer if he credits the source of the material, in this case the BBC, because his piracy may then count as 'fair dealing'. A more reasonable suggestion is that, by crediting the BBC, the pirate is putting his head in the common-law noose of 'passing off' his book as something apparently backed or blessed by the BBC. Probably the pirate is safer if he just pirates!

Last year a ten strong committee chaired by Mr Justice Whitford produced a report on British Copyright Law running to nearly 300 pages. Our new laws will be based on this report; but it doesn't appear to acknowledge the loop-hole. Likewise the official Government attitude seems to be that word-for-word reproduction in print of a broadcast interview must be a clear breach of copyright, even if the law doesn't say so. Only an expensive test case in court—or a change in

the law—will settle the issue one way or the other. So it would seem to make sense for any new laws on copyright to make quite clear that to lift a hard-produced broadcast interview, word-for-word off the air, and then sell it in print is legally naughty.

In the meantime, and until the law is changed, it seems that there is one way that broadcasters can safeguard themselves against such piracy. If the broadcast interview is transcribed by the station before it is broadcast, so that the station has a written copy of what it subsequently broadcasts, then any unauthorised publication of that interview will be a breach of copyright in the written transcript held by the broadcaster.

Moral. If you have a hot property interview *only* on tape, have it transcribed *before* it goes out over the air, and date and sign the transcription in front of a witness.

## Remixed

THE SUNDAY TIMES, recently tracing the history of England's large country houses, inevitably picked on Shipton Manor in Oxfordshire—better known to the recording business as The Manor. It was bought in the early Seventies by Richard Branson of Virgin, reportedly for just £25 000, but has since been converted and renovated to the tune of £½ million—Branson's reward for having had the bright idea in the Sixties of selling rock records at cut price. As 'The Sunday Times' briefly mentioned, in 1956 the then owner had a garish picture painted high in the hall. This showed the local villagers offering up a miniature replica of the Manor to a nude goddess floating above a mountain top. Ten years later the new lady owner of the Manor took exception to such rudity, and obscured the goddess with a cloud over the mountain. So far none of the new residents of the Manor has got round to restoring the masterpiece to its original 'lewd' splendour. But it is already featured on *Tubular Bells*—or rather, it may be or may not be, depending on which version of *Tubular Bells* you play.

Mike Oldfield made *Tubular Bells* between autumn '72 and spring '73, and it was released in May '73. Although essentially an overdub epic featuring Mike Oldfield, MC Vivian Stanshall came in for one track to announce each instrument in turn. After this track had been recorded, there was some pretty heavy drinking by all concerned, and the outcome was some mics strung out of the studio and round the Manor House. As an overdub to *The Sailor's Hornpipe*, Stanshall staggered—both physically and verbally—around the Manor and the mics. En route he

chanced the garish painting and described it in such a rambling, drunken fashion that the tapetrack was finally adjudged too much for the masses and left out of the final *Tubular Bells* mix. So the May 1973 issue is devoid of drunken Stanshall.

But last year came *Mike Oldfield Boxed*, a re-issue of all Oldfield's work, including *Tubular Bells*. It was decided that the Great British Public was now ready for Stanshall in all his original glory, so the boxed mix of *Tubular Bells* has a very different *Sailor's Hornpipe* from the original (1973) issue. Comparative listening is rewarding.

So re-mixing a multitrack master for re-release (which in the case of the *Mike Oldfield Boxed* set differs from the original versions in more ways than just the Stanshall Hornpipe section) is a very practical possibility. This prompts an interesting thought: how many issues of a decade ago would benefit from a remix and re-release? Or would it just be a temptation to tamper with perfection?

## Broadcast cassettes

NOW THAT a *Uniset* player, from Nordisk in Denmark, is finally available at a halfway-to-reasonable price (around £2000), will the *Uniset* take off—or is it too late?

The *Uniset* idea of a 6.35 mm and much improved version of the Philips 3.8 mm *Compact Cassette* design was unveiled to the NY AES Convention in September 1974. At around that time its mentors, BASF, were obviously well aware of the chicken-and-egg problems inherent in launching a software system without hardware. So BASF offered the *Uniset* to various Japanese hardware manufacturers.

In Europe, EMT and Studer played with *Uniset* machine designs somewhat half-heartedly. Meanwhile, broadcasters moaned about NAB cartridge problems; heads clogged by the lubricated tape and azimuth phase errors are well known. Then, around Easter 1976, a consortium of Japanese companies launched the 6.35 mm *Elcaset* onto the predominantly domestic market—not even a blind man could have failed to notice the similarity to the *Uniset*.

Already several firms are producing *Elcaset* machines for the domestic market, and it can only be a question of time before an enterprising Japanese firm with a foot in both the domestic and professional camps (like Teac or Technics, for instance) has a go at making a *Elcaset* machine with cue and fast wind for broadcasting use. In the meantime, at least two manufacturers are working independently on cue-tone systems for standard 3.8 mm cassettes, and at least one London studio is using a home-grown cue system for triggering the playback of sound effects dubbed onto standard cassettes.

Perhaps the stylish new Danish *Uniset* machine may have arrived just in time to give the system a fair chance in the race. And at least one Japanese company is backing both horses. Aiwa, a Japanese hardware manufacturer which was part of the consortium backing the *Elcaset* system, recently showed a *Uniset* machine at a hi-fi show in Japan. ■



# The Professional's Choice



## The Adaptable A77

The industry's workhorse. Over 400 versions ensure that an A77 is suited to your particular application. Make your choice from five tape speeds, three track configurations, Dolby noise reduction, varispeed, three enclosure styles, power amplifiers, remote controls, voice-operated auto-start, balanced input/output, NAB or IEC equalisations, built-in loudspeakers... etc., etc. The standard echo and track-to-track facilities of the A77 are as well known as its proven track record over the past decade. The machine by which all others are judged.

## The Versatile A700

The deck that closes the gap between top ranking amateur tape recorders and full grown professional studio machines. Full logic control and motion sensing, 3 tape speeds, real-time counter, open head format, built-in mixer with balanced mic. inputs and RIAA pre-amplifier make the A700 a self-contained and versatile recording system.

## The Modular B77

Latest addition to the Revox range, the B77 with its logic control, self-sharpening tape cutter, easy access to heads, remote and varispeed controls and modern styling make it the natural choice of the semi-professional and the true Hi-Fi enthusiast.

Sole U.K. distributors, F.W.O. Bauch Limited, 49 Theobald Street,  
Boreham Wood, Hertfordshire WD6 4RZ

# STUDER REVOX

# Survey: noise reduction equipment

*This survey is divided into two parts. The first part will deal with two-stage compressor/expander (ie compander) systems: specifically the three systems offered by dbx, Dolby and Telefunken (Telcom). The second part will be concerned with single-stage expanders and noise gates.*

*Readers unfamiliar with the design philosophy of the three compander systems are referred to a comprehensive article by Frank Ogden published in the September 1976 issue.*

*Forthcoming surveys include test equipment (July), power amplifiers (August) and monitor loudspeakers (September). Manufacturers and agents are invited to submit product details for publication to reach the editorial offices (address page 3) at least two months before the issue publication date (preferably a lot earlier).*

## COMPANDER SYSTEMS

**dbx**  
**dbx Inc, 71 Chapel Street, Newton, Massachusetts 02195, USA.**  
**Phone: (617) 964 3210.**  
**Telex: 922522.**  
**UK: Scenic Sounds Equipment, 97-99 Dean Street, London W1V 5RA.**  
**Phone: (01) 734 2812/3. Telex: 27939.**  
**Agents in most countries.**

The by now well-known dbx noise-reduction system is available in a wide range of configurations for simultaneous encode and decode, switched encode or decode, and encode or decode-only.

All units feature the same 2-way compression/expansion system based on a 2:1 linear decibel slope applied to a 100 dB range. Attack and release times are program dependent. It is claimed that the system provides 30 dB of noise-reduction and a simultaneous 10 dB increase in headroom. Frequency response is a quoted  $\pm 1$  dB 30-20k Hz, total harmonic distortion typically 0.1% and equivalent input noise approximately -90 dBm.

### MODEL 142

A 2-channel unit for broadcasters. The processing can be switched between encode or decode for recording or replaying such items as dbx-encoded NAB cartridges. The unit can also be used for 'normal' noise reduction on, for example, tape machines, or for improving the signal-to-noise ratio of land lines or microwave links.

**Price: £485 (\$750) approx.**

### 150 SERIES

Three units for the small recording studio: *Model 152* features two channels of switchable encode or decode; *Model 154* is a 4-channel version of the *Model 152*; and *Model 157* has two channels that provide simultaneous encode and decode facilities. Two *Models 154* or *157* can be rack-mounted with the *RM-150* mounting kit.

**Prices: Model 152 £310 (\$475) approx; Model 154 £485 (\$750) approx; Model 157 £400 (\$600) approx.**



*dbx K9-22 replacement for Dolby card*

### MODEL 158

Provides eight channels of simultaneous encode and decode. The system is modular and contains its own power supply module plus a spare noise-reduction module for emergencies.

**Price: £1495 (\$2400) approx.**

### MODEL 187

A 4-channel system for 'professional' recording



*dbx model 193 for Nagra IV-S*



*dbx model 158 8-channel unit*

studios. The processing is switchable between encode or decode. With an optional plug-in accessory the system can be remote-controlled from a tape machine (to follow the record/replay mode) or from a desk.

**Price: £1330 (\$2150) approx.**

### MODEL 216

A modular 16 or 24-channel system providing simultaneous encode or decode facilities. Each module contains the processing circuits for two channels of noise reduction, and can be remote-controlled from a tape machine or desk. A spare module is also provided for emergency backup.

**Price: £5250 (\$9500) for 16 channels, £7500 (\$14k) for 24 channels.**

### MODEL 193

A 2-channel simultaneous encode and decode unit for the Nagra IV-S tape machine. Power is derived from the Nagra's batteries or mains unit. Front-panel

56 ►



# Presenting plug-in 46 track capability.



## Featuring Studer TLS 2000 flexibility.

The difference between a 32 Track Machine and the Studer 46 Track system may only appear to have the obvious advantage of 14 additional tracks and yet it offers unrivalled flexibility.

The principle is simple as is the installation. Merely plug-in two 24 track A80's with the Studer Tape Lock System and 46 Track facility is attained.

And you can go to almost any lengths to install the

system, quite literally. Machines can be positioned side by side or on separate floors, interconnection being by means of a standard 3-pole audio line. Updating existing A80 systems is simplicity itself.

As for flexibility you have the advantage of 46 track capability synchronously locked between the two tape transports for recording and mix down, or the independent use of two 24 track machines.



**Installed and working  
at TRIDENT STUDIOS  
since September 1977.**

## F.W.O. Bauch Limited

**49 Theobald Street, Boreham Wood,  
Hertfordshire, WD6 4RZ Tel: 01-953 0091**

# STUDER INTERNATIONAL AG

CH-8105 Regensdorf, Phone (01) 840 29 60, Telex 58489

STUDER REVOX AMERICA INC., Nashville, Phone (615) 329-9576, Telex 55-4453

STUDER REVOX CANADA LTD., Toronto, Phone (416) 423-2831, Telex 06-23310

STUDER FRANCE S.à r.l., Paris, Phone 533 58 58, Telex 24-744

## SURVEY: NOISE REDUCTION

jack sockets provide monitor outputs to drive an external loudspeaker or headphones.

**Price:** £530 (\$850) approx.

### K9-22

A plug-in replacement for the Dolby *Cat 22* module. It is compatible in external dimension and interfaces directly with the main frame of Dolby *361*, *M16* and *M24* systems, including power supply and switching functions.

**Price:** £156 (\$250) approx.

## DOLBY

**Dolby Laboratories Inc, 731 Sansome Street, San Francisco, Ca 94111, USA.**

**Phone:** (415) 392 0300. **Telex:** 34409.

**UK:** Dolby Laboratories Inc, 346 Clapham Road, London SW9 9AP.

**Phone:** (01) 720 1111. **Telex:** 919109.

Agents in most countries.

There are two standard Dolby noise reduction systems: the 'professional' A system and the B system for consumer use. Both systems act as a constant gain amplifier over a wide range at low and high levels. Level dependent, variable gain action occurs only over a limited range and only in the side path of the system, while the main path always acts as a constant gain amplifier. In both systems the attack and release times depend on the signal conditions to minimise distortion products and modulation effects. The Dolby A system uses four frequency bands in the side chain, which together cover the full audio bandwidth. The Dolby B system, however, uses only one band in the side chain, whose cut-off frequency is controlled by the signal. This sliding action is claimed to be specific to Dolby noise reduction, like the dual-path, differential approach.

### MODEL 360/361

A rack-mounting, single-channel unit with Dolby A characteristics, switchable between encode and decode.

**Frequency response:**  $\pm 1$  dB, 30-20k Hz.

**Distortion:** less than 0.1% at 1 kHz and  $\pm 8$  dBm.

**Phase response:** less than 5° error, encode/decode.

**Noise reduction:** 10 dB from 30 to 5k Hz, rising to 15 dB at 15 kHz.

'Subjective noise reduction effect is independent of the signal level and is independent of the noise level over a wide range. Dynamic characteristics are maintained'.

The *Model 361* is identical to *Model 360* except for built-in relay switching of operating mode. The changeover can be controlled automatically to follow the record/replay functions of a tape machine.

### MH SERIES

A multichannel rack-mounting unit with built-in encode/decode changeover facilities. It is available in 8, 16, 24 and 32-track formats. Frequency response, distortion, phase response and noise reduction identical to *Model 360*. Crosstalk is 80 dB between any two channels.

### MODEL 330

A 2-channel unit incorporating Dolby B encoder/decoder for use in tape duplication and quality monitoring. Distortion and phase response are identical to *Model 360*.

**Frequency response:**  $\pm 1$  dB, 30-15k Hz.

**Noise reduction:** 3 dB at 500 Hz, 6 dB at 1 kHz and 10 dB at 4 kHz and upwards.

### MODEL 334

A 2-channel unit incorporating Dolby B encoder/decoder for use in fm broadcasting. A change of pre-emphasis time constant to 25  $\mu$ s is achieved when the noise reduction is activated, reducing the need for hf limiting. Specifications virtually identical to *Model 330*.

58 ►

Dolby model  
M16H, 16-channel  
unit

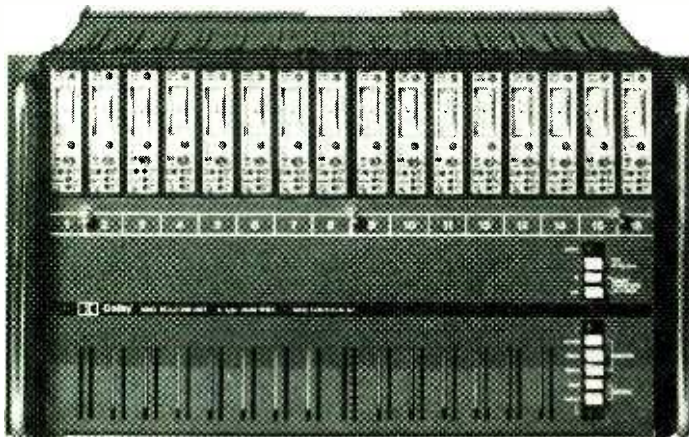

Dolby model  
334 FM  
broadcast unit



Dolby model 361 unit

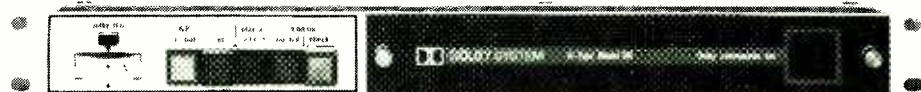

## Worldwide agents for audio & design recording.

### Australia

Audio & Recording, Holden Hill, S.A.  
Tel: 261 1383

### Austria

Soundmill Vienna, Peter J. Müller.  
Tel: 222 Telex: 75922.

### Brazil

Serion Ltd, Sao Paulo. Tel: 34 8725.

### Canada

Noresco (Mfg) Co. Ltd., Ontario.  
Tel: (416) 661 0541.

Telex: 065-24478, a/b Norescomfg.

### Denmark

Ole Christensen, Audiophil,  
Copenhagen. Tel: (01) 341 622.

### Eastern Europe

Denis Tyler Ltd., West Drayton, UK.  
Tel: (089 54) 43681. Tlx 23977.

### Finland

Harold Burgen, Helsinki. Tel: 692 5308.

### France

3M France, Paris.  
Tel: (1) 031 61 61. Telex: 695185

### West Germany

Elmus GmbH, Berlin.  
Tel: (030) 312 2012.

### Greece

Audiolab Hellas, Athens.  
Tel: 822 5222. Tlx 5800.

### Holland

Pieter Bollen, Eindhoven.  
Tel: (040) 512 777 Tlx 59281

### Italy

Roje Telecomunicazioni, Milan.  
Tel: 415 4141. Tlx 39202.

### Japan

Nissho-Iwai Co. Ltd., Tokyo.  
Tel: (03) 544 8311.

### New Zealand

General Video Co. Ltd., Wellington.  
Tel: 872 574. Telex: 31255.

### Norway

Siv. Ing. Benum & Co., Oslo, 2.  
Tel: (02) 56 57 53.

### South Africa

Eltron (Pty) Ltd., Johannesburg.  
Tel: 23 0018.

### South East Asia

Brunei, Indonesia, East Malaysia,  
West Malaysia, Singapore — c/o  
O'Connor's (Pty) Ltd., Singapore 5,  
Tel: 637 944. Tlx Oconsin RS 21023

### Sweden

KMH Ijud Ab, Stockholm.  
Tel: (08) 98 07 55. Telex: 13366.

### Switzerland

Jim Duncombe, Zurich. Tel: 72 56 877.

### United States

Audio & Design Recording Inc.,  
Honolulu. Tel: (808) 845 7226.

### UK and All Other Territories

Audio & Design Recording Ltd.,  
Reading, UK. Tel: (0734) 53411.  
Telex: 847605 a/b Tillex G.



# THE 19" PARKING SPACE



## S03 Sweep Equaliser

A 3-band sweep equaliser offering 40dB control range switchable on each section. Input attenuator and optimum modulation indicator.

## S04 Parametric Equaliser

A 3-band fully parametric equaliser with 40dB range; shelf option with variable slope on Hi and Lo sections. Each section switchable with optimum modulation indicators.

## S23 Auto-PAN effects module

offers different *pan* patterns with *trigger*, *speed* and *envelope* following functions.

## S27 Dual Electronic Crossover

Provides *stereo* dual crossover, or *mono* **triple** crossover networks at 18dB/oct.

## S05 Dynamic Noise Filter

This programme controlled high-pass filter automatically attenuates hum and rumble. It has variable slope (0-18dB/oct) and three t/o frequencies. Can also be used as a 20/40dB noise gate.

## S06 Dynamic Noise Filter

Similar to S05 but being the low pass version, cleans up hiss and HF splash without affecting wanted HF transients. Alternatively acts as a wide-band noise gate.

## S07 Octave Equaliser

Ten-band octave equaliser set on standard ISO centre frequencies from 31.25Hz — 16kHz. Optimum modulation indicator.

**S14 Quad PPM l.e.d column** has brightness control and can be ganged with other S14 modules.

## S01 Compressor-Limiter

A simple-to-operate multi-ratio compressor with overall peak limiter and l.e.d gain reduction meter.

## F300 Expander-Gate

Peak and averaging side-chains; variable slope with up to 40dB range; adjustable release/attack and external trigger create the most sophisticated unit available.

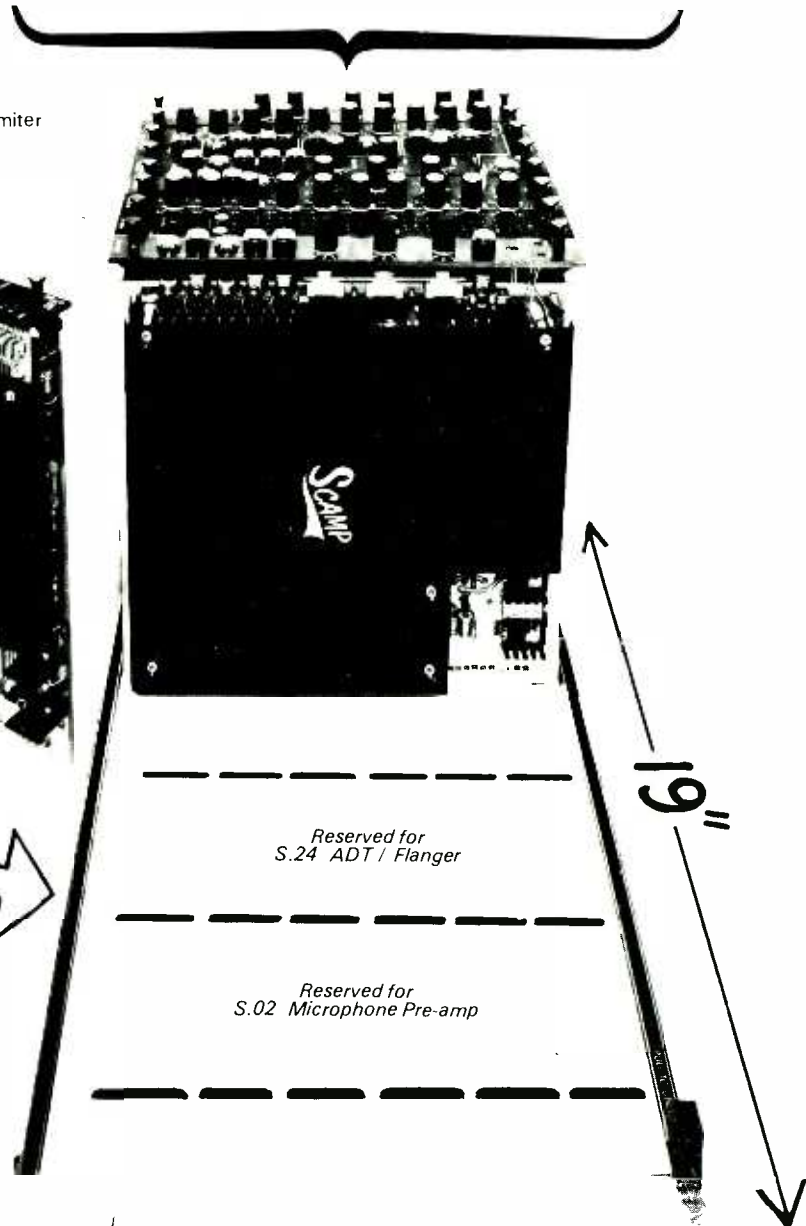
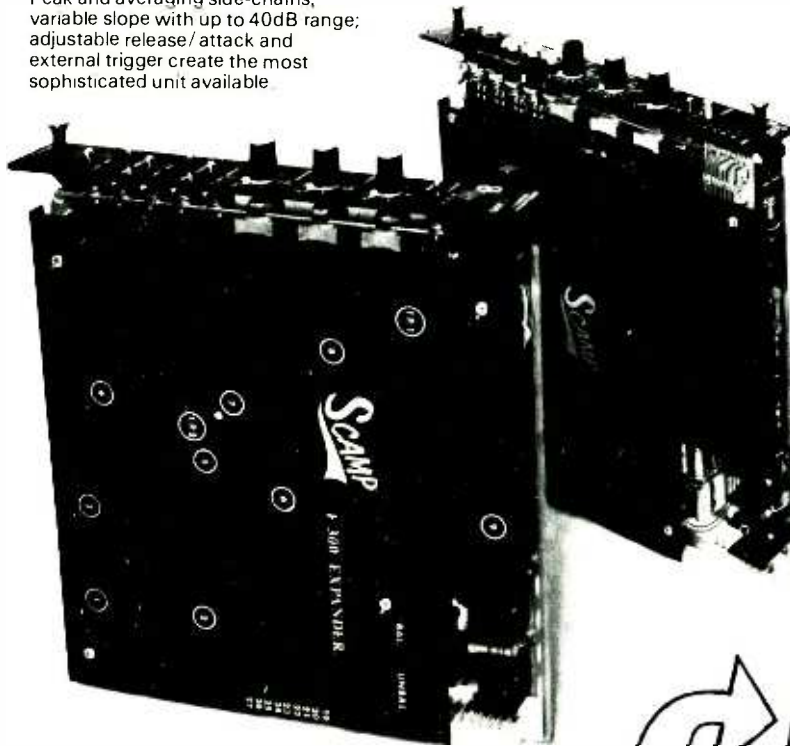

In this 19" parking space there is ample room for an impressive array of the kind of equipment successful studios need. You choose the unit combination that suits your need and budget. Parking lot flexibility means that as your business grows so can your SCAMP system. Simply add the units you need, when you want them. There's nothing comparable on the market.

audio & design recording ltd

St. Michaels, Shinfield Road, Reading, Berks, U.K. Tel: Reading (0734)-84487. Telex: 847 605. Manufacturing Members of APRS.



## SURVEY: NOISE REDUCTION

### MODEL CP50/100

Rack-mounting cinema processors for the reproduction of Dolby A-encoded optical and magnetic sound tracks.

### CAT NO 22

The basic noise-reduction module employed in all Dolby A-type equipment. A half-speed version—*Cat No 40*—is also available.

## FUTURE FILM DEVELOPMENTS

Future Film Developments, 36/38 Lexington Street, London W1R 3HR, UK.  
Phone: (01) 437 1892. Telex: 21624.

### DNR SERIES

A portable unit containing two Dolby *Cat No 22* modules, plus the necessary buffer amplifiers, automatic record/replay switching etc for interfacing with Nagra *IV* single and two-channel tape machines. Dimensions match that of the Nagra case and weight is under 4.5 kg. Power is derived from internal batteries. Basic price around £1000.

## TELEFUNKEN

AEG-Telefunken, Postfach 547, D-3340 Wolfenbuettel, West Germany.

Phone: 05331831. Telex: 95651.

UK: Hayden Laboratories Ltd, Hayden House, Churchfield Road, Chalfont St Peter, Bucks SL9 9EW.

Phone: Gerrards Cross 88447. Telex: 849469.

US: Gotham Audio Corporation, 741 Washington Street, New York, NY 10014.

Phone: (212) 741 7411. Telex: 236779.

Agents in most countries.

### TELCOM C4

See reviews in the March '77 issue, p74, and this issue, p00.

The system is based on a 2-way compression/expansion principle using a 1:1.5 slope. The input is split into four bands—30-215 Hz, 215-1.45k Hz,

*Inside a naked Telcom c4 unit*

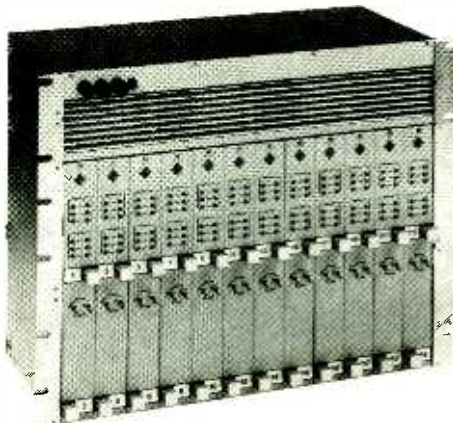
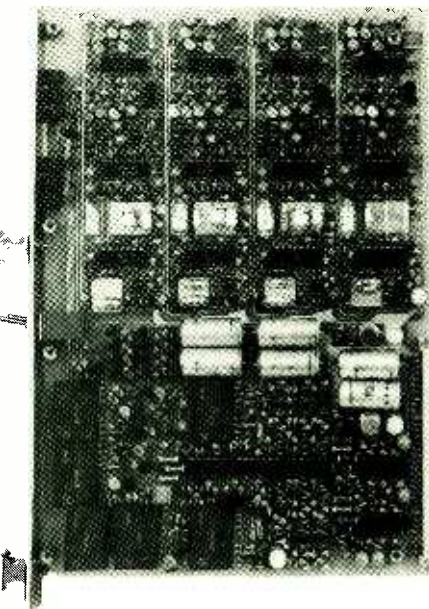

24 channels of Telcom c4 noise reduction

1.45-4.8 kHz and 4.8-20 kHz—before compansion. Two modular units are currently available: the *c4* and the *c4D*. The *c4* is a 2-channel switched encode or decode unit for use with the Telefunken *M15A* multitrack, while the *c4D* is a direct replacement for the Dolby *Cat No 22* module.

Frequency range: 30-20k Hz.

Dynamic gain: greater than 30 dB.

Signal-to-noise: greater than 94 dB, weighted and unweighted.

Distortion: less than 0.2% thd.

Price: *c4* £938; *c4D* £367.

## EXPANDERS/NOISE GATES

### ALLISON

Allison Research Inc, 2817 Erica Place, Nashville, Tenn 37204, USA.

Phone: (213) 874 6615.

Export: Gotham Audio Corp, 741 Washington Street, New York, NY 10014, USA.

Phone: (212) 741 7411. Telex: 129269.

UK: FWO Bauch Ltd, 49 Theobald Street, Borehamwood, Hertfordshire, WD6 4RZ.

Phone: (01) 953 0091. Telex: 27502.

### KEPEX MODEL 500

Type: one-way gain expander.

Process: wide-band gain expander. Input signals greater than the threshold level will raise the gain of the unit to 0 dB; signals below threshold are attenuated by the amount set on the range control (up to 60 dB).

Threshold: -35 to +20 dBm, adjustable.

Ratio: 2:1 from 0 to 15 dB expansion, increasing to 4:1 at 60 dB expansion.

Attack time: less than 20  $\mu$ s.

Release time: 50 ms to 6s, adjustable.

Frequency response: (system alone)  $\pm 1$  dB, 20-40k Hz.

Distortion: less than 0.5% thd, under normal operating conditions.

Noise: minimum 85 dB below rated output.

Price: on application.

## AUDIO & DESIGN

Audio & Design Recording Ltd, St Michaels, Shinfield Road, Reading RG2 9BE, UK.

Phone: Reading (0734) 53411. Telex: 847605.

US: Audio & Design Recording Inc, PO Box 23047, Honolulu, Hawaii 96822.

Phone: (808) 845 7226.

Agents in most countries.

### F300 EXPANDER/GATE

A full frequency, low-level noise expander or gate from the *Scamp* range. The unit uses peak or rms-type sensing characteristics. Threshold is variable between -40 and +10 dBm for source noise reduction or effects use. The unit is said to improve signal-to-noise ratio by up to 40 dB where wanted signal is only 2 dB above noise. Suitable for all types of programme material.

Attack time: 25  $\mu$ s, 1 ms and 10 ms/40 dB range (max).

Release time: 25 ms to 5s, continuously variable.

Distortion: <0.1% at line level; 0.3% worst case.

Frequency response:  $\pm 0.5$  dB, 20-20k Hz.

Noise: in effects use less than -86 dB ref +8 dBm

60 ▶

*Audio Designs' model 301*

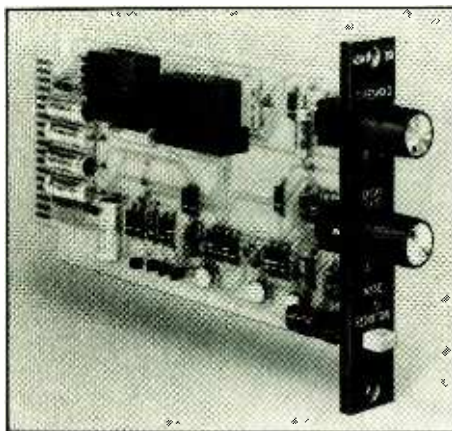

## PPM2: IEC268-10A; Draft BS5428

The latest refinements of BBC programme monitoring philosophy are now embodied in an International Standard.

The new IEC Standard defines considerably closer tolerances than BS4297 for temperature stability and specifies for the first time the frequency response performance at all signal levels as well as requiring a wider response than previously. Performance to isolated tone bursts is defined in a more stringent way and a new clause specifies the reading to be given when very low levels of signal are applied.

PPM2 is a standard performance drive circuit which can be mounted on the rear of a meter movement or by separate fixing holes. Connections are to a gold plated edge connector, with terminals also provided if direct wiring is preferred. It is manufactured under licence from the BBC and meets the requirements of the BPO, IBA, EBU and broadcasting organisations of other countries. Ernest Turner meter movements 642, 643 and TWIN are available from stock, as are flush mounting adaptors and illumination kits.

The coaxial red and green pointers of the TWIN offer an unrivalled method of monitoring stereo. PPM2 drive circuits are aligned for decay tracking such that any two boards will produce pointer overlay on a TWIN during fallback. This allows accurate checking of channel balance during items of programme intended to be centre stage.

Stereo Disc Amplifier 2 \* 10 Outlet Distribution Amplifier 2 \* Stabilizer \* Peak Deviation Meter \*  
Chart recorders

## SURREY ELECTRONICS

The Forge, Luicks Green, Cranleigh, Surrey GU6 7BG (STD 04866) 5997



# OTARI

## OTARI's DP-6000 gives you duplications at 64:1!

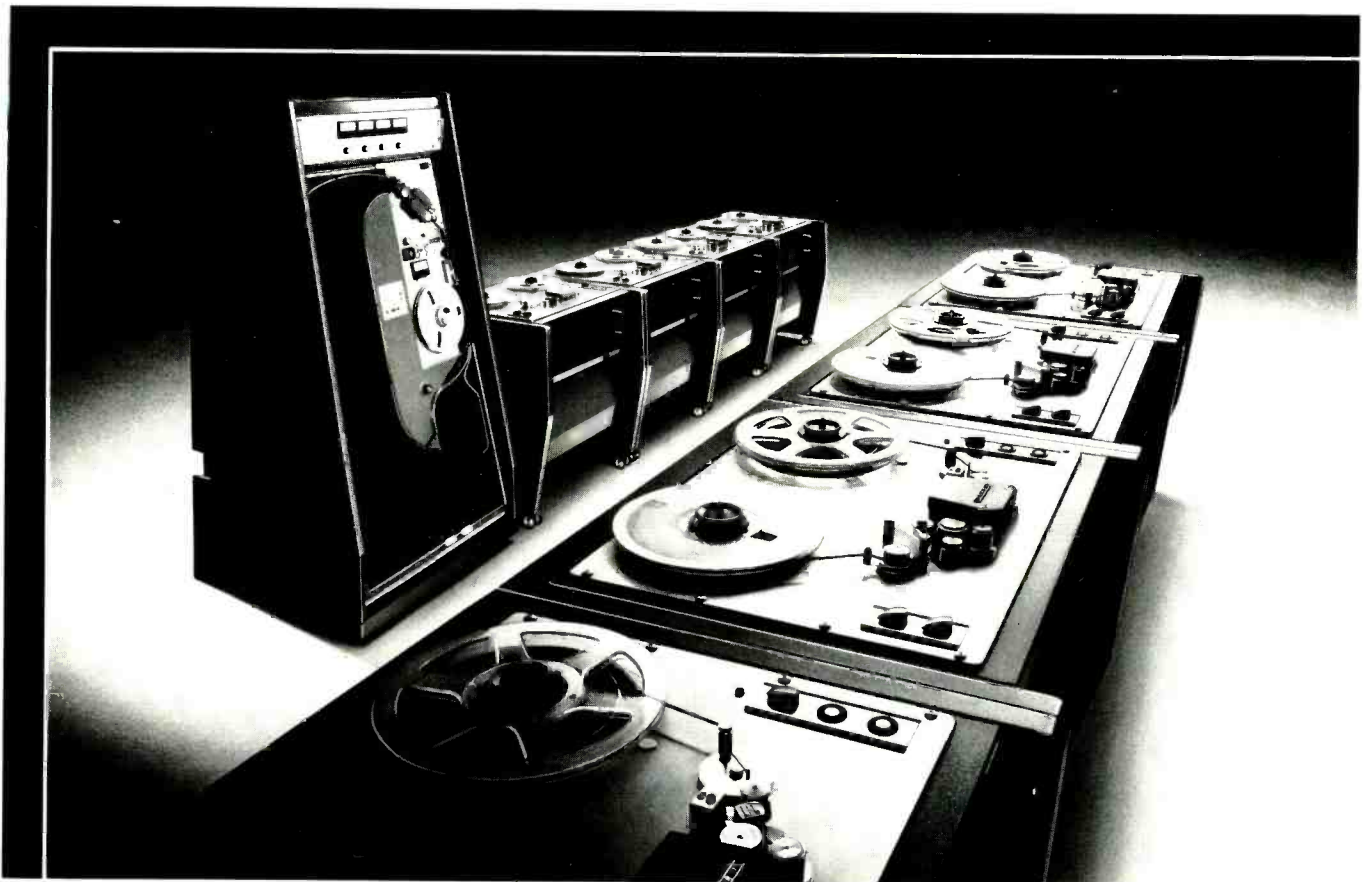

**O**TARI's DP-6000 duplicator is designed for quality sound duplications at the super high speed of 64:1! Its uniquely slanted loop bin insures smoothest 240ips transport of your 3 3/4ips master. Up to 10 slave units are centrally and automatically controlled. A quartz-crystal bias generator is employed, and crystal-coated ferrite heads assure clean, clear duplications for years on end.

Behind this sophisticated system stands the proven reliability of Otari

technology. Otari studio master recorders, duplicators, QC monitors and tape loaders are meeting rugged everyday production schedules with the highest performance standard in every sector of audio recording and duplicating industries.

**Japan:** Otari Electric Co., Ltd., 4-29-18 Minami Ogikubo, Suginami-ku, Tokyo 167, Japan  
**U.K.:** Industrial Tape Applications, 1-7 Harewood Avenue, Marylebone Road, London NW1  
**France:** Reditec, 62-66, Rue Louis Ampère, Zone Industrielle des Chanoux, 93330 Neuilly-s/Marne  
**Belgium:** Trans European Music S.A., Koeivijverstraat 105, 1710 Dilbeek, Brussels

Please send me details on

DP-6000

Name \_\_\_\_\_

Company \_\_\_\_\_

Address \_\_\_\_\_

SS

## SURVEY: NOISE REDUCTION

(weighted  $-3$  dB at 25 kHz); for noise-reduction use less than  $-103$  dB ref  $+8$  dBm (same weighting).  
**Price:** £195 approx.

### SO5 DYNAMIC NOISE FILTER

A low-frequency, single-ended processor from the Scamp range using frequency conscious, peak-sensing characteristic that imposes a variable slope roll-off to attenuate low-level lf (rumble etc). Maximum slope is 18 dB/octave; minimum 0 dB/octave (flat) when above threshold. It is claimed that the unit will improve signal-to-noise ratios by up to 18 dB/octave below 100, 200 and 400 Hz turnover frequencies without modulating the high-frequency content. The filter is said to be ideal for reprocessing old masters or attenuating source noise. Optionally, it can be switched to full-frequency 20 or 40 dB range noise gating.

The model SO6 from the Scamp range is identical to the SO5 except for turnover frequencies of 2, 4 and 6 kHz—making it a high-frequency, single-ended processor.

**Price:** £195 approx.

Shure model  
 M625  
 Voice-gate



## AUDIO DESIGNS

**Audio Designs and Manufacturing Inc, 16005 Sturgeon, Roseville, Michigan 48066, USA.**  
**Phone: (313) 778 8400. Telex: 231114.**  
**International: Ampex International, 72 Berkeley Avenue, Reading, Berkshire.**  
**Phone: 0734 55341. Telex: 847611.**

### MODEL 301

**Type:** noise suppressor.

**Frequency response:**  $\pm 0.25$  dB, 20-20k Hz.

**Distortion:** 0.15% typical, 0.35% max.

**Noise output:**  $-73$  dBm above threshold,  $-90$  dBm no input.

**Threshold:** adjustable from  $-40$  dBm.

**Attack time:** 5  $\mu$ s.

**Decay time:** 10-500 ms/dB.

**Available gain reduction:** 85 dB.

**Power:** +20V, 50 mA.

**Dimensions (wdh):** 2.5 x 13.3 x 19 cm.

**Price:** \$275.

Left: Audio & Design F300 expander gate. Middle: EMT 258 noise filter. Right: Audio & Design SO5 dynamic noise filter gate

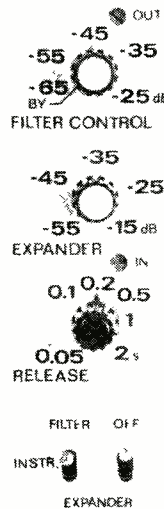
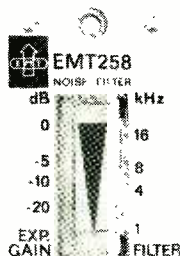
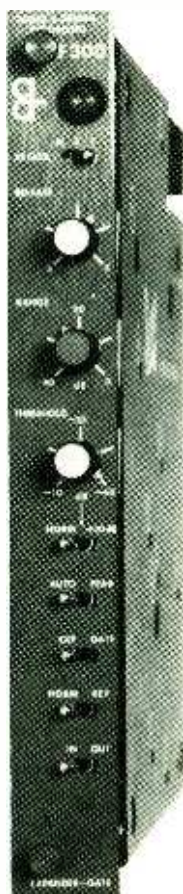

### EMT

**EMT-Franz VG mbH, D-7630 Lahr, Postfach 1520, West Germany.**

**Phone: 07825/512. Telex: 754319.**

**UK:** FWO Bauch Ltd, 49 Theobald Street, Borehamwood, Hertfordshire, WD6 4RZ.

**Phone: (01) 953 0091. Telex: 27502.**

**US:** Gotham Audio Corporation, 741 Washington Street, New York, NY 10014.

**Phone: (212) 741 7411. Telex: 129269.**

### EMT 258

**Type:** one-way lowpass filter and expander.

**Process:** lowpass filter, whose turnover frequency is determined by the programme material being processed.

**Filter:** turnover frequency 1-20 kHz, programme dependent; release time 0.05-2s, adjustable; threshold (signal)  $-25$  to  $-65$  dB, adjustable.

**Expander:** total range (at 100 Hz) 20 dB; frequency range below 2 kHz; release time less than 50 ms for 10 dB.

**Frequency response:** (system alone)  $\pm 0.5$  dB, 40-15k Hz.

**Distortion:** less than 0.5% thd at internal zero level.

**Noise:** greater than 80 dB rms at 0 dB output level.

**Price:** on application.

### ROGER MAYER

**Roger Mayer Electronics Inc, 225 East 57th Street, New York, NY 10022, USA.**

**Phone: (212) 486 1544.**

**Denmark:** Lake Audio APS, Artillerivej 40, DK-2300 Copenhagen S.

**Phone: 570 600.**

**France:** 3M France Minicom Division, Boulevard de l'Oise, 95000 Cergy.

**Phone: 749 0275.**

**Holland:** Peter Bollen Geluidstechnik, Hastelweg 6, Eindhoven.

**Phone: 512 777.**

**Norway:** Audiotron, Tollburgt 7, Oslo 1.

**Phone: 417535.**

**Spain:** Mike Llewelyn-Jones, AP Postal 8178, Madrid 8.

**Phone: 415 6350.**

**Sweden:** Tal & Ton Musik & Elektronik AB, Kungsgatan 5, S411-19 Gothenberg.

**Phone: (31) 130216.**

62 ►



### REVOX B77

The new Revox with full logic, easy editing, various spec. option. Check our new low prices on this and the A77 range.



### ALLEN & HEATH SD12-2

New 12/2 Sound reinforcement mixer which may also be used for 4 track recording.

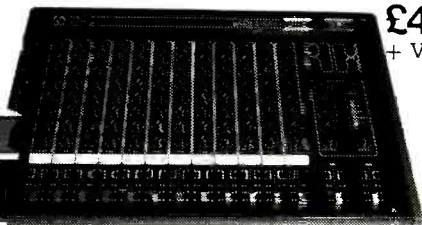

£430 + VAT

### H/H STEREO 12

Quality 12/2 desk from a manufacturer needing no introduction - many features at a sensible price.

£330 + VAT

on demonstration with companion echo/effects module.

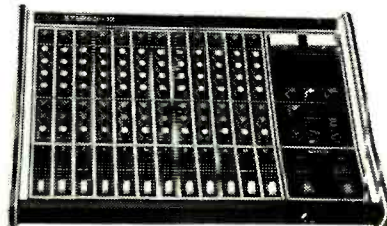

# Roger Squire's PRO-AUDIO

## BRITAIN'S LEADING SUPPLIERS OF PROFESSIONAL AUDIO EQUIPMENT

### QUAD 405

Unique "current dumping" monitor amplifier

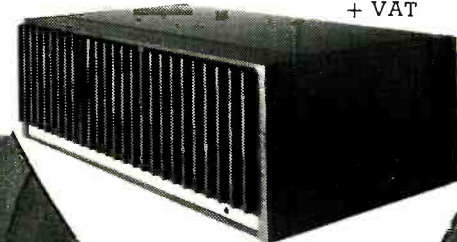

£145 + VAT

### TEAC TASCAM 80-8

Economic operation, simplicity of use - 8 track recording at a price for those with more talent than money.



£1984 + VAT

DX-8 8 channel DBX Uni: £690 + VAT

All Teac/Tascam multi-track range on full demonstration.

### ANGLE POISE MICROPHONE ARM



£14.75 + VAT

We are sole U.K. distributors of this product. Available with wall, table or clamp mounting bracket.

All prices correct at the time of going to press.

You'll find the approach quite different at Roger Squire's Pro-Audio, it's something known as service. Like other suppliers we carry large stocks (a wider range and larger than most). Yet before the point of purchase we want you to be convinced you are making the right choice.

You are invited to visit our showrooms where you will find a vast range of mixers, multi-track tape machines, microphones, monitor amps, etc. wired ready for demonstration, which together with our Technical Advisory Service is an unbeatable combination.

Should you meanwhile wish to consider the extent of our product range, it's contained in our NEW 60 page catalogue.

We would be pleased to send a copy FREE of charge upon request.



Branch Manager: Cliff Lake  
Sales Engineer: Dave Whitaker  
55 Charter St., London, NW8 6JN  
Telephone: 01-722 8111 Telex: 298133

Showrooms open - Tuesday - Saturday 10.00 am - 5.00 pm.  
Late night Weds. until 8.00 pm.  
Local parking - 5 mins. from St. John's Wood Tube.  
EXPRESS UK AND EXPORT DELIVERY SERVICE

AGENTS FOR:  
AKG · BEYER · CALREC · SHURE · TEAC · TASCAM · MM · CHILTON · CENARY · H/H · ALLEN & HEATH · BRENNELL · RECORDING STUDIOS DESIGN · HILL  
SOUNDCRAFT · OTAMI · FERROGRAF · REVOX · UHER · QUAD · AMCRON · BOSE · TANNOY · JBL · KLARK-TEKNIK · YXR · DEB · TECHNICS · RUSSCO  
STANTON · TAPECASTER



## SURVEY: NOISE REDUCTION

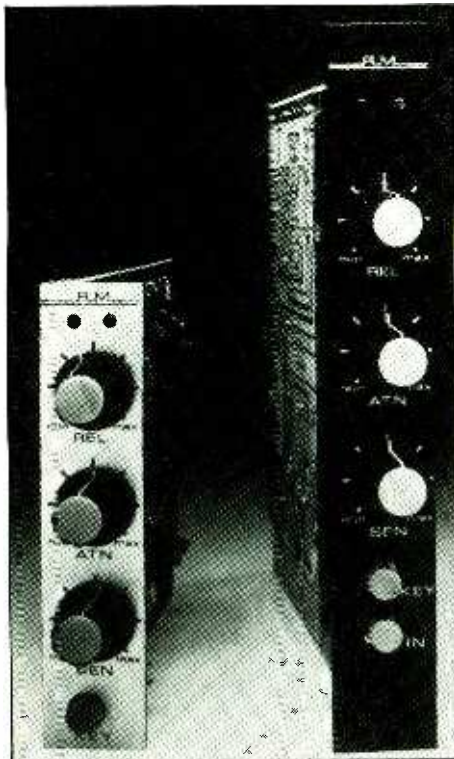

Roger Mayer noise gates

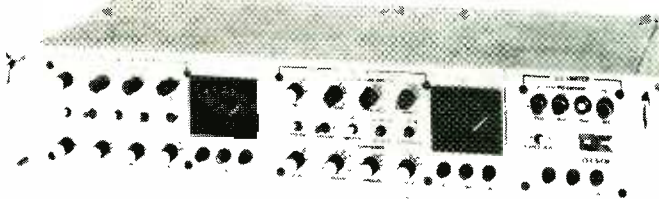

Orange County  
OCACLX processor  
including a noise  
gate/expander

### Roger Mayer cont'd

**UK:** Scenic Sounds Equipment, 97-99 Dean Street, London W1V 5RA.  
Phone: (01) 734 2812. Telex: 27939.

#### MODEL RM68

A single-channel noise gate. Also available as Model RM68X which retrofits into Kepex rack.

**Attack time:** 150 ns.

**Release time:** 30 ms to 5s, continuously adjustable.

**Frequency response:**  $\pm 1$  dB, 20-50k Hz.

**Output noise:** -96 dBm.

**Distortion:** 0.05% under normal operating conditions.

**Features:** two leds—red for gating and green for non-gating; keying input; up to 16 units fit optional card rack.

**Price:** RM68 £67; RM68X £78.

#### ORANGE COUNTY

Orange County Electronics Corporation Ltd,  
1125 Empress Street, Winnipeg, Manitoba R3E  
3H1, Canada.

Phone: (204) 775 8151.

PO Box 369, Pembina, North Dakota 58271, USA.

Phone: (204) 775 8151

For agents in Australia, Brazil, South Africa and Sweden see October '77 issue, page 40.

#### OCACLX MODULE

**Type:** single or dual-channel unit combining a compressor-limiter, expander and gate, with facility for external key. Expander slope 1:2; gate slope 1:20.

**Frequency response:**  $\pm 0.5$  dB, 5-100k Hz.

**Distortion:** 0.05% thd with no gain reduction; better than 0.1% thd at 15 dB gain reduction.

**Noise:** 89 dB with expander/gate in; 100 dB out (both at 30 dB gain).

#### SHURE

Shure Brothers Inc, 222 Hartrey Avenue, Evanston, Ill 60204, USA.

Phone: (312) 328 9000.

UK: Shure Electronics Ltd Eccleston Road, Maidstone, Kent ME16 6AU.

Phone: 0622 59881. Telex: 96121.

Agents in most countries.

#### MODEL M625 VOICEGATE

A voice-activated microphone gain controller, typically for pa applications to block out unwanted background noise below a preset level.

Price: £110 approx.

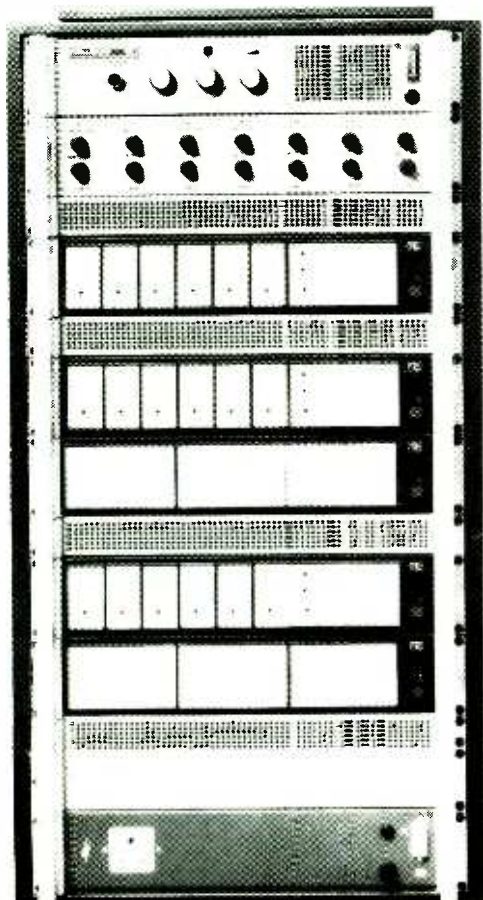

# Millbank sound systems give you power over people

An effective sound system contributes to the overall control of a number of important operating functions in any commercial or industrial premises.

Paging, staff location and internal communication, automatic announcements, pre-recorded music, radio and audible emergency warning systems are desirable – if not statutory – components in every building specification.

Millbank manufacture PAC-SYSTEM, probably the world's most flexible range of sound equipment and have an International network of specialists who will supply and, if necessary, plan and install the system to exact requirements.

Complete the coupon today and begin your bid for power!

Yes I'm ready! Send me  Information on equipment and services.

Tickets to see Millbank at Communications 78 exhibition.

Name

Address

Millbank Electronics Group Limited, Uckfield, Sussex TN22 1PS, England.  
Telephone: Uckfield 4166 (0825 4166) International 825-4166  
Cables: Euraudio Uckfield Sussex. Telex: 95505 MILBNK G.

**ME**  
MILLBANK



# SENNHEISER microphones



## the professionals

For your free copy of the 100 page Sennheiser Catalogue complete the coupon and post to us right away.

### Hayden Laboratories Ltd

HAYDEN HOUSE, CHURCHFIELD ROAD,  
CHALFONT ST. PETER, BUCKS SL9 9EW.  
Telephone: Gerrards Cross (02813) 88447

**HAYDEN**

Please send me a free copy of the 100 page Sennheiser  
Microphone Catalogue

Name \_\_\_\_\_

Company \_\_\_\_\_

Address \_\_\_\_\_

Code SS578

# work

## Now it can be told

No offence, but Stockport, Cheshire on a wet winter's day isn't too welcoming. But the locals are warm and friendly. Can you tell me the way to Waterloo Road, I asked one old chap. 'Up there past the Hip Tung Chinese Restaurant [yes, really the Hip Tung!] past the lights and over the hill.'

'You'll be wanting Strawberry Studios', he added eyeing my regulation blue denims and scruffy hair. 'Yes, but how did you guess', I played along. 'You look like one of those', he chuckled and disappeared off into the misty gloom.

The Strawberry building in Waterloo Road is equally old and unprepossessing from the outside. But to pass through its doors is to quite literally jump in sci-fi fashion to New York or California. Outside in the street it seems inconceivable that an audio masterpiece like Eric Stewart's *I'm not in love* could have been put together here; once inside it all makes sense.

There has been no shortage of reports in the past on Strawberry and how it began and where it's gone. No need here then to go over old ground. But some interesting things have happened since our last report. For a start the studio proper has been given the Tom Hidley treatment. The control room, of course, was treated years ago, and is one of the few Westlake rooms in Europe. All the rest are Eastlake. What's the difference—other, of course, than the obvious one that Eastlake is Hidley's European

operation and Westlake was American. It's hard to pin down the differences in words but the engineers working at Strawberry on the Saturday afternoon that I called last January, Dave Rohl and Martin Lawrence, mention how all the hf dispersal treatment is in front of the engineer, with a very live acoustic in front of the desk and a totally dead acoustic to the rear. Another suggestion is that in a Westlake control room there's rather more of that characteristic stone on the control room walls. But realistically, isn't it just that Tom Hidley has no set pattern for any one studio, just a guiding set of principles that are adapted to each individual location?

On the subject of 'laking', whether West or East, I took the opportunity of raising a point that had previously proved contentious. When I reported a year or so ago on some studios that *hadn't* invested in 'laking' treatment, I quoted the justification offered by those studios—namely that a flat acoustic characteristic isn't necessarily the be all and end all of studio design. To redress balance I asked Dave and Martin for their views on the value of 'laking'. It proves to be equally logical and persuasive.

'The point', they say, 'is not necessarily to have the control room acoustically flat, but to have available the reference point of an

acoustically flat control room. We bring in spectral analysers every two months and check all the equipment so that we know we have that flat starting point. From there we can deliberately change the sound in any direction—and not in a hit-and-miss manner'.

Like how? Well the monitoring system in the control room at Strawberry is currently deliberately rolled-off by around 3 dB/octave in the region 12-16 kHz. The reason? That way the engineers can mix for the 'right sound' at studio levels (which remember are far higher than domestic listening levels) but end up with a balanced sound on tape that is automatically also right for cutting, pressing and playing on domestic equipment. That slight roll-off at the top end in the studio monitoring chain will encourage the engineers to make the master tape just a little too bright at the top end during mixdowns. Likewise Strawberry has been considering a slight boost in the bass at around 50 Hz. In this way the engineers will tend to put just a little less bass on the tape than would normally be there for a 'right' sound in the control room. This slight cut in deep bass on the master tape—but not in the control room during monitoring—avoids a perennial problem: the producer who wants to hear so much deep bass in the mix that it will inevitably cause problems at the disc-cutting stage.

'The advantage of a standard room', reiterate Dave and Martin, 'is that you can doctor the room acoustics and monitoring sound to taste, and whatever way you wish; but at all times you know exactly what you are doing and you can always go back to the standard situation and start again.'

There's another point on the quality of monitoring. 'It's all too easy to OD on sound,' says Martin

Lawrence, 'when you're mixing for hours on end at high level on a good system.' This is one reason why Strawberry have an essentially domestic hi-fi system (Harman Kardon, Fons, Mordaunt-Short) permanently set up in the leisure room downstairs under the studio. This system is virtually permanently hooked up to an output of the desk upstairs. So what is being mixed on the studio monitors can be heard by off-duty musicians and engineers downstairs on the kind of equipment that is likely to be used by the general public for playing the final product.

'Laking' of the studio was only recently completed and it's impressive both in sight and acoustic feel. Dave Rohl explains the way they worked with Tom Hidley: 'Really we more or less told him what kind of thing we wanted and he produced a design that was what we wanted—except for what was impossible.' One whole wall area of the large studio is now faced with mirrors. Another wall is partially mirrored to enable engineers in the control room to see round the corner into the areas that were previously out of sight. This has answered the visibility problem without the need to introduce video monitors, and with them all the associated problems over audible whistles and electrical interference. Apart from looking spectacular—like a penthouse view over a city at night—the mirrors also have an acoustic function. Angled backwards from the vertical they throw all the arriving sound up into characteristic Hidley traps in the ceiling and behind the mirror wall. All the traps are the same: large volumes of space with slats covered in glass-fibre suspended to hang freely. The slats vibrate with whatever sound enters the trap so that it soaks up 'acoustic excess' like sponge. In a

*The control room and studio at Strawberry. The left photograph shows Dave Rohl taking a break at the wrap-round Helios 28124 console. In the other photograph Ritchie Close is gently caressing the keyboards.*

66 ►





The Soundcraft Series 3 console is ideal for 16- or 24-track recording studios demanding technical sophistication on a restricted budget.

It has all the facilities professional engineers expect, and one or two other features thrown in that should raise an eyebrow or two.

The technical specifications are excellent, partly due to a new range of integrated devices which have high slew rate, extended power bandwidth and ultra low noise. We have succeeded in using IC's throughout where previous attempts with inferior devices had failed. Look at the figures below and judge for yourself.

If you've never used a Soundcraft desk before, you're in for a pleasant surprise. They handle easily, look beautiful (that doesn't make the sound better but will make you feel better) and are very reliable. We have a comprehensive two year warranty that is rarely used.

Please ask us to send you the 8 page colour brochure which tells all, then compare the Series 3 with other consoles offering the same high standard of facilities and specification. You'll find they cost two or three times more than ours.

Just think what you could buy for the studio with the money you can save.



# Soundcraft Series 3.

- 4-band EQ, each channel with sweepable frequency
- 8 auxiliary sends.
- Auto Solo - pre fade or stereo post fade.
- Penny & Giles conductive plastic faders.
- 16-track monitor mix into mix buss.
- Channel assign to groups and stereo mix buss.
- 250 point TT patch bay.
- XLR or punch block interface.
- VU or LED array metering

THD	+4dBu line input to any line output at +4dBu, 20Hz <0.03%, 1kHz <0.01%, 20kHz <0.05% Signal at mic input with 50dB gain (200Ω at source), 20Hz <0.1%, 1kHz <0.01%, 20kHz <0.1%
Frequency response	+4dBu line input to any line output at +4dBu, 25Hz: -3dB, 20kHz: -1dB Signal at mic input with 50dB gain (200Ω at source), 25Hz: -3dB, 20kHz: -1dB
Noise	Relative input noise with 20kHz Bandwidth, < -126dBu Mixing noise, 24 channels routed to mix all at unity gain, < -80dBu (DIN audio weighted)
Input impedance	Mic input, 800Ω (1,5kΩ with pad) Any line input, not less than 5kΩ
Input gain	Maximum mic, 85db Maximum line, 70dB
Output capability	+22dBu into 600Ω



Sophisticated. Reliable. And astonishingly Economic.

Soundcraft Electronics Ltd  
5-8 Gt. Sutton Street, London EC1V 0BX, England. Tel: 01-251 3631 Telex 21198

Soundcraft North America  
PO Box 883, JFK Station, Jamaica, New York 11430, USA. Tel: (212) 528 8158 Telex 01-2203

Prices (correct at time of going to press) 24/16 £10,712 \$27,426 (FOB New York), 32/16 £13,350 \$33,986 (FOB New York). All other territories on request.

[www.americanradiohistory.com](http://www.americanradiohistory.com)

## WORK

control room this prevents sound from bouncing round the room to confuse the monitor image or produce standing waves to colour the acoustic at odd frequencies. In a studio it means that the drums can play alongside the bass with only the minimum of screens to separate them, and little risk of audio breakthrough between bass and drum tracks on the tape. The mirror wall of the studio faces a large area of wooden floor; the rest of the studio is carpeted on walls and floor alike. There is thus an acoustic division between both halves of the studio, and it's as precise as the visual division between wood and mirror on one side and carpet on the other. You can stand across that wood-to-carpet dividing line and hear a live sound in one ear and a dead sound in the other. The live sound is rather hard to describe. Although there's a strong first reflection off the wooden floor and glass mirror walls, there is very little else. The sound disappears off into the traps after its first reflection.

When I called at Strawberry the builders who had handled the studio treatment had moved off down to London to start on the Strawberry mastering/cutting room. Things were running somewhat behind schedule for the simple reason that the Stockport studio had soaked up materials, especially wood, faster than supplies could be brought through.

As previously promised we'll report on the London opening as and when it is ready. Meanwhile Strawberry in Stockport remains busy and thus faced with the problem, also previously touched on. How to remain busy as a studio without creating the potentially dangerous impression in the business that you are fully booked up for ever, so there is no point in ever trying to book. It's not just a studio problem. By the time the film *Star Wars* finally opened, the distributors had achieved the ultimate in public relations. So much advance publicity had surrounded the launch of the film that everyone assumed it would inevitably be booked solid for years ahead. So most people never even bothered to try and buy a ticket. As a result, there were seats available at many shows and punters who would have liked to have seen the film stayed home and watched tv. When I visited Strawberry it was booked solid ahead for seven months. So inevitably anyone trying for a booking in that period would be refused.

'We hate refusing work', says Rohl. 'Last year we had to turn down a McCartney album which,

of course, we would love to have done. But if we *are* booked solid there is nothing we can do. The studio runs 24 hours a day and the equipment is usually only switched off for a couple of hours at the most so there's no slack to take up.

But we don't want to give the impression that there is no point in even trying to book in here. So what to do? We can hardly put an advert in *STUDIO SOUND* saying Strawberry now has time available—immediately people would suspect the worst.'

It's a good question to which I have absolutely no good answers.

For the past couple of years Strawberry has been booked intermittently by Chrysalis on what was until recently a secret project. Now all can be revealed. Engineer Dave Rohl is also a musician (keyboards) and a writer. He worked with the band Mandala, which later became Sad Café. The record company Chrysalis asked Dave to reform Mandala and, along with his wife Gilly, he wrote a project album. In fact it is intended as the first of three albums to be released over a 3-year period, with the possibility of an animated film. The trilogy is based on a fantasy world, most conveniently compared to 'Lord of the Rings'. But Rohl is worried about both the 'project' album tag and the 'Lord of the Rings' comparison.

'Reviewers get handed out a project album and wince at the

thought', he says. I'll second that; I wince at the thought of project albums. 'Anything relating to a fantasy world gets compared with "Lord of the Rings"', he goes on. 'Which is ridiculous because Tolkien wasn't even the first in the field.' I'll second that also; it's curious how other works in the genre (like Musrum) have just never clicked in the same way.

The Rohl project—if he'll pardon the description—was due for delivery to Chrysalis by February 1 and release on April 1. 'I'm in trouble if we don't make those dates' says Dave, 'because we have got Barclay James Harvest coming into the studio directly after.'

The first album is provisionally titled *Eye of Wendor*. It stands a better than average chance of getting a first listening by reviewers, if only by virtue of its pedigree (Strawberry Studios) and its artistic line-up. The idea was to not only reform the provisional Mandala group, but expand it, as if into a club. There are now around a couple of hundred musicians in that club. All of them have worked on *Wendor*, most of the 'names' being personal friends of Dave Rohl who have worked out of enthusiasm for free.

On the disc there's Justin Hayward, Eric Stewart, Graham Gouldman, Noel Redding (who came over from Ireland specially) and Maddy Prior who was due to call into Strawberry and record on

her way down to London from the Lake District the day after I visited' There's also Kevin Godley and Lol Creme, a choir (the Northern Gerald Brown Singers) and a 30-man string section booked out of the Hallé orchestra. Because Strawberry is 24-track ('If you go above that you are inevitably into the area of computer mixing', they say) it has been no mean task to build up an album from an occasional line-up like that.

The 24 tracks soon disappear. The strings alone were recorded with one mic per stand or pair of musicians; Hayward solos with four of his own harmony tracks; then there is the choir, the backing musicians and so on. It's all added up to an engineer's nightmare with each of the 24 tracks on the A80 used to what might seem like impossibly full potential. For instance, on some tape tracks there are around nine separate items spaced in time: track one might have a few bars of flute here, a few bars of percussion there, a voice next and so on. To re-equalise and rebalance between items during a mix has meant four hands, those of Martin Lawrence and Dave Rohl, working together in preprogrammed computer fashion.

Although the critics will doubtless give *Wendor* an ear, if only because of its pedigree and participants, this won't help overcome their ever-hardening resistance to self-indulgent project albums. The long list of names on the sleeve could even work against the album. Some of the worst records ever made have come out of impromptu jam sessions by name musicians who felt all they had to do to make a good record was get stoned and play together. But an incongruous musical mix and incompetent performance sounds just that, whatever the names on the label.

I'm happy to report, on the strength of a couple of tracks heard at Strawberry, that *Wendor* seems by no means self-indulgent. What I heard was that dirtiest of all words in some circles: tuneful. It was also beautifully arranged (four separate arrangers have worked on this first album) and some tracks might even make single material. Whether anything will be released as a single, however, is quite a different matter. Although record companies are happy to have their signed stars join in for love and free on an album for a rival label, they aren't so happy to see a track from that album released as a single.

For me there is only one incongruity in the whole project. I still can't reconcile the sunny Californian sound of Strawberry with the sight of Stockport on a wet winter's day.

**Adrian Hope**



Unmistakably Tom Hidley acoustic treatment and TM-3 monitoring.



# RA200/ADS1

## Frequency response analysis with a difference

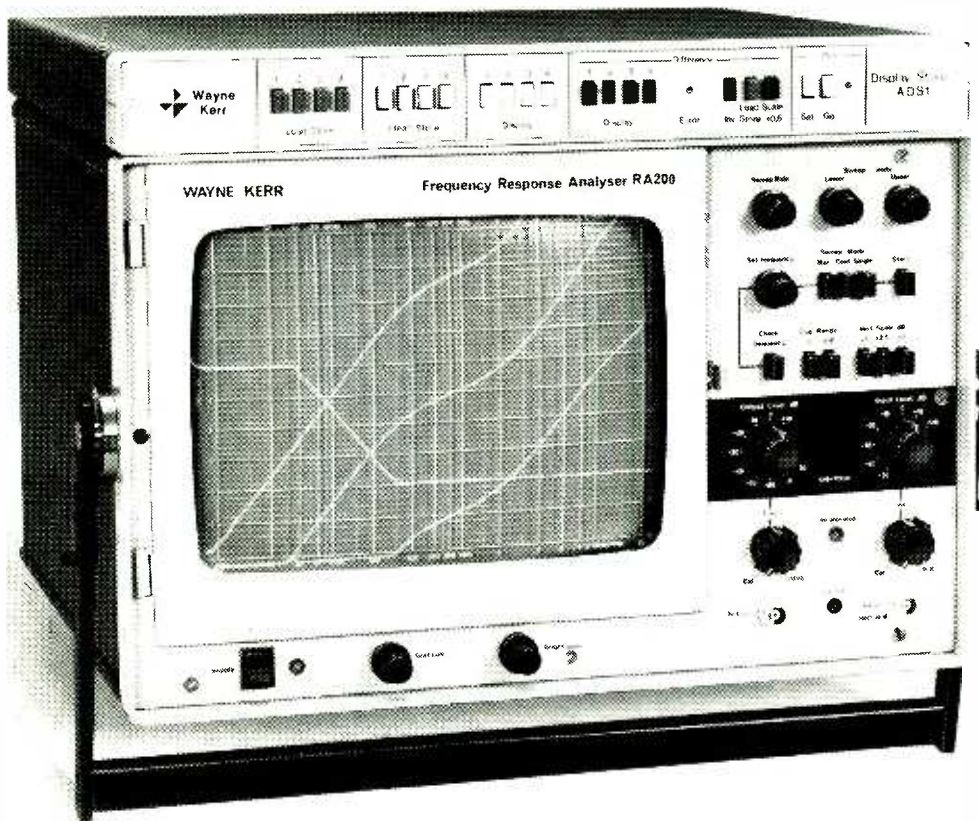

The Wayne Kerr RA200/ADS1 is undoubtedly unique. It gives fast, accurate frequency response measurements for any audio system—displaying up to five different curves as gain/frequency plots on a long-persistence CRT. The basic unit, the RA200, performs all the detector and sweep functions, requires no synchronisation, and will adjust automatically to the incoming frequency.

#### Four Channel Digital Store

The matching display store, the ADS1, is a fully compatible digital storage unit powered by the RA200, and can give continual updating of each curve stored to ensure fast, precise readouts.

It incorporates rechargeable batteries to permit stored data to be retained for up to two weeks when the unit is switched off.

#### The RA200/ADS1

This complete unit provides facilities for displaying the difference between any two stored curves, or comparison of any new input with a stored reference curve. Minor variations from a desired characteristic can be readily amplified, and departures from a linear response clearly shown as deviations from a straight line by use of the store 'invert'. Slow-acting pen recorders can also be driven by the unit.

For more details fill in the coupon or contact your nearest distributor:

Tekelec-Airtronic, Cite des Bruyeres, Rue Carle-Vernet, 92310 Sevres, France.  
Tel: 072 7535

Keithley Instruments GmbH, Heighofstrasse 5, 8000 Munchen 70, West Germany, Tel: 7144065.

G & P Electronics AG, Bernerstrasse Nord 182, CH-8064 Zurich, Switzerland, Tel: 794670.

C N Rood B.V., PO Box 42, 11-13 Cort van der Lindenstraat, Rijswijk ZH 2100, Holland, Tel: 99 63 60.

Unitronics, Torre de Madrid, Princesa 1, Piso 12 Oficina 9, Madrid 8, Spain, Tel: 241 1496.

Scandia Metric AB, Back 171 19, Solna 1, Banvakssvagen 20, Sweden, Tel: 820460.

Please send me further information on the Wayne Kerr RA200/ADS1.

Name \_\_\_\_\_

Company \_\_\_\_\_

Address \_\_\_\_\_

Tel: \_\_\_\_\_

 **Wayne Kerr**

Wilmot Breeden Electronics Limited  
442 Bath Road, Slough, Berkshire SL1 6BB England

SS5/78

## There's an old mill by the stream

By the time you've finished reading this sentence, the name Cadbury will already have produced an image in your mind of, almost without doubt (you can see I'm giving you plenty of time) . . . chocolate.

Cadbury brothers Richard and George saw the potential of chocolate when they took over their father's failing enterprise in April 1861, and built the business up so successfully that it's no wonder we associate their name with chocolate. Now, Dik Cadbury, great grandson of co-founder Richard, has launched his own enterprise that has nothing whatever to do with chocolate products or the famous company producing them. He's built the 16-track Millstream Recording Studio in Cheltenham, Gloucestershire. But far from conforming to the aloof financier stereotype one may have expected, Dik Cadbury is primarily a rock musician; quiet spoken, rather shy, and totally committed to the studio.

The setup, adjacent to a public park in central one-way Cheltenham, comprises Dik's house originally built as a mill, and opposite the detached studio building which started life as the grain warehouse. The old mill stream runs between the two. Halfway up the narrow access road is a small but adequate car park. The studio idea came about almost by accident. 'I bought the house first,' explained Dik, 'and at that stage the warehouse, which had been used by two potters for some time, was up for sale as a pottery studio. To begin with I was looking for somewhere to rehearse: I didn't have a garage or a garden to build on, so I had a look around the pottery studio. I soon realised that the premises would need a lot of doing up, which would be expensive; so I would have to hire the place out as a rehearsal space, to pay for the renovation. Then it occurred to me that a greater return could be gained by converting the premises to a full studio capability, for a proportionately lower investment, taking into account the extensive sound-proofing necessary when building a rehearsal space. I then started to investigate the viability of the idea, and it all snowballed from there.' An architect was engaged, and work started in December 1976.

The studio building has been largely rebuilt and completely modernised both inside and out. Two independent air conditioning systems were fitted, regulating the studio and control room respectively, and the beige and chocolate (don't be daft—not *real*

chocolate) decor is complemented by dimmer-controlled lighting.

The 32m<sup>2</sup> studio has a length-to-width ratio of around 2:1 with a low ceiling along roughly half the length, above which is the control room. The 20m<sup>2</sup> control room 'looks' into the studio underneath via a double glass panel and two large mirror panels mounted at an appropriate angle on the facing studio wall. A staircase connects the two levels, at the top of which is a coffee-making area and toilet. A payphone is conveniently situated at the foot of the stairs, alongside the studio entrance which is directly opposite the main building entrance.

Back in the studio, the hessian-faced walls conceal the talkback speaker, and the two reverse talkback mics connected in series situated at either end. The wall is built up on a 10 cm wooden frame supporting a random density *Rockwool* filling of between 5 and 10 cm thickness. This is supplemented by polythene sheet panels positioned at random underneath the hessian facing over 30% of the total wall area. The ceilings are coated with random perforated fibre-board. 'Our studio consultant was Roger Peyton,' said Dik, 'who's a very good bloke—he advised us on acoustical finishes and materials, suggested equipment, wired it in, and modified it where necessary. He's also our flying doctor if we ever experience serious technical problems.'

The resident technician and second engineer is Jonathan March, who was the road engineer when I was with the Decameron band. He installed all the wiring and just about everything else, besides keeping all the equipment in good running order. He's recently made some isolation screens, should we ever need them.' (The four wooden framed screens were of a standard design; *Rockwool* filling with hessian one side and gloss painted chipboard the other.) 'Since we opened in December last year, we've achieved superb separation just by close miking and careful positioning. But I wanted the screens so that we were ready for a wide variety of recording requirements.' By positioning the vertical screens across the room's width the studio can be acoustically cut in half, visibility being maintained by perspex panels in the top sections of the screens. 'Were areas designated for particular instruments?' I asked. 'Not specifically,' returned Dik. 'The low ceiling area is naturally more "dead", and so tends to be

used for drums. But we had a punk band in recently and the drums sounded better, in the punk sense, out in the "brighter" high ceiling area.'

In common with the control room hardware and wiring, the studio is plumbed for 24-track capability, between two 12-input mic panels. 'Right from the start we wanted to be sure we could expand easily,' commented Dik. Lavish servings of foldback decorate the walls at regular intervals, the panels housing a level pot and channel selector: 1 + 2 (stereo), 3 and 4. Beyer *DT100* cans hang on adjacent hooks. 'The armoury of mics, ranging from AKG *C414* and *C451* to Beyer *Soundstar* and Shure *SM58* all have their place, says Dik. And when the sun sets slowly in the west, that place is the store cupboard under the stairs which, if need be, could be quickly converted into a booth.

We left for the control room. On my way out, I was surprised to see a clock on the wall, a detail many studios prefer to omit! Both studio and control room doors were packed with *Rockwool*, and carpet faced on the operating side. Rubber seals on the frame cosseted the door on closure; this is effected by a slot in the frame of a few degrees off vertical and a sprung peg in the door actuated by a conventional lever handle. The combination thus operated on the linear screw principle. My criticism would be that to close you pushed down, and to open you pulled up; very confusing after a lifetime of doing it the other way round!

In the control room, Tannoy

*HPD* monitors hang from runners mounted in a slide spanning the width of the room, an X-Y gimbal arrangement permitting omnidirectional adjustment of monitor angle. These are powered by Turner *A500* amps installed in a standard rack system, which would otherwise have been empty, in an opposite corner. 'We hope to pack the rack with goodies like a Marshall *Time Modulator* and Rebis stereo compressor once the cash flow improves', said Dik, a man who does not lack foresight. A better example of his philosophy lies in the desk built by Solid State Logic which is kitted out for 16/16 operation. The desk takes the form of two 16-track capability input areas (only the left one being used) and an output, talkback, monitor select and mode-select central area. 'We installed this desk on the advice of Roger Peyton, making sure we could go up to 32/24 without buying a whole new frame, hence the blanked area on the right.' The desk came from Acorn Studios, whose manufacturing division is, in fact, Solid State Logic Ltd. Acorn are at present updating to 24-track with a completely new desk. Millstream's desk is apparently the first of its kind, and its compact appearance can be misleading. Each channel, costing the same as a Neve counterpart, boasts compressor/limiter (four of which are fitted), parametric eq, in-line monitor mix on faders, and solid state 32-channel input/output patching. Dik is keen to install vca fader grouping which can be simply plugged in (once again when funds permit).

The interior of Millstream's control room with the Scully 16-track sulking in the corner.





A patch panel fitted in the desk provides breakjack access to all inputs and outputs, and is consequently always in circuit. Studio vision is over the shoulder via the aforementioned double glass and mirror system, while primary tape machines stand to the right. These are the Scully 16-track and Studer B62. Above, high speed Revox A77, Beogram 1902, and Pioneer (cassette) CTF 2121 machines, plus a 24-track Dolby unit are shelved. At present the Dolby operates on the Studer and Revox machines

only, but the plan is to Dolby the Scully soon, (the Pioneer cassette deck is fitted with integral Dolby B). The high speed Revox has been modified with a 14-turn vernier varispeed pot (!), permitting 100 per cent speed increase. Needless to say, the Revox machine's prime function is to provide time-based effects, but it also doubles for copies. Not all studios provide a transcription deck, and I put this to Dik. 'Our concern is to provide as complete a service as possible to the client. When installing the Beo-

gram 1902, which we considered was the best of its kind available, we knew that if and when clients brought test pressings in, we could check that stage rather than stopping at the master tape stage. We want people to look at the place and think, they've taken some trouble, they mean business; they haven't bought Otari or Teac, they've gone for the 'big' names with a proven track record, like Scully and Studer, albeit secondhand. And we took pains to achieve a high standard environment. A lot of 16-track

studios in London that I've visited are very unpleasant to work in. They've got most of the gubbins, but really they're just holes in the ground when it comes to comfort. We've aimed to provide a pleasant alternative, still offering a high standard of quality.'

The resident engineer is John Acock, who spent a number of years at De Lane Lea, moving with them to The Music Centre in Wembley. He has an impressive track record, including work with Showaddywaddy and Steve Hackett (ex Genesis), for whom he has just finished engineering and co-producing an album in the States. 'Basically I've followed a policy of choosing experts carefully, and trusting them,' said Dik. 'I've every faith in John's basic ability as an engineer, as have a lot of other people. And Jonathan March, although he hasn't the same experience as John, is a competent second engineer with a natural technical gift. So I think my trust will pay off.' And how does Dik fit into studio operation, apart from holding the vital purse strings? 'I see myself as being more active on the artistic front,' Dik replies, 'moving ultimately into the area of production. I session in the studio on guitars and backing vocals sometimes, and help out on the desk. Other than that, I try to keep the whole thing together and make sure people get what they want.'

What of plans for the future? 'Our first priority is, naturally, to get studio bookings flowing healthily'. (Dik again) 'We've had interest shown by a record company whose acts are locally based, and we've just started contacting musician friends and associates. Once the studio picks up we could look at other ideas like launching our own label. But for the moment, we're aiming at the middle recording market. Studios in the area—names that spring to mind are Rockfield, Chipping Norton and The Manor—are all 24-track and charge much more per hour than we do. I think there must be a lot of musicians working in this area who don't want to spend that sort of money but want a high standard of quality without having to use a middle market studio in London.'

So Cheltenham, famous as the home of National Hunt Racing, Cheltenham Ladies College and (allegedly) gout-ridden ex-colonels, is all set to be put on the more modern maps as the home of a compact, comfortable 16-track recording studio. 'The next six months will tell me whether I'm right or not,' concluded Dik, '... but I think I am.'

**Richard Dean**

A feature of the Solid State Logic 16/16 board is the solid-state patching controlled by the rotary switches at the base of each channel module.

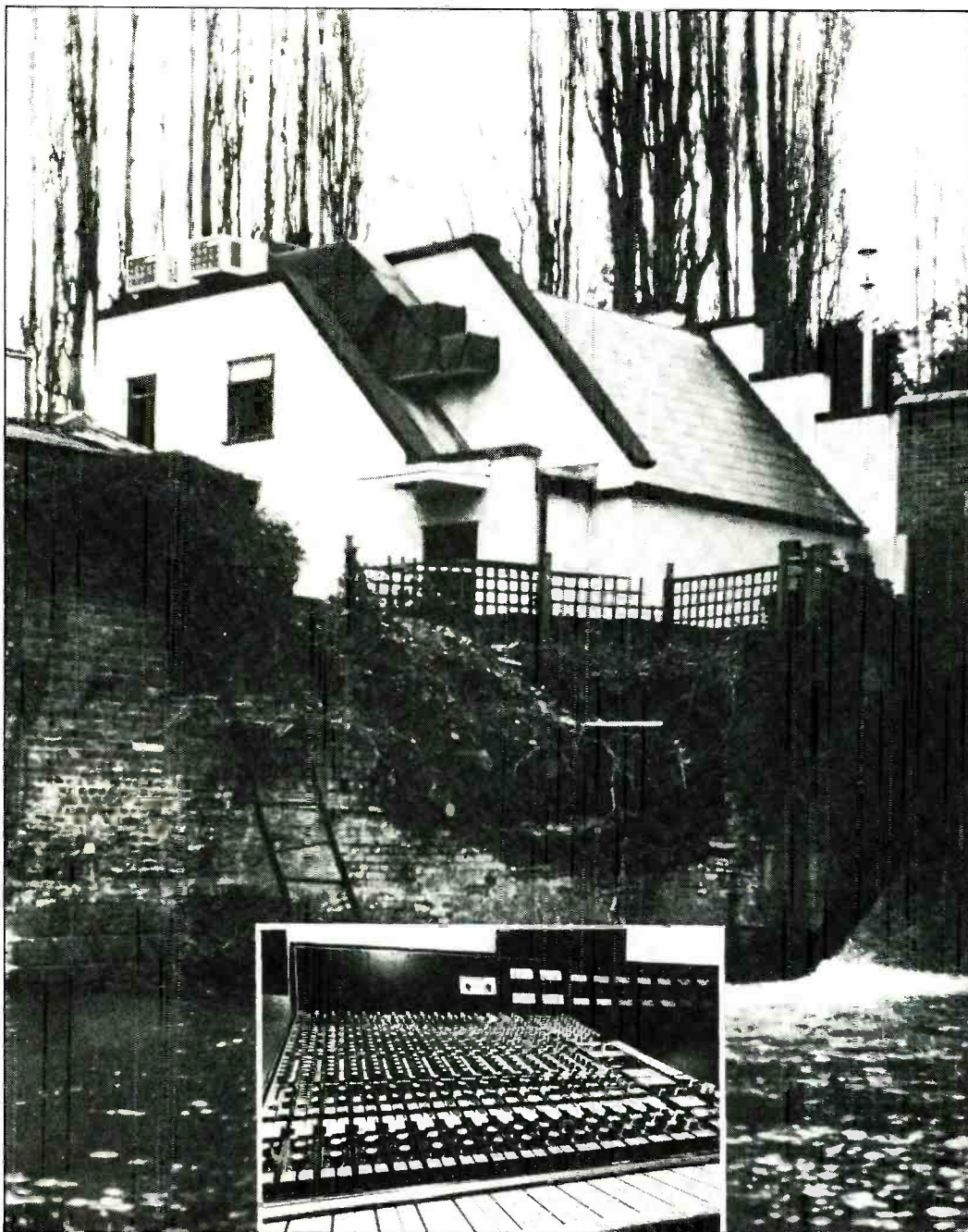



# EVENTIDE CLOCK WORKS

## MODEL 1745 M DIGITAL DELAY

Electronically controlled reverberation and delay effects are a reality today with the Eventide *Model 1745M Digital Delay System*. Unequalled versatility and portability combine with studio quality specs to provide the optimum solution to any delay line requirement. Pitch change card optional.

## HARMONIZER

The Eventide *Harmonizer* may well be the most versatile special effects instrument ever packaged in a single chassis! Judge for yourself it's a full-fledged Digital Delay Line including a pitch changer with a 2 octave range. An anti-feedback unit allows boosting sound levels. It can be used to speed up and slow down tapes and can create some of the wildest effects on record.

## INSTANT FLANGER

Old model phasing units used analog circuitry to modify the frequency spectrum. Eventide's *Instant Flanger* uses a true time delay circuit, producing many more nulls and thus a much deeper effect than previously available with an all-electronic unit.

## OMNIPRESSOR

The Eventide *Omnipressor* is a professional-quality dynamic modifier, combining the characteristics of a compressor, expander, noise gate, and limiter in one convenient package. Its dynamic reversal feature makes high level input signals lower than corresponding low level inputs.

## The choice of these professionals

Advision · Air · Anvil · Audio G.M.B.H. (Ger)  
 · Audio International · B.B.C. · Balkanton  
 (Bulgaria) · Basing Olford · Berwick Street · C.B.S.  
 (UK and Ger) · Central Sound · Chalk Farm ·  
 Chappels · Chipping Norton · D.J.M. ·  
 Deutsche Grammophone (Ger) · Dureco  
 (Holland) · Eddie Olford · Eden · Eel Pie · Elton  
 John · Emerald Records · Essex Music · Freddie  
 Starr · G.T.B. (Ger) · Gentle Giant · George  
 Harrison · Good Earth · Gooseberry · Heriot  
 Watt University · I.B.C. Island · Island Records  
 · K.P.M. · Kingsway · Lansdowne · Led  
 Zeppelin · Look Records · M.E.H. · Maison  
 Rouge · Majestic · Manor · Marquee ·  
 Mathew Fisher · Mill Studios · Morgan · Music  
 Centre · Olympic · Orange · Phonogram  
 (Holland) · Pink Floyd · Polydor (UK and Ger)  
 · Power Play (Swiss) · Pye · R.A.K. · Radio  
 Edinburgh · Radio Zurich · Rampart · Record  
 Star (Ger) · Rhett Music · Riverside · Rockfield ·  
 Roundhouse · Sarm · Scorpio · Signford ·  
 Studio 70 (Ger) · Sweet · Tal & Ton A.B. (Den)  
 · Tapestry · Trident · T.W. Music · Ulster  
 T.V. · Utopia · Union (Ger) · Velvet Music ·  
 Wessex

For details on prices and hire facilities contact



**Feldon  
 Audio  
 Limited**

126 Gt. Portland Street,  
 LONDON, W.1. 01-580 4314  
 Telex: London 28668

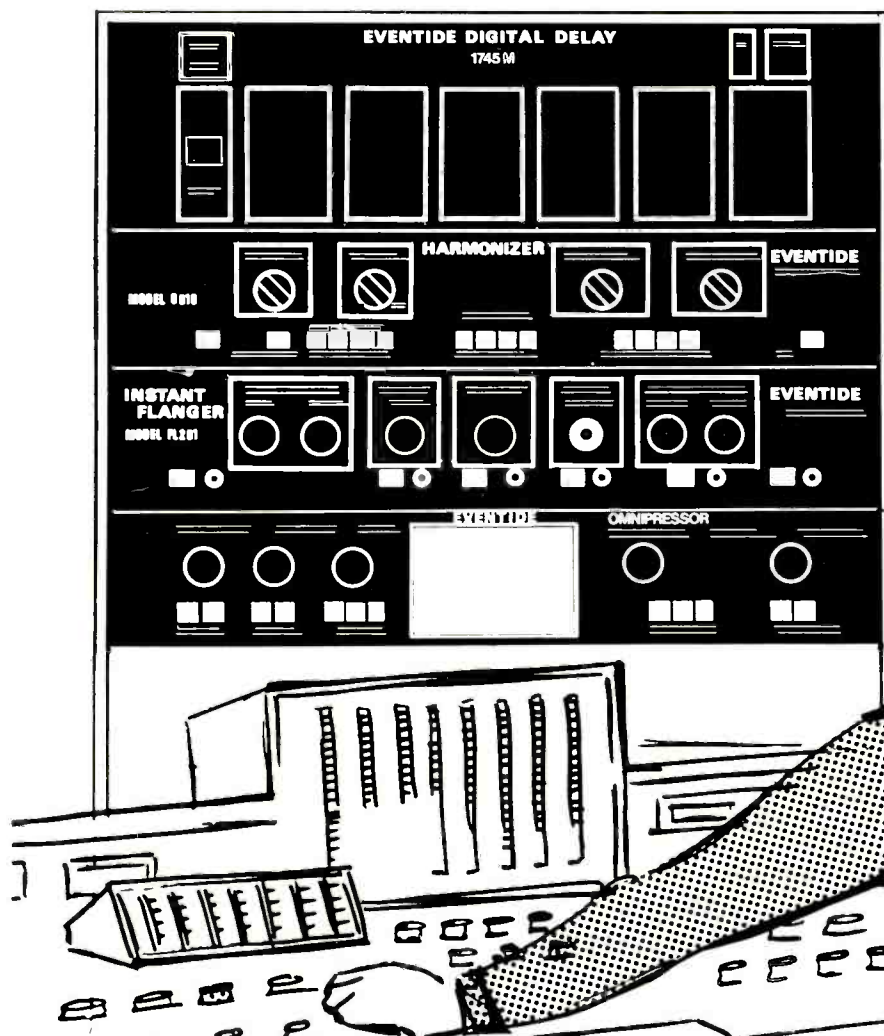



**RUGGED  
RELIABLE  
CONSISTENT**

**ITC -the first name in cartridge machines**



Every professional broadcaster is acutely aware of the need for a NAB cartridge machine that has been specifically designed for continuous use, long life and minimal maintenance in the heat of a frenzied studio.

That's why ITC build their machines with rugged features . . . like a warp-free deck plate, hewn from a  $\frac{1}{2}$ " slab of hardened aluminium.

It's therefore not surprising that ITC machines have proven so reliable in numerous broadcast stations on both sides of the Atlantic. To ensure a performance this consistent, every new model is tested to withstand more than a million stop/start operations without failure or need of adjustment.



SP

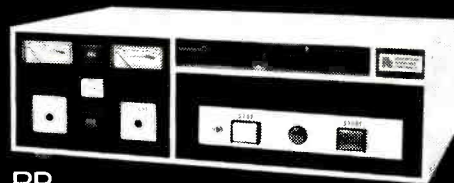

RP



PDII

The ITC range includes single reproducers, recorder/reproducers with optional high-speed cue and motorised record azimuth, plus the PD II economy mono-only reproducers and recorders.

**F.W.O. Bauch Limited**

49 Theobald Street, Boreham Wood, Herts WD5 9RZ Telephone 01-953 0091

# reviews

## dbx K9-22, Dolby Cat 22 and Telcom c4D noise reduction systems

Hugh Ford

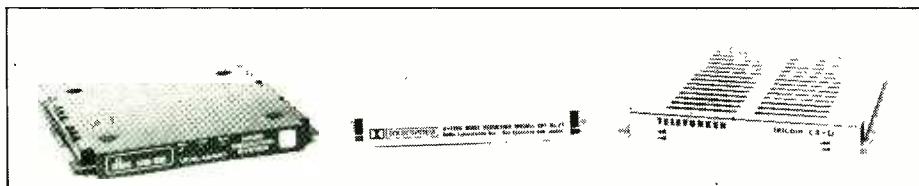

### MANUFACTURER'S SPECIFICATIONS

	dbx	DOLBY	TELCOM
<b>Input</b>	>300k ohm.	10k ohm balanced floating.	—
<b>Input level:</b>	350 mV for 0 dBm.	350 mV min for 185 nWb/m (0 vu).	300 mV.
<b>Output:</b>	less than 1 ohm.	20 ohms for load $\geq 200$ ohm.	—
<b>Output level:</b>	+22 dBm max into $\geq 200$ ohm load.	+22 dBm max bridging +21 dBm into 600 ohm +20 dBm into 200 ohm.	+22 dBm maximum.
<b>Frequency response:</b>	+0, -0.75 dB, 30-15k Hz	$\pm 1$ dB, 30-20k Hz.	30-20k Hz.
<b>Total harmonic distortion:</b>	0.1%.	At +8 dBm <0.1% @ 1 kHz <0.2% 40-20k Hz.	$\leq 0.2\%$ .
<b>Noise reduction:</b>	>30 dB.	10 dB, 30-5k Hz rising to 15 dB @ 15 kHz.	—
<b>Overall noise:</b>	>-80 dBm at input.	record/replay 80 dB, ref 185 nWb/m 20-20k Hz.	$\geq 94$ dB signal-to-noise.
<b>Signal delay:</b>	16 $\mu$ s.	24 $\mu$ s code or decode.	—
<b>Phase error</b>	<5°, 20-20k Hz.	<5°, 20-20k Hz code or decode.	—
<b>Record/replay accuracy:</b>	$\pm 1$ dB/20 dB.	$\pm 1$ dB, 30-20k Hz.	—
<b>Compression ratio:</b>	2 : 1.	2 : 1 maximum.	1.5 : 1.
<b>Number of bands:</b>	1.	4.	4.
<b>Internal oscillator:</b>	none.	Dolby tone.	Telcom tone.
<b>Price:</b>	£155.	£220.	£367 (approx.)

**STOP PRESS** Since figure 1 (the block diagram of the dbx system) was prepared, we have been told that information in the handbook from which the figure was derived contained several inaccuracies. In particular, the upper bandpass filter (from 'record') in the figure should be labelled as having a range 22-32k Hz, and the range of the lower one 11-22k Hz. Consequently, the range of the bandpass filter in the replay side of the system should read 11-22k Hz.

ALL three of these noise reduction systems consist of plug-in boards which fit into the common Dolby noise-reduction system mainframes, such as the 360, 361 or M-Series units. The intention is that the type of noise reduction system in use can be changed by just fitting alternative boards, which all draw their power from the Dolby mainframe. Similarly, the input and output signals use mainframe components such that it is first necessary to align the mainframe gain controls for use with Dolby. In fact, the Telcom system doesn't have any user controls, while the dbx K9-22 card has three multitrack gain controls for the record, play and bypass modes.

All three systems use good quality components mounted onto double-sided printed circuit boards, with the Telcom system having far more components than Dolby or dbx. While neither Dolby nor Telcom systems have any preset controls, six factory preset controls are to be found on the dbx board, in addition to the three user controls already mentioned.

As will be seen from the following description of the principle of operation of the three systems, there are substantial differences in the degree of noise reduction and the means by which it is obtained.

### dbx K9-22

Fig. 1 is a block diagram of the dbx system in the record and replay modes. Both modes use the same circuitry that is switched in order to achieve the record or the replay sequences shown in the diagram.

In the record mode the input signal is first passed through a bandpass filter, which has -3 dB points at 22 Hz and 32 kHz to eliminate spurious signals outside the audio frequency band affecting the compression of the wanted audio signal. It is then passed through a pre-emphasis stage that boosts high frequency signals by 12 dB. This pre-emphasis, together with a reciprocal de-emphasis in the replay mode, reduces the degree of modulation noise in the higher frequencies. This is based on the principle that modulation noise associated with even low frequency tones is wideband noise. Noise at frequencies near the tone will be masked by the presence of the tone itself but the higher frequency noise will not be masked. Hence the pre-emphasis will reduce the effect of the high-frequency modulation noise associated with lower-frequency tones.

The band-limited and pre-emphasised signal is then passed through a voltage-controlled amplifier to tape the gain of the amplifier being controlled such that the signal to tape is compressed 2 : 1. The control signal to the voltage-controlled amplifier is derived from the signal-to-tape by first passing this through a 11-22k Hz bandpass filter. This removes unwanted out-of-band frequencies, particularly in the replay mode where excessive high-frequency response of the tape machine could cause mistracking of the decoder.

The 'clean' signal is then subjected to further pre-emphasis to compensate for the earlier signal pre-emphasis, and then fed to a true rms detector from which the control signal for the voltage-controlled amplifier is derived.

With the exception of the input filter, identical components are used in the replay mode. But in this instance the rms detector controls the voltage-controlled amplifier as a 1 : 2 expander,





## AUDIO MEASURING INSTRUMENTS

### NEW ITEMS

#### DMS4 Distortion Measuring Set. Precision

#### DMS5 Distortion Measuring Set. General Purpose

The DMS4 is a precision instrument intended for laboratory use, capable of measuring total harmonic distortion to better than 5 parts per million (0.0005%).

The DMS5 is intended for general purpose use in the studio, test department, or factory and can measure to 0.001% T.H.D.

Both instruments cover the frequency range 10Hz-100kHz and are semi-automatic nulling. The instruments will operate from any signal source. Nulling to zero is automatic after the DMS has been accurately tuned to the test frequency. The instrument will thus continually read distortion whilst adjustments are made to equipment under test providing the test frequency is not changed.

### EXISTING ITEMS

#### LDO3 Low Distortion Oscillator

A continuously variable frequency laboratory oscillator with a range 10Hz to 100kHz having virtually zero distortion over the audio frequency band with a fast setting time.

#### Specification:

Frequency range: 10Hz to 100kHz (4 bands)

Output voltage: 10V r.m.s. max.

Output source resistance: 150 ohms or 600 ohms (unbalanced)

Output attenuation: 0-100 dB (eight 10 dB steps plus 0-20 dB variable)

Output attenuation accuracy: 1%

Sine wave distortion: Less than 0.001% 10Hz to 10kHz (typically below noise of measuring instrument)

Square wave rise and fall time: 40/60 n.secs.

Monitor output meter: Scaled 0-3, 0-10 and dBv or dBm

Mains input: 110V/130V, 220V/240V

Size: 17in. (43cm) x 7in. (18cm) high x 8½in. (22cm) deep

#### LDO3B Low Distortion Oscillator, balanced output

As LDO3 but additionally fitted with output amplifier and screened transformer providing a 600 ohm floating balanced output and 150 ohms unbalanced Unbalance: -80 dB 1kHz, -60 dB 10kHz.

#### ANM1 Audio Noisemeter, average sensing

#### ANM2 Audio Noisemeter, true r.m.s. reading

#### ANM3 Audio Noisemeter, Quasipeak/true r.m.s. reading

The noisemeters have 16 measurement ranges from 10µV f.s.d. to 300V f.s.d. incorporating a 5in. minor scale of excellent linearity calibrated in Volts and dBv or dBm. The instruments are in accordance with DIN 45.405 and incorporate recommended weighting characteristics.

#### Brief Specification for all noisemeters:

Frequency response as voltmeter: 4 Hz to 250 kHz, ±0.5dB

Input impedance: 1 M ohm shunted by 30 pF

Attenuator accuracy: 0.25%

Meter scale linearity: 1%. Typically better than 0.5%

Waveform error in true r.m.s. instruments: ±1% for crest factor 10

Noisemeter included weighting characteristics: WIDE BAND (flat response voltmeter)

DIN 'AUDIO BAND'

IEC/DIN 'CURVE A'

CCIR

Size: 11½in. x 7½in. x 8½in. deep overall (28 x 18.5 x 22cm.)

## RADFORD LABORATORY INSTRUMENTS LTD.

Ashton Vale Road, Bristol BS3 2HZ

Telephone 0272 662301

USA Patrick McVay. Tel. 201 746 5461



## NEW GENERATION MIXERS

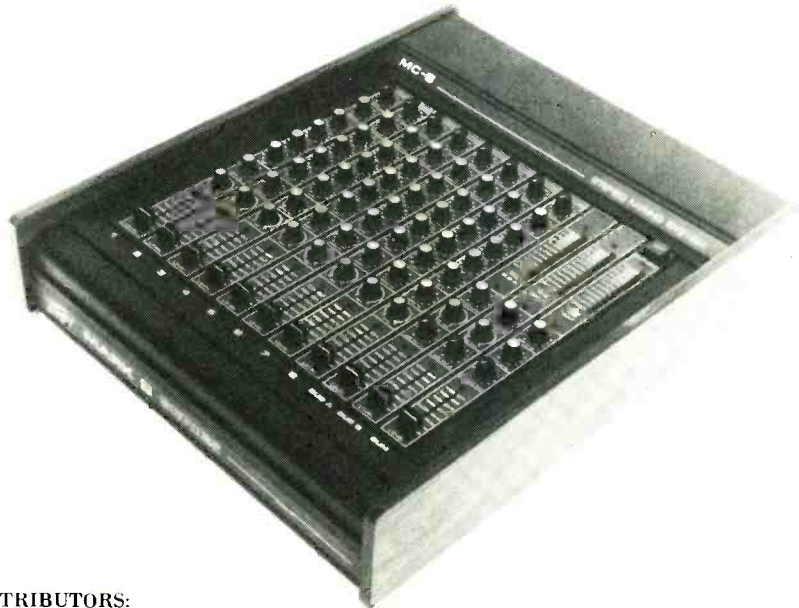

SEND  
NOW  
FOR  
FULL  
DETAILS

UNITED KINGDOM AND EIRE DISTRIBUTORS:

## PEAVEY ELECTRONICS (UK) LTD.

UNIT 8, NEW ROAD, RIDGEWOOD, UCKFIELD, SUSSEX TN22 5SX

## REVIEWS : NOISE REDUCTION

thus restoring the original signal levels. As a result of phase shifting in the tape machine it is likely that the peak levels of the audio waveform will be distorted. Hence the use of an rms detector (which is not peak sensitive) is a very important feature of the dbx system.

### Dolby Cat 22

As can be seen from fig. 2, the Dolby system has little similarity with the dbx system. In particular the Dolby system splits the audio frequency spectrum into four frequency bands, each of which has its separate control system. Referring to fig. 2 it can be seen that the input audio signal is first passed through a 30 kHz lowpass filter to remove unwanted high-frequency signal that could affect the control system. The audio signal is then passed via a subtractor and an adder to the signal output, the noise reduction signal being added to the input signal in the record mode or subtracted from the input signal in the replay mode.

The output signal from the subtractor is passed through four separate chains, each of which produces a noise reduction signal for a particular frequency band and has rectifier time constants to suit. The top chain in fig. 2 covers frequencies above 9 kHz, the next frequencies above 3 kHz and the bottom chain covers 80 Hz to 3 kHz by adding the below 80 Hz and the above 3 kHz bands, and subtracting this signal from the unfiltered signal.

Each band then has its own voltage-controlled amplifier that is controlled by the output from an 'average' rectifier. This has peak clipping and an optimised attack and decay time appropriate to the particular frequency band.

The four outputs from the voltage-controlled amplifiers are then added to form the noise reduction signal. This signal is not linear with relation to the input level of the four noise reduction chains, such that at both high and low signal levels there is no compression or expansion. At intermediate signal levels, however, the Dolby system acts as a 2 : 1 compressor or expander.

In order to locate this 2 : 1 part of the input/output characteristic at the correct signal level when decoding signals from tape, level standardisation is essential. Thus there is a built-in oscillator for recording the characteristic 'Dolby tone' onto tape, where 'Dolby level' is standardised at 185 nWb/m or Ampex operating level.

One large advantage over dbx system is that the Dolby system uses band splitting, such that the noise variations with signal level are restricted to the frequency band in which the signal exists. Thus noise is masked by the signal itself with the Dolby system, while with the dbx system the noise variations with signal level are wide band and not masked. On the other hand the dbx system offers a much larger noise reduction capability.

### Telcom c4D

In some respects the Telcom system is a mixture of the dbx and Dolby systems, in that it is a band-splitting system like Dolby but with a constant compression/expansion curve that eliminates the need for accuracy in level settings.

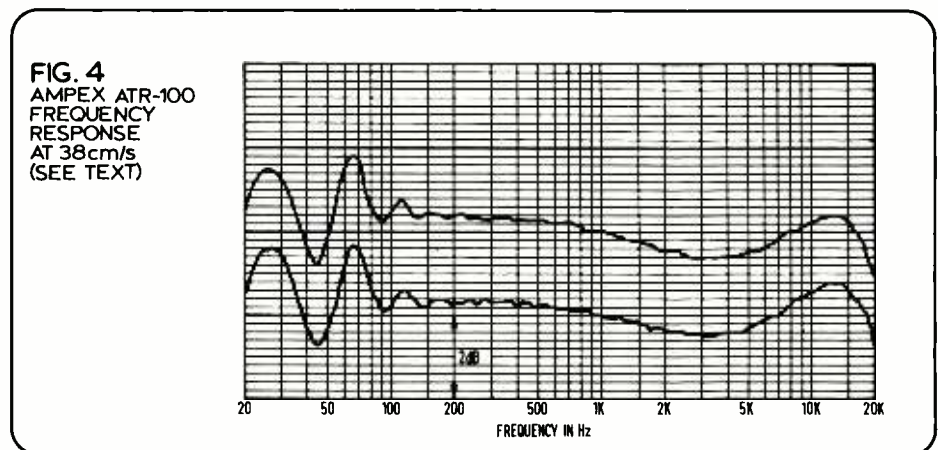
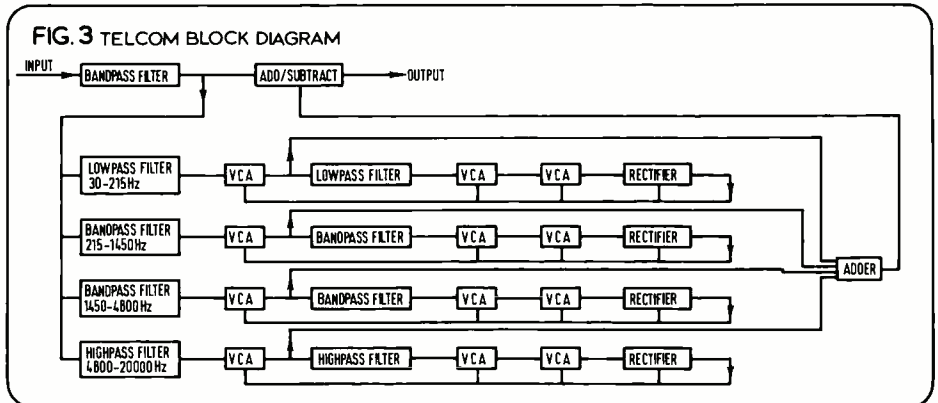
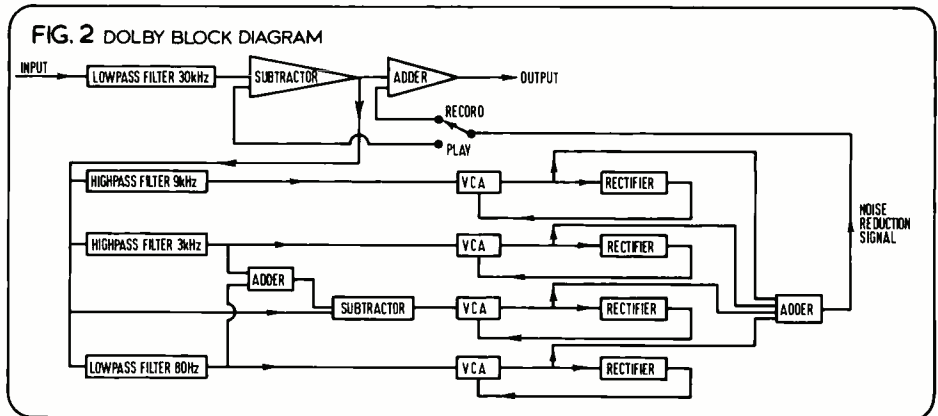
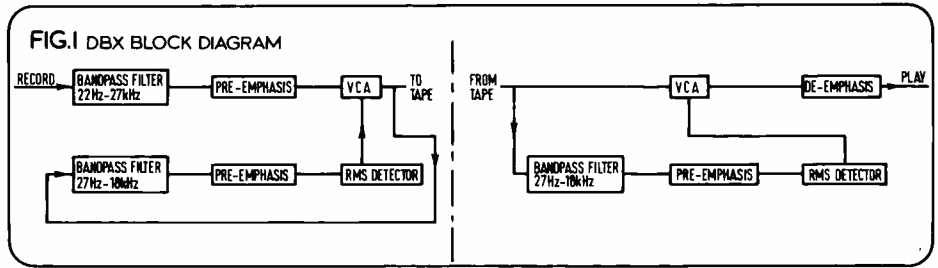



**Amber4400A multi-purpose test set.**  
**Next to your Oscilloscope, perhaps the most powerful test instrument you can own.**



Amber 4400A Test Set. UK list £2350 (Oscilloscope not included)

The Amber model 4400 Multipurpose Audio Test Set—a powerful, comprehensive test instrument combining in a single package almost all the test and measurement facilities needed for professional audio testing.

Use it to plot the frequency response of a tape recorder, a microphone or a speaker. Look at the slope characteristics of a filter or equalizer. Equalize a monitor system, measure the crosstalk in a console, check the gain of an amplifier or plot the phase response of a preamp—the 4400 will give you a fast, concise and accurate picture of the performance of a piece of equipment.

It incorporates a function generator with low sine wave distortion, 10 octave log

sweeper, tone burst generator, noise generator and high power (over +30 dBm) output amplifier. It has an auto-ranging digital dBm meter with over 150 dB measurement range, a frequency counter, a multifunction filter that can be used as a spectrum analyser and four digital memories that give you X Y frequency and phase response plots on any non-storage oscilloscope.

A fantastic time saver both in new product development and regular equipment maintenance. If you're involved in professional audio—acoustics, studio equipment, tape recorder maintenance, whatever—find out what the incredible Amber 4400 can do for you.



Sole UK Distributor  
 Scenic Sounds Equipment  
 97-99 Dean Street  
 London W1V 5RA  
 Telephone 01 734 2812, 3, 4, 5  
 Telex 27 939 SCENIC G

**amber**

Manufactured by  
 Amber Electro Design Limited  
 1064 Cliff Road  
 Montreal, Canada H3E 1H4  
 Tel: (514) 769 2739

Exclusive export agent  
 Gotham Export Corporation  
 741 Washington Street  
 New York, New York 10014  
 Tel: (212) 741-7411  
 Telex: 12 9269

Oscilloscope photographs of some typical examples of plots made using the 4400 and an oscilloscope

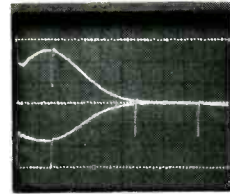

Swept sine wave frequency response plot of the reciprocal action of a low frequency equalizer. The small negative spikes are markers at 62Hz, 1kHz and 8kHz. The amplitude window between the top and bottom reference lines is 30dB. The horizontal axis is log 20Hz to 20kHz.

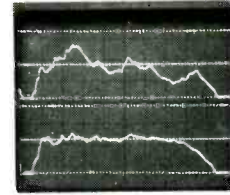

Frequency response of the speaker and room in a monitor system. The top trace with 40dB window between reference lines is before equalization, the bottom trace after equalization. The source was pink noise and the plots were made using the spectrum analysis mode with a 1/3 octave bandwidth.

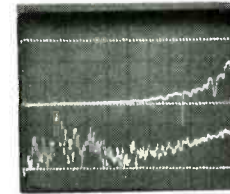

Spectral analysis of the noise floor of a tape recorder playing back an erased tape. A 2% filter bandwidth was used. Bottom reference line is -90dBm top -30dBm. Second trace is phase shift versus frequency between two reproduced tracks. Top reference line is +180°, middle 0° and bottom -180°. The marker is at 4kHz in the 20Hz to 20kHz sweep.

**Probably the best cassette sound you've ever heard**

Large runs for record companies and smaller runs for studios all given the same precise attention with regard to quality and speedy turnaround. **Blanks wound any length.**

Collection and delivery service door to door for both cassette and master tape copying.



**SOUND RECORDING PLANT**

Contact Dave Rees at 061-795 7666 to discuss your requirements.

**A BRAND NEW FOUR CHANNEL COMPRESSOR/LIMITER from CATHEDRAL**

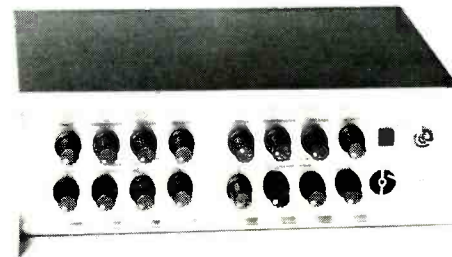

Four identical compressor/limiters, completely self powered, in high quality instrument case.  
 Low noise, low distortion.  
 Ideal for four-track studio, and many recording applications.  
 Very low crosstalk.  
 Ensures accurate levels and gives maximum 'punch' to your recordings.  
 Competitive price.

**CATHEDRAL SOUNDS LTD.**  
 FOURWAYS, MORRIS LANE, HALSALL, ORMSKIRK  
 LANCS. L39 8SX  
 Telephone: Halsall (0704) 840328

# IF YOU NEED JACKFIELDS WHY NOT TALK TO THE SPECIALISTS?

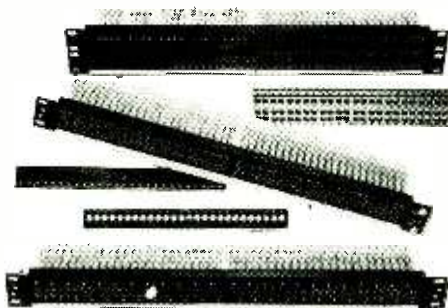

## PANELS AND ASSEMBLIES

No supplier offers a wider range of panels, inserts and accessories for just about any configuration. And you can get them in any stage of assembly . . . individual components, sub-assemblies, or complete pre-wired and connectorised assemblies ready to install. Our Bantam range gives a space saving of up to 50 per cent.

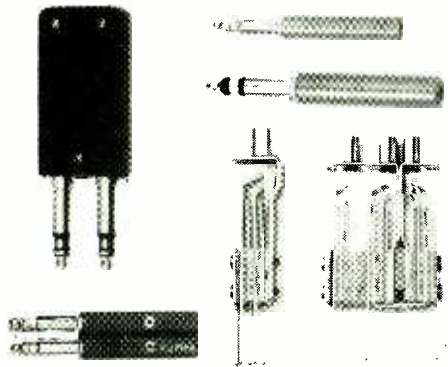

## JACKS AND PLUGS

Singles, twins, back-to-back, 2+1, patch and switchboard cords, in long frame and Bantam, and our new Printed Circuit Board Jacks. Most standard types are available for immediate off-the-shelf delivery.

For further information on these and our range of B.P.O. type components, telephone or send the attached below to:

## C.A.E. LIMITED

70/82 Akeman Street, Tring, Herts. HP23 6AJ

Tel. (044 282) 4011 Telex: 82362 BATECO G

Please visit us at Stand 4332 at Communications '78 Exhibition.

Please send us copy of current catalogue

NAME .....  
COMPANY .....  
POSITION..... Tel.....  
ADDRESS .....

## REVIEWS : NOISE REDUCTION

Purely for the sake of identifying tapes that have been encoded with the Telcom system, the unit includes an oscillator which alternates between 550 and 650 Hz every half-second (unlike the Dolby level tone which is a frequency modulated tone). This oscillator is activated by the Dolby tone pushbutton on the Dolby mainframe.

Fig. 3, a block diagram of the Telcom system, shows that there is a considerable similarity to the Dolby system. The main signal path con-

sists of an input bandpass filter followed by an adder/subtractor, which adds or subtracts the noise reduction signal from the input signal depending upon whether the unit is coding or decoding. Also the noise reduction signal is derived from four chains, each covering a discrete frequency band.

The Telcom frequency bands of 30-215 Hz, 215-1.45k Hz, 1.45-4.8k Hz and 4.8-20k Hz are different from the Dolby system. In addition, each band is filtered separately, as opposed to the adding and subtracting arrangement in Dolby. Each band filter is, in fact, a 6 dB/octave

78 ►

FIG. 5  
DBX

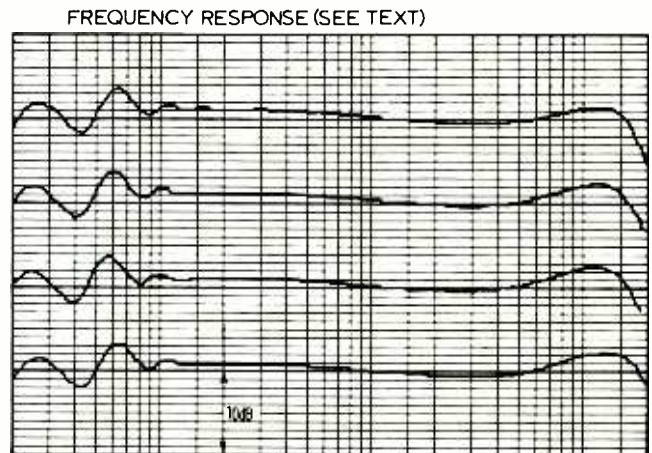

FIG. 6  
DOLBY

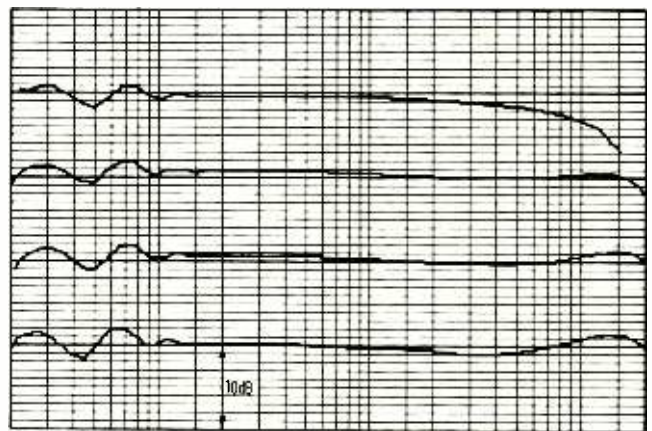
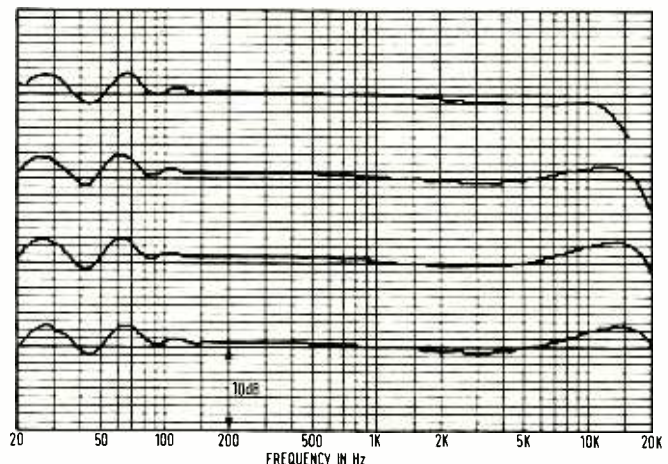

FIG. 7  
TELCOM





# Big tough cable drums from Keith Monks



CD1

Every Keith Monks cable drum is a multi-purpose carrier – for microphone, speaker or power cables. They're built of tough reinforced steel, with firm-standing rubber feet. And there are four different models to suit every job.

- \* Each one has a removable centre drum – use one frame, several reels, to save time, cost and space.
- \* Each one has a nylon-dipped black paint finish – hard-wearing and rust resistant, for indoor and outdoor use.
- \* They all stack with other frames of the same size – make rigid, stable space-savers.

Check this table to find the cable drum to suit you!

Model No.	Capacity Standard twin-screened cable	Multi-core cable
CD1	100m	50m (standard microphone cable)
CD2	200m	30m 3/4" Multicore
CD3	400m	60m 3/4" Multicore
CD4		200m 1/2" Multicore

Weight range: 10lb to 120lb

And if there isn't a cable drum to suit your requirements – modifications and special designs can be made to order!

Find out more about Keith Monks cable drums – just get in touch at the address below – we'll be pleased to send you more information without obligation.

**KEITH MONKS (AUDIO) LTD.**  
 26 Reading Road South, Fleet, Hants.  
 Telephone: Fleet (02514) 20568 or 20569.  
 Telex: 858606.

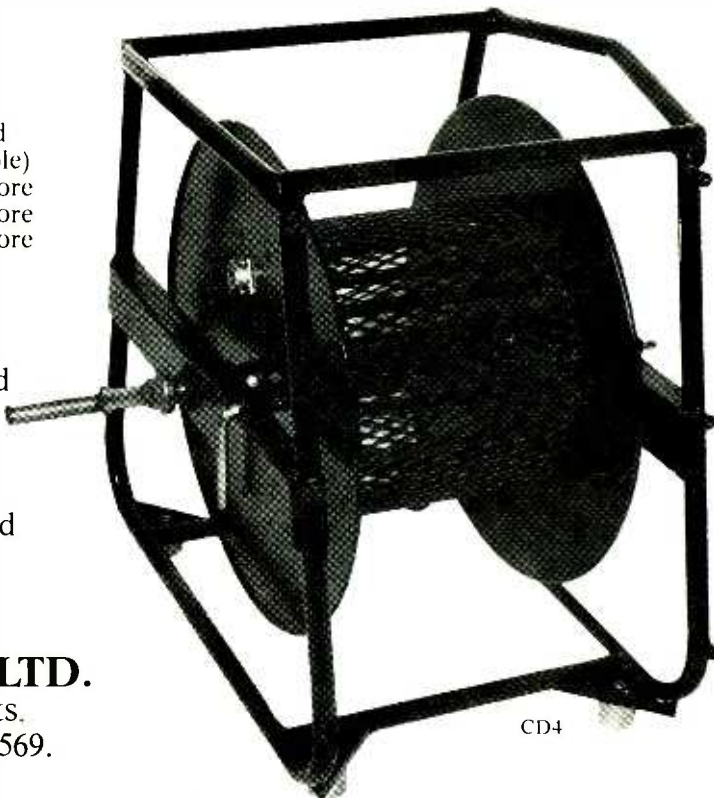

CD4

Distributed throughout the world by recognised distributors.

## REVIEWS : NOISE REDUCTION

filter arranged such that there is an overlap between the bands. Each filter output is fed to a voltage-controlled amplifier and thence to an adder that produces the noise reduction signal for the adder/subtractor.

The control signal for the voltage-controlled amplifiers is derived from a rather complex arrangement. The first stage is a 12 dB/octave filter which, in combination with the previous 6 dB/octave filter, defines the control bands precisely, and thus reduces noise breathing that would result from out-of-band signals getting into the control system. The subsequent arrangement of voltage-controlled amplifiers followed by a peak-sensing rectifier effects a control system that gives a 1.5 : 1 compression/expansion ratio. This remains linear over a wide dynamic range, thus eliminating the need for accurate level setting.

### General differences

To summarise the above, we have the dbx system that offers up to 30 dB noise reduction in addition to an improvement in headroom using a 2 : 1 constant compression. It is a wideband system—and thus does not take advantage of the masking effect—and is potentially subject to noise-breathing effects.

The Dolby system offers about 11 dB noise reduction without any improvement in headroom. However, it is a 4-band system that takes advantage of the masking effect and is less likely to suffer from noise-breathing effects. The compression slope is not constant, being 1 : 1 at high and low signal levels but 2 : 1 at mid levels, making it critical to set the 'Dolby level'.

Thirdly, we have the new Telcom system which, like Dolby, uses the masking effect with its four frequency bands, but has a 1.5 : 1 constant compression. Noise reduction is about 25 dB and there is an improvement in headroom.

From the point of view of print-through, the

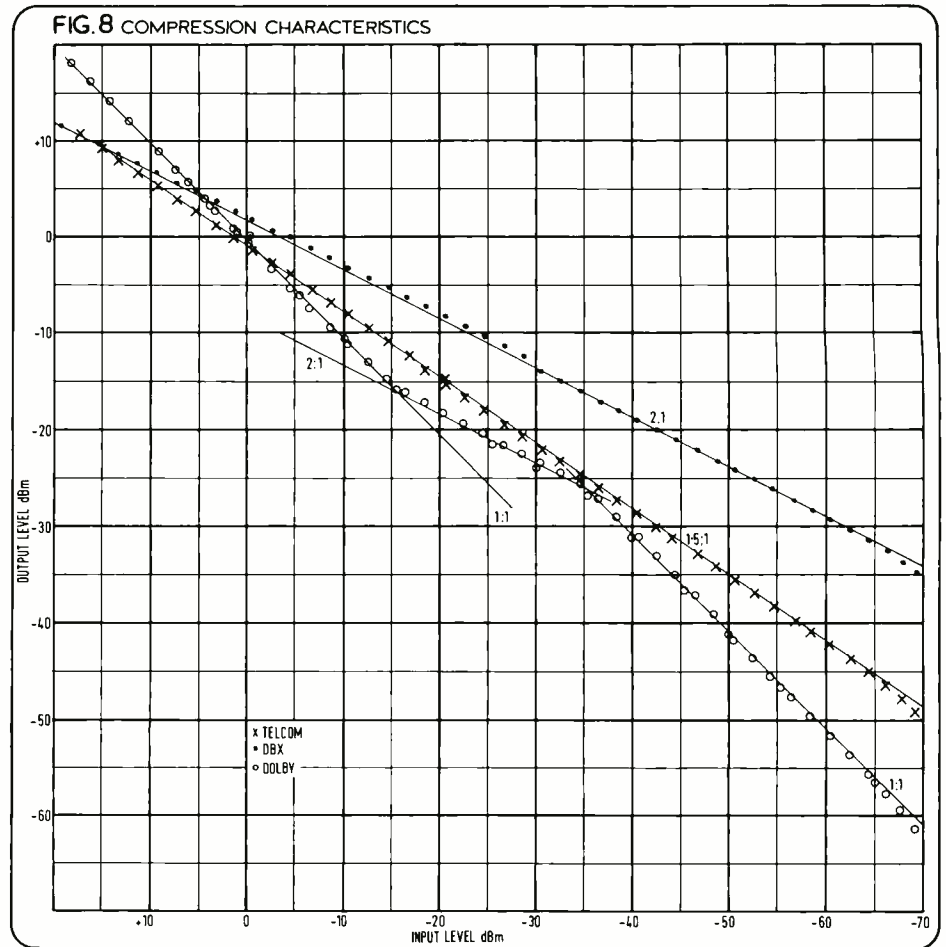

dbx system offers the best performance, followed by Telcom and Dolby; but considering modulation noise the Dolby and Telcom systems should be advantageous. Of course, frequency response errors in the tape machine

will be magnified with all systems in proportion to their compression ratio. It is here that the Telcom system clearly offers an advantage because of its 1.5 : 1 compression ratio and lack of need for an alignment level. 80 ►

# Broadcast pattern audio jackfields from Future Film Developments

19in Rack Mounting, from one to six rows of 20, 24 or 26 Jacks. The jacks are mounted on a plastic block which is in turn mounted on a 19in panel. Each row is fitted with a legend (designation) strip and wire support bar. The panel is steel, cadmium plated, chromate passivated and stove enamelled hammer-tone silver.

**ALSO** Audio Patch Cords . Microphone Cable . Installation Cable . Multiway Cable . Post Office and Rendar Jacks . Cable Markers . Lever Keys . Linear Faders . Cannon Connectors . Preh Connectors . Tuchel Connectors . Switchcraft Connectors .

Military Tri-Lock Bayonet

Connectors . Audio Attenuators . Wahl and Weller

Soldering Irons . PML Microphone Accessories

. Hellermann Sleeves and Tools . Crimp Terminals

. Cable Drums . AB Engineering Wire Strippers and

De-Solder Guns.

**FUTURE FILM DEVELOPMENTS**

36/38 Lexington Street, London W1R 3HR  
TEL: 01-437 1892, TLX: 21624. ALOFFD G





# RDG AUDIO VISUAL PRODUCTIONS LTD.

12 HILL VIEW, NEWPORT PAGNELL, Sales

DUNSTABLE 607192 evenings 0908 61300/0525 403528

## RECORDING MACHINES

Studer A80 16 track	9,500
MCI 24 track auto locate	10,000
MCI 16 track auto locate	9,000
Studer Mk2 A80 8 track	5,500
Leevers Rich G9 8 track	3,000
Otari MX730 8 track, immaculate	4,500
Revox A700, overhauled	600
Teac 3340 industrial version	450

## CONSOLES

Sonag 24 x 24	9,000
Trident B 18 x 8	6,800
Trident B 24 x 16 x 16	13,000
Alice AD 6/2	200
Chilton 10/2 Mic/Line inputs	370

## MICROPHONES

Neumann M49 FET	250
Neumann M49 valve	300
Neumann U87 as new when available	225
Neumann U67 as new when available	240
Beyer M160 as new	85
Neumann made stereo mikes valve	350
Neumann made mono condenser transistor	150
Neumann power supply for 5 valve mikes	200

## VARIOUS

Ampex 4 track head block	250
Lockwood Majors new black	each 345
Amcron DI50 as new	250
A and D F760 XRS stereo complex limiters	600
A and D stereo phaser	400
JBL 4311 one only	150
PPM's complete with electronics	40
Tweed Audio Comp/lims in 19in. rack and PSU (3) complete	650
BEL Electronics phasers new 19in. rack mounting	280
BEL Electronics flangers new 19in. rack mounting...	290

AVAILABLE SHORTLY EMT 140 STEREO ECHO POA

WANTED URGENTLY ALL MAKES OF VALVE MICROPHONES

## Trust James to get it together time after time

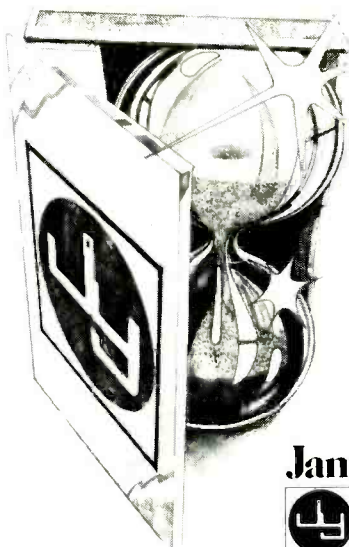

We provide a total product package for the industry. Orders of up to 30,000 perfect copies per week from your 1/4" or 1" master present no problem. For smaller runs we can turn your order around in 48 hours.

Design and print of your cassette stationery is part of our service together with choice of shell types and colours.

Full Dolby facilities are available in house. Your inquiries are invited for the manufacture of 8 track cartridges.

### James York Limited



Fossebridge Cheltenham  
Glos GL54 3JW  
tel Fossebridge (028572) 423

We have a lot to live up to ... and we do.

Dolby is a registered trademark of Dolby Laboratories Inc.

## BRITISH CARTRIDGE REPRODUCERS

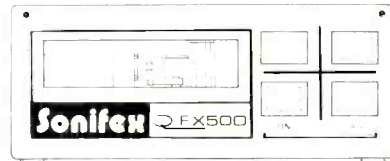

We have thoughtfully produced a comprehensive range of NAB cartridge machines suitable for most applications. Try us.

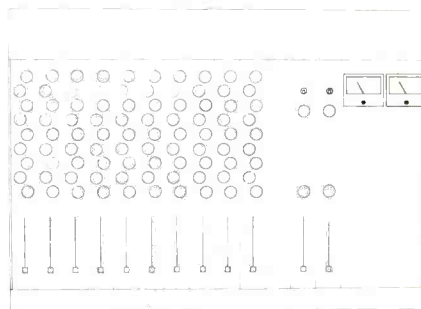

Soundmixers.

Carefully designed, tastefully and ergonomically presented and not least, excellently specified. Mono, stereo and multigroup.

## SONIFEX

15 College St., Irthlingborough, Northants.

Enquiries: Tel. 0933 650700

## REVIEWS : NOISE REDUCTION

### Performance

The three systems were evaluated using an Ampex *ATR-100* tape machine equipped with a stereo headblock and equalised to the CCIR standard of 35  $\mu$ s at the tape speed of 38 cm/s. The machine was biased and equalised for 3M *Scotch 206* tape that was used for all tests.

Initially the Dolby *Cat 22* board and main-frame were adjusted for the normal Dolby level of 185 nWb/m. The dbx *K9-22* card was then adjusted in the record, replay and bypass modes for unity gain at  $-4$  dBm (0 vu), which corresponded to 320 nWb/m or approximately 4 dB above Dolby level.

The Ampex *ATR-100* frequency response was practically identical for both channels, as shown in fig. 4 for a recording level  $-20$  dB with respect to 320 nWb/m. The resulting record/replay frequency response for the three noise reduction systems was then plotted at 10 dB increments from 10 dB above 320 nWb/m to 20 dB below 320 nWb/m, as shown in figs. 5, 6 and 7 for dbx, Dolby and Telcom respectively. Inspection of these figures shows that the frequency response errors in the *ATR-100* are magnified to the anticipated degree at lower levels, with the dbx system introducing the largest errors and the Dolby system the least. At the  $-10$  dB recording level the dbx system gave distinct advantages at high frequencies, with the Dolby system and its 1:1 ratio at this level leading to compression effects from tape.

The compression characteristics of the three systems are shown in fig. 8, which depicts the record input and output of the noise reduction systems. It can be seen that all three systems follow their theoretical curves to within a fraction of a dB over the range of inputs from 10 dBm to  $-65$  dBm. Below this instrumentation errors account for the deviation from the theoretical curves.

Measurement of third harmonic distortion at a recording level of 320 nWb/m for the *ATR-100* alone and with each of the three noise reduction systems showed significant differences (figs. 9, 10, 11 and 12). It can be seen that the dbx system achieves a very significant improvement between 80 Hz and 5 kHz, but that below 80 Hz the distortion is substantially worse. Similarly, the Dolby system makes matters slightly worse at low frequencies, but makes little difference at other frequencies. Telcom also makes little difference at higher frequencies but generally improves matters in the bass region.

Measurement of the intermodulation distortion to the CCIF method was carried out using two tones separated in frequency by 70 Hz and examining the third-order difference frequency distortion component. The results reveal that at a recording level of 320 nWb/m the Dolby system made no significant difference but, as is to be seen from fig. 13, the dbx system offered a significant improvement at high frequencies. The Telcom system, on the other hand, deteriorated the distortion to a significant extent above 4 kHz, as well as increasing the lower frequency intermodulation distortion.

The effects of applying a sudden burst of

FIG. 9  
ATR-100

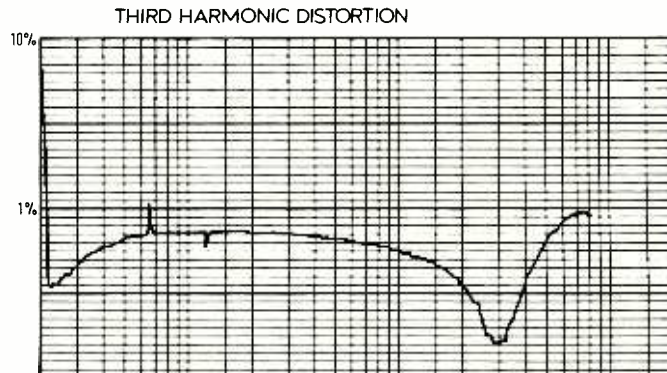

FIG. 10  
DBX

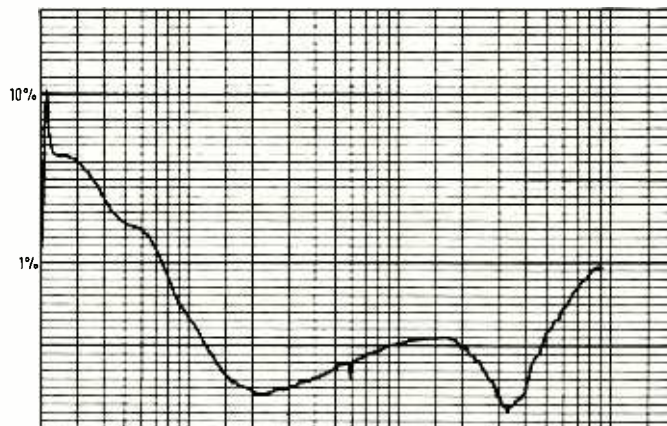

FIG. 11  
DOLBY

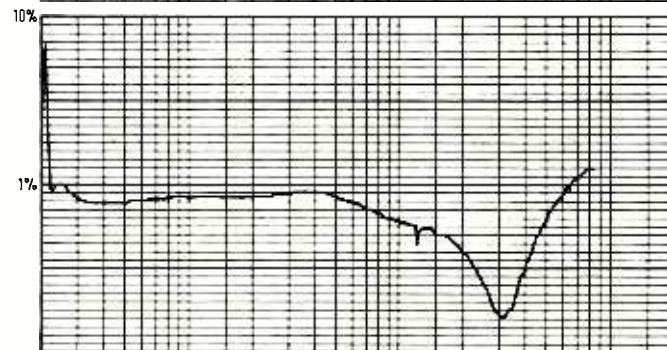
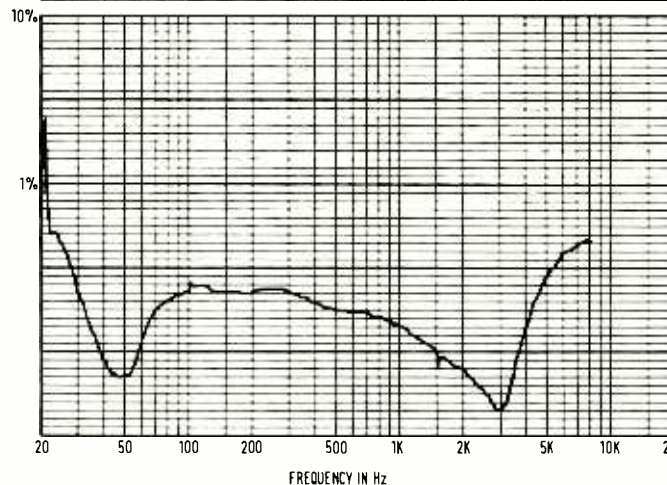
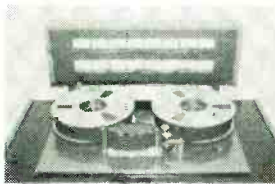

FIG. 12  
TELCOM







## CADEY

Speed 15 ips, EQ; NAB.  
 Freq. response; 30 to 18 kHz or —2dB.  
 Signal to Noise: —60 dB unweighted.  
 Wow and flutter: 0.1% maximum.  
 Teak console.  
 Full logic, no motion sensing.  
 Inputs: for low impedance unbalanced lines—mono jack.  
 Outputs: 600 ohm unbalanced—mono jack.  
 All machines fully remote controlled.

Prices: 8 track on 1" ... .. £1780.00  
 16 track on 2" ... .. £3480.00  
 24 track on 2" ... .. £4300.00

All prices exclusive of VAT at 8%.  
 Fully modular machines approx. 5% extra.

Contact: **Steve Wadey, CADEY RECORDERS,**  
 59 Yantlet Drive, Strood, Kent. 0634-76117

SQL SALES LTD present the new  
**SPR-1 UNIVERSAL SYNCHRONISER**  
 FOR ALL YOUR FILM SOUND TRANSFERS



- \* Handles 50Hz AND 60Hz Neopilot sync. pulses
- \* Resolves 10Hz, 25Hz and 30Hz Subaudio (SN) pulses
- \* Drives and slaves ALL modern portable reel-to-reel recorders
- \* Use with Nagra III/IV and our spool adaptors for ALL 6.25mm. AND 3.81mm (SN) sync. tapes.
- \* Locks to line frequency, built-in crystal or ext. ref.
- \* Unrivalled for versatility and economy

Send for fully descriptive colour brochure to:—

**SQL SALES LTD.,**  
 2 HIGH ST., PORT ST. MARY, ISLE OF MAN  
 Telephone: 0624 - 83 4294  
 Telex: SQL Sales, c/o 629313 COMCAB G  
 New York Agent: John Messenger, Apt 2H, 300 W. 23rd St.,  
 N.Y. 10011 Telephone: (212) 6919567

AVAILABLE SOON — SQL - 3 Control Unit for  
 Nagra SN recorders (3 mic inputs)



## Our slaves are yours to command

Loop bin cassette duplicating, Dolby A and B systems, fixing heat-seal cassette labels, open reel duplicating, large or small runs.

Sound Communication (Publishers) Limited,  
 Dewsbury, West Yorkshire. Telephone (0924) 469436

## LEADS

Now available—very reliable, high quality leads custom-built to your own requirement for use in Studio, Broadcast or P.A. We supply any quantity at highly competitive prices.

Multicore lead systems a speciality.

For further details please ring Francis Williams on Fowlmere (0763 82) 550 anytime, or write to: Rector's Cottage, Hillview, Fowlmere, near Royston, Herts.

★★ As used at DJM's new multi-studio complex in London ★★

## Direct inject with *Susan Blue* It feels great!

Active Direct Injection Box  
 Featuring 10 Mohm input impedance, Input attenuator, Balanced and unbalanced outputs, Phantom power or internal battery plus Hum loop suppression.

Passive Direct Injection Box,  
 Featuring switched High/Low input impedance, Balanced output plus Hum loop suppression.

Also a range of Microphone Splitters.

Manufactured by: Sun Recording Services Ltd., 34-36 Crown Street, Reading, Berks. RG1 2SN. Tel: 0734 595647

Distributors:  
 London Future Film Developments Tel: 01 437 1892 • Sweden KMH Studios AB Stockholm Tel: 69 8800 • Holland CADAC Holland, Hilversum Tel. 035 17722 • West Germany Elmus GmbH, Berlin Tel: 0312 2012



# Cuemaster

professional NAB Cartridge  
recorders and replay  
machines

## CUERAC®

Automation systems for  
Broadcasting and P.A.

## schafer

Automation systems for  
Radio

## MULTI-TRACK

parametric equalisers

## MELLOTRONICS

400FX Effects Console

Technical Translations



## Granet

Communications Ltd.

39 BEECHCROFT MANOR, OATLANDS  
DRIVE, WEYBRIDGE, SURREY KT13 9NZ

Weybridge (0932) 47785

### REVIEWS : NOISE REDUCTION

4 kHz tone at 0 dBm level starting at the zero crossing point of the waveform is shown in figs. 14, 15 and 16. It can be seen that the dbx system has a very considerable overshoot, Dolby a small overshoot and a clean attack, and the Telcom system a unidirectional overshoot plus a slight droop at the onset of the burst. It is felt that the dbx overshoot is excessive and that this could be troublesome with the electronics of some tape machines.

A similar exercise, but via tape this time, was to apply a constant-level 1 kHz signal and then to apply a 4 kHz burst 20 dB higher in level for a period of approximately 8 ms. The resulting replayed waveform for the dbx, Dolby and Telcom systems are shown in figs. 17, 18 and 19 respectively. It can be seen that all systems gave fairly 'clean' results, but that dbx took almost 6 ms to stabilise the burst level and Telcom left a small spike at the end of the burst.

Turning to the noise reduction capability of the systems, tape was recorded via the systems without any input signal and then replayed with and without the noise reduction in circuit

TABLE 1 NOISE REDUCTION

	dbx	Dolby	Telcom
A-weighted rms	29.5 dB	10.8 dB	24.7 dB
CCIR-weighted ref			
1 kHz quasi-peak	30.0 dB	11.0 dB	25.7 dB
CCIR-weighted ref			
1 kHz rms	29.7 dB	10.7 dB	24.9 dB

FIG 13 INTERMODULATION DISTORTION

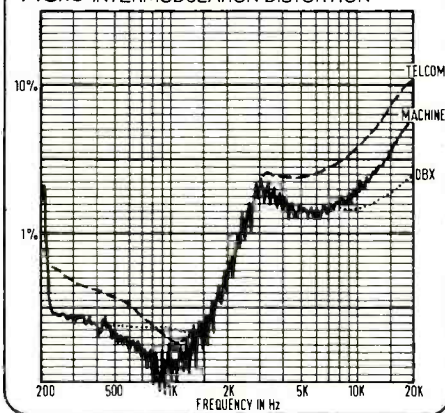

FIG. 14 dbx K9-22,4 kHz tone burst to 0 dBm. Horizontal scale: 20 ms/division.

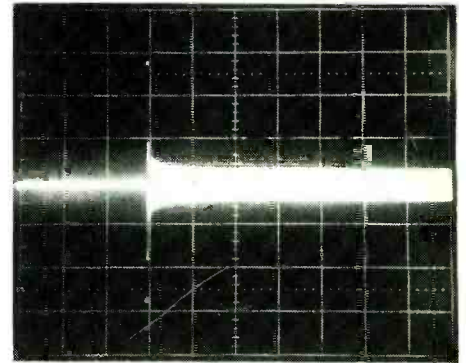

FIG 15 Dolby Cat 22,4 kHz tone burst (as fig. 14).

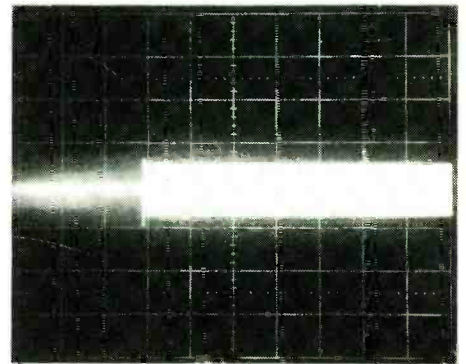

FIG. 16 Telcom c4D,4 kHz tone burst (as fig. 14).

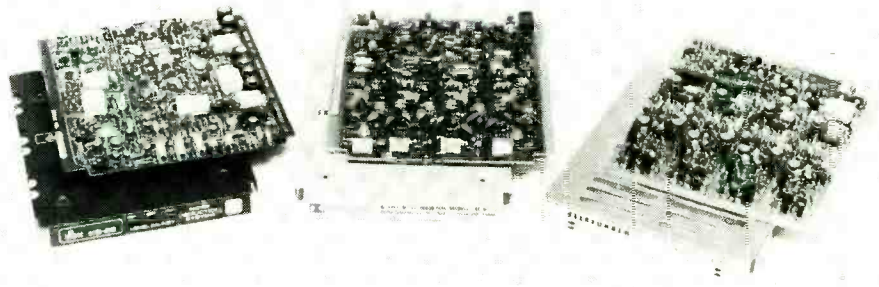
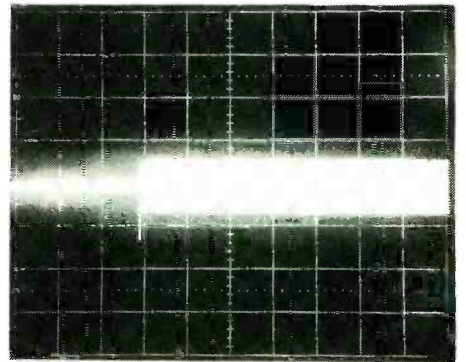



FIG. 17 dbx K9-22, 1 kHz signal with 4 kHz tone burst (see text).

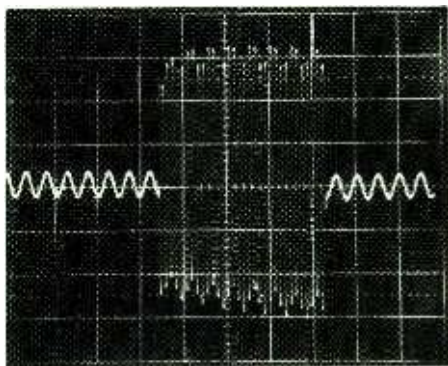

FIG. 18 Dolby Cat 22, 1 kHz/4 kHz tone burst (see text).

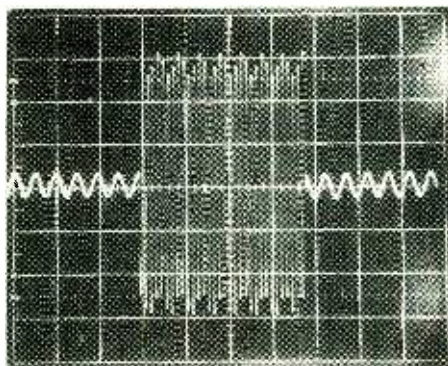
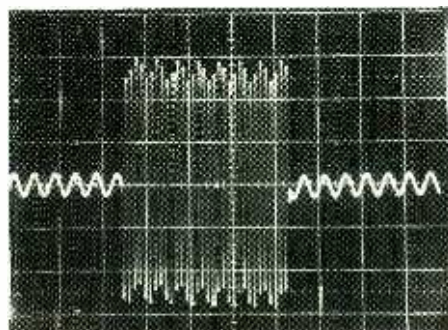
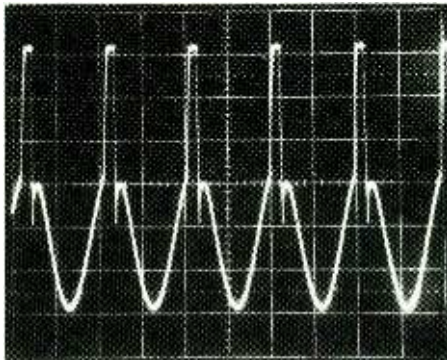

FIG. 19 Telcom c4D, 1 kHz/4 kHz (see text).



(table 1). At first sight it appears from the figures that the dbx system gives the most noise reduction. However, this depends, in fact, upon the noise performance of the machine with which it is used and upon the adjustment of levels in the Dolby mainframe. With the system gains adjusted as described, the performance of the dbx system was limited by its own noise performance; a comparison on normal bias/erase noise from tape, with and without the noise reduction systems in circuit, resulted in the output

FIG. 20 Telcom c4D, record overload for 1 kHz sinewave (see text).



noise levels given in table 2. It can be seen that under the measurement conditions used, the Dolby system gave in round figures 10 dB noise reduction in comparison with machine/tape noise, the dbx system 18 dB and the Telcom system 25 dB.

In practice the dbx system records more noise onto tape in the absence of an input signal (as do the other systems to a limited extent) and this factor reduces the subjective effects of noise breathing.

In addition to the noise level, the maximum output level available in the record and replay modes is, of course, important. Here the Dolby system gave +19 dBm output from the mainframe at the onset of clipping into either an open circuit or a 600-ohm load. Dbx gave +18 dBm in the play mode or +12 dBm in the record model—a satisfactory combination in view of the 2 : 1 slope of the system's compressor/expander—while Telcom gave a similarly satisfactory performance with +18 dBm in replay or +11.5 dBm in record. However, overloading the Telcom system in the record mode gave very nasty and severe distortion, as shown in fig. 20 for a 1 kHz sinewave.

Returning for a moment to the noise reduction performance, the noise spectrum was investigated by feeding each system with white noise at -30 dBm and then examining the noise output spectrum with and without a 1 kHz sinewave signal at 0 dBm. Thus the noise spectrum with and without an input signal was examined, as shown in figs. 21, 22 and 23 for the dbx, Dolby and Telcom systems. It can be seen from fig. 21 that the dbx system just shifts the noise spectrum in level over the complete audio band; the noise spectrum having less density at high frequencies due to the inbuilt pre-emphasis and de-emphasis. On the other hand, the Dolby system exhibits little change in the noise spectrum at high and low frequencies due to the band splitting system, but alters the noise level in a band about the signal frequency. Telcom gives a similar effect to that shown by Dolby, but would appear to be slightly more likely to give noise breathing since the level of the complete noise spectrum is shifted slightly upwards in level. 84 ▶

TABLE 2 OUTPUT NOISE OFF TAPE

	no noise reduction	dbx	Dolby	Telcom
A-weighted rms	-63 dBm	-81 dBm	-74 dBm	-88.5 dBm
CCIR-weighted quasi-peak	-49.5 dBm	-66.5 dBm	-60.3 dBm	-75 dBm
CCIR-weighted rms	-54.5 dBm	-72 dBm	-65 dBm	-80 dBm

EMS VOCODER 2000

for the treatment and modulation of human speech and the production of speech-like effects from music or other sounds. Used by radio, television, studios, groups and theatre.

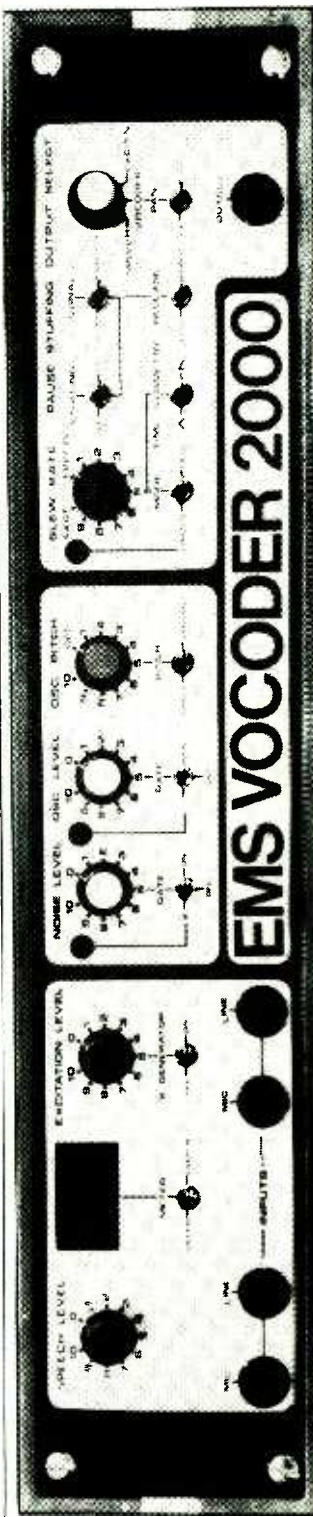

Electronic Music Studio Supplies  
 Zen On Music Co Ltd  
 25 Higashi Gokencho  
 Shinjuku-Ku  
 Tokyo

Electronic Music Studio Supplies  
 5832 Westminister Avenue  
 Montreal  
 Quebec H4W 2J8

EMA (Electronic Music Studios of America, Inc.)  
 269 Locust Street  
 Northampton  
 Massachusetts

EMA West Germany  
 7257 Ditzingen 3/Hiemeringen  
 Finkenstrasse 4  
 07152 - 53273

EMS  
 The Priory  
 Great Milton  
 Oxford  
 08446 - 729

EMS  
 Electronic Music Studios



Q.  
What's smaller  
than a breadbox,  
tells the truth,  
and won't  
flutter your RFI  
or wow  
your wallet?

A. **FIDELIPAC**<sup>®</sup>  
WOW &  
FLUTTER METER.

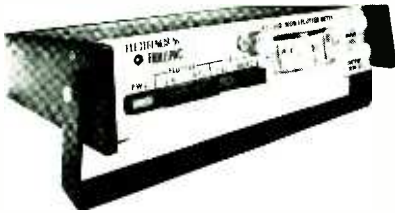

For less than \$350.00 you can have a portable, solid-state instrument that quickly and accurately measures the wow, flutter and drift characteristics of any sound reproducing device . . . cartridge or reel-to-reel tape recorder, turntable, film chain, etc. It's easily connected to your equipment and features a standard phone output jack for oscilloscope connection as well as a self contained switchable weighting filter. With its internal precision 3,150 Hz reference oscillator and its complete immunity to EMI and RFI, Fidelipac's Model 65-390 Wow and Flutter Meter is truly indispensable for your test bench or studio.

For more information,  
contact Fidelipac

Prices shown are domestic U.S. and do not reflect shipping, customs duties, VAT or similar charges and are subject to change without notice.

**ELECTRONICS by**  
**FIDELIPAC**<sup>®</sup>  
109 Gaither Drive  
Mt. Laurel, NJ 08057  
(609) 235-3511

<sup>®</sup>Trademark

## REVIEWS : NOISE REDUCTION

Listening tests with various types of material confirmed that the Dolby system was the least prone to noise breathing, followed by Telcom and dbx. This order of merit also applied to modulation noise associated with high-frequency recordings, where the Telcom system definitely appeared to be inferior to Dolby. This finding correlates with the different noise spectra exhibited by Dolby and Telcom and although the filter shapes were not investigated, it would appear that the Dolby system has better separation between the found frequency bands.

So far as replay noise is concerned, the Telcom system was by far the quietest using the Ampex *ATR-100* with the levels adjusted as described earlier in this review. As expected

the Dolby system gave the least noise reduction.

Unfortunately, listening tests were limited by both lack of time to use the systems and also the inability to make a/b comparisons, so it was not possible to make detailed comparisons. However, none of the three systems were found to have faults such as exhibiting clicks or other similar peculiarities associated with compressors. Undoubtedly 'fine' listening tests will reveal differences between the systems in terms of sound quality, but from the work done it would appear that the most expensive Telcom system offers very good noise reduction which can exceed that of the dbx system. The differences between Dolby and dbx are fairly well known, and I would recommend anyone who has the money available, to give serious consideration to the Telcom system if they want the noise reduction capability of dbx together with the subjective performance of Dolby. ■

FIG. 21  
DBX

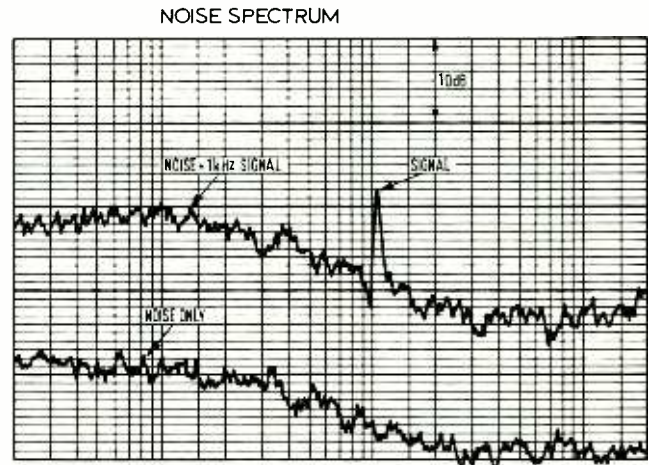

FIG. 22  
DOLBY

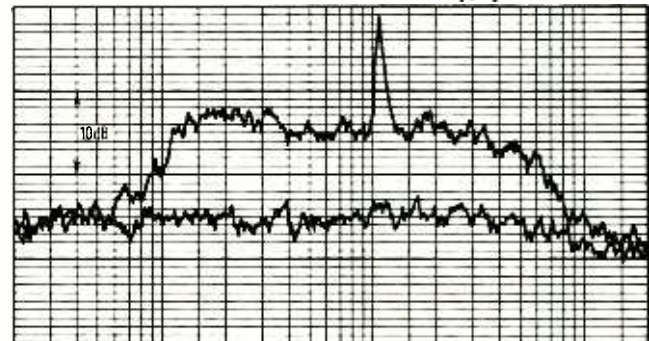
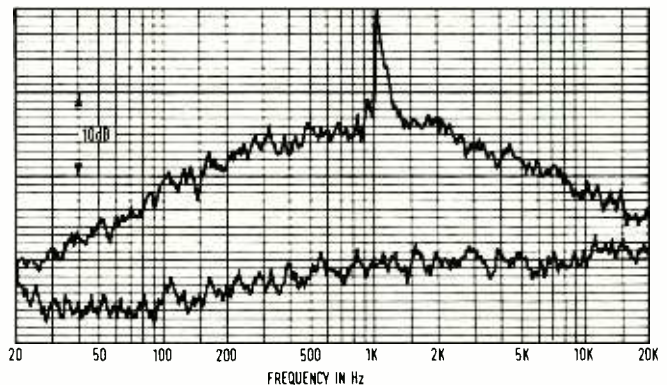

FIG. 23  
TELCOM





# Air in. Noise out.

**ACOUSTIC  
VENTILATOR**

The Airvac is a new kind of ventilator that cuts problem noise entry to an acceptably low level while allowing natural ventilation.

Compact and easy to install, the Airvac fits into solid or cavity walls and achieves an average noise attenuation of 48dB over the octave band structure of the sound spectrum.

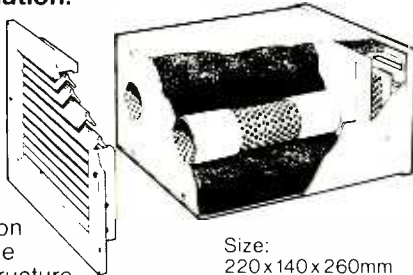

Size:  
220 x 140 x 260mm

Send for our technical literature

## Greenwood Airvac



specialist acoustic ventilator systems

GREENWOOD AIRVAC VENTILATION LTD  
PO Box 3 Rustington West Sussex BN16 3LH Tel. (09062) 71021

# Update.

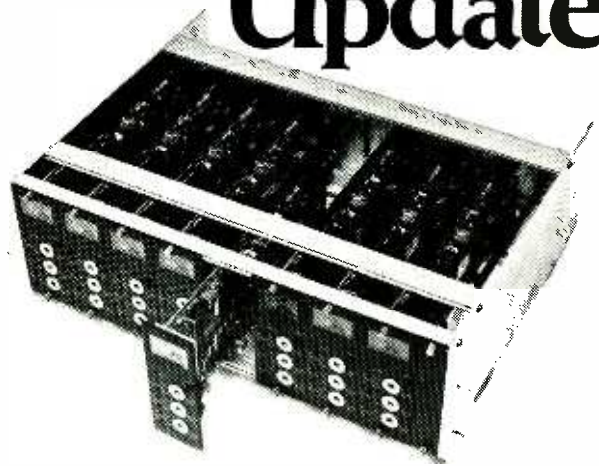

Install this new 19" unit from Soundcraft Magnetics and bring the electronics of your multitrack tape machine right up to date.

The unit has 8 plug-in modules with studio line level interfaces, and fully professional specifications.

Line out—switched replay, line in and sync. Separate sync line out for foldback or noise gate use.

Remote control unit is standard; compatible tape heads and power supplies are available.

S/N 72dB (Ref. 320 nWb/m A weighted).

Get up to date by calling Soundcraft.

Soundcraft Magnetics Ltd  
5-8 Great Sutton Street,  
London EC1V 0BX Telephone: 01-251 3631 Telex: 21198

**SOUNDCRAFT**  
MAGNETICS LIMITED

## LEASING CAN SAVE VALUABLE CAPITAL

### Why not lease equipment?

Studio leasing offers **the best** leasing agreements within the music industry for purchase of studio equipment.

For further details, contact

Box No. 785

## SHEFFIELD SOUND CENTRE

SPECIALISTS IN HI-FI

Main agents for Teac, Tascam, AR, Uher, Dokorder, Revox, Spondor, JBL, Dahlquist, Tannoy, Lowther, Ferrograph, Marantz, Bic Technics, Quad, Armstrong, Sony, Nagra, IMF, Dbx, Otari, and many more.

Competitive prices, terms, part exchange

101a and 107 ECCLESALL ROAD

Tel: 0742 23365

# DIRECT BREAKTHROUGH!

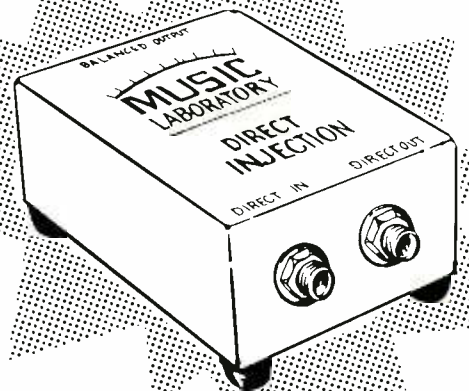

At last, a D.I. box to meet the most stringent requirements. Utilising the best matching transformer available. Housed in factory-finished rugged box, as used in professional recording studios.

Frequency Response: 10Hz—20kHz  $\pm$  1 db.

Telephone for details: 01 349 1975-6

76 LYNDBURST GARDENS,  
LONDON N3.



# Classified Advertisements

Advertisements for this section must be pre-paid. The rate is 18p per word, minimum £3.60. Box Nos. 45p extra. Semi-display rates on application. Copy and remittance for advertisements in **JULY 1978** issue must reach these offices by **12th MAY 1978** addressed to: The Advertisement Manager, **Studio Sound**, Link House, Dingwall Avenue, Croydon CR9 2TA.

**Note:** Advertisement copy must be clearly printed in block capitals or typewritten.

Replies to Box Nos. should be addressed to the Advertisement Manager, Studio Sound, Link House, Dingwall Avenue, Croydon CR9 2TA, and the Box No. quoted on the outside of the envelope. The district after Box No. indicates its locality. **SEX DISCRIMINATION ACT 1975:** No job advertisement which indicates or can reasonably be understood as indicating an intention to discriminate on grounds of sex (e.g. by inviting applications only from males or only from females) may be accepted, unless (1) the job is for the purpose of a private householder or (2) it is in a business employing less than six persons or (3) it is otherwise excepted from the requirements of the Sex Discrimination Act. A statement must be made at the time the advertisement is placed saying which of the exceptions in the Act is considered to apply.

## SITUATIONS VACANT

### FIELD & TEST ENGINEER/TROUBLESHOOTER

A vacancy has arisen for a person fully conversant with sound recording equipment and studio maintenance procedures including tape machines.

The successful applicant will be given responsibility to organise service contracts and will be able to communicate with all levels of studio personnel.

If you are looking for a progressive career, involvement with design projects and the opportunity to travel, then contact:

**Andy Munro**

### ALLEN & HEATH — BRENELL

Pembroke House  
Campsbourne Road  
Hornsey, London, N8

Tel. 01-340 3291  
Telex: 267727 BATGRP G



Neve are leading designers and manufacturers of professional sound control and distribution systems used throughout the world in television, film broadcasting and recording studios. We have vacancies for

### AUDIO TEST ENGINEERS

Opportunities are now being offered to personnel of C & G/ONC standard in Electronic Engineering to join an interesting and progressive company as Test Engineers on audio systems. The position offers interesting and varied work from fault finding at component level to thorough checking of complete systems. Applicants should have proven experience with analogue and digital circuitry, and the ability to work to close limits as part of a team.

### CONSOLE DESIGN ENGINEERS

Practical experience of electronic and mechanical design within a manufacturing environment, and qualification to HNC desirable. The work will involve technical liaison and interpretation of customers requirements, the production of system block diagrams and specifications and the provision of engineering support for production staff.

We can offer interesting, secure and well paid employment to suitably experienced candidates. Our company is situated in a modern plant in rural surroundings and free transport is provided from Cambridge, Royston and surrounding villages. Extensive relocation assistance will be offered where applicable.

37½ hour week, 4 weeks holiday a year and subsidised canteen facilities.

Please write or telephone Personnel Manager, The Neve Group of Companies, Cambridge House, Melbourn, Royston, Herts. Telephone: Royston 60776.



## SERVICE ENGINEER

The U.K. importers of a varied range of sophisticated electronics products for professional audio use require a highly capable and self-motivated **Service Engineer** for London service lab and occasional field work.

It is probable that the engineer for whom we are looking will be up to 35 years old and be qualified to HNC/Degree level. More important than formal qualifications however, are practical familiarity with audio systems, the ability to work calmly when all around are panicking and above all, a genuine interest in audio.

In return we offer a good starting salary with regular reviews and a pleasant working environment.

Please write or telephone:

**David Hawkins**

**SCENIC SOUNDS EQUIPMENT,  
97-99 Dean Street, London, W1V 5RA**

Tel: 01-734 2812

## LANSDOWNE STUDIOS

### REQUIRE TECHNICAL MAINTENANCE ENGINEER

Preferably experienced with Studer machines and Cadac equipment

Contact: **Adrian Kerridge,  
Lansdowne Studios,  
Lansdowne Road,  
London W11 3LP  
Tel: 01 727 0041**



## Design/Development Manager

£11,000+

France

Our client is a major French manufacturer of professional electro-acoustic equipment for use in recording or broadcasting studios.

The appointed candidate will manage a team of engineers and technicians involved in development of existing equipment/systems and research into new products in order to maintain the technical lead of the company.

He should have a degree in electrical engineering/electronics and substantial experience of the manufacture of sophisticated electro-acoustic equipment - from scratch.

Based in Paris - French is the working language. Age 35-50.

Please telephone for initial discussion or write (quoting reference 6228) to the consultant advising the company, P. S. Lewis, Mervyn Hughes Group, 2/3 Cursitor Street, London EC4A 1NE. Telephone: 01-404 5801.

### Mervyn Hughes Group

Management Recruitment Consultants

## AUDIO/PULSING ENGINEER

Experienced engineer wanted for sound studio. Studer/Teac/Otari equipment used for multi-track recording and dubbing of music/voice-over/sync. tracks. Starting salary circa £3800 including some overtime.

Apply: John Heaton, Electrosonic Ltd., 815 Woolwich Road, London SE7 8LT. Tel: 01-855 1101

## SITUATIONS—WANTED

★EXPERIENCED MAINTENANCE ENGINEER seeks position in lively enthusiastic studio. Box No. 784, c/o STUDIO SOUND. E

★Young man (19) seeks employment in recording studio, amateur experience, technical qualifications. Pete Willison, 10 St. Monica's Avenue, Luton, Beds. E

## WANTED

★Wanted: studio mixer, 16 or 24 into 8 (Soundcraft or similar), also Lockwood or Tannoy monitors, cash waiting. 01-987 1681. E

★Wanted: desk cassette copier, good condition, for speech recordings. Also the following books: 'Recording Studio Handbook' (Saga-more Publishing) and 'Modern Recording Techniques' (Howard Sams Publishing). Phone Limerick 43893, or write to International Songwriters Association, Limerick City, Ireland. E

## STUDIO FACILITIES

### LEEVERS-RICH EQUIPMENT LIMITED

REQUIRE

## TEST ENGINEERS

Due to the increasing demand for our PROLINE PROFESSIONAL RECORDERS, we require additional TEST engineers for test and calibration. Experience in professional audio and digital techniques essential. Salary commensurate with age and experience.

Apply to Mr. L. G. Harris on 01 874 9054, 319 Trinity Road, London SW18 3SL.

## Get binding!

Keep your copies of STUDIO SOUND in smart black binders (each holds 12 copies) with title in golden block letters on the spine. Price: £2.00 each which includes inland and overseas postage. Send your order with cheque or postal order to: Modern Book Binders Ltd. Chadwick Street, Blackburn, Lancs. (state clearly your name and address and the relevant magazine title).

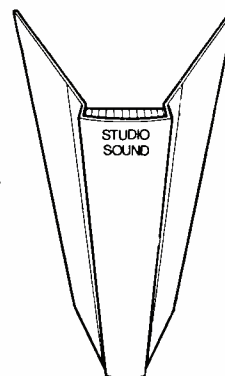

LINK HOUSE GROUP

★Colour Video Services Ltd. have a vacancy for a sound maintenance engineer at Portman Close. His duties will include maintenance of 16mm dubbing theatres and transfer bay, plus project work. Please apply to: Mr. F. Weinell, Colour Video Services Ltd., 22-25 Portman Close, Baker Street, London, W.1. Tel. 01-486 2881. E

**SPR**

SPEECH RECORDING  
CASSETTE DUPLICATING  
OPEN-REEL DUPLICATING  
LANGUAGES/AUDIO-VISUAL

## SPEECH-PLUS RECORDINGS LTD

32, PAGES WALK, SOUTHWARK, LONDON SE1 4SB.

01-231 0961/2

### COUNTY RECORDING SERVICE

From your tapes we cut master discs, demo discs, using our Scully lathe fitted with the latest ME/76 UK stereo disc-cutting system. Dolby 'A', Dolby 'B' and DBX Noise Reduction. Telephone Bracknell (0344) 54935. London Road, Binfield, Bracknell, Berks, England

## RAC MIXERS

### NEW COMPLETE UNITS

RAC LIM2 limiter/compressor	£72.50
RAC E2 Disc preamplifier	£65.00
RAC MA4 two channel mike amp	£87.50
Also MA3.3 mic amp card meets IBA studio path spec.	£19.00

ALL PRICES EXCLUDE V.A.T.

### RUGBY AUTOMATION CONSULTANTS

19 Freemantle Road, Rugby, CV22 7HZ  
Tel. 0788-810877

- ★Revox's urgently wanted. The Music Laboratory. 01-349 1975. X
- ★Wanted. Revox and Teac Tape Recorders. Best prices paid. R.E.W. Professional Audio. 01-836 2372. X
- ★Tannoy speakers wanted. The Music Laboratory. 01-349 1975. X
- ★Teac 3340 (S) urgently wanted. The Music Laboratory. 01-349 1975. X
- ★Fanfare Records. Tape-disc pressings, demo's, masters, any quantity. Studio/mobile Neumann disc cutter. S.A.E. brochure. 1 Broomfield Close, Rydes Hill, Guildford. Tel. 0483 61684. X
- ★Your Tapes to Disc. Mono or Stereo cutting. Vinylite pressings, Sleeves/Labels. Top professional quality. S.A.E. for photo leaflet. Dero Records, "Eastwood," Cove, Dunbartonshire, Scotland. X
- ★Aerco Productions Ltd. Quality disc pressings Professional Record Producers and engineers. Publishers. S.A.E. leaflet. 27 Chobham Road, Woking, Surrey. 04862-4667. X

## FOR SALE—TRADE

### OFFSHORE CASSETTE DUPLICATING

High Quality - Low Cost  
No order too small or too large. Inlay cards and labels designed and printed.

**VIKING MANN STUDIOS**  
29A Duke St., Douglas, I.O.M.  
Telephone (STD 0624) 3872

- ★Tape/disc masters, demos (Scully/Westrex), pressings, cassettes, mobile recording Studio. Free brochure. Tam Studio, 13a Hamilton Way, London, N.3. Tel. 01-346 0033. X

HIGH SPEED CASSETTE COPYING IN MONO OR STEREO AT COMPETITIVE PRICES

Long or short runs.  
Blank cassettes supplied in bulk.  
A growing reputation for reliability.

**MORARD SOUND PRODUCTIONS**  
THORNTON HEATH, SURREY  
Telephone 01-689 7424

## 3M 16 TRACK TYPE 56

Used only in the Stones mobile from 1971-4 and maintained as a spare machine since. Has varispeed, Maglink capability and Dolby switching. Is in exceptional condition and has had little use compared with a machine from a busy studio. The arrival of our second M79 24-track is the only reason for sale.

Price £9,000. Mobile Studio. 352-0005/9

## SOWTER TRANSFORMERS

### MAKE YOUR OWN MICROPHONE SPLITTER WITH SOWTER TRANSFORMER TYPE 4079

This transformer has a high impedance nominal 200 ohm primary, balanced and centre-tapped, and two secondaries each for 200 ohms loading. Suitable for most types of microphone requiring loads up to 1200 ohms, it will handle 2.3 volts (rms) at 30 Hz so that for normal levels DISTORTION IS NEGLIGIBLE. When each secondary is loaded with any values of resistance from 200 ohms to 2500 ohms THE FREQUENCY RESPONSE IS PLUS/MINUS ½dB from 20 Hz to 20 kHz.

This transformer is contained in a Mumetal can 33 mm diameter x 37 mm high with two tapped holes in the lid for fixing. (The height is increased to 60 mm if a one hole fixing bush is required.) The hum reduction of the can is at least 30 dB and the colour coded end leads are normally 20 cm in length. Further details of THE CONSTRUCTION OF A SPLITTER USING THIS TRANSFORMER ARE AVAILABLE ON REQUEST. The following price breakdown is valid for three months:

In lots of	1-5	6-12	13-24	Strictly nett
PRICE EACH	£7.55	£7.25	£7.05	ex works Ipswich

Extras are 20p per transformer for postage and packing, and VAT is 8% overall. Dispatch for small quantities is EX STOCK but otherwise not more than 2 weeks from receipt of remittance. FOR EXPORT p. and p. is AT COST and there is no VAT. The weight of one transformer and packing is approx. 200 gms.

We also invite your inquiries for PRACTICALLY ANY TYPE OF AUDIO TRANSFORMER and will quote by return.

### KINDLY NOTE OUR NEW ADDRESS AND TELEPHONE NUMBER

**E. A. SOWTER LTD.**  
Transformer manufacturers and designers  
The Boatyard, Cullingham Road, IPSWICH,  
Suffolk IP1 2EG, ENGLAND  
Tel. 0473 52794 and 0473 219 390

## REVOX EDITING CONVERSION

Fits all models A77  
KIT £75 plus VAT — FITTED £85 plus VAT  
New machines supplied standard or converted  
**SOUND ASSOCIATES LIMITED**  
23 Redan Place, LONDON W2 4SA  
Tel: 01-229 0101  
Authorised Revox Industrial Agents

## FOR SALE—PRIVATE

★Ampex AG/350 ½in. ¼-track recorder with s/sync remote and many tapes, excellent condition £950. Tel. 01-520 7677. E

★Ampex 8-track headblock and guides for MM1100/1200, very little used, excellent condition. £1,100 o.n.o. Box No. 783, c/o STUDIO SOUND. F

★Disc lathe with Grampian cutting head, blanks, etc. Also 19 reels 10½in. x ¼in. BASF LR56, offers. 0942 55500. E

★Klark Teknik 1in. 8 track tape machine with dual capstans, separate sync and playback output amps, transport remote and two L.E.D. counters. Offers around £3,750. Modified Allen & Heath 14-8-8 Mod 1 mixer complete with mini jack bay, 2 x comp/limiters and noise gate, £1,250 o.n.o. 3 x Tannoy 15in. golds in Lancaster cabs, £230 the three. Tel. Kim on 0203 394821 after 6 p.m. and weekends.

★Alice 828 mixer, 8 into 2. Six weeks old, immaculate £375. Ortofon tone arms, brand new £25. Also 70 metre 19 way Belden (XLRs' both ends), for hire £14/week. 0661 23365. E

★Cathedral Sound manufacture a professional standard compressor/limiter module for under £25, mixer modules, and complete mixer channels. Professional discounts available on Revox, N.E.A.L., Sennheiser, also MM mixers. S.A.E. details. Cathedral Sound, Fourways, Morris Lane, Halsall, Lancs L39 8SX. Tel. Halsall (0704) 840328. X

★Revox, Teac, Otari, Brenell, Tascam, Nakamichi, Tannoy sales and service. The Music Laboratory. 01-349 1975. X

★Wow and flutter meter, Rank Kalee type 1740, similar to latest model, calibrated and in good working order. £150 plus VAT. Burgess Lane & Co. Ltd., Thornton Works, Thornton Avenue, London, W.4. 01-994 5752 and 5953. X

★Sennheiser at professional discounts. Paul Simmon Ltd., 2 Market Street, Halifax. Tel. 0422 52240. Mon-Sat 0900 to 1730; half-day Thursday. E

## SERVICES

## LEASING CAN SAVE VALUABLE CAPITAL

### Why not lease equipment ?

Studio leasing offers the best leasing agreements within the music industry for purchase of studio equipment.

For further details, contact

Box No. 000



To hire the very latest  
**NAGRA & SENNHEISER**  
 sound equipment, contact

**HAYDEN HIRE**

For further details, telephone  
**01-723 4441/2**

Hayden Laboratories Limited  
 6 Bendall Mews, Bell Street, London NW1

**Griffiths Hansen  
 (Recordings) Ltd**

Recording studio specialising in speech and drama for  
 education, advertising, industrial training, sales and  
 promotion work.

Open reel and cassette duplicating.

Public address installation and hire for conferences and  
 exhibitions etc.

**12 BALDERTON STREET, LONDON W1Y 1TF**  
 (Opposite Selfridges) 01-499 1231

FULL INFORMATION  
 ON ADVERTISING IN  
**STUDIO SOUND**

TELEPHONE 01-686 2599

and ask to speak to

**MIKE STORMER**

**TRAD**

**WATFORD 47988**

All Studio Equipment bought and sold.  
 See our advertisement on page .

149B St. Albans Road, Watford,  
 Herts.  
 Tel. Watford 47988

**WOLLENSAKS**  
**CASSETTE FAST COPIERS**  
 2770 mono & 2772 stereo, meticulously aligned  
 by Experts. HEAVY DUTY RECORDERS: 2551  
 Visual Sync & 2520 9 watt.  
**SOUND CASSETTE SERVICES Ltd.**  
 P.O. Box 2, Gerrards Cross, Bucks. SL9 7PH  
 Tel. 0281 3 84409

**REVOX**  
 SERVICE CENTRE

Service and overhaul.  
 High speed conversions.  
 Head changes.  
 Sel-sync.  
 Automatic double tracking.  
 Varispeed/varipitch.



01 349 1975

**Scotch**

**PROFESSIONAL TAPE**

Type 206, 207, 250, 256  
 available on 10 1/2" metal  
 NAB reels. 206 and 207 on  
 5" reels.

Quantity discounts.  
 Prices on application.  
 Mail Order service.



01 349 1975

**FOR SALE**

**GAUS LOOP-BIN**

Model 1260 - 1/2" 50 Hz

**BRAND NEW-NEVER USED**

Hispavox, S.A. Torrelaguna, 64  
 MADRID, SPAIN

Telex: 22931

Tel. (01) 4 15 23 04

Ask for Denise

**IF YOU NEED . . .**

Cassette Duplication	Empty Tape Spools
Blank Cassettes	White Tape Boxes
1/4" Tape	8T Cartridge Bodies
Leader Tape	Lubricated Tape
Splicing Tape	Head Cleaner Tape

Why not ring us on 01-399 2476/7 and let us  
 quote you for your next requirements.

**MEDIATAPE LIMITED, 29a Tolworth  
 Park Road, Surbiton, Surrey.**

01-399 2476/7

# INDEX TO DISPLAY ADVERTISERS

<b>A</b>		<b>M</b>	
AKG Equipment .. .. .	39	Macinnes Laboratories Ltd. .. .. .	28
Alice (Stancoil) Ltd .. .. .	18	Magnetic Tapes .. .. .	16
Allen & Heath .. .. .	19	MCI Ltd. .. .. .	37
Amek .. .. .	24	Midas .. .. .	IFC
APRS .. .. .	46	Millbank .. .. .	62
Audio & Design Recording .. .. .	56, 57	Monks, Keith .. .. .	77
Audio Developments Ltd .. .. .	18, 20	Music Laboratories .. .. .	33, 85
Audio International .. .. .	90, IBC	Mustang Communications .. .. .	86
Audix Systems Ltd. .. .. .	50		
<b>B</b>		<b>N</b>	
Bauch, F. W. O. .. .. .	53, 55, 71	Neal/Ferrograph .. .. .	21
BGW .. .. .	50	Neve, Rupert & Co Ltd. .. .. .	31
<b>C</b>		<b>O</b>	
Cathedral Sound .. .. .	75	Otari .. .. .	59
Comm, Access & Design .. .. .	82		
<b>D</b>		<b>P</b>	
Documents Group .. .. .	81	Page, John, Ltd. .. .. .	26
Dolby Laboratories .. .. .	12	Peavey Electronics (UK) Ltd. .. .. .	73
<b>E</b>		Protex Fastners .. .. .	20
Eagle International .. .. .	25	<b>Q</b>	
Electro-Voice .. .. .	17	Quad 8 .. .. .	14
EMS .. .. .	83	<b>R</b>	
<b>F</b>		Radford Audio .. .. .	73
Feldon Audio .. .. .	70	R.D.G. Audio Visual .. .. .	79
Fidelipac .. .. .	84	REW Professional Audio Ltd. .. .. .	67
Fraser Peacock Associates Ltd. .. .. .	7	Rose Morris .. .. .	4
Future Film Development .. .. .	78	Rolling Stones .. .. .	37
<b>G</b>		<b>S</b>	
Gelf Electronics .. .. .	20	Scenic Sounds .. .. .	16, 31, 75
Grahams Electronics .. .. .	26	Sheffield Sound Centre .. .. .	85
Granet Communications .. .. .	76	Shure Electronics Ltd. .. .. .	23
Greenwood Ventilation .. .. .	86	Sonifex .. .. .	79
Griffiths Hanson .. .. .	87	Sound Communications .. .. .	81
<b>H</b>		Soundcraft .. .. .	65, 85
HH Laboratories .. .. .	25	Sound International .. .. .	22
Hampstead Hi Fi .. .. .	10	Sound Recording Plant .. .. .	75
Hayden Laboratories Ltd. .. .. .	27, 63, 85	Squires, Roger .. .. .	61
Helios .. .. .	47	Studio Group Services .. .. .	86
<b>I</b>		Sun Recording .. .. .	81
Industrial Tape Applications .. .. .	9, 11, 13	Surrey Electronics .. .. .	58
Ivie .. .. .	5	<b>T</b>	
<b>K</b>		Trad Electronics Sales Ltd. .. .. .	22
Klark-Teknik Ltd .. .. .	OBC	Trident .. .. .	8
		Tweed Audio .. .. .	10
		<b>W</b>	
		Wadey .. .. .	81
		Williams, F. P. .. .. .	81
		Wilmot Breeden .. .. .	67
		<b>Y</b>	
		Yorke, James .. .. .	79

## Harrison Master Recording Consoles Are Available Through the Following Professional Audio Distributors

<b>AUSTRIA, SWITZERLAND and EASTERN EUROPE:</b>	Studer International AG Althardstrasse 150 CH-8105 Regensdorf, Switzerland Tel: (01) 840 2960. Telex 58 489
<b>BENELUX (BELGIUM, THE NETHERLANDS and LUXEMBOURG):</b>	Heijnen B. V. Steedalerstraat 56 NL-6940 Genneep, Netherlands Tel: (08851) 1956. Telex 48039
<b>BRAZIL:</b>	Larex Electronica LTDA Avenida Princesa Isabel, 7 grupos 915 Rio de Janeiro 20.000 Brasil Tel: 275-1695. Telex 2121616
<b>CANADA:</b>	J-MAR Electronics Limited 6 Banigan Drive Toronto, Ontario M4H 1E9 Canada Tel: (416) 421-9080
<b>COLOMBIA, EQUADOR, PARAGUAY, VENEZUELA and CUBA:</b>	Division Internacional Spica CA Avenida Sanz — Edificio Escar Local B — El Marques P.O. Box 75442 El Marques Caracas 107, Venezuela Tel: 35.14.19. Telex 25547
<b>DENMARK:</b>	Quali-fi A/S Strandvejen 730 DK-2930 Klampenborg, Denmark Tel: (01) 631711. Telex 16527
<b>FAR EAST (Except Japan):</b>	Studer-Revox Hong Kong Limited 108 Asian House 1 Hennessy Road Wanchai, Hong Kong B.C.C. Tel: 5-278571. Telex 84640
<b>FINLAND:</b>	Into OY Lepolantie 16 SF-00660 Helsinki 66, Finland Tel: (90) 742133. Telex 121836
<b>FRANCE:</b>	Studer France 12-14, rue Desnouettes 75015 Paris, France Tel: 533 58 58. Telex 204744
<b>GERMANY:</b>	Franz Vertriebsgesellschaft mbH. (EMT) Elektronik, Mess- und Tonstudioteknik Postfach 1520 D-763 Lahr 1, West Germany Tel: (07825) 512. Telex 754319
<b>GREECE:</b>	Electronica O. E. 9, Valaoritou Street Athens 134, Greece Tel: 3619096. Telex 214888
<b>ITALY:</b>	Audio Products International Via Gaspare Spontini 3 20131 Milan, Italy Tel: (02) 27 38 96. Telex 32402
<b>JAPAN:</b>	Shindenshi Manufacturing Corp. 1-47 Sasazuka, Shibuya-Ku Tokyo, Japan Tel: (03) 460-6052. Telex 2425108
<b>MEXICO:</b>	Accurate Sound Corporation 114 5th Avenue Redwood City, California 94063 Tel: (415) 365-2843. Telex 348327
<b>SPAIN:</b>	Neotecnica, s.a.e. Marques de Urquijo, 44 Madrid 8, Spain Tel: 242-0900. Telex 22099
<b>SWEDEN:</b>	ELFA Radio & Television AB Industrivaegen 23 S-171 17 Soina, Sweden Tel: (08) 730 07 00. Telex 104 79
<b>UNITED KINGDOM:</b>	Scenic Sounds Equipment 97/99 Dean Street Soho, London W1, England Tel: (01) 734-2812. Telex 27939
<b>U.S.A.</b>	Westlake Audio 6311 Wilshire Boulevard Los Angeles, California 90048 Tel: (213) 655-0303. Telex 698645
	Studio Supply Company P.O. Box 280 Nashville, Tennessee 37202 Tel: (615) 327-3075
	PRO Sound, Inc. Seven Wynnewood Road Wynnewood, Pennsylvania 19096 Tel: (215) 642-2744
	Willi Studer America, Inc. 1819 Broadway Nashville, Tennessee 37203 Tel: (615) 329-9576. Telex 554453
<b>EXPORT AGENT:</b>	Audio Systems International 146 North Orange Drive Los Angeles, California 90036 Tel: (213) 933-2210. Telex 686101
<b>FACTORY:</b>	Harrison International Corp. Post Office Box 22964 Nashville, Tennessee 37202 Tel: (615) 834-1184. Telex 555133

"Still No Compromise"



Harrison Systems, Inc.  
P.O. Box 22964 • Nashville, Tennessee 37202



# Progress from HARRISON

Second Edition Models 4032 + 3232

Automated Master Recording  
Consoles

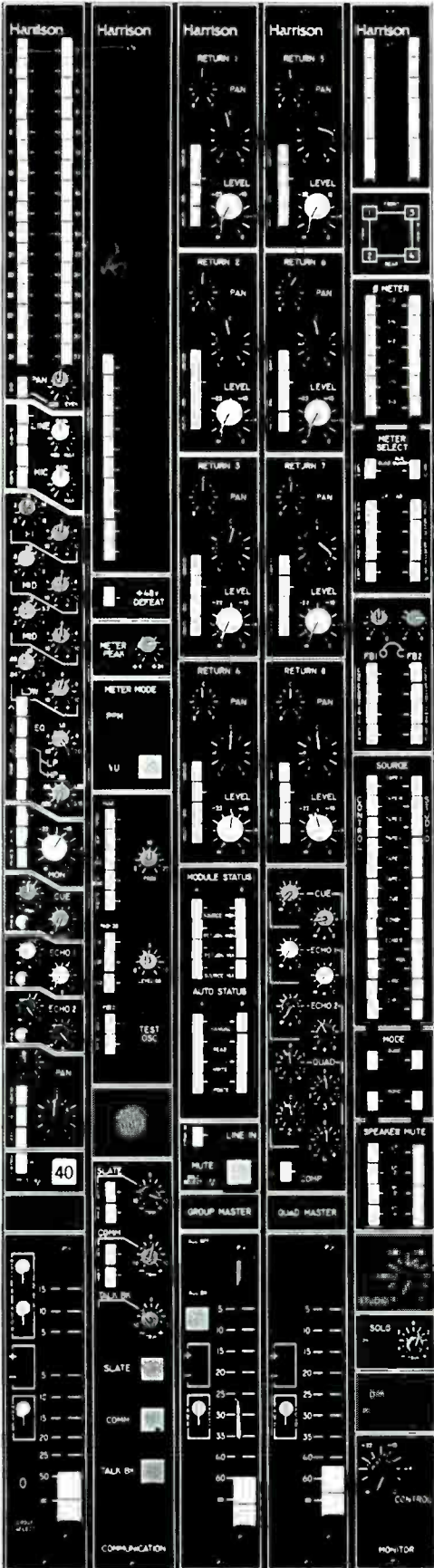

In response to your suggestions,  
Harrison's Second Edition consoles  
offer you many new features and functions.

- Programmable and Manual Muting.
- Group Muting.
- Fader Automation Null Lights.
- 2 Stereo Foldback Systems With Extensive Source Selection.
- Optional High Resolution Phase Meter.
- 2 Phase Meter Source Selection Matrices.
- Pink Noise Generator.
- 48 Volt Phantom Power On/Off Switch.
- Improved Parametric Equalizer Range.
- Optional Step-Type Equalizer.
- Stereo and Quad Meter Source Selection Switches
- Optional 36 Segment, High Resolution Light Meter With Front Panel VU and PPM Characteristic Selection.
- Master VU/PPM Characteristic Selection Switches
- Optional NTP Meter Overbridge.

“Still No Compromise”

**Harrison** 

Harrison Systems, Inc.  
P.O. Box 22964 • Nashville, Tennessee 37202

# There's no-one else.

When we first went into business some five years ago, we decided that we would produce an equaliser to beat all others.

Quite an ambition.

But we have achieved it.

All over the world Klark Teknik equalisers have earned themselves the reputation of being the best form of equalisation available, and the ultimate in tone control for sound recording, reproduction and measurement systems.

Why?

Because we designed our equalisers to be completely compatible with every customer's own personal requirements.

Because we opted for assembling our equalisers by hand rather than by a production line.

Because we can give you, the end user, a specification that cannot be bettered.

Because, quite simply, we understand what you want.

Yes, our products cost a great deal.

But we know that you will only pay more if you can get the results you want - every time.

We guarantee that you will.

The only way is to prove it for yourself.

Just take one of our equalisers on trial for a couple of weeks.

Then you'll understand what we mean.

And what you mean to us.

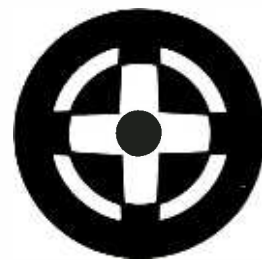

**KLARK-TEKNIK RESEARCH LTD**

You know it's the best.

Worldwide Distributors:

AUSTRALIA: Klarkon Enterprises, S. Melbourne. BELGIUM: A.R.C. Sprl., Bruxelles. CANADA: Hammond Industries, Toronto. DENMARK: Teamsound, Helsingør. FRANCE: R.E.D. Studio Centre, Paris.

GERMANY: Hausman Concert Electronics, Berlin. HOLLAND: Pieter Bollen, Eindhoven. ITALY:

Laboacustica Srl., Roma. JAPAN: Continental Far East Inc., Tokyo. NORWAY: Siv. Ing. Benum, Oslo.

NEW ZEALAND: General Video, Wellington. SINGAPORE: Ultralinear International. S. AFRICA:

Colosseum Acoustics, Johannesburg. SPAIN: Mabel Sdad., Barcelona. SWEDEN:

SATT Elektronik, Stockholm. SWITZERLAND: Dr. W. A. Gunter, Zurich.

TAIWAN: Yang's Audio Visual, Taipei. USA: Hammond Industries, Syosset, NY.

To: Klark-Teknik Research Limited, Summerfield, Kidderminster, Worcs. DY11 7RE.  
England. Telephone: Kidderminster (0562) 64027.  
Please tell me more about your DN22 & DN27 graphic equalisers and  
also about your new analogue time processors.

Name: \_\_\_\_\_  
POSITION: \_\_\_\_\_  
COMPANY: \_\_\_\_\_  
ADDRESS: \_\_\_\_\_