

January 1978 50p

studio sound

AND BROADCAST ENGINEERING

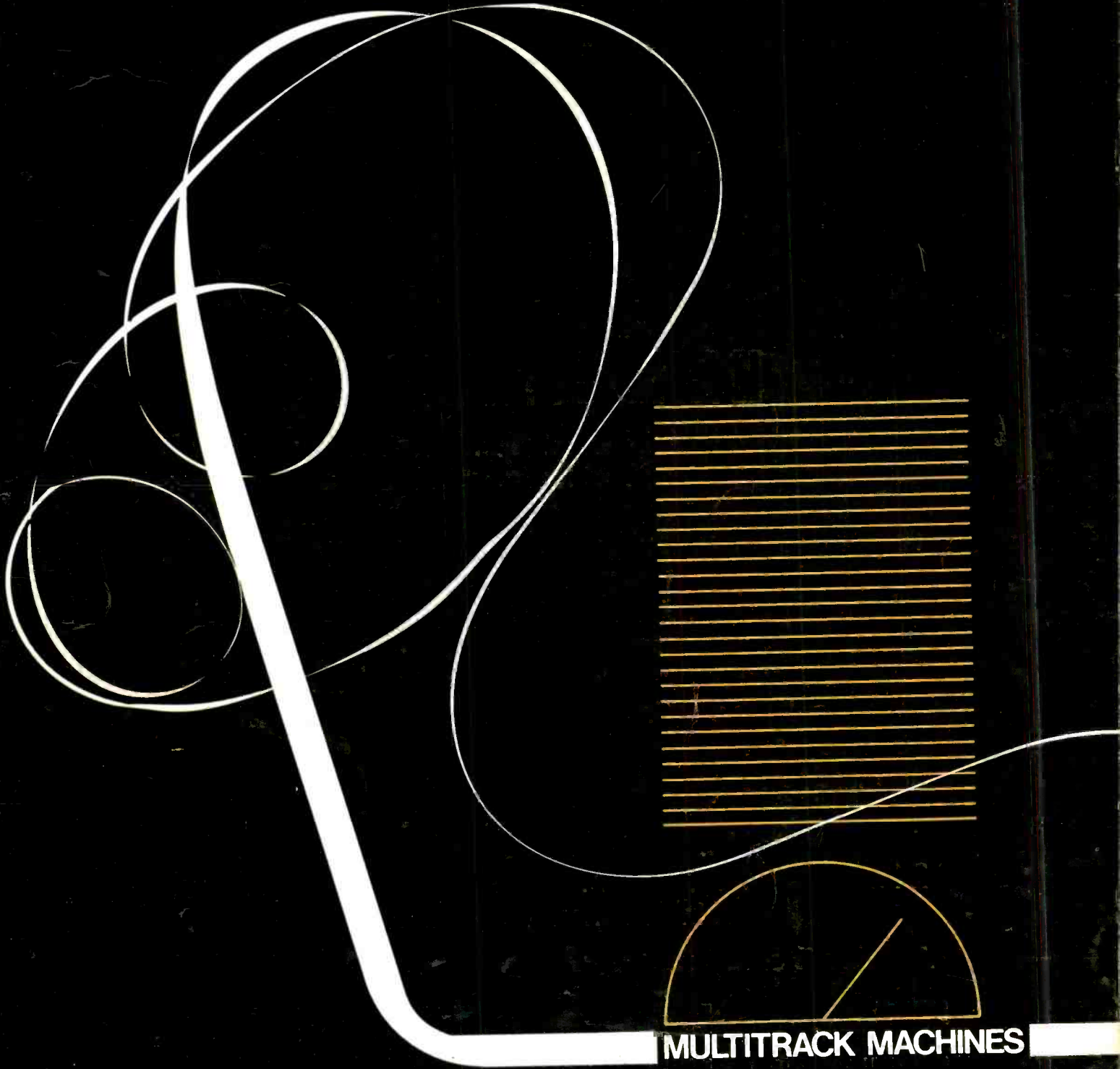

MULTITRACK MACHINES

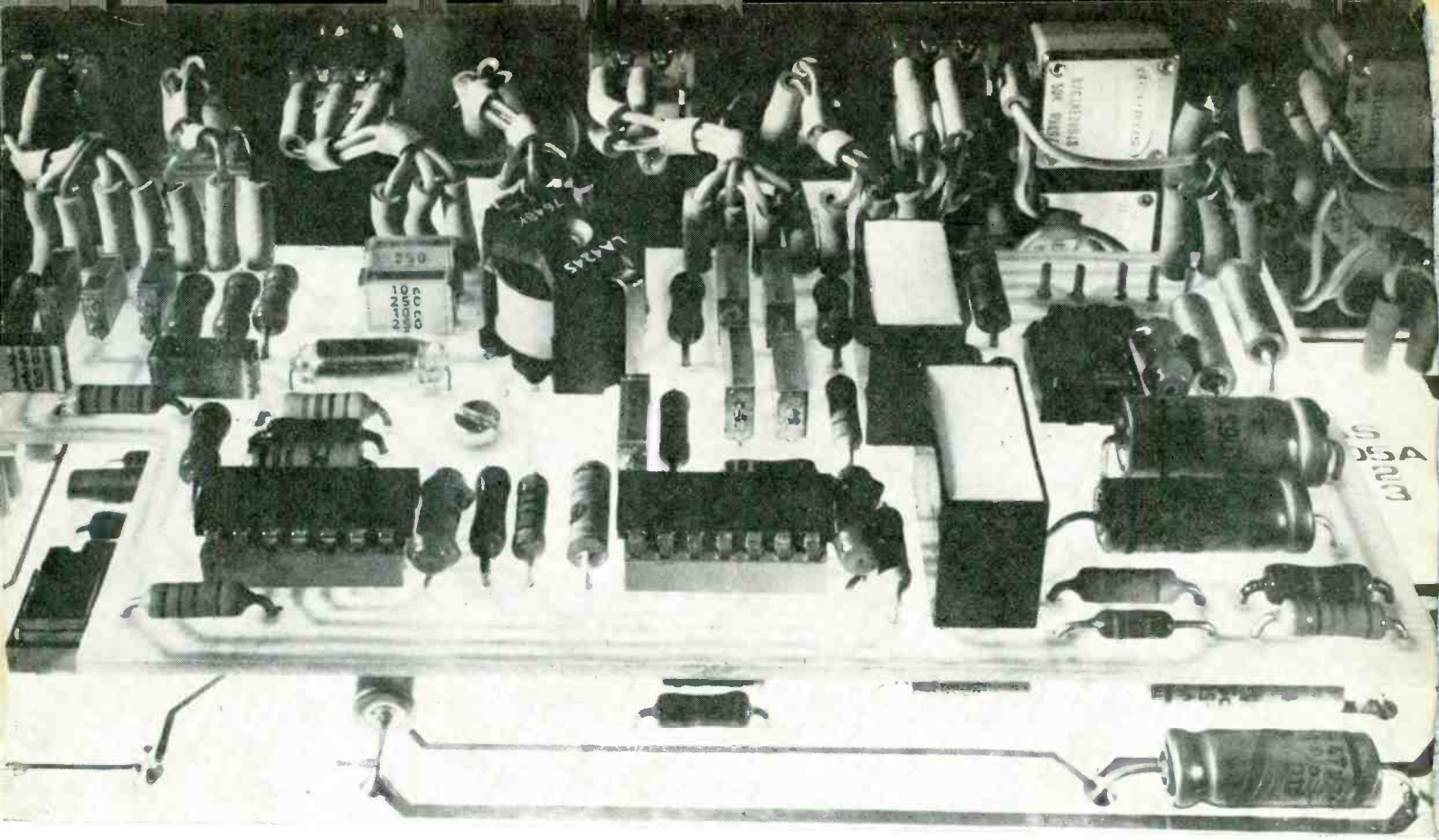

INSIDE MIDAS

Most consoles look impressive and inspire new flights of engineering imagination. However, in use, the faders may not be as smooth as they feel, the controls may not respond as they should, and the switches may click more ways than one.

In time, your inspiration will become severely limited if the faders and rotary controls act as noise generators, and if the switches refuse to go click at all. The Midas P.R. system creates a lasting impression. All switches have gold contacts, all rotary controls have cermet or conductive plastic tracks, and the Penny & Giles faders need no introduction. The modular frame system will survive many years of mobile use and the versatile range of 24 modules will cater for recording, broadcast and sound reinforcement applications.

For details of this uniquely versatile system please contact:

MIDAS U.K.
JEFF BYERS
54-56 STANHOPE STREET,
EUSTON,
LONDON NW1 3EX.
01-388-7060 01-387-7679

MIDAS EUROPE
LOUIS DE POTESTA,
23, AVENUE D'AVRIL,
1200 BRUSSELS,
BELGIUM.
322-771-3063

MIDAS U.S.A.
CHARLES AKINS,
SOUND WEST
5042 RUFFNER STREET,
SAN DIEGO,
CALIFORNIA 92211
714-560-7727

MIDAS CANADA
BOB SNELGROVE,
GERR ELECTRO-ACOUSTICS,
365, ADELAIDE ST. EAST,
TORONTO,
ONTARIO M5B 4R9
416-868-0528

EDITOR
RAY CARTER

ASSISTANT EDITOR
MEL LAMBERT

EDITORIAL PRODUCTION
DRUSILLA DALRYMPLE

CONSULTANT
HUGH FORD

SECRETARY
WENDY SMEETH

ADVERTISEMENT CONTROLLER
DOUGLAS G. SHUARD

ADVERTISEMENT MANAGER
TONY NEWMAN



THE LINK HOUSE GROUP

Editorial and Advertising Offices:

**LINK HOUSE, DINGWALL AVENUE,
CROYDON CR9 2TA, ENGLAND**

Telephone: 01-686 2599

Telex: 947709

Telegrams: Aviculture Croydon

© Link House Holdings Ltd 1977

All rights reserved.

STUDIO SOUND is published on the 17th of the preceding month unless that date falls on a Sunday, when it appears on the Saturday.

SUBSCRIPTIONS

STUDIO SOUND is available at an annual subscription of £8.20. All enquiries to: Subscription Dept, Link House, 25 West Street, Poole, Dorset BH15 1LL. Poole (02013) 71171.

OVERSEAS READERS

For overseas readers, outside Europe,* who require STUDIO SOUND within days of publication instead of weeks, we have the facility to send the magazine by Accelerated Surface Post (USA only) or Airmail.

The Accelerated Surface Post charge is \$10 per annum. The Airmail charge is £12 (sterling) per annum.

If you would like your copies of STUDIO SOUND sent by either of these methods, please write to the Editorial Office at Croydon.

On receipt of your remittance all subsequent issues of STUDIO SOUND will be sent to you by ASP/Airmail.

*All copies to Europe are sent Airmail.

BINDERS

Loose-leaf binders for annual volumes of STUDIO SOUND are available from Modern Bookbinders, Chadwick Street, Blackburn, Lancashire. Price is £2 (UK and overseas). Please quote the volume number or date when ordering.



MEMBER OF THE AUDIT
BUREAU OF CIRCULATIONS

Total average net circulation of 11299 per issue during 1976. UK: 6433, Overseas: 4866.

studio sound

AND BROADCAST ENGINEERING

Full circle

By and large the overriding argument for making direct-cut albums is one of quality. Without doubt the clarity and dynamic range of such a recording is quite breathtaking—hardly surprising when you consider the number of line, record and replay amps, noise-reduction systems, and other electronic ‘sound-benders’ eliminated from the recording chain; not to mention the intermod, harmonic distortion and phase inaccuracies caused by at least two stages of tape recording and replay.

However, from the record company’s point of view the main drawback against extensive use of direct-cut is the limited number of lps that can be lifted from the original acetate, plus the final cost of the product. Add to this the fact that many groups and/or producers appear to be hooked on the ‘safety’ of the 24-track syndrome (they would be very reluctant to commit themselves to a continuous 17-minute take) and it is easy to see why direct-cut is seldom utilised.

Hats off then to Warsaw Pakt, producer Mim Scala, and the lads at Trident for taking the plunge and doing the first direct-to-disc recording in the UK (and probably Europe for that matter). It is not uncharitable to describe the band’s music as New Wave (raw, earthy and unpretentious) and they wanted to capture on vinyl the ‘feel’ of a live gig. What better way than to use direct-cut? The band set up their pa rig in the studio, invited in an audience and let rip. Parallel feeds from the pa mics were taken into Trident’s control room and then up to the cutting room.

It’s a pity that the event was treated as a media happening—Trilion were making a video recording of the session, Capital Radio were giving practically an hour-by-hour account of the recording’s progress, and the distributors, Island Records, had laid on a fast car to rush the acetate to the pressing plant in an attempt to set some sort of world record in album marketing.

But pr gimmicks aside, the resultant lp is pretty spectacular. Here the cleanness and sheer balls of the bass and lead guitar are a revelation. Ok, there are a couple of ‘bum chords’ and some chat between the songs, but the overall sound is just what rock is about. In that respect Warsaw Pakt *et al* have succeeded in what they set out to do. They have demonstrated that direct-cut isn’t just about quality; it can give reality to the music as well. So how come it’s taken so long in the UK? Own up record companies, the facilities are there, you’re just scared to give it a try.

contents

FEATURES

AUDIO CONSOLES Don Richter and Martin Jones	34
‘IN NATURE . . . THERE ARE CONSEQUENCES’ Mel Lambert	44
AES 58th CONVENTION, A REPORT Ray Carter	46
SURVEY: MULTITRACK TAPE MACHINES	54

COLUMNS

NEWS	24
AGONY	32, 60
LETTERS	32
BUSINESS	42
WORK	62

REVIEWS

ORBAN PARASOUND 418A STEREO LIMITER Hugh Ford	68
MARSHALL TIME MODULATOR Hugh Ford	74
BANG & OLUFSEN WM1 WOW AND FLUTTER METER Hugh Ford	80

JANUARY 1978 VOLUME 20 NUMBER 1



76 LYNTHURST GARDENS,
LONDON N3. 01 349 1975-6

Treat yourself!

MODEL 5

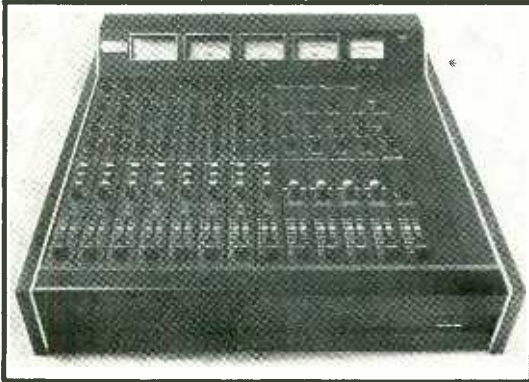

80/8

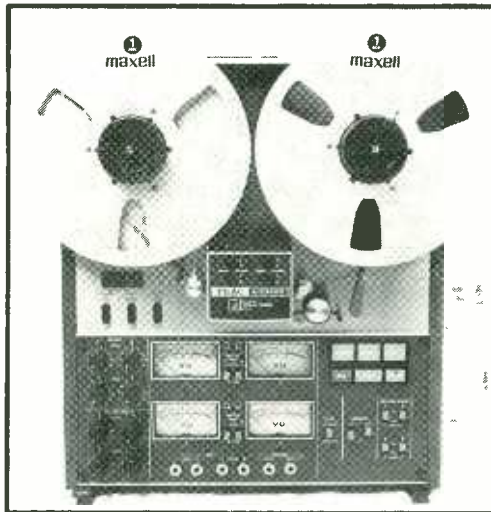

3340 S

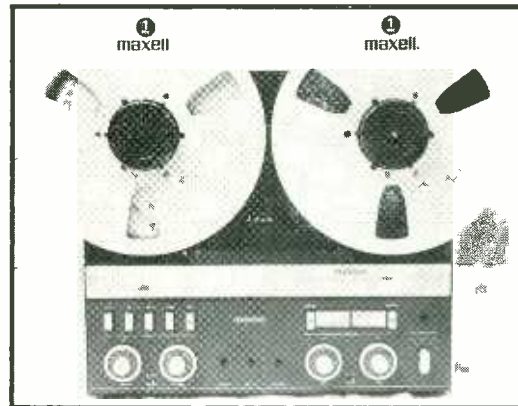

A77

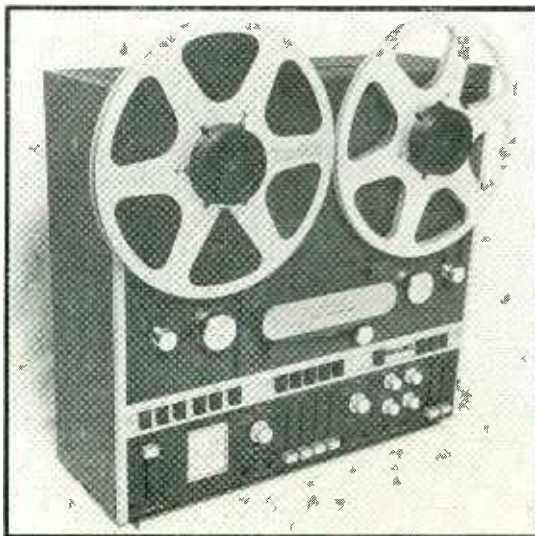

A700

TEAC MODEL 5

8 into 4. Separate control room and studio mixing facilities. Adaptable control at your fingertips.

TEAC/TASCAM 80/8

Professional 8 track 1/2" format. Full line up facilities. Easy operation. Incredible value.

TEAC 3340 S

Superb 4 channel multi-track recorder. Ideal for demos.

REVOX A77

Ten years' proven reliability. Over 400 versions available.

REVOX A700

Studio mastering machine.

NAGRA

complete the picture...



...with their new NAGRA E

A dilemma Nagra were suffering for some time, was how to produce a self-contained Professional Tape Recorder which incorporated all the qualities of their highly acclaimed Nagra 4.2, but could be marketed in the lower price range. Almost anyone can manufacture a cheaper version of a successful product but Nagra were determined not to sacrifice standards for economy. Well, we are happy to announce they have achieved the perfect solution with the new Nagra E.

The astounding saving of around 50% has been principally achieved by the simplification of the speed stabiliser—a single operating speed of 7½ ips is provided. The tape deck and transport mechanism are closely similar to that

used on the Nagra 4 Series, which has become renowned worldwide for its reliability and performance.

Good news, for the operator in the field, is that the new model is slimmer and lighter than the 4.2 and comes complete with a measuring probe, circuit diagram and some essential spares. This means that bias adjustment resulting from tape type change can be easily carried out away from base. A single microphone input is provided which can be switched to accept dynamic or condenser types.

TECHNICAL DATA

Dimensions: 13.8 x 9.3 x 4in (351 x 336 x 104 mm)
Weight: 12.6 lbs (5.75 kg) with tape and batteries
Wow and flutter: ± 0.1%

Reels: 7 in cover open, 5 in cover closed.

Loudspeaker: 1.0W, both switchable Tape/Direct
Headphones output

Frequency response recorded at -20 dB: 30—15,000 Hz ± 2 dB

S/N ratio, ASA "A": better than 66dB

Temperature range: 4°—158°F (-30 to + 70°C)

Please send me further details of the new NAGRA E and other models in the range.

Name _____

Address _____

HAYDEN

HAYDEN LABORATORIES LTD
Hayden House, Churchfield Road, Chalfont St. Peter,
Bucks, SL9 9EW Tel: Gerrards Cross 88447

SS1/NAG

Rebis RA 301

Two Channel Compressor/Limiter

- Programme related variable attack and release controls
- Low 'worst case' distortion figure
- Compression continuously variable to 30db



For full specifications of the Rebis RA301 Compressor Limiter and the RA402 Parametric Equaliser, contact :- Scenic Sounds Equipment 97-99 Dean Street, London W1V 5RA Telephone : 01-734 2812/3/4/5

Gelf

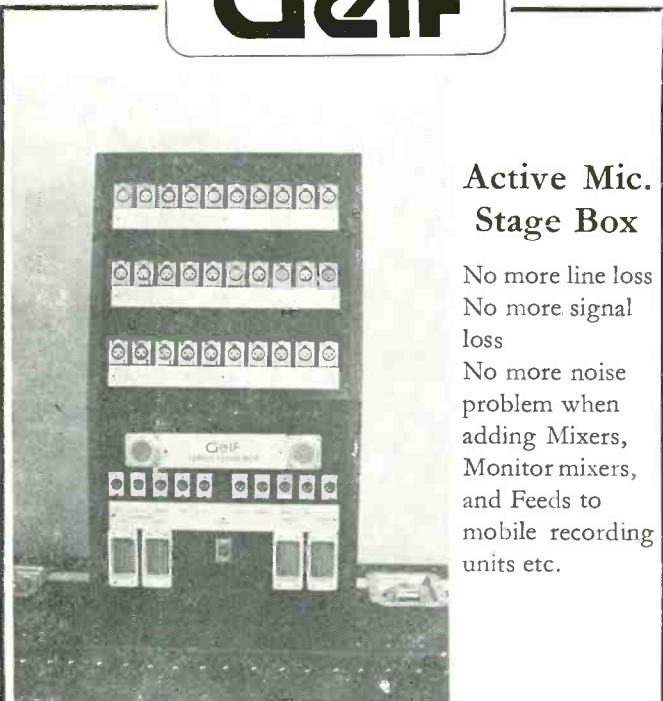

Active Mic. Stage Box

No more line loss
No more signal loss
No more noise problem when adding Mixers, Monitor mixers, and Feeds to mobile recording units etc.

Gelf electronics Ltd

6 Duncombe Street, Bletchley, Milton Keynes.
Tel. Milton Keynes (0908) 77503

Probably the best cassette sound you've ever heard

Large runs for record companies and smaller runs for studios all given the same precise attention with regard to quality and speedy turnround. **Blanks wound any length.**

Collection and delivery service door to door for both cassette and master tape copying.



**Contact
Dave Rees
at
061-795 7666 to
discuss your
requirements.**

TRUE PROFESSIONALS

Including: EMI, Decca (UK), BBC, Pink Floyd, Hawker Sidley, Metropolitan Police, The Who, Queen, Thames TV, ITN, Capital Radio, Decca (France), Ministry of Defence, Birds Eye, Rolls Royce, Crown Agents, Madame Tussaud's, Island Music, Chappells, Dick James Music, Neve, Alice, Israel Defence Ministry, Yes Music, University of Bucharest, Pye TVT, Avon Health Authority, Government of Seychelles, Philippines Radio, London Broadcasting, Rolling Stones, Thin Lizzie, British Railways, Natural History Museum, Virgin Records, Kirilo Savic Institute of Belgrade, all British Universities, London Weekend TV, BOC, Wings, IBM, every Local Radio Station, Post Office Research, Rank Organisation, and many others.



REVOX A77
Used in more broadcast and recording studios than any other recorder.



3.77
Based on the A77 chassis and introduced at the request of the recording industry to meet their requirements of 3-speeds, full editing facilities, motion sensing and immediate access to the heads. Designed and rebuilt by ITA.

ACKNOWLEDGE

That ITA has more to offer: **Location.** In Central London — easy parking. **Delivery.** Large stockholding covering 500 versions for immediate delivery. **Servicing.** By Revox factory trained staff. Quickest turnaround time. Machines supplied or rebuilt for special requirements. **Pricing.** Check our prices — you will find them lowest ALWAYS.



REVOX B77
For the Hi-Fi enthusiast and semi-pro user, a new model, variable tape speeds and attractive styling.

ITA'S ADVANTAGES



1-7 Harewood Avenue, Marylebone Road, London NW1. Tel: 01-724 2497.
Telex: 21879.

HOW TO BE AN OVERNIGHT SUCCESS IN 10 YEARS



Overnight successes often don't last longer than the next day. It's taken 10 years and a lot of mixers to produce the ALICE ACM system—and we think it's here to stay!

Alice (STANCOIL LTD.)
38 ALEXANDRA ROAD, WINDSOR, ENGLAND Telephone Windsor 51056/7 Telex Aegis G 849323



The only battery operated professional tape recorder offering all the following facilities in one compact unit:

STELLAVOX® Sp 8



- compact, slim and lightweight
- preadjusted modular plug-in headblocks for mono and stereo
- optional plug-in: 50/60 Hz crystal; 50/60 Hz synchroniser; balanced line outputs; 48 V converter for phantom microphones
- two microphone inputs switched for any dynamic or condenser types
- two controlled line inputs, adaptable to microphones
- two fixed level mixer inputs
- fully modular construction
- optional (real-time) encoder
- exceptional modulation reserve
- very low power drain for long battery or accumulator life

JOHN PAGE LIMITED

169 OLDFIELD LANE, GREENFORD, MIDDLESEX, UB6 8PW

☎ 01-578 0372/2641

TELEX: 24224 REF 568

SHEFFIELD SOUND CENTRE

SPECIALISTS IN HI-FI

Main agents for Teac, Tascam, AR, Uher, Dokorder, Revox, Spondor, JBL, Dahlquist, Tannoy, Lowther, Ferrograph, Marantz, Bic Technics, Quad, Armstrong, Sony, Nagra, IMF, Dbx, Otari, and many more.

Competitive prices, terms, part exchange

101a and 107 ECCLESALL ROAD

Tel: 0742 23365

Griffiths Hansen (Recordings) Ltd

Recording studio specialising in speech and drama for education, advertising, industrial training, sales and promotion work.

Open reel and cassette duplicating

Public address installation and hire for conferences and exhibitions etc.

12 BALDERTON STREET, LONDON W1Y 1TF
(Opposite Selfridges) 01-499 1231

The unique TEAC range from ITA

Only ITA offer such a wide range of models—always in stock.

TASCAM 80-8

This 8 track recorder is available with or without DBX noise reduction.

Immediate delivery.



A2340 SXH

All the advantages of 15 ips operation now available on this model. Outstanding value among 4 channel recorders.

Exclusive to ITA.

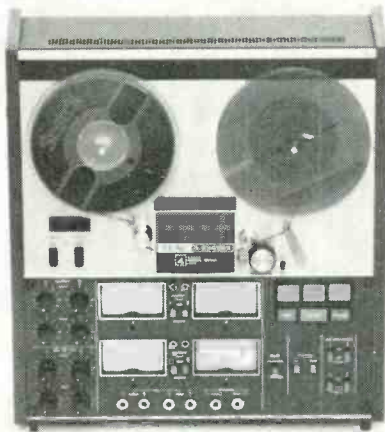

A3340S Industrial

This upgraded version of the A3340S standard model features 63dB signal to noise ratio.

Exclusive to ITA.



We hold the largest stock of TEAC in the UK for immediate delivery. Visit our new showrooms for a demonstration.



MIXERS

The Tascam Series Model 3 and Model 5. In stock, and available for demonstration.



ITA

1-7 Harewood Avenue,
Marylebone Road, London NW1.
Tel: 01-724 2497
Telex: 21879

Mod II The Expandables



In today's recording world it is essential to maintain flexibility within your chosen operational format.

Our basic package deal can give you a low cost 8 track studio which can grow as far as you can take it!

for full details of Mod II and Brenell multi-track tape machines write today or visit — our demonstration studio at Pembroke House.

Allen and Heath Brenell Limited,
Pembroke House, Campbourne Road,
Hornsey, London, N8 7PT.
Telephone: 01-340 3291 Telex: BATGRP 267727

Audiotechniques Inc.,
142 Hamilton Avenue,
Stamford, Connecticut 06902, U.S.A.

NEW PRODUCTS BULLETIN

ITA



**ORBAN
PARASOUND from USA**

Dual channel multispring reverb unit. Each channel features four springs — far smoother than single spring systems. "Twang" and "boing" are virtually eliminated by incorporating a floating threshold limiter. Bass, mid-range EQ and bandwidth controls. The best compact reverb unit available.



ITAM Compliment

New Stereo compressor limiter. Competitively priced. Free standing self-contained unit, accurate stereo tracking, stepped 1:1, 1:5, 3:1 plus limiting ratio at 20:1. Switchable attack time, variable release time, automatic release time. Input attenuation to accommodate large range of inputs. Pre-set adjustable output. Switched link for stereo tracking. Visual representation of compression. £247 + VAT



TRIDENT Fleximix

Can be built up from stereo through 4 channel to 8 channel groups with unlimited number of input channels. Well thought-out and superbly constructed to the highest standards. ITA always have Fleximix in stock for demonstrations and immediate delivery.



**OTARI
DP4050 0CF
IN CASSETTE
DUPLICATOR**

Now with 3 3/4" + 7 1/2" master capability and Ferrite heads. Duplicates 6 cassettes each run at 8 times speed. Over 80 stereo C60 per hour. Unquestionably the finest in cassette copier available from the world's largest duplicator manufacturer.



AUDIO & DESIGN

The latest range of SCAMP modules are designed to meet all the requirements of sophisticated studios. We have a full range in stock for inspection.

QUAD

The new 405 power amplifier is now in stock. 100 watts per channel — simply the best, for £££'s less! Immediate Delivery!

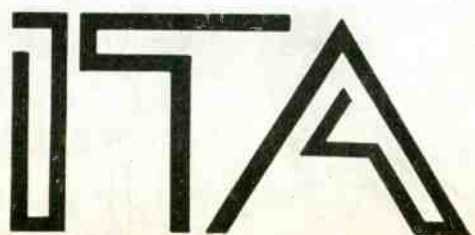

1-7 Harewood Avenue,
Marylebone Road, London NW1.
Tel: 01-724 2497
Telex: 21879

R.D.G. AUDIO VISUAL LTD.

12 HILL VIEW, NEWPORT
PAGNELL, BUCKS.

Tel. Dunstable 607192 Newport Pagnell 613009

	£
MCI JH116 16 tracks	11,500
Ampex MM1100 16 tracks	9,500
Ampex MM1000 16 tracks	7,000
3M M79 16 tracks	9,200
Studer A80 Mk.2 8 tracks	8,750
Ampex MM1100 8 tracks (BRAND NEW)	6,500
Ampex AG440 8 tracks	3,900
Ampex AG440 Stereo	1,200
Studer A80R Stereo (200 hours)	3,400
Leevers Rich 8 tracks	3,600
Ampex AG440 4 tracks (½ inch)	1,600
Studer 8 track Head Block (new)	750
Various Revox and Teac machines from ..	300
MCI 428 console, 2 years old	12,000
Sonag console (French made (24 x 24))	10,500
API 16-8-16 prewired 24	10,000
Trident "B" 18-8	6,500
Allen & Heath 16-8-16 MOD 2	2,100
Studer 12-4-2 1 year old (new price £11,500)	6,000
ITAM 10-4	450
Alice AD62 Mod 2	220
Neumann U87 as new	225
Neumann U67 as new	240
Neumann stereo cutting machine with vari- able pitch and depth, with ES59 head ..	5,880
Neumann stereo rack complete for above ..	1,260
Ortofon Stereo cutting head DSS661	2,200
Sansui Professional QS 4-channel encoder/ decoder type QSE-4/QSD-4, brand new	2,850
Eventide digital delay, 8 months	2,500
JBL 4343, new pair	1,890
Spendor BC1 pair	180
Lockwood Major type pair (Reds)	250
BGW 250B, new	398
Crown DC150	250
Crown D60	150
HH TPA 25D	45

**WANTED URGENTLY: ALL TYPES OF
STUDIO EQUIPMENT. WE HAVE CLIENTS
WAITING FOR DOLBY UNITS**

EX-STOCK

MINI MIXING CONSOLES MK I

No. 1 18 Input channels
8 Output Groups
16 Track Monitoring

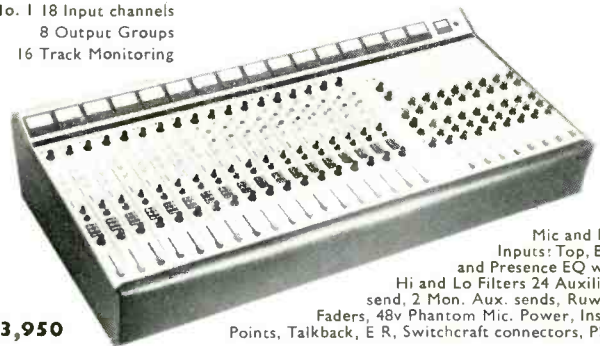

£3,950

Mic and line
Inputs: Top, Bass
and Presence EQ with
Hi and Lo Filters 24 Auxiliary
send, 2 Mon. Aux. sends, Ruwido
Faders, 48v Phantom Mic. Power, Insert
Points, Talkback, E R, Switchcraft connectors, PSU.

No. 2 12 Input channels
4 Output Groups

8 Track Monitoring
E R
3 Aux. sends
Group reinsert
Insert points
Ruwido faders
Switchcraft
Connectors.



£2,400

2 Audio and Design
F760 Limiter/
Compressors

RAINDIRK LTD.

33A Bridge Street,
Downham Market, Norfolk
Telephone: 03663-2165

POWER AMPLIFICATION BY MUSTANG



Our SS.100 and SS.50 are economical amplifiers with outputs of up to 150 and 80 Watts RMS into 8-15 ohms, typical THD figures being 0.1%, slewing rate > 10v/µs, noise > 90dB down, zero level input, and full electronic protection.

Considering these points with their proven reliability and robust construction, plug in output transistors and driver board, optional balanced input and 100V line output, and virtually ex stock despatches we reckon we take some beating! Contact us now for the full technical specifications.

Manufacturers of mixers, integrated mixer amplifiers and slave amplifiers, studio power amplifiers, transformers, lighting control equipment and cabinets for the home and export markets. Contact us for full illustrated technical brochures.

MUSTANG COMMUNICATIONS

Nelson Street, Scarborough,
North Yorkshire YO12 7SZ
England
Telephone 0723-63298



Some of our products need no introduction



Up to date thinking is the key to ITAM's design philosophy. The 805 Master Recorder brought 8 channel recording within the reach of the smaller studios, and is still the most advanced 8 channel 1/2" recorder available, featuring modular electronics and variable tape speed. ITAM Mixers offer an unbeatable combination of performance and sensible price. 4 and 8 output group versions available.



Something New

The Compliment

An entirely new stereo compressor limiter.

One of the few free standing units available, the Compliment brings you excellent performance at a competitive cost.



- ★ Variable ratio.
- ★ Compression range greater than 30dB.
- ★ Variable attack and release times.
- ★ Less than -78dB signal/noise.
- ★ Low distortion.
- ★ Accurate stereo matching.

itam

1-7 Harewood Avenue, Marylebone Road, London NW1.
Tel: 01-724 2497 Telex: 21879.

Mix With Success Mix With Trident

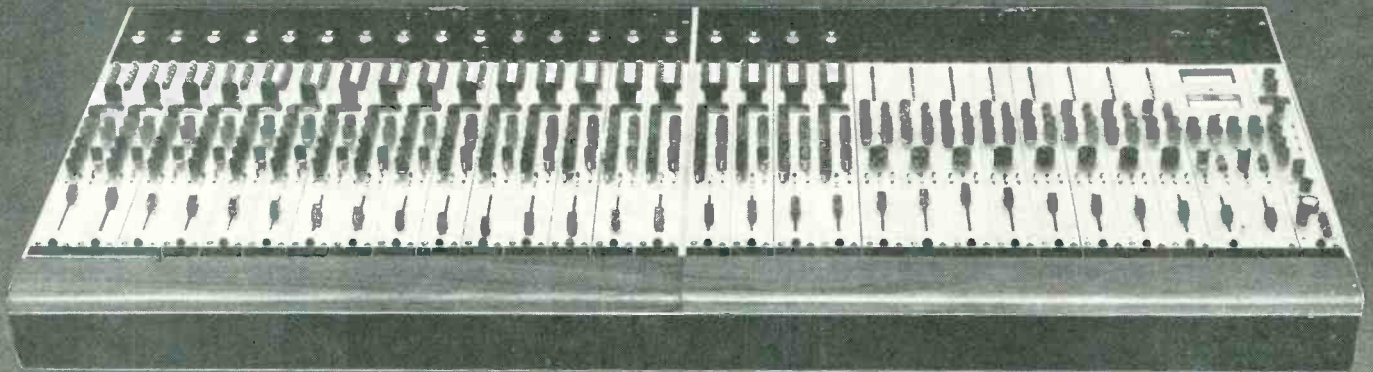

The Trident Fleximix system can help you make a success of any recording whether in the studio or on the road; in fact anywhere where a sound mixer is required. For a little over £2000 you can buy a 10 input-2 output configuration, which could subsequently be expanded to a system with 10 mixed outputs, any number of input channel and 24 track monitoring. Expansion is simply achieved by slotting-in additional channel modules. When available slots are used up another mainframe is added. Modules may be placed in any sequence. No factory rework or rewiring is necessary. Additional mainframes may be either rigidly or flexibly coupled to the original system and flight cases are available to accommodate any arrangement.

A number of exciting new modules will shortly be available, which will extend even further the system's versatility. These will include a Compressor/Limiter module, Quad joystick module and Line-balancing module.

TRIDENT AUDIO DEVELOPMENTS LTD.

Sales Office: 112/114 Wardour Street

London W1V 3AW

Tel. 01-734 9901 Telex: Tridisc 27782



Factory address:

Shepperton Studios,

Squiresbridge Road,

Shepperton, Middlesex.

Tel. Chertsey (09328) 60241.

APRS

ASSOCIATION OF PROFESSIONAL RECORDING STUDIOS

PROGRAMME FOR 1978

CANNES

MIDEM

20-26 JANUARY

The annual get-together of 5000-6000 people from all over the world interested in every aspect of recording and publishing of music.

At MIDEM APRS will issue a 40-page Catalogue of its members to advertise recording facilities in Great Britain.

HAMBURG

AES CONVENTION

FEB 28 MARCH 1-3

British manufacturers are exhibiting as part of this Convention in a joint British Overseas Trade Board/Association of Professional Recording Studios venture.

APRS will issue a Catalogue.

LONDON

COURSE FOR NON-TECHNICAL STUDIO STAFF

SPRING

For studio personnel. An introductory course to basic electronics and physics, upon which the operation of studio equipment depends.

LONDON

APRS 78

JUNE

11th Annual Exhibition of Professional Recording Equipment at Connaught Rooms, London.

GUILDFORD

5th ENGINEERS COURSE

SEPTEMBER

UNIVERSITY OF SURREY, U.K. A course of lectures, demonstrations and discussions for studio engineers, to exchange views on techniques and problems of common interest.

HOME COUNTIES

OR LONDON

MANAGEMENT

AUTUMN

A weekend course for managers on management.

For further information on above, or for application for membership (in all divisions) write to **The Secretary, APRS, 23 Chestnut Avenue, Chorleywood, Herts WD3 4HA, United Kingdom.**

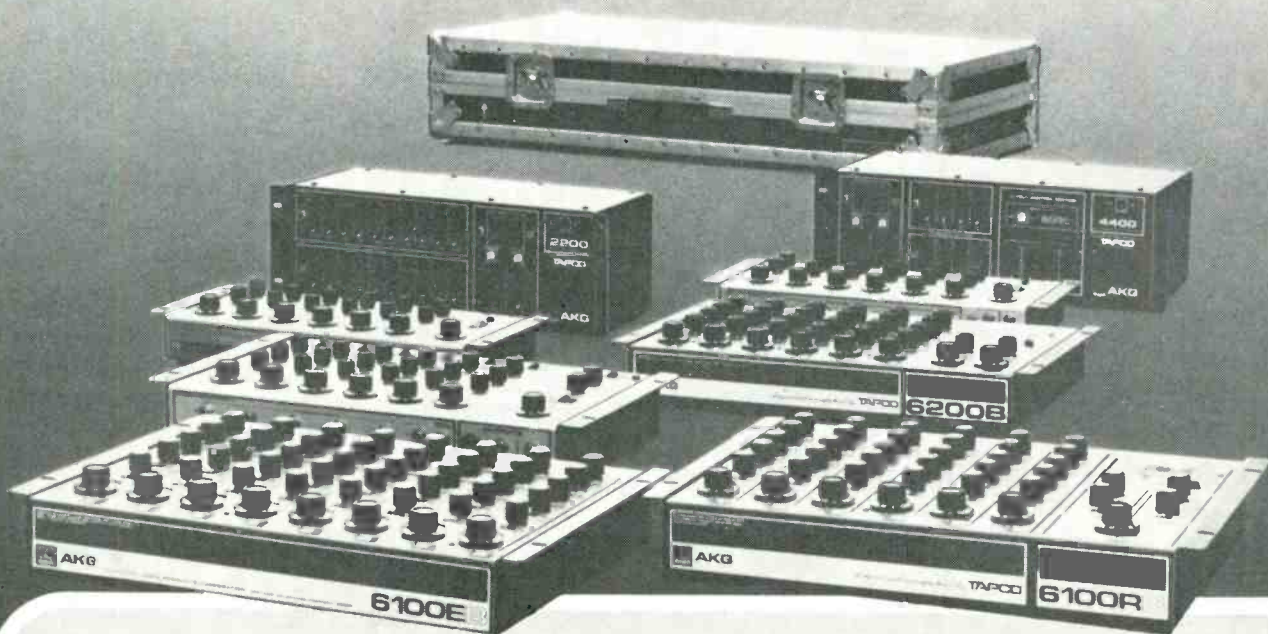

„Roadability” par excellence.

AKG's new range of Sound Equipment brings together certain essentials:

- economical design and rational layout
- reliable rotary controls taking up the minimum of space
- all-metal cases of compact and robust design
- individual functions easily seen at a glance

Special features include:

- special auto-pad technique, i.e. automatic sensitivity matching to the input stage

eliminates overload problems

● a choice of jack and XLR sockets allow either semi-professional equipment, including Hi-Fi components, or professional audio equipment to be readily connected
AKG's new mixer/equalizer/reverb programme is ideally suited to professional musicians,

discotheques, p.a. systems and keen amateurs. Providing complete compatibility with the existing range of AKG dynamic and condenser microphones so extensively used in broadcasting and recording studios, these new AKG products will enable you to get the best from both instruments and voices.

ADV 220/E

AKG acoustics

designed and manufactured by

TAPCO
TECHNICAL AUDIO PRODUCTS CORPORATION



182/4 Campden Hill Road Kensington **AKG Equipment Ltd.** London W8 7AS Tel. 01-229-3695. 01-727-0788



All under one roof



Showrooms open -
Tuesday - Saturday
10.00 am - 5.00 pm
Late night Weds
until 8.00 pm

**the widest range of studio equipment
for professional and home recording studios**

**DEMONSTRATION STUDIOS · LARGE STOCKS AVAILABLE
PERSONAL CALLERS WELCOME · FRIENDLY SALES & TECHNICAL ADVICE SERVICE**

SOUNDCRAFT SERIES II STUDIO MIXER

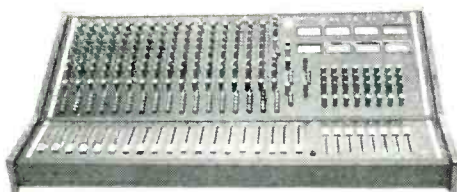

One of the finest mixers currently available, the Soundcraft series II studio mixing console represents the highest standard of manufacture and electronics design. The mixer is available in 12, 16 or 24 channel with 4 or 8 outputs.

The unparalleled range of facilities include: full EQ on all channels, remix controls, LED overload indicators, pre and post fade cue send, output routing, comprehensive monitoring, plus much more. Full details and specs on request. Price dependent on configuration.

Typically 12 into 4 from **£1865 + VAT.**

Soundcraft Series I and II NOW IN STOCK

FAST EXPORT AND UK DELIVERY SERVICE

MM ELECTRONICS - MP175 12/2



Superb value for money in studio quality mixers! The MP 175 represents the first really cost-effective solution for small studios and bands.

It features an uncompromising technical specification, with 4 way EQ, 2 aux. send groups, echo return - many options available. Basic price **£250 + Vat**

Entire MM range also available

CALL IN OR PHONE TO DISCUSS YOUR REQUIREMENTS

**Sole UK distributors
of ANGLEPOISE
MIC STANDS**

available for wall,
table or clamp
mounting.

Ex-stock
£14.75
+Vat



**Instant Start
BROADCAST TURNTABLES**



Russco Technics

**PROFESSIONAL. NAB
CART. MACHINES**

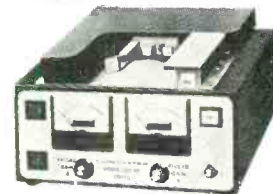

Wide range of exclusive models

AGENTS FOR

**AKG · ALICE · ALLEN & HEATH · BEYER · CALREC · CHILTON · HH · KLARK TEKNIK
MM · NEAL · QUAD · RUSSCO · REVOX · TECHNICS · TANNAY · TEAC · TASCAM · UHER**

Roger Squire's

STUDIO EQUIPMENT DIVISION

**BRANCH MANAGER: TONY KINGSLEY
SALES ENGINEER: DAVE WHITTAKER
55 Charlbert St., London, NW8 6JN
Telephone: 01-722 8111**

Local parking - 5 mins from St Johns Wood Tube



MXT-1000 AUDIO MIXING SYSTEM

The new MXT-1000
A unique system enabling
your own requirements to
be built from standard
equipment

8 channel, 2 group MXT -
1000 - each channel fitted
with compressor

Manufacturers of
sound systems
and electronics

Station Road, Wenden
Saffron Walden
Essex CB11 4LG
Saffron Walden
(0799) 40888

audix

TAPES?

WHO ELSE BUT JAMES YORKE CAN...

- Record, dub, mix, synchronise — in house for world markets.
- Load cassettes from C2 to C95 with an accuracy typically better than 5 seconds.
- Supply tapes in screwed, welded, lugged or lugless cassettes in a variety of colours.
- Provide labelling, inlay card design and packaging — even shrink wrapping — the way you want it — fast.
- Offer a loop bin duplicating system for stereo tapes to the highest standard.
- Deliver in as little as 48 hours.
- Do all this — and more — at out of town prices for runs of 10 to 100,000.

We also manufacture a wide range of standard tapes from the budget priced James Yorke "Soundrider" range to a top quality supergrade which is approved and purchased by the most fastidious users.

Suppliers to education authorities, government departments, retail trade and the professional.

Tapes? Who better than James Yorke.

James Yorke Limited, The Old Post Office, Fossebridge,
Cheltenham, Gloucestershire GL54 3JW.
Tel: Fossebridge (028572) 423.



GRAHAMS



TEAC
TASCAM SERIES

KEITH MONKS

JBL 4315, 4343, 4301 monitors on demonstration
+
Quad 405, Revox B77, Alice A&H and all accessories
at professional prices

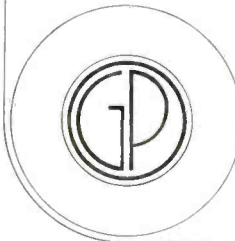

GRAHAMS professional

86-88 PENTONVILLE ROAD,
LONDON N1
Telephone 01-837 4412, ext 66

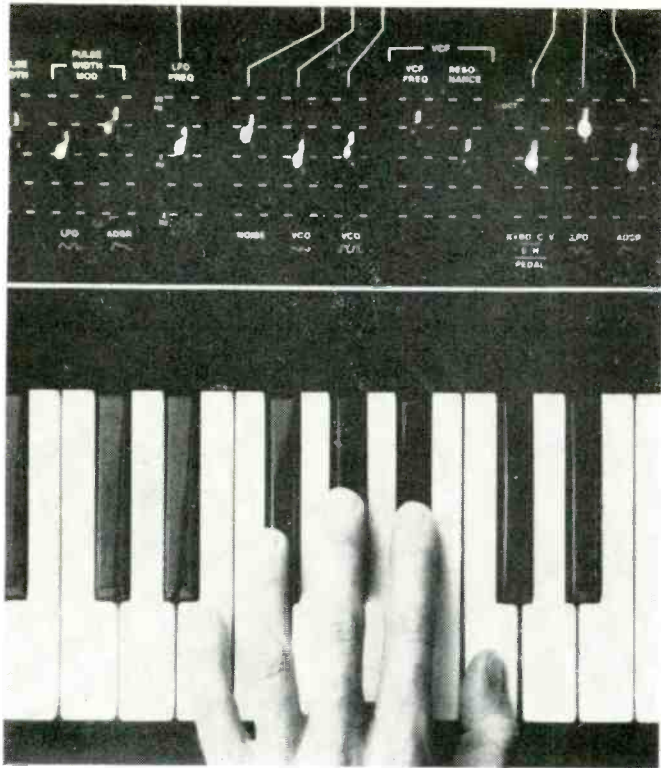

THIS IS WHERE TOMORROW'S GREAT MUSIC IS COMING FROM.

We think musical styles change because musical talents change.

There is hardly a musician making money today who doesn't know as much about recording music as he does about playing it. And recordists know as much about playing music as they do about recording it.

Because both know the equipment that captures music can also be used to improve it.

So while musical styles may change, the interdependence of musician, recordist, and the instruments they use will not. And that is the reason for the TASCAM Series by TEAC.

For not very much money TASCAM lets both musician and recordist get their hands on mixers and recorder/reproducers that let both tailor their music their way.

For every kind of music, for every kind of need, at home and on the road, by price and application, everything we make

has the same goal as everything you make—be the best.

Because it still takes great talent to make great music.

TASCAM SERIES BY TEAC®

A new generation of recording instruments for a new generation of recording artists.

TELEDYNE ACOUSTIC RESEARCH
HIGH STREET, HOUGHTON REGIS, DUNSTABLE, BEDS. LU5 5QJ



The Model 5-EX shown with four optional 201 input modules. Model 5 shown with optional 204 talk back/slate module.

GAUSS THE No. 1 NOW 64:1

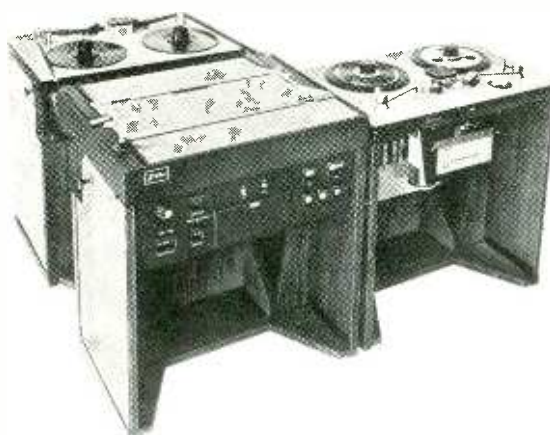

Over recent years GAUSS technology has reshaped the cassette duplication industry. The most sophisticated product of GAUSS research and development, the Series 1200 unit (with attendant slaves), is recognised as the world's standard for optimum duplication quality, giving maximum return on investment. Now our newly introduced 64:1 capability lets

you double your production rate. Your $3\frac{3}{4}$ master is reproduced on slaves running at 120 IPS, maintaining the unmatched quality that you've come to expect from GAUSS. To update existing units in the field we offer conversion kits that interface simply with our existing 32:1 system. GAUSS set the standard for quality tape duplication. Now GAUSS sets the pace.



CETEC INTERNATIONAL LTD.
CETEC AUDIO · GAUSS · SPARTA · JAMPRO

SAPPHIRE HOUSE, 16 UXBRIDGE ROAD, EALING, LONDON W5 2BP Telephone: 01-579 9145 Telex 935847

APRS

78

Wednesday 21

Thursday 22

Friday 23

JUNE 1978

EXHIBITION OF
PROFESSIONAL
RECORDING EQUIPMENT

Apply now for *Exhibition Space*

23 Chestnut Avenue,
Chorleywood, Herts,
England WD3 4HA

NOW YOU CAN COPY 2 STEREO MUSIC CASSETTES IN LESS THAN 4 MINUTES!

Now available in the UK—the latest in the Wollensak range of heavy duty cassette equipment. The 2772A/V can make superb STEREO cassette copies at the touch of a button.

Wollensak 2772A/V High-Speed Desktop Duplicator features:

- ★ Frequency Response—40-10,000 Hz \pm 3 dB
- ★ Wow and Flutter—0.15% RMS maximum
- ★ S/N Ratio—within 3 dB of master
- ★ Tape Speed—13.3 times original speed 25 i.p.s.
- ★ Speed Accuracy— \pm 1%
- ★ Crosstalk—40 dB minimum at 1 kHz
- ★ Industrial Price—£1,322.66 plus 8% VAT

Write for further details OR RING 01-947 7551 for Demonstration.



Please Note—The Wollensak stereo copier can only be supplied to recording studios, industrial or educational users or professional companies.

fpa

the cassette people—
FRASER PEACOCK ASSOCIATES LTD.
94 High Street, Wimbledon Village, S.W.19

Radford

THE FACILITY



SEE THE TEAC TASCAM RANGE
AT RADFORD HI FI LTD., 52-54 GLOUCESTER RD., BRISTOL BS7 8BH
Tel. (0272) 422709 Telex 449135 CONTACT ROGER WALL

The Teac / Tascam Centre

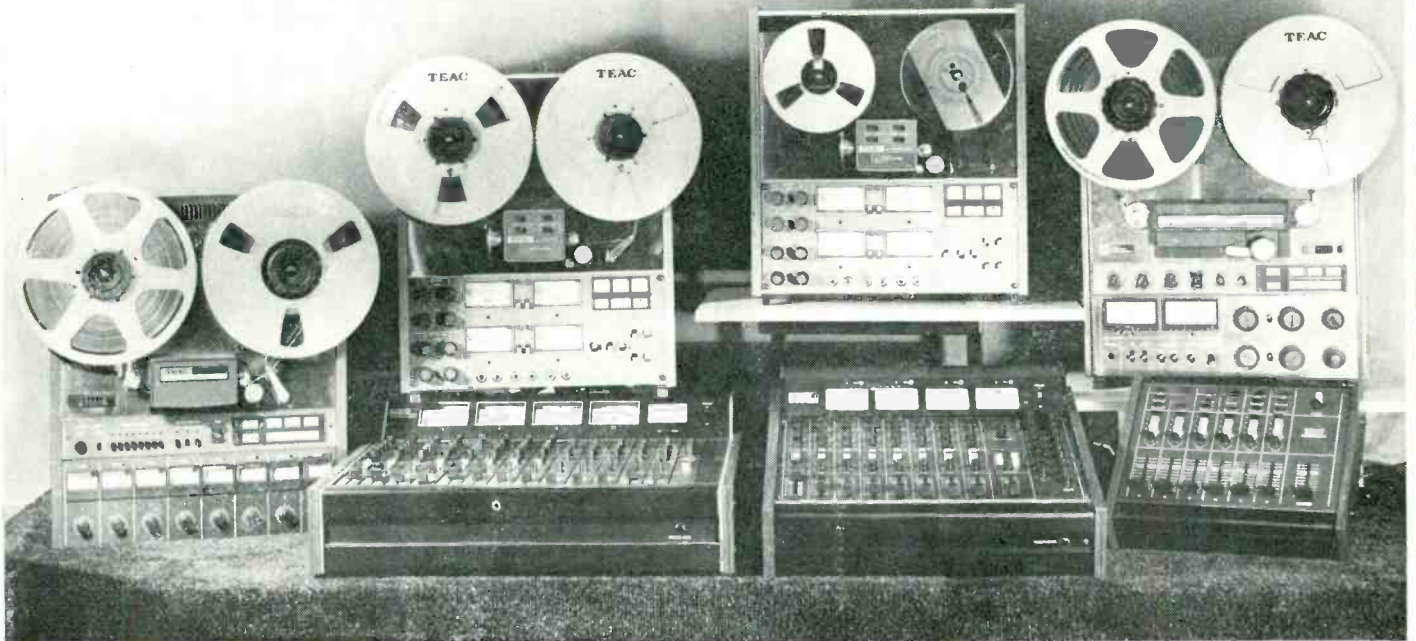

For the first time in the West End of London, the entire TEAC/TASCAM range of professional recording equipment is on demonstration under one roof.

REW have the TEAC/TASCAM range in stock for immediate delivery, backed of course by the famous REW service.

Also in stock, a full range of recording equipment, microphones, speakers and accessories.

Interested customers should phone John Cowan or Les Adams on 01-836 7851 to arrange an appointment for a demonstration.

TASCAM 80-8

8 track, $\frac{1}{2}$ " tape, 15 ips, studio quality tape recorder.

TASCAM DX8

8 channel DBX Noise Reduction unit. All functions automatically selected by the 80-8 recorder.

TASCAM Model 5

8/4 professional quality audio mixer. Mic/line inputs, cue and echo sends, sophisticated equalisation, solo, direct inputs, panning, peak LED, buss inputs, tape cueing, monitoring for studio and control room, line and aux outputs, XLR mic inputs, optional talk back.

TASCAM Model 3

8/4 audio mixer — mic line and phono inputs, switched mic attenuation, comprehensive tone controls, panning, full monitoring. Built-in 8-2 submixer enables a

further 8 line inputs to be used with gain and panning.

TEAC Model 2

6/4 audio mixer, mic/line inputs — switched mic attenuation, high and low cuts, panning.

TEAC A3340S

4 channel tape deck with simul-sync. $10\frac{1}{2}$ " spool capacity — $7\frac{1}{2}$ + 15ips, mic/line mixing, cue lever, solenoid controls.



REW Professional Audio, 126 Charing Cross Road, and 17 Denmark St., London WC2. Tel: 01-836 2372/7851

Mail Orders and Overseas Enquiries to: REW House, 10-12 High Street, Colliers Wood, London SW19. Tel. 01-540 9684/5/6.

GETTING INTO MULTITRACK

PA:CE ~ MM Provide the Economical Answers



MP 175 12 ~ 4

- 4 Band EQ
 - Low Noise -125 dBm ref input.
 - PFL - Talkback, Compressor.
 - Full 12 into 4 operation
- CIRCA £400

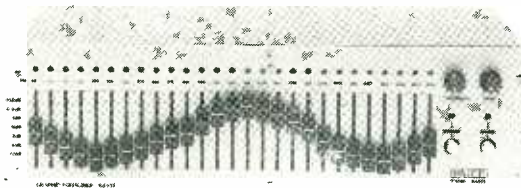

SR 271 Graphic Equaliser

- 27 Frequency bands at ISO Standard frequencies
 - 12 dB Boost & Cut per band
 - Peak LED's
 - Mic ~ Line inputs
- CIRCA £200



AP 360 Dual Power Amp

- 140 watts per channel into 8 ohms
 - Total harmonic distortion 0.04 at 1 KHz 100w
 - Frequency response 7 Hz - 30 KHz -3dB
 - Hum & Noise -105 dB
 - Damping factor > 200.0
- CIRCA £200

PA:CE Ltd. KNEESWORTH STREET, ROYSTON, HERTS. Tel (0763) 45214

BBC/3M digital recording system

The BBC and 3M have collaborated in the development of a digital recording system that comprises a 32-channel multitrack using 25.4 mm tape, a 2 or 4-channel mastering machine using 6.35 mm tape, and the necessary interface hardware. Both the multitrack and mastering machine are based on 3M *M79 Isoloop* transports and record the digitised audio signals longitudinally along the tape, rather than in a helical-scan format utilised by most experimental digital recorders derived from video tape machines. The new system will retain all the features of conventional analogue tape machines—overdubbing, remote control, simu-sync, track bumping etc—but offers a 90 dB signal-to-noise ratio, reduced modulation noise, distortion and wow and flutter, plus simplified eq and bias settings.

Initially the system will use digital-to-analogue converters to 'decode' the digitised signals for multitrack playback and mixdown, and then re-digitise the information for recording on the mastering machine. 3M has plans, however, for a second-generation system that will do away with the intermediate decoding, allowing the digital information to be manipulated and mixed without the inherent generation loss involved with two stages of decoding and digitisation.

The present system is derived from a 10-channel machine that the BBC Research Department has been developing over the last couple of years. This machine made use of an unusual 42-track head that recorded four tracks of digital information per channel plus two for the overall time-code. The four tracks per channel format enables any tape drop-outs to be detected and corrected during playback. By improving the error detection and correction techniques, 3M has been able to maintain more than adequate quality from a one track per channel format.

'Tentative' technical specification certainly looks impressive:

Frequency response: ± 0.3 dB, 30-15k Hz; -2 dB at 20 Hz and -3 dB at 20 kHz.

Signal-to-noise: > 90 dB.

Harmonic distortion: $< 0.03\%$, 100-

20k Hz at max input/output level ($+28$ dBm).

Intermodulation distortion: $< 0.03\%$, for any two frequencies, 100-20k Hz at max input/output level.

Crosstalk: greater than -90 dB, worst case including sync mode.

Print through: 'not measurable'.

Wow and flutter: 'not measurable'.

Tape speed: 1.14 m/s with $\pm 10\%$ vernier.

Playing time: > 30 minutes with 2.19 km of recommended tape on 31.7 cm reels; 45 minutes with 35.6 cm reels (maximum size).

Dimensions (w x d x h): 94 x 57 x 99 cm.

Marketing of three initial systems in the USA is planned for the latter part of 1978, with full marketing production due in 1979. Studios are advised to start saving hard; the system is expected to cost about \$150 000 or £80-90 000. 3M Company, Building 224BW, 3M Centre, Saint Paul, Minn 55101, USA. Phone: (612) 733 1110. Telex: 297434.

UK: 3M United Kingdom Ltd, 3M House, PO Box 1, Bracknell, Berks RG12 1JU. Phone: Bracknell (0344) 26726.

Swedish Eastlake

Studio Bohus, Sweden's first Eastlake-designed studio, opened recently in Kungälv, some 6 km from Gothenburg. Status Quo and Abba were amongst the first groups to use the new studio.

Tom Hidley's handiwork at Studio Bohus

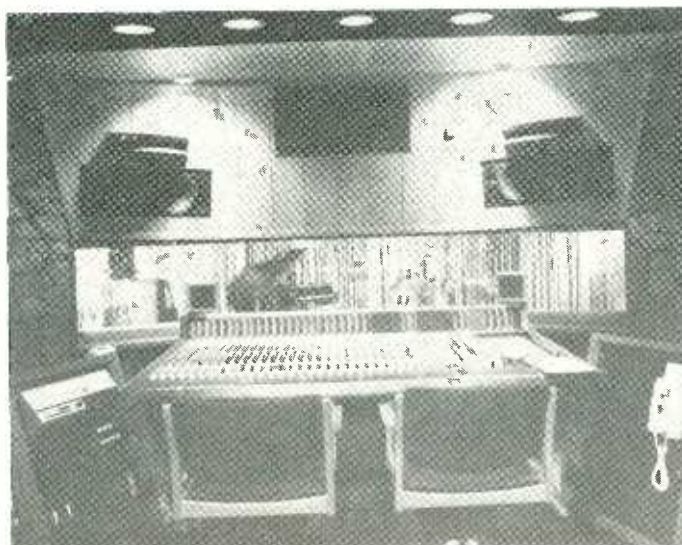

In addition to the 100 m² studio and isolation room, four bedrooms, a billiard room, music room, kitchen and sauna are housed within the purpose-built, 2-floor building.

The control room equipment centres around an automated Harrison 32/32 console, an Ampex *MM1200* 24-track and Ampex *ATR100* and Studer reduction machines. Monitoring is via an Eastlake *TM3* stereo system, and a comprehensive range of ancillary equipment is available.

Studio Bohus, Utmarksavägen 6-8, 44201 Kungälv, Sweden.

Phone: (303) 10990.

3M United Kingdom move

The company now resides at 3M House, PO Box 1, Bracknell, Berks RG12 1JU.

Phone: Bracknell (0344) 26726.

Portable cassette machine

The new Uher *CR240* is equipped with Dolby noise reduction, measures only 235 x 185 x 59 mm, and weighs a mere 2.7 kg. The cassette insertion slot and all controls are mounted on the front panel.

The machine is a development of the *CR210*, but has several design differences. Two peak-reading level meters are provided, and the record level controls can be switched for individual or tandem operation. Separate leds show record, play back or standby modes, plus 'Dolby on'. An autoreverse facility is no longer provided, the space being necessary for the Dolby circuitry.

Power is derived from internal batteries, a NiCd rechargeable battery that gives up to 10 hours continuous use per charge, or from a mains/recharging unit. Price in the UK should be about £400.

Uher Werke Munchen, Barmseestrasse 11, D-8000 Munich 71, West Germany.

Phone: (089) 78721.

UK: Uher Limited, 28 Spencer Street, St Albans, Herts AL3 5EG. Phone: St Albans 30236.

Cassettes and carts

A 'new style' cassette specially designed for high-speed duplication with non-jamming ptf-e-type foils is available from Professional Tape Marketing Associates. Cassettes can be supplied in any length from C3 to C96, and carry an unconditional 25-year guarantee against manufacturing fault. Precision of loading is a claimed $-0, \pm 10s$.

The company can also supply 'at a remarkably competitive price' broadcast cartridges that meet the new NAB AA standards.

Professional Tape Marketing Associates Ltd, Cassette House, 57 Manor Park Crescent, Edgware, Middlesex HA8 7LY, UK.

Phone: (01) 951 0488.

FRAP piccolo pickup

A new pickup for use with the *W-200* and *W-250* series pre-amps has a response claimed to be flat from 100 to 20k Hz, and produces no key noise or feedback. The *WP-1* transducer measures only 28 mm in length and 8.8 mm in diameter, and is designed to fit any silver or wood piccolo. Installation takes about two minutes.

FRAP, PO Box 40097, San Francisco, Ca 94140, USA.

Phone: (415) 431 9350.

Broadcast and theatre mixer

Tore Seem A/S of Norway has introduced a new desk developed especially for small radio and tv studios, ob vans, theatres and audio-visual studios, or where an ancillary mixer is needed to supplement the facilities of a permanent installation. The *TSM 12-2/4* is equipped with 12 input channels, two echo returns, two group outputs and four auxiliary outputs. Two stereo ppm bargraph instruments are provided for monitoring. Tore Seem A/S, Postboks 4, N1344 Haslum, Norway.

Phone: (02) 533975.

26 ►

The time has come...

Marshall Electronic Model 5002 Time Modulator

The Marshall 5002 Time Modulator is a new and incredibly versatile analogue delay and effects unit featuring a 90db total dynamic range/15KHz frequency response.



Automatic Double Tracking
Automatic Triple Tracking
Positive Flange
Over 6 Octaves of Flange
Negative Flange
Stereo Synthesis
Loudness Enhancement
Speaker Delay Compensation

Pitch Changing
Pitch Detune
Chorus
Vibrato
'Cardboard Tube' Echo

And Many More Time Domain
Related Effects

**As well as stepless delay from zero to over
100 milliseconds without quantising noise.**



Sole UK Agents:
Scenic Sounds Equipment 97-99 Dean Street, London W1V 5RA.
Telephone : 01-734 2812/3/4/5.

Marshall Electronic Joppa, Maryland 21085, USA

NEWS

Teach yourself recording techniques

The D'arblay Sound Studio Workshop is an unusual concept. It comprises a set of six cassettes and associated booklets designed to take even the beginner from the basics of the nature of sound through to the potential of multi-track recording. After studying the material, purchasers of the 'workshop' can make use of three additional services: at least one visit to Anemone Sound Studios for a 'hands-on' feel of a desk and associated studio hardware; promotion of them and/or their material through a company known as Theatrical and Musical Promotions, who will listen to and comment on demo tapes and, if they are good enough, approach a&r departments; and a 'Sound Swap Shop' that will allow instrumentalists, producers, writers, engineers, singers, etc to be put in touch with others who have similar interests.

It is intended that the scheme be run on a personalised basis, and therefore numbers have been limited to 10 000. The total cost of the package is £30; there are no further charges. We hope to carry out an in-depth assessment of the cassette and booklets in a forthcoming issue.

D'arblay Sound Studio Workshop, D'arblay House, 10 Poland Street, London W1V 3DE, UK.
Phone: (01) 439 9613.

ITC in UK

International Tapetronics Corporation has appointed FWO Bauch as the exclusive sales and service representative for ITC tape cartridge equipment in the UK and Ireland. FWO Bauch is in the process of obtaining a stock of cart machines for sale, and spare parts to support ITC gear already in service.

1978 AES conventions

The 59th convention and exhibition will be held in Hamburg from February 28 to March 3 1978. For further details contact Dr Joerg Sennheiser, Sennheiser Electronic KG, Postfach 3002, Wedemark 2, West Germany.

The convention chairman of the 60th convention and exhibition, which is to be held at the LA Hilton from May 2-5, is Dale Manquon, 1623 West Victory, Glendale, Ca 91201, USA.
Phone: (213) 248 6988.

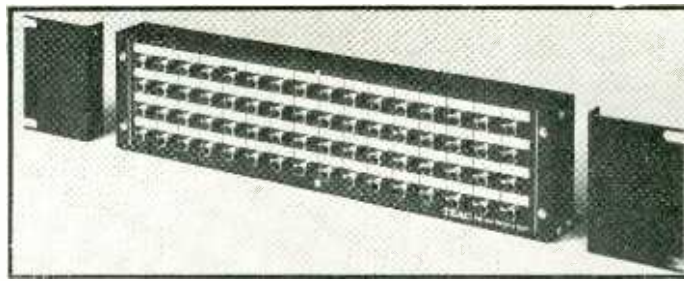

PB-64 patch bay using phono sockets

Tascam goodies

TEAC has introduced three new add-on units for use with the Tascam Series of mixers and tape machines.

The PB-64 patch bay is essentially a metal box with a 4x16 array of phono (RCA) sockets moun'ed on either side. Tape or mixer inputs and outputs are plugged into the back, and double-ended jumpers used to interconnect them on the front-panel.

The MB-20 meter bridge comprises four vu that can be switched in pairs to read at -20, -10, -2 or +4 dB. It has a built-in headphone amp linked to a 4x2 push-button 'mixing' matrix for monitoring mixer buss output or off-tape signals.

The Model 1 is a line-level, 8/2 submixer that can be used to provide additional foldback and monitor mixes. For example, linked to the submix inputs and cue outputs of a Model 3 mixer a second, entirely separate, foldback chain can be established. Another potential application could be to extend the inputs of a Model 5 mixer to handle the eight outputs provided by an 80/8 machine. In its original configuration, inputs on

the Model 5 need to be switched to 'line inputs' when the tape is to be played back, upsetting any mic eq and level settings. Also only four inputs are available for cue, making overdubs involving more than four pre-recorded tracks difficult. By connecting a Model 1 directly to the 80/8, a stereo submix can be provided for the auxiliary input of the Model 5. A second Model 1 connected between the 80/8 and the Model 5's 'tape' inputs enables off-tape signals to be mixed onto the cue busses. (Alternatively, the inputs of two Model 1s can be cascaded to form an 8/4, or connected via their busses to make up a 16/2 submixer.)

TEAC Corporation, 3-7-3 Nakacho, Musashino, Tokyo 180, Japan.
Phone: (0422) 531111.
Telex: 2822551.

UK: Teledyne Acoustic Research, High Street, Houghton Regis, Dunstable, Beds LU5 5QJ.
Phone: Dunstable (0582) 603151.
Telex: 825467.

US: TEAC Corporation of America, 7733 Telegraph Road, Montebello, Ca 90640, USA.
Phone: (213) 726 0303.
Telex: 677014.

MB-20 4-channel meter bridge and headphone amplifier

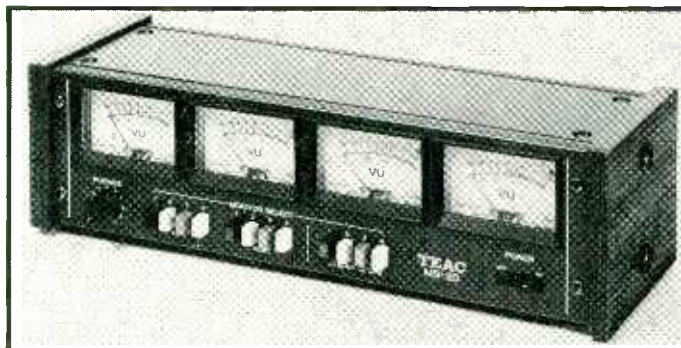

SMPTA award

The Society of Motion Picture and Television Engineers in America has conferred a special commendation award on C B B Wood, MBE, for his 'many outstanding contributions to motion pictures and television'. Before taking up his present position as head of the BBC's engineering information

department in 1971, Bill ('Woodie') Wood worked for 26 years in the Beeb's research department. During that time he made many contributions to television film recording and to the work that led to the introduction of colour television, particularly the integration of colour film with television.

A & H desk for Prince of Wales

Allen and Heath has supplied a 28-input/4-output modular desk to the Prince of Wales Theatre, London, for the forthcoming production of *I Love My Wife*. The console was modified from a standard 24/8 studio model, and includes a custom-built sub-master module that provides a pan-to-stereo output, sub-group solos and echo return to stereo. The theatre already has an A and H SD12/2 stereo desk, which will be used as a sub-group mixer for the 'floating' stage microphones. The resultant sound reinforcement system will thus be capable of handling 40 mic or line inputs, with phantom powering throughout.

Allen and Heath/Brenell Ltd, Pembroke House, Campsbourne Road, Hornsey, London N8, UK.
Phone: (01) 340 3291.

Meter leaflet

A new 4-page leaflet from Ernest Turner contains brief electrical and dynamic performance characteristics of each type of vu and ppm meter made by the company, together with details of scaling, application notes and suggested driver circuits. The vu meters are supplied with scaling and performance parameters conforming to ANSI C16.5-1954 standard, and ppms to BS 4297:1968. Many models can be supplied to comply with BBC specifications. An additional back-of-panel mounting unit is available with twin co-axial movements housed in a single case, enabling comparative readings to be made on the same dial. Copies of the leaflet are available from Ernest Turner Instruments, 50/52 Marefair, Northampton NN1 1NY, UK.

Phone: Northampton (0604) 36209/30201. Telex: 31364.

Telonic Altair/Berkeley

Telonic Altair UK has changed its name to Telonic Berkeley UK. This results from the acquisition of Telonic UK's parent company, Telonic Altair Inc, by Berkeley Controls Inc of California. In addition to its own range of electronic testing and measuring equipment, the new company will sell and service all Berkeley products in the UK. Telonic will also continue to distribute National test gear, including the new VP-7750A wow and flutter meter.

Telonic Berkeley UK, The Summit, 2 Castle Hill Terrace, Maidenhead, Berks SL9 4JR.

Phone: Maidenhead (0628) 28057.

28 ►

The IE-30A Audio Analysis System from IVIE

- 1/3-octave Spectrum Analyzer
- Full-octave Spectrum Analyzer
- Precision Sound Level Meter
- True RMS AC Voltmeter
- RT₆₀ (Reverberation)*
- THD (Harmonic Distortion)*

For the first time, a real time analyzer and precision sound level meter have been combined into a portable audio analyzer "system" with features and accuracies rivaling the best laboratory instruments available.

The fully digital IE-30A comes standard with a precision laboratory microphone calibrated in dB-SPL and remoteable up to several hundred feet, a test probe with three precision attenuator settings for calibrated dB μ V measurements (true rms, average or peak), nickel cadmium batteries with charger, and a hard shell, foam lined travel case.

*Using optional accessories



Other features include selectable detector responses, gated mode operation for measurement of reflections and time delay events, dual nonvolatile memories that store or accumulate data that can be recalled to the IE-30A display up to weeks later.

The IE-30A was designed to accommodate an inexpensive new family of optional accessories. The IE-17A measures RT₆₀ (reverberation time) in 1/3-octave bands up to 99.99 seconds with 10 millisecond resolution. The IE-15A measures total harmonic distortion (THD) to less than .01%.

SPEC BRIEFS

- 1/3 octave or full octave bands 30 filters on ISO centers 25Hz to 20KHz
- Highly selective three pole-pair filters exceed ANSI S1.11-1966 Class III, B.S. 2475-1964, DIN 45652 and IEC255-1966.
- 1/3 octave display weighted A, C or Flat
- LED array 30 x 16. Resolutions of 1, 2 or 3 dB for display ranges up to 45dB.
- Precision SLM has *Fast, Slow, Impulse* or *Peak* responses with A, C or Flat filter weightings
- 4 digit 0.1dB resolution readout with display hold mode
- Meets requirements of:
ANSI S1.4-1971 TYPE S1A, S1C, BS 4197-1967
DIN 45633 B1.1, B1.2 (Impulse) IEC 179-1973
- 30 to 149 dB SPL re 20 μ N/m²
- Microphone is omnidirectional condenser Type 1 (Precision) Flat 10Hz to 20KHz
- Signal outputs for recorders, oscilloscope displays and voice prints



IVIE ELECTRONICS, INC.
500 West 1200 South
Orem, Utah 84057 U.S.A.
(801) 224-1800
TELEX or TWX 910-971-5884

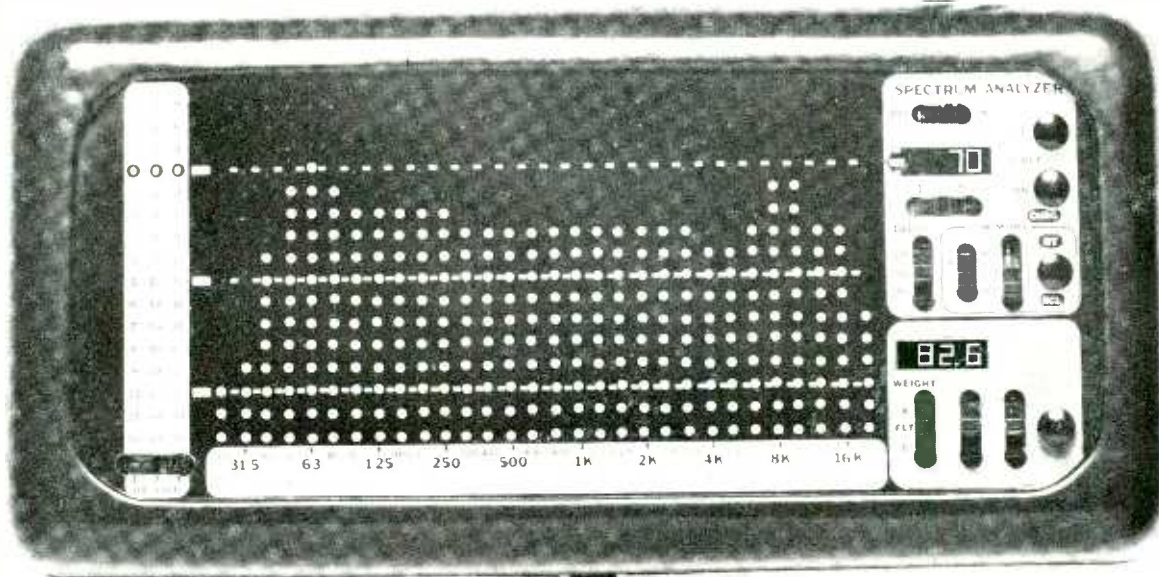

Contact any of these Ivie Distributors for further information:

Australia, Melbourne
KLARION ENTERPRISES
Tel 61 3801

Belgium, Brussels
S E D
Tel 02-522 70 644

Finland, Helsinki
MS AUDIOTRON
Tel 410688

France, Paris
RED,TEC
Tel 935 97 86

Italy, Milano
ROJE TELECOMUNICAZIONI
Tel 415 41 41 43

Italy, Roma
ROJE TELECOMUNICAZIONI
Tel 480 029 - 465 630

Japan, Tokyo
ELECTORI CO
Tel (03) 950-6262

Malaysia, Indonesia, Singapore
ELECTRONICS & ENGINEERING
Tel 75873

Netherlands, Amsterdam
SELETRONIC
Tel (02963) 4838 4966

Norway, Oslo
MORGENSTIERNE & CC
Tel (02) *35 61 10

Spain, Madrid
NEOTECNICA
Tel 242:0900

Sweden, Stockholm
ELFA
Tel 80 730 07 00

Taiwan, Taipei
ASIA ELECTRIC TRADING CO
Tel 5925545-8

United Kingdom, London
FWO BAUCH
Tel 01-953 0091

Venezuela, Caracas
ELECTRONICA GRAMCKO
Tel. 351419

High-power ir headphone system

Sennheiser has introduced a high-power version of the *Infrasport* infra-red headphone system (see May issue, p24). Although it has been designed primarily for use in large conference centres—simultaneous translation in several languages being its main application—the system could be used to provide foldback in a large recording or film studio.

The new units comprise a 9-channel transmitter, high-power radiators equipped with an 8 x 14 array of infra-red leds, and a receiver unit that contains a photodiode, a 9-position channel-select switch and a volume control. Headphones are simply plugged into the receiver and the required channel selected. In its present configuration the foldback signals will obviously be monophonic; if there is sufficient demand, however, Sennheiser plan to develop a stereo receiver/headphone unit.

The system was demonstrated recently at Shepperton Film Studios. Eleven high-power radiators were mounted along one wall of a large sound stage measuring 50 by 40m, by 13m high. Although Hayden Labs, who had organised the demo, were quick to point out that normally a room of this size would be fitted out with between 40 and 50 radiators, spaced more evenly around the walls, the results were still impressive. Your reporter was able to wander the full length of the stage—some 40m away from the radiators—and still receive good signals. Turning away from the direction of the radiators resulted in a reduced signal and increased noise level, but this was restored somewhat by facing a reflective piece of polythene that had been fixed to the rear wall.

Unfortunately, the main drawback of the system could prove to be its price. The 9-channel transmitter, which provides the frequency-modulated signal and dc supply to up to eight radiators, costs £965; the radiators are £397 each; and the receivers cost £76 (all UK prices).

Sennheiser Electronic, 3002 Bissendorf, Hanover, West Germany. Phone: 05130 8011.

UK: Hayden Laboratories Ltd, Hayden House, Churchfield Road, Chalfont St Peter, Bucks SL9 9EW. Phone: Gerrards Cross 88447.

Telex: 849469.

US: Sennheiser Electronic Corp, 10 West 37th Street, New York, NY 10018.

Phone: (212) 239 0190.

Telex: 421608.

**dbx for Georges Pompidou Centre**

Noise reduction equipment valued at over £250k was delivered recently to the Georges Pompidou Centre for the Performing Arts, Paris. Under the direction of Pierre Boulez, the Centre is involved with research into electronic music using computers. Claimed to be a factor in the decision to adopt dbx was the relative ease with which encoded material can be processed by a computer.

Belgian 24-track

Kritz Recording Studio is situated in central Belgium, but can be reached from Brussels in just 45 minutes, or from Paris in only two hours. Rates are £42 (\$68) per hour, £384 (\$622) per 10-hour day, or £2112 (\$3425) per week.

The control room boasts a Sound Techniques 28/24/24 console equipped for quadrasonic monitoring. Tape machines include a 24-track Lyrec with varispeed and autolocator, and Studer stereo models. Ancillary gear comprises AKG and Eventide echo units, dbx and Dolby, plus facilities for compressing, equalising and phasing to your heart's content.

Up to 80 musicians can be accommodated in the studio, with a separate area for percussion. A Weber N-Y grand, Gibson and Fender guitars and Faylor amps, a Hammond *L100* organ with Leslie cabinets, two drumkits and assorted percussion instruments are provided.

There should be no communication problem during sessions; all the engineers speak Dutch, French, German and English. Kritz Recording Studio, Noordlaan 10-Industriezone, 8720 Kuurne (Kortrijk), Belgium. Phone: (056) 351184.



Grahams Electrical, well-known in hi-fi circles for their friendly sales staff and it-doesn't-matter-how-long-it-takes-we-want-our-customers-to-be-satisfied attitude towards equipment demos, recently opened a new showroom in London for the professional and semi-pro user. The new showroom is to be known as Grahams Professional. The range of gear they can supply is pretty comprehensive: Acoustic Research, JBL, Kef and Rogers studio and pa monitors; Allen & Heath, Alice and Tascam mixers; Revox, Studer, Brenell, Otari, Sony, Tandberg and TEAC tape machines; AKG, Beyer, Calrec and Shure microphones and cans; NEAL, Nakamichi and JVC cassette machines; BGW, HIH, Quad, NAIM and Phase Linear power amps; Klark-Teknik graphic equalisers; dbx stereo and 2-channel noise reduction units; plus Keith Monks mic stands, booms, cable drums and accessories. In addition, they say they are willing to chase around and get quickly the more esoteric items a studio may need. Grahams Professional are to be found at 86-88 Pentonville Road, London N1 9HS. Phone: (01) 837 4412, extension 66.

Wow and flutter meter

The model 65-390 from Fidelipac measures only 23 x 20 x 5 cm (w x d x h), and weighs just 1.8 kg. Both IEEE or DIN measurements can be made at a fixed frequency of 3.15 kHz provided by the built-in sine wave oscillator.

Pushbuttons provide selection of full-scale deflection ranges of $\pm 5\%$ drift, 0.1 or 0.5% flutter. Meter accuracy is a claimed 3% of the reading for flutter, and within 1% for drift measurements.

Fidelipac, 109 Gaither Drive, Mount Laurel, NJ 08057, USA. Phone: (609) 235 3511.

Something up his sleeve

Couldn't help wondering about a fairly bizarre example of microphone technique quoted in the latest *Vitavox Newsletter*. Apparently, during the recent Cambridge Folk Festival the Cambridge Symphony Orchestra were to give a concert in a large marquee to a gathered throng of some 3500 people. The soloist was James Galway, playing the Mozart Flute Concerto no 2.

To make sure that his flute could be heard beyond the first few rows, Galway was provided with a Shure lavalier mic which was clipped to his coat cuff. The output of the mic was fed into the house pa mixer via a 200 Hz highpass filter, and then into a single power amp feeding a Vitavox 10-cell horn with S3 drivers mounted about Galway's head.

According to the *Newsletter*, the results were truly a delight. However, they don't say where they put the mic lead.

Film production course

The North West branch of the British Kinematograph, Sound and Television Society are holding a lecture course entitled 'Film production for industry and education', to be held at the University of Salford during February and March 1978. Subjects covered during the course include equipment, scripting, camera work, sound recording, editing, track laying and dubbing, laboratory technique and presentation. Fees are £5 for BKSTS members and £7.50 for non-members. Budding Cecil B DeMilles wanting enrolment forms and a syllabus should write to 1 Bradbury, Hon Sec, NW Branch BKSTS, 26 Harper Fold Road, Radcliffe, Manchester M26 0RU. Phone: (061) 736 6221. 30 ▶

The Professional's Choice

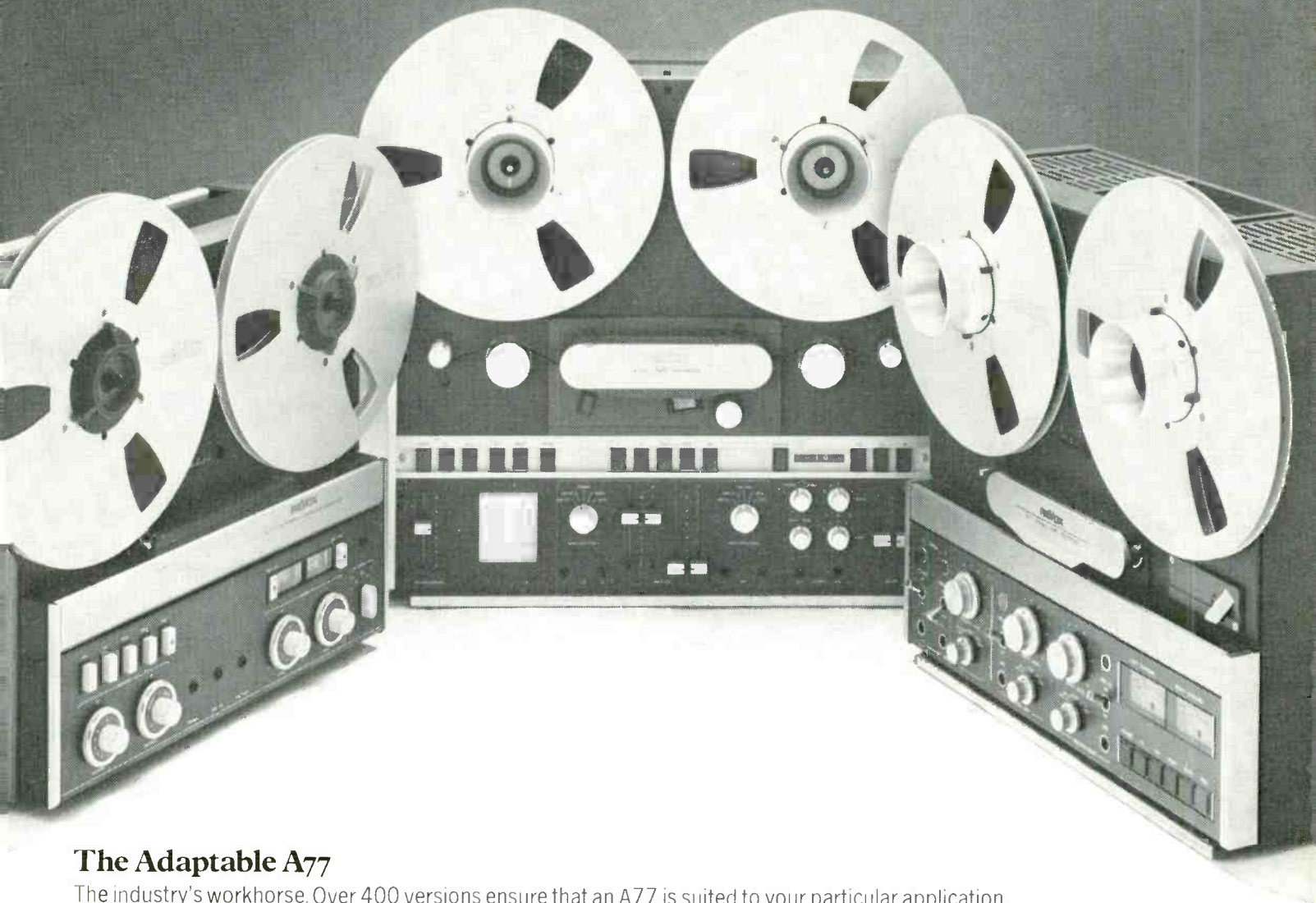

The Adaptable A77

The industry's workhorse. Over 400 versions ensure that an A77 is suited to your particular application. Make your choice from five tape speeds, three track configurations, Dolby noise reduction, varispeed, three enclosure styles, power amplifiers, remote controls, voice-operated auto-start, balanced input/output, NAB or IEC equalisations, built-in loudspeakers.... etc., etc. The standard echo and track-to-track facilities of the A77 are as well known as its proven track record over the past decade. The machine by which all others are judged.

The Versatile A700

The deck that closes the gap between top ranking amateur tape recorders and full grown professional studio machines. Full logic control and motion sensing, 3 tape speeds, real-time counter, open head format, built-in mixer with balanced mic. inputs and RIAA pre-amplifier make the A700 a self-contained and versatile recording system.

The Modular B77

Latest addition to the Revox range, the B77 with its logic control, self-sharpening tape cutter, easy access to heads, remote and varispeed controls and modern styling make it the natural choice of the semi-professional and the true Hi-Fi enthusiast.

Sole U.K. distributors, F.W.O. Bauch Limited, 49 Theobald Street, Boreham Wood, Hertfordshire WD6 4RZ.

STUDER REVOX



MCI desk
in Super
Bear's
control
room

Super Bear

... is the name of a new fully-automated, 24-track residential studio situated in a mountain village in the French Alps, only 15 minutes from Nice and the Cote d'Azur. On-site amenities include a swimming pool, table tennis, mini golf and rehearsal/recreation rooms. If that isn't enough, as it says in the brochure: 'Night life is just a limo ride away, to clubs with which the studio has arrangements (all part of the service).'

The control room and studio bear the unmistakable Eastlake touch, with two isolation rooms (one live, the other dead) being available for strings and things. Pride of place in the control room is an MCI JH-500 automated console equipped with 28 input channels, 32 outputs and plasma display monitoring. Tape machines are also by MCI: track laying is handled by a JH-16 Series 24-track with varispeed, and two 2-track and one 4-track are on call for mastering. Twenty-eight channels of both Dolby and dbx do their best to keep the noise down.

Monitor loudspeakers comprise four Eastlake TM3s for quadraphonic balance, two JBL 4311, two Auratone Super Sound Cubes and two Tannoy Lancasters. The list of ancillary and signal processing gear reads like a STUDIO SOUND survey: three UREI 1176 compressor-limiters; two dbx RM160 compressor-limiters; two Allison Gain Brain units; four Allison Kepex noise gates; two EMT 140 stereo echo plates; two Marshall Time Modulators (see review, p74); and a 2-channel Rebis Audio RA401 parametric equaliser. There should be enough there to keep even the

most inveterate knob twiddler happy.

Musicians are also well catered for. The 10x8m studio sports a Bechstein Grand, a Gibson Les Paul DeLuxe and a Ludwig drum kit, plus an H/H bass amp and a Fender Deluxe Reverb amp.

Use of the studio will set you back a hefty £7500 per week, but this is an all-in figure and includes everything a band could want (except, we have been asked to point out, an infinite supply of Southern Comfort). Obviously the cost goes down for a longer booking.

Super Bear Studios, SARL, Quartier les Gerps, 06440 Berre-les-Alpes, France. Phone: Nice 918120. Or contact Bill Clark at the studio's London office. Phone: (01) 739 2138.

Stellavox TD88

John Page, UK agents for Stellavox, has pointed out that the tape machine described on p46 of last month's survey as the 'TD88 transport' is, in fact, self-contained and comes complete with record and replay amps for line-in/line-out operation. The machine's interchangeable headblock features plug-in pebs with eq trimmers and is available with optional selfsync. In its basic format using 6.35 mm tape the TD88 costs about £2500; 'multiformat' machines capable of handling 12.7 or 16 mm tape with interchangeable heads and guides cost approximately £5000.

John Page Ltd, 169 Oldfield Lane, Greenford, Middlesex UB6 8DW. Phone: (01) 578 0372. Telex: 24224 (Reference 568).

Tannoy loudspeakers

Although some of you may have already seen them at this year's APRS exhibition, Harman UK tells us that the new Tannoy Buckingham and Windsor monitor loudspeakers are now in production at their Coatbridge factory in Scotland. The Buckingham has three drivers—two tandem 30 cm bass units and a mid-range/treble transducer—while its smaller brother is fitted with the same mid-range/treble unit but has only one bass driver.

Spec-wise the Buckingham certainly looks impressive: frequency response is a claimed ± 3 dB, 35-20k Hz; sensitivity 95 dB spl at 1m from an input of 1W; and a power handling capacity of 200W continuous integrated programme material, or 250W to DIN 45573.

The combined mid-range/treble unit is of a particularly unusual design. To reduce interaction with the bass drivers it is housed in a separate transmission line chamber within the speaker cabinet. The separate mid-range and treble transducers are mounted concentrically within one another, and spaced to ensure that both transducers appear to radiate from one single point in space. Harman UK claims that this concentric approach is the only correct way of ensuring that the radiation pattern within the monitoring area is smooth and uniform. The mid-range transducer utilises a very high energy barium ferrite magnet and Ferro Fluidics to improve heat dissipation and maintain constant coil resistance. The treble transducer comprises three separate parts: a pressure unit; a phase-compensating throat

Tannoy Buckingham

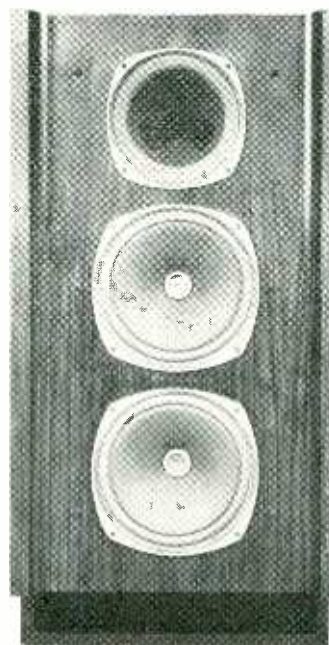

and exponential horn assembly; and an acoustic lens that increases the dispersion of hf energy.

The Buckingham costs £765 with a rosewood cabinet, and £693 in walnut.

Harman (Audio) UK Ltd, St John's Road, High Wycombe, Bucks HP10 8HR.

Phone: Penn (049 481) 5221.

Telex: 837116.

■ In case you are as confused as we were about the Harman/Tannoy tie-up, it is worth pointing out that on September 1 1977 the hi-fi division of Tannoy Products was renamed Harman (Audio) UK. To add to the complication, Harman are also distributing and marketing JBL loudspeakers in the UK.

A&D phone number

Audio and Design Recording's new telephone number is Reading (0734) 53411.



AKG D170 cardioid mic

New AKG microphone

The D170 cardioid dynamic mic is now available in the UK. Designed for stage rather than studio use, the mic features an all-metal housing, rugged wire mesh grille and built-in wind and pop screen. Frequency range is a claimed 25-15k Hz, sensitivity at 1 kHz 0.19 mV/ μ bar, and input impedance 200 ohm. Price in the UK is £50. AKG Equipment Ltd, 182/4 Camden Hill Road, London W8 7AS. Phone (01) 727 0788 and 229 3695. Telex: 28938.

AKG catalogue

Full specifications of the complete range of AKG headphones, headphone/microphone combinations, phono cartridges, dynamic microphones, CMSE (electret-condenser) and CMS (studio-quality condenser) microphones, reverb units and microphone accessories (stands, booms, plugs, goosenecks, mounts, windscreens etc) are to be found in the new 1977/78 catalogue. Copies can be obtained from the address given above. ■

TRAD

SALES and SERVICE

Telephone: Watford 47988
Specialists in Service and Repair of T.R.D. recorders. All parts, motors, etc., available. Collection and delivery: London and Home Counties. Prices ex-Watford. Delivery extra.

FOR SALE

1 Yamaha Grand Piano, new	£2,500
1 Studer A80 24 track Mark 2A	£17,500
4 Studer A62 Stereos, new heads, each	£1,500
1 Studer A80 16 track Mk1...	£10,000
1 Neve 28-8-16 console	£18,500
1 new 8 track dual capstan	£3,300
1 Ampex MM1100 24 track with 16 h/b and autolocate	£15,500
1 MCI JH416 console with 20 modules wired for 24 track	£10,500
1 Trident B 30-16-16 console	£19,500
1 Trident B 24-16-16 console	£17,000
1 Eventide 1745A digital delay	£2,750
2 Ampex AG440 stereo each	£1,100
1 Otari MX5050 2 track, shop soiled	£550
1 Studer A80 stereo, only 140 hrs. use	£4,200
1 Uher 4200 IC new	£325
1 Ampex 350 Stereo on Console	£550
Various s/h AKG, STC mics in stock	P.O.A.
1 Dolby M16, as new	£4,200
2 Spondor BC111's	£275
1 Rapid cue cart machine	£300
Disa stereo light band PPM unit with amps complete ideal for cutting	£275
1 Teac A-3340s, new head, s/h	£450
1 Rosser 10/4 desk, PPMs	£1,900
14 STC 4033 microphones, each	£17
New boom mic stands, each	£16
Male and Female XLR connectors in line each	£1
1 Roland space echo	£260
Jackfields, 20 way, per row...	£14
2 Heavy duty 6' x 19" racks, each	£30
2 Revox HS77 2 track, each	£360
2 Philips valve comp/lim., pair	£300

WANTED—ALL STUDIO EQUIPMENT

All prices are exclusive of VAT

**149B ST. ALBANS ROAD
WATFORD, HERTS.**

Tel. WATFORD 47988

Telex 262741

Master-Room Reverberation Units



A complete range of superbly natural sounding reverberation devices equally suitable for fixed or portable operation. Master-Room models are in reliable daily use with broadcasters, film dubbing facilities, multi-track music recording studios and P.A. companies.

Illustrated:
Master-Room Model MRRIII fixed decay time stereo output reverberation unit

U.K. List £1016



Sound columns not shown

Master-Room Model CSR23 EQ two independent channel variable decay time reverberation unit with comprehensive reverb return equalisation

U.K. List £1484

For full details on the MICMIX Master-Room range contact:

**Scenic Sounds Equipment,
97-99 Dean Street, London W1. Tel: 734 2812**

Belgium
S.E.D., Rue Bara Straat 146,
1070 Bruxelles. Tel: 522 7064

A.R.C. SPRL, Rue Th. Decuyper 134,
1200 Bruxelles. Tel: 771 3063

Denmark
Lake Audio APS,
Artillerivej 40,
DK-2300 Copenhagen S
Tel: 570 600

France
3M France SA, Mincom Div.,
Boulevard de l'Oise,
95000 Cergy
Tel: 749 0275

Holland
Pieter Bollen Geluidstechnik,
Hastelweg 6, Eindhoven
Tel: 512 777

Norway
Siv Ing Benum AS, Skovvn 22,
Oslo 2. Tel: 565 753

Sweden
Tal & Ton Musik & Elektronik AB,
Kungsgatan 5,
411-19 Gothenburg
Tel: 130 216

letters

Early stereo for film

Dear Sir, Adrian Hope is not quite correct when he states in the *Business* column (October 1977, p48) that the stereophonic films shown at the Telekinema during the Festival of Britain used the left-hand optical track from one 35 mm combined print and the right-hand track for the second, hence introducing phasing problems. If my memory serves me, and after even 26 years I am still not quite senile, the sound was played from three magnetic tracks recorded on a separate 35 mm magnetic film on a reproducer interlocked with the two action projectors.

It is true that the experiment was never wholly successful, although its technical limitations never diminished the perpetual queues. The greatest problem was obtaining 35 mm magnetic stock. It was practically unobtainable in those days, and the only bulk eraser available was firmly screwed to the floor at the RCA Hammersmith plant. A couple of mixing errors or the odd technical hitch (and these were not unknown) meant an hour's delay while a fast car drove from Waterloo to Hammersmith and back.

Elaborate plans were made to record the music on the only recorder available, in the Telekinema, using an orchestra in the unfinished Royal Festival Hall—several hundred yards away—with the aid of GPO lines. But in the hurly burly of getting the exhibition site ready for opening day the lines were scarcely connected at one end before a well-placed pickaxe sliced them at the other. In despair the orchestra was transported to the Crown Film Unit's studio at Beaconsfield for a mono recording. And mono it remained.

We had fun shifting the sound effects from side to side by means of probably the first panpots in Europe. Indeed we worked hard every weekend that summer from closing time on Saturday until the exhibition opened on Sunday, trying to improve the general effect. But we never kidded ourselves that the results were genuine stereo. What a pity that Raymond Spottiswoode, who spent over a year of unremitting toil in trying to perfect the whole programme, should have lost his life in a quite unnecessary motor accident.

Yours faithfully, Ken Cameron, 25 Brookfield Crescent, Kenton, Middlesex HA3 0UT, UK.

Coincident Miking

Dear Sir, I couldn't agree more with Brian Preston when he refers to the use of Schoeps microphones for coincident microphone technique (November issue).

For the past six months I have used a Schoeps CMTS 501 stereo mic for outdoor sound effects work, along with Nagra IV S and Sennheiser 851 gun mic, and apart from yielding recordings of the highest quality it is also extremely robust. This latter point was proven beyond doubt when

a rutting red deer stag (which was making his debut for a recording contract [in joke]) decided to attack the Land-Rover in which I was seated. The driver started the engine to make a quick getaway and the resulting sound in the cans nearly rendered me deaf. The resulting recording of 'A Land-Rover engine with crashing red deer antlers in the background' came out perfectly modulated, which also says a great deal for the limiters in the Nagra too!

Best stereo positioning is achieved when the mic is in the double figure-of-eight mode. However, on one instance it had me completely fooled. The occasion was a carnival procession and a brass band had just passed the mic. Every drumbeat had moved across the stereo field foot by foot (the recording is an experience in itself). However, just as the band faded left it began to fade right as well. Strange? I looked around to see behind me a chemist's huge plateglass window halfway between my position and the band. The back of the right-hand figure-of-eight had picked up the 45 degree reflection off the plateglass window. This was soon remedied by holding the mic to my right instead of my left.

The performance of this mic has now been slightly bettered by the Schoeps collette pair on the 19 cm binaural mount. Even with double cardioids, stereo positioning has to be heard to be believed and monitoring on cans really does deceive your ears. Sounds from behind the mic are so realistic that experimenters are always turning their heads. Definitely not the mic to be used when recording angry red deer stags I can assure you!

Yours faithfully, David A Hastilow, Eel Pie Recording and Film Productions, The Boat House, Ranelagh Drive, Twickenham, Middlesex TW1 1QZ, UK.

Dear Sir, A hefty pat on the back for you for publishing Brian Preston's article 'A coincident microphone technique' in the November issue.

Here is an example of that all too rare bird in the classical music recording field: a man who responds to what his ears are telling him rather than unquestioningly accepting the practices of the control room automatons with their mountains of ever more sophisticated electronic hardware.

Quite recently I was present at a recording session of a Bach concerto for string orchestra, violin and oboe. The sound in the hall, a London church noted for its excellent acoustics, had a warmth and brilliance that did full justice to Bach's masterpiece. Had this wonderful sound been captured on the control room monitors? It had not! Only the oboe sounded authentic; the strings were tinny and the solo violin was so hideously distorted that it seemed to have taken on monster dimensions, stretched in its sound picture between one monitor and the other.

The cloth-eared multimic brigade will continue

on its unmusical path, but speaking as a musician (a violinist) I am willing to stick my neck on the block and predict that the really significant achievements in classical music recording in the future will be made by the Brian Prestons of this world, as indeed has happened in the past. The way ahead will be opened up by the music-lovers; individuals who realise that the rich, subtle sounds of classical instruments are not captured by umpteen microphones suspended only a metre or so above them.

Yours faithfully, Adrian K Baker, Senlac Recordings, 15 High Wickham, Old Town, Hastings, East Sussex TN35 5PB, UK.

Our apologies to Brian Preston for forgetting to mention that he is a co-director of Crescent Records, Bath.—Ed.

AES paper

Dear Sir, Upon reading Gordon Skene's report of the 57th AES Convention in Los Angeles, in the July 1977 issue, I noticed a mistake. You reported (on p. 64) that Paul Klipsch had given a well received talk on discotheques. Mr Klipsch has not honoured the society with a paper since the 51th Convention. It was, in fact, myself who delivered the paper, with Stephen S. Oakford and Gregor T. Long, both of Diversified Designs, as co-authors.

Yours faithfully, Paul D Colvin, President, Diversified Designs, General Manager, Audio Specialists of San Diego.

agony

Back in the middle of last summer, when BBC Matrix H quadraphonic broadcasts were all the rage, an odd thing happened. A quad outside broadcast from St Alban's Cathedral went on the air, sounding decidedly unimpressive in surround-sound. In fact, it sounded more like mono. Which wasn't surprising, because it was mono. A panic at the transmission end, involving talkback problems, had left the signal going down the line in mono. It wasn't until a couple of minutes into the broadcast that panic buttons in London were pressed and the St Alban's signal switched to Matrix H encoded stereo. Something similar happened a few years back when, with great pride, a live stereo broadcast from the new Sydney Opera House was transmitted in glorious mono. In fact, it went out from commercial gramophone records because the plug to the satellite was pulled, through industrial action, and the BBC were left desperately looking for a disc recording of the music being played live down under. It was a pity they couldn't find a stereo record, because I bet I wasn't the only one who spent the best part of the programme wondering what was wrong with my stereo tuner. Moral on such occasions? Look for the simple answer.

Also, if you live in London, you may have noticed that for a long while phone-in programmes broadcast by one of the independent local radio stations sounded very monophonic, particularly during the ad breaks. Since the station only uses a single microphone for the presenter, it isn't until a carefully prepared, stereophonic advert hits the airways that you begin to wonder. In fact, one of the pair of battered A77s, used to provide the 7-second profanity delay, blew a record amp a long while ago and the whole system has only recently been replaced.

Lyrec of Denmark . . .

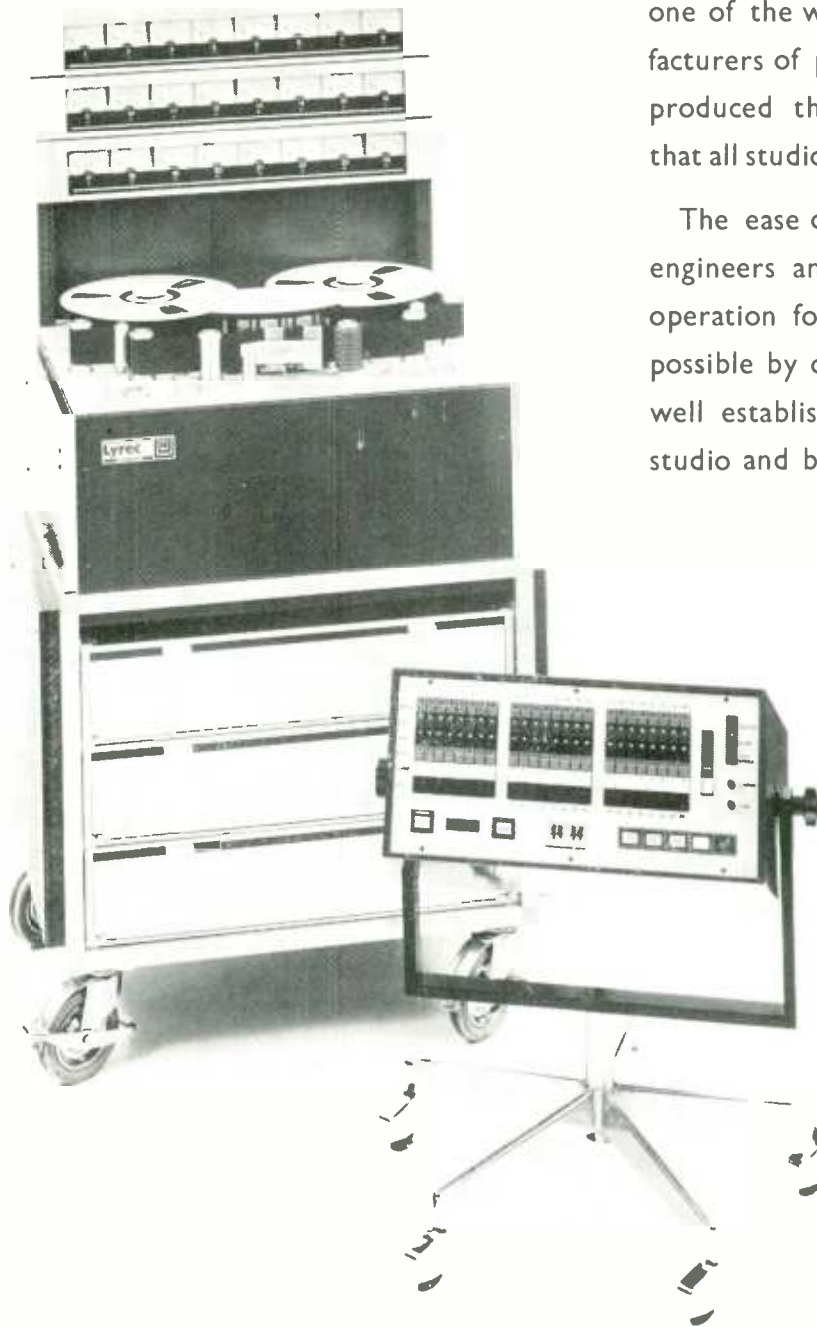

one of the world's oldest established manufacturers of professional audio recorders has produced the model TR532 which assumes that all studio engineers are equally important.

The ease of serviceability for maintenance engineers and smoothness and flexibility of operation for recording engineers, all made possible by our 30 years experience and our well established contacts with users in the studio and broadcasting fields.



Lyrec Manufacturing A/S, Hollandsvej 12, DK-2800 Lyngby
Tel. 02-87 63 22 Tel. Sweden 042-153045

UK: Lyrec (UK) Ltd., 17 Erncroft Way, Twickenham, Middx.
TW1 1DA. Tel. 01-891 2770.

Benelux: SAIT, Ch. de Ruisbroek 66, 1190 Brussels. Tel. 02 376
20 30.
Sound Techniques Nederland bv, Groenelaantje II, Alkmaar.
Tel. 072 112944.

France: Soracitel, 161 Boulevard Lefebvre, 75015 Paris. Tel. 01
828 05 64.

Germany: Studiosound & Music GmbH, Schöne Aussicht 16,
6000 Frankfurt/M I. Tel. 0611 28 49 28 (*local agent*)

Italy: Roje Telecomunicazioni S.p.A., Via Sant'Anatalone 15,
20147 Milano. Tel. 02 415 41 41.
Roje Telecomunicazioni S.p.A., Via Di Porta Pinciana 4,
00187 Rome. Tel. 06 480 029.

Norway: Siv.ing. Bjorn Benum A/S, Boks 2493, Solli, Oslo 2.
Tel. 02 56 57 53.

Spain: Mike Llewellyn-Jones, Ap. Postal 8-178, Madrid-8. Tel.
01 637 07 52.

USA: Rupert Neve Inc., Berkshire Industrial Park, Bethel,
Connecticut 06801. Tel. (203) 744 6230.
Rupert Neve Inc., Suite 616, 1800 N Highland Avenue,
Hollywood, Calif. 90028. Tel. (213) 465-4822.

Canada: Rupert Neve of Canada Ltd., 2717 Rena Road, Malton,
Ontario. Tel. 416-677 6611.

Japan: Nissho Electronics Corporation, Konwa Bldg, 12-22
Tsukiji 1 Chome, Chuo-Ku, Tokyo. Tel. (03) 544-8311.

Australia: Rank Industries Australia Pty. Ltd., P.O. Box 632,
Chatswood. Tel. 406 5666.

Audio consoles

Don Richter*

and Martin Jones†

* AUTOMATED PROCESSES

† RUPERT NEVE

The focus of any professional audio system is its control console. This one unit can include a wide variety of functions but is basically a facility for the control, processing, mixing and distribution of audio signals. Consequently, audio consoles for different applications will contain many facilities in common: input amplifiers, mixing circuits, switching, level control, metering, monitoring, etc. However, the detail of different installations can vary widely. Is your console missing something useful?

YEARS AGO there were at least four very distinct categories of professional audio equipment. The divisions were based on economic considerations, relating to quality, durability and, to some extent, quantity sold. The categories in descending order of cost were: film, recording, broadcast and sound reinforcement. Broadcast was further divided into large networks and independent operators, with the network consoles approaching, and sometimes exceeding, the complexity of recording consoles. Broadcast was the first to have mass-produced standard consoles manufactured by large corporations. Most of these versions were 'on-air' boards with limited facilities for change, but with extra emphasis on duplication to ensure minimum downtime since air-time is expensive.

The introduction of transistorised channel amps and high-quality tape machines became great levellers for the four categories of consoles: size, quality, reliability and durability became very similar for all. The possibility and desirability of using a multitrack tape machine to record a live concert, along with the elaborate in-house facilities of the new concert halls, led to an increased complexity of major sound reinforcement systems. In fact, their consoles began to resemble those of film, recording and broadcast studios.

Broadcasters, particularly the large tv networks, were soon putting together complex shows from prerecorded and live performances, with very tight flying edits and split-second major scene changes. Some of the early systems were hodge-podges of almost all the available audio equipment that happened to be lying around a particular tv station. Large, entirely live, broadcasts, such as the Ed Sullivan variety show, were unbelievable in their complexity. Not just one console was used—many pieces of gear were lashed together to provide the facilities for preset mixes of large orchestras, small ensembles, soloists, announcers, audience participation, commercials and so on. These would be switched in and out instantaneously as the production called for them, with as many as 80 microphones connected at any one time waiting their turn to be live.

Recording studio facilities were also increasing rapidly from 6 or 8-in/1-out to 16/2, 24/4, 24/8, 24/16, 24/24, 32/32 etc, with additional outputs to cue, echo, solo, foldback, delay, simultaneous mix, multimonitoring and so on. The uncertainty of just how big a console may eventually have to be, plus the desire for ever more ancillary equipment, led to the introduction of modular designs and large patchbays.

Independent console designers and assemblers soon appeared on the scene, making many contributions to technique, styling, circuitry and concepts. An added impetus was given to the established electronic manufacturers to produce not only amplifiers, but small active equalisers, limiters and other signal processing components to be used by the independents in their consoles. Some of the

independent console manufacturers managed to invade the broadcast domain. By and large, however, broadcasters stuck with their usual suppliers, who could provide turnkey installations with transmitters, antennae, cameras, switchers and the myriad of other equipment they needed.

For a while the broadcast console and its related equipment were relegated to a much less important position, because of the vast sums of money needed on the video side. On-air boards were still needed in quantity, but with little variation from past concepts—and still at a price. The advent of stereo broadcasting, the need for more coverage, the growing concern for improved quality and, to some extent, the pressure exerted by musicians and artists who worked in both the recording and broadcast media—all these factors necessitated an update of production boards to fulfill current needs; a pressure that resulted in a great deal of activity in broadcast audio.

Broadcasters have always needed to protect their equipment and transmission lines from rf and magnetic interference. Generally speaking, this means completely-enclosed metal cabinets or housings and balanced or floating transformer-coupling to the outside world, plus fairly hefty levels and lots of headroom. When many recording studios began using tv monitors, digital devices of one sort or another, relay switching and other non-audio devices in close proximity to critical low-level microphone and summing circuitry, they found themselves facing many of the same problems as broadcasters: protection from the outside world (although they obviously did not have the headache of long-line transmission). A while ago recording studios moved away from the 600 or 150 ohm matching philosophy, and started to adopt the European approach of high-impedance in/low-impedance out, which saved a lot of power and heat. Some broadcasters are now accepting this 'high/low' technique, but it is probably the single biggest difference existing between broadcast and recording consoles considered broadly.

Output levels are generally higher for broadcast, but the difference between +4 and +8 dBm can be accommodated with sufficient headroom if a little care is exercised in choosing the basic amplifier circuits. Frequency response and distortion specifications are generally very similar, and it is not too difficult to satisfy the more stringent requirements without excessive cost. Ergonomics, the need to insert various ancillary gear, and reliability requirements are similar in both types of console. As a result, broadcast and recording consoles seem to be growing more and more alike, since the needs and desires are growing ever closer to each other.

In general, the networks seem to be more orientated towards functional furniture, and require colour coordination for console housings. In the past the niches allotted to audio equipment in a broadcast studio have been very limited, but are now tending to increase in size. Although the duties of mixing engineers are growing

more similar, recording engineers usually mix at a much higher level than broadcast engineers; this may be a difference that will be long standing.

Future equipment design should see the remaining gaps being lessened. Indeed, film and sound reinforcement consoles should follow the same pattern whatever the course. Improvements in circuitry, performance or concept will quickly be translated into all consoles, regardless of their initial source. The changes will probably occur even more rapidly than in the past because of the bigger base and more sophisticated approaches to solving problems. The future of recording and broadcast consoles are inexorably tied together, and should be a fast moving and exciting experience.

DR

THERE are normally three distinct stages to the music recording operation, namely multitrack recording, mixdown to 2 or 4-track master, and finally disc or cassette transfer. The studio control room console normally handles the first two stages, while a specialised unit will feed the disc cutting lathe or cassette copier.

A typical large music recording console will have 40 input channels, each one having selectable gain ranging from +80 dB to -10 dB. Equalisation is incorporated on every channel, including high-frequency and low-frequency boost and cut controls with switchable shelving frequencies, two separate mid-range boost and cut controls with a wide range of selectable frequencies, and highpass and lowpass steep cut filters. Some of the more advanced equalisers have switchable peaking characteristics on the hf and lf controls as an alternative to the shelving type. Track identification and setting-up of equalisation and echo is greatly facilitated by two types of channel solo switching: 'mono' solo which simply diverts the monitors to the output of a specific channel so that it is heard alone in mono form, with the track laying or mixdown operation being unaffected and 'muting' or 'position' solo which, as the name suggests, actually mutes all other channels except the one switched to solo. This has the valuable property of leaving the image in its appropriate position in the stereo or quad sound stage, together with its contribution to the overall reverberation. Track laying or mixdown is inevitably interrupted by the latter operation and, for security, a 'solo safe' facility is built in so that the operator can lock out the positional solo while recording on to tape.

The individual tracks of the multitrack tape machine may be fed either directly from channels or via mix busses. For example, a solo vocalist signal will come in through one channel and be fed to one track of the tape, whereas a drum kit signal may come via a dozen microphones, feeding 12 channels that are then mixed down to feed only two tracks on tape.

Auxiliary outputs from the channels, switchable pre or post main fader, are used for feeding echo and reverberation devices and also for foldback mixes to musicians.

A dry studio acoustic is necessary to achieve the isolation between instruments required for effective multitrack recording. As a result performers have difficulty hearing each other, and they may also be inhibited by apparent lack of response to their own sound. A foldback mix on headphones largely overcomes the problem, the addition of reverberation and equalisation on foldback outputs improving the illusion. Multiple foldback feeds on each channel enable several simultaneous balances to be tailored to the needs of different musicians. Stereo foldback is now very popular; this, of course, involves an associated panpot on each channel.

In principle, any multichannel mixer can be used for multitrack recording as long as there is an output available from each channel. In practice, the main distinguishing features of the multitrack console are in the metering and monitoring.

It is essential that each track should have a level meter. These are normally of the volume unit indicator type (vi or vu) but peak programme meters (ppm) are preferred by certain studios. Metering can be, of course, a separate topic on its own. In brief, the ppm can be relied upon for clear indication of overload conditions, whilst the vu gives a better indication of programme loudness. The engineer learns by experience how much apparent under-modulation to allow on a vu meter to avoid overload on various signals. Signals with a very high crest factor (peak-to-rms ratio), like percussion

instruments, will be recorded as low as 10 dB down on normal vu level. Peak-reading led overload indicators can usefully supplement a vu, or may be fitted to warn of overload in a particular channel input section.

During track laying channel levels are set for maximum tape modulation to optimise the signal-to-noise ratio, but it is unlikely that these relative levels will constitute an adequate balance for monitoring. A separate mixdown of the 24 or more track signals is therefore provided in the monitor section, normally giving two or four outputs with stereo and quad panning. Monitor controls are sometimes in line with the channels, a configuration which gives the most compact console, suitable for the smaller studio. Many users, however, prefer the greater flexibility afforded by a separate monitor section. By appropriate use of the monitor faders during track laying, the producer can anticipate the sort of balance he will be looking for during the long mixdown process that follows after the expensive musicians have gone home. Echo, and sometimes equalisation, on monitor give full scope during tracklaying, the tracks themselves often being recorded 'dry' and with a minimum of equalisation.



The control room at Threshold is typical of present-day multitrack recording installations

Tracklaying is not necessarily completed in one session; 'over-dubbing' on vocal or instrumental tracks is commonplace. Here the existing tape tracks are played off the record head of the tape machine, to maintain synchronisation with the overdubbed track being recorded. The performer is fed a foldback mix, while the operator monitors a mix of the existing tracks in replay plus the output of the channel in overdub mode. It is essential that the design of a console ensures that overdub monitoring is readily achieved.

The mixdown operation involves replay of the multitrack tape via the console channels, which are selected, normally via panpots, to two or four output groups feeding the 2 or 4-track master tape. The operator adds further equalisation as required, echo and reverberation being fed back as appropriate into the mix via echo return channels, which often incorporate their own equalisation. The dominant console controls in the mixdown process are the channel and group faders. It is essential that these fall readily to hand, have a smooth action and give clear indication of their relative position. These requirements are fulfilled by the horizontal slider fader which has become virtually standard in music recording consoles. Fader tracks are normally of conductive plastic compound, giving an exceptionally long life and low-noise operation.

The control of dynamic range of individual tracks and the 36 ►

AUDIO CONSOLES

final mix is a vital operation achieved by patching in limiters and compressors. Choice of appropriate attack and decay times and threshold level is part of the creative process, while equalisation in the limiter side-chain can produce additional selective control.

Supplementary features on a typical music recording console will include a line-up oscillator with a selection of frequencies, remote control of reverberation plates and tape machines, and a digital stop-clock for timing tracks. Communication with the studio is provided by a talkback microphone selectable to foldbacks and to tape for reference on the recording. Talkback to tape normally has a low-frequency 'slate' tone superimposed to aid location on fast wind, when it is heard as a bleep. An alternative monitor output feeds speakers in the studio for playback to performers as required.

The achievement of a pleasing balance can be a highly repetitive task. Fortunately, this is a field where the application of the computer and the latest data storage media have relieved the operator of much routine work, thus freeing him for greater creativity in liaison with his producer. The close attention to ergonomics, which has been a feature of the latest automated mixdown systems, has resulted in the full integration of tape machine control, and led to the acceptance of computer-assisted mixing in major studios worldwide.

The third stage of the music recording process is transfer from master tape to cassette or disc using a separate disc-mastering console. Further equalisation is normally available here, together with additional compressor-limiters and noise reduction decoders and encoders. For disc cutting, a preview tape head is used to control pitch and depth of cut in advance of the signal to the cutter head. The preview signal is handled by the disc-mastering console and subjected to identical equalisation and limiting as the main programme. A phase meter provides close monitoring of the difference (vertical cut) signal to minimise cutting problems. Where necessary, controlled lf crosstalk can be introduced (vertical bass cut control) to avoid excessive vertical amplitudes with negligible programme degradation. Provision is made for automatic diameter-compensating lf equalisation controlled from the cutting lathe. Comprehensive monitoring and metering, switchable to any signal path, including a disc replay pickup, gives the cutting engineer confidence in the quality of his cut.

Sound broadcasting

In the early days of broadcasting, sound balance was achieved by careful positioning of the performers relative to the microphone. A conventional studio control room was irrelevant to this requirement, and one central control room served all studios for both rehearsal and programme conditions. The central control room at Broadcasting House, opened in 1932, is described in the *BBC Year Book* for 1933 as follows: 'This room contains all the amplifiers, control apparatus and switch gear for handling all studio programmes and rehearsals and outside broadcasts . . . incorporating in the design everything necessary to meet the somewhat exacting requirements of the programme producers.'

The present-day relevance of the latter statement to custom broadcast consoles is remarkable! In addition to the central control room, a novel feature of BBC Broadcasting House was the inclusion of the first broadcast studio mixers as we know them. These were the 'dramatic control panels' used in the special control room associated with a complex of drama studios. They included many features that are still important in the design of broadcast consoles: comprehensive talkback and cue facilities; automatic muting of the studio loudspeaker when faders were opened; and switching between rehearsal and transmit conditions. Eleven input channels with master output and an echo return fader produced a format still familiar to the broadcast engineer.

The post-war development of facilities in the music recording field naturally created a demand for more elaborate broadcasting consoles. Equalisation in every channel is now commonplace, while flat slider faders have generally replaced rotary knobs except in the simplest consoles. To the recording studio engineer many broadcast faders may appear to be upside down, with the 'open' position near to the operator to reduce the risk of opening a channel by accidentally knocking a fader.

Multitrack music recording is now a feature of many broadcast

facilities, the consoles sharing many features with those of specialist recording studios. The broadcast industry has made its own contribution with such developments as the echo mixture control, facilitating variation of direct to reverberant sound ratio; the stereo width control; and telephone line interfaces for 'phone-in' programmes — just a few of the special features to be found on present-day broadcast desks. Stereo m/s (sum and difference) networks provide separate signals for stereo encoder feeds and the essential checks of mono compatibility.

Once again drama requirements have recently inspired new developments, this time in the form of the central control of channel routing with digital memory facilities. In this way the entire desk configuration can be changed instantly to any one of several pre-selected grouping combinations, thus facilitating scene changes in drama and variety programmes.

The ppm is a common form of metering in many broadcasting organisations, with the normal operating level peaking to -8 dBm; many broadcasting organisations however, especially in the USA, still find the loudness indication of the vu meter to be the best metering for their particular purpose. The particular needs of the broadcast industry have given rise to the development of that useful instrument the stereo ppm, with two coloured pointers indicating the levels of the left and right channels on one meter scale.

The special switching and cue facilities of the early control panels are further extended today to minimise the risk of interference with the transmission. For instance, logic circuits ensure that the studio loudspeaker is automatically muted whenever there is a danger of feedback howl, such logic including the channel mic-line switching, channel fader, group selector, group fader and main fader. This is achieved by the interconnection of microswitches built into the faders. Such switches can also operate indicator lamps on those microphones that are live at any one time. It is normal for broadcast desks to include a rehearsal/transmit selection key, the transmit mode inhibiting the line-up oscillator, talkback-to-programme circuits and studio loudspeakers.

The smaller broadcast station, of which British local radio is a good example, has its own particular requirements. Self-operated disc jockey programmes are common, the dj often being the only human intervention between the programme origin and the 38 ▶

The sound reinforcement console at the Royal Opera House, London





**Sound
transmission
by
Infra-Red
light**

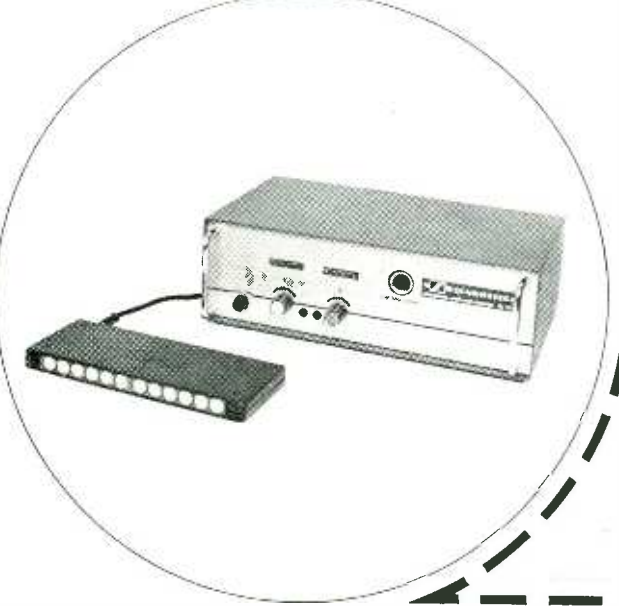

SENNHEISER INTRODUCE INFRAPORT

The two channel Infraport system has been introduced to provide a very flexible studio foldback system offering:--

- ★ Very high sound quality
- ★ Complete freedom of movement for the artist
- ★ Individual headphone volume adjustment
- ★ The possibility of stereo foldback
- ★ No trailing cables

The system comprises of a master transmitter which feeds infra red radiators placed around the studio. The headphones have built-in receivers, which provide independent volume controls for each capsule. A three position switch on the headphone selects Channel 1, Channel 2 or stereo operation.

Systems are available for 1, 2 or 9 channel transmission with a choice of eight different receivers.

For further information and a copy of our free brochure, complete the coupon and send to:--

Hayden Laboratories Ltd

Hayden House, Churchfield Road,
Chalfont St. Peter, Bucks SL9 9EW
Telephone: Gerrards Cross (02813) 88447

Please send me a free brochure on Sennheiser Infraport

Name _____

Company _____

Address _____

Code SS/1177



AUDIO CONSOLES

transmitter. Complication should therefore be avoided. Channels are provided either for low-level (microphone) or high-level (music) operation. In the case of a stereo station, the microphone channels will be fitted with panpots, and each music channel may in fact be a twin unit, giving full stereo facilities on the single fader. Channel equalisation is either rudimentary or absent. All music sources are selectable to the voice-over 'ducker', which provides an automatic fade during announcements; it is important that the ducker should provide accurate tracking of the two stereo channels to avoid image shift in the programme.

Stereo sources may be disc, tape, cartridge or incoming programme lines. Input selector switches, giving a choice of several stereo inputs on certain channels, enhance flexibility. Slick programme operation is facilitated by rapid-start turntables and cartridges, using either the fader microswitch or a pushbutton adjacent to the appropriate fader. The stereo programme output signal is fed via distribution amplifiers, often within the console, which provide independent output to the transmitters, the 'logging' recorder and auxiliary studio feeds. The rf rejection properties of console circuitry, important in all applications, are especially vital in some of the smaller units, where the studio is commonly immediately next door to the transmitter.

Outside broadcast requirements range from the full multitrack recording facility, which would not be out of place in a major studio, right down to the portable suitcase-sized mixers designed for battery operation. On the other hand, some of the small portable units contain a remarkable degree of sophistication, with elaborate communication switching, off-air receiver and tape replay facilities, line equalisers and comprehensive monitoring and metering. Ruggedness and reliability are of paramount importance. Recent developments in miniature circuitry have allowed many professional features to be built into very compact portable mixers for both broadcasting and recording applications.

Television

Many of the features found in radio desks also apply to the television field. Nevertheless, because of the different background of development, certain variations exist between radio and television requirements. For instance, the precise law of certain controls, such as echo mixture, may differ between radio and tv—even within the same organisation. In several tv applications, quadrant faders are still preferred to the flat version, the angular feel being deemed a useful source of additional feedback for the engineer.

Typical large tv consoles have up to 50 input channels and, in addition to the usual audio and cue switching facilities, will contain video selector buttons for several picture monitors. It is common for tv desks to be linked into complex talkback systems because the communication requirements of a large television production facility are very sophisticated, the contact between producer, vision mixer, camera control, sound engineer etc being fundamental to the smooth running of the presentation. There is a trend towards computer-controlled communication systems that even interface with the main video programme switchers, thus providing automatic talkback routing as necessary.

Until recently all television desks were inevitably designed for mono operation only, but the trend towards simultaneous broadcast on stereo radio, and the requirement to issue discs of certain popular programmes, has led to the recent specification of stereo facilities, and thus a significant increase in complexity.

Certain aspects of television work are, of course, closely allied with the requirements of the film industry which are discussed below. Post-production dubbing of both film and video tape, in which music and effects are added to a dialogue track, is an increasing requirement where a great deal of fresh thinking is taking place.

Film sound

There are three distinct operations in the production of a film soundtrack. The first is the recording of dialogue and any effects available at the time of shooting. The second stage is music recording where the orchestra is located in a studio with film projection facilities, the conductor taking his cues from the film. The third stage is sound track dubbing where the final sound track, often 3-channel stereo, is assembled from synchronised dialogue,

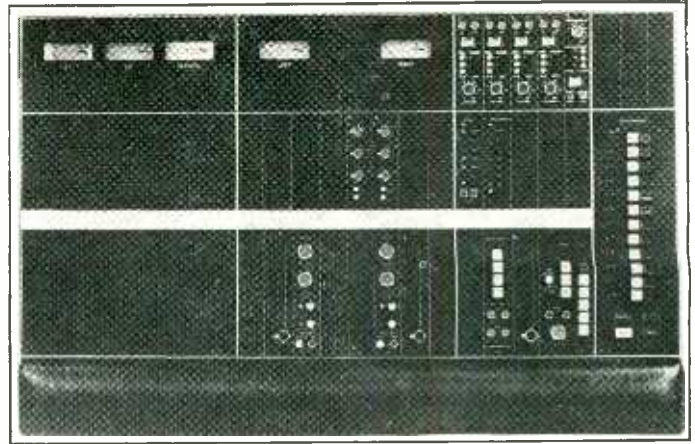

A disc-mastering console

background music and special effects, which must be dubbed in carefully to match the action.

Equipment for recording dialogue on location is often of the simplest type, small portable mixers being the general rule. In contrast, facilities for the recording of background music bear a close similarity to those of a music recording studio. Indeed, there is a growing tendency to use multitrack recording as one stage of the process.

The final dubbing operation is a complex one, often involving at least three operators each having separate responsibility for music, effects, dialogue etc. Consoles for this application must take due account of the space required for the operators, each having his own control position. Ergonomics are absolutely vital, particularly as the operators must concentrate on the screen; the controls must fall comfortably to hand at all times, and yet allow space for scripts and other notes. Certain users prefer equalisation and panpot controls to be stepped rather than smooth, so that changes can be made by counting notches rather than looking down at the panels. The channel equalisation is located close to the faders for ease of operation.

Other special features of film desks include the following: background suppressors (noise gates) to reduce noise from multiple generations of recording; notch filters to modify sound recorded in poor conditions on location, eliminating unwanted interfering tones etc; integrated control of sprocketed tape machine and monitor to allow 'rock-and-rolling' for repeated dubbing attempt on a specific length of film; twin-needle ppms for accurate level matching; and 'signal present' indicators on channels to warn of signal arrival a feature particularly useful for rapid sound-track compilation for newsfilms.

Recording for the cinema involves the Academy Filter, which is incorporated to give some high-frequency pre-emphasis to compensate for the roll-off in cinema systems. It is difficult to be more specific about this filter as the required characteristics will vary from one studio to another, reflecting the differences between film companies.

Theatre and sound reinforcement

The range of audio equipment available today has opened up in recent years a variety of applications in the field of auditorium sound. These applications divide naturally into two groups: theatre sound effects, and acoustic modification. In this context, the latter term covers sound reinforcement (amplification of direct sound) and assisted reverberation systems (amplification of reverberant sound to increase reverb time).

Theatre sound consoles are normally designed to cater for sound effects and sound reinforcement. In many respects, these are similar to small music recording and broadcast consoles, a typical installation having 20 input channels and up to eight output groups; a common feature is for these groups to feed a matrix of level controls (typically 8 x 8) which give instant selection of a wide variety of output mix combinations to multiple auditorium loudspeakers, thus providing the appropriate sound image position. Equalisation provided in the console may vary widely; some

When you're serious about sound... ...you need Keith Monks audio equipment

When you're serious about sound, you care about quality. Not just sound quality, but equipment quality, too. Because good equipment is fundamental to good sound.

The finest equipment in the world comes from Keith Monks – trendsetters in the professional audio industry. You'll already know about the huge range of Keith Monks products, from amplifiers and microphone booms, to cable clips and radiomikes.

Every item in the Keith Monks range is precision-engineered for quality performance. Every product is tried, tested, proven in use by professionals throughout the world.

And here are some brand-new products – all with the same Keith Monks quality hall-mark!

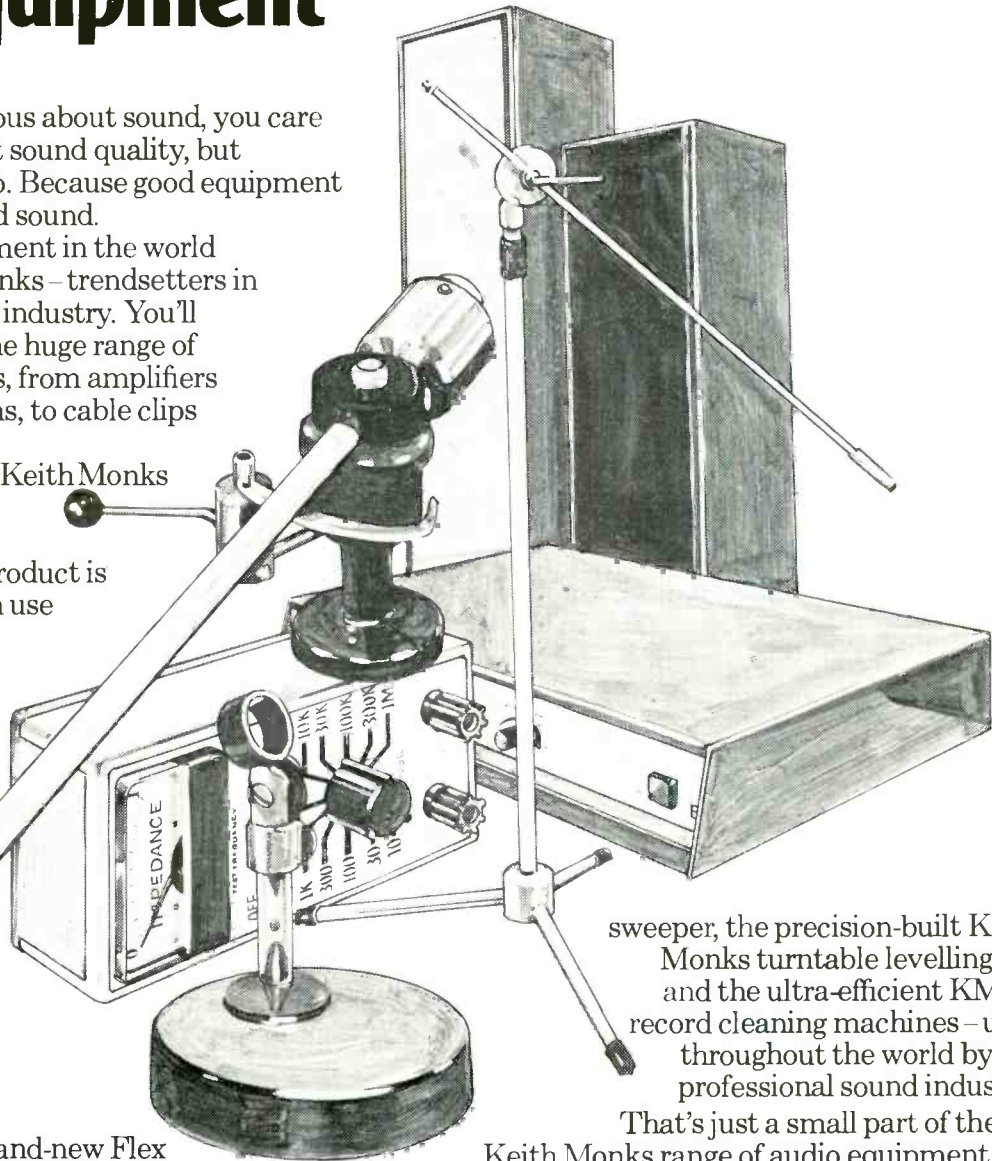

sweeper, the precision-built Keith Monks turntable levelling kit, and the ultra-efficient KMAL record cleaning machines – used throughout the world by the professional sound industry!

That's just a small part of the big Keith Monks range of audio equipment. It's made by professionals, for professionals, with skill, care and quality.

Because we know you're serious about sound.

Get your free copy of the 28 page illustrated Keith Monks Audio catalogue, by contacting us at the address below:

KEITH MONKS (AUDIO) LTD.,
26-28 Reading Road South, Fleet, Aldershot,
Hants. GU13 9QL. Tel: Fleet (02514) 20568.

- * The brand-new Flex 30, an XLR to XLR 12in gooseneck. The gooseneck everyone's been asking for is finally here!
- * The famous Keith Monks go-anywhere cable drums. Still in the same range of sizes to suit every job, still the same drums – but now with XLR sockets!
- * IMP/XLR Impedance tester – designed for quick and easy use in the field. An essential for every PA service or installation engineer. Fitted with XLR socket.
- * And of course, the internationally respected range of record-care equipment, including the unique Keith Monks anti-static record-



AUDIO CONSOLES

operators find channel equalisation unnecessary, while others prefer hf and lf boost and cut with a single mid-frequency control.

In sound reinforcement applications a $\frac{1}{3}$ -octave band graphic equaliser on each output is a useful aid in equalising loudspeakers and their environment, and therefore reducing acoustic feedback problems. Speech reinforcement systems commonly include a frequency shifter to further reduce the howl-round threshold. Power amplifiers are normally installed in a rack separate from the main control console, and will range from a minimum total output in the region of 100W up to the larger outdoor systems with a capability of many kilowatts.

Public address for outdoor rock concerts requires facilities very similar indeed to those of the recording studio, and may in fact include multitrack recording for later issue on discs. In these circumstances the stage instruments will all be separately miked, even if they contain their own loudspeakers, thus giving the sound balance engineer complete control over the mix.

Rock is not the only type of music which can benefit from electro-acoustical treatment; top grade audio equipment is in use for the reinforcement of classical music of various types, not only in open air concert venues, but also for the judicious amplification of choral music in a cathedral setting. High technical performance and ample power reserve are essential features for such applications.

Consoles for large-scale sound reinforcement systems commonly incorporate solid-state audio time delay units to permit signal distribution to the various power amplifiers feeding multiple speakers. With correct choice of time delay, so that the arrival time of the amplified sound gradually increases as one moves away from the stage, the 'Haas' effect ensures a natural sound image position with first-class audibility.

Recent years have seen the development of several electro-acoustical systems which can provide an auditorium with adjustable reverberation time. Examples are assisted resonance, using narrow-band acoustic feedback, and the various ambiophonic techniques employing a number of wide-band amplification channels to add reverberant sound energy to a room. All of these systems require multiple special-purpose filters and equalisers, and must maintain a very high standard of technical performance over an extended period of time. In contrast to the other consoles described, these reverberation systems are not subject to continuous control by an operator during use. Indeed, such intervention would be undesirable. The appropriate reverberation time is preset before a performance, often by remote control. For this reason, ergonomics are of minimal importance and vertical rack mounting is normally selected as the most efficient method of construction, and such systems are normally

kept quite separate from the normal theatre sound system. Although not cheap, electro-acoustic reverberation systems do provide a cost-effective solution to the perennial problem of the acoustics of the multipurpose hall, and are therefore likely to be installed in increasing numbers.

Common features and trends

One of the common factors in all the fields described is the requirement for custom-building, which enables the exact provision of the necessary facilities. To an increasing extent however, standard products are fulfilling the major needs of certain applications, such as music recording and sound reinforcement.

All professional audio applications have in common stringent technical standards: not only must frequency response and distortion performance be immaculate, but the achievements of major manufacturers in terms of linear phase response and minimum transient intermodulation distortion are now recognised as subjectively important. It often happens in the audio industry that a technique developed for a specialised use can, with some imagination, be applied in a different field. An illustration of this is the simple noise gate which cuts off signals below a certain level. This device, originally developed for background noise reduction in the film industry, has been used creatively in the music recording industry by separating the control chain from the main audio path, and using one sound to gate a different signal. Impulsive sounds gating musical notes can produce particularly unusual effects.

There are other new concepts discussed here that will undoubtedly see wider application. The memorised console routing, developed for broadcast use, could be applied with advantage in music recording studios, perhaps combined with computer-assisted mixing, thus enabling instant return to a previous grouping configuration. Such a system would also facilitate the rapid changes required in theatre work.

We are now seeing computer-assisted mixing applied to post-production video tape dubbing. When integrated with a suitable synchroniser, this provides complete control over a video recorder and two audio machines run in any required sync relationship. All mixing actions are memorised for future repetition, together with programmed starts for effects cartridges, etc. The dubbing mixer's task can thus be facilitated by the continuous updating of cues and crossfades, etc, until the desired result is obtained. Such a system is the natural partner to the computer-assisted video tape editing facility.

Further development possibilities are numerous, and it is likely that future audio systems will appear vastly different from those of today in terms of shape, size, facilities and specification. One thing only is certain—at the centre will be, in one form or another, the audio control console.

MJ

Broadcast pattern audio jackfields from Future Film Developments

19in Rack Mounting, from one to six rows of 20, 24 or 26 Jacks. The jacks are mounted on a plastic block which is in turn mounted on a 19in panel. Each row is fitted with a legend (designation) strip and wire support bar. The panel is steel, cadmium plated, chromate passivated and stove enamelled hammer-tone silver.

ALSO Audio Patch Cords . Microphone Cable . Installation Cable . Multiway Cable . Post Office and Rendar Jacks . Cable Markers . Lever Keys . Linear Faders . Cannon Connectors . Preh Connectors . Tuchel Connectors . Switchcraft Connectors .

Military Tri-Lock Bayonet Connectors . Audio Attenuators . Wahl and Weller Soldering Irons . PML Microphone Accessories . Hellermann Sleeves and Tools . Crimp Terminals . Cable Drums . AB Engineering Wire Strippers and De-Solder Guns.



FUTURE FILM DEVELOPMENTS

36/38 Lexington Street, London W1R 3HR
TEL: 01-437 1892, TLX: 21624. ALOFFD G

Radford

THE FACILITY



SEE THE TEAC TASCAM RANGE
AT RADFORD HI FI LTD., 52-54 GLOUCESTER RD., BRISTOL BS7 8BH
Tel. (0272) 422709 Telex 449135 CONTACT ROGER WALL

ATTENTION!

STUDIO EQUIPMENT SERVICES

have moved to:

**The Olde Shoppe,
Ye Olde Oxgate Farm,
Coles Green Road,
London N.W.2**
Tel. 01-452 1979
Telex no. 87515

Located at the base of the M1

We stock Ampex tape, Demagers, Splicers,
Spools, X.L.R., Stands, Mics, etc.

We supply and service Revox, Uher, Otari,
Neal and Teac. Plus a range of signal processors
e.g. a new British low noise flanger/phaser/
vibrato/delay unit at **£400** plus VAT

Not forgetting the most essential
SERVICE

CHILTON

If you are searching for a *Quality* mixer which has attention to *detail*, many *facilities* and **NO** hidden snags + *impressive* appearance, seek out the new CHILTON QM1 series.

The price is very competitive due to full in-house manufacture. 12-4 and 16-8 + Add-on Input modules.

Our very popular M10/2 and M16/2 are also available, from £410.

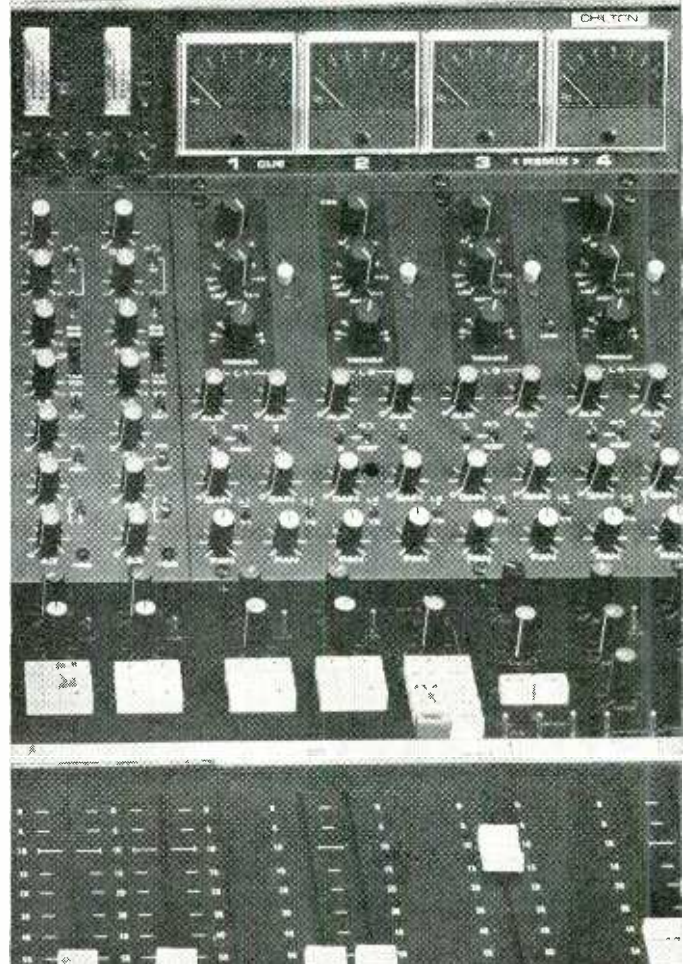

MAGNETIC TAPES LTD.

Chilton Works, Garden Road
RICHMOND, Surrey TW9 4NS

Telephone: 01-876-7957

Play the game

THERE'S AN OLD ADAGE that everything comes home to roost in the end; and it's one that press and public relations officers would do well to bear in mind.

A musician friend was telling me about the gig he did with American singer Peggy Lee at the London Palladium last March. They hadn't been able to run through every number during the rehearsal, so for some of the live performance that night, the band were sight-reading! Being high-calibre musicians they managed without problems, and reviewers of the concert didn't notice anything untoward. Even so several of the musicians couldn't wait to hear how the sight-read numbers would sound on the 'Live-in-London' album being made of the concert by Polydor. But before the Polydor album came out, a couple of late-night Capital Radio programmes featured 'Peggy Lee live' tapes, also made at the Palladium. Rather puzzled, I phoned the Capital press office about why both Polydor and Capital had apparently independently recorded the same event. The press officer checked and assured me that Capital knew nothing about any live recording made by a record company at the Palladium concert. 'I've talked to the engineer who was there,' said the press officer, 'and, as he says, he would hardly have failed to notice if there had been anyone else recording it. They'd have been falling over each other's cables, wouldn't they? Perhaps the album was made at another concert.'

Well, being an inquisitive sort of person at the best of times, and feeling sure that there couldn't have been another Peggy Lee Palladium concert that no one, not even the musicians, knew about, I awaited the release of the Polydor album. Sure enough, it was packaged as 'recorded live at the London Palladium on 13th March, 1977'. So back I went to Capital's press office to ask the date of *their*, supposedly quite independent, Peggy Lee concert and recording. It was the same date! Capital then acknowledged that their two 'live recording' broadcasts had in fact originated from a finished master tape which had come in from Polydor. Capital told me that they had done a deal with Polydor, 'and paid all the musicians', for two broadcasts of the master tape before it was issued as an album. Inevitably I couldn't help wondering why Capital hadn't said this in the first place. Equally inevitably, I couldn't help wondering how many other album master-tapes have been and will be broadcast as station originals.

So I phoned the Musicians Union, who very promptly reminded Capital that such goings-on are contrary to the agreements

negotiated between British musicians and the independent radio stations. And breaking agreements over broadcast recordings is now a much more risky business than many people realise. It's not just a question of a £5 fine and a slap on the wrist; under the Performers' Protection Act, 1972, the misuse of a recording can cost the offender up to £400 in fines and two years in jail, or both!

The story didn't quite end there. Capital had assured me that all the musicians had been paid for the two broadcasts, over and above the fee paid for the Polydor recording—but my grapevine information was otherwise. The MU also promptly checked this out and found that by September (six months after the concert) no such payments had been made. This followed 'an administrative misunderstanding'. No comment. But if one thing in this world is certain I'll bet it's that the musicians will now be paid for those two broadcasts they didn't know they were making.

As evidenced by their prompt and business-like handling of the Peggy Lee episode, the MU does a pretty good job when it comes to protecting its members' rights. It may also, for instance, be very clever and convenient for studio engineers to get a cheap, multivoice sound by running one vocalist through the same passage several times and quietly recording each try on separate tracks (as we all know is done now and again when budgets are tight). But it's no fun for the singers or musicians who would otherwise have been booked for the job.

However once in a while the MU rules do seem to militate against its own members; for instance, the rulings which mean that in practice most library music recordings have to be made abroad (in theory at least) to the obvious advantage of European studios, engineers and musicians. And in the area of jazz in particular, the MU has in the past

Peggy Lee



made and enforced a few decisions which could at best be described as curious. In a recent book, 'All This And Ten Per Cent', ex-agent Jim Godbolt describes some of these in colourful and delightfully frank fashion. In fact, it seems that much of the 25 years which Godbolt spent dealing with jazz and pop musicians was spent squabbling with MU officials. Exaggerated or not, it certainly makes entertaining reading. For instance, anyone in the studio business old enough to remember the postwar years and interested in jazz will recall the frustration of seeing some of the greatest jazz names the world has ever known prevented from performing in this country by a dispute between the British and American unions. In some instances, where noted musicians did play in this country, court actions followed. Of course it certainly wasn't all the British MU's fault. And it was our Hardie Radcliffe who, with his American counterpart Petrillo, arranged a Paris meeting to hammer out the exchange deal which is still in operation today. This stipulates that (with a few exceptions) a British band of pop or jazz musicians must always tour the States in return for work permits enabling a similar number of US musicians to play here; and *vice versa*. But a lot of opportunities were missed before the deal was struck. 'Why do you want to bring Louis Armstrong in, when you can hear Kenny Baker? You can't tell me there's a finer trumpet player in the world than Kenny,' are the words which Godbolt attributes to union official Harry Francis. In the event, Louis Armstrong became one of the first musicians to play here after the deal. He performed after a one-legged tap dancer in a converted boxing ring that revolved continuously like the Post Office Tower restaurant (except on the night when Princess Margaret attended and the ring was rocked backwards and forwards to improve the royal view). As Kenny Baker's number one fan, I would say he (Baker) could probably have blown Armstrong out of the ring that night, but that was hardly the point. We wanted to form our own opinions.

Sadly, evidence that comparable union intransigence still persists was to be found in a letter to *The Times* last year and is currently to be found in the racks of many record shops: look for Decca PFS4393. *Kenton Live in Europe* was recorded in Holland during the American band's 1976 European tour, and it was originally Decca's intention to make the recording at a London concert. Decca Phase-4 a&r man, A R D'Amato, approached the MU for permission to record the Kenton band for Decca at the Festival Hall and wrote in *The Times* about how he was refused permission because Kenton, hardly surprisingly for an American band, was not using British musicians. Despite appeals, and even an offer of extra payment via the MU to their pensions fund or a charity of their choice, the answer was a flat 'no'. As a result Decca was forced to record the album in Holland, which involved taking sterling out of the country, increasing overheads, and reducing the profit margin. Perhaps the most significant outcome of all this is that the MU never replied to the Decca letter published in *The Times*. ■

NOW AMCRON INTRODUCE THE EQ-2 Equalizer

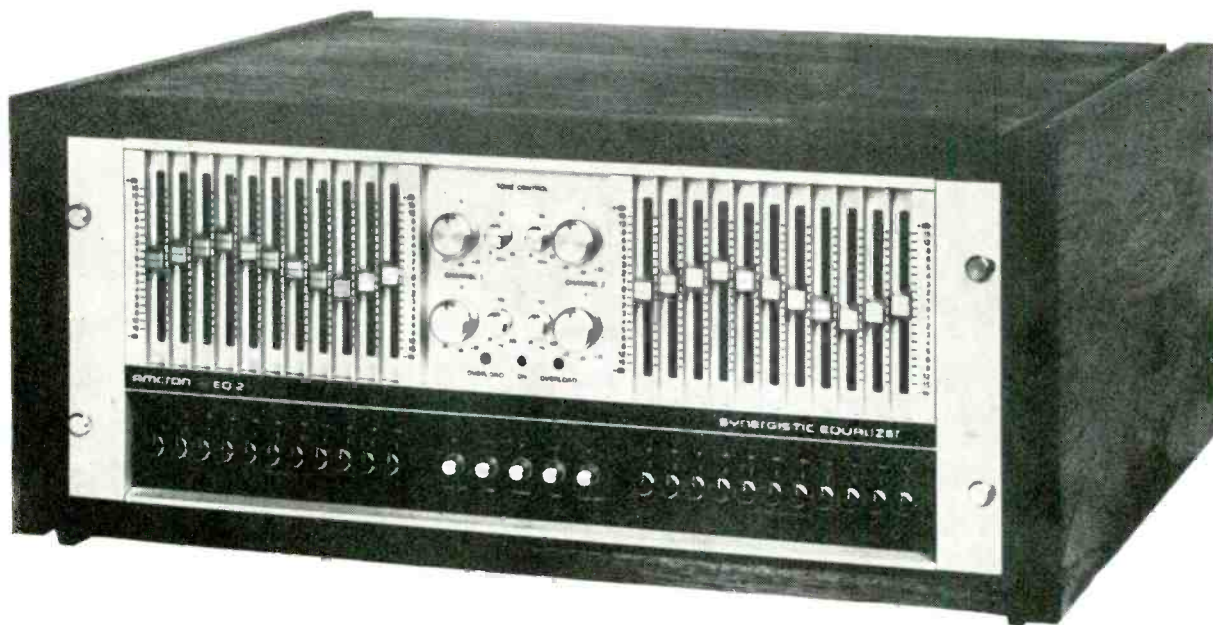

The AMCRON EQ-2 is a stereo equaliser designed for professional use, and offering eleven bands per channel of full equalisation from 20 Hz to 20 kHz. The filters are half octave set on octave centres, and each has a control permitting the centre frequency to be varied by ± 0.5 octave. The two channels can be cascaded to provide a full range half octave equaliser, and shelving type tone controls are provided allowing adjustment of the Bass and Treble.

The EQ-2 has been designed, and built to the usual high AMCRON standard, and is supported by the normal 3 year warranty on parts, and labour. Leaflets are available on request.



MACINNES LABORATORIES LTD.

MACINNES HOUSE, CARLTON PARK INDUSTRIAL ESTATE,
SAXMUNDHAM, SUFFOLK IP17 2NL TEL: (0728) 2262 2615

MACINNES FRANCE S.A.R.L.

18 RUE BOTZARIS,
PARIS 19

Tel. 206 60 80 et 206 83 61

'In nature, there are
neither rewards nor punishments -
there are Consequences.'

R.G. Ingersoll, 1833-1899

Mel Lambert

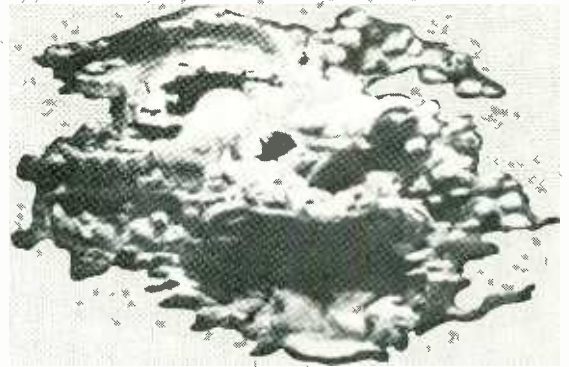

The concept of Consequences is a 'mind-movie'.

The musical ideas are explained in the January issue of 'Hi-Fi News and Record Review'. Here we relate the engineering side of the realisation.

EVERYTHING about the 3-album *Consequences* by ex-10cc members Lol Creme and Kevin Godley is awe inspiring. Across six sides of vinyl it chronicles the struggle between Mankind and an extremely irate Nature, culminating in a piano concerto intended to save the world. The ensuing holocaust is contrasted with a banal and trivial conflict over a divorce in a solicitor's office, featuring the many voices of comedian Peter Cook. The total project took some 16 months to record, initially at Strawberry North and then for three months at The Manor. Total recording costs were around £200 000, half of which was provided by Lol and Kevin.

The power house and 'star' of the album is undoubtedly the *Gizmo*, a device developed by Lol and Kevin over the last six years. Basically it is a small battery-powered gadget that clamps to the bridge of a guitar and mechanically bows and vibrates the strings with miniature motor-driven wheels. But in the hands of Lol Creme—with a little help from a multitrack tape machine—it becomes a full string orchestra, a brass and percussion section, and even a chorus. Lol worked exclusively with the *Gizmo* in the control room, by plugging it through a pre-amp/di box and straight into the desk.

With a total running time of just over two hours, *Consequences* certainly demands your undivided attention, especially when listening on cans. One's senses are constantly bombarded with weird and wonderful effects, many of which are so ingenious that they warrant description in some detail. The tidal

wave on *Honolulu Lulu* (and subsequently on *The Flood*) was recorded by engineer and third member of the team, Martin Lawrence, as Lol and Kevin threw more than 200 buckets of water against the wall of the car park at Strawberry. The rhythm was added in the studio by dropping small pieces of modelling clay into a bucket of water, and then editing the tape into loops to create syncopated time.

The fireworks segment on side 1 was taken from a display specially organised on Salisbury Plain. Unfortunately, the first attempt was ruined by the excited reactions of numerous onlookers. A repeat show was arranged with the help of Paines Wessex who contributed extra-large fireworks. After the tapes had been cleaned up, Lol and Kevin orchestrated the sounds of the fireworks using the *Gizmo* and *Kepex* noise gates.

Strangely enough, it was found that the recording of Peter Cook's dialogue on sides 3, 4 and 5 was considerably harder than first imagined. The dynamic range of Peter's voice is large, switching rapidly from a whisper to a burst of shouting, which meant instantaneous and continuing adjustments of the channel faders. Furthermore, an enormous amount of editing was required to make the music fit the dialogue. On *Please, Please, Please*, for example, Peter recorded numerous 'pleases' that were then leaded up and adjusted to suite the backing tracks. Although these had already been recorded, it still took about three months at The Manor to record and mix all of Peter's contributions.

To find out more about their motives and methods, John Atkinson (News Editor of *STUDIO SOUND*'s sister magazine *Hi-Fi News and Record Review*) and I spent an afternoon with Kevin Godley and Lol Creme at Polygram's London offices.

Consequences is a pretty complex album set. How do you respond to comments that it doesn't work on a first hearing; that it takes a while to get into it?

LC: We agree. It wasn't done with the thought in mind that this has to work, that you have to get off on it first time. It was luck that it worked in the way it does—if

it works at all—because it was done in such an experimental fashion. Basically, now that we have learned how to make it, people—and that includes us as well—have got to learn how to listen to it.

KG: After all, if we spent 16 months putting it together you're not going to get it all in one hearing. In fact you could well be thrown on first hearing; it wasn't intended as something you could talk over while it's on.

Do you want to educate your audience, so they can be appreciative of how the effects come about?

LC: Yes. To remove the mystique we want to do a lecture tour about the way we make records. We're going to take a small studio to the campuses, to show them first of all how a studio works, and then invite them, perhaps, to make a record for themselves on the spot. We think we could more or less produce something enjoyable out of any noise they care to make.

KG: We want to take it to the people at street level and show them how easy it is to make albums, without all the crap you have to go through to get into a studio these days. Like getting a band together, doing a demo, and so on.

LC: I think people should know what a studio is all about. If they understand that it's treated as an art form, with a background of respect, they'll perhaps get even more enjoyment out of knowing what went into making a record. Rather than assuming that all these long-haired idiots just went in and rattled it all off . . . and now they're making thousands and thousands of pounds. It would be interesting for people to know about these things—I'm fascinated by watching how films are made, the 'film-of-the-film'.

Had you mapped out the overall sequence of the album beforehand to give some form of running order?

LC: We had about ten different experiments, and there were cross experiments. Each side would have its own kind of feel—if you really get into the album as we did. Each side has its own particular motive, a different kind of angle, and there were sound



Lol Creme and Kevin Godley with the *Gizmo* attached to a Strat

experiments that tended to be pure production. And we were trying to get a broader span of frequencies on the record than we'd done before. There were about a million different things that we wanted to try. It was a case of: 'If we're ever going to have a chance to do it, this is it; do it now or forget it'. We'd opted out: we'd blown our bread on it so we might as well try everything we wanted to try, whether it's commercially successful or not.

Martin Lawrence, who engineered *Consequences*, seems to have made quite an important contribution to its realisation?

KG: Oh totally. He was our apprentice with 10cc and used to do the sound on the road for the group. He began as a tape jock at Strawberry. Why did we choose him? Obviously we'd worked with him a little bit on the road and he had the right temperament. We realised that we needed someone with patience above and beyond the call of duty. When we began he didn't know too much about a studio; we moulded him in a sense. LC: We did these first few days of experiments with Mart and the *Gizmo* in order to do it away from the group. For the sheer sake of not doing it with Eric [Stewart] because it would have had the atmosphere of being something to do with 10cc. So we used Martin, who wasn't an engineer at all really, just an apprentice, and we got on so well. We could tell him what we wanted, and he would get it, or we'd show him if he couldn't do it. After the first week we figured that this guy's got the right temperament. When we decided to carry on with *Consequences* it was natural to ask him if he wanted to get involved. He had a very good job with the group and we showed him the alternatives: to stay with the band, or we'll take you with us. We told him that we were going to do a triple album, or possibly more, which might never go on the market. He could come out of it a pauper or he might make a name for himself, but if he wanted to come with us he was welcome. He said he would, and now at the end of it he's got to be one of the best engineers in the world. For the sheer ability to get what a producer wants, he's superb.

Was it a case of your having an idea of a particular sound, and then Martin coming up with a way of achieving it?

LC: It didn't quite work out like that. We wanted to get certain sounds, but you need someone who's prepared to spend three days being told that it's wrong; try it like this, try it like that until what comes out of the speakers is right. And then you know that's the engineer for you. If you get an engineer who after about ten minutes says: 'Look man, I know what you want but you can't do it', or 'I can't do it', or 'You're wasting your time, what's the point in trying to get a guitar to sound like a saxophone; let's get a saxophone in', you're in trouble. It took us three days to get that saxophone sound. Martin didn't know how to get it, we didn't know how to get it; but between the three of us we got it eventually.

KG: The great thing for Mart is that he's developed his own totally individual style. When we went to The Manor there were other engineers around who remarked on how bizarre his style was.

LC: For example, when we were doing a straight vocal, if there was a pause where there was no singing, instead of leaving the fader up he would pull it down and push it back up again. That's become the natural way of engineering, you get a much cleaner recording. Initially, we would say: 'What a clean recording, you can't get much cleaner than that'. It became so drummed into him that when it came to doing a lot of vocals, like on side 3, he was doing everything so cleanly that it became a pain in the arse; you can only go so far! But now he's developed a style by being thrown in at the deep end for such a concentrated period of time, that he can handle almost any instrument and get the right kind of sound. He's learned how to use dynamics; we made him do things that he thought couldn't be done. We'd push levels; he'd say you can't do that and we'd say don't worry you can. Now he's got the capability and experience to do all kinds of tricks, if he gets the opportunity to work with other musicians.

You seem to be pretty knowledgeable about recording techniques.

LC: We've been using studios for over ten years and have had quite a lot of experience between the two of us. We know our way around most of the tricks of the trade, but we're not technical wizards.

KG: Martin was good in a way because he's basically a musician—his father was Syd Lawrence [the bandleader]—and he's got a great musical ear.

LC: He wasn't just watching the meters. While the two of us were doing the 1000 or so overdubs, we were relying on Martin to not only record it properly, but also listen out for bad takes. An engineer has got to have an excellent ear and have fabulous patience—because he was in on the project he didn't complain. It was like a pioneer spirit for everyone; we were all learning.

KG: It wasn't just a job. He was as much a part as we were.

LC: If you do something for the right reasons, you get the best out of yourself and everyone you're working with. It was the same with Pete [Cook]. He didn't go away and write the script, he came and lived with us and we all worked together on it. We got a lot more out of ourselves in that respect.

Why the move to The Manor? Were you taking up too much of Strawberry's time?

LC: That was it exactly.

KG: And it has an Eastlake control room.

LC: When we made the move and were telling the record company what we wanted, I said I was after an Eastlake room which was our reference. And, if possible, a Helios board because we were all used to working with them; especially for Martin who would have to make the physical change. We also knew what we could get out of a Helios board. Strawberry was ideal for the *Gizmo* recordings—a lot of that was because we had Aengus equalisation there. But for some reason The Manor came into its own for vocals; the presence on vocals is just right. And piano, because they've got the most incredible Bösendorfer Grand. Mind you, it's awful for drums—we had to record them in the billiard room. Strawberry is good for drums.

Apart from the tricks with the faders, how did you achieve such an extraordinary dynamic range on the record?

KG: Melvyn Abrahams at IBC deserves a big pat on the back for the cutting.

LC: He was cutting it all the time we were recording it. As we finished a side he had a practice cut; he'd been doing practice cuts for 15 months until we came together on the last day and did it all. And then Kevin came back and we did it all again!

What do you do next, recording wise?

LC: We haven't a clue, we haven't really thought about it all.

KG: I'd like to go to South America. I don't want to play any instruments, I'd just like to go to a recording studio in South America, dig the atmosphere there and play with those musicians. And maybe try a few experiments with them.

Lol Creme and Kevin Godley, thank you very much.

AES 58th Convention, a report

Ray Carter

The 58th Convention of the Audio Engineering Society was held from November 4 to 7 1977 at the Waldorf-Astoria, New York.

CONGRATULATIONS to everyone who survived the Waldorf Astoria in November, both physically and financially. It even outstripped the Paris convention in terms of inhospitable surroundings—air conditioning appeared to be non-existent, and rip-offs were prolific to the point of pollution. And there's no way that it can be put down to New York because it's not very expensive and the majority of people are perfectly friendly—though in New York they certainly are out to make a faster buck at any given moment.

Considering the conditions, the AES organising committee did an excellent job, and the only legitimate complaint against them appeared to be the venue. Conventions, in the recording industry anyway, are not intended merely for the presentation of equipment and papers; they are also a time for meeting people to discuss anything and everything to do with recording, and this requires congenial surroundings at congenial prices.

This state of affairs was probably exacerbated by the fact that the exhibition was full of physical realisations of so many things discussed and hinted at in the past. Very little was unexpected, and natural development probably describes the exhibition fairly explicitly. But in no way does that imply boring. The sheer reality of ideas had everybody talking: 'Have you seen . . .?' 'What do you think about . . .?' 'Oh yes! We must talk about that after the show.' I've never seen an exhibition continue so solidly 'til the early hours of every morning.

And, whatever else, 3M featured heavily. Digital recording had arrived in conversational force; not because it sounded so much better—that was inevitable—but the price? Until now studios have usually been able to justify (to themselves) thousands of dollars / pounds outlay for a few extra dB of noise reduction/dynamic range or another zero in the distortion figure; but this one could take some

doing. The pair of 3M digital tape machines (32-track on 25.4 mm tape plus 2 or 4-track on 6.35 mm tape) is presently being offered at just under \$150 000—about £80 000—and that's well over twice the price of the best available analogue equivalent. (Actual details of the 3M machines are given in this month's 'News', p24.)

Possibly the greatest problem here is that the recording industry may not be large enough to generate sufficient orders to substantially reduce this price. It is not solely caused by high development costs, it's the components too. They're not particularly expensive, there's just a lot of them and 3M are working hard at reducing the number of integrated circuits—hopefully the extra development costs won't equal the cost savings developed.

The convincing demonstrations of digital recording were not only being given by 3M (in 2-channel prototype format) but also by Soundstream with the 4-channel version of their machine.

By using an existing 25.4 mm tape deck (the demonstration machine was a Honeywell instrumentation deck as used by the US Navy) together with Ampex #60 digital audio tape (or equivalent) they have steered clear of any tape transport problems and concentrated solely on the processor. Once again the claimed figures are outstanding: unmeasurable wow and flutter; non-existent audio print-through; 4-channel price \$50k, 8-channel \$75k. Perhaps Soundstream have got the commercial side in perspective: they are strongly suggesting hire of the equipment as opposed to sale but, of course, they are in no way averse to the prospect of a sale.

Mitsubishi also were exhibiting their pcm tape machine (with equally impressive specifications) together with their pcm cassette tape deck, which uses vtr/vcr technology and video-cassette format. It was perhaps a pity that both these machines were overshadowed (at the show) by their pcm *Laser Disc Player*. This application of pcm technology demands more than a passing comment, since 48 ►

The led display panel of the new Allison 'Great Equaliser'. The complete unit is shown below.

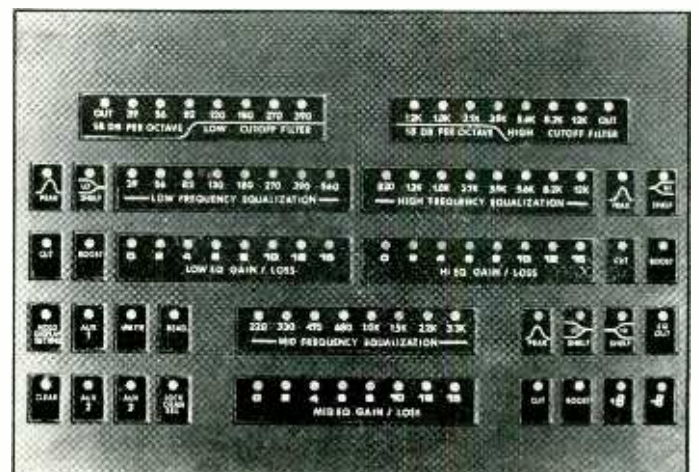
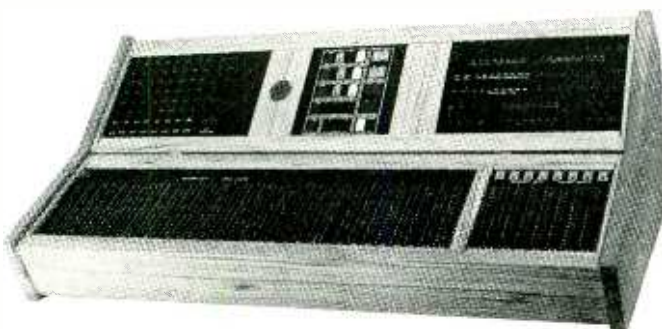

Are you really serious about a new console?



Model Pacifica 28 Input/16 output

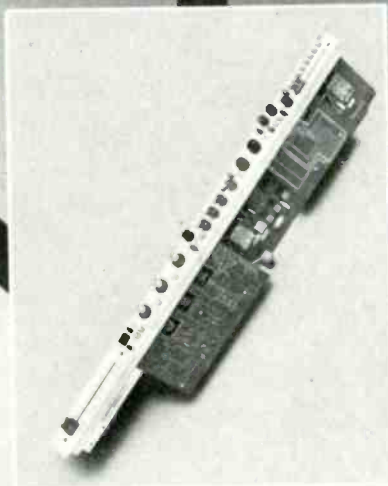

7200M Input/Master Mix Module

We know that buying a large multi-track console is no small decision. For most professionals, it's one of the largest investments you'll make — a decision that you'll have to live with for years.

There are a lot of companies making consoles. Many perform adequately. Others are compromises. Few have all of the features and performance at a reasonable price. So, what are we leading up to? A simple statement of fact that you should consider seriously if you're really interested in an outstanding console system: Quad/Eight has an enviable reputation for quality and reliability. It's something we've worked at for over 10 years. We've also had a reputation for building the industry's most expensive systems too. Now, relax. Our new modular series consoles look expensive. Truth is, they're priced right in the same category as our best competition. In addition to having the best human engineering for operational ease, they're loaded with more features and performance:

- 3 band, 33 overlapping frequency equalization
- Peak Indication common to Mic & Line
- Six auxiliary mixing busses from each input
- Two solo mixes, monitor & positional
- Discrete amplifiers used in the primary signal paths
- High-quality conductive plastic rotary controls
- Penny & Giles Faders
- Color-Coded aluminum knobs
- Individual phantom power switching
- Four fully equalized echo returns
- + 28dBm output level
- Noise: — 129dBm E.I.N.,
I.M. Distortion: 0.1% max.

If you're really serious about a new console and the quality of your work, then do yourself a favor and contact us for full information on a new outstanding line of modular consoles.

*The Coronado, 40 Input/24 Output equipped with Compumix III available in October, 1977.



For the Artist
in Every Engineer

Quad/Eight International
Quad/Eight Electronics

11929 Vose St., No. Hollywood, CA 91605
(213) 764-1516 Telex: 662-446

AES 58th CONVENTION, A REPORT

a quoted >98 dB dynamic range certainly changes many aspects of disc cutting. We will, therefore, have a feature next month on the 'laser sound disc'.

On the analogue front, one item of particular interest wasn't to be found in the exhibition hall. When you see someone walking around with a 76 mm editing block (Xedit, by the way) something is obviously about to happen. Whether it's Hamburg, Los Angeles, London or New York, 1978 will probably see the advent of the long awaited, much discussed 76 mm tape machine. But, once again, what about the price? Well at least it won't be in the (present) digital league. The MCI 76 mm machine (32-track) which is all but rolling out through the doors of Fort Lauderdale, should be priced at around \$42 000 (and under £26 000 in the UK). Particular points of interest are that the machine is smaller than the present range of multitrack machines and it has three switchable speeds: 38.2, 50.8 and 76.2 cm/s (that's 15, 20 and 30 ips for imperialists, like me). MCI are proposing that 51 cm/s is the best speed to use with modern tapes, obviating some of the well known problems of 38 and 76 cm/s. It has also been suggested that due to the 22-23 minutes playing time at 51 cm/s, less tape will be 'wasted' at the end of reels and consequently the extra cost of 76 mm tape should be nullified—but I'm still not fully convinced it will work out that way in practice.

MCI did, however, introduce their *JH-45* synchroniser at the show, so here's to 62-track recording.

In general the 'new' analogue offerings were fairly minimal. Gotham Audio were showing the multitrack *M15A* from Telefunken with c4 noise reduction (we hope to review this machine next month) together with a 1942 Magnetophon *RE2*—the first ac-biased tape machine (a touch of nostalgia for the centenary year).

Aimed at the low-cost multitrack market, MCI introduced their 8-track version of the *JH-110A Series* of machines using a new 25.4 mm tape transport configuration. This machine also has an 'automatic monitor' switching feature which drops-in when the machine goes into the 'record' mode—the monitor switches from the 'cue' mode to the 'input' mode automatically. New 'electronics' are also being used in this version of the *JH-110A Series* as in the new *JH-100A* broadcast tape machine—for example, the playback amp has 20 dB headroom at 30 Hz.

Recording consoles were once again being shown with increasingly comprehensive facilities, but this aspect of desks seems to be reaching a shelving point in the 24-track plus area. Over the past few years there has been a very rapid growth in console facilities—broader eq facilities, more and more channels, automation—and it appears that the large desks have reached a stage where manufacturers are taking a timely stock of the situation. Primarily the goal has been automation and this in itself warrants much user and manufacturer analysis. No doubt as recording and mixing engineers become more conversant with, and consequently more demanding of, their automated set-ups, modifications and expansions will begin to appear; so how long before the 'computers' become as custom-built as the desks? Judging by the speed at which engineers have grasped and exploited automation to date, it won't be very long.

Harrison 864 Auto-Set with data cart memory

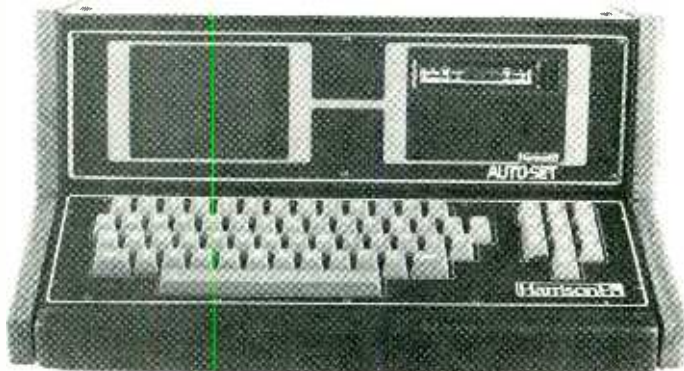

The latest automation system has come from Harrison this time and it certainly offers a different operational approach to the subject. The *864 Auto-Set* has been designed specifically to provide either memorisation of the position of up to 63 console faders, or record on a data cartridge up to 630 separate 'snapshot' mixes or static mix scenes. The latter feature is intended more for live performance and television production where no recorder channels are available for storing data, and enables pre-set microphone/routing arrangements to be changed at the push of a button. But the memory function does not lack in sophistication: up to ten 'situations' (Harrison language for a choice of one of the four mixes on each of 63 channels) can be stereo and then called directly into sequence through the 'jump' command, the 'crossfade advance' or the 'time advance'. In addition, the *Auto-Set* has a built-in crt display to show the status of each channel (and many other things besides). Rather than use a bar histogram format, Harrison have opted to write the actual value in dBs relative to an optimum level. Pretty confusing to read in a hurry, but sufficiently analytical for setting up a mix.

The next logical step in the automation of console function has already been taken by Allison who were demonstrating the concept of *The Great Equaliser*. This effectively patches into a *65K Series* programmer offering automated eq as well as level. With an existing installation the comprehensive eq facilities (low cut, high cut; and variable low, mid and high) would replace those on the console, so Allison will probably find their main market in new installations with a further possibility of oem for console manufacturers. The led display panel (see photo) indicates the eq status of any selected channel, and override is quickly selected by hitting the 'write' button and adjusting as required.



Soundcraft Series III with 16 output groups

Just an idea for those who are the proud owners of Allison programmers: we at STUDIO SOUND have been thinking again and suggest the possibility of having a few automated eq channels to 'patch-in' where needed—let's face it, some instruments can be a real bitch to eq.

On a different tack several companies were making the excursion from the safer waters of 8-track into the stormy seas of the big league.

Soundcraft has now made the jump to 16 outputs with the *Series III* consoles. Two frame sizes are available to accommodate up to either 24 or 32-input channel modules plus the required number of group output modules. Each input channel features a 4-band equalisation section with ± 15 dB peak and dip and continuously variable centre frequency for 14 ranges from 40 Hz to 16 kHz. Three solo modes are offered: channel solo, auxiliary master-send solo, and monitor channel solo. The consoles come



The CPR-16 Computer Programmed Reverberation

The Quad Eight CPR-16 represents a revolutionary breakthrough in the application of advanced computer technology for the professional audio marketplace.

Two years in development, the CPR-16 is the first product to embody advanced digital technology in a configuration which will allow an unprecedented degree of control over the reverberant field by signal processing.

It offers the user a flexibility beyond the now ordinary mechanical methods; every possible aspect of the reverberant field is capable of alteration by the engineer. Reverberation time can be changed from zero to twenty seconds in sixteen steps, even during operation, without signal degradation. High and low frequency damping rates can be controlled over a wide range which previously was only achieved by time-consuming and clumsy rearrangements of complex arrays of absorption plays in live chambers or rooms. The simulation of "room size"

can be modified with a single control which adds a variable delay before the first echo or reflection signal.

And, most importantly, the CPR-16 allows the prominence and density of resonant modes to be altered. Thus, the density and diffusion rate of echoes can be tailored to match any room, electromechanical device, or whim.

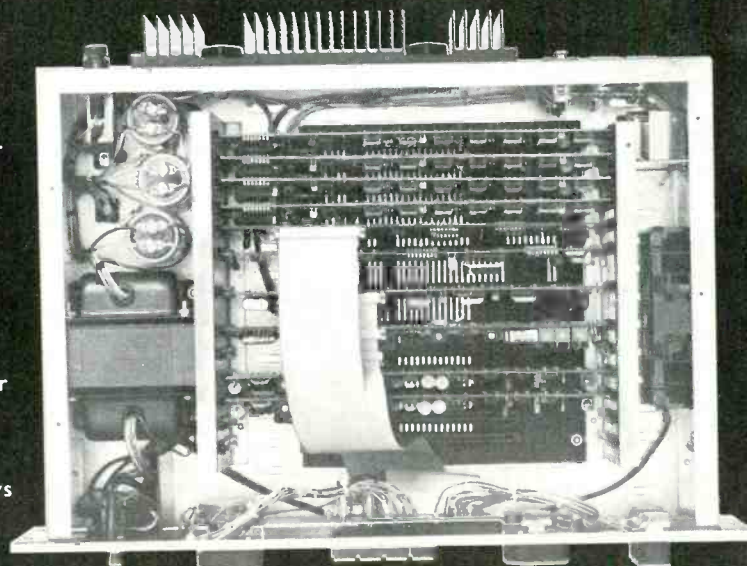

The CPR contains two individual reverb programs and one "open" program provision for future custom sound processing effects. Program 1 is analogous to a live acoustical chamber, and Program 2 creates a simulation of an artificial plate. Program 3 switching facility is pre-wired for a plug-in programming module and Program 4,

ECHO allows a "Tape-Echo" simulation that is unobtainable by present mechanical methods.

The CPR-16 incorporates control over every critical aspect of the reverberant field. If you have a special application which requires a previously unavailable sound processing effect, information on custom programs is available from the factory.

Write us or call for a detailed brochure on the revolutionary CPR-16. The age of affordable digital processing for audio has arrived. If you've been waiting for technology to catch up with your imagination, your time has come.



Quad/Eight Electronics • Quad/Eight International 11929 Vose St., No. Hollywood, Ca. 91605 • (213) 764-1516 • Telex: 662-446

AES 58th CONVENTION, A REPORT

complete with 20-segment led metering, switchable to vu or peak ballistics, and with a reading range of 32 dB (-16 to +16 dBm); if you want 'ordinary' vus (how quickly fashions change—a few years ago they would have been offered as standard) they are available as an option. Prices for the 'everything included' 24/16 package are \$22.5k (fob NY) or £10.5k—value for money by anybody's standard.

An interesting modular concept was introduced by Sound Workshop with their new *Series 1600* console. This is available in several mainframe sizes from up to 12-in/8-out to a maximum configuration of 36-in/32-out. The standard modular concept has been extended in the *1600* to take in the rear sockets of the channel, such that no low-level lines have to be routed via an edge connector. The various sections of the module, such as input, output and eq, have been built on separate pcbs 'to make for easier servicing'.

The modular approach has also been extended to the patchbay.

Below: the new Iv'e IE30A $\frac{1}{3}$ -octave analyser (more details next month).

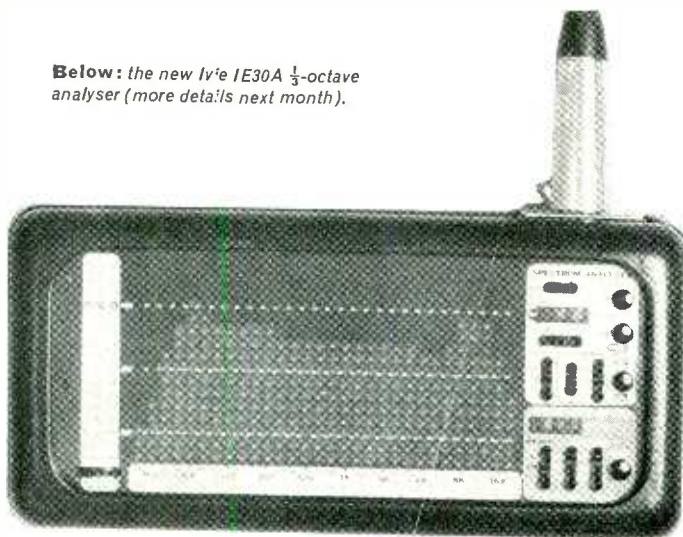

Right: Trident stereo limiter-compressor.

Below: Teac 1618 desk.

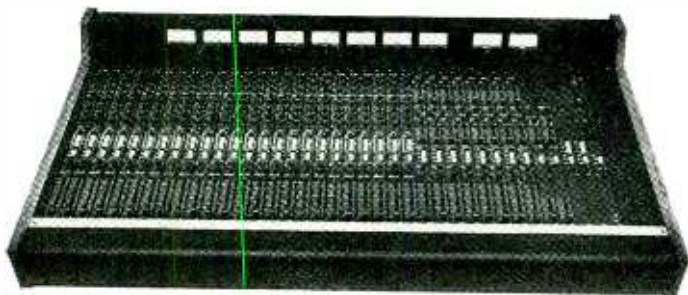

Instead of being wired directly, the jacks for each input/output module are mounted on a vertical pcb. All the wiring associated with a given channel is contained in a separate harness that plugs into both the module and the patchbay card via edge connectors. Thus initial studio wiring is simplified to a large extent, and a complete patch bay can be easily added after the initial installation. The company also plans to introduce four other new goodies in the near future: a vca grouping package using dbx units that will plug into the input modules without the need to replace the faders; a

plug-in 3-band parametric eq module with sweepable frequency range (20:1), 3-position bandwidth (Q) control, as well as shelving on low and high bands; a microprocessor-based system providing level and muting automation that will interface directly with the vca modules; and a spectrum analyser to convert the led column

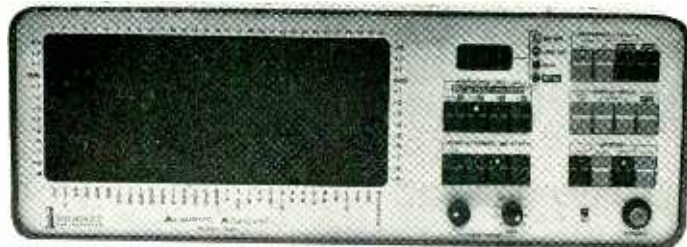

Inovonics Model 500 $\frac{1}{3}$ -octave analyser (More details next month)

indicators to a 16-band unit which will follow the control room monitor selector and analyse left, right or sum.

In the 'special effects' department, Eventide were demonstrating their new *S1006* digital delay line which employs a hardware multiplier and read-only memory to provide, in effect, no less than 16 outputs. But the company is quick to point out that these outputs are not independently variable or accessible—otherwise the machine would be rather pricey and a trifle unwieldy. Instead, 16 variable delay, amplitude and phase settings are stored in roms for each of the 32 user or remotely-selected programs, and these signals are split between two actual outputs in various combinations. Thus a stereo signal is available from the monaural input. The unit is so new that, as Eventide quaintly puts it, no 'catchy name' has been given to it yet. The price is expected to be virtually identical to that of the *Harmonizer*—they weigh almost the same and are in the same chassis.

Ever thought of putting voltage-controlled attenuators onto your quad panpots? Well, Asgard have beaten you to it with their new *Model 440* automatic panning system. The start and finish position—front, back, left and right—of the input signals, plus the rate and direction as it passes between them, can be preset on front-panel controls. To allow the operator to follow the progress of the panned



signal in its voyages, a built-in 25 x 25 cm crt display is provided. If that isn't enough, the unit also sports one of the butchest-looking trade marks you are likely to come across: a truly hunky viking warrior straight out of mythology (Thor and Asgard; get it?).

Turning to test gear, ADI had on show their new *type 1003* $\frac{1}{3}$ -octave spectrum analyser, features include 31 digital non-recursive filters on standard ISO frequency centres; three digital averaging times; eight independent digital cmos rams; digital peak accumulation in each channel; 8 x 7 cm crt readout; 3-digit channel identification and frequency readout; random pink noise generator; and mic, line and A-weighted inputs. ADI was not slow to point out that the *1003's* price tag of \$4450 compares very favourably with the \$18k one would need for the only other digital analyser on the market. And, what's more, their unit has eight storage memories against the three provided by its more expensive competitor. The company also has an active equaliser to match, the *type 1503*—details will be given in next month's survey.

Presently the recording industry is moving at quite a rate, and I would thoroughly urge anyone who possibly can to make the effort of attending AES exhibitions, even if only for a day. And next month we will carry a News page devoted to some of those items new at the show that we don't have space to mention here. ■

CONSOLE AUTOMATION

22 FACTS

FROM



There is a lot of talk and lots of promises. There are many delays and a lot of confusion. And there are facts, undisputed cold facts. Twenty-two of these facts from MCI are at:

Conny Studios, Cologne, Germany • Star Studio, Hamburg, Germany • Arco Studio, Munich, Germany • Metronome Studios, Copenhagen, Denmark • Studio Katy, Brussels, Belgium • Otta Studios, Berre-Les-Alpes, France • CBS Studios, London, England • KMH Studios, Stockholm, Sweden • American Zoetrope, San Francisco, U.S.A. • Criteria Recording, Miami, U.S.A. (two systems) • Master Sound, Atlanta, Georgia, U.S.A. • Sound 80, Minneapolis, Minnesota, U.S.A. • National Recorders, New York, U.S.A. • Radio Televizija Beograd, Belgrade, Yugoslavia • Quadrophonic, Nashville, Tennessee, U.S.A. • Audio Industries, Los Angeles, California, U.S.A. • Klarion, Melbourne, Australia • DJM Studios, London, England. (two systems) • Triad Recording, Fort Lauderdale, Florida, U.S.A. • The Mill, Cookham, Berkshire, England •

The eight-month track record listed above clearly states that MCI's JH-50 Automation system is a reality, not a promise. Simplicity. Ergonomics. Reliability . . . No talk. No empty promises. No delays. No confusion. Delivery any time. Are you ready? MCI is.



The Art of the States

MCI (PROFESSIONAL STUDIO EQUIPMENT) LTD

MCI House, 54-56 Stanhope Street,

London, NW1 3EX Tel: 01-388 7867/8 Fax: 01-261 1111

AMITY S PROFESSIONAL A

All U.K.
From over 90%

N.A.B. CARTRIDGE EQUIPMENT

Exceeds all NAB and IBA performance Standards



In regular
use at:

BBC Radio, BBC Television
John Wood Studios, Leeward Sound
and many others

Please send me further details of the Amity
Shroeder range of cartridge equipment:

Name

Company

Address

.....

.....

Broadcast standard and reliability now
in use by the major radio and t.v.
companies in Great Britain. Designed and
built in the U.K. from the finest
components available. Send in the
coupon for further details or ring
us for a demonstration.

AMITY SHROEDER LTD

SHROEDER AUDIO PRODUCTS

Manufacture
U.K. Components

ALL D.C. SERVO 25.4/50.8mm TAPE TRANSPORTS

Assembled on machined flat aluminium casting

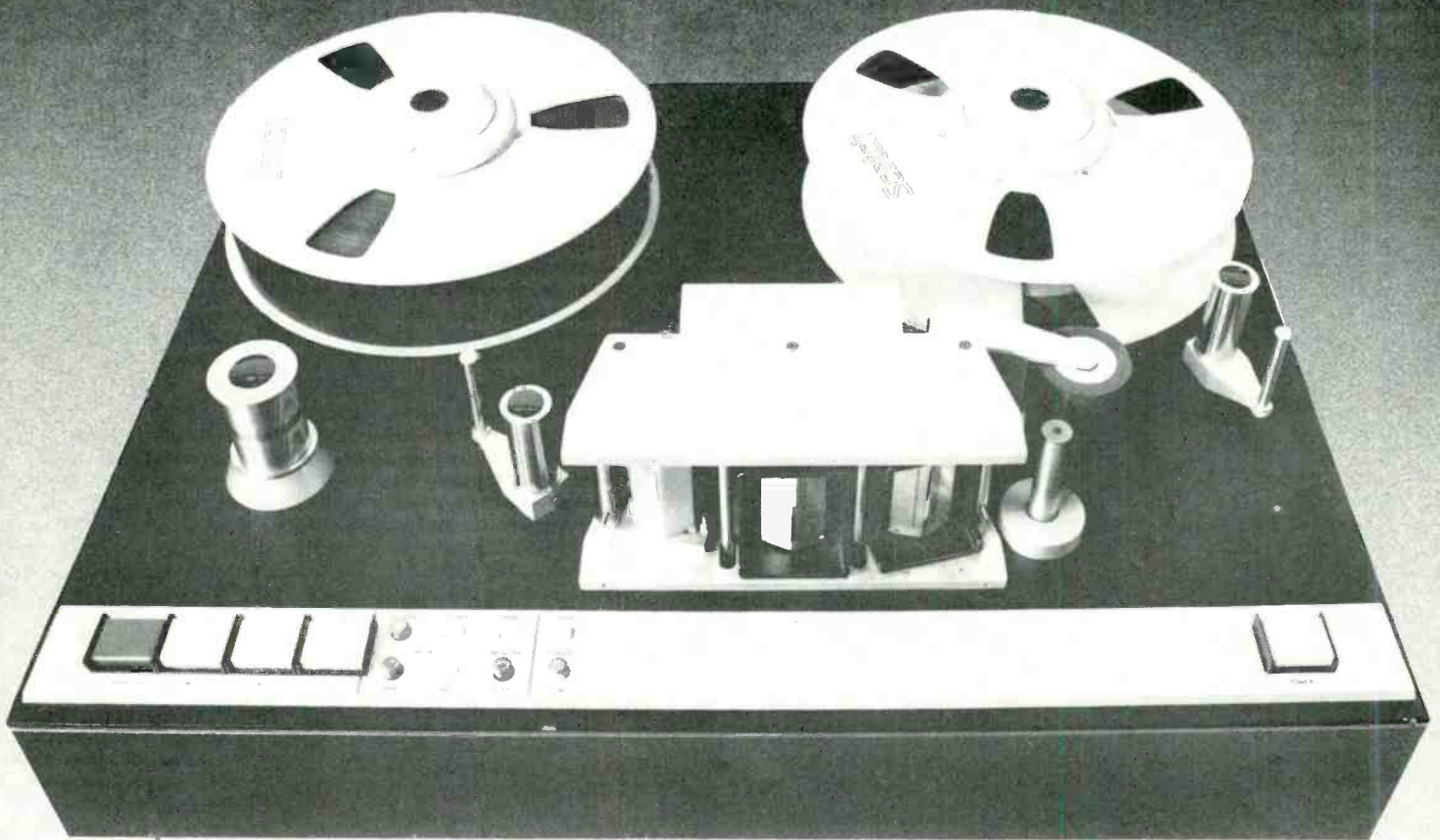

Fast becoming the standard transport both at home and overseas

Wide tape transports available to companies wishing to build their own multitrack audio recorder. All D.C. Servo spool motors, phase locked D.C. Servo Capstan, and motion sensing IC logic control system provide superb tape handling and performance. Send in coupon or ring us for further details

3/4 NEW COMPTON STREET, W.C.2
01-836 7811

TELEX : LONDON 23197

Please send me further details of Amity Shroeder wide tape transports:

Name

Company

Address

.....

.....

Survey: multitrack tape machines

Forthcoming surveys include studio designers and consultants (March), cartridge machines and turntables (April) and noise reduction (May). Information from manufacturers for inclusion should reach the editorial offices (address p3) not later than six weeks before the issue publication date (preferably a lot earlier).

ABE

ABE Apparatebau und Elektronik, Becker GmbH & Co, Kommanditgesellschaft, D-7750 Konstanz, Otto-Raggenbass-Str 5, West Germany.
Phone: (07531) 21536.

MTR SERIES

Tracks/speeds: 8 on 25.4 mm, or 16, 24 or 32 on 50.8 mm; 19 and 38 cm/s.

Frequency response: ± 1.5 dB, 30-18k Hz at 38 cm/s.

Noise: ≤ 52 dB, unweighted, at 38 cm/s for 24-track.

Wow and flutter: $\leq \pm 0.05\%$, DIN-weighted, at 38 cm/s.

Features: logic control with motion sensing; +30 to -50% varispeed; CCIR or NAB equalisation; full selsync; Dolby noise reduction option.

Price: on application.

Ampex
MM-1200



ACCURATE SOUND

Accurate Sound Corporation, 114 5th Avenue, Redwood City, Ca 94063, USA.
Phone: (415) 365 2843. Telex: 348327.

MODEL 2600 TRANSPORT

Tracks/speeds: 8 on 12.7 or 25.4 mm (or 50.8 mm on special order); 9.5/19 or 19/38 cm/s, or all three.

Features: see last month's survey, p40.

Price: \$1425 plus \$1.8k for head assembly.

AMITY SHROEDER

Amity Shroeder, 3 & 4 New Compton Street, London WC2H 8DD, UK.
Phone: (01) 836 7811 and 240 3159. Telex: 21359.

WIDE TAPE TRANSPORT

Tracks/speeds: 8, 16 or 24 (depending on heads) on 25.4 or 50.8 mm (rapid conversion); 38 and 76 cm/s.

Wow and flutter: $\leq 0.05\%$, DIN 45507 weighting.

Features: transport only, assembled on aluminium casting; power supplies housed separately; full logic interlock with motion sensing.

Price: £2890 without heads; conversion kit for alternative tape width £275.

AMPEX

Ampex Corporation, 401 Broadway, Redwood City, Ca 94063, USA.
Phone: (415) 367 4151.

UK: Ampex GB Ltd, 72 Berkeley Avenue, Reading RG1 6HZ.

Phone: Reading (0734) 55341. Telex: 847611.

Agents in most countries.

AG440C

Tracks/speeds: 8 on 25.4 mm; 9.5, 19, 38 and 76 cm/s in any combination.

Features: see last month's survey, p40.

MM1200

Tracks/speeds: 8 on 25.4 mm, or 16 or 24 on 50.8 mm; 19/38 or 38/76 cm/s.

Frequency response: ± 2 dB, 50-18k Hz, 'overall' in sync and record modes.

Noise: 64 dB for 8 and 16-track; 59 dB for 24-track (ref peak record level to unweighted noise) using 456 tape at all speeds.

Wow and flutter: 0.04% peak, ANSI-weighted (DIN 45507).

Features: full logic control with motion sensing;

dc (phase-lock servo) direct-drive capstan; comprehensive record ready/safe and input/sync/repro selection and led indicators for each track (plus master and standby monitor controls); electronic minutes and seconds counter plus 'search-to-cue' facility with accuracy of $\pm 0.5s$ at 38 cm/s; local or remote mounting of control module; plug-in head block with automatic tape tension correction for 25.4 or 50.8 mm tape width; removable vu meter panel for ease of maintenance. Optional extras include PURC (pick-up recording capability accessory) for 'clean, precise insert edits'; variable speed oscillator for -50 to +150% varispeed; plus EECO time-code synchroniser and other video-orientated accessories.

Price: on application.



Brenell Mini 8

BRENELL

Allen and Heath/Brenell Ltd, Pembroke House, Campsbourne Road, Hornsey, London N8, UK.
Phone: (01) 340 3291. Telex: 267727.

US: Audiotechniques Inc, 142 Hamilton Avenue, Stamford, Conn 06902.

Phone: (203) 359 2312. Telex: 996419.

Agents in most countries.

MINI 8

Tracks/speeds: 8 on 25.4 mm; 19 and 38 cm/s.

Frequency response: ± 2 dB, 30-20k Hz.

Noise: -60 dB, unweighted, ref 0 dB vu.

Wow and flutter: $\pm 0.05\%$, DIN-weighted. 56 ►

THE GREATEST LITTLE 8 TRACK IN THE WORLD

THE NEW FULL LOGIC BRENELL MINI 8



The first one inch tape recorder to bring true professional standards within the grasp of the smaller budget conscious studio.

For further information and a full colour brochure contact Andrew Stirling or Andy Munro at:

**Allen and Heath/Brenell Limited, Pembroke House, Campsbourne Road,
Hornsey, London, N.8. Tel: 01-340 3291 Telex: 267727 BATGRP G**

SURVEY: MULTITRACK TAPE MACHINES

Features: full logic interlock with touch-sensitive switches and motion sensing; remote control incorporating digital readout counter and individual record/standby channel status; self-centering hubs to reduce mechanical vibration; horizontal or vertical operation.

Price: £3696.

CADEY

S C Wadey, 59 Yantlet Drive, Strood, Kent, UK.
Phone: Medway (0634) 76117.

MULTITRACK

Tracks/speeds: 8 or 16 on 25.4 mm, or 16 or 24 on 50.8 mm; 38 cm/s.

Frequency response: ±2 dB, 30-18k Hz.

Noise: -60 dB, unweighted, on *Scotch 206*.

Wow and flutter: ≤0.1% ('end of reel included').

Features: full logic interlock but no motion sensing; 2-head configuration—erase plus record/replay/sync head; comprehensive remote control, incorporating deck commands and record safe/ready and playback on single pushbutton for each track; valve bias and erase oscillators; teak console construction (not floor standing).

Price: 8-track on 25.4 mm £1.5k; 16-track on 25.4 mm £2.2k; 16-track on 50.8 mm £2.8k; 24-track on 50.8 mm £3.6k.



Cadey 8-track

ITAM

Industrial Tape Applications Ltd, 1-7 Harewood Avenue, Marylebone Road, London NW1, UK.
Phone: (01) 724 2497. Telex: 21879.
France: Son Professionnel, 29/31 Avenue Andre Morizet, Boulogne, Paris 92100.
Phone: 605 3363.

805

Tracks/speeds: 8 on 12.7 mm; 38 cm/s.

Frequency response: ±3 dB, 40-22k Hz via tape; ±3 dB, 70-17k Hz for sync mode.

Noise: 65 dB, weighted, ref 900 nWb/m.

Wow and flutter: 0.06%, 'record/replay'.

Features: relay-solenoid logic (based on Studer/Revox transport); servo-controlled capstan with 100% varispeed; modular plug-in electronics; facility for switching Dolby A and dbx noise reduction; line in/out plus headphone output per channel; full selsync on all channels; available in console or table-top versions.

Price: £1890; optional 8-channel dbx noise reduction unit £630.

Models 810 and 1610, 8 and 16-track machines running on 25.4 mm tape, are to be announced in



Itam 805

the near future. The new machines will feature dynamic braking, motion sensing, full logic control and servo speed control.

LYREC

Lyrec Manufacturing A/S, Hollandsvej 12, DK-2800 Lyngby, Denmark.
Phone: (02) 876322.

TR532

Tracks/speeds: 8 on 25.4, or 16 or 24 on 50.8 mm; 38/76 cm/s.

Frequency response: ±1 dB, 60-18k Hz at 76 cm/s for record/repro.

Noise: between 58 dB for 24-track and 62 dB for 16-track; both rms unweighted values at 76 cm/s.

Wow and flutter: ≤0.04%, peak weighted.

Features: full logic control with motion sensing; dc-servo direct-drive capstan; comprehensive remote control unit incorporating ready/safe/sole and sync/repro/line controls for each channel, tape motion selection, digital timer with reset, search-to-cue and 19-152 cm/s varispeed; full selsync plus 'aux sync' on all tracks; servo-controlled winding tape tension with adjustable winding speed limit; swivel-mounted transport; interchangeable head-blocks. Optional tape position controller has 'search/load-to-position' facilities for store and recall of starting-points of up to 16 different takes.
Price: 8-track \$19.9k; 16-track \$26.3k; 24-track \$32.9k; tape position controller \$2.4k. (All prices fob Copenhagen.)

Lyrec TR532

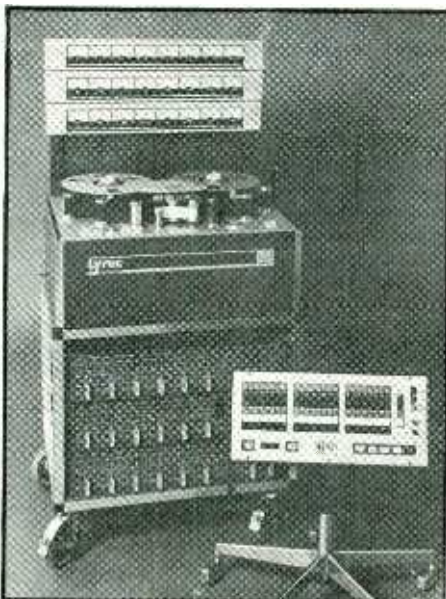

MCI

MCI Inc, 4007 NE 6th Avenue, Fort Lauderdale, Florida 33308, USA.

Phone: (305) 566 2853. Telex: 514362.

UK: MCI (Professional Studio Equipment) Ltd, MCI House, 54-56 Stanhope Street, London NW1 3EX.
Phone: (01) 388 7867. Telex: 261116.

Agents in most countries.

JH-16 SERIES

Tracks/speeds: 8 on 25.4 mm, or 16 or 24 on 50.8 mm; 38 or 76 cm/s.

Frequency response: ±2 dB, 30-16k Hz in reproduce; ±3 dB, 30-16k Hz in 'cue' mode; both at 38 or 76 cm/s.

Noise: 64 dB in reproduce; 60 dB in 'cue' mode; both below +4 dBm output, unweighted.

Wow and flutter: <0.05% peak, DIN-weighted, at 38 or 76 cm/s.

Features: full logic control with motion sensing; phase-locked capstan and dc servo-controlled reel motors; quick-change heads; ±20% varispeed plus interface for external voltage control; comprehensive remote control. *Autolocator 11*, available as an option, has search-to-cue facilities, master status push buttons to select tape/input/overdub for each track, plus transport controls.

STOP PRESS: MCI has announced an 8-track *JH-110A Series* machine using 25.4 mm tape (see last month's issue, p42).

MCI JH-114

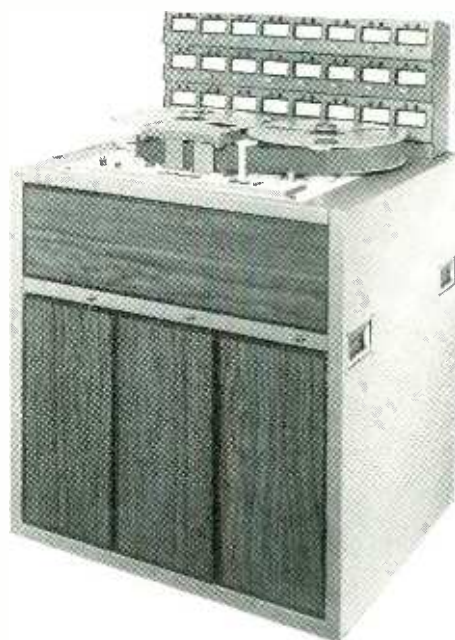

3M

3M Company, Building 224 BW, 3M Centre, Saint Paul, Minn 55101, USA.

Phone: (612) 733 1110. Telex: 297434.

UK: 3M UK Ltd, 3M House, PO Box 1, Bracknell, Berks RG12 1JU.

Phone: Bracknell (0344) 26726.

Agents in most countries.

M79

Tracks/speeds: 8 on 25.4 mm, or 16 or 24 on 50.8 mm; 19/38 or 38/76 cm/s.

Features: see last month's survey, p42.

Price: on application.

DIGITAL RECORDING SYSTEM

The BBC and 3M are collaborating in the development of a digital recording system, which comprises a 32-track machine using 25.4 mm tape and a 2 or 4-track mastering machine. Further details are to be found in a News item, p24.

58 ▶

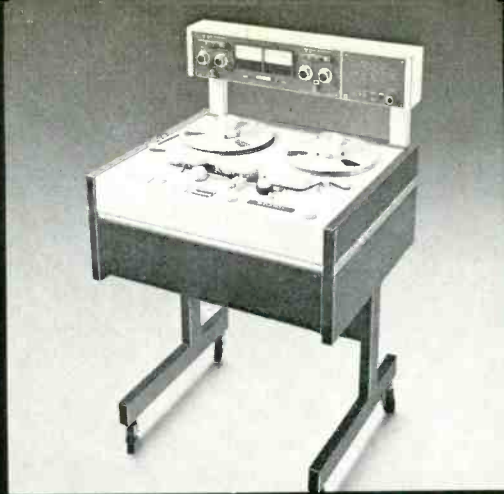

STUDER A80/RC
Professional Tape Recorder
Choice of leading music studios, radio and
TV stations, worldwide.

Performance — we guarantee it...

tomorrow's generation with features you requested,
available today



STUDER INTERNATIONAL AG

CH-8105 Regensdorf, Phone (01) 840 29 60, Telex 58489

STUDER REVOX AMERICA INC., Nashville, Phone (615) 329-9576, Telex 55-4453

STUDER REVOX CANADA LTD., Toronto, Phone (416) 423-2831, Telex 06-23310

STUDER FRANCE S. à r.l., Paris, Phone 533 58 58, Telex 24-744

F.W.O. BAUCH LTD., Boreham Wood, U.K., Phone (01) 953-0091, Telex 27502

www.americanradiohistory.com

SURVEY: MULTITRACK TAPE MACHINES



3M M79

OTARI

Otari Electric Co Ltd, 4-29-18 Minami Ogikubo, Siginami-ku, Tokyo 167, Japan.

Phone: (03) 333 9631. Telex: 26604.

UK: C E Hammond & Co Ltd, 105/109 Oyster Lane, Byfleet, Surrey KT14 7LA.

Phone: Byfleet 51051. Telex: 26525.

US: Otari Corporation, 981 Industrial Road, San Carlos, Ca 94070.

Phone: (415) 593 1648. Telex: 3764890.

MX-5050-8

Tracks/speeds: 8 on 12.7 mm; 19 and 38 cm/s.

Features: similar to MX-5050-QX 4-track machine described in last month's issue, p44.

Price: £3038.

MX-7308

Tracks/speeds: 8 on 25.4 mm; 19/38 or 38/76 cm/s.

Frequency response: ± 2 dB, 30-20k Hz at 76 cm/s; ± 2 dB, 30-18k Hz at 38 cm/s.

Noise: ≤ 65 dB for repro; ≤ 53 dB for sync mode; ANSI A-weighting.

Wow and flutter: $\leq 0.04\%$, peak-weighted to ANSI S4.3, at 76 cm/s.

Features: full logic control with motion sensing; synchronous servo-controlled or direct-drive capstan; full selsync on all channels; head lifter defeat for cueing; plug-in heads; available in console or chassis versions.

Price: £5355.

SCULLY

Audio/Electronics Division of Dictaphone Corporation, 475 Ellis Street, Mountain View, Ca 94043, USA.

Phone: (415) 968 8389. Telex: 345524.

UK: Lee Engineering, Napier House, Bridge Street, Walton-on-Thames, Surrey KT12 1AP.

Phone: Walton-on-Thames 43124. Telex: 928475.

284B-8

Tracks/speeds: 8 on 25.4 mm; 9.5/19 or 19/38 cm/s with ac capstan, or 9.5/19 or 19/38 or 38/76 cm/s with dc-servo capstan drive.

Features: similar to 280B Series machines described in last month's survey, p44.

Otari MX-7308



Scully 284B-8

SOUNDSTREAM

Soundstream Inc, 375 Chipeta Way, Salt Lake City, Utah 84108, USA.

Phone: (801) 583 5711.

DIGITAL RECORDING SYSTEM

Tracks/speeds: 8 or 16 on 25.4 mm; 76 cm/s.

Features: see last month's survey, p46 (± 1.5 dB, dc to 17k Hz frequency response; -85 dB unweighted noise; 'zero' wow and flutter; 90 dB dynamic range; im distortion less than -80 dB; crosstalk better than -85 dB; noise reduction 'unnecessary').

STEPHENS

Stephens Electronics Inc, 3513 Pacific Avenue, Burbank, Ca 91505, USA.

Phone: (213) 842 5116.

CAPSTANLESS MULTITRACK

Tracks/speeds: 8 on 25.4 mm, or 16, 24, 32 or 40 on 50.8 mm; 38/76 cm/s, plus 128 cm/s 'scan'.

Noise: 69 dB for 8 and 16-track; 66 dB for 24-track; 65 dB for 32 and 40-track at 76 cm/s. (74, 71 and 70 dB respectively for tape 'stopped'.)

Wow and flutter: 0.045% for 8-track; 0.02% for other formats; both at 76 cm/s.

Features: full logic control with motion sensing; capstanless tape transport system utilising servo-operated supply and take-up motors coupled with motion sensing; integral vso system provides 25-203 cm/s varispeed; reels may be of differing sizes (and may be interchanged) because self-adjusting electronics 'guarantees proper tape tension'; optional self-contained 12V battery pack providing over four hours of recording time; sync lock for vertical sync pulse or 60 Hz on tape; various remote control units and Q11 autolocator containing 10 memory locations available as extras. Standard deck is mounted in a custom-built wooden cabinet Model 811D electronics features separate rotary channel-select switches for record/ready/sync

10 OUTLET DISTRIBUTION AMPLIFIER 2



One floating input, 10 floating outputs at 600 ohms for general studio work or feeding multiple slave pa amplifiers. Electronic input circuit which withstands mains or static voltages on the signal lines.

DISTORTION, all outputs loaded, at +16dBV.7.

1KHz —80dB, 0.01%

60Hz—20KHz —66dB, 0.05%

INTERMODULATION DISTORTION 50Hz + 7KHz, 4:1

Output +12dBV.7. —86dB, 0.005%

The unit meets the IBA 'signal path' specifications and is available as a complete unit or as a set of all parts excluding the case and XLR connectors.

STEREO DISC AMPLIFIER 2

SUPERLATIVE PERFORMANCE FOR BROADCASTING, DISC MONITORING AND TRANSFER. November, page 98

SURREY ELECTRONICS

The Forge, Lucks Green, Cranleigh, Surrey GU6 7BG
Telephone STD 04866 5997

NEAL FERROGRAPH

SIMONSIDE WORKS . SOUTH SHIELDS
Tyne & Wear NE34 9NX . England
Telephone . South Shields (0632) 566321
Telex: 537227 . Telegrams BRITFERRO South Shields

Dear Sirs,

We are proud to present the pick of our newly
combined product range

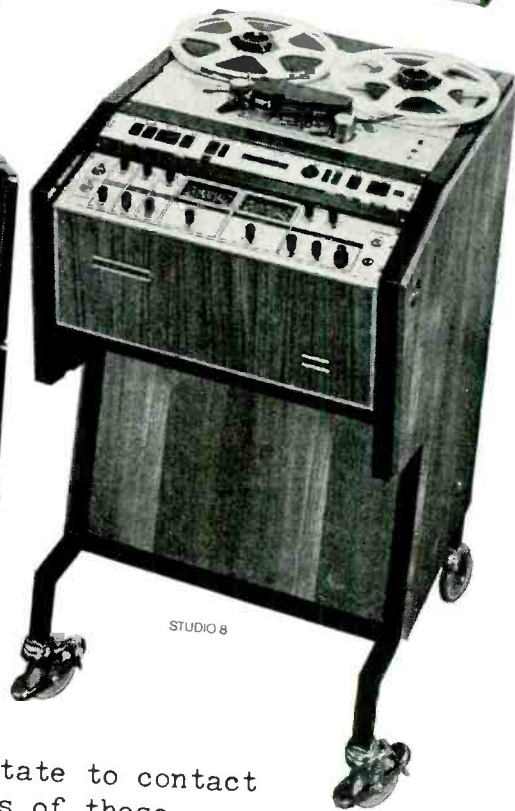
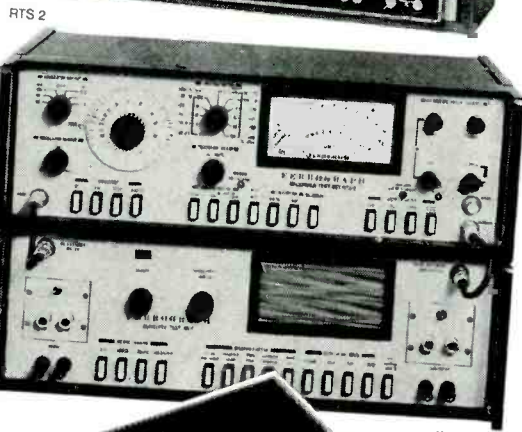
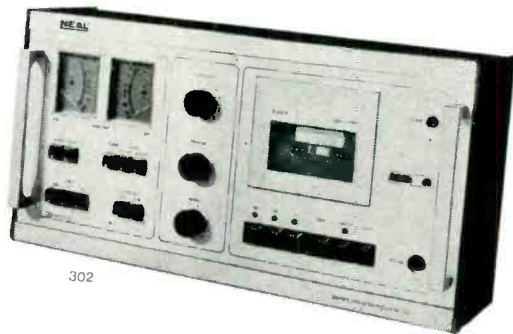

103

Please do not hesitate to contact
us for full details of these,
and other exciting examples of our expertise.

Yours faithfully,

SURVEY: MULTITRACK TAPE MACHINES

selection; model 821A is a multiplex system with one rotary switch and separate channel led indicators.

Price: \$15.4k or £9.6k for 8-track; \$22.4k or £12.6k for 16-track; \$28.4k or £15.5k for 24-track; \$38.8k or £21.8k for 32-track; \$46.2k or £26.0k for 40-track. Remote control units about \$2k; Q11 autolocator from \$3.3k or £5.8k.



Stephens capstanless multitrack machine

Studer A80/vu in its more unusual 'broad beam' 24-track chassis

STUDER

Willi Studer, Althardstrasse 150, CH-8105, Regensdorf, Zurich, Switzerland.
Phone: (01) 840 2950. Telex: 58489.
UK: FWO Bauch Ltd, 49 Theobald Street, Borehamwood, Herts WD6 4RZ.
Phone: (01) 953 0091. Telex: 27502.
US: Studer Revox America Inc, 1819 Broadway, Nashville, Tenn 37203.
Phone: (615) 329 9576. Telex: 554453.
 Agents in most countries.

A80/VU Mk II

Tracks/speeds: 8 on 25.4 mm, or 16 or 24 on 30.8 mm; 9.5/19 or 19/38 or 38/76 cm/s.
Frequency response: ± 1 dB, 60-18k Hz via tape; ± 2 dB, 60-12k Hz in sync mode; both at 76 cm/s for 16-track.
Noise: 62 dB, NAB-weighted, for up to 16-track record/repro at 38 and 76 cm/s; 57 dB for 24-track under same conditions.
Wow and flutter: $\leq 0.04\%$, DIN-weighted, at 38 and 76 cm/s.
Features: similar to A80/RC described in last month's survey, p46. In addition, pre-wired for autolocator, comprehensive remote control and varispeed; full selsync on all channels; variable spooling in 'edit' mode; amplifier functions may be remote-controlled; pivoting transport; available in metal or teak consoles, or transport plus electronics module. TLS 2000 tape lock system can be used to synchronise two machines to an accuracy of ± 100 μ s, with a lock-up time of about 3s.
Price: on application.

TEAC

TEAC Corporation, 3-7-3 Naka-cho, Musashi, Tokyo 183, Japan.
Phone: (0422) 531111. Telex: 2822551.
UK: Teledyne Acoustic Research, High Street Houghton Regis, Dunstable, Beds LU5 5QJ.
Phone: Dunstable (0582) 603151. Telex: 825467.
US: TEAC Corporation of America, 7733 Telegraph Road, Montebello, Ca 90640.
Phone: (213) 726 0303. Telex: 677014.

TASCAM SERIES 80-8

See review in last month's issue, p58.
Tracks/speeds: 8 on 12.7 mm; 38 cm/s.
Frequency response: ± 3 dB, 40-18k Hz in sync mode, overall, including 'contour effects'.
Noise: 65 dB weighted; 60 dB unweighted (ref 3% thd 10 dB above 0 vu at 400 Hz); an extra 30 dB of noise reduction possible with optional DX-8 dbx unit.
Wow and flutter: 0.04% rms, NAB-weighted; 0.06% peak, ANSI-weighted.
Features: full logic control with motion sensing; -10 dB (0.3V) line in/out configuration (for interface with Tascam Series mixers, but adjustable ± 8 or ± 10 dB); optional remote control and DX-8 dbx noise reduction unit (the latter automatically selects encode or decode function in sympathy with record/sync/replay modes of 80-8); full selsync; digital tape counter with memory ('stop at zero'); cue facility in fast wind; overload leds on each channel; vertical or horizontal operation.
Price: £2204; DX-8 dbx unit £767.

TASCAM SERIES 90-16

Tracks/speeds: 16 on 25.4 mm; 38 cm/s.
Frequency response: ± 3 dB, 40-18k Hz, overall in sync mode.
Noise: 65 dB weighted; 60 dB unweighted (ref 3% thd 10 dB above 0 vu at 400 Hz); an extra 30 dB of noise reduction possible with optional dbx unit.
Wow and flutter: 0.03% rms, NAB-weighted; $\pm 0.04\%$ peak, ANSI-weighted.
Features: full logic control with motion sensing; -10 dB (0.3V) line in/out configuration; ac servo-

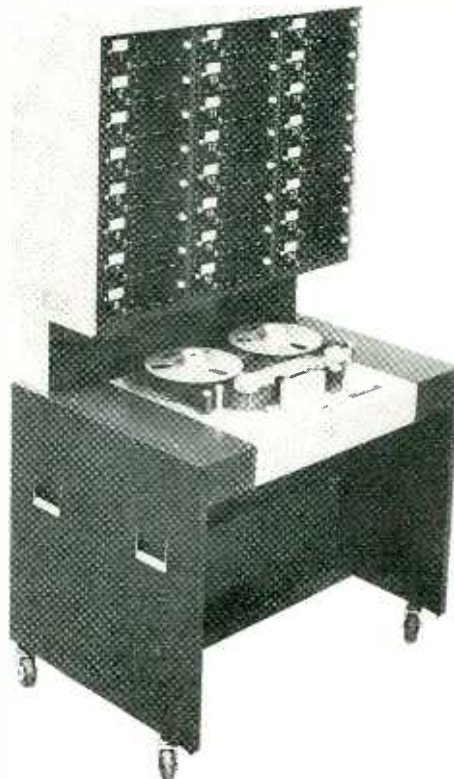

Telefunken M15A with drawers holding rec/repro amps and space for 24 channels of Telcom c4 noise reduction

controlled direct-drive capstan; remote control and $\pm 30\%$ varispeed options; full selsync on all tracks; 'output select' and 'function select' panels may be removed from machine and located on console; integral dbx interface available as option for subsequent addition of pcbs (which will automatically select encode/decode in sympathy with function mode); two led indicators per channel—green led triggers at -10 dB vu and red at $+10$ dB vu; minutes/second counter and 'return-to-zero'; reel height adjustment; cue button to defeat tape lifters; hinged transport.
Price: on application.

TELEFUNKEN

AEG-Telefunken, Postfach 2154, D-7750 Konstanz, West Germany.
Phone: 862460. Telex: 733233.
UK: Hayden Laboratories Ltd, Hayden House, Churchfield Road, Chalfont St Peter, Bucks SL9 9EW.
Phone: Gerrards Cross 88447. Telex: 849469.
US: Gotham Audio Corporation, 741 Washington Street, New York, NY 10014.
Phone: (212) 741 7411. Telex: 236779.

M15A

Tracks/speeds: 8 on 25.4 mm, or 16, 24 or 32 on 50.8 mm; 19/38 or 38/76 cm/s.
Features: see last month's survey, p50. In addition multitrack machines have an optional separate sync output, and can accommodate up to 24 channels of Telcom c4 noise reduction.
Price: 8-track £10.6k; 16-track £16.0k; 24-track £22.2k; 32-track £29.1k.

agony

A certain London-based, all-news independent local radio station recently mounted an outside broadcast from the 'Motor Fair'. As the presenter was leaving the studio a little man in a raincoat came up to her.

'Just wanted you to know, luv,' he said, 'that my boss is a big fan of yours. When I'm driving him around he always makes me turn up the car radio when you're on.'

The presenter blushed prettily and enquired who he worked for.

'Jim Callaghan,' he replied.

PROLINE 2000TC

You now have to choose...

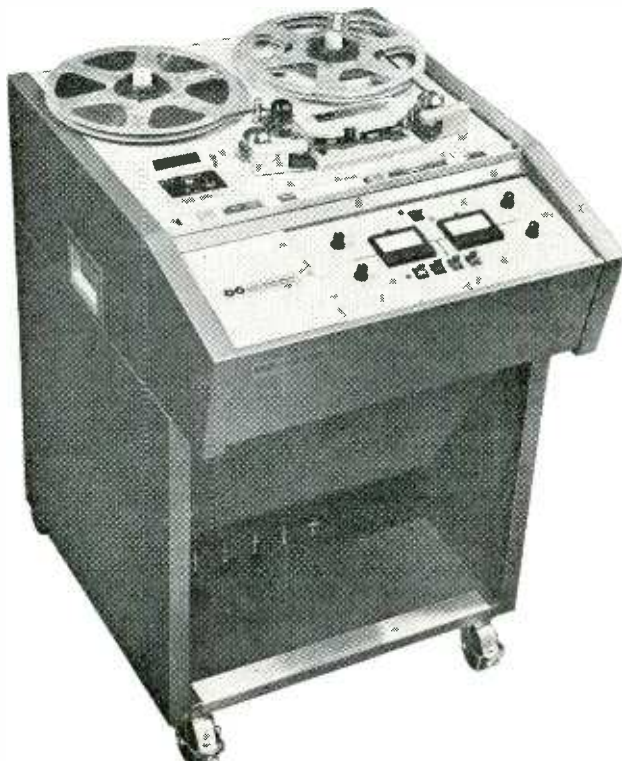

**because the choice
of audio recorders has just
been increased!**

It's sound sense to choose the new Proline 2000 TC now that the choice of Proline Professional audio recorders has been increased to two. Proline Professional have already been acclaimed for their performance and reliability world-wide with the economically priced Proline 1000. And now, from Leavers-Rich, largest and most experienced manufacturers of professional recorders in Britain, comes

the Proline 2000 TC with a Twin Vari-speed servo capstan.

The Proline 2000 uses electronics in place of mechanics — on board solid state analogue switches — modular construction for easy maintenance, and a host of other high technology concepts adding up to the most sophisticated recorder in large scale production in Britain today.

Have a word with Tony Costello or John Robinson at 01-874 9054 Leavers-Rich Equipment Ltd 319 Trinity Road London SW18 3SL Telex 923455



work

Regents Park Recording

Rockfield in the middle of London? Well, not quite, but an interesting new approach to country-style recording in the Metropolis is to be found in Queen's Terrace, just around the corner from St John's Wood tube station, three stops up the line from Oxford Circus. It's the brainchild of Duncan Bruce, previously—and still, for that matter—heavily involved in radio and tv commercials.

Bruce, it can safely be said, has had some success in the commercial field. Working originally from a small studio in Belsize Park, a couple of miles farther up the hill towards Hampstead Heath, Bruce has not only clocked up awards, for instance for 'Black - and - White Whisky' commercials in colour (if you see what I mean) but is responsible for a string of radio and tv ads that will ring many a

mental bell. 'Vogue Interiors', with the catchy music and that nice upper-crust Noel Coward pair on top, is one; 'Falmer's' jeans, 'British Leyland' and 'Air Canada' are others. 'Barretts Liquormart' (dare I say it?) is another. 'I hate to admit it,' I admitted, 'but that original Barretts campaign on Capital, with "Barretts, Barretts, Barretts" hammering at me day and night, made me resolve never to go near a Barretts liquor store as long as I live'. 'Fair enough,' says Bruce, 'but I mentioned that because I knew you'd know it. Everyone in London knows the Barretts ads, because we handled it as an ongoing project for over a year, and by the end everyone knew about Barretts.' Fair comment indeed. And I also have to admit that I have in fact long since broken my promise and purchased booze from Barretts. Advertising can work! Laskys is next on the list for a big campaign; and it will be interesting to see how Bruce follows John Cleese.

Duncan Bruce, in fairly long-time association with freelance engineer Stephen Lipson, originally produced from a small home studio, but later he was booking thousands of pounds' worth of other people's facilities. Came the inevitable conclusion: 'we need a studio of our own'. Backed up by Lipson's working knowledge of and enthusiasm for Rockfield, Bruce started looking for a London base with country style. Originally he had hopes of something in Hampstead, but space in Hampstead costs a fortune, and Bruce has very positive ideas about space. 'We've seen so many people take small premises, put in good equipment, start making a success of things and then find they have no room to

expand. What we wanted to do was start off with space and the bare minimum of equipment and then, if that million-pound advance ever comes through, invest it on inside improvements and equipment.' As it turned out, the 'bare minimum' of equipment is nothing to be sneezed at.

A couple of years ago Bruce found his dream space: an old parish hall in Queen's Terrace, St John's Wood, across the road from a church. The parish hall, which has a truly beautiful peaked roof of hardwood beams, had been used for all manner of things over the years, including military training during the war. When Tom Hidley called to give some helpful advice he enthused over the possibility of recording strings under that roof. In the event, the recording studio is downstairs in the basement, with fairly simple acoustic treatment put together by Bruce, Lipson and a university friend taking a PhD in acoustics. The studio acoustics somehow found their way into the thesis, so the friend's professor gave his views. Not, one would think, the best way to design the acoustics of a studio. The world is full of PhDs in science who can't mend a fuse, and in sociology who are grossly unsociable. (I once knew a PhD in child psychiatry who cemented broken glass on the walls around his house to keep out the neighbour's children.) But in this case it worked. When Hidley called, Bruce and Lipson winced at the thought of what he might say. In the event, the only suggestion was a bass trap in the basement studio ceiling. Otherwise no problems, although the monitor equalisers do iron out a few bumps.

The parish church opposite is now a Greek Orthodox church and seems fairly seldom used. This is all to the advantage of the Regents Park Recording Company, which is the title under which Bruce's studio operates, because there is always free parking for a dozen or so cars in the churchyard. This is important, because St John's Wood is a meter area, and although wardens only show up once a week Sod's Law says you can't ignore their presence or, more to the point, assume their absence.

It took two years to get the parish hall into studio form, one year of that being spent on planning problems. Mickie Most's Rak Studio down the road (on which we hope perhaps to report later) appears to have had similar problems. It's the same old story, as for instance encountered by The Who in Battersea. Joe Public, and Joe Councillor in particular, know that rock

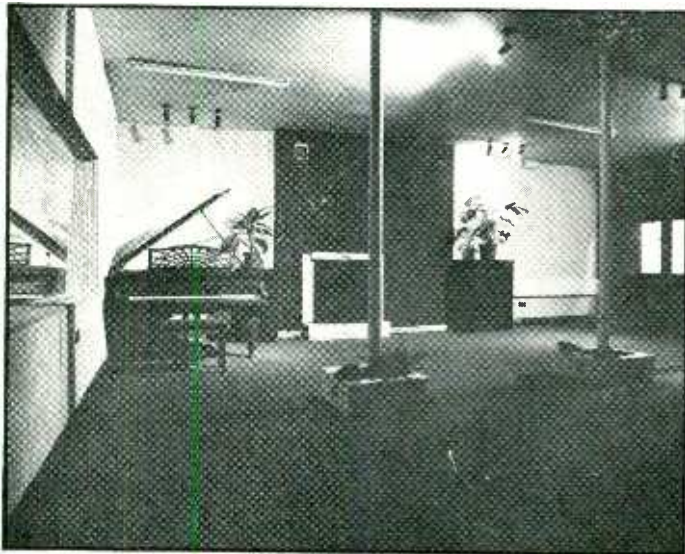

Above: The studio resplendent with plants climbing up the pillars—yes, that is a fireplace in the background

Right: The 20/16 Amek desk tastefully surrounded by even more plants



Single-track to 24 channels; there's an Ampex professional recorder for you

Absolute Precision from One Channel to Four

ATR-100 — our finest ever audio recorder. For monaural, two-channel or four-channel work, it will give you recordings (and playbacks) that simply cannot be matched by any other machine.

Quality shows in the fully servoed transport with automatic tension control and dynamic braking. The liftout remote control has LED indicators that show how every channel is set up.

There's search-to-cue, 60 or 120 ips shuttle under capstan control and super fast rewind. And many performance specs are a full order of magnitude better than those of other recorders in this field.



ATR-100

The Multitrack Recording Machine

Ampex gives you a lot of reasons to buy an MM-1200 multichannel audio recorder: fidelity, versatility and reliability. Performance specifications alone make this the leader among professional multi-track recorders.

The comprehensive features of the MM-1200 include: a choice of 8, 16 or 24 channels, electronic tape timer, search-to-cue, quick-change heads, and pull-out modular electronic bays for instant servicing.

It all comes together in the Ampex MM-1200 and that's why, sooner or later, you'll buy an MM-1200 for your studio.

MM-1200

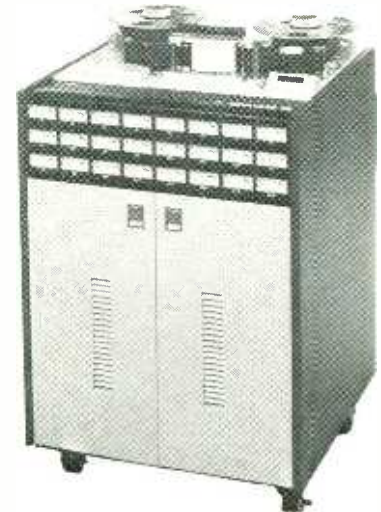

AG-440C

Versatile, Reliable Production Recorder

AG-440C capability takes you from one to eight separate channels of sound for imaginative, creative production work.

Use this machine for mastering, sweetening or mix-down work, and trust it to turn in a reliable, professional performance every time. Offering Sel Sync* synchronizer as a standard feature, the AG-440C has earned a permanent position in the world lineup of fine recording instruments.

*™ Ampex Corporation

The Many Ampex Options

	AG-440C	ATR-100	MM-1200
Console Version	✓	✓	✓
Rack-mount	✓	✓	—
Portable case	—	✓	—
Video Layback Head	—	—	✓
Multi-point Search-to-Cue	—	✓	✓
Disc Mastering Preview Version	—	✓	—
MQS Synchronizing Equipment	✓	✓	✓
Variable Speed Oscillator	✓	✓	✓

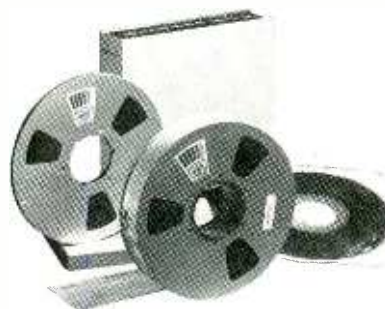

And For Every Machine, the Best Tape

Ampex tape. Tape with superior handling qualities to protect your machines. Tape with capture qualities that record your material without adding to or subtracting from it. Tape that is protected by extraordinary control during manufacture, and packaged for user convenience and easy storage. Quality in every format.

For further information, please call your nearest Ampex sales office or write to:

Ampex International,
72 Berkeley Avenue,
Reading, England.
Tel: (0734) 55341
Telex: 847611

Athens (Greece)	682.3819
Frankfurt (W. Germany)	60581
Fribourg (Switzerland)	22.73.31
Paris (France)	609.91.55
Reading (England)	85200
Rome (Italy)	54.69.91
Stockholm (Sweden)	28.29.10
Utrecht (Netherlands)	612921

AMPEX

WORK

groups make a lot of noise. So, they argue, a recording studio catering for 'those people' will make a lot of noise and disturb all the neighbours. The neighbours and the council take a lot of convincing that if a studio leaks much sound out it will also leak traffic and aircraft sound in, and will consequently fail as a studio.

Certainly, the Queen's Terrace setup does have a fairly country feel about it. The upstairs administration, handling studio work and radio and tv commercial production side by side, comes all under that same beautiful wooden roof. A couple of dogs look bored with it all. Downstairs, their music studio is 93 square metres with the control room half that size. In all, the building is 325 square metres, with room to expand out back. 'We won't outgrow the building, and any move would be to open an additional studio right out in the country,' says Bruce.

The studio has a line of pillars down the centre, serving the essential purpose of keeping up the ceiling and the inessential but useful purpose of providing somewhere for vines and creepers to grow. But so far vines and creepers have not grown happily, and the next move will be rubber plants. If that fails, *plastic* plants perhaps? There's a glorious Victorian fireplace with a serviceable chimney that has been swept ready for fires this winter. 'I like the idea of sessions around a log fire,' says Lipson.

Equipment was all bought new. 'There's so much second-hand equipment on the market now,' says Bruce, 'that it's getting very easy for anyone to go 16-track on a budget. But we didn't want to go 16-track on a budget. Studio equipment goes through a lot of hard use, and to buy it second-hand seems to me like buying a second-hand racing car. It's especially important for us, an independent studio that can't afford to hold spares of this, that and everything, to be able to rely on the manufacturer's aid at literally a few minutes' notice.' So they bought a new 3M 16-track, a Revox A700 for mastering (soon to be replaced by new Studer B67s), and an Amek 20/16 desk. The 3M machine has autolocate, with which everyone is very pleased, though when I called there was a degree of puzzlement as to why the lead from the autolocate keyboard to the machine couldn't be extended in length; all attempts at extending it had produced autolocate malfunctions. In

addition to Lipson and Bruce there's engineer Martin Adam, maintenance engineer Roger Peyton (not on the permanent staff but on 24-hour call), and a few admin ladies upstairs along with the dogs. The studio monitors are Tannoys in Lockwoods (new again), driven by Turner power amps, with an Eventide Phaser, Compex limiter, Master-Room echo and dbx 160. Everyone had good words for 3M and Lockwood service and speed. There is no noise reduction—the 3M machine (with 38 cm/s, 76 cm/s and varispeed facility) is always run at 76 cm/s. Mixdown is then to 38 cm/s master. 'Although it costs £45 every quarter of an hour on master-tape,' says Lipson, 'this is still cheaper than charging clients for full Dolby or dbx facility. After all, once the backing tracks are down, tape costs are covered.' But there is clearly some interest in dbx, and a thought for the day is their discovery that dbx-encoded tapes can sometimes give just the effect the producer wants if played back *without* decoding. Although the very compressed sound may not be right for cymbals, it can prove just the job for tightening guitar, bass or drums. It's definitely worth a try.

Lipson, by his own admission, is not 'a decibel man'. Although he knows what he wants of equipment and how to get it (and everyone seems unanimous in their delight at the way the Amek desk does more or less all anyone could want of it) he has little interest in the how and why. In fact he verges on mild contempt for 'clever producers who want to fiddle with knobs, without really knowing what they do or being able to hear the difference'—as witnessed by one producer who was happily fiddling during one session with knobs that weren't even in circuit. 'I'm only interested in getting the sound,' he continued. 'If recording with dbx and playing back without dbx gives the right sound, then that's what I'll do. I'd soak the tape in vodka if it helped.'

So what kind of work is the studio handling? They see themselves on the unspoken grading ladder as being up some rungs from the demo market, below the master 24-track big league, and just about 'in there' at the bottom of the 16-track big league. This seems a fair assessment. The studio is welcoming, the facilities and equipment clean, new and adequate—bordering-on-sparse. But it's all part of the plan that makes sense, namely to invest future profits and advances in hardware, rather than the search for larger premises. Doubtless with this in consideration there's currently a flat 'introduction' rate of

£20 an hour—anytime.

Virtually every morning is taken up with self-generated work, that is to say radio and tv commercial tracks; and this is a very tight regime. There is no room for the music-biz 'Hi man, what's cookin?' approach. In the ad business you may have to mike up a 4-piece group in ten minutes and then start getting something down. The rest of the time is on the other side of the fence. There's been a fairly wide range of music work, from a fair amount of punk, through middle-of-the-road rock, to full orchestral—thanks to the large studio floor. It's interesting to hear the views of people working professionally with the punksters. 'So far, they're not interested in recording techniques and hardware—they want to get in and get on with the job. They want a raunchy sound, like the sound they get live,' says Lipson. And getting that raunchy sound can be difficult. The punk groups are, on the whole and to use neutral terms, not particularly talented when it comes to pure musical ability. Much of their success lies in on-stage atmosphere. Lipson, being a guitarist himself and with a lot of experience in miking studio guitar setups to sound live and loud, can speak the right language. There's a boxload of tricks, like, for instance, the simple and cheap, but nice, MXR Dyna-comp gadget that is normally used for stage work but Lipson has found can be useful in a studio. A mixture of di and miked amps, several amps separately miked, with or without stage gear, a bit of eq, and so on can all contribute. There are no rules. In one case it took five hours to get the right guitar sound, but without it the band would have been lost. At the same time, Lipson doesn't want to spend too long on mixdown. 'Too many people say—"It'll all sort itself out on the mix,"

but I try to get it right and straight on the multitrack, so that mixing doesn't drag on. I was forced to spend six hours on one track recently, and it felt like a lifetime.'

Already there's talk of a move up to 24-track, but with some reluctance. Staying with 16-track means more discipline, and the need to mix down somewhere along the line. But it's the same old story: 'We'd like to use you, but you're only 16-track . . .'. When the time for upgrade comes, it will be all equipment out and replaced by all new. 'We deliberately didn't leave space on the desk for upgrading it to 24,' they say. 'We'd never have been really happy with the results.'

We talked later, over a drink, about the abominable standard of early radio commercials in this country. Sadly the laws of libel probably prevent us from reminding readers of some of those glorious first atrocities that were so bad that they will one day become cult collectors' items—if you have any on tape, don't erase them! I was interested to hear Bruce talk with competitive respect for one of the few other men in the field making listenable commercials: Tony Hertz of Radio Operators. With a bunch of new ilr stations scheduled to open over the next few years (politics permitting) and the public gradually becoming more aware of what a good radio commercial sounds like, the few professionals in this business look like having an assured future. 'We like to think of ourselves as the "Marks & Spencers" of adverts,' says Bruce. 'Whatever you buy at Marks, even if it's only a pair of socks, you know it'll be of good quality. In the radio business, not everything you make can, or even should, be an award winner—but it should be of consistent quality, whatever the budget.'

Adrian Hope

CADEY

1" 8 TRACK ...	£1470.00	
1" 16 TRACK ...	£2180.00	All exclusive of
2" 16 TRACK ...	£2780.00	VAT (8%)
2" 24 TRACK ...	£3600.00	

Enquiries 0634-76117

Reliability in its most compact form the TELEFUNKEN "magnetophon" 15A Multi-Track the complete system



Unprecedented flexibility and operating ease. A system approach to all accessories: a micro-processor based autolocator with 9-position memory and stop timer, remote track selectors and a capstan speed controller with crystal precise digital speed read-out. The TELEFUNKEN "Magnetophon" M15A multi-track. All in all a totally new generation of master recorders from the inventors of modern tape recording. Up to 32 tracks on 2" tape! 12 1/2" tape diameter capacity. Versions with the TELEFUNKEN telcom c4 noise reduction compander (built-in for up to 24 tracks). Readily upgradable to higher track configurations. Crystal locked 7.5/15 or 15/30 ips tape speeds, NAB/CCIR/AES switchable equalization and clock-timed record/erase functions to permit gap-less, inaudible electronic splicing. It's the recorder for the engineer who wants to pay for performance - not for gadgets: the experienced professional.

WAK 544 E

Coupon

Please send me the brochure on
»magnetophon 15A
Multi-Track-Systems«

Name _____

Address _____

Telephone _____

Hayden Laboratories Ltd.
Churchfield Road
Chalfont St. Peter, Bucks. SL9 9EW
U.K.
Gerrards Cross 88447

GOTHAM
AUDIO CORPORATION

741 Washington Street
New York, NY: (212) 741-7411
1710 N. La Brea Ave.,
Hollywood: (213) 874-4444
USA

AEG-TELEFUNKEN
Magnetbandgeräte
P.O. Box 2154
D-7750 Konstanz
W.-Germany



**professional tape recorders
by AEG-TELEFUNKEN**

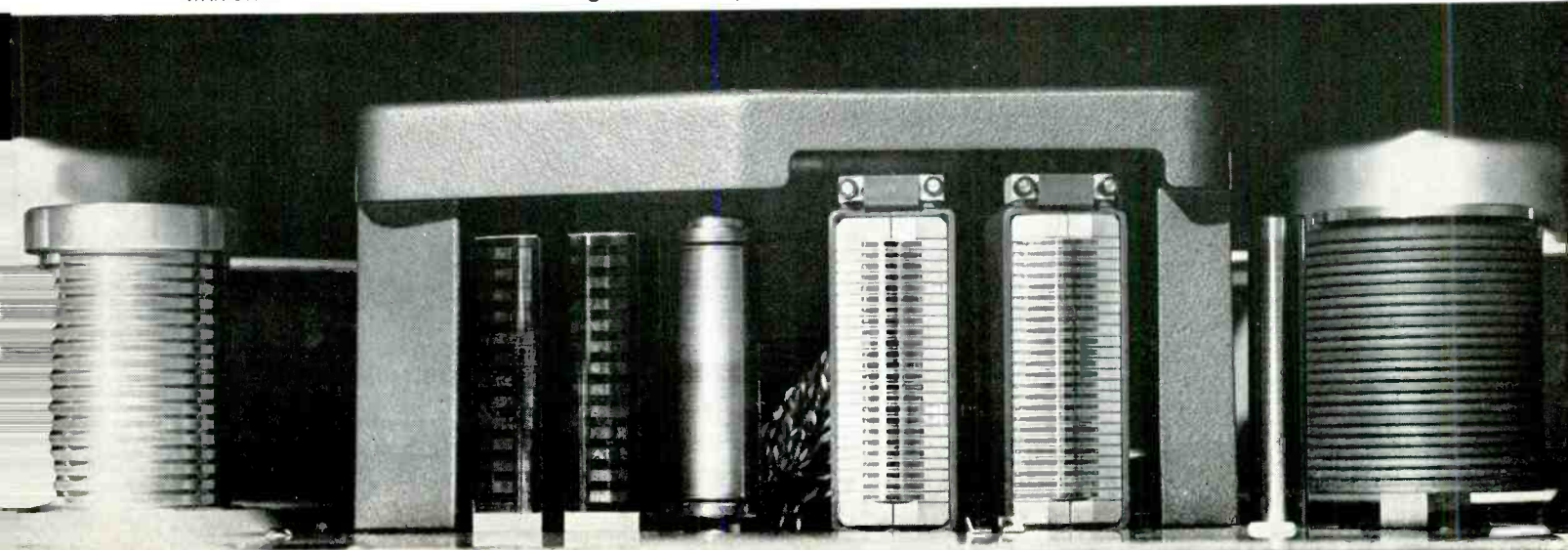

Electro-Voice

MODEL RE20 DYNAMIC CARDIOID

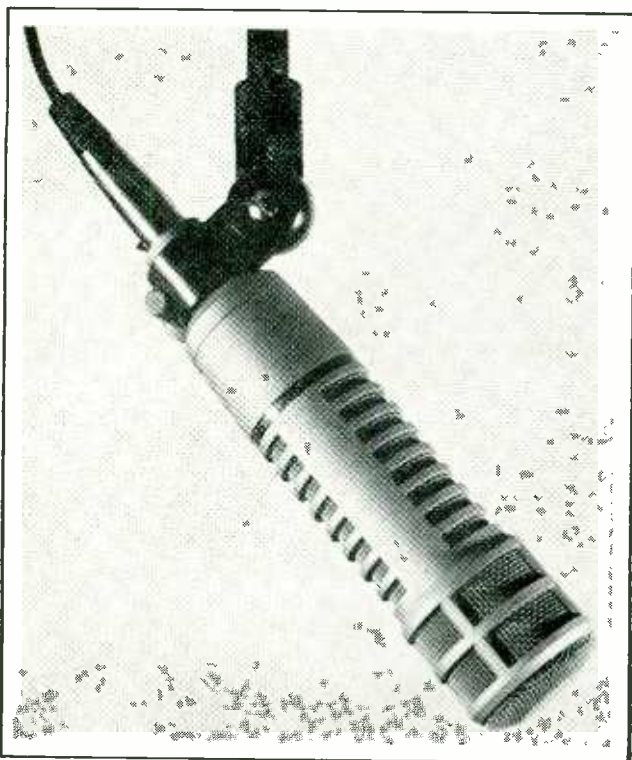

DESCRIPTION AND APPLICATIONS

The Electro-Voice Model RE20 is a professional quality dynamic cardioid microphone created especially for recording, broadcast, and sound reinforcement applications requiring essentially flat response over a very wide frequency range. The wide frequency response, coupled with excellent transient response, makes the RE20 easily comparable to the finest condenser cardioid microphones. Unlike standard condenser cardioid microphones, however, the RE20 is virtually free of bass-boosting "proximity effect" when used close, because in design it is a Continuously Variable-D® microphone. An easily operated "bass tilt down" switch corrects spectrum balance for use in long-reach situations, or other applications where bass attenuation is needed.

A true cardioid microphone, the RE20 offers greatest rejection at 180° off axis — directly to the rear of the microphone. Directional control is so effective that the frequency response is nearly independent of angular location of sound source, creating virtually no off-axis coloration yet providing greatest possible rejection of unwanted sounds.

An integral blast and wind filter covers each acoustic opening on the RE20. At recording sessions and on stage, singers can "close talk" the microphone, singing with their lips almost touching the grille screen with no worry of "p-pops" or excessive sibilance. Part of the filter also shock mounts the internal microphone element, reducing the transfer of vibrations from external sources.

Using the mechanical nesting concept of design — the internal transducer parts are nested one within another — the RE20 is able to withstand all rigors of professional use. The diaphragm, made of Electro-Voice Acoustalloy™ is not affected by extremes of temperature and humidity. Further protection is provided by the extremely rugged exterior steel casing.

The RE20 is supplied wired for 150 ohms impedance. Fifty- and 250-ohm impedances are available through a simple wiring change.

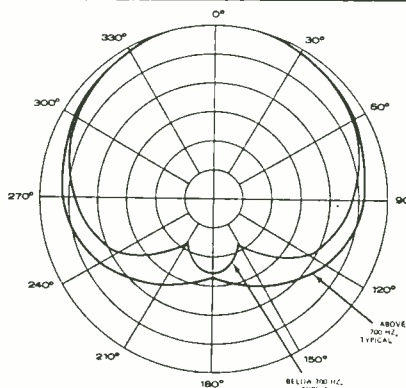

SCALE IS
5 DECIBELS
PER DIVISION

Polar Response

SPECIFICATIONS

Element:	Dynamic
Frequency Response:	45–18,000 Hz
Polar Pattern:	Cardioid
Impedance:	50, 150, and 250 ohms changed by solder connection
Output Level:	–57 dB (0 dB = 1 mw/10 dyne/cm ²)
EIA Sensitivity Rating:	–150 dB (150 ohm output)
Diaphragm:	Electro-Voice Acoustalloy™
Case Material:	Steel
Dimensions:	8-17/32" (216.7mm) l., 2-9/64" (54.4mm) widest diameter, 1-15/16" (49.2mm) body diameter
Finish:	Fawn beige micomatte
Net Weight:	1 lb., 10 oz. (737g) without cable
Cable:	15' (4.6m), 2-conductor shielded, rubber-jacketed, brown broadcast-type cable, supplied with Switchcraft A3F connector on microphone end.
Accessories Furnished:	87213 Stand Adapter
Optional Accessories:	Model 309 shock mounted stand adapter for use with floor stand or recording boom.



gulton
... ..

Gulton Europe Limited

To: Electro-Voice Division,
Gulton Europe Limited,
Maple Works, Old Shoreham Road, Hove,
Sussex BN3 7EY. Tel. (0273) 778401/2/3/4

- Send me details of EV Microphones
 Ask your Representative to call.

NAME
POSITION
COMPANY
ADDRESS

Tel.

WOW,
HOLD
IT!



Bring Prices DOWN



Benefit from a dynamic new Electro-Voice sales policy. All professional microphone prices REDUCED! Many other products down in price too!

NEW RETAIL PRICES

all prices exclude VAT

RE20 now £288.67	DOWN	£43.18
RE16 now £172.01	DOWN	£27.79
RE15 now £165.47	DOWN	£24.78
RE11 now £108.33	DOWN	£17.57
RE10 now £99.40	DOWN	£14.85
DO54 now £76.18	DOWN	£12.77
DS35 now £78.57	DOWN	£11.78
635A now £56.54	DOWN	£8.46



Tony Platt is Chief Engineer at Pebble Beach Sound Recorders Ltd., back in January they were making a start on an Album featuring Sonny Worthing (Transatlantic label—doing nicely in Europe thank you), Tony decided that he needed something special in the way of microphones—a mike that would give superb voice reproduction without assistance from any electronic gadgets which a balance engineer would normally have to use in order to obtain such a wide frequency response from the human voice. He even knew the mike he wanted, an ELECTRO-VOICE RE20, the problem was where could he get an RE20 in the UK — and quickly.

Persistent searching, phoning, and asking finally revealed that E-V products are now marketed in the UK by the Electro-Voice Division of Gulston Europe Limited, just around the coast!!

Tony Platt got his RE20, fast. He regards the RE20 as essential when using 24 track recording in order to retain clarity and low noise build-up on multiple vocal overdubs.

Electro-Voice

ELECTRO-VOICE DIVISION
Gulston Europe Limited,
Maple Works,
Old Shoreham Road,
HOVE, Sussex BN3 7EY
Tel. (0273) 778401/2/3/4
Telex: 87172

reviews

Orban Parasound 418A stereo limiter

Hugh Ford

MANUFACTURER'S SPECIFICATION

Input: impedance 100k ohm balanced; active transformer input; -10 dBm input produces 10 dB gain reduction with input attenuator fully clockwise; absolute input overload occurs at +21 dBm.

Output: impedance <400 ohm unbalanced; level +4 dBm nominal with output attenuator fully clockwise; peak level approx +12 dBm.

Frequency response: ± 0.5 dB, 20-20k Hz below hf limiter threshold.

High-frequency limiter: controls hf peaks attempting to exceed a threshold defined by a single time constant roll-off of 75, 50, 37.5 or 25 μ s, $\pm 3\%$; roll-offs are switch selectable from front panel, and hf limiter is defeated in 'flat' position; attack time approx 3 ms; release time varies around 15 ms, according to programme history; control element is a junction fet.

Broadband limiter: attack time 1 to 2 ms; release time program-controlled by means of quadruple time constant release time analog processor; release time may be scaled fast or slow by means of continuously variable control available to user; range of gain reduction ≤ 15 dB; compression ratio in excess of 200:1; interchannel tracking ± 1.5 dB max, ± 1 dB typical; control element is a junction fet.

Separation: 50 dB or better, 20-20k Hz.

Noise: -30 dB typical; -75 dB maximum. (Level below limiting threshold at 100 Hz, 20-20k Hz bandwidth.)

Total harmonic distortion: <0.1% from 100-8k Hz.

Operating controls: input and output attenuators (left and right ganged); release time; hf limiter time constant 75, 50, 37.5 and 25 μ s, plus 'flat'; meter selector—left and right input, left and right output, gain reduction or ± 15 V power supply; ac line on/off.

Indicators: ac power pilot lamp; overload led (lights if attempt is made to exceed possible broadband agc range); meter with vu A-scale and characteristic.

Power requirement: 115/230V ac $\pm 10\%$, 50-60 Hz, approx 6W.

Dimensions (wxhxd): 483 x 89 x 254 mm.

Operating temperature range: 0-50°C.

Price: £685.

Manufacturer: Orban Parasound, 680 Beach Street, San Francisco, Ca 94109, USA.

UK Agent: Scenic Sounds Equipment, 97/99 Dean Street, London W1.

THIS limiter is specifically designed for applications where it is necessary to limit the hf energy in an audio signal, such as cassette duplication and other systems that employ any form of pre-emphasis. Essentially, it uses two separate control mechanisms: a broad band limiter, which has a fast attack time and a release time that depends upon the programme material and the front-panel setting; and a high-frequency limiter. The latter is activated by switch-selected time constants of 75, 50, 37.5 or 25 μ s (in addition to a 'flat' position), and comprises a limiter with an attack time similar to the broadband limiter and a fast release time.

The combination of the two limiters allows the overall programme level to be protected

in a conventional manner, while dealing with excessive hf levels in accordance with the selected time constant without having a long-term effect upon the overall output level at lower frequencies. Naturally this is a stereo device with the two channels having their control elements permanently linked, such that either channel will control the gain of the other to eliminate shifting of the stereo image.

A minimum of controls directly associated with the limiter are provided, these being the release time control for the broadband limiter and the time constant switch for the high-frequency limiter. In addition, there are ganged input and output level controls in the form of potentiometers, a led input overload indicator, and a switch that selects the function of the front-panel vu meter. This can indicate input or output level for either channel, gain reduction, or the level of internal power supplies.

To the rear of the unit are the barrier-strip type input and output connectors that provide an electronically-balanced input and unbalanced output for each channel, and also allow the signal and chassis earths to be separated. Finally there is a fixed power lead plus a properly identified power fuse.

Within the case the audio electronics are contained on a single very high quality pcb which, unfortunately, does not have component identifications to aid servicing; the layout, however, is very tidy. Power supplies are mounted on a small separate board, and access to all controls and components is excellent. Similarly, the external finish of the standard rack-mounting case is to a high standard, with clear identification of all controls and a generally pleasant and workmanlike appearance.

Inputs and outputs

The electronically-balanced inputs were found to have an input impedance that was constant at 100k ohm, irrespective of control settings. This high value should be more than adequate for interfacing the unit with both professional and semi-professional equipment. The maximum possible input level before input clipping was found to be +22 dBm, with the onset of limiting at low frequencies or in the 'flat' mode of operation occurring at -20 dBm input.

On the output end the unbalanced output had a source impedance of 6 ohm, with a drive capability of +20 dBm into 600 ohm. The limiter is thus compatible with virtually any other equipment. When switched to read input levels the vu meter indicates the input level before the attenuator, with zero vu corresponding to +4.5 dBm—which strictly should be +4 dBm. However, when the meter is set to read output level it is connected before the output attenuator, and is arranged such that at maximum output gain the zero vu reading corresponds to +6.6 dBm—a rather odd arrangement? But it is pleasing to report that the meter is a genuine vu instrument to the ASA standard.

Frequency response

The overall frequency response in the 'flat' mode or before hf limiting in the other modes is shown in fig. 1. It can be seen that the response is very flat up to 10 kHz, with only a small drop of -0.6 dB at 20 kHz. In the pre-emphasised modes the high-frequency limiter

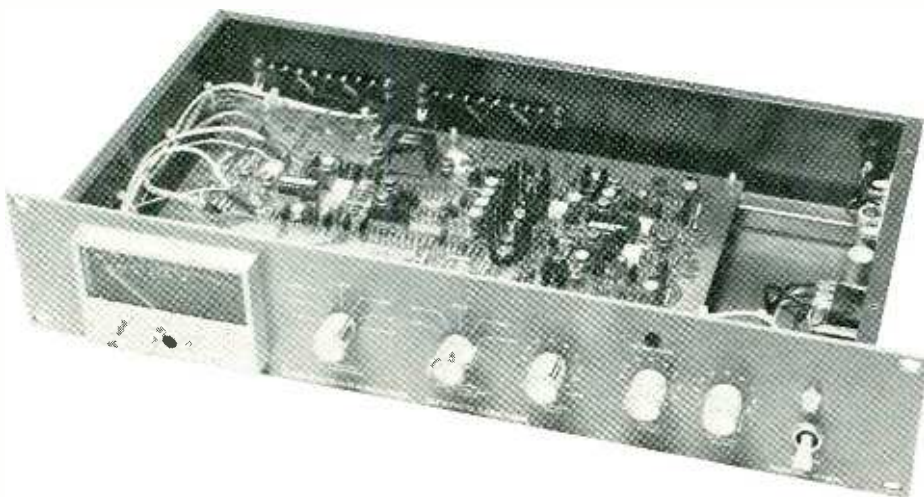

**The unusual masterpiece : half-inch, eight-track.
Otari MX5050-8SD for discriminating recordists.**



If you have been thinking eight-track machines are bulky and costly, this unusual one will change your idea. It's exceptionally compact, yet comes with every feature critical professional applications require. DC-servo capstan motor for less than 0.05% wow/flutter, with $\pm 7\%$ pitch control. 63 dB S/N and greater-than-50 dB crosstalk. Selective reproduce on all eight tracks. Motion sensing control logic, front panel edit and adjustable cueing control for fast-mode monitoring. Front adjustable bias, record equalization and output level. 600 ohm

+4dBm fixed output with XLR connectors. And it comes with the latest plug-in card electronics. The compactness and performance make it ideal for live recording.

In short, the MX5050-8SD is an exception of eight-track professional recorders with performance, reliability and economy internationally proven in hundreds of applications producing high quality 15 and 7-1/2 ips masters. For the full story of this unique model, get in contact with your nearest Otari distributor.

**Please send me details on
MX5050-8SD**

Name

Company

Address

SS

Japan: Otari Electric Co., Ltd., 4-29-18 Minami Ogikubo, Suginami-ku, Tokyo 167, Japan U.K.: C.E. Hammond & Co., Ltd., 111 Chertsey Road, Byfleet, Surrey KT14 7LA
France: Reditec, 62-66, Rue Louis Ampère, Zone Industrielle des Chanoux, 93330 Neuilly-s/Marne West Germany: Peter Strüven GmbH, 2 Hamburg 53, Bornheide 19
Belgium: Trans European Music S.A., Koeivijverstraat 105, 1710 Dilbeek, Brussels Italy: Exhibo Italiana S.R.L., 20052 Monza, Via F. Frisi, 22
Switzerland: Audio Bauer AG, CH-8048 Zürich, Bernerstrasse-Nord 182, Haus Atlant Australia: Klarion Enterprises Proprietary Ltd., Regent House, 63, Kingsway, South Melbourne, 3205

Cuemaster

professional NAB Cartridge
recorders and replay
machines

CUERAC®

Automation systems for
Broadcasting and P.A.

schafer

Automation systems for
Radio

MULTI-TRACK

parametric equalisers

MELLOTRONICS

400FX Effects Console

Technical Translations



Granet

Communications Ltd.

39 BEECHCROFT MANOR, OATLANDS
DRIVE, WEYBRIDGE, SURREY KT13 9NZ

Weybridge (0932) 47785

ORBAN PARASOUND 418A

follows the selected time constant. The resulting curves are shown in fig. 2 for the 'flat' position and the four pre-emphasised positions. In theory the -3 dB points should be at the frequencies indicated by arrows on the figure, but it will be seen that all curves arrive at about -2 dB at these points—better accuracy could be justified here.

Noise and distortion

Output noise at maximum output gain referred to the output signal level for onset of limiting is a reasonable indication of the limiter's available dynamic range. The following figures relate this measurement to various noise measurements; both channels give identical results:

Noise measurement method	Dynamic range
rms band-limited 20-20k Hz	78.6 dB
A-weighted rms	81.5 dB
CCIR-weighted ref 1 kHz rms	72.7 dB
CCIR-weighted ref 1 kHz quasi-peak	67.8 dB

The above figure shows a noise performance that is adequate for the preparation of cassette master tapes, discs and other end products. However, a better noise performance would be

desirable for other applications.

Individual harmonic distortion was checked under various conditions, and found to be unusually good for the type of equipment. The performance within the audio band at 5 dB of limiting is given in fig. 3. This shows that the predominant third harmonic is less than 0.1% below 15 kHz, and also that low-frequency distortion is very good at a mid-position release time setting. Naturally, the low-frequency distortion rises at shorter release times, but no limiter can solve this problem.

Similarly, the intermodulation distortion to the CCIR twin-tone method was very low at a consistent 0.07% from 20 Hz to 20 kHz at 5 dB of limiting, and less than 0.01% at signal levels 20 dB below limiting.

Dynamic performance

Fig. 4 shows in the upper trace an input burst of 10 kHz tone with a duration of 1 ms driving the limiter into 10 dB of hf limiting, while the lower trace shows the limiter's output. As can be seen there is a fair amount of overshoot, and the manufacturer states in its literature that this is a compromise situation and is inaudible. It is my opinion, however, that such overshoot may cause troubles in other equipment being fed by the limiter, and certainly puts the limiter out of running for broadcast applications.

Subsequent to the overshoot, the attack time

72 ▶

ORBAN PARASOUND 418A STEREO LIMITER

FIG. 1
FREQUENCY
RESPONSE IN
FLAT' MODE
0dBm OUTPUT

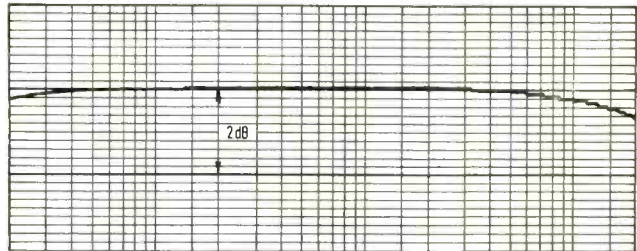

FIG. 2
HF COMPRESSOR
TIME CONSTANTS

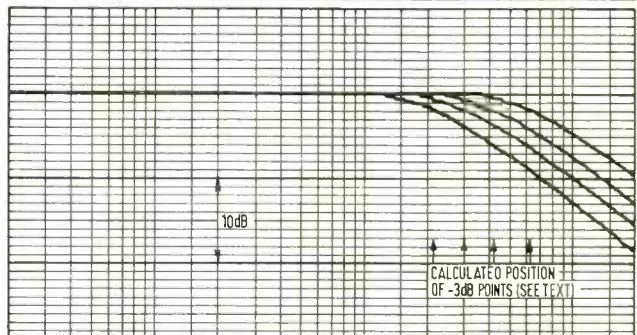
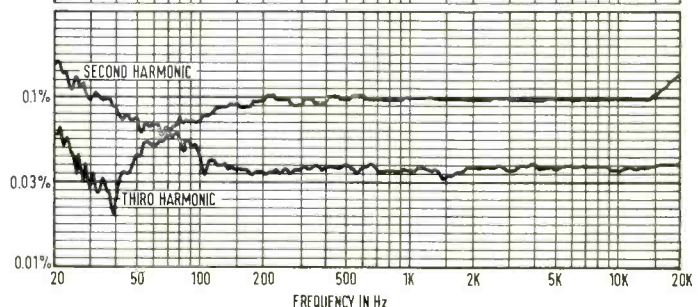

FIG. 3
HARMONIC
DISTORTION AT
5dB LIMITING



OUR RESPONSE TO SCOTCH 256 IS JUST ABOUT UNPRINTABLE

3M did their best.

Everyone had been asking for a mastering tape that cut right down on the print-through effect.

But it had to have a high dynamic range—like Scotch 250.

3M came up with their new Scotch 256 High Performance Mastering Tape. With a high dynamic range of 67dB, and a low print-through of -59dB.

Some baby, they claimed, developed and produced

especially for Europe.

They wanted studios that could really test it.

The sort of place that recorded artists like Rod Stewart, Nana Mouskouri, John Denver, Jethro Tull, Yes and Alice Cooper.

In London or even Brussels.

Naturally we obliged.

And as a result we're still not printing anything—on or off the record.

morgan

®/TM Scotch is a trademark

Morgan Recording Studios, London & Brussels.

For the Flutter you can't afford

EMT have an extraordinarily versatile flutter meter at a price you can afford—the low cost EMT 422.

Flutter and FIM (frequency inter-modulation) distortion measurement can be made in five ranges from 0.1% to 10% FSD to DIN/ANSI/IEC standards. In addition, three further filters can be selected for a rapid initial analysis of flutter frequencies. Weighted peak and slow speed deviation values are clearly displayed on separate large size meters.

A unique feature is the programmable threshold level option which provides an instant visual indication at three preset levels for simplified quality control and production line testing.

Outputs are provided for use with external filters, graphic recorders or oscilloscopes to further extend the EMT 422's unique capabilities.

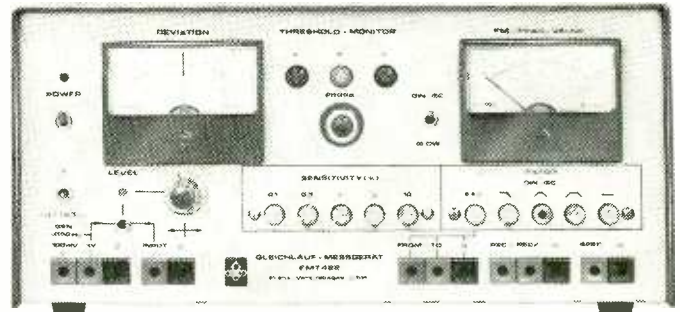

F.W.O. BAUCH LIMITED

49 Theobald Street, Boreham Wood, Hertfordshire, WD6 4RZ. Tel: 01953 0091



ELEKTRONIK, MESS- & TONSTUDIOTECHNIK

EMT-FRANZ VG mbH.

Postfach 1520, D-7630 Lahr, Tel. 07825/512

Telex: 754319 - Franz D.

ORBAN PARASOUND 418A

is very rapid, with the recovery in this case also being fast—in the order of 6 ms—confirming that the high-frequency limiter does not have any long-term effect on the output level.

A toneburst identical to that defined above was used to investigate the performance of the stereo tracking, with the output of the limiting channel and of the other channel, when fed at a low level, being shown in fig. 5. It can be seen that the gain reduction in both channels is almost identical. Also the recovery times are virtually identical.

Unlike the high-frequency limiter, the broadband limiter has its release time effected by the front-panel control, but retains a fast attack time. The effect of the release time control is illustrated in fig. 6, which shows that the recovery from 10 dB of limiting can be set between about 500 ms and 6s—a very practical range.

Other matters

Crosstalk between the two channels was found to be worst at high frequencies: -60 dB between 10 and 20 kHz, falling at approximately 6 dB per octave below 10 kHz to greater than -100 dB below 80 Hz; no problems in this area.

While the vu meter can be used to indicate the degree of gain reduction in operation, the

Indicated reduction	Actual reduction
1 dB	0.2 dB
3 dB	2.0 dB
5 dB	4.5 dB
7 dB	7.4 dB
10 dB	13.0 dB

FIG. 4

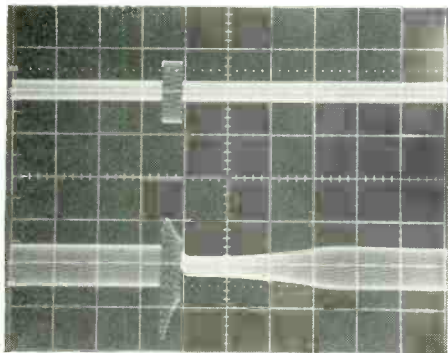

response time of the meter in this mode was very slow, such that the function was of little use on programme material. Also the accuracy of the meter was none too good in the gain reduction mode, as is shown in the table (see above).

The other function of the vu meter, that of indicating the level of the internal power supplies, seems to be of little practical use and a rather old-fashioned idea derived from valved equipment.

A further matter which caused disquiet was that the inputs to the limiter were found to be de-coupled as far along the chain as the input-level metering. It is felt that dc isolation should certainly be provided at the inputs, in addition to protection of the input amplifiers against mains voltages.

Summary

This appears to be a very useful limiter for the production of master tapes and similar applications, the selectable pre-emphasis being a very valuable tool that could well be used by many manufacturers of pre-recorded cassettes. Noise performance was quite adequate and the distortion performance unusually good for a limiter; the overall performance from other points of view was also good. While the operational controls are effective, it is felt that the metering arrangements are, to say the least, peculiar: the input metering reads the line input and not the limiter's input; the output position reads the limiter's output (which will remain constant under limiting conditions) and not the line output; and the gain reduction indication only shows gain reduction is occurring, as opposed to showing its level.

Of course, these comments are not related to the overall performance as a limiter, and it is felt that this is, in fact, a very useful device at a reasonable cost.

FIG. 5

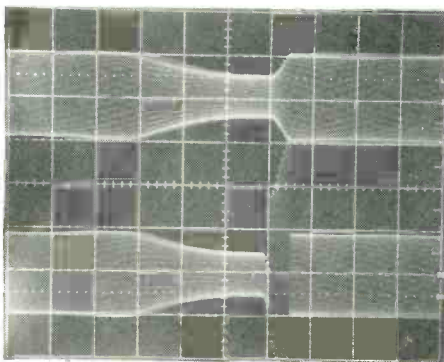
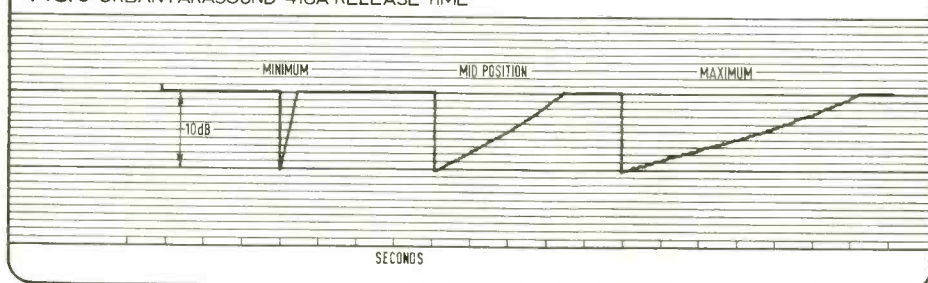

FIG. 6 ORBAN PARASOUND 418A RELEASE TIME



Worldwide agents for audio & design recording.

Australia

Audio & Recording, Holden Hill, S.A.
Tel: 261 1383

Austria

Soundmill Vienna, Peter J. Müller.
Tel: 222 Telex: 75922.

Brazil

Serion Ltd, Sao Paulo. Tel: 34 8725.

Canada

Noresco (Mfg) Co. Ltd., Ontario.
Tel: (416) 661 0541.

Telex: 065-24478, a/b Norescomfg.

Denmark

Ole Christensen, Audiophil,
Copenhagen. Tel: (01) 341 622.

Eastern Europe

Denis Tyler Ltd., West Drayton, UK.
Tel: (089 54) 43681. Tlx 23977.

Finland

Harold Burgen, Helsinki. Tel: 692 5308.

France

3M France, Paris.
Tel: (1) 031 61 61. Telex: 695185

West Germany

Elmus GmbH, Berlin.
Tel: (030) 312 2012.

Greece

Audiolab Hellas, Athens.
Tel: 822 5222. Tlx 5800.

Holland

Pieter Bollen, Eindhoven.
Tel: (040) 512 777 Tlx 59281

Italy

Roje Telecomunicazioni, Milan.
Tel: 415 4141. Tlx 39202.

Japan

Nissho-Iwai Co. Ltd., Tokyo.
Tel: (03) 544 8311.

New Zealand

General Video Co. Ltd., Wellington.
Tel: 872 574. Telex: 31255.

Norway

Siv. Ing. Benum & Co., Oslo, 2.
Tel: (02) 56 57 53.

South Africa

Eltron (Pty) Ltd., Johannesburg.
Tel: 23 0018.

South East Asia

Brunei, Indonesia, East Malaysia,
West Malaysia, Singapore — c/o
O'Connor's (Pty) Ltd., Singapore 5,
Tel: 637 944. Tlx Oconsin RS 21023

Sweden

KMH ljud Ab, Stockholm.
Tel: (08) 98 07 55. Telex: 13366.

Switzerland

Jim Duncombe, Zurich. Tel: 72 56 877

United States

Audio & Design Recording Inc.,
Honolulu. Tel: (808) 845 7226.

UK and All Other Territories

Audio & Design Recording Ltd.,
Reading, UK. Tel: (0734) 53411.
Telex: 847605 a/b Tillex G.

Take a COMPEX and a GIZMO —listen to the 'Consequences'

...says Martin Lawrence*

"When it comes to a choice of Compressor/Limiters, I always use the ADR Compex-Limiter on things that really matter. Although simpler compressors are available, they do have their limitations, whereas the Compex is truly multi-purpose.

'Consequences' for instance, extensively features the Gizmo. This amazing device produces infinite possibilities in sound and has a very wide dynamic range. To produce particularly low bass effects, I recorded some Gizmo pieces at 30 ips and replayed at 15. This doubled the apparency of random peaks, and levels generally became a serious problem — which the Compex-Limiter easily controlled! Set up on 2:1 compression slope with overall peak limiting, it achieved exactly the artistic effect that I required; what's more, I know that it couldn't have been done any other way.

On drums, the Compex excels. The compressor, limiter and noise gate functions can be so arranged as to create a tight, fat, clean sound. On overdubs too, I find the expander introduces a useful element of source noise reduction, while still leaving the compressor and peak limiter facilities available, simultaneously — on the same channel!

But, most important of all, using the Compex at successive stages, ensures that cutting problems are avoided and that the final product accurately resembles my efforts as an engineer. There is no doubt in my mind that for level control and auxiliary equipment, Audio & Design produce the best range of multi-purpose 'tools' available."

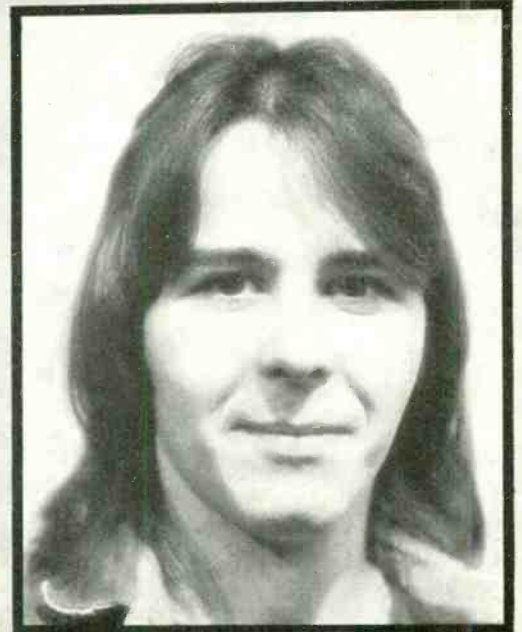

*Freelancer Martin Lawrence engineered and mixed the Lol Creme/Kevin Godley three album masterpiece 'Consequences' which was released worldwide on 17th October by Phonogram.



The F 760X-RS Compex Limiter is one of Audio & Design's wide range of creative engineering 'tools'. Write, phone or telex for details by return.

audio & design recording ltd.

St. Michaels, Shinfield Road, Reading, RG2 9BE, UK. Tel: (0734) — 53411



Manufacturing Members APRS

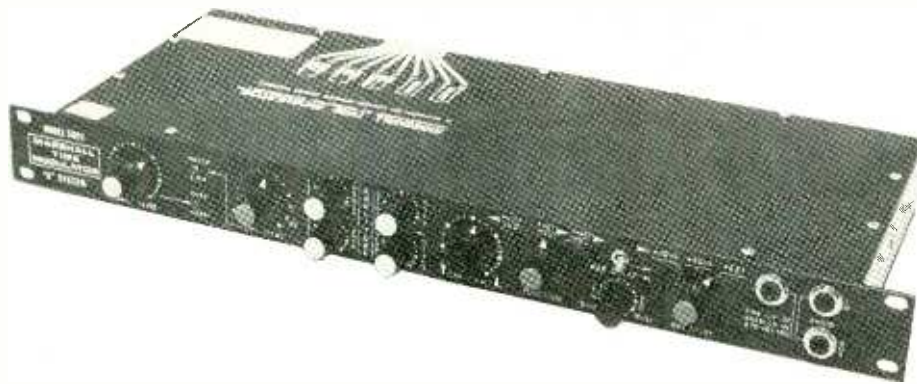

Marshall Time Modulator

Hugh Ford

MANUFACTURER'S SPECIFICATION

Maximum time before overdrive: 50 ms.
Maximum time with primary line in overdrive and secondary in ext: internally adjustable to more than 150 ms.
Frequency response: 30-15k Hz with the equivalent of 28 filter poles at 15 kHz.
Input impedance: 30k ohm, unbalanced.
Output impedance: 1 ohm; to drive 600 ohm or greater.
Nominal input level: +4 dBm.
Output drive: +18 dBm.
Doppler pitch change/vibrato range: >4 octaves.
Flange notch cancel depth: >80 dB.
Dynamic range: 90 dB at mean average delay.

Control voltage input impedance: 100k ohm.
Control voltage range: internally limited at $\pm 10V$, front-panel attenuated.
Gain: continuously variable for each parameter to above unity.
Power requirements: bipolar 20-24V, internally regulated.
Dimensions (wxdxh): 432 x 178 x 44.5 mm; rack standard.
PRICE: £1006.
Manufacturer: Marshall Electronic, Box 177 Joppa, Md 21085, USA.
UK Agent: Scenic Sounds Equipment, 97-99 Dean Street, London W1.

THE MARSHALL *Time Modulator* is a combination of electronic delay lines that are voltage controlled to give various special effects such as phasing, double-tracking and flanging. In addition, it can operate as a conventional voltage-controlled delay line, but its real value lies in the overall combination of delay lines and internal mixing facilities which eliminate the use of many controls on a mixing console.

Fig. 1 is a block diagram of the *Time*

Modulator. Working from the single-ended input, there is an input-level potentiometer followed by an overload detector that illuminates a red led indicator under even transient overload conditions. After this the audio signal is split so that there is a feed-through path to the output summing amplifier, and a path via the delay system which acts overall as a signal inverter. The signal applied to the delay system is derived from two sources: the input signal, and a signal fed back from the output via a

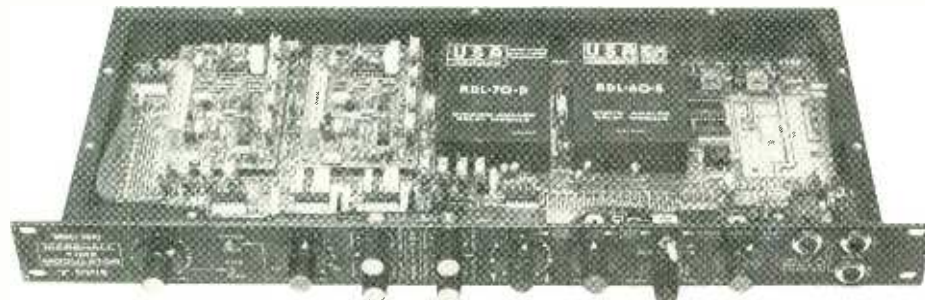

feedback control.

The delay line system consists of two separate analog delay lines, with an internal dbx system being used to reduce noise from the delay systems. The delay identified as 'primary' is always fed by the input, and its output feeds the output summing amplifier via a level control. Delay 2, effectively a unity gain device, is fed from selected taps on delay line 1, and feeds the output summing amplifier at a fixed level. It follows that the final output signal can be a combination of the input signal and two separate delayed versions of the input signal, with or without feedback around the delay system.

Both delay lines have their delay time voltage-controlled over a wide range. The control voltage is derived from a combination of a manual control and an internal sinewave oscillator, which covers the frequency range 0.1-10 Hz. In addition, there is a front-panel jack socket for applying an external voltage control from zero to +10V. Any attempt to drive the delay times out of range illuminates a front-panel indicator lamp which, like the overload lamp at the input, is illuminated as the overload is approached to give warning before disaster strikes.

A single rotary switch provides three modes of operation—audio delay, time modulation or phase shift—with appropriate controls being activated in each mode. In the delay-line mode the first delay line can be set over the range 1-50 ms, and the control voltage has a linear relation to the delay time. In the time-modulation mode of operation, however, the relationship between the delay times and the control voltage is exponential, and the time range of the first delay line becomes 1-25 ms. Similarly, in the phase shift mode the control law is exponential, but the range of the first delay line is shortened to between 200 μs and 6 ms, with the possibility of 12 ms under reduced performance conditions.

While the foregoing is but an abbreviated description of the *Time Modulator*, it can be seen that it is indeed a versatile device capable of effects that would require two separate delay lines and a number of channels on the desk. Furthermore, being an analog device, it does not have the various disadvantages of digital delays and, as will be seen, the noise performance is good in comparison with other analog delay units because of internal noise reduction.

In construction the *Time Modulator* is a slim unit designed for mounting in a standard 483 mm rack. However, it does not have its own power supply unit, and requires an external source of ± 20 to $\pm 24V$ dc, which is stabilised within the unit.

The power supplies and the audio input and output are connected by a single printed-circuit edge connector at the rear of the unit, with the signal connections being duplicated by single-pole 6.3 mm jack sockets on the front panel. The rear connections form part of the extremely tidy pcb that contains the majority of the electronic components, there being two 'piggy-back' boards containing the remainder. Wiring to the front-panel controls is also in the form of a printed circuit, but of the flexible type this time.

All components are clearly identified, as are the rear-panel connections and the front-panel controls. Overall the *Time Modulator* has a

76 ►



fact: the 10 most common nuisances in PA can be cured. permanently. instantly.

These 10 problem solvers in your toolbox are like 10 new tricks up your sleeve. Or 10 hours of saved time. Or money in the bank. They tailor the sound, match the lines, smooth out the peaks, fill in the valleys, make molehills out of troubleshooting mountains. Snap one in. Out go the hassles. Without soldering, or splicing, or internal equipment modifications:

Problem:	Solution:	
Input Overload	A15A	Microphone Attenuator prevents input overload. Ideal where very strong signals are applied to a microphone input.
Phasing	A15PR	Phase Reverser reverses the phase of a balanced line without modification of equipment.
Low-Frequency Noise	A15HP	High Pass Filter provides a low-frequency microphone cutoff to reduce unwanted low-frequency noises and proximity effect.
High-Frequency Noise	A15LP	Low Pass Filter provides high-frequency cutoff to reduce objectionable high-frequency noises.
Lack of Presence	A15PA	Presence Adapter adds voice-range intelligibility and extra brilliance.
Sibilance	A15RS	Response Shaper provides excellent sibilance filtering; flattens microphone response.
Line Level to Mic Input	A15LA	Line Input Adapter converts balanced low-impedance microphone input to line level input.
Matching/ Bridging/Isolating	A15BT	Bridging Transformer, a balanced unit, matches balanced or unbalanced devices of different impedances.
Troubleshooting	A15TG	Tone Generator produces a continuous 700 Hz low-impedance microphone level signal — extremely useful in setting-up and troubleshooting lines. Helps check levels, connections, mixer inputs, and cables. Allows one man to do the work of two!
Microphone Impedance Matching	A95 and A97	Series Line Transformers make it possible to connect low-impedance lines to mid- and high-impedance inputs (or vice-versa). Completely reversible. Solves problems of excessive high-frequency loss and objectionable hum.

Shown Actual Size: 114mm (4½ in.) long x 19mm (¾ in.) diameter.



Send for the free Shure brochure, SEL3025



Shure Electronics Limited, Eccleston Road, Maidstone ME15 6AU—Telephone: Maidstone (0622) 59881

MARSHALL TIME MODULATOR

thoroughly professional appearance and a first-class mechanical design and layout. It would have been nice, however, to find the rear-panel connector mechanically shrouded, since this is clearly prone to mechanical damage with the disastrous result that the complete major circuit board would have to be written off!

The front-panel layout, which comprises black knobs with white pointers that align with quite adequate panel markings in white on the black panel, is functionally excellent, with easy access to the controls and ease of resetting to any required condition by means of 'set up sheets'.

Inputs and outputs

The audio input is unbalanced (without, surprisingly, the option of transformer coupling) and was found to have an input impedance that varied from 11.1k ohm at maximum input sensitivity, up to 25.9k ohm at minimum gain. Although this is a rather large range, the impedance is high enough not to give trouble with normal studio equipment, and the impedance was generally nearer to the high limit for practical control settings.

With the input control set for maximum sensitivity the input overload point was at +12.5 dBm, with the overload lamp illuminating some 4.5 dB lower at +8 dBm input; the input level at lower sensitivity settings is effectively infinite. Operation of the overload indicator was found to be very rapid, such that it readily indicated overload on programme peaks, but it would have been better if the lamp had been 'slugged' so that it remained

illuminated longer on peaks.

The maximum output level was found to be +19 dBm at the onset of output clipping when loaded with a 600 ohm load; or the equivalent of +21.4 dBm into a high impedance. These levels are certainly more than adequate, and the low output impedance of less than one ohm is excellent. However, there is no indication of output overload, which is a condition that can easily occur, particularly when the feedback mode of operation is in use.

A further front-panel jack connector, this time in the form of a 3-pole jack socket, allows for external voltage control over the range 0 to +10V for the full time range. The input impedance of this connection was found to be 47.6k ohm, which is adequately high but below the specification of 100k ohm.

The overall available gain in the audio chain in both the delay mode and the phasing mode was found to be 8.5 dB, with unity gain occurring at the mid-point settings of either the input gain control or the overall output gain control. But I would emphasise again that the overall gain can be extremely high when the feedback mode is in use, and an output overload indicator would be valuable in these circumstances.

	0 dBm output at 1 kHz	No signal
Band-limited rms noise (20 Hz to 20 kHz)	90 dBm	81.5 dBm
A-weighted rms noise	93 dBm	89.5 dBm
CCIR-weighted noise (ref 1 kHz rms)		> 79 dBm
CCIR-weighted noise (ref 1 kHz quasi-peak)		> 75 dBm

Noise and distortion

Due to the use of an internal dbx noise reduction system, the unit's noise performance varies not only with the mode of operation but also with the signal level applied. However, in the common modes of operation this was not particularly significant, the tabulated noise levels being recorded at the output with the input and overall gains set to maximum, and the time modulation mode selected.

Having regard to the drive capability of +21.4 dBm the above noise levels represent a most excellent available dynamic range. Also the level of spurious hf outputs was such that they are unlikely to cause trouble in other equipment.

As with noise, the level of harmonic distortion varies with the signal level, but again the variations are not unduly wide. Fig. 2 shows a typical situation at an output level of 0 dBm with the *Time Modulator* set to maximum delay in the normal delay line mode. It can be seen that while the third (and for that matter higher) harmonic distortion is generally below 0.3% the second, but less objectionable, harmonic level is high.

Similarly the intermodulation distortion to the CCIR twin-tone method was found to be high, with a consistent 3% second order and 0.3% third order difference-frequency distortion over the audio passband.

Frequency response

The overall frequency response in most modes of operation is shown in fig. 3 for both delay lines (which are virtually identical). As can be seen the response is adequately flat up to 15 kHz where the very sharp filter comes into play in order to stop any beating effects with the unit's internal clock frequency.

The performance in the time modulation

78 ►

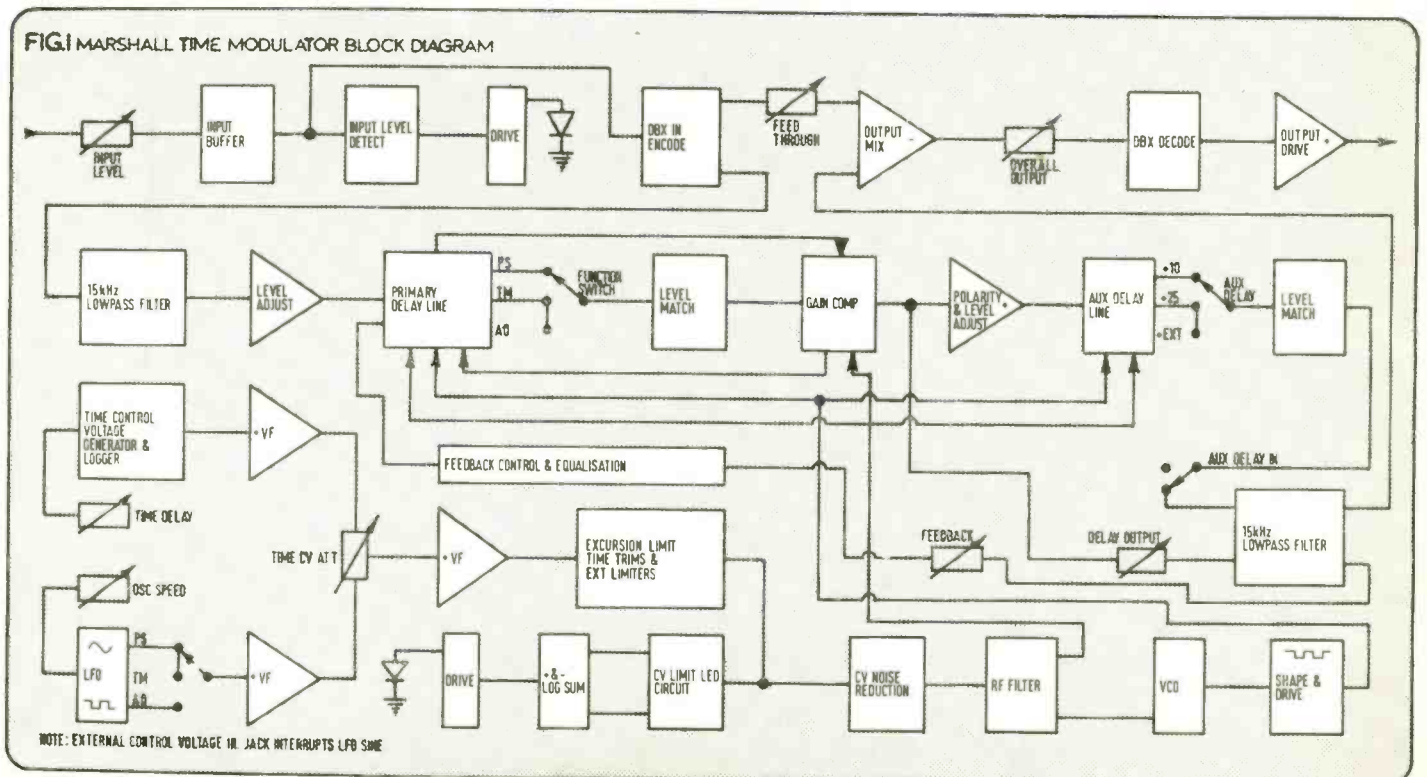

NEUTRIC

SWISS MADE

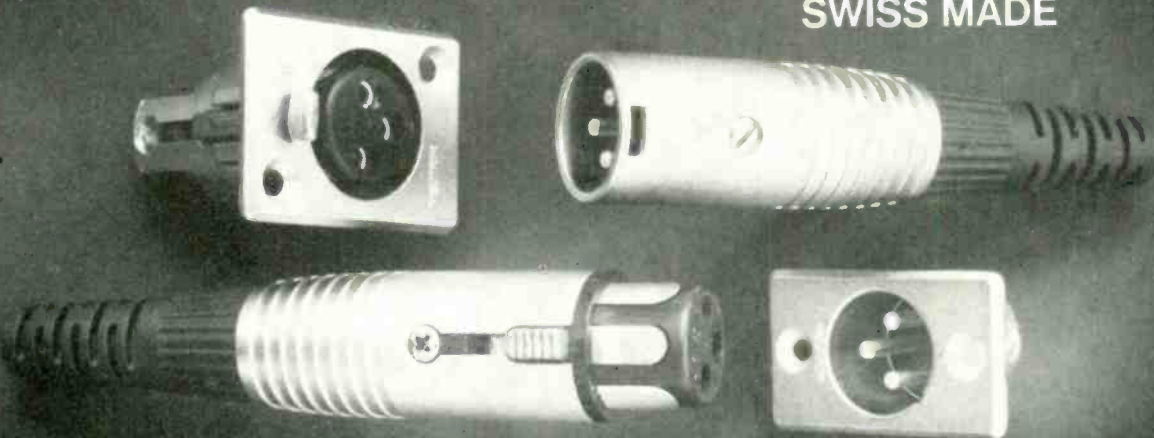

**A New Range of Competitively Priced Connectors
for Microphones, and Sockets for Mixers, Amplifiers Etc.**

Sole U.K. Agent:

G.E. ELECTRONICS (LONDON) LTD.
Eardley House, 182/4 Campden Hill Road, London.
Telephone: 01-727 0711/3 Telex: 23894

Main Distributors:

FUTURE FILM DEVELOPMENTS LIMITED, LONDON.
A.C. FARNELL LIMITED, LEEDS.

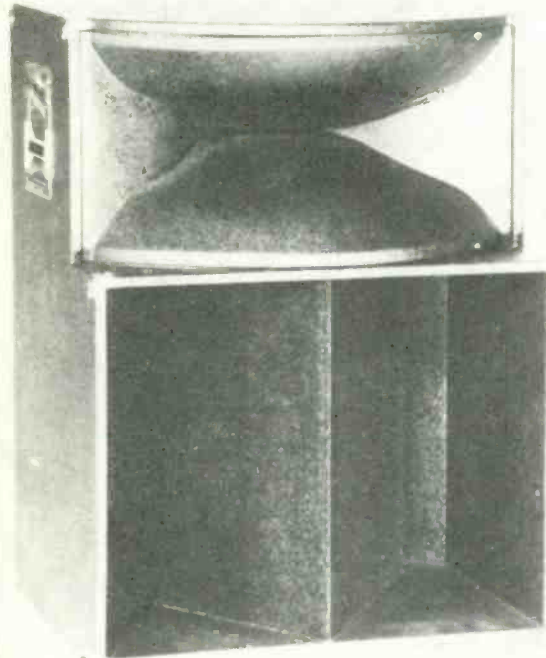

SP-1

SPIDER BIN

200 Watts (40 Volts RMS Programme)
 ± 3 dB 60-3000 Hz 6 dB/octave roll off
3000 Hz to 13000 Hz Compensate for
roll off with standard tone control

500 Hz Crossover (12 dB/octave)

Dispersion: 45°V x 90°H 2000-13000 Hz
105°V x 90°H 500 Hz

Dimensions: 77.5 cm x 61 cm x 103 cm

Weight: 67.5 kg

AVAILABLE IN TWO SECTIONS
MODEL 22 COMPRESSION DRIVER
AVAILABLE SEPARATELY

PEAVEY—WHAT EVERY SPEAKER SYSTEM WOULD LIKE TO BE!

FULL DETAILS FROM: **PEAVEY ELECTRONICS (U.K.) LTD.,**
49 THE BROADWAY, HAYWARDS HEATH, SUSSEX RH16 3AS

IF YOU NEED JACKFIELDS WHY NOT TALK TO THE SPECIALISTS?

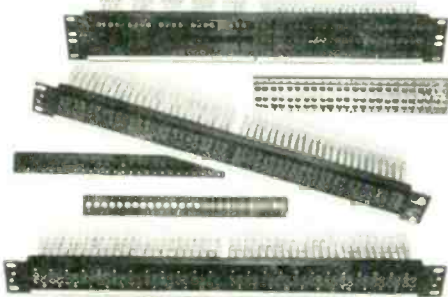

PANELS AND ASSEMBLIES

No supplier offers a wider range of panels, inserts and accessories for just about any configuration. And you can get them in any stage of assembly . . . individual components, sub-assemblies, or complete pre-wired and connectorised assemblies ready to install. Our Bantam range gives a space saving of up to 50 per cent.

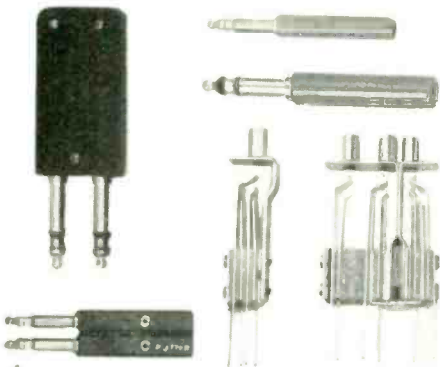

JACKS AND PLUGS

Singles, twins, back-to-back, 2+1, patch and switchboard cords, in long frame and Bantam, and our new Printed Circuit Board Jacks. Most standard types are available for immediate off-the-shelf delivery.

For further information on these and our range of B.P.O. type components, telephone or send the attached below to:

C.A.E. LIMITED

70/82 Akeman Street, Tring, Herts.
HP23 6AJ
Tel. (044 242) 4011 Telex: 82362 BATECO G

Please send us copy of current catalogue

NAME
COMPANY
POSITION..... Tel.....
ADDRESS

MARSHALL TIME MODULATOR

mode is shown in fig. 4, which illustrates the degree of cancellation of discrete frequencies that appears as a comb filter. In fact the depth of the 'notches' is extreme, with 111 dB of cancellation of a 1 kHz tone being measured —far in excess of specification.

The phasing mode produces a similar comb filter pattern, but in this instance there is an 18 dB rolloff resulting from phase cancellation. This is produced by the fact that the delay section is inverted at the output, and the through feed is not.

Other matters

The available delay times were checked and found to be adequately close to those specified, with the control voltage lamp becoming illuminated when the delay setting approached 60% of the maximum available delay. On the other hand, the minimum delay at which the control voltage lamp illuminated was found to be close to the minimum available delay.

The power requirements were virtually unaffected by the input voltage over the

specified range, with the positive rail requiring a maximum of 90 mA and the negative rail 150 mA under full drive conditions into a 600 ohm load.

Summary

The Marshall *Time Modulator* must be one of the most versatile effects generators on the market, and it is fair to say that its performance is far better than the majority of similar products. It is felt, however, that the distortion at all program levels is on the high side, but this is not necessarily of any significance for many applications.

The standard of construction and layout can be fairly said to be to the very highest standards, and although some practice is necessary to 'drive' the *Time Modulator*, all controls are clearly identified and have easy access. ■

Manufacturer's comment

'We have had a chance to check on the distortion figures that you gave us and find it unusually high. Perhaps that unit is out of adjustment from shipping vibrations. We get 1% second harmonic distortion typically.'

MARSHALL TIME MODULATOR

FIG. 2
HARMONIC DISTORTION AT MAXIMUM DELAY

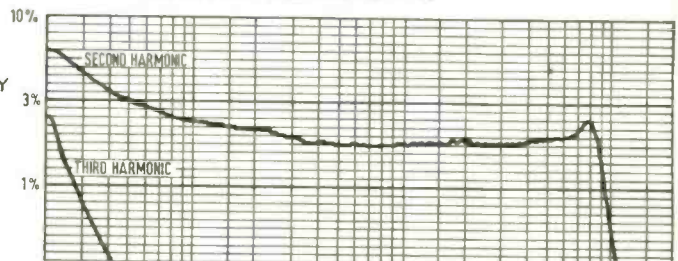

FIG. 3
FREQUENCY RESPONSE OF DELAY LINES
0dB OUTPUT

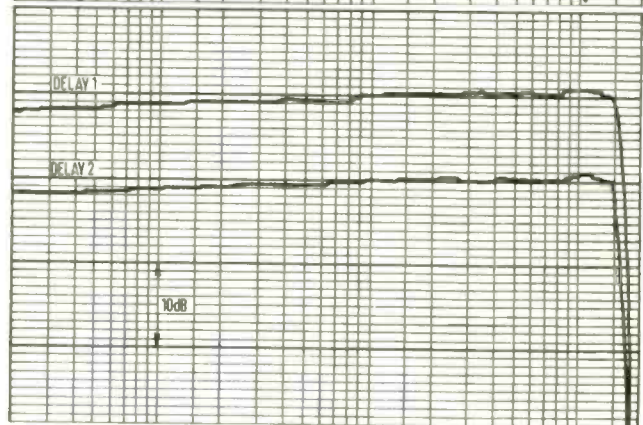
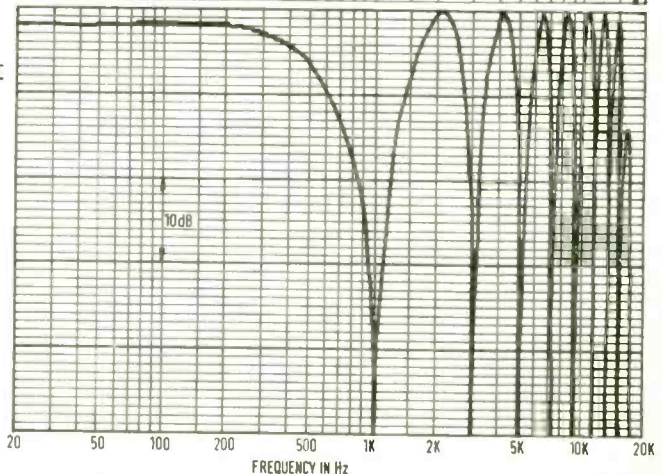

FIG. 4
FREQUENCY RESPONSE IN TIME MODULATION MODE



There is a Dolby noise reduction unit for every professional application

Professional recording and transmission applications



360

The Dolby 360 is a basic single-channel A-type noise reduction unit for encoding or decoding. This unit is normally used in a fixed mode such as in disc cutting or landline sending or receiving; the operating mode is manually selected.



361

The Dolby 361 is similar to the 360, providing a single channel of A-type noise reduction, but with relay switching of operating mode and tape recorder connections. The changeover can be controlled automatically by the recorder.

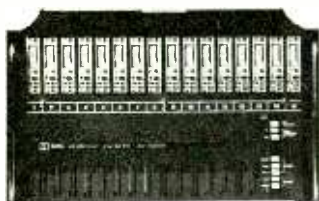

M-Series

The Dolby M16H A-type unit is designed specifically for professional multi-track recording, and incorporates 16 channels of noise reduction in a compact chassis only 10½ inches high. The similar M8H is an 8-track version, and the M8XH allows simple extension of the M16H for 24-track use.

Noise reduction module



Cat no. 22

The Dolby noise reduction module, Cat no. 22, is the basic functional unit employed in all A-type equipment. The Cat no. 22 is available as a spare or in quantity to OEM users for factory installation. A half-speed version of the module (Cat no. 40) is also available.



Dolby Laboratories Inc.
Dolby, Dolbyized and the double-D symbol are trade marks of Dolby Laboratories Inc

Motion picture industry



364

The Dolby 364 Cinema Noise Reduction Unit is intended primarily for use with Dolby A-type encoded optical sound-tracks. The 364 also includes a standard 'academy' filter for conventional tracks, and provision for playback of magnetic sound tracks with or without Dolby system encoding.



E2

The Dolby E2 Cinema Equalizer is a companion unit to the 364, and has been specifically designed to solve the response equalization problems of cinemas. Used with the 364 and Dolbyized optical sound-tracks the E2 enables most cinemas to achieve modern sound reproduction standards without replacement of existing equipment.

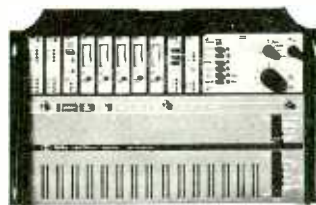

CP100

The Dolby CP100 Cinema Processor is designed for the reproduction of all current and presently foreseeable film sound-track formats including conventional optical and magnetic tracks, Dolby encoded monaural optical tracks, Dolby encoded magnetic sound-tracks and the new stereo optical release prints. Up to three noise reduction modules can be incorporated. Typically, three channels of theatre equalization, as in the E2, will be incorporated, but facilities exist for five channels of equalization and the connection of an external quadraphonic decoder.

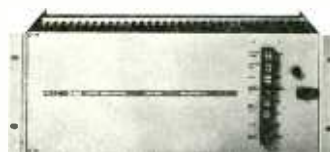

CP50

The new Model CP50 is intended for the reproduction of all optical soundtrack formats, Dolby encoded and conventional, mono and stereo. The unit is designed to interface with an existing fader and magnetic stereo installation. A wide range of accessories is available.

731 Sansome Street, San Francisco, CA 94111
Telephone (415) 392-0300, Telex 34409
Cable Dolbylabs

Professional encoders for consumer media



330

The Dolby 330 Tape Duplication Unit is a professional quality unit with B-type (consumer) noise reduction characteristics. The unit is used for encoding duplicating master tapes in the high-speed duplication of Dolbyized cassettes, cartridges, and open-reel tapes. The 330 is a two-channel unit.



334

The 334 FM Broadcast Unit allows broadcast stations to encode stereo FM broadcasts with the Dolby B-type characteristic. The unit also provides for a reduction of high frequency pre-emphasis to 25 microseconds; this reduces the need for high frequency limiting, thus allowing a significant additional improvement in reception quality.

Test set (A-type)



Cat no. 35

The Dolby NRM Test set, Cat no. 35, permits rapid verification of performance of Cat no. 22 noise reduction modules without their removal or the need for additional test equipment.

Noise weighting filter



Cat. Nr. 98A

Noise weighting filter to CCIR/ARM characteristic (recommended by Dolby Laboratories). Filter is used with average responding meter (ordinary millivoltmeter) allowing noise measurements to be made on tape recorders, tapes, FM tuners, etc, with results which correlate closely with the subjective effect of the noise. Filter can be used for the testing of professional and consumer equipment.

346 Clapham Road, London SW9 9AP
Telephone 01-720 1111, Telex 919109
Cable Dolbylabs London

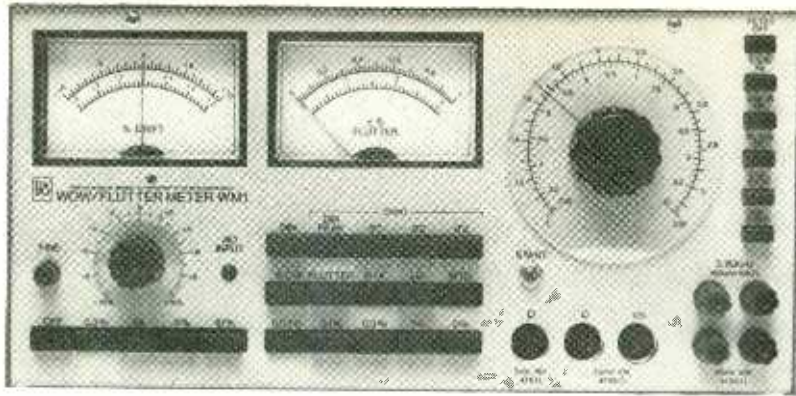

Bang & Olufsen WMI wow & flutter meter

Hugh Ford

MANUFACTURER'S SPECIFICATION

OSCILLATOR

Waveform: sine.
Frequency: 3.15 kHz.
Stability: approx 5×10^{-5} within 8 hours; approx 5×10^{-4} within 1 year.
Output: voltage approx 100 mV rms; impedance 10k ohm.

DRIFT METER

Range: $\pm 0.316\%$; $\pm 1\%$; $\pm 3.16\%$; $\pm 10\%$.
Accuracy: $\pm 3\%$ full-scale.
Offset: 0 to $\pm 10\%$ (calibrated).

WOW/FLUTTER METER

Range: $\pm 0.0316\%$; $\pm 0.1\%$; 0.316% ; $\pm 1\%$; $\pm 3.16\%$...
Accuracy: $\pm 3\%$ full-scale.

FILTERS

Wow: 0.2-6 Hz (± 3 dB).
Flutter: 6-300 Hz (± 3 dB).
Weighting: to DIN 45 507/IEC 409.
Linear: 0.2-300 Hz (± 3 dB).

METER CIRCUITS

DIN: specifications to DIN 45 507/IEC 409.
DIN peak: specifications to DIN 45 507; automatic indication of the highest peak value of wow/flutter measured in a period of 30s.
Sigma 1, Sigma 2 and Sigma 3: automatic indication of the highest peak value of wow/flutter, without random peaks of periods 32% (Sigma 1), 5% (Sigma 2) and 3% (Sigma 3) in the period of measurement.

IT IS probably a little-known fact that Bang & Olufsen are not newcomers to the test gear business, and that they manufacture a range of equipment aimed at servicing requirements and production line measurements.

The wow and flutter meter reviewed here is a completely new venture, and simply reading through the specification shows that it is a comprehensive instrument, on a par with the most sophisticated meters but at a highly competitive price.

Basically there are four parts to the instrument: an internal oscillator; a drift indicating section; a wow and flutter section; and a spectrum analyser. The oscillator section is at the fixed international standard frequency of 3150 Hz for recording wow and flutter tests. It has outputs fed to a pair of terminal/banana sockets on the standard spacing, and also to a 5-pole DIN socket for tape recorder testing.

The input to the instrument has four convenient connectors: a pair of terminal/banana sockets, again on standard spacing; a tape-recorder DIN socket; and two further DIN sockets for magnetic or ceramic cartridges that have appropriate input sensitivities and impedances.

While the oscillator is always fed to the outputs, the absence of an input signal of adequate level and within range in frequency is indicated by a red led in the drift section of the instrument. This section comprises a clearly scaled meter with ranges of ± 10 and ± 3 , which operate in conjunction with five interlocked pushbuttons giving ranges $\pm 10\%$, and $\pm 3\%$ $\pm 1\%$ and $\pm 0.3\%$ drift plus an 'off' position.

The drift zero indication can be calibrated from the internal oscillator by means of two controls: a $\pm 10\%$ drift offset control, which is calibrated; and a fine adjustment that is uncalibrated. Even on the most sensitive range the response of these controls was found to be very good, enabling quick setting of the zero drift point.

Turning to the wow and flutter section; this is most comprehensive, including not only normal DIN measurements but also sigma and quasi-peak measurements over 5s or 30s periods. The section is based on a second meter that is calibrated from 0 to 3 and 0 to 1, providing ranges of full-scale \pm wow and flutter between $\pm 3\%$ and an extremely sensitive $\pm 0.03\%$ in a 3:1 sequence. Above the interlocked selector switches for these ranges there is a further two rows of interlocked buttons. The first selects the type of measurement in terms of 'weighting', such that the instrument can indicate wow, flutter or wow and flutter in either the flat unweighted mode or in the presence of the IEC (DIN) weighting curve. Actually, I'm not sure if it's a good idea to have the option of analysing wow or flutter in the presence of the weighting curve, because it's easy to fall into the trap of accidentally leaving one of these buttons pressed. It might have been better to interlock all these possible functions to prevent such mishaps.

The other row of pushbuttons selects the type of metering out of five possibilities. Naturally, there's the standard IEC (marked 'DIN') metering condition, but in addition there is a 'DIN peak' condition, which indicates

FREQUENCY ANALYSER

Range: 1 to 316 Hz in 5 ranges: 1-3.16 Hz; 3.16-10 Hz; 10-31.6 Hz; 31.6-100 Hz; 100-316 Hz.
Bandwidth: 10% (± 3 dB).
Attenuation: 40 dB/octave.

Linearity: frequency better than $\pm 5\%$; amplitude better than ± 1.5 dB.

Remote option: control voltage 0 to ± 10 V in all ranges (linearity better than $\pm 5\%$); input impedance approx 10 kohm.

INPUTS

Common input for wow, flutter and speed stability. Automatic indication of insufficient input signal voltage ('no input'), together with automatic connection to internal reference oscillator.

Phono low-impedance: 5-pole DIN; voltage 3 mV to 10V; impedance 47 kohm $\pm 5\%$.

Phono high-impedance: 5-pole DIN; voltage 30 mV to 10V; impedance 470 kohm $\pm 5\%$.

Tape: 5-pole DIN; voltage 30mV to 10V; impedance 470 kohm $\pm 5\%$.

OUTPUTS

Speed stability: voltage ± 1 V dc $\pm 3\%$ full-scale; impedance 10 kohm $\pm 1\%$; BNC connector.

Wow/flutter ac: voltage 1V ac $\pm 3\%$ full-scale; impedance 10 kohm $\pm 1\%$; BNC connector.

Wow/flutter dc: voltage 1V dc $\pm 3\%$ full-scale; impedance 10 kohm $\pm 1\%$; BNC connector.

Remote (optional): 37-pole multisocket. All functions and ranges can be remote controlled (ttl compatible).

Mains power: 110/220V ac $\pm 10\%$, 50-400 Hz; consumption approximately 10W.

Temperature range: 0-50°C.

Dimensions (w x d x h): 323 x 210 x 160 mm.

Weight: 5.7 kg.

Price: approx £500.

Manufacturer: Bang & Olufsen a/s, 7600 Struer, Denmark.

UK Agent: Bang & Olufsen (UK) Ltd, Eastbrook Road, Gloucester.

the highest peak over a 30s period, and also three sigma options that indicate the highest value of wow and flutter over 32%, 5% or 3% of the period of measurement (excluding random peaks). The latter functions are initiated by pressing a 'start' button, whereupon the meter indicates zero until the end of the period of measurement when it then indicates permanently the measured value.

In my opinion these sigma functions are very valuable tools, as they eliminate the need to interpret a meter movement, which always depends upon the operator. Thus more consistent measurements can be made.

The spectrum analyser section operates in conjunction with the wow and flutter section, which is used as the indicator for the output of the analyser; thus analysis is performed with any of the previously-mentioned weighting or metering conditions. The analyser covers the frequency range 1-316 Hz in five ranges by a 3.16 : 1 sequence achieved by pushbutton range selection. Actual indication of frequency is by a large diameter dial clearly calibrated from 1 to 3.16 and 3.16 to 10. In operation the dial is tuned to the desired frequency and the indication of the wow and flutter meter is read, the wow and flutter range switch being used as a 10 dB attenuator while searching for low levels at any give frequency.

Presentation of the operator facilities is excellent, with very clear marking of all controls and indicators on the front panel of the case. It is annoying, however, that the



PHILIPS

Before you buy a cassette, explode it.



If you're one of the many people who don't have much time for technical drawings, you may just change your mind next time you have a cassette that jams on you.

Because these two little strips of transparent foil you see in the picture above, are Philips' unique way of making sure it doesn't happen again.

You see, since Philips invented compact cassettes in the sixties, we reckon we know more about them than anyone else. Including their snags, like tape jamming.

That's why we invented the Floating Foil system to keep the movements of the cassette quite steady. The improved regularity of the cassette movement also has the splendid effect of improving the sound quality.

Philips compact cassettes come in three qualities - Standard and Super - C60, C90 and C120 minute playing times and Hi-Fi Chromium Dioxide 60 and 90 minutes.

Philips invented the compact cassette. Now we've improved it.

Simply years ahead



BANG & OLUFSEN WMI

case is not provided with a tilting foot, which is so useful when one has to read meters.

Internally, the instrument is based on a mother board into which five further boards are plugged. The oscillator board can be purchased as either a RC oscillator or a crystal oscillator. All boards and components are of good quality, but no component indentifications were provided. However, it is suspected that this is because the review sample is an early unit, and that production units will be suitably identified. In spite of this small detail there is certainly no cause for complaint about the standard of construction or finish.

Finally, before dealing with the actual performance, mention must be made of the rear-panel facilities that include BNC sockets providing a dc drift output of 1V for full-scale drift meter indication; a dc and an ac wow and flutter output at the same level; and an optional remote-control output. This last output is said to be a ttl-compatible interface, and is clearly included for measurements with automatic test equipment—a field in which the Bang & Olufsen factory has much expertise and experience.

Oscillator section

The oscillator parameters of concern in wow and flutter meters are frequency stability and absolute frequency, so both these were carefully investigated.

Frequency was plotted with a resolution of

1 part in 10^6 over a period of 2.5 hours from switch-on in a cold room. The crystal oscillator did not exhibit any observable drift at all—more than adequate! However, the actual frequency was found to be 3149.86 Hz—0.0044% below nominal—and this accuracy is not good enough for determining the absolute speed of some of the very best modern recorders.

At the two oscillator outputs the voltage was found to be 102 mV rms from a source impedance of 4750 ohm, both of which are satisfactory, but the impedance is lower than specification.

Drift meter

Setting of the zero drift indication was well 'tuned' with the coarse and fine controls, and while the long-term stability of the zero point was good it was found necessary to reset the zero point from time to time when using the most sensitive ($\pm 0.3\%$) range.

Accuracy of the drift measurement was checked at a minimum of four scale points on each range and found to be at worst 2% of full-scale indication, which is certainly more than adequate and within the specification of $\pm 3\%$ of fsd. Although the accuracy of the drift offset control is not specified, this too had adequate accuracy, with a worst case error of only 5% of the full-scale capability of $\pm 10\%$ offset.

The rear-panel drift output was found to be $+0.993, -0.987V$ dc for full-scale drift indication. Allowing for meter readability, this is very accurate in comparison with the specified

$\pm 1V$ from a source impedance of 10 050 ohm, which in turn is within the quoted 10k ohm $\pm 1\%$.

Wow and flutter section

This can be considered in two parts: the weighting networks and the metering section. So far as the weighting networks are concerned, only one filter is required for measurements to the IEC/DIN standard. The characteristics of this filter are shown in fig. 1. It can be seen that the accuracy of the filter is well within the standard requirements. In the unweighted mode, the IEC/DIN documents specify the flatness of the characteristics and the upper and lower frequency roll-off points. Fig. 2 shows that these requirements are easily met.

In addition to the standard requirements, the instrument includes separate 'wow' and 'flutter' filters. The characteristics of these are shown in fig. 2, and correspond to the manufacturer's specification.

Turning to the other meter characteristics specified in the IEC/DIN standards, the effective meter ballistics—as tested with unidirectional bursts of frequency variation—were well within the standard requirements as follows:

burst length	actual indication	standard requirement
100 ms	100%	100 $\pm 4\%$
60 ms	87%	90 $\pm 6\%$
30 ms	60%	62 $\pm 6\%$
10 ms	22%	21 $\pm 3\%$

The actual indicated wow and flutter was found to be within 2% of full-scale deflection, which is far better than the standard requirement of $\pm 10\%$ and within the manufacturer's specification of $\pm 3\%$. While the other metering facilities were not investigated in detail, the 'DIN peak' facility worked effectively and the three very useful sigma functions appeared to do all that is claimed of them.

Analyser section

This section of the instrument was found to be effectively connected in series with the weighting or filter curves and the metering section, thus providing a means of determining the most offending wow and flutter components without having to calculate the effects of weighting curves. It is, however, perhaps peculiar that a 100-316 Hz range has been included, since even in the linear mode the overall frequency response is falling off in this area.

In practical use the analyser section functioned well, and its frequency and amplitude calibrations were well within the manufacturer's specification on all ranges.

Summary

The Bang & Olufsen WMI wow and flutter meter is a most welcome addition to the market where there is a shortage of good meters at anything like a reasonable price. It is well made and meets the important requirements of the IEC/DIN wow and flutter standards with great ease. In addition, the instrument has other facilities including the sigma functions and a spectrum analyser. A pure wow and flutter meter with this performance is not easily found at the same price, and as a result this instrument is to be thoroughly recommended. ■

FIG. 1
B & O WMI
FREQUENCY
RESPONSE OF
WEIGHTING NETWORK

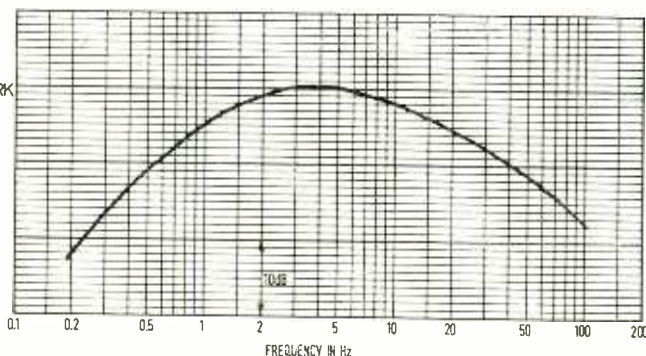
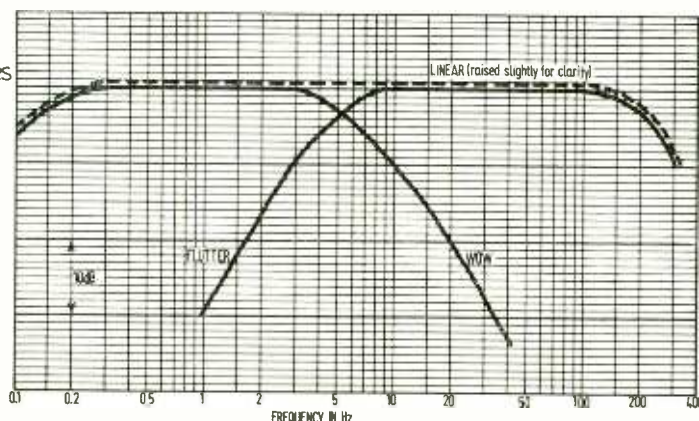

FIG. 2
B & O WMI
FREQUENCY
RESPONSE OF FILTERS



what do you get from **TWEED?**

The answer is simple:

Quality, Reliability and
Performance at Modest Cost.

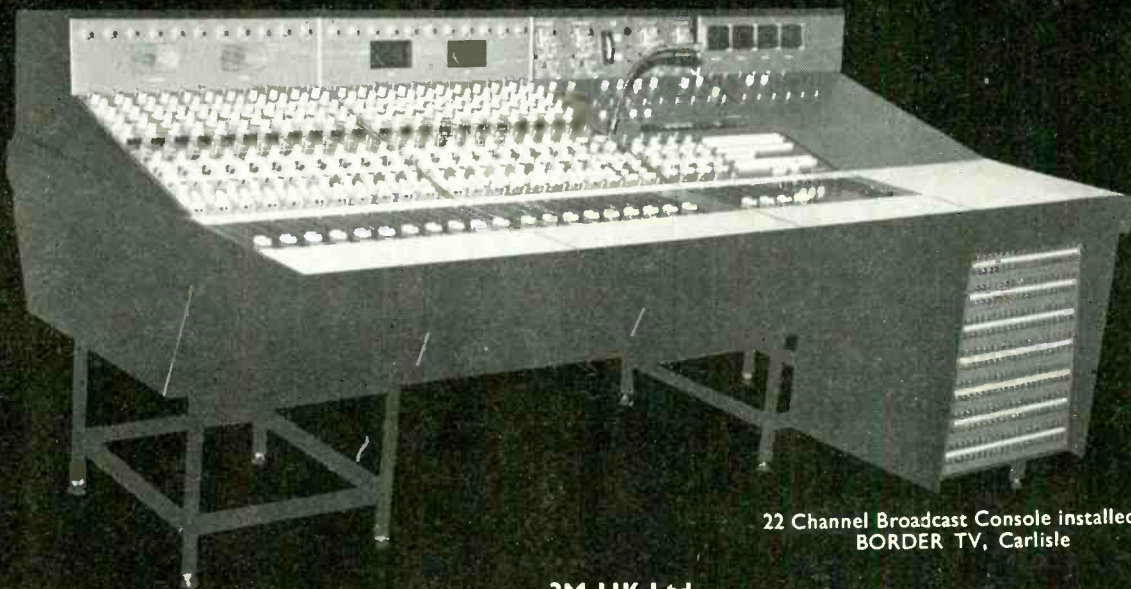

22 Channel Broadcast Console installed at
BORDER TV, Carlisle

Specialists in Audio Control equipment for the
Broadcast and Sound Recording Industries

TWEED AUDIO



Pinnacle Hill Ind Estate
Kelso, Roxburghshire
Tel: (057-32) 2983 Telex: 727633

3M UK Ltd

Witley Gardens
Witley Walk, Southall
01-547 5929/6045
Telex: 932510

Sait Electronics

Chausse De Ruisbroek 66
B-1190, Bruxelles
Telex: 21601

Exhibo Italiana

Via F Frisi 22
20052 Monza
Italy
Telex: 25315

Pro-Technic AS

Lyder Sagensgt 19
OSLO 3

Classified Advertisements

Advertisements for this section must be pre-paid. The rate is 18p per word, minimum £3.60. Box Nos. 45p extra. Semi-display rates on application. Copy and remittance for advertisements in FEBRUARY 1978 issue must reach these offices by 21st DECEMBER 1977 addressed to: The Advertisement Manager, Studio Sound, Link House, Dingwall Avenue, Croydon CR9 2TA.

Note: Advertisement copy must be clearly printed in block capitals or typewritten. Replies to Box Nos should be addressed to the Advertisement Manager, Studio Sound, Link House, Dingwall Avenue, Croydon CR9 2TA, and the Box No. quoted on the outside of the envelope. The district after Box No. indicates its locality. **SEX DISCRIMINATION ACT 1975:** No job advertisement which indicates or can reasonably be understood as indicating an intention to discriminate on grounds of sex (e.g. by inviting applications only from males or only from females) may be accepted, unless (1) the job is for the purpose of a private householder or (2) it is in a business employing less than six persons or (3) it is otherwise excepted from the requirements of the Sex Discrimination Act. A statement must be made at the time the advertisement is placed saying which of the exceptions in the Act is considered to apply.

STUDIO FACILITIES

SPR SPEECH RECORDING
CASSETTE DUPLICATING
OPEN-REEL DUPLICATING
LANGUAGES/AUDIO-VISUAL

SPEECH-PLUS RECORDINGS LTD
32, PAGES WALK, SOUTHWARK, LONDON SE1 4SB. 01-231 0961/2

★ **Fanfare Records.** Tape-disc pressings, demo's, masters, any quantity. Studio/mobile Neumann disc cutter. S.A.E. brochure. 1 Broomfield Close, Rydes Hill, Guildford. Tel. 0483 61684. X

★ **Your Tapes to Disc.** Mono or Stereo cutting. Vinylite pressings, Sleeves/Labels. Top professional quality. S.A.E. for photo leaflet. Dero Records, "Eastwood", Cove, Dunbartonshire, Scotland. X

□□□□□□□□□□□□□□□□□□□□□□□□
□□□□□□□□□□□□□□□□□□□□□□□□
COUNTY RECORDING SERVICE
From your tapes we cut master discs, demo discs, using our Stully lathe fitted with the latest ME/76 UK stereo disc-cutting system.
Dolby 'A', Dolby 'B' and DBX Noise Reduction.
Telephone Bracknell (0344) 54935.
London Road, Binfield, Bracknell, Berks, England

★ **Sound News Productions.** Britain's oldest full-time tape/disc/cassette transfer service. Direct transfers, pressings for private and for the trade. Fund-raising advisory service for Societies, Choirs, Bands. (Ferroglyph, Vortexion, Revox equipment promptly serviced.) 18 Blenheim Road, London W4. Tel. 995 1661. C

████████████████████
WOLLENSAKS
CASSETTE FAST COPIERS
2770 mono & 2772 stereo, meticulously aligned by Experts. HEAVY DUTY RECORDERS: 2551 Visual Sync & 2520 9 watt.
SOUND CASSETTE SERVICE
P.O. Box 2, Gerrards Cross, Bucks. SL9 8EG
Tel. 02813 84409

★ **Tape/Disc Masters, Demos (Neumann Lathe).** Pressings, Cassettes. Mobile Recording Studio. Free Brochure. Tam Studio, 13a Hamilton Way, London, N.3. Tel. 01-346 0033. A

HIGH SPEED CASSETTE COPYING IN MONO OR STEREO AT COMPETITIVE PRICES

Long or short runs.
Blank cassettes supplied in bulk.
A growing reputation for reliability.

MORARD SOUND PRODUCTIONS
THORNTON HEATH, SURREY
Telephone 01-689 7424

★ **Gemini Sound Services.** 4 track mobile recording unit and well equipped studio available for voice/music recordings for commercials, audio promotions, films and television. Record production from performance to pressings. Woking (Surrey) 60268. A

FOR SALE—TRADE

★ **Cathedral Sound** manufacture a professional standard compressor/limiter module for under £25, mixer modules, and complete mixer channels. Professional discounts available on Revox, N.E.A.L., Sennheiser, also MM mixers. S.A.E. details. Cathedral Sound, Fourways, Morris Lane, Halsall, Lancs. L39 8SX. Tel. Halsall (0704) 840328. X

SOWTER TYPE 3678 MULTITAP MICROPHONE TRANSFORMER
Primary windings for 600 ohm, 200 ohm and 60 ohm with Secondary loadings from 2K ohm to 10K ohm. Frequency response plus/minus ±dB 20 Hz to 25 kHz. Contained in well finished Miumetal box, 33mm diameter by 22mm high, with colour coded end leads, low distortion. DELIVERY (small quantities) EX STOCK. HIGHLY COMPETITIVE PRICE. FULL DETAILS ON REQUEST
E. A. SOWTER LTD, Dadham Place, Ipswich, IP4 1JP
Telephones 0473 52794

★ **Leevers Rich Prolin 100 Stereo Tape machine,** 7½/15, in wooden portable case, as new, used only few hours, £1,280. Master Room MR3 Reverberation Unit, excellent condition, £865. 2 x Neve 2252 Compressor/Limiters in rack-mounted unit with power supply, £150. Audio & Design F600 Limiter, £70. 01-994 3811. A

★ **Wow and flutter meter,** Rank Kalee type 1740, similar to latest model, calibrated and in good working order. £150 plus VAT. Burgess Lane & Co. Ltd., Thornton Works, Thornton Avenue, London, W.4. 01-994 5752 and 5953. X

FOR SALE

- 1 x Ampex 4 Track ½ Tape
- 2 x Ampex AG 350
- 1 x Ampex AG 300
- 1 x 3M series 400 8 Track
- 1 x Sound Techniques 20 input 10 output Desk
- 2 x Pairs Tannoy 15" Golds Chassis
- 1 x Pair Tannoy 15" Red Chassis
- 1 x Allison Automated Programmer. Series ED128

Offers? Contact:
Jim Dowler, Olympic Sound Studios.
748-7961



Our slaves are yours to command

Loop bin cassette duplicating, Dolby A and B systems, fixing heat-seal cassette labels, open reel duplicating, large or small runs.

Sound Communication (Publishers) Limited,
Dewsbury, West Yorkshire. Telephone (0924) 469436

Get binding!

Keep your copies of STUDIO SOUND in smart black binders (each holds 12 copies) with title in golden block letters on the spine.
Price: £2.00 each which includes inland and overseas postage. Send your order with cheque or postal order to: Modern Book Binders Ltd. Chadwick Street, Blackburn, Lancs. (state clearly your name and address and the relevant magazine title).

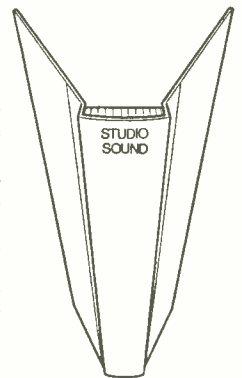

LINK HOUSE GROUP

★Revox, Teac, Otari, Brenell, Tascam, Nakamichi, Tannoy sales and service. The Music Laboratory. 01-349 1975. X
 BGW 202 £275; BGW 250B £265; BGW 500D £450; Amcron 1C 150 s/h £176; Amcron D60 £215; Klark-Technic Graphic Eq. £299; Nakamichi 610 £266; Nakamichi 620 £299; Phase Linear 400B £299; Phase Linear 2000 £175; Teac A 3300SX £335; Teac 3300SX 2T £350; Yamaha B.I. £680; Yamaha C2 £310. V.A.T. extra. Tel. 01-486 0552. A

UHER

OFFICIAL DISTRIBUTORS & MAIN SERVICE AGENTS SINCE 1969

4000IC	£229-00	42/4400IC	£275-00
SG561	£335-00	SG521	£258-00
5000	£245-00	SG510	£155-00
CR210	£310-00	CR240	£370-00
CG300	£125-00	CG320	£180-00
CG330	£162-00	CG340	£160-00
CG350	£226-50	CG362	£333-00

A selection of accessories:

Z212 (Lead acc)	£17-00	Z214 (NiC acc)	£26-00
Z124 (Charger)	£25-00	Z131 (Charger)	£19-20
A124 (mixer)	£86-00	F411 (Akustomat)	£25-20

REVOX

A77 Series high or low speeds, with or without Vari-speed
 B77 New Series
 A700 Series

Attractive discounts available to industrial/educational users.

Please apply for a quotation.

OTARI

One each of the following Professional models available at the old prices:

MX5050 QXHD	4 channel	£1388-00
MX5050 2SH	2 channel	£731-00

To Industrial/Educational users only

VAT and carriage extra

We are approved contractors to HM Government, broadcasting and local authorities.

PHOTO ACOUSTICS LTD

255a St Albans Road (entrance Judge St), Watford, Herts Tel. 32006

STOP PRESS!
 WE ARE EXPANDING

Early in 1978 we shall be operating from additional premises in the MILTON KEYNES area. Watch our future advertisements for more information.

TRAD

WATFORD 47988

All Studio Equipment bought and sold. See our advertisement on page 31.

149B St. Albans Road, Watford, Herts.
 Tel. Watford 47988

SOWTER TRANSFORMERS

FOR SOUND RECORDING AND REPRODUCING EQUIPMENT
 We are suppliers to many well-known companies, studios and broadcasting authorities and were established in 1941. Early deliveries. Competitive prices. Large or small quantities. Let us quote.
 E. A. SOWTER LTD.
 Transformer Manufacturers and Designers
 7 Dedham Place, Fore Street, Ipswich IP4 1JP
 Telephone 0473 52794

OMNIDIRECTIONAL

3M M56 16 track, v.g.c.	£7000
Bose 1800 amplifiers plus transit cases, each	£550
Ampex AG440 stereo	£1150
Neumann microphones, U87s, U77s, from	£185
Shure SM58s, as new	£65
Roland space echo, as new	£240

Lots of other microphones in stock, new and used. KM83s, KM84s, KM86s, D12s, D224s, D190s, M88s.

All studio equipment wanted.
 Desperate for all microphones.
 Microphone problems, sales and service call:

OMNIDIRECTIONAL 01-328 7057

FOR SALE—PRIVATE

★10 into 2 Chilton Mk. II Mixer. Fully balanced throughout. Treble, switchable mid, bass E.Q. and 2 auxiliary outputs on all channels. Spare power supply. £1,000 o.n.o. For details phone 061-338 3264. A

★Ampex AG440 Stereo Tape Recorder mounted in 19in rack, accessories include full remote control. Superb condition; less than 250 hours use. £1,250. Apply Box No. 778 c/ STUDIO SOUND (London). A

★Portable Lamb P.M.L.422 Mixer. Modified to bal input, mic's with mains unit 4 in 2 out. £175. Kidderminster 850529. A

★Reslo RXA and TXT Radio Mic. Set. Good condition with all accessories and case. £250. 21 Woodall Road, Rotherham, South Yorkshire. A

★Scully 8 track Jin 280 £2,200. Allen mid mixer, model 2. 16 in to 8, £2,600. 8 Dolby 361 units £2,000. 1 Klark Teknik graphic equaliser £325. Tel. Colnbrook 4333. A

★Pair Tannoy 15in Golds Lancaster Cabinets, one slightly scratched. £180 o.n.o. plus carriage. Ian Hague. Beaford Centre, Winkleigh, N. Devon. Beaford 201. A

★2 AKG C451EB Amplifiers with CK9 capsules, touchel connectors. £150 o.v.n.o. Tel. 01-686 7509 after 7pm. A

★10/2 Mixer. Wooden console and metalwork complete, half the modules wired. Hammond Spring, Jackfield, Patchcords. S/Sound Constructional Articles. £60. 01-373 9057. A

SERVICES

★R. Beaumont, specialist audio repairs and Philips VCR service, 21 Southway, Ilkley, West Yorkshire. Tel. 0943 607021. X

★Tape copying service. Open reel and cassette available. The Music Laboratory, 01-349 1975. X

★For hire at very reasonable rates: Audio Development Micro and Pico Mixers, AKG, Sennheiser, STC and Sony ECM50 microphones, Nagra IV and IS tape recorders. Telephone 01-940 6276 evenings. B

REVOX

SERVICE CENTRE

Service and overhaul.
 High speed conversions.
 Head changes.
 Self-sync.
 Automatic double tracking.
 Varispeed/varipitch.

MUSIC LABORATORY

01 349 1975

★Need something special designed? We offer an electronic design service backed up by full prototype and production capability. We understand professional audio. One-off gadget or production design. Talk it over with Hamill Electronics Ltd., 492 Kingston Road, London SW20. 01-542-9203. D

FAST SERVICE

on Bell & Howell Projectors, Ferrograph, Otari, Revox, Tandberg and Uher Tape Recording equipment.

We have manufacturer-trained engineers to deal with your problems quickly. Special arrangements for BBC/IBA "Stringers".

New equipment also supplied—contact us for an advantageous quotation.

PHOTO ACOUSTICS LIMITED

255a St. Albans Road (entrance in Judge Street), Watford, Herts. Tel. 32006

SES

The tape machine people.
 Rapid repair services with facilities second to none.

REVOX—OTARI—TEAC
 NEAL—UHER

Sales and Service.

Ampex tape stocked.

Contact—Ian Downs.

01-4521979

Telex 87515

WANTED

★Revox's urgently wanted. The Music Laboratory. 01-349 1975. X

★Wanted. Revox and Teac Tape Recorders. Best prices paid. R.E.W. Professional Audio, 01-836 2372. X

★Tannoy speakers wanted. The Music Laboratory, 01-349 1975. X

★Teac 3340 (S) urgently wanted. The Music Laboratory. 01-349 1975. X

SITUATIONS—WANTED

★Experienced Balance Engineer, Producer Studio Manager requires position London or abroad. Many credits. Box No. 776 c/o STUDIO SOUND, London. A

★Enthusiastic young man (21) seeks position with Recording Studio, U.K. or abroad. Willing to work hard study and start at any position. Have own equipment. Box No. 777 c/o STUDIO SOUND. A

Why Buy a New Machine
UPDATE YOUR REVOX
 Our EDITING CONVERSION fits
 all versions of the A77

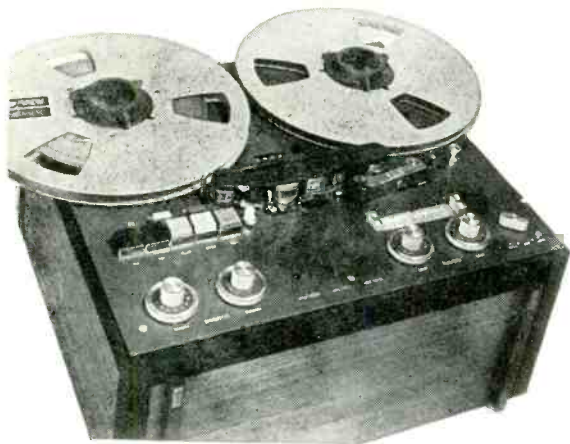

- ★ Easier Editing. ★ Easier Head Cleaning.
- ★ End of Tape Lamp switching
- ★ No Interference with the Electronics.
- ★ The original Revox Specification is unchanged.
- ★ Conversion Kits £75+VAT. Your machine converted £85+VAT.
- ★ New Machines Supplied—Standard or already Converted.

SOUND ASSOCIATES LTD [K.L. Sound], 23 Redan Place, London W2.
Tel: 229 0102

SITUATIONS VACANT

★Audio Tonstudios in Berlin (48 tracks auto-mix) require: one young top and creative Re-Mix Engineer with 2-4 years recording experience. Apply to: Audio Tonstudios, Ostpreussendamm 138, D-1000 Berlin (West) 45. A

★Olympic Sound Studios have a vacancy for a qualified maintenance engineer who has at least two years practical experience in the 'studio' field. Call Jim Dowler 748-7961. A
 ★Earn generous commission with your Cassette Recorder. Congenial social occupation. Details: A.R.C., 23 Arcadian Gardens, London N22 5AG. A

Senior Development Engineer

Pye TVT Limited are major manufacturers of television and radio systems and equipment. We require an Engineer to work in our modern Studio Equipment Development Laboratory on the design of circuitry for our audio equipment range.

The successful candidate will exercise full responsibility for circuit design in a wide range of projects including audio mixing, assignment, communications and digital applications.

Previous experience of audio circuit design, together with a desire to continue this design capability into new, "state of the art", economic products, will encourage you to write or phone for further details and an application form to:

Dave Barnicoat, Personnel Officer,
 Pye TVT Limited, P.O. Box 41, Coldhams Lane,
 Cambridge CB1 3JU. Telephone: Cambridge 45115



Pye TVT Limited
 The Broadcast Company of Philips

A member of the Pye of Cambridge Group

For
 further
 information
 on
 Advertising
 in
**STUDIO
 SOUND**
 please
 telephone
 the
 Advertisement
 Manager
TONY NEWMAN
 on
01-686 2599

Harrison Master Recording Consoles Are Available Through the Following Professional Audio Distributors

AUSTRIA, SWITZERLAND Studer International AG
 and **EASTERN EUROPE:** Althardstrasse 150
 CH-8105 Regensdorf, Switzerland
 Tel: (01) 840 29 60. Telex 58 489

**BENELUX (BELGIUM,
 THE NETHERLANDS
 and LUXEMBOURG):** Heijnen B. V.
 Steendalerstraat 56
 NL-6940 Gennep, Netherlands
 Tel: (08851) 1956. Telex 48039

BRAZIL: Larex Electronica LTDA
 Avenida Princesa Isabel, 7 grupos 915
 Rio de Janeiro 20.000 Brasil
 Tel: 275-1695. Telex 2121616

CANADA: J-MAR Electronics Limited
 6 Banigan Drive
 Toronto, Ontario M4H 1E9 Canada
 Tel: (416) 421-9080

**COLOMBIA, EQUADOR,
 PARAGUAY, VENEZUELA
 and CUBA:** Division Internacional Spica CA
 Avenida Sanz — Edificio Escar
 Local B — El Marques
 P.O. Box 75442 El Marques
 Caracas 107, Venezuela
 Tel: 35.14.19. Telex 25547

DENMARK: Quali-fi A/S
 Strandvejen 730
 DK-2930 Klampenborg, Denmark
 Tel: (01) 631711. Telex 16527

**FAR EAST
 (Except Japan):** Studer-Revox Hong Kong Limited
 108 Asian House
 1 Hennessy Road
 Wanchai, Hong Kong B.C.C.
 Tel: 5-278571. Telex 84640

FINLAND: Into OY
 Lepolantie 16
 SF-00650 Helsinki 66, Finland
 Tel: (90) 742133. Telex 121836

FRANCE: Studer France
 12-14, rue Desnouettes
 75015 Paris, France
 Tel: 533 58 58. Telex 204744

GERMANY: Franz Vertriebsgesellschaft mbH. (EMT)
 Elektronik, Mess- und Tonstudioteknik
 Postfach 1520
 D-763 Lahr 1, West Germany
 Tel: (07825) 512. Telex 754319

GREECE: Electronica O. E.
 9, Valaoritou Street
 Athens 134, Greece
 Tel: 3619096. Telex 214888

ITALY: Audio Products International
 Via Gaspare Spontini 3
 20131 Milan, Italy
 Tel: (02) 27 38 96. Telex 32402

JAPAN: Shindenshi Manufacturing Corp.
 1-47 Sasazuka, Shibuya-Ku
 Tokyo, Japan
 Tel: (03) 460-6052. Telex 2425108

MEXICO: Accurate Sound Corporation
 114 5th Avenue
 Redwood City, California 94063
 Tel: (415) 365-2843. Telex 348327

SPAIN: Neotecnica, s. a. e.
 Marques de Urquijo, 44
 Madrid 8, Spain
 Tel: 242-0900. Telex 22099

SWEDEN: ELFA Radio & Television AB
 Industrivaegen 23
 S-171 17 Solna, Sweden
 Tel: (08) 730 07 00. Telex 104 79

UNITED KINGDOM: Scenic Sounds Equipment
 97/99 Dean Street
 Soho, London W1, England
 Tel: (01) 734-2812. Telex 27939

U.S.A.
 Westlake Audio
 6311 Wilshire Boulevard
 Los Angeles, California 90048
 Tel: (213) 655-0303. Telex 698645
 Studio Supply Company
 P.O. Box 280
 Nashville, Tennessee 37202
 Tel: (615) 327-3075
 PRO Sound, Inc.
 Seven Wynnewood Road
 Wynnewood, Pennsylvania 19096
 Tel: (215) 642-2744
 Willi Studer America, Inc.
 1819 Broadway
 Nashville, Tennessee 37203
 Tel: (615) 329-9576. Telex 554453

EXPORT AGENT: Audio Systems International
 146 North Orange Drive
 Los Angeles, California 90036
 Tel: (213) 933-2210. Telex 686101

FACTORY: Harrison International Corp.
 Post Office Box 22964
 Nashville, Tennessee 37202
 Tel: (615) 834-1184. Telex 555133

"Still No Compromise"



Harrison Systems, Inc.
 P.O. Box 22964 • Nashville, Tennessee 37202

Progress from HARRISON

Second Edition Models 4032 + 3232

Automated Master Recording
Consoles

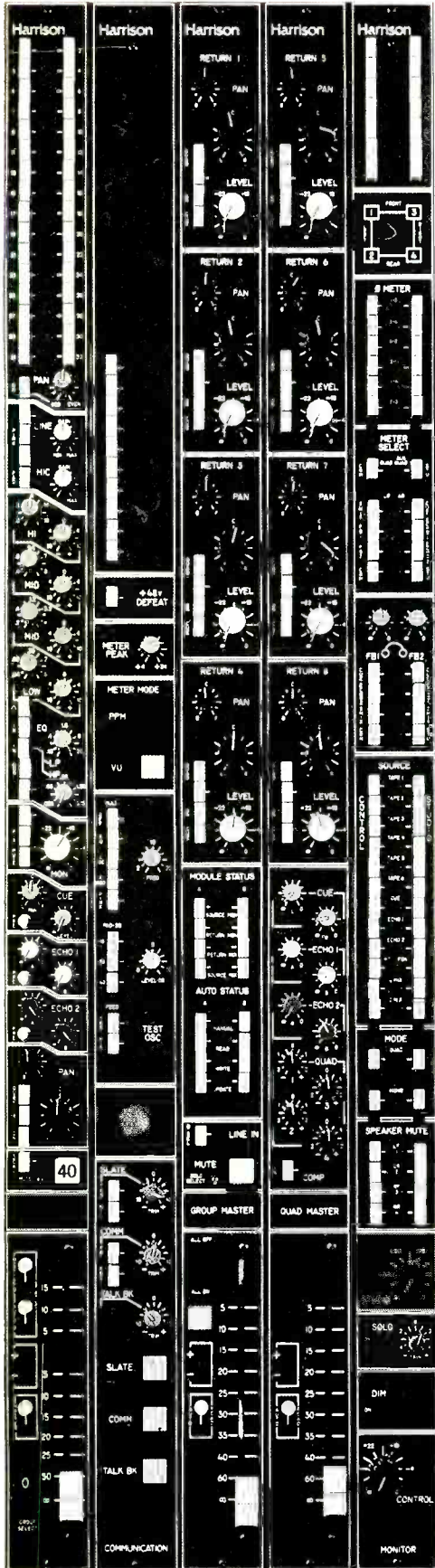

In response to your suggestions,
Harrison's Second Edition consoles
offer you many new features and functions.

- Programmable and Manual Muting.
- Group Muting.
- Fader Automation Null Lights.
- 2 Stereo Foldback Systems With Extensive Source Selection.
- Optional High Resolution Phase Meter.
- 2 Phase Meter Source Selection Matrices.
- Pink Noise Generator.
- 48 Volt Phantom Power On/Off Switch.
- Improved Parametric Equalizer Range.
- Optional Step-Type Equalizer.
- Stereo and Quad Meter Source Selection Switches
- Optional 36 Segment, High Resolution Light Meter With Front Panel VU and PPM Characteristic Selection.
- Master VU/PPM Characteristic Selection Switches
- Optional NTP Meter Overbridge.

“Still No Compromise”

Harrison 

Harrison Systems, Inc.
P.O. Box 22964 • Nashville, Tennessee 37202

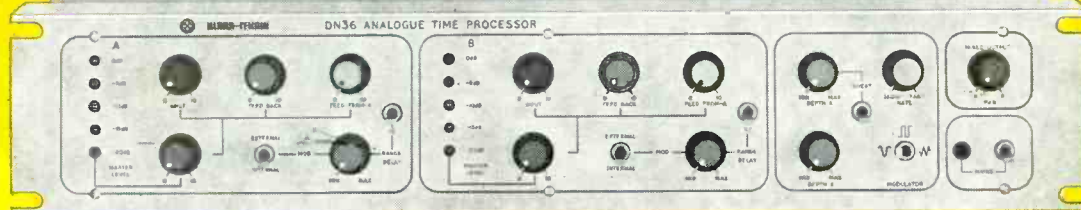

DN 36 ANALOGUE TIME PROCESSOR A NEW EXPERIENCE IN SOUND



KLARK-TEKNIK

Kidderminster · Worcestershire · England

Telephone (0562) 64027 · Telex 339821

Agents throughout the World