

studio sound

September 1976 35p

AND BROADCAST ENGINEERING

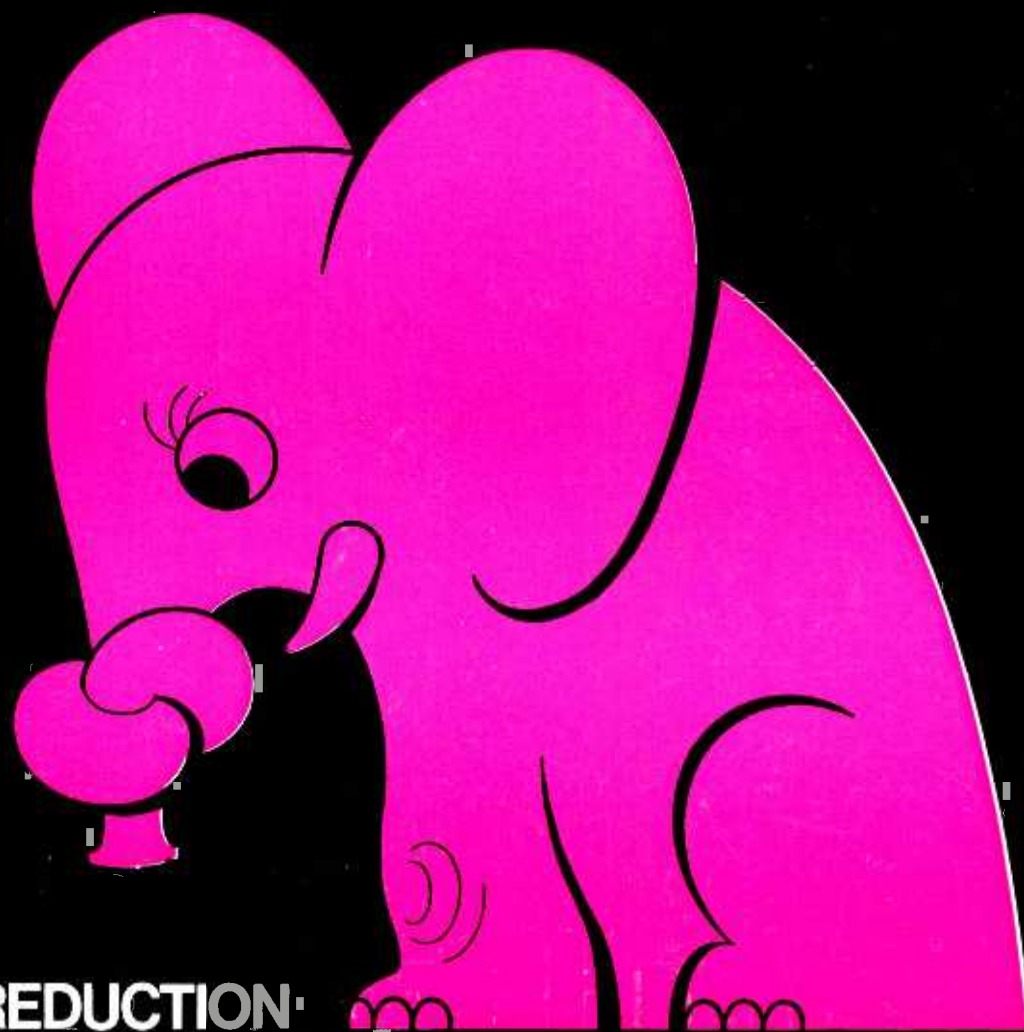

NOISE REDUCTION

The choice is not limited Why compromise?

We know it helps the manufacturer to set rigid standardisation of their equipment formats – most do! It doesn't help you. The penalty need not be a sharp increase in cost.

We at Cadac do not expect you to suffer these short comings. Our fully modularised range of equipment leaves the flexibility of choice with you – and the cost? Lower than you would expect on a console for console comparison basis.

The most versatile recording equipment in the world.



VOGUE P.I.P STUDIOS -FRANCE

The leaders in music recording consoles
and techniques.

cadac

Cadac (London) Ltd.
141, Lower Luton Road Harpenden Herts. AL5 5EL
☎ Harpenden (STD 05827) 64351 Telex 826323

EDITOR RAY CARTER
TECHNICAL EDITOR FRANK OGDEN
EDITORIAL PRODUCTION
DRUSILLA DALRYMPLE
CONSULTANT HUGH FORD
EXECUTIVE ADVERTISEMENT
MANAGER
DOUGLAS G. SHUARD
ADVERTISEMENT MANAGER
TONY NEWMAN
ADVERTISEMENT REPRESENTATIVE
PHYLLIS BIRCH

THE LINK HOUSE GROUP
Editorial and Advertising Offices:
LINK HOUSE, DINGWALL AVENUE,
CROYDON CR9 2TA
Telephone: 01-688 2599
Telex: 947709, EXCHMART CROYDON
Telegrams: Aviculture Croydon
© Link House Holdings Ltd 1976
All rights reserved.

STUDIO SOUND is published on the 14th of the preceding month unless that date falls on a Sunday, when it appears on the Saturday.

SUBSCRIPTIONS
 All enquiries to: Subscription Dept, Link House, 25 Vest Street, Poole, Dorset BH15 1LL. Poole (02013) 1171.

DISTRIBUTION
STUDIO SOUND, published monthly, enables engineers and studio management to keep abreast of new technical and commercial developments in electronic communication. It is available without charge to qualified readers; these are directors, managers, executives and key personnel actively engaged in the sound recording, broadcasting and cinematograph industries in any part of the world. Non-qualifying readers can buy **STUDIO SOUND** at an annual subscription of £5.80 (UK) or £6 (Overseas). Express (air mail) as follows (extra charge over paid or free subscription): Argentina (B), Angola (B), Australia (C), Austria (X), Barbados (B), Belgium (X), Bermuda (B), Botswana (B), Brazil (B), Bulgaria (X), Canada (B), Chile (B), Colombia (B), Cyprus (X), Denmark (X), Finland (X), France (X), Ghana (B), Greece (X), Iceland (X), Hong Kong (B), Hungary (X), Ireland (X), India (B), Indonesia (B), Iran (A), Israel (A), Italy (X), Jamaica (B), Japan (C), Kenya (B), Lebanon (B), Malawi (B), Malaysia (B), Mexico (B), Monaco (B), New Zealand (C), Nigeria (B), Norway (X), Peru (B), Philippines (C), Poland (X), Portugal (X), Rhodesia (B), Rumania (X), Singapore (B), South Africa (B), Spain (X), Sri Lanka (B), Sweden (X), Switzerland (X), Tanzania (B), Thailand (B), Trinidad (B), USA (B), Virgin Islands (B), West Germany (X), Yugoslavia (X), Zambia (B).

RATES
 Europe goes air mail regardless 2nd class air mail
 A £18.78 (12 Issues)
 B £18.84 (12 Issues)
 C £22.56 (12 Issues)

ADVERTISERS
 Loose-leaf binders for annual volumes of **STUDIO SOUND** are available from Modern Bookbinders, Chadwick Street, Blackburn, Lancashire. Price is £1.50 (UK and overseas). Please quote the volume number or date when ordering.



Total average net circulation of 8899 per issue during 1975. UK: 5689, overseas: 3210. Total average net circulation of 10030 for January 1976. UK: 6003, overseas: 4027.

studio sound

AND BROADCAST ENGINEERING

For nearly ten years Dolby A has effectively been the industry standard for noise reduction: other systems, despite their merits, amounted to opposition rather than competition. However, more tracks and greater use of ping-pong within the rest of the recording chain now pressurises studios into overriding the wishes of their accountants by obtaining a double inventory of noise reduction equipment. And of course the force for change is aided, as always, by the persistent technological rhetoric of those who have something to sell to those who haven't yet bought their quota; but that's life.

The fact remains that pressure is not the same thing as need; it poses the question: does the industry really require another, perhaps better, noise reduction system. Without a doubt, Mrs Dolby's talented son made multitrack recording a viable proposition. Without his invention, it is probable that the Floyd would have stuck to rock and Pierre Boulez would only have been able to score in mezzo-forte and above. Those 10 to 15 dB helped them a lot, but would 30 dB of noise reduction as claimed by dbx and Telefunken have done much more?

The answer would appear to be not yet, but soon maybe. The limiting factor rests in the quality of the vinyl disc, the cartridge/cassette or whatever. There really isn't an awful lot of point in producing a master tape with a decoded dynamic range of a million decibels when the finished product possesses a mere 60 dB—if you're lucky. If the man who operates the stamper or duplicator was out on the beer the night before, you won't even get 55 dB. So the wide dynamic range of which the master is capable will have to be squashed to fit the package and once again, *pp* becomes *mf*.

But there should be a demand for the wide open range from the consumer. For most who will ever get to read this, it will be preaching to the converted; as anybody who has ever listened to a live take through the studio monitors without an interceding tape generation knows (or rather hears) there's a whole world of difference between that and the subsequent tape replay.

Some people say (and nowhere more vociferously than at Sansome Street, San Francisco) that Dolby has fewer audible side effects in operation. However, there are very few who, having heard dbx (the only widely available alternative at the time of writing) have not been impressed by the difference another 20 dB can make. Naturally, a/b comparisons (between live and tape) show all the deficiencies of the tape recording process, but squashing noise adds one whole lot to the subjective impression of reality.

It is therefore just as important to propagate a wide dynamic range consumer replay system, such as dbx encoded discs, as to promote wide range systems in the studio environment—a chicken and egg situation with the egg featured as the end product. After all, noise reduction belongs as much to the consumer as to the recording studio. It's the end result that's important.

contents

FEATURES

DOLBY IN THE CINEMA David Robinson	28
DBX FOR DISC Larry Blakely	32
NOISE REDUCTION Frank Ogden	36
SURVEY: NOISE REDUCTION AND CONTROL	44

COLUMNS

NEWS	22
LETTERS	26
AGONY	34
WORK	50

REVIEWS—Hugh Ford

SURREY ELECTRONICS PEAK PROGRAMME METER	54
HARRISON ELECTRONIC BAR DISPLAY METER	56
A & R STUDIO LEDMETER SYSTEM PLM14	58
ERNEST TURNER VU METER 642 AND PEAK PROGRAMME METER 902	60
NTP LIGHT DIODE PEAK PROGRAMME METER 177-700B	62
AND NTP BAR GRAPH PEAK PROGRAMME METER 177-800	63
SHINOHARA ELECTRIC SEW VU METERS PE70 AND SD830	64
MILLBANK PEAK PROGRAMME METER O78B AND PEAK READING VU METER O78F	66
SIFAM VU METER R34A	67
BACH-SIMPSON PPM MOVEMENT 543 AND VU METER 1347	68

ITA-Europe's Leading Distributor

2 Channel



REVOX A-77

The famous A77 has been consistently improved over the past 8 years and is now available in the latest Mk. 4 version. The wide choice of specifications includes versions for duplicating and logging applications. Backed by UK's £340st service.

£340+VAT.
Hire service. *Immediate delivery.*



REVOX A-700

The new big Revox — ideal for all studio requirements. Highly sophisticated design features include servo tape tension, full deck logic, crystal controlled servo electronics, 3 speeds, tape footage counter

£690+VAT. *Immediate delivery.*

4 Channel

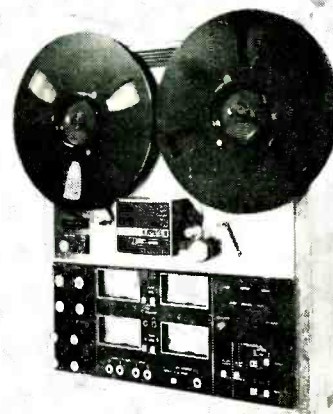

TEAC A3340 (S) RECORDER

Industrial version upgraded to studio requirements, with increased signal to noise performance and improved reliability. Four totally independent channels each with sel sync, input mixing, switchable VUs and all the facilities for easy multitracking. This industrial model is in more studios than any other version.

Available only from ITA. (Semi-pro versions also available.)
Immediate delivery

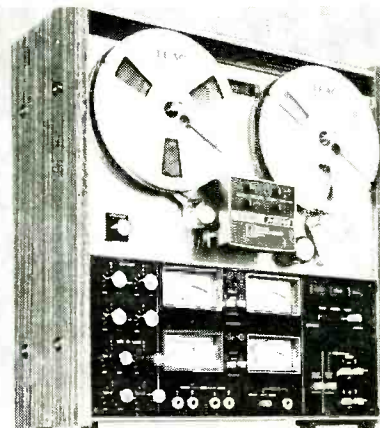

TEAC A2340 HIGH SPEED

The only budget recorder under £400 with 15 ips! Same spec. as ubiquitous 3340 but 7 inch spools. Don't accept less!

£384+VAT.

Agfa PEM 368
Scotch 207

} Lowest Prices

Hire Facilities
Finance Available

of Multitrack Equipment

8 Channel

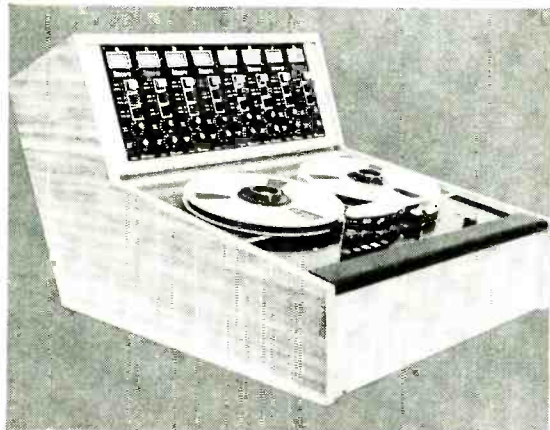

ITAM 805 master recorder

Fully modular electronics using plug-in PCBs throughout. Separate sync and replay amps give identical levels. Switchable VU's with slow decay. Individual oscillator for each channel. Dolby A switching facility. Comprehensive facilities include sync on all channels, servo controlled capstan, modular electronics, variable speed (optional), relay-solenoid operation. Compact console presentation for easy portability. £1790+VAT. Full console optional extra.



MIXERS



ITAM 10-4

Ten balanced inputs, four output groups, 4 limiters, bass mid and treble EQ, modular construction, headphone monitoring. Extremely high quality construction only matched by mixers costing around £1000. £690+VAT. Twenty input version £1190+VAT. Immediate delivery. Also available for hire.



ITAM 10-8

Expanded version of the famous 10-4, with 8 output groups and comprehensive monitoring facilities. Additional 10 inputs optional. £1260+VAT.

Industrial Tape Applications

ITA

5 Pratt Street, London NW1 0AE.
Tel: 01-485 6162 Telex: 21879

WHY CHILTON MIXERS?

We are manufacturers in the true sense of the word; producing Teak Cabinets, Sheet Metal Work, Tooling, Front Panel and Printed Circuit Artwork, etc, our products are accurate with an attention to detail that is second nature to us.

The popular M10/2 (10 in 2 out) portable mixer shown is supplied as a basic unit with 10 line inputs inc PPM, Oscillator, LF/HF equalisers, 1 aux and PFL. You choose the number of microphone or gram inputs, the channels to have presence, switchable HF/LF filters or ducking. In addition a 2nd aux channel, talk-back, and/or compressors can be fitted.

Ring or write for full information, if however our standard range is unsuitable it may be possible to modify one to suit your requirements.

M10/2 Mk 4 BASIC	£410 + VAT
16 input version	£585 + VAT
12 in 4 out Mk2	£675 + VAT

**MAGNETIC TAPES LTD, Chilton Works,
Garden Rd, Richmond, Surrey TW9 4NS**

Telephone 01-876 7957



AUDIO MODULES



BUILD YOUR OWN

Mixers, Consoles, or add on to old equipt.

easy to use

10 different MODELS

Mic (Low-Z, Hi-Z), Mag. Phono, NAB Tape,
Active Equalizer, Line Amp, Power Amp.

From \$16.50 to \$43.50 Pro-NET (domestic)
check your nearest distributor for local prices.

Send for NEW Catalog over 280 items for Audio

SESCOM foreign distributors:

Australia: Klarion Enterprises Pty. Ltd., So. Melbourne

Canada: Chas. L. Thompson, Ltd., No. Vancouver BC
John R. Tilton Ltd., Scarborough Ont.

England: Future Film Developments, London

Greece: Laboacustica Hellas: Athens

Holland: Iemke Roots Import, Amsterdam

Italy: Laboacustica Srl, Roma

Norway: Roger Arnhoff Studio a.s., Oslo

SESCOM, INC.



"QUALITY ENGINEERED SOUND PRODUCTS"
P.O. Box 590, Gardena, CA 90247 USA
(213) 770 3510, TWX 910 346 7023

Can a Machine or Musical Instrument
Talk or Sing?

The EMS VOCODER



Answers
the
Questions!

—the first VOCODER-SYNTHESIZER is already in
action at the West German Radio.

More information: **EMS (London),
277 Putney Bridge Road,
London SW15**

seen from the professional angle



the 201 is something quite personal...

The M 201 Hypercardioid moving coil microphone is designed for recording or broadcasting. The M 201 offers excellent separation characteristics in extreme accoustical conditions.

Specifications:

Frequency Response: 40-18000 Hz.
 Output Level at 1 kHz: 0,14 mV/ μ bar \approx -56 dbm (0 dbm \approx 1 mW/10 dynes/cm²). EIA Sensitivity Rating: -149 dbm. Hum Pickup Level: 5 μ V/5 μ Tesla (50 Hz). Polar Pattern: Hypercardioid. Output Impedance: 200 Ω . Load Impedance: > 1000 Ω . Connections: M 201 N (C) = Cannon XLR-3-50 T or Switchcraft: 2+3 = 200 Ω , 1 = ground. M 201 N = 3-pin DIN plug T 3262: 1+3 = 200 Ω 2 = ground. M 201 N (6) = 6 pin Tuchel.
 Dimensions: length 6", shaft \varnothing 0,95".
 Weight: 8,60 oz.



BEYER DYNAMIC

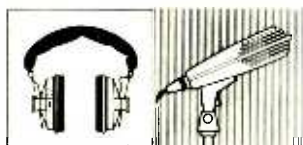

BEYER DYNAMIC (GB) LIMITED
 1 Clair Road, Haywards Heath, Sussex.
 Tel: Haywards Heath 51003



SALES and SERVICE



**WE ARE OVERSTOCKED
 LOW, LOW PRICES**

14th AUGUST - 14th SEPTEMBER

MICS, TAPE RECORDERS, SPEAKERS, ETC

For example:

- | | |
|--------------------------------------|---------|
| EMI TR90 RECORDERS | £65.00 |
| AKG DI90 MICS | £22.00 |
| ZONAL 1" TAPE, NEW , per reel | £6.00 |
| BTR 4 | £150.00 |
| 8 CHANNELS SCULLY REPLAY ELECTRONICS | £350.00 |

WRITE OR PHONE FOR COMPLETE LISTS

VISIT US TO HAGGLE!

**DOG HOUSE
 COPLE, BEDFORDSHIRE**

Telephone: Cardington 404

Specialists in Service and Repair of TRD recorders.
 All parts, motors, etc available. Collection and delivery: London and Home Counties.

INTRODUCING A NEW TAPE DECK FROM A COMPANY THAT NEEDS NO INTRODUCTION.



Besides the standard 1 inch 8 track you see here, there's a $\frac{1}{2}$ inch 8 track and a 2 inch 16 and a 24 track.

Their features include full solenoid transport functions. Full sync facilities. Full modular electronics. Silent drop-ins. Instant start cue. N.A.B. and C.C.I.R. equalisation.

See and hear it at our demo studio. Pembroke House, Campsbourne Road, Hornsey, London N8.

Where you can also take the opportunity to look over the Allen & Heath Mod II mixer. It's offered with the tape deck in a uniquely priced package deal.

Or for more information call Andrew Stirling 340 3291

brenell

ACOUSMAT APOLLO ELECTRONICS FRANCE

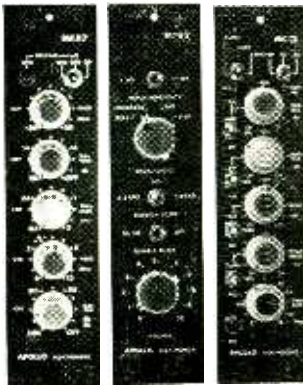

PROFESSIONAL
audio plug-in units.
More than 20 models.
Input channel, amplif.
Equalisers, compressor,
Expanders, generators,
Line amplifier, etc . . .

**PERFORMANCE AND
RELIABILITY AT A
MODERATE COST . . .**

24 PINS DIL

HYBRID MODULES
33 x 20 x 15mm



—HM80: general purpose AC control module (with 32 applications free)
—HM70: low noise 70dB gain micro amplifier
—HM30: Compressor limiter 34dB comp. 0.3% THD

Application data on request/APRS std 22
22 RUE STE AMBROISE-PARIS 75011-FRANCE

A Mini Mixer with a true **PROFESSIONAL STUDIO SPECIFICATION**

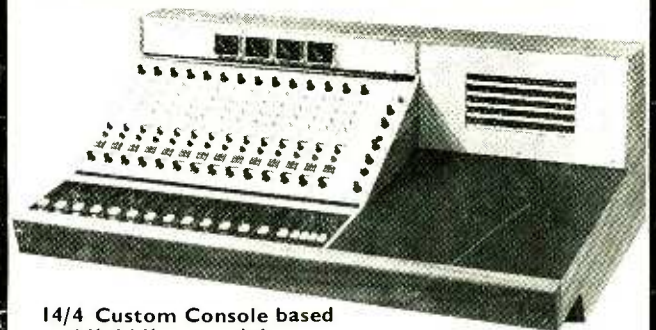

**14/4 Custom Console based
on Mini Mixer modules.**

STANDARD MIXER

10 Input Channels, 4 Output Groups.
Auxiliary Sends and Echo Returns.
XLR Connectors to balanced Mic Inputs and Line Returns.
Normalised Insert Jacks.
Low Noise and High Output levels.
Portable

Extension units, PPM's, Limiters etc. also available.

SOUTH AFRICA

Prosound, Musicians Sound
Centre, J'burg. Tel. 642-87-21

SPAIN

TELCO Sociedad Limitada
Madrid. Tel. 221-5606

HOLLAND

Pieter Bollen, Eindhoven
Tel. 040-512777

BELGIUM

ARC, SPRL, Brussels
Tel. 771-30-63

DENMARK

Audiophil, Copenhagen F
Tel. (01)fa. 5209

WEST GERMANY

Elmus GmbH, Berlin 12
Tel. 030-312-2012

RAINDIRK LTD.,

Downham Market, Norfolk.
Tel. 2165 and 3617

MOBILITY

— WE HAVE THE ANSWER

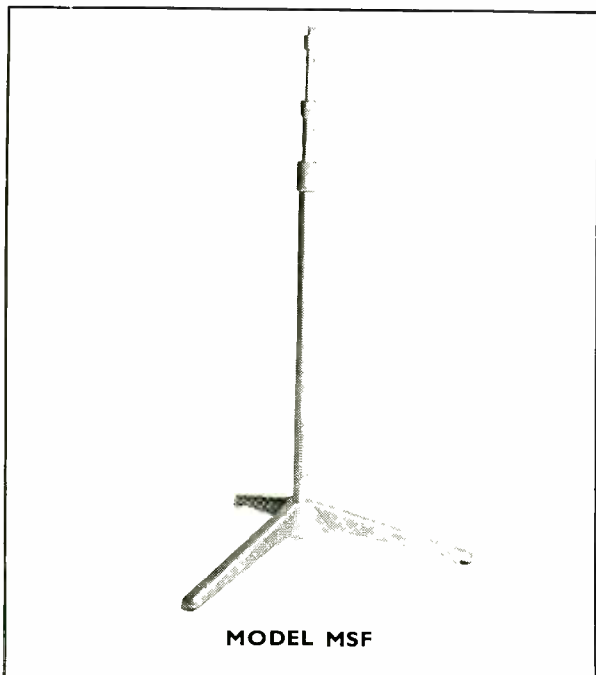

A lightweight microphone stand with folding legs which with the three section telescopic upright makes a compact portable stand. Adjusts in height from 28" to 72". Finished in all-black nylon covering for extra durability.

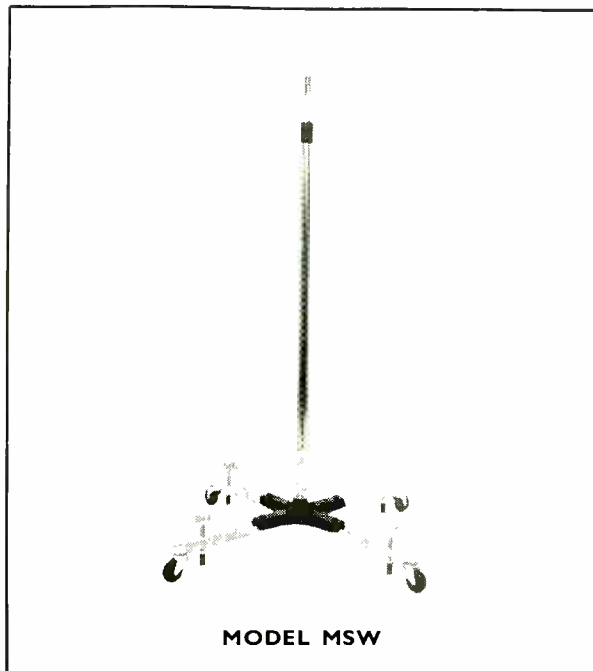

A new studio stand with a heavy reinforced base fitted with wheels. When in position floor jacks can be lowered to prevent further movement. Adjusts in height from 3' 10" to 6' 10" and can be fitted with boom arms from our range of 15 models.

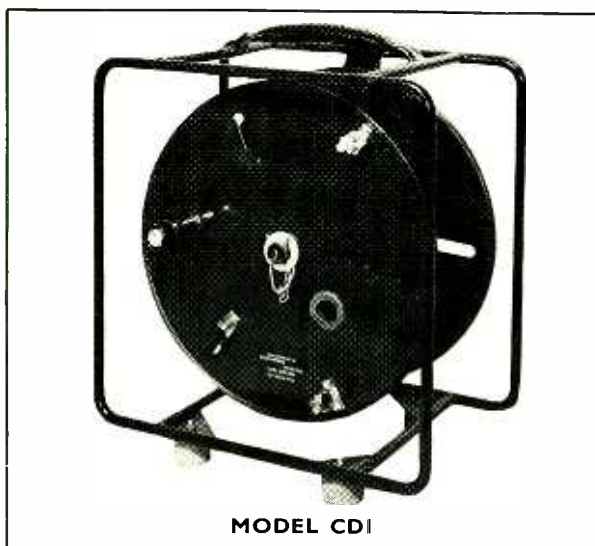

Our well-known cable drum covered in black nylon coating. The drum is removable and spares always available.



Cable drum specifically designed for larger diameter cables. The winding handle folds inward and locks for storage. The drum is removable. All black nylon finish.

KEITH MONKS (AUDIO) LTD

26-28 READING ROAD SOUTH, FLEET, NR. ALDERSHOT, HAMPSHIRE, ENGLAND

TELEPHONE FLEET (02514) 3566 or 7316 TELEX 858606

SOLD WORLDWIDE THROUGH APPOINTED DISTRIBUTORS. LIST ON APPLICATION

TRAVELLING LIGHT

WITH RUGGED, PORTABLE MIXERS FROM AUDIO

Our wide range of Portable Mixing Consoles are designed and built to the highest technical specification and are in use world wide by the most discerning of professionals.

Because we realise that some of our clients find themselves working in strange out of the way places but still requiring studio quality away from studio conditions, we've made our battery operated mixers extra light and extra rugged to stand up to the rigours of arduous travel and useage.

No matter what your mixing requirements are we've got a unit to suit you — so contact us today and we'll give you some sound advice.

Audio
DEVELOPMENTS

HALL LANE, WALSALL WOOD, WALSALL,
WEST MIDLANDS WS9 9AU.

Telephone: BROWNHILLS (STD Code 05433) 5351

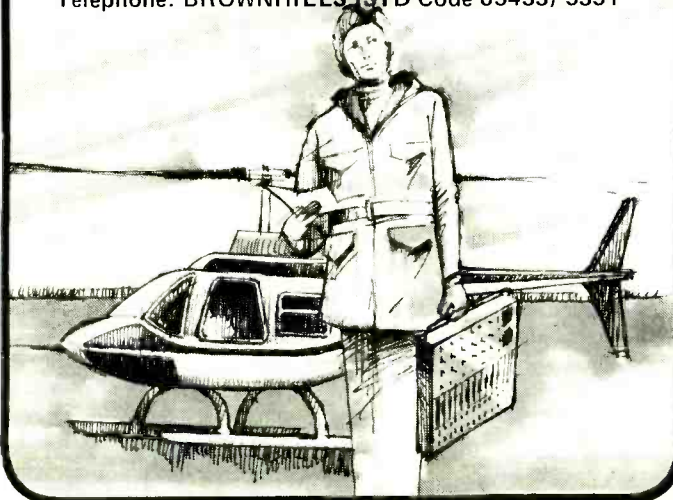

MULTI-TRACK

Vari-band sweep equaliser.

Five selections, 20-100 Hz, 100-600 Hz, 600-3 kHz, 3 kHz-6 kHz, 6kHz, 20 kHz.

Each section continuously tunable.

+15 dB boost or cut.

Bandwidth variable between 2 dB per Octave and 16 dB per Octave.

The most flexible equaliser on the market—at a down-to-earth price.



Sole Distributors:—

Mellotronics Ltd.,
35 Portland Place,
London WIN 3AG
Tel. 01 637 0692

For details ring Peter Granet

The catalogue no professional can afford to be

without Yours FREE from REW!



If you're setting up a mini recording studio, building a P.A. system, or even just looking for a microphone or a reel of tape, this catalogue is an absolute must! It contains the most comprehensive range of Microphones, Mixers, Multi-Channel Tape Recorders, Amplifiers, P.A. Speakers, Echo Units, Equalisers, Noise Reducers, etc.,

from leading manufacturers such as AKG, Amcron, Allen & Heath, Bose, Teac, JBL, HH, Quad, Revox, Tannoy, etc.

OUR PROFESSIONAL TRADE PRICES ARE THE LOWEST IN THE UK

Send large SAE for your free copy now to:
Dept. SS, REW Professional Audio,
10-12 High Street, Colliers Wood,
London SW19.

West End Showrooms:
146 Charing Cross Road,
London WC2. Tel: 01-240 3064/5.

Telex high speed cassette copiers...



functional versatility, operational simplicity.

The Telex two channel Copier I has earned a reputation for fast, easy, dependable use. The new Copier IV now adds the versatility of track selectable, four channel operation.

As easy to use as paper copiers, the Telex cassette copiers feature automatic control. Just select the tracks for copying and push the copy button. When copying is completed all cassettes are automatically rewound and indicator lights signal the stoppage of tape movement. Inserting or removing the master cassette automatically turns the unit on and off. A rewind button provides manual rewinding of all cassettes and the Copier IV has bias select for either ferric oxide or chromium dioxide tapes.

Their compact design and wood grain styling suit the Copiers to desk top use, while optional add-ons can provide up to five copies simultaneously. For higher production capacity,

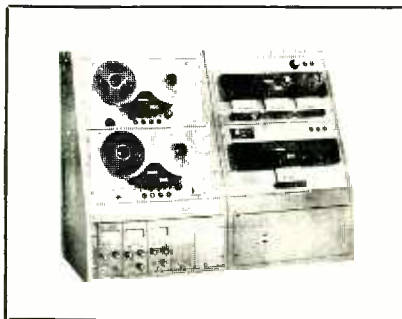

there's the Telex series 300 tape duplicator with modular flexibility to expand as your requirements change. For complete information on both products write:

AVCOM SYSTEMS LTD
STANLAKE MEWS LONDON W12 7HS
01-749 2201. Telex: 897749 Avcom

RADFORD

Amplifier Specifications

Almost all audio amplifiers are used for the reproduction of speech and music through loudspeakers. It is thus very difficult to specify objective tests which have some relevance to the end use. Arbitrary performance parameters have evolved which are obtained by standardised universal measurement techniques, which by familiarity, have come to be accepted as valid criteria—for the want of something more meaningful.

Discriminating listeners, professional and others have always been aware of the disparity between promotional specifications and practical performance of amplifiers. Subjective tests have been carried out by music societies, audio groups and hi-fi magazines which reveal the poor listening performance of popular present day conventional transistor amplifiers when compared with valve amplifiers of 10-15 years ago, such as the Radford STA25 and STA100. (For example, see Hi-Fi for Pleasure Magazine, December '75 and subsequent correspondence.)

A common weakness of the present day popular transistor amplifier is its inability to maintain its rated output voltage into loads much below 8 ohms and supply current to a reactive load. Loudspeakers present a complex load to an amplifier and some nominal 8 ohm systems have an impedance of less than 4 ohms at some frequencies with a stressing phase characteristic. This combination produces listening fatigue and a sense of unease, due to transients produced by the switching operation of the protection circuits, and the crossover switching of the quasi-complementary output stages when driving practical dynamic loudspeakers near the rated level. Published tests have shown that some transistor power amplifiers rated at 100 watts output cannot provide as high an **effective** sound pressure level as a good valve amplifier rated at 25 watts output.

The ZD100 power amplifier is rated a nominal 100 watts per channel. It uses true complementary symmetry output with additional circuitry for neutralising crossover switching transients at high current drive. It maintains its maximum output voltage before clipping into loads down to 2.8 ohms before protection circuit operation—providing over 90 watts into 8 ohms, 150 watts into 4 ohms, and 200 watts into 2.8 ohms per channel, at virtually zero harmonic distortion, with plenty of current for reactive loudspeakers. The ZD100 is all aluminium construction and passes the F.T.C. original maximum dissipation pre-conditioning test without thermal stripping. It has been designed for continuous duty studio use and is a worthy successor to the STA100 valve amplifier. Various input options are available including XLR sockets and 10k ohm line bridging transformers.

Write or telephone for leaflets:

Radford Audio Ltd

Ashton Vale Road

Bristol BS3 2HZ

Avon

Tel. 0272-662301

THE DOCUMENT SQN CONTROL UNIT

gets the best out of your mini Nagra

Reduce your film sound recording channel to 1.25kg (2lb, 12oz). Our SQN Control Unit is designed to exploit fully the excellent basic specification of the Nagra SN making available for the first time all the facilities of the big recorders. These include:-

- * manual gain control and VU meter
- * direct monitoring without tape running
- * before/after monitoring with tape running
- * headphone amplifier giving extra 9 db gain
- * 10Hz (or 30Hz) crystal sync. pulse generator
- * LED indicates sync. pulse being recorded
- * a.g.c. option retained
- * battery test button
- * 6 hours' continuous recording on Mallory Mn 1604 9Volt battery
- * built-in powering for Sennheiser MKH series r.f. condenser microphones
- * built-in pre-amp for dynamic or self-powered microphones (200-600Ω)
- * bass cut switch (cut adjustable internally over wide range)
- * input sockets for line in and bleep signals
- * the lowest of low profiles
- * minimal transport costs for your sound kit
- * a product that has been extensively tested in all extremes of climate

The SQN-1 Control Unit
will be exhibited at
PHOTOKINA
(10 to 16 September)
Stand E.1, Hall 12
Schweizer Filmtechnik



Illustrated Brochure available from:-

DOCUMENT GROUP LONDON LTD.,
THIRD FLOOR, 8-12 BROADWICK STREET, LONDON W1V 1FH.
Telephone: 01-437 4526/7 Cables: FILMDOC LONDON W1 ENGLAND.

SIS

*Budget
Price*

**British made
professional
cartridge reproducer**

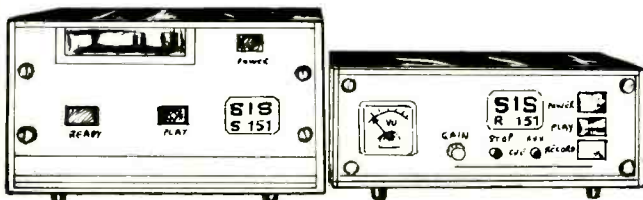

Ask for literature

SIS Ltd, 57 St Andrews Road, Northampton NN1 2PB
Telephone: Northampton (0604) 32965/ 30559

CD/SIS1

YOUR SPECIALISTS IN LANGUAGE RECORDING

AUDIO CASSETTE—
REEL TO REEL DUPLICATION
ALL PUBLIC ADDRESS EQUIPMENT HIRED
CONFERENCES AND EXHIBITIONS COVERED

TEL: 01-499 1231

Griffiths Hansen (RECORDINGS) Ltd (Est 1953)

12 BALDERTON ST. LONDON W1Y 1TF

THE SPECIALISTS

REVOX . NAKAMICHI . TEAC
TANNOY . AKG . YAMAHA
JBL . AMCRON . SPENDOR

Demonstrations by appointment

THE MUSIC LABORATORY

01-346 4469

Soundcraft-Series II

revised specification.



The Series II range of recording consoles are now available with many more facilities as standard, enabling the engineer to record four and eight-track with the four-group output mixers, eight & sixteen-track with the eight group mixers. Input modules are available in groups of four channels. All connections between the channels are by multipin connectors and a mother board system. Two types of equalisation:— the standard module features the Soundcraft four-band E/Q with the addition of a high pass filter (bass cut), 12dB/octave below cut-off frequency, continuously

variable between 20Hz and 350Hz. The special module features sweepable frequency of the two mid-frequency peaking and dipping equalisers, addition of a low pass filter to the HF shelving equaliser, and the same 50Hz shelving equaliser and high pass filter as supplied on the standard module. There are four cue sends from each input and monitor channel.

Write for complete details direct to Soundcraft Electronics Ltd., or to the local agent or distributor if listed below.

SOUNDCRAFT – Mixing Consoles to the World of Music

- U.S.A.** Franchised dealer network — Serviced by Manufacturers Representatives — write for your local dealer.
- CANADA.** Franchised dealer network — write for your local dealer.
- NETHERLANDS.** Selectronic B.V., Sluisplein 3-4, Ouderkerk aan de Amstel. Tel: (02963) 3838/3966.
- SWEDEN.** Ing. Jan Setterberg, Forstavsgatan 1, S-431 36 Molndal. Tel: (031) 13 02 16 87 58 93.
- GERMANY.** Franchised dealer network — write for your local dealer.
- BELGIUM.** Delta Equipment, Rue de Calevoet 112, 1180 Bruxelles. (02) 376 60 34.
Calevoet Straat 112, 1180 Brussel. (02) 376 60 34.
- SWITZERLAND.** Professional Audio Systems, 4132 Muttentz, Kappeliweg 41. Tel: 061/41 51 56.
- AUSTRALIA.** Klarion Enterprises (Pty) Ltd., P.O. Box 379, South Melbourne, Victoria 3205. Tel: 61 3801. Cables: Klarionmelb.
- SOUTH AFRICA.** Tru-Fi Electronics S.A. (Pty) Ltd., P.O. Box 31801, Braamfontein, TVL 2017. Tel: Johannesburg 838 4930.
- JAPAN.** C.M.C. Inc., Kasumi Building No. 503, 21-20 Nishi-Azabu, 3-Chome, Minato-ku, Tokyo 104.



5-8 Gt Sutton Street London EC1V 0BX Tel: 01-251 3631/2/3 Telegrams: Soundcraft LDN EC 1

TASCAM

COMES TO THE MIDLANDS
AT
Libby's



TASCAM
80.8 8 TRACK RECORDER
PRODUCER

90.16 16 CHANNEL
RECORDER PRODUCER

MOD 3 MIXER 8 in/4 out

MOD 5 MIXER 8 in/4 out

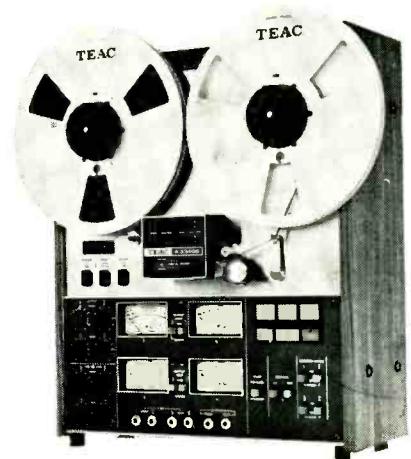

ALSO IN STOCK
QUAD, REVOX
Libby's SHURE, AKG

HI-FI

RECORDS

PHONE 021 554 8557

244 SOHO ROAD BIRMINGHAM B21 9LR

12/2 PORTABLE — A comprehensive design without compromise



Specialists in Audio Control
equipment for the Broadcast and
Sound Recording Industries



TWEED AUDIO

ELECTRONICS

ROSEWOOD INDUSTRIAL ESTATE, KELSO, ROXBURGHSHIRE
SCOTLAND TELEPHONE 2983 STD 05732

JP



STELLAVOX

Perfection in
professional recording
and mixing

The NEW STELLAVOX Sp7 is a most
portable — 3 x 8½ x 10½ inches — yet rugged
magnetic tape recorder.

Only 8lbs with tape and batteries makes it ideal for all
location recording — film; television; radio.

The Sp7 has mono full track, stereo and pilotone facilities all on the same
machine. Just a simple change of the SHD head assembly. Four standard speeds.
Fast rewind.

Only nine pounds in weight and as small as the Sp7 recorder, is the battery-powered
STELLAVOX AMI 48 Professional mixer offering five identical balanced microphone line
inputs; two main faders allowing both mono and stereo use; two balanced outputs; double
demodulator; voltage control.

JOHN PAGE LIMITED

SALES — SPARES — SERVICE

169, Oldfield Lane, Greenford, Middx, UB6 8PW.

Telephone: 01-578 0372/2641

Telex: 24224 Ref 568

ACADEMY

COMPACT HIGH QUALITY MONITORING

ACADEMY I 85W.
 ACADEMY II 60W.
 ACADEMY III 50W.

ADVANCED ENCLOSURE DESIGN.

All models available with Power Amplifiers, Mounting Saddles,
 Castors and Lifting Handles.:

Incorporating TANNOY HPD Drive Units.

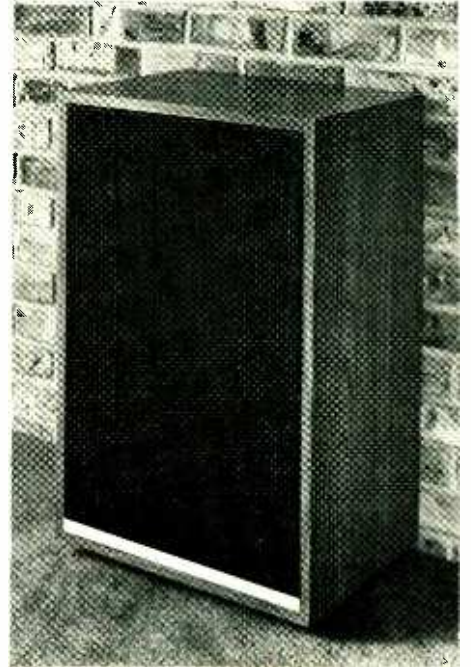

LOCKWOOD

LOWLANDS ROAD, HARROW, MIDDX. HA1 3AW ENGLAND
 Telephones: 01-422 3704 and 01-422 0768

MINIFLUX

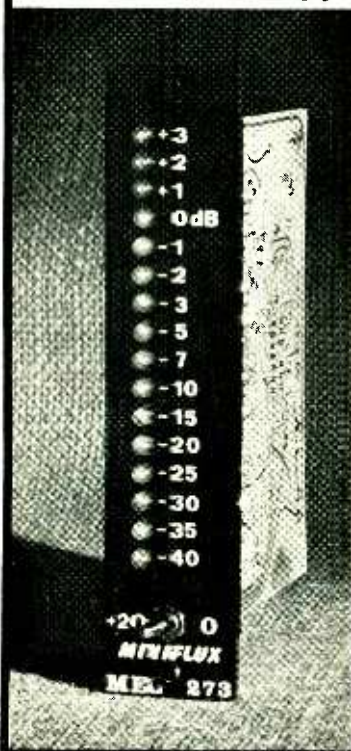

MEG 273 Peak Level Indicator uses a column of green and red LED lamps which ignite alongside a dB scale in accordance with input signal levels.

The indicator has no moving parts and its very high sensitivity allows it to be used at Test Tape levels and for system noise checks. The display is easily readable in multi-channel applications and its vertical orientation is ergonomically suited to the slider movement in mixers.

The circuit has been subject of long-term development and uses only five integrated circuits. The accuracy is ± 0.1 dB. Max. sensitivity: 60 mV to give 0 dB. Input Z: 100 kohm unbalanced. Supply: -32 to -50V. Integration time and Decay to IEC 268-10.

MINIFLUX electronics limited
 8 Hale Lane London NW7 3NX England **Tel: 01 959 5166**
 ATHENS: 815 858 PARIS: 357 16 97 STOCKHOLM: 08-83 60 00

Get binding!

Keep your copies of **STUDIO SOUND** in smart black binders (each holds 12 copies) with title in golden block letters on the spine. Price: £2.00 each, which includes inland and overseas postage. Send your order with cheque or postal order to: Modern Book Binders Ltd., Chadwick Street, Blackburn, Lancs. (state clearly your name and address and the relevant magazine title).

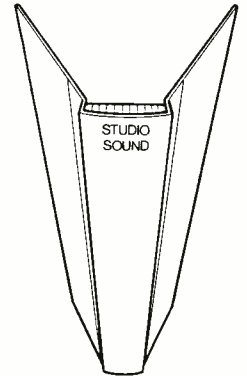

LINK HOUSE GROUP

WE CARE FOR OUR REVOXES— WHY NOT LET US CARE FOR YOURS?

We can do anything you can dream up for the A77 within reason, and without detriment to the normal performance of the A77, such as:

- 1 Any speed from 30 i.p.s. down to $\frac{1}{2}$ i.p.s. without any of the usual problems.
- 2 Improving specifications to the most amazing standards for the professional user.
- 3 Pause control.
- 4 Balanced line mic inputs with or without phantom speed up to 21 volts.
- 5 Cannon input and output.
- 6 RAPID SERVICE.

WE PROVIDE IMMEDIATE SERVICE TO THOSE WHO URGENTLY REQUIRE THEIR REVOXES.

Radio Recordings

Tel. No. 01-586 0064

ALL MACHINES WE REPAIR OR MODIFY LEAVE US WITH A SPECIFICATION SHEET

Roger Squire's the specialists in deejay equipment for radio studios

PROFESSIONAL EQUIPMENT AT COMPETITIVE PRICES FOR BOTH BROADCASTING STUDIOS—AND RADIO RECORDING STUDIOS

ALL PRICES ARE NETT PROFESSIONAL

JINGLE MACHINES

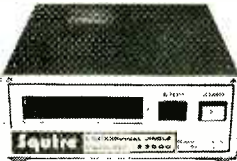

SQUIRE S3000 Mk. II
R/Playback compat. £158



SPOTMASTER
Model 1000 £350

BROADCAST TURNTABLES



RUSSCO from £180

INSTANT
START

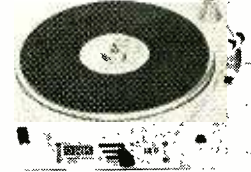

QRK from £150



Allen and Heath MINIMIXERS
6 into 2 — ONLY £148

We now stock the
Chilton range of
professional
Studio Mixers



Chilton Mixers
PRICES FROM £410

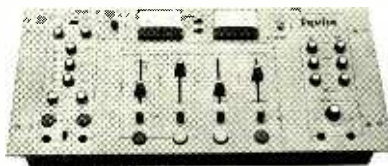

Squire S4000 6ch M/S Mixer £218

FEATURING
Remote starts
Voice auto fade
Full studio spec.

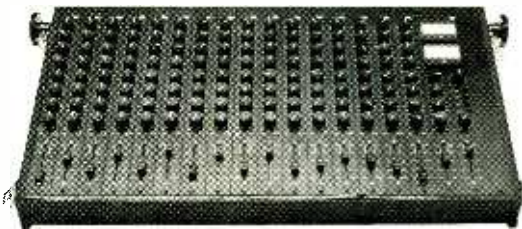

ALLEN & HEATH		
16/2	...	£580
14/2	...	£527
12/2	...	£474
10/2	...	£421

ALSO

Stanton 500 AL Cartridges	£14.95
AKG Studio Mics, from	£56.00
Anglepoise Mic Stands	£14.75

Budget-priced mixers, from	£59.00
Uher Interview Recorders	£284.00
HH variable echo units	£134.00

UK CUSTOMERS VAT EXTRA

DELIVERY ANYWHERE IN UK *plus* EXPORT SERVICE

Most items available ex-stock. Prices subject to change without notice.

Showrooms open Tuesday—Saturday Closed Mondays

OPENING TIMES 10.00 a.m. - 5.00 p.m. LATE NIGHT WEDNESDAYS UNTIL 8.00 p.m.

Talk to our Manager Tony Kingsley.
He knows about Radio Studios.

SOME ITEMS ALSO AVAILABLE FROM
OUR MANCHESTER BRANCH.

Roger Squire's

STUDIO EQUIPMENT DIVISION
55 CHARLBERT STREET, LONDON NW8 6JN
Telephone 01-722 8111

"I PAY **LESS** THAN 38p
FOR A DUPLICATED C60 CASSETTE"

Recordings are equal
in quality to major
record labels

Stay as you are—
you must be using
duplitape

Recordings are poor and
inconsistent because
cassettes are low quality
and produced by
"in cassette" method
of copying. Also
programme lengths are
fixed not flexible

"I PAY **MORE** THAN 38p
FOR A DUPLICATED C60 CASSETTE"

Quality is poor

Avoid bankruptcy—
bring your product
quality into line with
consumers' requirements
and reduce prime costs

Quality is good

You are too
benevolent

Your regular duplicating
company probably
sub-contracts to
duplitape. Pocket the
difference—go direct

USE duplitape FOR THE SAME "READY
FOR RETAIL" QUALITY AS EMI, DECCA,
CBS, ETC., WHO'S CASSETTES ARE ALSO
RECORDED BY THE "LOOP BIN" METHOD.
ANY PROGRAMME LENGTH FROM C1/2
TO C131 WITH ABSOLUTE CONSISTENCY.

DUPLICATING COSTS

1000 up 38p free mastering
500 up 40p
250 up 43p
100 up 46p

including library case
Based on C60 length

duplitape

5 PRATT STREET
CAMDEN TOWN
LONDON, NW1 0AE
Tel. 01-485 7833

NEW FROM E.S.E.

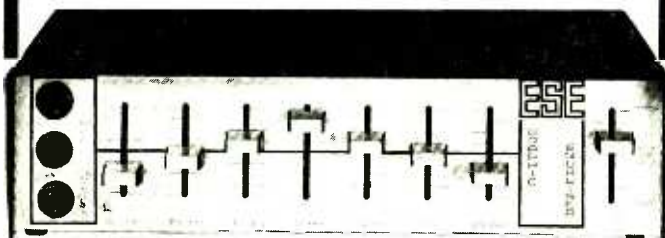

A full frequency range graphic equaliser **YOU** can afford ! !

For **JUST £35.00 plus V.A.T.**

You can tune out all unwanted
noises at **seven** different fre-
quencies!

Bring all your recordings, P.A.,
discos, lead guitar, bass guitar,
organ, **anything** amplified to life
at the touch of a **slider** ! !

No more annoying amplifier
noises—just clear, true sound !
Frequencies from 60 Hz to 10 kHz !
Cut or boost each frequency by
maximum of 15 dB !

Hi and lo gain inputs.
Powered by just two PP3 batter-
ies which last for ages. Or built
in mains power unit available at
£9.50 + V.A.T.

Try it and you'll buy it — it will
change your concept of sound.

Trade enquiries welcomed.

Condensed Technical Spec.

Max. output: terminated to 600Ω
+10 dB > 1.6 volts peak to peak,
2.5 volts R.M.S.

Signal to noise ratio: input ter-
minated with 47k resistor. All filters
at max. better than -70 dB.

Frequency response: All filters at
central better than ±2 dB.

Filter slope: Better than ±13 dB
per octave.

Filter ranges: Max ±15 dB at 60,
180, 480 Hz, 1, 2.4, 5 and 10 kHz.

To: E.S. Electronics, 2 Upper
Fant Road, Maidstone, Kent.
Please send me 1, 2, 3, 4, 5
of your Graphic Equalisers. I enclose
cheque or postal order for £.....
having added £1.50 for p. & p. on each
item ordered and V.A.T. I understand
that two batteries are included.

Name

Address

Tel.

S.S.6

POWER AMPLIFICATION
BY MUSTANG



Our SS.100 and SS.50 are economical amplifiers with outputs
of up to 150 and 80 Watts RMS into 8-15 ohms, typical THD
figures being 0.1%, slewing rate > 10v/μs, noise > 90dB
down, zero level input, and full electronic protection.
Considering these points with their proven reliability and
robust construction, plug in output transistors and driver
board, optional balanced input and 100V line output, and
virtually ex stock despatches we reckon we take some beating!
Contact us now for the full technical specifications.

Manufacturers of mixers, integrated mixer amplifiers and slave amplifiers,
studio power amplifiers, transformers, lighting control equipment and
cabinets for the home and export markets.
Contact us for full illustrated technical brochures.

MUSTANG
COMMUNICATIONS

Nelson Street, Scarborough,
North Yorkshire YO12 7SZ
England
Telephone 0723-63298



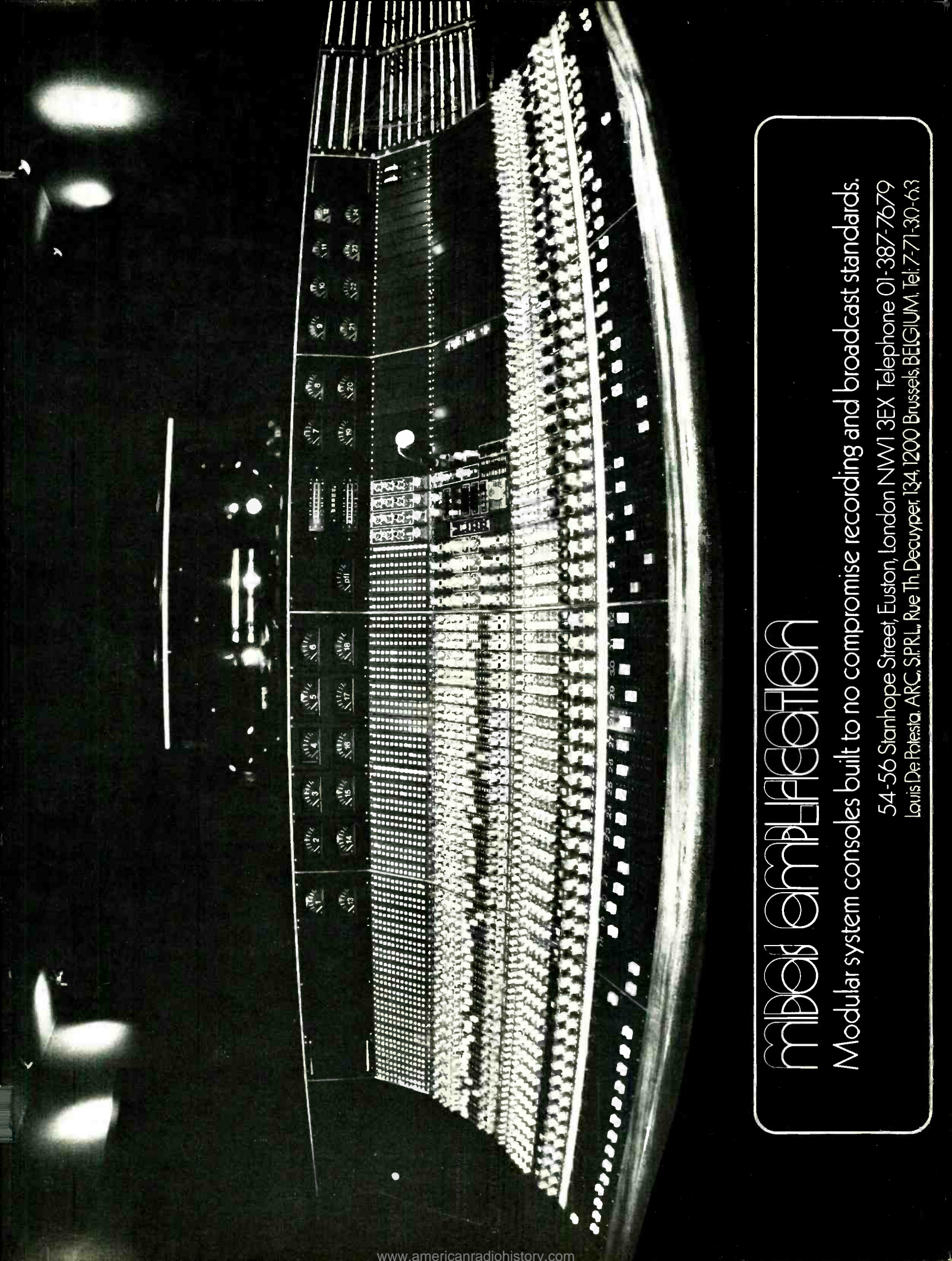

MBEOL AMPLIFICATION

Modular system consoles built to no compromise recording and broadcast standards.

54-56 Stanhope Street, Euston, London NW1 3EX Telephone 01-387-7679
Louis De Polesia, ARC, S.P.R.L., Rue Th. Decuyper, 134, 1200 Brussels, BELGIUM, Tel: 7-71-30-63

12 CHANNEL STEREO MIXING CONSOLE

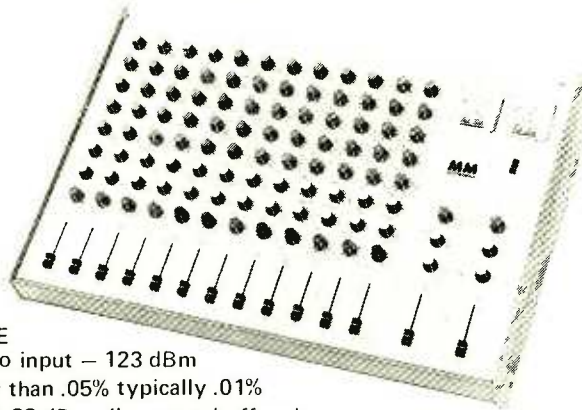

PERFORMANCE
 Noise reference to input – 123 dBm
 Distortion better than .05% typically .01%
 Overhead level at 22 dBm all outputs buffered
 £250 Retail

**12 Channel Export Model
 16 Channel Mixing Console
 8 Channel Stereo Mixer**

For further details contact TONY GIPP
 (0223) 66559

20 into 4 to be announced shortly

MM
ELECTRONICS

French's Mill, French's Road, Cambridge (0223) 66559

SENNHEISER

The new ace in our pack

We are pleased to reveal the new trump card in the Sennheiser range of stereo headphones. Once you have tested the superb closed ear HD 224X, you will appreciate what a winner we have. In the meantime, just take a look at this specification.

Transducer principle	Closed ear
Frequency response	16 - 20 000 Hz
Nominal impedance	200Ω acc. to DIN 45 500
Nominal SPL at 1000 Hz	94 dB per system (10μ bar Δ 1Pa) at 1mW of power (corresponding to 450 mV at 200Ω)
Nominal load	0.5W acc. to DIN 45 582
THD	≤ 1% to DIN 45 500
Weight	approx 252g without cable

Supplied with 3 metre cable terminated with a jack plug

HAYDEN LABORATORIES LIMITED
 Hayden House, Churchfield Road, Chalfont St. Peter, Bucks. SL9 9EW
 Telephone: Gerrards Cross (02813) 88447



HAYDEN

Please send a free copy of the Sennheiser Stereo Headphones Brochure.

Name

Address

Code 55 224/9

REVOX

buy it first
it's built to
last

We sold more Revox's than every other dealer in UK last month, which must speak for itself for our prices, availability and service.

TRY US SOON — WE TRY HARDER

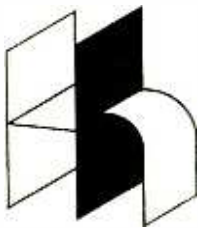

AUDIO CENTRE SHEFFIELD
284 GLOSSOP ROAD
SHEFFIELD S10 2HS
Telephone (0742) 730064

CALREC MICROPHONES

Professional British Capacitor mics for studio/hifi use at low low prices

Entertainment Series		Studio Series	
CM602/652 (Card.)	£26.80	CM1003C (Omni)	£51.75
CM654 (Vocal card.)	£26.80	CM1001 (Omni)	£51.75
CM655D/656D (Card.)	£33.00	CM1050 (Card.)	£51.75

POWER PACKS

mains: CP621A £14.22 battery: CP611 £11.21
PRICES INCLUDE POSTAGE AND VAT AT 12½%

All Calrec mics and accessories available for rapid delivery UK and Export

BIZARRE AUDIO

316 Endsleigh Ct., Euston Rd., Bloomsbury, London W.C.1
Wide range of loudspeaker units and crossovers in stock

AT LAST —

A STEREO DISC CUTTING HEAD

made in Britain by British engineers at about half the cost of any other stereo cutter head!

For full details call

COUNTY RECORDING SERVICE
LONDON ROAD, BINFIELD, BRACKNELL,
BERKSHIRE, ENGLAND

Phone BRACKNELL (0344) 54935

Now a sturdy one-year-old,
MCI UK in only twelve months
have become a major supplier
of quality studio equipment.

Growth demands space, so



Have Moved

**MCI HOUSE is now located
behind Euston Centre.**

**We are the new neighbours of
Thames TV and Capital Radio.**

**Call us now on 01-388 7867/8
or Telex 261116.**

Our new address is:

**MCI HOUSE, 54-56 STANHOPE ST.
LONDON NW1 3EX.**

**Answering machine on
continuous 24 hour duty.**

**From our new premises we aim
to make our customers the best
equipped in the world.**



The art of the States

MCI (PROFESSIONAL STUDIO EQUIPMENT) LTD.
MCI House, 54-56 Stanhope Street,
London NW1 3EX. Tel. 01-388 7867/8.

Live QS broadcast in UK

Radio Clyde, the Scots independent local radio station, has carried out a couple of experimental QS four channel matrix transmissions direct from the Kelvin Hall, Glasgow.

Programme material, taken from the Proms 76 concerts given by the Scottish National Orchestra, was broadcast live from the Radio Clyde IBA transmitters, after passing through a Sansui four channel encoder producing the matrixed stereo signal for transmission. This experiment, carried out on June 26 and July 2, was carefully monitored by the IBA. This is the second QS transmission carried out by an IIR; the first involved Piccadilly Radio, Manchester (in April) where programme material consisted of QS encoded discs and synthesised from stereo sources.

Allen and Heath/Brenell link

Following the take-over of Brenell Engineering by Allen and Heath, the latter company now offers an eight track package of an Allen and Heath model 2 mixer and a Brenell 25 mm eight track recorder for around £4000. Both machine and desk are manufactured under the same roof in Hornsey, London.

Both companies will continue to manufacture under their own brand names, but offer the claimed

advantage of one after sales service for both.

Allen and Heath Ltd, Pembroke House, Campsbourne Road, Hornsey, London N8. Phone: 01-340 3291.

5 slot player

Broadcast Electronics now manufactures a three or five station option to complement the range of cartridge machines. Designated the 5000 range, the latest *Spotmaster* offers the claimed high phase stability *Phase Lok III* head bracket, slide out decks, air damped solenoids and direct drive hysteresis synchronous motor. Both mono and stereo models employ a muting circuit which disconnects the signal lines from uncommitted decks thus reducing the output noise level.

All decks will operate through either a mixer unit or a switcher; the standard *Spotmaster* mixer accessory allows for overlap of audio from one deck to the next while a switcher selects an output from only one deck at a time and automatically selects the output from the last deck to be started. Thus, if an operator starts a wrong deck, he can immediately start the correct deck and the first will automatically recue.

Three deck models can be supplied with a recording facility on deck three only; this offers the possibility of playback on three decks with record on one. All models can be supplied for 'A' and 'B' sizes or 'A' size only.

The company has recently introduced a broadcast fm audio processor which provides compressor/limiter/expander functions in one box. The *Spotmaster CLE-FM Sound Britener* uses only two controls to set the operating characteristics: the Average/Peak ratio control sets the dynamic range from as little as 1 dB to 35 dB. The Return Rate Control determines the speed with which low level signals are expanded.

The unit has three switch selectable modes of operation. NORMAL provides gated compression/limiting/expansion. LIMIT ONLY functions as a limiter/compressor. TEST puts the unit into a straight line amp mode. The processor uses a pre-emphasis circuit during operation and a complementary de-emphasis on the output. Different pre-emphasis time constants can be selected and jumpers on the output board may be used to disable the de-emphasis network.

Broadcast Electronics Inc, 8810 Brookville Road, Silver Spring, Maryland 20910, USA. Phone: (301) 588 4983.

UK: Broadcast Audio (Equipment) Ltd, PO Box 31, Douglas, Isle of Man. Phone: 0624-4701.

Tv for record pr

Increasing use of video cassette promotional material by record companies was one of the reasons which prompted REW to open a tv studio facility in London's West End. Although not to broadcast standard, the three camera colour studio provides effects generators, caption camera, ten to four sound mixing, four channel sound recording and 60m² of studio floor.

Playback, either direct or sourced from an Ampex 25 mm vtr or Sony Philips cassette machines, can be viewed by up to 20 people in a conference pre-view room. The control room gains visual access to the studio through the usual double glazed window with the editing electronics housed in a separate room. A *CML 800* prompter, said to be to BBC design, should help clients reduce the number of retakes necessary.

Richard Murray, for the company, stated that the role of the studio is not to provide broadcast material whether programme or advert. Rather, it enables cheap screen tests, at rehearsals and tv

style checks for wouldbe superstars to be carried out effectively at £400 a day in lieu of the £1000+ figure associated with broadcast facilities. He also mentioned the use of video cassettes in getting bands on the road. A cabin carried cassette could sell a support band to a foreign tour promoter much cheaper than the return air fare and expenses for the record company executive. And possibly sell even harder.

REW Studio, 146 Charing Cross Road, London WC2. Phone: 01-540 9684.

New cans

Sennheiser has developed two pairs of dynamic stereo headphones—one at each end of the range. The first is the *HD 224* which employs closed construction making them suitable for foldback applications. The units are claimed to be light and readily adjustable with soft, close fitting ear pads. They incorporate a new design of transducer capsule.

The second set of cans are intended for consumer applications and, although mucho cheapo, the subjective quality (many thanks to Sennheiser for the free pair) goes way beyond the 'made in Hong Kong' look (they weren't; they are manufactured in Germany). Using open construction, they weigh only 80g.

Hayden Laboratories has opened a London showroom at 6 Bendall Mews, Bell Street, London NW1. The building will also house the new London based service facilities. Hayden Laboratories Ltd, Hayden House, Churchfield Road, Chalfont St Peter, Bucks. Phone: 88447. Sennheiser Electronic, 3002 Bissendorf/Hann. West Germany. Phone: 05130-8011.

Harris sales manager

The Broadcast Products Division of the Harris Corporation has announced the appointment of George W Hamilton as manager of international sales administration—that means he becomes the interface between company and client for the overseas business. In this capacity, he will look after bids and sales and co-ordinate support activities. George Hamilton joins the company after much experience in broadcasting with Middle East organisations.

Harris Corporation, Broadcast Products Division, 123 Hampshire Street, Quincy, Illinois 62301, USA. Phone: (217) 222 8200. 24 ▶

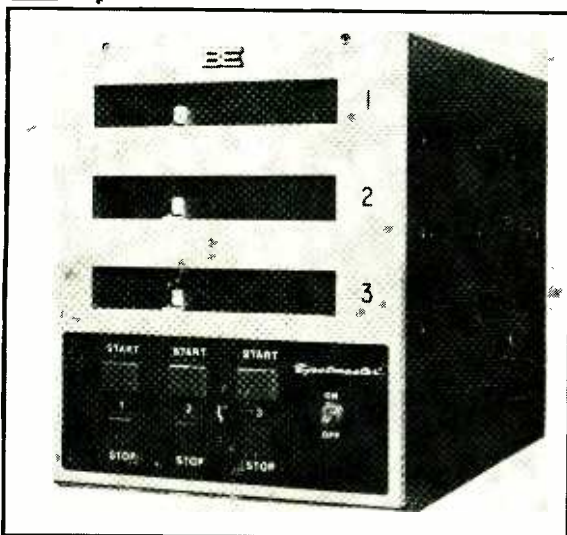

Spotmaster 5000

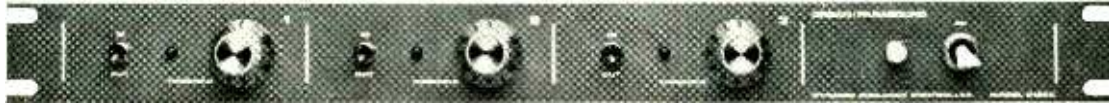

Orban Parasound's Model 516EC Dynamic Sibilance Controller

The elegant solution to one of recordings oldest problems.

Featuring three independent de-essing channels in a single unit 19" x 1½" rack panel. This Orban product has been designed to eliminate the current compromise between desired vocal equalisation or limiting and acceptable levels of sibilance.

The model 516EC provides effective and *automatic* sibilance control during the recording and re-mixing of vocal tracks for record, cinema and broadcasting use.

- Simple and repeatable operation.
- Constant de-essing over a wide (20db) input level range.
- Low noise and distortion.
- No audible 'pumping' effects.
- LED indication of de-essing operation.
- Click-free in/out switching for each channel.



Orban Parasound's Two Channel Parametric Equaliser

The most cost-effective professional equaliser available today.

Two totally independent channels each with four overlapping 4.3 octave range bands. Continuously variable tuning, equalisation level *and* bandwidth controls on each band.

Up to 16 db boost, minus infinity cut available on each band.

'Constant Q' rather than reciprocal equalisation curves. Extremes of equalisation are musically useful instead of being peaky and ringy.

Click-free in/out switching.

L.E.D. overload indication

For full information or a demonstration of the 516 EC dynamic sibilance controller, the 621B Parametric Equaliser or any other Orban product contact :

Scenic Sounds Equipment, 27-31 Bryanston Street, London W1H 7AB. Phone No. 01-935 0141.

Orban/Parasound San Francisco, California 94109

NEWS

New from Sescom . . .

A range of audio modules based on a series of plug-in units for easy access and maintenance. They have been specifically designed for use in audio mixing desks and, as such, are available in a wide range of sensitivity and equalisation characteristics for incorporation at any point within the system organisation. Signal and power lines are generally pin compatible to enable a straight module swap for different channel characteristics. The modules include all necessary resistors, capacitors and interface transformers as an integral part of every unit; they also feature the use of octal plugs and sockets for connection. At present the range comprises:

MIC 1 to **Z** mic pre-amp.
MIC 2 hi Z high gain pre-amp.
MIC 3 lo Z high gain, mic pre-amp for use with low output models.
SA 1 hi Z low gain pre-amp.
PH 1 magnetic phono pre-amp.
NAB 1 tape head playback amp equalised to NAB.
TC 1 active equaliser.
LA 1 high gain line amplifier.
LA 2 low gain line amplifier.
PA 1 mini power amplifier (12W into 8 ohms).

The same company also manufactures a condenser power supply that will power up to six condenser mics simultaneously. Designated model **MS7**, the unit, which costs \$198, provides a closely regulated 48V dc at up to 16 mA total load current. It will operate from all national and international power supply line standards. Further information from: The Sales Manager, Sescom Inc, PO Box 590, Gardena, Ca 90247, USA. UK: Future Film Developments, 90 Wardour Street, London W1V 3LE. Phone: 01-437 1892/3.

Distortion meter▼

The **DM-155** distortion meter measures down to 0.01% full scale deflection; it incorporates an automatic null facility. The unit oper-



Sescom MS condenser power supply and (below) octal based modules

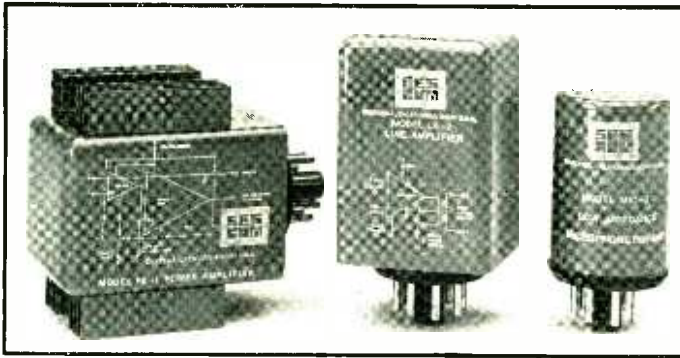

ates over the range 10 to 110k Hz with a vernier control providing continuous adjustment over that range. Fundamental rejection is quoted as being greater than 80 dB relative to the distortion side tones.

It also includes a high sensitivity voltmeter offering 14 ranges from 30 μ V to 100V rms full scale in 10 dB steps, with a frequency response from 10 to 300k Hz. Residual noise is less than 10 μ V rms, or below 5 μ V with the low pass filter in circuit. The unit cost £775.

NF Circuit Design Block Ltd, 3/20 Tsunashima Higashi, 6-chome, Kohoku-ku, Yokohama, Japan. Phone: 045-542 0411.

UK: Lyons Instruments Ltd, Hoddesdon, Herts. Phone: 67161, telex: 22724.

Stereo delay unit▼

Lexicon has recently introduced a stereo version of the **Delta T-102** digital delay system—the **102S**. The new unit incorporates two independent channels on the one chassis; it also includes a vco clock to the delay circuitry enabling manipulation of the input signal in the time domain. This produces the usual effects including variable ad, flanging, vibrato, time delay pan-

ning and heavy pitch modulation.

The two delays can be used independently with totally different signals. For example, the vco may be set to control only one channel while the other remains clocked by the crystal oscillator. Quoted specifications include: 90 dB dynamic range, 0.2% total harmonic distortion, 192 ms delay per channel with 3 ms taps, dual five position leds to indicate headroom and modular, field expandable construction.

Lexicon Inc, 60 Turner Street, Waltham, Mass 02154, USA. Phone: (617) 891 6790.

UK: FWO Bauch, 49 Theobald Street, Borehamwood, Herts. Phone: 01-953 0091.

Music for airtime

Radio RIS, Rome intends to begin a series of weekly broadcasts of contemporary music; this includes modern composition (perhaps avante garde) but not popular commercial material. The station asks, through this magazine, for composers to send in tapes of their work for eventual inclusion in the broadcasts. It states that biographical information should be included as well as composer notes and details of the performance.

From a technical point of view, tapes should be recorded at 19 cm/s in half track stereo or mono on 6.25 mm format. No noise reduction should be used. Other tape speeds are acceptable.

Radio RIS is one of many private fm radio stations that have sprung up around Italy since a constitutional court ruling declared that the RAI, the national Italian broadcast network, monopoly to be illegal. The station is now in the process, together with others, of forming a national network of local fm radio which will enable a greater diversity of programme material.

Entries of possible material, enquiries and correspondence should be sent to James Dashow, Radio RIS, Via Acherusio, 18, 00199, Roma, Italia. Any language is acceptable.

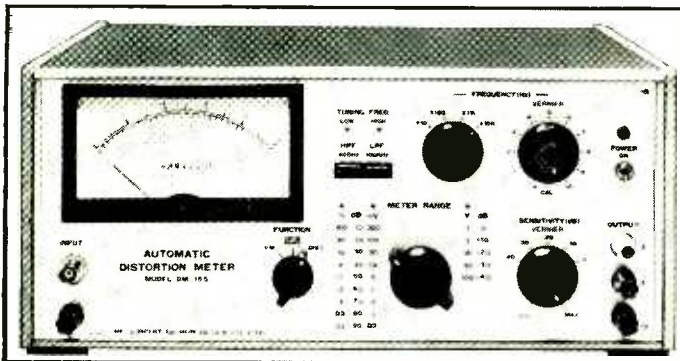



Fully professional Studer quality at affordable prices

The new generation of professional STUDER tape recorders is designed for the use in broadcasting, television and recording studios as well as theatres and scientific laboratories. The low-cost STUDER A67 includes a wide range of modern features:

3 servo controlled AC motors – Crystal controlled capstan servo – Variable tape speed (2½" . . . 22½") with external frequency – Tape tension control during all operating modes – Control logic with memory – Illuminated push buttons – Remote control of all tape transport operating modes – Automatics for continuous program – Mechanical counter, indicating Min & Sec – AC-Mains supply 50 or 60 Hz, 110 . . . 250 Volts – Opto electronic end of tape sensor – Head block with aluminium die-cast frame –

Tape lifter, may also be operated manually – Long life heads – Audio electronics module with plug-in cards in front of tape deck – Playback, record and bias amplifier boards have all necessary adjustments accessible from the front of the recorder – Switchable for equalization CCIR or NAB – Optional: VU-Meter/panel with peak indication (LED) – Head phone jacks – Available with or without VU-panel, as portable or console version or as chassis for 19" rack mounting – ½-inch, 4 track version in preparation.

STUDER

STUDER INTERNATIONAL AG
Professional Audio Equipment
CH-5430 Wettingen, Switzerland

F.W.O. BAUCH LTD. 49 Theobald Street, Boreham Wood, Hertfordshire WD6 4RZ Telephone: 01 953 0091

letters

Dear Sir, Mr Jerry Bruck (STUDIO SOUND April 1976 pp 44-48) gives, with the authority of experience, some hard but necessary sayings. 'Progress' in recording techniques during the present decade seems to be heading the industry for a crisis. Too many people are telling me that the records they play and replay, despite lower technical 'quality', are those made before a cut-off date somewhere between 1965 and 1969. If this trend continues, sales of modern recordings may be at risk. Indeed is it not already true that reissues of older recordings, including transcriptions of 78s, are more popular now than ever before?

Hence the need to re-emphasise, as Mr Bruck so convincingly does, that distortions of space, place and acoustic perspective are indeed distortions, no more forgivable than any other kind of distortion. Hence also the timeliness of Mr Bruck's injunction to any engineer having a few channels to spare to connect them to a pair or quad of close-spaced directional microphones, and have a listen to remind himself of what he may have forgotten during years of pan pot training.

The danger of this experiment is that it will not, and can not, produce true surround-sound, and it may therefore be misinterpreted unless this limitation is clearly realised. As with the success of Gina Lollobrigida, there are two obvious reasons for this as well as some more fundamental ones. First, the session will not have been laid out and balanced for quasi-coincident pick-up, and therefore there will be obvious faults. Second, the problem with purist techniques is that they have never been tried by Mr Jerry Bruck. He describes how he progressed from microphones many metres apart to microphones only centimetres apart, but the end of this road is not Bruck's Sputnik but the Craven-Gerzon Collapsar, ie the sound-field microphone.*

In his flattery of quoting me (Hi-Fi News & Record Review: November 1975 p 121; March 1976 p 79) Mr Bruck invites me to sharpen my slide-rule, which shows me that the apparent spacing of the Sputnik microphones corresponds to half a wavelength at about 500 Hz. This means that the microphone signals are de-phased over about half the octaves, or 97% of the frequency range, of the audio spectrum. The result is therefore a quad of monophonic signals which when played into suitably disposed loudspeakers give a rough impression of directionality. It is in fact back to back-to-back mono, but still falls short of the capabilities of a surround-sound system properly engineered according to the technology and psychoacoustic theory which is now known.

Raw microphone signals are in general not ideal loudspeaker signals for surround reproduction, and the reason is simply that there is no reason why they should be. The clue to how Mr Bruck gets away with it is given in his statement

*Gerzon M.A. 'The Design of Precisely Coincident Microphone Arrays for Stereo and surround Sound' AES 50th Convention 1975.

that 'there is no provision for mixing channels' When de-phased signals are mixed, whether for surround or any other purpose, all hell breaks loose. There are various ways of overcoming this. One is to train oneself through long years to be insensitive to the distortions that result (particularly popular in countries that have a tradition of spaced microphone stereo). Another is to ensure that no microphone can hear the same sound as any other, even if this means placing a microphone between the legs of the harpist (see STUDIO SOUND April 1976 p 64). However, the best way is surely along the road that Jerry Bruck has pointed out to us.

Note incidentally that the word 'quad' has been used above in a correct sense (literary authority from 1888) of abbreviation for 'quadruple'. Whatever his intentions, Mr Bruck in fact uses the word in this correct sense in most of his article. I can not, however, accept his use of language in saying that 'the real potential of quadrasonic sound is in its ability to restore timbral nuances, intensify perspectives and to provide . . . the sense of total environment which finally includes both musician and listener'. Rationally engineered surround reproduction can indeed do this, but no 'quadrasonic' arrangement which involves mixing of de-phased signals can do so correctly, for the reasons already indicated.

Where have all the Blumleins gone? Gone to pan pots everyone? On the contrary, this age has its Alan Blumleins, and the name of at least one of them has been mentioned in this letter. Yours faithfully, Peter Fellgett, University of Reading, Dept of Engineering and Cybernetics, 3 Earley Gate, Whiteknights, Reading.

In his response to my diatribe in your April issue, Professor Fellgett generously allows me a handgrip on the Holy Grail, while sternly refusing me its enveloping warmth. Hardly would I surround myself in such finery, lest The Man in the White Suit turn out not to be such a smart Alec.

Professor Fellgett errs in assuming that I have 'never' tried coincident techniques, for I have; and in fact still employ them for stereo setups where I must position the recording pair close to a group with a soloist. In such cases, coincident microphones offer a very stable centre image, providing the soloist with sonic sea-legs on replay.

What coincident placement does not do, in my experience, is recreate the spaciousness and ambience of a locale as convincingly as do slightly-spaced microphones. Perhaps this is because, when we listen, we do not do so from a 'point' (although some learned heads may come to that) but rather from two separate, perpetually-shifting, but inter-related points, commonly known as ears. It is precisely with the latter that I detect the superiority of

spaced-array microphones over coincident.

Granted, to deal mathematically with the variety of listening postures adopted by these curious appendages would be enough to confound a computer; nevertheless, I am reluctant to controvert the problem by positing an aural Cyclops who may then savour the Siren's wail with the aid of the Craven-Gerzon Collapsar.

As for 'de-phased signals': he who designed our ears to flank that great Melon of Thought which lies between, seems to have been unaware of any problem; nor are we while listening to our favourite pre-war Sonic Spectacular on multi-driver loudspeaker systems.

I intend no disrespect to Professor Fellgett and his considered commentary, for amidst that feast he has seen fit to brush a few crumbs in my direction. Such morsels form the meagre diet of the 'Purist' and I am grateful, but I fear I can not digest the dessert entire. If Professor Fellgett means to suggest that I am another Alan Blumlein, then he is (again) sadly mistaken. There is a vast gulf fixed between the creative genius and the inspired hack, for the one makes possible the other, and I hope to know my betters.

Respectfully, Jerry Bruck, Posthorn Recordings, 185 Avenue C, New York City, USA.

Dear Sir, I am most grateful to Mr Jerry Bruck for confirming, though not in those words, that he has never used coincident microphones. Coincident actually means coincident, not merely close-spaced, and the allowable margin of error may be seen from the equalisation curves of Gerzon.* These curves show that the microphones of a 'recording pair' can not be in effective coincidence; the size of the shield is too great.

This is a matter of fact, if words mean what they do. However, the relative merits of close-spaced and coincident microphones are a matter of taste, about which there is no disputing except in correspondence columns. It is perfectly possible that the randomness of phase of microphones a few tens of centimetres apart gives a more pleasing result, at least to some listeners, than the rather more systematically wrong phases of a close-spaced but non-coincident pair.

Nevertheless when signals derived from approximately ear-spaced microphones are fed to respective loudspeakers, the fact that the listener has two ears means that the doubling of receptors has (so to speak) been done twice, and I personally find this very noticeable in actual listening. By contrast, by using coincident microphones the listener can be placed in a better approximation to the original sound-field, and this does have merits which should not be overlooked.

Coincidentally, Peter Fellgett, University of Reading, Dept of Engineering and Cybernetics, 3 Earley Gate, Whiteknights, Reading.

By now it must seem to many readers that Professor Fellgett and I are addressing ourselves with undue concern, to the opposite ends of our Lilliputian Egg; our Purist fervour mounting in inverse proportion to the remaining centimetres of disputable distance between microphone capsules. One hesitates, lest a crusade be summoned forth to decide the matter. In fact the term 'coincident pick-up' has been borrowed by Professor Fellgett and his associates from the jargon of the recording industry and applied to a unique theoretical

construction which may one day be commercially practicable but which at the moment, alas, is unavailable to such as myself.

Were this deplorable situation to be remedied I would be second to none in my curiosity to try 'true coincidence' for, matters of rhetoric aside, my taste still functions at the behest of my ears and I would gladly imperil my opinion if provided with a sufficiently persuasive Collapsar however Craven or Gerzonian. At least in this regard Professor Fellgett, in his latest communiqué, has placed his ear to the heart of our mutual concern and if he will forget 'Utter Coincidence' in this instance I would join him there.

Mindful of preserving two centuries of memorable tranquillity, I propose we lay down our arms and prick up our ears. The issue is surely one that may be got at by listening and experimentation, and so long as we all lend a critical ear to the recorded results, we ought to be able to arrive at some, perhaps even pleasurable, observations.

Indeed if virtue be its own reward then Messrs Gerzon, Fellgett and the numerable others including myself who use and espouse simple microphone techniques, may yet find our reward in what used to be known before automated mixdown as the 'record art'. May our remaining differences keep us mere centimetres rather than worlds apart.

In close accord, Jerry Bruck, Posthorn Recordings, 185 Avenue C, New York City, USA.

Dear Sir, Congratulations. By lumping Canada (via Toronto) in with USA East in the June issue, you've put yourself in a front-running position for the Hiscocks' rubber microphone award.

Notwithstanding the continentalist view of sound recording expressed by Al Lawrence, there are some substantial differences between recording in the USA and Canada. Three influences are the state-run radio network (Canadian Broadcasting Corporation), the state-run National Film Board, and the fact that a

substantial amount of Canadian recording is done in Quebec in the French language.

Should anyone be interested, I can arrange for a fuller explanation on the rules and effects of the CRTC Canadian Content Regulations. There's much debate in Canada as to whether this sort of thing really works.

I notice that France is reluctant to allow Canada to take part in an international conference, the French view being that Canada will simply support the American position. This sort of article encourages that point of view; it's not going to do much for your popularity in this country.

Yours faithfully, Peter Hiscocks, Electrical Department, Ryerson Polytechnical Institute, 50 Gould Street, Toronto, Ontario, Canada.

While writing my article on the East Coast recording scene I asked the then editor of STUDIO SOUND, Michael Thorne, if I could include Toronto. My reasons were that I like Toronto as a city, respect its recording business, and find obvious parallels between it and New York where I am based. Approval was granted, thereby ensnaring us in an international *faux pas*.

Michael had advised me that he was dividing the USA into an East Coast and West Coast, though I did not immediately grasp the significance of USA and instead began to think in grandiose terms of the Eastern geographical section of the Northern Hemisphere. I was born and raised in Upstate New York and spent many summers in the Thousand Islands. Thus I feel a greater affinity to Ontario than to our own Florida or Tennessee.

Putting aside my personal feelings, I believe Toronto parallels New York in that its recording business draws from a larger base than even a Philadelphia, Miami or Nashville. The CBC, the film business and commercial jingles all provide work for technicians, musicians, arrangers and producers in Toronto, which I believe is the foundation for any enduring recording enterprise. In addition I have seen significant commerce between NY and Toronto

on the part of producers and musicians. I can not speak with authority on Montreal and did not include it because the majority of recordings made there seem to be strictly limited to the French-speaking market and are thus isolated from what I considered to be the remainder of the East Coast.

Unquestionably the Canadian Content Regulations have had an effect on the entire Canadian recording business. However, those rules do not restrict affluent recording groups from travelling to Canada if they so desire. One of the major premises of my article was that recording stars are no longer bound to a certain few cities but can travel nearly at will and still find the latest equipment and highly competent people to accommodate their needs. Toronto has already benefited to some degree from such activity.

The last-mentioned point concerning the French opinion of Canada's role as a possible satellite of the US would certainly seem to be politically inspired. It was not my intention to foster that opinion. Rather, I had hoped to make readers around the world even more aware of the potential of Canada, and most noticeably Toronto, as an important recording centre. Thankfully the expression and appreciation of the recording arts and sciences are, as yet, rarely limited by artificial political boundaries.

Yours faithfully, Al Lawrence, 222 Martling Avenue, Tarrytown, NY 10592.

It's always easier to include material in a broad survey than to leave it out. And easier for people to find fault when there aren't any encyclopaedic areas of available space.

In the interests of a global view, the strongly emergent East Canadian scene seems fair to include in USA East. I'm sorry that Mr Hiscocks took offence at geographical labels and thus lowered the discussion to a parochial level rather than sympathising with the broad and necessarily sparse international coverage intended.

Yours faithfully, Michael Thorne.

Broadcast pattern audio jackfields from Future Film Developments

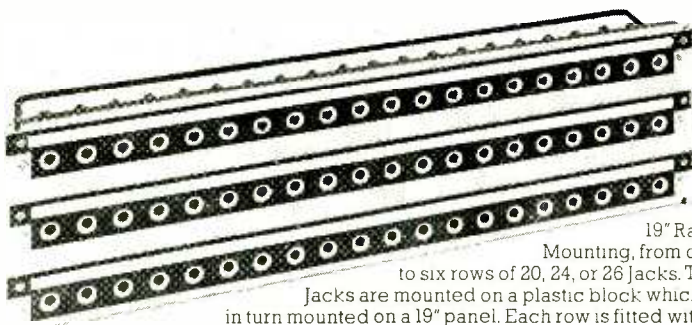

19" Rack Mounting, from one to six rows of 20, 24, or 26 Jacks. The Jacks are mounted on a plastic block which is in turn mounted on a 19" panel. Each row is fitted with a legend (designation) strip and wire support bar. The panel is steel, cadmium plated, chromate passivated and stove enamelled hammertone silver.

ALSO Audio Patch Cords · Microphone Cable · Installation Cable · Multiway Cable · Post Office & Rendar Jacks · Cable Markers · Lever Keys · Linear Faders · Cannon Connectors · Preh Connectors · Tuchel Connectors · Switchcraft Connectors · Military Tri-Lock Bayonet Connectors · Audio Attenuators · Wahl and Weller Soldering Irons · PML Microphone Accessories · Hellermann Sleeves and Tools · Crimp Terminals · Cable Drums · A.B. Engineering Wire Strippers and De-Solder Guns.

FUTURE FILM DEVELOPMENTS,

90 Wardour Street, London W1V 3LE.
Tel: 01-437 1892 Telex: 21624

DOLBY IN THE CINEMA

In the optical pre-amplifier module current signals are generated by the photocell and enter the *CP100* via an input transformer to raise the level and, equally important, to provide balanced isolation for the low level signals. The first stage is a discrete transistor amplifier (for lowest noise) which drives a low pass filter to limit the bandwidth. An integrated circuit amplifier provides variable gain to compensate for different cell outputs, which are caused by variations in mounting methods and illumination. Following this gain stage is an equalisation stage with special characteristics. In common with all scanning systems, the output from the photocell will drop when the scanned wavelength becomes comparable to the height of the slit through which the light passes, falling to zero when the two are equal. The shape of the response curve is not a simple 6 dB/octave slope, but the more complex shape of $\frac{\sin \phi}{\phi}$ (where $\frac{\phi}{2\pi}$ is the slit height). Simple RC

equalisers used on slit-loss compensators do not produce correct compensation, and a more complex circuit has to be derived. While the shape of the curve is similar for differing slit heights, the null frequency obviously varies from slit to slit, so the circuit has to be easily adjustable. The second stage in the amplifier provides such adjustment, and fig. 4 shows the effect of replaying a pink noise film firstly without and then with the circuit in operation.

A further component of the *CP100* is a six-channel ganged fader to alter simultaneously the level in the possible six channels. It is also remotable to allow control from either projector or from the auditorium, without using mechanical linking methods across the width of the projection booth, a scheme often still used. The tracking accuracy of the voltage control amplifier used can be somewhat relaxed from that of one destined for use in an automated mixing console. Tracking is only critical in a region of ± 10 dB around the nominal operating point—the remainder of the range is used only during complete fades when a degree of mistracking can be tolerated.

The other module of interest is the mono-stereo optical format module. Early tests⁴ showed that a major problem with two-channel

FIG 4 Adjustment of optical preamplifier hf control using a pink noise film loop

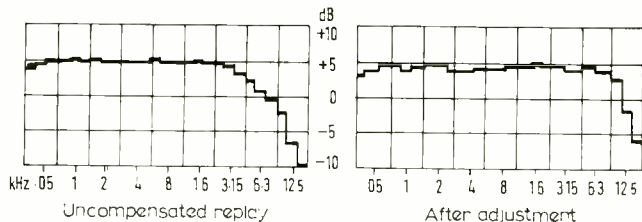
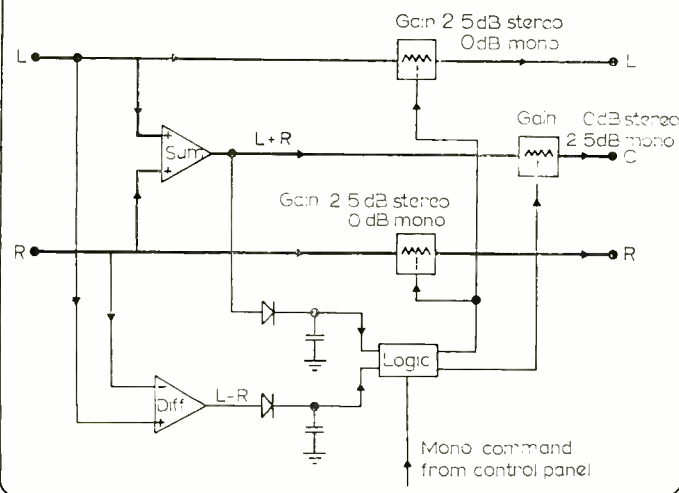

FIG 5 Block diagram of the mono-stereo optical format module



sound was the incorrect localisation of sounds, particularly for viewers near the edges and front of the auditorium, and for centre screen dialogue. A suggestion⁵ for reinforcing the centre with a mixture of the left and right signals improved directivity but was still not fully satisfactory in certain situations. Experiments showed the need for further reinforcement and a series of listening experiments was started which showed that very simple gain-riding circuits could provide a significant improvement in 'hardening' the centre channel information.

Fig. 5 is a block diagram outlining the principle used. The left and right signals pass through two separate variable gain amplifiers whose gain can be made to change by about $2\frac{1}{2}$ dB. These signals are also summed (S) and pass through a third variable gain amplifier whose gain is also changed by $2\frac{1}{2}$ dB but in the opposite sense to the others. In situations which are fully stereophonic, the gains are such that there is a differential gain of about +5 dB between the outside speakers and the centre, while in monophonic situations the centre speaker is reinforced by 5 dB with respect to the outside pair.

The controlling signal is derived with some care and the diagram shows a simplified version of the circuit indicating that the control is derived by comparing signal amplitudes and phase differences between the two incoming left and right signals. The resulting control signals pass through variable time constants circuits before being fed to the variable gain amplifiers.

In practice the listener is not aware of the action of these amplifiers, partly because of the relatively slight gain change, and partly because any gain changes follow the action changes seen on the screen. The variable time constants are arranged so that sudden changes in sound location, such as occur on camera shot changes, are reacted to very quickly; even for those very close to the centre or outside speaker, any noticeable audible change is fully masked by the visual change. When the action is changing slowly, then the time constant is also long, thus removing attenuation from the gain change.

Apart from these three modules, the circuitry is straightforward and the engineering involved is mainly human and systems engineering. The operating controls which are grouped together in the upper right-hand corner select non-sync sources (interval music, etc), three format modules, mono-stereo and Dolby noise reduction. Two remote box replicas of this panel may be mounted near each projector for remote operation, the 'active' box being selected by a projector changeover key with the 'dead' box allowing pre-selection of, say, a format change which will be activated on changeover. A lower row of pushbuttons control selection of certain remotable functions or completely automatic operation via a normal cinema automation unit. Various emergency by-pass facilities are also provided offering a limited service in the event of a failure in any of the modules.

Since this paper was written, 20 *CP100* units have been installed, the majority in the UK and the USA. In addition to stereo-optical films such as *Lisztomania* and *River Niger*, the six-track stereo-magnetic Dolby encoded release of MGM's *Logan's Run* has resulted in further US and Canadian cinemas equipping with the *CP100*.

Adapted, with permission, from a paper presented at the 54th Convention of the Audio Engineering Society.

REFERENCES

1. Technical Bulletin 'Standard electrical characteristics for theatre sound systems—April 20, 1948'. Motion Picture Research Council, 1948.
2. R M Dolby 'An audio noise reduction system' *Journal AES* 15:383-388, October 1967.
3. I Allen 'The production of wide range, low distortion optical soundtracks utilising the Dolby noise reduction system' *Journal SMPTE* 84:720-729, September 1975.
4. R E Uhlfig 'Stereophonic photographic soundtracks' *Journal SMPTE* 82:292-295, April 1973.
5. R E Uhlfig 'Two and three channel stereophonic photographic soundtracks for theatres and television' *Journal SMPTE* 83:729-732, September 1974.
6. I Allen 'Use of Dolby noise reduction and equalisation techniques with stereophonic variable area soundtracks' paper presented at SMPTE 117th Conference, Los Angeles, September 1975.
7. Film *Tommy*, produced by Ken Russell for Robert Stigwood organisation and Columbia Films, Elstree studios, 1975.

The Amcron Story

1967

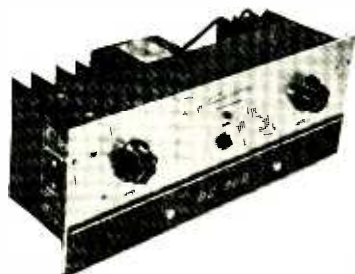

1976



In 1967 Amcron (Crown International) introduced the world's first 'Super-Amp'. This was the DC300! it rapidly became a must for all the major recording studios and top bands such as Zeppelin, Jethro Tull and the Moody Blues.

The DC300 set new standards of sound reproduction never previously available for bands or studios, let alone the Audiophile (whoever he is). Coupled with the incredibly rugged construction, and small size of this 600 watts amplifier, it is not surprising that the DC300 became a legend in its time.

The designer of this classic is still in charge of the design work at AMCRON despite rumours that he has moved on to at least five other establishments! Indeed, he has since been responsible for the DC300A, the D150A and all the rest of the AMCRON range of superb power amplifiers.

Now in 1976, the DC300A is 'the' amplifier in all the world's recording studios and is still the only choice for bands such as Zeppelin, Jethro Tull and the Moody Blues, plus quite a few others such as Wings, the Stones, the Rollers, Elton John, 10c.c., Pink Floyd, Barkley James Harvest, The Real Thing and so on . . .

Perhaps this is because the DC300A amplifier offers the following features:

- ★ Total Harmonic distortion at full power, 1Hz-20kHz below 0.05%
- ★ I M distortion 0.01 watt to 150 watts into 8 ohms below 0.05%
- ★ Hum and Noise better than 110db below 150 watts.
- ★ Power Bandwidth +1 db, -0 db from DC to 20kHz at 150 watts into 8 ohms
- ★ Full 3 year warranty on parts and labour :
- ★ Patented Crown Protection Circuitry requires no circuit breakers or relays
- ★ Designed to operate into load impedances as low as 1 ohm
- ★ Manufactured by a company founded in 1946 and represented by the MACINNES people continuously for the last ten years!



MACINNES LABORATORIES LTD.

MACINNES HOUSE, CARLTON PARK INDUSTRIAL ESTATE,
SAXMUNDHAM, SUFFOLK IP17 2NL TEL: (0728) 2262 2615

MACINNES FRANCE S.A.R.L.
45 RUE FESSART,
PARIS 19e
Tel. 203.30.01

DBX FOR DISC

high frequency pre-emphasis a dbx encoded disc played back on a conventional record player (with no dbx decoding) would be unpleasant to unlistenable.

When recording a 2:1 compressed (encoded) signal, time on a record can be nearly doubled for the same dynamic range as present releases allow. In fact, over 20 minute sides have been cut on 17.8 cm discs at 7 cm/s using the dbx II process. When utilising the dbx encoded disc process, two pocket albums could be re-released on one disc. The dbx encoded disc can provide a weighted surface noise of -90 to -95 dB below 7 cm/s (inaudible).

Recording and manufacturing the dbx disc

dbx encoded discs can be made from any master tape; this results in a disc which is as audibly quiet as the master tape. Dolby A noise reduced tapes can also be used for dbx encoded discs if decoded prior to dbx II disc encoding. dbx encoded master tapes must be decoded with the dbx professional system (type I) and then re-encoded with the dbx II system. The encoder is placed in the disc recording chain as indicated in fig. 4. Since dbx master tapes provide full dynamic range and no audible tape hiss, the dbx master tapes will provide better results for dbx encoded discs.

When mastering encoded discs, it is necessary to place a dbx II encoder in the preview head electronics as well, so the variable pitch system will respond appropriately to the compressed (encoded) signal being cut on disc.

Summarising, dbx encoded disc manufacture involves the simple addition of a suitable encoder to the record mastering system. All other phases of the record manufacturing process remain the same. The cost of a dbx II disc encoder system is less than \$2000.

Future of the dbx encoded disc

The phonograph record is still the most preferred reproduction medium to date. Years ago when eight track cartridges and cassettes entered the market, many predicted that the pre-recorded tape format would surpass phonograph record sales. Today record sales still outnumber by far those of pre-recorded cassette and eight track cartridge formats. The dbx encoded disc process if universally adopted will allow the phonograph record to evolve to its next stage at only a very moderate cost to the record manufacturer and the record buyer. This can be done utilising existing record manufacturing techniques; record companies could provide high quality, wide dynamic range, low surface noise discs simply by adding a dbx II encoder to a disc mastering system. Currently, disc decoders are being manufactured by dbx as add-on units for consumer audio systems. At the same time, dbx has embarked on a licensing programme for major manufacturers of tape recorders,

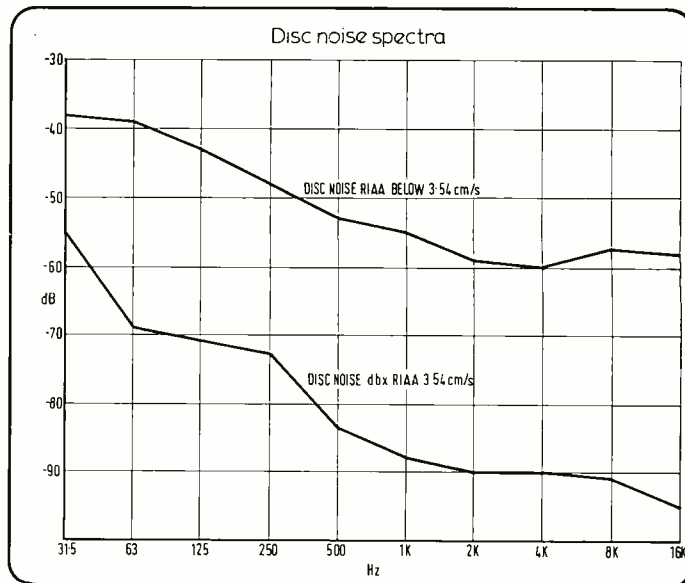

receivers and amplifiers. To date, Teac produces tape machines incorporating type II decoders. Further, other major manufacturers are in negotiation to follow the Teac lead. Every consumer dbx tape recorder offers the potential to decode encoded discs, and it is from these machines that the hoped for widespread acceptance of dbx technology, both disc and tape, will come.

Estimates from dbx tape machine sales have been used to produce estimates for the number of decoders in consumer hands over the next few years. By 1977, there will be 50000 decoders; by 1978, 200000; by 1979, 400000. By 1980, there could be 1.5m. Of course, from then on, numbers will grow at a more rapid rate. Within a year, dbx II will be available in an integrated circuit form which will ultimately lead to an add-on disc decoder for less than \$100. The time scale for this is approximately one year.

There are currently 12 commercially available encoded discs available from Klavier Records, 10515 Burbank Blvd, North Hollywood, California. Retail price for dbx encoded discs is \$8.00. There are a number of other record companies showing great interest in this wide dynamic range process. In some recent research we found that the initial stages of introducing the lp record were similar to that which we are experiencing with the dbx encoded disc. We are committed to the concept of the dbx encoded disc and we are certain that in a few short years, the dbx encoded disc will be a commercial reality.

FIG. 4 dbx II block diagram

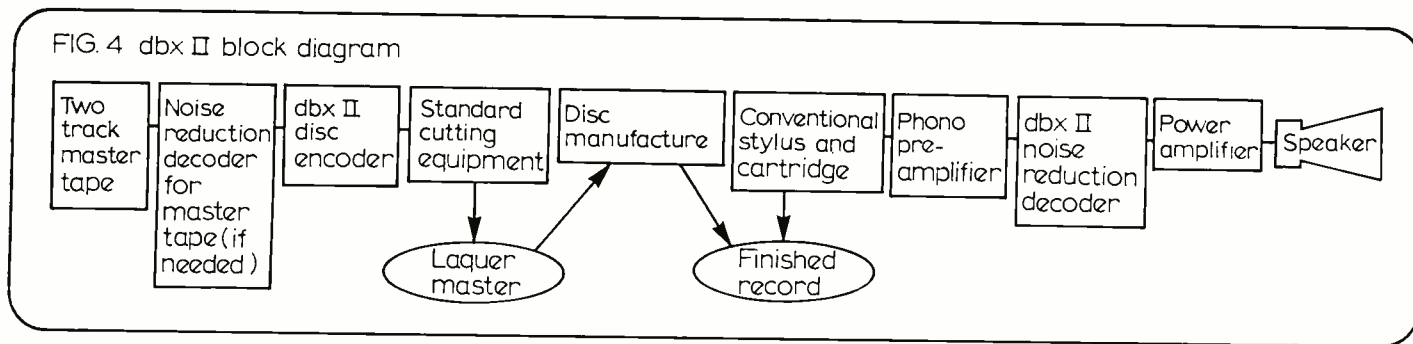

agony

For some time, the old BTR 4 tape recorder hadn't been performing as well as it did ten years ago. Whatever the trouble was, it seemed to be accompanied by a strange smell which permeated the

control room. At last the machine stopped completely. The maintenance man was called and the source of the trouble—and smell—found. On inspection within the machine with the back removed, it was found that the casing of the capstan motor, mounted at the bottom of the cabinet, had rusted through completely.

For there are few machines on sale which will double up effectively for use as a lavatory by the studio cat.

*Consoles for all applications; sound reinforcement systems; electronic
crossovers*

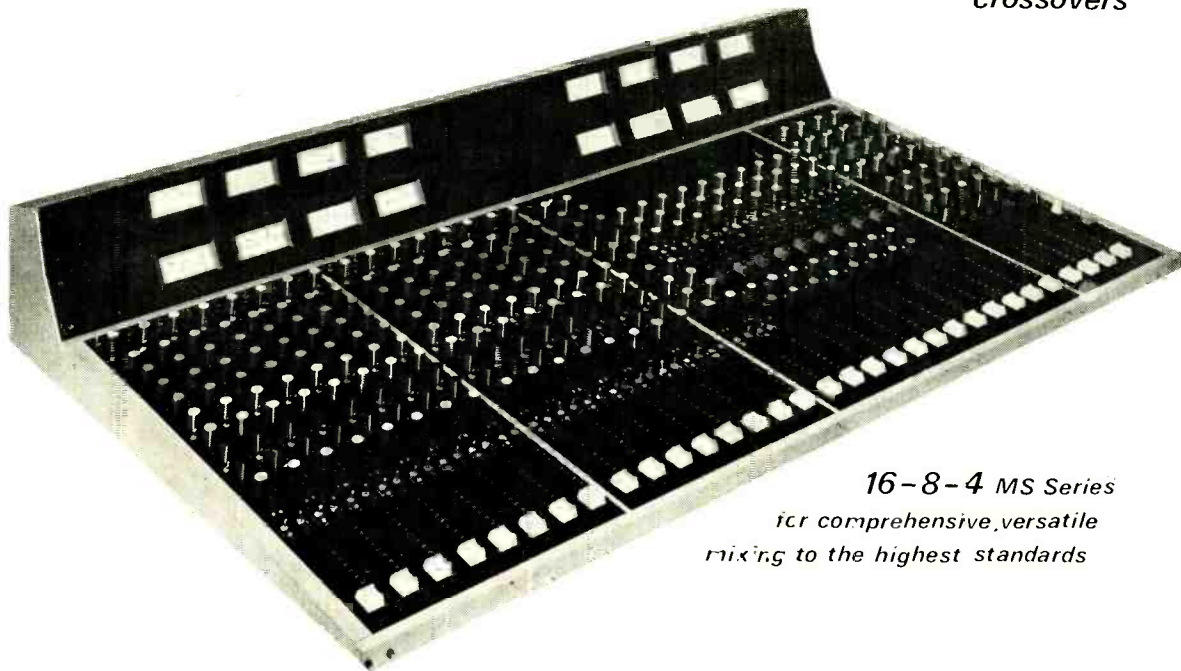

*16-8-4 MS Series
for comprehensive, versatile
mixing to the highest standards*

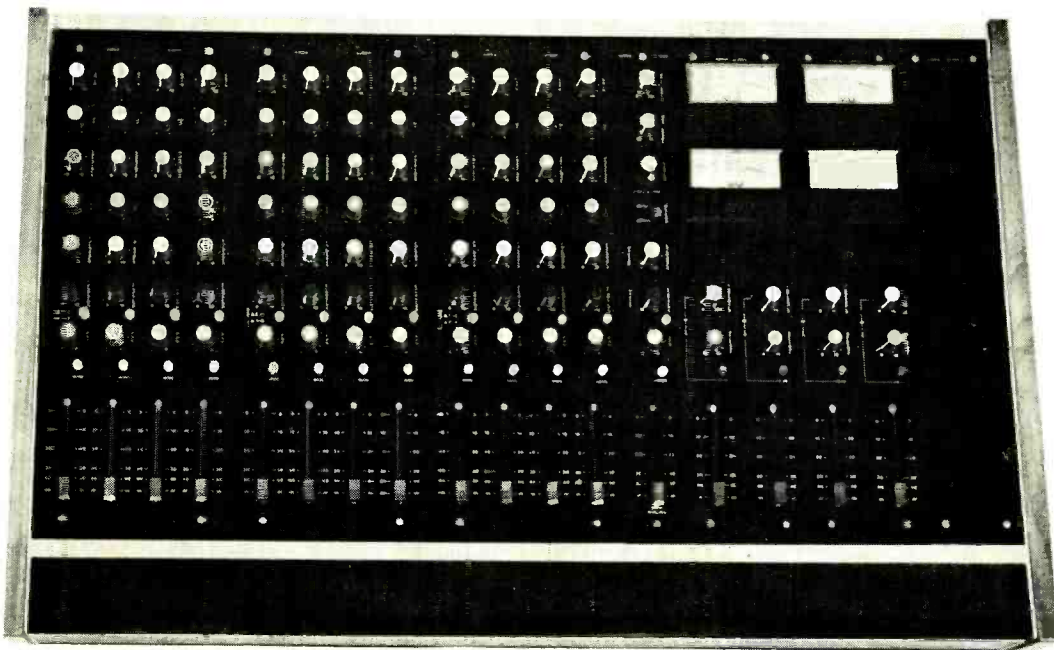

*X Series: up to 24 or more in, 2 or 4 out; options include eight-track monitoring, two foldbacks
and many others*

*London representation (P. A.) IAN JONES 16 Wallasey Crescent, Ickenham, Uxbridge, Middx
tel Ruislip (71) 73271*

*AMEK SYSTEMS & CONTROLS Ltd 2nd floor Islington Mill, Salford M3 5HW
Lancs, England tel 061-834 6747*

Noise reduction

FRANK OGDEN

The level of noise reduction for a given system is only one criterion upon which to judge its effectiveness. The first part of the article deals with the operational compromise inherent in a companding system while the second part describes the commercial adaptation.

Part 1

WHEN MAN left his cave on that first, windy day, he soon found that he could hear more of what he wanted to hear by cupping his hands to his ears to pick out wanted sounds from the background wind noise. A first basic attempt to differentiate between wanted and unwanted noise by using a degree of directivity. Further, he could improve matters by concentrating on the wanted sound, almost oblivious to the noise of the pounding wind and rain. This last act was, of course, an early application of psychoacoustics. Both the effect and phenomenon form an integral part of viable noise reduction systems, but, in the first instance, it is helpful to look at noise in terms of its source of origin and the attendant qualitative and quantitative value.

All electronic systems generate noise. Of these, a solid metallic conductor generates the least; the actual level depends on its absolute temperature. From there on, things get noisier enabling thermal noise to be used as a yardstick for electronic circuit noise evaluation in much the same way as perceived loudness of a sound can be related to the threshold of hearing. It is interesting to consider how closely the dynamic range of carefully designed electronic hardware (as in mixing consoles and peripheral amplification) matches that of the ear. Fig. 1a relates the dynamic range of various electronic sub-systems (measured in terms of the noise voltage level below maximum output) to an audiometric scale of the approximate spl encountered in a number of different environments, shown in fig. 1b. Direct comparison is possible because input voltage to a sound transducer relates directly to the generated spl. Further, it illustrates what everybody knew all along that the weakest link in the overall recording system is the tape machine matched only by the inherent weakness in all the consumer replay systems, except the dbx encoded disc. The foregoing comparisons make it appear rather tough on the tape recording process and the consumer software side, but it overlooks one important fact: the average domestic listening environment allows, neighbours permitting, a usable dynamic range of a mere 65 dB—precisely the same value as the lowest common denominator in the overall recording chain. Why then do people twitter on about noise reduction in the various media?

The answer to that is almost straightforward: the noise induced by successive tape generations is cumulative. A second generation tape will be approximately 6 dB noisier than the first, discounting

other effects such as increased distortion and intermodulation. The third generation tape will be about 3.5 dB noisier than the second or 9.5 dB down on the original tape. This generally fits in with the view that the multitrack recording process causes a total build up of about 12 dB or more depending on complexity. Using Dolby A will bring the overall signal-to-noise ratio back to well over 60 dB at reduction master playback stage—and some opinions suggest that this level of background noise can even be beneficial. The reasons for this involve psychoacoustics. If an instrument with sharp attack or otherwise high harmonic content such as strings or brass is recorded at low level, perhaps -40 to -50 dB, its high frequency content can be subjectively increased, hence the realism enhanced, by the addition of wide band noise at a level about 10 to 15 dB below this, when listening in an environment allowing a corresponding dynamic range. Push the noise floor farther down the scale in the same listening room and the instruments appear to lose their edge even though the real spectral content hasn't changed. It is almost as if the low level white noise (or pink if purists prefer) provides an artificial threshold of hearing on which the ear can base the 'new' dynamic scale.

Although more noise reduction and increased dynamic range are not at the forefront of the record companies' and studios' agenda, it could benefit the consumer if and when wide range software becomes available, and make the recording engineer's job easier—it helps to eliminate the need to gain ride some wide range recordings which is, in itself, a form of compression.

Many systems have been devised to level expand tape machine outputs, either wideband or with a frequency selective action proportional to the machine output level. They operate by

FIG 1a Noise in electronic systems referenced to same level

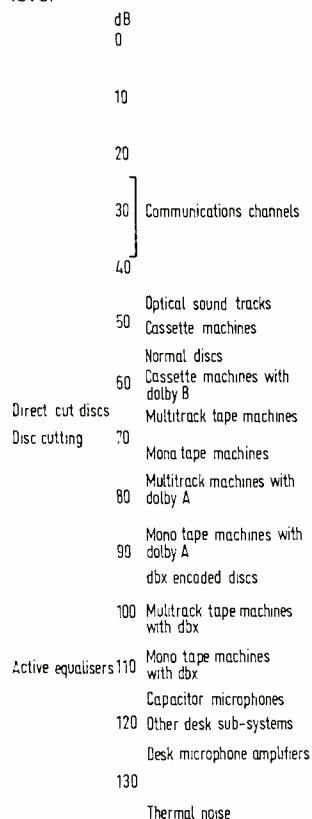
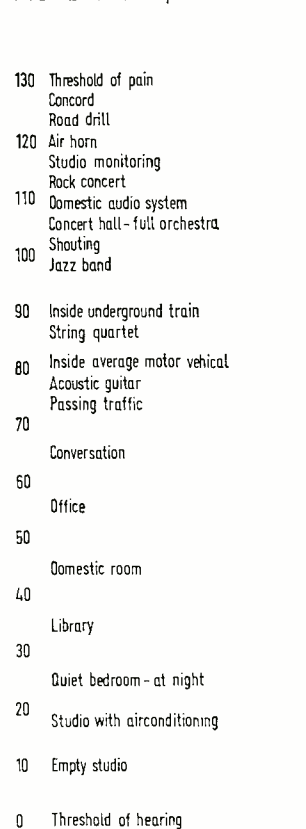

FIG 1b Sound pressure level



attenuating or modifying the frequency spectrum of low level signals allowing high level ones to pass through unchanged, as shown in fig. 2. The process is gentler on the ears than might be expected because the ear detects spectral changes less readily in low level signals than in high ones; however the system response must be adequate to open fully on high level transients. Although the system, *dynamic noise limiting*, finds no regular application in playback because it damages the programme dynamics, it can be useful in cleaning up old or otherwise unprocessed material, especially when used in conjunction with a delay line to provide preview information for the control circuits.

Leaving aside digital processing and dismissing one way systems outlined above, the only viable alternative becomes a two way compressor/expander system, the principle used in all commercial noise reduction systems. But first a look at the basic system and what it's trying to suppress. In the simplest form, it takes the wide dynamic range of the input signal, compresses it within a range that the tape machine can handle and lays this on the tape. On replay, the signal is passed to an expander which stretches the compressed dynamic range to the same value as the original signal.

FIG 2 Simple dynamic noise limiter operates by curtailing frequency response with reducing signal input

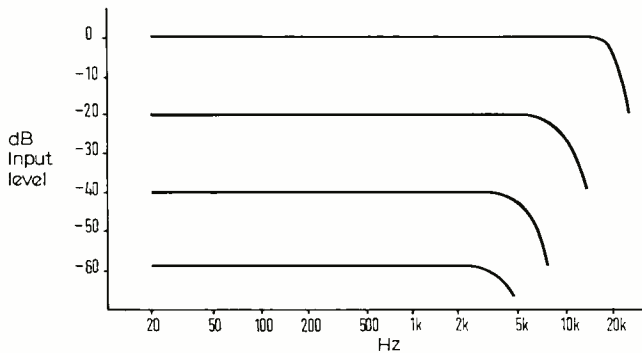

The process is outlined in fig. 3. The ratio between the original and compressed state gives the compression ratio of the system providing that the compression process follows a regular law—the Telefunken and dbx systems operate in this way. Such *high level compansion* systems, so called because they operate on high level signals as well as low ones, offer considerable advantage over *low level compansion*—Dolby A, B—in terms of ease of decoding the dynamic range contained in the compressed transfer medium. However they suffer the handicap that the high level signals, by definition the area most

FIG.3 Schematic companding system

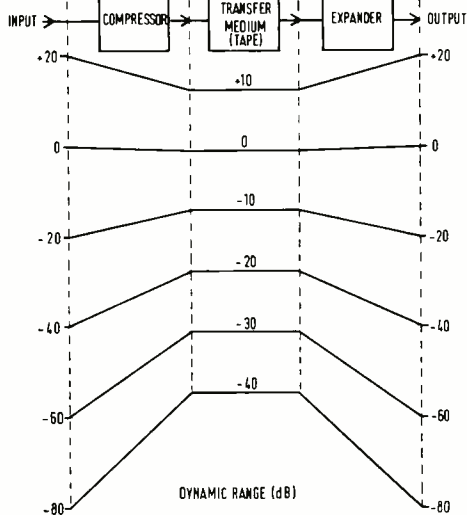

aurally sensitive to irregularities in the signal processing, are subject to companding action which can be rather less than perfect when the intermediate generation is an analogue tape recorder. Low level compansion systems boost up the low level signals above the medium noise floor and attenuate down on replay without any companding action on high level signals. The difference between low and high level systems is illustrated in fig. 4.

FIG.4 Compaender transfer characteristics

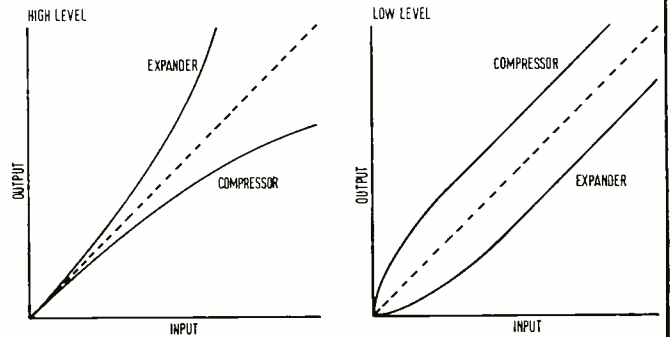
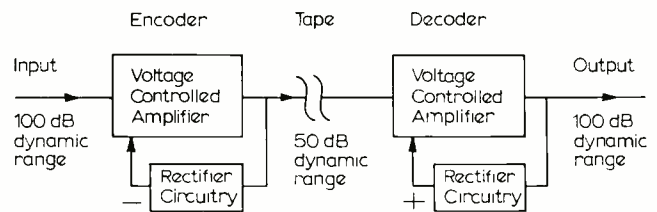

Fig. 5 shows a basic 2:1 noise reduction system; an input signal is compressed into half its original dynamic range before being passed on to the recording amplifiers. This means an increase of 4 dB in signal level at the input to the compressor will be translated to only a 2 dB increase in level on tape. This implies that, if the tape recorder is capable of 60 dB of dynamic range, the overall system range will be a rather staggering 120 dB. Low noise electronics could allow the practical result to approach the theory, but there has to be a drawback otherwise it would be too much like something for nothing. There is.

FIG.5 Basic 2:1 noise reduction system



All noise reduction systems work on the principle that a high level programme signal will heavily mask low level background hiss, especially if the programme spectrum is basically similar to that of the noise which it covers. That's psychoacoustics, but it doesn't work so well if the spectra are far removed from each other. For instance, a strong, low frequency programme, such as is found in solo piano will lift up the system gain in the tape 38 ▶

FIG.6 Noise modulation by programme envelope

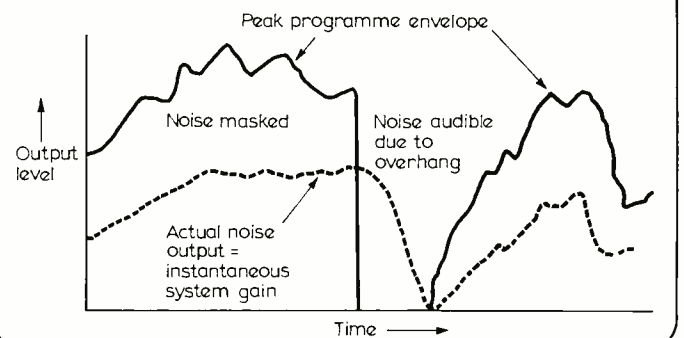

NOISE REDUCTION

playback mode amplifying the tape hiss, which was always there, along with the wanted signal. The high frequency background tape noise can be plainly heard breathing in sync with the programme. Further, the basic system has very finite time constants inherent in the compressor/expander action producing gain overhang following the abrupt cessation of a programme transient momentarily allowing audible noise through. Fig. 6 illustrates this effect—programme envelope noise modulation. Those who have heard it will testify that modulation breathing can be rather more obnoxious than the steady state variant. Unfortunately, that's not the worst of it. High level signals themselves produce a real increase in wide band tape noise due to the increased number of magnetic domains passing across the tape head. Fig. 7 shows the change in noise spectrum of a typical tape recorder between the no signal state and a 100 Hz tone recorded to the 3% total harmonic distortion mol (maximum output level). Note that the whole noise spectrum moves up by about 10 dB while the area closer to the tone centre is much higher still. This effect is called *noise modulation*. The sideband

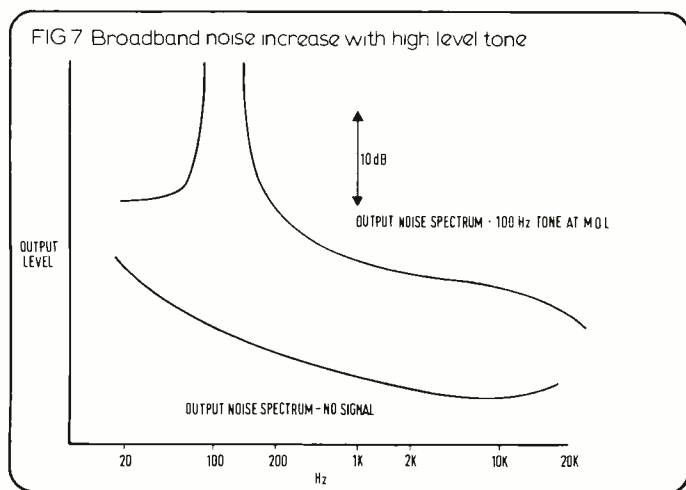

noise flanks adjacent to the tone centre are caused by surface irregularities in the tape coating called *asperities* which tend to lift the tape away from the head in the vicinity of the gap, and also by the inevitable inconsistencies in the tape coating. Both create noise amplitude modulation of the tone to produce the noise sidebands shown in fig. 7.

Under conditions of low frequency high level programme material, the tape will produce very audible background noise that won't be reduced by a simple compander circuit. Further, there is no currently marketed noise reduction system that will heavily decrease sideband noise. This is because the nearer the noise spectrum is to the signal spectrum, the more difficult it becomes to separate out and remove.

There is also another problem. What part of the signal should be used to control the operation of the compressor in recording, and the expander in the playback mode? The most obvious answer appears to involve peak detection of the signal to produce a dc voltage proportional to the crest of the programme envelope; however, further inspection shows that this won't be satisfactory when used with tape recorders. More often than not, most tapes are recorded right up to the maximum operating level while programme peaks can go beyond. The inevitable result is that tape saturation lops the top off the programme peaks, albeit softly, causing mistracking problems between the compressor and expander resulting in irregularities in the replay dynamic range. Likewise, the tape machine might produce phase shift of some of the signal components which can show up as variance in the time taken for various parts of the signal spectrum to get from the tape head to the output. This means that the peak envelope will occur at the wrong time once again causing mistracking on playback. Commercial systems have largely solved this problem by peak clipping or rms detection—more on this topic later.

The compression process on any signal involves the production of third harmonic distortion; the amount produced depends on attack

and decay time of the compressor action. By the same token, since frequency is a function of time, the lower the frequency, the greater will be the distortion produced. Since practical noise reduction involves compression, it might be thought that the overall system, whether banded, wideband or whatever, would produce intolerable distortion at low operating frequencies. Fortunately, this is not the case. Encode (compress) and decode (expand) circuits produce components which are out of phase with each other and, as such, are very nearly self-cancelling. Very nearly because of 'distortion of distortion' inherent in the tape recording process.

Finally, there are problems arising out of imperfections in the intermediate transmission/storage medium—in the case under discussion, the tape recording process. Everyone knows that there isn't a tape machine produced, or, for that matter, a tape manufactured for use with it, that does its job without creating some discrepancies between the output and input signal. The overall system creates programme discontinuities and amplitude variations as in dropouts; there are inevitably frequency response errors, particularly in the bass end where head contour effects cause considerable ripples. Further, the editing process can introduce step function changes in overall programme levels. Lastly, all systems add noise.

Taking the last point first, all compansion systems will reduce noise induced by the transmission medium by an amount generally dictated by the compression ratio. However, the other tape recording defects mentioned will be aggravated by a similar amount to the effective noise reduction obtained. This is particularly true of high level compansion systems such as dbx and Telefunken. Low level systems, for instance Dolby, can only be affected by recording errors at low signal levels where the resultant multiplied inaccuracies are not so audible (this assumes that they were audible in the first place; as most people will realise, their presence can be more problematic than subjective). Fig. 8 shows a before and fig. 9 an after curve of

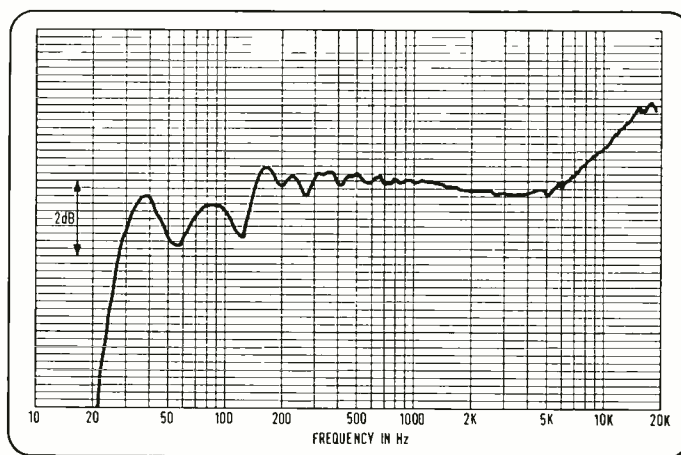

Above: Fig. 8. Basic tape machine response.

Below: Fig. 9. As fig. 8, but with 2:1 compansion. Graphs courtesy of Hugh Ford Engineering.

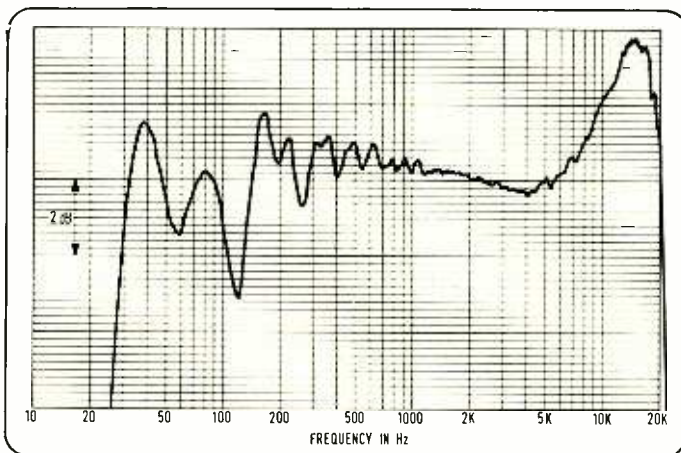

DOLBY NOISE REDUCTION

The First Successful Decade: 1966 - 1976

Dolby noise reduction has staying power. The A-system has been around for ten years. If you have read our technical papers and otherwise followed our progress, you're probably familiar with the reasons for this success. Here are ten quick reminders.

1

The Dolby system works like a constant-gain amplifier in two critical dynamic regions — low levels and high levels. Error-free signal handling is thus ensured at the dynamic range extremes. Compression and expansion occur only at easy to handle mid-levels.

2

The system employs a simple adding and subtracting scheme which automatically results in mathematically exact complementary compression and expansion. There are no approximations, so the signal must come out the same as it went in (just get the Dolby Level right).

3

Compressor overshoots with high-level transient signals are suppressed without audible distortion, because of the basic system layout (dual signal paths). Since there are no overshoots to be clipped by the recorder, there is no impairment of even the most extreme transient signals.

4

The freedom from overshoot is a result of system philosophy, not an ultra-short attack time, so it is possible to utilize relatively gradual gain changes. This yields a compressor output which is remarkably free from modulation distortion. There is thus no need to depend upon cancellation of modulation products by the expander (which relaxes recorder performance requirements).

5

The reproduced dynamics of low-level signals are essentially immune to rumble in the input signal and head bumps and other frequency response errors in the recorder — the system has a solid low-level 'gain floor'.

6

The system gives a pre-determined amount of noise reduction which is realistically useful (set at 10 dB).

7

The noise that remains has a subjectively constant level. Noise modulation effects are almost non-existent.

8

The principles and parameters used in the Dolby system result in a high margin of safety. The system works well with all types of audio signals — speech, music, effects — and practically all types of noises. High noise levels (from multi-generation copies, for example) do not impair performance.

9

The system functions reliably on a day in, day out basis, with real workaday recorders and other equipment.

10

All of the above have been proved in ten years of dependable service to the industry — 25,000 professional channels in use by well over a thousand studios in more than 50 countries around the world.

The Dolby A-system now looks forward to

The Second Successful Decade: 1976 - 1986



Dolby Laboratories Inc

'Dolby' and the double-D symbol are trade marks of Dolby Laboratories Inc.

731 Sansome Street
San Francisco CA 94111
Telephone (415) 392-0300
Telex 34409
Cable Dolbylabs

346 Clapham Road
London SW9
Telephone 01 - 720 1111
Telex 919109
Cable Dolbylabs London

NOISE REDUCTION

frequency response using a 2:1 system. The actual system is dbx—however, it is intended to illustrate the principle rather than a particular technology. Although first generation tapes might not show audible defects, overdubbing and track jumping produce cumulative errors which will eventually become noticeable. Of course careful machine alignment will minimise the problem. In the same way, editing should be given more consideration regarding programme levels—a 2 dB step in recorded level will be decoded to a 4 dB output variation using a 2:1 system.

Part 2

The second part of the article looks at the interpretation of the requirements for a viable noise reduction system by three organisations—Dolby, dbx and Telefunken. Burwen would have been included if their 3:1 compansion system had proved a commercial proposition; however, it didn't.

Dolby A

The most important feature of the Dolby system is the low level compansion operation. This implies that all dynamic processing operations take place at low and intermediate levels where any system inaccuracies will be least audible. A succinct summary of operation is given in the original paper by system inventor Ray Dolby: 'Low level signal components are amplified in four independent frequency bands prior to recording/sending, which is accomplished by adding the four outputs of four filter and low level compressor channels to the main signal. During reproduction, the filter and compressor network is connected in a complementary way. Low level components are subtracted from the incoming signal, and noise acquired in the audio channel is thereby reduced as well.' Figs 10 and 11, taken from the original paper, show the basic block diagram of the overall system and side chain processor respectively.

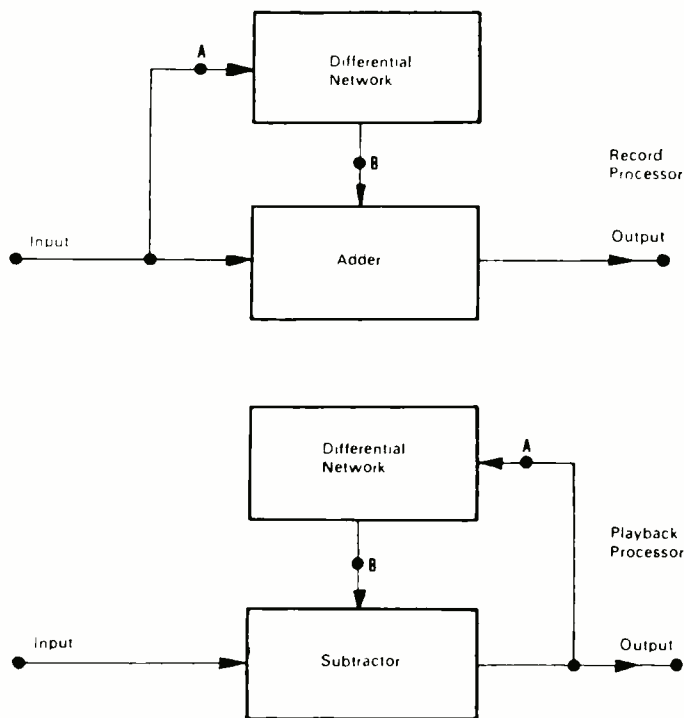

Fig. 10. Basic Dolby system.

As stated in the summary, the side chain processor divides the signal into four frequency bands with compressor thresholds 40 dB below the peak operating level; if individual frequency components are more than 40 dB down on operating level, they will pass through their particular band side chain without undergoing any form of compression. Similarly, once they have reached peak operating level referenced to the side chain input, they will have caused the band compressor to traverse its full

operational range effectively disconnecting that band from the side chain output. Band structure is 1) 80 Hz low pass, 2) 80 to 3k Hz bandpass, 3) 3 kHz highpass, 4) 9 kHz highpass. This gives the classic 10 dB of noise reduction up to 5 kHz rising to 15 dB at 15 kHz. In other words, the side chain processor will either add (record) or subtract (playback) up to 15 dB of gain to or from the main signal path.

The band splitting principle minimises what is, perhaps, the greatest disadvantage of the simple wideband compander—modulation noise by the programme envelope. From the foregoing system description, it is evident that a narrow spectrum signal will only affect one, or at the most two bands leaving the rest unaffected. For instance, a strong signal at 50 Hz will cause side chain compression in band 1 (80 lowpass) without touching bands 3 and 4; that means if they don't change their gain, then there won't be much, if any, subjective change in audible hiss. There is another advantage to the band splitting principle—since the compressors only have to work over a limited frequency range, their operational characteristics, such as attack and decay times, can be designed for optimum performance thus reducing gain overhang and modulation products caused by too slow or rapid gain changes respectively.

In passing, it should be noted that the Dolby compressors have a certain operational elegance. Fig. 11 shows that for each band

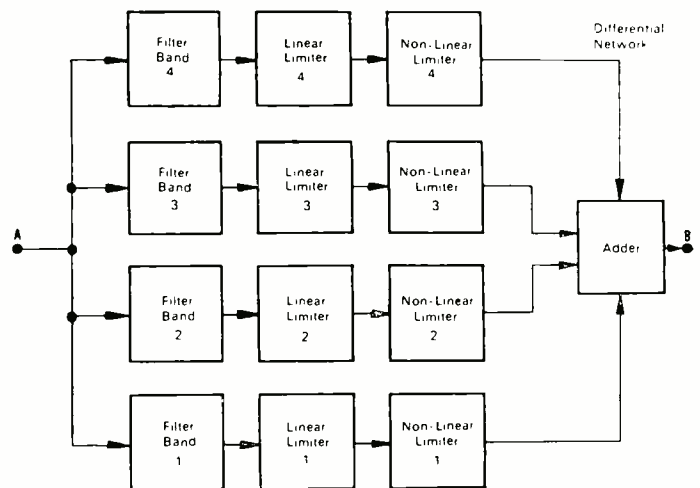

Fig. 11. Dolby A side chain schematic.

there is a band filter, a linear limiter and a non-linear limiter. The linear limiter operates as a variable gain amplifier while the non-linear limiter acts as a hard limiter. A heavy transient applied to the linear compressor amp would result in an unavoidable overshoot in gain leading to transient spikes in its output. These, however, are clipped off within a couple of dBs above the peak level. If this occurred in the main signal path, it would necessitate impossible reductions in the overall dynamic range of the unit. If they were left in, they would cause problems with overloading of subsequent equipment. The practical answer is in the way the system works. Hard limiting occurs only in the side chain leaving a smooth transient passage through the main signal path. Despite their addition to the main signal they cause only a momentary (Dolby claims 1 ms or less depending on frequency) increase in distortion to a few percent because of their relatively low amplitude compared to that of the main signal. Taken as a whole, it easily overcomes the overshoot problems encountered in the simple wide band expander model.

dbx

A summary of system operation has been described by David Blackmer, the inventor.

'dbx Inc has developed an elegantly simple noise reduction system based on the compressor/expander concept. An economically feasible rms level sensor was designed to accurately calculate the true rms value of complex waveforms. This eliminates tracking errors in compression and expansion due to tape recorder phase shift. Linear decibel compression and expansion over a dynamic range in excess of 100 dB was developed to eliminate the necessity of 42 ▶



PHILIPS

SM 8

- 8 channels, 2 outputs as standard.
- Can be expanded to 16 channels.
- Equalisation and auxiliary bus facilities.
- Cueing and talkback.



For smaller sound and television studios and outside broadcast systems.



SM8 in a DJ-operated studio.

Audio Mixing Units for studios and outside broadcasting

SM 12

- Revolutionary 30mm module.
- 12 channels, 4 outputs/groups.
- Can be expanded to 36 channels, 3 outputs/groups.
- Comprehensive equalisation, echo return, cueing auxiliary and talkback facilities.
- A versatile mixing system in a nutshell.

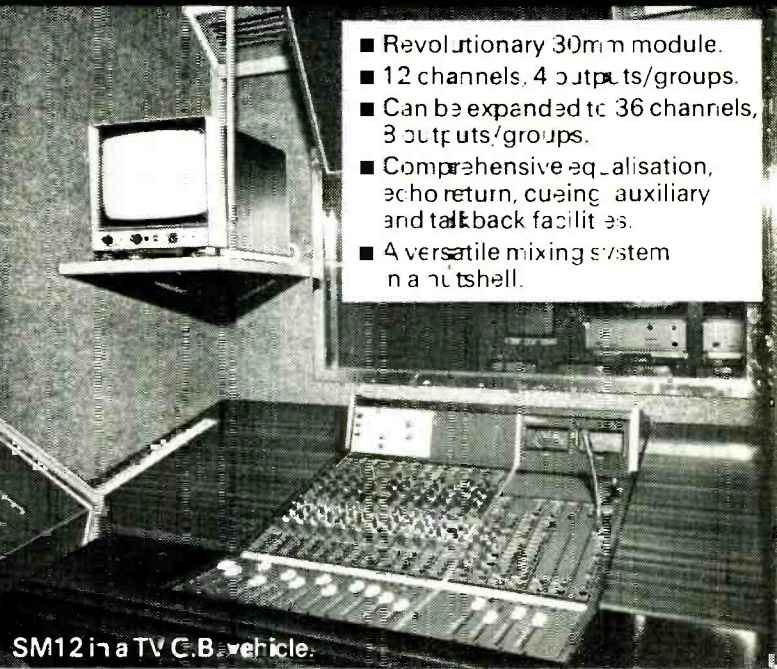

SM12 in a TV C.B. vehicle.

Designed for major sound and television studio and outside broadcast applications.



Pye TVT Limited

PO Box 41 Coldhams Lane Cambridge England CB1 3JU
Tel: Cambridge (0223) 45 15 Telex: 81103

A member of the Pye of Cartridge Group

NOISE REDUCTION

level matching and pilot tones. Pre-emphasis and de-emphasis were added to the signal and level sensors to reduce tape hiss to the degree that it cannot be heard even in the presence of strong low frequency signals which do not mask the hiss. This pre-emphasis and de-emphasis is accomplished without the danger of overload or high frequency self erasure on the tape.'

As the summary indicates, dbx is a simple companding system with a 2:1 compression ratio. However, it incorporates two basic additions to produce a satisfactory operational performance. The first is a 12 dB pre-emphasis from 5 kHz and above which suppresses potential envelope modulation effects by the same degree. Since this pre-emphasis takes place in the main signal path, it is clear that some action would have to be taken to prevent high frequency saturation of the tape; as it is, the tape medium is rather low on high frequency record levels without boosting them by a further 12 dB. Adding pre-emphasis before the control circuits to the compressor section provides the answer. A 20 dB pre-emphasis, starting at 1600 Hz, actually reduces the 15 kHz record level by about 5 dB; the lower curve in fig. 12 shows the actual machine

Fig. 12. Record characterisation of dbx.

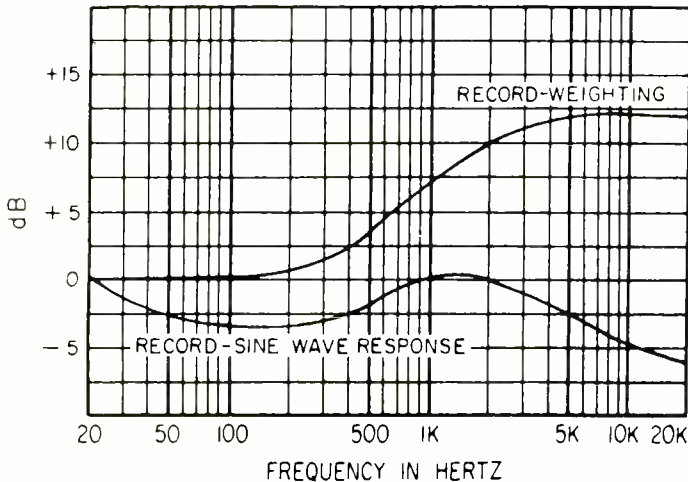

record level for a constant voltage sine wave drive over the frequency range. The upper curve depicts the main signal path pre-emphasis. Fig. 13 depicts the overall system.

Regarding the actual noise reduction performance, its potential, at first sight, would appear to provide around 120 dB of dynamic range where as the manufacturers claim about 90 — a noise reduction figure of around 30 dB over the 60 dB of which most mastering machines are capable. The difference is caused by the

Fig. 13. dbx system schematic.

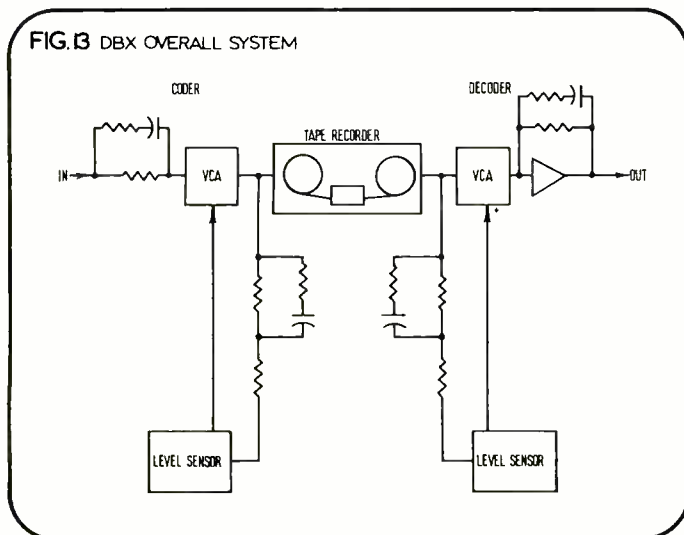

pre-emphasis within the system, accommodated at the expense of dynamic range. However, when the basic value is 120 dB, this can be done quite happily.

dbx Inc makes much of the operation of the level sensing circuits. These circuits are particularly important when it comes to improving the performance of the basic compander because the one circuit controls the overall tracking of system whereas, with four bands as in Dolby and Telefunken, they have the benefit of four bites at the cherry—if only one band is out of step, mostly you don't notice. But when you've only got one band . . . The dbx circuit features rms detection which represents the sum of the energy of all frequency components present without regard to their phase relationships. The normally complicated design is accomplished with analogue multiplication techniques: the circuit squares the input signal by doubling its logarithm and then feeds it back through an anti-log generator. The signal is then averaged out and used to derive the control signal. It does this fast. The manufacturers quote an attack time of 20 μ s and a release rate of 240 dB/s. In common with its simple origins, dbx follows a regular compression law throughout its operating characteristics and therefore doesn't require the accurate record to replay alignment of reference level systems.

Telefunken

The *Telcom CA* system is the latest noise reduction system to hit the market. So far, the most that anybody has seen of it is the specification pamphlet upon which the following is broadly based. It deserves close attention since it answers the problems raised by the simple compander system in an interesting, if rather expensive looking way.

Manufacturer's quoted specification

Frequency response: 30 to 20k Hz.

Compression control system: logarithmic.

Frequency bands: 4 (30 to 160 Hz to 1.6 to 5 to 20 kHz).

System compression ratio: 1.5:1 = 33% slope.

Nominal level: +6 dBm.

Input level range: -88 to +22 dBm.

Noise reduction gain: 30 dB with typical professional machines.

Signal to noise: better than 94 dB.

Total harmonic distortion: less than 0.2%.

As indicated in the specification, the system divides the input signal into four bands for subsequent processing by the compressor section. This action obviates the need for any kind of pre-emphasis, either in the signal or control circuit paths. The individual compressors operate with a 1.5 to 1 regular compression law over their entire dynamic range offering the usual advantages of unfussiness about level matching etc.

In many ways, Telefunken has appeared to combine the Dolby A and dbx into one package. For instance, Dolby A has always had few critics concerning audible operation, apart from one or two purists who have always maintained that it did something funny to drums and reverberation channels; this implies that band splitting works. From dbx, it borrows the regular law characteristic outlined above. Both dbx and Telefunken would appear to have similar propensities for removing noise from tape. The latter claims that its baby produces a basic 90 dB of noise reduction from a 60 dB dynamic range tape machine; naturally, the system operating characteristics extend from machine self noise through to the maximum operating level of the tape, some 10 dB or so above reference level. However, Telefunken seems to have an inbuilt advantage over dbx in that, since the compression slope is lower (1.5:1 as opposed to 2:1) it should tend to magnify less the basic deficiencies of the tape recording process.

Regarding the basic mechanics, fig. 14 shows the band division within the compander, and fig. 15 the individual transfer characteristics. The compression slope is obtained by serial connection of three voltage controlled amplifiers. The control system is arranged so that the output of the last amplifier is detected and the derived signal used to control the parallel control inputs of all three such that the output of the final amplifier in the chain is always held constant. Under these conditions, the output of the first amplifier (connected to the input of the second) will be compressed to the required 33% slope below the original input signal at the head of the chain.

Looking at the three systems without too much subjectivity, each fulfils one of two roles. The first is the operational requirements

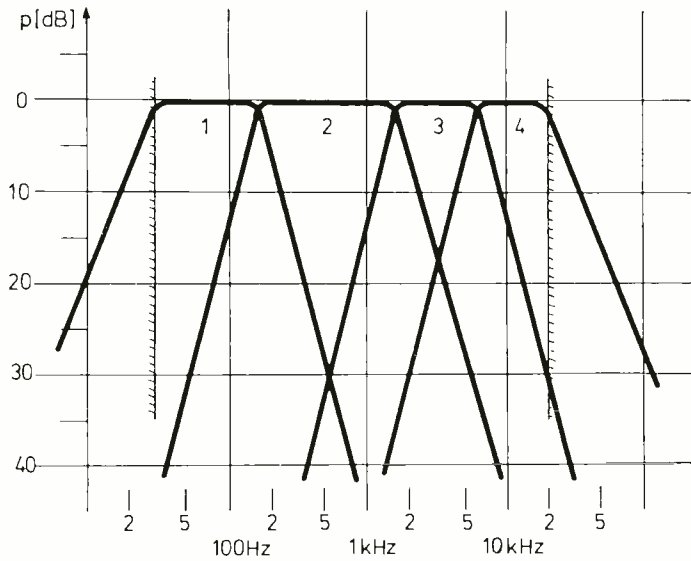

Fig. 14. Telefunken band division.

of present generation master tapes. Present consumer software doesn't allow an expression of dynamic range much in excess of 55 dB and, therefore, the demands on master tapes are not much more than this. Under these conditions, Dolby A provides all the noise reduction that the current software market requires. Further, it does so with a lack of audible intrusion for which it has been well known over the ten years or so of its existence. Under these conditions, it seems unnecessary to flash out a lot of money on the other systems which are definitely more effective at their job. However, it must be pointed out that dbx (Telefunken is still an operational uncertainty) has had its critics, some of whom have said that it produces audible side effects.

In the future, things could be very different as to the demands of a practical noise reduction system. In the other role, if wide range consumer recordings become widely available (such as dbx or digitally encoded discs) which undoubtedly they deserve to be, then dbx, Telefunken or some other wide range professional noise reduction system will become a necessity. Dolby A will no longer meet the performance requirements and replacement will be obligatory.

One technology overshadows all. If advances in digital processing allow ready adaptation to the professional and domestic market, then further discussion on 'which system' will become purely academic. However, this could be quite a long way off since the dbx claim of 100 dB dynamic range is quite a lot for an alternative digital system to live up to. ■

Fig. 15. Telefunken transfer characteristics.

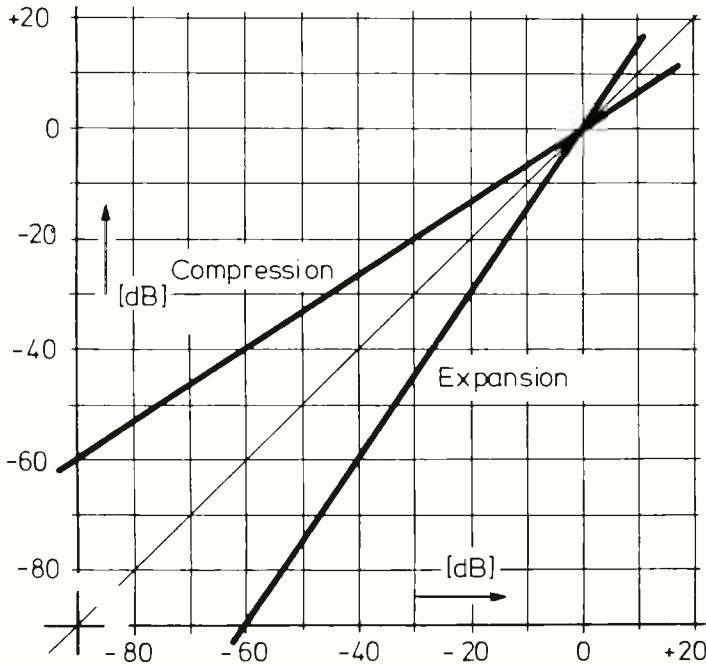

If you're on air, our production mixer won't let you down.

The S6/2 is unique.

The unit has been designed for the production of tape collages for radio, TV, film and broadcast recording studios.

Its features include auto start, auto fade, R.I.A.A. equalisers. An on air light and peak reading V.U. metres to mention just a few.

See and hear the S6/2 at our demo studio, Pembroke House, Campsbourne Road, Hornsey, London N8.

Or for more information call Andrew Stirling 340 3291.

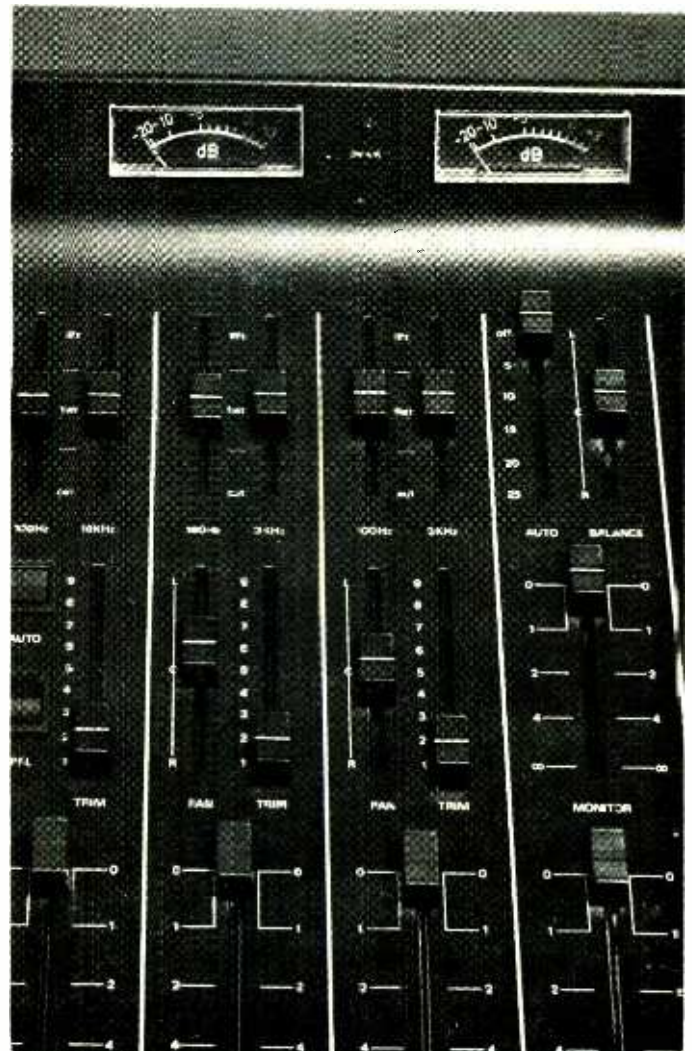

Survey: noise reduction and control

Future surveys will comprise Tape Machines (October) Equalisers (November) and Broadcast and Sound Re-inforcement Mixers (December). Manufacturers are invited to submit product details for publication to reach the magazine office (address on p3) at least six weeks before publication date.

ALLISON (USA)

Allison Research Inc, 2817 Erica Place, Nashville, Tenn 37204, USA.

Phone: (213) 874 6615.

Export: Gotham Audio Corp, 741 Washington Street, New York, NY 10014, USA.
Phone: 212-741 7411.

UK: FWO Bauch Ltd, 49 Theobald Street, Boreham Wood, Hertfordshire WD6 4RZ.
Phone: 01-953 0091.
Telex: 27502.

Kepex Model 500

Type: wide band gain expander.

Attack time: less than 20 μ s.

Release time: 50 ms to 6 s.

Active expansion ratio: 2:1 from 0 dB to 15 dB expansion, increasing to 4:1 at 60 dB expansion.

Threshold of expansion: variable from -35 dBm to +20 dBm.

Insertion loss: 0 dB, 20 dB gain available.

Frequency response: 20 Hz to 40 kHz \pm 1 dB.

Distortion: less than 0.5%.

S/N: 85 dB below rated output.

Input: 3 k Ω , +17 dBm.

Output: 600 Ω unbalanced, +17 dBm

Power requirements: +24V at 75 mA, +100V at 3 mA.

Price: £183.81.

AUDIO DESIGN RECORDING

Manufacturer: Audio & Design (Recording) Ltd, St Michael's, Shinfield Road, Shinfield Green, Reading RG2 9BE.

Phone: 0734 84487.

USA: co-ordinated by Gregg Dixon, 1019 N. Winchester, Chicago, Illinois 60622, USA.
Agents in 17 countries.

F300 Expander

Type: full range variable attenuation expander.

Input: 10 k Ω balanced, unity gain.

Output: 1 Ω unbalanced, max +30 dBm.

Distortion: 0.1% thd at line levels rising to worse case 0.3 dB for 10 dB expansion.

Response: 20 Hz to 20 kHz \pm 0.5 dB.

Thresholds and noise: normal -40 dBm to -10 dBm, noise -103 dB ref +8 dBm. Effects -20 dBm to +10 dBm, noise -86 dBm ref +8 dBm.

Release: 25 ms to 5s.

Attack: 25 μ s/40 dB (fast), 1 ms (medium), 10 ms (slow).

Range: 0 to 40 dB continuously variable.

Slopes: expand 1:1 to 3:1, 1.5:1 at 10 dB range, 2:1 at 20 dB range, 3:1 at 40 dB range. Gate 20:1 (with hysteresis).

Auto mode: an averaging characteristic network, operating 10 dB below the peak sensing side chain threshold.

Format: card module for SCAMP rack system, up to 17 per 48 cm width.

Power 30V unbalanced dc.

Price: on application.

SO 5 and SO 6

These are selective expanders which provide low level attenuation at high or low frequencies. Rather than use a fixed filter to attenuate low frequency spill on a track, or hf noise on a low frequency signal, these units only filter when there is no unwanted signal in the area of attenuation. The action is dynamic and the filter slope is progressively variable, opening to a flat response at a point determined by the threshold control. The SO 5 is a high pass version and the SO 6 low pass.

Input: 10 k Ω balanced unity gain.

Output: 1 balanced.

Distortion: 0.05% at 1 kHz thd.

Response: 20 Hz to 20 kHz \pm 1 dB -3 dB worse case.

Noise: -93 dB ref 8 dBm.

Threshold: -30 dBm and above, -40 dBm gate.

Slope: dnf filter variable 0 to 20 dB ratio. Gate 20:1 ratio.

Range: gate mode -20 dB/40 dB.

Format: card module for SCAMP rack.

Power: 30V unbalanced dc.

SO 5: high pass turnover 100 Hz, 200 Hz and 400 Hz.

SO 6: low pass turnover 2 kHz, 4 kHz and 6 kHz.

Prices: on application.

AUDIO DESIGNS (USA)

Audio Designs and Manufacturing Inc, 16005 Sturgeon, Roseville, Michigan 48066, USA.

Phone: (313) 778 8400.

International: Ampex International, 72 Berkeley Avenue, Reading, Berkshire.
Phone: 0734 55341.
Telex: 847611 AMPEX RDG.

ADM Model 301

Type: noise suppressor.

Input: +24 dBm max, 600 Ω .

Output: +24 dBm max, 10 Ω , loading 600 Ω .

Frequency response: 20 to 20 kHz \pm 0.25 dB.

Distortion: 0.15% typical, 0.35% max.

Noise output: -73 dBm above threshold, -90 dBm no input.

Gain: 0 dB.

Threshold: adjustable from -40 dBm.

Attack time: 5 μ s.

Decay time: 10 ms to 500 ms/dB.

Available gain reduction: 85 dB.

External fade control: 0 to -15V.

Power: \pm 20V, 50 mA.

Dimensions: 2.5 x 13.3 x 19 cm.

Price: \$250.

DBX

dbx Inc, 296 Newton Street, Waltham, Mass 02154, USA.

Phone: (617) 899 8090.

UK and NW European agents: Scenic Sounds Equipment, 27-31 Bryanston Street, London W1H 7AB.

Phone: 01-953 0141.

Telex: 27939 SCENIC G.

Professional units.

187

187 provides switchable record or play noise reduction for four channels, (ie each unit has four processors).

Input impedance: 10 k Ω balanced floating.

Input level: nominal +4 dBm, max +28 dBm into 10 k Ω , +24 dBm into 600 Ω .

Output impedance: 600 Ω nominal with 80 Ω source.

Max output level: +24 dBm into 600 Ω .

Frequency response: 30 Hz to 20 kHz \pm 1 dB for full compression-expansion cycle.

Distortion: 0.1% typical, 0.2% max for full cycle.

Equivalent input noise: -90 dBm.

Reduction of noise added to the signal by the tape recorder: at +4 dBm signal level, hiss and high frequency modulation noise are reduced by 10 dB on signals with dominant energy below 500 Hz. At -16 dBm signal level there is an additional 10 dB of noise reduction, at -36 dB an additional 20 dB, at -56 dBm an additional 30 dB and finally at -76 dB there is a total of about 40 dB of noise reduction.

Connectors: standard three pin XLRs.

Dimensions: 48 x 8.8 x 26.6 cm, 5.5 kg.

Power requirements: 105V to 125V, 220V to 240V available, 50 to 60 Hz.

Price: 187 £1380, \$2150.

216

Type: 16 track tape noise reduction system with simultaneous record and replay processors, (ie 32 processors).

Basic specification as for 187.

Connectors: eight 27 way connectors for connection to tape recorder and mixer. All mating connectors and full leads terminated with XLRs are supplied as standard. Leds indicate channel status. One spare two channel module (four processors) is supplied as a spare.

Dimensions: 48 x 17.7 x 26 cm, 19.5 kg.

Price: £5450, \$9500 for 16 track. 24 track £7790 \$14000.

K9-22

Type: dbx processor physically and electrically interchangeable with Dolby Cat No 22 noise reduction module. Once correctly aligned, the K9-22 may be used to replace some or all Dolby A modules in any of the units using the Cat No 22 module. Module is externally switched to record, replay or bypass by controls on Dolby main frame.

New range



8 channel, 2 group MXT-1000 - each channel fitted with compressor

MXT-1000 AUDIO MIXING SYSTEM

The new MXT-1000 - select:

- Number and type of input channels
- 2, 4 group working, or stereo operation
- Metering and monitoring requirements
- Inbuilt power supply or batteries
- Optional modules - talkback, oscillators, etc
- Optional free standing console
- Type of faders

A unique system enabling your own requirements to be built from standard equipment

Manufacturers of sound systems and electronics

Station Road, Wenden
Saffron Walden
Essex CB11 4LG
Saffron Walden
(0799) 40888

audix

SURVEY: NOISE REDUCTION

Input level: 350 mV for 0 vu.
Output level: +22 dB into 200Ω or greater.
 Remaining specification similar to 187.
Price: £193, \$250.

192
Type: two channel noise reduction unit for the Nagra IV-S portable tape recorder. Unit is two channel switchable record or play and is contained in a small package which attaches directly to the bottom of the Nagra case. Connection to the recorder is via a single connector which provides inputs, outputs and power for the noise reduction unit. Basic specification as above.
Dimensions: 22.9 x 3.2 x 18.1 cm, 1.1 kg.
Price: £416, \$600.

Units for small recording studios, semi-professional recordists and those who want cheapo dbx.

Basic specification
Input impedance: 50 kΩ unbalanced.
Input level: max +21 dB, nominal 775 mV (0 dBm) for unit gain record and play, *Model 157* adjustable, record 100 mV to 3V (-18 dBm to +12 dBm), play 300 mV to 3V (-8 dBm to +12 dBm).
Output impedance: 100Ω unbalanced.
Output level: +21 dBm max into 10 kΩ bridging, +17 dBm into 600Ω.
Noise reduction: in excess of 30 dB.
Frequency response: 30 Hz to 20k Hz ± 1 dB for the complete encode-decode cycle.
Distortion: 0.3% thd, 0.05% above 1 kHz.
Connectors: audio phonos.
Dimensions: 22.8 x 8.8 x 26.6 cm, 3.2 kg.

Model 157
Type: two channel simultaneous encode-decode.
Price: £414, \$600.

Model 154
Type: four channels switchable encode-decode.
Price: £487, \$750.

Dolby A noise reduction Cat. 22

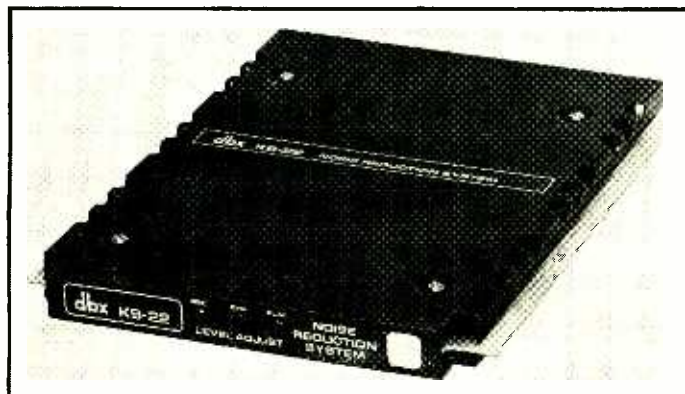

dbx K9-22 card noise reduction system

Model 152
Type: two channels switchable encode or decode
Price: £320, \$475.

DOLBY (UK)
Dolby Laboratories Inc, 346 Clapham Road, London SW9 9AP.
Phone: 01-720 1111.
Telex: 919109.
USA: Dolby Laboratories Inc, 731 Sansome Street, San Francisco, Ca 94111.
Phone: (415) 392 0300. Telex: 34409.
 Distributors in 40 countries, details on application.

Professional recording and transmission equipment 360 series
Type: *Model 360* has one signal processor which may be switched for either play or record mode by front panel mounted switches. *Model 361* is similar with addition of relay control of record/play mode and line in/line out switching.

Signal levels: min input for Dolby level 350 mV, 600 mV for DIN level. Max output +22 dB into bridging load, +21 dBm into 600Ω, +20 dBm into 200Ω. Input and output levels adjusted by multi-turn pots.

Overall frequency response: 30 Hz to 20 kHz ± 1 dB.

Overall harmonic distortion: at +8 dBm, less than 0.1% at 1 kHz, less than 0.2% from 40 Hz to 20 kHz.

Noise reduction: Dolby A-type professional characteristic, providing 10 dB of noise reduction from 30 Hz to 5 kHz rising to 15 dB at 15 kHz.

Overall noise level: record/playback, 80 dB (unweighted 30 Hz to 20 kHz bandwidth) below Dolby level.

Matching between units: ± 1 dB at any level and frequency, 30 Hz to 20 kHz.

Stability: no routine alignment required.

Construction: Plug-in noise reduction module *Cat No 22* and changeover relays accessible through

front panel.
Dolby tone oscillator: internal oscillator provides for establishing correct operating level on an international basis. Recorded at Dolby level (185 nWb/m) and characteristically modulated.

Input: 10 kΩ balanced floating.
Output: transformer, 20Ω balanced floating.
Connectors: audio 3 pin XLR, remote control 5 pin XLR, mains IEC.
Power requirements: 100V to 130V and 200V to 260V, 50 Hz to 60 Hz.
Dimensions: 48.3 x 4.4 x 22.8 cm, 5.5 kg.
Prices: 360 £260, 361 £290.

M16H
 Chassis with 16 noise reduction processors with built-in record/playback changeover facilities; circuitry is also automatically transferred between input and output of tape recorder.
Dimensions: 49.3 x 26.7 x 28 cm, 20.5 kg.
Price: £2200.

M8H
 Similar to above but chassis only fitted with eight processors. May be expanded later to 16 channels.
Price: £3950.

M24H
 Consists of *M16H* and *M8XH* (functions controlled by *M16H*) to provide 24 noise reduction channels.
Dimensions: 49.3 x 53.3 x 28 cm, 36 kg.
Price: £5850.

M Series specification
 Basic specification as for 360/361.
Switching: all electronic, 200 μs changeover time, led indication of channel status and common facilities.

Signal delay: constant with frequency, 18 μs per channel.

Phase error: less than 5° 200 Hz to 20 kHz overall encode/decode.

Connectors: screw terminals standard, other types (XLR) to order at extra cost.

Cat No. 22
Type: the Dolby noise reduction module *Cat No 22* is the basic functional unit employed in all A-type equipment. It is available separately either as a spare or so that it may be built into original equipment to provide integral noise reduction facilities.
Price: £160.

Cat No 35
Type: noise reduction module test set and test extender which enables *Cat No 22* modules to be checked without their being removed from equipment.
Price: £95.

Motion picture equipment 364

Type: cinema noise reduction unit. Basic specification as for 360/361 but operates in three different replay modes as follows.

Dolby film: replays and decodes Dolby encoded film sound tracks (either optical or magnetic) with resulting noise reduction (10 dB up to 5 kHz, 15 dB at 15 kHz), no filter in circuit.

New print, non Dolby: replays all other film prints except those which are noisy or worn. No noise reduction but standard Academy filter in circuit (-15 dB at 8 kHz).

Clean-up: for old films or noisy prints. 6 dB clean-up noise reduction plus standard Academy filter in circuit.
Price: £335.

E2
Type: single channel cinema equaliser consisting of two sections, head equaliser and house equaliser. (No noise reduction.)

Head Equaliser: interfaces projector with 364 noise reduction unit. Provides high frequency aperture loss correction up to 12 dB at 8 kHz.

House Equaliser: provides equalisation to 'combat' house amplifiers, speakers and acoustics.

Controls: bass ± 10 dB at 63 Hz, treble ± 11 dB at 8 kHz, one third octave controls giving ± 8 dB at

Multichannel Peak Programme Meter

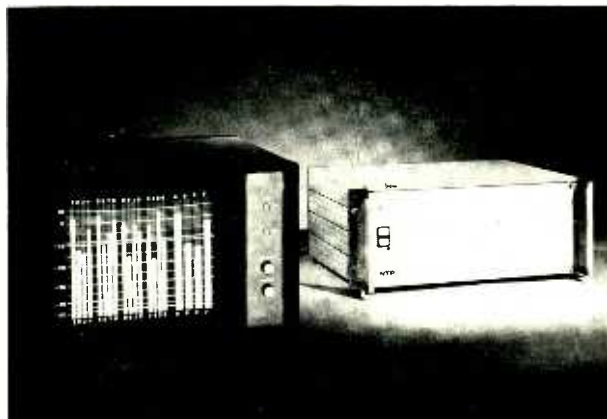

Colour Display 24 Input – and 4 Master Channels Peak Indication According to IEC/DIN

This new NTP design is primarily intended for studios using the multichannel technique.

Up to 28 channels in standard version and 36 in special version may be indicated on the easy to read vertical bargraph display. The channels are divided into groups of 4, and the bars are background illuminated. In the overload range the colour of the bars changes to red. In order to identify particular channels for instance those in record mode, soloists etc. the colour of these bars may be selected remotely from the mixing desk.

The scale is electronically generated which gives an outstanding accuracy. Two standard scales are available DIN or Nordic, but special scales according to customers requirements can be supplied.

NTP

NTP ELEKTRONIK A/S

44, Theklavej Reg. no. 32426
DK-2400 Copenhagen NV Cable-address Electrolab
Telephone (01) 10 12 22 Telex 16378 ntp dk



TEN CHANNEL STEREO MIXER B2000

Balanced microphone, balanced line inputs, 600 ohm balanced outputs. HF, MF and LF equalisation each channel. Echo send and foldback and Pan controls. VU Meters or PPM's, from **£905.00**

SIX CHANNEL MONOPHONIC MIXER B1000 from £357.00

AMPLIFIER CIRCUIT CARD ASSEMBLIES
Available ex-stock.

Mic amp. Mixer. Equaliser, HF-LF. Equaliser MF. Line amplifier. Tone Oscillator. Limiter. Peak Programme Meter. Talkback amplifier.

SONIFEX SOUND EQUIPMENT
15 College Street, Irthlingborough, Northants.
Tel: 0933 650700

-TURNER-

STEREO POWER AMPLIFIERS
(from 100 watts to 500 watts)

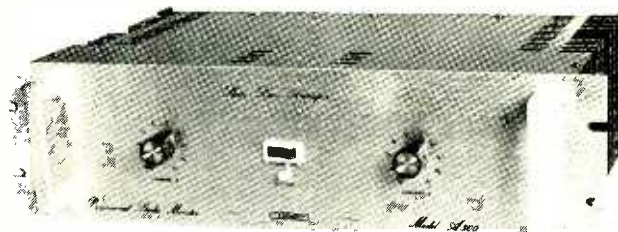

Professional Stereo Power Amplifier designed and manufactured to the very highest standard.

TURNER POWER is setting a new standard in the studios for ultra clean monitoring, and with bands on the road for ruggedness and reliability.

Customers include: Air Studios, Wessex Studios, Gooseberry Studios, Lansdowne Studios, Decibel Studios, Queen and leading hire companies.

TURNER ELECTRONIC INDUSTRIES LTD.
175 Uxbridge Road, London W7 3TH. Tel. 01-567 8472

SURVEY: NOISE REDUCTION

27 ISO centre frequencies (40 Hz to 16 kHz).
Price: £325.

CP100

Type: cinema processor designed for the reproduction of all current and presently foreseeable film sound tracks. The processor includes (or is wired to accept) the following modules:

Stereo optical playback module incorporating amplifiers and changeover functions for two projectors. Standby stereo optical playback module.

Changeover module which incorporates the projector changeover logic.

Five meter modules to check and calibrate internal signal levels.

Non-sync module with inputs for two stereo sources and also for pa microphone.

Six channel ganged fader electronically controlled and remotable.

Local control module for setting volume levels in the auditorium, selecting film format and also providing a monitoring control for booth loudspeakers.

Noise reduction modules, standard Dolby A *Cat No 22* (space for three).

Equalisation modules, up to five, details as for *E2*.

Mono/stereo format module with logic circuit to ensure stable centre screen dialogue. Space for two further format modules allowing the acceptance of magnetic inputs, or for processing of any other cinema format.

Facilities module allowing for local or remote control of projector changeover, fader control and format selection. This module incorporates a bypass key to remove the complete unit from the signal path in case of failure.

Dimensions: 49.3 x 26.7 x 28 cm, 16.5 kg.
Price: £2300.

Professional encoders for consumer media (B-type)

330

Type: two channel tape duplication unit for the B-type characteristic encoding of master tapes for high speed duplication.

Input: 10 k Ω or 600 Ω balanced floating.

Output: transformer, balanced floating 20 Ω .

Signal levels: min input 350 mV for Dolby level corresponding to 185 nWb/m.

Max output: +22 dB into bridging load, +21 dBm into 600 Ω , +20 dBm into 200 Ω .

Overall frequency response: 30 Hz to 15 kHz \pm 1 dB.

Total harmonic distortion: at +4 dBm less than 0.1% at 1 kHz, less than 0.2% from 40 Hz to 20 kHz.

Encoding characteristic: Dolby B-type, +3 dB at 500 Hz, +6 dB at 1 kHz, +10 dB from 4 kHz upwards.

Low pass filter: built-in 16 kHz low pass filter giving 45 dB attenuation at 80 kHz.

Overall noise level: better than 80 dB below Dolby level.

Cross talk: better than 50 dB between channels.

Signal delay: 27 μ s.

Phase difference between channels: less than 5° 20 Hz to 12 kHz overall.

Matching between units: better than 1 dB.

Stability: no routine alignment required.

Connectors: XLR input and output, 5 pin XLR for remote control of nr in-out and oscillator.

Panel controls: nr in-out, Dolby tone, remote/local operation. Toggle switch mode selector behind access plate for selecting encode or decode.

Dimensions: 48.3 x 4.4 x 22.8 cm, 5.5 kg.
Price: £525.

334

Type: fm broadcast encoder with B-type characteristic. Basic specification as for 330 but additionally converts the 75 μ s pre-emphasis to effectively 25 μ s. Such transmissions are approved by the FCC as compatible with normal reception equipment.
Price: £525.

EMT (West Germany)

Manufacturer: Franz Vertriebsgesellschaft mbH, D-763 Lahr 1, Postfach 1520, West Germany.

Phone: 07825 512.

Telex: 754319 FRANZ D.

USA: Gotham Audio Corporation, 741 Washington Street, New York, NY 10014, USA.

Phone: (212) 741 7411.

UK: FWO Bauch Ltd, 49 Theobald Street, Boreham Wood, Hertfordshire WD6 4RZ.

Phone: 01-953 0091.

Telex: 27502.

EMT 258

Type: noise filter with dynamic turnover frequency and expander function.

Input: balanced floating 30 to 600 Ω source, 10 k Ω load, -8 dB to +6 dB.

Output: impedance 40 Ω , load 200 Ω , level -20 dB to +6 dB, max +21 dB.

Frequency response: 40 Hz to 15 kHz \pm 0.5 dB.

Distortion: 0.5%.

S/N: 80 dB unweighted at 0 dB.

Expander: total range at 100 Hz to 20 dB, frequency range below 2 kHz, release time 50 ms for 10 dB.

Filter: turnover frequency 1 to 20 kHz, release time 0.05s to 2s. Threshold of the signal amplitude which determines the turnover frequency, adjustable -25 dB to -65 dB.

Dimensions: 4 x 19 x 11 cm.

Price: £519.

FUTURE FILM DEVELOPMENTS

Future Film Developments, a division of Allotrope Ltd, 90 Wardour Street, London W1V 3LE.

Phone: 01-437 1892.

Telex: 21624.

DNR series

Type: portable noise reduction unit mounted in compact case for use with Nagra IV portable tape recorder.

Noise reduction: uses *Cat No 22* modules (two off) to provide standard Dolby A-type characteristics. Full details under Dolby heading.

Power: 20-28V dc at 300 mA max for stereo, 200 mA mono.

Internal batteries: provide 10 hrs operating time for mono, 6 hrs for stereo, per charge.

Dimensions: 33.1 x 21.6 x 6.2 cm, 4.5 kg.

Price: DNR-Q4S \$1852, supplied with rechargeable battery pack, and leads for connection to Nagra. Power supply \$216.16. UK prices under revision.

NEVE (UK)

Manufacturer: Rupert Neve & Company Ltd, Cambridge House, Melbourn, Royston, Hertfordshire SG8 6AU.

Phone: 0763 60776.

Telex: 81381.

USA: Rupert Neve Inc, Berkshire Industrial Park, Bethel, Conn 06801, USA.

Phone: (203) 744 6230.

Telex: 969638.

2257

Type: background noise suppressor.

Threshold: 0 to -40 dBm in 2 dB steps.

Attenuation depth: adjustable from 3 to 33 dB in 3 dB steps.

Recovery: 100 ms, 270 ms, 1s.

Gain: 0 dB (preset).

52 ▶

There are 85 Recording Studios in The Creative Handbook



Useful, isn't it!

For more information telephone 240 0856

One of the
SCAMP-aigners
for
**NOISE
 REDUCTION**

The F300 Expander-Gate

- eliminates low level source noise
- attenuates, automatically, non-contributing tracks
- tightens-up loose acoustics
- separates and controls cross-mic pickup

yet, being a single ended processor of superb quality, does not affect transient performance and remains totally compatible with any other system.



audio & design recording

St. Michael's Shinfield Road Reading RG2 9BE Berkshire U.K. Tel. Reading (0734) 84487

Representation in — Australia — Belgium — Brazil — Canada — Denmark — France — Finland — Germany — Greece — Holland — Italy — Japan
 New Zealand — Norway — Portugal — South Africa — Sweden — Switzerland — U.S.A.

work

Maison Rouge

Jethro Tull are one of the latest bands to give in to a desire for their own recording facilities. The basis on this occasion, as it has been on others, is a mobile recording truck, but eventually La Maison Rouge will have a large studio, a control room and offices near where the truck is parked off Fulham Broadway. They hope completion of the project won't take more than six months.

The truck has been in operation about nine months, during which time Robin Black, ex-Morgan chief engineer and some time producer, and engineers Trevor White and Peter Smith, have been to divers locations to record gigs or long sessions at country retreats. Much of the work, naturally, has been with Tull, such as recording a live Paris concert shown on *Old Grey Whistle Test*, and two albums in the south of France: *Minstrel in the Gallery* and, soon to be released, *Too Old to Rock and Roll, Too Young to Die*. The albums were recorded both in four channel and two channel stereo versions. The truck was also used for three weeks in Devon by Mallard, formerly the Magic Band of Captain Beefheart, who hired a seven-bedroomed country house near Dartmoor to record an album for Virgin.

So fast do things move in recording these days that the mobile has already had two refits in that nine months. Nothing major, but new equipment has been installed to meet demands for this or that facility. There has to be a limit to what you can do in a truck but Maison Rouge have done their best to push those limits out a little further. Jethro Tull production manager Andy Truman explained the basic difference he thought there was between this truck and others: 'Most mobiles are there so that you can get something down on tape and then you go into a studio and mix it down. The point about this one is that you can mix down as well.'

It was often essential, he said, especially when recording concerts, to hear a playback as soon as the gig was over. Then you could do overdubs if necessary before all the gear was packed away. In any case, the overdubs should be done where

the original recording was made. 'Anyone who books a mobile for one night of a tour is living in cloud cuckoo land,' said Truman. 'They've got to guarantee that the performance is perfect on that night.' It wasn't so much that equipment might fail, it was simply that an artist's performance varied.

What it means is that they've had to find room for stereo machines

and echo plates as well as the desk and a multitrack tape machine. They've arranged that the stereo tape machines are stored in alcoves under the two large Tannoy monitors and pulled out when they're needed. The Studer A80 24 track is between the monitors, and there are two Studer stereo machines as well as a four track which can be converted to two.

For mixing four channel tapes they use four JBL L100 monitors fixed on brackets round the inside of the truck. Two front JBL 4315's can also be used for two-channel monitoring if a client prefers.

The desk was built by Helios, on whose desks Robin Black had worked a lot before. Helios were used to this kind of work and two other manufacturers they had asked about the projects weren't able to provide the same facilities in a small space.

There are 32 input channels and 24 out. The first 24 channels are grouped together, then comes the monitor mixer, and then the last eight channels. This grouping keeps the remix channels together. The channel equalisation seems comprehensive, with three-frequency high pass filter, variable mid and bass boost and cut, 12 dB boost and cut at 10 kHz, and an overall 18 dB cut which takes down the sensitivity of the whole channel. The panning controls on each channel allow that channel to be placed anywhere laterally, vertically or horizontally on the lines joining the plan of the four quad output positions. Further adjustments can be made elsewhere using four quad pan pots.

There are four separate foldbacks and any one of them could be reached either by the producer or the engineer for instructions exclusive to that foldback channel, as in the case where the engineer wants to say something uncomplimentary to the md about that brass player with a bottle under his chair. There are three echo sends on the main mixer and two on the monitor. The truck carries an EMT plate and a Master Room unit. The channel routing is interesting in that it is accompanied by two rows of multiposition rotary switches with sources and destinations shown on an illuminated alpha-numeric display.

Robin Black, who after all is using the desk more than anyone, had removed a spotlight from the lighting track above the desk, and the first impression of the desk, on which all the channels and knobs are black with white markings, was that it might be hard to read. He said he didn't find it so, and that



above: Maison Rouge—a view of the interior

below: A slightly different view of above



Another SCAMP-aigner for NOISE REDUCTION

The S05/S06 Dynamic Noise Filter

- provides a 0-18dB/octave programme controlled filter at one of three turnover frequencies
- offers high pass version (dynamically attenuates hum etc)
- or low pass version (dynamically attenuates hiss etc)
- filters statically if required
- optionally provides 20/40dB noise gate function

yet, being a single ended processor of superb quality, can filter noise from wanted signal, giving a flat response at onset of noise masking, without affecting transient performance, whilst remaining totally compatible with any other system.

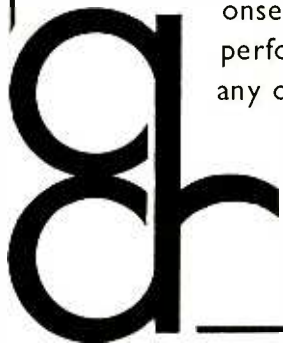

audio & design recording

St. Michael's Shinfield Road Reading RG2 9BE Berkshire U.K. Tel. Reading (0734) 84487

Representation in — Australia — Belgium — Brazil — Canada — Denmark — France — Finland — Germany — Greece — Holland — Italy — Japan
New Zealand — Norway — Portugal — South Africa — Sweden — Switzerland — U.S.A.

WORK

there was little point in putting bands of coloured knobs on because he knew where everything was. The legends seemed clear enough, not hidden by the knobs themselves, even though the desk is very small and tightly packed.

As well as a full complement of vu meters there are two light beam ppms which can be switched to any of the 24 tracks. 'Usually they're on the two stereo tracks,' said Robin Black. 'They're very important for cutting—you can read the transients and tell if it's going to distort on disc.' Everything is switchable from the desk, it appears, including the small Studer autolocate, varispeed and the switching for the two Dolby *M16* units. Sync pulsing is available for film soundtracks. According to choice a two track 6.25 mm or cassette copy can be made of the recording while the performance is going on.

There are about 32 microphones, 'a mixture of good studio mics and good live mics'. The truck carries boxes which allow bands to parallel off their mics for feeding to the pa or allow Maison to take a feed from the pa mics. The boxes also give a

warning light when the tape is being changed in the truck. For an extra charge, another 24 track tape machine can be provided for overlap. There's a cctv link between truck and stage.

Black and Truman say that the response inside the truck is flat. Normally, said Black, a tape sent away for cutting needs slight adjustment to the equalisation during cutting to allow for little peculiarities in the room response. 'But we've been lucky up to now. We've been able to cut flat.' Although their approach to the acoustic treatment had been to rely less on systematic analytical design than the evidence of their ears, they said the room had been measured a week or so before and had been found to be flat, though within what limits they didn't say.

Andy Turnbull was keen to emphasise that the mobile was meant to be comfortable. 'We think the real growth area is the big superstar musicians who want to do their own solo albums, like Steve Howe of Yes, for example. But a band's on tour for six months, they're making albums with their own band for three months, so that means they have three months at home, three months in which to do solo projects. If they record them in studios they're away from

home all over again. With the mobile they can do a complete album and never leave home. They can be with their families. They can do all the recording and mixing in the same truck. Now in most mobiles you wouldn't want to do that, and in any case many of them haven't got the sound you can get in a studio.'

It wasn't just a matter of looking after the engineer and producer: 'Most mobiles don't tend to cater for the guy who's not actually mixing.' He thought it a good idea, therefore, to get a large coffee table to put at the back of the truck, in front of the soft couch they'd already got. They had done 'considerable research' to discover a coffee that was palatable throughout 24-hour recording and mixing sessions, and he thought they had found it in a blend made by Jacksons of Piccadilly. I can't disagree.

Maison Rouge have paid tribute to the efficacy of the British motor industry by using a Mercedes *808* truck. The reasoning is that a Mercedes, though perhaps slower than some other trucks, is a good deal more reliable and, in any case, Mercedes spares would be more easily available in Europe and worldwide than Ford or Commer. They intend, as they already have

done, to do a considerable amount of work in Europe and further afield. The truck, which was coach-built for Maison Rouge by Wildon, is air conditioned, and has a 10 kW generator. At the moment they park it next to a near-derelict building near Fulham football ground. It took two years to find a site that would allow them to park the mobile and on which they could build a permanent studio at some future date.

They hope to have room for 35 musicians in the permanent studio and, at first, they will use the truck as the control room. Then the studio will have a control room of its own and the truck, when it isn't out somewhere, will be available for mix-downs. They'll also build offices for Maison Rouge and, by the sound of it, a rather decadent recreation area for off-gooing musicians. The walls will be covered in repro Toulouse Lautrec, and the decor will suggest nothing so much as a rive gauche bawdy house. 'We'll put in a vcr machine and some tapes, a tv set and a hi-fi system. It'll be somewhere for the musicians to go when they're not doing takes.' Unlike other studios, Andy explained, there wouldn't be a space problem, and parking would be easy. Sounds really nice.

John Dwyer

SURVEY: NOISE REDUCTION

Frequency response: 20 Hz to 20 kHz ± 0.5 dB.
Noise: with 3 dB depth -86 dB measured wide band.
Distortion: at +20 dBm into 600 Ω , 0.03% at 1 kHz, 0.05% at 10 kHz, 0.1% at 100 Hz.
Input: 10k bridging floating.
Output: 80 Ω source balanced floating.
Power: 24V dc.
Dimensions: 4.6 x 22.2 x 27.3 cm.
Price: on application.

SHURE (USA)

Manufacturer: Shure Bros Inc, 222 Hartrey Avenue, Evanston, Illinois 60204, USA.
Phone: (312) 679 5830.
UK: Shure Electronics Ltd, Eccleston Road, Maidstone ME15 6AU.
Phone: 0622-59881.
Telex: 96121.

M625-2E

Type: voice gate for pa applications.
Frequency response: 40 Hz to 20 kHz ± 3 dB.
Hum and noise: on mic input 124 dB below 1V.
Input trigger level: adjustable from -62 dBV to -96 dBV on mic input, high level input -40 dBV to -74 dBV.
Hold time: 0.5s to 30s.
Distortion: 0.5% max thd at 2 kHz.
Dimensions: 10 x 8.5 x 26 cm, 1.9 kg.
Price: £84.80.

SOUNDOIER (USA)

Soundolier Inc, 9380 Watson Industrial Park, St Louis, Mo 63126, USA.
Phone: (314) 962 9870.
International distributor: Royal Sound Co Inc, 248 Buffalo Avenue, Freeport, NY 11520, USA.
Phone: (516) 868 2880.
Telex: 960219 Royal Free.

MG-1500

Type: masking noise generator.
Output: buffered output for 600 Ω load.
Filters: 14 active adjustable broadband filters centred at 200, 250, 315, 400, 500, 630, 800 Hz, 1k, 1.25k, 1.6k, 2k, 3.15k, 4 kHz for room and loudspeaker acoustics equalisation.
Filter characteristics: each $\frac{1}{3}$ octave filter adjustable ± 10 dB, response variable from flat to 12 dB/octave roll off.
Noise generator: based on digital circuits.
Active low cut filter: adjustable from 30 Hz to 150 Hz with 12 dB/octave.
High cut: from 5 kHz for difficult situations.
Power: 117V ac.
Dimensions: 48 cm x 13 cm.
Price: on application.

TEAC (Japan)

Manufacturer: Teac Corporation, Shinjuku Building, 1-811, Nishi-Shinjuku, Tokyo, Japan.
Phone: 03-343 5151.
USA: Teac Corporation of America, 7733 Telegraph Road, Montebello, Cal 90640, USA.
Phone: (213) 726 0303.

UK: Industrial Tape Applications, 5 Pratt Street, London NW1 0AE.
Phone: 01-485 6162/7833.
Telex: 21879.

AN-300

Type: Dolby B-type noise reduction system.
Processors: Four units, switchable record/play.
Frequency response: 20 to 20 kHz ± 1.5 dB.
Noise reduction: 5 dB at 1 kHz, 10 dB at 10 kHz, better than 6 dB overall.
Sensitivity: tape input 0.1V, line input 1V, 70 k Ω impedance.
Outputs: record 0.3V, monitor 0.3V.
Distortion: 0.2% harmonic.
Multiplex filter: 35 dB at 19 kHz, -30 dB at 38 kHz.
Channel separation: better than 55 dB.
Oscillator: Dolby B 400 Hz tone.
Dimensions: 41 x 17 x 25 cm, 7.5 kg.
Price: £225.

AN-180

Type: Dolby B-type noise reduction system.
Processors: four units, two record and two replay.
Frequency response: 20 Hz to 20 kHz ± 5 dB.
Noise reduction: 5 dB at 1 kHz, 10 dB at 10 kHz, better than 6 dB overall.
Inputs: mic and line.
Outputs: tape and line.
Distortion: 0.3% harmonic.
Channel separation: 50 dB.
Oscillator: Dolby tone 400 Hz.
Dimensions: 41 x 14 x 32 cm, 7 kg.
Price: £129.

AN-80

Basic specification as above but with only two processors providing switchable stereo record/replay. Also omits mic input.
Price: £92.

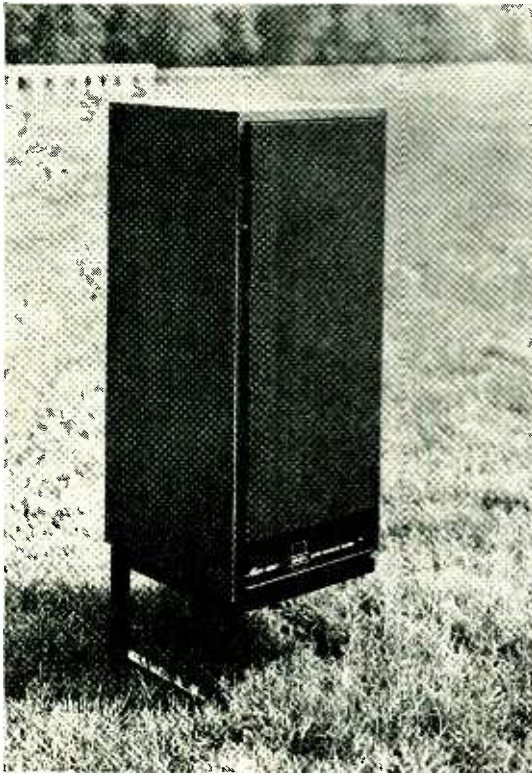

LOOK WHAT HAPPENED WHEN ALICE AND PETE GOT TOGETHER . . .

They produced the ALICE-KEELEY Q.A.M.3. QUALITY ASSESSMENT MONITOR LOUDSPEAKER. A development of the I.B.A. approved A.701.

It is fitted with an integral 100 watt 'Current Dumping'* amplifier—need we say more? For professional use, the Q.A.M.3-P is available with balanced input and thermal power limiting.

The four unit acoustically loaded bass reflex speaker is the result of countless hours of development time, aimed at producing a unit to complement the superb quality of the amplifier.

IT DOES !

The Q.A.M.3 is the first in a new Alice range of Hi-Fi equipment with professional facilities and performance. Soon you will be hearing about the P.S.C.1 Stereo Pre-Amplifier and P.200 Stereo Power Amplifier.

For up to date information contact Barry Porter

Alice (Stancoil Ltd), Sales Office : 38 Alexandra Rd,
Windsor, Berks. Tel. Windsor 51056/7

*The amplifier fitted to the Q.A.M.3 incorporates output circuit techniques patented by the Acoustical Manufacturing Co Ltd, manufactured under licence by Stancoil Ltd.



WILMSLOW AUDIO

THE Firm for speakers !

Tannoy - Gauss - Radford - Kef - Goodmans -
Celestion - Fane - Decca - Peerless - Baker, etc.

From stock:

RADFORD ZD22 Zero distortion stereo preamp
RADFORD HD250 High Definition Stereo amplifier
RADFORD Low distortion oscillator
RADFORD Distortion measuring set
Expected soon: RADFORD ZD100 and ZD200, 150
watt and 250 watt per channel, zero-distortion power
amplifiers!

(Speakers) **Wilmslow Audio, Swan Works, Bank
Square, Wilmslow, Cheshire**

(P.A. etc.) **Wilmslow Audio, 10 Swan Street,
Wilmslow, Cheshire**

(Hi-fi etc.) **Swift of Wilmslow, 5 Swan Street,
Wilmslow, Cheshire**

Tel. Wilmslow 29599 (speakers), 26213 (Hi-fi. PA etc.)

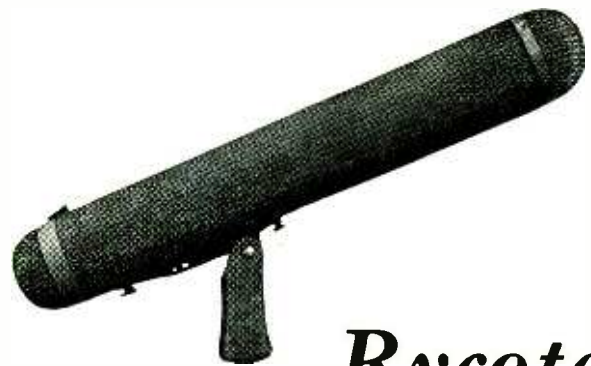

Rycote

Microphone Windshields
& shockmounts

Durable, lightweight, made to last.

Rycote

Edgehill Farm, Edge, Stroud, Glos. GL6 6PA

Telephone: Painswick 813615

reviews

In the audio business we all use meters for two distinctly different purposes, measuring steady state conditions and measuring audio signals. When measuring steady state conditions the response time of the meter is of little importance provided that it is not so fast that the needle moves all over the place with low frequency test signals; furthermore, most test signals are sine-waves so that the type of rectifier used in the meter is of no interest.

Three very different types of meter rectifier are in common use, true rms, average and peak. The true rms rectifier is related to power measurement in that its output is related to the square of the voltage, or to be more precise the square root of the sum of the squares of a combination of voltages derived from

$$\text{Watts} = \frac{\text{Volts}^2}{\text{Resistance}}$$

The average rectifier meter characteristic is a very different animal, because its output is proportional to the average voltage, whilst the peak rectifier's output is proportional to the peak voltage.

An illustration of these factors in relation to audio signals can be demonstrated by reference to a one-second section of speech eg 'the

time has come'. Taking the rms value of this is zero, the average is at -3.3 dB and the peak at +12.5 dB.

If we now consider the normal types of meter used for audio, the vu meter and the peak programme meter, we have a peak reading meter and an average reading meter in the form of the vu meter. If these are used to measure the level of the one-second section of speech the peak meter will read 15.8 dB (3.3 dB + 12.5 dB) higher than the vu meter.

The point of this is the source of much misunderstanding. Most engineers realise that peak on a peak programme meter is around peak signal, but many who should know better do not realise that 0 vu should be set to be between 10 dB or 12 dB below the peak signal handling capability of a system. Of course the meter's ballistics are also very important, but these are well defined for the genuine vu meter by American Standard ASA C16.5-1954 and for the British type ppm by British Standard 4297:1968. While there are a number of alternative standard ppms of other nationalities, there is only one vu meter standard and any meter which does not conform is not a vu meter—there are all too many meters labelled 'vu' which are nothing like standard vu meters.

In addition to the 'standard' meters we are reviewing a number of light type meters; these are generally aimed to have the same rectifier characteristics and effective ballistics as the standard vu or ppm, but are not standard meters as such. However, in multichannel situations it is virtually impossible to observe, say, 24 meters simultaneously, and it is my opinion that the light type meter affords far better readability in these situations. This is particularly true of overload conditions when the light type meter usually changes its display colour to red—this immediately attracts the eye and gives warning of overload.

Many electronic systems and electro-mechanical transducers do not of course have equal signal handling capabilities at all audio frequencies, so simple indications of signal level do not provide adequate information: this is particularly true of disc cutting and tape duplication for domestic systems. It is here that some type of spectrum analyser is required, such that the signal level in discrete frequency bands can be observed and suitable equalisation used to limit the signal amplitude and thus avoid system overload.

A large variety of 'real time' spectrum analysers are on the market with something like a 10:1 price range. Some display the instantaneous peak levels and are thus suitable for 'live' audio signals, while others have a long averaging time and are only suitable for steady state signals such as occur during equipment testing or when equalising rooms.

Level meters are essential in all studios, and while a spectrum analyser would always be a useful facility, it is also essential in tape duplicating and disc cutting.

Hugh Ford

Surrey Electronics Peak Programme Meter

MANUFACTURERS SPECIFICATION

Input: floating. Either leg may be grounded to unbalance.

Input impedance: 90k floating; 45k unbalanced.

Input sensitivity for reading mark 4: 0 dB, -20 dB, -40 dB (V.775) strappable.

Scale law: 4 dB increments between marks from 1 to 7.

Calibration Accuracy:

Scale Mark	Input Level dB (V.775)
1	-12 ± 0.5
2	-8 ± 0.2
3	-4 ± 0.3
Burst Duration	Reading relative to Mark 6
100 ms	0 ± 0.5 dB
4	0 ± 0.2
5	+4 ± 0.3
6	+8 ± 0.2
7	+12 ± 0.5

Frequency Response at any mark:

40 Hz to 20 kHz	0 ± 0.3 dB
10 Hz	-2 ± 0.3 dB
5 Hz	-6 ± 0.5 dB

Rise Time: the response to isolated bursts of 5 kHz tone whose steady amplitude results in a deflection to Mark 6 is as follows:

10 ms	-2.5 ± 0.5 dB
5 ms	-4.0 ± 0.75 dB
1.5 ms	-9.0 ± 1.0 dB

The 10 ms tone burst gives a deflection which is normally 80% below its steady state reading. This width of tone burst is the integration time of the instrument.

Fall back time: the rate of fall back is 8.7 dB/s. The time taken for the pointer to fall from Mark 7 to Mark

1 is between 2.5 and 3s.

Price: £71.70.

Manufacturer: Surrey Electronics, The Forge, Lucks Green, Cranleigh, Surrey.

THE SURREY Electronics peak programme meter is designed to meet the British Standard (BS 4297) requirements for peak programme meters which is based on the original BBC requirements. In addition the Surrey Electronics unit has an extended high frequency response up to 20 kHz which is an improvement upon the British Standard requirements which do not specify limits above 15 kHz.

An Ernest Turner peak programme meter movement is embodied in the unit, and this in itself is designed specifically to meet the standard requirements which specify the scale layout in some detail and also the size of the scale, its markings and the pointer.

The drive circuits are mounted on a small glass fibre printed board which has the same dimensions as the meter surround (102 mm x 79 mm) and which mounts directly on to the meter's terminals. Both the signal input and the 24V dc power supply may be either connected to pins on the board or may be connected by means of an edge connector at one side of the board. Alternatively the board may of course be located remote from the meter movement. The board is cleanly laid out with

high quality components including seven integrated circuits and four pre-set potentiometers, three of which are multi-turn types. These controls serve the purpose of setting the meter law and also adjusting meter zero and fine adjusting the overall gain.

As normally supplied the meter mark 4 corresponds to an input of 0.775V rms sine-wave, but the gain may be increased by 20 dB

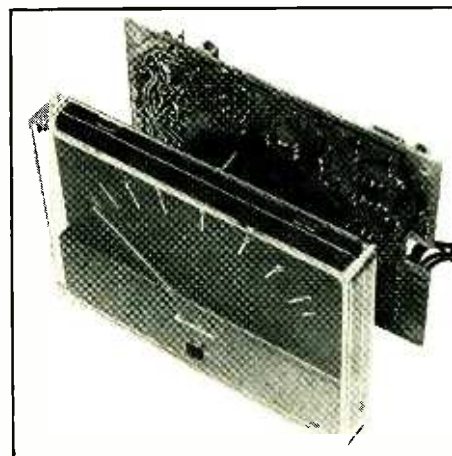

FIG.1 SURREY ELECTRONICS PPM FREQUENCY RESPONSE

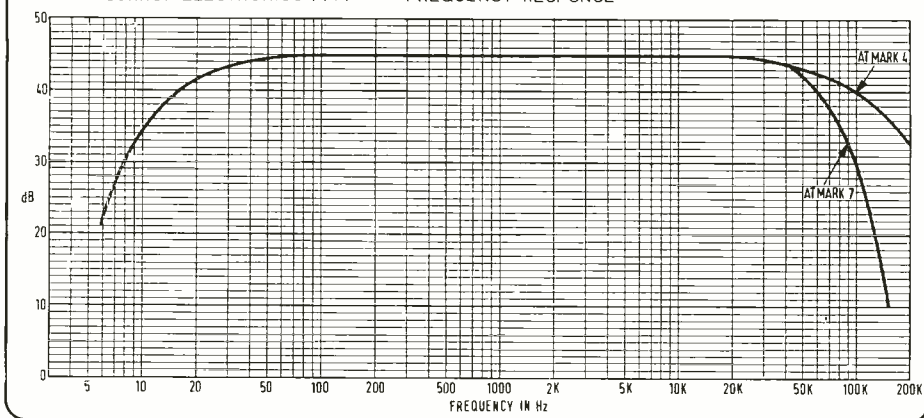
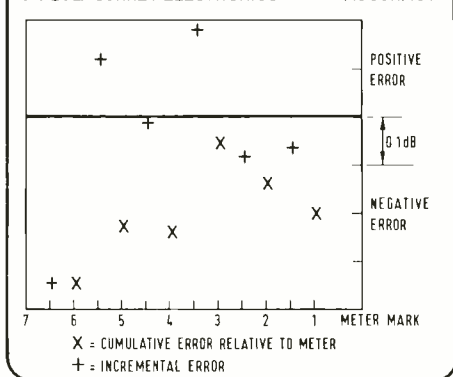

FIG.2 SURREY ELECTRONICS PPM ACCURACY



gain available a fine gain adjustment is provided. This gave an available gain adjustment of +1.2 dB to -0.5 dB about the nominal 0.775V = mark 4 condition.

Fig. 2 shows the scale linearity for each scale mark on the meter at 1 kHz working down from scale mark 7 which is taken as the zero point. In the figure '+' represents the error between adjacent scale marks and 'x' represents the cumulative error relative to scale mark 7. It is to be seen that the meter is well within the standard requirements at all scale points.

Dynamic performance of the instrument was checked by the normal method of using bursts of 5 kHz tone of varying lengths with the following results:

Burst Duration	Indication	British Standard
Steady state	Mark 6	Mark 6
100 ms	+0.5 dB	0 ± 0.5 dB
10 ms	-2.0 dB	-2.5 ± 0.5 dB
5 ms	-4.5 dB	-4.0 ± 0.75 dB
1.5 ms	-10 dB	-9.0 ± 1.0 dB

The above figures show that the instrument is just within specification, but checking the fall time from meter mark 7 showed that it was well within specification at 2.74s against the specification of between 2.5 and 3.2s. Any errors introduced by asymmetrical waveforms were negligible and the response to very short pulses and also the overload characteristic were well within the British Standard requirements.

A final point is that the instrument appeared to be generally insensitive to power supply voltage variations even up to ±20%, about the nominal 24V dc at which voltage the supply current was found to be constant at 37 mA.

Summary

The Surrey Electronics peak programme meter unit was found to be within the requirements of British Standard 4297 and to exceed the standard so far as frequency response was concerned. The unit takes a very convenient form in that it is the same size as, and mounts on the back of, the moving coil meter. This means that there is no need to provide a housing for the meter drive circuits; all that is required is the signal feed and a 24V dc power supply.

or by 40 dB by means of links on the printed board. A further facility is to be able to wire a second meter in series, and also to be able to fit a few extra components to obtain the standard 'slugged' meter response time.

The signal input to the meter is electronically balanced with full protection against excessive input voltages, the input sensitivity 'as found' being within 0.05 dB of the nominal 0.775V rms for a meter indication of mark 4 at 1 kHz. The input impedance at 1592 Hz was found to be 71 000 ohms in the unbalanced mode when using the 'hot' input, or 46 700 ohms when using the other input in the unbalanced mode. In the balanced mode the input impedance was found to be 93 800 ohms with a common mode rejection of at least 45 dB at 1 kHz. Clearly these input impedances are completely suitable for all normal applications and the use of an electronically balanced input in lieu of a transformer input is a clear advantage from the point of view of low frequency loading of lines.

The frequency response at scale marks 4 and 7 is shown in fig. 1 from which it is to be seen that, at both scale marks, the response is well within standard requirements and is extremely flat up to 20 kHz. This response curve was plotted at the 0.775V = mark 4 meter sensitivity and will also be correct at the 20 dB increased gain, but some loss of high frequency performance is to be expected where the 40 dB available gain increase is used.

Other than the two 20 dB steps of inbuilt

STATE-OF-THE-ART DUNLAP CLARKE Dreadnaught 1000 and 500 audio power amplifiers

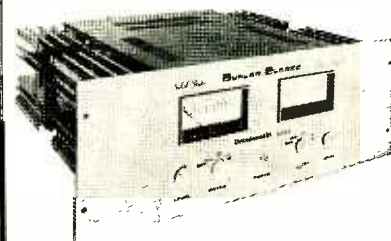

Model 1000 specifications

continuous power output per channel with both channels driven into 8 ohms across 20 to 20,000 Hz at less than 0.25% T.H.D.	250 watts
continuous power output per channel with both channels driven into 4 ohms across 20 to 20,000 Hz at less than 0.25% T.H.D.	500 watts
continuous power across 2 ohms	800-1000 watts
T.H.D. from 0.1 watt to 250 watts per channel with both channels driven into 8 ohms across 20 to 20,000 Hz	0.25% maximum 0.025% typical
intermodulation distortion at 60 and 7,000 Hz mixed 4:1 at any power from 0.01 watt to 250 watts into 8 ohms	0.1% maximum 0.025% typical
frequency response at 250 watts per channel	20 to 20,000 Hz, ±0.5 dB, -0 dB
frequency response at 1 watt per channel	20 to 20,000 Hz, ±0.05 dB
slew rate	greater than 25 V/μs
signal to noise ratio	100 dB minimum
load impedance	2 ohms or greater
input impedance	100 k ohms
input sensitivity	1.75 volts RMS for full output
power line requirements	120 V AC, 60 Hz + 240 V AC 50 Hz
temperature rise at full power fan on low (silent) speed	less than 40°C
dimensions, amplifier only	19"W x 7"H x 12"D
net weight, amplifier only	85 pounds

Model 500 specifications (identical to Model 1000 except for the following):

continuous power output per channel into 8 ohms	150 watts
continuous power output per channel into 4 ohms	300 watts
input sensitivity	1.2 volts RMS for full output
temperature rise at full power	60°C maximum
net weight, amplifier only	60 pounds

front panel features

- power on/off switch, lighted push-button
- professional quality meters with true VU characteristics
- five position meter switch indicates following power levels at 100% or 0 VU
 - 0 full power
 - 3 half power
 - 10 one-tenth power
 - 20 one-hundredth power
 - Off meter out of circuit
- individual channel level controls to balance unequal drive from preamp and prevent amplifier overload

exposure electronics

STATE-OF-THE-ART AUDIO ENGINEERS
DEDICATED TO PERFECTION
Richardson Road, Hove, Sussex

Harrison Electronic Bar Display Meter

MANUFACTURER'S SPECIFICATION

As such no specification was available at the time of writing, but the following is extracted from manufacturer's publicity information and from inspection of the sample meter.

Display format: twelve leds with wide angle lenses in vertical array, each forming a rectangular illuminated box.

Level indication: top four leds coloured red to indicate 0 vu, +1, +2 and +3 vu as per vu meter scale. Lower eight leds coloured yellow as per vu meter scale and associated with calibration marks at -1, -2, -3, -5, -7, -10 and -20 vu.

Effective ballistics: as per standard vu meter to ASA specifications.

Peak detector: the complete display bar will flash on for 50 ms when a pre-set peak level is exceeded, with red sectors at double normal intensity.

Peak level range: adjustable from +4 dBm to +24 dBm input.

Zero vu accuracy: the transition from the top yellow indicator to the bottom red indicator (0 vu) occurs at +4 dBm input, ± 0.1 dB.

Display dimensions: individual segments 15 mm wide by 7.6 mm high forming a bar indication 15 mm wide by 91 mm high.

Overall dimensions: panel area 43 mm wide by 127 mm high. Depth behind panel 119 mm excluding printed circuit board connector.

Power requirements: twin rails at +15V and -15V dc.

Price: £108.00. \$169.00.

Manufacturer: Harrison Systems, PO Box 22964, Nashville, Tenn 37202, USA.

UK: Scenic Sounds Equipment, 27-31 Bryanston Street, London W1.

disappearance of the display at -20 vu was somehow different to the moving coil vu meter failing to move.

The peak overload function of illuminating the complete bar display with the red sector at twice normal brilliance was extremely easy to see, and while, at first sight, the display time of only 50 ms was thought to be rather short, there was no problem whatsoever in observing the display of this duration.

Measurement results

So far as the ASA standard for vu meters is concerned, only a small part of this standard can relate to light type displays as they are step type displays without a meter scale as such. In practice the Harrison display had the same calibration marking as the standard vu meter with the first red indicator being illuminated at +4.1 dBm (internally adjustable over the range +4.5 to -3.14 dBm), which complies with the sensitivity of the standard vu meter. The input impedance was however 10 000 ohms in comparison with the 7800 ohms of the standard vu meter when correctly operated in series with a 3900 ohm resistor.

The frequency response was checked at indications of +3 vu and -5 vu with similar results, the overall response being shown in Fig. 1 which shows that the response is flat from above 20 kHz down to 6 Hz at which point the reading became unstable as it does with the standard vu meter.

Relative to the illumination of the zero vu led, the other leds in the Harrison meter became just illuminated at the following levels: +2.6, +1.8, +0.95, -0.95, -2.14, -3.55, -5.07, -6.93, -9.66, -13.32 and -19.98 vu, this spacing corresponding reasonably to the meter scale.

Checking the rectifier characteristic showed that the correct average rectifier law was incorporated and that any reversibility error was insignificant, furthermore the effective 'ballistics' of the meter were such that the rise time to zero vu was 288 ms and the fall time to zero 250 ms. Both of these are within tolerances for the standard vu meter of 300 ms $\pm 10\%$ for the rise time and 'a similar fall time'. However, as is only reasonably expected, the Harrison meter did not have any overshoot as is required of the moving coil instrument.

Initially, some difficulty was experienced in making the peak detection facility work at all. Eventually it was discovered that a diode had been inserted the wrong way round and, once this error had been rectified (pun not intended)

58 ▶

THE HARRISON bar display meter is intended to be a direct replacement for the normal vu meter for consoles and other applications with the added advantage of a peak level detector which may be pre-set to any desired level to indicate a peak overload condition. This added facility is of course particularly valuable for indicating tape overload, as the normal vu meter can be very deceptive so far as peak levels are concerned and it is often the tape which overloads before the electronics.

A black panel forms the front panel of the meter, with a scaling in red vertical array from zero to +3 vu and in white below zero to -20 vu with the normal vu meter scale points above and below zero vu. In the absence of an adequate input signal no other features are visible on the front panel except a rectangle for inserting the required channel number and the Harrison trade mark.

In the presence of a signal of sufficient amplitude, illuminated rectangles appear to form a vertical bar from the bottom of the panel to the top of the panel as the input level is increased from -20 vu. Once zero vu is exceeded red rectangles appear above the previously illuminated yellow rectangles corresponding to the red sector of the standard vu meter scale.

This format is achieved by means of a single plastic light guide which is mounted in front of the 12 led indicators which themselves are mounted directly on to a fibreglass printed circuit board. This board is surprisingly uncrowded with its seven integrated circuits and three transistors, in addition to which there are only two variable controls. All connections to the printed board are by means of a single ten-way printed connector at the rear of the board.

As reviewed the unit came in a small demonstration box which included the required power supplies and also a moving coil vu meter, but the bar display itself is easily mounted, either by securing it by its front panel with two small bolts, or by arranging a couple of card guides and a suitable pcb connector.

In practical use it was found that the display brilliance was completely adequate in even bright room lighting and the entry of the display into the red sector was quite eye catching—far easier to observe than the entry

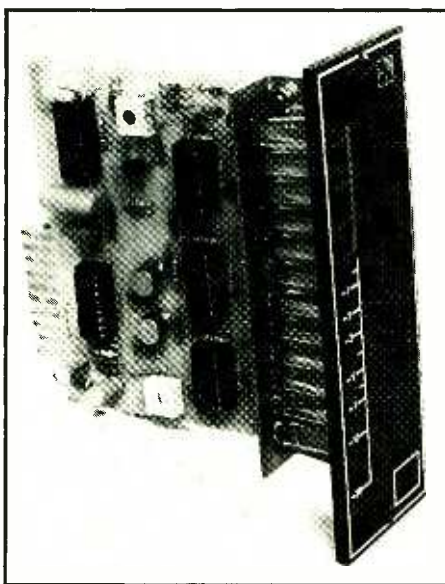

of a normal vu meter into the 'danger zone'. This is of course a great advantage when one has to observe a multitude of meters when it is quite impossible to keep a proper lookout on, say, 24 meters simultaneously!

From subjective observations the effective 'ballistics' of the display had a close relation to the moving coil vu meter, but the complete

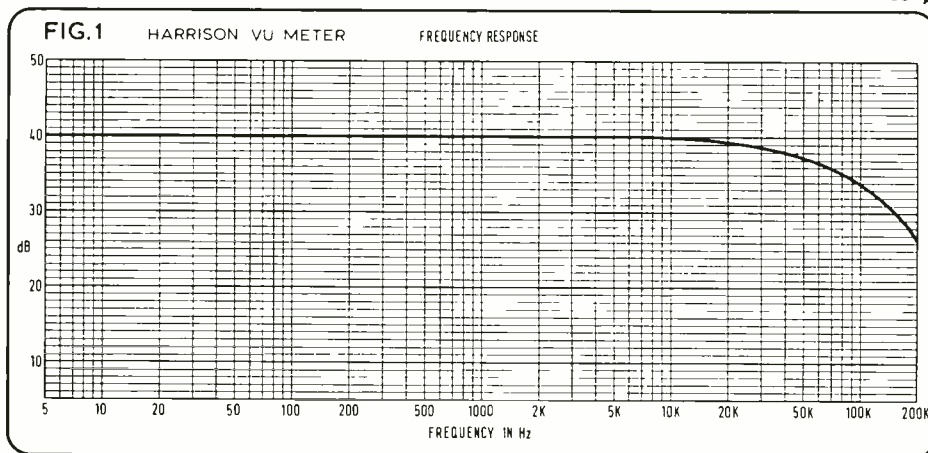

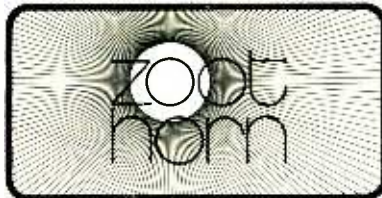

PMR Series 2 studio and portable mixing consoles



Input channel features:—

Switched input gain (triple-ganged)
 H.F. 3 turnover frequencies $\pm 15\text{dB}$
 Sweep equaliser 1, 30 Hz — 15 KHz $\pm 15\text{dB}$
 Sweep equaliser 2, 30Hz — 15KHz $\pm 15\text{dB}$
 L.F. 3 turnover frequencies $\pm 15\text{dB}$
 High and Low pass filters 12dB/Octave

Other Features Include:—

- 1, 2, 4 or 8 track routing.
- Illuminated v.u. (or P.P.M.) per channel.
- Modular construction.

Module Options

- Sub-Mix module.
- Compressor/Limiter.
- Auxiliary send and return
- P.F.L./Talkback/Stereo Monitor
- Output module with stereo monitor
- Foldback master module with 3 band E.Q.
- Stereo Disc and Tape inputs with continuously variable high and low pass filters.

Overall Specification of System

Output Clip Point + 28dBm balanced + 22dBm unbalanced
 Noise:— For -50dBm input, + 4dBm output -75dBm.
 Frequency Response: within $\pm \frac{1}{2}\text{dB}$ 20Hz — 20KHz.
 T.H.D. Typically .01% for + 4dBm output.

ZOOT HORN 31 STATION ROAD LONDON SE25 5AH MANUFACTURERS OF PROFESSIONAL AUDIO SYSTEMS Tel: 01-653 6018/8483

Spendor Loudspeaker Specifications

BCI & BCII

Size 25" x 11 $\frac{1}{4}$ " x 12"

Weight BCI—15 kilos; BCII—17 kilos.

LF Unit Spendor 8" (BCI 1" voice coil plastic cone)
 (BCII 1 $\frac{1}{2}$ " voice coil plastic cone)

HF Units Celestion Type HF 1300 and STC Type 4001G

Crossover Points 3kHz-13kHz

Nominal Impedance 8 ohms

Frequency Range 45Hz-25kHz

Frequency Response +3dB, 60Hz-14kHz

Power Rating BCI 40 watts peak programme.
 BCII 50 watts peak programme.

Sensitivity BCI 0dB; BCII +1dB
 relative to 1 dyne/cm²/volt applied

Max Sound Pressure Level BCI 101dB; BCII 103dB

Input Connection Terminals

BCIII

Size 31 $\frac{1}{2}$ " x 15 $\frac{1}{2}$ " x 15 $\frac{1}{2}$ "

Weight 34 kilos

LF Unit Spendor 12" (plastic cone)

MF Unit Spendor 8" (1 $\frac{1}{2}$ " voice coil, plastic cone)

HF Units Celestion Type HF 1300 and Type HF 2000

Crossover Points 700Hz-3kHz — 13kHz

Nominal Impedance 8 ohms

Frequency Range 30Hz-20kHz

Frequency Response $\pm 2\frac{1}{2}\text{dB}$, 50Hz-14kHz

Power Rating 70 watts peak programme

Sensitivity +2 $\frac{1}{2}\text{dB}$ relative to 1 dyne/cm²/volt applied

Max Sound Pressure Level 105dB

Input Connection "XLR" 3-pin

These loudspeakers are also available to the professional market with built-in amplifiers rated at 25 watts and 50 watts, designated BCIA, BCIIA, BCIIIA.

Spendor Audio Systems Limited, Station Road Industrial Estate, Hailsham, Sussex

Stravinsky made us do it.



Stravinsky . . . and every composer who has ever written music with the range, power and majesty of "Rites of Spring" . . . music that demands far more than any stereo can deliver without adequate amplifier power.

The Phase Linear 700B Power Amplifier faithfully reproduces the most difficult passages of the most demanding recorded music. It lets *all* of the music through at realistic volume levels. You never have to reach for your volume or tone controls to prevent clipping.

The 700B has the highest power, widest frequency response and lowest distortion of any stereo amplifier in the world. Take Stravinsky to your dealer and listen to what we mean.



Phase Linear 700-B

THE POWERFUL DIFFERENCE

Please send me literature on Phase Linear products SSI

Name _____

Address _____

Distributed by: C.E. Hammond & Co. Ltd,
111 Chertsey Road, Byfleet, Surrey KT14 7LA
Telephone: Byfleet 41131 Telex: 262525

HARRISON ELECTRONIC BAR DISPLAY METER

all was well. The level at which the peak facility illuminates the complete bar display is controlled by an external dc voltage in the range 0 to +5V corresponding to peak detection at between +4 dBm (0 vu) and +24 dBm. It was found that the detection time was extremely small and that the meter had no trouble in detecting a single cycle of 20 kHz sine wave; this is therefore a very valuable facility not only for working with tape but also for avoiding overloading radio transmitters etc . . .

The final aspect investigated was the power requirement from the $\pm 15V$ dc lines which was found to be surprisingly low, (see table next column).

Large variations in the power supplies did

	+15V	-15V
All indicators on peak detect	70 mA	33 mA
All indicators on in normal	50 mA	31 mA
No indicators on	12.5 mA	13.6 mA

affect the calibration, but up to $\pm 10\%$ variations had no real significant effect when the unit is used as a vu meter.

Summary

The Harrison meter is a valuable tool which in some ways is easier to observe than a normal vu meter, this being particularly so when one considers overload indication. From the points of view of meeting the vu meter standards, the Harrison meter does all that should be expected from a light indicating meter.

In addition to these benefits, the extremely fast peak threshold indication is a really valuable tool for avoiding overload of any part of an audio system. ■

A & R Studio Ledmeter System PLM 14

MANUFACTURER'S SPECIFICATION

Indicated range: a vertical scale from +8 to -30 dB in steps as follows: +8, +6, +4, +2 (red leds), 0, -2, -4, -6, -8, -10, -15, -20, -25, -30 (green leds). The indicators are selected 7-1 size light-emitting diodes on a spacing of 5 mm.

Accuracy: +8 to -10 dB: within ± 0.2 dB of reading
-15 and -20 dB: within ± 0.3 dB of reading.
-25 and -30 dB: within ± 0.5 dB of reading.

Frequency range: within ± 0.5 dB 20 Hz to 20 kHz. (± 0.25 dB typical) for any indicated level above -15 dB.

Attack/decay: switchable to either ppm or vu mode via a push button on the front panel. With a sine wave drive, the same meter reading is retained when switching between modes (± 0.2 dB).

ppm mode: to BS 4297 (1968) over ppm range of meter (+8 to -20 dB).

vu mode: attack and decay to Bell vu characteristics.

Input: electronically balanced; may be unbalanced by grounding 'cold' terminal. Max. sensitivity for 0 dB reading 500 mV (-4 dBm). Min. sensitivity for 0 dB reading 5V (+16 dBm). The sensitivity is continuously adjustable between the above limits via a 10 turn preset accessible through the front panel. Input impedance: substantially resistive and between 18k ohm and 30k ohm (dependent on sensitivity).

Lamp brightness: continuously variable by remote control or may be preset on card if required.

Operating temperature range: 0-60°C ambient. Drift over this temperature range ± 0.1 dB for all levels, +8 dB to -20 dB. Pro rata below -20 dB.

Power requirements: +24V, stabilised, at 65-100 mA (dependent on brightness setting). Card contacts via 8 pin gold plated edge connector.

Module size: overall, including front panel: 24 mm wide, 126 mm high, 98 mm deep.

Case/power supply for multichannel ledmeter: The standard case will accept up to 16 of the PLM14 modules, plus one power supply card (normally supplied with case). Blank front panel modules are available so that the meters may be grouped into sets eg for stereo or quad. The unit is self powered from 120 or 240V ac mains (50-60 Hz) with a max power requirement of 50W. The max system ambient temperature is 45°C.

Prices: PLM14 single card assembly including front panel, 1 to 4 £40; 5 up £36. Case and power supply with barrier strip connectors £74 (when supplied with at least four PLM14).

Manufacturer: A & R, French's Mill, French's Road, Cambridge.

UK agent: Triad, Shepperton Studios, Shepperton, Middlesex.

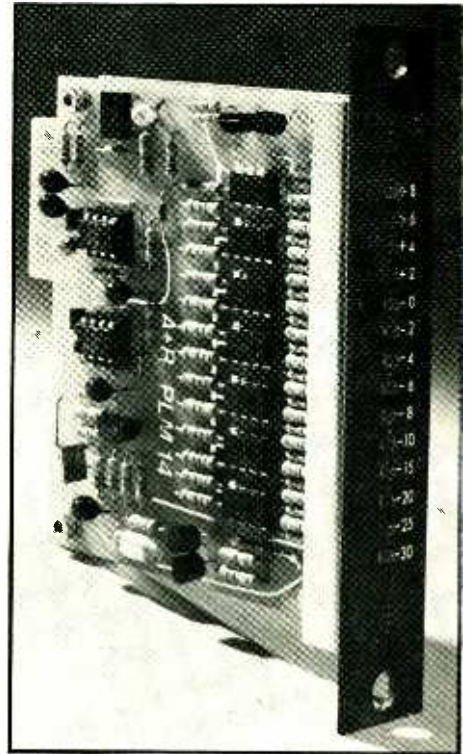

THIS LIGHT emitting diode level display comprises small vertical modules which mount into a main frame to form an extremely compact multi-channel display. With such a small display area it is possible to assimilate information from all channels in a single glance, unlike the task of watching a host of conventional meters which are either spread over a large area, or are too small to read.

In addition, the use of green led indicators for normal levels and red indicators for excessive levels gives instant warning of overload conditions. The red indicators are set to come on at +2, +4, +6 and +8 dB above the zero level with green indicators at 2 dB steps below zero to -10 dB and then 5 dB steps to -30 dB, thus providing a 38 dB range of readability.

EVERYTHING REVOX A77

AUTO RECYCLE
VARIPITCH
BALANCED IN AND OUT
FULL TRACK HEADS
ENDLESS LOOP (A77)
HIGH SPEED PHOTOCELL TAPE
READER
PROGRAMMABLE TRANSPORT
CONTROLLER
AUTOMATIC/MANUAL TRACK
SELECTOR
VH S77 15/30 IPS
LOGGER 15/16 IPS
VARIABLE SPEED (50%) (A77)
VARIABLE SPEED (100%) (A77)
IN-SYNC
SERVICE MANUALS
REMOTE CONTROLS.

**BARGAIN PRICED
REVOX'S ALWAYS
AVAILABLE-**

*for example the A77 1102's
virtually as new £325*

CALL **PRO
MIDLAND SOUND**
PLUS-PRO-SERVICE!

MIDLAND SOUND LTD., 57 Albert Street,
Rugby, Warwickshire. Tel. Rugby 71419.

I am interested in a rebuilt Revox
Model No.

I am interested in the following special
Revox Mod.

Name

Address

SS2

FIG. 1
A + R METER
ERRORS IN INDICATION

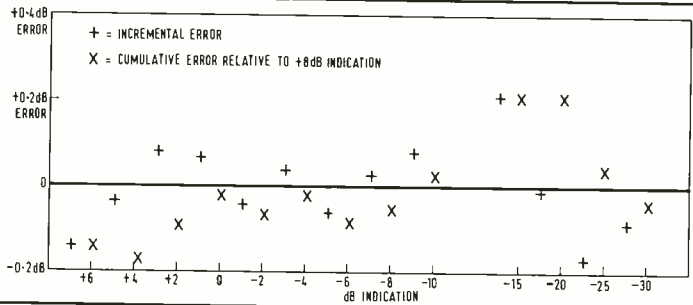
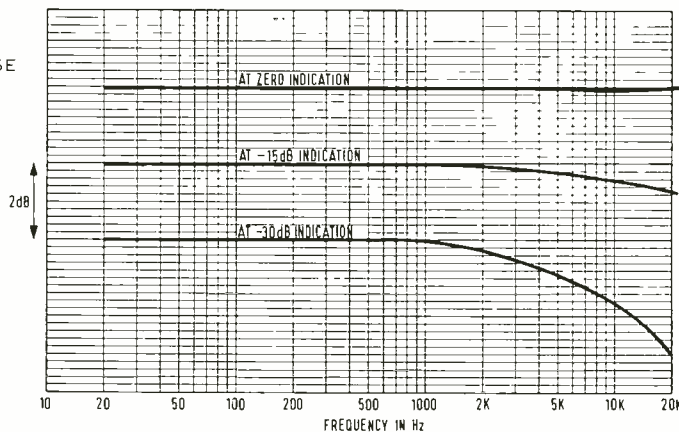

FIG. 2
A + R PPM METER
FREQUENCY RESPONSE



The review sample was unfortunately a prototype unit; the specification relates to production units which will have certain known differences. These will be mentioned in the review. The mainframe contains power supplies for 16 PLM14 indicator modules which are plugged into printed circuit connectors in the mainframe. In addition, there is a power supply board housing a power indicator, and also a brightness control which affects the brightness of the complete display. The display brightness could be controlled over a large range, and it was found that all the individual led indicators had even brilliance. In the production unit, each module will also house the ppm vu meter characteristic changeover switch, the review sample having only the ppm time constants.

At the rear of the mainframe there is an illuminated power on/off switch and a 20 mm power fuse in addition to a fuse on the power supply module. Neither of these were identified with fuse ratings (this may be only a prototype problem). The input and output connections are also at the rear of the mainframe in the form of barrier strips, which, in the prototype, the connections are duplicated on McMurdo sockets. The power transformer is a toroidal type mounted on the back panel, with the rectifier and smoothing capacitor being mounted internally.

Generally the standard of construction was neat and tidy with clean layouts on fibreglass printed boards which are to be screen printed with component identifications. Unlike the production units, the prototype had an unbalanced input which was variable over the range 0.49 to 6.28V at 1 kHz for zero indication. The input impedance varied between 25 500 ohms in parallel with 34 pF at minimum gain to 19 800 ohms in parallel with 100 pF at maximum gain.

The accuracy of the level steps relative to +8 dB indication is shown in **fig 1** which plots both the incremental and the cumulative errors which are substantially less than 0.18 dB down to -10 dB indication, and level down to -30 dB indication less than ± 0.21 dB—a really excellent performance!

Fig 2 shows the frequency response at 0 dB, -15 dB and -30 dB indications and demonstrates that the specification is met, but the errors increase at high frequencies and low levels; but not to a serious extent.

Investigations into the 'dynamic' performance as a peak programme meter in terms of British Standard 4297:1968 so far as it applies to light indicating instruments revealed that the rise time was very close to standard as follows:

5 kHz tone burst duration	Indication below zero	
	measured	standard
100 ms	0	0 \pm 0.5 dB
10 ms	-2.2 dB	-2.5 dB \pm 0.5 dB
5 ms	-4.0 dB	-4 dB \pm 0.75 dB
1.5 ms	-8 dB	-9 dB \pm 1.0 dB

The fall time from zero indication to -25dB was found to be 3.6s which is on the long side; however, it is understood that the manufacturer will be using closer tolerance capacitors in the metering circuit in production. Finally, the unit was checked with asymmetrical waveforms and found to completely lack asymmetry errors.

Summary

Judging by this prototype unit the A & R peak programme meter looks very promising as a light emitting diode meter which indicates in accordance with the British Standard peak programme meter.

Ernest Turner VU Meter 642

MANUFACTURER'S SPECIFICATION

Type of rectifier: the meter shall employ a full wave rectifier.

Dynamic characteristics: if a 1000 Hz voltage, such as to give a steady reading of 100 on the voltage scale, is suddenly applied, the pointer should reach 99 in 0.3s, and should then overswing the 100 point by at least 1% and not more than 1.5%.

Frequency response: the sensitivity of the instrument shall not depart from that at 1000 Hz by more than 0.2 dB between 35 Hz and 1000 Hz, or more than 0.5 dB between 25 Hz and 16000 Hz.

Impedance: the impedance of the instrument shall be 3900 ohms when measured with a sinusoidal voltage deflecting the pointer to the 100 mark on the scale.

Sensitivity: the application of a potential of 1.228V rms at 1000 Hz (4 dB above 1 mW in 600 ohms) to the instrument in series with an external resistance of 3600 ohms (making a total resistance of 7500 ohms) shall give a deflection of between 71% and 80% of full scale.

Overload: the instrument shall be capable of withstanding, without injury or effect on calibration, peaks of ten times the voltage equivalent to a deflection to the 100 mark for $\frac{1}{2}$ second, and a continuous overload of five times the same voltage.

Mounting: it is necessary to state whether the instrument is to be used on a ferrous or non-ferrous panel and to give the thickness of the panel so that the instrument can be calibrated to read correctly when so used.

Price: £16.85 for five or more units.

Manufacturer: Ernest Turner Electrical Instruments Ltd, High Wycombe, Bucks.

US: Crompton Instruments Inc, 2763 Higgins Road, Elk Grove Village, Chicago, Illinois 60007.

THE vu meter being reviewed is but one of a series of vu meters which are manufactured by Ernest Turner, including waterproof instruments and a number of case styles and sizes. Also both standard scale printings are available, ie large lettered vu's and small 0 to 100, or vice versa.

As is standard, the instrument was supplied with the required 3600 ohm series resistor which was within tolerance at 3609 ohms; however, the impedance of the instrument itself was measured as 3450 ohms at 1 kHz at 0 vu, which is 5% below the nominal value.

The instrument's scale was to the accepted standard so far as layout was concerned, but the scale background colour was white as opposed to the original specification of a cream colour (*munsell 2.93Y (9.18/4.61)*). Also in

non-compliance with the original specification, the scale bore the legend '0 vu = 1.228V = 7500Ω at 1000 ω where no markings are permitted on the scale other than those associated with the scale itself.

Calibration accuracy of the scale was excellent with less than 0.1 dB error in reading between +3 vu and -5 vu below which the accuracy of reading deteriorates due to the standard cramping of the scale. The measured results were an actual -6.81 vu at -7 vu, -9.77 vu at -10 vu and -19.52 vu at an indication of -20 vu.

It was confirmed that the instrument's rectifier was of the correct average characteristic and that it was of the full wave type

without asymmetry errors. The instrument's rise time was found to be exactly to standard at 300 ms, and the fall time at 270 ms was close to the recommended time.

Finally the instrument was subjected to an intermittent overload of ten times zero vu indication and also to a continuous overload of five times zero vu indication without any ill effects.

Summary

So far as the ballistics and electrical performance are concerned, this meter was a genuine vu meter to the US Standard *C16.5-1954*, the only deviation from standard being the scale background colour.

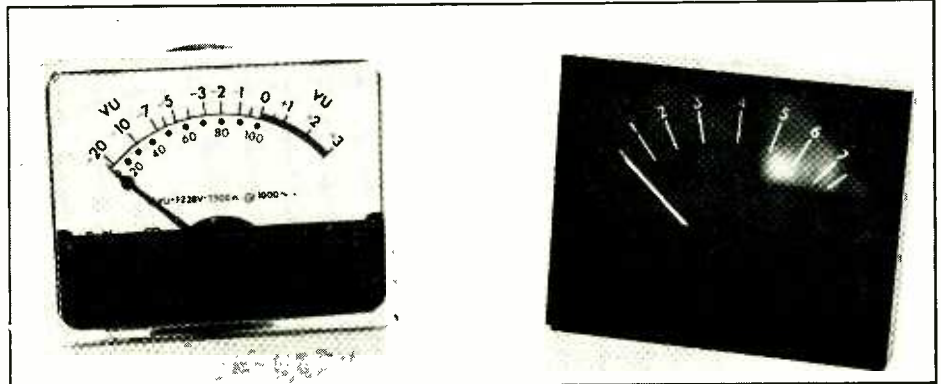

Peak Programme Meter 902

MANUFACTURER'S SPECIFICATION

The meter movement is to BBC Specification ED 1477.

Zero: left hand.

Scaled: 7 Radial lines.

Resistance: 600 ohms $\pm 5\%$.

Full scale deflection: 1 mA.

Price: £13.80.

THE review instrument is but one of a large variety of sizes and styles of peak programme meter movements, including twin movement instruments, which are available from Ernest Turner.

While the manufacturer quotes BBC specifications, these are the basis of British Standard *4297:1968* 'Specification for the characteristics and performance of a peak programme meter', which covers not only the performance of the movement, but also of the complete instrument.

The scaling of the review instrument was in accordance with the standard, but this particular movement which has a specified pointer length and scale radius. The accuracy of the scale marking was as follows for marks 1 through 7:

scale mark	actual % full scale current	standard % full scale current
Full scale	100%	100%
7	93.3%	93%
6	80.3%	80%
5	67.0%	67%
4	51.3%	51%
3	34.8%	35%
2	21.9%	22%
1	9.7%	10%

The above figures are well within the allowable error of $\pm 1\%$ and the full scale sensitivity was found to be precisely 1 mA with the internal resistance measuring 603.96 ohms, which is within the specified 600 ohms $\pm 5\%$.

Both the movement damping and the speed were checked to BS 4297 with the result that the overshoot was found to be 3%, which is within the permitted 5%, and the damping was as follows:

dc pulse duration	peak reading relative to mark 7	
	measured	standard
80 ms	-4 dB	-3.5 dB ± 1 dB
20 ms	-19 dB	-19 dB ± 1 dB

Summary

The performance of the review sample was well within the specification so far as all measured parameters were concerned, and whilst this particular sample was not to the standard dimensions other models are of course available which meet this requirement when it is needed.

F M BROADCASTERS

PEAK DEVIATION METER

A RACK MOUNTING UNIT FOR OFF-AIR MONITORING OF MONO OR STEREO STATIONS DURING PROGRAMME

It consists of: an illuminated meter, with deviation calibrated in KHz, percent and decibels switchable ± 20 dB sensitivity for accurate readings of stereo pilot tone level a high impedance probe head which you install in a monitor receiver an fm calibration standard, producing accurate 75KHz deviation with 400Hz and 53KHz modulation for calibration and checking of the instrument

The peak detector has a very fast attack time, so checking on limiter spikes or other transients which could occupy an excessive bandwidth. Meter ballistics are defined and the fall back rate is as a peak programme meter. Without the calibration standard and probe it is also useful for monitoring the level of composite stereo multiplex at transmitters fed from coders or rebroadcast receivers.

SURREY ELECTRONICS

The Forge, Lucks Green, Cranleigh, Surrey GU6 7BG

STD 04866 5997

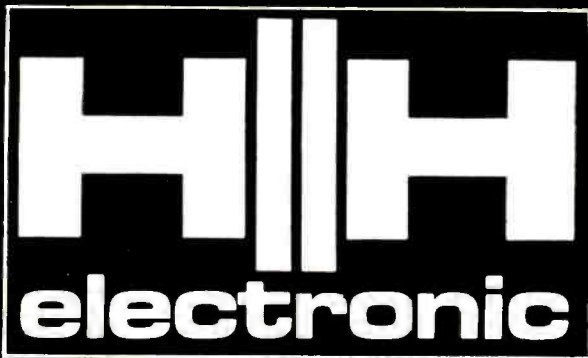

A fantastic new generation of instrument amplifiers – V-S MUSICIAN & V-S BASSAMP

STOP PRESS

A most important communication to musicians who play electric musical instruments.

WHY

H.H. Electronic have developed a totally new generation of instrument amplifiers 10 years ahead of their time, incorporating new controls, new techniques and producing new sounds. The signals from your musical instrument will be transformed into controllable super sounds.

HOW

FIRST. The new instrument amplifiers have the best calibrated tone control system ever built into any amplification – as good as many studio mixers.

SECOND. A new and unique feature called the "Voice" Control has the ability to change the basic sound character of the amplifier.

THIRD. The amplifiers can produce soft creamy valve distortion *at any volume level* not just at full output; alternatively the sound can be as clean as the clearest transistor amplifier. You have the choice and the control!

FOURTH. A truly vast range of sounds! The V.S. Musician can be set to sound like a 5 watt practice amp, a 100 watt valve amp on full steam, a clean and tingly transistor amp or any other amp you may favour.

FIFTH. The Secret. A new unique, protected, patented and fully encapsulated circuit module that will only ever be available on H.H. equipment.

SIXTH. H.H. amplifiers are made to the highest standards in the industry bar none!

Don't take our word for it – call in at your local H.H. dealer and experience the new V.S. Range. Afterwards your amplifier will simply have to be H.H.



H.H. Electronic, Industrial Site, Cambridge Road,
Milton, Cambs Tel. Cambridge 65945.
Please send me details of the V-S range and
other new products.
Name
Address

NTP 177-700B Light Diode Peak Programme Meter



Additional gain: (*1) (*2): 40 dB \pm 0.5 dB.
Noise level ref to input: better than -106 dBu (3.8 μ V).
Total scale length: 148 mm.
Standard scales: +5 to -50 dB DIN
 +5 to -40 dB Linear
 +9 to -36 dB 'Nordic'
 All three types are available for horizontal or vertical mounting.
Number and colour of led's: 9 red and 55 green.
Connector: Tuchel T2700.
Mechanical outline: A1 module (190 x 40 mm by 103 mm deep).

Price: on application.
Manufacturer: NTP Elektronik A/S, Theklavej 44, 2400 Copenhagen, Denmark.

Performance

As received, the sensitivity for zero indication was measured as 1.547V rms at 1 kHz, which is so close to the specified 1.55V that one could not possibly expect better. The linearity of the display measured at 5 dB intervals is shown in fig. 1 together with the manufacturer's specified limits, from which it is to be seen that the sample had errors in the order of one half of the permitted errors.

An additional feature was that the indication at high or low levels gave an identical frequency response as is shown in fig. 2, and corresponding to the published specification which, as is only sensible, gives a high frequency roll off outside the audio band.

Checking the rectifier characteristics showed that it had the correct peak reading characteristic with no readable asymmetry errors, and in fact the complete instrument easily met the requirements of the proposed IEC Publication 268-10 *Programme Level Meters for Sound System Equipment*.

This document quotes integration times identical to those in the specification, and measurement of the performance gave the following results:

Burst length	Indication	Standard requirement
10 ms	-0.5 dB	-1 dB \pm 0.5 dB
5 ms	-2.0 dB	-2 dB \pm 1 dB
3 ms	-3.5 dB	-4 dB \pm 1 dB
0.4 ms	-14 dB	-15 dB \pm 4 dB

In addition, as received, the fall-back time was correct at 1.5s for a fall from 0 to -20 dB, but this time was adjustable over the range 1.2s to 2.6s by means of a pre-set control.

If the fall back blocking feature is used this inhibits the fall back and the indication is held with negligible fall back—clearly this is a very useful feature for disc cutting or tape duplication where it is essential to control peak levels.

The audio input impedance was virtually constant at 19 800 ohms irrespective of frequency, and as was to be anticipated the extra available 20 dB gain was accurate and did not degrade the frequency response.

Summary

This NTP light meter was a pleasure to use, and furthermore it met the important parts of its realistic specification with flying colours. The only matter which came to light was that the power consumption was rather above specification at 158 mA, display on.

MANUFACTURER'S SPECIFICATION

Supply voltage: 24V to 32V dc.

Dynamic Measuring Range (*1): +5 to -50 dB.

Measuring Errors: -10 dB Below -10 dB

1 kHz steady signal, 25°C \pm 0.5 dB \pm 1 dB

Within full freq range, 25°C +0.5/ -1 dB +0.5/ -2 dB

Within full temp range 1 kHz \pm 1 dB \pm 2 dB

Polarity shift of Unsymm Wave 0.5 dB 1 dB

Integration Time: conforming to DIN 45406 and IEC proposal of Sept 1970.

10 ms for -1 dB \pm 0.5 dB

5 ms for -2 dB \pm 1 dB

3 ms for -4 dB \pm 1 dB

0.4 ms for -15 dB \pm 2 dB

Fall-back time: adjustable (*1) 0-20 dB 1.5s.

THE review sample of this type of NTP instrument was the horizontal version of the above variant 3, but with all red leds in the display. The black finish on the front panel carried silver legends; the upper scale was calibrated in percentage from 0.3 to 180% in a logarithmic scale while the lower calibrations was in decibels from -50 dB to $+5$ dB on a linear scale.

There is a small slot between these two scales which widens above the 0 dB or 100% mark. Behind this slot there is an array of 55 leds in the narrow section and a further three rows of nine leds in the wide section, such that the wider section which represents overload appears much brighter and is larger in area. In practice it was found that this form of meter was extremely easy to observe, and as an additional feature, the display brightness may be remotely controlled over a wide range making the meter satisfactory for use in either bright or dim environment, such as television control rooms.

In brief, the circuit consists of a transformer coupled input followed by audio amplification which includes the optional 20 dB extra gain. This is followed by two operational amplifier rectifiers which in turn are followed by logarithmic converter having two pre-set controls for achieving the proper linearity at half scale and at low level. The output from the converter feeds the time constant circuits the output of which feeds two up/down digital counters which provide a digitally coded signal driving the individual leds in the display via a diode matrix.

FIG.1 NTP LIGHT METER TYPE 177. INDICATION ERRORS WITH RESPECT TO ± 5 dB AT 5 dB INTERVALS

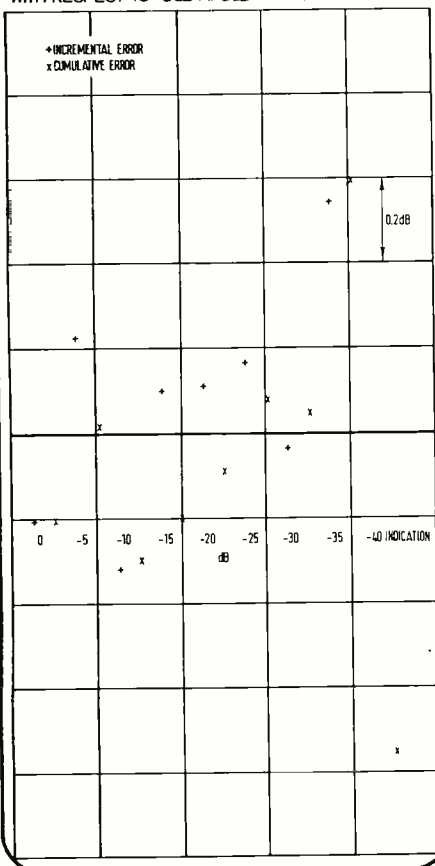
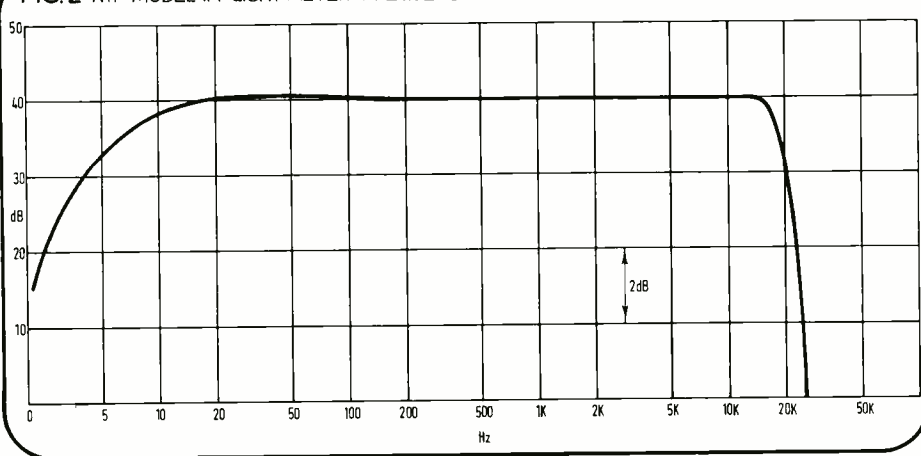

FIG.2 NTP MODEL 177 LIGHT METER - FREQUENCY RESPONSE



NTP BAR GRAPH PEAK PROGRAMME METER 177-800

MANUFACTURER'S SPECIFICATION

Supply voltage: 24V dc $\pm 5\%$ or 30V dc $\pm 5\%$.

Maximum ripple voltage: 0.1V p-p.

Dynamic measuring range: 55 dB.

Measuring errors ± 5 to -10 dB Below -10 dB

1 kHz steady signal, 25°C ± 0.5 dB ± 1 dB

within frequency range, 25°C $+0.5/-1$ dB $+0.5/-2$ dB

within temperature range, 1 kHz ± 1 dB ± 2 dB

Polarity shift of asymmetrical wave 0.5 dB 1 dB

10% change of supply voltage 0.2 dB 0.2 dB

Tracking between channels: 0.5 dB.

Integration time: 10 ms for -1 dB ± 0.5 dB.

5 ms for -2 dB ± 1 dB.

3 ms for -4 dB ± 1 dB.

0.4 ms for -15 dB ± 2 dB.

Conforming to DIN 45406 and IEC proposal of Sept. 1970.

Fall-back time: 1.5s/20 dB adjustable.

Overload indication: an eight times increase of the light intensity.

Scale length: 127mm.

Number of elements per channel: 101.

Colour: neon orange.

Standard Scales: ± 5 to -50 dB DIN.

$+9$ to -36 dB 'Nordic'.

1-7 'BBC' (4-0.775V).

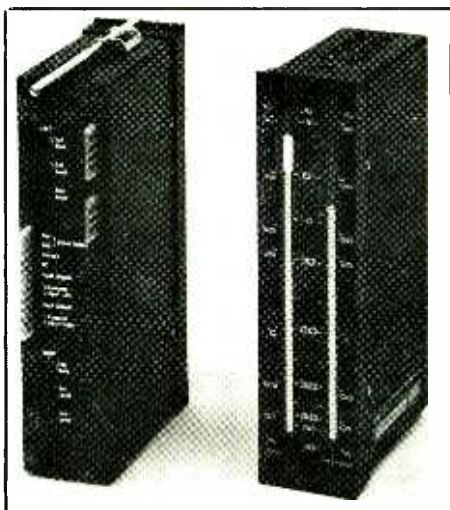

All types are available for horizontal or vertical mounting.

Dimensions: 164 x 40 mm front by 87.5 mm depth.

Colour: black.

Accessories: 10 pole edge connector type CCL-10DV. Spacing: 3.96 mm. Two fasteners for panel mounting.

Notes. Because of the floating supply voltage, no input transformers are needed. 40 dB common-mode rejection is obtained by differential Op-amp technique.

If the Dual-log. Amplifier is removed, the 177-800 can be used as a dc-voltmeter, with a sensitivity of 1V for full scale deflection (10 mV resolution).

Price: on application.

Manufacturer: NTP Elektronik A/S, Theklavej, 44, 2400, Copenhagen, Denmark.

THE NTP type 177-800 is a dual light type bar meter with an unusual display consisting of a ladder of 101 rungs in the form of neon coloured bars. The review sample was the vertical mounting version which consists of two meters in vertical array on the small front panel which is coloured matt black with silver legends; a linear dB scale is situated between the two meters and a percentage scale either side of the meters. The dB scale ranges from $+5$ dB to -50 dB with a red bar printed on the panel above 0 dB and above which point, the display intensity is considerably increased.

Behind the front panel there is a metal case with three printed board connectors emerging at the rear. In fact there is a ten-way connector which is used when the meter is utilised for conventional audio level indicating, and the remaining two connectors fit into the same size socket and are used when the meter is utilised as a dc voltmeter with 1V full scale deflection. Also on the rear panel there is access to six pre-set 270° potentiometers which are the only pre-set controls and serve to set fall back time, reference level and low level linearity for each channel. I would have preferred to see multi-turn controls here, as the adjustment is rather coarse.

Internally there are three good quality printed boards which plug into a mother board. While the individual components are not identified, the instruction book gives good layout diagrams and servicing information. The circuit of the meter is rather unusual as not only are the audio inputs electronically balanced, but also the electronics are completely isolated from the dc supplies by a dc/dc

64 ▶

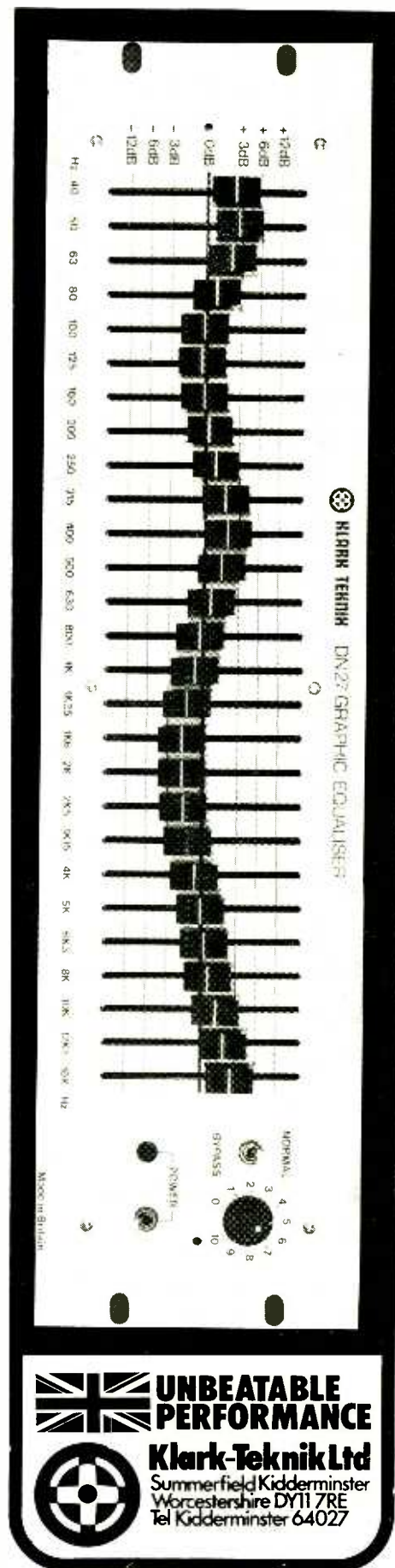
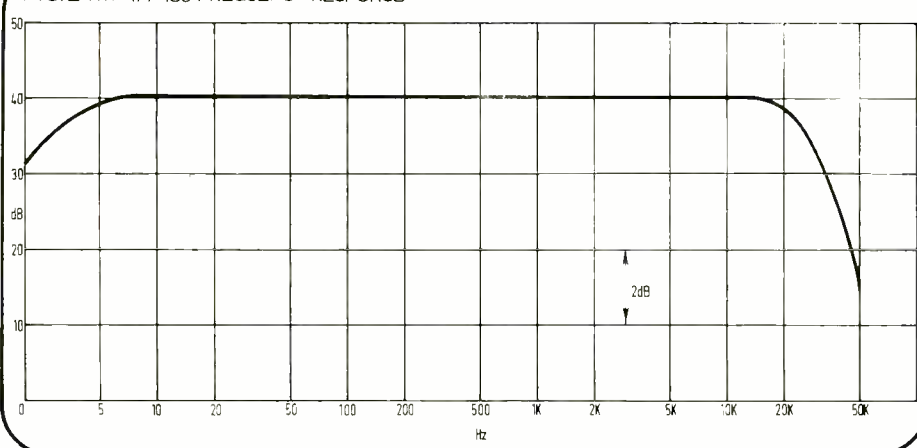

FIG.2 NTP 177-180 FREQUENCY RESPONSE



UNBEATABLE PERFORMANCE
Klark-Teknik Ltd
 Summerfield Kidderminster
 Worcestershire DY11 7RE
 Tel Kidderminster 64027

NTP 177-800

converter which provides an internal $\pm 12V$ for the electronics and also a $+240V$ dc for the display.

In use the display was adequately bright for strong room lighting, but the increased intensity section above 0 dB indication was not as eye-catching as might be desirable. However the large number of display elements was a distinct improvement on almost all led types of bar meter which give a jumpy display as opposed to a car speedometer type thermometer display. Furthermore, as a dual channel meter, the unit was unusually compact and eminently suitable for multi-channel work.

Performance

As received the sensitivity for 0 dB indication was identical on both channels and as near as could be expected to the nominal 1.55V rms sine wave. The linearity of the display was also identical on both channels, and the incremental and cumulative errors in indication with respect to $+5$ dB indication and at 5 dB intervals is shown in fig. 1. It is to be seen that the errors are within specification, but they tend to be biased in one direction. The frequency response was checked at 0 dB and at -20 dB indications on both channels and found to be as near as identical as makes no difference, the overall response being shown in fig. 2 which illustrates a useful high frequency roll-off outside the audio band.

The rectifier characteristics of the instrument were of the peak variety and without asymmetry or polarity problems. The effective ballistics of the instrument met the proposed IEC

standards as is shown in the following table:

As received, the return time to -20 dB was found to be on specification at 1.54 seconds, but this could be adjusted over the range 8.6s to 1.12s if required.

The dc power requirement at 24V was found to be almost constant irrespective of the display status at 190 mA, but it should be noted that the 24V and 30V versions of the instrument are

Burst length	Indication	Standard requirement
10 ms	-1 dB	-1 dB ± 0.5 dB
5 ms	-2.2 dB	-2 dB ± 1 dB
3 ms	-4.0 dB	-4 dB ± 1 dB
0.4 ms	-17.0 dB	-15 dB ± 4 dB

not identical and that a component change is required to change the voltage rating. On the audio end the input impedance was constant with frequency at 20 000 ohms and the common mode rejection was over 60 dB at 1 kHz, falling to 45 dB at 10 kHz.

If it is required to use the meter as a dc voltmeter, the input board is removed and the input connector transferred to the alternative input connectors. The instrument then becomes a very high input impedance (over 20M ohms) voltmeter with a full scale deflection of $1V \pm 500 \mu V$ (as measured). However, in this mode the scaling is linear and the front panel scale is somewhat confusing in spite of the resolution of the display which is 10 mV per 'ladder step'.

Summary

This NTP meter was found to be entirely within its strict specification and to offer a very compact twin channel level display to the proposed IEC standards. It is not a cheap instrument, but where precision is required one has to pay a price. The facility of using the meter as a dc meter is somewhat a 'spin off' in the design, and perhaps NTP could save a little on the cost of the meter if they forgot this facility which is unlikely to be in much demand.

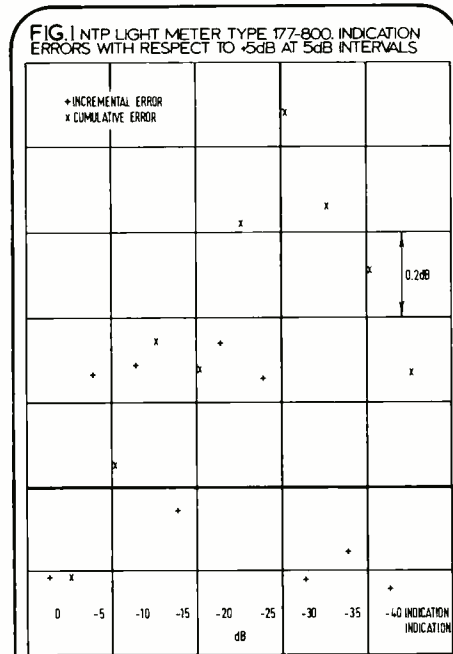

Shinohara Electric SEW VU Meters PE70 and SD830

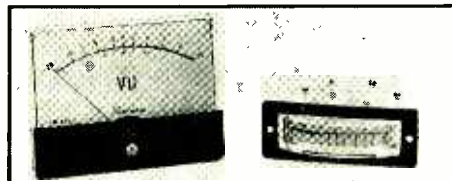

MANUFACTURER'S SPECIFICATION

Edgewise Model PE.70 vu meter

Front: 90 mm x 34 mm.

Panel hole: 70 mm x 31 mm. Overall depth 70 mm.

Fixing: two drillholes.

Accuracy: $\pm 2\%$.

Clear plastic model SD.830.

Front: 110 mm x 83 mm.

Panel hole: 58 mm diameter.

Fixing: four threaded studs.

Accuracy: $\pm 2\%$.

Ready wired to accept illumination lamp.

Price: PE.70 £5.25, SD.830 £5.25.

Manufacturer: Shinohara Electrical Inst. Works Ltd Japan.

UK Agent: ITT Instrument Services, Edinburgh Way, Harlow, Essex.

THE edgewise type instrument cannot as such meet the mechanical standard for vu meters as the standard specifies the scale layout; however, there is no practical reason why level should not be indicated on an edge-wise meter. Both meters had the normal vu meter scale points, but rather peculiarly the

rectangular meter was scaled such that -20 vu corresponded to 0% where these should of course be separate scale points.

In other respects, the scales were of the correct colours and the rectangular meter had a facility for scale illumination. General appearance of both meters was good, but it was rather interesting to note the circuit of the edgewise meter through its clear plastic case; the meter movement was seen to be connected in parallel with a resistor, and the combination connected in series with a single diode. Half wave rectifiers such as this are a complete disaster and are in contradiction with vu meter standards—more about this later!

Both meters were supplied with external series resistors of nominal 3600 ohms resistance which was found to be within 2% of nominal. The sensitivity of the meters for zero vu indication was $+4.6$ dBm for the edge type and $+4.3$ dBm for the rectangular type at 1 kHz with the series resistor, the sensitivity of the former being rather far from the standard of

$+4$ dBm. Furthermore, the frequency response of both meters was outside the vu meter standard due to lack of high frequency sensitivity. The -0.5 dB points were found to be at 4 kHz and 6.5 kHz with -1 dB points at 9.7 kHz and 19 kHz for the rectangular and edge types respectively.

The accuracy of the scale was perhaps one of the better points with the following results being obtained at 1 kHz.

Meter ballistics were such that both meters exhibited severe overshwing on the application of a continuous tone, to the extent of $+0.5$ dB and $+1.5$ dB with a 300 ms tone burst reading $+0.5$ dB on one meter and -0.5 dB on the other. Fall times were reasonable at 230 ms and 340 ms, but here again overshwing was serious.

With both meters, the application of an asymmetrical waveform gave disastrous results with the indication changing from 0 vu to no indication when the polarity of the waveform was reversed, a further indication that the rectifiers in both meters are half wave devices.

This practice is positively lethal, as the measured second harmonic distortion introduced at 1 kHz when the meters were applied to a 600 ohm source at 0 vu was just under 1% with as much as 0.4% fourth harmonic.

Summary

These meters may be used as sine wave level indicators at low frequencies, but they bear no relation to the standard vu meter.

indication	actual deviation from 0 vu	
	Edge meter	Rectangular meter
+3	+2.8	+3.1
+2	+1.9	+2.1
+1	+0.9	+1.0
0	0	0
-1	-0.9	-1.2
-2	-1.8	-2.2
-3	-2.8	-3.1
-5	-4.7	-5.3
-7	-6.5	-7.3
-10	-8.6	-10.3
-20	-17.5	*

*Meter has incorrect scaling.

When did you last see sixteen meters

At one glance ?

The recording engineer's problem of continuously scanning a long array of moving-coil meters is eliminated with the new Trident/AR compact signal-level indicator system—and at a price you can afford!



The LED columns are viewable over a wide angle and the front panel single-knob brightness control gives precise adjustment for comfortable vision in all control room lighting conditions.

The use per channel of a single column of LED's comprising, 10 green for normal levels and 4 red for overload conditions, gives immediate, positive indication of signal amplitude over a dynamic range of nearly 40 dB.

Each meter section is switchable between Bell VU and BBC PPM characteristics and individually adjustable for sensitivity. The system is self-powered and fully modular.

The 16 channel unit illustrated above is contained in a 5.25in. rack mountable case. Larger or smaller systems are available and OEM enquiries for individual cards are welcomed.

Trident Audio Developments Ltd.,
Sales Office: 4-10 North Road,
London N7 9HN.
Tel. 01-609 0087. Telex: Tritape 264773



Factory Address:
Shepperton Studios, Squiresbridge Road,
Shepperton, Middx.
Tel. Chertsey (09328) 60241

Microphones



and
Mixer's

The Eagle PRO range of microphones is for Professionals. (But we've got a lot of different mikes for less exacting jobs as well). They're all meticulously engineered, guaranteed and cost less than any others of the same quality. Omni- and uni-directional capacitor mikes. Lavalier capacitor mikes. And a lot of other studio equipment you're sure to need.

Send the coupon and get the full catalogue.

Please send me your catalogue with details and prices of mikes, mixers and studio equipment.

NAME

ADDRESS



Eagle International Ltd., Precision Centre, Heather Park Drive, Wembley HA0 1SU
 Tel(01)-902 8832

Eagle

SS1



PROLINE PROFESSIONAL

**SOUND
 SENSE
 IN
 '76**

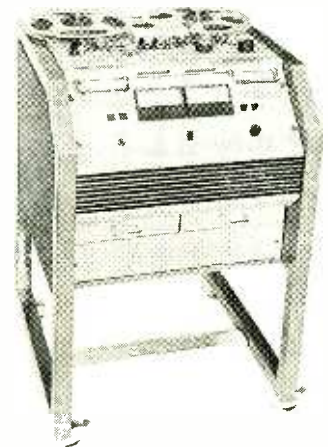

Excellent performance, ruggedly reliable and economically priced, what could be more sensible these days. A demonstration is just a phone call away. Contact the United Kingdom's largest and most experienced manufacturers of professional recorders.

LEEVERS-RICH (Inc Bias) Equipment Limited,
319 Trinity Road, London SW18 3SL. 01-874 9054
 Cable: Leemag London SW18
 Telex: 923455

IF YOU NEED JACKFIELDS . . . WHY NOT TALK TO THE SPECIALISTS ?

Our new Bantam range gives a space saving of up to 50 per cent.

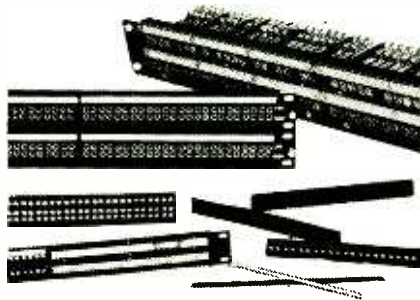

PANELS AND ASSEMBLIES

No supplier offers a wider range of panels, inserts and accessories for just about any configuration. And you can get them in any stage of assembly . . . individual components, sub-assemblies, or complete pre-wired and connectorised assemblies ready to install.

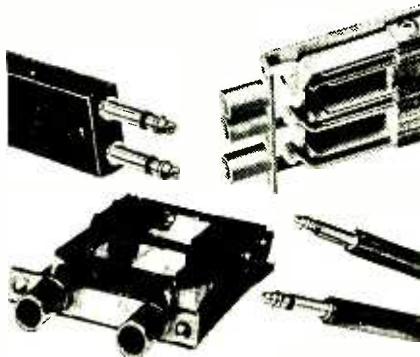

JACKS AND PLUGS

Singles . . . twins . . . back-to-back . . . 2+1 . . . patch and switchboard cords . . . most standard types are available for immediate off-the-shelf delivery.

For information on these and our range of B.P.O. type components contact: COMMUNICATION ACCESSORIES and EQUIPMENT LIMITED.

CAE LIMITED

70/80 AKEMAN STREET,
TRING, HERTS HP23 2PJ

Tel. (044 282) 4011

Telex: 82362 A/B BATELCOM

Millbank Peak Programme Meter 078B

MANUFACTURER'S SPECIFICATION

Peak programme meter circuit mounted to a meter 8.5 cm square, each division represents a 4 dB step. The logarithmic amplifier ensures a linear scale: calibration is by preset control with a basic sensitivity of -20 dB. Power requirement 24V dc negative earth at 4 mA.

Price: £25.99

Manufacturer: Millbank Electronics Group, Uckfield, Sussex.

THE meter movement has a black scale with white calibration marks from one to seven as per the British Standard peak programme meter specification, but the unit does not claim to meet this specification and only claims to be a peak reading meter with 4 dB scale markings.

The electronics section is a small fibreglass printed circuit board which mounts on the movement's terminals, having three skeleton type preset potentiometers, one of which is the sensitivity control. The board is basic and unmarked with identifications, and no adjustment instructions, circuit or even connection diagram for wiring the four-pin connectors was supplied. As the meter movement is not a standard peak programme meter, the movement alone cannot be used with other electronics to form a ppm, and as will be seen the combined characteristics of the electronics and the movement have an unusual time constant. Initial inspection of the electronics board revealed a completely unsoldered joint.

Relative to the mark seven on the meter, the calibration accuracy of the other meter marks, which should be in 4 dB steps, was as follows:

Mark	dB relative to mark 7	ideal level
7	0	0
6	-3.1 dB	-4 dB
5	-6.8 dB	-8 dB
4	-12.1 dB	-12 dB
3	-16.6 dB	-16 dB
2	-20.5 dB	-20 dB
1	-26.4 dB	-24 dB

Clearly the logarithmic curve of the electronics is rather rudimentary, but the rectifier characteristic was found to correspond to peak detection and no asymmetry errors were significant. Furthermore, checking the frequency response at both the seven and three mark showed that it was substantially flat from 16 Hz to 200 kHz.

The unbalanced input always offered a load in excess of 50 000 ohms which is normally more than adequate. The input sensitivity was found to be 79.3 mV at maximum gain for mark seven, which is close to the specification. On the other hand the current drawn from a 24V source was 17.8 mA, which is far in excess of the specified 4 mA.

Checking the effective meter ballistics showed that a tone burst of 190 ms duration was required for the pointer to reach mark seven, and that the fall back time to mark one was 2.5s. While I have no objection to the fall back time, I feel that the rise time is somewhat long for a peak programme type meter.

Summary

This is rather a basic peak reading meter with a rather inaccurate linear decibel scale. While the meter does read peak, the attack time is relatively slow and it is difficult to judge how much margin should be allowed between meter peak reading and system overload. If cash is short this can be a useful meter, but its performance is rather restricted.

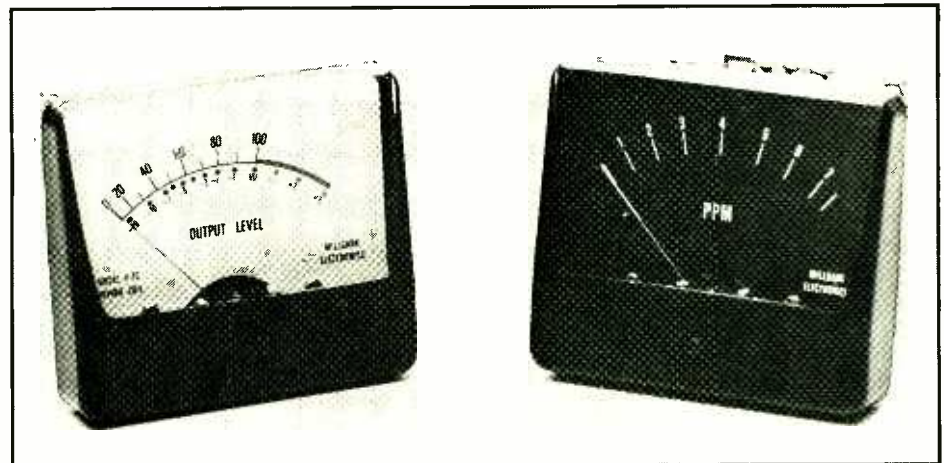

Millbank Peak Reading VU Meter 078F

MANUFACTURER'S SPECIFICATION

A peak reading vu meter circuit mounted to a meter measuring 8.5 cm square with a logarithmic scale and a linear amplifier: calibration is by preset control with a basic sensitivity of -20 dBm. Power requirement 24V dc negative earth at 4 mA.

Price: £25.99.

Manufacturer: Millbank Electronics Group, Uckfield, Sussex.

THE review meter as supplied was identified with the legend 'output level' and bore a vu meter type scale in black and red on a white background. The major calibration was zero to 100, the latter coinciding with the division between the black-red sectors of the scale as per a vu meter, and with the subsidiary scale in the form of a vu meter scale with the

normal calibrations.

No claim is made that this is a vu meter, and checking its performance showed that it was nothing like a vu meter. The electronics section of the module is a small fibreglass printed circuit board which bolts on to the rear of the meter by means of the meter terminal screws. This board is fairly basic without component, or other, identifications and with four terminal pins for connecting the power supplies and the unbalanced audio input. A single skeleton type preset potentiometer is provided as a gain control at the input, the centre tap being capacitively coupled to the electronics.

The maximum available sensitivity at 1 kHz for 100% or 0 dB was found to be 42.2 mV (-25 dBm), which is rather less than the manufacturers literature suggests. The frequency response was flat from 3.1 Hz right up to 200 kHz and the input impedance was above 50 000 ohms at all input sensitivity settings.

Checking the calibration accuracy at various scale points on the dB scale yielded the following figures, which are not particularly impressive at the low end (see above):

The meter ballistics were effectively such that an isolated tone burst of 160 ms duration was required to raise the indication from zero

indication	actual	indication	actual
+3 dB	+3.1 dB	-3 dB	-2.9 dB
+2 dB	+1.9 dB	-5 dB	-4.6 dB
+1 dB	+0.9 dB	-7 dB	-6.3 dB
0 dB ref.	0 dB	-10 dB	-8.6 dB
-1 dB	-1.1 dB	-20 dB	-14.6 dB
-2 dB	-2.0 dB		

input to the 0 dB mark (100%), and that the fall back time, from 0 dB (100%) to the -20 dB mark, was 4.8s. This represents a rise time between a vu meter and the normal ppm with a slow fall which is often no bad thing. Clearly the rise time is such that the operator requires experience of this particular meter to achieve desired levels.

The rectifier characteristic and the sensitivity to asymmetrical waveforms was checked; the results were that the reading is unaffected by asymmetrical waveforms. Finally the power consumption was found to be 17.7 mA which is grossly in excess of the specified 4 mA.

Summary

This is quite a neat little unit which will no doubt find applications where a standard meter cannot be justified, or where line levels are too low to drive a genuine vu meter. ■

Sifam VU Meter R34A

MANUFACTURER'S SPECIFICATION

To ASA specification C16.5 1954.

Fixing: three M2.5 studs equally spaced on a 73 mm pcd.

Dimensions: overall width 91.2 mm. Overall height 74.4 mm panel cut-out 63.5 mm.

Scale length: 69.8 mm.

Price: £12.95.

Manufacturer: Sifam Electrical Instrument Co., Ltd., Woodland Road, Torquay, Devon.

THE two model R34A samples of the standard vu meter provided for review are but part of a large range of meters manu-

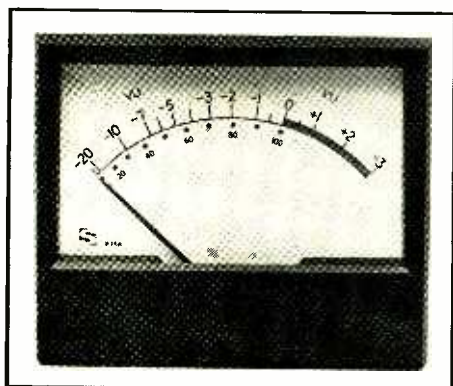

factured by Sifam, including a number of types of vu and ppm movements to the accepted ASA and British standards. The R34A is a clean professional-looking instrument with correctly laid-out and correctly coloured scales and scale plate enclosed in a black surround. Other than the scale marks, the scale also included to Sifam trade mark and the model number, neither of which should strictly appear on the scale plate.

Calibration accuracy of the scale of both samples was excellent with errors of less than 0.1 dB between +3 vu and -5 vu with errors within the readability of the instrument at lower levels. When used in series with the standard 3600 ohms resistor (which was not supplied) the sensitivity for 0 vu indication was 3.9 dBm for both instruments, which, allowing for readability errors, is as near the ASA specification of +4 dBm as can be expected. Furthermore, the frequency response was absolutely flat up to 120 kHz, falling to -0.5 dB at 200 kHz. The rectifier characteristics were found to be to standard, and the application of asymmetrical waveforms did not give any measurable polarity errors. Tone burst testing showed that the rise time of the movement was within specification, but on the slower limit. The overshoot and fall time were correct.

Overload testing to the ASA standard did not give any errors or other disasters, and no stability problems were encountered.

Summary

The two sample instruments exhibited identical performance and so far as electrical and mechanical performance are concerned they fully complied with ASA C16.5-1954. The only minor point is that the samples both had marks other than the scale marks on the scale plates.

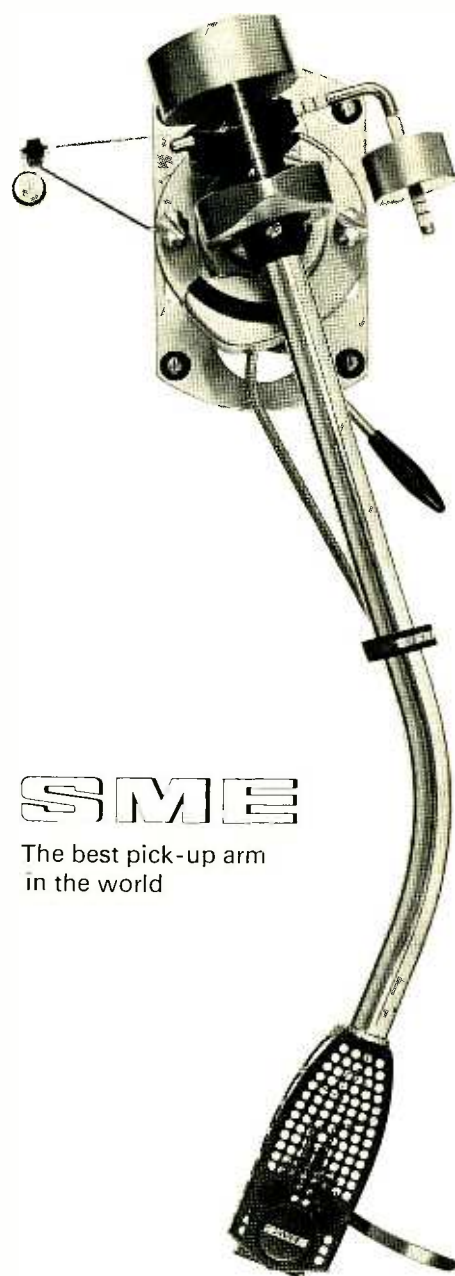

SME

The best pick-up arm
in the world

Chancing your arm!

Looking about that's what some folk are still doing.

Fit your deck with an SME the *original* precision pick-up arm. Now with improved lift, the most sensible, most precisely engineered arm ever built.

SME arms are different, you can see it, feel it, . . . hear it. Change now and have the good will of your cartridge.

For complete specifications and independent reports write to:

Dept 1037, SME Limited
Steyning, Sussex, England, BN4 3GY

Bach-Simpson VU Meter 1347

MANUFACTURER'S SPECIFICATION

None provided. Assumed to ASA Standard C16.5 1954

Price: £16.26

Manufacturer: Bach-Simpson Ltd, London, Ontario, Canada.

UK: Bach-Simpson (UK) Ltd, Trenant Industrial Estate, Wadebridge, Cornwall.

THE model 1347 meter is a vu meter approximately 82 mm square requiring 45 mm clearance behind panel. Fixing is by means of four studs and two massive terminals provides electrical connection. No standard 3600 ohm series resistor was provided.

A large part of the front of the meter is clearplastic with a white scale plate, as opposed to the recommended yellowish colour. The scale calibration has the normal calibration points in black below 0 vu and red above 0 vu, but personally I found the scale confusing to read as it does not have a printed arc dividing the vu calibrations and the percentage calibrations.

As received the mechanical zero required adjustment, but once this was done, the scale

calibration was within 0.2 dB at all scale points above the -20 vu mark with respect to 0 vu. When used with the standard 3600 ohm series resistor, the sensitivity for an indication of 0 vu was +3.81 dBm which is close to the nominal +4 dBm.

The frequency response was very flat with no readable error up to 43 kHz where the reading was about 0.1 dB high, falling to zero error at 150 kHz and -0.1 dB at 200 kHz. Investigations into the rectifier characteristics showed that the rectifier had the correct average reading and that no reversal or asymmetry error was present. Tone burst testing revealed that the rise time of the movement was on the slow side at 350 ms for the standard condition as opposed to 300 ms $\pm 10\%$, but the fall back time was to specifications. Overload testing produced considerable noise from the instrument, but no adverse effects were apparent so far as accuracy was concerned.

Summary

While this sample of the instrument was generally to the American Standard for vu meters, the rise time was out of specification and as a rather minor point for some applications the scale background colour was not to the standard recommendations. Personally I did not like the scaling of the instrument without the conventional scale arc which made it confusing to read. ■

Bach-Simpson peak programme meter 543

MANUFACTURER'S SPECIFICATION:

None provided. Assumed to BS 4297:1968.

Price: £15.72.

Manufacturer: Bach-Simpson Ltd, London, Ontario, Canada.

UK: Bach-Simpson (UK) Ltd, Trenant Industrial Estate, Wadebridge, Cornwall.

IN lieu of alternative standards the performance of the Bach-Simpson movement was examined in terms of British Standard 4297:1968 'Specification for the characteristics and performance of a peak programme meter'. The sample meter was housed in a black rectangular case approximately 100 mm wide by 68 mm high with a rear of panel protrusion of approximately 47 mm. As per the standard, the movement had a matt black scale-plate with white calibration point and a scale as standardised. The scale dimensions were to standard as was the accuracy of the calibration marks:

Scale mark	Actual % full scale current	Standard % full scale current
Full scale	100%	100%
7	92.7%	93%
6	79.8%	80%
5	66.3%	67%
4	50.5%	51%
3	34.2%	35%
2	20.9%	22%
1	9.07%	10%

Full scale deflection occurred at a current of 1.028 mA. The internal resistance was measured as 541 ohms which is outside the standard of 600 ohms $\pm 5\%$. Checking the overshoot characteristic showed that the movement was on the upper limit of +5% at scale mark 7, while a speed-check showed that the movement failed to meet standard as follows:

dc pulse duration	Peak reading relative to mark 7	
	Measured	Standard
80 ms	-8 dB	-3.5 dB ± 1 dB
20 ms	-21 dB	-19 dB ± 1 dB

Summary

While this Bach-Simpson movement was to the standard for peak programme meters as far as styling and dimensions were concerned, it was outside the ballistics standard. Also the movement's resistance was outside the accepted limits. ■

Get binding!

Keep your copies of **STUDIO SOUND** in smart black binders (each holds 12 copies) with title in golden block letters on the spine.

Price: £2.00 each, which includes inland and overseas postage.

Send your order with cheque or postal order to:

Modern Book Binders Ltd.,
Chadwick Street,
Blackburn, Lancs.

(state clearly your name and address and the relevant magazine title).

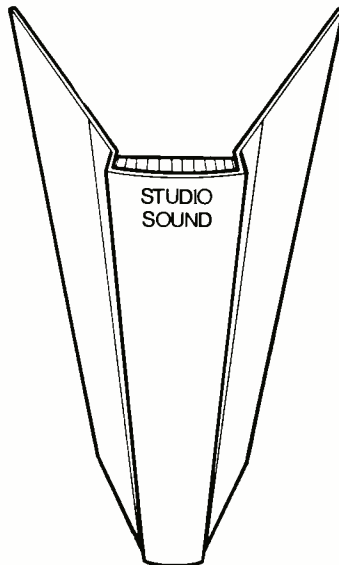

LINK HOUSE GROUP

Introducing the Hill 24 into E + 8, as delivered to
Studic Sound Services, Holland.

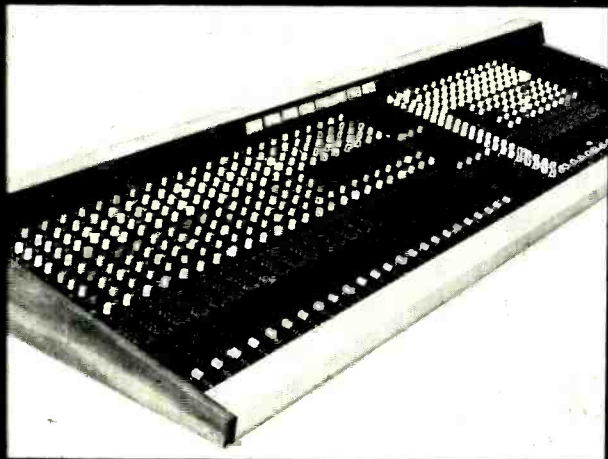
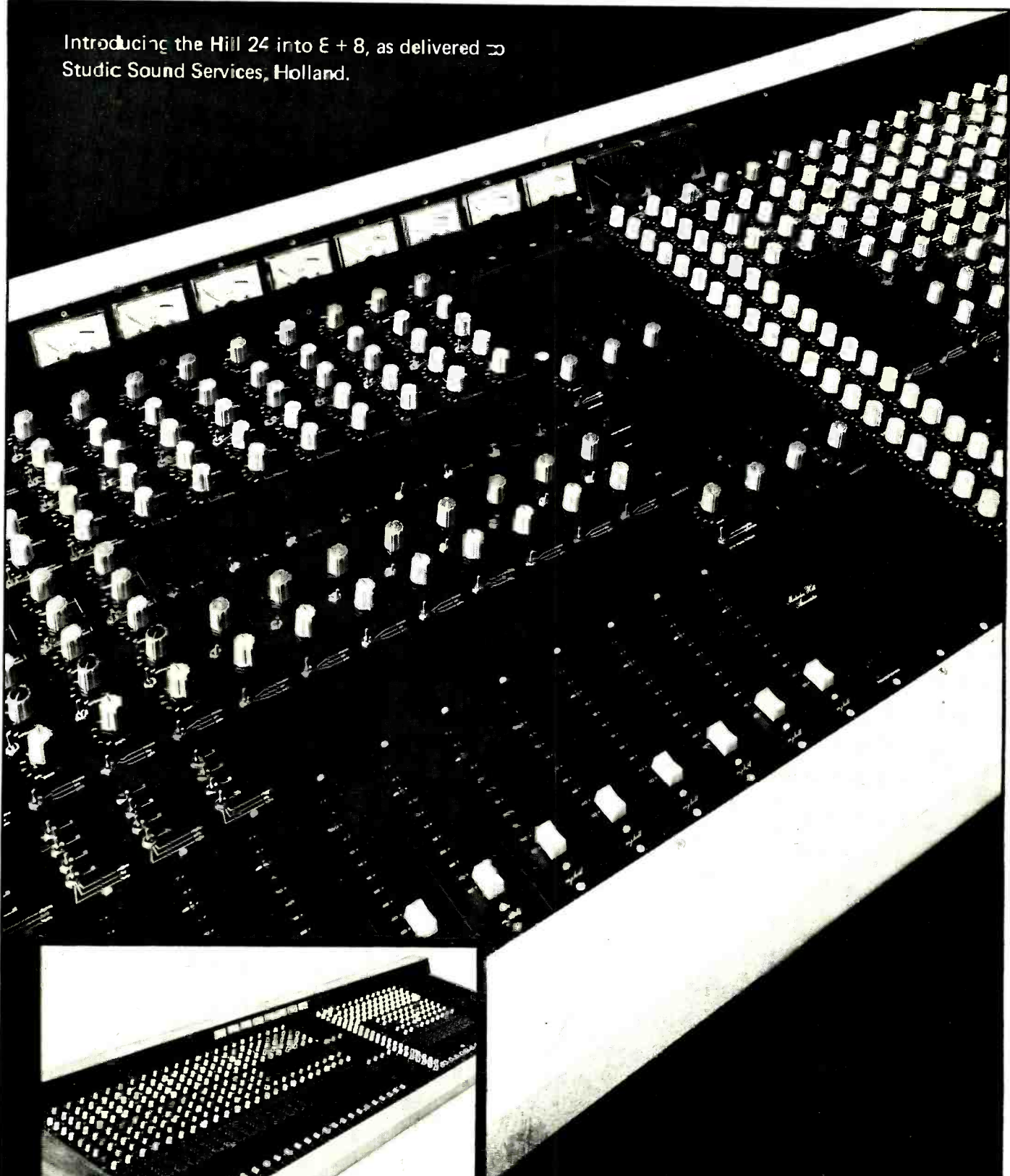

Malcolm Hill Associates

3 MAIDSTONE ROAD, MARDEN, TONBRIDGE,
KENT. Tel. Maidstone (0622) 831545.

Classified Advertisements

Advertisements for this section must be pre-paid. The rate is 14p per word, minimum £2.80. Box Nos. 35p extra. Semi-display rates on application. Copy and remittance for advertisements in **OCTOBER 1976** issue must reach these offices by **19th AUGUST 1976** addressed to: The Advertisement Manager, **Studio Sound**, Link House, Dingwall Avenue, Croydon CR9 2TA.

Note: Advertisement copy must be clearly printed in block capitals or typewritten. Replies to Box Nos. should be addressed to the Advertisement Manager, Studio Sound, Link House, Dingwall Avenue, Croydon CR9 2TA, and the Box No. quoted on the outside of the envelope. The district after Box No. indicates its locality. **SEX DISCRIMINATION ACT 1975:** No job advertisement which indicates or can reasonably be understood as indicating an intention to discriminate on grounds of sex (e.g. by inviting applications only from males or only from females) may be accepted, unless (1) the job is for the purpose of a private householder or (2) it is in a business employing less than six persons or (3) it is otherwise excepted from the requirements of the Sex Discrimination Act. A statement must be made at the time the advertisement is placed saying which of the exceptions in the Act is considered to apply.

STUDIO FACILITIES

Roger Squire Studios

DJ IMPROVEMENT COURSES · RADIO COURSES
JINGLES SERVICE · RADIO AUDITION TAPES
55 Charlbert St, London, NW8 6JN. Tel. 01-722 8111.

★**J & B Recordings.** Tape to disc. 12in. L.P. £4.00. 7in. 45 r.p.m. £1.80. E.P. £2.00. Pressings—stereo/mono. Tape copying. 14 Willows Avenue, Morden, Surrey. 01-648 9952. X
★**Fanfare Records.** Tape-disc pressings, demo's, masters, any quantity. Studio/mobile Neumann disc cutter. S.A.E. brochure. 1 Broomfield Close, Rydes Hill, Guildford. Tel. 0483 61684. X

FERROGRAPH SALES UHER

We are contractors and suppliers of the above equipment to H.M.G. Depts., Broadcasting and Local Authorities. For competitive quotation contact the specialists:—

PHOTO ACOUSTICS LIMITED
255a St. Albans Road, (Entrance in Judge Street),
WATFORD, Herts. Tel: 32006

★**Your Tapes to Disc, Mono or Stereo cutting.** Vinylite pressings, Sleeves/Labels. Top professional quality. S.A.E. for photo leaflet. Deroey Records, "Eastwood", Cove, Dunbartonshire, Scotland. X

DIN TEST RECORDS

Small supplies now in stock
DIN 45541 (Frequency) DIN 45542 (Distortion)
DIN 45543 (Cross Talk) DIN 45544 (Rumble)
DIN 45545 (Wow and Flutter)
£5 each and VAT

LENNARD DEVELOPMENTS LTD
206 Chase Side, Enfield EN2 0QX
Telephone: (01) 363-8238/9

★**Custom Pressings.** High quality pressings and demo's manufactured from your tapes in our own record pressing plant and disc-cutting studio, speedy delivery and very competitive prices. For further details contact Anglia Pressings, 112 Beach Road, Scrabby, Great Yarmouth. X

SOUND EFFECTS

for film, TV, stage and disc from our huge library of tapes collected since 1959

MAGNETIC EFFECTS LTD 23 REDAN PLACE
LONDON W2 4SA
01-727 9801

STUDIO EQUIPMENT SERVICES

are INDUSTRIAL SUPPLIERS

TEAC—TASCAM
REVOX—UHER

We supply, design, build, modify, install and service professional Audio and Studio Equipment.

01-200 1229

★**Sound News Productions.** Britain's oldest full-time tape/disc cassette transfer service. Direct transfers, pressings for private and for the trade. Fund-raising advisory service for Societies, Choirs, Bands, Ferrograph, Grundig, Philips, Revox equipment promptly serviced. 18 Blenheim Road, London W.4. Tel. 995 1661. M

★**Multitrack Mobile/Studio Recording.** Professional Demos, high quality, low cost. JBL, Revox, Quad, AKG. 01-520 8363. J

WOLLENSAK 2770AV

CASSETTE FAST-COPIER

SCS Appointed Main Dealers
Demonstrations Personal Service Maintenance
Cassette Fast-Copying—Short or Long Runs
Full Information on Request

SOUND CASSETTE SERVICE (SSI)
PO Box 2, Gerrards Cross, Bucks SL9 8EG
Tel. 02813 84409

FOR SALE—TRADE

★**Disc-cutting styli** for all types of mono and stereo disc-cutting heads. Heater windings fitted, relapping and specials. County Recording Service, London Road, Binfield, Bracknell, Berks. Tel. Bracknell 54935. X

SOWTER TRANSFORMERS

FOR SOUND RECORDING AND REPRODUCING EQUIPMENT
We are suppliers to many well-known companies, studios and broadcasting authorities and were established in 1941. Early deliveries. Competitive prices. Large or small quantities. Let us quote.
E. A. SOWTER LTD.
Transformer Manufacturers and Designers
7 Dedham Place, Fore Street, Ipswich IP4 1JP
Telephone 0473 52794

★**Revox A700s** from £774 plus 8% VAT. **Revox A77s** from £365 plus 8% VAT. A comprehensive selection of spares and accessories are also available at import prices. Delivery about 3 days from receipt of order/funds via direct import facility. We also offer a prompt, competent hospital and conversion service here in Reading. Telephone Reading (0734) 690177 or Wokingham (0734) 781970. M

TRAD

GARDINGTON 404

All Studio Equipment bought and sold.

See our advertisement on page 57.

Dog House, Cople, Bedfordshire

★**Cathedral Sound** manufacture a very useful compressor for less than £25, and a range of input and mixer modules from £12.50. A stamp will bring details by return. Cathedral Sound, Fourways, Morris Lane, Halsall, Lancs. L39 8SX. Telephone Halsall (0704) 840328. X

SALE

CONTENTS OF 16 TRACK STUDIO including: Tape recorders, Mixing consoles, Microphones, Reverberation devices, Dolbys, Compressor/Limiters, Delay units, Grand piano, Microphone stands, etc.

Viewing by appointment with Malcolm Jackson, **The Studios, Rickmansworth, Herts, England**

Tel. Rickmansworth 09237-72351
Telex 262284 Amsdr G

★**Revox and Teac Sales and Service.** Most models from stock. Immediate delivery. The Music Lab. 01-346 4469. H

★**Save over £100.** For a limited period only. Studio quality Neal 103 Dolby cassette recorder. Wollensak transport. £216 post free. Cathedral Sound, telephone Halsall (0704) 840328. K

SOWTER TYPE 3678

MULTITAP MICROPHONE TRANSFORMER
Primary windings for 600 ohm, 200 ohm and 60 ohm with Secondary loadings from 2K ohm to 10K ohm. Frequency response plus/minus ±dB 20 Hz to 25 kHz. Conrained in well finished Mumetal box. 33mm diameter by 22mm high, with colour coded end leads, low distortion. DELIVERY (small quantities) EX STOCK. HIGHLY COMPETITIVE PRICE. FULL DETAILS ON REQUEST

E. A. SOWTER LTD, Dedham Place, Ipswich, IP4 1JP
Telephone 0473 52794

★4 Spondor BC111 speakers, teak cabinet and suspension units: £340 per pair plus VAT. Two century stereo amplifiers, 100 watts per channel, £200 each plus VAT. Three Westrex acousti-lens loudspeakers £600 for two, £750 for three plus VAT. Tel. 021-356 9636. J

UPDATE YOUR UHER 4000S TO 4000L SPECIFICATIONS!

Using only genuine Uher parts, we will fit the latest "L" type motor and all electronics to bring your machine fully up to 4000L specs internally. At the same time, your machine will be fully checked and adjusted.

The cost is moderate at **£55 + 12½% VAT + £4 return carriage and insurance.**

IN STOCK:

Uher 4000S—Reconditioned **£75**
Uher 4000L—Reconditioned **£145**
Plus VAT and carriage.

All overhauled to makers specifications and fully guaranteed.

PAUL SIMMON LTD.

2 Market Street, Halifax,
W. Yorks.

Tel: 0422 52240/57442.

★Unique opportunity to purchase professionally built discotheque unit, originally designed and built for mobile use but would suit permanent installation in club. Console comprises Millbank mixer, Thorens turntables, sound to light and sequencing equipment, Bose amplifier and four speakers with tripods, all leads and accessories with Switchcraft X.L.R.'s used throughout. Ultra reliable equipment, must be seen and heard to be appreciated. All in excellent condition. Asking about £2000. Large, well maintained van also available worth about £400. Box no. 742, c/o Studio Sound. J

PROFESSIONAL REPAIR SERVICES

Repairs, overhauls, etc., to Ferrograph, Revox, Tandberg, Uher, 8 and 16mm Projectors and other A/V equipment. Maintenance and quantity quotations to Educational or Industrial users.

PHOTO ACOUSTICS LIMITED

255a St. Albans Road, (Entrance in Judge Street),
WATFORD, Herts. Tel: 32006

10 OUTLET DISTRIBUTION AMPLIFIER



One floating input, 10 floating outputs at 600 ohms for general studio work, feeding multiple slave pa amplifiers or driving foldback headphones. Electronic input circuit which withstands mains or static voltages on the signal lines. DISTORTION, all outputs loaded, at +12dBV.7.

1KHz 0.005%
30Hz—20KHz 0.05%

The unit meets the IBA 'signal path' specifications and is available as a complete unit or as a set of all parts excluding the case and XLR connectors.

STEREO DISC AMPLIFIER

SUPERLATIVE PERFORMANCE FOR BROADCASTING, DISC MONITORING AND TRANSFER. Magnetic cartridge to balanced lines with HF and LF filtering. Mains powered. Meets IBA specification.

STABILIZER

FOR HOWL REDUCTION. BALANCED AND UNBALANCED VERSIONS BOXED OR RACK MOUNTING.

Shifters are proving effective in the following situations:

Sound reinforcement for television studio audiences.
Foldback monitoring on stage.
Live microphone telephone conference systems with a 5Hz shift each way giving 10Hz round the loop, which is effective in the small non-reverberant rooms involved.
Group hearing aid systems for teaching deaf children.
Microphones or radio microphones for discussion groups or floor questioners who are within the intended coverage of the PA loudspeakers as well as for straightforward sound reinforcement and public address.

SURREY ELECTRONICS

The Forge, Lucks Green, Cranleigh, Surrey GU6 7BG
Telephone STD 04866 5997

CASSETTE FAST COPYING MONO/STEREO

One off or on-going work.
From 15p (+VAT) per copy. Details from:
GOSPEL CASSETTES (SS)
67 Ashfield Drive, Halifax,
West Yorkshire HX3 5PQ.
Tel: Halifax (0422) 59403

RAC MIXERS

Custom-built mixers for groups, P.A., hospital broadcasting, recording, discos, etc.

RAC plug-in audio modules for building your own mixers.

RAC power amplifiers for P.A. etc.

Dealers for a wide range of quality audio equipment.

APRS manufacturing members.

RUGBY AUTOMATION CONSULTANTS

19 Freemantle Road, Bilton, Rugby,
Warwickshire CV22 7HZ

Tel. 0788-810877 (Rugby)

Call, write or phone us

WANTED

★TEAC 3340 (S) urgently required. Top prices paid. The Music Lab, 01-346 4469. H
★All Revox tape recorders urgently required. Top prices paid. The Music Lab. 01-346 4469. H

★Grampian or B.B.C. type cutterheads required Any condition acceptable. Box No. 738 c/o STUDIO SOUND. L

★All Nagra equipment urgently required for cash. J. J. Francis (W.G.) Ltd., Manwood House, Matching Green, Harlow, Essex CM17 0RS. Tel. Matching 476. X

★Lost: Circuit diagram for response BM104 mixer. £10 given for a legible copy. Also wanted microphones. Tel. Pulham Market 438 (Norfolk). J

★Wanted urgently: Ampex 300 electronics for spares. Also wanted, Ampex 8 track MM1000 or similar machine. Tel. Epsom 24870. K

SERVICES

SOUND SYSTEM ENGINEERS

Keep in touch with the Public
Address Industry.

JOIN THE



The Official Association which
represents the Public Address
Industry — Membership details
from

The Secretariat, APAE, 47
Windsor Road, Slough, Berks
SL1 2EE

★R. Beaumont, specialist audio repairs and Philips VCR service, 21 Southway, Ilkley, West Yorkshire. Tel. 094-33 2026. X

FOR SALE—PRIVATE

★JBL Century L100A. Pair. Mint condition. Orange. £295 o.n.o. Tel. Mr. R. Dixon-Fyle, 01-802 4241 Ex. 58. J

★B & K Type 2304 pen recorder. £200. Tel. 01-402 4055. J

★AKG C451 capacitor microphones £40 each. Tel. 01-402 4055. J

★One pair studio monitor speakers by Acoustic Research, model AR Lst. Six months old, complete with stands, boxes and manufacturer's five year guarantee. £375 o.v.n.o. Contact J. W. Brookes after 6 p.m. Ring Chorley 79786 Lancs. J

★6/2 mixer, based on Allen and Heath pcb. Echo, foldback, unbalanced inputs. Mains psu, handbook. £75. Medway 55888. J

★1in. 8-track machine, custom-built, valve based, with manual deck. Quiet and reliable. Price £1,250 plus VAT. Phone Medway (Kent) 76117. J

ALLEN & HEATH 24 CHANNEL MIXER

Low-high input.
3 Band Equalisation.
8 Sub Groups out to stereo.
PFL all functions incl echo plus auxiliary modules.
All facilities terminate to a rack field.
6 built-in noise gates.
Input/Output/FL, all on VU Facility.
FOR LEASE, HIRE OR SALE
Contact (10.30 am-6.00 pm)
MR P. S. WALMSLEY (01-499 0671)

JOHN D. WOOD

**PHOTOGRAPHIC OR REHEARSAL
STUDIO
PUTNEY, LONDON SW15**

8,700 sq ft approx
**LEASEHOLD INTEREST
FOR SALE**

Apply:
23 Berkeley Square, London W1X 6AL
01-629 9050 (Ref PMS)

PAIR OF SENNHEISER

Professional 405 Condenser Microphones with mains power pack. Each microphone complete with approximately 100ft of cable. Both microphones are in excellent condition and hardly used.

Soundtex 4 channel mixer also available specially adapted to take condenser microphones. All offers considered.

Phone CHRIS NEWMAN 051 608 2305 (office)
051 327 6215 (home)

SITUATIONS VACANT

**QUALIFIED
ELECTRONICS
ENGINEER**

We are a progressive Company manufacturing music cassettes and 8 track cartridges.

The position of Chief Electronics Engineer has become vacant and we require an experienced person in this field to fill it.

A wide range of production equipment is involved including high speed tape duplicators.

Salary will be commensurate with experience and qualifications and the successful applicant will also be expected to play an important role in the technical management of the division.

All applications will be treated in strictest confidence.

Contact **Mr. Ronald Holmes, Director,**
Immediate Sound Services Ltd.,
6 Orsman Road, London N.1.
Tel: 01-739 9672/3/4/5

PYRAL

Pyral require to recruit a high calibre
REPRESENTATIVE

Must be conversant with the Magnetic Film and Studio Tape Markets

Only people with good sales records to the industry need apply

**SALES REPRESENTATIVE
PROFESSIONAL DIVISION**

This situation is open to applicants with proven sales records but not necessarily with recording tape. The successful applicant will sell Video and Sound Tape to existing and developing customers and contacts.

Good salary, commissions and Company car supplied in line with position in the Company.

Pyral is a member of the Rhone Poulenc Group and supplies a complete range of domestic and professional products to the world markets. The technological and financial backing is substantial.

The continued growth of this division has created further staff vacancies and those people who consider they can make our presence felt in the market can be assured of a long association with this Company.

Applications in writing in strictest confidence to:

Mr. F. D. Walter,
Pyral Magnetics Limited,
Airport House,
Purley Way,
Croydon, Surrey CRO 0XZ.

The Institut de Recherche et de
Coordination
ACOUSTIQUE/MUSIQUE (I.R.C.A.M.)
Paris (France)
Director **PIERRE BOULEZ**
is looking for a

**SENIOR RECORDING
ENGINEER**

who will be responsible for all recording and sound transmissions at I.R.C.A.M. as well as for the choice of relevant equipment for the institute.

Applicant should be experienced sound engineer of the first order with extended musical training and should have professional competences in electronic engineering. Experience in digital electronics would be an asset.

The position is available from the first of January 1977 but the exact starting time is negotiable.

The salary is commensurate with the experience and the standard of performance required. Applications should be sent with number 6513 to Monsieur TRINH - 35, boulevard de Sébastopol 75001 PARIS - FRANCE

Audio Development Engineer

Pye TVT are major manufacturers of television, radio and outside broadcast vehicle systems and equipment.

We would like to hear from engineers, aged between 25 and 35, who have experience and interest in professional audio projects, with qualifications ranging from B.Sc. to City and Guilds full technical certificate.

The job will entail the design of a wide variety of audio systems and associated equipment, together

with the generation of circuits, parts lists and technical information for handbooks.

We offer a good starting salary, with considerable fringe benefits, and the prospect of a progressive career with a leading Company in the world broadcasting markets.

Please write with details of qualifications and career so far to:

David Barnicoat, Personnel Officer



A member of the Pye of Cambridge Group

Pye TVT Limited

PO Box 41 Coldhams Lane Cambridge England CB1 3JU
Tel: Cambridge (0223) 45115 Telex: 81103 PYE TVT CAMBGE

HANSA TONSTUDIOS IN BERLIN

the major music recording studios in Germany require—

2 YOUNG TOP RECORDING ENGINEERS

with at least two years music recording experience

Apply to:

HANSA TONSTUDIOS
Nestorstrasse 8-9
1 Berlin 31
Germany

NEVE ELECTRONIC LABORATORIES LIMITED

Leading designers and manufacturers of professional sound control and distribution systems used throughout the world in the television, film, broadcasting and recording studios, have an immediate requirement for:

ELECTRONIC DESIGN ENGINEER

This is a challenging and rewarding position. The design team has responsibility for the custom design of our sound mixing consoles through from detailed discussions with the customer to liaison with production and test departments.

Applicants should have direct experience in Audio System Design and education to degree or HNC standard is desirable.

A good salary is offered, together with relocation assistance, company pension scheme and four weeks holiday.

Please apply:

Personnel Manager,
Neve Electronic Laboratories Ltd,
Cambridge House,
Melbourn,
Royston, Herts.
SG8 6AU.

Tel: Royston 60776



REVOX A77 EDITING CONVERSION

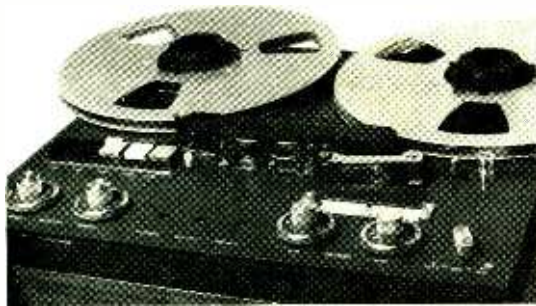

Developed for Professional Editing
Easy Access to the Heads
Switchable end of tape lamp

Converted Machines Supplied
Existing Machines Converted
Kits Available

K.L. SOUND
23 REDAN PLACE, LONDON W2 4SA
01-229 0102

SITUATIONS VACANT (Continued)

★Experienced technical manager required to plan, install and run new medium sized cassette duplicating plant. Partnership considered. Write in confidence giving details of recent experience: Box 743, c/o *Studio Sound*. K

**TRIDENT
RECORDING STUDIOS**
require experienced
maintenance engineer.

Please ring Carole at 734 9909

RECORDING STUDIO with INTERNATIONAL REPUTATION

Located in the country one hour from Montreal, Canada, has opening for first class maintenance engineer with at least 5 years' experience. Trident board, Studer etc. Must have perfectionist attitude. Permanent employment. Must like country living. Preferably married or equivalent.

Send resume (or phone) to:

Yael Brandeis
R.R. No. 1
Morin Heights
Quebec, Canada J0R 1H0
(514) 226-2419

SITUATIONS—WANTED

★Electronic engineer, experienced audio design, noise problems, studio maintenance, seeks new challenge in London studio environment. Tel. 01-864 9209 or 0602-396032. Ask for Roger. J

★Top disc cutting engineer well known in recording industry seeks very good position. Please write stating salary to Box no. 741, c/o *Studio Sound*. J

It helps

to mention

STUDIO SOUND

when replying to

ADVERTISEMENTS

INDEX TO DISPLAY ADVERTISERS

Alice (Stancoil) Ltd.	53
Allen & Heath Ltd.	43
Amek Systems & Controls Ltd.	35
Apollo Electronics	8
Audio & Design Recording Ltd.,	49, 51
Audio Centre Sheffield	21
Audio Developments Ltd.	10
Audix	45
Avcom Systems Ltd.	11
Bauch, F. W. O., Ltd.	25
Beyer Dynamic (GB) Ltd.	7
Bizarre Audio	21
Brenell Engineering	8
Cadac (London) Ltd.	2
CAE Ltd.	66
County Recording Service	21
Creative Handbook	48
Document Group London Ltd.	12
Dolby Labs Inc.	39
Duplitape	18
Eagle Int. Ltd.	65
Electronic Music Studios	6
E.S. Electronics	18
Exposure Electronics	55
Future Film Developments	27
Griffiths Hansen (Recordings) Ltd.	12
Hammond, C. E., Ltd.	58
Hayden Labs Ltd.	20
Hill, Malcolm, Associates	69
H.H. Electronic	61
Ind. Tape Applications	4, 5
Klark Teknik Ltd.	63
K. L. Sound	74
Leevers Rich (inc Bias Electronics)	65
Libby's Hi-Fi	14
Lockwood & Co.	16
Macinnes Labs Ltd.	31
Magnetic Tapes Ltd.	6
MCI Ltd.	21
Mellotronics Ltd.	10
Midas Amplification	19
Midland Sound Ltd.	59
Miniflux Elec. Ltd.	16
M.M. Electronics Ltd.	20
Monks, Keith (Audio), Ltd.	9
Music Lab., The	12
Mustang Communications	18
NTP Elektronik A/S	47
Page, John, Ltd.	15
Pye TVT Ltd.	41
Radford Lab. Instruments Ltd.	11
Radio Recordings Ltd.	16
Raindirk Ltd.	8
REW	10
Rycote	53
Scenic Sounds Equipment	23
Sescom Inc.	6
Shure Electronics	76
SIS Ltd.	12
SME Ltd.	67
Sonifex Sound Equipment	47
Soundcraft Electronics	13
Spendor	57
Squire's, Roger	17
Surrey Electronics	60
Trad Sales & Service	7
Trident Audio Dev. Ltd.	65
Turner Electronic Ind. Ltd.	47
Tweed Audio Electronics	15
Ward-Beck Systems Ltd.	75
Wilmslow Audio	53
Zoot Horn	57

Ward-Beck at the XXI Olympiad



The XXI Olympiad, a dedication to excellence within the framework of competition. A challenge for the athletes. A challenge for the supporting communications equipment.

Ward-Beck is proud to have been chosen by Canadian Broadcasting Corporation to supply WBS 75046 Mobile Audio Consoles to broadcast the 1976 Olympic Games to the world.



Tomorrow's Technology Today.

Ward-Beck Systems Ltd., 841 Progress Avenue, Scarborough, Ontario, Canada M1H 2X4
Telephone (416) 438-6550. Telex 06-23469

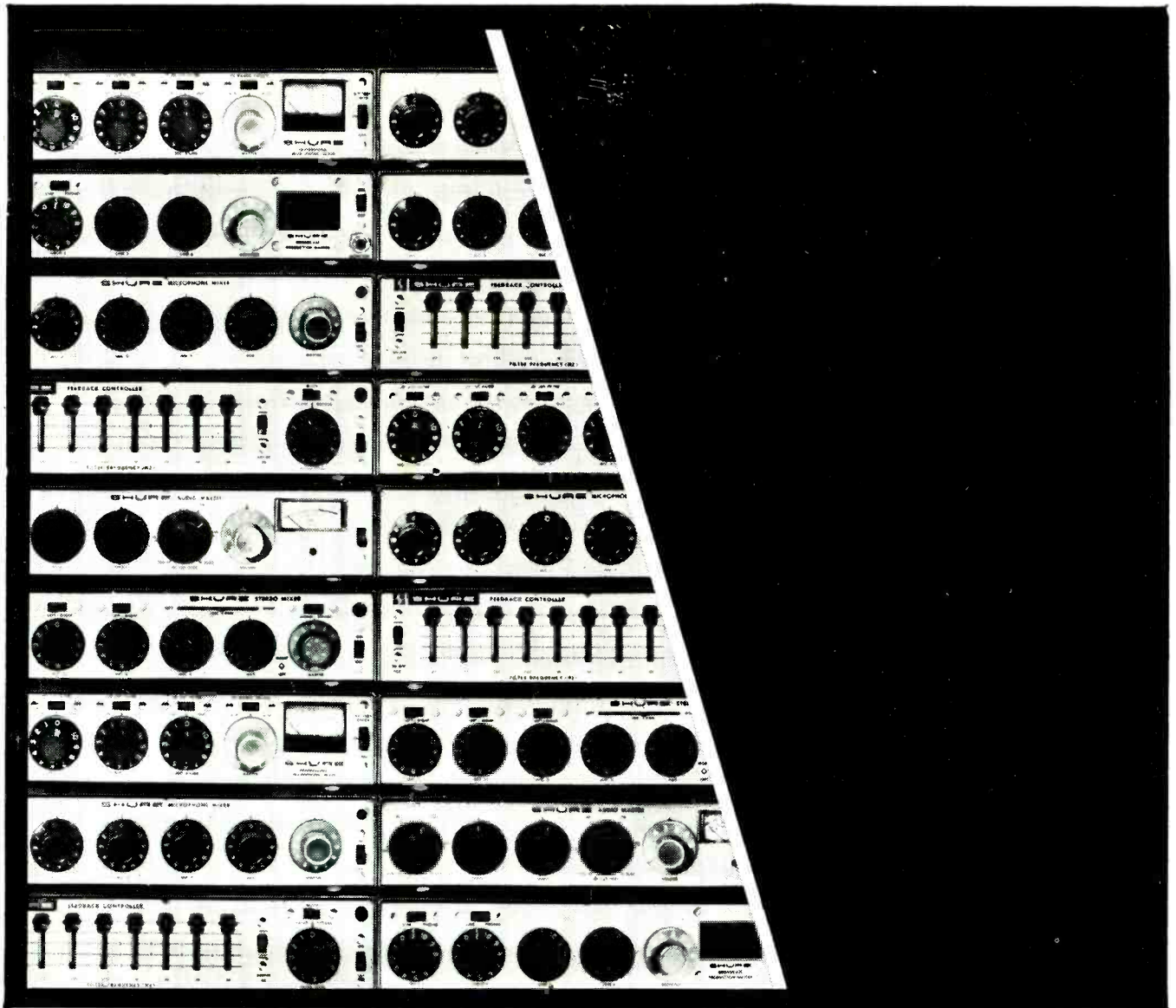

It's a mod, mod, modular world.



Simplify, simplify! Instead of paying more for bigger, bulkier audio control components, pay less for compact Shure modular components that—singly or in combination—handle critical functions flawlessly. Cases in point: (1) the *M67 and M68 Microphone Mixers*, the original high-performance, low-cost mixers; (2) the *M610 Feedback Controller*, the compact component that permits dramatically increased gain before feedback; (3) the *M63 Audio Master*, that gives almost unlimited response shaping characteristics; (4) the *M688 Stereo Mixer*, for stereo recording and multi-source audio-visual work; (5) the *M675 Broadcast Production Master*, that works with our *M67* to create a complete production console (with cuing!) for a fraction of the cost of conventional consoles; and (6) the *SE30 Gated Compressor/Mixer*, (not shown above) with the memory circuit that eliminates “pumping.” For more on how to “go modular,” write for the Shure Microphone Circuitry Catalogue.

Shure Electronics Limited
 Eccleston Road, Maidstone ME15 6AU
 Telephone: Maidstone (0622) 59881

