

February 1975 25p

studio sound

AND BROADCAST ENGINEERING



TEST TAPES
RECORDING TAPES
TEST DISCS

New from Cadac Stereo Portable Console

Standard configurations available: 10/2 or 10/4 expandable to 20/2, 20/4.

10/2, 10/4 available ex-stock; other configurations are available on short delivery times, 2-6 weeks.

Mic/line inputs—Two Echo Sends—Two Foldbacks—PFL—Monitoring—Five Frequency Oscillator, Comprehensive Talkback.

Equalisation divided into 5 bands covering 10 frequencies—curves:—reciprocal shelving and bell networks. High quality accurately matched linear faders. Fully balanced throughout.

Performance specifications to Cadac's usual high standards. Telex, phone or write for complete technical information and prices.

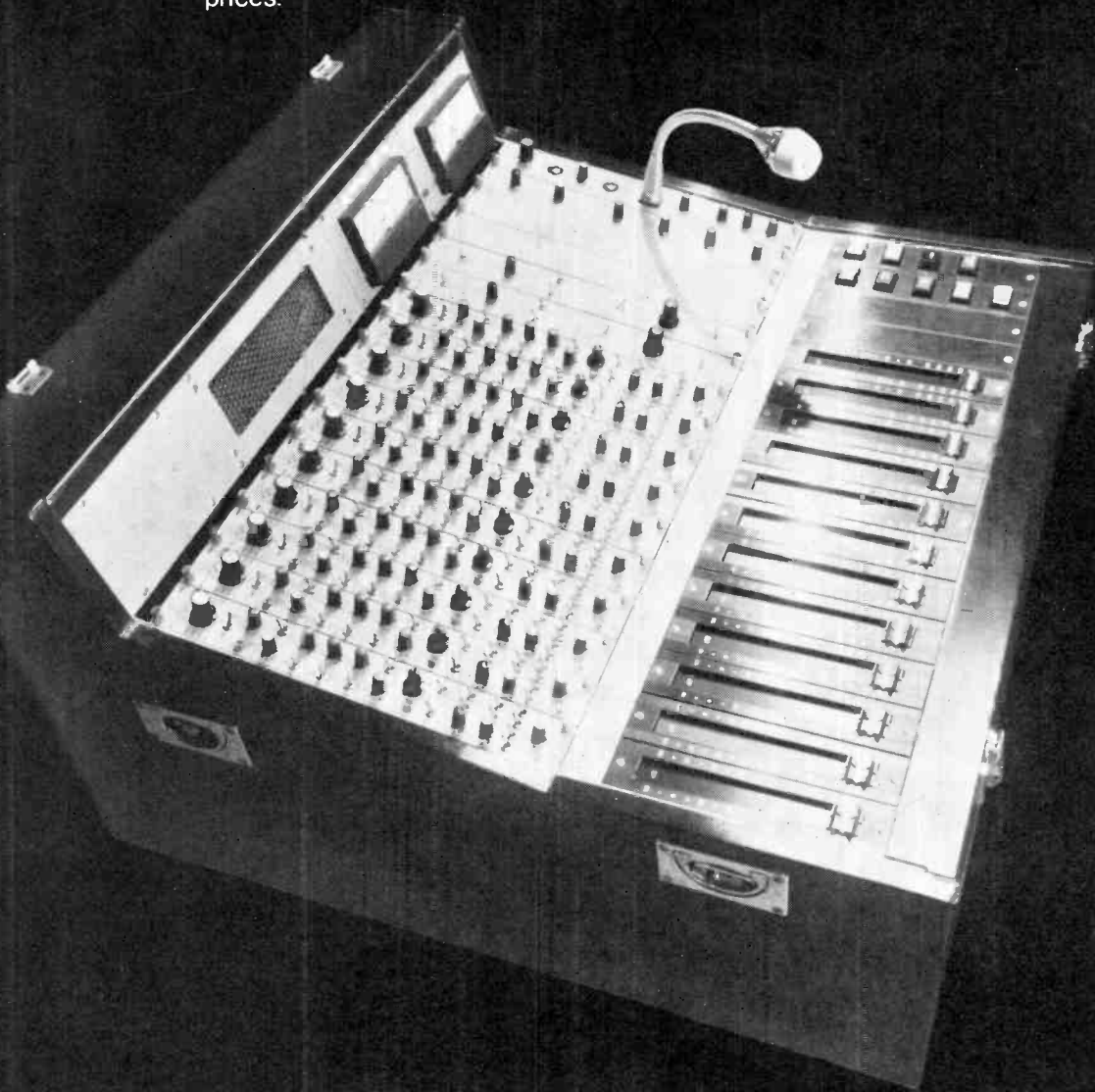

cadac

The leaders in music recording consoles and techniques.

Cadac (London) Ltd.
141, Lower Luton Road Harpenden Herts. AL5 5EL
☎ Harpenden (STD 05827) 64351 Telex 826323

studio sound

AND BROADCAST ENGINEERING

EDITOR MICHAEL THORNE
ASSISTANT EDITOR FRANK OGDEN
EDITORIAL PRODUCTION DRUSILLA DALRYMPLE
MAGAZINE SALES MANAGER DON BAILEY

FEBRUARY 1975 VOLUME 17 NUMBER 2



THE LINK HOUSE GROUP

Editorial and Advertising Offices: LINK HOUSE, DINGWALL AVENUE, CROYDON CR9 2TA. Telephone: 01-686 2599

Telex: 947709

© Link House Publications Ltd 1975. All rights reserved.

CONTENTS

FEATURES

RECORDING TAPE By Angus McKenzie	20
CLYDE By Jeff Barron	28
CAPITAL By Adrian Hope	34
TEST DISCS By Hugh Ford	38
TEST TAPES By Angus McKenzie	46
EQUALISATION AND PRACTICAL RECORDING By Frank Ogden	52
AZIMUTH By Angus McKenzie and Tony Faulkner	54

COLUMNS

NEWS	12
PATENTS	16
LETTERS	18
AGONY	36

REVIEWS

B & W DM4/D5 LOUDSPEAKERS By John Fisher	56
---	----

SUBSCRIPTIONS

STUDIO SOUND, published monthly, enables engineers and studio management to keep abreast of new technical and commercial developments in electronic communication. The journal is available without charge to all persons actively engaged in the sound recording, broadcasting and cinematographic industries. It is also circulated by paid subscription to manufacturing companies and individuals interested in these industries. Annual subscription rates are £4.17 (UK) or £4.20 overseas.

CORRESPONDENCE AND ARTICLES

All STUDIO SOUND correspondence should be sent to the address printed on this page. Technical queries should be concise and must include a stamped addressed envelope. Matters relating to more than one department should occupy separate sheets of paper or delay will occur in replying.

BINDERS

Loose-leaf binders for annual volumes of STUDIO SOUND are available from Modern Bookbinders, Chadwick Street, Blackburn, Lancashire. Price is £1.25 (UK and overseas). Please quote the volume number or date when ordering.

STANDARDISATION is a very boring subject. Most people ignore it. Whether it's wise to do that is open to question, but certainly in the underground cocoon of a tired studio in the small hours, all that seems appropriate is putting the music on tape and getting it from there under the arm of a satisfied producer who has to catch the morning plane to New York. Sometimes.

In the December issue, we published an article by Stephen Brown which expressed concern with the proliferation of digital codes for automated mixer information storage. Naturally, we hope that at an early stage in the development of such techniques there will be decided a common language which permits its easy transfer from one studio to another from one side of the world to another.

That is often more than can be said for bread and butter master tapes. Just as the professional engineer is awake to the needs and limitations of the following cutting, broadcasting or duplicating stage, he will know about the need for replaying his tape anywhere under the same electrical conditions. Accordingly, he includes with every set of masters Dolby or standard reference tones (see, it says what they are on the box). In addition he puts on a bit of 10 or 15 kHz so that whatever the relative phase of the tracks, in principle azimuth can still be tweaked to give optimum results elsewhere.

If the balance engineer were relying scrupulously on his test tape, on the evidence of the results obtained and discussed in detail elsewhere in this issue he may differ from a similarly careful engineer down the road. This may even be by an audible amount, not just academic tenths of a decibel. There doesn't seem much he can do about that.

The demands on magnetic tape are becoming heavier. Wide use of Dolby noise reduction emphasised the need for playback reference levels, and the advent of matrix encoding has reawakened concern about azimuth stability and accuracy. It isn't hard to get everything right given a useable standard. But if the ground is uncertain, then mismatches are going to creep in by accident and can be compounded. This leaves the magnetic tape industry two options: either it attempts to reduce the discrepancies between its standards published in the form of test tapes, or it proposes, even tacitly, that the limits of practical error are those found, and are due to the difficulties of communication and intercomparison.

STUDIO SOUND is published on the 14th of the preceding month unless that date falls on a Sunday, when it appears on the Saturday.



MEMBER OF THE AUDIT
BUREAU OF CIRCULATIONS

Total average net circulation of 7,641 per issue during 1973.

ITA—Britain's Leading Distributor

REVOX

REVOX A-700 SERIES



The new big Revox - ideal for all studio requirements. Highly sophisticated design features include servo tape tension, full deck logic, crystal controlled servo electronics, 3 speeds, tape footage counter.

Immediate delivery.

++ EUROPE'S LOWEST PRICES ++

REVOX A-77 SERIES Mk4



The famous A77 has been consistently improved over the past 8 years and is now available in the latest Mk. 4 version.

The wide choice of specifications includes versions for duplicating and logging applications. Backed by UK's fastest service.

*Hire service.
Check our prices.
Immediate delivery.*

OTARI

OTARI MX-7000 MASTER RECORDER

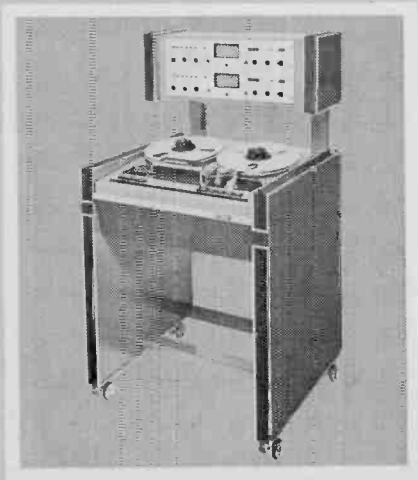

A field-proven master recorder from Japan's biggest manufacturer of professional tape recorders and duplicating equipment. Features include 3-speed operation, rugged construction, front panel EQ on record, play and bias, FET inputs, plug-in head assembly.

Track configurations: Mono, Stereo, 3-channel (NAB cartridge compatible), 4-channel $\frac{1}{2}$ or $\frac{1}{4}$ inch, 8-channel one inch.

Prices approx. 60% of comparable products.
Quick delivery.

of Studio and Broadcast Equipment

TEAC®

TEAC A3340(S) 4-CHANNEL RECORDER

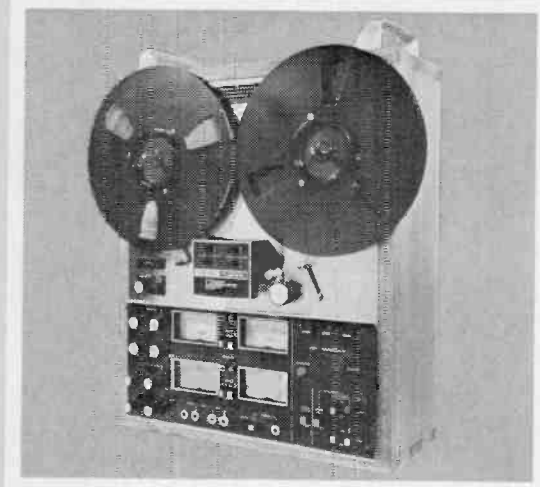

Industrial version upgraded to studio requirements, with increased signal to noise performance and improved reliability. Four totally independent channels each with sel sync, input mixing, switchable VU's and all the facilities for easy multitracking. This industrial model is in more studios than any other version.

*Available only from ITA.
(Semi-pro version also available)
Immediate delivery.*

Ten balanced inputs, four output groups, 4 limiters, bass mid and treble EQ, modular construction, headphone monitoring. Extremely high quality construction only matched by mixers costing around £1000. **£590 + VAT**

Twenty input version **£930 + VAT**.
Immediate delivery.
Also available for hire.

ITA 10-4 MIXER



OTARI

OTARI DP-4050 CASSETTE COPIER



Ideal for one copy or ten thousand. Eight times copy speed, foolproof operation for non-skilled personnel, modular construction, servo-controlled direct capstan drive.

Immediate delivery.

++EUROPE'S LOWEST PRICES++

Industrial Tape Applications

ITA

5 Pratt Street, London NW1 0AE.
Tel: 01-485 6162 Telex: 21879

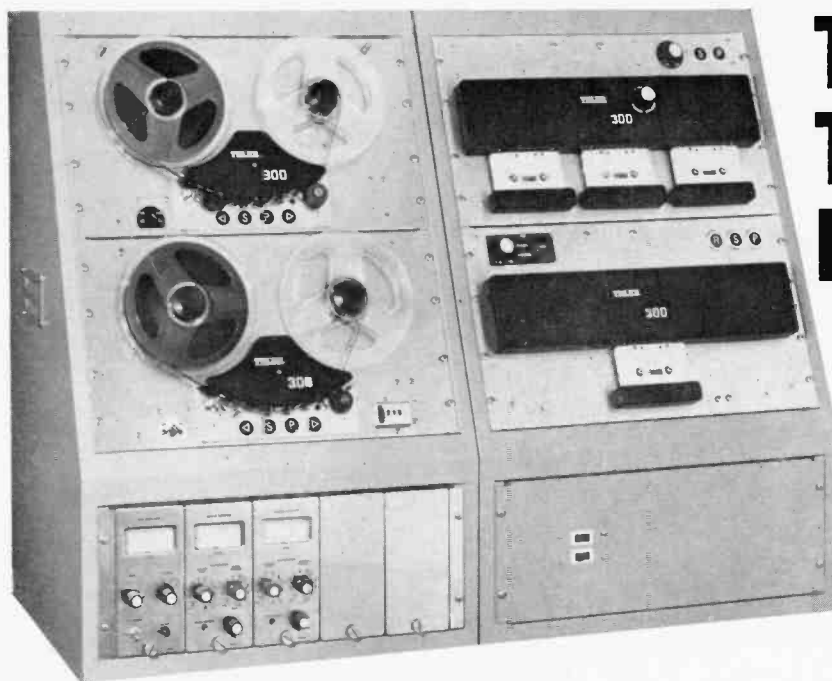

TELEX TAPE DUPLICATORS

modular system
flexibility for reel to
cassette, cassette to
cassette or reel to reel
operation.

mono or stereo.

designed for continuous
production.

prices from £1664.00

Avcom Systems Ltd., Stanlake Mews, London, W12 7HS.

01 749 2201



Microphones

— by **Grampian**

of course!

Model DP4 selected for the Design Centre, London.

GRAMPIAN REPRODUCERS LTD

HANWORTH TRADING ESTATE
FELTHAM, MIDDLESEX
TELEPHONE 01-894 9141



“sounds perfect”

AT LAST your search is over. If second best just will not do, you should be using our range of high reliability equipment which includes power amplifiers, 100v. line transformers, microphone transformers, rack cabinets, and some superb electronic lighting control units. Delivery—usually ex-stock.

Write now for the full details.

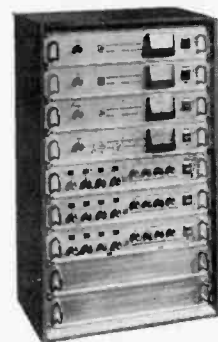

MUSTANG COMMUNICATIONS

NELSON STREET · SCARBOROUGH
YORKSHIRE · YO12 7SZ

Telephone (0723) 63298

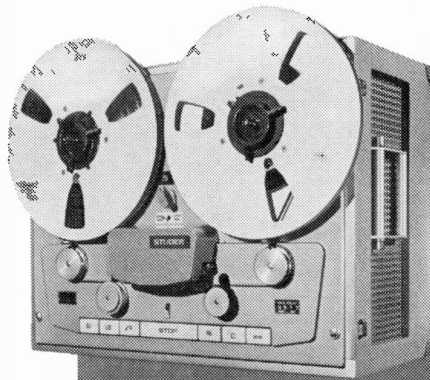

The Versatile Studer B62

Combining operational simplicity with proven reliability. All versions available with or without VU-panel

PORTABLE:
in robust
carrying
case.

FUNCTIONAL:
in compact
broadcast
trolley.

ELEGANT:
in A80-style
console.

ADAPTABLE:
in chassis form —
for vertical or
horizontal
mounting.

STUDER

F.W.O. Bauch Limited

49 Theobald Street, Boreham Wood,
Hertfordshire. Tel: 01-953 0091

THE *New* TANNOY

Monitor

HIGH PERFORMANCE DUAL

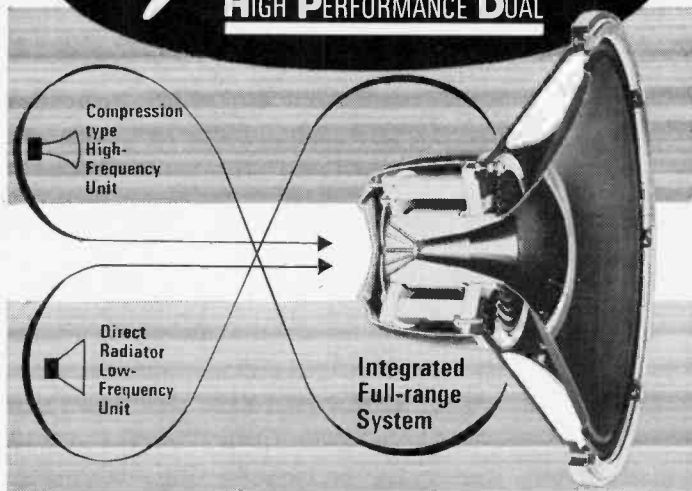

The Monitor H.P.D. represents a further outstanding improvement of a loudspeaker system which has become regarded as a quality standard over the last 25 years by Recording Studios throughout the world. There is a very good chance that your favourite records and tapes were monitored on Tannoy Dual Concentric loudspeakers, and to select these superbly engineered, individually hand-assembled speakers for your music system assures you of the same professional performance.

	260 mm 10"	310 mm 12"	410 mm 15"
Power Handling Capacity*	50W	60W	85W
Frequency Response	27-20,000 HZ	25-20,000 HZ	23-20,000 HZ
Intermodulation Products	less than 2%	less than 2%	less than 2%
Impedance via Crossover network	8 ohms (5 ohms min.)	8 ohms (5 ohms min.)	8 ohms (5 ohms min.)

*INTEGRATED PROGRAMME MATERIAL

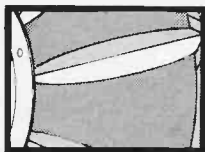

The Girdacoustic Cone improves frequency and transient response, gives much increased power handling capacity and greater mechanical stability.

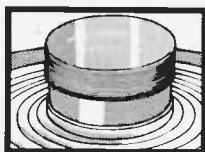

The High Temperature Voice Coil assures absolute climatic stability and great mechanical strength together with much improved power handling capacity.

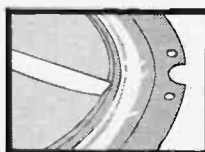

The Tanoplas Surround gives low bass resonance with excellent mechanical stability and freedom from edge reflections.

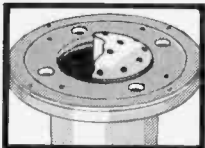

Patented Magnetic Shunt combined with specially treated and selected steel gives maximum magnetic flux in the unique Tannoy twin gap system. Improves sensitivity and damping.

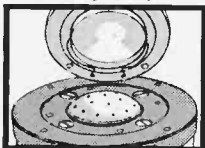

Unique High Frequency Unit with separate diaphragm and voice coil coupled to the horn by a 19 element phase-matching system.

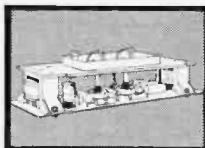

High Power Crossover Unit with solid dielectric condensers throughout, combined with treble and roll-off controls.

Designed to sound better—naturally...

TANNOY

NORWOOD RD. WEST NORWOOD SE27 9AB
Tel: 01-670 1131 Telex: 949755

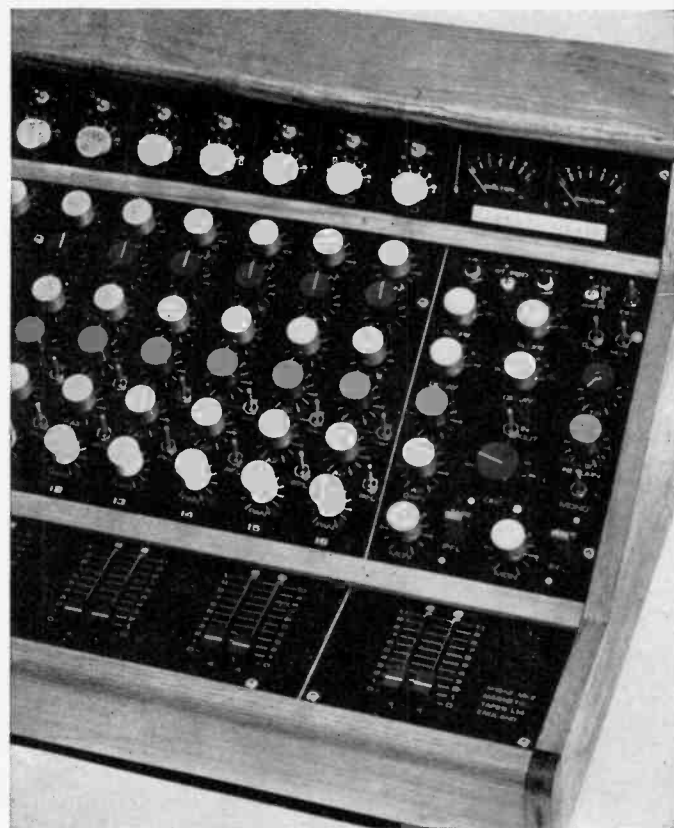

WHY CHILTON MIXERS?

We are manufacturers in the true sense of the word; producing Teak Cabinets, Sheet Metal Work, Tooling, Front Panel and Printed Circuit Artwork etc., our products are accurate with an attention to detail that is second nature to us.

The popular M10/2 (10in 2out) portable mixer shown is supplied as a basic unit with 10 Line inputs inc PPM, Oscillator, LF/HF Equalisers, 1 Aux and PFL. You choose the number of Microphone or Gram inputs, the channels to have Presence, Switchable HF/LF Filters or Ducking. In addition a 2nd Aux channel, Talk-Back, and/or Compressors can be fitted.

Ring or write for full information, if however our standard range is unsuitable it may be possible to modify one to suit your requirements.

M10/2 Mk4 BASIC £350.00+ VAT
16 input version £515.00+ VAT
12 in 4 out Mk2 £565.00+ VAT

MAGNETIC TAPES Ltd., Chilton Works,
Garden Rd., Richmond, Surrey, TW9 4NS

Telephone 01-876 7957

TAPING IT EASY

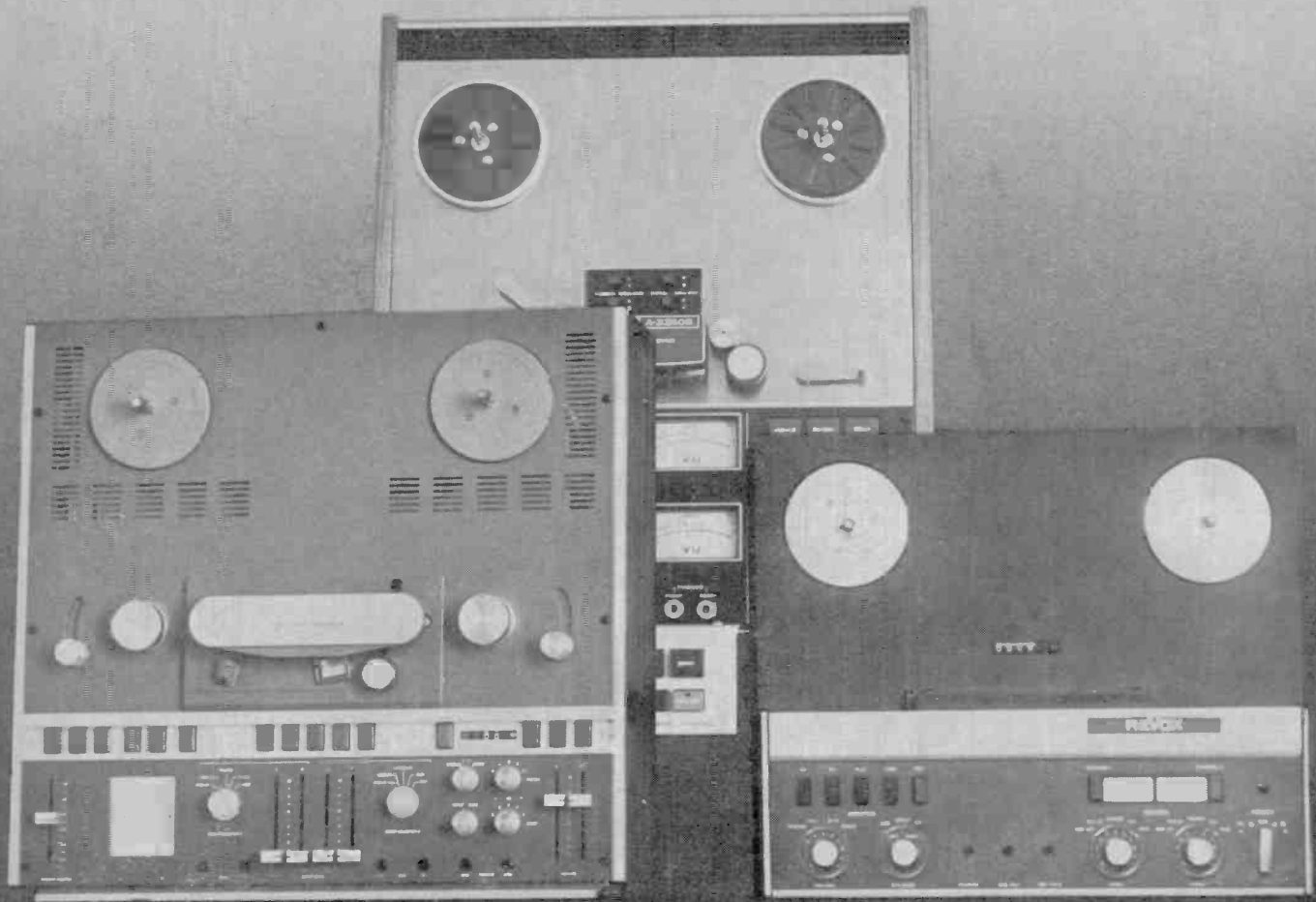

We can't just supply the best models of Teac and Revox tape decks

We also run one of the fastest most reliable servicing operations in the business.

And we modify your equipment to any specifications you require.

If you live in the London area, we'll collect your machine and do our best to re-deliver in 24 hours.

We also keep a comprehensive stock of accessories.

That's why you can tape it easy with.

**Taylor
Hutchinson**
Ltd

105 High Street, Eton, Bucks., SLA 6AF. Phone Windsor 51403

NEW

VFX-2 DUAL CHANNEL CROSSOVER/FILTER

The Amcron VFX-2 provides continuously variable filters which can be used to perform either crossover or band pass functions. The dual channel unit employs two filters per channel, each continuously variable from 20 Hz to 20k Hz. Filter rolloff is at a fixed 18dB/octave.

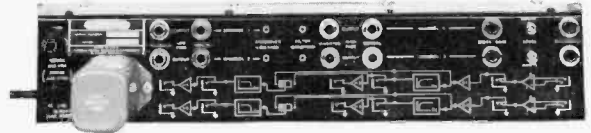

Our London stockists for all AMCRON equipment are REW (Audio Visual) Ltd., 146 Charing Cross Road, London WC2. Tel. 01-240 3883, and also at 10-12 High Street, Colliers Wood, London SW19. Tel. 01-540 9684.

or Direct to sole agents:



MACINNES LABORATORIES LTD.

**MACINNES HOUSE, CARLTON PARK INDUSTRIAL ESTATE,
SAXMUNDHAM, SUFFOLK IP17 2NL
TEL: (0728) 2262 2615**

BIAS RECORDERS



FOR PEOPLE WHO WORK WITH TAPE

**BIAS ELECTRONICS LTD. 01 540 8808
572 KINGSTON RD., LONDON SW20 8DR**

NOW AVAILABLE IN U.S.A. FROM

**ACOUSTIGUIDE CORPORATION
(212) 988 3016**

210 EAST 86th St., NEW YORK, N.Y.

PROFESSIONAL AUDIO PLUG-IN UNITS

- ★ Superb performance and reliability at moderate cost
- ★ Specially designed, 190 x 45 x 115mm, very rigid and lightweight castings house the electronics most effectively
- ★ McMurdo 16-way red range rear connector for all units
- ★ Supply voltage required 24VDC negative earth

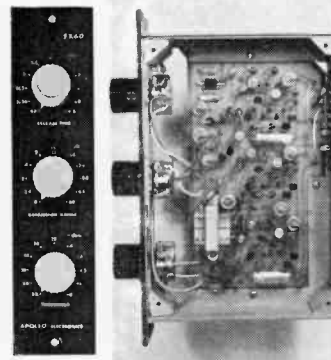

MC12 complete input channel for professional sound mixing desks.
MCX7 compressor-limiter-expander with built-in extra facilities.
MA80 input amplifier, Gain 0-80dB cont. adj., 4 pos. low cut filter.
PE16 tone equalizer, Treble and Base +1 dB, 7 Pres. freq. 0 to +16dB.
CL36 compressor limiter, Max. compr. 36dB, comp. ratio 1:1 to 1:72.
EX60 expander, for 0 to 60dB reduction of noise, crosstalk and interf.
LA26 line output amplifier, Gain 0-26dB, Zout. 50 ohms balanced.
PA10 monitor amplifier, 10W RMS into 8 ohms load, 32 VAC Supply req.
EPF4 echo send, pan-pot, foldback monitoring, for sound mixing desks.
TB90 mic. amp., Built-in dyn. mic., Gain 90dB, press-to-talk switch.
M112 12 input to single output summing amplifier, unity overall gain.
MP62 magn. P-U amplifier, 4 equalisations, sensitivity and 2 filter sw.
TH68 tape relay amplif., single NAB equal. but adj. from 1 and 7/8 to 15 IPS.
TRP1 tape relay amplif. and monitor amplif., dual NAB, A-B monitoring.
TRR1 tape record amplif. and bias amplif., dual NAB, record/safe/sync. sw.
TRE1 tape erase amplifier with erase kill switch.
TRB1 tape bias oscillator, can drive up to 24 pairs of TRR1 and TRE1.
PS24 power stabilizer, input 30VAC, output 24VDC/1A short circ. prot.
SG56 wien bridge oscill., 5 spot freq., 6 levels-72 to +6dBm.
HM80 general purpose audio control hybrid module.
HM70 microphone and playback hybrid module.
HM30 compressor—Limiter hybrid module.

APOLLO ELECTRONICS
96 MILL LANE, LONDON NW6 1NQ
Telephone: 01-794-8326

before...

you buy another mixer, consider our new product range.

Illustrated below is the new MOD 2 modular, 16 x 8 with 16-track monitoring, and all the most up-to-date operational features. We also have a new P.A. desk, a repackaged minimixer system with 4-track capability, an intercom system

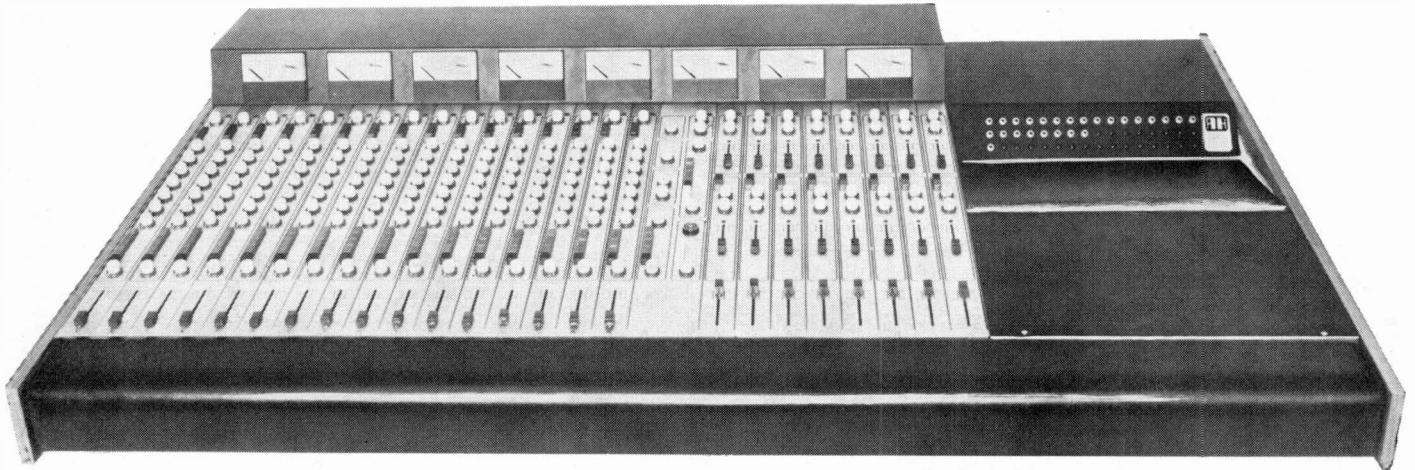

ALLEN & HEATH Ltd., Pembroke House, Campsbourne Rd., Hornsey, LONDON N.8. Tel: 01-340 3291 (10 lines)

Altec Sound Equipment by Theatre Projects



9846B Biampifier Studio Monitor Speaker System

For further information on the Altec range of sound equipment please fill in the coupon below and return to:

**Theatre Projects/Sole UK Agents
10 Long Acre London WC2E 9LN
Telephone 01-240 5411**



Please send me further information on the Altec range

Name: _____

Address: _____

Telephone Number: _____

I am particularly interested in: _____

Automated Advision

ADVISON CAN CLAIM to be one of the first recording studios to use programmable multitrack master reduction facilities. The system, supplied by Quad/Eight (page 69 December) promises to take the drudgery out of mixdown work allowing greater scope for the skills of the engineer/musician.

The Compumix system was specified by studio manager Roger Cameron and technical engineer Dave Dearden and now forms part of the Quad/Eight 32/6 quadraphonic reduction console on which even two of the pan pots are available for control by the tape data tracks. For creative mixing, it is necessary to give up two audio tracks on the master tape; in return, the system provides the engineer with the opportunity to compare previous mixes (one master tape track per mix) or to update and compare these mixes with each other. If the man finds that he's overdone it, he has the option to 'update' the channel faders during replay, illuminating an led when the control has been pushed to a -15 dB baseline for correction. Because the channel faders are voltage controlled, the new Advision desk offers control over a group of channels by one voltage on one fader.

To illustrate the advantages of the installation, Roger did a dummy reduction with a recently-recorded master. An oscilloscope connected to the multiplexed fader control voltage buss clarified what was happening in terms of real time fader 'position'. He first set up the channels manually, listening to each on its own and then to the whole establishing a baseline to work from. The content of the first mix, having been memorised by the system, was updated on specific channels during replay to improve the balance. Roger then decided that he wished to fade in the rhythm section ahead of the rest of the band in classic fashion; this was achieved by nominating the relevant channel faders with the numbered thumbwheel switch fitted to each channel. This links those faders with the same number keeping their relative positions constant. The band was further divided into percussion and lead in the same manner. He brought the rhythm in as planned reducing the level

when the other sections were faded in. The actual operation appeared on the 'scope as a series of steps in the trace moving in accordance with fader position for all the utilised tracks.

The man wasn't happy with the lead guitar; it sounded rather overbearing in comparison with the rest of the mix. This proved an easy situation to remedy requiring no more than the push of the 'write' button on the offending channel and a replay with more manageable levels of lead guitar. To ensure that the fault had been rectified, the former mix was played and compared with the rewritten version. The instrument sounded generally better but was now rather thin at certain points in the passage. Slight adjustments with the channel in the 'update' mode cleared any remaining problem as evinced by a quick comparison with the previous mix.

What do the musicians think of the new system? Greg Lake refused to use it insisting that he preferred the feel of a manual console. Five hours later, he decided to give the £8000 addition a try. It took him rather less than five hours to decide that the new desk, far from being a hindrance, was indeed a knockout

both in terms of time-saving and ease of operation. Roger Cameron says that this reaction is typical—most people new to the idea of automated mixing seem frightened of the prospect, but find that in practice things are much easier than they feared; indeed, the most important feature is that the machine releases the operator to indulge whatever talents that he/she may possess.

Wollensak cassette deck

DETAILED SPEC MACHINE from 3M seems to offer quite a lot of facilities in line with most of the second generation cassette recorders. In addition, it boasts Dolby 'B' processors which may be used with external apparatus etc. The transport is the same as the NEAL 102/103 and as such needs no further mention. Price: £231.48. 3M, 3M House, Wigmore Street, London W1. Phone: 01-486 5522.

AKG man

BARRIE DENTON, the likeable ex-Shure man of 13 years standing, has changed sides to join his former rivals, AKG, at the post of technical sales manager. Managing director Peter Eardley remains in charge of bunnies.

Hospital radio unwell

DUE TO BEGIN transmission in January was 3CN Royal Free Network, based on the Royal Free Hospital, Pond Street, London NW3. As part of the locally orientated hospital broadcasting system, it had been mooted since 1967, when the hospital itself had called in a consultant to prepare specifications of equipment needed for such a service. Unfortunately, these needs and subsequent specifications didn't coincide with the eventual ones, for the hospital did not understand what was required.

It is at least comforting to know that something is being bought for the NHS, but what arrived was a ten into two Pye mixer designed for pa work, having neither pfl nor tape recorder outputs, a Philips N4308 quarter track recorder operating at 9.5 cm/s and two Philips GA 160 turntable units which are fine except the arm lifts up when you switch the motor off. Such bureaucratic over-enthusiasm means that the new operational staff is now in possession of unwanted equipment and have no money to buy the necessary gear.

Michael Binstock, of 50 Kingsmere Park, London NW9, is looking for charity. If anyone has a

14 ►

Roger Cameron at the Quad 8 desk



WHO'S WHO IN SOUND

R. G. JONES
RECORDING STUDIOS

ROBIN JONES:
Managing Director
"When the time
came to expand
we naturally
chase Neve again."

NICK SYKES:
Recording Engineer
"Neve promised
a futuristic service..."

GERRY KITCHINGHAM:
Chief Balance Engineer
"...and they delivered!"

In sound recording when you get big you've got to get better no matter how good you were in the first place. Which is why R. G. Jones installed a new Neve 8038 sound control console in

expanding their Wimbledon studio. With 24 input channels and 16 output groups their potential and facilities are more than equal to any demand.

 **Neve** internationally sound people

Rupert Neve, Cambridge House, Melbourn, Royston, Herts. Telephone: Royston (0763) 60776. Or Cambridge (0223) 53454. Telex 81381. Cables Neve Cambridge.
2719 Reno Road, Malton, Ontario L4T 3K1, Canada. Telephone: 416 677 6611. Telex 0696 8753.
Berkshire Industrial Park, Bethel, Connecticut 06801, U.S.A. Telephone: (203) 7446230. Telex 969638. Hollywood Office: Telephone: (213) 465 4822.

NEWS

suitable small mixer which they would consider loaning or exchanging, please let him know. Day phone is 0438 4371, evening 01-205 3897.

NEAL cassette deck

DESCRIBED AS a transcription cassette deck, the new model 103 claims 'CCIR weighted, Dolby noise reduction on' noise figures of 64 dB using CrO₂ tape. The corresponding figure for ferric oxide tape is 62 dB. Short-term speed stability, quoted in terms of DIN weighted rms, amounts to .09%. Claimed to be unique in cassette machines, the 103 has adjustable bias with the exact level monitored by the programme vu meters. To set the bias, the user alters the amount according to the tape that he is using by reference to figures published by NEAL for each tape. VAT unweighted price of the 103 is £241. North East Audio Ltd, 5 Charlotte Square, Newcastle-upon-Tyne NE1 4XF. Phone: 0632-26660.

PA74—Leeds

SUCCESS FOLLOWS SUCCESS. That is the verdict on this year's show staged by the APAE at the Parkway Hotel, Leeds. After the very fruitful PA73, an even better follow-up by PA74 was thought to be nigh impossible; however, they did it—and in some style. The show was small, some 23 manufacturers exhibited, but seemed entirely in keeping with the nature of the public address industry; because of the 'all friends together' atmosphere, it appeared that most business was done in, and by, the bar.

In more detailed aspect, the show provided some interest for recording men, particularly if they were involved in ob or mobile recording. Keith Monks Audio displayed some folding microphone stands that weighed a mere 4½ pounds; they seemed very strong, were full-size and possessed an acoustic damping device in the base. KMAL also showed a very useful recess plate, complete with lid, allowing the fixture of two XLR sockets in the floor without fear of something else to trip over. Allen & Heath shared the same stand, their neat little mixers filling up everywhere KMAL mic stands weren't. For the midget size, they incorporated equalisation, foldback, panning, variable headroom and lots of other goodies.

In a larger size came two portable mixers from Soundcraft Electronics

offering a full range of facilities in differing presentation; one was encased in a wood surround and the other looked rather like an ammunition box. The former, of 12/4 format, suggested use for recording on location into a four channel machine. Standard features include pfl, switchable pfl metering, channel limiters, foldback, echo, equalisation and output metering with all relevant outputs at line level. The latter, possessing most features required of a pa, seemed to be orientated directly into that field. This view was enhanced by the 16/2 format. Most striking feature was the robust-looking metal case, complete with clasps, suggesting more a sea trunk than a piece of 'delicate' electronic gear. Philip Dudderidge, a director of Soundcraft, said there would be few problems involved housing the 12/4 in a sturdy metal case similar to that of the 16/2.

Roll-out cable drums were exhibited by CTH, the metal formers incorporating recessed XLR sockets. In addition, they displayed a range of small broadcast mic mixers that 'were very popular with the BBC'.

The Audix men were very amiable but confessed to exhibiting little of interest to STUDIO SOUND readers. However, on prompting, they uncovered some very fruity-looking monitor amplifiers with power potentials of up to 200W. On the export front, Audix are pledged to retrieving some £40 000 of Arab oil money by way of an exchange for broadcasting equipment.

Pressing shortage not alleviated

DESPITE THE ASSERTION made in our November issue, the pressing plant of French Decca turns out a mere 25 000 000 per year, not per month as stated.

Evening classes

EVENING CLASSES ENTITLED 'How Computers work' and 'Modern Colour tv Receivers' commence on January 21 and January 23 respectively. The courses, of two hours each session for nine weeks, cost £3.00. Apply: Senior Administrative Officer, South London College, Knight's Hill, London SE27 0TX. Phone: 01-670 4488.

Power amplifier

DELIVERING A CLAIMED 100 watts per channel into 8 ohms, the P-250 stereo power amplifier from Ken-sonic Laboratory Inc boasts a full power bandwidth from 20 Hz to 20 kHz. The makers further state

that the amplifier produces less than 0.1% total harmonic distortion at rated output; the half power distortion level is 0.05%. Other features include variable speaker damping, level metering and full short circuit protection. Ken-sonic Laboratory Inc, 2124-6 Motoishikawa-Chome, Midori-Ku, Yokohama, Japan. UK agents: Belmont A/V Ltd, Fircroft Way, Edenbridge, Kent TN8 6HA. Phone: 073-271 4116.

Ear defenders

MIGHT BE USEFUL for communications in the noisy environment of a recording studio, the ear defenders from Seawell will protect the ears from continuous exposure to high level sounds as well as enabling one-way talk through to the operator/wearer. The two channel defenders operate from an internal battery to give cordless flexibility, the info signals picked up from an inductive loop surrounding the working area. The units look like conventional cans and possess a similar weight—about 350g. They meet GPO approval and are available from Planned Equipment Ltd, Belvue House, Belvue Road, Northolt, Middlesex UB5 5HP. Phone: 01-841 6251.

Super cassettes

YET ANOTHER FIRM has produced a new model of cassette which 'is believed to be the best ferric oxide cassette for all machines . . .'. Of their LH tape, BASF state 'compared with other tapes, it gives a 50% increase in sound quality etc'. Other things claimed are 'a super smooth, wear resistant and mechanically rugged coating . . ., drop outs virtually eliminated etc'. Price is £1.30 for C90. BASF UK Ltd, PO Box 473, Knightsbridge House, 197 Knightsbridge, London SW7 1SA. Phone: 01-584 5080.

Teac turntable

THE DIRECT DRIVE turntable type TN400 features a dc servo direct coupled motor and an unusual magnetic suspension system reducing bearing induced rumble. The manufacturers claim a signal-to-noise ratio (no baseline given) of 60 dB with a corresponding short-term speed stability of 0.03%. The unit weighs 8.5 kg and costs about \$300. Teac Corporation of America, 7733 Telegraph Road, Montebello, California 90640. Phone: 213-726 0303. UK agents: Acoustico Enterprises Ltd, Unit 7, Space Way, North Feltham Trading Estate, Feltham, Middlesex. Phone: 01-751 0141.

Grosvenor studios

TO DESCRIBE the new Birmingham-based Grosvenor studios as a complex is to be exact; it has arisen, phoenix-like, from the old Hollick and Taylor recording studio and now encompasses sound on film dubbing, film editing, voice over, soundtrack synchronising film preview as well as an ultra-professional 16 track sound recording studio. Many hurdles barred the path, in the shape of planning authorities, finance gnomes, recalcitrant builders and petulant neighbours; none of these, however, prevented the creation of a major sound recording studio outside London.

The history of the new studio dates back towards the end of the last war when Mr Hollick, an enthusiastic radio engineer (the expression 'electronic' was yet to be created) met Mr Taylor, a competent young pianist and film cameraman. This classic encounter resulted in an old van fitted out with mobile recording gear used for location recording of local events. The fame of the duo spread, enabling them to trade in their

John Taylor and drum booth—see Grosvenor Studios



rather tatty equipment for something a little better. They could be credited with the first private mobile. This situation persisted until the early sixties when the 'pop scene' caused an explosion of business to overtake them and precipitated a new studio challenging the then acknowledged supremacy of Liverpool. This new studio enjoyed patronage by the names to the point of doing five sessions a day. The advent of local radio persuaded John Taylor that a new studio was required—hence the new complex.

The new Grosvenor studios occupy a large Victorian house about eight miles from Birmingham city centre in the quiet residential suburb of Handsworth Wood. From the front, the house retains its former identity; from the rear a very sturdy-looking windowless concrete extension tells all. The building is divided into four major sections; the first is the upper floors serving as John Taylor's spacious maisonette. The second section constitutes the reception area unfinished at the time of the visit. The third area consists of a small studio and control room, tape dubbing room, film soundtrack and projection room; the fourth section houses the main studio and control room.

The smaller Studio 2 finds use for talk over, jingle production and commentaries for films or slide lectures; it is also used for recording small musical ensembles. The associated control room has a double-glazed window at one end; the film transfer suite uses a similar window to allow projection of film pictures on to a screen mounted permanently within the studio. The acoustics, including those of the larger studio, were engineered by Sandy Brown Associates who also

specified the design for the air conditioning; it is essential that the air ducts do not create unwanted rumble or reduce the acoustic isolation between the working floor and the world outside. The corresponding control room houses a 10/4 Trident 'B' series desk feeding into a Studer A62. Additional dubbing material is provided by a brace of Sony TC 850 pro tape decks and a similar number of EMT turntables. As with the larger studio, Audio Design compressor limiters look after headroom with Spendor speakers handling the monitoring.

John Taylor describes the tape dubbing room as the place where anything can be transferred to anything else; this small but essential room contains the hardware to replay or record in virtually any medium. As well as the Revoxes that proliferate everywhere in the complex, there is an ITC NAB broadcast cartridge record replay machine, a domestic open reel unit, a cassette recorder and an eight track cartridge recorder as well as EMT turntables. To enable the two-way transmission of programme material anywhere in the complex, the relevant rooms are fitted with very simple mixers jacked as necessary into a common low impedance mixing buss; in practice, most of the material originates from the dubbing room. The other very obvious occupant of this room takes the shape of an MSS mono disc cutting lathe which, according to John, 'works very well on its good days'.

Studio 1 is large (10m x 12m x 4m) and is approximately twice the size of the predecessor. John Taylor says that this new studio will house up to 35 musicians in relative comfort enjoying the same

benefits of ultra quiet air conditioning as in the smaller studio. This, and other acoustic areas in the complex, have been lined with sound-absorbing boxes designed by Sandy Brown to reduce decay times to manageable proportions. According to John, these do their job so effectively that Grosvenor studios now manufacture the boxes under license for direct supply to other studios with reverberation problems. Because both studios share a common wall, special account has been taken in the design of this structure; the wall employs an 11 cm air cavity between 23 cm thick solid concrete producing a very high degree of acoustic isolation. Most prominent feature of the studio is the drum booth; it takes up one corner of the room and looks very much like a classic bass reflex speaker cabinet of hyper-proportions. Certainly, the booth is functional; one imagines that an energetic drummer could sustain a Ginger Baker solo without injury to flying elbows. A permanently connected monitor loudspeaker ensures that the man keeps time with everybody else.

The engineer (at the time of writing Richard Crowe) keeps a check on things around him by looking through a large double-glazed window with a direct view on to the studio floor. He juggles the sound levels with a group of very closely-spaced faders, an unusual arrangement on the Trident 24/16 'B' series desk, balancing the sound with the aid of Spendor BC3 monitors. Because of earlier failures of the KEF tweeters fitted in these units, there are now four cabinets to produce the required sound pressure level. Masters are recorded on a Studer 16 track A80 with editing and specialised effects handled by the ubiquitous Revox. The acoustics of the control room were also decided by Sandy Brown; the purple walls are liberally sprinkled with his bright yellow boxes resulting in a rich, uncoloured sound and a striking, if bizarre, colour scheme.

Everything about the studio gives one the impression of professionalism; this includes the way that the leads between equipment are largely unseen with nothing left lying around to trip over, the recessed mic sockets strategically placed around the operating floor to avoid strangulation of visiting musicians, but most of all, the visible competence of everybody working at the complex.

AES 75

THE AES 50TH CONVENTION will be held at the Cunard International Hotel, Hammersmith, London W6

from March 4 to 7. A full preview will be published in *STUDIO SOUND* next month. Convention enquiries should be addressed to Sam Black, The Modino Press Ltd, 1 Pembroke Road, Ruislip, Middlesex. Phone: 71-76201.

Variable mode speaker

REVEALED AT THE AUDIO show, a new loudspeaker from Omal claims to provide variable bass characteristics to suit individual room conditions. Operating from transmission line to damped bass reflex mode, the speaker has a complex array of mechanical 'trap doors' to achieve these varied functions. To complement the bass radiator, the mid and tweeter possess their own controls to adjust the relative acoustic energy levels. A hasty demonstration of these speakers proved rather disappointing, but this may have been due to the unsatisfactory test conditions. Ambionic Sound Reproducers Ltd, Omal House, North Circular Road, London NW10 7UF. Phone: 01-965 8787.

Mincom move

THE RECORDING MATERIALS Division of 3M have moved shop and now reside at Southall. The new address is Witley Works, Witley Gardens, Southall, Middlesex. Phone: 01-574 5929/6045.

The move comes about through increased activity in the division resulting in a need for more space to expand.

Tuning standard

THE EMT 117 TS TUNING standard, operating from an internal battery, claims to provide a pitch accuracy exceeding DIN 1317. The tone, audible through the internal loudspeaker, is variable in one-cycle steps from 435 Hz to 445 Hz. A socket provides output for relay to an external amplifier/speaker; the manufacturers state that the timbre sounds like that of the oboe. FWO Bauch Ltd, 49 Theobald Street, Boreham Wood, Herts. Phone: 01-953 0091.

Alice pulls it off

IN A LITTLE FLURRY of self indulgence, Alice (Stancoil Ltd) announce the signing of a contract to supply complete broadcast systems to the local radio stations—Teesside and Plymouth. They further state that there are projects under way concerning Radio Forth and the new National Theatre. Alice (Stancoil) Ltd, 38 Alexander Road, Windsor, Berks. Phone: Windsor 51056.

The Main Studio—Grosvenor Studios



THE FOLLOWING list of Complete Specifications Accepted is quoted from the weekly *Official Journal (Patents)*. Copies of specifications may be purchased (25p) from the Patent Office, Orpington, Kent BR5 3RD.

November 6

- 1378252** Eastman Kodak Co.
Apparatus for scanning information bearing media.
- 1378290** Dawe Instruments Ltd.
Ultrasonic transducers.
- 1378292** Marconi Co Ltd.
Information transfer systems.
- 1378284** Cosmocord Ltd.
Separable ear defender.
- 1378310** RCA Corporation.
Special effects generators for providing iris-type television displays.
- 1378355** Ball Bros Research Corporation.
Antenna assembly.
- 1378356** Ball Bros Research Corporation.
Dual slot antenna device.
- 1378357** Joannou, C. J.
Phonograph record player turntable and motor assembly.
- 1378427** Western Electric Co Inc.
Methods and apparatus for forming images and systems utilizing the same.
- 1378506** Lucas (Industries) Ltd, Joseph.
Cartridge-operated tape players.
- 1378521** RCA Corporation.
Passive vertical convergence circuit.
- 1378578** Plessey Co Ltd.
Temperature compensated acoustic surface wave resonator.
- 1378643** Matsushita Electric Industrial Co Ltd.
Apparatus for loading and ejecting a cartridge.
- 1378753** Defence, Secretary of State for.
Multiplex telecommunications systems.
- 1378772** RCA Corporation.
Recorder-producer system.
- 1378784** Taylor, P. H.
Sound radiating apparatus and systems.
- 1378792** Philips Electronic & Associated Industries Ltd.
Current source for supplying a current having an exponential wave form.

November 13

- 1379044** Sleishman, D. E.
Drum pedal device.
- 1379053** Crosfield Electronics Ltd.
Colour scanners for image reproduction.
- 1379054** RCA Corporation.
Special effects generator.
- 1379354** International Business Machines Corporation.
Turntable.
- 1379355** International Business Machines Corporation.
Laminar record member.
- 1379364** Kabel-Und Metallwerke Gutehoffnungshutte AG.
Mounting device for a radiating high-frequency line.
- 1379365** Hughes Aircraft Co.
Liquid crystal compositions.
- 1379372** Northern Electric Co Ltd.
Electroacoustic transducer having an inverted diaphragm.

- 1379396** Sperry Rand Corporation.
Magnetic disc storage assembly.
- 1379422** Siemens AG.
Bell arrangements.
- 1379494** Blaupunkt-Weke GmbH.
Television receiver circuits.
- 1379528** Grundig EMV.
Method of transmitting television images.
- 1379559** International Computers Ltd.
Modulation circuits.
- 1379597** Tobias, M. B.
Signal-rectification circuits.
- 1379605** Owens-Illinois Inc.
Image generation and recording.
- 1379609** Hell GmbH, Dr-Ing Rudolf.
Methods of and apparatus for stabilising the intensity of a fluctuating light beam produced by a high-intensity light source which also fluctuates in brightness.

November 20

- 1379657** Marconi Co Ltd.
Phase correcting circuits for diversity reception.
- 1379663** Minnesota Mining & Mfg Co.
Audio-visual system.
- 1379664** Central Telephone.
Transmitter-receiver.
- 1379698** Kahn, L. R.
AM stereophonic transmission and reception.
- 1379725** Western Electric Co Inc.
Multiplexing or demultiplexing networks.
- 1379732** Moon, R. T.
Radar-reflecting construction.
- 1379765** Morat GmbH, Franz.
Controlling a machine with signals derived from a pattern.
- 1379766** Morat GmbH, Franz.
Device for scanning and/or printing a sheet.
- 1379767** Morat GmbH, Franz.
Apparatus for reproducing a pattern.
- 1379771** CBS Inc.
Decoder for quadrasonic sound.
- 1379774** Nippon Victor KK.
Recording and/or reproducing systems and apparatus for a four channel record disc.
- 1379775** Pusch, G.
Monitoring apparatus.
- 1379801** Sonab Development AB.
Radio communication system.
- 1379856** Akademie Der Wissenschaften Der DDR.
Circuit arrangement for linear voltage-frequency or current-frequency conversion.
- 1379890** Steidinger, S.
Tape recorder drive mechanism.
- 1379904** Rank Organisation Ltd.
Video apparatus.
- 1379905** Rank Organisation Ltd.
Film transport apparatus.
- 1379955** Eastman Kodak Co.
Ultrasonic transducer.
- 1379974** Clarke Chapman Ltd.
Monitoring and indicating position.
- 1379984** Electronic Research Associates Inc.
Decorative loudspeakers.
- 1379988** Sony Corporation.
Amplitude control circuits.
- 1380052/3** Agfa-Gevaert.
Process for the application of a magnetic sound stripe to a motion picture film material.

- 1380078** American Cyanamid Co.
Light modulating device containing electrochromic material.
- 1380080** Baldwin Co, D. H.
Electronic musical instruments.
- 1380132** RCA Corporation.
Continuous television film projection system.
- 1380151** Stanton Magnetics Inc.
Protective circuitry for an electro-acoustic transducer.
- 1380185** Ferranti Ltd.
Television systems.
- 1380188** Singer Co.
Visual display system.
- 1380259** Eastman Kodak Co.
Photographic process of rendering an auxiliary silver image bleach resistant.
- 1380260** Eastman Kodak Co.
Photographic silver-bleach inhibiting compositions.
- 1380268** Eastman Kodak Co.
Process of selectively treating silver images.

November 27

- 1380375** Okikiolu, G. O.
Systems of materials for focusing and deflecting focused energy fields.
- 1380379** Westinghouse Electric Corporation.
Silicon carbide junction thermistor.
- 1380408** Siemens AG.
Acousto-optical light deflectors.
- 1380469** Polor-Hydraulic GmbH.
Audio-visual playback apparatus and a sound and picture disc adapted therefor.
- 1380475** Western Electric Co Inc.
Acousto-optic light deflectors.
- 1380485** Matsushita Electric Industrial Co Ltd.
Automatic switching device for EVR players.
- 1380486** Matsushita Electric Industrial Co Ltd.
Colour camera tube having colour strip filter and an index electrode.
- 1380502** Western Electric Co Inc.
Systems for the synthesis of speech from alphanumeric data.
- 1380509** Eastman Kodak Co.
Strip cartridge.
- 1380520** Compagnie Industrielle Des Telecommunications Cit-Alcatel.
Transmission and reproduction of trichromatic images.
- 1380546** GTE Sylvania Inc.
Vertical synchronizing circuitry.
- 1380615** Wiggins, D. G. J.
Tuning unit for guitar.
- 1380623** Ted Bildplatten AG AEG-Telefunken-Teldec.
Circuit for delaying a television signal by one line duration.
- 1380641** Xerox Corporation.
Electro-optic methods.
- 1380651** Western Electric Co Inc.
Transversal equalizers.
- 1380714** Vogel, P. S.
Television image modulator.
- 1380718** Brown Communications Ltd, S. G.
Telecommunications headsets.
- 1380805** RCA Corporation.
Record transport apparatus.
- 1380914** Rola Celestion Ltd.
Diaphragm assemblies for electro-acoustic transducers.

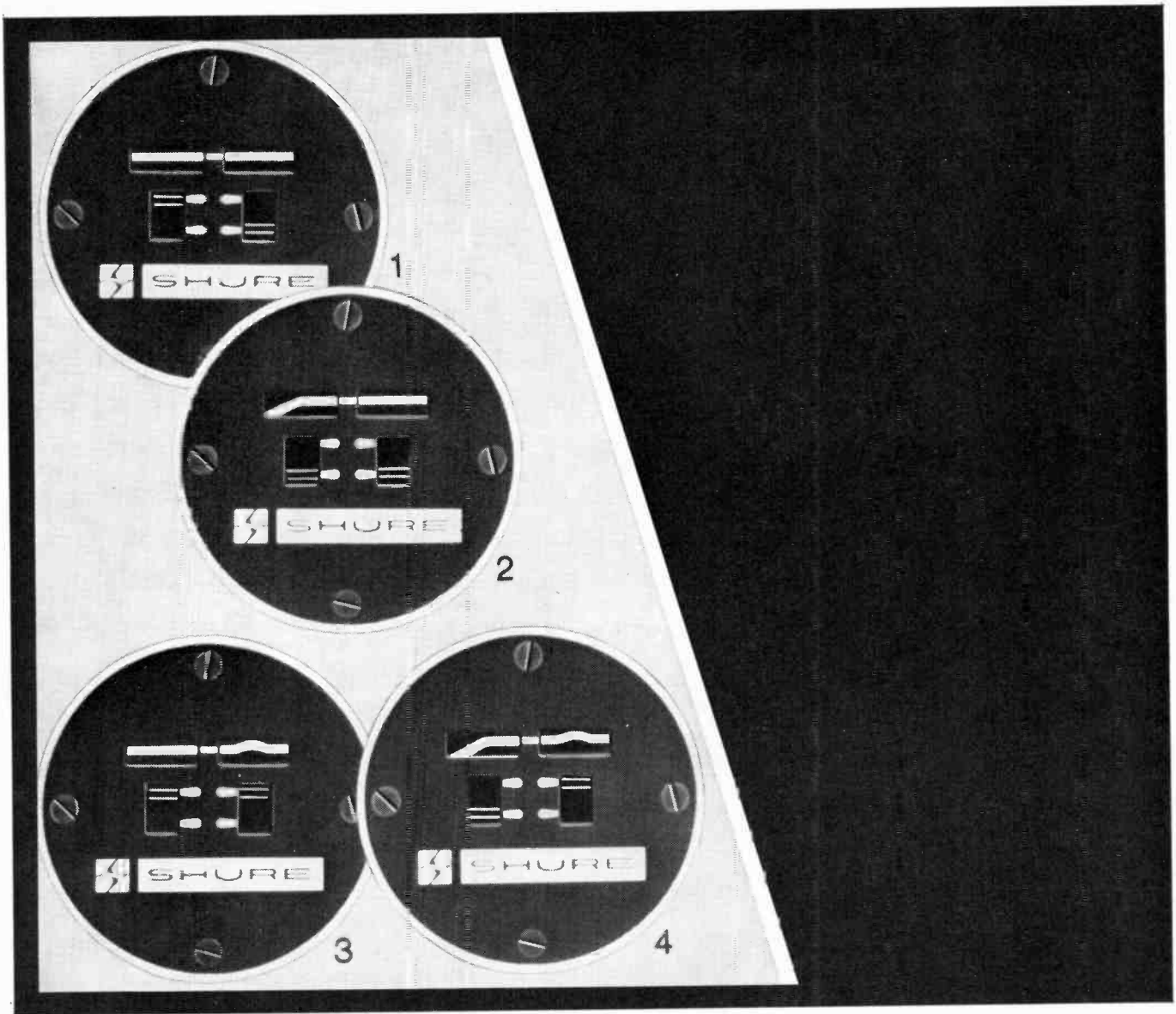

What you see is what you get.

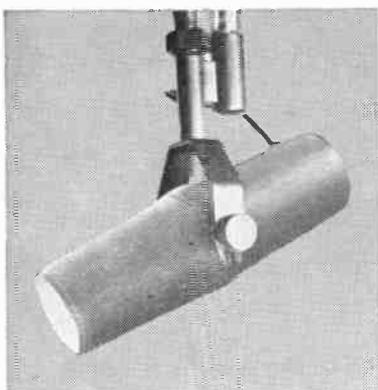

The extraordinary Shure SM7 professional microphone features something you've never seen before: a *built-in Visual Indication Response Tailoring System* that offers you four different frequency response curves—and shows you the curve you've selected with a graphic readout (see above) at the back of the microphone! Choose: 1. flat response; 2. bass roll-off; 3. presence boost; 4. combination of roll-off and presence. And there's more: the SM7 delivers exceptional noise isolation with a revolutionary pneumatic suspension mount . . . an ultra-wide, ultra-smooth frequency response . . . an integral "pop" and wind filter . . . and a cardioid pickup pattern that looks "text-book perfect." The Shure SM7 Studio Microphone was extensively field-tested in recording studios and broadcasting stations! Write:

Shure Electronics Limited
 Eccleston Road, Maidstone ME15 6AU
 Telephone: Maidstone (0622) 59881



Dear Sir, In reference to Adrian Hope's letter (October 1974, page 58) the following information may clarify his understanding of the system.

The Perspecta Sound was created for pseudo stereo in optical sound, developed by Fairchild Sound Equipment in Long Island, New York, USA.

This system was used in almost all wide screen films produced by MGM in the 50s, even the *Tom and Jerry* cartoons.

The use of Perspecta Sound in *Around the World in 80 Days* was only for the theatres with no 70 mm projectors and its six tracks of magnetic sound, making possible the showing of this movie on a standard Cinemascope projector with four magnetic tracks, using the integrator on track four which is the sound effects band, dividing this one in three pseudo stereo bands and splitting the effects. Its loudspeakers were usually located in the ceiling of the movie house or in its lateral and back walls, in three sections to enhance the general stereo feeling.

Some correction was necessary also, in the anamorphic lens. Cinemascope has a lateral expansion of 2:1. The copies released for this special version of Mike Todd's *Around the World in 80 Days* had a relation of 1.5:1. The projector speed was 24 frames per second.

I know the whole story because I was involved directly in this matter when that

movie was shown in Havana, Cuba in that special way in the Happy 50s.

Yours faithfully, Juan Marquez, Chief Engineer, 6 West Recording, Inc, New York City, USA.

Dear Sir, Thank you for forwarding the page prints of Hugh Ford's forthcoming article on our Automated Remix System to Mr Lindauer.

The following is submitted as a postscript to Hugh Ford's remarkably detailed and lucid review of the Automated Processes Mixdown Memory System (STUDIO SOUND, December 1974).

The model 554P programmable parametric equaliser, described in the article, has been superseded by a completely programmable unit designated model 954. This equaliser has the same basic voltage control as described in the review, except that high, mid and low frequency filters are programme-controllable in both broad and narrow (notch) modes, with shelving selectable in high and low bands as well. All three bands have continuously variable overlapping frequency control and continuously variable boost/cut of 15 dB.

Perhaps the following explanation will further clarify some of the arithmetic associated with the programmer. The carrier frequency of the encoded data channel, as recorded on tape, is switch selectable either 5 kHz (for restricted bandwidth applications) or 8 kHz.

Each data word consists of four complete cycles of the sinewave carrier, which at 8 kHz requires .5 ms for 16 function channels, to 128 ms for the total capacity of 256 channels. Level change or other control information is thus updated from 125 times per second to approximately eight times per second, depending upon the number of function cards installed in the system. A newly-developed accessory permits a substantial increase in the number of channels which can be accommodated at the same time by sampling faster-moving controls, such as faders, at the normal rate, while updating the less frequently modified functions such as equalisers at a slower rate.

It is unfortunate that the only equipment available to Mr Ford at the time of his review was a demonstrator, hastily thrown together for a trade show about two years ago. It has been shipped all over the world several times since then, returning to the factory occasionally only to have newly-developed items added. It is, therefore, hardly representative of an actual studio installation. We hope that Mr Ford will have the opportunity to evaluate one of the many Automated Remix Memory Systems actually installed and in operation in studios in the United States and Europe.

Yours faithfully, Saul Walker, Vice-President—Engineering, Automated Processes Inc, 80 Marcus Drive, Melville, New York 11746, USA.

PATENTS

1380917 RCA Corporation.

Channel monitoring system.

1380924 RCA Corporation.

Tracking control for recorder-reproducer systems.

1380927 RCA Corporation.

Record web control and drive apparatus.

1380928/29/30 Magnepan Inc.

Electromagnetic transducer.

THE LAST YEAR or so has seen a rash of patents for matrixing four channels into two, and now, with the National Quadraphonic Radio Committee due soon to report to the FCC on four channel broadcasting, a rash of multi-channel radio patents seems likely. It is generally agreed now that although matrixed broadcasting may be a useful stopgap (the FCC allows matrix transmissions, but the IBA and BBC do not) the long-term answer must be in discrete multiplexing. All the systems being considered by the NQRC transmit L+R and L-R in conventional manner (L+R modulates the carrier and L-R a suppressed sub-carrier) and all standardise on transmitting a third discrete channel by modulating the sub-carrier with a phase shift through 90°. Recently published British patent No 1367429 from Siemens AG dates back to April 1972 and could be very important in that it appears to protect much of this common thinking on the transmission of three discrete channels.

What Siemens claim protection for is as follows: A first audio signal is transmitted by modulating the carrier, a second audio signal

by modulating a suppressed sub-carrier, and a third audio signal by modulating the same sub-carrier phase-shifted by 90°. Taking the three discrete transmitted signals as K1, K2 and K3 and the four signal sources (eg horizontal surround sound sources) to be transmitted as Lv, Rv, Lh and Rh, matrixing for transmission is in accordance with equations:

$$K1 = Lv + Lh + Rv + Rh$$

$$K2 = Lv + Lh - Rv - Rh$$

$$K3 = Lh + Rh.$$

In the receiver, reconstitution is in accordance with the equations:

$$Lv + Lh = \frac{1}{2}(K1 + K2)$$

$$Rv + Rh = \frac{1}{2}(K1 - K2)$$

$$Lv + Rv = K1 - K3$$

$$Lh + Rh = K3.$$

These sum signals are fed to a quadrangle of loudspeakers with a right-hand loudspeaker receiving Rv+Rh, a left-hand loudspeaker receiving Lv+Lh, a front loudspeaker Lv+Rv and a rear loudspeaker Lh+Rh.

Of course although the patent refers to right, left, front and rear signal sources and loudspeaker positions, these could equally well be front left, front right, rear left and rear right, in accordance with current, more conventional practice. It will be interesting to see what kind of monopoly this patent gives Siemens in practice over the other would-be multi-channel broadcasters.

IN BP 1365213, the Matsushita Electric Industrial Company Limited, of Japan, proposes interesting new ideas on the decoding of stereo radio broadcasts. Although the patent specification is replete with mathematics, the

essential idea behind them is fairly clear. The inventors define a stereo transmission mathematically as a carrier signal modulated by a composite signal which can be expressed as:

$$(L+R) + (L-R)\sin 2\pi f_s t + P\sin \pi f_s t$$

where L is a left channel audio signal, R is a right channel audio signal, f_s is the frequency of a suppressed subcarrier modulated by the (L-R) signal, and P is a constant, the signal $P\sin \pi f_s t$ being a pilot tone at half the subcarrier frequency. The standard subcarrier frequency is of course 38 kHz and the pilot tone 19 kHz. On reception the stereo receiver demodulates and decodes, to give discrete L and R signals. The signal necessary for demodulating the subcarrier is most conveniently obtained by filtering the 19 kHz pilot signal and using a frequency doubler.

The Japanese suggest that this presents potential problems due to beat frequency components and the possibility of loss of channel separation due to phase errors arising between the pilot and demodulating signals. The new and alternative approach, they suggest, is to demodulate the composite signal as follows: Two, rather than one, demodulating signals are produced, both being of frequency $f_s/2$ but one differing in phase by $\pi/2$ radians with respect to the other. Demodulation is with a first multiplier to which the composite signal and one of the demodulating signals is applied, the output of this multiplier being applied to a second multiplier along with the other demodulating signal. This technique is claimed to overcome the beat frequency and phase error problems noted by the inventors.

Adrian Hope

REW AUDIO CONTRACTS

LONDON'S LEADING CONSULTANTS AND DISTRIBUTORS FOR P.A., STUDIO AND PROFESSIONAL AUDIO EQUIPMENT



TEAC 3340

The Teac A 3340 professional model is a very high quality, 4 track (separate) recorder. Operating at 7½ and 15 i.p.s. with full built-in sel-sync facility. Potential 8 input source (4 line and 4 mic) incorporating separate mixing controls on front panel. In stock.

NETT PROFESSIONAL PRICE ON APPLICATION

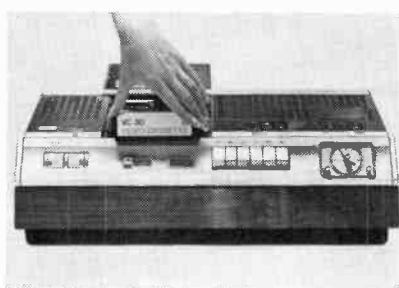

PHILIPS N1500 VIDEO CASSETTE RECORDER

Records all TV programmes in full colour.

Recommended Retail Price £449 + VAT.

REW CASH PRICE £409 + VAT

While stocks last. Video Cassettes extra.



REVOX A77

The world famous A77 1102 Series III semi-professional recorder, available in 3½ and 7½ i.p.s. or 7½ and 15 i.p.s. speeds + sel-sync and varipitch conversions. This machine proves a long standing favourite with the REW Audio Contracts range of mini-studios. In stock.

NETT PROFESSIONAL PRICE ON APPLICATION

The standard for P.A. amplification, industrial and laboratory use. No fancy gimmicks or fragile meters on the DC 300A, just plain solid functional design.

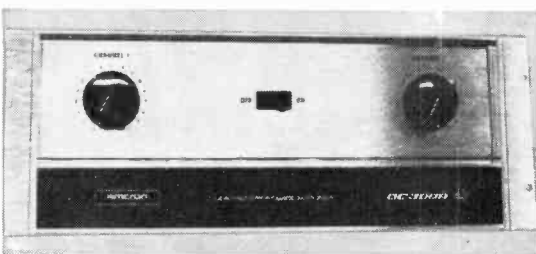

AMCRON DC300A

Frequency response ±0.1 dB dc to 20k Hz; Power response +1 dB -0 dB dc to 20k Hz; 1 HF output 420W RMS into 8 ohms, 800W RMS into 4 ohms; IM distortion less than 0.05% from 0.01W to 150W RMS, typically below 0.02% less than 0.01% at 150W; Hum and noise 110 dB below 150W RMS, typically 122 dB (unweighted) input sensitivity 1.75V ±2% for 150W into 8 ohms.

NETT PROFESSIONAL PRICE ON APPLICATION

The D150 is engineered to provide maximum total performance in universal adaptation. Two massive heat sinks and entire chassis are utilised to prevent thermal failure, the predator of most high power amplifiers.

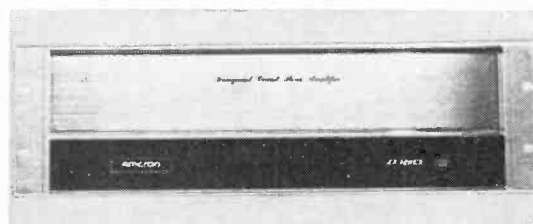

AMCRON D150

utilised to prevent thermal failure, the predator of most high power amplifiers.

Frequency response ±0.1 dB 20-20k Hz; power response ±1 dB 5-20k Hz; power output 75W RMS per channel into 8 ohms 20-20k Hz at rated distortion, typically 100W RMS per channel at 8 ohms, 140W per channel at 4 ohms; IM distortion less than 0.05% 0.01W to 75W, harmonic less than 0.05% 0.01W to 75W 20-20k Hz.

NETT PROFESSIONAL PRICE ON APPLICATION

SCOTCH 207 at very competitive prices

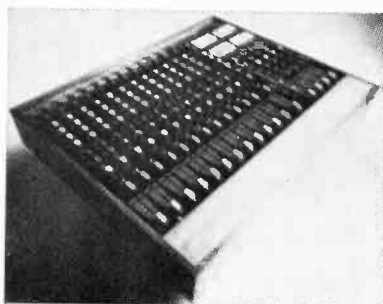

SOUNDCRAFT 12/4

Just arrived—12/4 Recording Console which is built into a teak case, incorporating 12 input and 4 output channels, output limiters, and full monitoring facilities. All input and output connectors are Switchcraft (XLR equiv.) except line input which are ¼" jack. 200 ohm mic. inputs are balanced. 4 band E.Q.; f/b send; echo send; pfl; channel switch; pan pots and faders.

NETT PROFESSIONAL PRICE £875 + VAT

REW Audio Contracts are able to offer the following microphones at professional prices (subject to stock) to bona-fide pro users.

AKG	AKG	SHURE	CALREC	BEYER	RESLO
D190	D707	515SA	CM652	M160	S80
D160	D900	588SA	CM655	M500	CABARET
D109	D1200	545		M260	S91
D12	D2000	565		M101	
D90	D202E1	548	Available in		
D200	D224E	SM57	DIN or CANNON (XLR) connectors.		
D202	C451*	SM58			

***VERY SPECIAL PRICE WHILE STOCKS LAST** **ALL PRICES ON APPLICATION** Full range of mic stands and accessories by KMAL.

*NOTE REW Audio Contracts and REW Video Contracts are registered trade names and are part of The REW Group of Companies.

ALL PROFESSIONAL AUDIO EQUIPMENT AT

REW Audio Contracts, 146 Charing Cross Road, London WC2. Tel: 01-240 3883

VIDIO, INDUSTRIAL AND STUDIOS AT

REW Video Contracts, 10-12 High St., Colliers Wood, London SW19. Tel: 01-540 9684/5 Telex 896194

Four years ago, in this magazine, the properties of the most popular commercial standard and long play tapes available in the UK were compared. For this survey, it was decided to be more comprehensive and to include some 'domestic' tapes, since many studios are now using them for copying work. Relevant parameters are summarised in the table; see text for discussions of evaluation and their relative importance.

Recording tape

ANGUS MCKENZIE*

NOWADAYS COMMERCIAL users are recording ever-increasing dynamic ranges, particularly with the utilisation of noise reduction systems, some of which may reduce high frequency noise, but not the subjective effects of modulation noise and print through. As intermodulation distortion is now generally regarded as more significant than harmonic distortion we now include intermodulation measurements around 1 kHz. Also, if this measurement is taken at 10 kHz rather than the old type of squash point measurement, a more valid indication is obtained of high frequency performance, which tallies better with subjective quality in that region. Ten per cent intermodulation distortion at 10 kHz is at a lower level than 1 dB squash (recording non-linearity or compression as compared with the overall sensitivity at -20 dB ref DIN), and the results published may well surprise many readers. Their relative importance is greater when using the DIN 35 μ s equalisation curve at 38 cm/s than when using NAB, but conversely for 19 cm/s they are of far greater importance if NAB equalisation is used rather than IEC.

All the main tests were carried out on a Philips *PRO 36* tape transport. All the measurements were taken to an accuracy of ± 0.05 dB, with the exception of mod-noise and print-through tests, which will be explained later. In several cases, measurements were taken on samples obtained from different sources and manufactured at totally different times, and this showed up some inconsistencies which, we are sorry to report, must be expected. It is not possible to pick out any particular tapes as being quite outstanding in all respects in terms of value for money, because users have different requirements and priorities.

If noise reduction systems are in use, the CCIR weighted noise, for example, may not be of particular importance; but modulation noise might be, since this noise occurs generally in the same frequency band as the signal producing it, although scrape flutter noise and longitudinal vibration effects are often confused with it. A tape with a very high output potential at middle frequencies but a poorer one at high frequencies is likely to give excellent results at a lower level, since middle frequency harmonic and intermodulation distortion will be lower. Tapes such as 3M *250* and Ampex *Grand Master* have very high outputs at middle frequencies, but it seems unwise to drive them very hard, because of the high frequency performance. Many interesting general conclusions can be made from the tests, and these are dealt with at the end of the survey.

All the tests were made with recording and replay gains set at the optimum levels for the particular test. The distortion and noise levels of the *PRO 36* were always much lower than those produced by any tape, the intermodulation distortion under the worst possible condition never being worse than 12 dB down on the tape measurement, even taking into account the recording head. Also, the weighted noise level of the replay amplifier was some 14 dB lower than the best tape. No distortion compensation circuits of any kind were used in the recording amplifier and all the actual tests were measured with the machine set up for NAB equalisation at 38 cm/s. The playback amplifier was set up using an average equalisation obtained from all the best NAB test tapes.

FIG. 1

3M 206
STABILITY AND
DROPOUT
AT 15kHz
(20dB BELOW 320nW/m)

PEN SPEED: 125 mm/sec
PAPER SPEED: 0.3mm/sec

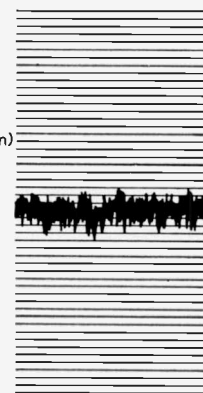
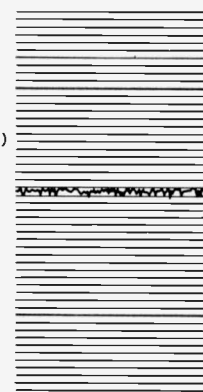

FIG. 2

AMPEX 407
STABILITY AND
DROPOUT
AT 15kHz
(20dB BELOW 320nW/m)

PEN SPEED: 125mm/sec
PAPER SPEED: 0.3mm/sec



A reference level of 320 nW/m was used from a BASF test tape, set up to give 0.775V out of the machine for the sensitivity, response and biasing measurements, and at 10 dB higher levels out for the signal-to-noise ratios. For all the distortion measurements a 10 dB lower level out of the machine was used. A Hewlett Packard *400 FL* Logarithmic milli-voltmeter was used for level measurements, and a *3580* audio spectrum analyser for most of the others. Bias current and waveforms were continually monitored, and chart recordings were taken of appropriate tests.

Harmonic distortion

The point at which 3% K_3 was produced by the tape at an input frequency of 1 kHz was measured at the biasing point corresponding to an overdrop of 4 dB at 10 kHz. The point at which this occurs measures slightly lower with the NAB curve than with the IEC one, since the former begins its treble boost on replay lower in frequency, thus exaggerating the 3 kHz output from the tape relative to the 1 kHz level. Note that a positive addition of 0.5 dB may be made for appropriate readings of distortion corresponding to use of the IEC curve, and this should be taken into account when relating these measured results to some manufacturers' specifications. We were amazed to find over 8 dB difference in the figures given by contrasting the worst tape with the best, but noted that the very high output tapes almost always had very poor signal-to-print

*Angus McKenzie Facilities Ltd.

ratios, but the reverse was true of the very low output tapes.

Many of the very high output tapes cannot be used to their full potential on some modest recorders, since in many cases we have found that record amplifiers are not capable of driving them, and some replay pre-amplifiers will overload quite badly at very high levels, particularly at low frequencies where feedback is at its minimum. Much external equipment, particularly those items which work at specific levels related to magnetic flux, may well also give trouble. A typical example is an original Dolby A301 unit which, unless modified, clips at approximately 18 dB into 600 ohms. In almost all cases we recommend that the very high output tapes are used well below their maximum output level point at 1 kHz. If lower output tapes are not driven fairly hard, signal-to-noise problems, without noise reduction, may well appear. Some makes of recorder include pre-distortion circuits in the record amplifier, and exceptionally low harmonic distortion figures can be achieved with their use. Although we have not tested any such machine's intermodulation distortion, we feel that this might rise rather dramatically under certain circumstances, and so great care must be taken with their setting up and use.

The harmonic distortion figures given for 1 kHz represent a 30.5 dB ratio between the fundamental 1 kHz output from the tape and the 3 kHz output, this measurement being for replay equalisation (NAB). One most important fact about the thicker oxide tapes is that they will not show longer wavelength improvements so easily as other types if narrow record gaps are used, since the flux may well not penetrate fully into the oxide. Some differences may be measured in general performance if either much narrower or much wider gaps are used, but since a 7 micron record gap seems fairly typical on modern equipment, such a gap was used. Both record and playback heads were ferrite. The replay head was nominally 3 micron, although we felt a 3.5 micron equivalent gap nearer the mark.

We also measured the K_3 distortion of 1 kHz at an output flux level of 320 nW/m and once again we were surprised to find the difference between the best and worst tapes was very wide, from 0.1% to 1%. This shows clearly that very high output tapes, if not driven too hard, can produce remarkably low distortion figures. We also found it interesting that the distortion can rise by 20 dB with a signal increase of 12 dB. However, we discovered by examining some of the tapes at intermediate levels that the rate of increase of distortion was not always quite the same, but space and time did not allow us to investigate this further.

Intermodulation distortion

Whereas pure harmonic distortion is musical in that all musical instruments have a very high percentage of their total energy in harmonics, intermodulation type distortion is totally unmusical. The extra frequencies produced usually bear no musical relationship to the frequencies producing them. Such distortion is therefore clearly more apparent than harmonic, and we decided to check measurements around 1 kHz and 10 kHz. For the former, two oscillators having frequencies of 950 Hz and 1050 Hz were mixed into the virtual earth mixing circuits of a Crown intermodula-

tion analyser, with the output being fed via a calibrated attenuator into the tape recorder. It was most important that equal amplitudes should be recorded, and these were constantly monitored with the audio spectrum analyser. The point at which a level of 850 Hz was reproduced 20 dB below the level of each of the main tones was noted. The output level relative to 320 nW/m was measured on the Hewlett Packard 400 FL, allowing meter readings to be noted theoretically to an accuracy of .05 dB, but rounded to the nearest appropriate reading. Such rounding up or down throughout the report was later further changed again, always in the same direction, to the nearest level fraction of a dB that we considered was relevant to the reliability of each particular test.

The 1 kHz 10% im figures were found to be approximately 1.25 dB higher in level than the 3% K_3 figures measured with a NAB curve, and more closely approximated to the K_3 figures that would have been measured with a 35 μ s curve.

For the im distortion figures at the higher frequency end the two oscillators were set at 9.5 kHz and 10.5 kHz respectively, and the 8.5 kHz output was noted in exactly the same way as for the 850 Hz figure. Note that in general lp tapes produced significantly better figures than the standard play ones, and that these figures tended to follow the treble response figures measured at 10 and 15 kHz. Tapes having a good modulation noise performance always sounded cleaner than the poorer ones, when listening to the 10 kHz intermodulation tests. 38 cm/s NAB has, inherently, 3 dB more head room at the treble end than IEC (DIN).

The last tape survey commented on the irony that most American tapes seemed well suited for the DIN curve and that European ones seemed to work better with the NAB curves. This is still true in many cases, but now that American manufacturers are introducing higher output tapes this is not so pronounced as it was. In this respect, see remarks in the print-through section.

Print through

The effect of pre- and post-print-through on tape has worried recording engineers since the introduction of magnetic tape recording. The main cause appears to be a variation of particle size in the oxide coating of the tape, but is also concerned with the type of crystal used. Unfortunately, ferric crystals which produce the highest output also seem to produce by far the worst print-through. Approximately 20 dB difference was noted between the worst and best examples, and we find this state of affairs horrifying, since many users tend to ignore the effect—just hoping that it won't occur.

A 1 kHz tone was recorded at exactly 3% K_3 point on each tape at each tape's measured operational bias point. After a recording time of one minute the tone was cut. The tape was then wound back slowly to the beginning, and stored for 72 hours at a reasonably even temperature of approximately 20°C. The tapes were all recorded and tested at approximately five-minute intervals in a non-stop sequence to avoid any chance of changes in temperature or environment which could affect some makes of tape. We decided for practical reasons to

measure post-print, but had we measured pre-print all the figures would have been marginally worse. The print-through measurement was taken using the audio spectrum analyser set to 10 Hz band width at 1 kHz, with time scanning from left to right and with approximately 80 dB signal-to-noise ratio available, and with 1 cm vertical deflection per 10 dB. The logarithmic output from the analyser was taken to a B&K 2307 pen chart recorder fitted specially with a linear potentiometer, and the entire system was pre-calibrated throughout.

While most impressed with the very best tapes, we were alarmed by the serious print-through of the worst ones. If print is a problem in your typical programming, we recommend that tapes showing figures better than 65 dB down should be chosen. Such tapes are likely to be more suitable for archive requirements, typically necessary in broadcasting and library work. Tapes with figures of 60 dB or worse should only be chosen with great caution.

It was clear in the tests that some manufacturers seemed virtually to ignore print-through, whereas others regarded it as one of the most important factors. In general, print-through will be exaggerated if the tapes are stored in too warm a temperature, or subjected to frequent and large variations of temperature. One of the most important reasons for storing master tapes end out is to encourage an engineer when playing back a tape to spool it through first, as this will remove a certain amount of print. In severe cases repeated slow spooling can improve matters, but each spool through makes progressively less improvement, and after four or five no further improvement can be expected. In general, print-through occurs particularly on the surface layer of oxide and in very severe cases a tape can be played through a machine having an exceptionally small dc current passed through the recording head. This must be done with the greatest care, and before any attempt is made the master should, of course, be copied. Sufficient dc to decrease the 15 kHz response of a tape by 2 or 3 dB should give a significant improvement, but depends on the time that has elapsed since the last play through or spooling, and the actual type of tape.

If Dolby noise reduction is in use, at first glance it would seem that print-through would be improved subjectively, but unfortunately since the noise is reduced by an equal amount at middle frequencies but a larger amount at very high frequencies, print-through can become just as disturbing. If a Dolbyed master tape having print-through is copied through to a playback medium which has considerably less dynamic range available, the print may well be obscured by the noise of the playback medium. It is surprising, though, that many otherwise excellent modern stereo lps of popular and classical music have noticeable print on them, as opposed to groove pre- and post-echo.

Most so-called 'wonder tapes' having remarkably high outputs at middle frequencies, and sometimes even at higher frequencies, have very poor print figures. This is most unfortunate, since in other respects these tapes have remarkable properties. It is no good having a signal-to-noise ratio of 70 dB if the signal-to-print ratio is -54 dB (3M type 250). Such a tape, unfortunately, could provoke a disaster

STANDARD PLAY TAPES

	Average standard play	Average long play	Agfa PER525	Ampex 406	Ampex 9472	BASF LGR30P	BASF SPR50LH	EMI 815	EMI 816	Maxell UD50	Memorex	Racal Zonal 317	Racal Zonal 101	3M 206	3M 250	3M 262	3M Classic
Bias, dB	0	-0.25	-0.25	-0.5	-0.25	-0.25	+1	0	0	+0.25	-1	0	-0.25	0	+1.5	+0.5	+0.25
Overdrop at 10k for +1 dB bias' at 1 kHz, dB	4	3.25	4.5	3.5	5	4.5	4.25	4	4	3.75	2.75	3.75	4.5	4.25	4.25	4.5	3
1k sensitivity, dB	+0.75	-0.25	+0.75	+0.5	+3	+0.5	-0.5	0	-1	0	+0.25	+1.25	-0.5	+0.75	+2	+1.5	+0.75
10k level, dB ref 1k	0	+1.5	-0.75	+1	+0.5	-0.75	-0.75	-0.5	-0.25	+1.25	+2	-1	+0.5	-0.25	+0.25	-1	+1.75
15k level, dB ref 1k	0	+2.25	-0.75	+1.5	+1.25	-0.5	-0.75	-0.5	-0.5	+2.5	+2.75	-1.5	+0.75	-0.5	+0.05	-1.25	+2.25
1k mol, NAB 50+3180 μs, dB ref 320 nW/m (k=3%)	+7.5	+6.5	+7.5	+6.5	+12.75	+7	+7.75	+6.25	+4.5	+7.25	+6	+8.25	+4.5	+7.5	+11.5	+8.75	+7.75
Trendell mod noise, dB ref 1k mol	-40	-40.5	-37.5	-40.5	-43.5	-38.5	-41.5	-39.5	-39.5	-41.5	-41	-40	-39	-40.5	-36	-39.5	-40.5
10% im 950+1050 Hz (850 Hz), dB ref 320 nW/m	+8.5	+7.75	+8.5	+8	+13.5	+8	+8.25	+7.5	+6.25	+8.25	+7.5	+9.75	+6	+8.5	+11.5	+9.75	+8.75
10% im 9.5k+10.5 kHz (8.5 kHz), dB ref 320 nW/m	+5.25	+6.5	+4.75	+6	+8	+4.75	+4.25	+4	+3.5	+7	+7.25	+5	+4.75	+4.75	+7	+4.5	+7.5
Signal to print, dB ref 1 kHz mol	-65	-62.5	-69	-64.5	-60	<-70	-70	-67	<-70	-68.5	-66	-62	-68	-62.5	-54	-63.5	-54.5
CCIR weighted noise, dB ref 320 nW/m NAB	-54.5	-55	-52	-53.75	-54.25	-52.75	-54.75	-54.5	-54.75	-55.25	-54.75	-54.5	-53.25	-56	-56.5	-53	-56.5
Harmonic distortion, % ref 320 nW/m NAB	0.4%	0.75%	0.4%	0.6%	0.1%	0.4%	0.4%	0.6%	0.95%	0.45%	0.65%	0.4%	0.9%	0.45%	0.1%	0.3%	0.45%
10% 1k im, dB ref weighted noise, NAB 38 cm/s	-63	-62.75	-60.5	-61.75	-67.75	-60.75	-63	-62	-61	-63.5	-62	-64.25	-59.5	-64.75	-68	-62.5	-65.25
10% 10k im, dB ref weighted noise, NAB 19 cm/s	-59.75	-61.5	-56.75	-59.75	-62.25	-57.25	-59.25	-58.5	-58.25	-62.25	-62	-59.75	-58	-60.75	-57.75	-57.25	-64
Mean of preceding two, cf IEC 38 cm/s	-61.25	-62	-58.75	-60.75	-65	-59	-61	-60.25	-59.75	-62.75	-62	-62	-58.75	-62.75	-65.75	-60	-64.75
15 kHz stability	—	—	fair	fair	fair	good	fair	fair	good	fair	fair	fair to poor	fair	poor	fair	fair	poor
15 kHz dropout	—	—	good	good	good	excel.	good	average	excel.	average	average	poor	v. poor	poor	poor	good	average
Wind—grading	—	—	8	8	10	10	10	10	10	2	3	10	10	7	8	8	8
Wind—comment	—	—	good	v good	fair	excel.	excel.	poor	excel.	poor	poor	poor	poor	good	good	good	good

LONG PLAY TAPES

	Average standard play	Average long play	Agfa PE36	Agfa PEM368	Ampex 407	BASF LP35LH	BASF LPR35LH	EMI 825	EMI Hydynamic	Maxell UD35	Memorex	Racal Zonal 417	3M 307	3M 209	3M Classic	TDK AUDUA
Bias, dB	0	-0.25	-1	+0.25	-0.75	-0.25	+0.25	-0.25	-1.5	+0.25	-0.75	0	+0.25	-0.75	+0.5	+0.5
Overdrop at 10k for '+1 dB bias' at 1 kHz, dB	4	3.25	2.75	3	3.5	2.5	3.0	3.5	2.75	3.75	2.75	3.5	3.25	3.25	3	3.5
1k sensitivity, dB	+0.75	-0.25	-0.25	0	+1	-1.75	-1.25	-1	-0.75	+0.25	0	+0.5	+0.25	-0.5	+0.75	0
10k level, dB ref 1k	0	+1.5	+2.5	+2.25	+0.75	+2.75	+2	+1.25	+2.5	+1.75	+1.75	+0.75	+0.25	+0.25	+1.75	+2
15k level, dB ref 1k	0	+2.25	+3.25	+3.5	+1	+3.75	+2.5	+1.75	+3	+2.5	+2	+0.75	+0.25	+0.25	+2.25	+3
1k mol, NAB 50+3180 μs, dB ref 320 nW/m (k ₃ =3%)	+7.5	+6.5	+5.5	+7	+6.75	+6.75	+6.75	+5	+4.5	+7.25	+5.75	+6.75	+7	+5	+8	+8
Trendell mod noise, dB ref 1k mol	-40	-40.5	-42	-44	-39.5	-40	-41.5	-36.5	-34.5	-42.5	-41	-38.5	-41	-40	-43.5	-51
10% im 950+1050 Hz (850 Hz), dB ref 320 nW/m	+8.5	+7.75	+7.25	+8.25	+8.5	+7.5	+7.75	+6.5	+6	+8.25	+7.25	+8.5	+8.25	+6.25	+9	+8.75
10% im 9.5k+10.5 kHz (8.5 kHz), dB ref 320 nW/m	+5.25	+6.5	+7.25	+7.5	+6.25	+7	+7	+5	+6.5	+7	+7	+5.75	+5	+4.75	+7.5	+7.5
Signal to print, dB ref 1 kHz mol	-65	-62.5	-	-65.5	-63.5	-	-65.5	-68	-68	-67.5	-66	-62.5	-58	-62.5	-53	-63
CCIR weighted noise, dB ref 320 nW/m NAB	-54.5	-55	-54.25	-54.5	-53	-56.25	-55.5	-54	-54.25	-54.5	-54.75	-54.25	-56	-56	-56.75	-55.25
Harmonic distortion, % ref 320 nW/m NAB	0.4%	0.75%	0.75%	0.5%	0.5%	0.65%	0.55%	0.9%	0.9%	0.4%	0.75%	0.6%	0.55%	0.85%	0.45%	0.4%
10% 1k im, dB ref weighted noise, NAB 38 cm/s	-63	-62.75	-61.25	-62.75	-61.25	-63.75	-63	-60.5	-60.5	-63	-62	-62.75	-64.25	-62.25	-66	-64
10% 10k im, dB ref weighted noise, NAB 19 cm/s	-59.75	-61.5	-61.5	-62	-59.25	-63.25	-62.5	-59.25	-60.75	-61.75	-61.75	-61.75	-61	-60.75	-64.35	-62.75
Mean of preceding two, cf IEC 38 cm/s	-61.25	-62	-61.5	-62.25	-60.25	-63.5	-62.75	-59.75	-60.5	-62.25	-61.75	-61.5	-62.75	-61.5	-65.25	-63.25
15 kHz stability	-	-	good	aver.	good	aver.	aver.	aver.	aver.	aver.	aver.	poor	aver.	aver.	aver.	v good
15 kHz dropout	-	-	fair	good	v good	fair	good	good	fair	good	fair	fair	good	good	fair	good
Wind—grading	-	-	5	10	10	4	7	5	10	10	9	2	10	2	2	2
Wind—comment	-	-	fair	excel.	fair	fair	fair	fair	poor	poor	poor	poor	poor	v good	poor	poor



■ TAPE SURVEY

if used for archive purposes for a valuable recording.

Bias

We checked the output from the top of the record head straight through a 10:1 divider probe into an ac millivoltmeter whose output fed an oscilloscope. Each tape was measured for an overdrop of 1 dB at 1 kHz and we then checked to see what this bias level created as an overdrop at 10 kHz. We felt this figure is important, since we noted far greater variations than originally expected. The variation seemed to depend just as much on ferric crystal structure as on the actual coating thickness. After much experimentation and lengthy discussion with colleagues in the tape recording field, we decided that the fairest way to evaluate the tapes effectively was to increase the bias current for peak output at 10 kHz, to increase the current further for a drop back of 4 dB, and to test both standard play and long play tapes in the same way. The bias seems to have been fair for all the tapes, and samples of them were also tested at lower and higher biases without any significant improvements. It will be seen that most of the tapes have been biased as they were in the last tape survey. Every test was performed with the bias current set to agree with the specified bias of 4 dB over drop at 10 kHz. The bias oscillator was very clean, and the heads were demagnetised several times during the tests, although at no time did this change any parameters, showing that it was not really necessary. Two bias figures are given. One is the strength of bias current required for each optimum bias with respect to the current required for EMI type 816, a tape which we found to need the average bias level. The other shows the amount of overdrop at 10 kHz corresponding to a 1 dB overdrop at 1 kHz.

Sensitivity

The record amplifier was set up after the replay amplifier had been carefully adjusted for a flat response, so that the overall response was extremely flat with a specific batch of EMI 816. We carried out the 1 kHz, 10 kHz and 15 kHz sensitivity tests at an input level giving an output from the reference tape of 32 nW/m at 1 kHz (20 dB below mono DIN reference level). The 10 kHz and 15 kHz figures published are the relative boosts or cuts with respect to the 1 kHz sensitivity of each tape. In almost all cases the 10 kHz intermodulation performance tallied closely with the 10 and 15 kHz sensitivity figures. In particular, lp tapes generally had better high frequency performances. The 15 kHz figures will give a good indication of a tape's suitability for use at lower speeds, but this must be taken with their dropout performances, which will have an important bearing on performance for such applications. We found that the very high output tapes were more sensitive at 1 kHz and conversely the low output tapes required more current through the record head for a given recorded flux. However, the increased sensitivity of a high output tape is not proportional to its 1 kHz 3% K_3 point, but approximates to just higher than the 1:2 ratio.

FIG. 3 AGFA PEM368 MODULATION NOISE

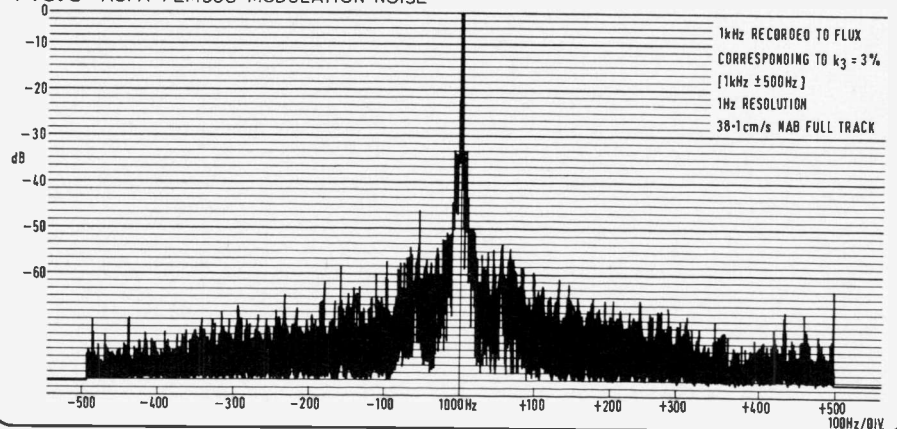

FIG. 4 AGFA FR4 (15 YEARS OLD) MODULATION NOISE

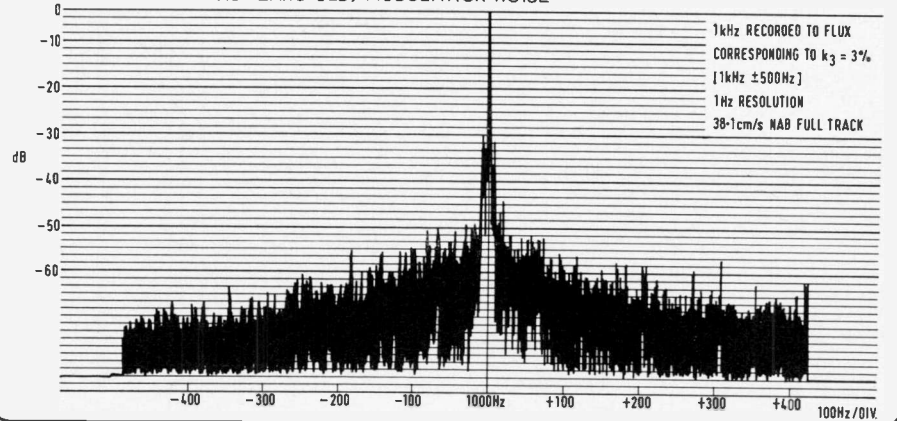

FIG. 5 MAXELL UD50 MODULATION NOISE

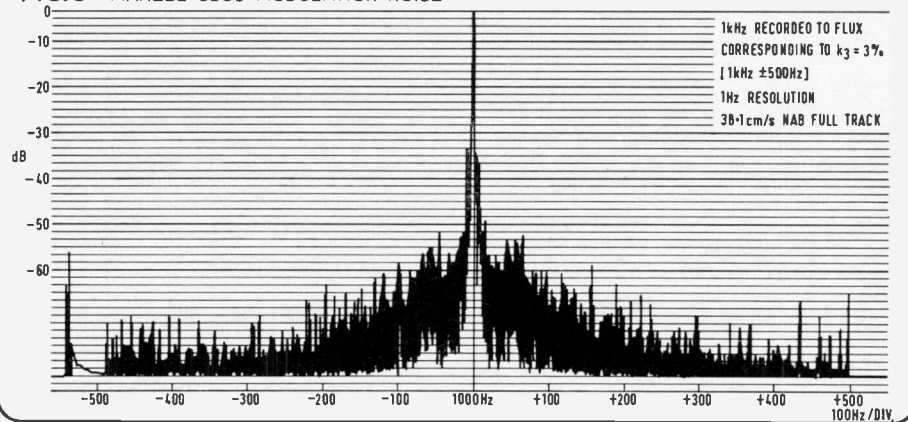
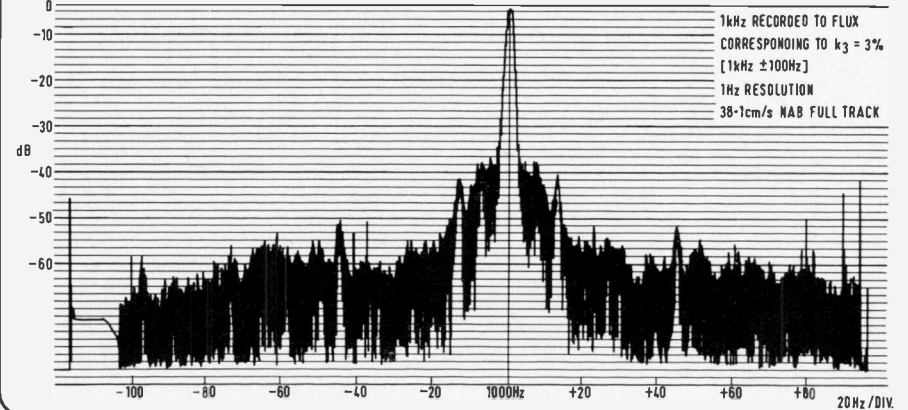
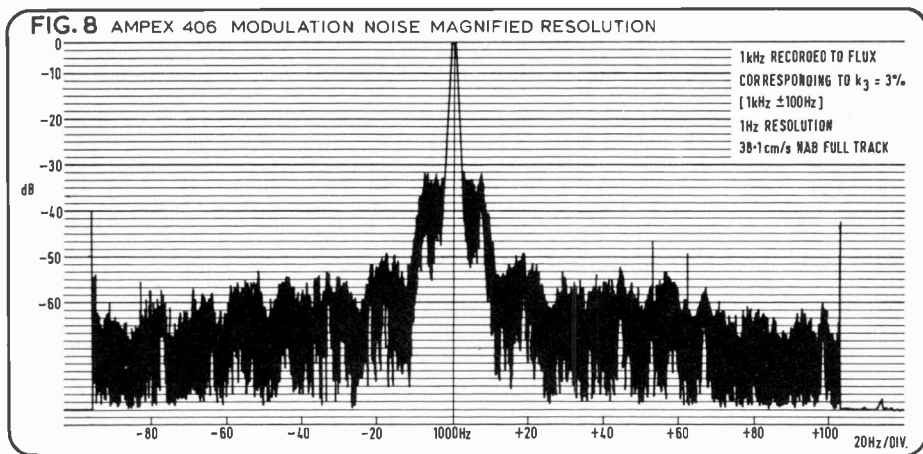
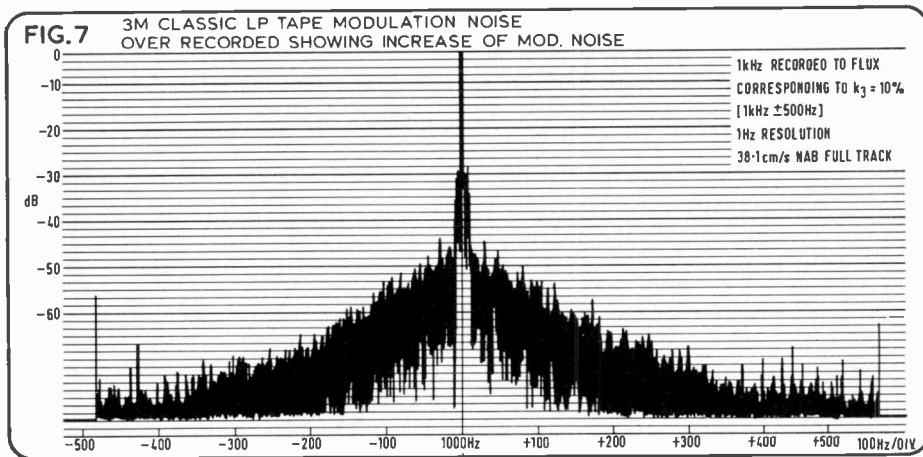

FIG. 6 MAXELL UD50 MODULATION NOISE MAGNIFIED RESOLUTION





Stability and drop outs

We recorded a 15 kHz frequency at 20 dB below DIN output level, and the output of the recorder was fed into the audio spectrum analyser (30 Hz band width) having 1 dB per vertical division sensitivity and law. The Y axis output was taken to the pen chart recorder (linear pot) running with a pen speed of 125 mm/s and a slow paper speed of 0.3 mm/s. The stability of the tape was estimated from the general width or furriness of the trace (see for example figs 1, 2). The dropout performance was given by the number of deviations noted from the mean greater than 0.5 dB. We noted that a tape having a number of dropouts usually had at least one major one, but on the other hand we discounted a measurement when only one large dropout occurred as this could have been caused by a non-typical event. We also noticed that the tapes creating more furriness in the trace had greater short-term variations across the spectrum analyser screen.

Dropout performance can be exaggerated seriously by poor tape transport mechanisms and typical examples of the cause of dropouts may be helpful. Insufficient back tension can cause serious problems, as can variations of

tension around the circumference of the payout spool. Look carefully to see if the tape is catching on either rim of this spool, causing swinging of a tension control guide or roller. Irregular running of rotating bearings either caused by poor matching or faulty ball bearings can also give trouble. Any fixed guides should be examined carefully to see if any flats have developed, since these can score the oxide surface and cause oxide shedding. This can cause an oxide particle to rest in the record or playback gap, either for a long time or until the head is cleaned. During tests, the heads and guider were cleaned after each tape had been tested. Some semi-'professional' machines are totally unsuitable for standard play tapes, let alone thick oxide-coated ones. Dropouts in such circumstances can become quite serious, and furthermore heads will frequently become worn quickly, especially when a tape has a comparatively rougher surface and a matt back. BASF LR56, for example, although an excellent tape for professional recorders, wore the heads of many semi-professional models very quickly, and the same can be said of Agfa type PER 555. Neither of these tapes is included in the report since we understand that

they are not now offered for sale. We looked at several tapes' consistency of output at 1 kHz with equipment having a resolution of .02 dB, and we found extremely interesting regular variations in output level. These variations take the form of a level change of the order of ± 0.05 dB every few cm of tape. The distance between maximum and minimum, however, varied from tape to tape, and we feel that it was due to minute coating thickness variations produced at the coating stage. One professional body contacted has told us that they have noted similar variations with a completely different measuring technique, mainly by the use of a stroboscopic lamp pointing on the surface of a moving tape from different angles, eventually seeing shadings every few cm, tallying almost precisely with our own findings. See section on modulation noise for further comments on coating thickness variations.

Noise levels

We measured the CCIR weighted noise of each tape relative to the output level given through the filter at a playback of a 320 nW/m 1 kHz tone. This weighted noise figure should be related to the distortion characteristics at middle and high frequencies of each tape. If 38 cm/s NAB equalisation is used, the most relevant ratio will be the weighted noise to 1 kHz 10% im measurement, but with 38 cm/s IEC we recommend that you take the weighted noise to the mean between 1 kHz and 10 kHz im column to allow for the 3 dB extra treble shelf boost required for IEC on record. If you are primarily interested in performance of the tapes at 19 cm/s then note the column of weighted noise below 10 kHz im. We have published these four columns to save time in making calculations from the other columns. The best tape, incidentally, was still 14 dB noisier than our replay amplifier.

When considering signal-to-noise ratios, bear in mind that if you are using a noise reduction system of the Dolby A type you should not be too concerned with small differences between tapes. However, with most other types of noise reduction system, noisier tapes may well produce hiss pumping effects, particularly at high frequencies. We feel that users should aim for a tape which has an acceptable performance in dynamic range, but is also good in relation to print-through, dropouts, stability and neatness of wind.

Modulation noise

This noise falls into three groups which are not necessarily inter-related. Basic mod noise is technically termed 'asperity noise', and is created directly by the size and type of oxide particles and their form of suspension in the binder, and indirectly with the type of backing.

Scrape flutter noise is transmitted along a tape to the replay head and produces an effect at high frequencies which can be quite distressing.

Longitudinal vibrations of the tape caused by very small rotatable guides or general deck vibration can also contribute to the noise around the frequency of modulation.

After considering different methods of assessing mod noise, we decided that the fairest way which coincided with subjective listening was one discussed by E. G. Trendell (AES

■ TAPE SURVEY

Journal Vol. 17 No. 6, Dec 1969). We would particularly like to acknowledge the help of EMI Tape at Hayes, who loaned us their one and only 'Trendell box' which allowed us to test over an extended period. We noted quite wide variations of readings, of which we took between five and ten for each tape, a higher number of readings being taken when the variation in the first five was wider. The table gives the arithmetical mean of all the readings taken for each tape. Trendell claims that tapes having a mod noise measurement better than 38 dB would not cause audible subjective effects, but we feel it would be safer probably to put the figure at 40 dB.

Modulation noise can become more severe if the wrap round the record and playback heads is incorrectly adjusted. Too little wrap round can cause bubbling and we noted a severe case of this some while ago on a Telefunken M28 which had been incorrectly set up. Although increasing the back tension can improve the tendency to bubbling, it usually increases scrape flutter, but some machines are provided with an anti-scrape flutter roller. These are placed very close to the record head to reduce tape vibration being transmitted to it. Such rollers are to be found on Telefunken recorders, and Studer incorporate one in their Revox 700 model.

We carried out some extremely interesting modulation noise analysis produced from 1 kHz tones recorded at 3% K₃. We noticed that the noise/frequency slope varied considerably from tape to tape, but also noted one of the most remarkable phenomena that we have ever encountered in tape testing, namely shoulders varying in frequency displacement from 1 kHz from manufacturer to manufacturer and tape type to tape type. For this test we used a 1 Hz bandwidth scan from 500 Hz to 1.5 kHz and found that each shoulder had its equivalent equally displaced the other side of the main 1 kHz carrier. To those conversant with rf technology, it will be apparent immediately that those shoulders indicate amplitude modulation, and we found that this modulation was not only consistent with the very small variations in output level referred to in the stability section, but also apparently to the rate at which the tape was coated at the

factory.

One example will be quoted because of possible importance of this finding to many tape manufacturers. We noted one displacement ± 12 Hz from 1 kHz. 12 Hz corresponds to approximately 3 cm of tape when running at 38 cm/s. We suggested to one manufacturer that 50 Hz vibration of equipment could cause a variation of 3 cm if the coating was being done at 1.5 m/s (3 cm x 50 Hz), and this was precisely the tape coating speed admitted by that manufacturer. Other shoulders noticeable at wider displacements might well correspond to slower coating speeds or faster vibrations in the equipment (eg from toothed wheels). Although we cannot be absolutely convinced of the significance of these results, tape manufacturers may well be interested to take the matter up further since the amplitude modulation detection may well prove an excellent method of detecting variations of oxide coating. One further point in this connection is the fact that different tape types can be virtually thumb printed by the shape of the 1 Hz scan, even making it possible perhaps to determine the actual coater used to make the tape. This could be of use in proving or disproving in legal cases whether or not two recordings were from the same tape, or source.

We also examined modulation noise with a 3 Hz bandwidth, and unfortunately very little variation from a normal mod noise curve could be seen, thus proving that an exceptionally narrow bandwidth is virtually obligatory with an extremely slow scanning speed.

Our pen chart took many minutes to be drawn in order to get a very accurate picture, which was well integrated in each 1 Hz frequency bandwidth. We have included six pen charts (figs 3-8) of modulation noise to show different displacements of shoulders and noise characteristics.

Winding neatness

Many masters made on tape which winds badly have been damaged by a thumb bending over an edge of tape which is standing proud of the average level of tape with respect to the spool flanges. This has often caused a dropout on one channel only, which has been extremely difficult to remove even with continual careful rewindings. We tested all the tapes for neatness of wind by spooling them at full speed from left to right and noting the quality of wind,

and then respooling from right to left and again noting the result. We marked each wind out of ten points, the higher the better. We were not able to understand why some tapes spooled badly in both directions whilst some in only one direction, not necessarily the same for every tape. We are convinced that this parameter is important when considering original master tapes, although some machines wind considerably better than others. We chose for the tests a machine having an excellent transport, but an average winding performance, a Revox A700, since we found that our Philips PRO 36 and Telefunken M5 wound rather better than the average professional machine.

In general, highly polished shiny-backed tapes gave a significantly worse winding performance than matt-backed ones, although note from the figures that this was not always so. If only recording full track, this parameter will only be of minor importance, but when recording two or more tracks across the width of the tape it becomes progressively more and more important. By far the worst spooling occurs when back lubricated tapes are used, and these are best wound on special transports designed for the purpose. Note that on the Continent almost all professional studios use matt-backed tapes because they purchase and use their tapes on 1000m hubs, frequently supplied without a backing plate. If the centre of such a spool falls out, and unless a special tool is available, it takes many hours to rescue a master tape.

Conclusions

It will be appreciated that this survey called for approximately 150 man-hours to complete, since we were aware that the figures might influence major changes in tape usage in various organisations. While fully appreciating that we have been most critical of some of the performances, we wish to make it quite clear that all the figures given relate specifically to the reels submitted by their manufacturers. In some cases it was found that these reels were below the average that we have experienced. Such an example is a batch of EMI 816 which gave 3% third harmonic distortion of 1 kHz of only 5 dB above DIN level, whereas our sample from approximately three years ago was 1 dB better; this was a pity, but we had to be strict about the tests to be fair to all. In our experience some manufacturers' products are more consistent than others, but we could not give a consistency report for all the tapes because some were so new to us, and therefore no comments are given. In their literature, manufacturers frequently quote tolerances, and clearly it is no use hoping that all the batches will be average, since we have found over the years tapes that have been outside specification, usually down rather than up in output.

We should like to see a tightening of sensitivity, bias requirements and maximum operating level, for if two reels having a sensitivity difference of 2 dB are edited together and they are noise-reduced, an edit may well be audible as a level change, particularly if the Burwen system has been used, and possibly with the DBX system. An A Dolbyed join in such circumstances, however, would probably be perfectly acceptable, although a variation in the high frequency response over a join might not be.

50 ▶

Mains powered self contained units

10 OUTLET DISTRIBUTION AMP

GENERAL STUDIO WORK ★ FEEDING MULTIPLE SLAVE PA AMPLIFIERS ★ DRIVING FOLDBACK HEADPHONES

Excellent distortion and LF performance with specially designed massive output transformer having separate secondaries for each 600 ohm balanced output, giving complete dc and ac isolation. Also available—kit of all electronics, excluding case and XLR connectors.

STEREO DISC AMPLIFIER

BROADCASTING ★ DISC MONITORING AND TRANSFER

Magnetic cartridge to balanced lines with HF and LF filtering.
TO IBA SPECIFICATION

Ring for leaflets.

SURREY ELECTRONICS

The Forge, Lucks Green, Cranleigh, Surrey GU6 7BG

STD 04866 5997

Within 2 years, 4-channel sound will be the rule. Sansui QS system puts you 2 years ahead.

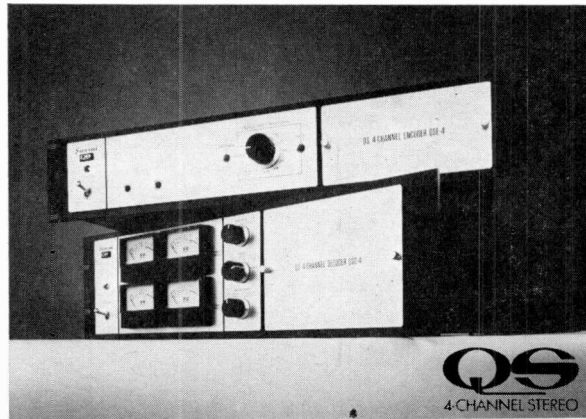

Now your listeners can enjoy the extra depth of 4-channel sound with the minimum of 2-channel conversion costs on your behalf.

Thanks to the Sansui QS 4-channel system. Now available for the first time in the United Kingdom.

Keep your equipment

The Sansui QS 4-channel system is used with all current stereo transmitters/receivers, cutting equipment and hardware. So there's no need to upgrade. The listener only requires a 4-channel receiver and 4 speakers to obtain astounding quadrasonic effects.

Excellent separation

Both encoding and decoding matrices are symmetrical. Together with the new QS Vario-Matrix in the decoder, an inter-channel separation of 20dB or more is no problem.

Maintains present hi-fi standards

High standards are maintained. Because of a unique phase shift technique, the quality as

well as the quantity of input information is preserved. In fact it gives better stereo perspective than conventional 2-channel sources.

Proven performance

In both Japan and the United States where 4-channel sound is becoming the rule rather than the exception, QS type matrixing is standard.

Listen to this remarkable equipment at the London showroom of Sansui.

It's right next to the GPO tower. Our technical experts are ready and willing to give advice on specifications and prices. Or send in this coupon for full information.

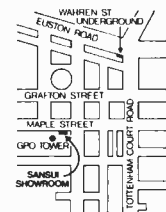

Vernitron Ltd., Thornhill Southampton SO9 2QF England

Sansui Audio Europe S.A., Diacem Building, Vestingstraat 53/55 - 2000 Antwerp Belgium

Sansui Electronics Corporation 55-11 Queens Boulevard, Woodside, N.Y. 11377, U.S.A.

Sansui Electric CO., Ltd. 14-1, 2-chome, Izumi, Suginami-ku, Tokyo 168, Japan.

To: Sansui London Showroom,
39/41 Maple Street, London W1P
5FU (Freepost) Telephone: 01-580 5353

Please forward all technical and price details on the new QS 4-channel encoder and decoder.

My name:

My address:

Postal code:

SS/2/75

Sansui

Sansui equipment is distributed in the United Kingdom by Vernitron Ltd., Thornhill, Southampton.

Despite a considerable population, radio broadcasting had been sadly neglected in Scotland until recently. Although the BBC would never admit it, network broadcasting is aimed more at England rather than Scotland—how often do you hear motoring flashes for the M8 relative to those for the Chiswick flyover?

Clyde

JEFF BARRON

ALTHOUGH THE GLASGOW region has a population of around 1.8 million, no BBC local radio station has been provided in Scotland. Admittedly there are regional programmes on Radio 4, but these aren't extensive. So it's hardly surprising that the commercial radio station in Glasgow, Radio Clyde, is such a success—over 70 per cent of the population listen to Radio Clyde at some point each week. Advertising is also very successful and there was an occasion in June when 94 per cent of available slots were filled, and Clyde's sales manager almost considered booking the other six per cent himself to make it a round 100 per cent. But generally the percentage of time sold is in the 70's and hopefully the 100 per cent mark by the autumn.

Programme material on Radio Clyde offers something for everyone—a wide variety of music, plus news, consumer advice, education, religion, politics and information tailored to the needs of everyone living in the Glasgow region. Radio Clyde broadcasts seven days a week, 20 hours a day, and was the first broadcasting organisation in Scotland to transmit programmes regularly in stereo.

Despite its small size, Clyde has produced some very ambitious programming—Scottish Opera's Royal Gala performance of *The Merry Widow*, Scotland's first stereo drama, *Benny Lynch*, and numerous other stereo outside broadcasts.

Now, down to hard facts. Radio Clyde have basically three studios—a news presentation studio, multitrack music recording studio and self-op music presentation studio. There is also a dubbing suite and two small recording booths. Outside broadcast facilities include two radio cars and an ob caravan.

Radio Clyde's chief engineer, John Lumsden, already has experience of radio broadcasting in Scotland—he built most of the technical facilities for Radio Scotland, the one that used to float in the North Sea. Clyde's studio complex was designed by John, and installed by Pye TVT. Pye's installation engineer was Russell Fleming, and after the installation was complete, John offered Russell a job with Radio Clyde which he accepted, so maintenance of the station is no problem, blue prints not being required, although they are available if necessary.

All the studios are fully floating and isolated

from the building's main structure. Acoustic treatment was also extensive and thus expensive. All studio windows are triple-glazed to reduce noise breakthrough although a drum kit going flat out does manage to pass one wall, but that's probably along the ducts, of which there are three levels. All signal cables are run along ducts at floor level, technical power runs halfway up the wall, and lighting power is carried at ceiling level; although of course all control gear for fluorescent lighting is outside technical areas. These arrangements reduce considerably induction of 100 Hz and other such nasties, into microphone circuits.

A baffled air-conditioning system is installed for ventilation of studio areas; and speaking of quietness (which I think we were), Clyde have a most unusual fire warning system in the studios—a bright yellow light with a revolving reflector similar to those on car roofs, is mounted in the ceiling of each studio—presumably this enables a visual warning to be given, without upsetting listeners at home, to the programme presenter, who will then put an lp on and clear off. Hopefully it would have been a false alarm and he'll be back in the studio before the lp finishes.

Studio A is the self-op presentation studio. Provided are a control desk for the presenter, an interview table and a phone-in desk in the corner. A Pye TVT SM8 desk specially designed for broadcasting has been installed in Studio A. This has two microphone inputs each with three sections of equalisation enabling presenters to 'adjust' their voice, but this may be bypassed. An AKG D202 is suspended on an anglepoise above the desk for the presenter, and an interview table in the studio has either a C451 or C414 depending upon requirements elsewhere. Experience has shown that more microphone channels would be useful, so the desk is to be suitably modified. Two Spotmaster/Russco turntables on the presenter's right-hand side appear on stereo gram modules. Each module accepts a high-level equalised input and provides for fine balance between channels. A stereo Penny and Giles 1500 series fader with backstop switches remotely starts the turntable as it is faded up and this provides, the presenters claim, very slick programming. Stanton 500 cartridges are used with the turntables and it's only recently after six months broadcasting that the first two styli have been replaced.

Four stereo high level modules each have selection for three sources. Again equalisers are provided together with fader backstop start facilities switched to the particular source selected. Two ITC 3D triple stack NAB cartridge machines are located either side of the mixer. All machines are started by pressing the large green button adjacent to the slot, this being more convenient than having six remote start buttons. Each stack has its three outputs mixed together and appear on separate high level input modules.

Stereo pre-fade-listen is available on all channels and is heard over the main monitor circuits, either loudspeakers or headphones, whichever is in use. Mostly Audiopak cartridges are used with the ITC cartridge machines, and they're to be found all around the station—laying on desks, in carousel racks, wooden wall racks and just piled high against the wall; it must all be something to do with



Tony Currie at the Pye desk in Studio A

Clyde's success.

Most tape machines at Clyde are of Bias manufacture and I was given two very good reasons for their choice—they're British and of such a price that Clyde could afford approximately twice as many Bias machines as opposed to a well-known Swiss make.

A two track Bias is mounted to the presenter's left, and this has been specially modified by Bias to a specification provided by Clyde. This machine provides a profanity delay for Clyde's phone-in equipment, which is situated in Studio A's corner. By means fair or foul, Clyde managed to obtain the phone-in number 041-204 0261 (their wavelength is 261 metres). They are also lucky in being situated close to the telephone exchange, this reducing the randomness of line impedance and omit telephone balancing problems. Radio Clyde also have PO Box 261 for mail. Pye balance units are incorporated throughout the station and these operate on the hybrid system with a tweakable to accurately balance line impedance.

Seven incoming phone lines and three outgoing lines all appear on key and lamp units in Studio A, and it's here that calls are answered by pushing the key downwards. When satisfied that the caller is sane, the studio producer will push the key upwards and studio output is returned to the caller enabling him or her to hear programme. On a separate panel, a yellow button is selected that feeds the call to one of two balance units where the line is tweaked. Upon depressing an adjoining red button, mixer clean feed is substituted for studio output, and the call or calls are fed to one of two mono channels on the mixer, where it is put on air; this allows a dual link on air. Finally a black button releases the call.

Monitoring facilities on the Pye desk are comprehensive. Three ppms are used for visual monitoring, one twin movement reading A and B, a mono reading ppm, and a ppm that may be selected to a variety of sources including pfl, desk output, foldback, and off-air, mf or vhf. Kef *LS5/1AC* loudspeakers with self-contained amplifiers are fed from the same selector that feeds the selectable ppm, and headphone outputs are also provided.

Studio B is Radio Clyde's main production studio and serves many varied roles. It measures approx 7m square. Apart from music, this studio handles discussion programmes, commercials, and anything more complicated than simple presentation.

The studio is four track equipped with a custom Alice mixer using type *AM* modules. This has basically 12 microphone channels, five high level stereo channels, and four groups, although more microphone inputs can be accommodated by rearranging. Four Alice limiters and two Pye compressor/limiters can be patched to any channel or group using a pin matrix panel. An *AKG BX20* stereo studio reverberation unit sits in the corner of B's control room and provides echo facilities for the Alice mixer. A special Bias tape machine running at 38 and 76 cm/sec can be used to delay reverberation. Three other Bias tape recorders are used in this studio, two stereo machines and a four track half-inch machine. Cartridge facilities include an *ITC 3D* stack with a *WRA* recording amplifier enabling the bottom deck to record. This is a useful feature because Studio B produces commercials which

are all on cartridges. There's a choice of two sets of monitoring speakers in Studio B's control room. A pair of Tannoy Lancasters are used for pop monitoring, whilst Kefs provide monitoring for more subdued recordings. A comprehensive jackfield enables all facilities to be over-plugged. Talkback from desk to studio appears on all foldback headphones, of many different makes, in the studio.

Studio B itself is equipped with a Steinway piano (the studio doors are angled to enable it to be brought through the sound lock), and also numerous acoustic baffles. Studio reverberation time is in the order of 0.2 sec, giving good separation between instruments and vocalists.

Radio Clyde's master control room (mcr) is situated between Studio A and B, and has an attached news presentation booth. Another Pye TVT *SM8* is installed here and this desk usually takes the other studios as sources together with the news booth, a stereo Bias, *ITC* triple stack, and two fader-controlled *Spotmaster/Rusco* turntables, and provides as its output the feed of Radio Clyde for the IBA vhf and mf transmitters. However this desk can be bypassed, and programmes originated directly from Studio A or B, enabling the news booth to be used with mcr for recording simple trails and commercials. The news booth is provided with a news reading table and an *STC 4038* ribbon microphone suspended from a stand. Connections are available via an assignment switcher to the three studios, although it normally works with mcr. This is a general design feature of Clyde—lines are available from most areas to mcr, enabling complex programmes to be originated from, for instance, dubbing, which will be discussed later.

Mcr is also used as a spare self-op studio if for any reason Studio A is out of commission, so there is an anglepoise stand with a *D202* hanging off the end mounted on the desk, and of course all other facilities are available except phone-ins.

Quad fm and am receivers monitor the IBA transmissions and normal monitoring in studios is off-air. Both receivers are modified in order that remote indication of carriers and pilot tone is available on mcr's main desk. In common with all commercial operations in this country, Radio Clyde's transmitters are leased

Studio B

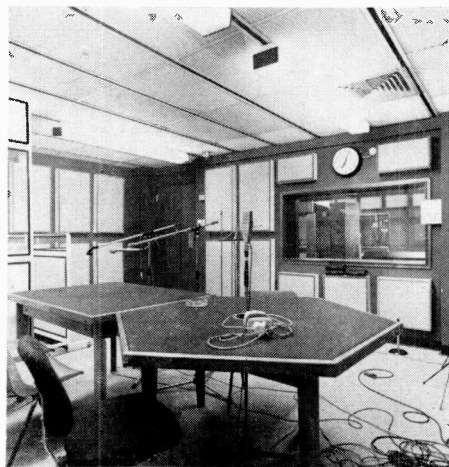

from the IBA. Twin transmitters are installed with auto changeover in case of failure, but very little trouble has been experienced, the IBA efficiently sorting out all problems. One difficulty that keeps occurring, not only in Radio Clyde, but with most other commercial stations as well, concerns Davis remote transmitter monitoring equipment. An over-air signalling system interrogates the transmitter to determine any malfunctions, systems covered being PO land lines, programme injection equipment, standby transmitter, and a house keeping circuit.

When a fault occurs at one of the transmitters, the Davis encoder there sends, over air, suitably phase modulated tones of 14 kHz in the case of vhf or 4.7 kHz for mf, which are picked up at Clyde in the Davis receiver/decoders, where they provide an indication, on lamps, of any of the previously-mentioned malfunctions. An interrogate button on the decoder enables a fault condition to be confirmed by causing the coded tones to be retransmitted, so verifying that it wasn't spurious reception that caused the fault indication.

However, more often than not, a fault indicated by this equipment proves to be malfunctions in the Davis equipment itself, and nothing to do with the transmitter which is still working, as usual, perfectly. Despite repeated complaints by most stations, the equipment is still inherently unreliable. Radio Clyde use their remote indicators from the Quad tuners to provide warning of transmitter failure.

Whilst on the subject of over-air signalling, remote operation of the stereo encoder at the transmitter is also provided by means of a high frequency tone, and generally if any substantial length of mono is to be transmitted, it is preferable to switch the transmitter to mono thus improving signal-to-noise for fringe listeners.

Supplementing standard ppm monitoring, Radio Clyde also have Philips Correlation meters. On a scale calibrated in per cent of correlation, the meter provides an indication, largely independent of input level, directly related to correlation (or relationship) of two input signals. One hundred per cent correlation indicates mono (both signals identical), while 0 per cent indicates two different signals (full stereo separation). The zero point on the edge reading meter is at one-third of the scale length from the bottom and the indication can go negative up to -50 per cent for signals having an anti-phase relationship. In-phase stereo signals will produce readings somewhere between 0 per cent and 100 per cent, and experience shows that at readings of 70 per cent or greater, poor stereo will result, whilst at readings of less than 30 per cent mono compatibility is in danger, and this is obviously important with more mono than stereo listeners. Negative readings immediately warrant investigation, since out-of-phase programmes disturb both mono and stereo listeners.

Radio communications are supervised from the mcr, these consisting of both vhf and uhf systems. One vhf communications channel is shared by all mobiles, two radio cars and two portable one watt transeivers. Programme material is returned to studios from uhf

AB Pearl Mikrofon- laboratorium.



DC63.
48 volt, variable pattern.
Also available as
cardioid only DC96.

For further information on the complete range of Pearl microphones, contact:

Allotrope Limited

90 Wardour Street, London W1V 3LE.
Telephone: 01-437 1892. Telex: 21624.

U.K. Representatives for:

AB Pearl Mikrofonlaboratorium - Sweden, Microphones & accessories.

HES Electronics - Brussels, TSV series telephone balancing units, and studio equipment.

Inovonics Incorporated - Campbell California U.S.A., Audio electronics.

Roland Zeissler Werk Für Elektro Mechanik - Cologne, Racks and instrument housings.

RADIO CLYDE

transmitters, again two radio cars and two Pye Pocketphones. A range of ten miles is obtained from base stations mounted on top of a nearby office block, using omni-directional aerials.

Talk back is installed between studios A, B and mcr, and provision is made for linking the vhf communications system into talkback routing for use by the studios. A separate intercom connects studios, offices, newsroom, library etc.

Across the corridor from the studios is a dubbing suite consisting of a small Alice mixer, two turntables, three stereo Bias tape recorders, and a Spotmaster cartridge recorder. The mixer has six channels, each a stereo high level input selectable to a number of sources, and two output groups. As suggested by its title, the dubbing suite is used for re-mixing programmes, and also reviewing and editing material.

Adjoining, and originally part of the dubbing suite, are two very small recording booths. Although still in a state of construction, one booth was essentially complete and will be described. A simple four channel mixer has a number of sources available on switches and these include a D202 microphone suspended above the mixer, a Bias tape recorder, Spotmaster cartridge machine, Philips cassette player, two radio car circuits, the remote AA studio near the Erskine bridge, Independent Radio News (a line feed), and via a Pye telephone balance unit the newsroom telephones which appear on key and lamp units repeated on most news desks providing access for all editors to all lines. These booths offer, in a very small space, all facilities required for producing news items and reports, and also editing, programme compilation etc.

In the adjoining newsroom, a bay-mounted

Teac recorder automatically starts to record whenever a dispatch is received from Independent Radio News, the company who supply national news, although Clyde produce almost all their own local news. Also mounted in this bay is another Quad fm/am tuner and this is used for quality off-air feeds of other radio stations. Radio Clyde didn't go to the expense of a radio distribution system and instead issued cheap transistor radios to all staff. Twenty Sony cassette recorders and three Uhers are available for news reporters use.

Radio Clyde's outside broadcast activities are extensive, equipment available consisting of two radio cars, an ob caravan, a small studio in the Automobile Association's HQ near the Erskine Bridge, and a ten channel stereo Audio Developments mixer with a stereo Uher. The mixer has its inputs modified so that it phantom powers all the AKG capacitor microphones. Permanent PO landlines are available to the Kelvin Hall (mainly orchestral music), to the Apollo Centre (pop, rock), and lines are to be installed to the City Hall. Of course lines also go to the AA studio, which is equipped with a four channel Shure mixer, and provides motoring reports. Each set of lines consists of a stereo music pair, and three control lines, one used for reverse programme feed, the other two for communications.

As previously mentioned, each car has a Pye vhf transceiver and also a modified Pye uhf transmitter. Provided the limiter in the mixer is set correctly so as not to overmodulate the carrier, the system is capable of quite high quality. A Pye uhf receiver is also mounted in each car enabling the car to relay broadcasts from the Pocketphone transceivers. This arrangement means that in the case of, say, a fire—when it is impossible to drive in close—the relatively weak signals from the pocketphones can be linked back to the studios via the radio car.

32 ►

Brian Ford
lacing a four
track Bias, in
Studio B's
control room



Alice at Swansea Sound Studio 3

Alice AM/18/8 multitrack console
designed for music recording and
direct 'on air' operation

Alice (STANCOIL LTD) ALEXANDRA RD, WINDSOR, ENGLAND. Tel Windsor 51056/7

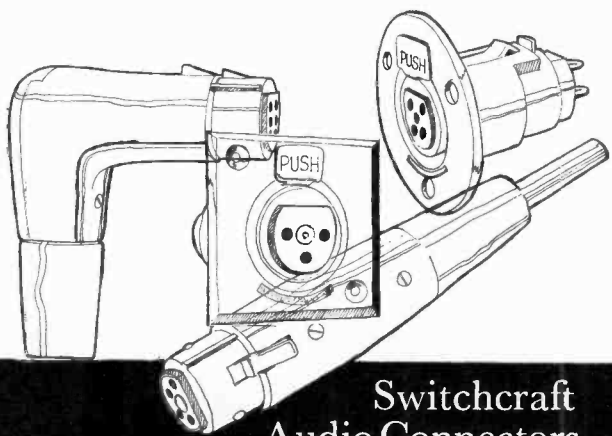

Switchcraft Audio Connectors

Complete range of Switchcraft audio connectors for all studio and ancillary equipments.

Versatile — 3, 4, 5 or 6 pole; wide variety of matching plugs receptacles adapters; readily interchangeable with other leading makes.

Streamlined — simple positive snap-in connection; cable clamping and latch lock.

Safe — self-polarisation; captive insert screw provides rigid assembly and electrical continuity; pin and contact insulation eliminates hum and noise problems.

Low Cost · Ex-stock · Quantity Discounts

Write now for free descriptive literature.

Sole U.K. Agent for Switchcraft QC Connectors

F.W.O. BAUCH LIMITED

49 Theobald Street, Boreham Wood, Herts. WD6 4RZ. Telephone: 01-953 009

A Mini Mixer with a true PROFESSIONAL STUDIO SPECIFICATION



10 Input Channels, 4 Output Groups.

Auxiliary Sends and Echo Returns.

XLR Connectors to balanced Mic Inputs and Line Returns.

Normalised Insert Jacks.

Low Noise and High Output levels.

Portable.

Extension units, PPM's, Limiters etc. also available.

RAINDIRK LTD., Downham Market, Norfolk.

Tel. 2165 and 3617

LOCKWOOD

SOUND TO REMEMBER

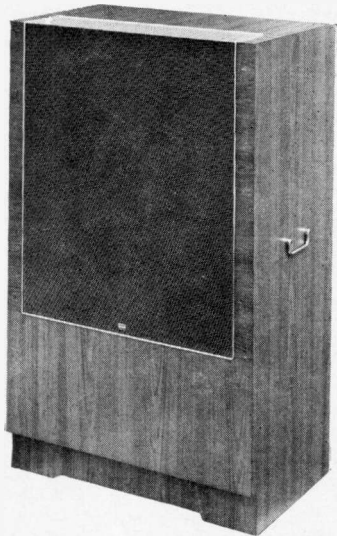

LOCKWOOD MAJOR

UNIVERSAL LOUDSPEAKERS
For Wall or Ceiling Mounting.

LOCKWOOD

MINI-MONITOR
For High Quality in Confined areas.

NEW MODELS

LOCKWOOD GEMINI MAJOR

4 Drive Units 160 W.

LOCKWOOD GEMINI MINOR

4 Drive Units 80 W

Lockwood Loudspeaker Protection Device Model LPD developed by M. Bradbury and S. Timms.

Protects any Loudspeaker against Overload Conditions.

LOCKWOOD

HARROW - MIDDX. - HAI 3AW

Tel. 422 3704 and 422 0768



Dave Murrice
in
Master Control

■ RADIO CLYDE

A four channel Alice mixer is mounted above the uhf equipment which in turn is mounted in place of the car's front passenger seat. Two car batteries, on the floor, enable full output to be kept up for three hours, and if longer broadcasts are anticipated, mains extension cables are taken along. The uhf aerials are mounted on a Clark extendable mast. Both cars have 8m masts which are supported by compressed air. At present omni-directional aerials are used for both cars and base station, but directional aerials are on order for both and the aerial at the base station will be supplied with a rotator remotely controlled over PO lines from MCR.

Unfortunately, several accidents have occurred with these telescopic masts. The problem is that drivers, after finishing an ob, drive off with the mast still extended; consequently the mast breaks off when the car either goes under a bridge or tree.

This has occurred twice at Radio Clyde (once whilst I was there) and most other organisations with Clark masts have had similar experiences. It's not the mast's cost that is worrying, but that delivery is over three months, so after their first accident Radio Clyde purchased a spare mast enabling both radio cars to remain operational. By some quirk of fate, John Lumsden had asked, only the previous day, for the just-repaired original mast to be reassembled and tested, so the car was only off the road for a short time. When time is available, they hope to install an interlock to prevent similar occurrences, one suggestion being a powerful horn mounted inside the car which would blast the offending driver's ear drums with many decibels of noise.

Radio Clyde have constructed from scratch an outside broadcast caravan with comprehensive facilities for either interviews or audio

balancing. The caravan is acoustically treated and contains apart from the equipment plenty of storage space for leads, microphones, tapes, beer etc, all the woodwork being done by Clyde's resident joiner, who after six months of broadcasting is still very busy. An Alice mixer similar to Studio B's is installed in the caravan and this has 12 microphone inputs, five high level stereo inputs, and four groups. Two EMT turntables are mounted in a side wing to the desk; these decks are used because the caravan is rarely perfectly horizontal and EMT turntables will operate over a wide range of tilt, also explaining their use by pirate ships.

Tannoy Monitor Golds driven by H/H amplifiers provide monitoring in the caravan. Teac two and four track recorders are mounted beside the desk, and the four track machine is equipped with Dolby B. Although the Teacs just meet the IBA specification for noise it was considered worthwhile having noise in hand since the four track recordings would at some stage be reduced to stereo. A second four track Teac with Dolby B enables ob tapes to be played back in Studio B for mixdowns. All inputs and outputs from the caravan appear on sockets mounted on a panel outside the caravan's door.

The ob caravan is often used with PO land-lines, but can be linked to a radio car, when the car becomes the link for both programme and talkback, and of course programmes may be recorded for later transmission.

All ob vehicles are kept, when not in use, in a penned-off portion of the Anderston Cross Centre car park (almost vertically below the station's offices) and power for battery chargers and audio tie lines to MCR are provided. Thus the caravan can be used as a third studio or for dubbing or even on air while garaged.

I should like to thank John Lumsden, Russell Fleming and Pete Shipton, Clyde's music balancer, for their help in the preparation of this article.

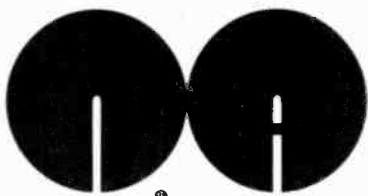

naim audio

MANUFACTURERS OF AUDIO EQUIPMENT

have moved.

You can now find our factory and showroom at...
11 Salt Lane, Salisbury, Wilts, SP11DT
The telephone number remains the same...

SALISBURY 3746



F760X-N
module
(80 x 190mm)

F760X Limiter-Compressor Expander

A truly remarkable little package; ideal for reduction work. Any function can be used independently or a combination of all three functions can operate simultaneously. Technically superb: physically compact and financially attractive. Who wants more?



AUDIO DESIGN RECORDING
St. Michaels, Shinfield Road, Shinfield
Green, Reading, Berks.
Tel: (0734) 84487

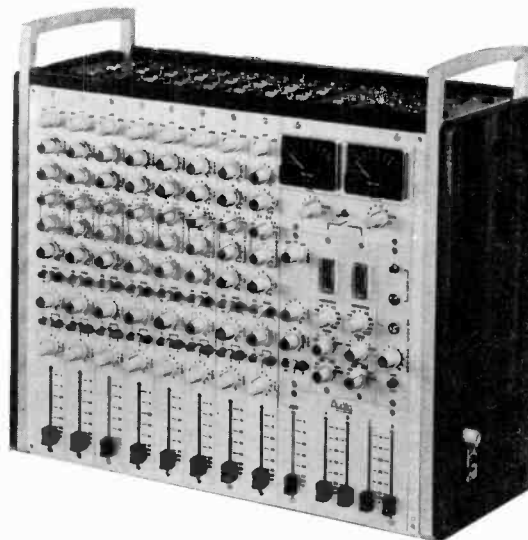

AD 007 PORTABLE MIXER

The Mini Mixer with the professional qualities and the professional performance.

- Battery or external power supply operable.
- 8 Inputs 4 Outputs all balanced into XLR connectors.
- 2 Compressors with stereo link.
- 2 Peak Programme Meters switchable to all channels and groups.
- Auxiliary send and returns.
- Modular construction is used to promote serviceability.
- Inputs extendable to 18 via the Ten Input Extension Unit.

Other facilities include insertion points in each channel and group, a line up oscillator and cue facility. The Extender Unit can also incorporate Talkback and Monitoring at the exclusion of input modules.

Customers so far supplied have been full of praise for the mixer. They include people in broadcasting studios and the live entertainment field.



Hall Lane
Walsall Wood
Staffs WS9 9AU

Tel. Brownhills 5351

Capital Radio was one year old on October 16. To celebrate the event, the station put on a week of outside broadcasts. The Capital mobile control room handled live broadcasts from as mixed a bunch of locations as any pr man could dream up—Woolworths in Croydon, a West End film premiere and Mary Chipperfield's circus on Clapham Common.

Capital

ADRIAN HOPE

WHEN AN ARTICLE looking at Capital after one year was proposed, it seemed a good idea to include one of the birthday week obs. And sheer curiosity made the Clapham Common circus gig a must. 'How on earth,' I kept asking people, 'do you do a radio broadcast from a circus? Do you relay the roar of intermittent applause and put mikes on the ground to pick up the sound of skittles dropped by jugglers, or do you get an elephant to swallow a pair of radio mikes and try for a dummy stomach recording?' The answer, of course, is that you do absolutely none of these things, nor do you even try and beat television at its own game. You do what Capital did—take Sarah Ward's regular late evening chat and music show out on location and hopefully interview interesting people on the spot. It all sounded quite a lot of fun for everyone and fairly straightforward; and I reckoned that writing it up should be likewise. But anyone who thinks that showbiz is all glamour and writing about it is a load of laughs has probably been reared on fan magazines; and they should keep reading them if they want to hold on to their illusions. As Roger Scott, one of the several Capital djs who went out into the mud of Clapham Common, remarked while sitting cold, wet and dressed as a clown on a pile of cable at the entrance to the ob van: 'If only they knew . . .'

A few minutes earlier a fan had prodded Nicky Horne in the back and asked him: 'Which one are you?'. 'I'm Nicky Horne,' he explained brightly. 'Oh. That's a pity,' said the fan, and disappeared off into the darkness. 'Ah well—that's show business—the roar of the greasepaint—the smell of the crowd,' came a voice from the corner. But don't get me wrong, I didn't hear a grumble all night, either from the engineers or the djs—even when they had buckets of water thrown over them in the ring. The circus performance had been arranged at fairly short notice and all profits were going to a charity for muscular dystrophy. Probably because Richard Attenborough is connected with both charity and Capital, the idea had then emerged of the station covering the performance for listeners, giving it publicity and bringing along most of the regular personalities to dress up as clowns and help things along. Michael Aspel was in there somewhere, resplendent in red ringmaster's regalia, and I kept seeing Wombles wandering in and out of the Capital dressing room caravan where Dave Cash was realising a life's ambition and putting on full clown's make-up. I never was too sure whether or not the Wombles were the genuine article or djs in disguise. It's hard to tell, with a Womble. Gerald Harper arrived later somehow looking smooth, while everyone else got muddier and muddier.

The whole event had, a few days previously, suddenly taken on rather more importance and become a whole lot more complicated for some people because somewhere along the line Princess Anne and Mark Phillips had been invited to the circus and had decided to accept. Because the Palace won't let anyone talk about a royal visit until it is officially confirmed, it wasn't until a few days before the ob that the necessary tablet of stone was handed down from SW1. This named eight Palace-approved photographers who would be allowed inside the big top for the performance. By what I can only assume was a Palace oversight,

STUDIO SOUND was not on the list. What's more, despite repeated assurances that our readers would be surprised to see these pages decorated with pictures of royalty, and that there was thus no incentive for us to take any, great emphasis was laid on the need to observe protocol. This involved our getting smartly out of the circus tent as soon as the royal car glided into view. Hence no pretty pix of the performance.

The royal entrance was timed at around 19.30 (the final nail went into the hastily-erected royal box all of five minutes beforehand) and the Capital broadcast was due to start at 22.00 and run on till 01.00. I turned up at Capital's Euston Tower studios mid afternoon and took the opportunity of having a quick look round before joining the four-man ob crew bound for Clapham Common.

Over the year since I was first at Capital a fair amount has changed. For one thing, what was unfinished is now finished, and whatever the IBA may say I still can't see that it was desirable to push the two London stations on to the air at such extremely short notice. Capital engineers (under Gerry O'Reilly) deserve some sort of a medal for meeting the deadline imposed on them. But there are clear signs that the practical experience gained over the year in running the station has thrown up quite a few ideas for improvement. And I can't help wondering for instance whether any re-routed cables can at this stage still be laid under the floor. Certainly the quality of disc reproduction should improve now that the previous cartridges used have been ditched (they just weren't sufficiently reliable under heavy duty broadcasting conditions) and replaced by Shure SC-35C professional cartridges (tracking at 4g). Also all thought of automating the use of tape cartridges (for jingles and commercials) has been abandoned, for a combination of logistic and technical reasons. For instance, when the content of a commercial break is automated, then there is much more of a problem if a cartridge fails than when it is under hand operation; if a commercial fails to come up, how is the machine operator to know whether it is the cartridge itself or the automatic machinery running it which has gone down? Also, Capital are clearly experiencing some of the problems of general quality (such as phase accuracy between channels, signal/noise ratio) bothering others such as Piccadilly Radio in Manchester.

A fairly major studio shift-round is also taking place. Until now, the newsreaders have been working in a corner of the main broadcast studio. Although both the djs running the programme and the newscaster who briefly takes over from him are wearing cans, there is still the need for the newscaster to move in and out of the studio during record breaks and to keep quiet until he is on the air. There is also close visual contact between the dj and the newsreader, which is fine unless the dj takes it into his mind to corpse the newsreader—as Kenny Everett did Graham Frear on several occasions. There is thus now a studio reshuffle going on to separate news from other broadcasting. At the same time there is a fairly drastic rethink on the whole business of djs self-opping their own programmes. No one is suggesting that the Capital djs should be asked to work in Radio 3 fashion, with all disc control out of their hands. But on the other



Top: OB omnibus

Centre: Inside

Below: Kenny Everett's mis-hap—repairs to PO land-line

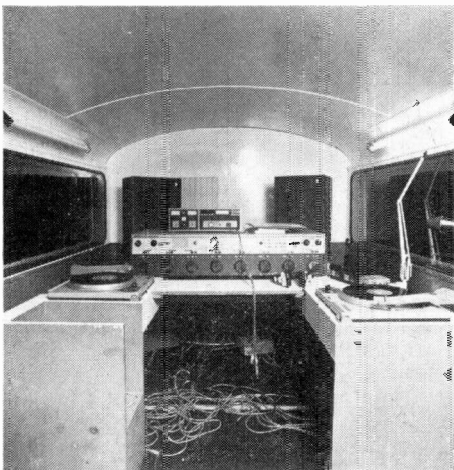

hand no dj with cartridge, disc and mike faders to control, a bright and breezy programme to do and different signal levels between all sources to contend with, can hope to keep a steady level signal running out of his desk.

Capital are now converting a previously little-used control room into new Studio One, which will provide something of a compromise between self-opping and engineer-opping. The Alice desk, which Capital used for a month at the Ideal Home Exhibition, is being built into the studio, along with three Gates turntables, and a triple-stack cartridge player. All the programme sources and faders for them will be at the dj's finger-tips and under his control, but only insofar as he can bring their levels up from zero to full and down again. The outputs from the Alice desk will be fed through to the main control room with talkback and visual link through the double-glass window. In the main control room the self-op signal will be fed through a Neve desk with master control, pre-set and override on all levels and circuits. This way, most of the strain can be taken off the dj, but without divorcing him from his programme—rather like a dual-drive car for instruction. Incidentally, the monitors used in this new Studio One, in some other of the Capital studios and in the ob trucks are Naim Audio speakers. But Capital master control and music mix monitoring is on KEF LS5 IAC.

The ob truck really comes in two parts. The mcr (mobile control room) has a Neve 12 in, two out desk with the Naim monitors, a Shure microphone mixer, a pair of Studer 19/38 cm/sec recorders, an Audio radio mike, a clutch of AKG D202s, and of course a store cupboard of power and audio lines. The other half of the ob setup is an old London open-topped bus with a sound-proof studio built into the lower deck. The bus studio has an American McMartin desk which although allegedly of modern design has more the look of a piece of 1940s army transmission equipment about it than a modern state-of-the-art desk. But, built like a tank, with rotary faders, it seems capable of withstanding a fair physical hammering under pretty miserable conditions—such as Clapham Common on a damp, wet, muddy winter's night. The McMartin was hired originally for the obs which Capital used to do from the Global Village London rock club and is still in the bus. I think it is fair to say that no one in the crew seems to like it very much, but as the broadcast results are good there is no real reason to replace it yet with anything more aesthetically pleasing.

We arrived at Clapham Common in the late afternoon with the bus and the mcr, the crew being Russ Tollerfield, Peter Jackson, Richard Jones (engineers), and Mike Sykes (technician). Although the circus is generator-powered there is also a mains supply available, and Capital plugged in. There had been some kerfuffle earlier about the Post Office lines via which the ob signals were to be piped back to the

Post Office Tower, with which Capital at Euston Tower has a permanent link.

In each main cable there are always several spare lines; some are domestic, some are music lines. Whereas ordinary, domestic telephone lines have loading coils along their length which limit the band width of the lines to 3 kHz, the music lines have no such coils. Nominally 600 ohms impedance balanced line pairs (no earth return is used) these are equalised at the nearest exchange and patched in to other music lines through to the next exchange and so on, down the route to the Post Office Tower. Equalisation is mostly top lift, to compensate for the hf roll-off which occurs due to the capacitative effect of long lengths of paired lines. The Post Office guarantees the music line capability as flat up to nine or ten kHz, but the Capital engineers tell me that quite often they find them pretty near flat quite often up to 15 or 20 kHz. At the moment signals are sent down the music lines at zero level, but I am told that when this country finally adopts EEC regulations (probably in 1975) the level may be reduced. There is seldom any hum problem on 600 ohm lines with levels of this order, and hf noise is the main bugbear. Whether level reduction aggravates this remains to be seen.

On Clapham Common the Post Office (who charge around £150 a day for providing music lines across London) had provided the necessary junction box where requested. But when the Big Top went up it put the junction 100 yards from where the ob vans had to go—and every extra yard of exposed cable is an extra risk of trouble. So the box had to be re-sited at short notice up a tree by the commodious Chipperfield caravan (reserved as a refuge for the royal party). Trying not to look like royal peeping Toms, the Capital crew scaled the tree and made the tie-up. As per normal practice, the cables were run at ground level and soon sank out of sight and out of mind into the mud.

Three line pairs were used, one the left channel leg, one the right channel leg and the other a control link. The control link worked fine, but when music and test tones were pushed down the stereo pair to Euston Tower very little dribbled out the other end. So up the tree went the engineers again to check the colour-coded connection and the fault was sorted out. Whereupon Kenny Everett drove up in his car and over the cable in the mud, slicing all three pairs clean in half. Luckily, there was still an hour or more to go before the Sarah Ward show went on the air, and there was time to shorten the cable to the break, and take it again from there. This time, though, the cable went up in the tree over the royal coach and down into the mcr.

'The last time we slung a cable up in the air,' recalled Russ Tollerfield, 'was on Christmas Eve, into St Martin's in the Fields—and we spent the whole evening warding off passing drunks who felt obliged to try and high-jump up and reach it'. The Christmas Eve cable was successfully defended but on another previous ob Capital lost an AKG D202 plus all its Cannon connectors to a passing stranger who had come equipped with wire cutters. He had it away from under their noses halfway through an interview.

The Clapham plan was for Sarah Ward first

■ CAPITAL RADIO

of all to interview some of the showbiz celebrities expected at the circus performance. This she would handle in the relative comfort of the bus with Mike Sykes engineering for her. (Actually the comfort is only relative, because both the mcr and bus are remarkably low-ceilinged. This gives the mcr very bass-heavy acoustics.) Then, when the celebrities had all gone off home or become drunk beyond repair in the entertainments tent, Sarah would go off with an engineer and the Audio radio mike to interview everyday circus folk in the muddy blackness behind the big top—Mike Sykes, the technician, remaining in the bus to put on records in between interviews. To get the picture straight, the McMartin desk and Gates decks in the bus are usually operated by a technician, with Sarah sitting alongside doing the chat and the interviews and giving the technician visual cues for musical inserts. There is a straight feed and talkback link between the bus and the mcr, and the engineer on the Neve desk in the mcr is able to talk on the control line to Euston Tower. Although all the programme records are played from the deck in the bus, and cartridges can also be played from there, all the commercial inserts originate from Euston Tower.

The Audio radio mike (with *D202*) has a range of about a quarter of a mile and operates on 175 MHz. For the circus the receiving aerial was perched up on top of the bus, and before the programme went on the air an engineer went off through lions, tigers and



Miss World contest

Clapham mud to check out for dead spots or interference. The signal coming back to the mcr was remarkably clean over the whole circus site; even the several, massive circus generators appearing to cause it no problems whatsoever. The only slight breakthrough was an occasional, intermittent splutter, probably thyristor pulses from the circus dimmers moving from one extreme setting to another through the critical central position where rf interference generation is at its greatest.

As the circus drew towards its close and the Capital djs struggled out of their makeup and costumes, the ob unit got ready for business. It soon became clear that rather fewer celebrities than expected had made it out to Clapham Common. There were also problems over some of the potential interviewees' wanting to get away earlier than the times scheduled for their spots; but all this seemed to leave Sarah Ward totally unmoved, thereby backing up what one of the engineers had said to me earlier—'She really is one of the most professional girls currently working in radio'. At exactly 10.04 pm the programme went uneventfully on to the air. 'Only two hours 56 minutes to go,' said someone in the mcr. Technically, those two hours 56 minutes passed pretty uneventfully. No one swung on the Post Office lines and cut Capital off the air, the interviewees turned up more or less when they should have done and reasonably sober, and no one quite froze to death.

Capital engineers work a seven-day fortnight; that is seven 12-hour shifts in a fortnight. This is on an on-off basis, which takes in one weekend and leaves one clear. Also, although everyone works half a day on and half a day off, there are, in fact, three shifts per day (six-thirty a.m. to six-thirty p.m., eleven a.m. to eleven p.m., and nine p.m. to nine a.m.). This staggering means that there are always more people on during the busy part of the day and only a couple working through the night.

The night shift at Capital, I am told, is the one that no one really likes. There is work all

through the night (like putting on repeat tapes) so there is no chance of sleeping and time tends to drag. Working in broadcasting is worth while, but it certainly doesn't have all the glamour that some outsiders would think. For instance, when I finally quit Clapham Common at midnight (after eight muddy, cold and hungry hours) the engineers on duty still had two hours more broadcasting and then around an hour of striking camp. The only thing that really matters, of course, is what it all sounds like, at home in the warm, coming in off-air. So I went home and caught some of the programme. Yes, Sarah Ward did make it sound like a fun occasion and no, none of the general dankness out there in the cold, October night came through. I don't know what they all earn, but I don't think I grudge them a penny of whatever it is.

Oddly enough, the biggest surprise of the evening for me was completely non-technical. I have always thought of the BBC as having the firmest hand on broadcasters in this country—after all it was they who sacked Kenny Everett and thus indirectly channelled him into Capital. But the BBC and their interpretation of the Charter doesn't hold a candle to the ever-present spectre of the IBA Code of Practice. This seems to hang over the commercial stations like a threatening cloud. All the ilr stations are on three-year rolling contracts. At the end of each year the contract is renewed for another three years, so any maverick can be told any year that the next three years will be his last. Up to a point it gives a sense of security (everyone knows that at any time they still have at least three years to go) and I am sure it also helps to keep everyone's socks firmly pulled up. But it could also make for a worried feel over the air. For instance while I was in the mcr there was repeatedly quite serious panic over the risk of any interviewee saying the wrong thing about the muscular dystrophy charity which was the object of the whole exercise. Apparently the Code says:

AGONY COLUMN

■ A certain well-known broadcasting organisation is under heavy pressure to cut down on internal spending, and a result is that they have to economise in unlikely directions. It isn't often realised how much electricity air conditioning and ventilation consumes; this organisation did so and so switched off the ventilation in their television studio. As a result, the cameras overheated. It was not feasible to switch them off, because doing so apparently blew some electronics. So the organisation continues to squander the taxpayers' money.

■ After the gig, the promoter was wandering around picking up the remaining little pieces of his dance hall. He had only got so far on his rounds when two heavyweights announced they were from a certain agency and informed him that they wanted the money for their band's appearance, didn't they guvnor. 'I'm sorry, you'll have to wait until next week when I send the cheques out.' 'No, really, we want it now.' 'Well I'm sorry you'll have to wait until next week.' 'Well we're sorry but we'll have to nail your feet to the floor.' Whereupon they took out of their pockets a hammer and several long nails. The promoter happened to find the money in his pocket.

Take a Quad 50E Amplifier

(a good start for any installation)



plug it into your monitor system and it bridges 600Ω lines to drive your speakers.

Take that same amplifier and, without changing it in any way, plug it into another installation to deliver 50 watts into 100 volt line * from a 0.5 volt unbalanced source. This versatility and its attendant easing of stocking and maintenance problems is one reason why large organisations use the Quad 50E.

* or indeed any other impedance from 5 to 250 ohms.

Other advantages appropriate to users of all

sizes include: Excellent power and frequency response (-1dB).

Low distortion (0.1% at 1kHz at all power levels).

Low background (better than 83 dB referred to full output).

Pre-set level control adjustable from front panel.

Unconditionally stable with any load.

Proof against misuse including open or short circuited output.

Small size (4 $\frac{3}{4}$ " x 6 $\frac{1}{4}$ " x 12 $\frac{3}{4}$ ") - (120mm x 159mm x 324mm).

QUAD
Products of
The Acoustical Manufacturing Co. Ltd.

for the closest approach to the original sound

QUAD is a Registered Trade Mark

Send for details to Dept SS, Acoustical Manufacturing Co Ltd,
Huntingdon PE18 7DB Tel: (0480) 52561

Due to the considerable number of test discs available, it is not possible to present a fair comparative review. Recorded tests are summarised, together with a brief description.

Test discs

HUGH FORD

BRUEL & KJAER

TYPE QR 2009 Stereophonic gliding frequency recording

Dimensions: 301.6 mm diameter.

Speed: 45 rpm.

Cutting angle: 10°.

Recording characteristic: IEC standard without treble pre-emphasis (constant velocity above 1 kHz).

Content: logarithmic frequency sweeps from 20 Hz to 20 kHz in 50s preceded by a 1 kHz reference and starting signal.

Recorded velocity at 1 kHz: 3.16 cm/s ± 1.0 dB.

Bands 1 and 5: 45° left modulation.

Bands 2 and 6: 45° right modulation.

Bands 3 and 7: lateral modulation.

Bands 4 and 8: vertical modulation.

Accuracy: ± 0.5 dB 100 Hz to 10 kHz. ± 1 dB 20 Hz to 100 Hz and 10 kHz to 15 kHz then decreasing to ± 4 dB.

Crosstalk: -30 dB 200 Hz to 5 kHz increasing to -20 dB at 50 Hz and 15 kHz.

Surface noise: (ref 3.16 cm/s at 1 kHz) -32 dB broad band or -65 dB in third octave bands.

Price: £25 per set of five discs or £7 for single discs.

TYPE QR 2010 Comprehensive laboratory disc

Dimensions: 301.6 mm diameter.

Speed: 33 $\frac{1}{3}$ rpm.

Cutting angle: 20°.

Recording characteristic: IEC standard without treble pre-emphasis (constant velocity above 1 kHz).

Content: Bands 1 and 2 (left and right) frequency response and crosstalk section frequency sweeps from 20 Hz to 45 kHz in 16.7s preceded by a 1 kHz reference and starting signal.

Recorded velocity at 1 kHz: 3.16 cm/s ± 1 dB.

Accuracy: ± 1 dB 100 Hz to 15 kHz, ± 2 dB 15 kHz to 25 kHz, ± 3 dB 25 kHz to 35 kHz then ± 4 dB above 35 kHz.

Crosstalk: -30 dB 200 Hz to 10 kHz increasing to -20 dB at 30 kHz.

Broad band surface noise: better than -45 dB below 3.16 cm/s at 1 kHz.

Bands 3, 4, 5, 6 and 7: left and right tracking ability tests 1 kHz for 15s each at the following levels ± 0.5 dB reference 10 cm/s at 1 kHz, $+8$ dB (distortion less than 4%) $+6$ dB (distortion less than 3%) $+4$ dB, $+2$ dB and 0 dB (distortion less than 1%).

Band 8 wow and flutter: section 3150 Hz for 60s with peak weighted wow and flutter less than ± 0.06 %.

Band 9: polarity test 1 kHz at reference level ± 0.5 dB left, right (3 seconds) L+R, L-R, L+R (1 second).

Band 10: crosstalk measurements at 30 kHz (crosstalk less than -20 dB) 5s of each Left -20 dB, Right -10 dB, Right -20 dB, Left -10 dB ± 2 dB reference 10 cm/s at 1 kHz.

Band 11: for rumble measurements 15s 315 Hz at -11.3 dB ref 10 cm/s at 1 kHz ± 1 dB followed by 60s blank groove with rumble less than -50 dB IEC 'A' weighted and -65 dB IEC 'B' weighted.

Band 12: crosstalk measurement requiring only an ac voltmeter, with cross talk better than -30 dB accuracy of tones ± 1 dB left 1 kHz at -20 dB 3s, right 1 kHz at 0 dB 2s.

Right sweep: 400 Hz to 10 kHz logarithmic in 7s at 0 dB, right 1 kHz at -20 dB 3s, left 1 kHz at 0 dB 2s.

Left sweep: 400 Hz to 10 kHz logarithmic in 7s.

Band 13 (left) and Band 14 (right): response and crosstalk measurement at short mechanical wavelengths, sweeps from 20 Hz to 20 kHz logarithmic in 15s preceded by a 1 kHz reference and starting signal. Recorded velocity at 1 kHz -10 dB ± 1 dB reference 10 cm/s at 1 kHz accuracy of level and crosstalk as bands 1 and 2.

Band 15: arm resonance investigation. Constant velocity sweep at: -20 dB ± 2 dB reference 10 cm/s at 1 kHz logarithmic from 5 Hz to 20 Hz in 50s preceded by 1 kHz reference and starting signal.

Price: £25 per set of five discs or £7 for single discs.

TYPE QR 2011 for testing and adjustment of hi-fi systems with pink noise

Dimensions: 301.6 mm diameter.

Speed: 33 $\frac{1}{3}$ rpm.

Cutting angle: 15°.

Recording characteristic: IEC standard. **Content:** Band 1A left, 1 kHz $\frac{1}{2}$ octave noise 60s for calibration, level -22 dB ± 1 dB reference 10 cm/s.

Band 2A: left $\frac{1}{2}$ octave bands of pink noise at -22 dB ± 1 dB reference 10 cm/s at 1 kHz from 20 Hz to 20 kHz in 500s preceded by 1 kHz reference and starting signal.

Voice announcement of centre frequencies for manual response measurement of listening rooms.

Band 3A: right but otherwise as band 1.

Band 4A: right but otherwise as band 2A.

Band 1B: left+right but otherwise as band 1A.

Band 2B: left+right but otherwise as band 2A.

Band 3B: left+right as band 2A but without voice announcements and with 150s duration for automatic response plotting.

Band 4: phase check. Left+right and left-right sections of wideband noise 20 Hz to 20 kHz of 30s duration each. Level -24 dB ± 1 dB reference 10 cm/s at 1 kHz.

Band 5B: left+right phase check for loud-speaker drive units. Level -22 dB reference 10 cm/s at 1 kHz, three sections of pink noise (1) 20 Hz to 1 kHz (2) 1 kHz to 4 kHz (3) 4 kHz to 20 kHz each of 15s duration.

Band 6B: for tracing resonant parts, sine-wave frequency sweep from 20 Hz to 1 kHz in 85s preceded by 1 kHz reference and starting signal. Left+right. Level -10 dB ± 1 dB reference 10 cm/s at 1 kHz.

Band 7B: for checking room distribution. Left+right wideband pink noise from 20 Hz to 20 kHz for 240s at a level -24 dB reference 10 cm/s at 1 kHz.

Price: £25 per set of five discs or £7 for single discs.

Manufacturers: Bruel & Kjaer, DK-2850 Naerum, Denmark.

UK Agents: B & K Laboratories Ltd, Cross Lances Road, Hounslow, Middlesex.

CBS LABORATORIES

TYPE BTR 150 broadcast test record

Dimensions: 305 mm nominal diameter.

Speed: 33 $\frac{1}{3}$ rpm.

Recording characteristics: RIAA standard.

Contents: Side A monophonic operation, Side B stereophonic operation.

Band 1A: lateral reference tone at 400 Hz, 0 dB level reference 5 cm/s at 1 kHz.

Band 2A: peaked calibration signal, 400 Hz continuous at 0 dB, 3 kHz 1.5 ms bursts at $+10$ dB at 15 per second.

Band 3A: spot frequencies from 50 Hz to 16 kHz with voice announcements, level -14 dB reference 5 cm/s at 1 kHz.

Band 4A: ballistic testing of VU meters, a one minute section of 1 kHz tone at 0 dB level, followed by 300 ms bursts.

Band 5A: wow and flutter measurement tone 3 kHz at 0 dB.

Band 6: silent groove for rumble and hum measurement.

Band 1B: left reference tone 1 kHz at 3.54 cm/s.

Band 2B: right reference tone 1 kHz at 3.54 cm/s.

Band 3B: left spot frequencies from 50 Hz to 16 kHz at -14 dB reference 3.54 cm/s at 1 kHz.

Band 4B: right spot frequencies as band 3B.

Band 5B: lateral reference tone 1 kHz at 5 cm/s rms.

Band 6B: vertical reference tone 1 kHz at 5 cm/s rms.

TYPE STR 100 stereophonic frequency test record

Dimensions: 305 mm nominal diameter.

Speed: 33 $\frac{1}{3}$ rpm.

Contents:

Band 1A: left sweep frequency 40 Hz to 500 Hz constant amplitude, 500 Hz to 20 kHz constant velocity, 1 kHz 0 dB level.

Band 2A: right as band 2A.

Band 3A: left spot frequencies 20 kHz to 20 Hz, same characteristics and level as band 1A.

Band 4A: tone arm resonance test, left sweep 200 Hz to 10 Hz constant amplitude, $+3$ dB relative to band 1A.

Band 5A: right channel as band 4A.

Band 6A: left 1 kHz reference tone at 0 dB reference 3.54 cm/s.

Band 7A: right channel as band 6A.

Band 1B: left playback loss test, 20 kHz to 1 kHz constant velocity at -15 dB.

Band 2B: right channel as band 1B.

Band 3B: right channel as band 3A.

Band 4B: lateral tracking test .001, .002, .003, .004 and .005 cm peak amplitude.

Band 5B: vertical tracking test as band 4B.

Band 6B: left channel as band 1B.

Band 7B: right channel as band 2B.

TYPE STR 101 seven steps to better listening

Dimensions: 305 mm nominal diameter.

Speed: 33 $\frac{1}{3}$ rpm.

BASF SPR50LH. THE PROOF OF THE PLAYING IS IN THE STANDING, THE CONDUCTING & THE WINDING UP.

BASF professional LH tape has a very low print-through, so it will happily stand in the archives for years.

And its special matt black backing conducts away static build-up and gives excellent high speed rewinding without air cushioning.

BASF SPR50 LH is available in $\frac{1}{4}$ ", $\frac{1}{2}$ ", 1" and 2" widths. For further information, please contact the Professional Tape Sales Department, BASF United Kingdom Limited, Knightsbridge House, 197 Knightsbridge, London SW7 1SA. Tel: 01-584 5080.

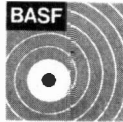

* Dolby A361 for hire *

- * REVOX A77 Mk III Recorders, standard and high speed model in stock. Sel-Sync model available.
- * New REVOX A700 1372 and 1374 now available.
- * NEAL 102 professional cassette deck from stock.
- * All leading equipment at competitive prices including A.K.G., Beyer, Ferrograph, Teac A3340, Quad, Tannoy, Spondor, Uher 4000/4200/4400, Report IC, and CR210 cassette recorder with facility for chrome tape.

131 The Parade, High Street, Watford WD1 1NA
Tel. Watford 34644

BAILEYS

Magnegraph Recording Company Ltd.

8 Hatway Street, London W11 0JL 01-580 2156 or 01-323 0888
(Junction Oxford Street & Tottenham Court Road)

SOUND PEOPLE WITH VISION - for 25 years.

MAGNEGRAPH

- Audio Cassette Duplication 10 - 100,000.
- Tape & Cassette Recorder Rentals.
- Video Design and Installation Service.

Reliability and Simplicity...

... is what most of Britain's commercial radio stations, the BBC and a host of the major recording studios look for in the 3D Series reproducer cartridge machine and cartridges.

The 3D Series reproducer is the machine they now use, it has mechanical strength for continuous and reliable D.J. and broadcasting requirements, the minimum of controls for simplicity of operation and provides for either single or multiple deck capacity.

The best cartridges for the best machine. Our cartridges are the only ones with a proven acceptability to the commercial stations, studios and the BBC and have most of the market to prove it. NAB cartridges come in all types, lengths and are in stock now.

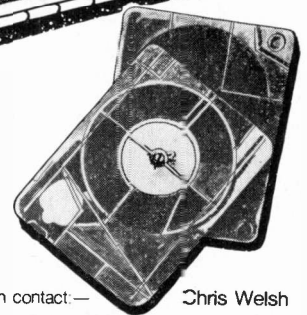
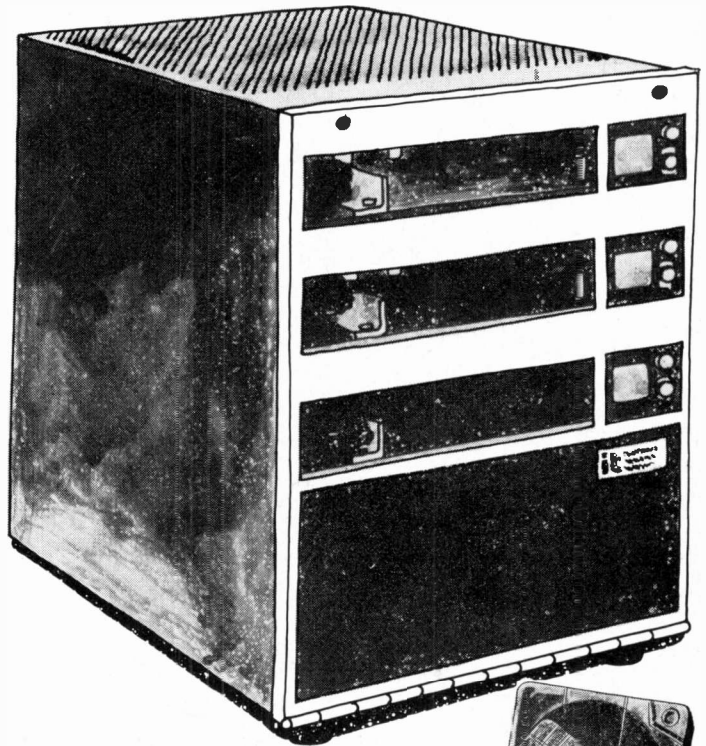

The best machines and cartridges from the company that has a reputation for reliability and service to the industry.

Short term hire of cartridge machines available.

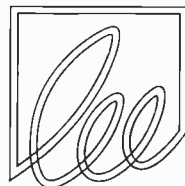

For further information contact: — Chris Welsh

LEE ENGINEERING

Ashley House, Ashley Road,
Walton on Thames, Surrey, KT12 1JE
Tel: Walton on Thames 28783/4
Telex: 928475 Cables: LEETECH

TEST DISCS

Contains tests that are intended for use without measuring instruments.

Contents:

- Band 1A:** left-right identification.
- Band 2A:** phasing test.
- Band 3A:** loudspeaker balance.
- Band 4A:** tone control setting ($\frac{1}{2}$ octave noise bands with pilot tone).
- Band 5A:** alternate phasing test. Side B stereo-monaural tests.
- Band 1B:** as band 4A.
- Band 2B:** buzz and rattle elimination (high level glide tone).
- Band 3B:** lateral tracking test.
- Band 4B:** vertical tracking test.

TYPE STR 111 square wave, tracking and intermodulation test record

Dimensions: 305 mm nominal diameter.

Speed: 33 $\frac{1}{3}$ rpm.

Cutting angle: 15°.

Designed for testing stereophonic pickups for transient and intermodulation distortion, tracking capabilities, dynamic compliance, damping, and high frequency stylus-tip mass.

Contents:

- Band 1A:** 1 kHz square wave. Lateral 5 cm/s, left 3.54 cm/s, right 3.54 cm/s, vertical 5 cm/s.
- Band 2A:** 300 Hz lateral tracking test, +6 dB +9 dB +12 dB +15 dB and +18 dB reference 1.12 x 10⁻³ cm peak amplitude.
- Band 3A:** 300 Hz vertical tracking test, +6 dB +9 dB and +12 dB reference 1.12 x 10⁻³ cm peak amplitude.
- Band 4A:** identical to band 1A.
- Band 1B:** 4 kHz reference tone -18 dB reference 1.12 x 10⁻³ cm peak amplitude, constant level for all intermodulation test bands.
- Band 2B:** lateral intermodulation test, 400 Hz at +6 +9 +12 and +18 dB.
- Band 3B:** vertical intermodulation test, 400 Hz at +6 +9 and +12 dB.
- Band 4B:** lateral intermodulation test, 200 Hz at +6 +9 +12 and +18 dB.
- Band 5B:** vertical intermodulation test, 200 Hz at +6 +9 and +12 dB.

TYPE STR 120 wide range pickup response test record

Dimensions: 305 mm nominal diameter.

Speed: 33 $\frac{1}{3}$ rpm.

For testing pickups above and below the audio spectrum to investigate causes of distortion in these spectra which may become audible, also checks for arm resonance, surface noise etc.

Side A: contains three groups of four bands as follows.

- Band 1A:** left sweep from 500 Hz to 50 000 Hz at constant velocity -8 dB reference 3.54 cm/s rms.
- Band 2A:** right channel as Band 1A.
- Band 3A:** lateral sweep from 500 Hz to 50 000 Hz at constant velocity -8 dB reference 5 cm/s rms.
- Band 4A:** vertical sweep as band 3A.
- Side B**
- Band 1B:** silent groove.
- Band 2B:** 1000 Hz reference tone left channel at 0.80 x 10⁻³ cm peak amplitude (3.54 cm/s rms velocity).
- Band 3B:** right channel as band 2B.
- Band 4B:** left channel sweep 10-500 Hz constant amplitude +12 dB reference 0.80 x 10⁻³ cm peak amplitude.
- Band 5B:** right channel as band 4B.
- Band 6B:** lateral sweep 10-500 Hz constant amplitude +12 dB reference 1.12 x 10⁻³ cm peak amplitude.
- Band 7B:** vertical sweep as band 6B.
- Band 8B:** silent groove.

TYPE STR 130 RIAA frequency response test record

Dimensions: 305 mm nominal diameter.

Speed: 33 $\frac{1}{3}$ rpm.

For rapid testing of professional equipment. Contains sweeps for automatic response plotting and also spot frequency checks.

- Band 1A:** left sweep 40 Hz to 20 kHz at -14 dB reference 3.54 cm/s rms at 1 kHz.
- Band 2A:** right channel as band 1A.
- Band 3A:** lateral sweep 40 Hz to 20 kHz at -14 dB reference 5 cm/s rms at 1 kHz.
- Band 4A:** left spot frequencies 20 Hz to 20 kHz at -14 dB reference 3.54 cm/s rms at 1 kHz.
- Band 5A:** left channel reference tone 1 kHz at 3.54 cm/s rms.
- Band 6A:** right channel reference tone 1 kHz at 3.54 cm/s rms.
- Band 7A:** lateral reference tone 1 kHz at 5 cm/s rms.
- Band 1B:** lateral spot frequencies 20 Hz to 20 kHz at -14 dB reference 5 cm/s rms at 1 kHz.
- Band 2B:** right spot frequencies 20 Hz to 20 kHz at -14 dB reference 3.54 cm/s rms at 1 kHz.

TYPE STR 140 RIAA pink noise acoustical test record

Dimensions: 305 mm nominal diameter.

Speed: 33 $\frac{1}{3}$ rpm.

Designed for acoustical testing of installations it contains spot frequency tones with voice announcements, continuous glide tones in $\frac{1}{2}$ octave bands synchronised for the General Radio Type 1521A recorder.

- Band 1A:** left sweep in $\frac{1}{2}$ octave band 30 Hz to 15 kHz at -14 dB reference 3.54 cm/s rms at 1 kHz.
- Band 2A:** right sweep as band 1A.
- Band 3A:** lateral sweep 30 Hz to 15 kHz at -14 dB reference 5 cm/s rms at 1 kHz.
- Band 4A:** left channel $\frac{1}{2}$ octave bands 30 Hz to 14 kHz at -14 dB reference 3.54 cm/s rms at 1 kHz.
- Band 5A:** left channel reference tone 1 kHz at 3.54 cm/s rms.
- Band 6A:** right channel reference tone 1 kHz at 3.54 cm/s rms.
- Band 7A:** lateral reference tone 1 kHz at 5 cm/s rms.
- Band 1B:** lateral $\frac{1}{2}$ octave bands 30 Hz to 14 kHz at -14 dB reference 5 cm/s rms.
- Band 2B:** right channel as band 1B.
- Band 3B:** wide band noise left channel at -10 dB reference 3.54 cm/s rms.
- Band 4B:** right channel as band 3B.
- Band 5B:** wide band noise with left and right channels in phase at -10 dB reference 5 cm/s rms.
- Band 6B:** wide band noise, left and right channels randomly phased, -10 dB reference 3.54 cm/s per channel.

TYPE SQT 1100 SQ system quadrasonic test record

Dimensions: 305 mm nominal diameter.

Speed: 33 $\frac{1}{3}$ rpm.

Comprehensive test record for SQ systems containing frequency sweeps for eight locations and logic checks etc.

- Band 1A:** lateral 1 kHz reference tone 0 dB 5 cm/s rms.
- Band 2A:** left front frequency sweep 40 Hz to 20 kHz, equalisation, 15 dB reference 3.54 cm/s at 1 kHz.
- Band 3A:** right front frequency sweep as band 2A.
- Band 4A:** right back frequency sweep as band 2A.
- Band 5A:** left back frequency sweep as band 2A.
- Band 6A:** pickup phase measurement. Lateral spot frequencies 63, 125, 250, 500, 1 kHz, 2 kHz, 2.5 kHz, 3.15 kHz, 4 kHz, 5 kHz,

6.3 kHz, 8 kHz, 10 kHz, 12.5 kHz, 16 kHz, 20 kHz, low frequency constant amplitude to high frequency constant velocity, 3 dB knee at 500 Hz, -1 dB at 1 kHz.

Band 7A: channel identification signals, centre front, right front, centre right, right back, centre back, left back, centre left, left front, centre front.

Band 8A: left 1 kHz 0 dB reference tone 3.54 cm/s rms.

Band 9A: right 1 kHz 0 dB reference tone 3.54 cm/s rms.

Band 1B: lateral 1 kHz 0 dB reference tone 5 cm/s rms.

Band 2B: AGC adjustment, lateral 1 kHz -27 dB to +12 dB in 3 dB steps.

Band 3B: single channel logic circuit dynamics. 1 kHz 0 dB level 1s on, 1s off, left front, centre front, right front, right back, centre back, left back.

Band 4B: alternating channel logic circuit dynamics, switching between channels 1 kHz 0 dB level 1s per channel, left front to right front, right front to right back, left back to left front, centre front to centre back, left front to right back, right front to left back, left front to centre front, left front to centre back, right front to centre front, right front to centre back.

Band 5B: (a) left front-left 3.54 cm/s rms. (b) right front-right 3.54 cm/s rms. (c) left back-clockwise helical modulation 3.54 cm/s. Left +90° relative to right, each 2.5 cm/s rms. (d) right back-counterclockwise helical modulation, 3.54 cm/s. Right +90° relative to left, each 2.5 cm/s rms. (e) centre front-lateral 3.54 cm/s rms. (f) centre back-vertical 3.54 cm/s rms.

Manufacturers: CBS Laboratories, High Ridge Road, Stamford, Connecticut, USA. **UK Agents:** Feldon Audio Ltd, 126 Great Portland Street, London W1.

Decca

TYPE SXL 2057 stereophonic frequency response test disc

Dimensions: 305 mm nominal diameter.

Speed: 33 $\frac{1}{3}$ rpm.

Contents: side 1 is left channel, side 2 is right channel otherwise identical in content. **Equalisation to British Standard 1928: 1955** (same as RIAA) to within ± 0.5 dB.

Recorded velocity at 1 kHz: is 1 cm/s at 45° with crosstalk better than -20 dB. Sides contain spot frequencies 12 kHz, 10 kHz, 8 kHz, 6 kHz, 2 kHz followed by locked groove, then 1 kHz reference tone is own band followed by spot frequencies 500 Hz, 250 Hz, 125 Hz, 60 Hz and 40 Hz.

Price: £2.55.

Manufacturers: Decca Records Ltd, 9 Albert Embankment, London SW1.

Deutsche Grammophon Gesellschaft

The following test discs are intended for making measurements to the appropriate DIN standards (German Industry Standards) as follows:

DIN 45 541: for frequency response.

DIN 45 542: for distortion.

DIN 45 543: for crosstalk.

DIN 45 544: for rumble.

DIN 45 545: for wow and flutter.

TYPE 1001 941

170 mm diameter disc for the testing and adjustment of turntables. Side A has unmodulated grooves with a large separation so the disc can be run through quickly. Side B has the diameter of the inner and outer grooves indicated.

TYPE 1001 942

170 mm diameter disc with a 5 kHz carrier for

42 ▶



**WE DESIGN
AND
MANUFACTURE
PROFESSIONAL
AUDIO
EQUIPMENT
AT
MODEST COST**

PHONE OR
WRITE FOR
QUOTATION

NEIL ROSS AT THE CONTROL OF TWEED AUDIO CONSOLE IN RADIO EDINBURGH STUDIO

10 CHANNEL 4 TRACK STANDARD PORTABLE MIXING DESK IMMEDIATELY AVAILABLE WITH COMPREHENSIVE FACILITIES



TWEED AUDIO

ELECTRONICS

ROSEWOOD INDUSTRIAL ESTATE, KELSO, ROXBURGHSHIRE SCOTLAND. TELEPHONE 2983 STD 057 32

Rycote make
WINDSHIELDS
almost indestructible

for
Sennheiser 815, 415, 435. AKG 451-CK1, CK8, CK9

also shock mounts, swivels, pistol grips and covers

RYCOTE, POOLHEAD LANE, TANWORTH-IN-ARDEN
WARWICKSHIRE B94 5EH Tel: EARLSWOOD 2339

EXPOSURE
HI-FI

Phone John Farlowe, 0273 777912

PHASE LINEAR

AMPLIFICATION
the powerful difference

FROM
400WATTS RMS per channel £435 + £34.80 VAT

TO
700WATTS RMS per channel £574 + £45.92 VAT

PRE AMP £488.75 + £39.10 VAT

IMPORT PRICES — TRADE & RETAIL — REPAIRS

from stock
Exposure (hi fi)
Richardson Road
Hove BN3 5RB
Sussex, England

16/2 PORTABLE SOUND MIXER
by **-TURNER-**



- * The TPS Series mixer offers all of the facilities of our 24 channel modular mixer . . . in a non-modular version.
- * From 12 to 24 channels.
- * Custom variations catered for.

Turner Electronic Industries Ltd
175 Uxbridge Road, London W7 3TH - Tel: 01-567 8472

■ TEST DISCS

measuring wow and flutter using a wow and flutter meter complying with DIN 45 507, for instance the type *J60* instrument manufactured by Elektromesstechnik, Lahr/Baden.

TYPE 101 944

170 mm diameter disc with a 3 kHz carrier for measuring wow and flutter using a wow and flutter meter such as the *EMT 418*.

TYPE 1101 495

170 mm diameter disc for testing stereo reproducing equipment. Side A has sections for symmetry and channel identification, channel balance and loudspeaker phasing. Side B contains recordings of a tramcar, aeroplane, railway and also 'My Blue Heaven' (Donaldson).

TYPE 1001 496

The same as the preceding disc but with text in French.

TYPE 1101 497

The same as the preceding disc but with text in English.

TYPE 1099 008

300 mm diameter disc with 5 kHz carrier for measuring wow and flutter, corresponds to type *1011 942*.

TYPE 1099 010

300 mm diameter disc with 3 kHz carrier for measuring wow and flutter, corresponds to type *1011 944*.

TYPE 1099 011

300 mm diameter disc with 45 rpm playing speed for measuring intermodulation distortion according to DIN 45 403 sheet 4. The recording is the sum of two frequencies 400 Hz and 4 kHz in the absolute velocity ratio 4:1 and in the identical level relation.

TYPE 1099 014

300 mm diameter disc for demonstrating the audibility of bandwidth distortion. A musical excerpt is recorded with the full frequency spectrum at the beginning, middle and end of the disc, while in between these excerpts the bandwidth is reduced in half octave steps in the high frequencies and then in the low frequencies. Finally the bandwidth is cut from both ends to a minimum of 355 Hz to 2.8 kHz.

TYPE 1099 015

300 mm diameter disc for demonstrating the audibility of non-linear distortion. A musical excerpt which contains middle frequencies on sustained notes and also a speech excerpt recorded with a limiter but which has been distorted in steps so that the second and third harmonic distortion have equal values. The distortion starts at 5% and increases to a maximum value of 30% second plus third harmonic in 3 dB steps.

TYPE 1099 103

300 mm diameter disc with 33½ rpm playing speed on side 1 and 45 rpm playing speed on side 2 for measuring stereo and mono level at 1 kHz.

Band 1A: left channel at 0 dB (8 cm/s) and -20 dB followed by right channel at same levels on band 2A.

Band 3A: lateral at 0 dB (10.8 cm/s) and -20 dB.

Band 1B and 2B: identical to bands 1A and 1B except at 45 rpm.

Band 3B: at 0 dB (12.3 cm/s) and -20 dB.

TYPE 1099 106

300 mm diameter disc for frequency response measurement according to DIN 45 547 (3180-318-75 µs) 16000-20 Hz with gliding tone. Side A is left channel, side B is right channel.

TYPE 1099 108

300 mm diameter disc for measuring intermodulation distortion of pickups. A gliding frequency pair of tones with 400 Hz separation, gliding from 1 kHz to 20 kHz is recorded in six level steps. This is intended for measuring intermodulation distortion to the CCIR method using a level recorder.

TYPE 1099 109

300 mm diameter warble tone disc for measuring loudspeakers.

TYPE 1099 111

300 mm diameter disc for measuring tracking ability. Both sides are identical and contain a 1 kHz reference tone followed by a 315 Hz lateral recording the amplitude of which is varied in 2 dB steps from 40 to 100 micron.

TYPE 1099 112

300 mm diameter universal frequency measuring test disc.

Side 1: contains gliding tone and fixed frequency sections from 30 Hz to 20 kHz for each channel with IEC (RIAA) equalisation, but with a 10 dB increase in level below 1 kHz. The left and right gliding tone sections are separated by blank grooves and are suitable for automatic level recording with the B & K type *4409* unit. A 1 kHz level section for the left, right, lateral and vertical modes ends side 1.

Side 2: contains 4 sets of gliding tones (left, right, lateral and vertical) separated by blank grooves so that automatic level recording of successive bands is possible. The equalisation is 3180-318µs without treble pre-emphasis.

There are then four bands of 1 kHz level tone similar to side 1. Finally there is a laterally recorded gliding tone section from 5 Hz to 500 Hz for arm resonance measurements.

TYPE 1641 001

300 mm diameter Hi-Fi stereo test disc. Contains, among others, the following sections: Linear and non-linear distortion, basis of two channel stereo alignment, phase, wow and flutter, rumble, crosstalk etc.

These discs are available from Beuth-Vertrieb GmbH, 1000 Berlin 30, Burggrafenstrasse 7 and 5000 Köln, Friesenplatz 16, Germany.

UK Agents: Lennard Developments Ltd, 206 Chase Side, Enfield, Middlesex supply the following discs at £2.50 each: DIN 45 541 (frequency response at 33½ rpm) DIN 45 542 (intermodulation distortion) DIN 45 543 (crosstalk) DIN 45 544 (rumble) and DIN 45 545 (wow and flutter 3150 Hz).

EMI RECORDS

TYPE TCS 101

Dimensions: 305 mm nominal diameter.

Speed: 33½ rpm.

A stereo frequency response test disc with a recorded equalisation characteristic to British Standard 1928-1960 except that the level of frequency bands above 10 kHz is reduced by 6 dB. The nominal recorded velocity of all 1 kHz bands is 1 cm/s rms. Alternate bands are recorded on left and right channels only (except 1 kHz lateral).

Constant frequency bands:

Band 1: 1 kHz lateral, 20, 18, 16, 14, 12 kHz.

Band 2: 10, 8, 6, 5, 4, 3, 2 kHz.

Band 3: 1000, 700, 400, 200, 100, 60, 30 Hz.

Band 4: 1 kHz lateral. The above bands are repeated on both sides.

TYPE TCS 102

Dimensions: 305 mm nominal diameter.

Speed: 33½ rpm.

A stereo frequency response record for checking performance and detecting resonances.

Gliding tone left channel: 1: 1 kHz; 2: 20-10 kHz; 3: 10-1 kHz; 4: 1000-30 Hz. Gliding tone on right channel as above.

TYPE TCS 104

Dimensions: 305 mm nominal diameter.

Speed: 33½ rpm.

A monophonic frequency response test disc with a recorded equalisation characteristic to British Standard 1928:1960 except that the level of frequency bands above 10 kHz is reduced by 6 dB.

Contents: Constant frequency.

Bands: 1: 1 kHz; 20, 18, 16, 14, 10, 8, 6, 5, 4, 3, 2 kHz. 2: 1000, 700, 400, 200, 100, 60, 30 Hz.

Gliding tones: 1: 1 kHz; 2: 20-10 kHz; 3: 10-1 kHz; 4: 1000-30 Hz.

TYPE TCS 105

Dimensions: 305 mm nominal diameter.

Speed: 33½ rpm.

Vertically cut frequency response test record. Has the same general content as type *TCS 104* except that 'Hill and Dale' recording is used.

TYPE TS 201 and TS 202

Dimensions: 175 mm nominal diameter.

Speed: 33½ rpm.

Cutting angle: 15°.

Type *TS 201* (Stereo) and type *TS 202* (Mono) discs are for checking tracking ability to British Standard 4852:Part 1:1972. The recorded levels approximate to the average levels found on disc records.

Content Band 1: 2 kHz 0 dB tone (1 cm/s rms).

Band 2: Glide tone 80 Hz to 8 kHz to 80 Hz.

Band 3: 80 Hz at -4 dB.

Band 4: 500 Hz at +16 dB.

Band 5: 1 kHz at +21 dB.

Band 6: 2 kHz at +22 dB.

Band 7: 5 kHz at +20 dB.

Band 8: 8 kHz at +18 dB.

TYPE RLPS 22

Stated by EMI to be a 'Wow Test' but no further information provided.

Manufacturers: EMI Records Ltd, Manchester Square, London W1.

HI-FI SOUND

TYPE HFS 75

Dimensions: 305 mm nominal diameter.

Speed: 33½ rpm.

The *HFS 75* test disc is intended for both aural testing and measurement of turntables and cartridges.

Content Band 1A: has signals for aural checking of channel location phasing and balance.

Band 2A: tracking and bias correction band with 300 Hz sinewave recorded at three discrete levels +11 dB, +14 dB and +18 dB reference 1.12 x 10⁻³ cm/s peak velocity, lateral.

Band 3A: is similar to band 2A but contains a vertical recording at +7 dB and +11 dB.

Band 4A: has pink noise at -15 dB reference 5 cm/s.

Band 5A: contains a 1 kHz reference tone at 10 cm/s followed by a blank groove for checking rumble.

Band 1B: bias correction recording of 300 Hz lateral at +15 dB reference 1.12 x 10⁻³ cm/s.

Band 2B: white noise at -15 dB reference

44 ▶

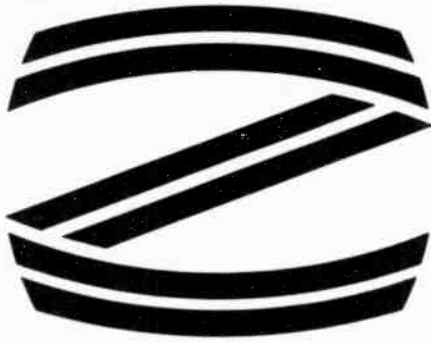

VIDEO HIRE AND SALES

ZOOM TELEVISION LTD

Pinewood Studios Iver Heath Bucks Tel. Iver 654044
Caledonian House Tatton St Knutsford Cheshire Tel. Knutsford 4330

mixing with the best

In order to fill the need for a small versatile truly professional mixer, Stellavox have designed the ultra modern Mixer type AMI 48. Using the same principles as the well known Stellavox professional tape recorder type SP7, the AMI 48 is : very rugged, with a die-cast chassis; very light and small, but with perfect operational comfort; battery operated, for use anywhere.

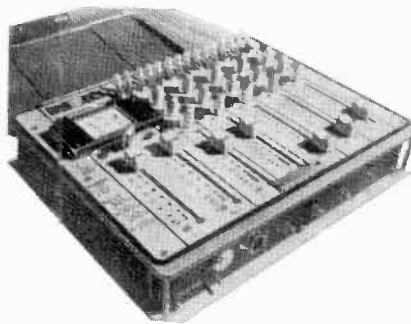

Being comprehensive, it offers not only the classical facilities of conventional big studio consoles, but many exclusive circuits: *powering for any condenser microphones* (parallel or phantom fed 12 V, phantom fed 48 V); very accurate *880 Hz tuning fork reference oscillator*; and the new *limiting circuits type SIL on all inputs and outputs*, allowing easy use of **STELLAMASTER** technology for extremely low noise recordings.

STELLAVOX

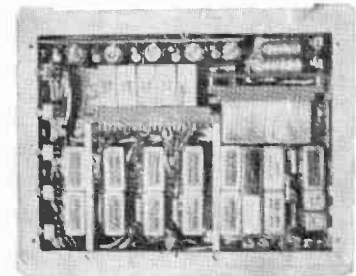

A. V. Distributors (London) Ltd.
26 Park Road, Baker Street,
London NW1 4SH.
Tel.: 01-935 8161.

Please send me further Stellavox details.

Name

Address

.....

.....

.....

SS2/75



THE ULTIMATE IN TONE CONTROL

Teknik 27s Graphic Equaliser

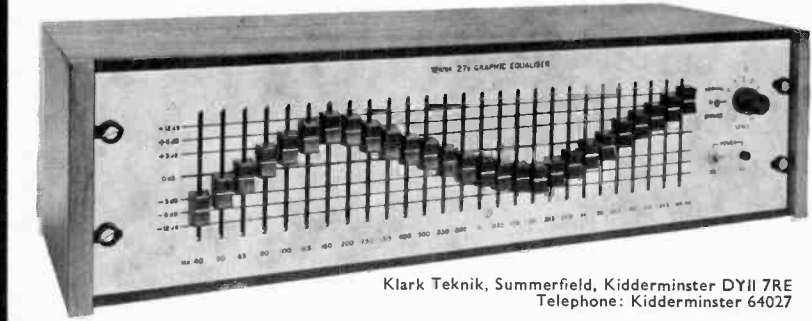

Klark Teknik, Summerfield, Kidderminster DY11 7RE
Telephone: Kidderminster 64027

TEST DISCS

5 cm/s.

Band 3B: as band 1B.

Band 4B: 1 kHz left and 1 kHz right at 5 cm/s for balance and separation checks.

Band 5B: 3 kHz at 5 cm/s for wow and flutter check, in conjunction with concentric groove at outside of disc.

Band 6B: as bands 1B and 3B.

Price: £2.

Manufacturers: Haymarket Publishing Group, Gillow House, 5 Winsley Street, London W1.

JVC

TYPE TRS-1001

Dimensions: 305 mm nominal diameter.

Speed: 33 $\frac{1}{3}$ rpm.

Monophonic disc intended for checking frequency response, mechanical impedance, wow and flutter, balance, signal-to-noise etc.

Equalisation side: A to RIAA except constant velocity below 1 kHz, side B to RIAA.

Contents bands 1A to 6A: contain 5s of tone at 5 cm/s peak velocity above 1 kHz with frequency $\pm 1\%$ and level ± 0.5 dB throughout.

Frequencies: 1 kHz, 15, 14, 13, 12, 11, 10, 9, 8, 7, 6, 5, 4, 3, 2, 1 kHz, 700, 400, 300, 200, 100, 70, 50, 30 Hz.

Band 7A: 1 kHz tone at 5 cm/s for 30s followed by 30s blank groove.

Band 8A: has 150s of 3 kHz tone with wow and flutter less than 0.03% rms.

Band 9A: mechanical impedance section with 30s each 400 Hz at 5 cm/s, 300 Hz at 3.8 cm/s, 200 Hz at 2.5 cm/s and 100 Hz at 1.1 cm/s.

Band 10A: 1 kHz at 5 cm/s.

Side 2 Band 1B: 1 kHz at 2 cm/s followed by bands 2B to 6B having 10s each of 15, 12, 10, 9, 8, 7, 6, 5, 4, 3, 2, 1 kHz, 800, 600, 400, 200, 100, 70, 50, 30 Hz.

Band 7B: 1 kHz at 2 cm/s.

TYPE TRS-1002

Dimensions: 305 mm nominal diameter.

Speed: 33 $\frac{1}{3}$ rpm.

Stereophonic disc intended for checking frequency response, wow and flutter, crosstalk, balance etc.

Equalisation: to RIAA except constant velocity above 1 kHz.

Sides A and B are identical except that side A is the left channel and side B the right channel (excluding the wow and flutter and reference level bands).

Crosstalk: better than 30 dB at 1 kHz, fre-

quency accuracy $\pm 1\%$ above 1 kHz or ± 1 Hz below 1 kHz.

Accuracy of recorded level: ± 0.5 dB.

Contents Band 1: 3 kHz wow and flutter band with less than 0.05% rms wow and flutter.

Band 2: reference level 1 kHz 5 cm/s lateral.

Band 3: unmodulated groove.

Bands 4 to 7: 10s of each 15, 12, 10, 8, 6, 4, 2, 1 kHz, 700, 400, 200, 100, 70, 50 and 30 Hz.

TYPE TRS-1003

Dimensions: 305 mm nominal diameter.

Speed: 33 $\frac{1}{3}$ rpm.

Stereo frequency response record for testing the high frequency response of CD4 pickup cartridges.

Side A is left channel only, side B is right channel.

Equalisation: is not used and the disc is cut at constant velocity 3.54 cm/s.

Contents Band 1: 1 kHz reference for 10s, followed by sweep from 1 kHz to 50 kHz in 28s which may be synchronised to B & K level recorders.

Bands 2 to 8: spot frequencies for 5s at the following frequencies 1 kHz, 50, 45, 40, 35, 30, 25, 20, 15, 10, 5, 1 kHz with crosstalk better than -20 dB.

Band 9: is as Band 1.

TYPE TRS-1004

Dimensions: 305 mm nominal diameter.

Speed: 33 $\frac{1}{3}$ rpm.

A record cut for undertaking quick checks of high frequency response, crosstalk and phase of CD4 cartridges. Primarily intended for checks during production.

Contents: Sides A and B are identical.

Band 1: lateral 1 kHz at 5 cm/s reference level.

Band 2 to 11: contain left followed by right channels at a recorded velocity of 3.54 cm/s as follows.

Bands 2 and 3: 60s each of 40 kHz.

Bands 4 and 5: 90s each of 30 kHz.

Bands 6 and 7: 60s each of 20 kHz.

Bands 8 and 9: 90s each of 10 kHz.

Bands 10 and 11: 60s each of 1 kHz.

Band 12: 60s of 370 Hz squarewave for polarity checking.

Band 13: 30s of 100 Hz recorded at 1.1 cm/s lateral.

Band 14: 120s of 30 kHz lateral recording at 5 cm/s for tracking loss checks on inner grooves.

TYPE TRS-1005

Dimensions: 305 mm nominal diameter.

Speed: 33 $\frac{1}{3}$ rpm.

Record for high frequency response and crosstalk tests on CD4 cartridges using level

recorders such as the B & K 2305/2307. Content frequency sweeps from 1 kHz to 50 kHz in 9 sets for left and right channels repeated in three groups.

Side B is identical to side A.

TYPETRS-1300

Dimensions: 305 mm nominal diameter.

Speed: 33 $\frac{1}{3}$ rpm.

For checking high frequency response and crosstalk.

Content: is 18 spot frequencies from 50 kHz to 1 kHz (2.5 kHz steps above 15 kHz, 5 kHz steps below 15 kHz). Side A is left channel, side B is right channel.

Manufacturers: JVC America Inc, CD4 Division, 50-35 56th Road, Maspeth, New York 11378, USA.

UK Agents: JCV (UK) Ltd, 453 Caledonian Road, London N7 who will order records when requested, but do not hold stocks.

ORTOPHON

Details as per Bruel & Kjaer Type QR-2010 Comprehensive Laboratory Disc.

Price: £11.50.

UK Agents: Feldon Audio Ltd, 126 Great Portland Street, London W1.

SANSUI

TYPE PR401QS 4-channel QS test record

Intended for home adjustment of QS 4-channel systems. Side A contains a series of balance and frequency response tests as well as phasing tests, also rumble, wow and flutter sections and sweep tones. These are followed by musical excerpts. Side B contains various musical selections.

Manufacturers: 201 Communications Inc, 201 East 42nd Street, New York 10017, USA.

UK Agents: Sansui Audio Europe SA, 39/41 Maple Street, London W1.

SHURE

TYPE TTR-103 trackability test record

Dimensions: 305 mm nominal diameter.

Speed: 45 rpm.

The record contains three trackability tests which may be used audibly, with an oscilloscope or with a wave analyser; it is recommended that all three methods are used.

Content: Band 1A to Band 4A left channel with 10.8 kHz signal pulsed at 270 Hz level increasing in steps 15, 19, 24 and 30 cm/s.

Bands 5A to 8A lateral 1 kHz with 1.5 kHz, level increasing from 20 cm/s through 25, 31.5 cm/s to 40 cm/s in steps.

Side 2 Bands 1B to 4B: as side 1 Bands 1A to 4A but right channel.

Bands 5B to 8B: lateral 400 Hz with 4 kHz, level increasing from 15 cm/s through 19, 24 cm/s to 30 cm/s in steps.

Price: £6.30.

TYPE TTR-110 audio obstacle course

Dimensions: 305 mm nominal diameter.

Speed: 33 $\frac{1}{3}$ rpm.

This disc is for subjective evaluation of tracking ability, and in addition to providing for checks on balance, level and phasing, contains various musical excerpts recorded at increasing levels. These excerpts include musical bells, sibilance tests, bass drum. While this is not in any way a calibration test disc, it is a useful check disc for comparing the performance of cartridges.

Price: £2.70.

Manufacturers: Shure Brother Inc, 222 Hartrey Avenue, Evanston, Illinois 60204 USA.

UK Agents: Shure Electronics Ltd, Eccleston Road, Maidstone, Kent.

SPECTRUM SHIFTER

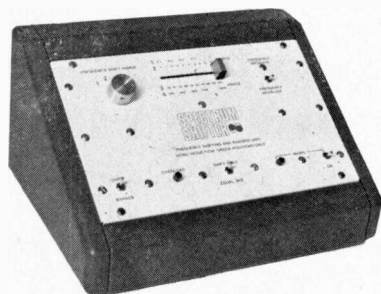

AN ENTIRELY NEW SOUND EFFECT

- * Audio shifts up or down by 0.1 to 1000Hz for weird music and speech effects.
- * 'EQUAL MIX' gives phasing and beating effects.
- * 1-10Hz range for versatile howl reduction applications.

SURREY ELECTRONICS

The Forge, Lucks Green, Cranleigh, Surrey GU6 7BG. S.T.D. 04866 5997

Announcing the new Maxell Ultra Dynamic cassette. We've added a little more Ultra to the Dynamic.

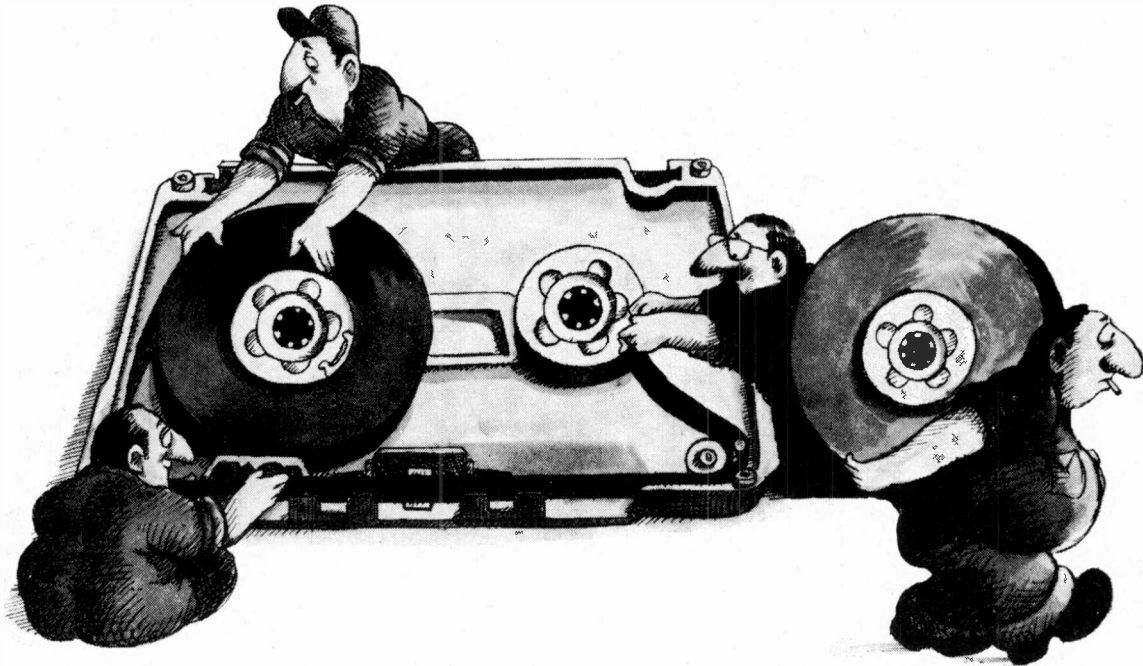

We wanted to make some really big improvements in our cassette. But there just weren't any big improvements left to make. So we made a lot of little improvements.

More hertzies.

We reduced the size of the tiny PX gamma ferric oxide particles on the surface of our tape. The result is our biggest improvement. The Hz now go up to 22,000 Hz which means you get higher highs. And the dynamic range is wider so the distortion is lower.

Little pad finally gets grip on self.

Other cassettes keep their pressure pads in place with glue—or rather don't keep their pressure pads in place with glue. So we've designed a little metal frame for the pad and now the pad is held in a grip of steel. With the result that you don't need to worry about signal fluctuations or loss of response any more.

Three little arrows.

The first five seconds of our new cassette is a timing leader and we've marked the place where it starts with three little arrows. Which means the next time you record Beethoven's Fifth, you'll include Beethoven's opening da-da-DAAA.

Amazing new miracle ingredient fights dirt fast!!!

The new timing leader's also a head-cleaner and what's amazing, new and miraculous about it is that it doesn't rub as it scrubs as it cleans. So it keeps your tape heads clean without wearing them down.

Our screws aren't loose.

We started putting our screws into square holes. That way the plastic shavings from the threads get trapped in the corners of the holes and can't cause trouble jumping around in the works. And the square holes hold the screws much more tightly.

Our new long-playing cassette is shorter.

We also have a new shorter length. The Maxell UDC-46. Twenty-three minutes per side. Which very conveniently just happens to be the approximate playing time of your average long-playing record. (Our other UD cassettes are 60, 90 and 120 minutes.)

Altogether we've made five new improvements in our Ultra Dynamic cassettes.

Five ultra dynamic new improvements.



maxell®

The answer to all your tape needs.

Sole U.K. Distributors



**ACOUSTICO
ENTERPRISES
LTD** *The Hi-Fidelity People*

Unit 7, Space Way, North Feltham Trading Estate,
Feltham, Middlesex. Tel: 01-751 0141 (4 lines)

Several tape manufacturers and one tape standards laboratory in the United States produce test tapes to either NAB or IEC general standards, at various speeds and tape widths. Levels, response accuracy and phase accuracy (azimuth) are examined and compared.

Test tapes

ANGUS MCKENZIE*

SEVERAL TAPE manufacturers and one tape standards laboratory in the United States produce test tapes to either NAB or IEC general standards, and at various speeds and tape widths. Levels, response accuracy and phase accuracy (azimuth) are examined and compared.

For many years there have been two accepted reference levels throughout the world, one having a flux of 320 nW/m as measured by the Deutsche Institute Norme (DIN), and the other having a level now alleged to be 185 nW/m, and commonly referred to as Ampex operating level. In earlier days Ampex operating level was defined as 200 nW/m, or 20 millimaxwells per mm.

The DIN reference of 320 nW/m originates from measurements taken of a large number of small pieces of tape that were lowered into a special coil detector to determine the magnetic induction produced, and measurements obtained from this method are defined as being open circuit flux. A large number of measurements have to be taken since we understand that there is a variability in the readings, and therefore an average has to be taken to obtain a mean. The measurement technique is extremely involved, and requires dc magnetisation of the tape with a measured dc current passed through a special record head. Having measured a flux by this method an ac signal of 1 kHz is recorded on to the tape with an rms level identical to the dc current that had been passed through originally, and the ac flux produced is then said to be the same magnetic flux as was given by the dc recording. A master tape thus produced resides at the DIN, and we understand that samples are also held by BASF and AGFA stored in a carefully-controlled environment. In the earlier days of tape recording a flux was measured that produced a given amount of harmonic distortion on a specific batch of tape, and it is probable that the existing DIN reference level dates back to these early measurements.

Ampex first commenced making professional recorders in America just after World War Two, originally at 76 cm/s, but followed shortly afterwards by models incorporating lower speeds. For many years, J. McKnight was in charge of the Ampex tape laboratories, and determined the levels of earlier tape that allowed recordings to be made at reasonable distortion levels when his pre-determined level was played back on to a meter so that it gave a reading of 0 vu. This level normally represents an input and output level of 4 dBm across 600 ohms, and engineers not peaking more than 0 vu on programme would have been peaking approximately 6 dB higher for a distortion level of around 2% or 3%. As American tapes improved, engineers using vu meters were encouraged to increase the allowable peak level, but unfortunately the situation soon arose whereby vu meter needles were regularly allowed to hit the end stop. Some American manufacturers now recommend that Ampex operating level should be replayed such that the level is indicated at considerably less than 0 vu, thus encouraging very high peak recording levels to be recorded. This can be unfortunate since confusion may arise with interconnections with the Dolby A noise reduction system.

McKnight measured flux by the short circuit method, which basically means that the oxide

is in touch with a special replay head as a measurement is being taken, and for this reason the actual flux level eventually calculated appears to be different to that measured by the DIN method. After measuring many test tapes over the years we found this difference to be about 1 dB, which has been confirmed by our latest measurements of flux, comparing Ampex and MRL from the States with EMI, Agfa and BASF in Europe. This in effect means that a theoretical difference of 4.8 dB between Ampex operating level and DIN mono reference levels measures around 3.8 dB, although the flux found on the EMI test tape was marginally higher. Unfortunately, this means the difference between the NAB and DIN marks on Dolby processors should be 3.8 and not 4.8 dB, and strangely the original *A301* corresponds more closely to this. Since McKnight re-measured Ampex operating level more carefully some years ago as 185 nW/m he has left Ampex to form his own company, McKnight Reference Laboratories. His test tapes, both to NAB and European standards, are available from Bauch Ltd of Borehamwood. Ampex produce tapes, available from their Reading office, to both NAB and IEC equalisation, although the latter are not usually held in stock since many studios using IEC prefer to purchase European test tapes. Agfa produce a smaller range of tapes to cover the IEC equalisation at all the more usual speeds and, at 19 cm/s only, they also produce NAB, since this is recognised by IEC as a domestic curve. BASF on the other hand produce IEC and NAB tapes at all speeds, and for all tape widths in normal use. EMI produce IEC test tapes only, from 9.5 cm/s to 76 cm/s. Acoustico, the present agents for Teac, distribute a 19 cm/s NAB tape at a reasonable price, and also a very reasonably-priced cassette test tape, which agrees accurately with the BASF one which we recently purchased.

Unfortunately, both the BASF and Agfa NAB test tapes contain reference levels at the DIN standard level of 320 nW/m, and this is often confused with Ampex operating level, some studios setting them incorrectly to 0 vu, and since they are using NAB equalisation have set them to the NAB mark on Dolby equipment.

This is most confusing. At the earliest opportunity it is suggested that BASF in particular should produce their 38 cm/s NAB tapes with Ampex operating level reference to replace their DIN level. Furthermore, since Ampex and MRL record their 38 cm/s test tapes at 0 vu (185/200 nW/m) we can see no reason why BASF should not do likewise, making their tape much more convenient for lining up with a recorder's internal vu meter. Conversely we found that the MRL DIN test tapes had a reference level of 200 nW/m measured by the McKnight method, and in practice we found this 3.1 dB below DIN level (not 4.08 dB, the theoretical figure). If there must be two standards of level, then surely they should inter-relate when tapes are to be produced to the standard other than that normally recognised in the country of origin.

Ergonomically, the order of tones on a test tape is most important, and there are two clear schools of thought as to whether low or high frequencies should begin a reference run. All the tapes, except Ampex, run low to high, but the Ampex tapes not only run high to low, but their highest frequency band, 15 kHz, is also

*Angus McKenzie Facilities Ltd

the azimuth section. It is felt that for practical applications the Ampex sequence is far more useful at 38 cm/s, but also that there should be an independent azimuth band of 10 kHz at operating level immediately before the 15 kHz section. In general use, a magnetised or worn playback head may not become apparent until after a portion of the 15 kHz tone has already been played back, and perhaps partly damaged. It is easy to say that a machine should always be demagnetised before playing any test tape, but there are occasions when this is forgotten. We also think that for standardisation's sake the 700 Hz Ampex operating level tone should be changed to one of 1 kHz. At 19 cm/s, Ampex put their operating level tone right at the end of the tape, which we found extremely annoying, the reason apparently being that the first 700 Hz tone on the tape also sets the reference level for the frequency run at -10 vu to avoid tape saturation at short wavelengths.

At 9.5 cm/s, Ampex record a level of -10 dB below operating level, but unfortunately their test tape stops at 7.5 kHz. The Ampex test tapes were all short, and a little crude, with very poor quality speech, unnecessarily lengthy at the beginning and normally not including any repetition bands. We were very concerned that at 38 cm/s there appeared to be a loss at the two lowest frequencies. In the most severe case this loss amounts to some 3 dB at 30 Hz on the 38 cm/s test tape; this has also been found by other users. Ampex were not able to give a reason for this at the time of writing. This problem did not exist on the McKnight tapes. The prices of the Ampex test tapes were quite reasonable, and they are very widely used. So many machines will have had their replay amplifiers designed to play Ampex tapes back flat, and this may well be a stumbling block to any corrections being made.

The McKnight test tapes are very well documented, since each tape is provided with a correction pen chart showing the deviation from a perfect playback curve according to McKnight's researches. Much useful information is included, and suggestions such as that fringing effect compensation might be made on low frequencies when playing the tapes back on wide guard band multitrack machines. The 38 and 19 cm/s test tapes start with a reference level, measured with the short circuit flux method, of 200 nW/m and it is difficult to understand why McKnight should have chosen this level which is now non-standard throughout the world, since Ampex operating level is the generally accepted standard for NAB equalisation. What is also confusing is that although McKnight's DIN and NAB 200 nW/m fluxes agreed to within 0.1 dB, there appeared to be an error between McKnight and Ampex at 38 cm/s, since the theoretical difference of 0.7 dB was only measured as 0.25 dB. However, at 19 cm/s McKnight again agreed between his DIN and NAB tapes, usually 1 dB above Ampex 19 cm/s. It would appear possible, therefore, that Ampex's 38 cm/s tape had slightly too high a reference level, and their 19 cm/s one was too low. The MRL then had a frequency of 500 Hz at the frequency run level, followed by frequencies of 8 and 16 kHz for rough and fine azimuth adjustment, followed by a frequency run from 31.5 Hz to as high as 20 kHz; the 38 cm/s tapes were recorded at operating level throughout, whereas the 19 cm/s tape frequency run was at -10 dB.

At 9.5 cm/s MRL use a 500 Hz reference level of 200 nW/m followed by a 250 Hz tone at -10 dB, and then 4 kHz and 8 kHz azimuth tones, and a frequency run from 31.5 Hz to only 10 kHz. The MRL tapes are wound end out and carry an announcement, recorded backwards, to remind users.

The BASF full track test tapes have a reference level of 320 nW/m (open circuit flux) at 38 and 19 cm/s for both NAB and IEC. These are followed by 1 kHz at -10 dB for a brief period, and then a very long azimuth band at 10 kHz. The frequency run extends to 18 kHz at both speeds, and each had a level of -20 dB. One particularly useful aspect of the BASF and Agfa tapes is their repetition bands, two of which are provided in sequence for frequencies of 4-18 kHz at 19 and 38 cm/s. Since the highest frequencies are the ones that lose magnetisation more quickly it is easy to check the main run against the first repetition at intervals, and then replace the main run with the repetition when a fall off becomes apparent. The second repetition can then be used as a reference for the replacement, thus giving the tapes a longer life. BASF test tapes are in general more expensive than any of their competitors, but because of the repetitions the extra cost may be considered justifiable. At 9.5 cm/s, however, there is unfortunately no repetition, and test tapes at this speed are the first ones to lose high frequencies because of the extremely short wavelengths recorded. Possibly at least one repetition band should be included, despite the fact that preserving azimuth at this speed is far more difficult. The reference level for this speed is at 250 nW/m and is at 333 Hz, which is followed by the same frequency at -20 dB. The azimuth band of 10 kHz is at the same level as is the frequency run extending from 31.5 Hz to 16 kHz, the shortest wavelength found on any quarter-inch test tape we have examined. All the BASF tapes finish with reference frequency at the end and at the appropriate response section level. The announcements are extremely clear with a very wide response, but we found a rather excessive top on the voice a little overbearing on repeated hearing. They were, however, extremely consistent between samples, and have excellent stability.

The NAB and DIN reference levels coincided extremely well at each speed, but we feel that their 38H NAB tape would have been far more acceptable if the entire run had been recorded at Ampex operating level. We also think it a pity that BASF do not issue their 19 cm/s test tapes with the azimuth and frequency run at a higher level. -14 dB below 320 nW/m, 6 dB above the existing level, seems easily accommodated on their modern tapes without problems at the high frequency end and would allow most passive meters such as vu types to be used for an approximate equalisation at this speed.

Agfa do not appear to recognise other than IEC standards, but do, however, publish 19H (NAB) as an alternative. The 38S (IEC) test tape contains the same frequencies as BASF, at the same levels and with two repetitions, but unlike BASF includes a gliding tone band from 31.5 Hz to 18 kHz, with some standard frequency markers. This gliding tone most conveniently synchronises with B&K chart recorders.

We find this gliding tone band

extremely useful, and cannot understand why BASF have now dropped it in their latest issues. Agfa's 19 cm/s tapes are again to the same format as BASF, but have no gliding tone at the end. At 9.5 cm/s Agfa's test tape only extended from 31.5 Hz to 12.5 kHz, but is more useful since two repetition bands are given, and this seems preferable to BASF's inclusion of 14 and 16 kHz bands, especially since it appears that there is some doubt about the accuracy of the highest tones on the BASF 9.5 cm/s test tape. In the UK, Agfa test tapes are more reasonably priced than BASF, but the stock held in London is nowhere near so extensive. Whereas BASF's announcements are in English, Agfa's are in German. Also, the BASF and Agfa 38 cm/s tapes were supplied oxide out on a flangeless core. Their 19S tapes were supplied oxide out, but the 19H and 9.5 cm/s tapes were oxide in, either on 13 cm or 10 cm normal cine spools with a large amount of leader at the end, or supplied on large hub reels. BASF are prepared to supply their 38 cm/s tapes on 18 cm cine reels to special order. Oxide out winding can be a little annoying, and one studio telephoned about a bad replay response on their Revox high speed model 77 which we had aligned for them. It was then discovered that they were playing a test tape with the oxide away from the replay heads. Both BASF and Agfa should correct this winding, since it is definitely not the convention in the UK.

EMI at Hayes produce test tapes only to the IEC broadcasting standards, and do not supply NAB tapes. Their standard 320 nW/m flux was found $\frac{1}{4}$ dB higher than BASF and Agfa, but they were consistent throughout all their tapes. Their price is reasonable, and we were delighted to find the tapes supplied in round metal cans to reduce any risk of demagnetisation. This is important, and should be taken up by the Continentals, and certainly by MRL and Ampex whose tapes have to make a long journey by air, since surprisingly-strong magnetic fields can be produced in the freight hold. The responses of the EMI tapes were found to lie pretty accurately along the average of all the tapes, to their credit. The inclusion of a 3 kHz wow and flutter band on the EMI test tape seemed questionable, since this band had a wow and flutter content higher than that found on many professional machines and was thus more or less useless. We feel that they would be better to drop this band completely, if they cannot produce a guaranteed maximum of .02% peak weighted DIN, since the wow is clearly audible (it measured .04% at 38 cm and higher on their lower speed tapes). EMI's 38 and 19 cm/s test tapes are very good value for money, but the azimuth did not seem to correspond with that found on the average Continental tapes. On their 9.5 cm/s tape we were alarmed to find that the azimuth changed slightly throughout the tape, and in order to obtain the readings shown in the chart the azimuth had to be tweaked continually during the high frequency bands. This gave an improvement of some 2 dB at 14 kHz. All the EMI test tapes also include a section of stroboscopically-marked leader to allow an accurate setting of recorder speed, but the general accuracy of their tones was rather poor. For example, 1 kHz was 0.75% high on the

TEST TAPES

38 cm/s tape, and this should be corrected to enable user to use frequency counters for very precise speed setting. Similar should be said about some of the Ampex and MRL tapes. It is felt that more attention should be paid by everyone (except BASF) to better consistency within their specification of $\pm 0.3\%$ of nominal. The frequency of the reference levels on each tape is given, to an accuracy of $\pm 0.1\%$, in the chart, for we cannot guarantee a closer measurement.

Ampex and MRL unfortunately do not use leader tape at the beginning or end of their tapes. We noticed some quite bad print-through on one of the MRL 19 cm/s tapes, which we noticed was recorded on 3M type 207. This print was noticed on both tone and announcements, and would make pen chart recordings look rather untidy when theoretically no modulation should be present between bands. This would affect chart recorders being driven by wave analysers having their tuning frequency driven automatically.

The variations in response on all the tapes at 38 cm/s were not too bad, but we noticed that BASF always had more hf level than their competitors. We were alarmed by the Ampex tapes' bass error at 38 cm/s. At 19 cm/s greater deviations were noticed, which became quite marked. We found that the American tapes were again down at the treble end compared with the European ones. BASF were at the top end of their apparent tolerance, whereas Agfa and EMI seemed to be along a fairly central line. MRL in particular always seemed to be slightly down in treble, and Ampex to a lesser degree, and we wonder if this could be caused by the air freighting.

We were very alarmed by the frequency response sections at 9.5 cm/s since there was an astonishing difference between the tapes' responses at 10 kHz, let alone higher. BASF's apparent boost of 3 dB above the average at 10 kHz looks rather suspicious. We checked the 8 kHz BASF band on the 9.5 cm/s tape against the 16 kHz bands at 19 cm/s by playing the lower speed tape at double speed, and correlating the tapes with appropriate time constant corrections. This showed an apparent inconsistency between the two BASF tapes of 1.5 dB, thus explaining half the error. If it can be accepted that BASF's 19S and 19H tapes are also slightly up in top, more of their hf apparent error at 9.5 cm/s can be explained. This point was raised with them at length in a phone call to Germany, and on looking up their calibrations of the test tapes they claimed that no excursion of the two 9.5 cm/s test tapes measured was greater than 1 dB. We feel that something must be wrong somewhere, and the matter needs serious investigation. One other rogue frequency was noted, this being the 7.5 kHz band of the Ampex 9.5 cm/s tape; this also seemed to be at an excessively high level.

If the reader is now disturbed about the frequency response of the different tapes, he will probably be even more so about the variations in azimuth noted, particularly at the lower speeds. For these measurements the two outputs from the tape recorder were corrected to a Hewlett Packard gain/phase meter, and the phase was observed on a digital meter. This was found to hover rather a lot,

TABLE 1: 38.1 cm/s, full-track. Frequency response sections

Frequency, Hz	NAB		MRL		IEC		MRL	
	0.2% slow	0.2% fast	0.2% slow	0.2% slow	0.3% fast	0.1% fast	0	0
30	-2.75	—	—	—	—	-0.2	—	—
31.5	—	0	0	-0.1	+0.3	—	+0.1	—
40	—	0	—	—	+0.5	-0.2	—	—
50	-1.9	—	—	—	—	—	—	—
60	—	—	—	—	—	-0.3	—	—
63	—	0	0	-0.6	+0.45	—	+0.2	—
100	-0.1	—	—	—	—	—	—	—
125	—	+0.1	0	-0.3	+0.3	-0.3	+0.3	—
250	0	0	+0.2	-0.3	+0.2	-0.2	+0.3	—
500	0	0	+0.1	-0.2	0	-0.1	+0.2	—
700	-0.1	—	—	—	—	—	—	—
1k	0	0	0	0	0	0	0	—
2k	—	0	-0.1	0	+0.2	0	-0.1	—
2.5k	+0.1	—	—	—	—	—	—	—
4k	—	0	-0.1	0	+0.2	+0.1	-0.3	—
5k	+0.2	—	—	—	—	—	—	—
6k	—	—	—	—	—	0	—	—
6.3k	—	0	—	0	0	—	—	—
7.5k	+0.1	—	—	—	—	—	—	—
8k	—	+0.1	-0.2	+0.2	+0.2	-0.1	-0.3	—
10k	0	+0.4	-0.4	0	+0.3	-0.1	-0.3	—
12k	0	—	—	—	—	-0.2	—	—
12.5k	—	+0.4	-0.4	-0.2	+0.5	—	-0.3	—
14k	—	+0.4	—	0	+0.3	-0.1	—	—
15k	0	—	—	—	—	—	—	—
16k	—	+0.4	-0.7	0	+0.4	0	-0.4	—
18k	—	+0.5	—	-0.1	+0.4	-0.2	—	—
20k	—	—	-0.8	—	—	+0.2	-0.5	—
Tape used	?	LGR30P	?	PER 525	LGR30P	816	?	?

TABLE 2: 19.05 cm/s, full-track. Frequency response sections

Frequency, Hz	NAB 50 μ S + 3180 μ S					IEC 70 μ S 19S			MRL
	Ampex	Agfa	BASF	MRL	Teac	Agfa	BASF	EMI	
30	—	—	—	—	—	—	—	-0.2	—
31.5	—	0	-0.1	-0.4	+0.9	0	0	—	0
40	—	0	-0.1	—	+1.2	0	+0.4	-0.5	—
50	0	—	—	—	—	—	—	—	—
60	—	—	—	—	—	—	—	-0.5	—
63	—	0	+0.2	-0.2	-0.9	-0.3	+0.2	—	+0.1
80	—	—	—	—	+0.1	—	—	—	—
100	0	—	—	—	-0.1	—	—	—	—
125	—	+0.25	0	0	0	+0.1	+0.1	-0.8	+0.2
250	0	0	+0.2	0	0	0	+0.1	-0.4	—
400	—	—	—	—	0	—	—	—	+0.2
500	-0.1	0	+0.1	0	0	0	0	-0.3	0
700	-0.2	—	—	—	—	—	—	—	—
1k	0	0	0	0	0	0	0	0	0
2k	—	+0.4	-0.1	-0.2	-0.2	+0.2	0	0	-0.3
2.5k	0	—	—	—	—	—	—	—	—
4k	—	+0.5	0	-0.4	0	+0.4	+0.2	0	-0.5
5k	-0.1	—	—	—	—	—	—	—	—
6k	—	—	—	—	—	—	—	0	—
6.3k	—	+0.6	-0.1	—	+0.3	+0.4	+0.2	—	—
7.5k	-0.3	—	—	—	—	—	—	—	—
8k	—	+0.5	+0.1	-0.6	—	+0.5	+0.4	-0.2	-0.7
10k	-0.5	+0.5	+0.25	-0.7	+0.5	+0.75	+0.5	-0.5	-0.75
12k	-0.5	—	—	—	—	—	—	-0.75	—
12.5k	—	+0.5	+0.25	-1	+1	+0.5	+0.6	—	-0.75
14k	—	+0.3	+0.5	—	—	+0.25	+0.7	-0.75	—
15k	-0.5	—	—	—	—	—	—	—	—
16k	—	0	+0.5	-1	+1.75	+0.25	+1	-0.75	-0.75
18k	—	0	+0.5	—	+1	0	+1.25	—	—
20k	—	—	—	-1	+1	—	—	—	-0.75
Tape used	406	?	LPR	206	206	PER 525	LPR	825	207
Speed Accuracy	Ampex 19H: +0.1% Agfa 19H: -0.8% BASF 19H: +0.3% MRL 19H: -0.8% Teac 19H: -0.2% Agfa 19S: -0.3% BASF 19S: 0 EMI 19S: +0.2% MRL 19S: -0.2%								

and therefore a dc millivolt meter connected to the output, giving a 10 mV change per degree indication, was used. If it is assumed that the average between all the azimuths of the 38 cm/s test tapes is reasonably accurate, the worst error was from the EMI tape, having approximately 33° phase shift between the two channels, when the recorder was carefully azimuthed to the average. At 19 cm/s the

difference between the two extremes was very marked, and at 9.5 cm/s this difference became very serious indeed. The MRL tape showed an error of 120° from another tape at 10 kHz and errors of this proportion would mean that a tape recorded on a machine azimuthed to one test tape and replayed on another machine azimuthed to the MRL tape could show a high frequency loss of some 12 dB at 10 kHz if the

TABLE 3: 9.5 cm/s, full-track. Frequency response sections

Frequency, Hz	Agfa 0.75% slow	BASF 0.1% fast	Ampex 0.4% slow	MRL 0.2% slow	EMI 0.2% fast
30	—	—	—	—	+0.2
31.5	+0.25	-1.8	—	-0.4	—
40	-0.25	-1.7	—	—	0
50	—	—	+0.5	—	—
60	—	—	—	—	-0.5
63	-0.25	-1.7	—	-0.2	—
100	—	—	+0.4	—	—
125	+0.25	-1.1	—	0	-0.25
250	+0.2	-0.75	+0.2	+0.2	0
333	+0.1	-0.5	—	—	—
400	—	—	—	—	-0.25
500	0	0	0	0	0
1k	-0.2	+0.2	-0.25	0	0
2k	-0.25	+0.5	—	0	+0.25
4k	-0.5	+1.25	—	0	+0.5
5k	—	—	+1.25	-0.25	—
6k	—	—	—	—	+0.25
6k3	0	+1.75	—	0	—
7k5	—	—	+2.75	—	—
8k	0	+3	—	0	-0.25
10k	+0.5	+3.75	—	-0.25	-0.75
12k	—	—	—	—	-0.75
12k5	+0.75	+4.25	—	—	—
14k	—	+4.75	—	—	-0.5
16k	—	+5	—	—	—

TABLE 4: Relative phase-shift at 10 kHz when replayed on 2-track tape-machine at optimum azimuth. Gain error predicted for 'mono' replay, paralleling the two tracks of a 2-track tape machine set for optimum azimuth.

	Shift	Gain error in 'mono'
Ampex NAB 38	+15°	-0.25 dB
MRL NAB 38	+10°	0 dB
MRL IEC 38	-15°	0 dB
BASF NAB 38	+10°	0 dB
BASF IEC 38	-5°	0 dB
Agfa IEC 38	+10°	0 dB
EMI IEC 38	-30°	-0.5 dB
Ampex NAB 19	-15°	-0.25 dB
MRL NAB 19	+15°	0 dB
MRL IEC 19	+65°	-3 dB
BASF NAB 19	-20°	-0.25 dB
BASF IEC 19	-25°	-0.5 dB
Agfa NAB 19	0°	0 dB
Agfa IEC 19	+50°	-1.5 dB
EMI IEC 19	-50°	-1.75 dB
Ampex 9.5	-25° (at 7.5 kHz)	-0.25 dB (at 7.5 kHz)
MRL 9.5	+120°	-11.75 dB
BASF 9.5	-10°	0 dB
Agfa 9.5	+25°	-0.5 dB
EMI 9.5	-15°	0 dB

NB: Optimum azimuth was determined for each speed independently, and represents an average of the test tapes being measured.

output channels are paralleled. Once again, we feel that some tightening up of the specifications must be done by international co-operation. There are perfectly reasonable scientific methods in any case, and these should be adopted with the greatest care to resolve the problem.

Upon investigating the production techniques of one manufacturer we were surprised to find that a machine was used to make the 9.5 cm/s test tapes which did not have automatically-controlled constant back tension. This may be the reason why several tapes had various azimuths. Quite possibly, other manufacturers also did not use constant back tension. Such lack of control will not only mean that each tape may vary in azimuth throughout the reel, but may not give the same result from one tape to another. Now that the problem has been mentioned, it is to be hoped that greater care will be taken.

Teac produce some test tapes, and two were

submitted for the review, a 38 cm/s wow and flutter tape which measured, on our best machine, 0.05% peak weighted DIN, and a 19 cm/s NAB tape which unfortunately was rather inaccurate, as will be seen from the table. It is fairly reasonably priced, however, and so may be found useful by engineers in less critical applications.

Test tapes are not cheap, and so great care should be taken in their use. They should be stored in an even temperature in a cupboard, not subject to draughts, and well away from any electrical wiring or magnetic fields. Always demagnetise the recorder before using a test tape, and if possible do not stop the transport during a tone band. Always wind through at very slow speed, if you have variable spooling, and if not it is better to play through the entire tape and then spool back well away from the heads. Make sure that all tape guides are in good condition. A tape may well not give accurate results for more than a limited period.

Some time ago, one importer started modifying high-speed models of their machine so that they could play back their laboratory test tape with a flat response. These machines all seemed to have a treble boost on replay, and eventually it transpired that they were using a three-year-old test tape which must have been used hundreds of times. Our personal practice is to keep one test tape for very routine service work, one for quality control, and a third one brand new with which we calibrate the older ones. Once a year or so we discard the routine tape and move the others down one place, a new tape being purchased as the standard. This allows older discarded tapes to be used for very routine maintenance work, without worry about possible damage.

Very frequently, comments are made about fringing effects at long wavelengths when replaying full track test tapes on multitrack machines. We erased half the width of one 38 cm/s tape, having noted all its measurements on a full track head block, and also on two stereo blocks, one fitted with a wide guard band replay head and the other with a narrow one. We were somewhat surprised to find that at the frequencies given for this test tape the maximum error noted was 0.75 dB, much less than we had expected on the wide guard band head. We also checked the high frequency end, and found that the fringing effect of the half track erasure was not greater than 0.1 dB on the output of the other track, even at 18 kHz. It would be interesting to see the results of more work done on this subject.

We also measured some half-inch test tapes and the order of frequencies etc was identical to the quarter-inch ones, as were their typical errors. With respect to azimuths, see the accompanying article on azimuth.

Finally, we have been somewhat worried by the practice of some studios making copies of test tapes for other studios. Serious errors can result, particularly if wider tapes are concerned, since any errors in the equipment used by the first studio will be passed on, and possibly emphasised by the second studio. Especially serious are level errors produced by inadequate height alignment of record and play back heads on eight, 16 and 24 track machines.

Making a test tape is a highly skilled business, and there are many variables. However, they are really essential for good interchange, and we hope that this article will encourage their wider use.

Three interesting tapes have been produced which will be of particular use in assisting azimuth and mechanical adjustment of the replay head. The first is the azimuth tape made by MRL, consisting of alternate very short sections of tone recorded considerably out of azimuth in opposite directions. When the replay head azimuth is correct, the outputs from each section will be at the same level. We tried playing this tape oxide out as a check, and found the azimuth to be extremely accurate, agreeing with the MRL 38 cm/s test tapes. The closest test tapes to these azimuths were BASF 38H (NAB) and Agfa 38S, and so a slight compensation from the average should be made when looking at the azimuth table. We found the tape extremely easy to use, and it is strongly recommended.

Both Agfa and BASF produce stereo test

■ TEST TAPES

tapes including separate levels on right and left of 510 nW/m at 1 kHz, followed by a section of 1 kHz recorded along the centre of the tape only. This allows replay heads to be

adjusted in height so that either no output is obtained or an equally small output from both channels. A white noise band then follows for azimuth adjustment, and finally tones independently on left and then on right for crosstalk checking of 63 Hz, 1 kHz, 10 kHz and 15 kHz. A standard length of DIN reference tape then

follows to allow biasing and record equalisation to be set up, if DIN standard professional tape is used. In practice, we have not used this tape very often for routine purposes, but have found it very useful for setting up new replay heads accurately, and we suggest that either would be very useful.

■ TAPE SURVEY

Now that the average professional and even domestic tape has a much higher output capability than older types, it seems hardly reasonable for some manufacturers to use legends such as 'high output' and 'low noise', or other such indications to claim that the tape is considerably above average. The Trade Descriptions Act is extremely strong in its effect, and some of these legends are too close to the wind for comfort. We also found that some tapes that were labelled or described by the manufacturer as 'low print' had nowhere near as low print as others not making this claim. In general we cannot understand why the tape industry has tended to neglect print-through, and must congratulate EMI, BASF and Agfa for producing tapes that should not give any print-through problems in general

use, unless stored badly.

We feel, as in our last report, that a good all round tape is the desirable one, and not one that might have an incredible dynamic range or a superb hf intermodulation performance. Although significant advances have been made in the last few years, some of which have astonished us, we nevertheless feel that the ideal studio tape is still to come. Perhaps we can stick out our corporate neck and propose a specification for such a tape; it should spool extremely well and have a good dropout and stability performance. It should also have a high frequency intermodulation as near as possible to the level of the 1 kHz im, and these two levels should be as high as possible consistent with a print-through of as far below -65 dB as possible, and ideally at -70 dB. Its weighted noise should be low, but above all it should be produced at a reasonable price, which is more than can be said for some of the so-called 'wonder tapes'.

Some of the tapes in our list clearly come

pretty close to the ideal, but we do not think it would be fair to name them, as it is only our opinion, and of course only one batch has been tested. It was not possible even to estimate any tendency to oxide-shedding since this is normally only found on poor or inadequately-serviced tape transports, or occasionally when a tape is of faulty manufacture. The dropout and stability columns, however, may possibly serve as a guide, although great care should be taken in their interpretation.

Finally, some of the tape types are rather difficult to obtain, since some importers are not normally associated with professional recording products. However, any such tapes that have come out well in the survey should eventually become more easily available if there is a demand for them. Don't forget, though, that the cost of a tape must be related to the performance, and your accountant may well have words to say if you are considering changing to a tape that could cost as much as 50% more than you are paying at the moment.

■ CAPITAL RADIO

'No plugging of charities', and everyone went out of their way to remind each other continually not to forget that there mustn't be any. The same kind of thing happened during the election, when originally the ilr stations were so anxious not to offend the IBA by slanting programmes politically that everyone with a political axe to grind was timed on air with a stop-watch. All this may be eminently fair but it hardly makes for stimulating radio and it is to the stations' credit that it doesn't show on the air more than it does.

The IBA's steadying hand is also much in evidence over two technical hot potatoes: Dolby B and quadrasonic matrix broadcasting. It has never been any secret that Capital would welcome the chance to do on-air tests with Dolby B encoded broadcasts and modified pre-emphasis (25µ sec instead of 50µ sec; see *News*, September 1974 page 31). The IBA have confirmed to me that they are 'carrying out closed-circuit tests' but they are 'not yet complete'. In the fullness of time, when the tests are complete, they 'may undertake on-air tests' and if they are satisfied they may then apply to the Home Office for permission to modify their transmission standards accordingly. In contrast to all these 'mays', it is worth noting that one station in a major European city has already run a secret two-week test involving the transmission of Dolby

B encoded programmes with modified time constant. The station hasn't yet publicly admitted the tests, but it has to be significant that not one single person wrote or phoned in to complain during that two-week period.

Capital (with an obvious eye to the three-year rolling contract) are, not surprisingly, unwilling even to discuss the Dolby B situation until the IBA has given them the official go-ahead. Likewise they are unwilling to talk about quadrasonic matrix broadcasting. The IBA, however, have confirmed to me that they have not yet been formally asked by any ILR station about the possibility of broadcasting QS or SQ test programmes, and only if they are asked will they then think about what they might do about it.

Meanwhile, Capital has more than enough future problems on its hands. Although (like LBC) its fm frequency is permanent, it is transmitting on a temporary medium wave frequency from a temporary aerial (as is LBC). Thus in 1975 both LBC and Capital must publicly commit commercial Hara-kiri and change their spots on the mw dial. All the publicity, the jingles and the reflexes conditioned in their listeners will go out of the window. They must each start afresh, with new jingles, new publicity and an entirely new spot on the dial, right at the other end of the medium wave (194 metres instead of 539). Why, one may ask, was the 539 temporary wavelength foisted on Capital in the first place? One uncharitable answer is that it was conveniently close enough to Veronica on 538 to settle that pirate's hash once and for all. But

more likely the wavelength clash was pure coincidence.

The re-launch of Capital on 194 is at least now to be spread over three months (194 and 539 will run together during that period), but the cost of the exercise to Capital is estimated at £150,000. Who will pay? 'Who do you think? We will,' said one of the engineers. 'I hadn't realised it until now,' said an off-duty disc jockey in a muddy circus costume from a darkened corner of the ob bus, 'but so far I suppose we've only been practising'.

Footnote

While this article was in the pipeline to publication news broke of the station's precarious financial position and likely redundancies. Hard facts are hard to come by and Capital is saying very little, which inevitably encourages rumours. But when the monthly cash shortfall was quoted by *Broadcast* magazine as £40 000 the figure was not contested. Also the station's news operation is definitely closing down.

In future news on Capital will be from IRN which is, after all, what was always envisaged by the original ilr planners.

For my own part I sincerely hope that Capital can succeed—but while they are paying £388 000 per year to the IBA for transmitter rental alone I fear for them. And in the context of Capital's struggle to survive it is worth noting that the original IBA rental estimate for the first year of the contract was £315 000—considerably less than the figure actually being paid, even though the contract has not yet officially begun.

ALL RIGHT
FOR 7 or 8
plus a couple
of
echo returns...

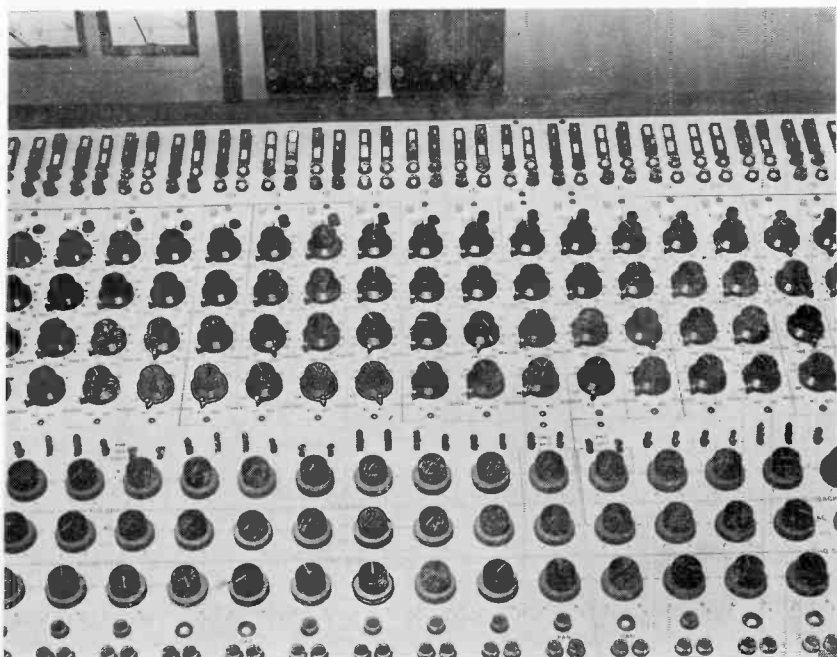
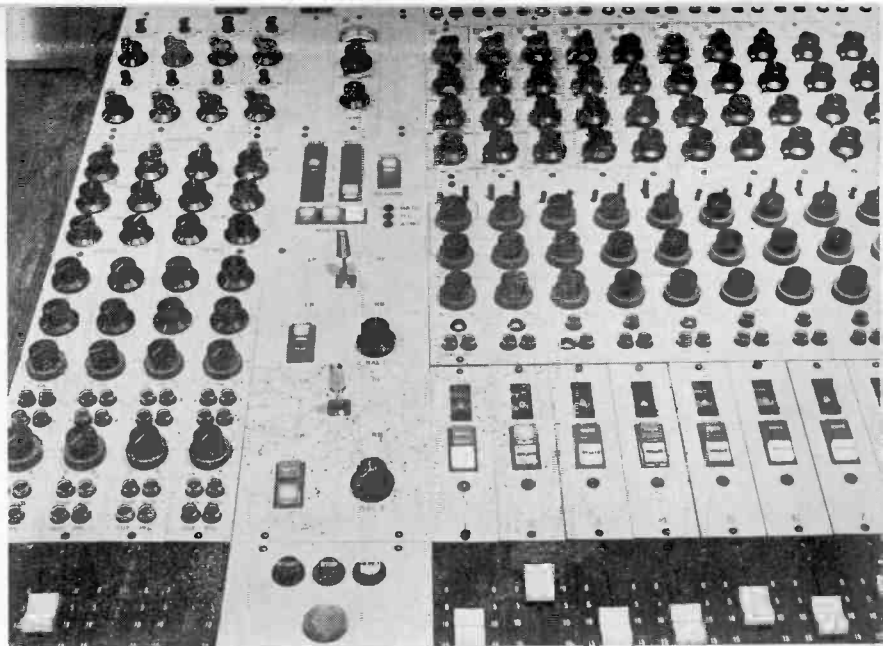

...but how
about when you
get to 16 or 24
or even 32?....
is your memory
infallable?
no one's is....

.... except

COMPUMIX

it memorises everything
and gives it back to you
faithfully... every time.

quad/eight by



helps you through the night

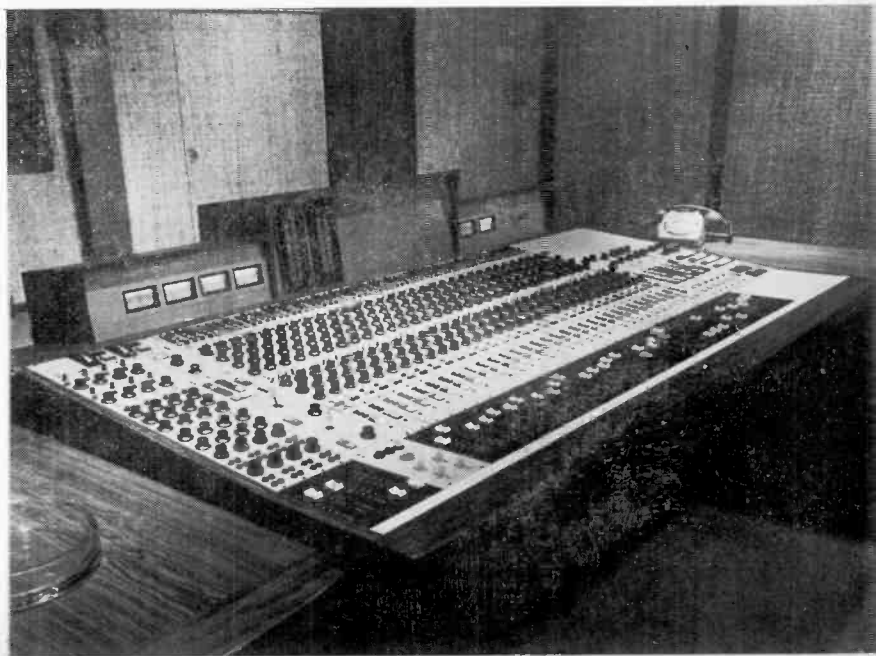

In the whole world there are about one thousand major professional recording studios, without including the broadcasting organisations equipped with their own recording facilities. Since the distance between multitrack and remix can be as many miles as there are copying rooms along the way, a unified standard would help. This survey of tape equalisation practice summarises the current position in the hope that overall standardisation may eventually be possible.

Equalisation and practical recording

FRANK OGDEN

CLEARLY, IT WAS IMPOSSIBLE to monitor the equalisation practice of the entire industry—apart from logistical considerations, the language barrier provides real problems—however, statistics were considered from all parts of the USA, Germany and England. At first sight, this may seem very partisan, but closer investigation reveals that this is an accurate reflection. In real terms, the USA makes up about 60 to 70 per cent of the entire recording industry followed by Europe with 18 per cent. Of the European figure, England accounts for well over half the total output and ten per cent of world production. Germany was chosen to represent other European interests for two reasons: together with France, it has the largest continental recording industry; the second reason was the difficulty of writing to French studios during a lingering postal strike.

USA

It was of no great surprise to learn that NAB, at various recording speeds, was virtually a universal standard for all classes of recording. In a speed/use/standard breakdown, the only serious rival was found to be the Ampex 17.5 μ s for use at 76 cm/s. This appeared to be used exclusively for multitrack master production as shown in the following breakdown.

The percentage figures given represent the proportion of American studios actually using a given standard; because most use more than one speed, any addition of the quoted percentages is meaningless.

Multitrack masters at 76 cm/s

60% 50+3 180 μ s NAB.
13% 17.5 μ s Ampex.
6% 35 μ s DIN.

Multitrack master at 38 cm/s

87% 50+3 180 μ s NAB.

Reduction master at 76 cm/s

12% 50+3 180 μ s NAB.

Reduction master at 38 cm/s

95% 50+3 180 μ s NAB

Reduction master at 19 cm/s

45% 50+3 180 μ s NAB.

England

Equalisation standards are much more confused in comparison with the States. Despite this, NAB has a significant lead over any other standard. One interesting difference to emerge is narrower spread of recording speed, less use being made of 76 cm/s corresponding with more at lower speeds.

The same remarks concerning the percentage figures for the American studios apply to the following British ones:

Multitrack masters at 76 cm/s

47% 50+3 180 μ s NAB.
12% 35 μ s DIN.
5% 17.5 μ s Ampex

Multitrack masters at 38 cm/s

82% 50+3 180 μ s NAB.
24% 35 μ s DIN.

Multitrack masters at 19 cm/s

10% 50+3 180 μ s NAB.
18% 70 μ s DIN.

Reduction masters at 38 cm/s

76% 50+3 180 μ s NAB.
53% 35 μ s DIN.

Reduction masters at 19 cm/s

50% 50+3 180 μ s NAB.
29% 70 μ s DIN.

Germany

In the land of DIN, one expects this to be the most popular system. It was. Having a comparatively small recording industry, about 20 major studios, it is rather pointless drawing statistical inferences of the 'if this trend was repeated etc' kind. It is enough to make generalisations.

The studios, except one or two, use the 35 μ s DIN standard at 38 cm/s for multitrack mastering. The odd man out uses 50+3 180 μ s NAB at that speed. All the studios indicated that they used the DIN standard at 38 cm/s for reduction masters; about half that number also used 19 cm/s with the 70 μ s DIN equalisation.

Overall results

The first table indicates the utilisation of the various speeds. This calculation is based simply on the number of recording studios using a given speed. It takes no account of the type of use or the equalisation standard.

76 cm/s—25% }
38 cm/s—60% } of all recording done.
19 cm/s—15% }

The next table gives the breakdown of the speed/eq standard utilisation. This is based on the total usage of an equalisation condition at a given speed:

	DIN	NAB	Ampex 17.5 μ s
76 cm/s	8%	78%	14%
38 cm/s	9%	91%	
19 cm/s	9%	91%	

Conclusions

People were invited to comment on equalisation, a suitable place being provided on the questionnaire form on which to write. Naturally, quite a few expressed a desire for a unified system. Typical comments ranged from 'How nice it would be if all the world were using one speed and equalisation' to this quote from a British studio: 'We are aware that, at present, we are working on split standards but are moving towards standardisation on one characteristic—probably NAB throughout, while leaving the capability to replay DIN tapes'. This sentiment was countered by another British studio. 'All available equalisations are out of date; none make full use of headroom, signal-to-noise or frequency response of today's tape.'

It is quite apparent from this survey that there is a nearly universal eq characteristic available to NAB standards. This certainly applies to the 38 cm/s and the 19 cm/s (91 per cent worldwide utilisation in each case) but it would appear that some users are reluctant for reasons mentioned above. Opinion seems very divided on what to do about high output tape. The first school of thought suggests that the improved midrange characteristics (in terms of much higher output for the same distortion levels) should be used with existing standards and recording levels, resulting in tapes with very low levels of intermodulation products—possibly the most audible manifestation of over-recording because the distortion products are harmonically unrelated to the programme material. This mode of application of high energy tapes is said to produce real advantages

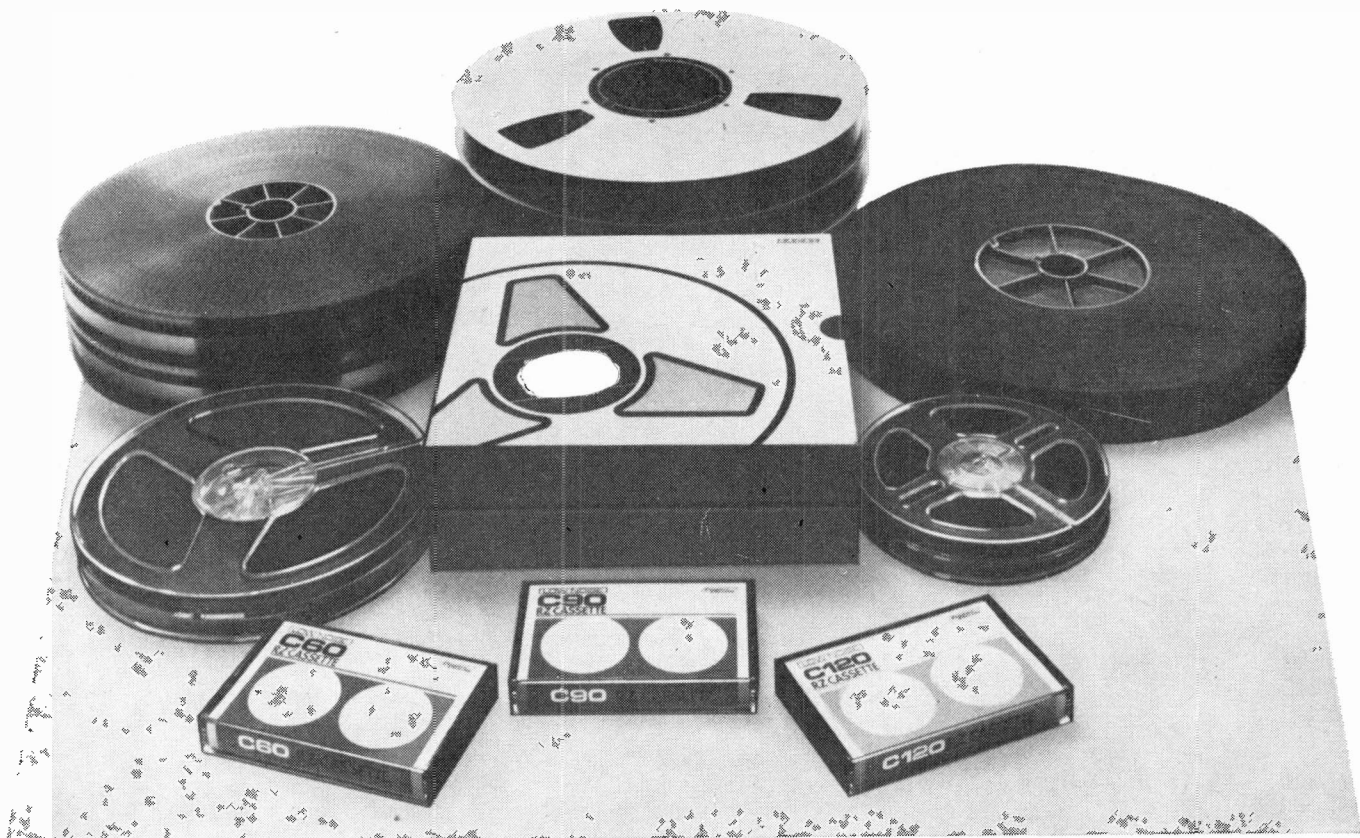

A sound combination

One of the best partnerships in audio reproduction is established when you use Racal-Zonal magnetic recording materials with your equipment. Whether it's sound recording film, audio tapes and cassette tapes, the name Racal-Zonal implies the highest quality. A fact which has been recognised by the British and overseas broadcasting authorities.

Racal-Zonal is itself a highly successful combination, blending Zonal's technology and

finesse in magnetic recording media with the vast experience of the internationally recognised

Racal Electronics Group.

A complete range of technically advanced audio products is now available from the company which specialises in the production of sophisticated magnetic recording materials. For further information contact Racal-Zonal. It could lead to a firm base for a sound proposition.

Racal-Zonal

the professional approach to magnetic recording media

RACAL
The Electronics Group

Racal-Zone Limited, Holmethorpe Avenue,
Holmethorpe Estate, Redhill, Surrey.
Telephone: Redhill 67171. Telex 43108.

The problem of azimuth alignment is of great significance to all users of tape recorders. Curiously, it is not always properly appreciated. On the evidence of many tapes exchanged between studios, more attention must be paid to accuracy and consistency.

Azimuth

ANGUS MCKENZIE
AND TONY FAULKNER*

THE PROBLEM OF azimuth is of great significance to all users of tape-recorders, and we feel it is all too often conveniently swept under the carpet both by manufacturers and users who should certainly know better. As well as our involvement in audio laboratory work, we also operate as a recording studio offering various facilities for copying and processing master tapes, as well as doing sessions. As such, we regularly receive tapes from other studios without any azimuth tones at all, and one has to rely on 'tweaking' the alignment until it sounds best in monaural reproduction. This is clearly not a particularly satisfactory situation, which could readily be sorted out by a studio simply recording 10 kHz or white noise or a few feet of tape at the beginning of the reel.

To a considerable extent this situation results from a not unjustifiable faith on the part of studio engineers in their test-tape which, naturally, they assume will be the same as everybody else's—so there should be no problem. However, as will be clear from the figures in the accompanying Test Tape Survey, there are considerable differences between one manufacturer's azimuth band and another's (and even in some cases between test tapes coming from the same maker). At this stage, we are unable to 'point the finger' at who is right and who is wrong—but the differences even at 38 cm/s are staggering.

For example, if you record 15 kHz tone on both tracks of a stereo tape-machine with its azimuth aligned to the Ampex 38 cm/s test tape submitted for the report, and then play the recording back in mono (both tracks combined) on a machine aligned to the EMI test-tape, there will be a loss of up to 3.5 dB at this frequency.

Azimuth is clearly a wavelength effect, which means that the slower the tape-speed the greater the problem at high frequencies. This is borne out at 9.5 cm/s, where a recording of 10 kHz made with azimuth aligned to the submitted MRL test-tape submitted for the survey would play back up to 15 dB down in mono on another machine aligned, say, to the BASF test-tape. Clearly this state of affairs calls for some clarification by test-tape manufacturers who, we humbly suggest, would do the industry a great service if they would get together and sort it out.

Having cast doubt upon the consistency of azimuth from one test-tape to another, the question obviously arises as to what the user can do to make sure that his carefully prepared master-tape will play back as well in someone else's studio as it did in his own at the time of the session. A tape which is played back out of azimuth will sound very fuzzy and wavy at the top end—particularly noticeable on brass, or cymbals—and will give string sound a curiously coloured quality.

There are various methods you can employ to set azimuth; but we suggest two particular ways of aligning a replay head to a test-tape. First of all we use a test-tape from a reliable source (a degree of healthy cynicism is not unjustifiable—but if you can see the difficulties major manufacturers have in preparing azimuth bands in sophisticated laboratories, what chance do you stand with a test-tape a friend has copied for you to save a bit of money). Generally, we employ a double-beam oscillo-

scope—with one channel driving one beam, and the other driving the second. This method can readily be extended to multitrack recorders by feeding one beam from the top track and the other one from the bottom track. You adjust the azimuth screw first for a maximum on one track, and then 'tweak' it a small amount either way as necessary to bring the two signals into phase. We have heard criticism of this technique, on the grounds that a different amount of reproduce equalization for the two tracks will introduce spurious phase-shift—but recent experiments with one of our machines (a Philips *PRO 36*) would indicate that the order of phase-shift introduced by varying reproduce equalization on the two tracks was *considerably* smaller than the difference between two test-tapes even from the same manufacturer. This method of head alignment is quite precise and does not call for particularly sophisticated test-gear—all one needs is a double beam oscilloscope with 'chop' switching ('alternate' switching could well produce unsatisfactory results depending upon the 'alt' frequency).

Various manufacturers have produced special azimuth alignment bands for test tapes, and these might well be of interest to engineers. Agfa and BASF both manufacture a stereo test tape, which includes a section of white noise for setting azimuth audibly. One listens to the tape in mono combining both of the tracks and adjusts for the least coloration of the noise and maximum hf hiss. The effect is most pronounced and offers a very clear demonstration of the sound 'distortion' produced by playing a tape out of azimuth. There is a 'swishing' akin to that produced by phasing, and there is a clear setting associated with the least coloration. Magnetic Reference Laboratories (MRL) produce a special azimuth test-tape, which consists of a recording of a middle-frequency tone. This tone varies in azimuth from one precise deviation from 'absolute' azimuth (90° to tape-direction) directly to another precise deviation the other side of 'absolute' azimuth. One sets the head to give an equal level on both recordings—and the reasoning is that when both levels come out the same, the head is aligned exactly between the two false azimuths and is consequently correct. The use of a relatively long wavelength signal means that the azimuth can be verified by playing the tape oxide-out and again checking that both tones give the same level. The technique is described in considerable length in instructions supplied with the tape, and when tried in practice we found it quite quick to perform. The frequency of the tone was nominally 2.1 kHz at 38.1 cm/s and the adjustment proved far more critical than one might initially expect. We azimuthed a full-track quarter inch machine using it, and then played the head alignment band of two MRL 38 cm/s reproducer alignment tapes and noted the output levels. We then played the same test tapes again, and noted the levels of the relevant azimuth bands, only this time we adjusted the replay head to give maximum output. Readjustment of the head for the NAB tape gave no readily detectable improvement, indicating that the azimuth of the two tapes was very close indeed. When the second MRL test-tape was replayed and reazimuthed there was a gain in the region of 0.5 dB at 16 kHz,

indicating that the MRL IEC tape (the one discussed in our survey) was clearly recorded with different head alignment. The concept behind this tape is clearly a very sound one, but regrettably our comments regarding agreement between manufacturers on their interpretation of 90° must still apply. However, for general studio use this tape is clearly to be recommended—it is suitable for all speeds, although one must be careful in using it for multitrack (ie stereo upwards) since azimuthing just one track is by no means satisfactory as not all the gaps will necessarily be as parallel as one might hope. We would suggest that outer tracks be combined to mono (with a phase inversion if necessary) to optimize the azimuth adjustment.

Head alignment in multitrack recorders is a considerable headache owing to obvious difficulties in the manufacture of multi-track heads—getting all of 24 gaps in line with one another, and all at 90° to the horizontal, is clearly a mammoth task. We would anticipate that this problem might be a major factor behind certain so-called old-fashioned engineers' reluctance to employ 16 track and 24 track techniques for classical recording—and it might also go part way to explaining the current enthusiasm in the USA for 76 cm/s master recording (the faster the tape speed, the longer the wavelength and the less noticeable the azimuth error). As an experiment, we investigated the relative phase-shift between each of the channels of a half-inch four track in our studio, and we were horrified at some of the results. We normally use the machine for quadraphonic master recording, and in accordance

with current practice, we allocate tracks 1 and 3 for the front channels. As we consider the front channels the most important, we chose to azimuth the replay head to make 15 kHz in phase for tracks 1 and 3 using a double-beam oscilloscope in the manner described earlier. With our particular head, this meant that track 2 was phase-shifted of the order of 30° at 15 kHz, which was certainly far from satisfactory when you bear in mind the critical importance of phase in quadraphonic matrix systems. After a degree of computation a more suitable method of alignment was derived, which reduced the error considerably. Fortunately all of our master tapes have azimuth tones at the start of them, and the variation in terms of overall head angle was within the variation from one test-tape to the next. The wider the tape, the worse the potential phase-error, particularly between top and bottom tracks—so one must really be sure of one's azimuth on multitrack recorders, particularly if one- or two-inch masters are likely to go to a studio somewhere else for remixing. We feel sure that incorrect azimuth can be put down as the cause of disappointing sound quality on more than a few records—and quite a lot of this degradation inevitably arises from the misguided practice of not putting tones on master-tapes going to other studios, or going for disc-cutting.

Setting the record head gap is done in very much the same way as setting the replay head. Of ten, it is a wise practice first to set the record head with sel-sync using a trusted test-tape, and then finally checking the system through overall, monitoring the replay head.

We find that white or coloured noise is a very clear indicator of correct azimuth adjustment and can be found either by using an inexpensive noise-generator, or else a radio tuner (vhf preferably) off station. One adjusts the record head to give minimum 'phasing' when listening to the replayed signal monaurally. Equally, the practice of phasing a high-frequency signal on a double-beam oscilloscope is applicable. Bearing in mind the delay between the record and replay heads particularly at lower tape-speeds, one must make sure that one is not choosing a so-called 'false peak'.

With a short wavelength, it is possible to set the head to give 360° phase-shift rather than 0° and this is avoided by first registering an absolute peak on one track and then 'nudging' the azimuth to bring the tracks into phase. The false peaks are of equal amplitude, equally displaced either side of the true azimuth. A little investigation will sort the situation out.

From a studio's point of view (at least a studio that wants its tapes to sound as good in someone else's studio, or on disc in the consumer's living room) there are several obvious points to be gleaned from investigations into azimuth. Firstly, set all of your machines very carefully to trustworthy commercial test-tapes—not a copy a friend made as a favour. Secondly, check the azimuth regularly to assure compatibility with other studios. Thirdly, put tones on the head of every tape leaving your studio to go to another—often tapes we have to copy for clients do not even have Dolby tone and it is very 'hit and miss' whether they will sound the same to us (or anyone else for that matter) as was intended.

■ PRACTICAL RECORDING

without the side effects normally associated with them.

Of the potential advantage of increased signal-to-noise available with these tapes, the same thinking suggests that the present level of noise on multitrack tapes, with a noise

reduction system, is perfectly adequate.

On the other side of the coin, critics of the present standards would argue that print-through problems can be reduced to negligible proportions by the application of an appropriate noise reduction system increasing still further the potential noise performance of the recording process. The resulting record

equalisation curve would include a midrange plateau as well as a speed selective top end pre-emphasis. It would probably retain a flat bass response. None of the existing standards has a curve remotely like this. What should happen? The product of time could well be yet another equalisation standard taking extended mid range performance into account.

Broadcast pattern audio jackfields from Future Film Developments

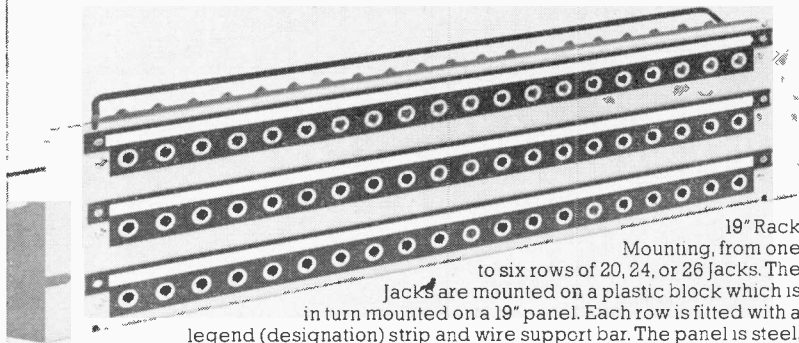

19" Rack Mounting, from one to six rows of 20, 24, or 26 jacks. The jacks are mounted on a plastic block which is in turn mounted on a 19" panel. Each row is fitted with a legend (designation) strip and wire support bar. The panel is steel, cadmium plated, chromate passivated and stove enamelled hammertone silver.

ALSO Audio Patch Cords • Microphone Cable • Installation Cable • Multiway Cable • Post Office & Rendar Jacks • Cable Markers • Lever Keys • Linear Faders • Cannon Connectors • Preh Connectors • Tuchel Connectors • Switchcraft Connectors • Military Tri-Lock Bayonet Connectors • Audio Attenuators • Wahl and Weller Soldering Irons • PML Microphone Accessories • Hellermann Sleeves and Tools • Crimp Terminals • Cable Drums • A.B. Engineering Wire Strippers and De-Solder Guns.

FUTURE FILM DEVELOPMENTS,

90 Wardour Street, London W1V 3LE.
Tel: 01-437 1892 Telex: 21624

BOWERS & WILKINS

DM4 + D5

By John Fisher

MANUFACTURERS' SPECIFICATION

DM4: small monitor loudspeaker

Drive units: DW200/4 Bass midrange unit 143 mm contoured Bextrene cone; 26 mm voice coil on aluminium former; long-throw suspension with flexible PVC (Vitrone) front suspension. Pressure die-cast chassis; high flux ceramic magnet assembly; hand assembled units, critically damped with applied compounds. Celestion HF1300 Mk II upper/mid-frequency unit (35 mm). 19 mm low-mass diaphragm plastic dome high frequency unit.

Dimensions h x w x d: 530 x 255 x 256 mm.

Weight: 11.1 kg.

Volume: 21 litres.

Power required: 10 to 30W.

Nominal impedance: 8Ω

Sensitivity at 400 Hz: 3.6W for 95 dB at 1m.

Frequency response: ±5 dB 80 Hz —20 kHz.

Crossover frequencies: 3.5 kHz, 14 kHz.

Crossover: third-order Butterworth with close tolerance components; 18 dB/octave. Series inductors of 1f unit ferrite cored; all capacitors close-tolerance polyester.

Cabinet: 19 mm 750 density chipboard with balancing veneers; reak, walnut, rosewood, white.

Acoustic loading: If loading by dense, critically damped enclosure with small vent; inner surfaces absorbent lined, with addition of long-fibre wool.

Price: £45

D5: compact two-way system for domestic use

Drive units: DW150/5 124 mm bass/midrange unit; contoured Bextrene piston with 25 mm voice coil on aluminium former; long throw voice coil and rubber roll surround. Pressure die-cast chassis; high flux magnet assembly. Units hand-assembled and critically damped with damping compound. PCH24/8 ultra-lightweight dome tweeter with 25 mm voice coil.

Crossover: third order Butterworth, 18 dB/octave; 1f unit series inductors wound on ferrite cores.

Dimensions h x w x d: 454 x 226 x 172 mm.

Weight: 6.35 kg.

Volume: 11 litres.

Power required: 10 to 25W; nominal impedance

8Ω; sensitivity: 10W for 95 dB at 1m at 400 Hz. Cabinet 12 mm high-density chipboard with balancing veneers; front panel 12 mm laminated ply; finished white, teak or walnut.

On Axis sensitivity

Terminal voltage for 74 dB SPL at 1m on tweeter axis

Speaker	No	Rms voltage	Stereo balance
DM4	10997	0.54	0.3 dB
	10998	0.52	
D5	9161	0.74	0.4 dB
	9162	0.71	

Intermodulation distortion

To SMPTE method with 50 Hz and 7 kHz in voltage ratio 4:1

Speaker	IM at SPL
DM4 10998	0.6% 84 dB 94 dB 3.2%
D5 9162	0.3% 0.6% Clips

Frequency response data

Measured on tweeter axis 1m from tweeter at 74 dB SPL at 1 kHz under anechoic conditions with B & K equipment. Both speakers of stereo pair measured and similar.

Impedance

Measured at constant current (100 mA) under anechoic conditions.

DM4

Design

This three-unit design is a successor to the renowned DM1. It uses a bass unit manufactured by B&W, with a highly compliant surround and with damping materials applied to the cone surface in a very similar manner to that on the DM2A and a number of other monitor loudspeakers by other manufacturers. Unlike some of the other damping compounds, that used on the B&W drive units is not tacky—so one escapes the nagging doubt as to what happens when the compound dries out; or does one?

The bass unit is just 9 mm smaller than that used on the DM2A monitor; instead of the eighth-wave transmission line used in the DM2A, the DM4 uses a damped vented cabinet (reflex) with a fairly dense filling of damping material, including the ubiquitous long-haired wool popularised by Dr Bailey some years back. In other respects the DM4 is similar to the DM2 in that it uses the Celestion HF1300 MkII tweeter (also used in the BBC LS3/6 design, and others) and the STC4001 super-tweeter used in commercial versions of the LS3/6 design.

The crossover between units is at 18 dB octave, and close-tolerance polyester capacitors are used rather than electrolytics; this is desirable in any loudspeaker, as it ensures closer control over the accuracy of the crossover frequencies than can be achieved with electrolytics, as well as giving better long-term stability and greater tolerance in the crossover to over-drive. The use of ferrite cored inductors would give some designers apoplexy on grounds of increased distortion and variation of inductance with drive level; on the other hand B&W would appear to take some considerable care in the choice of their components, and

B + W DM4 No. 10998

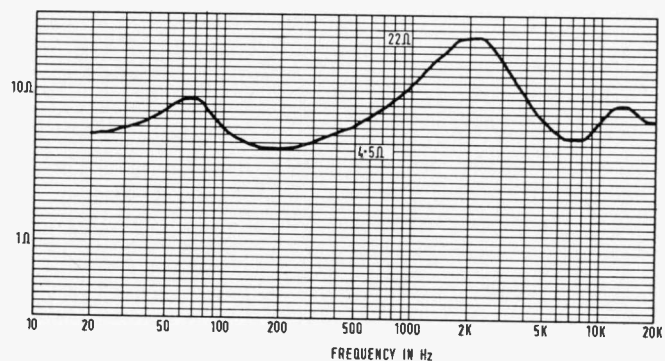

unless anyone can hear anything wrong with the result, B&W may well be right in arguing the advantage that ferrite cored inductors have in offering lower resistance and consequently better damping by the amplifier than would be the case with an air-cored inductor with more turns.

The DM4 is extremely well made and finished, and comes with a very comprehensive manual and its own response curve taken on B&K equipment in B&W's own test chamber. The whole unit is remarkably solid and heavy for its size (having just pulled my back by lifting a pair of them awkwardly; perhaps I speak with too much feeling there!) and beautifully finished; the review samples were well matched and finished in walnut veneers, with aluminium trim and an open synthetic fabric for the grille; the front grille panel is

held in place with velcro tape, and has no audible effect on the sound.

It is designed to handle 30W, and, on symphonic material, appeared to take the full output available from a Quad 303 without distress; it will produce very loud sounds in small control rooms or in a good-sized domestic listening room. Sensitivity is somewhat higher than that of the Spendor and Rogers versions of the LS3/6, and adequate listening levels for many purposes should be available with 10-15W amplifiers. The modulus of impedance is shown in Hugh Ford's measurements on the review sample: it drops to about 4.5Ω, and while this should not cause any difficulties with the majority of modern amplifiers there are a few around that might object. Many speakers have worse impedance curves than this!

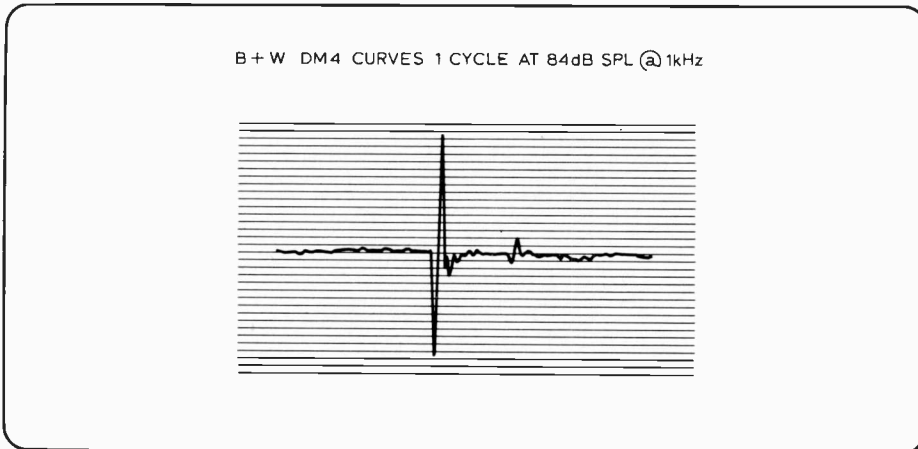
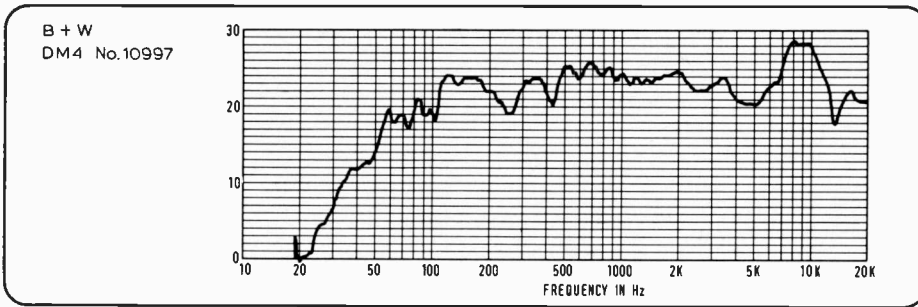

Test conditions

The performance of the *DM4* was assessed subjectively using direct comparisons between live and reproduced sound, live broadcast material and good quality tapes. The material included speech, applause, music of all kinds and a musical box. The speakers were used for some months for general listening and in direct comparisons with other monitor loudspeakers. The comments of a number of technical and non-technical people were invited; their listening was carried out on an informal basis, and though this prevented control of listening conditions, it did enable each person to listen to the speakers to best advantage; it is also less boring for the reviewer! Listening was mainly carried out in a well-furnished listening room with speakers well away from the walls and corners, and raised some 0.5m from the ground on small tables, and also with the speakers mounted forward on shelves.

Speech tests were carried out using recordings made with various capacitor microphones under nearly anechoic conditions, to enable a

good comparison to be made with the live voice. A similar comparison was carried out with a small musical box.

Performance: General

Initial listening tests were carried out with amplifier tone controls set flat and without consulting the response curves which had already been taken by Hugh Ford. After some time a preferred setting of the tone controls on the control unit was arrived at and generally adhered to for the rest of the listening tests.

Balance

The sound balance of the *DM4* is very similar to that of the *DM2*, its larger brother, and suggests some restriction in the bass with a slightly too bright top. The brightness is mainly a small general excess of high frequencies, which can readily be corrected by a treble cut of $-\frac{1}{2}$ on the Quad *33*; on some material there was a suggestion of persisting sparkle at the top end; this ties in with comments on the *DM2* and the *DM4* response curve as measured,

though it is not as serious as that curve might suggest. The effect of the shape of the response at the top end, even with the slight treble cut, is to give a slightly forward, airy sound. At the bass end, $+\frac{1}{2}$ on the Quad restores most of the warmth, though a more complex contour control would be needed to restore the extreme bass properly, and this would in any case reduce the music level at which the system would overload. The dispersion and balance are well maintained off axis.

Coloration

The slight high-frequency coloration—and with the treble cut, it is very slight—has been mentioned; there were few real vices if any. The bass is extremely tight and will stand lifting without booming. The mid-range is particularly clean and clear. There was rarely any bother from sibilants or the like. The sound was generally clear and transparent, as befits a small monitor loudspeaker.

Image

Stereo images were remarkably clear and crisp, and steady. No doubt this is partly the result of mounting the drive units in a straight vertical line. Localisation is very well maintained off axis. The sound is analytical and much to be preferred to the dull sound of a number of monitors and the strident noises of a number of more expensive domestic boxes. One can listen to the music and not the speaker.

Similarity

On programme and noise tests the similarity of sound and sensitivity were found to be exceptionally good, and this would appear to be borne out rather startlingly by the response curves of the two speakers tested, which can be virtually superimposed. For once 'matched pair' means something other than matched veneers! A professional monitor should, however, be reasonably interchangeable with any other of the same type; obviously we were unable to check this with a sample of two.

Speech

Live/loudspeaker speech tests produced excellent results with the bass $+\frac{1}{2}$, treble $-\frac{1}{2}$ correction applied on the Quad *33*. With the cancel button depressed, the sound was rather bright and forward; with the slight correction of balance it seemed very clear and natural. There was little or no tendency to boom on male speech.

Broadcast speech produced the same slightly over-bright sound, requiring similar correction. Rarely was there any complaint of sibilant emphasis, despite the sparkle noted earlier at

58 ►

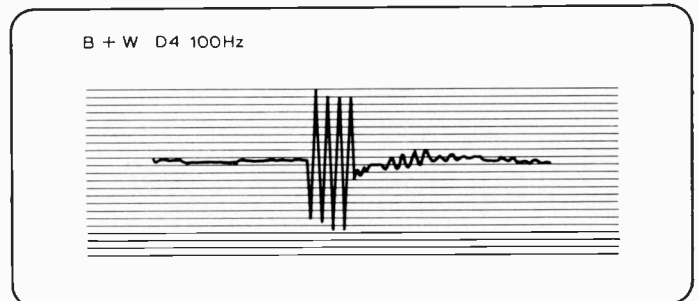
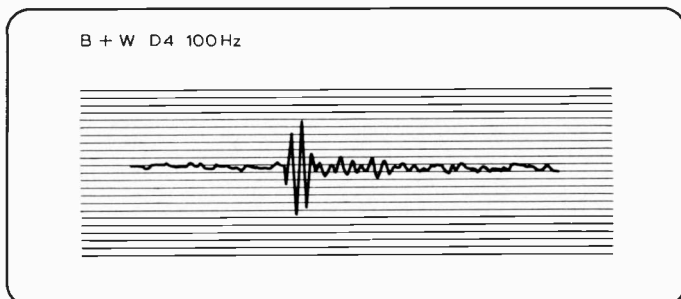

B & W DM4 AND D5

the upper end. Results in reproducing broadcast stereo drama, and the BBC's experimental quadraphonic broadcast, were very good; the speakers do little to flatter microphones with presence bumps though.

Musical box

Similar A-B comparisons to the speech tests were made using a dead recording of a small musical box. This produced quite the most convincing reproduction of the original, at the appropriate level, of any speaker tried to date, with the possible exception of the smaller *D5* which—with response also suitably corrected—produced almost indistinguishable results. With the speaker and musical box a few cm from each other it was virtually impossible not to be confused as to which was which when listening at about 1-1.5m; in double-speaker mono, the trick was almost as convincing. The transient performance at middle and upper frequencies would appear to be excellent, and this is borne out by Hugh Ford's tone-burst and single-cycle tests.

Solo singer

With correction applied, voices were natural and uncoloured, with a slight presence that is not there on all monitors. The male voice had a natural warmth, female voices were natural and clear. Very good sound. Boys' voices sounded airy rather than hairy.

Solo strings and quartet

These reproduced well, with characteristic edge. Slightly more bass lift was sometimes felt worthwhile. The sound was well handled to above a natural or comfortable level.

Organ

Clear and satisfying. Extreme bass not as

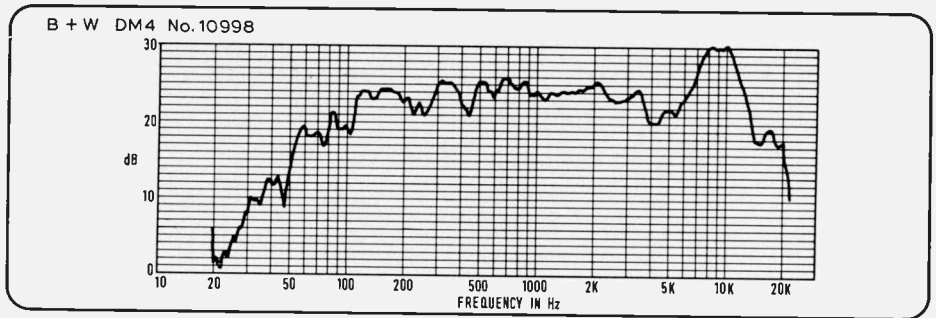

full as original; something of the depth of a reverberant church acoustic lost. Will tolerate surprising pedal levels before seriously overloading. There is some chuffing with high-level inputs below about 30 Hz, which should discourage one from going too far in trying to recover lost pedals.

Large orchestra

Well reproduced and focused, with a satisfying sound. Flat treble and +1 bass sometimes preferred, though the speech setting generally proved adequate. Splendid impact on brass tuttis, unstrained and precise; strings warm without chrome-plating. Piano clear and natural; bass tight and firm.

Chamber orchestra

Good bite to strings; unclouded woodwind, slight lack of warmth which was not a function of bass control setting. Generally clear and analytical sound. Flute a little breathy.

Percussion

Cymbals sharp and clean; triangle clear and bright; bass drum a little thin; snare drum tight and bright in sound. Pleasing and accurate.

Harpichord

Clear, clean and bright. Convincing. Well handled at high levels. Good definition.

Choral music

Very clear and natural, well controlled at climaxes; never harsh. Lack of 'size' to the acoustic image.

Piano

Handled remarkably well, both solo instrument and with orchestra/voices. Some difficulty in reproducing the full sound of a piano played in the same room, but otherwise does justice to good piano sound.

Rock

I would not regard this kind of speaker as well suited to balancing pop, because of the relatively modest power handling and the high power levels required of monitoring loudspeakers. However at modestly uncomfortable levels the speaker should do justice to the aims of the producer, and could well be used in the context of editing. Folk music is well handled, with a bright forward sound that will not encourage unnecessary presence control.

D5

Design

The *D5* is primarily a two-unit domestic loudspeaker, intended for bookshelf or wall mounting. It uses a 124 mm bass unit made by B&W, of similar construction to the ones used in the *DM4* and *DM2* designs. It also uses a small dome tweeter; the dome is soft and appears to be coated with a similar damping dope to that used on the bass driver; the tweeter is edge driven with a 25 mm voice coil, and off-axis dispersion is excellent. The design combines a number of economies with the attention to detail in materials and craftsmanship that have proved so successful in other B&W designs. While the sound is slightly different in balance from that of the *DM4*, with correction they sound remarkably similar, something borne out by the (uncorrected) response curves as measured by Hugh Ford.

Its dimensions are remarkably modest for a speaker of this performance, and this fact makes it well suited for listening in confined spaces. As supplied, the hf unit is mounted below the lf unit, presumably to place the hf unit at about ear level for a seated listener when the speaker is shelf mounted. Inverting the speaker is recommended if the unit is operated nearer the floor; this makes a subtle

but worthwhile difference to the balance.

The manufacturers point out that the bass response of the *D5* (and also the *DM4*) has been tailored for shelf mounting; mounting the speakers close to a wall will give fuller bass than away from a wall on stands, and mounting in a corner will increase the bass further; however, particular rooms may give rise to coloration when speakers are used in the corners, and some experiment, with tone controls set flat, may therefore be necessary to find the optimum positioning before any corrections to the balance are made with the tone controls. Unfortunately it is not always

possible to choose the optimum position for the speakers, whether in studio or domestic applications. The question of positioning should however be borne in mind in the context of my preferred tone control settings and positioning of the speakers; the same settings need not necessarily be right everywhere.

Listening conditions and general performance

Similar listening conditions and tests were used to those described in connection with the *DM4*.

Balance

The general balance of sound from the *D5*

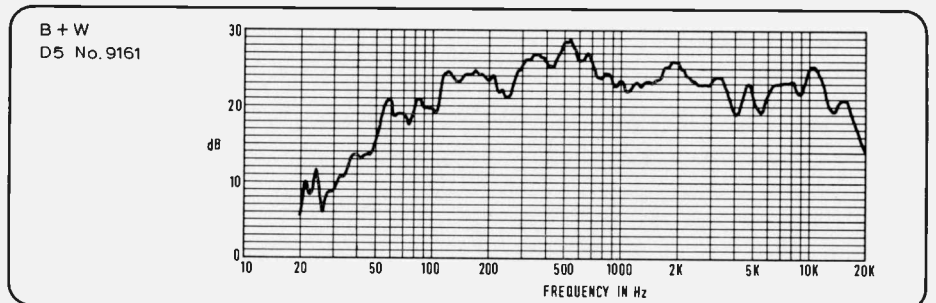

is slightly dimmer than that of the *DM4*, and it lacks the 'sparkle' at the top. The lack of extreme bass is also a little more evident and less easy to correct. In other respects however their performance is remarkably similar.

My preferred setting was $+\frac{1}{2}$ to $+1$ setting of the Quad 33 for bass (usually the lower figure) and $+\frac{1}{2}$ on the treble. This gave a very similar balance to the corrected sound from the *DM4* and BBC *LS3/6*. The sound was darkened as the speaker was moved nearer the corner of the room, and a listening position with the speaker several feet out from a corner but near a wall was preferred.

Coloration

With the correction applied to the balance, coloration was slight. At the top end coloration was felt to be even lower than that of the *DM4*, but the response seemed slightly more restricted. Bass coloration was minimal, with just a hint of boominess on some material with substantial bass lift. Material, containing large low-frequency signals, was not reproduced quite so well as with the *DM4*; this is a reasonable trade off for the considerable reduction in speaker size.

Image

As with the *DM4*, images were clear and sharp. Stereo was clear, with stable images. Although not an ideal arrangement, *D5* speakers were used successfully with Spendor *BCI* speakers in quadraphonic listening tests with good success. Reproduction of the BBC's dawn chorus recording in the experimental quadraphonic broadcast was remarkable.

Similarity

As implied by the above, sensitivity and response of the samples sent for review were very close indeed—as with the *DM4*. It is a pleasure to encounter such consistency in an essentially domestic product.

Speech

Live/speaker comparisons rapidly established the preferred $+\frac{1}{2}$ settings for the tone controls; with the cancel button depressed the sound was lacking in body and a little lifeless. There was very little tendency to boom on male speech that could not be attributed to other factors, and consonants, particularly sibilants, were clean and natural. With correction, speech from the test tape was very like that of the person speaking beside the loudspeaker. One was occasionally aware of a lack of extreme top, but the general impression was of a loudspeaker with few vices.

Musical box

With the *DM4*, the *D5* has produced some of the closest reproduction of the original that I have heard on this A-B test.

Solo singer

Good presence; a live sound; some female voices almost uncannily natural.

Solo piano

Slightly lacking in body, but no vices; a very acceptable sound.

Solo strings and quartet

A tight, clear sound; slightly lacking the bite of the *DM4* and some other good monitors. Double bass inclined to overload if the sound level is high (the speakers are less sensitive than the *DM4*) or with large amounts of rumble in the signal.

Organ

Satisfying reproduction; pedals and traffic

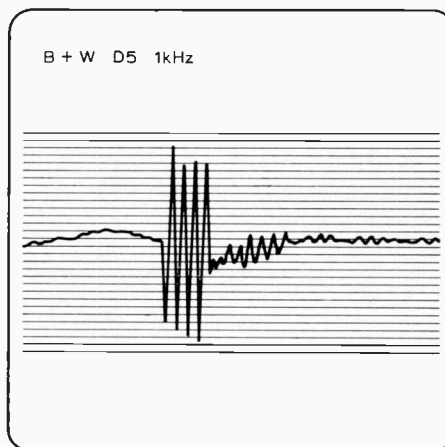
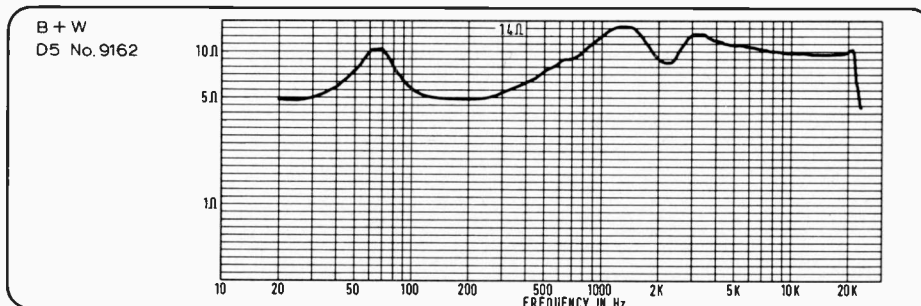
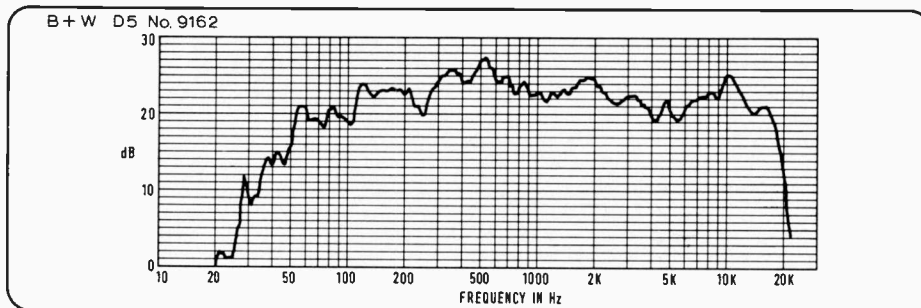

rumble may overload the speaker if generous bass boost is used at high levels, otherwise no problems. (There is some frequency doubling at high levels at very low frequencies as might be expected, this is apparent on tone rather than on the majority of programme material.)

Large orchestra

Strings have quite an edge, the brass a little less tight and controlled than the *DM4*; extreme bass lacking and piano perhaps a little thin, but generally a very acceptable sound.

Chamber orchestra

Strings good, with slight uncertainty about double-bass; good woodwind; flute slightly lacking in characteristic breathiness. Good overall.

Percussion

Cymbals sharp and clean; triangle clear and clean; bass drum slightly thin, boomy if over-corrected. Snare drum—tight, bright sound.

Harpisichord

Clear and convincing, good attack.

Choral music

Slightly forward sound, otherwise clean and effortless to quite loud levels; some loss of

body to the reverberation and acoustic image on large-scale pieces.

Piano

A little thin but a perfectly acceptable sound at reasonable levels; does justice to good recordings while not flattering the bad.

Rock

Not capable of handling high levels of electric bass but capable of more than adequate reproduction for domestic purposes, editing, etc. Pleasant reproduction of real folk.

Conclusions

I would rate both the *DM4* and *D5* as very acceptable speakers for professional use *where space precludes the use of larger monitor systems* and where, for the same reason, power input and sound output levels can be restricted.

The *DM4* is larger than the *D5*, handles slightly more power and is rather more sensitive; its frequency response at the extremes is perhaps slightly wider than the *D5*.

On white-noise testing both types showed slight colorations: the *DM4* its 'sparkle' at the top and a fierceness lower down (3-4 kHz) that was tamed by the slight top cut used in programme listening and certainly not nearly as apparent on speech and music as on this test; the *D5* similarly showed a slight darkness and fierceness at lower middle frequencies that became lost on programme except when the speaker was very close to a corner. Generally the sound was much cleaner and less coloured than that of the majority of speakers in their price ranges.

The differences between the speakers are largely ones of size, power handling and price; they can sound very similar indeed, and performance is excellent. The *D5* may be more easily overloaded at low frequencies (including rumble) and this could perhaps lead to damage if used carelessly in professional applications. It occupies very little space, however. Either would be a very good choice as a domestic loudspeaker. I think I may be forgiven for being enthusiastic about *both* these designs.

Classified Advertisements

Advertisements for this section must be pre-paid. The rate is 8p per word, minimum 80p. Box Nos. 20p extra. Semi-display rates on application. Copy and remittance for advertisements in MARCH 1975 issue must reach these offices by 17th JANUARY 1975 addressed to: The Advertisement Manager, Studio Sound, Link House, Dingwall Avenue, Croydon CR9 2TA.

NOTE: Advertisement copy must be clearly printed in block capitals or typewritten. Replies to Box Nos. should be addressed to the Advertisement Manager, Studio Sound, Link House, Dingwall Avenue, Croydon CR9 2TA, and the Box No. quoted on the outside of the envelope. The district after Box No. indicates its locality.

STUDIO FACILITIES

ANGLIA PRESSING COMPANY

(Yarmouth Recording Studios)

Specialists in small orders of 7" and 12" vinyl pressings, manufactured in our own pressing plant. SPEEDY DELIVERY—COMPETITIVE PRICES Leaflet available

112 Beach Rd., Scratby, Gt. Yarmouth
Tel. Gt. Yarmouth 730136. Member A.P.R.S.

★County recording service stereo and mono masters and lacquer discs from your tapes. Telephone Bracknell 4935. London Road, Binfield, Bracknell, Berks.

S.G.S. RECORDING STUDIO

DEMOS AND MASTER PRESSINGS
MULTITRACKING FACILITIES 01-778 0450

Complete studio service. Mobile studio service engineers. Music publishing. Independent production Group P.A. and amps serviced and sold. Disco equipment installed.

131A ANERLEY ROAD, LONDON S.E.20
Studio 01-778-0450 Messages 01-688 0728

PEAK PROGRAM METERS TO BS4297

also 200KHz version for high speed copying:
Drive circuit, 35 x 80mm, for 1 ma L.H. zero meters to BBC ED 1477. Gold 8-way edge con supplied.

	4 off	10 off	50 off
Complete kit	£10.00	£9.50	£9.00
Built and aligned	£14.00	£13.30	£12.60
ERNEST TURNER PPM meters. Below scalings stocked			
Type 642, 71 x 56mm	£12.60	£43.	£15.00
TWIN MOVEMENT, scale 86 x 54mm	£37.00.		



PUBLIC ADDRESS : SOUND REINFORCEMENT
In any public address system where the microphones and loudspeakers are in the same vicinity acoustic feedback (howl-round) occurs if the amplification exceeds a critical value. By shifting the audio spectrum fed to the speakers by a few Hertz the tendency to howling at room resonance frequencies is destroyed and an increase in gain of 6-8dB is possible before the onset of feedback.

SHIFTERS IN BOXES with overload LED, shift/bypass switch, BS4491 mains connector and housed in strong diecast boxes finished in attractive durable blue acrylic. Jack or XLR audio connectors.

Type	A	B	C
Input impedance	200Kohm	200Kohm	10Kohm
Output impedance	2Kohm	20or600ohm	20or600ohm
PRICE	£58	£68	£84

SHIFTER CIRCUIT BOARDS FOR WW July 1973 article
Complete kit and board £24 Including p.s.u. and Board built and aligned £31 mains transformer
DESIGNER APPROVED

SURREY ELECTRONICS

The Forge, Lucks Green, Cranleigh, Surrey GU6 7BG
(STD 04866) 5997
CASH WITH ORDER less 5% U.K. post free, add VAT

RECORDS MADE TO ORDER

DEMO DISCS MASTERS FOR RECORD COMPANIES	VINYLLITE PRESSINGS
---	------------------------

Single discs, 1-20, Mono or Stereo, delivery 4 days from your tapes. Quantity runs 25 to 1,000 records PRESSED IN VINYLLITE IN OUR OWN PLANT. Delivery 3-4 weeks. Sleeves/Labels. Finest quality NEUMANN STEREO/Mono Lathes. We cut for many Studios UK/OVERSEAS. SAE list.

DEROY RECORDS
PO Box 3, Hawk Street, Carnforth, Lancs.
Tel. 2273

★Essex Recording Studio, 19/20 Poland St., W.1. From in-house to fully commercial in eight smooth-running months. 16T A80, 2T A80, 2T B62, 2 Revox HS. Dolby, Kepex, Eventide, Teletronix. Neumann/AKG mics. EMT and Master-Room reverb. 24 Channel Trident board. 16T from £21.00 p.h. Phone Jay Denson—734 8121 for details.

★J & B Recordings. Tape to disc—latest high level disc cutting, all speeds. Master pressings, studio, mobile. 14 Willows Avenue, Morden, Surrey. MITcham 9952.

★Anglia Pressing Company. 7in. and 12in. pressings from your tapes, also Stereo/Mono masters and demo-discs. Neumann lathe. 112 Beach Road, Scratby, Great Yarmouth, Norfolk. Telephone 0493 730136.

TIME CONSUMING JOBS ARE MY SPECIALITY

I MAKE PATCHBOARDS, PATCH CORDS, SWITCH BOXES, DRILLED AUDIO PANELS, etc. To your specifications. A QUICK PROFESSIONAL SERVICE WITH MODEST PRICES.

For personal attention dial 01-969 3742. Ask for JOHN FRANCIS. NO JOB IS TOO SMALL.

COMPACT CASSETTES PROFESSIONAL HIGH-SPEED DUPLICATION

Dolby B—compression and equalisation available—competitive prices on small runs—full productions undertaken—music and language specialists.

Contact Chris Sands
AUDIO EDUCATION COMPANY
01-723 6635

★Fanfare Records. Tape-disc pressings, demo's, masters, any quantity. Studio/mobile Neumann disc cutter. S.A.E. brochure. 1 Broomfield Close, Rydes Hill, Guildford. Tel. 0483 61684.

★Sound News Productions. Britain's oldest full-time Tape/Disc/Cassette transfer service. Direct transfers, pressings for private and for the trade. Fund-raising advisory service for societies, choirs, bands. 18 Blenheim Road, London W4. Tel. 995 1149.

FOR SALE—TRADE

RAC MIXERS

Custom-built mixers for groups, P.A., hospital broadcasting, recording, discos, etc. RAC plug-in audio modules for building your own mixers.

Sony, Akai, TEAC, Tandberg, Marantz, Lux, Nikko, Dual, Quad and Armstrong dealers. Shure, Calrec, AKG mikes and stands, etc. APRS Manufacturing members.

RUGBY AUTOMATION CONSULTANTS
19 Freemantle Road, Bilton, Rugby,
Warwickshire CV22 7HZ
Tel. 0788-810877 (Rugby)
Call, write or phone us

DUE TO EXPANSION—FOR SALE

Our immaculate Scully 284-8 eight-track recorder, fitted new head block, recent service, spares include—head block etc.

Offers over £3,500

Two J.B.L. Studio Monitors L200, in new and perfect condition. Fair £650

One Alice Noise Gate, brand new ... £85

Four Shure Mikes Dymamics. Each £15

Three Boom Stands £30

Two D.J. 100 Power Amps. £30

Phone: POYNTON 6001. (Cheshire)

DIN Test Records

Small supplies now in stock

DIN 45541 (Frequency)

DIN 45542 (Distortion)

DIN 45543 (Cross-Talk)

DIN 45544 (Rumble)

DIN 45545 (Wow and Flutter)

£5 each and VAT

LENNARD DEVELOPMENTS LTD.

206 Chase Side, Enfield, EN2 0QX

Telephone: (01) 363-8238/9

FOR SALE—TRADE (Continued)

★**Audiofact No. 1!!** You can build 8 Cathedral Complimitters into your mixer for LESS than the cost of ONE medium competitor—and they perform. P.S. Ask about our Low Distortion Oscillator and Graphic Equaliser. S.a.e. details. Cathedral Sound, Fourways, Morris Lane, Halsall, Lancs L39 8SX. Tel. Halsall 840328.

★**Neumann KM54A, Pair**, in cases with all leads and power supplies £100 the pair. Also AMG D258 £30. Ring John 01 748 6815.

FOR SALE—PRIVATE

★**Two Shure 315 Studio Ribbon Microphones**, £25 each, £45 both. Tel. Whitstable 3941.

★**Ex-Lab Gaumont-Kalee Flutter Meter Type 1740**, £235. Mike Clements, 836 6699, ext. 275.

★**Cambridge P100 Amplifier**, nine months old, £90. Phone: Steve, 01-892 2545.

★**For sale.** Telequipment Type D53 dual beam oscilloscope with type CD wide band amplifier and type G high gain amplifier, £160. Wayne Kerr Type A321 narrow band wave analyser 20 Hz to 20 kHz, £25. Telford Type P oscilloscope camera with 6 films, £32. Leever's Rich Type ER30A bulk eraser, £5. Olivetti Logos 245 printing calculator (ideal for VAT!), £175. Shure VNI5E stylus (unused) £5. Various spare parts for PIONEER equipment £50 the lot. Offers considered. Tel. Sunbury-on-Thames 83232.

★**Amcron S.X.724 Tape Deck and Phase Linear 400 Power Amplifier**, £900.00 D. D. Wood. Phone: Berkhamsted 4777

WANTED

★**Lee Electronics.** The Tape Recorder and Hi-Fi Specialists wish to purchase good quality Tape and Hi-Fi equipment for cash. 400 Edware Road, W.2. Phone PAD 5521.

MISCELLANEOUS

AMCRON IN EDINBURGH
2 years free service

HI-FI
CORNER
—clearly better hi-fi.

1 Haddington Place, Edinburgh EH7 4AE
Telephone 031-556 7901

SITUATIONS WANTED

TEMPORARY EMPLOYMENT WANTED

Temporary employment for 6 or 12 months is required by a number of undergraduate students. They are reading for the degree of B Mus. (Tonmeister) and the four-year course is of the 'sandwich' type including a period of employment in the recording or broadcasting industry. Apart from studies in music, acoustics and electronics, the students have experience in microphone balance, tape operation, mobile recording etc. using fully professional equipment.

It will be noted that the introduction of 12-month attachments means that the University can now offer continuity of staffing to an employer. This is felt to be an improvement on the previous six-month scheme.

Interested employers are asked to contact **John Borwick, Senior Lecturer (Recording Techniques), Department of Music, University of Surrey, Guildford, Surrey. (Tel: 71281).**

SITUATIONS VACANT

TOP ARTISTS RECORDING STUDIO

Well established in the heart of Paris, have an opening for experienced recording engineer who is also able to do some maintenance on electronic recording equipment. Excellent prospects for a bachelor aged about 25. Living accommodation, bachelor flat, will be provided.

Please contact today.

LOULOU GASTE STUDIOS,
5 Rue du Bois de Bologne,
Paris 16, France.

★**Technician** required by expanding tape firm for work in their tape copying department and for servicing a range of audio visual equipment. A knowledge of tape editing and a good musical ear are essential and a thorough understanding of electronics is desirable. Apply with full details to: **Tim Hodson, Arrowtabs Ltd., Humber Road, NW2 6EP.**

GRANADA TELEVISION

TRAINEE SOUND ENGINEERS

We have vacancies for bright young men to train as Engineers (Sound) in our Manchester Studios. Candidates should be trained electronic engineers in the age range 20 to 25 years, possessing at least a physics A level or an ONC in physics or electrical engineering. They may lack practical experience of sound at professional level but they must be knowledgeable about the theory of sound studio techniques and equipment. In addition they will be able to show evidence of an informed interest in some field of music.

Appointments will be at a salary of £2,498 per annum progressing by five annual increments to £3,500 per annum. We offer excellent conditions, including four weeks paid holiday and generous Granada Group pension and life assurance benefits.

Write with full details to:—

R. J. CONNELL,
Quay Street, Granada Television Ltd.
MANCHESTER M60 9EA

BBC TV FILM DEPARTMENT

REQUIRES

ASSISTANT FILM RECORDISTS

To undertake the operation of recording and reproduction equipment in sound transfer and dubbing areas situated in various television premises.

Candidates must have practical knowledge and experience of film sound transfer and/or dubbing recording methods and techniques, coupled with an understanding of the use of sound and film production.

Salary: £2,397 p.a. rising by annual increments of £111 to £2,952 p.a.

Candidates who do not meet the full requirements of the advertisement may be considered for appointment as Trainee Assistant Film Recordists at a salary of £2,127 p.a. with promotion to Assistant Film Recordist upon satisfactory completion of a one year training period. This would apply to applicants in the age group 18 to 28 with G.C.E. 'O' Level standard of education who have some knowledge of basic electronic theory and are able to show evidence of a practical interest in recording. A course is scheduled to start early in 1975.

Based at Ealing or Shepherd's Bush.

Write or telephone immediately for application form (enclosing addressed foolscap envelope) to Appointments Department, BBC, London, W1A 1AA, quoting reference 74.G.1138SS, telephone 01-580 4468, ext. 4619.

SITUATIONS VACANT

(Continued)

DEPARTMENT OF MUSICAL INSTRUMENT TECHNOLOGY

Full Time Courses.

Higher Diploma Course:

Advanced studies for those who are 19 years of age or over and who have suitable educational or industrial qualifications.

Higher Diploma in Musical Instrument Technology.

Certificate Courses in:

Piano Tuning, Construction, Repair and Maintenance.

Early Stringed Keyboard Instrument Construction: Harpsichord, Clavichords.

Fretted Instruments: Guitars, Lutes, Violas and Cellos.

Electronic Musical Instruments.

Part Time Courses.

Block Release or Day Release.

Stringed Keyboard Instrument Design and Manufacture.

Violin Making.

Early Fretted Instrument Making.

Piano Tuning and Maintenance.

Woodwind Instrument Maintenance.

Further information from:—Senior Administrative Officer,
London College of Furniture, 41 Commercial Road,
London E1 1LA. Tel: 01-247 1953



Leading supplier of sound control consoles and ancillary equipment for the broadcasting, recording and film industries have a vacancy in the Research and Development Laboratory for a

Senior Design Engineer

who should be of degree or equivalent standard in electronics and have had at least three years experience in audio engineering. He will be responsible, under the Chief Designer, for a small team working on the design of sophisticated sound control equipment. He must be able to see a project through from its conception to its successful introduction to the Company's product range.

Please apply to the Personnel Manager,

NEVE ELECTRONIC LABORATORIES LTD

Cambridge House, Melbourn,

Royston, Herts, SG8 6AU

Telephone: Royston (0763) 60776

KEEP IN TOUCH WITH STUDIO SOUND 25p

Place a regular order with your Newsagent or take advantage of a POST FREE Annual Subscription.

INDEX TO ADVERTISERS

Acoustical Manufacturing Co. Ltd. .. 37	Feldon Audio 51	Racal Zonal 53
Acoustico Enterprises 45	Future Film Developments Ltd. .. 55	Raindirk 31
Alice (Stancoil) Ltd. 31		Revox 64
Allen & Heath 11	Grampian Reproducers Ltd. 6	R.E.W. Audio Visual Ltd. 19
Allotrope Ltd. 30	Industrial Tape Applications 4, 5, 63	Rycote 41
Apollo 10	Klark Teknik Inc. 43	Sansui Audio 27
Audio Design Recording 33	Lee Engineering 39	Shure Electronics 17
Audio Developments 33	Lockwood 32	Surrey Electronics 26, 44
Avcom 6	Macinnes Labs Ltd. 10	Tannoy 8
AV Distributors Ltd. 43	Magnegraph 39	Taylor Hutchinson Ltd. 9
Baileys 39	Magnetic Tapes Ltd. 8	Theatre Projects 11
BASF 39	Mustang Communications 6	Turner Electronic Industries Ltd. .. 41
Bauch, F. W. O., Ltd. 7, 31	Naim Audio 33	Tweed Audio 41
Bias Electronics Ltd. 10	Neve, Rupert, & Co. Ltd. 13	Zoom TV 43
Cadac (London) Ltd. 2		
Exposure Hi Fi 41		

ITAM 805 MASTER RECORDER
ADVANCE SPECIFICATION SHEET

Features:

- * 8-channel professional master recorder on half inch tape.
- * Servo controlled capstan motor, with optional variable speed facility.
- * Relay-solenoid operation.
- * All channels fully modular, using plug-in fibre glass printed circuit boards with gold-plated contacts.
- * Sel sync on each channel. Separate sync and replay amplifiers giving identical sync and replay output levels.
- * Each channel has safe-record-sync selector with flashing indicator showing ready to record position.
- * VU meter readings designed to give a slow decay time, similar to PPM.
- * VU meter is switchable between input and output.
- * High efficiency switching oscillator comes on slowly resulting in freedom from clicks. All oscillators are locked to a common frequency.
- * Individual oscillator on each channel reduces crosstalk.
- * Double-gapped erase head for maximum erasure.
- * Each channel has line input and line output sockets plus additional headphone output socket.
- * Modern compact-console presentation — easily portable for location work.
- * Dolby A switching facility.

Technical specifications:

Tape speed	15 ips
Tape width	0.5 ins.
Capstan motor stability	99.7%
Wow and flutter	0.08%
Signal to noise ratio	63dB weighted ASA (57dB unweighted) ref. 640 pico Webers.
Frequency response	\pm 2dB 40Hz to 18KHz.
Frequency response (sync mode)	\pm 2dB 50Hz to 15KHz.
Crosstalk	35dB
Inputs	100 millivolts up to 20 volts. 20K ohm impedance.
Outputs	1. Headphones 600 ohms. 2. Line 600 ohms OdB.
Distortion	Less than 1% at Ampex and Dolby level.
Oscillator frequency	100 KHz.
Complement each channel	11 transistors, 3 IC.

Options:

Variable speed, remote control

Price:

£1,790.00 + VAT

U.K. Agent: Industrial Tape Applications,
5 Pratt Street, London, NW1 0AE.
Tel.: 01-485 6162/7833
Telex: 21879

How to keep the musical excellence you've already paid for:

Your tape system

The tape equipment of your system is your musical memory bank. It is the one area where only the best makes sense. Choose carefully, select a recording instrument that neither adds nor detracts from the sound you put into it. Few machines really meet this requirement. The Revox A77 does – and by a safe margin.

Your tape recorder and your money

A truly professional quality tape unit is your wisest audio investment. It will last for years and years.

Witness the number of Revox machines built more than 20 years ago that are still in service! It's hardly surprising then, that Revox recorders command very high prices second or third hand – if you can find them available!

Revox owners seldom change – other than to a later model Revox.

It's also interesting to note that our warranty records show that on average our users have bought 2 or 3 other makes before choosing Revox. Then we read the lament "I only wish I'd bought a Revox sooner."

When you play it later, will it still sound the same?

At first sight this could seem an unnecessary question. It's not though. In the course of time a high fidelity enthusiast upgrades one or more units in his system.

With time, rising affluence plus advancing technical innovation in all aspects of audio, will bring better reproduction within the scope of all.

The recordings that you make now could, therefore, sound even better in the future – when, as finances permit, you add a better amplifier or loudspeaker to your equipment.

Conversely, a poor recording made now will sound really inferior when exposed to more exacting playback.

With the Revox A77 you will retain the excellence of every recording to enjoy now – and perhaps appreciate even more in the future.

So visit your nearest Revox Dealer for full information and a demonstration.

Record it on a Revox A77

REVOX



Revox C. E. Hammond & Co Ltd; Lamb House Church Street London W4 2PB,
Revox Corporation, 155 Michael Drive Syosset N.Y. 11791 U.S.A.
Revox Corporation 3637 Cahuenga Boulevard West, Hollywood California 90068.
Revox International: Regensdorf 8105 ZH, Althardstrasse 146 Switzerland.

© Admark International
The illustration contains optional extras.

BHE