

STUDIO SOUND



CMP

United Business Media

POSTPRODUCTION • RECORDING • BROADCAST

www.studio-sound.com



PLUS XXX

France is first with 88R



REVIEWS

- Auratone 5C Super Sound Cube
- Terrasonde Audio Toolbox Plus
- Manley 16x2 Tube Mixer
- CLM Dynamics DB8000s
- Mindprint T-Comp
- Joemeek TwinQ

Family Affair: Nile Rodgers updates a Chic classic
Paradiso: Performance art and high-performance recording
Harry Potter: Mixing magic and sound
Plug-ins: Expanding the 'plug-in' principle



Transparent Performance



The Hit Factory, New York



Abbey Road Studios, London



Guillaume Tell, Paris



Sphere Studios, London



Record Plant, Hollywood



The SL 959 monitoring panel extends the flexibility of the SL 9000 console to allow multi-format surround monitoring

New York
+1 (1)212 315 1111

Los Angeles
+1 (1)323 463 4444

Tokyo
+81 (0)3 5474 1144

Paris
+33 (0)1 3460 4666

Milan
+39 039 2328 094

Over 180 leading international studios currently enjoy the creative flexibility of the SL 9000 console

- SuperAnalogue™ audio response faithfully tracks the most delicate and powerful of music performances
- Flexible automation and monitoring allow every small detail to add a voice to the mix
- Dynamic range that comfortably exceeds the specifications of 24-bit analogue to digital converters
- Bandwidth that extends nearly two octaves beyond a 96kHz digital recorder

No wonder the SL 9000 is the definitive recording and mixing console

Solid State Logic



SL 9000

International Headquarters: Begbroke, Oxford OX5 1RU, England

T: +44 (0)1865 842300 F: +44 (0)1865 842118 E: sales@solid-state-logic.com W: www.solid-state-logic.com

ANALYSIS

- 4 Editorial**
Formative choices and the how long is now
- 6 Soundings**
Breaking news on professional audio, post and broadcast
- 64 Classifieds**
Take a tour of the backstreets of the pro-audio marketplace
- 67 Letters**
Continuing the NS-10 debate and picturing *Studio Sound's* people
- 68 World Events**
Updating the pro-audio events calendar
- 68 Stereotypes & Top 10**
A new look at audio industry characters and their listening habits
- 70 Backchat**
The Hit Factory Criteria, Miami's Trevor Fletcher fields exacting and exasperating questions

FEATURES

POSTPRODUCTION

- 48 Harry Potter**
Mixing magic and sound for the season's movie theme proves to be a neat trick for supervising sound editor Eddy Joseph

RECORDING

- 16 Plus XXX**
Paris studio is the first with an AMS Neve 88R analogue console
- 36 We Are Family**
Updating a Chic classic to humanitarian ends sees Nile Rodgers recording in NY and LA with a cast of hundreds
- 43 Recording Paradiso**
A bizarre performance in an abandoned Dutch power station provides a unique recording opportunity

TECHNOLOGY

- 54 Plug-ins**
Is adapting the processor 'plug-in' principle to dedicated recording systems the next big thing in recording?
- 61 Dr John**
Recording using magnetism has become a branch of technology with a remarkable number of applications

REVIEWS

- 18 Auratone 5C Super Sound Cube**
The definitive loudspeaker review returns to the Auratone on the trail of the NS-10's secret
- 23 Terrasonde Audio Toolbox Plus**
Repackaged and revamped, the Toolbox threatens to make test and measurement a glamorous part of audio
- 26 MindPrint T-Comp**
A hybrid of technologies makes this German stereo compressor sound as good as it undoubtedly looks
- 28 CLM Dynamics DB8000s**
This Scottish-born 8-channel mic preamp package is perfectly matched to the needs of MDM users
- 31 Manley 16x2 Tube Mixer**
The latest 'must-have' mixer is alive and well, and full of valves—and it's hunting you down
- 34 Joemeek TwinQ**
A 'best of' twin channel strip brings buckets of character to the recording process

COLUMNISTS

- 58 Technology**
Barry Fox weighs the conflicting requirements of bit rates and channel count in British DAB
- 58 Business**
Dan Daley talks terminology in the workplace and the law court, and finds it more powerful than technology
- 59 Delivery**
Kevin Hilton searches out forgotten players in television light entertainment and surround sound comedy

48



23



26



31



54

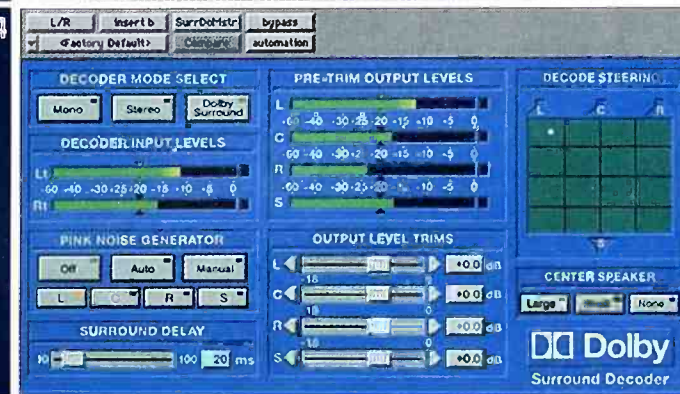

43



Formative choices

AN OLD SCHOOL FRIEND tracked me down over the Internet recently and instigated a series of exchanges that are still running. It's given me a lot of laughs, a lot of gossip and some valuable insight in to passed events. Because we were once both in what could be generously described as 'a band' together and because he also still plays, the conversation has predictably turned to what we have been listening to. His appraisal of my list revealed a pattern of likes and dislikes that can be traced back pretty much directly to what turned me on to music in the first instance. It's not been such an earth shattering revelation for me but it has served to underline how important initial steps and grounding are in shaping future development. It's also a lesson that can be applied to your appreciation of audio gear.

It is very hard to change initial and long-standing impressions and appreciations. You know what you like for a whole string of reasons that either collide and combine in to equipment that intrigues you or they don't. If you take loudspeakers as about the most personal aspect of production equipment, then the chances are that unless you are truly open-minded and progressive in your quest to constantly seek out and audition new models, you will most likely continue to choose a particular monitor 'type' for reasons that you can't accurately identify or quantify.

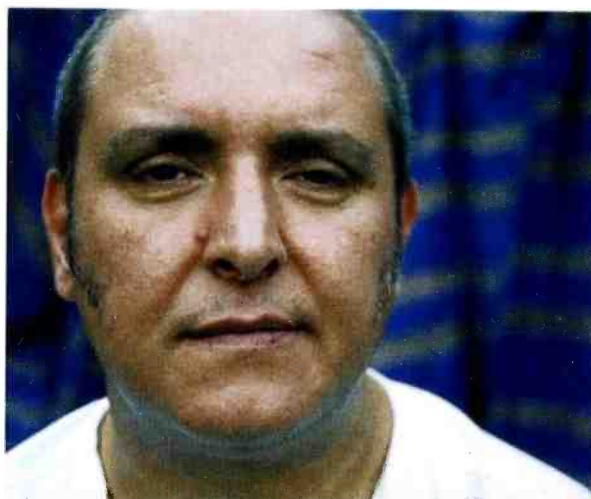

Saying that you like them or that they work for you sounds a little feeble when confronted by similar sentiments from someone who swears by a completely different type—yet we all do it.

We bench test the ubiquitous Auratone in this issue, and like our look at the NS-10 before, we hope that as a result in the near future we will be able to pin some sort of logic and reason to the type of monitors that we arrive at using.

Zenon Schoepe, executive editor

Forever Young

IT'S A MISTAKE to covet youth. You don't have to be very smart—or very old—to realise it, but it's a mistake that many of us make regardless. And on top of its innate futility, it's a straight struggle between intellect and emotion that frustrates us on all levels.

With its emphasis on youth and youth culture, much of the media is an unhealthy place for chronophobes. Surrounded by good looks, fit bodies and endless energy, our concerns over our own growing failings are likely to be antagonised on a daily basis. It's human nature, but it may not be the kind of human nature we believe—and fear.

A recent study of our ability to accommodate change produced some surprising results. Apart from the anticipated confirmation that we become increasingly less well-equipped to handle change as we get older, the report highlighted the increasing rate of change experienced in the Western world. Where once society advanced at a rate that made our physical ageing the primary concern (whether catching food or a mate), today's world is most demanding of our intellectual

agility. My figures may be a little off (being the product of an ageing memory) but the statistics tell that if you're not still listening to new musical forms at the age of 23, there's a 95% probability that you never will. Similarly with fashion, if you're not still experimenting at 39, you've probably finished forever.

The backlash—for there has to be one—is emerging through the likes of the Long Now Foundation, dedicated to the enjoyment of the present over hunger for the future. Established by ex-super computer designer Danny Hills, one of the Foundation's aims is to build 12 clocks that will run for 10,000 years. These are to be distributed around the world as a reminder of the larger scheme of things. One clock is built, but there's no delivery date on the second...

By definition, most older operators are naturally ill-suited to new technology. How strange then, that pro-audio is so usefully populated by a balance of younger and older souls. It's tempting to believe that eternal youth is not quite such a stranger here than in the rest of the world... But tell me: would you rather be young or rich?

Tim Goodyer,
editor



CMP Information,
7th Floor, Ludgate House,
245 Blackfriars Road, London SE1 9UR, UK.
Fax: +44 (0)20 7579 4011.
Net: www.studio-sound.com

Emails: (initialsurname@cmpinformation.com)
Direct lines: +44 (0)20 7579 (extension).

EDITORIAL

Executive Editor: Zenon Schoepe. X: 4604
Editor: Tim Goodyer. X: 4719
Production Editor: Dawn Boulwood. X: 4157
Secretary: Eileen Sullivan. X: 4169

Consultant Editors:

Broadcast: Florian Camerer, ORF, Vienna.
Chris Wolters, VTM, Brussels.
Postproduction: Paolo Biondo,
International Recording, Rome.
Lloyd Billing, The Tape Gallery, London.
Recording: Arthur Baker, producer-remixer.
Trevor Fletcher, Criteria Studios, Miami.

Consultants: Francis Rumsey; John Watkinson
Columnists: Dan Daley; Barry Fox; Kevin Hilton
Bench-testers: Keith Holland; Paul Miller
Regular Contributors: Jim Betteridge;
Richard Buskin; Simon Croft; Andy Day;
Ben Duncan; Dave Foister; Tim Frost;
Neil Hillman; Rob James; Caroline Moss; Philip
Newell; Terry Nelson; Martin Polon;
George Shilling; Simon Trask

ADVERTISEMENT SALES

Group Ad Manager: Richard Lawn. X: 4432
Ad Manager: Sue Gould. X: 4491
Deputy Ad Manager: Sam Patel. X: 4440
Classified Sales: Wendy Clarke. X: 4723
Ad Production: Mark Saunders. X: 4739
Circulation Manager: Luise Mulholland. X: 4257
PA to the Publisher: Lianne Davey. X: 4211
Associate Publisher: Joe Hosken. X: 4179
Publisher: Steve Haysom. X: 4459
Executive Director: Paul Gallo

SUBSCRIPTIONS

UK £52; Europe £69; Overseas: \$130; Single £6

For subscriptions contact:
Studio Sound, United Business Media International
Ltd. Tower House, Lathkill Street, Market
Harborough, Leicestershire, LE16 9EF, UK.
Tel: +(0) 1858 438893
Fax: +(0) 1858 461739
Email: lmulholland@cmpinformation.com

WAIT!

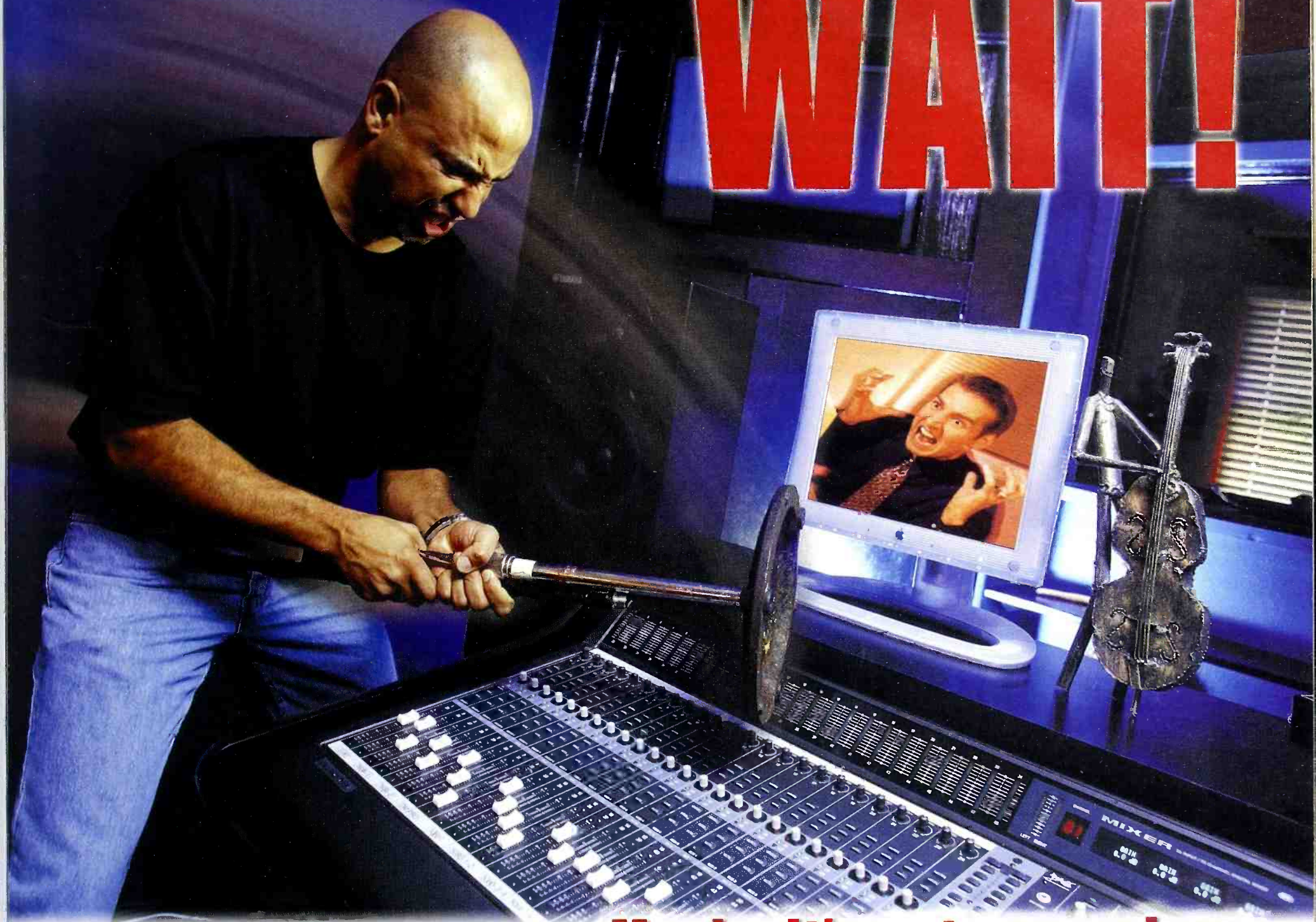

Maybe it's not your mixer

You know how impact and detail get lost through recording and mixing. And you just can't EQ, compress or mix the life back in. When you're at wit's end, the Aphex Model 204 can save your sanity.

The Model 204 renews and vitalizes your sound. The Aural Exciter® restores and improves definition and detail. At the same time the Optical Big Bottom® solidifies and strengthens the bass without hogging all the level.

If you need professional and impressive sound you owe it to yourself to get a Model 204. You'll probably save your sanity and a lot of perfectly good mixers. You've got a problem - We've got the solution!

The all new Aphex Model 204 Aural Exciter and Optical Big Bottom



APHEX
SYSTEMS

SOLUTION DELIVERY SERIES

11068 Randall Street, Sun Valley, CA 91352 U.S.A • 818-767-2929 Fax: 818-767-2641 www.aphex.com
Aphex, Aural Exciter and Big Bottom are registered trademarks of Aphex Systems • No mixers were harmed in the production of this ad.

CONTRACTS

US-Australia: New York's Absolute Audio has expanded the selection of Quadriga modules on its AudioCube 4 system. Absolute will be adding automated audio archival services to its mastering business across the US. Meanwhile, LA-based National Audio Restoration Services has added Analogue Observer, BWF-Editor and AudioFile-Inspector modules to its AudioCube 4-11 system. NARS is expanding its film sound restoration to include archive analysis. With two further sales two systems to Australian National Archive, the install base of Quadriga systems now totals 32 in eight countries. Cube-Tec, US. Tel: +1 905 469 8080.

Germany: Florian Senfter of Zombie Nation has recently added a pair of TL Audio's flagship VP-1 channel strips to his Munich studio. The DJ and Producer's 'Kernkraft 400' was one of Europe's biggest selling dance records of 2000. TL Audio. UK. Tel: +44 1462-680888.

Holland: Cinevideogroep has installed an AMS Neve Libra Live Series II console in its newly commissioned digital Outside Broadcast Van 10. Cinevideogroep, The Netherlands. Tel: +3135 672 5725. AMS Neve, UK. Tel: +44 1282 457011.

Japan: Tokyo Sound Production has completed a new digital post suite centred on a 25-fader Soundtracs DS-3



console. The BS-MA room was built for one of Japan's main satellite broadcasters, BS Asahi, but operated by Tokyo Sound Production to deliver sports and entertainment shows including *Soccer 2002* dedicated to the World Cup. Tokyo Sound Production, Japan. Tel: +81 3 3423 0881. Soundtracs, UK. Tel: +44 1372 845600.

US: Fresh from its launch at InterBee, AMS Neve's new Logic 7 console has found its first home in Burbank at West Productions' new digital stage. With clients including 20th Century Fox, Paramount, Nickelodeon and Warner Bros, the Logic 7 will go to work on the *X Files* for Fox, *Branian McGee* for Nickelodeon and *Nightmare Room* for Tollin and Robbins. AMS Neve, UK. Tel: +44 1282 457011.

Biggest OBs in TV

US-Europe: Two new TV OB vehicles have claimed credit for being the largest in the world and in Europe. Both trucks have been commissioned by US-based National Mobile Television—directly in New York and through its subsidiary CTV Outside Broadcasts in Europe. Both will provide outside broadcast coverage of sports, entertainment and corporate productions.

NMT, the world's leading provider of mobile television production equipment, unveiled DX11 as the largest digital expandable mobile unit in the US, at New York City's Tavern on the Green restaurant in Central Park at the same time as CTV Outside Broadcasts put OB4 on the road in Europe.

DX11, equipped with hot technology from Canon, Grass Valley Group, SSL and Thomson Multimedia, is a 53ft digital expando with a 47ft long, 5ft wide expansion. Its total width when show-ready is 21ft. The truck is capable of holding 24 cameras and 26 VTRs with an internal routing system providing a combined analogue and digital matrix capable of 192 inputs and outputs. OB4 is a quadruple two-tier expando 4:3/16:9 OB van. Measuring 14.1m by 6m (when fully expanded), it is capable of holding 30 cameras and 20 VTRs or DDRs. Its internal routing system provides a combined analogue and digital matrix capable of 256 inputs and 320 outputs. OB4 also

houses a separate edit suite.

'DX11 and OB4 bring the combined count of mobile production units of NMT and CTV to 46, not including additional support vehicles,' said Jerry Gepner, president of National Mobile Television. 'For sports, entertainment or corporate telecasts, no other company matches NMT's resources of analogue and digital standard definition, and digital high definition platforms.' NMT, US. Net: www.nmtv.com. CTV Outside Broadcasts, UK. Net: www.ctvob.co.uk.

Concurrently, market and technology information bureau SCRI International has determined that some 84.3% of US TV stations expect to be transmitting a digital signal by the end of 2002. The figure is derived from the results of SCRI's *DTV Migration Survey of US TV* which shows how TV Stations expect to fund the transition to HDTV. This assumes contractors' schedules to retrofit towers or construct additional antenna supporting devices will be completed on time and equipment delivery (encoder, transmitter, transmission line and antenna) schedules are met.

Meanwhile, a recent announcement from the National Association of Broadcasters claims that 68.2% expect to have a digital signal on the air before 1st May, 2002 and a further census of stations conducted by NAB found that some 95.8% of US television homes would be in markets served by at least one digital signal by that date. NAB also announced that the total number of stations broadcasting in digital is 206. Sixty-eight markets now have stations transmitting DTV signals that serve 69.39% of US TV

households. SCRI's 2001-2006 DTV Migration Report Series includes TV Station Trends and Products reports as well as a Production/Post Production DTV Migration Trends report. Net: www.scri.com/sc_reprt.html

Cedar partners Mackie, AMS Neve

UK-Belgium: Cedar it to be the first manufacturer formally to support the Soundscape brand since Mackie's acquisition of the Belgian Sydec operation. The renamed Mackie Designs (Belgium) BVBA, will support the Soundscape range and Cedar Audio has been first to sign a Soundscape development, sales and support agreement with Mackie.

The agreement followed Mackie taking full distribution responsibilities for the Soundscape brand. An official statement read, 'This move ends a previously announced distribution agreement between Mackie and Soundscape Digital Technologies, the UK based company that has been marketing and distributing Sydec products under the Soundscape brand name since 1993. Under this new arrangement, Mackie will assume responsibility for the distribution and marketing of Sydec-developed Soundscape products worldwide.'

'I contacted Mackie in the USA as soon as the news broke,' said Gordon Reid, MD of Cedar Audio. 'Given that our aims are the same, it proved to be straightforward to

Wizoo for Steinberg

BREMEN-BASED SAMPLE LIBRARY provider Wizoo has entered into a joint venture with Steinberg to generate and manage all sounds for Steinberg software products, as well as consolidating its output of stand alone libraries and OEM packages in a new venture, Wizoo Sound Design GmbH. The move also provides Steinberg with a lever into the sample library market. Wizoo managing director Peter Gorges spoke exclusively to *Studio Sound*.

Q: What are the operational differences between Wizoo GmbH and Wizoo Sound Design GmbH?

The former Wizoo GmbH, a combination of a book publishing company and a sound-sample CD-ROM vendor, has been segmented into two separate companies called Wizoo Publishing GmbH and Wizoo Sound Design GmbH. While Wizoo Publishing retains the publishing business (books, magazine articles and related services), Wizoo Sound Design carries on developing samples and sounds for all kinds of samplers and synthesizers. A new and very important task of Wizoo Sound Design is our role as Steinberg's exclusive content provider-agency.

Q: How are the sounds designed—what equipment is in the Wizoo studio?

Our main sound design team uses a professional studio located close to Bremen. These guys have been developing samples for a couple of hardware manufacturers, first of all Yamaha (nearly all samples in the new Motif series come from there), Kawai, Roland, Steinberg, Emagic and others.

We're not doing any magic or applying super secret techniques or technology. I think our main capital is long-term experience in creating musical instrument samples and a strong backup by big

companies such as Steinberg, who supply the financial means that are necessary for creating professional libraries.

Q: Apart from Steinberg, which MI-software vendors will Wizoo supply?

We will cater to everybody who is interested—there is no limitation by Steinberg. We are actually working together with a couple of companies, but I cannot reveal who this is without hurting NDA restrictions, but it's mainly major software-hardware manufacturers.

Q: Is this an exclusive deal with Steinberg—will all sound FX in Cubase and related products be Wizoo-generated?

They will be organised for Steinberg by Wizoo, but not all get generated by us because there's the danger of a 'monoculture' - which neither we nor Steinberg would appreciate. We will be using a healthy mixture of self-produced, high-quality sounds along with libraries that we buy or license from other sound manufacturers.

One important task we carry out for Steinberg is to evaluate the libraries that get offered to them and handle all library acquisition for them. In short, Wizoo Sound Design is both a content manufacturer and content agency for Steinberg. While this is an important and rewarding task, we won't forget our own identity.

Q: Will there be Steinberg-branded CD-ROM sample libraries?

Yes, there will be Steinberg-branded library products—not only CD-ROMs.

Q: What is Steinberg's stake in Wizoo, and on what investment basis?

Steinberg has 60% in Wizoo Sound Design, 0% in Wizoo Publishing. Wizoo Publishing holds 40% of Wizoo Sound Design. Both Wizoo companies share their office backbone, but apart from this it's all separate teams.

Wizoo Sound Design, Germany. Tel: +49 421 701870. Net: www.wizoo.com

CONTRACTS

UK: BBC Technology has contracted the Pro-Bel division of the Chyron Corporation to upgrade its Digital Transmission Area. The new facilities provided under the contract include MPEG video servers, an enhanced Fibre Channel network, a Pro-Bel MAPP Media Browse system with 300 hours of storage, as well as additional Compass Automation facilities. The project was undertaken by BBC Technology's Consulting & Projects, on behalf of BBC Broadcasting & Presentation and will enhance material caching for programme preparation and on-air operation. The new Browse application forms part of the existing MAPP Media Management System, and will replace a VHS-based system used for viewing material and verifying Compass Automation schedules. Chyron Corporation, UK. Tel: +44 1189 214294.

Switzerland: French-language broadcaster Television Suisse Romande has installed a second Aysis Air console in its main transmission centre in Geneva. The 96-channel, 40-fader console is in Studio 4 and will be used for surround postproduction work and live broadcast. With two channels broadcasting to more than 1.5m, TSR transmits over 23,000 hours of programmes each year. SSL, UK. Tel: +44 1865 842300.

Italy: State broadcaster RAI is to refurbish its main recording studio at Via Asiago in Rome, with Munro Associates updating its earlier 1997 design to include surround monitoring, a cinema screen and a stage. The revised facility will handle recording of chamber and small classical ensembles as well as jazz and pop. In addition, it will be the venue for live light entertainment broadcasts and concerts. Another Italian broadcast facility, Channel 5, is to take a Soundtracs DS-3 console for installation in its RTI music branch where it will replace an Amek Hendrix. RAI, Italy. Tel: +39 6 36 86 6291. Munro Associates, UK. Tel: +44 20 7403 3808. Soundtracs, UK. Tel: +44 1372 845600.

France: The French Canal Plus TV channel has installed a new transmission management system for its Nodal communication facility based on Netia software. The system manages programme data including decryption, conversion, processing, and destination assignment (video recorder, editing room, OB studios). The Netia system manages the Nodal system as an integrated whole, increasing transmission capacity while maintaining quality and reliability. Netia, France. Tel: +33 467 59 0807.



Japan: Differing needs have pushed two major Japanese companies in different technical directions but to a common manufacturer—while Sony Music Entertainment has installed three 72-channel AMS Neve 88R analogue consoles in its new Tokyo complex, major film company Toei has replaced a Soundcraft TS24 with a DFC on its Dubbing Stage. The 88R consoles are installed in three of the five bau:ton-designed recording studios at Sony (pictured), where five 33609 Limiter Compressors, five AMS DMX-15s and five AMS RMX-16 have also been placed. 'We chose analogue consoles because digital consoles would not have been suitable because of the bandwidth,' commented Sony's Mr Watanabe. Meanwhile, Toei's DFC will be working on feature films and TV programmes. Sony Music Entertainment, Japan. Tel: +81 3 5786 8810.

agree a new contract between Cedar and Mackie, and to give the green light for Mackie to begin selling and supporting our de-click and de-hiss processes. Indeed, I understand that Mackie has already received orders for the products, so I'm doubly pleased that we were able to reach this agreement so quickly.'

Erik Wijnen, general manager of Mackie Designs (Belgium) added, 'Mackie is committed to continue the development, support, marketing and distribution of the Soundscape product range. It is in this context that we have entered into an agreement with Cedar to offer their well-known and highly respected software in combination with Soundscape products.'

Tony Williams, sales director of Mackie UK, concluded, 'Mackie is now swiftly establishing a new structure for Soundscape, and today I'm pleased to announce that Mackie UK will be representing Soundscape in the UK. This confirms Mackie's long-term interest in high-end digital recording, editing and mixing products for the pro-audio world.'

Concurrently, Cedar and AMS Neve have announced their intention to port audio restoration and noise reduction processes to AMS Neve platforms. After successful feasibility studies, a series of developments will make a range of Cedar's audio restoration and noise suppression processes available on AMS Neve platforms.

'The collaboration was agreed in principle at the AES Convention in Amsterdam,' said Reid. 'However, we were determined not to announce anything until we were sure that

we could produce a range of products that met both companies'—and their customers'—expectations and requirements. We are now looking forward to releasing the first product later this year, with more to follow in 2002 and thereafter.'

Guy Gampell, business development manager at AMS Neve added, 'The removal of noise and other unwanted artefacts is an essential part of postproduction and Cedar's standing in this area is second to none. As such, we see the integration of these processes as a logical development for our class-leading products. We look forward to a long and successful partnership with Cedar Audio.'

Euphonix embraces HDCD

US: Last year's acquisition of Pacific Microsonics by Microsoft brought the software giant access to the technology behind HDCD and Pacific's Model Two processor. More recently, Microsoft and Euphonix have agreed that Euphonix will manufacture, sell and support the HDCD Model Two, a high-resolution analogue-to-digital converter designed for DVD and CD mastering and that the two companies will collaborate on marketing efforts to continue the growing adoption of HDCD (high-definition-compatible digital) technology. To date, more than 5,000 recordings have sold more than 300m HDCD encoded CDs.

'The Model Two fits into our philosophy of offering the absolute highest quality audio equipment,' said Dave Hansen, vice president of product marketing at Euphonix. 'With the addition of the Model Two, we now offer a powerful end-to-end audio solution for professional recording, mixing and mastering.'

Further, under the agreement, Euphonix is able to apply HDCD technology to future products.

'Euphonix is perfectly positioned to help the recording industry benefit from HDCD technology,' said Dave Fester, general manager of the Digital Media division at Microsoft. 'As a leader in the industry with a strong reputation as innovators of software-based professional audio equipment, Euphonix has the expertise to support the growing demand for HDCD technology among professionals and music lovers.'

Euphonix, US. Tel: +1 650 846 1150.

Islam on the air

Malaysia: A new Islamic radio network has been launched from the Malaysian capital Kuala Lumpur. The station, IKIM FM, is the first Islamic radio station to commence broadcasting in the country, where the majority of the population is Muslim.

The Malaysian government set up the network with the intention of correcting what it sees as an increasing trend towards distorted religious teaching. The M\$12.8m (US\$3.4m) project is being funded entirely by the country's Institute of Islamic Understanding. This is a think tank established in 1992 by Malaysia's Prime Minister, Mahathir Mohamad, with the aim of promoting better understanding of Muslim principles.

A recent study indicated that as a medium of communication, radio has a significantly larger audience than either television or newspapers. But while so far there has been no actual preaching on IKIM FM, there are brief readings from the Koran, four times in an hour. At the same time, the music the station plays is restricted to a mix of Islamic pop songs and secular easy-listening Malay-language tunes. Mid-tempo folk-type songs are interspersed with romantic secular songs with reverent lyrics.

The playlist is vetted by a committee that includes Muslim clerics. Certain artists, like the country's controversial R&B artist, Ning Baizura, are banned, if their religious values are suspect. This female recording artist incurred the wrath of religious leaders last year when, in a magazine interview, she talked of her sexual preferences, along with her taste in undergarments. Station director Johanni Salleh points out that IKIM FM doesn't favour rock songs, and says it won't be playing any rap music. Meanwhile, at weekends, the station broadcasts re-enactments of selected hearings from the local Islamic court, along with chat shows revolving around current issues facing the international Islamic community.

While pointing out that most of the other

CONTRACTS

UAE: Dubai-based UAE Radio & Television has appointed Television Systems Ltd to equip its new transmission installation. The project involves transferring two analogue channels transmitted from two control rooms to a new room that will handle four primary networks using two control positions. The new installation will also handle four 'opt out' services. TSL equipment included static and dynamic UMD's and UMD control system, audio monitoring units and loudspeakers and other manufacturers equipment including a Pro-Bel TX-320 Master control Television Systems, UK. Tel: +44 1628 687200.

Nigeria: Two new studios complete with a central technical area are to be built for Niger State radio stations by UK-based facility design house Megahertz Broadcast Systems. The studios will serve on-air and programme production requirements respectively with both capable of live transmission. The contract follows MBS' construction of TV and radio stations for Nasarawa State and Delta State. MBS, UK. Tel: +44 118 948 4017.



Brazil: Sao Paulo's music recording and DVD authoring facility Mosh Studios has installed a 48-track Fairlight Merlin recorder and 96-input SSL Axiom MT console for a new 5.1 mixing suite, designed by Jeff Sorbes. Since opening earlier this year, the suite has hosted DVD music video projects for the Universal, BMG, Warner Music Group, and Sony Music Entertainment record labels. Owner Oswaldo Malagutti Jr commented, 'In Brazil, the name Fairlight has a very good reputation. It inspires trust in the minds of producers and other clients... I knew that a Fairlight system would bring in business and pay for itself over time.'

nearly 40 radio stations in Malaysia are basically music-based, Salleh maintains that IKIM FM has a better balance, since it includes information and instruction on moral values. Although station officials insist that the station will not be used to air government propaganda, at the launch of the new radio station Prime Minister Mahathir indicated that he hoped it would help correct misconceptions among Malays about the Muslim religion—particularly those he claims are being spread by the fundamentalist Pan-Malaysian Islamic Party, the nation's biggest opposition group. The editor of that party's newspaper, Zulkifli Sulong, sees the opening of the new Islamic radio station as, 'A battle to prove who is more Islamic, and who deserves the support of Muslims in this country.' Even so, it remains to be seen whether the formula for an Islamic radio station will be successful enough to capture the ears of more than a minority of listeners. The Head of Programmes at one of Radio Malaysia's provincial radio stations opined, for instance, 'Nowadays, most radio listeners are youngsters, and they like to hear more pop music rather than listening to people talk and talk. At our station for instance, we broadcast about 60% music, with 40% talk.' The same ratio characterises Malaysia's 23m population—more than 60% are Muslim, with the other 40% made up of Buddhists, Christians and Hindus.

music • studio • graphics • offline • online • sound • DVD • web design

Ever done it in a barn?

The NEW Barn Music Studio with it's acoustic design and sensitive ambience, the perfect Recording Environment, West London with ample parking.

For more information contact Emma Goodall on 01895 834433.

LYNX
post production

"The 88R is absolutely spectacular*"

Nothing compares



LONDON · PARIS · LOS ANGELES · TOKYO · SYDNEY

 Neve

HEAD OFFICE – AMS Neve plc · Billington Road · Burnley · Lancs BB11 5UB · England
+44 (0) 1282 457011

FRANCE – +33 1 34 27 67 53 · GERMANY – +49 61 31 9 42 5220

HOLLYWOOD – +1 (818) 753 8789 · LONDON – +44 (0)20 7916 2828

NEW YORK – +1 (212) 965 1400

e-mail: enquiry@ams-neve.com – <http://www.ams-neve.com>

 SPHERE studios

*Malcolm Atkin
SPHERE STUDIOS, LONDON

CONTRACTS

France: Paris' Dubbing Brothers film and video dubbing studios has undergone a major design and installation project. Directed by Brothers' technical head Frederic Echelard, the Belgian FAR design consultancy was required to deliver highly consistent acoustic conditions at a variety of different listening positions in each room, meeting the challenge with a radical reshaping of the rooms. Dubbing Brothers considers acoustic accuracy and listening consistency essential in its success. Dubbing Brothers, France. Tel: +33 1 4917 5490. FAR, Belgium. Tel: +32 4259 7412.

UK: Van Morrison's private studio, The Wool Hall, is the first UK studio to install an SSL MT Plus console. Originally built



by Tears For Fears, the studio later saw commercial use with the likes of Joni Mitchell, Paul Weller and 808 State, with an SL6056 analogue console. The arrival of the 96-channel desk marks the facility's return to commercial operation, opening in April 2002. Meanwhile, Island Records' London production studio has upgraded its monitoring to a DynaudioAcoustics M3A active system using two Chord 1032 amplifiers and XTA's new 96k digital crossover. The Wool Hall, UK. Tel: +44 1373 830731. Island Records, UK. Tel: +44 8741 1511. SSL, UK. Tel: +44 1865 842118. Unity Audio, UK. Tel: +44 1440 785843.

Californians take Command of DAB

UK: Silicon Valley's digital radio innovator Command Audio is planning to use the UK as a 'testing ground' for rolling out its Personal Radio interactive DAB system into mainland Europe. The move is intended to precede the incorporation of the technology into a single chipset 'designed with mobile applications in mind'.

The news follows the founding earlier this year of Command Audio UK, a joint venture with Capital Radio and UBC Media Group. Although the fledgling company has yet to open its doors officially, it will become 'a Europe-wide base, if not quite a European office' for the roll-out operation, according to marketing director Steve Wallace, who branded the UK 'a bleeding market' for DAB.

'We see the UK as the leading market in the world for DAB,' he explained, dismissing concerns over slow public take-up of the system in the UK as akin to the early limited acceptance of mobile phones. 'Consumers in the UK are innovative,' he insisted, adding that 'the full power of DAB will open up when there's some kind of convergence' between digital broadcasters and the mobile communications industry. 'People like Orange and Vodaphone have already launched audio based services. They want a platform. We have spoken to them,' he said.

The Personal Radio technology—which allows DAB users to select from a wide range of on-demand, interactive programming with accompanying text and image files—was most recently demonstrated at Amsterdam's IBC exhibition in September. However, the system had previously been successfully tested across UK DAB bandwidth in a joint exercise with network provider NTL, described at the time as a 'significant step in making Personal Radio a reality'.

According to Wallace, the months following the tests have been spent 'crystallising relationships in the UK. It's important to have industry leaders on board. Throughout the UK we've been trying to set up all the pieces we need for a great



UK: The BBC's premier radio and concert venue, The Golders Green Hippodrome, has seen a refit of its control room including the installation of a 72-input SSL 9000j console and PMC BB5 XBD monitoring system. The monitors were chosen following their success at the BBC's Maida Vale radio music recording complex. Built in 1913 and home of the BBC Concert Orchestra since 1972, the venue is a regular feature of Radio 3 and Radio 4 broadcasts.

system.' He added, however, that those relationships would not stretch across national borders. 'The partners we're working with in the UK are not necessarily the market leaders in Europe,' he explained. 'For example, in Germany our focus is on building relationships with people like Deutsche Telecom.'

'The problem with digital radio so far is that there's not been anything new or interesting enough to warrant a purchase,' he further reasoned, speculating that the technology's popularity would reach critical mass in three to five years.

Command Audio, US. Tel +1 650 631 6421.

News of IBC Daily

UK: IBC, the event for content creation, management and delivery, has awarded United Business Media's CMP Information a contract to publish the official daily newspaper of IBC for a 3-year period commencing in 2002. *Studio Sound's* sister title *TVBEurope* will drive the editorial content of the new *IBC Daily News*, led by editor-in-chief Fergal Ringrose.

IBC publicity director Michael Crimp said, 'We believe that the *IBC Daily News* is a world-class publication. Competition for the contract was hot but in the end the strength of the editorial proposal from CMP Information gave them the edge. We look forward to them meeting and beating the high standards set so far.'

Steve Haysom, Publisher of CMP Information's Entertainment Technology Europe division commented, 'We are delighted to have this opportunity to work closely with IBC, and believe we can offer a strong media partnership going forward—not just through *TVBEurope*, but also *Studio Sound*, *Content Creation Europe*, *Pro Sound News Europe* and *US*, and *Digital TV* and *Videography* in the US, along with our other group titles. This combined editorial knowledge and newsgathering strength will be at the disposal of the new *IBC Daily News*, under Fergal's direction.'

'In awarding us this contract,' Haysom continued, 'we believe IBC is recognising the editorial excellence and innovation we have achieved in the entertainment content creation, management and delivery space.'

eMonitor

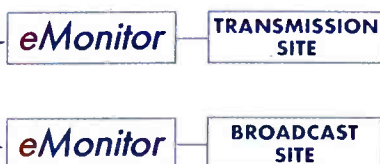
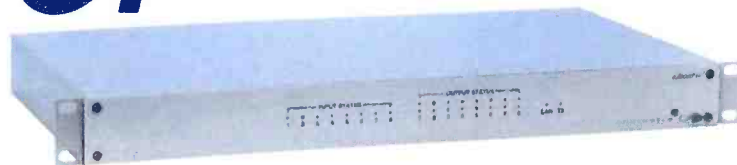

- Remote system monitoring via a web browser
- Automatic email alerts
- Built in Audio Line fail detectors
- Comprehensive logging

The *eMonitor* allows monitoring of remote systems via standard web browsers, enabling you to check on the status of your system and make routing changes from any PC connected to the Internet (or internal LAN/WAN).

AUDIONICS
professional broadcast equipment

PETRE DRIVE, SHEFFIELD S4 7PZ UK
TELEPHONE +44 (0)114 242 2333 FAX +44 (0)114 243 3913
Email emanitor@audionics.co.uk • <http://www.audionics.co.uk>

VariPhrase

elastic audio stretches your creativity



- Sampled audio under MIDI control
- Free V-Producer software for PC / Mac
- WAV, AIFF, AKAI and Roland S class
- Expandable to 138Mb via SIMMS
- 6 separate outputs as standard
- 40 COSM based effects as standard
- 2 x SCSI ports as standard
- 250 Mb ZIP drive as standard
- Digital ins and outs as standard



VariPhrase

**Think of what it should be like,
Instead of how it is.**

Years of neglect, trapped in cramped, restrictive conditions have taken a heavy toll on audio, leaving it tired, inflexible and uninspiring.

The VP-9000 VariPhrase Processor allows you to undo these years of shame by providing independent control of pitch, time, formant and groove - in realtime!

So now, sampled audio keeps its original length no matter which note is played, or if you like, changes its length while maintaining pitch.

Breathe new life into accapellas by making them sing totally new melodies. You can even combine multiple loops of totally different tempo and key in an instant.

Whether you're looking to save time in a busy studio, or just want the impossible, VariPhrase technology breaks down barriers by the bucketload.

But we saved the best till last...

Free with each VP-9000 comes the V-Producer software, for PC and Mac. Giving easy access to the phenomenal power of unrestricted audio, this software works alongside your inspiration, allowing you to bend the laws of sampling physics graphically.

Do the right thing. Liberate audio from captivity!

VP-9000

V-Producer

Intermusica (East Europe) +36-23-511011 Roland Italy +39-02-93778300 Roland Austria +43-512-2644260
 Roland Portugal +351-22-8080060 Roland Benelux +32-14-575811 Roland Scandinavia +45-39-166200
 Roland Espana +34-93-3081000 Roland Switzerland +41-81-9759999 Roland France +33-1-60073500
 Roland UK +44-1792-615020 Roland Germany +49-40-5260090

Roland
 WE DESIGN THE FUTURE

APPOINTMENTS

Fairlight ESP has appointed John Lancken (pictured) to the position of COO. Based in Sydney, Australia, Lancken assumes responsibility for the development and execution of world-wide strategy, product development, marketing and operations. Lancken was previously senior vice president of world-wide sales, CEO of Fairlight USA and director of sales & marketing. Fairlight has also announced Karl Seglins as vice president of marketing, with responsibility for the



development and implementation of marketing communications including public relations, advertising, collateral development, electronic marketing and trade-show and event marketing. Seglins reports directly to John Lancken.

We are honoured that IBC, the World's Electronic Media Event, has chosen the leading international electronic media publishing group to partner for the future.

Business

US: Following US-based **Digigram's** agreement to implement Peak Audio's CobraNet real-time ethernet audio distribution in its products, Digigram is to collaborate with fellow Americans Audio Precision on a special version of AP's Application Note for PC Audio Device Performance Tests, for launch at the New York AES show. A free CD-ROM will be available from AP, and can be used with System Two Cascade or System Two audio analysers. Free seminars on the new software will be conducted at AES. Digigram, Us. Net: www.digigram.com

German-based **Klotz Audio** Interface Systems is opening a French office in October. As a division of the main Klotz corporation, Klotz Cables France will supply products and services for radio/and TV broadcasting, rental, studios, installation, stage and live sound. Claude Blanc will head the French operation reporting to Frederic Kromberg, the company's european sales manager who commented, 'Requests for Klotz' products on the French pro AV market had soared over the last three years, so that opening our own French office was the logical course of action'.

Japan: Audio-Technica's AT4033 Special Edition marks not only the 10th anniversary of its flagship mic but marks a decade in which the Japanese company evolved from high-end hi-fi manufacturer to an established pro-audio brand. Introduced at the 1991 AES show, ten years has seen some 50,000 AT4033s sold world-wide paving the way for their use by such 'names' as Phil Ramone, Ed Cherney and Hugh Padgham and their use, alongside other A-Ts stalwarts at events including the Olympic Games, the Grammy Awards, the Rolling Stones *Bridges to Babylon* tour and the Superbowl. The AT4033 currently enjoys the company of the AT4050 large-diaphragm multi-pattern mic, the AT4060 tube microphone and the AT895 digital array mic system in Audio-Technica's catalogue.



Telos Systems and **Omnia** have named MidiaRadio their Brazilian representative. Rio de Janeiro-based MidiaRadio distributes broadcast products to the country's radio community, including Rio de Janeiro's Tupi Radio Network, Radio y TV Bandeirantes of Porto Alegre, Radio Itatiaia, Minas Gerais and Radio Estudio Reunidos, Pernambuco. Raquel Passos, MidiaRadio sales manager commented, 'After selling various brands of audio processors for years, MidiaRadio found that the processing power and performance of Omnia overshadowed all others. The superb quality and afford-

ability of Omnia processors and Telos codecs and hybrids make them a favourite with Brazilian Broadcasters.'

'MidiaRadio brings with them an intimate understanding of the Latin American broadcasting industry,' added Mary Ann Seidler, international sales director for Telos Systems. Telos Systems, Net: www.telos-systems.com www.midiaradio.com.br

TC-Helicon Vocal Technologies and parent company IVL Technologies have agreed the first license to their IVL Vocal Harmony patents to **Steinberg Media Technologies** for its VoiceMachine VST

FX rentals

ALL OF THE GEAR
ALL OF THE TIME

Digidesign Pro Tools, Prism ADA-8, Apogee AD8000, IZ RADAR 24, Sony PCM3348HR, Mackie HDR 24/96, Tascam MX2424, Mackie HUI, Otari UFC24, Euphonix FC727, Tascam DA98, Alesis ADAT, Tascam DA45, Panasonic SV3800, Studer A827, Otari MTR90, Ampex ATR102, Revov C374, Millennia ST-1, Trident MTA, API 2100, TC System 2000, DACS Freq, and many more!

020 8746 2121
24 hours

www.fxgroup.net



The Audio Toolbox Plus

Can you imagine an audio laboratory in a 20cm x 15cm package? Neither could we, so we made one!

Acoustics

FFT Analyzer (1/12 octave), RTA (1/3 octave), RT60, Energy-Time Graph, SPL Meter, Noise Criteria, Sound Study Graph. Includes octave, 1/3 octave, and A/B/C filters.

Audio Test

Sweep Signal Generator, Stereo Level Meter, Stereo VU/PPM Meter, Frequency Counter, Amplitude & Impedance Sweeps, Distortion Meter, Signal/Noise

System Tools

SMPT/EBU/Film Time Code Reader, Analyzer, and Generator with jam-sync, 2-channel Audio Sample Scope, Speaker & Mic Polarity Tester

Utilities

Headphone Monitor Amplifier, Phantom Power Tester, Cable Tester, User Memory Download, More...

Also available rack-mounted



TerraSonde is distributed by Expotus
www.expotus.co.uk sales@expotus.co.uk
t: +44 (0)1923 252998 f: +44 (0)1923 252978
www.terrasonde.com

NEW TOOLS AT ABBEY ROAD...

Whatever you want in a recording,
You'll always need the best



That's why Abbey Road have equipped their new
Digidesign™ Pro-Tools™ rig with 48 channels of
A/D and D/A conversion by Prism Sound.

The Dream ADA-8:

- Integrated, modular audio A/D and D/A system
- Sampling rates from 32k to 96k including 44.1k and 48k standards
- Built-in 4-curve Prism Sound SNS noise-shaping
- Two digital I/O slots for AES I/O PLUS direct Workstation Interface or other digital format
- 8-channel peak metering switchable between record/play
- Separate stereo monitor output on digital and analogue ports
- Mix to the monitor output from selected channels on record or replay paths
- Simultaneous 2-path operation (e.g. A/D and D/A)
- 1-wire and 2-wire AES operation and format conversion at 96k sampling
- Exploit existing 16-bit MDM's for 24/96 projects with built-in MR-X bit mapping (compatible with Prism Sound MR-2024T)



"At last the ultimate 8 channel converter by Prism delivers exactly what Abbey Road needs. This is a quality box and amazingly versatile. I use the ADA-8 both as a stand alone converter — excellent for surround mixing, and racked-up for hard disk recording. Pro-Tools has never sounded so good! The ADA-8 has a stunning sound and is my first choice converter be it for pop mixing or orchestral recording."

Peter Cobbin - Senior Engineer/Mixer
Abbey Road Studios

Prism Media Products Limited
William James House,
Cowley Road, Cambridge.
CB4 0WX. UK.

Tel: +44 (0)1223 424988
Fax: +44 (0)1223 425023

sales@prismsound.com

Prism Media Products Inc.
21 Pine Street,
Rockaway, N.J.
07866. USA.

Tel: 1-973 983 9577
Fax: 1-973 983 9588

www.prismsound.com

APPOINTMENTS

Telex EVI Germany has appointed Christian Grefl export sales assistant with responsibility for sales and customer support for all Telex brands in west and eastern Europe, Africa and the Middle East. He has spent the last five years as a professional sound technician.

BBC Technology recruited Stephen McKenna to the new post of sales director. McKenna was formerly Sun Microsystems sales director managing media and entertainment technology services and products.

The Rockford Corporation has promoted Rex Whitehead to director of product planning, directing product development for the company's mobile, professional and home theatre divisions. Whitehead will report to president and chief executive officer, Gary Suttle. Whitehead joined Rockford as senior product manager after over 10 years with Pioneer Electronics of North America.

HW International has appointed Saffron Wynn-Jones to head its marketing department. She formerly served with pro-audio reseller LMC Audio Systems as marketing manager.



UK: London's Grand Central post house has purchased an Audient ASP510 surround sound management system to interface with its Digidesign Pro Tools-ProControl rig. The setup is sited in Studio 3a, the music production suite catering for both stereo and 5.1 sound. Technical and financial director Ivor Taylor commented, 'The ASP510 offers a solution for surround monitoring for a mixed stereo, surround and 5.1 setup. It came straight out of the box and it was all there, no hunting for any other parts or interfaces.' Grand Central's clients consist of major advertising agencies and television production companies.

plug-in. Fred Speckeen, CEO and managing director of TC-Helicon commented, 'TC-Helicon's ongoing strategy is to introduce and pioneer such innovative new technologies under the TC-Helicon brand and, once they are established, to license them selectively to other key market segments. We are working to build this new, exciting Voice Processing segment of the market, and truly appreciate the recognition and encouragement we have had from the industry.'

Over the past 18 months, **Klotz** has supplied cables to projects including the Sydney 2000 Olympic Games and the Formula 1 racetrack at Kuala Lumpur. The company's most recent successes are the expansions to Eurodisney Park in Paris, and the Warner Brother Movie World project in Madrid.

UK-based distributor, **Boxer Systems**, has established a new pro-audio systems division, to be headed up by former UK Office sales director Terry Finn. Finn's considerable experience in pro-audio will be brought to bear on Boxer's expanding line of equipment from manufacturers now including Aardvark, Digital Audio Denmark, Millennia, Prism and Z-Systems. Meanwhile, the German **Lawo** operation has taken on international distribution of the Kelkheim-based Alphaton line. Popular with international broadcasters, studios and hire companies, this includes mic and line splitter systems, high-quality DI boxes, and test and measurement equipment for stage and installed systems.

Look for the Logo 





Plugs

- Meets EIA/IEC standards
- Unique plug finger design without rivets
- Sturdy die cast metal shell
- Excellent strain relief
- Unified appearance of metal shell



Original Design - Original Quality

<p>NEUTRIK AG Liechtenstein Tel: +423 237 2424 Fax: +423 232 5393</p>	<p>NEUTRIK (UK) Ltd. Great Britain Tel: +44 1983 811 441 Fax: +44 1983 811 439</p>	<p>NEUTRIK Zürich AG Switzerland Tel: +41 1 736 5010 Fax: +41 1 736 5011</p>	<p>NEUTRIK USA Inc. USA Tel: +1 732 901 9488 Fax: +1 732 901 9608</p>	<p>NEUTRIK Ltd. Tokyo Japan Tel: +81 3 3663 4733 Fax: +81 3 3663 4796</p>	<p>NEUTRIK Vertriebs GmbH Germany/Netherlands Tel: +49 8131 28 080 Fax: +49 8131 28 0830</p>
---	--	--	---	---	--

www.neutrik.com

NEUTRIK
CONNECTING THE WORLD

SOUNDTRACS
DIGITAL
PRODUCTION
CONSOLES

world class - world wide

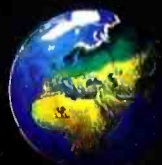

NEW SOUNDTRACS D4

In a complex and demanding World, the transition to the future necessitates serious capital equipment decisions. The digitally inspired future for audio consoles has created unimagined efficiencies and productivity gains. Yet the selection of equipment and lack of standards seems to cause endless anxieties.

With a Soundtracs digital production console it doesn't have to be this way.

By choosing Soundtracs, you enjoy the benefit of an independent manufacturer with 30 years experience and a global reputation for a solid, dependable and proven software system.

Soundtracs Digital: World Class, World-wide.



SOUNDTRACS DPC-II



SOUNDTRACS DS-3



SOUNDTRACS DSM

film and
video post

broadcast production

OB trucks

theatre and auditorium
sound

music production

SOUNDTRACS

Head Office: Soundtracs PLC, The Clock House, 4 Dorking Road, Epsom, Surrey, KT18 7LX, England Tel: +44 (0) 1372 845 600 Fax: +44 (0) 1372 845 656 Email: sales@soundtracs.com
USA West Coast Offices: 844 N Seward Street, Hollywood CA 90038 Tel: +1 323 465 0070 Fax: +1 323 465 0080 Email: soundtracs@fairlightusa.com
USA East Coast Offices: 2 West 45th Street, Suite 605, New York NY 10036 Tel: +1 212 8191289 Fax: +1 212 8190376 Email: soundtracs@fairlightusa.com
Japan Offices: 3-3-11 Ikejiri, Setagaya-Ku, Tokyo 154-0001, Japan Tel: +81 (3) 5432 4151 Fax: +81 (3) 5432 4533 Email: sales@fairlight.co.jp



www.soundtracs.com

PLUS XXX

Paris has claimed the installation of the first AMS Neve 88R in the world. **Zenon Schoepe** visits Plus XXX to report on the reasoning and the business sense

CLAUDE SAHAKIAN'S PLUS XXX complex in Paris enjoys an enviable reputation across the continent. The studio's policy of continual investment allows it to maintain its position at the forefront of the music recording community while a client base that boasts at least half of its producers and engineers as being non-French qualifies it as a truly international operation.

Paris is enjoying an unprecedented level of investment at present, most notably in the film post sector which has seen enormous recent upgrades, but Plus XXX is in the limelight again with the installation of the world's first AMS Neve 88R analogue desk in

facturer long before it ever became public knowledge. It was a situation that allowed the studio to have useful input in to the creation of the desk.

'The biggest problem for any desk manufacturer is understanding how engineers actually use it and how they are likely to want to use it in the future,' explains Plus XXX's technical boffin Olivier Bolling who heads the studio's 'preventative' maintenance department. ('When we buy vintage gear we replace all the components before we put it in the control rooms, we're not in the business of waiting for them to break.')

'We discussed the multitrack returns on the desk, selection of the different speakers and what engineers

very early on following a modification of the VR frame to accommodate them,' continues Bolling. 'In terms of sound, in our opinion this desk sounds better than the 9000J and the VR. We have one VR specialist engineer who has been coming in to this room regularly and he says that the modifications over the VR, while they are small ones, make the 88R sound like a 1073. We've also had a lot of compliments about the dynamics section and there have already been some mixes through where they used a couple of channels of outboard dynamics but everything else has used the desk dynamics. That's unusual in a studio like ours where we have an incredible range of outboard.'

The desk is fitted with the standard 88R mic pres as the optional remoted pres have only just been made available but Plus XXX will be opting for 'at least a couple to start with' in the near future. Studio 1 is used for a mixture of tracking and mixing, like all the rooms at Plus XXX, and is the most expensive room at the facility but Sahakian stresses that the differential is not that great over his 9000J in Studio 2.

'Both rooms have large live areas, the same tape recorders and Pro Tools systems, the only difference is the console,' he says.

Each of the rooms has a 2-inch 24-track, HR DASH (the studio has a total of three), 1/2-inch with SR, five Mix Farm Pro Tools system and Euphonix converters throughout as the result of extensive listening tests at the studio. These are used for conversion to and from MADI to Pro Tools and can also be employed as front ends to the DASH.

'We are very happy with the 88R in all respects,' says Sahakian. 'We love the sound and it's an exciting desk for engineers to use. Software has been an issue but it is always an issue.'

'We did Beta testing on Encore for V and we know the team and the programmers very well and they have been responsive to our suggestions and observations,' continues Bolling. 'The mix tree for passes is now very ergonomic and logical.'

The VR was 72-channel with empty strips—hence the ability to accommodate early 88R strips for testing—while the 88R is 84-channel and Sahakian identifies the matrix and the ability to split the console and its automation as potentially very useful features. Installation was straightforward as there was a fundamental similarity in size between the two desks, the patch was extended well in advance and everything was tested and waiting when the desk arrived.

Acoustically the room has remained unchanged aside from the addition of an extra custom-made ded-



Studio 1—a room affectionately known as the Neve room—where it replaces a VR.

The last time I visited the studio was to report on the acoustic refit and installation of one of the first SSL 9000Js together with multichannel Genelec 1035 configuration in Studio 2, a design that is practically identical to that found in the 88R-equipped room.

Claude Sahakian combines a relaxed and easy going demeanour with a notoriously hard-nosed business sense and it's safe to say that he knows exactly what he wants. A studio owner who has paid his dues as an engineer and producer, he is unusual in also having a background in pro audio manufacturing.

Plus XXX was keen on the idea of the AMS Neve 88R since it first heard the rumours and Sahakian says he had been discussing the desk with the manu-

expect. AMS Neve was receptive and pleased to get the feedback for things like where to install the insert point for the Dolby, for example, because we wanted to insert a digital encoder-decoder for AC-3.'

Monitoring considerations were important for Plus XXX because while its multichannel work has been limited, it wanted to make sure that its new desk was as futureproof in this respect as possible. The studio had custom-built a monitoring panel for its previous VR desk for precisely this purpose but wanted more. Plus XXX claims the central panel's additive solo monitoring is a direct result of its input. Genelec S30s are used as a nearfield 5.1 system and the switching arrangement permits the surrounds and sub to be locked in place while flicking to the large Genelecs on the LCR.

'We were able to test some of the 88R modules

icated sub for 5.1 work which augments the Genelec sub used on the main system.

'It's interesting that we had a slight dip in the room's low-end response with the VR which has evened out since we put the 88R in,' observes Sahakian. 'It seems that the VR was a very expensive bass trap!'

The smaller Studio 3 runs a SSL 4000 with a smaller Pro Tools system but the same complement of machines. 'It's the way we allow people to work,' explains Bolling. 'The main elements are on DASH, the drums are on the 2-inch, the vocals and anything else that needs editing is on Pro Tools and then they mix to 1/2-inch. Nothing is wasted! And we have to make sure that every machine is working to the best of its ability.'

'What we have here are the three most important desks—the 9k, 4k and now the 88R.'

Recent developments include the construction of a small studio with an adjoining recording area in what was accommodation space at the back of the restaurant. Based around MIDI and Pro Tools there are plans to expand it to increase the recording area and Bolling is keen to investigate generic hardware controllers that can span across Steinberg and Emagic packages and not just Pro Tools. Built originally as a room for clients who wanted to concentrate on working to hard disk away from the more expensive main rooms, the new studio has taken on a life of its own and is now also being booked for smaller projects and preproduction work by those keen to enjoy the Plus XXX experience.

With the VR going into Studio 1 in 1993, what then is the life expectancy of the 88R? 'It'll be a long time but it all comes down to the analogue-digital question,' answers Sahakian. 'We know that digital

consoles will eventually replace analogue but nobody really knows when. What I do know is that with a console of this quality it will be in demand for a very long time. The console remains the centre of the whole sound chain, everything has to go through it at some point, and I don't believe that any digital desk can match this desk for sound quality.

'If you're working in postproduction then the convenience of digital is more important than the sonic capacity but we do music recording and mixing here,' he continues. 'I believe that the renewal cycle on digital desks is shorter because the technology is constantly improving so you have to be sure that when you invest you will be able to see your money back fairly quickly.'

What characterises Plus XXX's progress and Sahakian's attitude in particular is the willingness to invest continually. 'We need to be ready to invest, sometimes we don't know in which products or which areas but we are prepared each year to spend money. You have to invest to stay at the front,' he says adding that this is reflected in repeat business.

'In the end we respond to demand from our clients,' he says. 'We have a lot of customers who love the old configuration in Studio 3 with the 4k,

for example, because they are comfortable with it and because they can work quickly and if we changed that desk, perhaps to a digital one, we would lose business in that room. It's important to draw a distinction between the sort of console that works for a producer in his own room and the type of console we require in rooms that can be used by anyone. If we got such a desk we would have to supply an engineer, free of charge of course. That becomes training and that is not our business.'

Contact:

Plus XXX, 37 Rue des Annelets 75019 Paris, France.

Tel: +33 1 4202 2102.

Net: www.plus30.com



Claude Sahakian

Unsurpassed

Red 1: quad mic-pre £1925 +VAT

the above uk dealers hold red products on demonstration.
for a list of dedicated red centres visit our website at www.focusrite.com/reds

Focusrite[®]

www.focusrite.com

red range - the industry reference for analogue signal processing

Auratone 5C Super Sound Cube

In readiness for the forthcoming analysis of the Yamaha NS-10M, *Studio Sound's* 'bench test' loudspeaker reviews continue with the Auratone 5C. **Keith Holland** reports

The reasons for the popularity of Yamaha's NS-10M as a studio monitor will soon become clear. When the results of *Studio Sound's* speaker bench tests were cross-referenced, it became apparent that the NS-10 shared certain significant characteristics with other popular models—specifically the Auratone 5C.

IN THE DAYS PRIOR to the NS-10, the Auratone 5C Sound Cube probably came closer to being adopted as a standard reference monitor than any other loudspeaker. Still in production today, it stands alone in this series of reviews as the only loud-

speaker having a single driver. The 5C consists of a magnetically-shielded, 110mm paper-coned driver mounted in a sealed-back cabinet of external dimensions

165mm wide x 165mm high x 145mm deep.

Fig.1 shows the on-axis frequency response and harmonic distortion for the 5C. The frequency range covered by this loudspeaker is seen to be limited compared with most moni-

tors, with -10dB occurring at about 120Hz and 14kHz. Within this range the response is very ragged, with pronounced peaks at 1200Hz, 7kHz and 12kHz. The harmonic distortion performance is surprisingly good for such a small loudspeaker though, with both the second and third harmonics lying below -40dB (1%) at all frequencies above 120Hz except for a sharp peak in 2nd harmonic to -35dB (3%) at 3.5kHz. Fig.5 shows that at 15° off-axis the peaks in response at 7kHz and 12kHz are reduced in height sufficiently for the response to lie between ± 5 dB limits from 200Hz to 13kHz. This suggests that this loudspeaker should not be pointed directly at the listener's ears, but instead should be used away from the axis. Overall though, the directivity is narrower than most monitor loudspeakers with

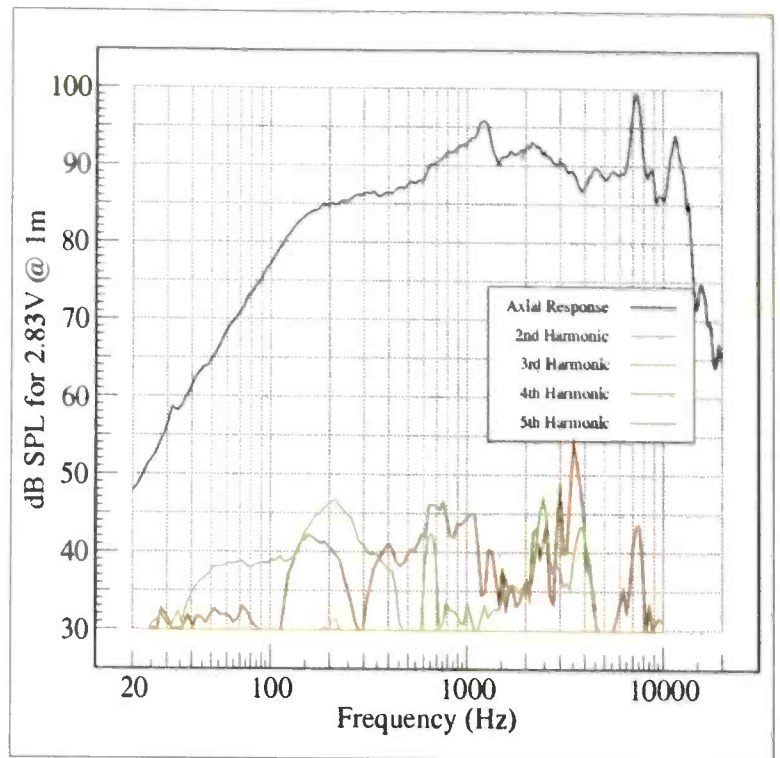

Fig.1: On-axis Frequency Response and Distortion

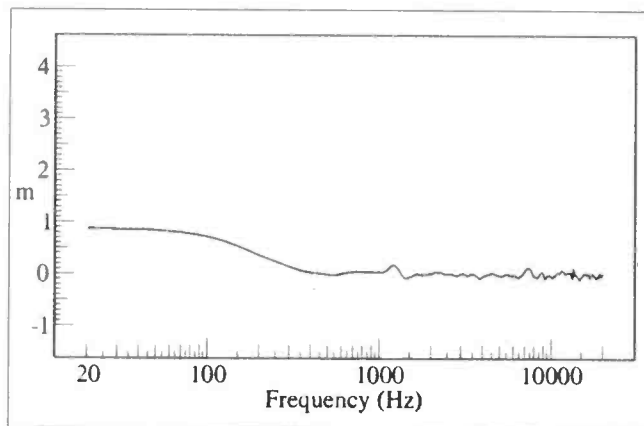

Fig.2: Acoustic Source

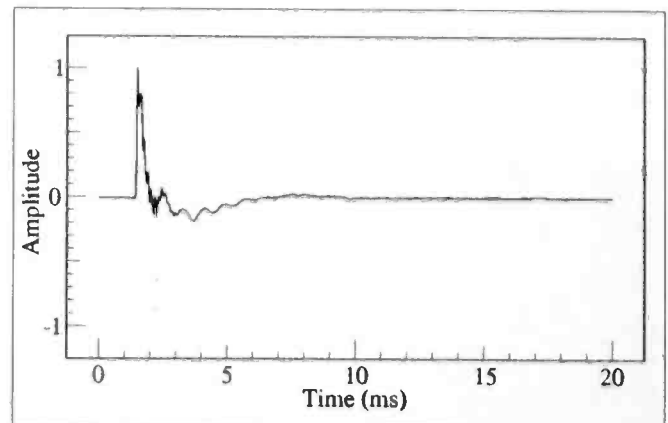

Fig.3: Step Response



VTC console

"There's nothing in its price range to match it."
Chris Tsangarides (Engineer - Gary Moore)

"It sounds absolutely amazing!"
Tom Girling (Engineer - Damon Albarn)

valve technology

There are hundreds of mixers on the market. But none that look, feel or sound like this one. If you're working with digital multitrack recorders, then the award winning VTC console offers something very special - the classic warmth of valves combined with the functional demands of modern music production. Believe us - the VTC simply has no competition!

STUDIO SOUND 2000 WINNER

TL Audio www.tludio.co.uk

TL Audio Limited, Sonic Touch, Icen Court, Icknield Way, Letchworth, Herts SG6 1TN UK
Tel: +44 (0)1462 680888 Fax: +44 (0)1462 680999 email: info@tludio.co.uk

DIGITAL RADIO By Soundcraft

As radio enters the digital age, Soundcraft delivers a powerful, flexible and affordable digital mixing solution that's equally at home in self-operator and large broadcast studios alike.



The new RM1d is available in 6 and 12 fader configurations, and combines years of Soundcraft radio know-how with a sophisticated and comprehensive feature set to bring all the advantages of digital mixing for radio under a familiar and intuitive operating surface.

Unlike other digital radio consoles, you won't find a long list of expensive extras. Total flexibility in input and signal routing, on-board Eq and dynamics, Lexicon effects, sophisticated monitoring and metering – it's all included in the already very competitive price. So for a straightforward, affordable solution to your digital mixing needs, call the radio experts: Soundcraft.

www.soundcraft.com

RM1d
DIGITAL

Soundcraft +44 (0)1707 665000
info@soundcraft.com
Soundcraft US 1-615-360-0471
soundcraft-usa@harman.com

 **Soundcraft**
A Harman International Company

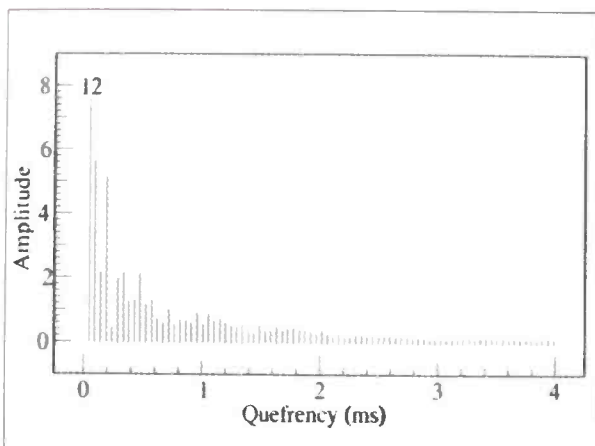

Fig.4: Power Cepstrum

beaming evident at frequencies above 3kHz. Due to the symmetry inherent in the design of this loudspeaker, the vertical and horizontal off-axis responses are identical.

The time domain performance of the Auratone 5C is demonstrated in Figs.2-4 and Fig.6 which show the step response, acoustic source position, power cepstrum and waterfall plots respectively. The step response shows a very clean and rapid rise with no timing problems between the mid- and high-frequency components due to the use of a single driver. The relatively rapid fall after the peak betrays the lack of low-frequency extension however, and the 'jaggedness' of that decay indicates the presence of high-frequency resonances as found in the on-axis frequency response. The acoustic source position is

seen to move a mere 0.8m behind the loudspeaker at low frequencies, which is typical of a sealed-box design with a second-order roll-off. The power cepstrum plot shows the most 'activity' of any loudspeaker tested to date. Note that the vertical scale has been halved in height compared to all the other reviews and yet the early spike still does not fit. This is due to the very rapid fall-off in high-frequency response. The plot also shows a very strong echo after about 190µs with further activity at 340µs and 480µs. These are probably due to

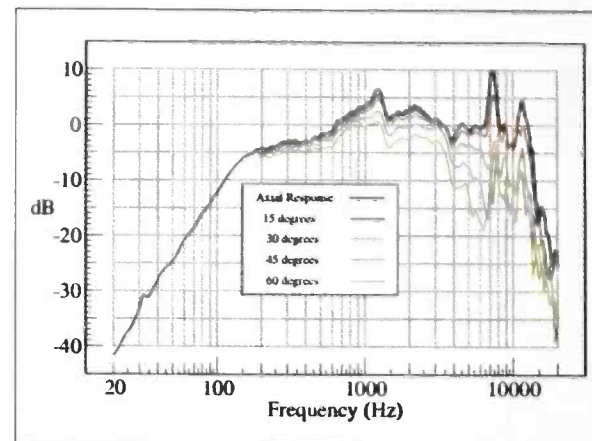

Fig.5: Directivity

SHAPING THE INVISIBLE

WORKING WITH AIR

Engineering, producing or performing - you are shaping invisible sound waves while constantly relating to what you hear. With AIR series we have taken a giant step forward in monitor performance. Combining science from Dynaudio Acoustics and TC Electronic, the AIR series redefines Monitoring by allowing precision alignment of monitors according to placement and application. Networking finally makes Central control of a 5.1 system possible.

Proprietary Dynaudio driver technology combined with innovative high-resolution precision filtering and time alignment technology from TC Electronic, made it possible for our engineers to take AIR performance way above what is known from conventional speaker technology. The AIR series deliver previously unheard precision and transparency.

Don't take our word for it, trust your ears, work with AIR and shape the invisible...

AIR
SERIES



- Central control from a dedicated remote
 - Solo and Mute on each channel
 - Level control - Preset recall
 - Bass management and more...
- Extensive control from PC/MAC software (optional)



- Bass Management with selectable crossover points
- Acoustic Placement Compensation
 - Preset Storage and Recall
- Programmable reference levels
- Level alignment in 0,1dB steps
- Bi-amplified, 2x200 watts

Leonardo da Vinci was among the first to use science to enhance his art. Being a musician, he also applied his genius to define the phenomenon of sound:
"Figurazione dell'invisibile - Shaping the invisible."

dynaudio acoustics
IF IT'S THERE - YOU'LL KNOW IT

TC ELECTRONIC A/S DENMARK • Ø + 45 8742 7000
TC ELECTRONIC UK • FREE ☎ 0800 917 8926 • FREE [FAX] 0800 917 6510
WWW.DYNAUDIOACOUSTICS.COM

Arrange a demo in your facility

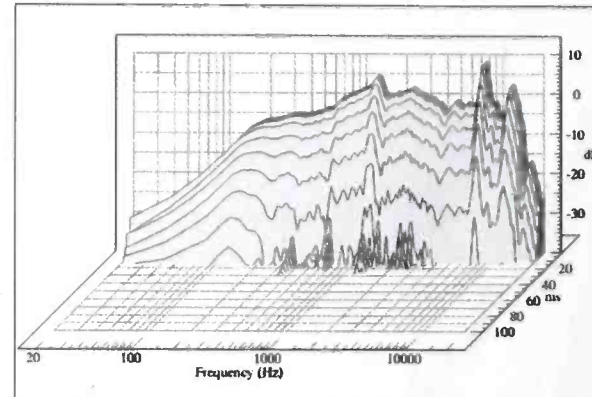

Fig.6: Waterfall

diaphragm-surround resonance problems. The waterfall plot shows a very rapid decay at low frequencies and only minor evidence of mid-range ringing. The high-frequency response peaks are seen to decay at around the same rate as the rest of the response.

The Auratone 5C is quite unlike any other loudspeaker in this series. The use of a single, relatively small driver in a small, sealed cabinet means that there will inevitably be some compromise in performance at both frequency extremes. The low-frequency extension is limited, although the harmonic distortion performance in this frequency range is acceptable, and the high-frequency response suffers from some fairly severe peaks, and quite narrow beaming. The mid-range performance does not suffer some of the problems associated with multiple driver systems however, which may endow the Auratone with a relatively 'clear' mid-range sound. Despite its lack of a 'hi-fi' specification, the Auratone has proved itself over time to be a valuable monitoring tool, but not, presumably, in situations where a wide bandwidth and smooth response are required. □

Methodology

Studio Sound, April, page 14.

Net: www.studio-sound.com/archive/apr98/r-tannoy.html

Realize Your DREAM

Introducing DREAM by Fairlight — Digital Recording, Editing And Mixing — a radically new suite of modular digital production and post-production systems heralding the dawn of a new era in digital audio for all film, video and multimedia applications. Compatible with Fairlight's widely acclaimed audio platforms and featuring the world-beating QDC Technology engine at its core, the DREAM family delivers higher performance, greater system integration and lower cost of ownership. Fairlight's revolutionary new editing model, the Binnacle™, is at the heart of all DREAM products, delivering a quantum leap in editing speed whilst retaining simplicity and ease of use. Binnacle™ (named after the housing of a ship's compass) presents a simple, structured approach to the editing process so you spend much less time driving the workstation and more time creating with it.

Designed to work as a team or independently, DREAM systems deliver 24-bit, 96kHz performance in multiple multi-channel, multi-format configurations and are all MediaLink networking ready. Furthermore, Fairlight's DREAM systems are based on an expandable open-architecture framework that can grow with your business.

DREAM Satellite

DREAM Satellite is Fairlight's new digital audio workstation, engineered to streamline and simplify the processes of audio acquisition, editing and track laying to a degree previously unobtainable. Expanding on the intuitive operation and ease of use of Fairlight's MFX generation, DREAM Satellite offers up to 48 tracks of pristine 24-bit, 96kHz digital audio quality. Designed for use with a studio's existing analog or digital mixer, DREAM Satellite is available in 16, 32 and 48 track configurations with a choice of analog and/or digital inputs and outputs.

DREAM Station

DREAM Station is a comprehensive digital audio recording, editing and mixing environment, capable of delivering final mixes in any format up to 7.1 surround. Station incorporates all the functionality of a 48-track Satellite integrated into a full specification, fully automated 56/16 mixing system. With third-party plug-ins rounding out the effects processing capability, and all the bussing, sub-bussing and monitoring facilities required for a vast array of post-production tasks, DREAM Station is all a studio needs for full production and mixing of the majority of short form, commercials and radio projects. Station may be further expanded with optional Sidecar bays in blocks of 8 faders and external metering options are available to enhance the high-precision on-screen meters.

DREAM Console

Representing the peak of performance for full-scale recording, editing, production and mixing of the most complex multi-format audio projects, DREAM Console is not simply a powerful mixing system but a complete recording and editing environment equipped with the degree of functionality and processing found only in dedicated large-format digital consoles. A fully configured DREAM Console offers 48 tracks of Binnacle™ editing seamlessly integrated with 192 channels returned to 48 mix busses, with 6-band EQ and filtering and two stage dynamics processing on 96 of these inputs, plus 48 returns with 2-band EQ, and 48 short fader paths that can share EQ and Dynamics with their associated full channels. The bus structure of the DREAM Console has been expressly designed for multi-format projects for the simultaneous generation of multiple, multi-channel formats up to 7.1 with individual level trims for each independent mix. The extensive automation system encompasses every parameter of every onboard function, including processing, routing and third-party plug-ins. With the same recording, editing and mixing capabilities as DREAM Station, but on a much larger scale, the DREAM Console delivers resources which have been hitherto unavailable on any system, at any price, and puts them within reach of any facility aiming at serious production and mixing work.

www.fairlight.net

Call (020) 7267-3323

fairlight
DIGITAL AUDIO WORKSTATIONS

Ronald Prent

on EMTEC tape

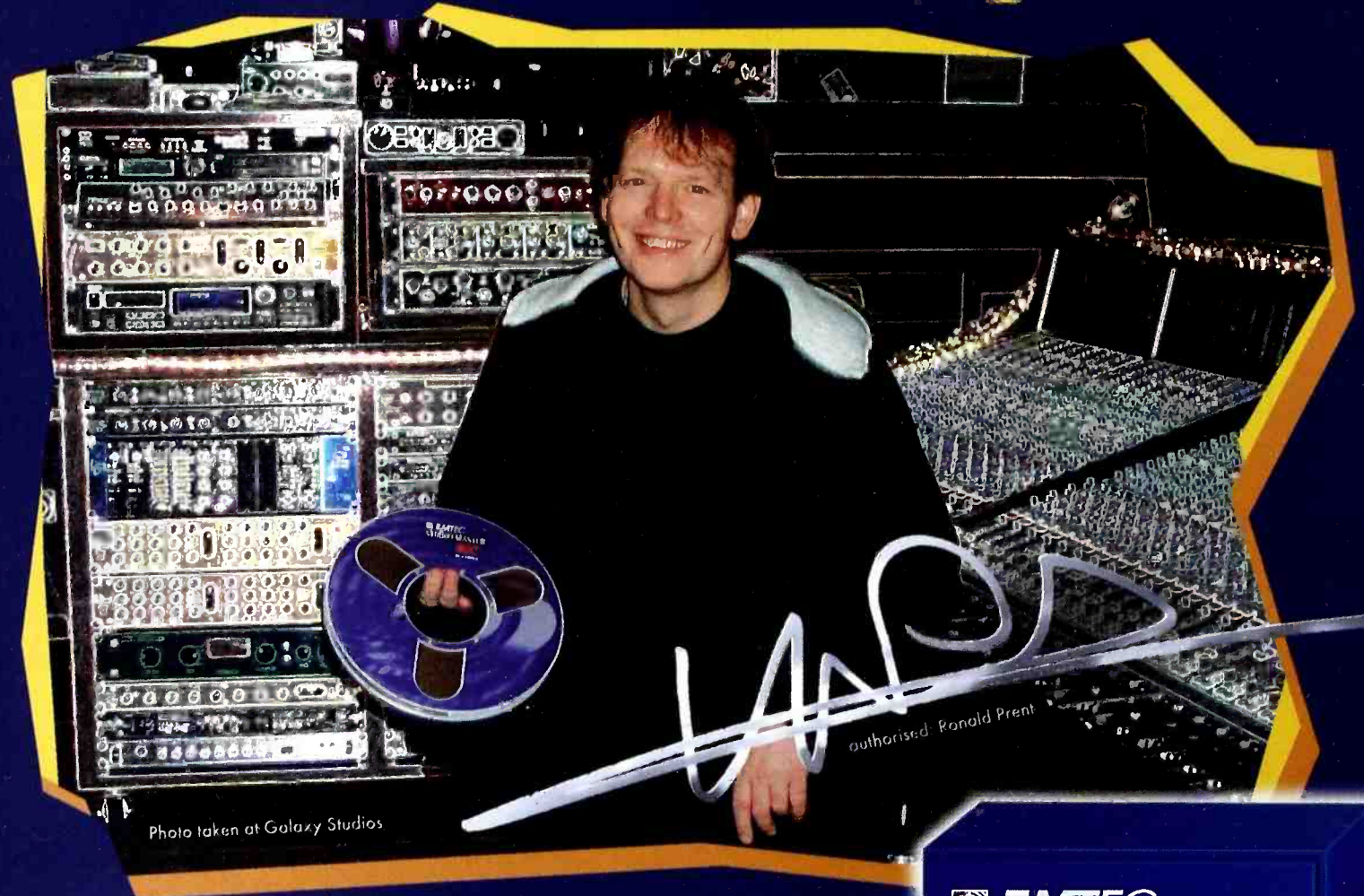

"If the choice is left to me,
I use **EMTEC Studio Master 900 maxima**. It is such a high-class analogue tape that I could not find a better one even after comparing several tapes with it. You get a super performance from **EMTEC Studio Master 900 maxima** even when you push up the level. The clarity is phenomenal. The little bit of noise that does come off the tape is much warmer and not offensive at all, making the tape very musical and punchy. I don't use anything else now."

Ronald Prent has had success as a recording engineer working with such artists as David Bowie, Police, Elton John, Def Leppard, Iron Maiden, Peter Maffay, Jule Neigel and Fury in the Slaughterhouse. He has also mixed award winning albums for Guano Apes, Kane, Rammstein, Pur and Scorpions.

EMTEC Magnetics GmbH
European Multimedia Technologies

Kaiser-Wilhelm-Strasse 52
67059 Ludwigshafen, Germany

For more information please contact:
UK: Ian Armstrong, Tel.: 07990/546903
ian.armstrong@emtec-group.com
Intl: James Rattray, Tel: +49(0)621/5920-366
james.rattray@emtec-group.com



www.emtec-group.com

 **EMTEC**
PROFESSIONAL MEDIA

Terrasonde Audio Toolbox Plus

With a tougher case and expanded software, Terrasonde's audio test set meets professional users on their own turf. **Andy Day** sounds it out

TO MY MIND the original Audio Toolbox did it all. Apart from the construction—a plastic box—Terrasonde's tester had all the standard audio utilities plus some really innovative tools and a very cool user interface. Well, in the 18 months or so since the first model appeared, a new version has arrived—a professional Plus version aimed at studio designers and contractors weighing in at UK£1,250.

My main criticism of the original Toolbox was over its lightweight construction; this has gone from one extreme to the other and it is now a bulletproof lump of metal. There can certainly be no criticism of the casing, it must be the most rugged of all the pieces of test gear out there.

Although American the unit comes in a suitcase package reminiscent of seventies cult British children's television series *Joe 90*, designed specifically to take the toolbox, AC power adaptor, the supplied high-quality detachable microphone and possibly a change of underwear if needed. Connections on the Plus Toolbox are the same as earlier, with provision for RCA, XLR-jack, microphone, MIDI in-out and headphones, allowing every type of cable test and access to the more advanced test functions. The new test features are a function



of a software upgrade that is also available for the original Toolbox too. For anyone unfamiliar with the original here are the test functions available in their relevant categories.

Acoustic analysis (room setup): Sound level meter (generally known as an SPL meter), LEQ measurement (a new function allowing measurement of the time average sound level), real-time analyser (RTA), reverb decay time (RT60), room noise measurement and sound study graph (average SPL over time).

Test functions (equipment evaluation and testing): Signal generator, Level-Frequency meter,

NEW TECHNOLOGIES

Studer's surround can

The Studer BRS processor allows the reproduction of surround and stereo audio signals—including the control room's acoustics—over headphones. The monitoring device allows the reproduction of loudspeaker position and the acoustics of a defined room over standard headphones. The system consists of the BRS processor with the measured data of the preferred rooms loaded. One version of the system is used with standard headphones while a second includes a headphone set with headtracker.

The BRS processor uses measured data from existing rooms with their loudspeaker systems, including the direct and early reflections and reverberation.

Room scanning measurements are a service Studer representatives provide using a dummy-head at the optimum listening position and BRS software.

In use, the listener plugs headtracking headphones into the processor and feeds the audio signal (stereo, surround, 5.1) into the BRS unit and chooses the desired room.

Studer, Switzerland. Tel: +41 1 870 7536.

Alpha 100 v1.9

Calrec Audio has announced v1.9 software for its Alpha 100 digital console, which provides 5.1 surround sound on all four main outputs and comprehensive monitoring and metering facilities for all elements in the surround mix. v1.9 also provides user-definable channel isolate facilities on snapshot memory recalls, multiple outputs, VCA grouping and enhanced dynamics.

Calrec, UK. Tel: +44 1422 842159.

Still compromising
with a 'standard' Cardioid?

TYPE 4011 CARDIOID MICROPHONE

Award winning technical performance

Highest SPL handling

Widest frequency range

and much, much more...

Never compromise on quality, visit dpamicrophones.com

DPA
MICROPHONES

www.dpamicrophones.com

Gydevang 44, DK-3450 Allerød, Denmark
Tel: +45 48 14 28 28, Fax: +45 48 14 27 00
Email: info@dpamicrophones.com

NEW TECHNOLOGIES

Logic 7 launched

AMS Neve launched the Logic 7 digital desk at Interbee in Tokyo as the 'spiritual' successor to the Logic 2. The Logic 7 features power from the DFC together with



multitrack music capability and 24–96 operation. The desk is presented in a strip design with local routing, display and bank selection that the company says will be familiar to Logic 2 and DFC users and offers 500 processing paths at 48kHz and 250 paths at 96kHz from a single engine. Encore automation provides compatibility with DFC, 88R, and Libra automation and Logic 1, 2, and 3 automation interchange and the desk is WorkFlow networkable. Other features include multimachine synchronisation, multichannel surround capability and DFC style monitoring. AMS Neve, UK. Tel: +44 01282 457011.

High-speed editor

US manufacturer 360 Systems has released the Short/cut 2000 high-speed model of the Short/cut editing system. The new product performs all editing operations faster

signal-to-noise-ratio, frequency sweeps and distortion meter (THD).

System Tools (for sessions): polarity tester (for speakers, mics and audio equipment), MIDI helper (to monitor activity on a MIDI line or remap MIDI information), MIDI transmit (for testing MIDI setups), time code analysis, reading and regeneration, and sample scope (a basic oscilloscope for checking word and video sync waveforms).

Utilities (anything else you think they may have forgotten): monitor amplifier, cable testing, phantom power testing and unit calibration.

It's quite a comprehensive list, however as this unit is aimed at the contractor market, some of the software features of the original have been dropped, notably the audio-to-MIDI timing tools, guitar preamp, tuner, hum canceller and the retro *Pong* game. This is a shame but not the end of the world, as you can download the old version of software if you really need the missing facilities.

I don't have enough space to go into each of the supplied tests in detail, but you can take it for granted they are all professional quality and fully customisable. The user interface is great and by clever use of a single dial and push control, selecting menus is easy. I used the RTA to set up my 5.1 mix room by generating pink noise from the Toolbox and taking measurements with the RTA, and then using the SPL meter to set absolute levels for all the speakers. You can also store responses in memory and download them to a Mac or PC for printing. This is a great feature for professional studio designers and cinema installers. Another interesting test for any studio is to check polarity from mic to speaker, particularly if you have digital equipment—you

may be surprised by what you find...

If you have occasional digital clicks or glitches when connecting equipment together digitally then the Sample Scope feature may give you some clues as to which piece of equipment is causing the problem. A common cause is unstable clock sources or clocks with jitter—cheap DAT machines for example.

If you work in postproduction, the most useful everyday function of the Toolbox must be the time code regen-analysis features. Normally you would have to buy a dedicated unit for this, but the Toolbox allows time code reshaping or jam syncing (with or without offset) and is a quick and easy way to see if you have good or bad time code on a tape (I'm talking to you Digibeta...)

The new Plus version of the Toolbox is a great improvement and is ideal for professional studio designers and cinema installers. The new construction certainly puts the Toolbox up there with the Abacus, Audio Precision, Lindos and Ivys of the world. Include the extra practical studio tools and it really is in a class of its own. Despite the boring image that test equipment conjures up, with the rapid increase in 5.1 audio studios, all-digital installations and audio post studios, the Toolbox is a useful and unique way to kill several birds with a solid metal box. □

Contact:

Terrasonde, US.
Tel: +1 303 545 5848. **Fax:** +1 303 545 6066.
Net: www.terrasonde.com
Rocky Road, UK.,
Tel: +44 1494 535333. **Fax:** +44 1494 535357.
Expotus, Europe. Tel: +44 1923 252998.

A NEW STANDARD IN PROFESSIONAL PATCHING



Manufactured in the UK by:

IS TRACK

21A Hankinson Road, Bournemouth, BH9 1HJ, UK
 Tel: +44 (0)1202 247000 Fax: +44 (0)1202 247001

- ▶ Two rows of 48 Bantam Jacks In a 1U panel
- ▶ Enclosed Jack keeps out dust and dirt
- ▶ 25 way D-sub or solder rear termination
- ▶ Half and full normalling on all channels
- ▶ Standard, gold or palladium contacts
- ▶ Suitable for balanced and unbalanced signals
- ▶ Lacing bar available for extra cable support
- ▶ Neat slide-in strips for socket designation
- ▶ Suitable for insert points without special leads

Signex
PRO AUDIO PRODUCTS

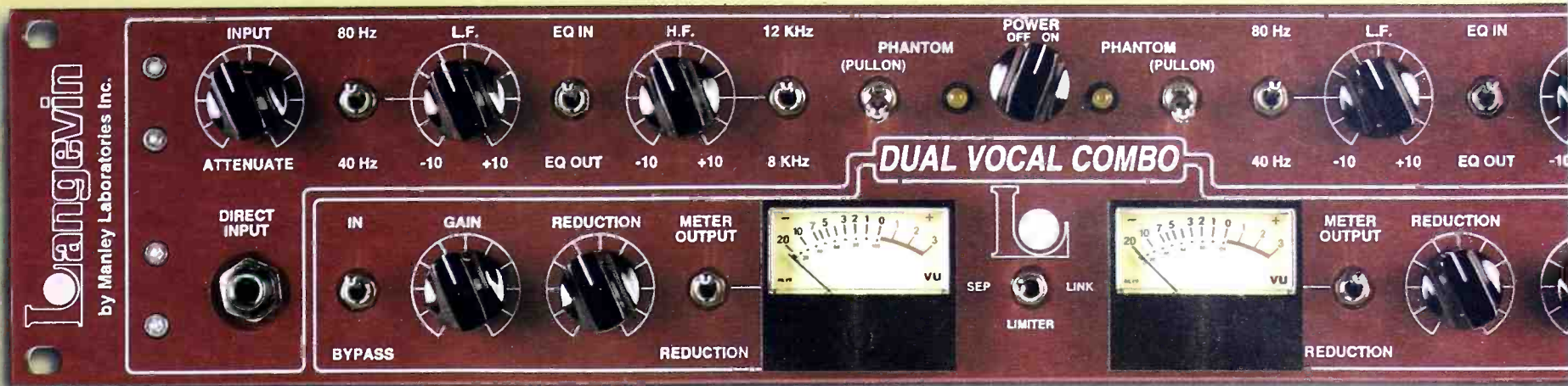

Langevin

DUAL VOCAL COMBO

STEREO MICPRE • DI • EQ • ELOP LIMITER
 BY MANLEY LABORATORIES, INC.

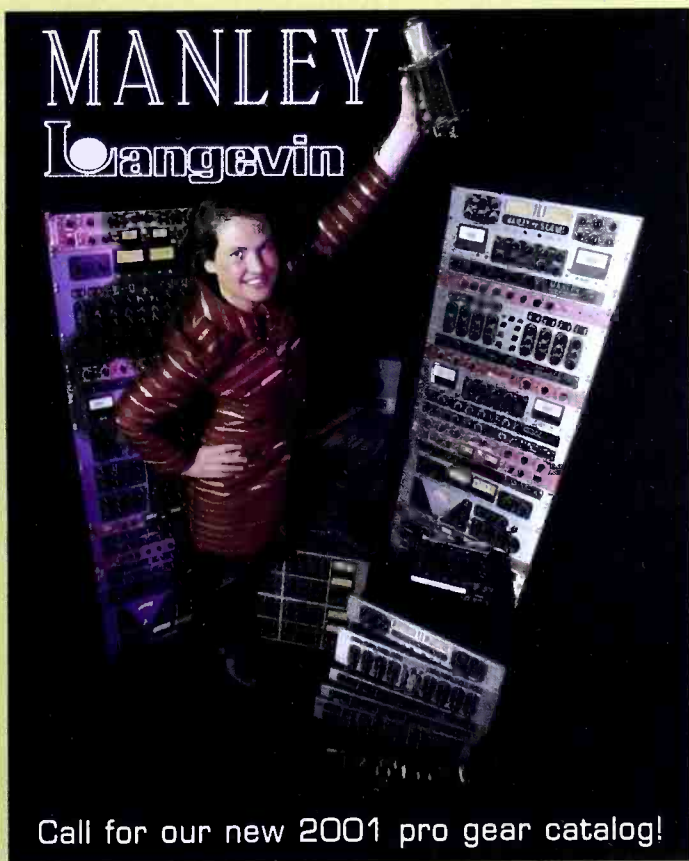

The Langevin Dual Vocal Combo is a 2 channel microphone preamplifier with 2 shelf equalizers plus 2 channels of electro-optical limiters. Full-on STEREO, baby!

This combo is the result of suggestions from our customers to combine two of our most popular Langevin products and make the price irresistible, half the price of the Voxbox in fact, for 2 channels of great sounding all-discrete channel strips. Sound interesting?

The DVC includes real VU meters, individual phantom power, limiter linking, and time proven circuitry. This is an ideal box for musicians and engineers on a budget and is equally at home in a big league studio, mobile recording truck, or live gig. It has the reliability, functionality, and the sound without the any of the complexity- the essential features without the "sea of knobs." Easy on the wallet, easy to love.

Built with precision and pride by:

Manley Laboratories, Inc.

13880 Magnolia Ave. Chino, CA. 91710 USA

tel: (909) 627-4256 fax: (909) 628-2482

→ www.manleylabs.com ←



NEW TECHNOLOGIES

than the original recorder-editor. Processing speed for internal functions has also been enhanced resulting in fast file loading, file saving and mapping of audio clips. 360 Systems has a series of upgrade kits so previous owners can upgrade to Short/cut 2000. The kits include new software, hardware and a revised operations manual. 360 Systems, US. Tel: +1 818 991 0360.

Shure KSM27 cardioid mic

Shure's KSM27 large diaphragm side address cardioid mic has a claimed response of 20Hz-20kHz. It uses a class-A transformerless preamp. 1-inch ultra-thin

Mylar diaphragm and an internal shockmount. The zinc diecast housing includes a hardened steel grille and accessories include a velveteen pouch and rubber isolated external locking shockmount. Price is US\$575. Shure, Germany. Tel: +49 71 3172140.



MindPrint T-Comp

As sharply priced as they are sharply styled MindPrint's outboard demands attention outside its native Germany. The T-Comp stereo compressor has **George Shilling's** ear

MINDPRINT SPECIALISES in the current vogue of input devices largely prompted by the rise in popularity of modular digital multitracks. The MindPrint line includes the EnVoice voice channel (*Studio Sound*, March 1999) and AN/DI Pro (*Studio Sound*, April 2001). T-Comp, however is a stereo valve compressor...

T-Comp is remarkably compact for a tube device, and oddly there are no vents or holes anywhere in the case. One of the two ECC83 valves is visible, mounted sideways behind a small glass panel in the front (as with the EnVoice), with the other just behind it. The case gets warm, but never completely roasts. Internal construction reveals precise German engineering to fit an abundance of components into this medium-sized 1U-high case—the valves appear almost impossible to remove, with little space beside their tops. The large torroidal transformer is encased with a heatsink. Most circuitry is on one board, including a couple of heat-sunk transistors, with a smaller board mounted above for front panel items including the meters. There is a hole in the circuit board and a blanked space at the back where the optional DI-MOD digital interface board goes—I didn't have one, but for the record, this features SPDIF phonos and can run at up to 48kHz at 24 bits. Rear panel analogue connectors are balanced jacks and

XLRs, the inputs being of the combi-type, with TRS sidechain insert jacks also provided, along with a ground lift switch and IEC mains socket.

The front panel has two layers: the painted panel has holes cut to reveal a chrome face around knobs and meters. The small, very slightly damped knobs are easy to operate, and the gain reduction meters are excellent. The smaller meters can be switched to show input or output levels, useful for showing signal present. A pushbutton is provided to switch to the digital input (if fitted). The INPUT and OUTPUT gain knobs are legended 0-8, both ranging from off to approximately 10dB gain, with unity coming at around 5 or 6 on the legending. The OUTPUT knob only operates when the COMP ON button is in. There is a similarly legended TUBE SAT knob which we will come to, followed by more conventionally-calibrated compressor controls for Threshold (+2 to -28dB), Ratio (1:1 to 1:Infinity, with 1:3.5 halfway), Attack (0.1ms-150ms) and Release (5ms-2000ms). When the central LINK button is activated, these four controls on Channel B are disabled. The FILTER button activates a sidechain high-pass filter set at around 300Hz, whilst the ADAPTIVE button activates an intelligent Auto mode for attack and release, although the controls for these settings remain active.

Despite the name, T-Comp is actually a VCA-

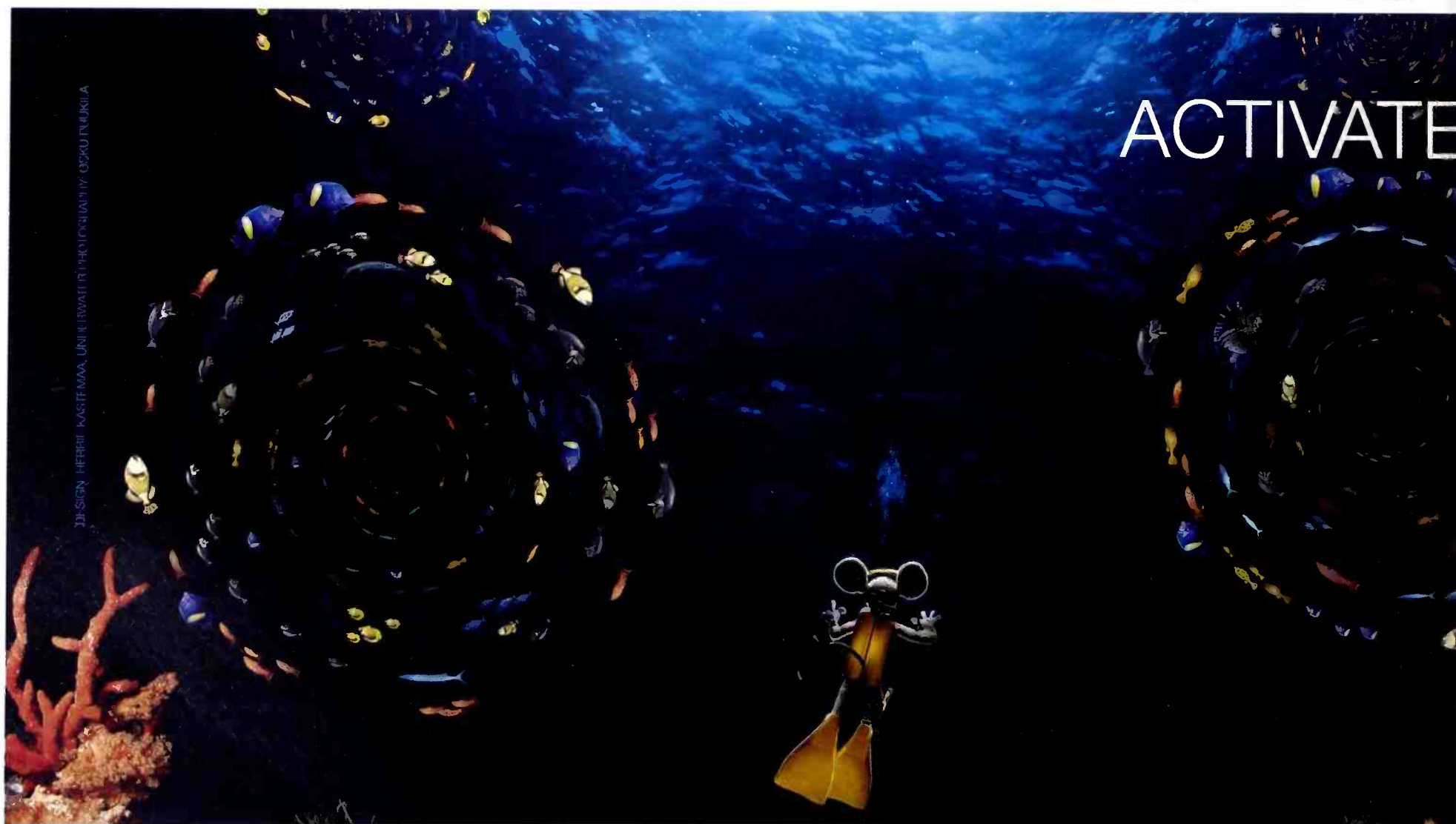

controlled compressor, with tube circuitry incorporated to add colour. The compressor section is very flexible, with a good range of settings available. Both attack and release can be set to extremely fast settings, although without the ADAPTIVE button in, the release won't run really long. The Adaptive circuit is very

some slight distortion. This was nothing special, and actually lowers the output level slightly, making the effect particularly unspectacular. There is some interaction between this feature and the amount of compression, but I found the character undesirable in most situations. This gentle distortion is also achievable



good indeed, giving a variable attack and release while still allowing the settings to be tuned. The release setting in particular varies widely, and a cleverly designed circuit retains the character of the original signal's transient attack. The overall compression character is fairly invisible, especially in Adaptive mode—but even without this function, you must have the front panel's LEDs blazing to get it really pumping. The filter circuit is an excellent idea, much like the Thrust circuit on the vastly more expensive API 2500 bus compressor. Useful especially across music mixes, it allows a pounding low-end to remain solid even when applying heavy compression to a track, and can really add excitement. Full (Deutsch) marks to MindPrint for this feature. The T-Comp was also a particularly worthy performer with a bass guitar signal, and with slower settings worked very well on vocals.

The TUBE SAT knob adjusts the drive of the Tubes and the Compressor On LED changes from green through yellow to red as the knob is turned clockwise. The effect is subtle until the knob is quite high, then one begins to perceive a slight dulling of the sound, and

by overloading the input. The maximum output level and input headroom are low compared to more expensive units, but at least the overload distortion has a relatively gentle onset, and the unit is quiet.

This is not a true 'valve' compressor; sonically, the TUBE SAT knob is the least appealing feature. But Adaptive mode and the sidechain filter make this a useful stereo compressor which works well with mixes and many solo instruments, especially if you like unobtrusive and fast compression—it can sound subtle, even with quite a few LEDs lit on gain reduction meters. The manual is poorly translated and unnecessarily patronising, but the T-Comp is easy to use, with plenty of LEDs showing status and levels. Well worth the asking price, this is an excellent entry-level compressor. □

Contact:

MindPrint. Germany.
Tel: +49 6851 9050. **Fax:** +49 6851 905200.
Sennheiser. UK.
Tel: +44 1494 551551. **Fax:** +44 1494 551549.

NEW TECHNOLOGIES

Blue Baby Bottle

Blue Microphones has released the Baby Bottle as its most affordable microphone to date at US\$649.99. The Class A discrete condenser features a 'lollipop' spherical grille with a gold sputtered diaphragm for a cardioid pattern. It comes in a cherrywood case. Blue Microphones, US. Tel: +1 805 370 1599.

New Microns

New models in the Micron 700 Series wireless microphone systems include the TX700 belt pack transmitter, TX703 hand-held transmitter, SDR770 small diversity receiver and MR700 monitoring receiver. All feature tough but lightweight one-piece aluminium cases with quick-access battery compartments. Available with a choice of switching bandwidths to suit individual applications, and with up to 100 frequencies, the 700 Series now includes a 32-frequency entry-level system—comprising a matching TX700 transmitter and SDR770 receiver—that is said to set a new, competitive price-point standard for high-end wireless audio. The Micron MDR762 twin diversity receiver is a mains-powered 1U rackmounting system incorporating two audio channels, and aimed at small studios and OB applications. Audio Engineering, UK. Tel: +44 20 8341 3500.

Wendt ENG Location Mixers

New from Wendt is the X5 5-channel stereo ENG location mixer targeted at multicamera and multiwireless setups. With a choice of vu or PPM metering and a choice of protective cases and output cables, the unit weighs 4.5lbs including case and batteries. The new

YOUR

BYTES



Genelec S30D and 2029B - the two Digital Monitoring Systems which match the sophistication and performance of the finest digital studio equipment, combined with an unparalleled ease of use. When you need a powerful full bandwidth nearfield monitor from 35 Hz to 50 kHz, then your choice is the S30D, and for precision closefield monitoring, the 2029B is the one. With both you have 96 kHz/24 Bit digital interface with AES/EBU connectors. And analog as well, of course. Activate yourself and visit our website: www.genelec.com to learn more about about your digital future.



GENELEC®
 ACTIVE MONITORING
 The Whole Truth And Nothing But The Truth

www.genelec.com

International enquiries: Genelec Oy, Olvitie 5, FIN-74100, Iisalmi, Finland, Phone +358-17-83881, Fax +358-17-812267
 In the U.S. please contact Genelec, Inc., 7 Tech Circle, Natick, MA 01760 Phone 508/652-0900, Fax 508/652-0909, Web: www.genelec.com

CLM Dynamics DB8000s

Offering flexible interfacing as well as quality amplification, CLM's 8-channel mic preamp package is perfectly pitched for MDM users, says **Dave Foister**

ONE SHORTCOMING OF a lot of '8-pack' products is the relative difficulty of interfacing them with their intended partners.

A box of eight mic preamps with eight output XLRs on the back needs a flail in one of various flavours to plug it up to an ADAT or DTRS machine, or anything else for that matter as few 8-track recorders have space for XLR inputs. The trouble is that unless you find room for multiple multiways, one or more of which will always be redundant, you have to dedicate your box to one particular family of recorders. American-based Audio Toys did it with the 8MX2, an amazingly useful and well thought out preamp-mixer box for Tascam machines. Now Scottish-based CLM Dynamics has gone one better connector-wise with a dedicated Tascam 25-pin as well as individual output sockets. This is the DB8000s, a logical development from the company's previous 2-channel and 4-channel offerings.

In fact there's a forest of output sockets on the back of this unusually big (3U-high) box, because each preamp has a total of four outputs: one to the Tascam connector, one on an XLR, and two more on balanced jacks giving additional buffered feeds for monitor and broadcast needs. This built-in DA capability is an important bonus that opens up even more potential for the package.

The circuits themselves are simple but have all the necessary facilities, and one or two more besides. They're controlled from a smart front panel that replaces the military green of early CLM designs with bright colours and distinctive rounded silver knobs. Each channel has the expected complement of controls for coarse and fine gain, phantom power, a 20dB pad and phase reverse, plus a low cut filter rolling off 12dB/octave below 80Hz. All the pushbutton switches have associated indicator LEDs, and the main gain control is switched in 4dB steps with a trim variable from -14dB to +6dB, allowing plenty of scope. There's a big LED meter to show output level, with an extra blue LED at the top to show the operation of a useful additional feature that we'll come to in a minute.

Round the back, each channel has two inputs: one for microphones on XLR and the instrument input that others might put on the front on a 2-pole jack. The discrete outputs are below these, the main being switchable between +4dB and -10dB on an XLR while the other independent feeds are fixed at +4 on TRS jacks. The immediate potential (no pun intended) problem of hum loops is dealt with initially by a global earth lift switch that places a 10Ω resistor between the XLR screens and mains earth; more intransigent problems can be sorted out with internal jumpers.

A particular enthusiasm of CLM is building in

provision for M-S working to an otherwise straightforward set of preamps. This is carried over big time into the DB8000s, on which each adjacent pair of channels can be used as an M-S decoder (or indeed encoder, as the processes are identical). As ever, the manual contains a good explanation of how the technique works, and of course with so many channels it's easy to rig a conventional stereo pair, convert it to M-S with one pair and back again with another, creating a very useable width control, a procedure again described very comprehensively in the paperwork.

The extra feature is a useful limiter, but since we can't use such obvious terms it's called SoftStop. This reflects its slight soft-knee characteristic that intro-

duces gentle compression a few dB below the chosen threshold. Its calibration is on a continuously variable pot that runs from -6dB to +24dB, and unlike some such circuits it can be switched out completely. With a view to stereo pairs, and obviously the M-S operation that the preamps offer, it's important that these limiters can be linked across adjacent pairs, and so they can, although both threshold controls remain operative throughout. I used this a fair bit, and found it to be pretty transparent in normal protective use, although not surprisingly it can be made to crunch if the threshold is dropped too far with a high signal level.

As supplied, the DB8000s has a 25-pin D-connector for direct connection to a Tascam-format analogue 8-channel input, and the manual shows pictures of an optional digital version. This has a TDIF 25-pin as well as an ADAT lightpipe output, together with a word clock input to keep everything synchronised. None of the available output options has a corresponding input, as the box stops short of providing even the most elementary of mixers. This is not a problem; the box is what it is, and with eight preamps of very high-quality and the small but well-chosen built-in extras, it's a surprisingly versatile unit. The plethora of outputs lends itself to all kinds of situations, particularly the live multitrack recording where secondary safety backup machines are needed, as it removes the need for outboard splitting. In the 8-pack market there's more than the usual proportion of me-too products, but this is an interesting and welcome addition. □

Contact:

CLM Dynamics, UK.
Tel: +44 7041 420188. **Fax:** +44 1382 534868.
Net: www.clmdynamics.com

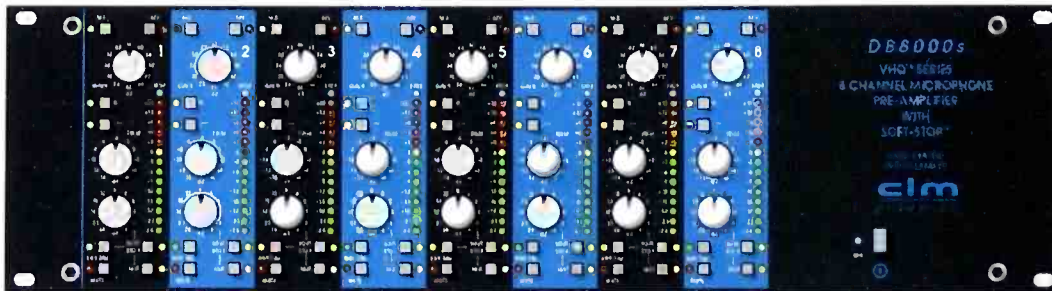

NEW TECHNOLOGIES

model joins the existing range of X2 2-channel and X4 4-channel location mixers.
 LTF, UK. Tel: +44 1895 813698.

Harrison broadcast desk

Harrison's TVD digital on-air broadcast desk has a compact control surface which can be controlled from three additional locations using Harrison's Satellite Touchscreens. Standard systems are supplied with 24 mic-line input channels, 18 stereo-line input channels, 12 mix-minus feeds (24 capable), 16 auxiliary sends, 5.1 input channels, four stereo groups, and four stereo and 5.1 programme buses. All signal processing is 40-bit with 24-bit A-D/D-A conversion (96kHz capable). System operators can enable-disable the console's processing elements—like EQ, dynamics and filters—and the desk has motorised, touch-sensitive faders and snapshot recall of every console parameter. Other standard features include 24 remotely-controlled mic preamps, continuous input metering and 8-character alphanumeric displays on all channels, 16 auxiliary sends from each channel, 24 assignable high-resolution digital bargraph meters, and panel-mounted AFL-PFL speaker. Harrison, US. Tel: +1 615 986 7700.

Precision Audio in Miniature

The Lindos MiniSonic MS1 Audio Analyser-Studio Aid is described as a complete hand-held, 2-channel analogue audio test set which can function as a quality tester, precision line-up tool, accurate stereo PPM, balanced-unbalanced convertor, stereo mic preamp, headphone amp and level convertor. The generator can produce sequences including 1/12-octave sweep, 1/12-octave sweep 10dB, ITU-468 test tonebursts weighted to give target peak at -50dBu and a PPM test toneburst weighted to give target peak 0dBu. The device weighs 600g and measures 215mm x 160mm x 33mm with a 32-bar LED single-mark display with 'shadowbar' (reduced brightness) for R channel, cursor, or other functions. A full Windows style control and results panel is supplied as standard, allowing access to additional features as well as displaying all information clearly on a single screen. Lindos, UK. Tel: +44 1394 380307.

Behringer Cable tester

Behringer has introduced the CT100 microprocessor-controlled cable tester which accepts XLR, mono, TRS (1/4-inch, 1/8-inch, TT), RCA and MIDI connectors. A LED display shows which input pin is connected to which output pin.

Separate shield and phantom power LEDs indicate proper shield connection and phantom power presence. The CT 100's cable



test mode only requires insertion of one plug and indicates shorts and opens in addition to checking continuity. It also includes a two-tone test generator. The Ultra-Voice Pro VX2000 combines a microphone preamplifier, dynamic processor and equaliser in a 1U rackmount. A discrete input stage includes a mic-line preamp and there's an expander, opto-compressor, opto de-esser, tube simulation and 3-band EQ. Behringer, Germany. Tel: +49 2154 9206 0.

E= By Gum² 'Analogue is dead. Long live analogue.'

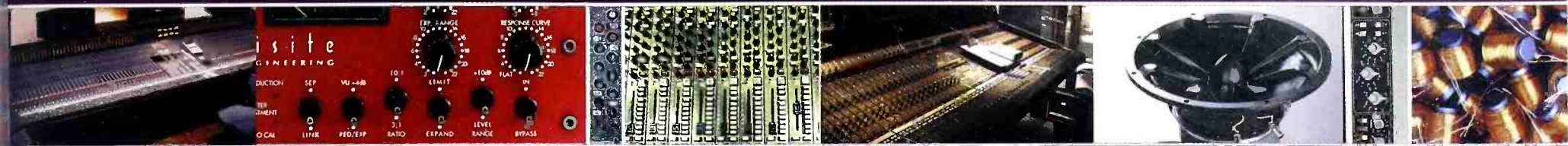

Because the future of digital is analogue it seems. As the world moves over to the convenience of computer based recording media, we are becoming inundated with pleas for help from engineers, producers and musicians throughout Europe all seeking the same solution to a similar problem; how to get the balls and punch back into their cyberecordings. Digital is great, but remains an infant in the mature world of sound. All too often recordings sound thin, compressed and have a synthetic gloss that immediately identifies them as new generation hard disc doodles. It doesn't have to be that way. Here at Funky Junk we specialise in helping our clients rediscover the quality that classic analogue front end and processing can add to their recordings and mixes. Here's what you do...



Front End. There is nothing you can do to beef up the sound off disc if the sound is not there to start with. For a fraction of the cost of a good computer, the right microphone and microphone preamplifier will enable 90% of everything you record to come alive. We specialise in the best vintage mic pre/eq by Neve, Calrec, Telefunken and others but also love and recommend modern units by API, Amek, Requisite Audio and others. An increasing number of clients are moving back to analogue desks, large and small. We have supplied small Neve BCM10, Melbourne and Kelso consoles around the world as well as larger desks such as 8014 or 5106 (Baby V) through to VR, Amek, Harrison, SSL and others. If the bank are less than helpful, we can suggest other cost effective high quality options such as the compact Amek BC2 or a variety of more modern small Neve and Calrec desks. Add a real desk to your Protocols or Radar and you will rediscover the quality you thought you'd left behind. And the knobs FEEL GOOD, the EQ WORKS and the faders sit in a line and fade.

Chase the fade.... And for that professional gloss on the mix? Well, unplug the plug-ins and rediscover the warmth of true compression from EAR, Requisite Audio, API, Neve, Focusrite, and the rest. Put an Alan Smart over the mix and give your meters a break. Eq? Neve, API, Calrec, and Amek are here to sweeten, darken soften or scream the sound. These and many more, whatever your needs or budget. Are you hearing us? Well, maybe you need to check out your monitoring. Do you really enjoy those NS10's, or are they the devil you think you know? Check out the latest from PMC, Dynaudio and others. And did you ever realise the extent to which a decent amplifier turns the average into the special? Ten minutes with a Bryston or Chamelion driving your sounds will open your ears (and probably that of the A+R man as well). We can help turn your sounds into music and your frown into a smile. We can supply the digiblah if required (and take your analogue in trade in), but our main concern is to help you tune your recordings and make them come alive.

Chase the fade.... And for that professional gloss on the mix? Well, unplug the plug-ins and rediscover the warmth of true compression from EAR, Requisite Audio, API, Neve, Focusrite, and the rest. Put an Alan Smart over the mix and give your meters a break. Eq? Neve, API, Calrec, and Amek are here to sweeten, darken soften or scream the sound. These and many more, whatever your needs or budget. Are you hearing us? Well, maybe you need to check out your monitoring. Do you really enjoy those NS10's or are they the devil you think you know. Check out the latest from PMC, Dynaudio and others. And did you ever realise the extent to which a decent amplifier turns the average into the special? Ten minutes with a Bryston or Chamelion driving your sounds will open your ears (and probably that of the A+R man as well). We can help turn your sounds into music and your frown into a smile. We can supply the digiblah if required (and take your analogue in trade in), but our main concern is to help you tune your recordings and make them come alive.

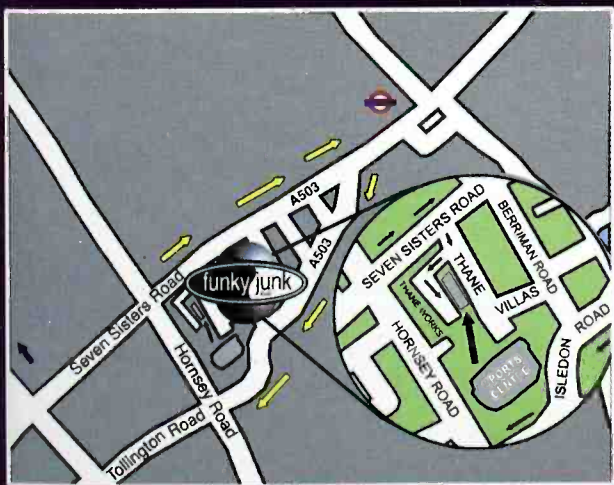

You can visit us in our splendid emporia in London, Paris, Milan or Stockholm, or tune into the website (www.proaudioeurope.com). You can call and we can have a mutual waffle or ask for a fax/e-mail list of the latest new and used goodies in stock. Or you can continue missing the mix you always wanted. By the way, before you ask, the Turtles and the Fish were liberated by the TLA (Turtle Liberation Army) and are now enjoying the freedom they always deserved...

Funky Junk Ltd.

5 Thane Works
Thane Villas
London N7 7UN

www.proaudioeurope.com

tel. +44 (0)20 &609 5479
fax +44 (0)20 7609 5483

sales@funky-junk.co.uk

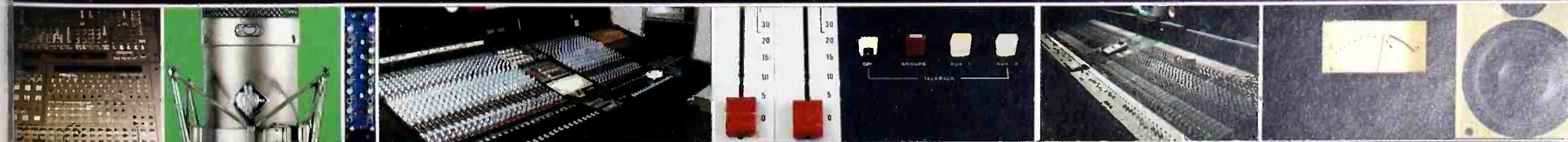

THE NEW ENVOY ENG
SYSTEM FROM AUDIO.
BECAUSE IN REAL
LIFE, YOU DON'T GET
A SECOND TAKE.

Info:

call: +44 (0)1494 511711

e-mail: info@audioltd.com

Capture every
moment with the Envoy
radio microphone system.

The receiver is purpose
designed to fit neatly into
the latest digital ENG cameras.

And with simple, infra-red remote
control, you don't need to be a sound
expert to use it. To find out more, visit

our web site: www.audioltd.com

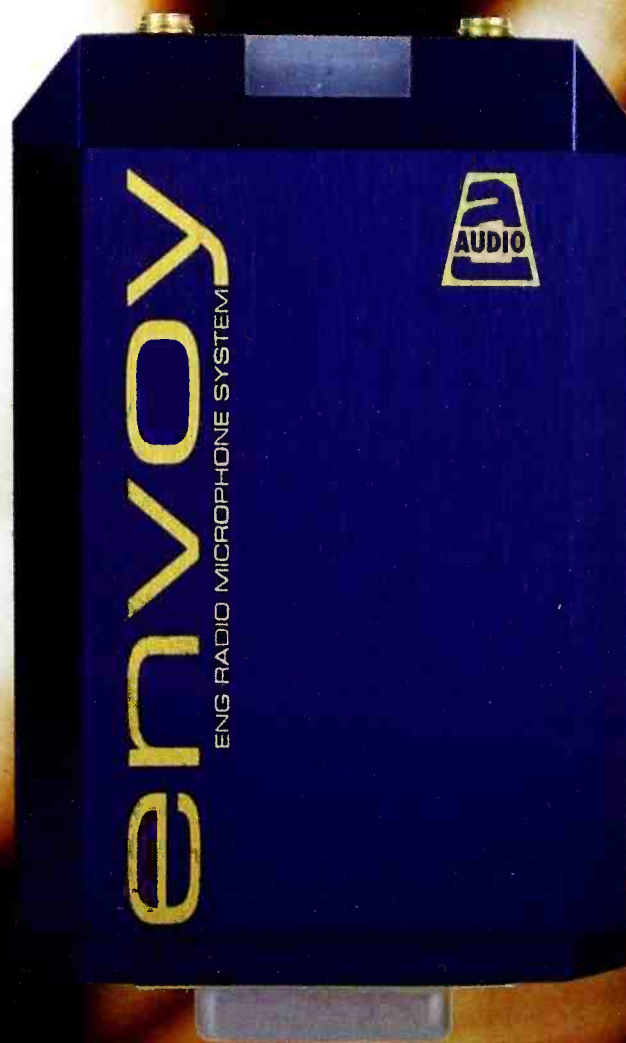

SOUND MADE SIMPLE

Manley 16x2 Tube Mixer

Sometimes you know what you want, other times you have to be told. **George Shilling** receives a lesson in desirability from Manley's modest mixer

WHEN I FIRST RECEIVED the 16x2, I thought, 'who would want one of these?' With no EQ and just one aux, you might wonder... But hang in there; there are three basic flavours available, featuring 16 mic channels, 16 line inputs, or a hybrid '8+8' with eight inputs of each type, which is the one I had for review (pictured). Also, Manley offers a number of custom options. If it doesn't do quite what you want it to Manley will happily make you a version that does—they have already designed a 32x8, and a version with LCR pan pots for example.

Designed by 'Hutch', the 5U-high mixer is in the usual

Manley house style, with smart etched quarter-inch thick front panel, thin mesh top and bottom, and conductive plastic pots. In its appearance, the only very tiny let down is perhaps the poorly designed '16x2' logo.

There is a separate power supply box, which is incredibly heavy, due mainly to an enormous transformer. The heatsinks on the rear get very hot during operation, and there is a slight physical hum from the box in operation—probably not a problem if this unit is stuffed behind a rack (it is not rackmountable). A large multi-pin connector on the rear connects a thick cable to the mixer itself; on the mixer end the cable goes deep inside the case through a grommet-strain sleeve without a connector.

A rocker switch enables the power supply, and a locking toggle on the front of the mixer switches the power on, lighting the LED on the front of the power supply, and the top vu meter on the mixer. The other meter illuminates after about 20s, as voltages stabilise and relays click into action to enable monitor outputs.

The rear of the mixer is awash with connectors:

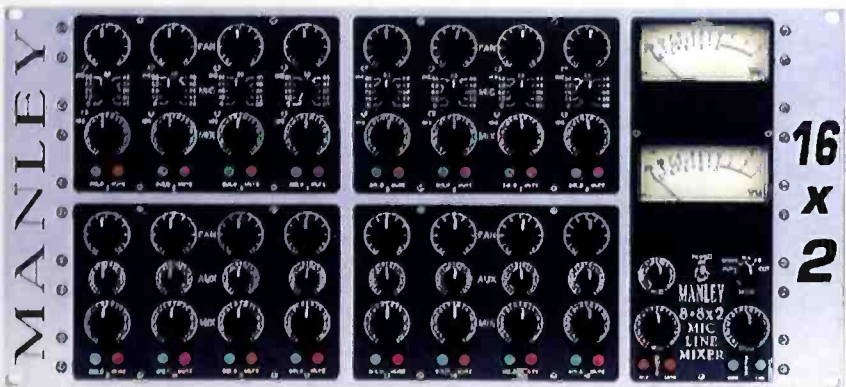

NEW TECHNOLOGIES

AKG Microtools

AKG has added to its WMS 40 series of miniature wireless devices with the Microtools range. All have gain controls, battery status LED, On-Mute-Off switch and run from a single AAA dry or rechargeable battery for eight–12 hours operation.

The Microtools Series, all of which can be used with the SR40 receiver, includes the SO 40 Snap-On miniature plug-on transmitter, which turns any hardwire dynamic or self powered condenser into a wireless microphone, and the GB 40 Guitar Bug spring-loaded, swivelling standard 1/4-inch jack for direct connection to guitar, bass and keyboards. The MP 40 Microopen miniature body pack transmitter provides a detachable C 407 miniature lavalier microphone with an integrated fixing clamp while the CU 40 is a universal charger for all Microtools. AKG, Austria. Tel: +43 1 86654 0.



CAD's 400 and M series

CAD's 400 series mics and drum packs have been boosted by the introduction of two new dynamics and one condenser, plus a patented drum mic mount. The series now includes the TSM 411 extended function dynamic, the KBM 412 extended low-end dynamic and the ICM 417 electret condenser mic. The TSM 411 is a Neodymium dynamic microphone that offers high SPL, super-cardioid pattern and wide frequency response for a wide range of drum and percussion applications. The ICM 417 was designed specifically for cymbal, hi-hat and

do you get
the full
picture?



Tibellusgatan 7, SE-76150 Norrtälje, Sweden
Phone: +46 176 13930 Fax: +46 176 13935
Email: adm@lundahl.se Web: www.lundahl.se

LUNDAHL
-TRANSFORMERS-
SWEDEN



beyer
presents the
new Black!

the DT 100's features remain unchanged
except now you have a choice between
Grey or Black!



Not that you follow fashion trends, but
everybody who's anybody will be wearing
them!

01444 258258
www.beyerdynamic.co.uk
sales@beyerdynamic.co.uk

beyerdynamic

NEW TECHNOLOGIES

overhead miking. CAD's DSM-1 drum shock mount design for lug type drums supplies solid mechanical support with duo-point shock isolation. New M Series condensers include the compact M177 cardioid in an externally biased capsule with a gold sputtered 1.1-inch diaphragm. The M 179 features a five-point detented pattern-control providing nine patterns, continuously variable between detents while the M9 is a servo-valve cardioid pattern true condenser with external power supply.
CAD, US. Tel: +1 440 593 1111.

Sennheiser stick mic

Sennheiser's evolution e664 condenser is designed for use as overheads on drumkits and for acoustic instruments such as guitars and strings. It claims low-



noise electronics, high output and a highly sensitive capsule that draws from the company's heritage in electret designs. A switchable low-frequency roll-off filter

internally, the mixer channels are on modular boards that can be removed individually. All channel inputs feature hybrid XLR-jack connectors, and all channels feature balanced TRS Direct Output jacks for recording directly to individual tracks. Mic inputs feature insert TRS send-return jacks which allow processing to be applied between the mic amp and the fader. It was deemed an unnecessary feature for the line inputs, so these holes are blanked. The mic inputs are divided into two banks of four, with each bank having a PHANTOM POWER locking toggle switch, preventing accidents and usefully allowing one to simultaneously use condenser types and sensitive ribbon mics. Among the main section's many inputs and outputs are external inputs that feed into the main mix at unity gain, enabling the chaining of multiple 16x2s. There is a terminal post for linking the solo bus of another mixer. And thoughtfully there are mini speaker outputs for alternative monitoring, switchable from the front, although the unit lacks a headphone output.

At the top of each channel is a large pan pot, with a gain law which reduces output by 4.5dB in the centre like some older consoles. At the bottom is a large rotary gain pot, controlling level to the stereo mix bus, as well as the direct channel outputs. However, the accompanying illuminating (relay) MUTE switch cuts only the signal to the mix bus, allowing recording to continue—a nice touch. There is also a latching illuminating SOLO switch, which mutes the other channels. Line inputs feature an aux send, preset as post-fade but internally configurable. Mic inputs feature a stepped gain switched in 5dB steps, and excellent, very tiny toggles for phase reverse (relay) and insert, each of which is accompanied by an LED. Main

options are comprehensive, with fader pots and mutes for mix, aux master and monitor, switching for dim, mini monitors, and monitor selection options for mix, mono, external inputs, tape inputs and ext.

Perhaps surprisingly, given the billing of this mixer, the mic amps are not valve. Four valves feature in the mix output stages, but otherwise this is a carefully designed solid state unit. The mic inputs sound as fantastic as the astonishing specs suggest: I did a direct comparison with a well-respected British model while recording electric guitar with a 57 in front of a Boogie, and the Manley instantly sounded stunningly different—far bigger in every way. I used it for vocal, acoustic guitar and percussion recording and it performed exceptionally, always clean, clear and large-scale.

I also took it to do a drum recording into a digital workstation and it was ideal for the job. I enjoyed the simplicity and the lack of onboard EQ perhaps led to more careful mic selection and placement—no bad thing. Of course, the inserts are available, and Manley promises an 8-channel passive EQ at some point in the future.

The unit sounds fantastic—the output (and internal stages) can handle up to 37dBu, and all other specs are equally astonishing. Uses for a mixer like this are endless, from location recording to studio recording, Pro Tools mixing and broadcast. So, who would want one of these? Well, just about everyone I showed it to, and especially me. □

Contact:

Manley Laboratories, US.
Tel: +1 909 627 4256. Fax: +1 909 628 2482.
Net: www.manleylabs.com

One smart radio.

Meet the radio mic with a brain.



The latest from Lectrosonics.

- Microprocessor control
- 256 selectable freqs
- RF scanning & analysis
- Outstanding audio quality
- Belt-pack and plug-on transmitters
- SmartSquelch processing
- SmartDiversity optimization
- Dual-band compandor
- One impressive radio mic

SBES
Stand 55

Call +44 (0) 1789 400 600
FAX +44 (0) 1789 400 630
e-mail: info@raycom.co.uk
web: www.raycom.co.uk



Sales - Hire - Service

GET CONNECTED WITH
THE WINTER ISSUE OF
STUDIO SOUND'S
What's New in Pro Audio

THE INDISPENSABLE GUIDE FOR ANYONE WORKING IN THE PRO AUDIO INDUSTRY, PROVIDING A COMPREHENSIVE ROUND-UP OF ALL THE LATEST PRODUCT RELEASES

For further information contact Sam Patel
Phone: +44 (0)20 7579 4440 Fax: +44 (0)20 7579 4011
email: spatel@ubminternational.com

www.studio-sound.com/wnipa

Indo-digital-dub

When Asian Dub Foundation hit the road the studio virtually comes with them. Their dub infused, live performances, mixing triggers, samples and effects with live instruments, are legendary for sheer musical excitement. Main ADF dub master Sun-J, has now committed his sequences, samples and effects to 24-bit sonic superiority with the TASCAM DA-78HR DTRS recorder; replacing his former banks of ageing, temperamental samplers.

Engineering a digital multitrack to deliver such critical levels of performance on the road is TASCAM's achievement; such brilliant creative use of it is Sun-J's.

DA-78HR & DA-98HR HIGH RESOLUTION DTRS RECORDERS



DTRS *the future of tape*

TASCAM

a whole world of recording

TASCAM 5 Marlin House Marlin's Meadow The Croxley Centre Watford Herts WD18 8TE
Sales Hotline: 01923 438880 Brochure Hotline: 01923 438888
www.tascam.co.uk email: info@tascam.co.uk

NEW TECHNOLOGIES

is included and the mic claims a 40Hz-20kHz response with a maximum SPL rating of 130dB. Sennheiser, UK. Tel: +44 1494 551551.

Mac ASIO

Symbolic Sound Corporation is beta-testing a Macintosh ASIO driver that can route eight 24-bit audio streams in and out of the Kyma.5 sound design environment. This means that any software that supports Steinberg's ASIO protocol can now use Symbolic Sound's Capybara 320 as a sound card. Besides gaining access to the Capybara's four (expandable to 8) channels of 24-bit/100kHz A-D and D-A convertors, ASIO users can now route signals through Kyma for live effects processing or mixing. A Windows 98/ME ASIO driver is planned for release later this year. Symbolic Sound Corporation is shipping Kyma.5 which it has dubbed 'recombinant sound'. The new release includes a searchable Sound Library containing over one thousand new sounds and effects. These are the built-in factory algorithms or plug-ins of Kyma. In the new Sound Browser, you can search the library, audition the sounds, and even combine sounds with each other in various ways. Kyma.5 provides a new, high-level graphic user interface between the Capybara sound computation engine and the sound designer. Symbolic Sound, US. Tel: +1 217 355 6273.

SIENA audio extension

The SIENA audio extension breakout box is a 19-inch unit which connects to the SIENA card via a multicore cable although other brand cards can be used with an

Joemeek TwinQ

The latest in a line of the popular green people's machine, the TwinQ combines EQ, compression and preamp. **Zenon Schoepe** prepares to meet a right character

REPRESENTING SOMETHING of a greatest hits from the Joemeek range, the TwinQ combines sections of processing that have established themselves as popular choices in their own right. What we have here is a dual recording channel CurrentSense mic instrument preamp, photo optical compressor, and Meequalizer in a 2U (with handles) box that can take a retrofittable

times are the same compound curve type as found on the original SC2.

The left channel controls are in charge when the stereo LINK switch is activated and there's an outstanding degree of rear panel I-O which has always appealed to me about Joemeek gear in an old-fashioned value sort of way. Mics are on XLRs, and line input and high- and low-level outputs are on bal-



24-96 digital output board.

Genetically the closest relative to the TwinQ in the Joemeek family is the VC1Q studio channel although the new box has no enhancer. Aside from being true dual-channel in operation, improvements have been made in the compressor's slope switch which now offers ratios from 2:1 to 15:1 at the extremes. On the shortest attack time the compressor is now fully effective within 0.5ms and release

anced jack along with TRS jack insert (sits directly after preamp) and front panel instrument level input.

Each channel has switches for phantom, subsonic high-pass filter (this is a 10Hz bottom end box), phase reverse, mic-line selection and EQ and compression bypass. All have associated LEDs and the meters can be switched to read gain reduction or level before the output control. Input gain and output level are on larger 'geared' pots and are



**RICHMOND
FILM
SERVICES**
+44 (0)20 8940 6077



**FOR ALL
DENECKE INC.
TIMECODE EQUIPMENT
SALES AND RENTAL**



NO
COMPROMISE

Brauner mic
hard bottom
German
Vintage valve
sound but
digitally quiet
The world's
best rely on
Brauner



4th
Design
Grammy
nominated
(Eric Clapton)
and it's
the best
microphone
in the world

UK +44 (0)20 8943 4949
louis@yabuk.com
GERMANY +49 (0)2856 9270
info@dirk-brauner.com
SPAIN +34 93 674 2100
fxspain@retemail.es

digimax

THE PUREST PATH TO DIGITAL

Combine eight channels of award winning, pristine mic pre-amplification, limiting and EQ enhancement with 24bit digital and analog output, and the Digimax seamlessly fits into any digital recording situation. The Digimax is the perfect front-end for DAWs and adding mic-pres to digital mixers and sound cards.

What do MOTU™ 2408®, Digi001®, Mackie™ HDR®, Tascam™ MX2424, Ensoniq™ Paris®, and Yamaha™ AW4416® have in common? **They are all compatible with the Digimax!**



- Eight Dual Servo Mic Pre-amps with 48v phantom, 2 Instrument Inputs
- Class A discrete Input Buffers, Ultra Low Noise
- Eight Dual Domain Limiters
- Eight EQ Enhancers
- 32kHz, 44.1kHz or 48kHz, 24Bit A/D Converters
- Eight Balanced Analogue TRS Outputs
- ADAT Lightpipe, AES/EBU or S/PDIF Outputs
- All 24 outputs, (analogue and digital) operate simultaneously
- Word Clock In and Out via BNC connectors



What Makes a Limiter Musical?

Most limiters use only Peak Detection. Most compressors use only RMS detection. The Digimax uses both RMS and Peak Detection simultaneously to give you the benefit of maximum gain before clipping while maintaining the musical transparency of a compressor. The end result? A fast, musical, natural limiter with the ability to catch anything you throw at it.

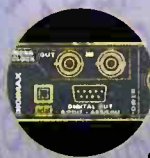

Well Connected!

The Digimax interfaces with more equipment than any mic-pre on the planet! Need balanced analogue outputs? How about 24bit ADAT outputs? What about 24bit AES/EBU or S/PDIF? The Digimax gives you all of these outputs and up to 24 channels *simultaneously!* So you'll never have a problem sending your audio across multiple platforms, both digital and analogue.

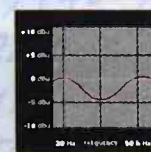

Add Some "Crystal" to Match your Mic or Instrument!

Each Channel of the Digimax features EQ Enhancement which uses a pre-set EQ curve. EQ Enhancement helps to tame the excessive midrange and accentuate presence for any audio source that may possess a characteristic midrange rise. This unique feature adds sheen and punch to any signal.



FREEPHONE TO RECEIVE OUR PRO AUDIO CATALOGUE NOW!

0800 7311990

www.hwinternational.co.uk

PreSonus
DIGITAL audio

FOR THE FULL STORY ON PRESONUS AND INFORMATION ON OTHER QUALITY PRO AUDIO EQUIPMENT FROM HW INTERNATIONAL, CALL OUR FREEPHONE TODAY!

vocal & instrument



studio condenser



drums & percussio

your sound, your choice...

On stage or in the studio, you want your vocals, your drums and your instruments to sound awesome, and with Superlux mics you're half way there.

If there's one place where you shouldn't compromise on quality it's in the studio. Yet this quality has usually come at a price because large diaphragm condenser studio microphones cost a small fortune. Until Now.

Superlux's CM-series offer large diaphragm condenser microphone solutions with studio optimized cardioid patterns, and 'super buffered' ultra low noise electronics in cost effective classic style enclosures.

Then there's the drum mics. Available in three packaged solutions, these mics really rock.

Compact, yet heavy duty and road ready, Superlux drum mics feature full-sized diaphragms to deliver fantastically rich, clean and punchy sound reproduction.

For vocals and everything else, there's Superlux's great range of dynamic mics which include quality mics for vocals, speech and instruments.

Whether you need a mic for stage, studio or bedroom, Superlux has the right mic for the job. The right mic for you.

And at the right price.

Superlux



Exclusively distributed in the UK by SCV London, 6-24 Southgate Road, London N1 3JJ
Tel: 020 7923 1892 Fax: 020 7241 3644 email: superlux@scvlondon.co.uk

www.scvlondon.co.uk



complemented by ATTACK (0.5ms-10ms), RELEASE (250ms-2.5s), and COMPRESSION pots and the 5-way SLOPE control already mentioned in the compression section. Finally there are three pots for the three fixed frequencies of the EQ.

Compression first then. The section equates to an SC2 in terms of control and sports the snob value switched SLOPE control rather than the continuous versions found on cheaper units. EQ is a little bit of a let down for me as someone who knows and loves the original Meequalizer that started the company's move in to 'tone' controls. Three bands pinned at 100Hz, 1.5kHz and 8kHz doesn't quite cut it even though this is broad and big stuff—the mid is set to give a Q of 1.1 at full choke. The beauty of the original Meequalizer was that it was broad and big and sweepable in the mid band. It may not seem a massive difference but if you'd used it you would appreciate its significance immediately.

That aside, the package is extremely strong although it is another permutation and take on established Joemeek building blocks. It is very easy to forget just how outrageous the whole Joemeek concept was when it arrived. Here was technology that flew in the face of much popular wisdom by putting the emphasis on what its stuff sounded like rather than how it measured, how many features it had, or, it has to be said, how it looked. The reality was that the stuff measured really well anyway but the sort of grungy compression emanating from the first boxes stood many attitudes on their head and it's where they have remained. We can thank the Ted Fletcher-driven manufacturer for playing a big part in re-establishing analogue as being cool, for all

the right reasons mind, at a time when we were teetering on the edge of a mass digital solution.

The mic pre is exceptional and I believe very underrated as a lot of people tend to connect Joemeek with compression primarily. That's a shame and those people are missing out. There's stacks of headroom in here and modern specs with vintage character. The EQ has already been discussed and remains a very flattering but very simple bit of processing.

Every time I encounter Joemeek compression I am reminded of what a fantastic sounding circuit it is and how it doesn't sound like anything else and cannot be mistaken for anything else. It's fun to use and you develop a real feel for the formula of material type and settings that produce a killer sound. You become skilled in the operation of what are only four knobs but they can make a profound difference. No one can tell you it's only gain reduction anymore.

You can use this box as the dual recording channel its maker intended, employ the preamps as an adjunct to a desk, or strap the compressor across the mix and start polishing.

Best of all, the TwinQ has enormous character. In these times of style over content and blander yet more efficient equipment, may there always be room for the manufacturers of gear with personality. □

Contact:

Joemeek-Fletcher Electroacoustics, UK
St Marys, Barton Road, Torquay, Devon TQ1 4DP, UK.
Tel: +44 1803 321921
Email: sales@joemeek.net
Net: www.joemeek.net

NEW TECHNOLOGIES



optional cable adaptor. Up to four microphones and lines can be connected to the front and there is a separate 48V phantom power switch on each microphone input. The second line input allows operation as phono preamp and all inputs are adjustable, the line inputs have -20dB switches. On the back it has eight single outputs via balanced 1/4-inch jacks and a stereo mix out on phono for internally mixing down all outputs to one stereo out.

SEK'D, Germany. Tel: +49 7946 776 11.

C-Lab

The new VTM-9 Option (virtual 9-pin machine/9-pin emulation) from C-Lab, allows the Time Machine synchroniser to directly control HD recorders such as Mackie HDR24/96 and Tascam MX2424. Software version 1.1 contains drivers for the VTM-9 option. With the Option 1-G, TimeMachine delivers total control of the Virtual TimeMachine (VTM), or any other connected 9-pin machine, via parallel interface. Using the SSL G-Series Mixcomputer, control of all current digital recording systems is possible directly from the SSL G-Series console and all the functionality of the G-Mix automation is retained.
C-Lab, Germany. Tel: +49 40 6944000.

THE ULTIMATE AUDIO INTERFACE

With 24-bit analogue inputs, sampling rates up to 200kHz, a low-jitter PLL sample clock and a choice of three multichannel analogue configurations, the new LynxTWO audio interface rivals the performance of many of the world's most desirable standalone converters. And with a list of features that includes AES/EBU and S/PDIF digital I/O, expansion modules for ADAT and TDIF support, powerful synchronization and timecode facilities plus an on-board digital mixer, you'll find its surprisingly low price tag equally attractive.

Unusually, the LynxTWO is the product of dedicated, visionary hardware and software engineers working together, not the wishful thinking of some marketing department. So you can count on exceptional compatibility with all major Mac and Windows-based audio and video applications.

For full details of the ultimate PCI audio interface card and a list of dealers, contact HHB or visit hbb.co.uk

Also available: LynxONE 2-channel audio interface card
All trademarks recognised as the property of their respective owners



Lynx
STUDIO
TECHNOLOGY

Manufactured in the USA by
Lynx Studio Technology, Inc. www.lynxstudio.com

Exclusively distributed by: HHB Communications Ltd · T: 020 8962 5000 · E: sales@hbb.co.uk
HHB Communications USA Inc · T: 310 319 1111 · E: sales@hhbusa.com
HHB Communications Canada Ltd · T: 416 867 9000 · E: sales@hhbcanada.com

www.hbb.co.uk

WE ARE FAMILY

In the wake of the terrorist attacks on New York, **Richard Buskin** talks to composer-producer Nile Rodgers and engineer Richard Hilton about the all-star cover version of Sister Sledge's hit, aiding the World Trade Center's victims

AVATAR STUDIOS in New York, formerly known as the Power Station, played host to a who's who of the entertainment industry on 22nd September for a recording of the classic Nile Rodgers-Bernard Edwards composition, 'We Are Family', in the same Studio A where Sister Sledge tracked the original hit single back in 1979. More than 100 celebrities were present at the Avatar session, and their efforts were supplemented the next day by the vocal contributions

Who's idea was it to make this recording?

NR: 'It was totally someone else's suggestion. I got three phone calls in succession—two from friends in South Africa and one from Zimbabwe—telling me that in their country and in a lot of their schools they play 'We Are Family' as an inspirational song. They told me, "Nile you need to record that song again. Your country needs it."

'It's hard for me as the writer, because that view of the

What did you use for the backing track?

RH: 'We used a track that was originally programmed by a very talented fellow from LA called Nataraj, who uses a rig that is based around Performer and some MIDI equipment. The track was sent to us at Nile's studio, where our assistant Darrel Herbert and I both worked on the kind of digital nip-and-tuck that we do to tracks to make sure that they're well set up rhythmically. Then I played a bunch of keyboards on it and Nile

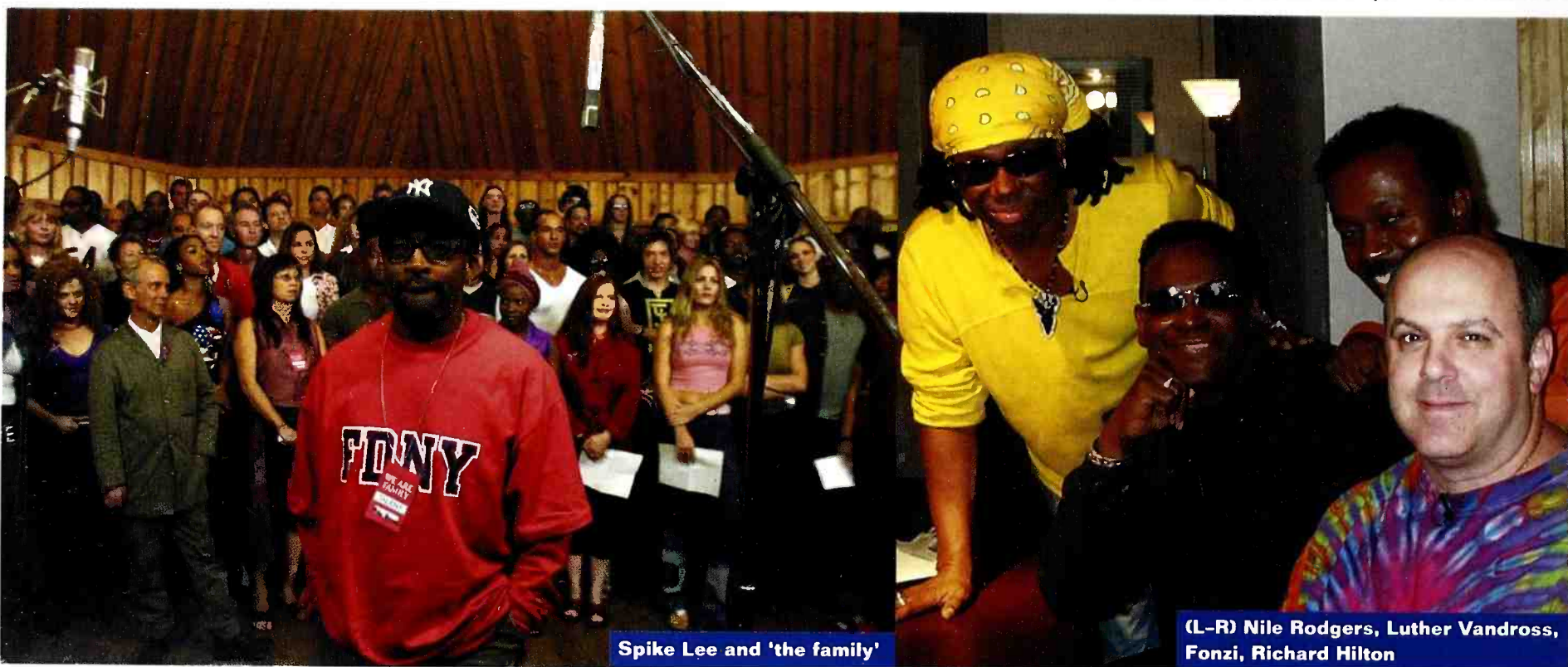

Spike Lee and 'the family'

(L-R) Nile Rodgers, Luther Vandross, Fonzi, Richard Hilton

© Interview pictures: Darrel Herbert

of another 80 celebs at the Record Plant in Los Angeles. Both studios donated their facilities, equipment and resources to the enterprise which sees part of the proceeds going to the victims of the World Trade Center attack via the community work of the Red Cross.

'We Are Family 2001' features an eclectic array of talent, ranging from Patti LaBelle, Diana Ross, Eartha Kitt, and Sister Sledge to John McEnroe, Jim Courier, and several New York City firemen. Nile Rodgers produced the two sessions with Richard Hilton engineering, while a couple of film crews also went about their business; movie director Spike Lee took charge of the video shoot at the same time as Globalvision's Danny Schechter oversaw footage for a documentary about the session.

An engineer since 1979, Hilton has worked alongside Nile Rodgers for the past 13 years, initially as a keyboard player and programmer for Chic, and more recently as his main man behind the console. In Avatar's Studio A, this comprised a 40-input custom Neve 8068 while at the Record Plant there was an SSL 9000.

song seems so inaccurate. That's not how I wrote it, but it's become this serendipitous anthem. You know, Nelson Mandela telling me this song is politically moving to him, and I'm thinking, "What are you talking about?" It's this song about these four sisters which I made up because I met them and liked them.

'First the humanitarian in me was interested, and then the artist in me took over. I kept thinking, "Artistically how can I make this recording represent everything that other people are telling me that it does represent to them?" Then I thought about how whenever you're in a restaurant and down at the other end some people are having a birthday party and singing 'Happy Birthday', no matter what you're doing you stop, pay attention to them and clap. And the reason why is because it sounds really great. You don't think about the fact that some people sing as great as Pavarotti and others sing like my stepfather. It's inspirational, and that's what I thought about recreating on a larger scale. You know, instead of having 20 people singing, what if it's 200 people? More important than what that would sound like, as an artist I say, "What would that feel like?"

played some guitars, and that's the track we went in with. In this case I brought it on CDs, because it is only one song and it's somewhat simpler to do on CDs.'

How did you approach that initial vocal session at Avatar?

RH: 'I looked upon it as a flying-by-the-seat-of-my-pants engineering gig, and I can't say that I've done anything like this before. I walked into the room, I looked around, and I had to make some quick decisions as to how I thought the recording could be best captured. I had to pipe in the backing track for 150 people, because clearly headphones weren't going to work, so we had to make sure that the studio monitoring situation was good, and I also knew that later on I would be dealing with tons of track leakage.

'For the ensemble recording I used an AKG C24 in the middle, 8-10ft in the air, and then a spaced pair of tube 47s 10ft to either side of that, as well as another spaced pair of 67s a further 10ft away on either side. The C24 I thought would match the characteristics of that particular room and give us a good, natural-sounding recording. In addition, Avatar Studio A has a sort of

WORLD CLASS PRODUCT, WORLDWIDE AUDIENCE.



TOTAL SOLUTION - TOTAL COMMITMENT

Rob Egelton
Channel 4 Television

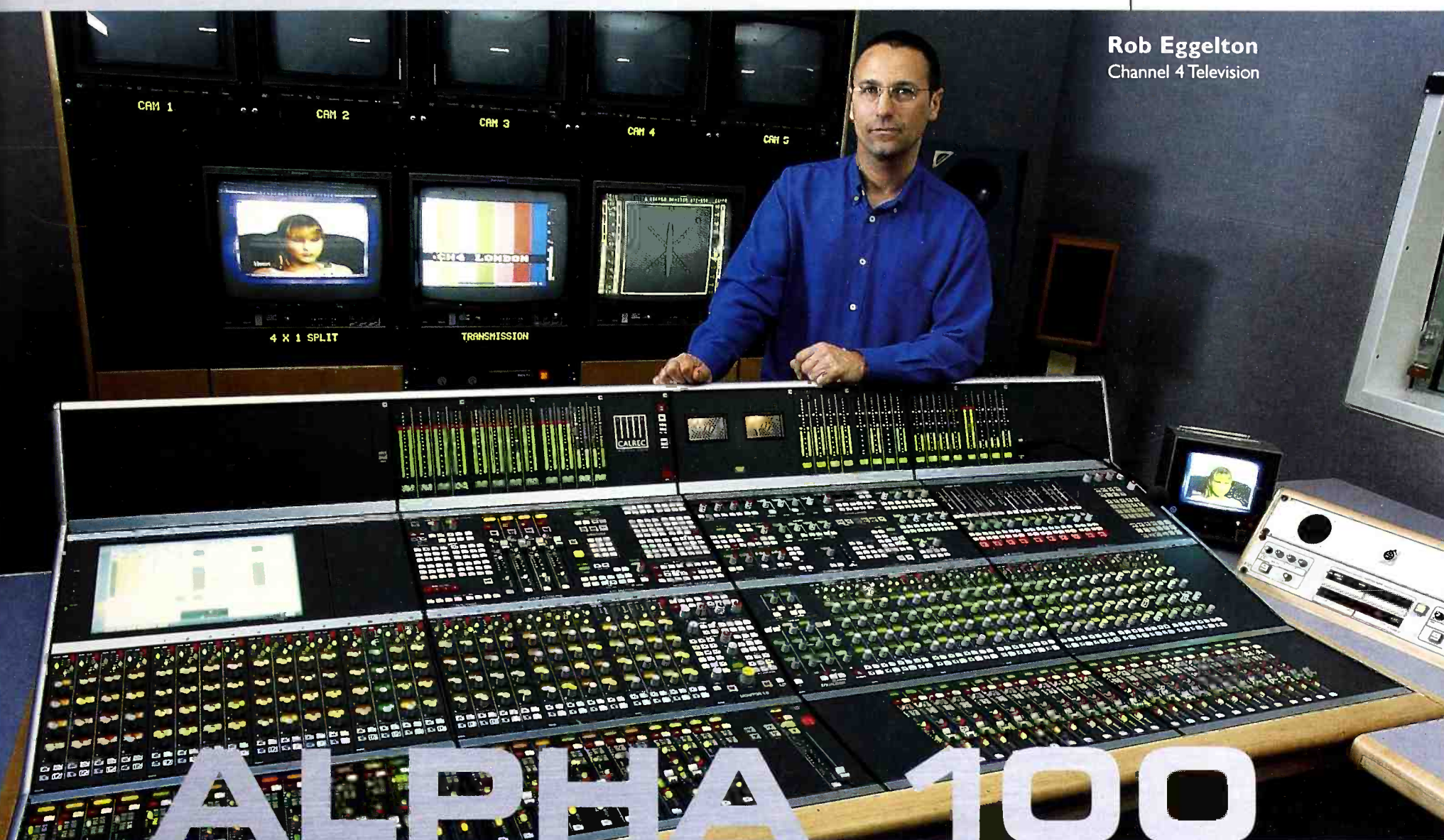

ALPHA 100 DIGITAL PRODUCTION CONSOLE

Worldwide users of the Alpha 100

- Designed specifically for live production and on-air operation.
- Easy to learn, intuitive to use
- Excellent audio performance with high input headroom
- Very fast cold boot and re-set times
- Automatic redundant DSP, control and power supply systems
- Hot-swap cards throughout - ALL cards and panels are removable and insertable under power
- Embedded control system allows for power-up and operation without PC
- Uninterrupted audio in the event of control system re-set
- 20 Auxes, Direct Output / Mix-minus System, flexible insert allocation
- 8 Stereo or Mono Groups, 4 Main Outputs providing any combination of Surround, Stereo and Mono
- 48 Multitrack / IFB Busses
- Powerful Input / Output Router

BBC Television

Channel 4 Television

Granada Television

SIC Portugal

WDR

The Ackerley Group

NBC Networks

NBC KNSD San Diego

NBC KXAS Dallas

NBC WTVJ Miami

NEP Inc



CALREC AUDIO LTD.
NUTCLOUGH MILL, HEBDEN BRIDGE,
WEST YORKSHIRE HX7 8EZ UK
TEL: +44 (0) 1422 842159
FAX: +44 (0) 1422 845244
EMAIL: enquiries@calrec.com
WEB: www.calrec.com

crown in the middle of the room, and up in the crown there are two U87s on a stand as a spaced pair. They are motorised so that you can raise and lower them. I used those, so I basically had four stereo feeds coming in.

'When you fill a room 70% to 80% with people, it's really a case of capturing the overall vibe. The goal was to get a big but not too ambient vocal sound, without having any particular mic positioned so close that it focussed on a poor, unfortunate soul whose business is playing basketball.'

Did you try to screen off the sound of the backing track through the monitors?

RH: 'I made them put the send to the studio speakers on a pair of faders so that I could mess around with

the phase to see if would help the leakage, but it had no effect whatsoever. It didn't matter. We had all of these microphone sources open, so the relationship between the phase of that track in the speakers would change according to the microphone. As a result, none of my grandiose ideas to minimise the leakage really made any difference.'

Did you run all the mics through limiters?

RH: 'Yes. I had a Summit DCL 200, as well as a pair of LA2As, a Neve stereo limiter and a pair of 1176s. I made do with that, but none of it was drastic. It was just in case somebody became completely overwhelmed by the fervour of the moment. It wasn't heavily processed.

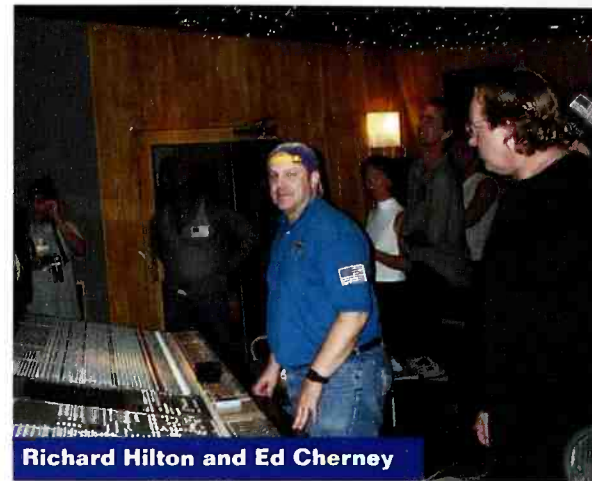

Richard Hilton and Ed Cherney

It was there to keep a reign on things just in case they got out of hand. I mean, you have to understand that at the New York session there were 100 to 150 people out there on risers, spilling all over the place, as well as Spike Lee's film crew and another crew shooting the documentary. We had people running all over the place. In fact, at any one time there may have been 50 to 60 people in the control room with me, which, as you can imagine, was a pretty unusual listening environment, what with everyone talking.

'We did four vocal passes at Avatar, and at various points during the last two passes members of the film crew stepped on cables or pulled power supplies. I lost microphones during those passes, and I'd be waving frantically; "Plug that thing back in". So, what I ended up using in both cities was the second pass...'

How were the lead vocals handled?

RH: 'Here's how it went in New York: After we'd recorded the passes by the assembled multitude and had been able to disperse them to a reasonable degree, Spike Lee requested that we set up the main vocal mic in a different visual location for the purposes of his film shoot. We therefore sectioned off a lead vocal area at the back of Studio A and, at the suggestion of assistant Ross Peterson, put up a Sony C800, and he was absolutely correct.

'People started teaming up into groups of three, four and five, and I joked that it was like a bakery where you take a number at the door and wait in line. In some cases they had the foresight and wisdom to agree to trade lines one at a time, and in other cases there'd be four people out there wailing at the top of their lungs through the whole thing, which in most cases was difficult to use. Anyway, in New York I recorded one or two passes of a total of 15 separate groups or individuals singing the lead vocal, and that was pretty thrilling.

'The goal set by Nile was just to get as much captured as possible, so generally speaking everybody got one shot through the tune. And the other reason for that was I had to be out of the studio by 8.30 to be on a red-eye plane to LA and I wanted to walk out with the tracks in my hand. I needed to arrive the next morning with the tracks, and I ended up taking the same CDs to LA that I had brought into the session in New York, because there was really no reason to play the New York performances for the people in LA.'

Was the approach the same in LA?

RH: 'At that session I was assisted by the very gracious and talented Ed Cherney, whose wife is the president of the Record Plant, so things tended to get done really quickly. I had Sam Negri assisting me with the Pro Tools—Darrel stayed behind in New York.

'There was a point in both sessions where I ran out into

CUBE-TEC



AudioCube Product Range

- Scalable Up To 64 Channels (With MADI), 24 Bit - Up To 192 kHz
- Expandable, Open Architecture
- Seamless Integration Of Mastering, Authoring, Restoration & Editing



QUADRIGA Product Range

- Automated, Quality Controlled Audio Archival
- BWF Supplement 2
- Sophisticated Security & Background Processing
- Specialized Import Modules For Audio Capturing



Virtual Precision Instruments

- 32 Professional Mastering, Restoration & DVD Authoring Tools
- 24 Bit/96 kHz, 64/32 Bit Floating Point Precision
- Unique Adaptive Processing Algorithms



Media Production Solutions

- DVD-Audio Authoring
- Supports Version 1.2 Of The DVD-Audio Standard
- Watermarking & Encryption



Quality Monitoring Systems

- Quality Control Of CD(R) Media
- Compliant With Redbook Standard
- Multiple Format Test Report Printouts

Cube Technologies GmbH

email: info@cube-tec.com

web: www.cube-tec.com



MIDAS
B2000
BROADCAST

TELEVISION AUDIO PRODUCTION CONSOLE
"One Less Thing To Worry About When On Air"

www.midasconsoles.com



Singers, sports stars and firemen join the family

the room and sang with the choir, and in order for me to be able to do that I wanted to feel like I could leave everything in the hands of somebody who I knew would be there should things go wrong. Since Cherney was running out there with me, I left Sam with the motor running.'

How did the miking compare to New York?

RH: 'In California I decided to let Ed give it a shot his way, because first of all he's a brilliant guy and I might learn something, and second of all

I'd just had the chance to do it my way the day before, so I figured "let's see what results we get here". Rather than have everybody at one end of the room facing the other end of the room, like we did in New York, Nile kind of wanted people milling around almost like a party atmosphere, and didn't want it to be quite so directional an event. Therefore, in Los Angeles we tended to mic from the four corners of the room—in two we had AKG C24s, and in the other two we had Neumann M49s, all of which went through various limiters. That yielded a different result from the more directional presentation. It tended to be a bit more ambient and a bit less pointy, but when those LA people started singing the verses they were tight and energetic.

'We only did two vocal passes in LA, and there were more solo vocalists there in relation to groups. Still, we got some really great performances in both cities, and with those in our possession we then went back to Nile's studio and made the decisions about which choir tracks to use before assembling the lead vocals. In fact, the lead vocal assembly was pretty involved, because Nile was concerned about making sure that when they cut the video together, everybody who took the time and trouble to contribute was fairly represented.'

'I developed a list that I called the "batting order", detailing the order that everybody appeared in, and while we didn't stick to it precisely, I did refer to it and made sure that everybody appeared within at least a few places of where they were in that batting order. That way, everybody got their due "face time" in the video.'

'After that, what with people having been various distances from the microphone, there was a need for me to go through and make it all sound consistent enough for it to read clearly as a lead vocal above the din of 200 people and the track. We didn't want some people to sound like they were collapsed back into the group, and this was accomplished through some fairly judicious use of Summit DCL 200 post-limiting. I spent a few hours massaging these two lead vocal tracks I ended up with—the reason why there were two was because there were a number of places where the end of a person's phrase would overlap the beginning of the next person's phrase, and I didn't want to be constrained by having them on one track.'

Where and when did you mix?

RH: 'On September 27th in Studio C at Kampo in New York, which is one of my favourite rooms to mix in, and again we were under some severe time restraints because in addition to mixing we had two more people to record that day; Luther Vandross singing and Steven Van Zandt playing guitar. Once more, film crews were involved in all of that, and as you know, once you invite a film crew into a recording session things take longer.'

'When it came time to organise and mix the track I had a sense that I didn't really want to do a lot of shifting of the New York and LA crowds against each other. I wanted to leave them more or less where they were. But what I ended up doing with each one was synchronise them to the track based on the rhythmic clapping. In other words, I would take the backbeat as dictated to me by the crowd clapping and line it up with the track in each city, and that sounded fine.'

NR: 'I'm so proud with the way that everybody is represented in this song. The quality that we were going for was vibe. With all of the technology and the equipment we have, there are many things that we can fix, but we don't have the vibe and the spirit plug-ins. If we had that, everybody would be Stevie Wonder. The day that we create that is the day that our art form really falls.'

The new ADDA 2408



24 bit 96 kHz AD/DA converter provides features you have never imagined!

- Same great sound and specifications as the ADDA 2402
 - 8-channel low noise microphone preamplifier with gain control in 0.5 dB steps, +48V, and low cut filter
 - Built-in 8-channel digital sub mixer for monitoring in L/R or M/S stereo, (optional D/A outputs for 5.1 monitoring)
 - A/D and D/D with ±180 degree phase inversion, and variable delay setting from 0 to 100ms (250 ms optionally)
 - Digital interfaces compatible with AES3, S/PDIF, TDIF, ADAT or ProTools (more interfaces to come)
 - Easy and accurate remote control via advanced PC or Mac program (MIDI or USB)
 - 8 slots for expansion cards
 - And much more!
- Introduction price EUR 5,498.- + VAT

Digital Audio Denmark

Digital Audio Denmark a/s. Gregersensvej · PO Box 141 DK 2630 Taastrup
Tel. (+45) 72 20 35 55 · Fax. (+45) 72 20 35 50
E-mail: info@digitalaudio.dk · Web: http://www.digitalaudio.dk

960L

the face of reverb



New Version 2.5 Software

Stereo 96kHz Reverb Algorithms • Multi-Channel 96kHz Reverb Algorithms • Stereo 48/96kHz Delay Algorithms
Multi-Channel 48/96kHz Delay Algorithms • Stereo Delay Programs • Multi-Channel Delay Programs
For a limited time, register your 960L at www.lexicon.com/registration to receive a free copy.

Lexicon

H A Harman International Company

Over 3000 items in stock
at the UK's lowest prices.

Studiospares

www.studiospares.com

PRODUCT GROUPS

Acoustic Booths
Acoustic Treatment
AES/EBU Cable
A-D Converters
Anti-Vibration Mats
Bantam Leads
Books
Cable over 100 typ
Cassettes
Coaxial Converter
Compressors

**Studiospares
are exhibiting
at SBES and
Music Live**

Connectors, 110 t
Cubase
DAT media & hard
DI Boxes
EDACs
External Drives
Felt, Sound Dead
Flight Cases
Guitar Accessorie
Harting Connecto
Headphones
Heatshrink
Insert Leads
Jaz Disks
K&M Stands
Keyboard Access
Leads, over 300 t
Lecterns
Looms and Snake
Loudspeakers
Media (every type
Microphones
MIDI
MiniDiscs/Record
Mixers
Multicore Cable
Multiway Connect
Music Stands
Optical Leads
Patch Cords
Patch Bays
PCI Cards
Phantom Pwr Su
Pop Screens
Racks (19")
Rack Accessorie
Rack Cases
Radlomics
RFI Filters
Rockwool
Samplers
Scart Leads
SCSI Leads
Sequencers
Signal Processin
Stage Boxes
Stands
Test Equipment
Tools
USB Hubs/Interf
Ventilation Panel
Wall Boxes
Wiring looms
XLR leads/plugs
Zimmer Racks
ZIP Drives

CABLE + CONNECTORS

543-320 EUROPA KABEL 32 paarig FSJ32

Multipair Mic Speaker Line Cable
All types always in stock

Over 100 connectors

XLR Jack Phono EDAC Harting Lemo Multiway

Over 200 leads

Audio Optical Digital Computer



ZIP + JAZZ DRIVES



250 MEG Zip Drives
Parallel and USB versions
1 Gig/2Gig Jazz Drives
SCSI Version

USB Zip 250

£135.00
exc VAT

ACOUSTIC TILES

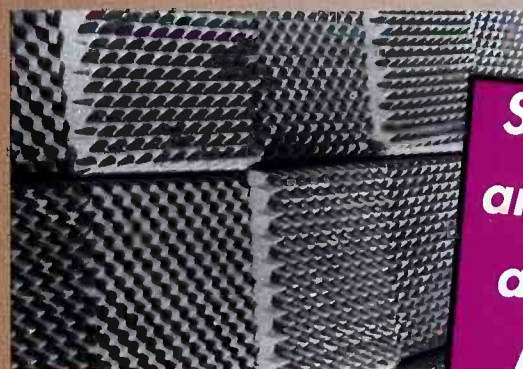

3 thicknesses for every application
The most cost/effective way to reduce reverberation. Manufactured for Studiospares

HNB BurnIT



HNB CDR830

£375.00
exc VAT

HNB BURNIT

Outsells all other CD Burners.

QUATTRO



Quattro

£199.00
exc VAT

M Audio Audiosport
Professional 4-in/4-out audio interface with
MIDI and USB.

SOUND ISOLATION ROOMS



Isolates sound
All metal construction. Modular, includes ventilation system. Easily relocated. Proven design.

MEDIA



TDK QUANTEGY HNB IOMEGA
Full range for all applications

WIRING + 19" HOUSINGS



SOUNDCRAFT M4/M8/M12



M8

£479.00
exc VAT

M4/M8/M12 series
Stunning looks matched by a very high specification. Many operational configurations.

Next day delivery nationwide.

Everything itemised in our free 200 page catalogue.

£3.00 + VAT flat rate delivery charge for all web orders on GB Mainland.

Studiospares Ltd. 61/63 Rochester Place, Camden Town, London NW1 9JU
tel 020 7482 1692 free fax 0800 731 3767 email sales@studiospares.com

Please send the new 2001 free catalogue to

NAME.....

ADDRESS.....

POST CODE StudioSound 11.01

STIRLING SYCO SOHO SHOW

COMING SOON

To be held late Jan/early Feb
- date and venue to be
announced

Exhibitors will include:

Digidesign

Tascam

M&K

Apogee

Yamaha

Glyph

Soundscape by Mackie

iZ RADAR

MOTU

Focusrite

Lexicon

Excell Speakers

More info at www.stirling-syco.com

event@stirling-syco.co.uk
for your ticket.

MORE STUDIOS SPECIFY M&K SURROUND SYSTEMS

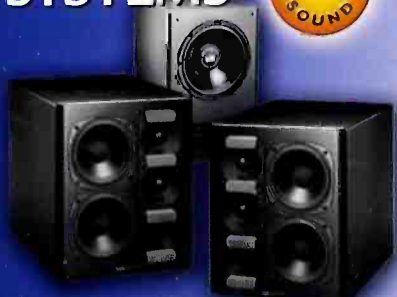

Two more studios join the swelling ranks of M&K users:

London: **The Production Factory**, where an M&K 2.1, and an M&K 5.1 system have been installed in two new rooms.

Nottingham: **The Confetti School of Recording** is now offering its students the benefit of M&K surround sound.

MORE PRO TOOLS IN TV AND POST



Sid Wells at **Videonetworks** knows all about Pro Tools and Digidesign because he purchased the first commercially available Digidesign system in the UK. This was supplied by Gary Robson at Stirling, along with the largest hard drive around at the time. "I remember it was about £3000 just for the 500 meg HD!" Things have moved on a bit since then and Sid has just ordered two new Pro Tools systems for the Audio studios he manages at Videonetworks Ltd. in Holland Park. These studios provide all the audio requirements for the Graphical Navigational Environment of Videonetworks' Homechoice service.

Environment of Videonetworks' Homechoice service.

"Pro Tools enables us to deal with lots of different requirements - mixing voiceovers, music and effects for the stings, promos and graphical menus that make up the HomeChoice Users Interface." says Wells.

HomeChoice provides a digital TV service using a BT ADSL line.

At **Goldcrest Post Production Facilities** a Pro Tools system complete with Pro Control, edit pack and fader pack is being installed in a new multi-purpose room. Andy Thompson at Goldcrest examined a number of alternatives in systems and suppliers: "Pro Tools and Stirling Syco won. Pro Tools won because to get the same sort of functionality with other systems would have cost much more. Also the ability to expand Pro Tools is much easier and it is becoming much more widely used in post-production. Stirling Syco won because we were confident in their ability to give us the support we require."



FIBRE OPTIC REPLACES MULTICORE FOR DELTA AND BBC

Otari's ND-20 Network Audio Distribution Unit continues to find favour in many different applications from studio to theatre use.

One of the latest to have purchased is **Delta Sound**, a sound design and rental company working in many fields from corporate presentations and events, to theatre productions.

"The decision to purchase was driven by the Commonwealth

Games in July next year, where we are handling the sound for the opening and closing ceremonies." explains Paul Keating of Delta Sound. "I realised that the scalability of the ND-20 would make it ideal for this event and would allow us to build a network with up to 96 channels of digital and analogue audio. We looked at all the other options and nothing came close in terms of versatility. The different I/O options are ideal for us where we may be running an event with standard multicore configuration one week, and the next sending 24 tracks of Pro Tools around the network. And of course you can send the input signal around an ND-20 network and output in different signal formats wherever you need to."

The **BBC** has also equipped the **BBC Wales** studios in Cardiff with an Otari ND20 system providing 24 mic inputs to 24 AES/EBU via fibreoptic cable from the studio to a Sony DMX-R100 console in the control room. They will also use the ND-20 for location recordings.



ar Meijer in mancentrale

young Dutch com- a stunning video signer whose pure- y his eye-catching nd passports. The rland Orkest con- and into the mid- mance had already ged with making a e soundtrack of a

end its time doing all purist classical of Diehl and part- imalist approach microphones it has psychological pur- liance on an Augan y, in the wake of ull-blown Merging nd this, augmented the heart of the rig

iso was not rigged nt in the recording ring the acoustic

Over 300
at the UK

Stirling
Syco

GRAP

GAMES SOUND BETTER THANKS TO



CABLE + CONNECTOR

643-320 EUROPA KABEL 32 paar

Multipair Mic Speaker Line Co
All types always in stock

Over 100 connectors
XLR Jack Phono EDAC Harting

Over 200 leads
Audio Optical Digital Computer

HBB BurnIT



HBB BURNIT
Outsells all other CD Burners.

MEDIA



TDK QUANTEGY HBB IOMB
Full range for all applications

Next day delivery
Everything item

£3.00 + VAT flat rate
Studiospares Ltd. 61/63
tel 020 7482 1692 free fax 0800 731 3767 email sales@studiospares.com



World leading provider of middleware solutions for the games industry and a developer of games for next-generation consoles **Criterion Software Limited** is installing a new Pro Tools 5.1 recording studio in its Guildford headquarters. Prior to completion of the studio, designed by Recording Architecture, the Pro Tools system was temporarily set-up in a spare office at Criterion with a Mackie 24/8 console also supplied by Stirling Syco.

Head of Audio at Criterion, Stephen Root, explains his equipment choice: "A pro studio was an essential when Criterion recruited me to head up its Audio Department to deliver the highest quality audio that is needed for the next-generation games consoles. The audio on computer games is becoming more and more focused and as a result we need to have the correct professional facility in house. So I talked to Stirling Syco and they put a complete package together centered on the Pro Tools 24 Mix Plus system. Pro Tools really works for us - it's so powerful and flexible. It scores over other systems because so much of the functionality is on cards rather than within the software, and coupled with the Control 24 mixer it gives us an integrated solution to our recording requirements."

He added: "Already we have been able to improve the audio quality on our games, in terms of music, voices and sound effects by bringing the writing and recording in-house, with the new studio we can make things sound even tighter."

The complete studio package from Stirling Syco includes the 64-track Pro Tools system with TDM Waves Gold bundle running on an Apple Mac G4 - soon to be upgraded to a new dual-processor Quicksilver G4 - and the Digidesign/Focusrite Control 24, plus three Digidesign 888 24-bit I/O interfaces. In addition there is a wide range of outboard equipment including a Lexicon PCM91 reverb, Eventide Orville, TC Electronics Finalizer 96k & Fireworx, a full 5.1 surround monitoring system from DynaudioAcoustics, Akai S6000, synths from E-mu and Kurzweil. "Stirling Syco were fantastic," says Stephen. "They listened to our requirements and came up with the complete system to meet our needs - right down to cables and mic stands - and all at an extremely competitive price. I can't wait to get the studio up and running!"

LEXICON 960L UPDATE

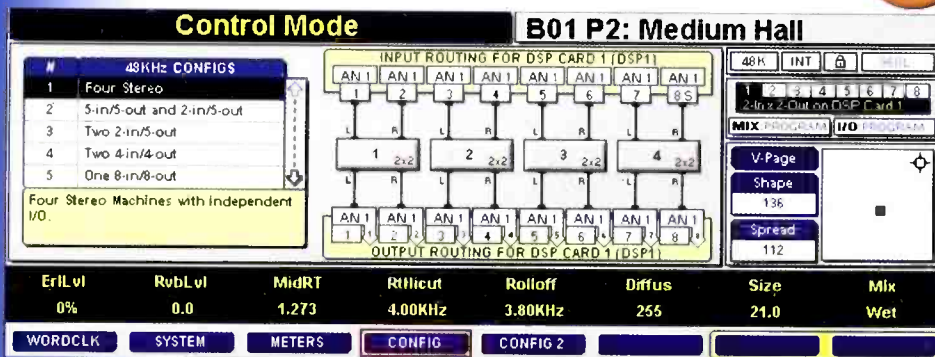

The 960L now provides more options for working in surround sound. A number of engineers feel that surround-reverb is not always the answer for 5.1 surround mixes, and would prefer to use multiple stereo devices. The 960L can now satisfy both these requirements. This feature enables the machine to be configured as four independent stereo reverbs each with their own inputs and outputs and unique programs (see LARC screenshot above). That's £2,700 per stereo reverb - pretty good value for this level of quality - even less for digital-only version.

TODD-AO SELECT APHEX 2020



The Apex 2020 FM Broadcast audio processor is increasingly being specified by TV broadcasters to solve their audio level problems. One of the latest is Todd-AO who are using it on the French and English channels of the Cartoon Network where the problem is continuity between programmes. The 2020 is used to maintain a constant audio level across all programmes and links.

SHOTGUN FOR HDTV
DIGITAL CAMCORDERS



The Sanken CMS-10 is switchable between a very sharp directional mono shotgun response and a specialised stereo shotgun mode that delivers a rich "Environmental Stereo Sound." Designed as a camera mounted microphone, the CMS-10 can also be mounted on a boom pole for field recording. The CMS-10 is small (less than 220mm length and 170g weight), an advantage in demanding field shooting, and the PPS diaphragm provides optimum durability in locations with high humidity and extreme temperatures. The CMS-10 is an excellent choice for creative engineers working in HDTV and H for movie production.

FORMAC STUDIO - TV FOR
YOUR M



1. Prov
2. Firew
3. Al
4. inpu
5. camc

£394.0
(incl. V

Phone: 020 7624 6000 - On-Line catalogue at www.stirlingsyco.com - Fax: 020 7372 6370

POST CODE StudioSound 11.01

XLR leads/plugs
Zimmer Racks
ZIP Drives

RADAR 24 UPDATE

NEW

RADAR 24 now available with 192kHz/24-bit/6 track option. Ideal for 5.1 mastering.



The release of 3.08 software by iZ Technology ushers in a new era of high-resolution multi-track recording for audio professionals worldwide. With the latest software and iZ Technology's incredible sounding S-Nyquist 192kHz A/D, D/A conversion board set, six tracks of 192kHz recording are now a reality for RADAR 24 users, complete with **real time** waveform display.

In the next release of software, which we have been assured will be with us very shortly, there are some other good features, including a **DSP Function** for level changes on individual tracks and cross-fades. Also coming soon is a **Mirror Drive** option, with twin 18GB drives, on the SCSI bus.

So you will have the security of a second drive recording your data - very useful, especially in live recording. Another great feature will be the ability to export **Broadcast WAV** files (DVD-RAM). So you will be able to import RADAR recordings into your Pro Tools or other workstation that reads Broadcast WAV files.

Recent RADAR 24 purchasers include: FX Rentals, Danny Chang, Stephen Street, Sain Studios, Eel Pie Studios, RG Jones Studios, Videolondon, Bryan Ferry, Rooster Studios, Stoneroom, Inchbrakie., Warehouse Studios, MCS Studios, Pet Shop Boys, Hackenbaker Sound, RAK Studios, Richard Harvey, Portishead, Angel Studios.

OVERTONES LOVES APHEX

Overtones provides recording, live sound facilities and support

to the independent music sector. Recently they purchased a number of the Aphex 1788 remote controlled mic pre-amps.

Lesley Willis, Director of Overtones explains their choice: "With funding from various sources including London Arts and the Regional Arts Lottery, our brief is to support the artistic vision of our clients across a wide range of musical genres from hip hop to classical. That places demands on us, which I in turn place on our suppliers - I expect greater things than normal. With mic pre-amps I'd almost given up in despair until Stirling Syco introduced me to the Aphex 1788. The stepped gain control on



most pre amps gives around 4-6dB jumps, which in the 'live' environments means play safe or compress the signal path - the 1788's continuously variable gain means you don't have to do that. These extraordinary devices manage to add nothing to the sound, take travelling well and have never once let us down. We've used them on everything from rehearsals for a forthcoming series of concerts with Sting and Katia Labeque, through Hip Hop at the Scala to the Lord Sainsbury Memorial Concert at St. Johns, Smith Square. They work equally well in our studios. I love 'em - which is why we now have 48-channels worth!"



AND M&K MILLER & KREISEL PROFESSIONAL A HIT IN WARDOUR STREET



'A Bomb in Wardour Street' is not just the title of a track by The Jam, but is also the name and location of the latest Soho studio to install a Stirling Syco-supplied surround sound system, based on Pro Tools and M&K monitors.

Peter Challis and Augusta Quiney, Directors of **A-Bomb** along with Neil Harris of Midnight Transfer in whose post-production facility the studio

is located, were keen to equip the new studio with the latest computer based systems. "We researched into both what our clients wanted and the systems available, and decided the Pro Tools route was definitely the way to go for editing, combined with Logic Audio for music production," says Challis.

"With both of these programs on the Mac G4, together with the TC 6000 for 5.1 mastering and effects, we have the best system for the type of work we do - music and sound design for commercials and films."

Challis also specified the Digidesign Focusrite Control 24 because: "We represent five other musicians and can be working on several projects at once, so I wanted a recall system that covered both the desk and the computer. The Control 24 gives me a fully integrated control surface, faders as well as plug-ins, and the sensitivity of the automation is incredible."

Completing the install are five M&K surround monitors, which Challis describes as: "Brilliant, I never thought that we'd be able to afford a set of monitors this good. They are just so accurate and transparent, and the great thing is that the clarity and balance remain the same at low level or when you crank them up."



ar Meijer in mancentrale

young Dutch com- a stunning video designer whose pure- his eye-catching and passports. The rland Orkest con- and into the mid- performance had already ged with making a e soundtrack of a

end its time doing all purist classical of Diehl and part- imalist approach microphones it has psychological pur- liance on an Augan y, in the wake of all-blown Merging and this, augmented the heart of the rig

iso was not rigged ent in the recording ring the acoustic

Over 300
at the UK

CABLE + CONNECTOR

643-320 EUROPA KABEL 32 paar

Multipair Mic Speaker Line Co
All types always in stock

Over 100 connectors
XLR Jack Phono EDAC Harting

Over 200 leads
Audio Optical Digital Comput

HMB BurnIT



HMB BURNIT
Outsells all other CD Burners

MEDIA



TDK QUANTEGY HMB IOM
Full range for all application

Next day delive
Everything item

£3.00 + VAT flat rate
Studiospares Ltd. 61/6
tel 020 7482 1692 free fax 0800 731 3767 email sales@studiospares.com

Stirling Syco

GRAPEVINE

DM-24 – FANTASTIC NEW DIGITAL MIXER FROM TASCAM

The first affordable digital mixer that combines 24-bit, 96kHz audio quality with:

- Highly flexible routing
- Extremely powerful built-in automation
- Built-in professional quality effects, dynamics processing and parametric EQ
- Custom 32-bit processor for true 24-bit performance throughout the digital signal path.

You don't need a computer for the DM-24's automation – it's all built-in. Up to 8 entire mixes can be stored in the DM-24. When a new mix is opened, the DM-24 automatically goes into its automation mode so any static changes you make are saved instantly, and you can offload all automation data via MIDI.



NEW AKAI Z-SERIES – WORLD'S 1st. TRUE 24-BIT, 96KHZ SAMPLERS



Massive memory options – up to 512 MB
USB Networking control software
Real-time sound control with Q-Link™ Modulator
Sample rate conversion (Z-4 only)

DESIGNER TALK: AUDIENT ASP 520 5.1 BASS MANAGEMENT CONTROLLER



Audient has recently introduced a new addition to its range - the ASP520 Bass Management Controller. We asked the designer, **David Dearden**, to explain why you need one:

"Any surround sound monitoring environment which does not have 5 full range loudspeakers in addition to a sub-woofer needs some form of Bass Management in order to hear the full bass response of the surround mixes. Due to lack of space, a typical surround room may only have full range speakers at the front, with smaller satellite speakers for the rear. In fact, many will have small speakers in all positions. Whatever the setup, it is vitally important that the missing 2 octaves which the smaller speakers can not handle properly is reproduced somewhere in the room, normally through a separate sub-woofer.

"The ASP520 is a uniquely flexible Bass Management Controller which permits the bass redirect source to be selected from any combination of the front left/right pair, the centre, or the rear left/right pair. In addition, the stereo near field speaker system can also be a redirect source. So you can listen in stereo on your nearfields, and still get a realistic bass response - even from an old pair of NS10s!

"Sub-woofers are rarely positioned in the optimum location, so some EQ is often necessary to compensate for room effects. With the ASP520 a 2-band, fully parametric EQ - tailored for LF equalisation, is included in the sub-woofer output, saving the expense of additional EQs."

DESIGNER TALK: SPL 2049 KULTUBE



The SPL 2049 is a stereo compressor with a broad range of control facilities to cover all typical compressor applications. Kultube designer **Ruben Tilgner** of SPL explains what makes it so special.

"There are three unique features we developed that make the Kultube so good. Progressive Time Control (PTC), discrete Gain Cells, and tube circuitry. PTC gives an automated time constant setting according to the input signal, ensuring perfect settings throughout the whole processing time rather than for just one instant. These automated settings can be influenced by the user settings of attack and release.

"We don't use industrial standard VCAs, because these are not normally designed for audio applications and are often a compromise between what you pay and what you hear. Instead the Kultube employs discrete transistor-based Gain Cells for this central task. The advantages are high levels of musicality and clarity in signal processing, and significantly improved distortion values over VCAs.

"The variable tube saturation circuit maintains a constant output level when the control is being adjusted from a hint of warmth to approaching dirty – applying variable tube effects for more density, weight or distortion has never been so easy."



STIRLING SYCO
Kimberley Road
London NW6 7SF
T: 020 7624 6000
F: 020 7372 6370
E: sales@stirlingsyco.com
www.stirlingsyco.com

DOWNTIME? – NOT IF WE CAN HELP IT!

Our reputation is important to me, that's why as well as being competitive on price we also have a dedicated technical support team. If you have a problem a trained technician will sort it, not a sales person like at some dealers. A large percentage of our customers come back to us time and time again because our sales and support teams are knowledgeable, friendly and professional – and if you are not happy with our support, then I want to hear about it!



Andrew Stirling

All prices shown are correct at time of going to press, and are subject to availability. E&OE

Phone: 020 7624 6000 – On-Line catalogue at www.stirlingsyco.com – Fax: 020 7372 6370

ocs3565oct01

POST CODE StudioSound 11.01

XLR leads/plugs
Zimmer Racks
ZIP Drives

RECORDING



Angels at play at *Paradiso*

experience of the great building's space, and for this Kompas decided to try the SPL-Brauner Atmos 5.1 microphone array (*Studio Sound*, July 1999), brought along specially for the event by SPL's André Inderfurth. This was placed close to the conductor's head—perhaps closer than the ideal in order to avoid getting too much of the amplified sound.

Kompas has a long-standing relationship with Dutch electronics designer Rens

Heijnis, and played a big part in encouraging and developing his Sonodore RCM-402 omni microphones (*Studio Sound*, September 1997). These are in regular use in the Kompas armoury, and six of them were rigged for *Paradiso* along with custom Heijnis mixers and electronics—the Sonodores need their own high-voltage power supplies rather than phantom, and Heijnis produces portable mixers with this provided. An AB pair of 402s flanked the Atmos array, another pair was placed centrally further upstage, and another was used for the choir. Multiple splits, both subgroups and individual feeds, were taken from the PA, which had a surprising collection of microphones ranging from Neumann KM184s to Shure Beta 58s and Y-corded DPA subminiatures on the strings, and including truckloads of AKG Blue Lines.

This lot was fed via cables draped through windows across cracked and overgrown concrete into another building, where an *ad hoc* control room was set up in what was once the security office of

→ Recently, some stuck in the past know-it-alls were seen defacing our ads to prevent people from finding out just how cool the new SPL Kultube[®] really is. They weren't interested in its true stereo operation, the unique "Tube Harmonics" control, the de-compressor mode, surround processing applications or our new interactive "Progressive Time Control" that makes musically sympathetic compression so easy to achieve. So we'll just have to wait until they get around to listening to the Kultube.

A great recording takes imagination, good ears and just three letters.

Sound Performance Lab: Tel. +49 (0) 21 63 - 98 34 - 0, Fax -20 • Mail: info@soundperformancelab.com
For detailed information please visit: www.soundperformancelab.com



all lies
stuff + mouse



the power station. Here we were treated to the unlikely sight of a 32-channel recording system with no mixer visible at the monitoring position. A couple of small mixers had to be drafted in later when it transpired that some of the feeds from the PA were at mic level, not line as had been indicated, but their sole function was to act as preamps. The main job of routing, mixing and monitoring the recording was to be done with mouse and screen—a bold approach even with a simple job and lots of time, but under these circumstances a real test of the system.

You might expect the Pyramix hardware to have dominated the control room, but so compact is it that you barely notice it, leaving the main mixing position looking as though someone has forgotten to bring something important. The system runs on a single (albeit pretty grown-up) PC, with its own outboard hardware interface boxes known as Sphynx. Each Sphynx handles eight channels, and is available with or without D-A convertors so that a rig can be built to meet a purpose without spending money on facilities that are not needed. In this case, although all four Sphynxes had A-Ds to give 32 inputs in total, only one had the D-As installed. There was no intention of bringing the 32 channels

marantz®

Professional

one touch (auto) mastering



Introducing the Marantz CDR500 Combination CDR Recorder/CD Player with AUTOMASTER™.

Until now "proper" Red Book mastering was only possible in a CD mastering studio.

When burning a CDR, everytime the laser stops errors are created in the linking points. These are skipped over during replay in a conventional CD player, producing the familiar muting effect between tracks.

Prior to pressing a CD, a mastering plant will search for and correct these errors before making the final Glassmaster, enabling the production of the complete CD in a single Disc At Once process. This involves the high speed transfer of the programme material to Exabyte tape or hard disk in an intermediary process that incurs additional cost and may introduce increased levels of jitter to the detriment of the recording.

The Marantz CDR500 with on-board AUTOMASTER™ enables you to produce a properly finalised CD ready for pressing; simple, quick & inexpensive.

And that's not all. A wealth of other professional features including DSP Audio Buffer, CD Text Writing, Normal and High speed (2x) duplication, full SCMS manipulation, balanced (XLR) analogue inputs with level trim, SPDIF Digital inputs/outputs and full CD/CDRW playback, combine to make the Marantz CDR500 the essential studio tool.

MARANTZ PROFESSIONAL - EXCEPTIONAL BY DESIGN

STUDIO SOUND
Award winner 2001
"Audio Recorder"
CDR500

CDR500 COMBINATION CD RECORDER/CDPLAYER

RECORDING

back out individually, so eight outputs was sufficient for the planned simultaneous 5-channel and 2-channel stereo mixes. An initial plan to run four DA-78s as a backup was abandoned when it became apparent that feeds were not at the expected level, making splitting awkward, and that Pyramix was going to handle the job standing on its head anyway.

The Sphinx interfaces deliver digital signals to cards in the PC via fibre optic connectors, and further cards also deal with time code and composite video synchronisation, both of which had to be connected to the video boys. The video 'control room' was set up inside the venue with trucks parked in the indoor garden at the back; four remote control cameras were all that was required, running on to separate



The Helpmancentrale auditorium showing controversial metal projection screen

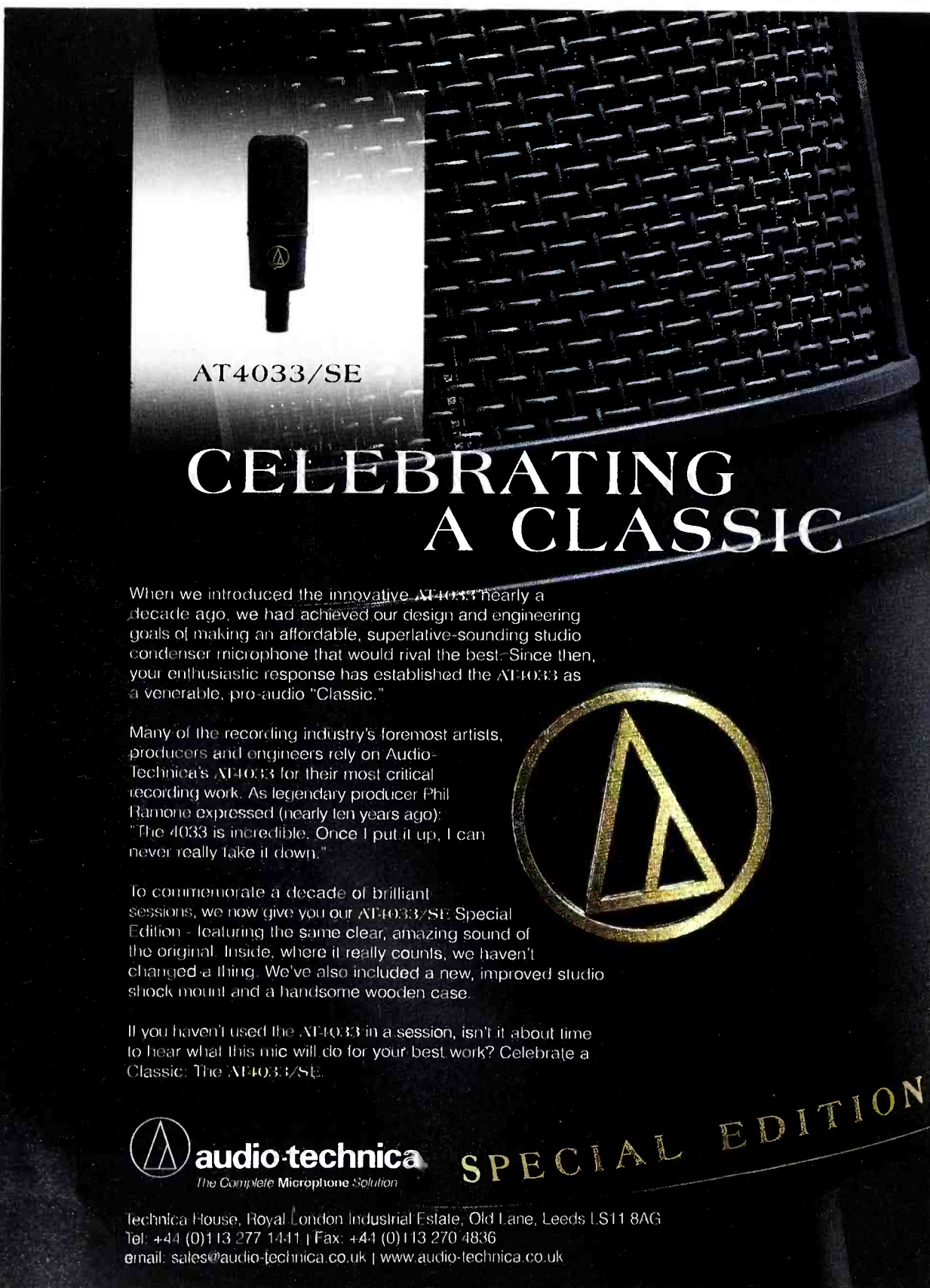

AT4033/SE

CELEBRATING A CLASSIC

When we introduced the innovative AT4033 nearly a decade ago, we had achieved our design and engineering goals of making an affordable, superlative-sounding studio condenser microphone that would rival the best. Since then, your enthusiastic response has established the AT4033 as a venerable, pro-audio "Classic."

Many of the recording industry's foremost artists, producers and engineers rely on Audio-Technica's AT4033 for their most critical recording work. As legendary producer Phil Ramone expressed (nearly ten years ago): "The 4033 is incredible. Once I put it up, I can never really take it down."

To commemorate a decade of brilliant sessions, we now give you our AT4033/SE Special Edition - featuring the same clear, amazing sound of the original. Inside, where it really counts, we haven't changed a thing. We've also included a new, improved studio shock mount and a handsome wooden case.

If you haven't used the AT4033 in a session, isn't it about time to hear what this mic will do for your best work? Celebrate a Classic: The AT4033/SE.



 **audio-technica**
The Complete Microphone Solution

SPECIAL EDITION

Technica House, Royal London Industrial Estate, Old Lane, Leeds LS11 8AG
Tel: +44 (0)113 277 1411 | Fax: +44 (0)113 270 4836
email: sales@audio-technica.co.uk | www.audio-technica.co.uk

machines for later integration with the pre-recorded visuals. There was even a special version of the ending produced for the DVD and not seen at the live performances, as it was felt the existing ending, featuring an increasingly bright white screen, would lose its impact on TV.

With so much handled internally in the computer, the Pyramix system looks deceptively simple, yet it has a capacity of 5.5 hours of 32 48kHz tracks on the internal hard drive. In fact running as it was, recording the full 32 tracks, producing a 5-channel mix, and slaved to video reference, it was still only showing a DSP usage of 35%. A single monitor handles everything, with a comprehensive mixer on screen using mouse and keyboard to operate it. The details of the user interface are unimportant here; what was impressive was the speed with which Oscar Meijer, on relatively limited acquaintance with the system, was able to set up the complex routing, adjust levels and produce a basic working surround mix. Mix data, both static and dynamic, can be stored in the system, although in this case it could only form a starting point for the full later mix. In any case, as the monitoring was far from ideal—five Sound Project X-Act powered monitors placed as close to the right positions as the room layout allowed, working in a room that was little more than bare walls—no reliance was to be placed on the monitor mix achieved live. Nonetheless the circumstances were quiet and detailed enough to allow any problems to be heard, the chief of which was the conductor's very loud monitor firing past his head straight into the main arrays; fortunately he was gracious enough to allow it to be moved.

Surround monitoring requires surround level and source control, and the flexibility of the Atmos control unit came into its own for this: its microphone signal were sent to Pyramix from the insert sends, while the finished mix was fed to its insert returns, allowing easy global volume control and instant comparison between the Atmos alone and the full mix—naturally the latter was far more detailed and up front, while the natural acoustic impression of the Atmos lent the surround image solidity and reality.

This job was seat-of-the-pants stuff, where normally simplicity and familiar techniques would be the natural route. By almost deliberately avoiding both, Kompas appeared to be taking a big chance with *Paradiso*, yet such is the efficiency of the chosen systems that it seemed little more challenging than setting up their usual half-dozen omnis for a simple stereo mix. The end result should be both a convincing record of a remarkable event and a powerful experience in its own right. □

finding the right audio dealer is your first move



G2-G4



F5xG4



H3xG4



NF6xG4

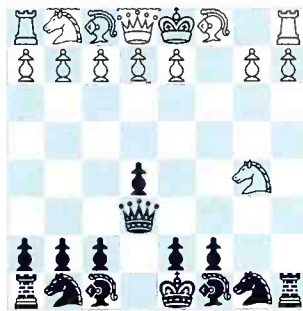

QD1-D3

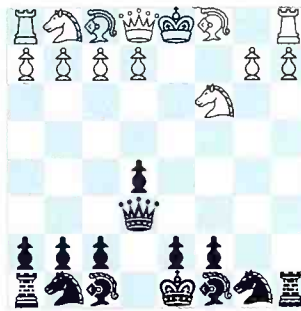

NG4-F6



RH1xH7

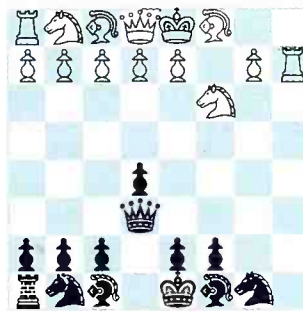

RH8xH7



QD3-G6



providing solutions...

media
tools

THE SOUND OF MAGIC

Harry Potter's adaptation from page to big screen saw supervising sound editor Eddy Joseph balancing tight deadlines and incomplete visuals with child actors and the game of Quidditch. **Kevin Hilton** reports

THE PHRASE 'the magic of the movies' is over-used but it is one that has stuck with the medium from the earliest days of special effects right up to today's computerised graphics and ear-bashing surround sound. Magic has also been a common subject for films, with just about every conceivable magician, conjurer, sorcerer and wizard—from Houdini to Merlin—being portrayed on the silver screen.

This month, arguably the youngest practitioner of the mystic arts joins these luminaries. *Harry Potter and the Philosopher's Stone* is one of the two most keenly awaited films of this year. The second is *The Lord of the Rings*, also an adaptation of a much-loved book, albeit a longer established and more literary work, that is due for release not long after the adventures of the apprentice wizard begin.

Harry Potter and the Philosopher's Stone (known as *Harry Potter and the Sorcerer's Stone* in the US) was the first novel to be published by British author JK Rowling, who has gone on to great acclaim, success and fortune. Just like *The Lion, the Witch and the Wardrobe*, undoubtedly a precedent if not a direct influence, the Harry Potter books have proved popular with children and adults alike as they are about what happens when 'ordinary' children escape the adult-dominated world into a realm where they have practical and mystical powers.

Directed by Spielberg alumnus Chris Columbus, whose credits include *Home Alone*, *Harry Potter and the Philosopher's Stone* stars Daniel Radcliffe as the young magician. The youngster is neglected by his aunt and uncle, played by two actors adept at grotesques, Fiona Shaw and Richard Griffiths, but he breaks out of that world when he enrolls at Hogwarts School of Witchcraft and Wizardry. This institution is overseen by Richard Harris as the headmaster; others involved include Maggie



Smith, Alan Rickman and Robbie Coltrane as the groundskeeper.

Hogwarts has been created at Leavesden Studios, 20 miles outside London. This extensive set has not yet been struck as, even before the first movie is released, the second in the series, *Harry Potter and the Chamber of Secrets*, is due to go into production next year. Other locations have included Gloucester Castle and various university colleges around Oxford.

The sound of magic is something that must have concerned many over the years, JK Rowling among them. It certainly has concerned Eddy Joseph since the end of last year, when he was engaged as supervising sound editor on this film. Joseph, whose previous credits include the very different and deeply impressive *Enemy at the Gates*, began work on *Harry*

Potter on 19th February this year.

A now common situation faced by audio post-production crews in the movie business is that even at the late stage they become involved in the proceedings, not all the visuals will have been completed. Indeed, at the time of this interview with Joseph, one of the key sequences, the Quidditch game, had not been finished. As the creation of the sounds relies partly on what is being seen, this means that a great deal of the film could not be locked off until a time worryingly near the release date.

This organic way of working was evidently something Chris Columbus wanted to achieve but it still proved vague in terms of explaining exactly what the film should sound like. Joseph says that during his first discussion with the director, Columbus said he did not want to use anything that sounded modern, futuristic or electronic. After this briefing, Joseph and sound effects editor Martin Cantwell spent a lot of time 'playing around' with various wind and animal noises. Cantwell also went to Penshurst Castle in Kent to record, among other things, creaking doors.

Like other sound designers working today, Joseph makes efforts to avoid using the generally available sound effects libraries. This is partly not to duplicate what others have done—Joseph says this is more important within the industry as other sound editors will recognise specific tracks, something that the average movie-goer is unlikely to do—and partly because, on this project, many of the tracks that were used did not exist in any library.

Joseph admits that some elements may be used from commercially produced collections but, in the main, he and Cantwell tend to record original sounds. 'Martin is always taping stuff when he hears a good sound, so that he can add it to his own library,' says Joseph, who



**Available
Now**

New Audio Logger

- Dedicated reliable 4 channel recording hardware with built-in hard-disk.
- Easy to use Windows remote operation for playback, archiving, streaming and configuration over a TCP/IP network.
- Independently configurable channel pairs to record at different sample rates, bit rates and in mono or stereo.
- Failsafe alarm indicators with remotes, and password protection with security access rights to system.
- Record inputs which can be controlled manually, by time or remotely.

SONIFEX

61, Station Road, Irthlingborough,
Northants., NN9 5QE, UK.

Tel : +44 (0)1933 650 700
Fax : +44 (0)1933 650 726

Email : sales@sonifex.co.uk
Internet : <http://www.sonifex.co.uk>

VS2108

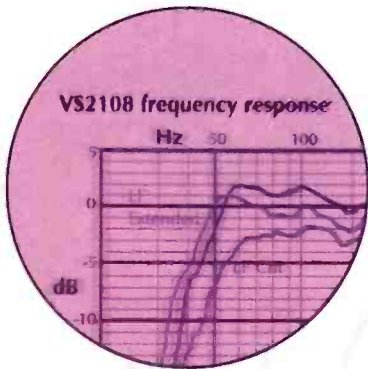

Roger Quested's got a bit of a thing about speakers.

With over 30 years experience in monitor and acoustic design you may even call him obsessive.

However, this single mindedness has produced many of the innovations we now take for granted in speaker design.

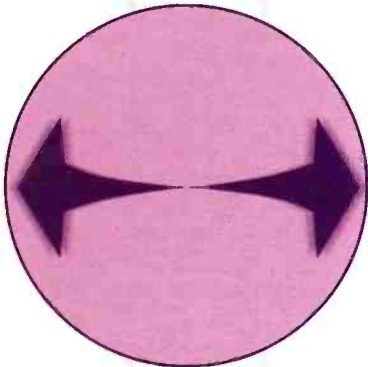

With Roger's range of smaller cabinets you can now bring Quested quality into your studio, whatever the size. The **VS2108** retains the superb stereo imaging and flat response which characterise the Quested range.

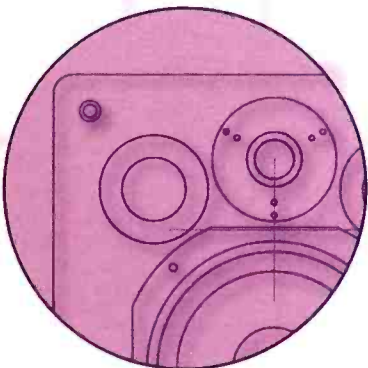

So next time you need serious monitoring, you won't have to think too hard. Chances are Roger Quested has done the thinking for you.

Quested users:

- Abbey Road
- Sarm West
- The Hit Factory
- Manor Mobile
- Sony Music Studios
- Euphonix
- Zoo
- Jungle
- The Sound Company
- Square Centre
- Sasha
- Talvin Singh
- Blade
- Hans Zimmer
- Vince Clarke
- Joan Armatrading
- Van Halen



Quested Monitoring Systems Ltd
Unit 2A, West Ealing Business Centre, Alexandria Road, W13 0NJ
tel 020 8566 2466 fax 020 8566 2488

...providing solutions

SALES

The MediaTools group has been supplying the professional audio industry for over 20 years. Our large demonstration facility is ideally situated in the heart of Soho's post production community and, with one of the UK's most extensive product ranges, we confidently provide for every area of the audio equipment market... from the smallest cable to the most demanding installation.



SUPPORT



When you purchase a system from MediaTools you also qualify for our comprehensive technical support. We have supplied hundreds of systems to working professionals and understand the importance of ongoing aftersales contact and service. In the event of difficulties you can relax in the knowledge that you have the backing of a team of experts consistently abreast of the latest technical developments. Our logged telephone and onsite support infrastructure reflects our commitment to keeping you working.

MediaTools - you can count on our support.

TRAINING

MediaTools offer structured training programs to help you quickly get up to speed with your new system. So whether you are a post-production facility making the move from Audiovision to Pro Tools or equipping a Music Technology department, we can provide targeted material to help you optimise your skills in the shortest time.



audio solutions for post production and music

12 Flitcroft Street London WC2H 8DL
(t) 020 7692 6611 (f) 020 7692 7619 www.mediatools.co.uk

media
tools

adds that the two of them spent a lot of time thinking about what the various great halls and other spaces featured in the film should sound like.

Audio post began with the team centred around just Joseph and his assistant laying down the various effects and dialogue tracks. When an early cut of the film had been assembled for viewing by Warner Brothers' president of world-wide theatrical production, Lorenzo di Bonaventura, Joseph put together to go with it what he describes as the best soundtrack he could offer at that time. 'The director and picture editor wanted to present what had already been done in the best possible shape,' he explains. 'I always mix down from 24-track to 2-track for the cutting copy but temps are getting

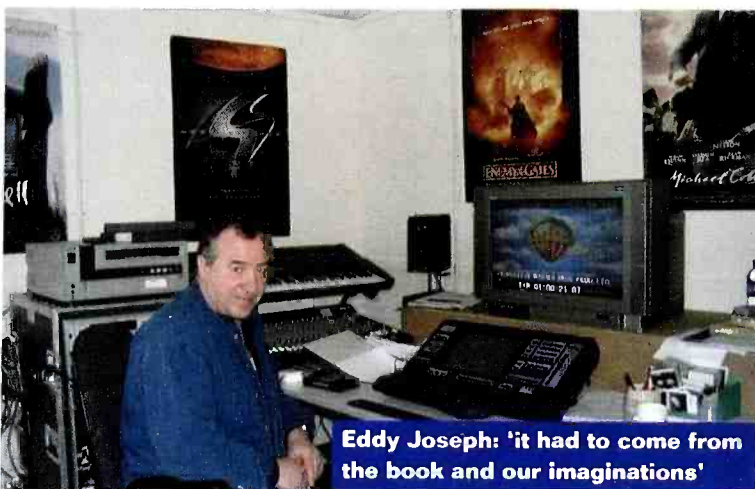

Eddy Joseph: 'it had to come from the book and our imaginations'

more extravagant these days.'

Joseph decided that the only way to give Di Bonaventura a good idea of what the finished movie would sound like was to produce a sample track and lock it up to the picture. This, he says, worked so well that it was decided to keep that and use it as a reference throughout the rest of the production. 'The sound design evolved from that,' Joseph observes.

Even so, for some of the sequences Joseph and Cantwell were still working purely to the script and whatever comments were coming from the production team. The Quidditch game is a prominent example of sound effects being created to fit with visuals that did not at the time exist. Quidditch is a game of 'super hockey' that is played in the air by 14 children on broomsticks.

Instead of one ball, as in the conventional ground-based game, this aerial, mystical version of hockey involves three balls, each of which had to have an individual sound. The Quaffle is a red ball that is passed around the field and is used to score goals. There are two Bludgers, small black balls that are designed to be hit towards opposing players with the intention of knocking them from their brooms. Then there is the Snitch, a golden ball the size of a walnut that flies around at high speed; when this is caught, the game is over.

Joseph and Cantwell decided that as the Bludgers are nasty, independent balls, they should sound like angry animals. In contrast, the Snitch has an elegant, humming bird-like sound. 'We didn't get any of that from the visuals,' Joseph says, 'it had to come from the script and the book and our imaginations. When I first heard I might be involved in this project, I read the book and enjoyed it. It also gave me some ideas about what things should sound like.'

The number of Harry Potter related web sites and the amount of interest the books and now this film has generated shows that people are willing to believe in Rowling's fantasy world. As he sees it, Joseph's task was to ensure the audience continues to believe when they finally see the movie. 'Everything has to be real,' he says. 'Hogwarts, for example, could not be seen to have

electricity, so everything is lit by candles, which have a sound of their own.' Prime amongst these are the flambeaus, which activate when someone walks past.

Among the other elements that sound had to make as real as possible for the audience are a troll and a three-headed dog called Fluffy. Despite the best of efforts, Joseph realistically knows that there will be some fans who will be disappointed with the way some things sound and look. 'Everybody who read the book has an idea of what the characters and places look and sound like,' he says, 'and we and the visual effects people won't be able to satisfy them all.'

Track-laying began at Leavesden Studios, where the sound effects and editing audio crew were working alongside the location personnel and cast. Production sound was recorded on DAT by John Midgely; while Eddy Joseph says some of the shots made it difficult to get the best possible 'live' sound, he says most of what was recorded was usable. 'We have used a lot of what was shot,' he says, 'partly because it was good and partly because, when you work with child actors, it's best to do a few takes on location. If you try to emulate it in ADR, it doesn't work as well, especially if you're redoing a performance that was pretty much made up on the spot.'

Joseph and his team moved to Shepperton Studios towards the end of the summer. In addition to Joseph and Martin Cantwell, Colin Richie edited the dialogue, Nick Lowe handled ADR and Peter Holt took care of Foley. It is common today for movie audio post to be split between two or more makes of digital audio workstation; the dichotomy is usually one for effects and one for dialogue and ADR.

The split on Harry Potter is not quite so obvious. Around half the effects were edited on two DAR SoundStation STORMs; the other half was laid to Avid Audio Vision running in Pro Tools mode. All production dialogue was edited on Audio Vision, with the effects and ADR being cut on the STORMs, which worked in conjunction with 'a couple' of DAR OMR8s. The decision to use DAR for ADR was, according to Joseph, a logical one as Nick Lowe owns a STORM. The Foley was put together on Akai DD8.

As Joseph points out, using the machines found in most studios makes file transfer easier but with the advances made in this field recently, it is not as difficult as it once was to pass material between different devices. The OMR8s were chiefly used for file transfer, with tracks on Avid or Pro Tools being passed through these to the STORMs and back again. 'It took a bit of working out because no-one has been doing this kind of thing,' says Joseph, 'but I think it will be something that will be done in the future. There are limitations with anything but there is also the chance to discover that you can do things you didn't know were possible on a certain machine.'



CD-R

INTERNATIONAL DISTRIBUTORS

AUSTRALIA: AUDIO PRODUCTS AUSTRALIA PTY LTD
Tel: 617 5502 8229 Fax: 617 5502 8229
Contact: Michael Guest

AUSTRIA: STUDER AUSTRIA GMBH
Tel: 01 865 1676 Fax: 01 865 167699
Contact: Reinhold Fliedl

BELGIUM: APEX
Tel: 089 30 63 13 Fax: 089 30 60 16
Contact: Rik Hoere

BRAZIL: VISOM BRASIL
Tel: 021 493 7312 Fax: 021 493 9590
Contact: Carlos De Andrade

CANADA: HHB COMMUNICATIONS CANADA LTD
Tel: 416 867 9000 Fax: 416 867 1080
Contact: Dave Dysart

CZECH REPUBLIC: AUDIOPOLIS
Tel: 02 3332 2132 Fax: 02 3332 4172
Contact: Jan Adam

DENMARK: INTERSTAGE A/S
Tel: 39 46 0000 Fax: 39 46 0040
Contact: Finn Juul

FINLAND: HEDCOM
Tel: 358 9 6828 4600 Fax: 358 9 6828 4674
Contact: Jarmo Roivas

FRANCE: MILLE ET UN SONS
Tel: 01 46 67 0210 Fax: 01 47 89 8171
Contact: Richard Broomfield

GERMANY: FOR-TUNE
Tel: 0711 39 69 380 Fax: 0711 39 69 385
Contact: Stefan Mayer

GREECE: KEM ELECTRONICS
Tel: 01 647 8514 Fax: 01 647 6384
Contact: Thimios Kolikotsis

HOLLAND: TM AUDIO HOLLAND BV
Tel: 030 241 4070 Fax: 030 241 0002
Contact: Peter de Fouw

HONG KONG: DIGITAL MEDIA TECHNOLOGY
Tel: 2 721 0343 Fax: 2 366 6883
Contact: Wilson Choi

HUNGARY: HELS CO LTD
Tel: 01 335 0859 Fax: 01 346 0267
Contact: Zoltan Szeles

IRELAND: BIG BEAR SOUND LTD
Tel: 01 662 3411 Fax: 01 668 5253
Contact: Julian Douglas

ISRAEL: BAND PRO FILM VIDEO INC
Tel: 03 673 1891 Fax: 03 673 1894
Contact: Ofer Menashe

ITALY: AUDIO EQUIPMENT SRL
Tel: 039 212 221 Fax: 039 214 0011
Contact: Marco Porro

MALDIVES: ISLAND ACOUSTIC PTE LTD
Tel: 960 31 0032 Fax: 960 31 8264
Contact: Mohamed Habib

MEXICO: PRO AUDIO DIGITAL
Tel: 525 531 58 58 Fax: 525 203 00 18
Contact: Ingacio Rodriguez Bach

NEW ZEALAND: SOUND TECHNIQUES
Tel: 09 846 3349 Fax: 09 846 3347
Contact: Stephen Buckland

NORWAY: LYDROMMET AS
Tel: 47 22 09 1610 Fax: 47 22 09 1611
Contact: Christian Wille

POLAND: DAVE S.C.
Tel: 22 826 4912 Fax: 22 826 4912
Contact: Bogdan Wojciechowski

PORTUGAL: ELECTROSOUND PORTUGESA
Tel: 01 417 0004 Fax: 01 418 8093
Contact: Carlos Cunha

RUSSIA: A&T TRADE INC
Tel: 295 796 9262 Fax: 095 796 9264
Contact: Alexei Gorsky

SINGAPORE/ASIA: SENNHEISER ELECTRONIC ASIA PTE LTD
Tel: 273 5202 Fax: 273 5038
Contact: Rick Shen

SOUTH AFRICA: E.M.S.
Tel: 011 482 4470 Fax: 011 726 2552
Contact: Mike Shepstone

SPAIN: LEXON
Tel: 34 93 602 1400 Fax: 34 93 602 1402
Contact: Angela Costa

SWEDEN: POL TEKNIK AB
Tel: 08 449 4440 Fax: 08 88 4533
Contact: Jarmo Masko

SWITZERLAND: GOTHAM AUDIO SWITZERLAND
Tel: 01 840 0144 Fax: 01 843 1050
Contact: Franz Ammann

SYRIA: HAMZEH & PARTNERS CO
Tel: 11 333 3753 Fax: 11 373 1573
Contact: Khaled Hamzeh

TAIWAN: DMT TAIWAN LTD
Tel: 02 516 4318 Fax: 02 515 9881
Contact: Honton Sze

TURKEY: BL MUZIK
Tel: 0216 4111918 Fax: 0216 4113243
Contact: Baris Buyuk

USA: HHB COMMUNICATIONS USA INC
Tel: 310 319 1111 Fax: 310 319 1311
Contact: David Beesley



FIRST WE LISTEN

HHB Communications Limited

73-75 Scrubs Lane · London NW10 6QU · UK
Tel: 020 8962 5000 Fax: 020 8962 5050 E-Mail: sales@hbb.co.uk
Visit HHB on line at <http://www.hbb.co.uk>

WHAT REALLY MATTERS IS THE SOUND

BurnIT
CDR830 COMPACT DISC RECORDER



Sonically, the 830 excels with its 24-bit AD/DA converters.

The 24-bit Delta-Sigma D/A converter has a beautiful, warm, balanced sound, clear in the highs with excellent stereo separation.

The CDR830 BurnIT is ideally suited for use in

the recording studio or broadcast environment.

The sound quality is superb, and the unit has the usual HNB reliability.

Candace Horgan
Mix, April 2001

...one of the main reasons to get a stand-alone CD burner is sound quality, and here is where BurnIT really excels. I have found all of HNB's CD recorders to have excellent audio quality ...

I just know what my ears tell me - that the BurnIT sounds great.

David Darlington
HomeRecording, June 2001

HNB Communications Ltd · 73-75 Scrubs Lane, London NW10 6QU
Tel: 020 8962 5000 · Fax: 020 8962 5050 · E-Mail: sales@hnb.co.uk

HNB Communications USA Inc · 1410 Centinela Avenue, Los Angeles, CA 90025-2501, USA
Tel: 310 319 1111 · Fax: 310 319 1311 · E-Mail: sales@hhbusa.com

HNB Communications Canada Ltd · 260 King Street East, Toronto, Ontario M5A 4L5, Canada
Tel: 416 867 9000 · Fax: 416 867 1080 · E-Mail: sales@hhbcanada.com

www.hnb.co.uk



POSTPRODUCTION

A STORM and an Audio Vision were kept on the stage at Leavesden during filming, enabling ADR to be carried out on site, with instantaneous access to the various libraries being used. 'The STORM allows you to instantly go from magneto-optical,' explains Joseph. 'The Audio Vision can only do that once you've shut the machine down and re-started it.'

Location dialogue was transferred from DAT and auto-conformed to the Audio Vision, while lines for ADR were conformed as STORM files through the OMR8. ADR is sometimes recorded long after the end of shooting, which can cause problems in terms of both getting the artist back from whatever they have moved on to and getting a performance that is as good as or better than the original. Members of the Cinema Audio Society in the US recently sent an open letter to pro-

ducers and directors saying that if ADR has to be done, it should be done either on site or as soon after the initial take as is possible.

This happened on *Harry Potter and the Philosopher's Stone*—only for reasons of expediency. A strike by members of the Screen Actors Guild was in the offing this summer, so all ADR was recorded by the end of June, pretty much as soon as the dialogue had been shot on location. While Joseph attempted to keep the amount of re-recording down to a minimum, there was one aspect that meant there was going to be at least some ADR.

It's that title. In the UK the book, and consequently the film, is known as *Harry Potter and the Philosopher's Stone*. In the US the title was changed at the suggestion of JK Rowling's American editor, Arthur Levine. He was concerned that the original title would give a 'mislead-

ing' idea of what the story was about. Levine and Rowling discussed various alternatives before the author came up with *Harry Potter and the Sorcerer's Stone*. While this makes the work sound less esoteric, it probably gave spurious credence to the accusation by the moral majority in the US that Harry Potter promotes witchcraft.

Either way, it caused problems for the sound crew. For the two main 'domestic' versions (the UK and the US), every reference to the Stone had to be made twice,



one referring to the Philosopher, one mentioning the Sorcerer. When the line was on screen, this called for alternative takes. As some lines were spoken by actors off-screen, these could be dealt with purely by ADR. Aside from the two main versions, the movie has also been prepared in 30 different languages, making for a total of 15,000 prints.

Joseph and his team prepared 16 tracks of dialogue, 16 tracks of ADR, around another 16 tracks of crowd noise and 16–24 tracks of Foley. There were up to 64 tracks of sound effects; Joseph says that there were more in some scenes and fewer in others. A greater number of tracks were also used on some elements to obviate the need for panning during the dubbing process to achieve surround effects. Joseph says that a 5-speaker configuration can be used to assign specific tracks to different parts of an effect, which will then move around the sound picture. Although *Harry Potter* is being presented in Dolby Digital EX, with six loudspeakers, it is still effectively five channels as the third surround is a matrix.

For flying sequences, Joseph explains that Tracks 1, 2 & 3 were assigned to the centre front channel, comprising the whoosh of flight on Track 1, the sound of the broomstick on Track 2 and the flap of Harry's cloak on Track 3. With these three elements in the middle, Tracks 4, 5 & 6 are used for the right front loudspeaker, Tracks 7, 8 & 9 for right surround, Tracks 10, 11 & 12 for left surround and Tracks 13, 14 & 15 for front left. Joseph says that if this can be done in the laying up process, then there is no need to use the pan stick during dubbing. 'It's more work but it is a more accurate way of doing surround,' he says.

The dub was engineered by re-recording mixer Ray Merrin in Theatre 4 at Shepperton, on a Harrison MPC desk and mastered to Akai. The music by John Williams, a specialist in lush fantasy scores, was recorded at AIR Lyndhurst. With the second Harry Potter film already announced, Eddy Joseph is not certain whether he will be working on it but can console himself with the knowledge that he has already created a good many of the sound effects that the young wizard will unleash next time round. It's obviously a kind of magic. □

Series Multicore Cables

 Ø 14,6 Fixed Installation Series LSZH tested by IMQ*	RSCS ZH 12 pairs 4-8-12-16-25-33-56
 Ø 14,1 Fixed Installation Series LSZH tested by IMQ*	RSC ZH 12 pairs 4-8-12-16-25-33-40-48
 Ø 20,5 Studio Installation 110 Ω	RSR CP 12 pairs 4-8-12-16-24
 Ø 17 Live & Studio Installation 110 Ω	RSR CPS 8 pairs 4-8-12-16-24
 Ø 16,9 Live & Studio Installation 110 Ω	RAC 08 pairs 4-8
 Ø 10 Theatre & Studio Fixed Installation	RSPFWJ 8 pairs 4-8-12-16-24-32-40-48-56
 Ø 11,8 Live Application	RSM012 pairs 4-8-12-16-25-33-40-48
 Ø 13,9 Broadcast/Live StudioTV & Fixed Installation	RSF 8 pairs 4-8-12-16-24-32-40-48
 Ø 16,9 Live & Studio Installation	RSCS 12 pairs 4-8-12-16-25-33
 Ø 15,9 Live & Studio Installation	RSC 12 pairs 4-8-12-16-24-33-40-48

the widest range to fit all the pro audio applications

in "STUDIO" - "LIVE" - "INSTALLATION"

the multicore cables family

REFERENCE laboratory

www.referencelaboratory.com e-mail: reflab@tin.it

QUALITY SYSTEM CERTIFICATE

CISQ CSQ

standard ISO 9002/EN2902



LISTEN CAREFULLY

Digital Dynamics. Control and creativity in one unit. In fact, Seriously Intelligent Digital Dynamics. Front panel or PC control, XTA's **SIDD** delivers outstanding audio performance and limitless versatility.



SIDD is a two-channel digital dynamics processor, incorporating all of the following functions with complete parameter control, including XTA's unique "look-ahead" attack time constants:

- Compressor
- Limiter
- Noise Gate/Expander
- Dynamic Equaliser
- Input EQ consisting of high and lowpass filters plus 6 bands of parametric EQ
- Side-chain EQ built-in to the Compressor, Limiter and Gate/Expander
- Delay, ADT and Harmonics
- Recallable user and factory Presets for instant set-up or scene changes

Seriously Intelligent Digital Dynamics For Front Of House System Control, Channel Insert, Stage Monitoring, Recording, Mastering and Broadcast



PLUGGING INTO HARDWARE

Once the exclusive province of computer-based recording systems, the 'plug-in' is about to move on.

Simon Trask looks at how hardware manufacturers are responding to software plug-ins

SOFTWARE EFFECTS PLUG-INS have become a familiar, indeed integral, element of computer-based recording packages. This is due in no small part to the third-party plug-ins market that has grown up around packages from the likes of Digidesign, Emagic and Steinberg, fostered by their use of open plug-in environments. Software hooks into Pro Tools, Logic Audio and Cubase VST enable effects developed by third-party companies to be 'plugged into' into the virtual mixer environments of these packages alongside any built-in effects. It seems unthinkable that any computer-based recording system could survive in the market these days without the attraction of the plug-in.

in' further effects. However, Tascam is also introducing another, rather more ambitious and expensive, product, the SX1 Integrated Audio Production Station. This all-in-one recorder-mixer-sequencer, which is based on the BeOS multimedia operating system, features the same built-in effects capability as described for the DM24—complete with the TC Works and Antares effects, but also has DSP plug-in capability, allowing further effects to be added. It's worth mentioning that for plug-in developers, who suffer from software piracy on the generic computer-based platforms, licensing their plug-ins for use on dedicated hardware systems opens up a welcome new revenue stream.

can run up to eight chains of mono effects—four stereo, with up to five different effects in each chain; the order of the effects is user-controllable, and you can have multiple instances of effects. Processing is to 48-bit precision on a 24-bit I-O. The Y56K's effects chains integrate into the AW4416's mixer environment and support the AW's snapshot automation capability. The (UK£799) card, which should be available by the time you read this article, comes with eight channels of ADAT I-O as standard (also available separately as a UK£199 card), and has an RS232 port for connection to a PC, enabling software updating via upgrades downloaded off the Internet. The Y56K is also available for the cheaper AW2816, and, according to Yamaha product specialist James Baker, will be available for 'a future product', which he wouldn't be drawn on. Asked if there were any plans for further third-party cards, he would only comment 'I don't believe it's going to be a one-off' and 'Yamaha and Waves are very close now'.

Yamaha's approach, then, has been to deal with a specific effects company and produce a plug-in card that has pre-selected effects from that company. Which of course is far from the freedom and flexibility of the computer-based platforms, which let users choose and then mix-n-match effects from any plug-ins companies that support the relevant plug-in protocol. As mentioned earlier, Mackie comes closer to this latter approach with the UFX (Universal Effects) card for its Digital 8-bus console. The D8b comes fitted with an MFX (Mackie Effects) card which runs the built-in Mackie effects. In addition to this the D8b can be fitted with up to four UFX cards, each of which can run up to four mono, two mono and one stereo, or two stereo third-party 24-bit effects, depending on the DSP requirements of the effects. These are fully integrated into the D8b's mixer section and support the console's automation capabilities, and are in addition to its built-in reverb and other effects and the 4-band parametric EQ, compression, and gating on all 48 channels and main LR channels.

Mackie introduced support for the UFX and third-party plug-ins capability with v3.0 D8b software. The company has attracted Antares (AutoTune), Drawmer (ADX100 compressor-limiter, expander and gate), IVL Technologies (Vocal Studio pitch-shifter-harmoniser), Massenberg DesignWorks (MDW2x2 High-Resolution Parametric EQ) and tc electronic (TC FX II M2000 reverbs, plus a TC Reverb which comes free with each UFX board) to its D8b console platform. A further five plug-ins—Delay Factor, Filter Machine, Time Pak, Saturated Fat, and RTA-31—are available from Acuma Labs, a small Vancouver-based company that was bought by Mackie last year but still operates with a measure of independence (a clever move which gets Mackie exclusivity from an apparently third-party company). In addition, Mackie will be introducing a new raft of some 10 plug-ins for the D8b around the time of the rescheduled AES convention, some from third-party names new to the platform.

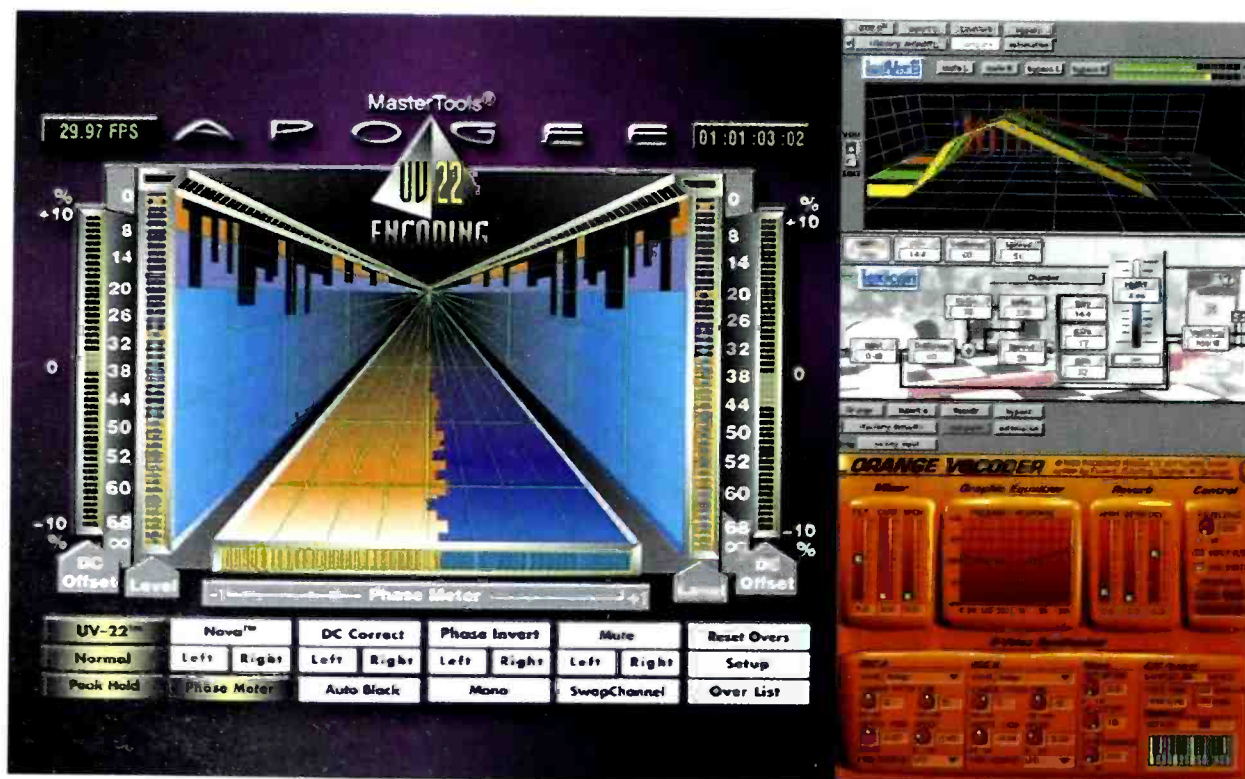

To date, plug-ins haven't really taken root in the world of hardware recorders and mixers. However, AMS Neve, Mackie Designs, Sony Oxford, Tascam, Fairlight and Yamaha are all starting to explore how they can adopt and adapt the plug-in concept in what has traditionally been a closed-system world.

None has embraced as open an approach as the computer-based systems, though Mackie with the UFX card for its D8b mixer has perhaps come the closest. Tascam with its new DM24 Digital Mixing Console has implemented two internal effects processors, one featuring a collection of own effects while the other provides third-party effects in the form of TC Works reverb (with over 100 presets) and mic and speaker modelling technology from Antares. It's interesting to see Tascam adopting third-party effects which are available as plug-ins for computer-based packages, and indeed have come from that world. On the DM24 they're provided built-in as standard, and there's no capability for users to 'plug

TC Works' parent company tc electronic is involved with another of the companies mentioned above, Yamaha, through the TC UNITY card for Yamaha's 02R digital console. This card, which can be fitted into one of the 02R's rear-panel YGDAI slots, allows you to run tc electronic's M2000 and/or Finalizer effects within the 02R mixer environment, including dynamic automation, along with the built-in effects processing (to access both the M2000 and the Finalizer effects on the one card you need to acquire a license code, which is an additional cost option). The UNITY card also has physical I-O options, in the form of AES-EBU and ADAT-TDIF extensions. With its more recent AW4416 Professional Audio Workstation Yamaha has adopted the same plug-in card approach, only this time it has turned to plug-ins developer Waves to provide the additional effects. The Y56K card, which uses two Motorola 56k DSPs, features Waves' Renaissance Compressor and EQ, L1 Ultramaximizer, SuperTap Delay, TrueVerb and DeEsser effects. You

Open for Creativity

mc²82

mc² Production

Broadcast

Production

Radio

Routers

OB Van

Service

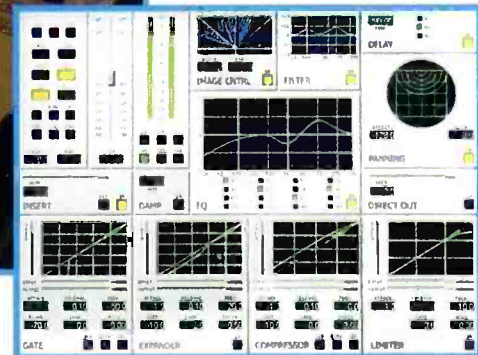
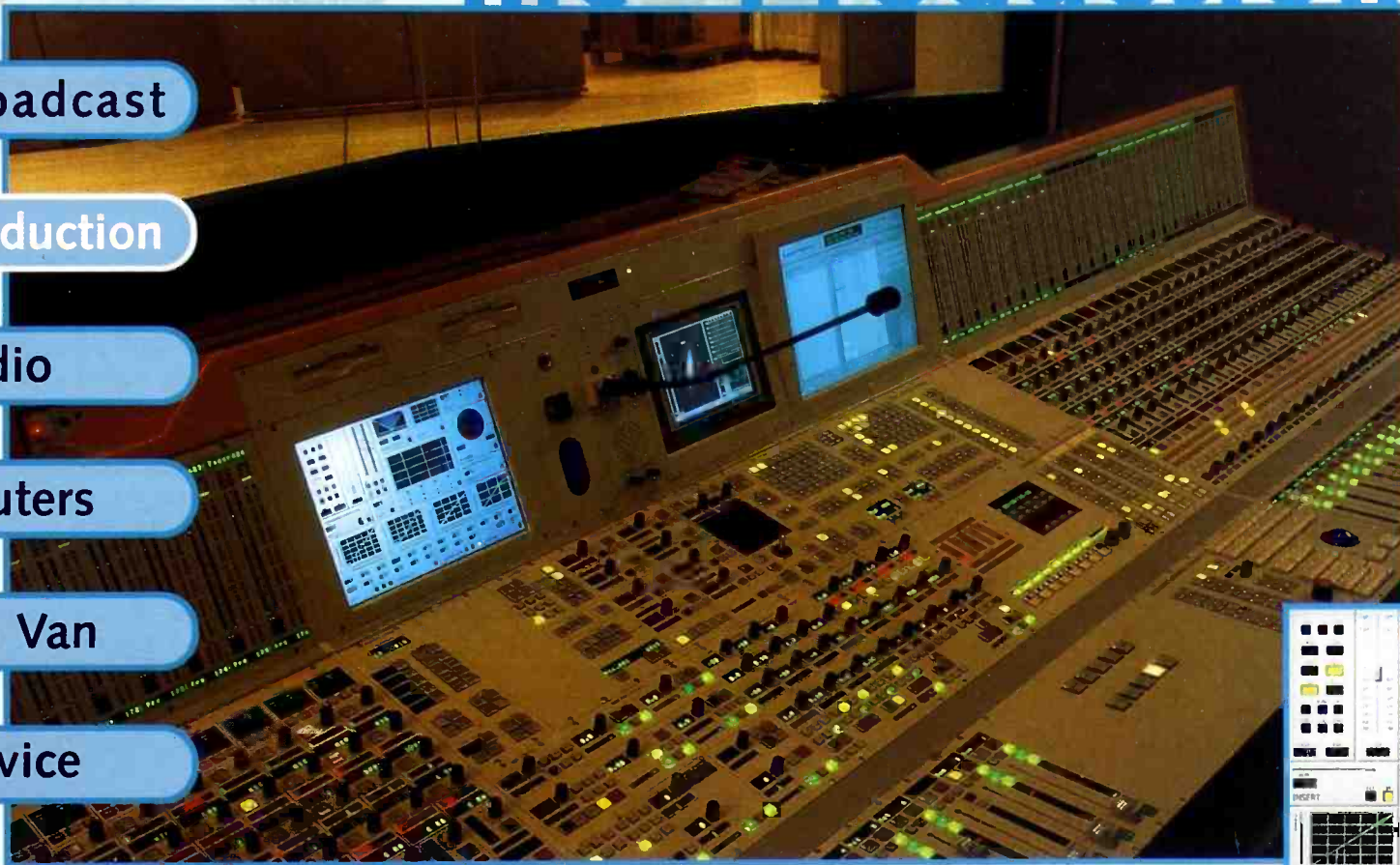

The digital mixing console mc²82 PRODUCTION combines the future-oriented ATM-Audio-Technology with an ergonomic, modular control panel. Designed for the every-day use in the context of complex productions, this mixing console opens a new dimension of creativity.

The powerful signal processing offers sound design in uncompromising quality in every channel. The variable DSP-concept allows the range from split console to inline console. You have access to 180 DSP channels.

Further features are **static and dynamic automation of all settings, substantial and full machine control including track arming and integrated digital patchbay with up to 2000 crosspoints.**

The channel display and the modern Graphical User Interface give you a quick and full overview.

Naturally, all fittings for surround productions are a standard with this mc² console.



NEC Birmingham
14/15 November 2001
Hall 8
Stand No 98 A

Inter BEE Tokyo
Otaritec
Booth 14-16
November 2001



NETWORKING
AUDIO
SYSTEMS



Inconjunction with
MUSICASIA

14th Presentation

Asia's Largest Exhibition on Professional Audio & Lighting, AV, Broadcast, Digital Network Solutions, Music and Special Effects Technologies.

THE ULTIMATE PLATFORM FOR NETWORKING AND BUILDING BUSINESS



**10 - 12 JULY 2002
HONG KONG CONVENTION AND EXHIBITION CENTRE**

Organized by:
JJR Exhibitions Pte Ltd
Tel: 65-227 0688 Fax: 65-227 0913
Email: juliana@jirx.com.sg

Business Reply Coupon Fax: 65-227 0913

Yes, we wish to exhibit at PALA 2002.
Please send us an invitation in due course.

Yes, we wish to visit PALA 2002.

My company activity:

Manufacturer Agent Retailer

Dealer Buyer

Company name: _____

Name: _____

Job Title: _____

Address: _____

Country: _____

Tel (area code): _____

Fax (area code): _____

Email: _____

STUDIO SOUND

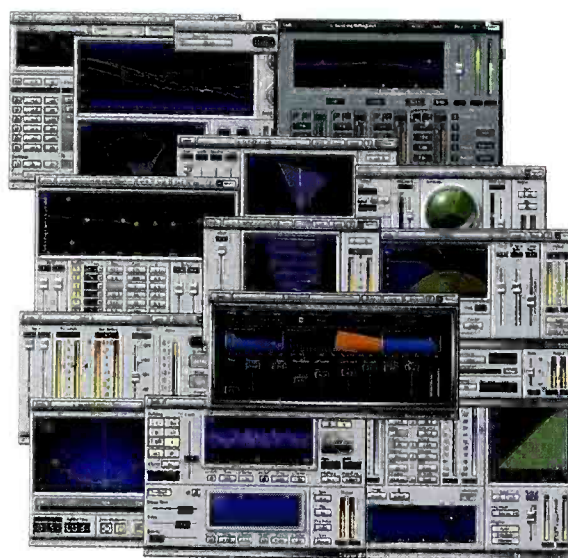

Mackie has also given its Sound Palette Series SP-2400 and 1200 controller amplifiers plug-in capability. The SP-DSP add-in option card, the first of a planned series of SP cards, adds an algorithm which provides ambient noise level sensing and program level control. And of course Mackie now operates on the computer-based side of the fence, having gained the Soundscape DAW line through its acquisition of Sydec earlier this year.

AMS Neve isn't a name that you would readily associate with third-party plug-ins, however the company is going down this route—first with its AudioFile SC audio editor, but with general plans to expand the concept to its consoles. Initially available plug-ins for the AudioFile SC are proprietary, developed in-house, and fall into three categories: time-based, frequency-based, and creative. These require an additional SAM card. However, the company has also recently signed up its first third-party developer, in a deal with Cedar Audio which will see Cedar make a range of its audio restoration and noise suppression technologies available on AMS Neve platforms. And according to AMS Neve's editorial products manager Mike Reddick the company is in the closing stages of finalising commercial agreements with other companies, from computer-based plug-in and traditional hardware fx backgrounds, to supply further effects. Another high-end console manufacturer that has made a foray into third-party effects is Sony Oxford, which has George Massenburg EQ (GML 8200) and dynamics (GML 8600) options available on the 12-card and 16-card versions of the OXF-R3 console. These were developed in-house by Sony Oxford in conjunction with Massenburg Labs (Sony doesn't offer its Oxford protocol outside of the company), and technically speaking they're not really plug-ins, as they're embedded in the console software and activated by the customer purchasing a one-time license and enabling the license code

on the console. The GML EQ then becomes a fifth EQ option under a button on each channel. The other four EQs were developed in-house by Sony Oxford; one is the Oxford's own EQ, while the other three are 'interpretations' of analogue EQs from other manufacturers' consoles.

However, in an interesting spin-off from its work on these EQs, Sony Oxford has made them available as a branded TDM plug-in for Pro Tools. Apparently, many

Oxford users are also Pro Tools users, hence the idea of doing a TDM version of the EQs came about. According to Sony Oxford design engineer Paul Frindle the work of converting and optimising the EQs to work under Pro Tools without overtaxing the DSP took six months, but the result is that the EQs in absolute terms are exactly the same as on the R3.

The plug-in effects concept, then, is gradually making its way into the world of dedicated hardware recorders and consoles. However, manufacturers vary in their approaches to introducing plug-ins and third-party effects, and there are various considerations that come into play, depending in part on what level and what sector of the market are being catered for. Companies need to ensure that they don't lose the immediacy, ease of use and reliability that are characteristic of dedicated hardware platforms, and this seems to necessitate adding plug-ins in a much more controlled way than the open house free-for-all of the generic computer-based platforms. Sony Oxford's Frindle says that at the high-end of the console market users are more likely to want more channels and I-O than have processing power taken up by plug-ins. Perhaps then lower-end consoles such as the Mackie, which are more closely attuned to the requirements of computer-based users, are freer to take up the plug-ins approach. Certainly for people who are used to operating within the compromises, complexities and unreliabilities of the generic computer-based platforms there are advantages to also using the likes of the D8b, with its optimised approach. Meanwhile, the recording products from Tascam and Yamaha suggest that dedicated hardware system manufacturers can no longer operate in a closed world, but need to offer at least a measure of the third-party openness and flexibility characteristic of the generic computer-based platforms.

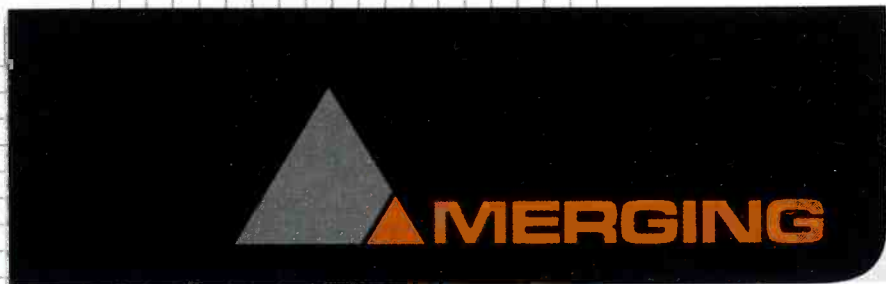

The **next damned**
closest thing to
analog

since DIGITAL
was **invented.**

Pyramix

Virtual Studio

Now with Multi-track **DSD Option!**



ADAT
16 Channel

AES-EBU
24 Channel

MADI
56-64 Channel

Mykerinos
High Performance
DSP Audio Card

TDIF
24 Channel

SDIF
24 Channel

Mic-Line +
AES-EBU
4+8 Channel

Pyramix V4.0 – the purest Digital Audio Workstation Ever!

www.merging.com

24/96 24/192 32/384



DSD
Direct Stream Digital



Contact Merging Technologies • info@merging.com • Switzerland Tel: +41 (21) 946 0444
USA Tel: +1 (847) 272 0500 • Europe/Asia Tel: +44 (0) 1606 892788



Beyond Broadcasting... WORLDCASTING

BroadcastAsia2002

The 8th Asian International Broadcast and Multimedia Technology Exhibition & Conference

CableSat2002
The 5th Asian International Trade Showcase for Cable & Satellite Technology & Services

Incorporating
Professional Audio Technology 2002
The 6th Asian International Trade Showcase for Professional Audio Equipment, Services & Technology

ComGraphics & Animation 2002
The 8th Asian International Trade Showcase for Computer Graphics and Animation Techniques, Products and Services

New Venue

Suntec Singapore

Exhibition 18 - 21 June 2002
Conference 17 - 21 June 2002

Reply Coupon Fax to us at (65) 835 3029/ (65) 732 6776

I am interested in

- Exhibiting at BroadcastAsia2002. Please reserve _____ (Minimum 9sqm) sqm for my company.
- Presenting a paper at/ attending* the BroadcastAsia2002 International Conference.
- Visiting BroadcastAsia2002. Please send me more details closer to the event. * Please delete as appropriate

Name: _____ Job Title: _____

Company: _____

Address: _____

Country: _____ Tel.: _____ Fax.: _____

Email: _____ Business Activity: _____

Or attach your business card

Organised By
Singapore Exhibition Services Pte Ltd
A Member of The Montgomery Network
47 Scotts Road, 11th Floor Goldbell Towers,
Singapore 228233
Tel: (65) 738 6776 Fax: (65) 732 6776
E-mail: events@sesmontnet.com

Worldwide Associate
Overseas Exhibition Services Ltd
A Member of The Montgomery Network
11 Manchester Square, London W1U 3PL,
United Kingdom
Tel: 44 (0) 20 7862 2080
Fax: 44 (0) 20 7862 2088
E-mail: broadcastasia@montnet.com

Endorsed By
ABU Asia-Pacific Broadcasting Union

Supported By
SBA SINGAPORE BROADCASTING AUTHORITY

Conference organised in association with
International Broadcasting Convention

The Official Airline
SINGAPORE AIRLINES

SS/BCA02

DIGITAL MAGNETIC RECORDING

Recording found a dear friend in magnetism as **John Watkinson** demonstrates with a look at a technology that shows up in a remarkable number of places

STARTING WITH CAVE PAINTINGS, man has wanted or needed to make a permanent record of some kind of information. Analogue recording continued that process, followed by digital recording. The advantage of digital recording is that many types of information can be converted to data; images, movies, audio, text, position, time and so on. After conversion the result is the same: binary numbers. Consequently a digital recorder generally neither knows nor cares what the data it records represent. The data only have to be reproduced accurately and the destination will take care of what it means. This is an advantage because the same data recorder can be used for computer code, video or audio.

Although there are other ways of recording binary (such as optical media or trained woodpeckers), magnetic recording is dominant because it is so flexible and economic. Magnetic recording relies on the hysteresis of certain magnetic materials. After an applied magnetic field is removed, the material remains magnetised in the same direction. By definition the process is nonlinear, and analogue magnetic recorders have to use bias to linearise it. Digital recorders are not concerned with the nonlinearity, and HF bias is unnecessary. This makes digital magnetic recording easier to do than analogue recording.

The concepts discussed here apply equally to digital VTRs, disk drives, DASH and DAT machines and even the magnetic stripe on a subway ticket. In all cases a recording medium which carries a magnetic layer moves with respect to a head which can write or read on the medium. In a VTR or a DAT machine, the heads revolve to give a high linear speed so that adequate bandwidth is available. In disk drives, the medium rotates at high speed and the heads move from one radius to another to access the data.

Fig.1 shows the construction of a typical digital record head. A magnetic circuit carries a coil through which the record current passes and generates flux. A non-magnetic gap forces the flux to leave the magnetic circuit of the head and penetrate the medium. The current through the head must be set to suit the coercivity of the tape, and is arranged almost to saturate the track. The amplitude of the current is constant, and recording is performed by reversal of the direction of the current with respect to time. As the track pass-

es the head, this is converted to the reversal of the magnetic field left on the tape with respect to distance. The magnetic recording is therefore bipolar. The recording is actually made just after the trailing pole of the record head where the flux strength from the gap is falling.

Fig.2 shows what happens when a conventional inductive head—one having a normal winding—is used to replay the bipolar track made by reversing the record current. The head output is proportional to the rate of change of flux and so only occurs at flux reversals. In other words, the replay head dif-

ferentiates the flux on the track. The polarity of the resultant pulses alternates as the flux changes and changes back. A circuit is necessary which locates the peaks of the pulses and outputs a signal corresponding to the original record current waveform. The amplitude of the replay signal is of no consequence and often an AGC system is used to keep the replay signal constant in amplitude. What matters is the time at which the write current, and hence the flux stored on the medium, reverses.

The head shown in Fig.1 has an irregular frequency response that causes some problems. At zero frequency there is no change of flux and no output. As a result, inductive heads are at a disadvantage at very low speeds. The output rises with frequency until the rise is halted by the onset of a phenomenon called thickness loss. As the frequency rises, the recorded wavelength falls and flux from the shorter magnetic patterns cannot be picked up so far away. At some point, the wavelength becomes so short that flux from the back of the tape coating cannot reach the head and a decreasing thickness of tape contributes to the replay signal. As wavelength further reduces, the familiar gap loss occurs. The frequency response is far from ideal, and steps must be taken to ensure that recorded data waveforms do not contain frequencies that suffer excessive losses. A more recent development is the magneto-resistive (M-R) head. This is a head that measures the flux on the tape rather than using it to generate a signal directly. Flux measurement works down to DC and so offers advantages at low tape speeds.

Heads designed for use with tape work in actual contact with the magnetic coating. The tape is tensioned to pull it against the head. There will be a wear mechanism and need for periodic cleaning. In the hard disk, the rotational speed is high in order to reduce access time, and the drive must be capable of staying on line for extended periods. In this case the heads do not contact the disk surface, but are supported on a boundary layer of air. The presence of the air film causes spacing loss, which restricts the wavelengths at which the head can replay. This is the penalty of rapid access.

Fig.3a shows that in azimuth recording, used in rotary head tape drives, the transitions are laid down at an angle to the track by using a head which is tilted. Machines using azimuth

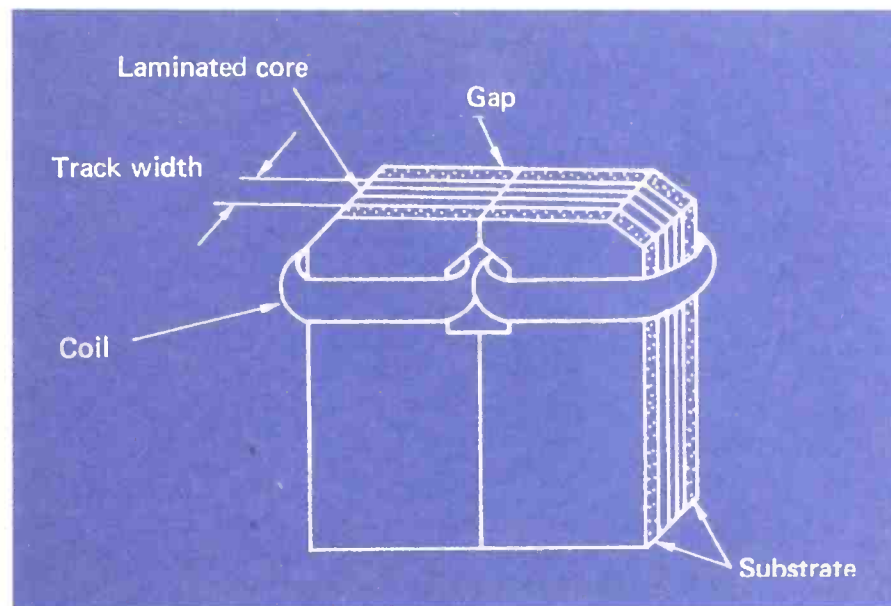

Fig.1: A digital record head is similar in principle to an analogue head but uses much narrower tracks

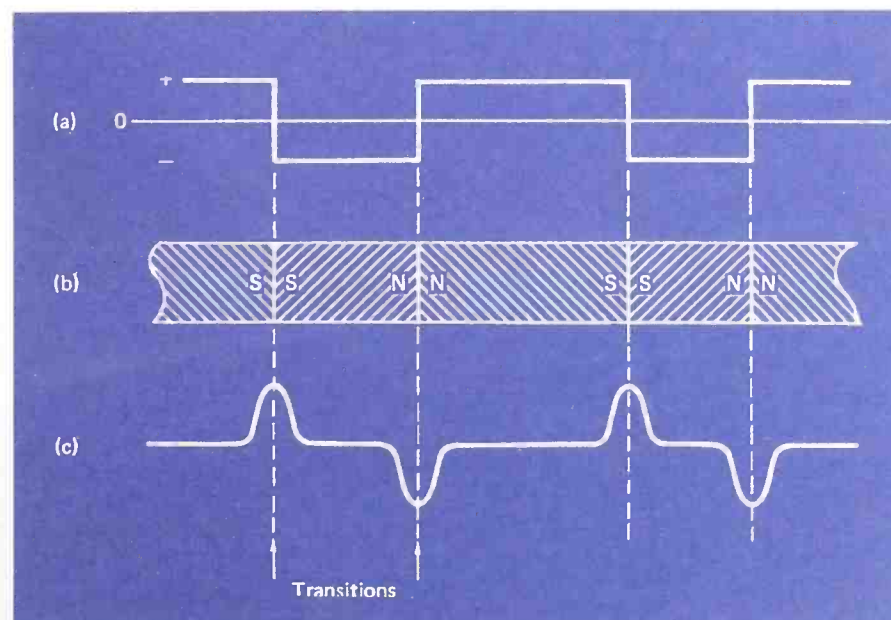

Fig.2: Basic digital recording. At (a) the write current in the head is reversed from time to time, leaving a binary magnetisation pattern shown at (b). When replayed, the waveform at (c) results because an output is only produced when flux in the head changes. Changes are referred to as transitions

Ad Index

AMS Neve	9
Aphex	5
Audio Ltd	30
Audio Technica	46
Audionics	10
beyerdynamic	31
Brauner	34
Broadcast Asia	60
Calrec	37
Cedar	OBC
Cube Technologies	38
Digital Audio Denmark	40
DPA Mics	23
Emtec	22
Fairlight	21
Focal Press	LI
Focusrite	17
Funky Junk	29
FX Rentals	12
Genelec	26/27
HHb	35, 51
HW International	UK BI
IBC	69
IIR	56
Isotrack	24
KT Group	39
Lawo	55
Lexicon	41
Lundahl	31
Lynx Video	8
Mackie	IBC
Manley	25
Marantz	45
Media Tools	47, 49
Merging Technologies	57
Neutrik	14
Prism Sound	13
Raycom	32
Reference Labs	52
Richmond Film Services	34
Roland	11
SCV	UK BI
Sennheiser	63
Solid State Logic	IFC
Sonifex	48
Soundcraft	19
Soundtracs	15
SPL	44
Stirling Audio	UK BI
Studio Spares	42
Tascam	33
tc electronic	20
Terrasonde	12
TL Audio	18
XTA	53

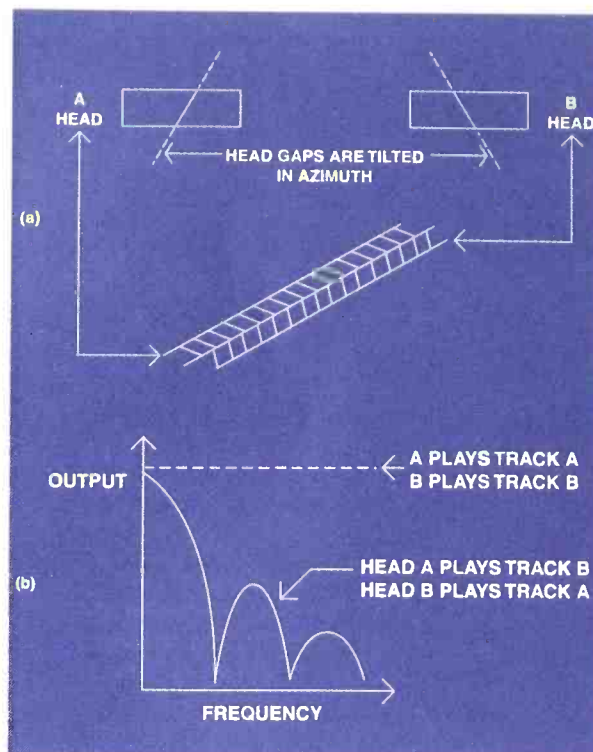

Fig.3: Types of head. (a) Azimuth heads record two types of track. (b) If a track is played by the wrong head, a massive loss of signal occurs

recording must always have an even number of heads, so that adjacent tracks can be recorded with opposite azimuth angle. The two track types are usually referred to as A and B. Fig.3b shows the effect of playing a track with the wrong type of head. The playback process suffers from an enormous azimuth error that serves to attenuate crosstalk due to adjacent tracks so that no guard bands are required. Since no tape is wasted between the tracks, more efficient use is made of the tape.

Tape, disks and heads do not know they are digital, and so act as analogue devices. The essential feature which makes a recorder digital is the way in which the replay signals are interpreted. In an analogue recorder, any waveform is legal and as a result noise and wow and flutter cannot be detected because they change one legal signal into another. In a digital recorder, the signal can only exist in a finite number of states and the analogue variations are eliminated by attributing the replay signal to the most likely or nearest discrete state.

The vital step of information interpretation in the replay circuit is known as data separation. The data separator is rather like an analogue-to-digital converter because the two processes of sampling and quantising are both present. In the time domain, the sampling clock is derived from the clock content of the channel waveform. In the voltage domain, the process of slicing converts the analogue waveform from the channel back into a binary representation. The slicer is thus a form of quantiser which has only 1-bit resolution. The slicing process makes a discrete decision about the voltage of the incoming signal in order to reject noise. The sampler makes discrete decisions along the time axis in order to reject jitter.

The slicer is implemented with a comparator which has analogue inputs but a binary output. The signal voltage is compared with the midway voltage, known as the threshold, baseline or slicing level by the comparator. If the signal voltage is above the threshold, the comparator outputs a high level, if below, a low-level results. The binary waveform at the output of the slicer will be a replica of the transmitted waveform, except for the addition of jitter or time uncertainty in the position of the edges due to noise, baseline wander, intersymbol interference and imperfect equalisation.

Digital coding combats jitter by making the time axis discrete using events, known as transitions, spaced apart at integer multiples of some basic time period, called a detent, which is larger than the typical time uncertainty. Fig.4 shows how this jitter-rejection mechanism works. All that matters is to identify the detent in which the transition occurred. Exactly where it occurred within the detent is of no consequence.

Once per detent, the receiver must make binary decisions at the channel bit rate about the state of the signal, high or low, using the slicer output. As stated, the receiver is sampling the output of the slicer, and it needs to have a sampling clock in order to do that. The only way in which the sampling clock can be obtained is to use a phase-locked loop to regenerate it from the clock content of the self-clocking channel-coded waveform. Digital recorders have discontinuous recorded blocks to allow editing. Each data block is preceded with a pattern of transitions whose sole purpose is to provide a timing reference for synchronising the phase-locked loop. This pattern is known as a preamble. □

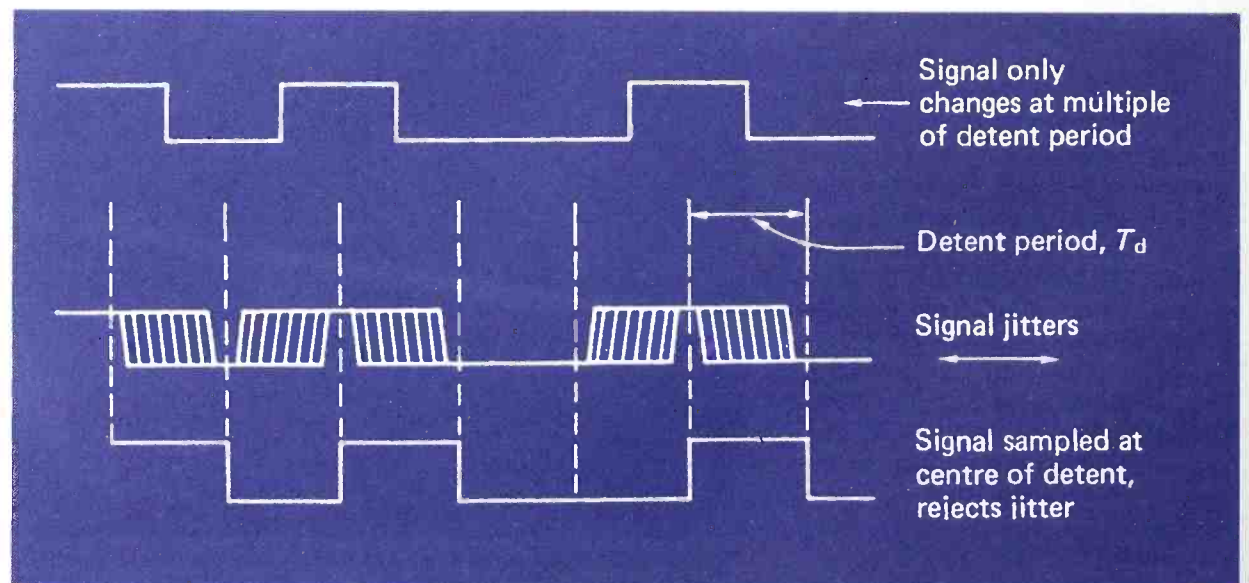

Fig.4: A certain amount of jitter can be rejected by changing the signal at multiples of the basic detent period T_d

BREATHTAKING

Neumann's
fastest selling
mic ever...

...and
their best



£1295
inc. VAT



M149

Quite simply one of the finest microphones in the world. A stunning combination of classic and state-of-the-art microphone technologies. Nine polar patterns, a seven step high pass filter, and all the latest technical innovations you'd expect. The M149 Tube is the ultimate microphone.

M147

In the short time that the M147 Tube has been available, it has become Neumann's fastest selling microphone. And not without good reason.

Incorporating the K49 capsule from Neumann's legendary U47 and M49 microphones, it combines a valve impedance converter and an innovative transformerless output circuit. Resulting in a stunning ultra low noise microphone that is equally at home as a superb spot mic.

To top it all, the M147 Tube is now available at a new unprecedented price. So whatever your budget, be with the best. Give your dealer a call.



The name Neumann has been associated with the manufacture of world-beating microphones for over 70 years. Today, the unique alliance of experience, proven design expertise and the latest technological developments that go into every Neumann, make us justly proud of the recognition by the industries most discerning organisations.



Neumann

Neumann, FREEPOST, High Wycombe, Bucks HP12 3BR.
Brochure line: 0800 652 5002. Fax: 01494 551 550.
Email: info@sennheiser.co.uk Web: www.neumann.com or www.sennheiser.co.uk

Appointments

Business Manager – Leading pro Audio Brand

Salary £35-50K+

A leading US manufacturer of studio recording products is seeking a key individual to help formulate and drive aggressive business activities in the UK and in Europe. You will have worked in a senior sales/marketing role and will be experienced in the recording equipment sector. International business experience will be advantageous. **E-mail or call Richard quoting job ref AM199**

Field Service Engineer

Location: North England/ Midlands

Salary £12-14k

On site repair of various forms of Sound equipment, 1st and 2nd fix in installation team. Work to be based in North East of England but with contracts carried out throughout the UK all candidates must be willing to travel on a regular basis. All candidates must be capable of working under their own initiative and of organising their own priorities when necessary. **Contact Ian quoting job ref SE225**

International Sales Manager – Live sound

Salary £30-40k

An established French Live sound manufacturer of loudspeakers and amplifiers are seeking an international Sales manager to head their export drive. Candidates should have a track record in export sales and be able to demonstrate sales growth they have achieved whilst managing export territories. A working knowledge of French would be an advantage. **Contact Richard quoting job ref AS817**

Professional Audio Sales

Location: South

Salary £20-30K Plus Comm

This world-leading manufacturer of studio recording and processing products is seeking an experienced and aggressive UK sales professional. If you have a sound understanding of studio technology and practice, and have the energy and commitment needed to succeed. **Contact Richard quoting job ref AS199**

Software Engineer

Location: South

Salary £25k -30K

This well-established UK manufacturer is seeking a software engineer with the following skills. A thorough knowledge of the C programming language and visual basic as well as assembly language programming (preferably for the PIC range). Some knowledge of C++ would be advantageous. **Contact Julie quoting job ref SP179/2**

Southern Field Sales

Salary £18-23K+

This High quality UK Pro-Audio distributor are seeking a salesman to cover AV, installation and MI dealers south of Birmingham. Would suit a retail MI salesman looking to develop his/her career into a field sales role. **Contact Ian or Richard quoting job ref SP231**

Export Sales Manager - Broadcast Electronics

Salary £35-45K+

This leading British manufacturer of broadcast electronics now seeks a technically well-grounded sales manager to manage and develop their business in the Asia region. Extensive travel together with substantial autonomy is offered for the right candidate. **Contact Richard quoting job ref 1815**



Taylor - Phillips

For all the latest updated positions check out our website: www.taylor-phillips.co.uk
 Taylor-Phillips, Recruitment Consultants, P O Box 230, Smarden, Ashford, Kent TN27 8ZG Tel: +44 (0) 1233 770 867 Fax: +44 (0) 1233 770 176
 Email: julie,ianorrichard@taylor-phillips.co.uk to discuss any of the above positions or to find out how Taylor-Phillips can help you with your specialist recruitment needs. We have a number of additional new vacancies coming through where details are still being finalised.

Equipment For Sale

WANTED

**'NEVE
 CONSOLES'**
 any condition...
 we will purchase
 worldwide



THE 'VINTAGE' NEVE SPECIALIST!!

Telephone: 01932 872672 Fax: 01932 874364 Telephone International: 44 1932 872672
 Fax: International: 44 1932 874364

Website Address: AESPROAUDIO.COM Email Address: aesaudio@intonet.co.uk

The Digital Village

Pro Tools and Outboard Specialists

New G4 in stock.

Call Gavin Beckwith -

London's leading Mac guru.

Avalon - Focusrite - Lexicon - Summit -

TC Electronic - TLA - Eventide -

Massenberg - Alan Smart -

Neumann - Oram

UREI - Cranesong

Mackie d8b Main Dealer

Call Niki Melville-Rogers

+44 (0)20 8440 3440



Fairlight Prodigy

39.999,- Euro

- 24 track, 24 bit recorder/editor
- Fully automated mixing surface w/ moving faders
- 24 bit I/O, 24 inputs & outputs (analog + AES/EBU)
- Surround monitoring w/ joystick panning
- Dynamics on every channel
- 9Pin machine control

More info:

Phone: +31 (0) 30 2414 070

www.boomerangsounds.co.uk

43A Elsinore Road, Old Trafford, Manchester, M16 0WG.
 Tel: 0161-873 7770, Fax: 0161-872 4494, sales@boomerangsounds.co.uk



Used Equipment Bargains

View the latest lists with hundreds of items on our web site.

ProTools Packages

All systems are setup, ready to use, and supported by our experienced engineers



Mac & PC Hard Disc Recording Specialists
 New & Used Recording Equipment Sales
 Maintenance, Installation & Studio Design

**Copy deadline for
 December issue
 is 19th November**

Equipment For Sale

The New Look Canford Catalogue Available Now!

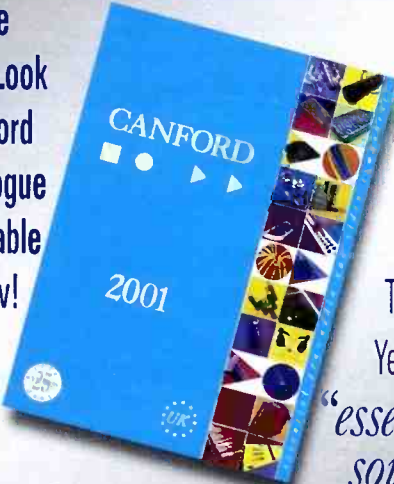

2001

This Year's "essential source"

CANFORD AUDIO PLC.
CROWTHER ROAD,
WASHINGTON, NE38 0BW, UK.

TEL: +44 191 418 1000
FAX: +44 191 418 1001
studio@canford.co.uk

BUY · SELL · TRADE

STUDIO, RECORDING & PA EQUIPMENT
+ all musical instruments & technology

STUDIO CLEARANCES UNDERTAKEN

MUSIC EXCHANGE

56 Notting Hill Gate, London W11 © +44 (0)20 7229 4805

OPEN 7 DAYS · LARGE SELECTION ON SALE

Time Code Dat Machine

Fostex D25 Time Code Dat Machine
4 Heads, Mint Condition
£3000 ONO

Tel +44 020 8992 3569

NEW AND USED VINTAGE EQUIPMENT



HARBORSOUND

180a CENTRAL STREET SAUGUS, MASS 01906
Ph: 001 (781) 231-0095 Fax: 001 (781) 231-0295
www.harborsound.com

Products & Services



MOVING COIL CONTACT MICROPHONES FOR SR PERFECTION

SCHERTLER & KOLEY LTD
VIA BEROLDINGEN 18
6850 - MENDRISIO - SWITZERLAND
TEL +41-91 630 07 10 - FAX +41-91 630 07 11
Info@schertler.com - www.schertler.com

Products & Services

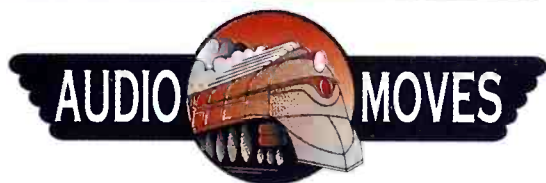

Professional movers of studio equipment within the UK and Europe · Experienced, reliable, fully insured and always on time.

Call Graham Cook on +44 (0)20 8450 9127 · (mobile: 07785 290754) · e-mail: audiomoves@easynet.co.uk

134 Cricklewood Lane, London NW2 2DP · Fax: +44 (0)20 8208 1979 · Storage facilities also available

Superfast Labels Ltd SELF ADHESIVE COMPUTER LABEL MANUFACTURERS

A4 SHEET LASER LABELS



www.superfast.co.uk

Tel: (01795) 428425 Fax: (01795) 422365

MAGNETIC TAPE HEADS SUPPLIED

* Professional Head Refurbishment Service *

SONDOR NOVA HIGH SPEED ELECTRONIC FILM PROJECTORS

Magnetic Film ARCHIVE Retrieval Reproducers & Recorders

Summertone Ltd.,
98 Scatterdells Lane, Chipperfield, Herts., WD4 9EZ UK
Tel: +44 (0) 1923 263220 Fax: +44 (0) 1923 260606
E-mail: terry@summertone.com Web: www.summertone.com

3M Professional Tape Machines

Service and spares. Secondhand machines available.
Studio electronic, acoustic and earthing problems solved. Audio equipment made to measure.

Audio Solutions Limited
9b, Ashbourne Parade, Hanger Lane,
Ealing, London W5 3QS
Tel: +44 (0)20 8998 8127 Fax +44 (0)20 8997 0608

ODR THE DATA STORAGE SPECIALISTS

***OPTICAL DRIVE REPAIR**
*** TAPE DRIVE REPAIR**
***DATA RECOVERY**

For further details see our web page or telephone.

Optical Drive Repair Ltd

Tel: +44 (0)1737 379999
e mail: service@odrl.co.uk
Web: www.o-d-r-l.com or www.odrl.co.uk

Mastering and Duplication

1000 CDs with Booklet+Inlay £650
High Quality CDR copies from 99p
Real Time Cassette Copying
CD/CD-ROM Mastering £60ph
Enhanced CDs, CD-audio, CD-ROM
Copy Masters, Compilations, Editing

Graphic design
5 years experience
Colour laser or litho printing
Large and small run specialists
Excellent quality and presentation



Repeat Performance Multimedia

6 Grand Union Centre
West Row
London W10 5AS

Excellent!

Tel. 020 8960 7222
visit us at
www.repeat-performance.co.uk

MUSICAL COCKTAILS

Digital Editing 25 CD's £53
CD Duplication 50 CD's £92
Pro-Audio Sales 100 CD's £164
Colour Booklets and Inlays on-body print.
available Please call for details. jewel case & VAT included

020 8427 5918

PRO-TOOLS SYSTEM

Complete Pro-Tools Mix Plus system for private sale.

Contact "Fraser@dircon.co.uk"

Telephone +44 (0)1825 732303

Mastering and Duplication



HILONGROVE

Where sound advice counts

CD Manufacturing
Quote, book and track online @ www.hiltongrove.com

CD Mastering
High End Studios. 48 BIT Technology. Cedar.

Design
Graphic designers. Reprographics. Quality print.

Quality Mastering. Quality Service. Quality Product

The Hiltongrove Business Centre
Hatherley Mews, London E17 4QP
Tel: 020 8521 2424
Fax: 020 8521 4343
Email: info@hiltongrove.com

3 Minutes walk from
Walthamstow Central Tube / Mainline
11 Minutes drive from the M25.



Pro Tools Digital Audio

Recording, Mixing & Editing
Consultancy, Troubleshooting & Training

Call Mike Collins on
+44 (0)20 8888 5318 +44 (0)7984 029734
email 100271.2175@compuserve.com
web www.mediashop.fsbusiness.co.uk

Design, Installation & Consultancy

AIR CONDITIONING & VENTILATION TO SOUND STUDIOS IS OUR SPECIALITY

We provide design only or design and installation for many well known clients. Whether it be for displacement free cooling, V.A.V., V.R.V., split, unitary or centralised call Mike Hardy of

Ambthair Services Ltd on
+44 (0)1403 250306 or Fax +44 (0)1403 211269

Web: <http://www.ambthair.com>
Email: cool@ambthair.com

THE STUDIO WIZARD

Will design, supply, build, train, install, debug and save you money!
So if you want a studio that works like magic call me!

07803 666789

From a little advice – to a complete construction project – at the right price!

email: info@studiowizard.com
Web: www.studiowizard.com

The Studio People

INTERNATIONAL
Studio design, build & wire from our own professional team
>> engineered to out-perform and look the best <<



+44 (0)7071-247-247

CALL US NOW FOR A FREE QUOTATION
AND WE'LL TURN YOUR DREAM INTO REALITY
www.studiopeople.com

New Edition Out Now



Over 300 pages
Fully updated and revised
More than 3,000 contributors
Bringing distributors and manufacturers...
...together

the international directory of professional
audio manufacturers and distributors

STUDIO SOUND Pro Sound News VOLUME 2

To order your copy please contact Eileen Sullivan on +44 20 7579 4169
or email esullivan@cmpinfor.com

International Studio Directory

Key:

	Analogue/Digital Console
	Analogue Recording
	Digital Recording
	Accommodation/Food
	Pro Tools
	Transport
	Surround Sound
	Maintenance
	Live Room
	Isolation Booths

Coral Sounds Studio
The home of Calypso Rhythm & Steelband Drums

Credits: George Michael, Robbie Williams, Bryan Adams
Now you have up to 25 words to write about your studio
18 Milling Avenue, Trinidad
Tel: +809 623 7789
www.coralsounds.com

Lion Studios
Be the King in this Recording Studio

This is where you can sell your studio either by some text and / or credits. This text can be changed with each insertion.
115 B Common Wealth Drive, Singapore 0314
Tel: +1 65 473 4627
www.lionstudios.com

Power Recording Studios

From writing to tracking, programming to Pro Tools, big recordings to the perfect mix, we have the power.
Unit 11 Empire House, Marvel Road, London, W3 7QH
Tel: 020 8932 9933 F: 020 8972 3031

Coral Sounds Studio
The home of Calypso Rhythm & Steelband Drums

Credits: George Michael, Robbie Williams, Bryan Adams
Now you have up to 25 words to write about your studio
18 Milling Avenue, Trinidad
Tel: +809 623 7789
www.coralsounds.com

Coral Sounds Studio
The home of Calypso Rhythm & Steelband Drums

Lion Studios
Be the King in this Recording Studio

Coral Sounds Studio
The home of Calypso Rhythm & Steelband Drums

Coming Soon: Studio Sound's new Studio Directory

As the recording studio industry becomes increasingly decentralised, the established communities of studios are being challenged by a new generation of 'world-class' studio spread around the globe. No longer are centres such as those in London, New York and LA the only places to host recording projects. Increasingly, recording is becoming a truly international endeavour with clients being prepared to travel widely in order to find the ideal recording package.

As the operator of such a studio, your clients need a better means of determining which facilities best meet their needs. In response, Studio Sound is to offer a concise and cost-effective means of bringing your facility and services to the attention of the recording and postproduction worlds.

The section will provide a quick and authoritative guide to those studios seeking new clients from an international audience, using easy graphical indications of facilities, equipment and services.

To make sure you don't miss out call Wendy Clarke now and reserve your space on:
+44 (0)20 7579 4723



EMAIL YOUR LETTERS TO THE EDITOR:

tgoodyer@cmpinformation.com

LETTER OF THE MONTH

Smart or
just lucky?

I HAVE JUST got around to reading the August and September issues of *Studio Sound* and I feel the need to comment.

Hmmm. It is interesting why people generally comment negatively on the NS-10M primarily because of its poor frequency response characterised by a peak at 1.5kHz. However, I believe this peak should be seen in conjunction with the low output in the 200Hz–300Hz region and not alone. Why? Well the reasoning is clear.

The measurement of frequency response published (in *Studio Sound* and in most loudspeaker specifications) is a free-field response, but who do you know uses their speakers in a free-field environment? If you make measurements of the NS-10M when it is set up on top of a reasonably large console then the response is much more pleasing, in fact you will probably measure twice just to be sure that what you see is correct. The extra baffling caused by the console will increase the level in the 200-300Hz region and the first (main) dip of the comb filter due to the reflection from the console will reduce the peak at 1.5 kHz. The resulting response is actually surprisingly smooth. I believe this is one of the rea-

sons the NS10-m is so popular, I have heard there are 300,000 of them. The question is were Yamaha ahead of their time or were they just lucky?

Finally, it is interesting to comment that a speaker that is flat when measured in free-field (most manufacturers seem to strive for flat free-field responses) will be far from flat when placed on a console, it will be dominated by excess upper bass and have a dip at 1.5kHz. Happy measuring!

**Peter Chapman,
Electroacoustic Engineer,
Struer, Denmark**

Tim Goodyer replies

Your comments are well founded Peter, as we will see in Keith Holland and Philip Newell's forthcoming evaluation of the NS-10M with respect to the other loudspeakers measures for *Studio Sound*. Tempering the free-field argument with real-world application is particularly important when interpreting speaker measurements—for both professional and domestic use.

This month's letter of the month wins a free copy of *Recording Spaces* by Philip Newell from the Focal Press range

Picture dis

AS I PICKED UP the August issue of *Studio Sound* again, with Neil Hillman included on the cover, I realised how nice it is to be able to put a face to a contributor's name. Each regular writer has his own distinctive style (some, like Neil, quite quirky at times!) and one often wonders just what they look like. Perhaps you would consider at some point, maybe in the January issue, including a 'rogue's gallery' of regular contributors' photos, with a short blurb about each? (Hopefully it won't be necessary to ambush them from an open manhole cover, as appears to have been the case with Tim Goodyer.)

**Stuart Tarbuck, Freelance
Recording Engineer,
Vancouver, Canada**

Tim Goodyer replies

The primary reason for not making regular use of writers' photographs is to avoid having beautiful people distract your

attention from important technical information, Stuart. It's an old problem that has plagued the beautifully-peopled world of pro-audio for decades. Sorry, but that's the way it is.

Or not.

While we are, admittedly, talking media here, we're definitely not talking Media (the only make-up artists on the magazine staff are cross dressers). And while we'd all agree that it's good to put names to faces, there are some faces you really don't need to see on a monthly basis. As a publishing house, we are also obliged to be mindful of the dangers of a copy of *Studio Sound* falling into the hands of minors... On top of which, the regular inclusion of stock mugshots simply takes up space that could be better used—whether on an article-by-article basis or in a 'rogues' gallery'. Much the same applies to authors' profiles (first time funny, second time silly, third time bed). Which only leaves the matter of my own 'ambush'... Can I just say that the paparazzo who

November
1–3

Broadcast India

World Trade Centre, Mumbai, India.
Email: saicom@bom2.vsnl.net.in
Net: www.saicom.com/broadcastindia

4–11

SMPTE

Pasadena, USA.

8–12

Audiovideo

Jakarta, Indonesia.

14–15

SBES

NEC, Birmingham, UK.

Net: www.sbes.com

15–17

Interbee International

Tokyo, Japan.

16–18

Reproduced Sound

Conference #17

Stratford Victoria Hotel,
Stratford-Upon-Avon, UK.
Contact: Institute of Acoustics.
Tel: +44 172 784 8195.

23–25

Music Live

Birmingham, UK.

Net: www.musiclive.co.uk

27–30

Radio, TV & Comms

Nizhny, Novgorod.

30–3 December



AES 111th Convention

Jacob K Javits Convention Centre,
New York, USA.
Contact: Exhibitions and Events.
Net: www.aes.org

December
6–8

ICE India 2001

Bombay Exhibition Centre,
Mumbai, India.
Email: exhibitionsindia@vsnl.com

6–8

BCS & Comms India

New Delhi, India.

7–8

Surround 2001

Beverly Hills Hilton, USA.
Contact: Exhibitions and Events.
Tel: +1 800 294 7605 x507.
Net: www.surroundpro.com

February 2002
3–6

SIEL

Paris Expo, Porte de Versailles,
France.
Contact: Exhibitions and Events.
Tel: +33 1 47 56 50 42.
Fax: +33 1 47 56 24 64.
Email: siel@reedexpo.fr
Net: www.siel-expo.com

4–6

ENTECH 2002

Darling Harbour, Sydney.
Contact: Exhibitions and Events.
Tel: +61 2 9876 3530.
Fax: +61 2 9876 5715.
Net: www.conpub.com.au

21–23

Broadcast Thailand 2002

Queen Sirikit National Conference
Centre, Thailand.
Contact: Overseas Exhibition
Services.
Tel: +44 20 7862 2082.
Fax: +44 20 7862 2088.
Email: ajones@montnet.com
Net: www.besmontnet.com

March
6–8

Convergence India 2002

Pragati Maidan, New Delhi, India.
Contact: Exhibitions and Events.
Tel: +91 11 463 8680.
Fax: +91 11 462 3320.
Email: exhibitionsindia@vsnl.com
Net: www.exhibitionsindia.org

13–17

ProLight + Sound 2002

Pragati Maidan, New Delhi, India.
Contact: Exhibitions and Events.
Tel: +91 11 463 8680.
Fax: +91 11 462 3320.
Email: exhibitionsindia@vsnl.com
Net: www.exhibitionsindia.org

May
21–23

Production Show 2002

National Hall, Olympia, London, UK.
Contact: Exhibitions and Events.
Tel: +44 20 7505 8000.
Email: toby.wand@media.emap.com
Net: www.productionshow.com

**Email your event details to
Dawn Boulwood:
dboulwood@cmpinformation.com
for prompt inclusion in World Events**

FOR INFORMATION ON ALL FOCAL PRESS TITLES VISIT
www.focalpress.com

The Event for...



Leading the world in electronic media

...visit

www.ibc.org

Exhibition • Conference



IBC2002
RAI Amsterdam
12 - 16 September
Exhibits 13 - 17

IBC
Aldwych House
81 Aldwych London WC2B 4EL
United Kingdom
Tel: +44 (0)20 7611 7500
Fax: +44 (0)20 7611 7530
Email: show@ibc.org
www.ibc.org

TREVOR FLETCHER

Having spent part of his childhood and most of his adulthood at The Hit Factory Criteria Miami, Trevor Fletcher's history is inextricably intertwined with the studio

MOST OF TREVOR Fletcher's life has been dedicated to Miami's Criteria Studios—both in its heyday as home to the Bee Gees and countless classic recordings and since its acquisition by New York's Hit Factory. His mother brought him into the facility to play under her office desk while the hits ripped through the consoles in adjacent rooms. Once old enough to need a job he took the job he wanted—in the recording studio.

His position has since given him an unequalled opportunity to track the fortunes of recording studios, the music business and recording technology—which he has done in equal measure and with unflinching enthusiasm.

How is the top end of the American recording Studio business after 11th September?

Let me say on behalf of everyone at both The Hit Factory New York & The Hit Factory Criteria in Miami that our thoughts and prayers go out to the families and victims of the tragic events of 11th September. Considering the gravity of the situation, it kind of puts things in perspective. We make records: this business is not life or death.

I think the high-end US recording facilities felt the economic impact immediately. The week of the 11th everyone was in shock. There was no travel. Clients couldn't get into the US, and the ones that were here couldn't get anywhere. For multiroom facilities that are as busy as we are, every day represents a substantial amount of revenue. Fortunately we were able to redirect our energies in a positive manner with our involvement in benefit projects spearheaded by Michael Jackson ('What More Can I Give') and Emilio Estefan ('Ultimos Adios').

It's only gradually that people have gone back to the business of making music. We'll be fine; don't worry about us.

How is the anticipated growth of Latin music developing?

It's interesting to hear people ask that question. I think it's inherently a bit naive. Latin music has always been a rich, vibrant and multifaceted tradition. It's only now that the English-speaking world is getting hip to it. While I'm pleased that more Hispanic artists are being recognised (both critically and financially), the music has always been there. I'm ashamed to say, I don't speak much Spanish but having lived in Miami for a long time I've become sensitive to the musical traditions. Perhaps the most illustrative example I can think of was a quote by one of my clients. 'The greatest thing about working in Miami is that it's so close to the United States.'

How is the Miami recording scene developing?

Great! There now exist facilities at every level of the technical spectrum. The musical infrastructure has finally developed to the point where we have clients come here



specifically for Miami players. It's 80° in January. What more could you want?

Who is the most exciting new artist you've had in the studio?

While he's not a new artist, we just finished an MTV Unplugged show for an artist named Alejandro Sanz. He's sold several million records in the Latin speaking world, but is only now gaining exposure in the Anglo world. He is a wonderful performer and a good guy. On the other end of the spectrum, we've been doing a great deal of work with producer Rodney Jerkins. He produced a girl on Sony named Rhona Bennett and some of the other stuff he's doing is really hot.

How important is analogue recording in 2001?

I think it's very important. It's an integral part of what a world-class facility provides. As it stands now, nothing can accurately replicate the sound of tape saturation, compression and so on. I believe that it is important to offer my clients the tools necessary to create their vision. You can't really tell Van Gogh 'sorry, you can't use yellow...' I have clients who will cut to analogue (16- OR 24-track) and then dump to digital (DASH or Disk), for them it's the best of both worlds.

Which piece of equipment should you have bought but didn't?

Timing; that's what it's all about. If you are going to be successful in the long term you can't ignore any equipment trends. If enough clients want a piece of gear you

have to be able to provide it or someone else will. So everyone eventually gets that critical piece of gear—it's just a matter of when. For example, Criteria should have purchased an AMS AudioFile when it was the precursor to Pro Tools. Rental units must have paid for themselves a couple of times over before a commitment to hard disk technology was made.

Which piece of equipment do you wish you'd never bought?

Every facility that hopes to remain technologically cutting edge has to make educated leaps of faith at times. Occasionally, some are bound to not work out. However, to publicly single out a specific product and manufacturer would be inappropriate. Just wouldn't do to burn any bridges. Besides, the requirements that my facility and clients have are very specific. What might not be right for HFC, might be a fine product for another facility.

Which single piece of equipment has most changed the recording process?

Since the earliest days of recording? I would say the advent of multitrack recording. In the modern era? I would have to say the evolution of hard disk recording has had the greatest impact on the recording process. The concept of random access, non-destructive editing and virtually limitless tracks has forever changed the way records are made. On the down side, what started out as a tool has become, in many ways, a crutch. I firmly believe it's addictive: it is a drug.

If you could have had any past recording session in your studio, which would it be?

A lot of my favourite records were done here. After 42 years and hundreds of gold and platinum records—to try and find one that inspires envy... that's a tough one.

I'm tempted to say Jimi Hendrix' *Are You Experienced*, but I'd have to go to with the Beatles—pick a record—any record. Such heavy artists, producer and engineers. If I picked Abbey Road and it were done here would it have been named *149th Street*?

What is your fondest memory of pre-Hit Factory Criteria?

I must admit I've spent a while thinking about this one. Lord knows there are some stories to tell. For a long time there was a film and video production company that rented office-studio space from Criteria. One summer about 13 years ago they had a happening intern. I married her.

Is Miami the coolest place in the world to run a recording studio?

Some days I think it's the hottest. Most days it's a pretty great thing. I think one of the things I enjoy most about Miami is that it's somewhere between New York and L.A. I like to believe that we've seen the vibe of both—taken the best points, added a little more cultural diversity and come up with a great place to make platinum records. □

In the dog-eat-dog world of active monitors,
ONLY THE HR824
 comes with an authentic
PEDIGREE.
 It's something to chew on.

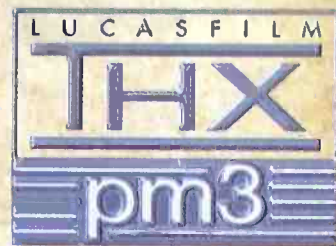

— Actually Mackie HR824 Active Monitors have *two* pedigrees: They're certified for use in Lucasfilm THX[®] pm3 Multi-Channel Mixing and Monitoring studios, too.

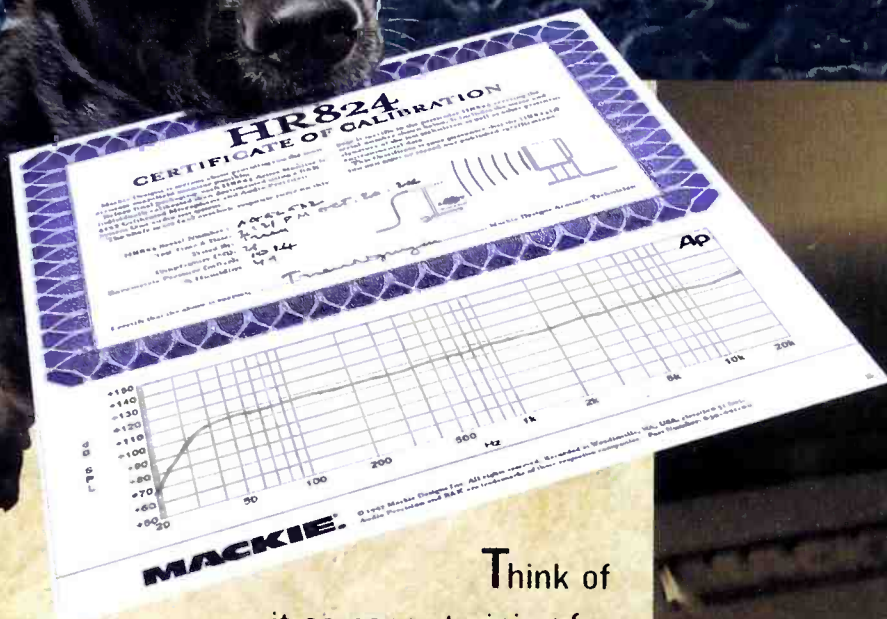

Think of it as paper training for active near-field monitors. Every Mackie Designs HR824 is hand-calibrated and comes with an individual frequency response print-out and signed certificate of accuracy. It's your guarantee that they live up to our claims of "ruler-flat" ± 1.5 dB 39Hz-22kHz response.

Quite frankly, the HR824 is not the cheapest active near-field monitor on the market today. But when the quality of your creative product is at stake, why would you consider spending less?

Because if your studio monitors aren't accurate, nothing else is either.

Hear the active THX[®] pm3-certified HR824 at a Mackie Dealer today.



www.mackie.com • UK + 44.1268.670.808 email: info@rcf-uk.com
 Germany +49.2572.96042.0 email: info@mackie.de • France +03.85.46.91.60
 email: rcf.commercial@wanadoo.fr • Italy +39.0522.354.111 email: mackieitalia@rcf.it

Made by Mackoids in Woodinville USA

DNS1000



CEEDAR

Post, dubbing, studio, OB...

Simple, effective real-time
digital noise suppression
with no loss of lip sync

Not hearing is believing

e-mail: info@cedaraudio.com

www.cedaraudio.com

tel: +44 (0) 1223 881771

fax: +44 (0) 1223 881778

