

June 1989

Recording

ENGINEER/PRODUCER

The Applications Magazine for Audio Professionals

\$4.00

AN INTERTEC PUBLICATION

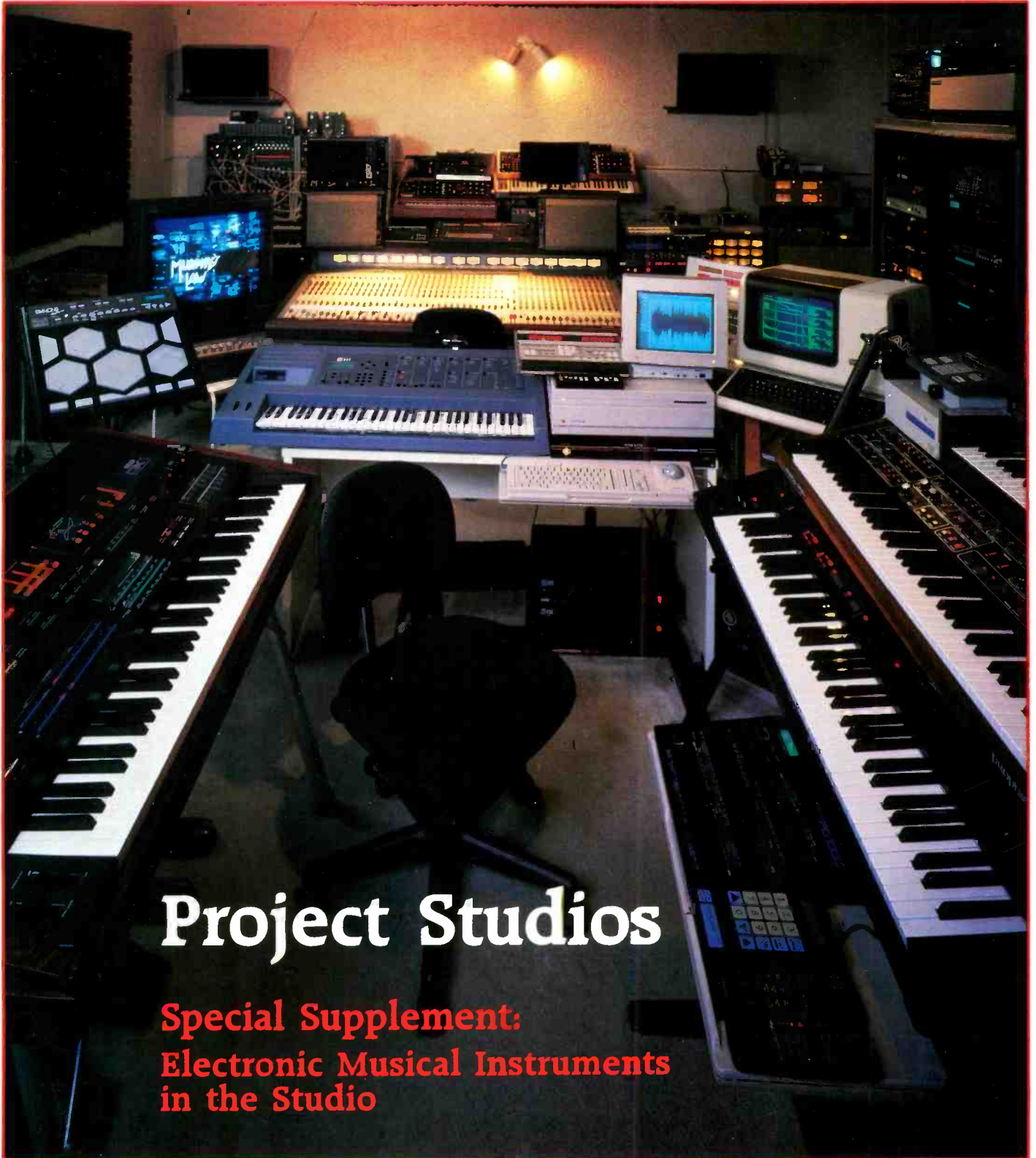

Project Studios

Special Supplement:
Electronic Musical Instruments
in the Studio

"**STILL . . . THE MOST AFFORDABLE FULLY PROFESSIONAL RECORDER ON THE MARKET.**"

Two new and still affordable versions of the most affordable fully professional recorder on the market join the A807 family—a 1/4" 2-track and a 1/2" 4-track 30 ips High Speed recorder.

Compare features, quality and price! You can't buy a 2-track or 4-track recorder that offers the same level of advanced technology, plus Studer audio performance and renowned Studer quality—at any price.

AGILE AND EASY TO USE

Radio, post-production, or studio—in whatever audio environment you operate—like all A807's, these new versions are fast, full-featured machines for making quick work of your production tasks.

A807 features include: • tape shuttle wheel • reverse play • right hand edit • tape dump • varispeed • multifunction tape timer and autolocator with programmable "soft keys"

• digital setting of audio alignment parameters for 3 tape speeds and 2 tape types • RS 232 port • a wide variety of configurations available now, with more to come in the near future . . .

STUDER AUDIO PERFORMANCE & RELIABILITY

Advanced phase compensated audio-electronics, Dolby HX Pro™, a massive die-cast chassis and headblock . . . these compact recorders are built with the same quality, precision and full-sized Studer sonics that have been synonymous with the Studer name for four decades.

So—if "affordable" is not the first word that comes to mind when you think of Studer—think again.

Then call your authorized dealer and arrange a test drive of the new, affordable High Speed A807's.



**THE 30 IPS
4-TRACK IS HERE!**

STUDER REVOX

Studer Revox America Inc.

1425 Elm Hill Pike • Nashville, TN 37210 • Phone (615) 254-5651

Available from Studer Revox Full-Line Professional Products Dealers. Or contact us directly. **Los Angeles** (818) 780-4234. **New York** (212) 255-4462. **Chicago** (312) 526-1660. **Dallas/Ft. Worth** (817) 861-1861. **Canada** (416) 423-2831.

Circle (1) on Rapid Facts Card

IT'S THE LITTLE THINGS ABOUT THE IL SERIES THAT YOU'LL APPRECIATE.

Take a close look at the Soundtracs IL Production console. An outstanding console that's achieving acclaim amongst commercial recording studios around the World. Designed to meet a production climate that's radically changing with engineering that matches efficiency with vision.

More important, though, listen to the way it sounds. This 32 bus console offers very low noise, minimal crosstalk and a degree of sonic transparency that sets new standards.

Combine these attributes with a sensitive yet effective equaliser section to create one of the sweetest sounds to be found anywhere, perfect for high quality track laying.

And while our crystal clear layout is free of gimmickry, we've included a number of unique features and sophisticated circuit designs which, together with Soundtracs Tracmix fader automation, provides versatility to set your creativity free.

Little things in themselves. But in the Soundtracs IL, add up to a rather special production console.



SOUNDTRACS PLC. 91 EWELL ROAD. SURBITON, SURREY
KT6 6AH ENGLAND TELEPHONE (01) 399 3392/8101
FAX (01) 399 6821 TELEX 8951073 STRACS G

SPECIFICATIONS:

- 48 OR 36 CHANNELS □ 104 OR 80 INPUTS ON REMIX
- INTERCHANNEL CROSSTALK BETTER THAN -88dB @ 1kHz
- MIX NOISE 32 INPUT ROUTED BETTER THAN -82dB

EXCLUSIVE US DISTRIBUTOR:

SAMSON[®]
Technologies Corp.

SAMSON TECHNOLOGIES CORPORATION, 485-19
SOUTH BROADWAY HICKSVILLE, NY 11801, USA
TELEPHONE (516) 932 3810, FAX (516) 932 3815

Circle 4 on Reader Service Card

CONTENTS

Project Studios

Computer/Studio Interfacing at Studio Malibu

To maximize efficiency and creativity, Studio Malibu depends on sophisticated hardware and software peripherals to control its synths and samplers.

By Jeff Burger..... 24

Special Supplement: Electronic Musical Instruments in the Studio

By Bob Owsinski..... 32



Brave New World

In just a few years, electronic musical instruments have become an essential part of most recording facilities.

Synthesizers and Samplers

The most common electronic music components have as many approaches as there are players.

Electronic Drums and Triggering Devices

Why should keyboardists have all the fun? With the right equipment, MIDI's possibilities are open to almost everyone.

New Applications

Electronic instruments have expanded beyond their original applications.

Other Features

Computer Software for the Audio Industry

A report on the audio-related software available for the Amiga, Atari, IBM/compatibles and Macintosh computers.

By Lynn Hedegard..... 46

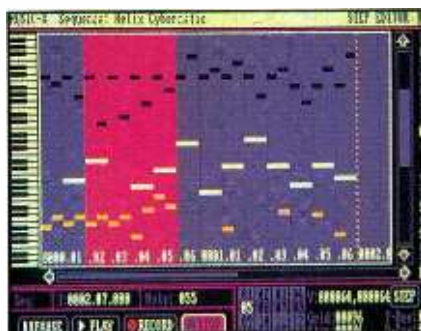

George Michael on Tour
Sound system design from Showco features the Prism system.

By David Scheirman..... 54



Departments

Editorial.....	4
Letters.....	6
News.....	8
Managing MIDI.....	14
SPARS On-Line.....	18
Understanding Computers.....	20
Engineer/Producer Index.....	63
Tracks.....	67
Studio Update.....	70
The Cutting Edge.....	71
New Products.....	72
Classified.....	77
Advertisers' Index.....	80
Engineer/Producer Index	
Reply Form.....	81
Tracks Reply Form.....	83
Rapid Facts Cards.....	85
New Subscriber and	
Address Change Cards.....	87

On the Cover

Studio Malibu, Malibu, CA. Photo by Johann Wolff, courtesy of Studio Malibu.



Volume 20, No. 6
RECORDING ENGINEER/PRODUCER (ISSN 0034-1673) is published monthly for \$26 to qualified readers, \$30 to non-qualified readers per year by Intertec Publishing Corporation, 9221 Quivira Road, Overland Park, KS 66215. Second-class postage paid at Shawnee Mission, KS and additional mailing offices. POSTMASTER: Send address changes to Recording Engineer/Producer, P.O. Box 12960, Overland Park, KS 66212.

In an age of disk and digital, why buy analog?

We know there are some applications where our 32-channel digital machine, the DTR-900, is the only answer. But if your business is such that you can do anything you want to do in the analog domain, and at the same time do less damage to your budget, then our brand new analog 24-channel MTR-100A may be the perfect machine for you.

When you consider that the MTR-100 will literally *change forever* the way engineers interface with audio machines, and



The MTR-100's auto-alignment saves you hours of time by eliminating constant tweaking and re-tweaking between sessions.

that this new way will save you hours spent in non-productive time, the analog choice begins to make even more sense. You see, the MTR-100 features full Auto-Alignment that allows total recalibration of the record and reproduce electronics. This means you can compensate for different tapes in a *fraction* of the time that it previously took, and your studio is not bogged down with constant tweaking and re-tweaking between sessions.

And if you think digital machines have a corner on high performance transports, think again! The MTR-100's new transport incorporates reel motors that approach one horsepower—you'll get fast wind speeds of up to 474 inches per second! Of course, the

transport is pinchrollerless to give you the legendary tape handling ballistics of our MTR-90.

What's more, with its optional EC-103 chase synchronizer, the MTR-100 maintains frame-lock in forward and reverse from 0.2X to 2.5X play speed,

and will typically park with zero frame error.

Then, there's the sound. New cylindrical-contour heads built by Otari especially for the MTR-100 result in remarkably low crosstalk and outstanding low-frequency performance. Pre-amps are located directly beneath the heads to further improve frequency response, and HX-Pro* is built-in for enhanced high frequency headroom. (An optional internal noise reduction package houses Dolby* SR/A.) Add all these features to gapless, seamless, punch-in, punch-out, which is also built-in, and your



Reel motors that approach one horsepower are driven by pulse width modulation amplifiers to tape speeds up to 474 ips.

MTR-100's sonic performance will rival, or beat any digital machine in the world.

So there you have it. With these powerful benefits available in analog, does it make sense to go digital? Sure, for some applications. But analyze your needs carefully before you buy. For many applications, a hot

analog tape machine like the MTR-100 is the right choice.

And because we can see both sides of the question, put us to work. We have information that can help you make the right decision. Call Otari at (415) 341-5900 for the "Technology You Can Trust".

OTARI®



Trademark Dolby Laboratories Licensing Corporation

Here Comes the Judge

As is often said, timing is everything. In this case, I'd like to have been wrong. In the January "Editorial" I wrote, "One solution, which no one wants to think about, is government intervention." Dateline Washington, Feb. 27. The Supreme Court hears the case of *Ward vs. Rock Against Racism*. The City of New York wants to require, through a city regulation, that all musical performers at Naumburg Bandshell in Central Park use a city-supplied sound system and sound technician.

Rock Against Racism, which sponsors an annual concert at the bandshell, says the regulations are unconstitutional because they are too broad and infringe upon First Amendment guarantees. The city says the regulations are part of its right to regulate noise in the urban environment.

While the city has the right to limit the sound level of concerts, the U.S. Court of Appeals for the Second Circuit said the Constitution permits only the "least-restrictive means available." The appeals court went on to rule that city control of the "mix" of sounds that make up the artistic presentation is too intrusive and the regulation violated the performers' right of free expression.

The Supreme Court accepted the City of New York's appeal last October and is expected to decide the case by early summer.

I first learned of this court battle in March. My first thought (after recovering from the shock) was: What can we as an industry do to help present an accurate voice of knowledge and experience to those who, admittedly, are unfamiliar with live sound practices? The answer I got was, "It's too late to do anything, the hearings are over, the matter is in deliberation." By now I was having to recover from shock Number 2. "You mean to tell me that the pro audio community was completely absent from the prejudgment process?" The answer was yes!

So here we are. We should have seen this coming. My comments in January were not at all prophetic. Rather, they were one more appeal to the sensibilities

of system designers and operators.

One of the key issues in this case revolves around the question of whether the house mix engineer is an integral part of the creative process or merely a technician. To put it another way, does the engineer serve a function similar to the conductor of a symphony orchestra? While there are similarities, there are significant differences. The primary difference is that the conductor does not have a master volume control that enables him to turn the level of the orchestra up beyond the level-generating capabilities of the acoustic instruments on stage. Another significant difference is that the orchestra is under the complete dynamic and artistic control of the conductor; the same cannot be said of the house mixer for any touring act.

While I don't like the idea of government intervention, I do feel that the concert sound system operators have a responsibility for their actions when controlling very high-powered reinforcement systems.

Perhaps the most disturbing aspect of this recent news is the pro audio community's total absence of representation in a case of such obvious importance. To my knowledge, we were not consulted as expert witnesses, nor did we have a representative voice organizing a unified position. In fact, I talked to several key people, and nobody even knew about these proceedings until well after anything could be done.

Is it that our channels of information and communication are so bad? Or that no one felt this issue was important enough for a response? I doubt the former; word travels fast on these streets. If nonchalance is the excuse, then our tiny, fragile industry deserves whatever consequences are forthcoming.

Where were the trade organizations such as the AES and SPARS?

Not long after hearing the news, I called Bruce Merley, president of SPARS, to see what he knew of the situation. He, too, was unaware of the story. At about this point I asked him if there was any reason why SPARS couldn't take a more active role—the role that a trade organization should take in representing an industry. He agreed that SPARS could, and probably should, be one of the more active organizations. Of course, the AES should also participate actively in matters such as this, but it seems uninterested in taking a leadership position on any non-technical issue.

Right now we are an industry without representation, leadership or direction. There is some progress on the hardware-standards level, but there is little or no representation when it comes to politically relevant topics such as this one, CBS's proposed Copycode legislation, or the recently settled (out of court) case involving an engineer's liability in a sampling/copyright infringement suit.

And there is more to come—you can be sure. In a case in Nevada, CBS Records and Judas Priest are being sued by the parents of two teenagers who committed suicide after allegedly listening to the band's "Stained Glass" album. There have been other suits of this kind, but what makes this case notable is that CBS was ordered to turn over the 24-track masters to be examined for subliminal messages.

While the defendants in such cases have First Amendment protections—and the judge in the Nevada case has said the case will not go to trial unless subliminal messages are found—it seems only a matter of time before engineers and/or producers are named in such suits. The fact that CBS was forced to turn over the 24-track master should be taken as an ominous sign. Does the pro audio community have a representative voice in these proceedings? I doubt it.

Still not convinced that we are (or are about to be) facing significant regulatory intervention? Consider this. In Europe, a regulatory commission (much like OSHA) is currently setting occupational safety standards for noise levels in the workplace. I'm told that these regulations will be enforced in recording studios as well as airports and shipyards. Consider the implications.

As an industry, we must address these issues before the political burdens outweigh the business, technological and economic burdens we already carry. *RE/P* is ready, willing and able to disseminate information and support the policies and decisions of intelligent leadership.

Are these events acceptable to you as a professional? They're not acceptable to me. And they won't be unless I get a say in their eventual outcome. Without representation and leadership, we are all going to be shut out of the policy-making processes that affect our careers.

Michael Fay
Editor

If Michelangelo had a QUADRAVERB, he might have mixed music instead of paint.



It's true. Music and painting are very similar. A stroke of red, a touch of chorus. A splash of blue, a wash of reverb. Either way, it's art. And every artform has its masterpieces. And its tools.

Introducing the Alesis QUADRAVERB. An all-new 16 bit digital, simultaneous multi-effects processor and dead-serious musical tool. With QUADRAVERB, your mixes will be mirror images of the sound in your head. No letdowns. No noise. No nonsense. No boundaries between art and creation.

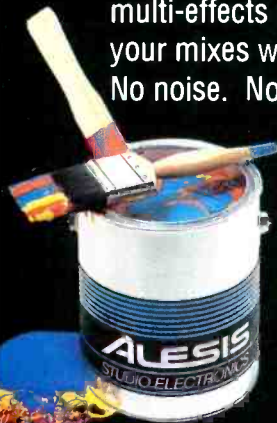

Inside, QUADRAVERB is alive with colors. Chorus, flange, phase shift, pitch detune and delay... all in stereo, to give your music depth and space. For absolute tonal control there are 5 bands of parametric and 11 bands of graphic e.q. And, of course, there's the unmistakable clarity and drama of the award-winning Alesis digital reverb programs.

With full programmability, 100 memory slots, and 90 factory programs created by the best ears in the business, QUADRAVERB gives you total artistic freedom. Plus, in QuadMode™, four of these flawless 20kHz bandwidth effects occur simultaneously. Like crunching thousands of dollars worth of studio gear into one rack space.

With very little cash, and even less effort, you can use QUADRAVERB on your next mix... plug it into your instrument rig... perfect your sound.

See your Alesis dealer today and hear what state of the art really means.

Michelangelo would agree, QUADRAVERB is a masterpiece.



LOS ANGELES:
Alesis Corporation • 3630 Holdrege
Avenue • Los Angeles, Ca. 90016

LONDON:
Alesis Corporation • 6, Letchworth
Business Center • Avenue One,
Letchworth, Hertfordshire SG6 2HR

Circle (8) on Rapid Facts Card

LETTERS

Not a dumping ground

From: John M. Woram, Rockville Centre, NY.

I sympathize with Kenneth Glaza losing out on a job opportunity because of the over-qualified syndrome [Letters, February]. That's a tough break, and I wish him luck in finding a more receptive employer soon. However, I don't think his problems can be attributed to William Moylan's excellent overview of the industry ["Employment Trends," December 1988], or to the dumping grounds at the University of Miami.

I had the pleasure of being affiliated with the U of M's music engineering program for a few years, and as far as I know, the school continues to unload about 15 to 20 graduates on the industry every semester, which is a bit short of Mr. Glaza's estimate of "hundreds of 'qualified people' per year." As for how many Dr. Moylan foists on the public, my best guess is "not enough."

Any beginner with the financial and intellectual stamina to survive a four-year college program or a *reputable* trade school program should be encouraged to do so. But anyone who goes to school should not think of it as an employment agency. A school is for getting an education. With luck, it will lead to a job (sweeping floors, if you're really lucky), but that's a fringe benefit.

Mr. Glaza's observations notwithstanding, most successful graduates of good programs spend at least a little time during their senior year trying to decide which job offer to accept. I don't suppose that's welcome news to someone who doesn't enjoy the same pleasant dilemma, but it does suggest there's always room for one more qualified person out there.

Since Mr. Glaza hopes to return to school for his own degree, I'll part with a little free advice: If the program has an elective called Positive Thinking 101, go for it.

WD-40 on LPs

From: Doug Pomeroy, Pomeroy Audio, Brooklyn, NY.

Your September issue carried a Studio Update/Talkback item regarding the use of WD-40 to aid in the removal of glue from adhesive stickers that were sometimes applied to the surface of LP records by radio

stations. It was also noted that WD-40 has a restorative effect, reducing surface noise.

Having experimented with this, I would make the following observation: WD-40, like other surface lubricants, can slightly reduce the surface noise of badly worn records. (The WD-40 Company does not make any claims for its product in this regard.)

If WD-40 is to be used to "restore" the surface, the LP should be carefully washed with warm soapy water and rinsed (ideally with distilled water) *before* application, so that surface dirt is not sealed under the WD-40 spray. (My experience is that noise is reduced more by the washing than by anything applied thereafter.)

A final word of caution: WD-40 remains oily where it is applied and should be washed off after use, or else it will spread to album sleeves, fingers, etc.

Teaching sound reinforcement

Editor's note: David Scheirman, RE/P's live sound consulting editor, recently received a letter from Jennifer Miles. Her letter stated that after managing a heavy metal band, she wanted to get into sound engineering, and asked if David could recommend a school or schools for her consideration. His reply is printed below.

When the issue of recording schools is brought up, it usually concerns the teaching of studio recording and not sound reinforcement. We invite any readers who are involved in live sound educational programs, or those who have recently attended such courses, to write us about your experiences.

Dear Jennifer,

Many young persons are interested in the field of live sound as a career. While there are hundreds of schools, both public and private, that offer instruction in recording techniques, few of them approach the subject of live sound.

My best suggestion to you is that you get in touch with professional concert sound companies in your own geographical area. Ask them if they ever take student interns on a work-study program from schools, and, if so, what schools they are relying on for help. This will give you a clear indication that an educational program does exist in your area that can

actually help to place you in your career field of interest. You may need to travel to another state.

There are a few excellent programs in this country, and more are starting to appear. Unfortunately, there are also some "schools" that claim to offer professional instruction in "sound engineering," but they are basically just capital redistribution firms. You give them you money. Period. Before you enroll in any school, check it out thoroughly.

Not to spec

From: Lachlan Westfall, president, International MIDI Association; secretary, MIDI Manufacturers Association.

In reading the article by Peter Jostins in the February issue ["MIDI and the Mixing Console"], I came across the statement, "As I have explained, the main problem with MIDI is that it is not capable of transmitting massive amounts of data. However, the current MIDI spec allows for a baud rate of 61.5K (instead of 31.25K), which doubles the amount of data that can be transmitted..."

This is completely untrue. Nowhere in the MIDI 1.0 detailed specification does it mention a higher baud rate.

January critique

From: Tom Young, head engineer, Audio Technologies Inc., Watertown, CT.

I was very impressed with the clarity of J. Russell Lemon's letter on phase shift and its audibility ["Letters," January]. Many articles have been written on the subject, and they are often difficult to comprehend well, partly due to the complexity of this phenomenon.

Your article on "Coping with Wireless Systems" was also about the best and easy to understand that I've read. Hats off to Bill Mayhew.

I read your magazine every month and hope you keep up with the coverage of live sound, as well as recording, acoustics, etc.

RE/P

Send letters to RE/P, 8330 Allison Ave., Suite C, La Mesa, CA 92041. Letters may be edited for length and clarity.

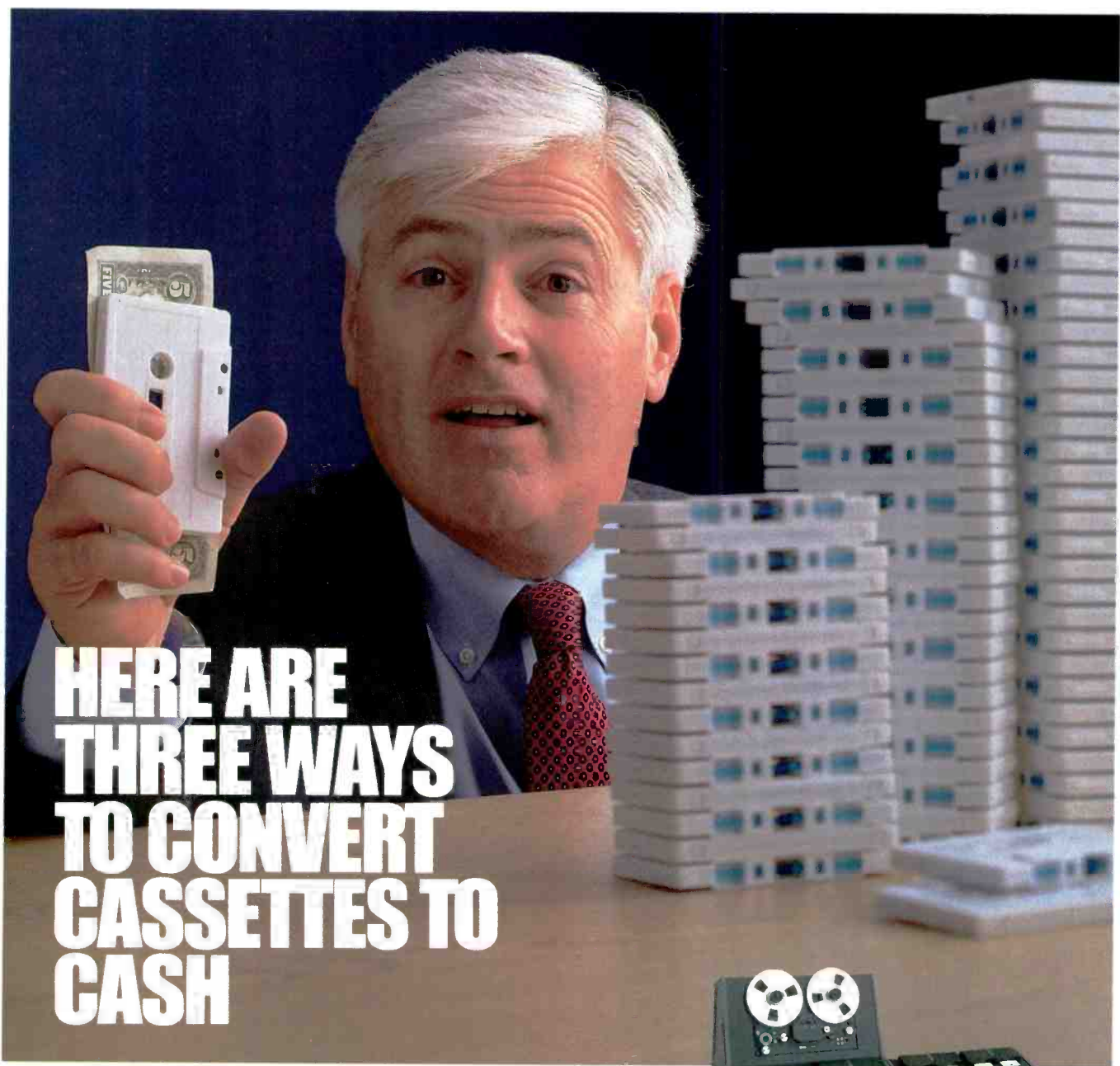

HERE ARE THREE WAYS TO CONVERT CASSETTES TO CASH

- ✓ **Add new profit opportunities** by starting your own high speed tape duplication department.
- ✓ **Increase production** of your current tape duplication department by adding modules as you grow.
- ✓ **Save the money** you're spending on cassettes now. Produce them yourself for only the cost of the tapes.

Telex is the leader in high speed audio tape duplication equipment with products ranging from the compact, economical

Copyette® series to the professional 6120XLP shown here. The Telex 6120 series provides outstanding audio quality, unlimited expandability and profitable production capabilities. It's available in high production 16X speed or 8X speed for highly critical audio needs.

Hearing is believing
For full details including specifications and a free demo tape, call or write today.

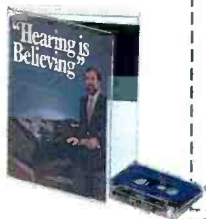

6120 High Speed Duplicator

Call toll free: 800-828-6107

Telex Communications, Inc.
9600 Aldrich Av. So.
Minneapolis, MN 55420

Name _____
 Company _____
 Address _____
 City _____ State _____ Zip _____
 Telephone _____

©1989 Telex Communications, Inc.



TELEX®

Circle (7) on Rapid Facts Card

www.americanradiohistory.com

NEWS

Companies offer free tape for SPARS membership

As an incentive to join the Society of Professional Audio Recording Services during its 10th anniversary year, Agfa, Ampex and 3M are each donating a 10-inch reel of 1/4-inch tape to new members of the organization. All three companies are advisory members of SPARS and encourage membership in the organization, a network of audio recording professionals, personal-use studio owners and manufacturers.

SPARS has created a new associate membership category for those in allied audio recording services and personal-use studios. Yearly dues are \$250. For more information, contact SPARS at 4300 10th Ave. N., Suite 2, Lake Worth, FL 33461; 407-641-6648.

MCA opens NoNOISE facility

After six months of Beta site testing, MCA has opened its new production studios in Los Angeles, which includes four suites for analog/digital transfer and 2-track editing, two CD mastering rooms with Sonic Solutions workstations and NoNOISE software, two cassette-mastering rooms, off-line video editing and duplication, vaults and a full technical shop. The facility is the company's distribution headquarters.

The initial R&D program involved MCA,

Sonic Solutions and Audio Intervisual Design, the West Coast representative. The system permits all of the editing, EQ and master preparation to be done in the digital domain on the hard disk.

UCLA creates electronic music program

The UCLA extension department of the arts has inaugurated a certificate program in electronic music, featuring courses in electronic music and synthesis, MIDI, personal computer hardware and software, film scoring, sound recording for film and video, and film and video post-production.

The program coordinator is Jeff Rona, president of the MIDI Manufacturers Association and a synthesist, composer and writer.

For more information, contact UCLA Extension at Box 24901, Los Angeles, CA 90024; 213-825-9064.

Info, photos sought for audio book

Author David Miles Huber is searching for historical information and photos for a coffee-table book, "The History of Recorded Sound." The book will highlight the progression of recording from Edison to the digital era and will be written for the audio/video professional.

Huber is seeking black-and-white and color photos, and articles that describe a favorite event, piece of equipment, person or era. Contributions will be returned on request, and acknowledgments and photo courtesies will be given.

For more information, contact Huber at Playback Communications, Box 1100, La Conner, WA 98257; 206-328-4835.

Obituary: Milton T. Putnam

Milton T. "Bill" Putnam, the founder of UREI Electronics and several recording studios, died April 13. He was 69.

Putnam's career in the audio industry can be traced to the 1940s, when he first published articles in *High Fidelity*. He developed many of UREI's best known products, including the 800 Series monitors, the 1176 limiter and the first low-noise tub mic pre-amplifier. Putnam pioneered half-speed mastering and engineered many Top 10 releases in the 1940s-60s.

Putnam founded Universal Recording, Chicago, United and Western Recording, Hollywood, and Coast Recorders in San Francisco.

In 1983, the Audio Engineering Society honored him for "Lifelong Contribution to Studio Design and to the Design of Audio Instruments and Equipment."

EDITORIAL

Michael Fay, *Editor*
Dan Torchia, *Staff Editor*
Pamela S. Fleener, *Associate Editor*
William Abrams, *Editorial Assistant*
Tom Cook, *Senior Managing Editor*
Pat Blanton, *Directory Issues Editor*

ART

Alecia Wright, *Graphic Designer*

BUSINESS

Cameron Bishop, *Group Vice President*
Dennis Milan, *Publisher*
Evelyn Hornaday, *Promotions Manager*
Cynthia Baker, *Marketing Coordinator*
Laurel Cash, *Executive Consultant*
Dee Unger, *Advertising Business Manager*
Tami Bartocci, *Advertising Coordinator*

Sales offices: See Advertisers' Index.

ADMINISTRATION

R.J. Hancock, *President*
Chuck Rash, *Corporate Circulation Director*
Sandra Stewart, *Circulation Director*
Doug Wilding, *Circulation Manager*
Barbara Clare, *Reader Correspondent*
Kevin Callahan, *Creative Director*

CONSULTING EDITORS

Jeff Burger, *Computers*
Paul D. Lehrman, *Electronic Music*
John Monforte, *Technical Consultant*
David Scheirman, *Live Performance*

RECORDING ENGINEER/PRODUCER is edited to relate recording science to recording art to recording equipment, as these subjects, and their relationship to one another, may be of value and interest to those working in the field of commercially marketable recordings and live audio presentation. The editorial content includes: descriptions of sound recording techniques, uses of sound recording equipment, audio environment design, audio equipment maintenance, new products.

CORRESPONDENCE

Advertising and Subscription:
9221 Quivira
Overland Park, KS 66215
913-888-4664
Telex: 42-4156 Intertec OLPK
Fax: 913-541-6697

Editorial:
Suite C
8330 Allison Ave.
La Mesa, CA 92041
619-464-5577
Fax: 619-464-2643

SUBSCRIPTIONS

Qualified:
United States (Domestic Only).....\$26.00
Foreign.....\$50.00
Non-qualified:
United States (Domestic Only).....\$30.00
Foreign.....\$60.00

Optional airmail for non-qualified readers is also available for an additional \$55.00 per year. Foreign subscriptions are payable in U.S. funds only by bank check or money order. Adjustments necessitated by subscription termination at single copy rate.

Recording Engineer/Producer is not responsible for any claim by any person based on the publication by **Recording Engineer/Producer** of material submitted for publication.

Photocopy rights: Permission to photocopy for internal or personal use is granted by Intertec Publishing Corporation for libraries and others registered with Copyright Clearance Center (CCC), provided the base fee of \$2.00 per copy of article is paid directly to CCC, 21 Congress St., Salem, MA 01970. Special requests should be addressed to Cameron Bishop, group vice president.
ISSN 0034-1673 \$4.00 + \$0.00.

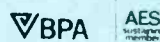

Member, Business Publications Audit of Circulation
Sustaining member of Acoustical Society of America
Member, International Communications Industries Association
Associate member of Society of Professional Audio Recording Services



©1989. All rights reserved.

W E C A R E

Did you know Abbey Road Studios uses

AGFA

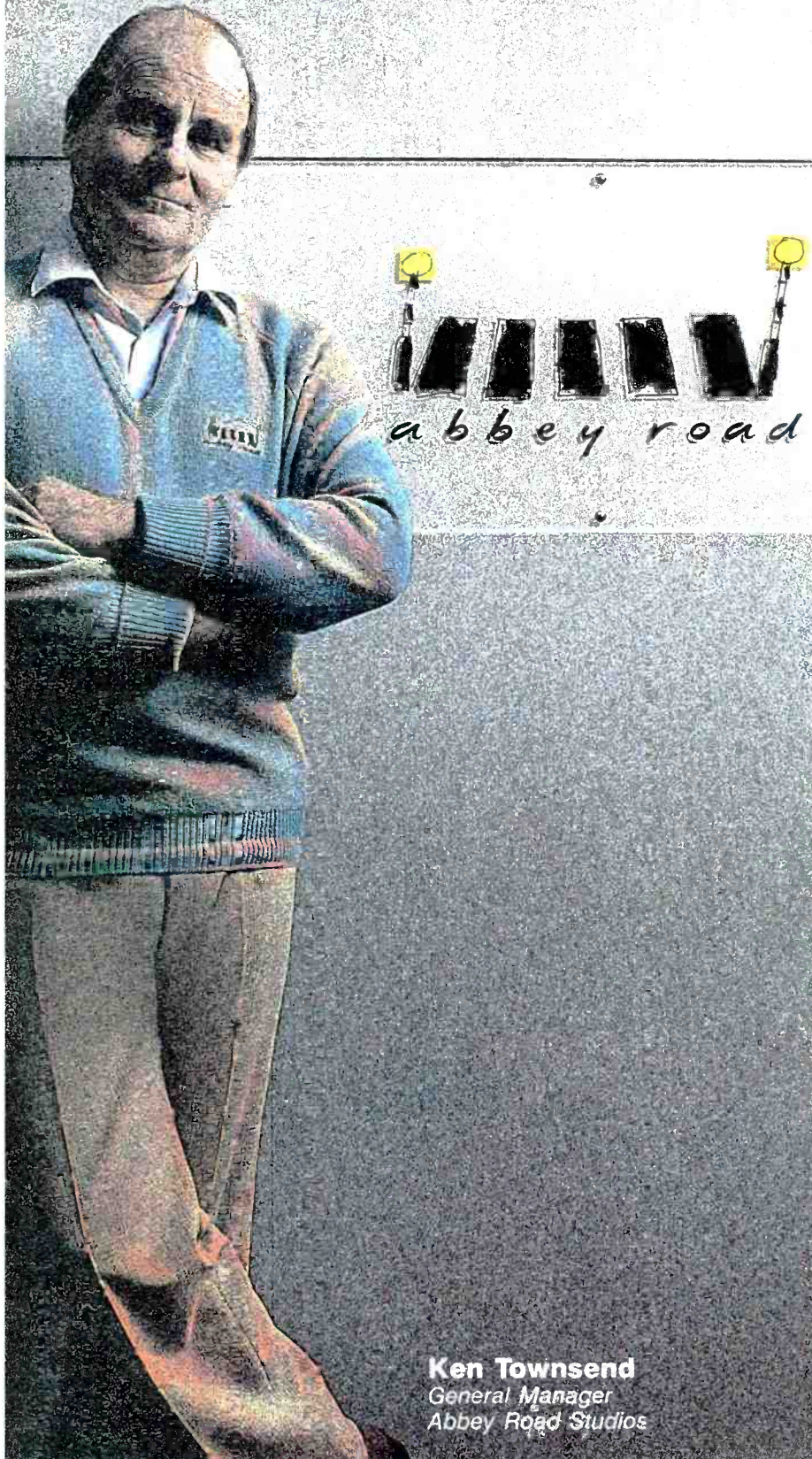

Ken Townsend
General Manager
Abbey Road Studios

Abbey Road Studios—the name evokes a time, an era—the Beatles.

Ken Townsend, Abbey Road general manager, has heard it all—from the record that put the street on the map to Pink Floyd's "Dark Side of the Moon".

Today, in a very modern state-of-the-art facility, Ken hears it on AGFA PEM 469. It's bias compatible and... "It simply sounds better," he says.

Townsend has helped keep Abbey Road on the leading edge for 35 years. He knows that it takes a quality tape to capture a quality performance.

He also knows that Abbey Road makes more than just music.

It makes music history.

AGFA magnetic tape—from research and development, through manufacturing, to delivery and service—we care!

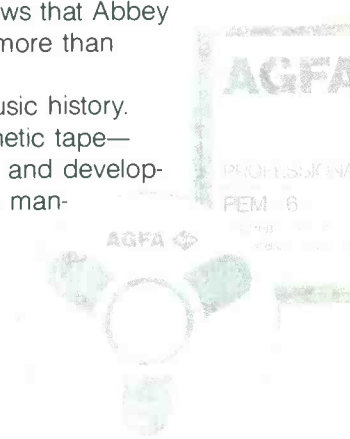

Agfa Corp., 100 Challenger Road,
 Ridgfield Park, NJ 07660 Telephone (201) 440-2500

AGFA 

NEWS

News Notes

DigiTech won Most Innovative Product of the Year for Rack-Mounted Effects award during the third annual Music and Sound Awards at Winter NAMM for its DSP 128 digital multi-effects signal processor.

Gary Davis & Associates has relocated to 3237 Donald Douglas Loop S., Santa Monica, CA 90405; 213-397-6625; fax 213-390-9917.

UREI Electronics has moved its entire operation to the Harman Business Campus in Northridge, CA. The relocation increases the company's manufacturing, warehousing and shipping capacities, and provides expanded new product development capabilities. The company's new address is 8400 Balboa Blvd., Northridge, CA 91329; 818-895-8734.

The band Metallica, currently one of the biggest grossing acts in America, is touring with a **TAC SR9000** as front-of-house console and a **TAC Scorpion** foldback console. The SR9000 is controlling 110,000W of the act's speaker system.

TGI, the holding company of **Tannoy**, has acquired **Audix**, a manufacturer of public address systems and broadcast equipment. Upon completion of the acquisition, a new company, **Tannoy-Audix Ltd.**, will be formed, consisting of Tannoy's systems division and Audix.

Samson Technologies, the U.S. Soundtracs distributor, has signed Everything Audio, Burbank, as its area dealer.

Bag End has moved to Box 488, Barrington, IL 60010; 312-382-4550.

Bruel & Kjaer has returned to a national direct sales network for its the Series 4000 microphones. The mics will now be offered through the company's 55 field application engineers, augmented by three regional representatives: Lee Furr for the West (800-444-4BNK), Tom Lanik for the East (800-336-4656), and Lew Frisch for the Southeast (404-636-2601).

Anita Baker's vocals on "Giving You the Best That I Got" were recorded directly into an **NED Direct-to-Disk** system. According to the company, it marks the first time that the vocals of a Top 10 single

were recorded straight from a microphone into a computer hard disk. Bruce Nazarian of **Gnome Recording**, New York, engineered the sessions.

Trident Audio USA has added two dealers to its national distribution network: **Harris Audio**, Miami and Atlanta, and **Audio Images Corporation**, San Francisco.

Renkus-Heinz conducted its second sound system design seminar in Irvine, CA, following Winter NAMM. More than 100 people attended the 2-day event, which covered HF drivers, mids, horns, woofers, complete speaker systems and the company's processor-controlled sound systems.

DOD Electronics has named **Crescendo and Associates**, Miramar, FL, as its sales representative of the year. Also, the company has presented **Gold Club Awards** to five rep firms for outstanding performance. The firms are **Harrison/New West**, **R.J. Marketing**, **Hanoud and Associates**, **Elliot Goldman** and **Gene Griffith Sales**.

As it celebrated its 25th anniversary in April, **Otari Electric Co.** changed its official name to **Otari Inc.**, reflecting the company's expanding business activities. The Tokyo headquarters has also moved into a new facility at 4-33-3 Kokuryo-cho, Chofu-shi, Tokyo 182 Japan; (0424) 81-8626; fax (0424) 81-8633.

New England Digital's initial production run of the **Synclavier 9600** has sold out, according to the company. **George Michael** and **Gloria Estefan** are among those who have purchased a system.

Paul Farrah Sound has changed its name to **Farrahs**, in response to many of its clients using the shortened name.

Neumann, the German microphone manufacturer, is celebrating its 60th year in business.

Full Sail Center for the Recording Arts has introduced an intermediate course on the **New England Digital Synclavier**. The course is designed for professional **Synclavier** and **Direct-to-Disk** operators to polish their personal skills. In the year since **Full Sail** became the official **NED** training center, 316 students have been graduated.

Aries America has relocated to 22122 S. Vermont Ave., Unit E, Torrance, CA 90502; 213-533-5112; fax 213-533-6883.

Neve has moved its Western regional sales and support office to 6353 W. Sunset Blvd., Suite 402, Hollywood, CA 90028; 213-461-6383.

AudioLine recently opened a branch office in Kansas City, MO. The office will offer professional audio equipment from more than 120 manufacturers and comprehensive demonstration facilities. **James "Ham" Strawn** has been named sales manager; the new address is 4049 Pennsylvania, Suite 100, Kansas City, MO 64111; 816-931-9166.

Al Jarreau has signed an agreement with **Audix** to endorse its microphones. Presently on tour in Europe and in the United States, Jarreau is using an **OM-2** dynamic mic. **Audix** is now manufacturing the **OM-1** and **OM-2** mics in its California facility.

Sam Ash Professional, a new division of **Sam Ash Music Corp.**, opened its New York office in February. The office is located at 723 Seventh Ave., Third Floor, New York, NY 10019; 212-719-2640; fax 212-302-4289.

Aesthetic Engineering, a new music software company formed by composer and software author **Laurie Spiegel**, is now shipping **Music Mouse** software, formerly published by **Opcode Systems**. The software package is available directly from **Aesthetic Engineering** for **Atari**, **Amiga** and **Macintosh** computers. The company's address is 2022 Taraval St., Suite 5408, San Francisco, CA 94116; 415-589-2191; fax 415-588-2851.

Klark-Teknik has signed a strategic alliance agreement with **Milab** to undertake international marketing for the company's microphones. Sales and service for **Milab** products is now shared between **Klark-Teknik** in England for specified markets in Europe and overseas; **Klark-Teknik U.S.** for the United States; and **Milab** for the rest of the world.

Americ Disc North America has opened a sales office in New York to provide optical disc replication services to U.S. customers. **Lisa Schraml** will head the office as director of marketing and sales.

LANDMARKS IN PERFORMANCE.

The AC 22 and AC 23
Electronic Crossovers.



P

rofessionals look for those landmark designs that show complete attention to every detail with the most advanced technology available.

The AC 22 and AC 23 Linkwitz-Riley crossovers from Rane are just such achievements in crossover design, combining such innovative features as:



- 24dB/octave slopes.
- Built-in electronic phase alignment.
- Automatic internal configuration switching.
- 41-detent frequency selection, and more.

Capabilities like this can deliver cleaner, more consistent sound quality with less fussing.

As a professional you deserve nothing less than landmark performance. Advanced crossover technology from Rane.

RANE

10802-47th Ave. W.

Everett, WA 98204

(206)355-6000

Circle (9) on Rapid Facts Card



NEWS

The office is located at 122 E. 42nd St., New York, NY 10168; 212-984-0720.

Crest Audio has entered an agreement with Jim Gamble & Associates to manufacture, market and distribute Gamble products worldwide. Gamble will continue to design and consult for Crest from his Tahoe City, CA, facility. The first products available will be the Series EX house and monitor consoles.

Renkus-Heinz recently celebrated the end of its 10th year in business.

Hydra Tech is a new company specializing in tour and studio support, including designing and building MIDI systems, modifications, programming and applications. Principals are Mitch Marcoulier, Ran Ballard and Tim Myer, all of whom worked on Michael Jackson's "Bad" tour. For more information, contact Myer at 213-396-6867.

Proshow USA, an A/V sales, rental and

installation company, has purchased Vista Sound, a sound reinforcement company based in the Northwest.

Gulton Industries, the **Electro-Voice** pro audio division in Canada, has changed its name to Mark IV Audio Canada.

Ariel has moved to 433 River Road, Highland Park, NJ 09804; 201-249-2900; fax 201-249-2123.

Sidereal Akustic Audio Systems has moved to 9974 Scripps Ranch Blvd., #120, San Diego, CA 92131; 619-578-4226; fax 619-578-4059.

People

Robert Gross has been appointed director of management information systems for Digital Audio Disc.

Lindsay Allen has been promoted to manager of professional audio tape products at Ampex's Magnetic Tape Division.

Jim Edwards has been named assistant sales manager for the Western region for Atlas/Soundolier.

David Roudebush has been named marketing and sales manager for Orban's professional products line.

Mike Cooper has joined the staff of CORE Systems.

JBL Professional has named **Neil Conley** sales manager for JBL and UREI products. **Bill Schuermann** has been named regional manager for the South Central U.S. territories and Mexico.

Warren Simmons of Ampex's magnetic tape division has retired after 20 years at the company.

Patricia Daniels has been named sales administrator at QSC Audio Products.

Marianne Smith has been named controller at API Audio Products. **RE/P**

Shown Actual Size

CARVER
PROFESSIONAL

PM-100

Magnetic Field Power Amplifier

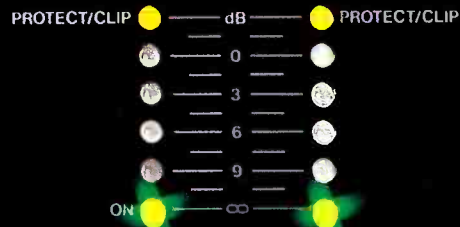

ONE RACK SPACE. 360 WATTS.

The ultimate single rack space amplifier. Unmistakably Carver. Ideal for station, stage or studio. See Carver Professionals' latest addition at your nearest Carver Dealer.



CARVER
PROFESSIONAL

Carver Corporation, P.O. Box 1237, Lynnwood, WA 98046
For more information, or the dealer nearest you call 1-800-443-CAVR

ready to go



Series VI

CONSOLES • RACKS • ENCLOSURES

Series VI factory assembled configurations, or individual stacking frame modules and components, are manufactured of 14 gauge CRS, welded, and shipped ready for equipment installation. No misalignments or unattractive hardware as often experienced with local assembly.

Five standard console system models, and a selection of mix and match accessories, assure the most cost-efficient task oriented flexibility for 19" width individual project requirements.

Enclosures for housing and protecting electronic equipment in audio, CCTV, communications, security, process control, training, laboratory, and energy management installations.

Five modern factories throughout the United States, ready to provide you with prompt service, realistic prices and assured customer satisfaction.

For Series VI catalog, please call (314) 349-3110, Sales Department, Atlas/Soundolier. FAX: 314-349-1251.



Professional Sound Loudspeakers



Ceiling Baffles and Enclosures



Omni-Purpose Speakers



Electronic Siren Loudspeakers



Microphone and Equipment Stands



Visual Call Systems



Voice/Tone Loudspeakers



ATLAS / SOUNDOLIER

DIVISION OF AMERICAN TRADING AND PRODUCTION CORPORATION
1859 INTERTECH DRIVE / FENTON, MISSOURI 63026 U.S.A.
TEL: (314) 349-3110 / TELEX: 910-760-1650 / FAX: (314) 349-1251

MANAGING MIDI

By Paul D. Lehrman

A Stitch in Time

And now, a MIDI success story.

One of the problems long associated with MIDI sequencers is the difficulty in getting them to work with pre-recorded tape tracks. Recording a "live" track along with an existing MIDI sequence is fairly easy—just make sure there's sync tone of one type or another on one track of the tape. But doing it the other way around, where human beings determine the tempos (which change from moment to moment) and the sequencer has to follow along, is very difficult.

To an extent, a few hardware designers have come up with ways to overcome this problem. Their devices construct "tempo maps" from the recorded music by having you press a "tap" button in time with the music as it plays, or by detecting audio pulses from a kick drum or other consistent rhythm track. The timing of these taps is recorded in the device's internal memory, referenced to SMPTE time code coming in from a track on the tape. The timings are stored as a "tempo map."

The next time the tape is played back, the tempo map is used to calculate the correct beat number and tempo from the tape's position, and that information is sent on to the sequencer in the form of Song Position Pointers and Clocks.

The problem with tempo maps in hardware is that they are generally not easy to edit, and often they can't be downloaded from the hardware device to some form of external storage. This means that every time you want to work on a tune, you have to reconstruct its tempo map. Some devices let you download their tempo maps as System-Exclusive dumps, but for studios lacking software that can handle that kind of data, this is not a good solution.

Perhaps most importantly, keeping a tempo map in hardware means that you

are always dependent on that hardware, and your sequencer must always be slaved to it. Thus, you can't even use your sequencer's own controls when editing, and if you have hardware that lacks its own "transport" controls, you actually have to roll the tape just to move around the sequence!

Now that MIDI Time Code allows SMPTE-to-MIDI conversion to take place at the software level—we don't need anything to generate clocks and pointers anymore—there should be a way to get these tempo maps into the sequencers themselves, so that sequences can be edited freely, without depending on the hardware all the time.

***Like most brilliant ideas,
ReClock is absurdly
simple.***

MIDI Files should provide a way of doing this: A MIDI File can consist solely of tempo information, and so it should be easy to get a tempo map from one device to another in that form. Unfortunately, although you can put a MIDI File on a floppy disk and send it to someone else through the mail, there is no agreement among the MIDI powers-that-be on how to transfer a MIDI File *over MIDI*. So until that agreement comes, there is simply no way for a hardware tempo-map device to get its information into a sequencer.

I've had a lot of clients bemoan this fact of MIDI life, so I think about it a lot. One day recently, a solution dawned on me. What if you were able to record a live "tap" track into a *sequencer* rather than a hardware device, and somehow convert that track into a tempo map? The sequencer could consider each tap as occurring on an even beat, and the differences in timing from one tap to the next would be converted into tempo changes.

The resulting track, consisting of nothing but tempo changes, could be saved as a MIDI File, and you could then construct the rest of the sequence on top of it. You could use your sequencer to lay the rest of the tracks and edit them, never going back to tape until you actually needed to hear what was on it.

The tap could be derived from your hitting a key or drumpad in time to the music, or from an audio-to-MIDI converter hooked up to a rhythm track. To ensure synchronization integrity while you are recording the tap track, the sequencer would have to be locked to the tape using MIDI Time Code, and running at a constant tempo—say 60bpm—so there would be a common timebase for the tape and the sequence.

I took this idea, posted it on a few music-network bulletin boards and challenged someone to come up with a way of implementing this. Sure enough, two days later I got a message on PAN from Doug Wyatt, a programmer for Opcode Systems, saying that he had written just such a program for the Macintosh and would be happy to post it as shareware. He called it "ReClock," and, like most brilliant ideas, it is absurdly simple.

ReClock takes a Type 1 (multitrack) MIDI File and asks you which track you would like to consider as the "metronome." The program then assumes that every note on the metronome track is a quarter note, and calculates the tempo changes between those notes necessary to make them all fall on even beats.

It then rewrites the MIDI File with all of these tempo changes. The *absolute* times of all the notes in the file stay the same, but the *musical* times—what beat and fraction the notes fall on—change.

This program very nicely solves the problem of deriving a sequencer tempo map from a live track. Tap along with the tape while the sequencer (running at a constant tempo) is locked to the tape and run the resulting sequence through ReClock. You'll end up with a blank sequence with all the right tempo changes. You'll have to figure out the correct SMPTE start point for the sequence, but that's pretty trivial, and you only have to do it once.

But ReClock has ramifications beyond this. You can also use it to re-time sequences that have nothing to do with tape. For example, you can play a florid improvisation into your sequencer, completely disregarding the metronome, and then overdub a second track, playing single

Paul D. Lehrman is *RE/P's* electronic music consulting editor and is a Boston-based producer, electronic musician and free-lance writer.

When there is no compromise there is no choice.

quote...

"Over the years we have compiled a list of the best features and the worst nightmares that we have encountered with every console: the AMS/Calrec UA8000 incorporates the BEST of the BEST.

In terms of ease of use, superb ergonomics, elegant electronic design, ease of maintenance, style of construction and sonic quality, the UA8000 console is a dream come true."

*Gary Brandt & Denny Shaw,
Alpha Studios, Los Angeles.*

"Studio 3 has been designed with our clients very much in mind, to provide them not just with the best facility in London but the best in the world."

*Ken Townsend,
EMI Abbey Road Studios, London.*

...unquote

UA8000 with TASC simply the best of the best.



AMS Industries plc
Circle (12) on Rapid Facts Card



Alpha Studios, Los Angeles.



Abbey Road Studios, London.



Music
Recording
Consoles



Hard Disc
Editor



Digitally
Assignable
Consoles



DIMX/DMX
Digital
Audio Processors



Calrec Standard
and SoundField
Microphones



Custom Broadcast
Consoles



Digital Mixing
Consoles

AMS/Calrec, AMS Industries Park, Burnley, Lancs. BB11 5ES.

Tel (0282) 57011. Telex 63108 AMS-G. Fax (0282) 39542.

AMS/Calrec, USA, 3827 Stone Way North, Seattle, WA 98103 USA.

Tel (206) 633-1956. Fax (206) 547-6890.



The Queen's Award for Export Achievement to Egelectronics Ltd 1984-85 and
AMS Industries plc 1986. In July 1985 Egelectronics Ltd became AMS Industries plc

BREATH-TAKING AUDIO

recreates what was on your final mix down
the way you want it heard
every time your client's cassette is replayed.

LISTEN TO AN EXAMPLE

Send for this free demo tape



Find out how easy and economical it is
to produce cassette copies you'll be
proud to have carry your name.



Toll-Free From California
800-231-TAPE (415) 883-5041
KABA Research & Development 24 Commercial Blvd., Suite E, Novato, CA 94949

Circle (13) on Rapid Facts Card

MANAGING MIDI

notes where you want the beats to occur.

Run the result through ReClock, and you'll end up with the same improvisation, only now it has a metric structure. You can quantize chords to bring them into line, add quick step-time flourishes, and cut and paste phrases at the measure or beat level—without destroying the rhythmic integrity of the original. You can even quantize all of the notes as a way of preparing the file before you send it to a notation program.

(Speaking of notation, it's only fair to point out that Finale, the music-transcription mega-program from Coda Music Software, has a similar function built into it. The program can also import and export MIDI Files, so theoretically it could be used for re-timing recorded sequences. But the function—called "time tagging"—is fairly clumsy to use, and the MIDI File implementation is very poor. ReClock is a much simpler and more elegant—not to mention cheaper—solution.)

ReClock is a perfect example of how useful ideas can spread through the MIDI community and find support. Now that MIDI Files are an established standard, we

ReClock is a perfect example of how useful ideas can spread through the MIDI community and find support.

can hope to see dozens of similar programs appear, which will meet all sorts of creative demands and will be modified and perfected as they travel around the industry.

ReClock is in the database section of Opcode's Special Interest Group on PAN, and possibly on other networks by now, as well. Get it, try it out and pay for it—it could be 15 of the best dollars you'll ever spend.

RE/P

Sam Ash
P R O F E S S I O N A L

We don't sell problems ... we solve them!

Sam Ash Professional is your new source for computer based recording technologies, multitrack, consoles, signal processing and microphones. You know Sam Ash as the musician's favorite store - now we can handle all your needs. Visit our consultants at our fully operating studio. Out of town please call.

DESIGN • SALES • SERVICE • PARTS
• INNOVATIVE FINANCING PLANS • RUSH DELIVERY

Some of our brands:

ATARI • DIGIDESIGN SOUND TOOLS • TASCAM • AKAI • SOUNDTRACS • AMEK
• SONY • PANASONIC • MEGAMIX • TRACMIX • NEUMANN • AKG • ELECTRO-
VOICE • LEXICON • SYMETRIX • dbx • YAMAHA • EVENTIDE • TC • ART • ALESIS
• TANNOY • JBL • UREI • YAMAHA • E-MU • KURZWEIL • OBERHEIM • KAWAI
• KORG • ENSONIQ ... and many more!

Sam Ash Professional

723 Seventh Avenue (at 48th Street) Third Floor
New York City • (212) 719-2640

©1989 Sam Ash Music Corp.

Circle (14) on Rapid Facts Card

The First MTR Capable of MIDI Control.

- ✓ Can slave to MIDI and run automatically.
- ✓ Can synchronize to video via SMPTE Time Code.
- ✓ Built-in full function Remote Control.
- ✓ Fully programmable— 10-position memory.
- ✓ Under \$2900.*

*Actual retail prices are determined by individual Fostex Dealers.



SERIAL PORT/
MODEL MTC-1



SERIAL PORT/
MODEL MTC-1
SYNCHRONIZER



The optional MTC-1 plugs into this MIDI port, your access to the world of MIDI. With a sequencer that supports our System Exclusive you'll be able to control all transport functions and make the R8 operate as a slave in your MIDI programming.

The R8 works with all major synchronization systems, but best of all, use the R8 with our complete line of generators, processors and controllers — all software based, therefore always current.

The entire front panel is removable, so you can control all functions — more than ever before -- right from your working position. Once you set up your R8 it acts like any other computer. Tell it what to do, and it does it. Faithfully.

Program up to ten memory points and you'll have Auto Locate, Auto Play, Auto Return, Pre-roll, and Zone Limiting commands right at your fingertips. The memory is fully accessible so you can change cue points and functions easily.

R8

The 8-Track Computer with the Built-in Remote.

Fostex®

©1989 FOSTEX 15431 Blackburn Ave. ■ Norwalk, CA 90650 ■ (213) 921-1112

Circle (15) on Rapid Facts Card

www.americanradiohistory.com

SPARS ON-LINE

By Bill Porter

Home Studio Competition: If You Can't Beat 'Em, Join 'Em

There has been a lot of talk lately about "personal use" studios creating stiff competition for the professional recording community. I know many studio owners who, fearing for their sizeable investments, are trying desperately to increase bookings—some with only limited success.

As a former studio supervisor, manager and owner, I fully understand the need to meet the bottom line. But, in fact, there have been many positive changes in the recording arena. And, with an open mind and positive attitude toward the new realities, you can turn the tables of business.

Since the technological explosion of electronic music instruments and less-expensive recording equipment, our industry hasn't been the same. The price of these new tools continues to fall, while the quality continues to get better and better. Today's recording industry has many people using this new technology to create their own composing/recording workshops. My position is: *If you can't beat 'em, join 'em.*

I'm sure that many studio owners have rooms that are lying dormant. It might be a second studio, lounge, disk-cutting area or storage space. What I propose may shock a few people, but it's based on my experience with the "do-it-yourself" craze.

The fact is, it takes considerable time and investment before the budding musician accumulates all the gear needed for a fully operational, personal-use studio. Also, many of the newcomers don't fully understand the equipment and techniques of quality recording. And there are still others who are quality-conscious but lack the training or the resources to make fully professional recordings. All in all, the scenario provides an excellent business opportunity for the professional recording

studio willing to accommodate this growing market.

I suggest you start by setting up three studios, each one equipped for a different kind of budget. If you visit your local music store that specializes in electronic musical instruments, you'll find that it is selling equipment at three general levels of sophistication and price.

To begin with, there's a basic keyboard with some limited features and a 4- to 8-track cassette or reel-to-reel tape recorder, probably with noise reduction. The next level includes such things as MIDI interface, synchronization, a sequencer, an 8- to 16-track recorder and some outboard processors. On an even higher level are keyboard "updates" with on-board sequencers, MIDI voice libraries, drum machines (many levels and prices), drum clocks, computers and SMPTE time code.

Your new studios can be equipped with the basics. Additional equipment requests can be rented on a piece-by-piece basis. This is an attractive arrangement for the client who can't afford to buy everything, but who wants specific gear for specific sessions. You might also allow clients to bring their own equipment for interface with your new studios. This will involve your studio engineering staff and should be billed accordingly.

To deal with the varying degrees of clientele experience, I suggest a simple questionnaire to determine their working knowledge and to prevent improper use of the equipment. When using outside equipment, be especially cautious of the input/output connections. The bulk of your maintenance problems will be in this area. The connectors are not designed for heavy use and can cause problems. Make sure they are easily accessible, and secure cables to avoid undue stress.

Your tape machines will probably require the most maintenance, so plan accordingly. After reasonable use and amortization, re-equip and update your studios. It's important to stay current. Also, your new clientele will make a good market for used equipment. You might even consider rent-to-own options.

If you don't consider yourself or your staff knowledgeable in this field of production/recording, visit the local high schools and colleges. You'll find a whole new breed of electronic music teachers who

can be of great help. You might even hire some students to assist you in your new electronic music studios. These young musicians can help you determine which gear is currently in demand. This part-time staff can also be valuable in attracting the business you are looking for.

As your clientele grows in knowledge and technique, they will become aware of equipment limitations. Your staff should be available to assist in their more-complex productions. Your clients may even want to step up to professional equipment, which, again, would involve your studio's professional staff.

Another area to be explored is the video market. Inexpensive video equipment has increased in quality and flexibility, making budget productions a reality. Your clients could produce their own music videos.

Dealing with non-professionals will require sound accounting procedures. This may seem obvious, but never forget that collecting revenues = making money = staying in business. Carefully research a financial plan before launching your new business.

I first encountered this kind of business practice years ago, as a teenager interested in photography. With very limited resources, I found that I could rent photo equipment and darkrooms for the developing and printing. It allowed me to expand my work greatly.

If you have doubts about the viability of the concept for the recording industry, take into consideration the success of the many studios that have implemented such ventures on a professional level. A wide range of MIDI studios now rent to musicians/producers and production companies as "electronic music workshops." Their success rests on the ready market of musicians who cannot afford the equipment investment for a complete electronic music studio.

A studio can accommodate these new kinds of clients at many levels to fit with the changing profile of the recording industry. SPARS has a catalog of useful literature and can offer valuable assistance. Carefully research your market, make a sound financial plan and test your ideas. You are only limited by your imagination and your instinct for survival.

RE/P

Bill Porter is an assistant professor at the College of Music, University of Colorado at Denver.

TAKE MUSIC TO THE Nth DEGREE AND TAKE A DIC//DAT SHIRT FREE.

Now you can show the world you take music to "The Nth Degree" with DIC//DAT, the definitive digital audio tape. With every 20 DIC//DAT cassettes you buy between January 1 July 31, 1989, we'll send you a distinctive DIC//DAT T-shirt free!



Win a car DAT player!

Every 20-tape purchase earns you one entry in a drawing to win a valuable DAT player that will take your car's sound system to the Nth Degree!



Make a statement about yourself as a professional on the cutting edge of recording technology. Wear our dramatic red, gold and black shirt that bears the words: "Taking Sound to the Nth Degree."



Call your local dealer today, or call 1-800-DAT-1DIC for the dealer nearest you. Enter as often as you like! Get one T-shirt and one contest entry for every 20 tapes you buy. (Note: T-shirt size extra-large only.)



DIC//DAT™

TAKING MUSIC TO THE Nth DEGREE.

DIC Digital Supply Corp.
2 University Plaza
Hackensack, NJ 07601
201-487-4605



© DIC DIGITAL SUPPLY CORPORATION, 1989

Circle (16) on Rapid Facts Card

www.americanradiohistory.com

UNDERSTANDING COMPUTERS

By Jeff Burger

On-line Database Services, Part 2

Jeff Burger is *RE/P*'s computer consulting editor and is president of Creative Technologies in Los Angeles.

Last month, we took you on-line with one of several subscription database services—IMC's *Esi Street*. We saw ways of navigating around the system while looking at basic services, such as electronic mail and bulletin boards. These areas are common to most such services.

This month we'll complete our tour by exploring the value-added services—areas

of special interest that carry a surcharge. For those just joining us, the system prompts typically are terminated with a colon. At those points, you type a response to navigate through the system. We've printed our commentary in *italics* and have taken a few editorial liberties for purposes of condensation.

OK, we're on-line again.

```
[MAIN] System Menu
COMM  DIRECT  SERV  IPS  UTIL  ASSIST  GAMES  OFF
INFO)rmation, or <CR> for full menu
```

MAIN>: IPS

[IPS] INFORMATION PROVIDERS MENU

HOTLINE..Billboard Magazine Editorial
 CHARTS...Music Popularity Charts
 NEWS.....International Newswires
 OAG.....Official Airline Guide
 SONGS....The LEAD SHEET Newsletter
 MAIN.....Return to MAIN MENU
 OFF.....Log-Off the System

BBS.....Bulletin Board System
 HR.....The HOLLYWOOD Reporter
 NEWSTAB...Newswire Search System
 POLLSTAR..America's Concert Hotwire
 STOCKS...Stock Market reports
 INFO.....System Information

IPS>: HOTLINE

Billboards Hotline

10. Billboard Charts
 20. Billboard Editorial

HA)rdcopy, M)enu, ALL, H)elp, Q)uit
 or enter Topic Number: 10

HSI....Top 100 Hot Singles
 CSI....Country Singles
 BSI....Black Singles
 ASI....Adult Contemporary Singles
 DSA....Dance Singles, 12 Inch Sales

TLP.....Top LP's and Tapes
 CLP.....Country LP's
 BLP.....Black LP's
 DSI.....Dance Singles, Club Plays

Format, B)ack, Q)uit, or <CR> = menu: TLP

T)wk = 4 Mar 1989
 T)wk, 1)wk, 2)wk, 3)wk

Billboard's Hotline service let's us look at the charts and editorial before they actually go into print. We can access a specific chart and even search for a particular artist or label.

Week, B)ack, Q)uit, or <CR> = menu: T

10, A)rtist, T)itle, L)abel, ALL Selections, B)ack, Q)uit, or <CR> = menu: ALL
 Enter search word for ARTIST: RETURN

```
BILLBOARD TOP LP'S AND TAPES
ISSUE DATE 03/04/89
TW  LW  C  TITLE                ARTIST                LABEL                CATALOG NO
1    1    P  Don't Be Cruel           Bobby Brown           MCA                  42185
2    2    P  Appetite For Destruction Guns N' Roses         Geffen               GHS 24148
3    3    P  Electric Youth          Debbie Gibson         Atlantic              81932
4    4    P  Traveling Wilburys      Traveling Wilbu      Wilbury              25796
5    5    P  Shooting Rubberbands At Edie Brickell &      Geffen               GHS 24192
```

--More--N

Enter Q)uit or <CR> for another chart: Q

This allows us to look back several weeks. For now let's just look at this week.

RELIABLE PLAYERS

BOB GLAUB ON QSC.

"What's the use talking..."

QSC amps sound great and always perform."

Bob has played bass guitar on
hundreds of records and countless tours.

The consummate reliable player.

*QSC Power Amplifiers... as reliable as
the players who use them.*

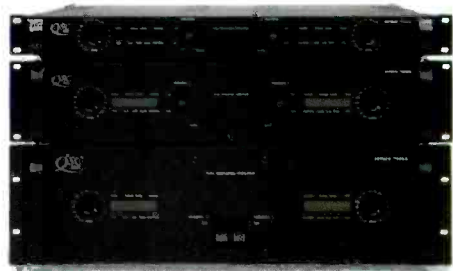

QSC

A U D I O

QSC Audio Products, Inc.
1926 Placentia Ave., Costa Mesa, CA 92627
714 645-2540



Circle (17) on Rapid Facts Card

UNDERSTANDING COMPUTERS

```
[IPS] Information Providers Menu
HOTLINE  BBS      CHARTS  HR      NEWS  NEWSTAB
OAG      POLLSTAR SONGS   STOCKS OFF   MAIN
INFO)rmation, or <CR> for full menu
```

IPS>: SONGS

The LEAD SHEET - Main Menu

```
=====
10. SONG SEARCH BULLETINS
20. ARTISTS DIRECTORY
31. THE REAL ROAD TO MUSIC BUSINESS RICHES
50. SEND A MESSAGE TO LEAD SHEET
51. LEAD SHEET INFORMATION
```

HA)rdcopy, M)enu, H)elp, Q)uit
or enter Topic Number: 10

SONG SEARCH BULLETINS - Page 10

```
=====
11. Week Ending Feb.  4
12. Week Ending Feb. 11
13. Week Ending Feb. 18
14. Week Ending Feb. 25
50. Place a tip or send a message
    to LEAD SHEET.
```

HA)rdcopy, M)enu, H)elp, Q)uit
or enter Topic Number: 14

BULLETIN # 14 Week Ending 25 Feb 89

FEMME FATALE: Rock. Need dynamite rockers with great hooks. Check out the band's recent hits like "Falling In and Out of Love" and "Waiting for the Big One" for casting ideas. Write FEMME FATALE on your envelope. Rush your top 3 candidates MAX! Contact: Bret Hartman, MCA Records, 70 Universal City Plaza, Universal City, CA 91608

-- More? --NO

HA)rdcopy, M)enu, H)elp, Q)uit
or enter Topic Number: Q

IPS>: OFF

Off At 19:00 02/23/89 EST
Time used: 02h 02m connect, 03m 45s CPU, 00m 23s I/O.
D42 DISCONNECTED 00 40 00:02:30 7590 677

Esi also offers a gateway to world news. You can tap into Associated Press, UPI, Dow Jones and more, as the stories are posted—just like the newspapers do. Searches can be customized to give you only that information which you're interested in. Esi even accesses standard travel information, such as airline schedules and accommodations, so you can be your own travel agent anytime.

One of the more industry-specific, value-added services provides a forum where record companies and producers solicit material for current projects.

Time to log off the system.

Obviously there are many other areas that we haven't been able to explore due to space. We hope these past two columns have provided some insight into the benefits of going on-line with your computer. For more information contact IMC or one of the other subscription services such as The Source, CompuServe or PAN.

REP

A LEGENDARY NEW CLASS OF SUPER-EFFECTORS



APPLIED RESEARCH & TECHNOLOGY INC.

The SGE-STUDIO SUPER-EFFECTOR-A stunning new effector/dynamics processor that does 9 effects at once with a built-in exciter, compressor, expander, noise gate, envelope filter, pitch transposer (2 octaves), all the effects of the Multiverb II, amazing distortion and overdrive, and bandwidth to 20kHz! Full real-time Performance Midi®! • **The MULTIVERB-EXT**-The new sampler/super-effector with Performance Midi®, 2 full seconds of delay, pitch transpose, 200 memories, digital sampling, all the effects of the Multiverb II and ultra wide bandwidth! • **The MULTIVERB II**-The year's hottest signal processor just got better! Performance Midi®, increased capability, full programmability, pitch transposing (2 octaves) ultra-wide bandwidth. • **The DELAY SYSTEM VII**-A brand new programmable sampler/studio digital delay that may be the finest sounding delay unit ever built! Totally accurate harmonic reproduction. 20kHz bandwidth! • **The DELAY SYSTEM V**-The same amazing delay circuitry and audio specs as the VII at an even more competitive price! • **The HIGH DEFINITION EQUALIZERS**-A new generation of circuitry provides incredible filter accuracy. There is minimum phase shift and no center point drift regardless of fader settings! XLR, TRS, term. strip connectors, failsafe hard wire bypass, Freq. response: 2Hz-165kHz, Signal/Noise Ratio (R.E. +20dBm) -115dB, THD <.005%.

Export Distributors:
THE NETHERLANDS/Audioscript B.V./Soest/02155-2044/FINLAND/MS-Audiotron/Helsinki/90-5664644/SWEDEN/Muskatör & Co./Möndal/031-878080/France/High Fidelity Services SA/Paris/(1) 2.85.00.40/CANADA/Yorkville Sound LTD./Scarborough/416-751-8481/ITALY/FRATELLI CRASIO/PAVIA/0385 48 029/WEST GERMANY/PME Audio/BAD FRIEDRICHSHALL/07136-6029/
SWITZERLAND/Musikengros P. Gütter/Sissach/061-983757/HONG KONG/Audio Consultants LTD./Kowloon/3-7125251/APAN/Nihon Electro Harmonix/Tokyo (03)232-7601/THAILAND/Beh Ngiep
Peng Musical Instruments/Bangkok/222-5281/INDONESIA/PT Kirana Yudha Teknik/Jakarta/3806222/SINGAPORE/Lingtec PTE. LTD./7471951/SPAIN/Aplicaciones Electronicas Quasar SA/Madrid/
0861300/TURKEY/Kadri Cadmak/Istanbul/(1) 1661672/DENMARK/M.I. Musik/Kobenhavn/1-854800/U.K./Harmon U.K./Sbough/075376911/NEW ZEALAND/Maser DigiTek/Auckland/444-3583/4/
ISRAEL/JAZZ ROCK/Tel Aviv/03-24-9941/ARGENTINA/Lagos Sarmiento/Buenos Aires/40-6455/NORWAY/AJDIOTRON OSLO/2 35 20 96/TAIWAN/Sea Power Co./TAIPEI/023143113/
GREECE/ZOZEF/PIRAEUS/014170151

Circle (18) on Rapid Facts Card

APPLIED RESEARCH & TECHNOLOGY INC., 215 Tremont Street, Rochester, New York 14608, (716) 436-2720, TELEX: 4949793 ARTROC, FAX (716) 436-3942

Computer/Studio Interfacing at Studio Malibu

By Jeff Burger

To maximize efficiency and creativity, Studio Malibu depends on sophisticated hardware and software peripherals to control its synths and samplers.

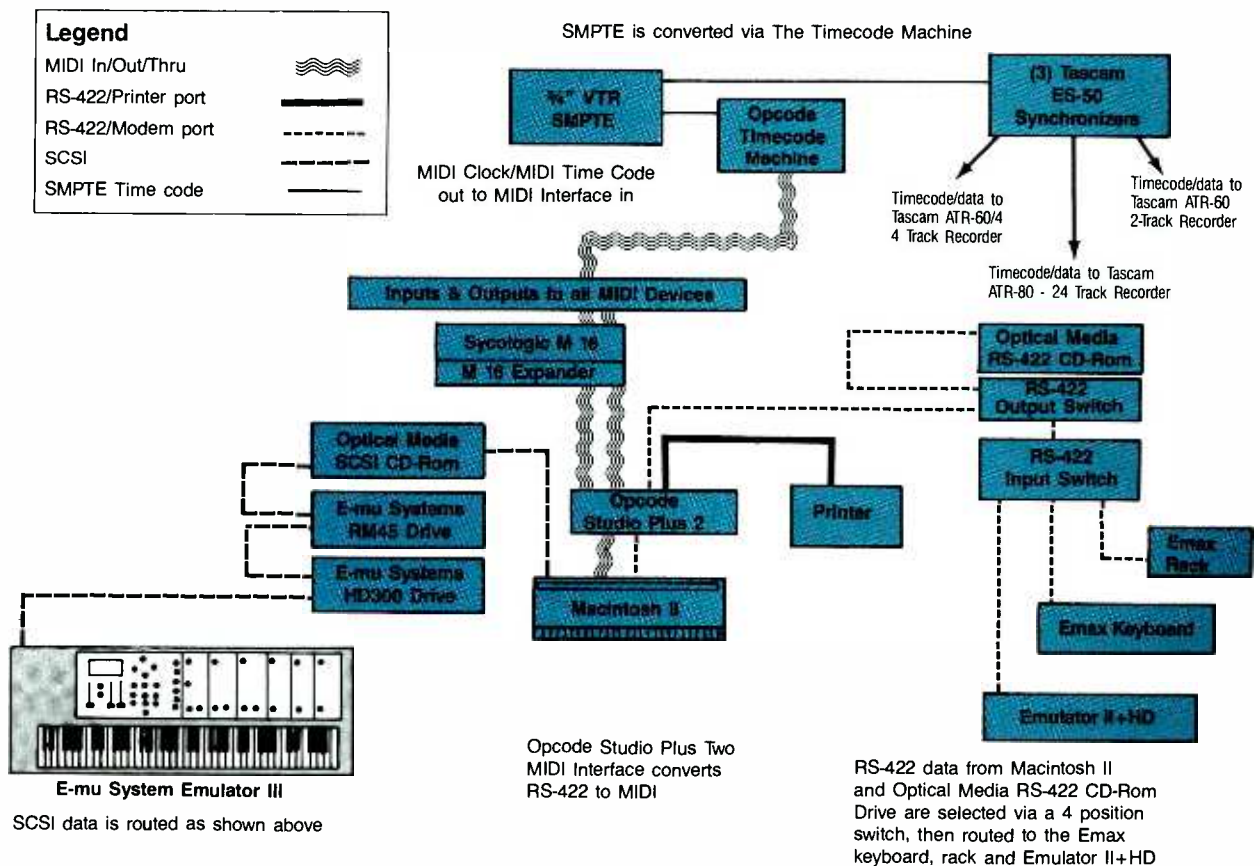

MIDI/SCSI/RS-422/SMPTE flow chart.

As computers creep into more and more studio applications, such as synchronization, sequencing, sound library management, sound design, automated sound effects and business management, an increasing number of communications pro-

ocols have come into play. MIDI, RS-422, SCSI and SMPTE are a few of the more prevalent examples.

Recently, *RE/P* visited Studio Malibu in Malibu, CA. Co-owned by John Bezjian and Dennis Anderson, the facility specializes in computer-controlled production. The studio has been used for film scores, industrial video soundtracks, commercials and TV soundtracks. For exam-

ple, composer/producer Jeanette Acosta uses the studio to create all of the music for the ABC-TV series "Murphy's Law," almost entirely from virtual tracks. We talked with Bezjian about computer applications in the studio.

Computer life

"The Macintosh II is the focal point of our studio," Bezjian says. "I'd worked with

Jeff Burger is *RE/P*'s computer consulting editor and is president of Creative Technologies in Los Angeles.

**SO SMART,
IT SPEAKS
A SECOND
LANGUAGE.**



Now, there's an audio recorder that talks video. The APR-5003V.

You can actually control the APR-5003V with a video editor. Because its 9-pin serial port communicates with Sony's BVE-9000 or BVE-900 editors. And ease of control is just one of many advantages for video post production.

The APR-5003V also offers a wide range of synchronization features, including resolve on play. Chase synchronization. Timecode generation with video reference. And offset with bit resolution.

Of course, the first language of any audio recorder is



9-pin serial port for control by Sony video editors BVE-9000 or BVE-900.

still audio. And you get the superb sonic quality you'd expect from Sony.

If you're in post production, and you're in the market for an analog recorder, remember whom to speak to. Contact your Sony Professional Audio Representative. East (201) 368-5185; West (818) 841-8711; Central (312) 773-6001; South (615) 883-8140.

Sony Communications Products Company, 1600 Queen Anne Road, Teaneck, NJ 07666. © 1989 Sony Corporation of America. Sony is a registered trademark of Sony.

SONY®

PROFESSIONAL AUDIO

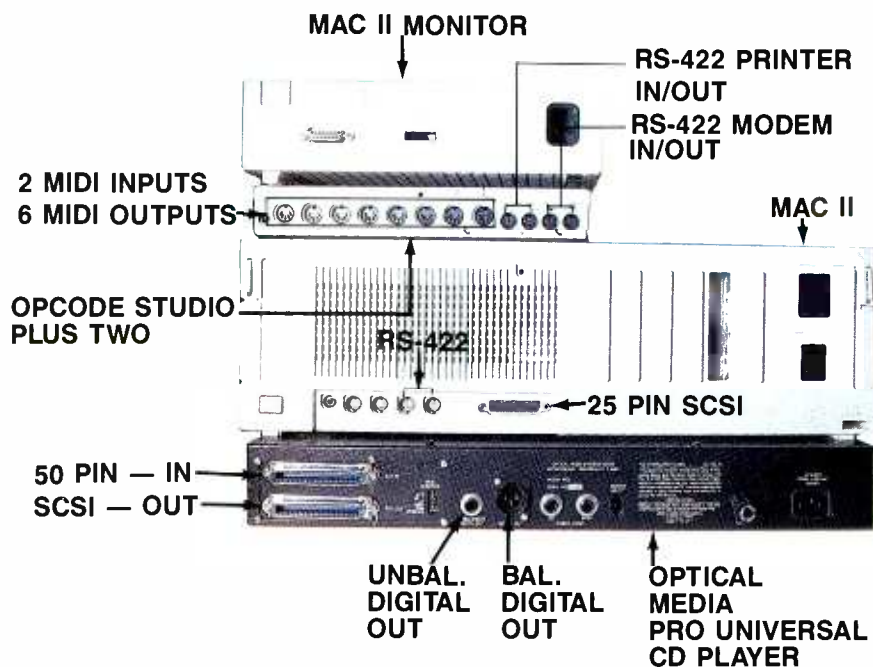

Photo 1. MIDI, SCSI, SMPTE and RS-422 rear panel ports for the Macintosh II, Optical Media International's Universal CD player and the Opcode Studio Plus Two interface.



Photo 2. Two racks of outboard equipment, including rack-mount sound sources and various signal processors.

dedicated music computers, like the Fairlight and Synclavier, but the Mac was my first all-around personal computer. What's amazing to me is the variety of software packages available for both music production and business." (See "Software Survey" on page 46.)

Apple's MultiFinder operating environ-

ment allows many applications to be resident in memory at one time. While they can't be run simultaneously, switching from one program to the next is as quick as clicking the mouse.

"Before MultiFinder, if I was running the sequencer and wanted to load a disk of sounds into the Roland D-50, I'd have to stop what I was doing, quit the sequencer, load the Opcode librarian, find the patch, send it to the instrument, quit the librarian, open the sequencer and load the song again. With MultiFinder and the multilibrarian, sounds for the D-50, Matrix 12, Yamaha DX series and other synthesizers are all available on one screen. A click on the MultiFinder icon and I'm back into the Performer sequencing package. I no longer have to break the creative process."

An additional application that runs under MultiFinder is a HyperCard stack that Bezjian designed to help clients operate the studio when he isn't available. (HyperCard is Apple's software environment that allows users to write their own interactive applications with a minimum of programming.) "My HyperCard stack is a sort of MIDI help file," he says. "If you're trying to figure out how to assign a MIDI channel on the Jupiter 6, you click on that stack and it tells you the proper sequence of buttons to press."

MIDI

At Studio Malibu, sequencing is typically handled with Mark of the Unicorn's Performer software, creating virtual tracks-

chasing picture via SMPTE. An Opcode Studio Plus II is employed as a MIDI interface for the Mac II. "Knowing how many times things get recorded and re-recorded," Bezjian says, "the 'Murphy's Law' composition/production team felt they'd have greater flexibility and better sound quality by eliminating the 24-track. We've literally done every track for a network TV show with the Macintosh playing a room full of gear—mixing right to the 4-track master that goes to the dubbing stage."

The studio's main work area consists of the Mac II flanked by various MIDI keyboards. While these instruments—an E-Mu Emulator III (E-III) and vintage Yamaha DX-1 and Prophet T-8—all double as MIDI controllers and sound sources, the room is filled with a multitude of additional MIDI sound sources, including:

- E-Mu—E-IIIr, Emax SE sampling keyboard, Emax rack, Emulator II (E-II), an SP-1200

- Roland—Jupiter-6, MKS-20, D-550
- 360 Systems—MidiBass
- Oberheim—Matrix 12
- Fairlight—CMI

Additional MIDI black boxes provide channel filtering for a Memorymoog Plus and MIDI-to-CV conversion for such analog collector's items as a Minimoog, Moog Source and a Polyfusion modular synthesizer. All this adds up to a total of 173 MIDI voices.

While Bezjian tends to treat the E-III/Mac II/CD/hard-drive combination as a single device for non-musical sound effects, he doesn't subscribe to the "everything-in-one-box" school of music. "I've done projects with only the Fairlight or Synclavier or E-III," he says. "But for musical sound sources, my older instruments are as valid as a sampler/hard-disk system. I prefer to have a MIDied Minimoog sitting there rather than have a Minimoog sample taking up valuable disk memory. There's also the investment aspect. People have a lot of money tied up in vintage equipment, and just because it's vintage doesn't mean it's obsolete."

To simplify the MIDI routing process, a Sycologic M-16 MIDI Matrix with expander provides cross-patching for up to 16 sources and 32 destinations at once. "The patch options are programmable and can all be called up with the touch of a button. The Sycologic even lets us name the patches intuitively," says Bezjian.

In a setup of this size, it's also possible to exceed the 16-channel limit inherent to the MIDI spec. The Opcode Studio Plus II is actually two MIDI interfaces, one for the modem port and one for the printer port, which can be thought of as independent MIDI buses. "Because Performer allows tracks to be assigned to 16 channels

★ LEGAL DAT TODAY ★

Are You Ready To Enter The True Digital Domain?



A DAT Recorder Is Like Having Your Own Home/Portable Recording Studio.

Master Quality Sound Production With No Distortion! No Tape Hiss!

- English Operating Manuals
- All Connecting Cables
- AC Converters



SONY PCM-2500

Professional two piece studio standard

- Wireless remote control
- Fully programmable
- Switchable sampling freq. 32/44.1/48 khz



SONY DTC-500ES

Sony's second generation bestseller

- Direct digital-to-digital
- Transmission capability
- Switchable sampling freq. 32/44.1/48 khz



SONY TCD-D10

Sony's #1 consumer portable

- High-speed (near-instant) index search
- Built-in clock/calendar
- Stereo microphone and windscreen



TECHNICS SV-D1100

18 Bit high resolution DAT

- Full function remote
- 6-speed CRV digital servo system
- Reduce conversion error by 75%



PANASONIC SV-250

A masterpiece of miniaturization

- 9" x 1 3/4" x 5 1/2" under 4 lbs.
- MASH A/D converter w/ 64X O. Samp.
- Digital-to-digital editing



CLARION DAC-2000

CAR STEREO

- Full-logic transport
- High-speed music search
- Intro tape scan

KENWOOD KDT-99R

CAR STEREO

- Din-size. Dual-chassis
- Wireless remote control
- Direct track access

Did You Know:

- **DAT** recorders offer you better sound quality than CD players, plus all the benefits of a cassette recorder.
- **DAT** cassettes are half the size of standard analog cassettes, and are a higher quality tape
- **DAT** recorders are fully programmable, with high speed (up to 300 times playback speed) indexing and music search.

CHOOSE FROM THE FOLLOWING

- Sony • Panasonic • Technics • Tascam
- Kenwood • Pioneer • Akai • Sharp • Alpine
- Nakamichi • Denon • Yamaha

Knowledgeable, Friendly Customer Service.

American International Audio Video

127 ROUTE 206 TRENTON, NJ 08610



DAT HOTLINE
609-888-4414

609-888-2930
FAX ORDERS

- USA Written Warranty
- Nationwide Service Centers
- Pro User Extended Warranties

FLEXIBLE LEASING PROGRAMS
START AT

\$69 per month

- NO MONEY DOWN
- QUICK APPROVAL
- COMMERCIAL ACCTS WELCOME

Circle (19) on Rapid Facts Card





Photo 3. Back panel of the Emulator III showing SCSI, RS-422, MIDI and SMPTE interfaces.

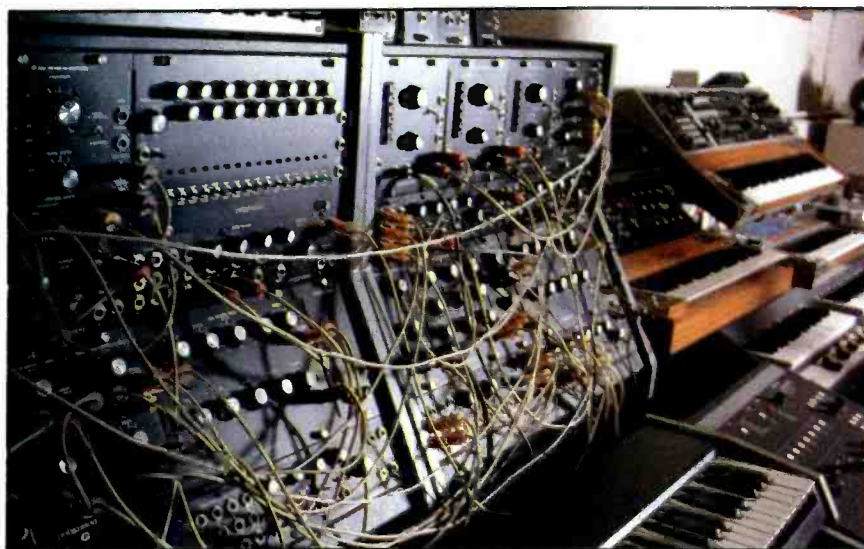

Photo 4. Some of the vintage synths at Studio Malibu. In the foreground is a Polyfusion modular synthesizer.

through either of the ports, the only problem is isolating certain instruments to one port. Bezjian solves this problem by having both ports output to the Sycologic switcher.

Studio Malibu employs two such switchboxes that determine source/destination routing of digital sample data. An A/B input box selects between the Optical Media International (OMI) CDS3 (RS-422 interface) CD player and the Mac II as the source. (The Opcode Studio Plus II provides the switchable option of MIDI or RS-422 on the modem port.) An A/B/C/D output box selects among the E-II, Emax and Emax rack as the destination.

SCSI

In addition to MIDI and RS-422 (see

sidebar, "Communication Protocols") for certain applications, Studio Malibu relies on a second communications protocol, SCSI. SCSI enables instruments to access mass storage devices with blinding speed. A SCSI chain unites in one network a 5Mbyte Mac II and its internal 40Mbyte hard drive, an 8Mbyte E-III, an E-IIIr, an external 300Mbyte E-Mu hard drive and an OMI Pro CDP Universal (SCSI and audio interfaces) CD player. As Bezjian puts it, "The Universal CD player has a multifaceted personality. The drive is intelligent enough to know that when you insert an E-III CD, its directory shows up on the E-III's display. When you insert a universal Macintosh format disk, it shows up on the Mac's desktop display as another installed disk drive. It could be the En-

cyclopaedia Britannica on CD-ROM, but for our purposes, it's OMI's Universal Sound disk with sample files for a variety of samplers—in Sound Designer Version 1 format.

"SCSI has definitely given a completely new perspective to the Mac's capability as a sound design tool," he says. "Prior to the Mac II, SCSI and programs like Alchemy, you had to spend megabucks on a system that would allow the manipulation of sound files in real time—while looking at waveforms on the screen. Now with SCSI and related tools, I can take a sound and display it instantly on the Mac screen.

"When I highlight a certain portion of the waveform, make an edit and tell the Mac to play that section, the E-III plays it in real time. If I change a preset on the E-III, the change shows up on the screen as if it were a completely integrated system built by one manufacturer."

Each SCSI device has its own ID number so that any of the devices can address any other discretely. For example, at Studio Malibu, the Mac II is ID No. 7; the Mac's internal 40Mbyte drive is ID No. 0; the main E-III is ID No. 6; and its internal drive is ID No. 1.

Blank Software's Alchemy plays an important role in sound design and sample transfer at the studio. The program is aptly named for not only its visual editing capabilities, but its ability to transform samples created for one sampler into usable files for others. "If we run out of voices on the E-III, we can create a facsimile on another instrument. The OMI Universal CD-ROM drive, operating over SCSI, allows us to quickly pull things into Alchemy on the Mac, send it via RS-422 to a compatible sampler or via MIDI to other devices that only accept MIDI Sample Dumps," says Bezjian.

SMPTE

Other applications necessitate a fourth protocol. SMPTE comes up in the patchbay along with all the audio. "There are times when the ¾-inch VCR has to be the master and other times when the master has to be the TASCAM ATR-80. Time code can be patched to feed the synchronizer or the computer. We use an Opcode Timecode Machine to convert SMPTE to either MIDI TC or Direct Time Lock, which goes into the Opcode MIDI interface for the Mac," says Bezjian. (As their preferred form of synchronization, Direct Time Lock is a proprietary MIDI permutation developed for Mark of the Unicorn's Performer software.)

Studio Malibu's synchronizer is a TASCAM ES-50/51, used as the transport control regardless of whether the 24-track or ¾-inch VCR is the master. "The ES-50/51 allows us to control up to three

The Audio Zealot Prevails Again!

NEW Aphex Aural Exciter® Type III

When the engineers got Marvin Caesar's memo, they said "@!%#" (impossible to themselves), but went to work. And, as usual, they delivered. In spades!

The result of their efforts is the Aural Exciter Type III loaded with exciting new features:

- Faster and easier to use
- Adjustable harmonics mixing
- Two modes of noise reduction
- *SPR™ Spectral Phase Refractor* to restore bass clarity and openness without adding any amplitude EQ or "bass boost"
- Overall quieter operation
- Servo balanced, transformerless I/O

- Null fill
- Remote controllable
- Sleek 1-RU chassis

Aural Exciters have become a standard in the recording, broadcasting and sound reinforcement industries. The Aural Exciter Type III offers a truly unique method to achieve clarity, definition and dimensionality in reproduction of sound. Program material literally "opens up", possessing more detail, intelligibility, as well as greater apparent frequency and dynamic range.

Audition the exciting new Aural Exciter Type III today. You will agree that at its low price, the Aphex engineers have created another work of magic.



APHEX
SYSTEMS

11068 Randall Street

Sun Valley, CA 91352

(818) 767-2929

FREE! *The Aphex Experience* Videotape. Send \$5 to cover shipping and handling to our address in this ad. Be sure to include your name, address and phone number. Allow 4-6 weeks for delivery.

© 1989 Aphex Systems Ltd.
Aphex and Aural Exciter are registered trademarks of Aphex Systems Ltd.

Made in U.S.A.

Circle (20) on Rapid Facts Card

Communication Protocols

MIDI

Probably the most common application of non-dedicated computers in today's studios is MIDI sequencing. Sequencing software essentially records information, from a device such as a MIDI keyboard, in a multitrack environment that allows for editing, manipulation and storage of the data. Tracks are then orchestrated, using various sound-generating devices, by assigning the sound sources to receive on any of the 16 MIDI channels corresponding to the transmit channel assignments.

Today, most synthesizers can load and save programs via MIDI System Exclusive messages to computer software packages that act as editors and librarians. Comparable software exists for most digital samplers, allowing them to load and save their sounds as MIDI Sample Dump Standard files. (See "Software Survey" on page x.)

MIDI cables terminate in 5-pin DIN plugs and carry data in only one direction. Generally, cables should be kept as short as possible and never longer than 50 feet (as per the MIDI spec). There is a danger of MIDI data becoming distorted after two or three devices in a MIDI Thru chain, requiring dedicated MIDI Thru boxes to split the signals for multiple devices or chains. Using a computer for sequencing or sound manipulation entails adding a MIDI interface to the computer (with the exception of the Atari ST and the Yamaha C1, which have built-in MIDI ports).

RS-422

For years, the computer industry has been using a bus protocol called RS-422 for communication between computers and peripherals. Although MIDI's 31.25Kbaud rate is

acceptable for performance data in the virtual track environment, it is too slow to handle the large amounts of data required for transmission of digital samples from one device to another. RS-422 is approximately 17 times faster than MIDI, largely because it is a parallel protocol (compared to MIDI's serial format). Several devices—such as the E-II, Emax and Optical Media's CD-ROM player—come with RS-422 buses to facilitate faster sample transfers.

RS-422 cables generally employ D-sub connectors on both ends. A single cable carries information in both directions. Also simplifying matters is the fact that RS-422 is generally used for communication between devices when no chaining is required. However, switchboxes that allow a computer to access more than one printer, or a single printer to be shared by multiple computers, are commonly available.

SCSI

A more recent communications protocol for computers and peripherals is SCSI (pronounced Scuzzy), an acronym for Small Computer Systems Interface. It's most commonly used to connect multiple devices, such as hard disks and CD-ROM drives, to computers. Because SCSI is hundreds of times faster than MIDI or RS-422, the latest wave of digital samplers—such as the E-III, Roland S-550 and Akai S-1000—incorporate SCSI buses, as well.

The SCSI specs allow for up to eight devices in a chain, with a *total* cable length not to exceed 25 feet. Each device has a default ID number that, in most cases, can be changed with either software or hardware switches. In this way, any

SCSI device can address any other SCSI device discretely.

While the connectors are always D-sub, be aware that they are implemented in 25-pin or 50-pin versions, depending on the manufacturer, so proper cabling is important. Also, though SCSI is a 2-way protocol, make sure that any intermediate devices in the SCSI chain have two connectors to facilitate passing the signal on. The devices on either end of a SCSI chain should use terminator connectors (either an internal or external adapter that fits between a SCSI device and a SCSI cable—a line filter adapter), while intermediate devices should not.

SMPTE

Ironically, SMPTE was originally used to synchronize tape machines, but facilities often use it to sync sequenced virtual tracks to a VCR. Many converters are available to transform SMPTE TC into MIDI Clocks and Song Pointers, to drive a sequencer. Once the user enters a SMPTE sequence location and the desired tempo—or even a tempo/meter map for complex passages—the sequencer can chase-lock to tape at any point in the composition.

Another increasingly common function of SMPTE-to-MIDI converters is conversion to MIDI Time Code (MTC), which is very useful for event-oriented sequencing. With conventional, music-oriented sequencers, triggering a car-by sample with frame accuracy can be tedious at best. Packages such as Digidesign's Q-Sheet A/V and Opcode's Cue provide event-oriented sequencing for compiling hit lists that can fire samplers at SMPTE reference points.

tape machines at once. We've had 24 tracks of audio, virtual instruments played live via MIDI and a voice-over on the 2-track machine—all synchronized to the main time code on the 3/4-inch video—mixed to 4-track through the TASCAM M-600 console," says Bezjian.

More to come

Studio Malibu is beginning to use MIDI-controlled effects devices for both

program changes and effects design. Bezjian is also looking into MIDI-based VCA packages for semi-automated mixing and the next wave of sample-editing software that features time-compression algorithms to stretch or squeeze voice-overs without changing pitch. Also, the studio's office Mac Plus will soon be connected by a local area network (LAN) to the studio's Mac II so that the two machines can access each other's files.

Bezjian and Anderson are obviously using synths, samplers and computers in a professional manner, yet it is interesting to note that there are so many communication protocols needed to accomplish their production goals. With this in mind, they are keeping a close watch on the development of a new communications protocol called MediaLink, which endeavors to incorporate the best of all the others, via fiber optics.

RE/P

SABER SERIES

building on success



- FOUR BAND EQ. SWEEP MIDS
- SIX AUX. SEND BUSES
- FULL MIDI MUTING
- FADER REVERSE ON ALL MONITORS
- EQ ON ALL MONITORS
- SOLO IN PLACE AND PFL
- MUTES ON AUX SENDS
- FULL SIXTEEN BUS
- 4 EFFECTS RETURNS, 2 WITH EQ
- CONNECTIONS FOR 2 TAPE DECKS
- CONNECTIONS FOR 3 SETS SPKRS
- 3 FREQUENCY OSCILLATOR
- 2 WAY TALKBACK
- PATCHBAY - AVAILABLE
- STEREO MODULE - AVAILABLE
- 3 INPUTS PER CHANNEL
- STAND INCLUDED

UK

69 Ship Street
Brighton BN1 1AE
Tel: 0273 23346
Fax: 0273 821767
Telex: 878235 MBIAHB G
Circle (45) on Rapid Facts Card

USA

5 Connair Road
Orange
Connecticut 06477
Tel: (203) 795 3594
Fax: (203) 795 6814

**ALLEN
&
HEATH**



Electronic Musical Instruments in the Studio

Bob Owsinski

A special editorial section	
Brave New World	page 34
Synthesizers and Samplers	page 36
Electronic Drums and Triggering Devices . .	page 42
New Applications	page 45

What LA's

Largest

Pro Audio

Dealer

Can Do

For You

With over 200 different brands of pro audio/video equipment, we offer you the best selection in the west. And we carry a much larger inventory so chances are we have what you need in stock.

We'll keep you abreast of new developments, new options, and updates for your equipment so you're always current and usually ahead of the rest of the industry.

New Demonstration Rooms

Since we moved to larger quarters here in Burbank we've opened *two* new fully equipped showrooms. In the Pro Room are three complete, operating production systems—consoles, monitors, tape machines (including 32 track digital), and signal processing/effects gear. Our second room has three more complete production systems set up to hear and compare. This room caters to the

audio/video needs of musicians and production studios.

Just the Facts, Ma'am

Things change quickly in pro audio. To make sure everyone here knows all the facts about the latest equipment, we've added a Product Specialist to our staff. His *only* job is researching equipment—reading brochures and tech manuals, going to trade shows, talking with manufacturers—and sharing that knowledge with our customers.

New Central Location

We're easy to get to from Hollywood, LA, and the valleys. And with more room, we've enlarged our technical and parts departments for even better service and support.

Come by and visit us in our new building. Turn some knobs in the demo rooms. Or just call and we'll be happy to discuss your pro audio needs.



Office Staff (l to r): Niki Simpson (Accounts Payable), Carol Gumbel (Controller), Shanah Metzelaar (Receptionist), Darrin Miller (Purchasing), Michele Schwartz (Accounts Receivable), Jim Kropf (Delivery), Front, Brian Cornfield (President)



Sales Staff (l to r): Nat Hecht, Paul Freudenberg, Paul Svenson (Sales Manager), Karyn Thomas (Sales Assistant), Philip Celia, Mark Lever, Vanessa Perea (Tape and Accessories), Garth Hedin, Robert Corn, Ben Ing (Product Specialist), Constantino Psorakis



Our Pro Demo Room: Three different fully operating production systems, plus a vast array of outboard gear



Sales/Service/Design

ea Everything Audio
Advancing with Technology

2721 West Burbank Boulevard • Burbank, California 91505
Phone (818) 842-4175 or (213) 276-1414 • Fax (818) 953-2908
Circle (22) on Rapid Facts Card



Technical Staff (l to r): Steve Smulian (Service Manager), Paul Hulse (Senior Technician), Rik Shannon (P.O.M.P.), Greg Dougan (Parts Manager), (Not Pictured: Nello Torri)

Brave New World

In just a few years, electronic musical instruments have become an essential part of most recording facilities.

It wasn't long ago that a synthesizer or electronic keyboard was only seen in a recording studio when a musician brought one in or when it was rented-in at the request of a producer. Today, synthesizers, samplers, computers and all of the peripheral items that go along with them are every bit as essential to the traditional recording studio environment as the console and tape machine. It is a rare studio that doesn't employ MIDI in some fashion.

When MIDI first arrived on the scene in 1983, it was initially looked upon as a way for keyboard players to layer several synths together to fatten their sounds or to create new timbres quickly and easily. This method proved to be a boon to producers, as well as keyboardists, because the many tracks that previously had to be recorded to create this same MIDI texture could now be saved as a result of this "MIDI sandwich." As sequencers became more sophisticated and user-friendly, the musician's ultimate dream of being able to construct and play an entire song by himself suddenly came within reach. With the introduction of samplers and sample players (such as drum machines), the musician could now not only construct the entire song by himself but, with a bit of newfound programming technique, could make the song (or the new term, "sequence") sound like an entire band or orchestra.

Perhaps the most significant product of the lower- to mid-priced synth/sampling technology has been the drum machine. From merely a dream less than 10 years ago, the drum machine is one of the first

products a musician and studio now buys. As real 16-bit samples have supplanted the analog oscillator voices, and programming and user interface have reached new levels of sophistication, the drum machine has transcended all expectations in terms of potential realism. And much to the surprise of music purists, the drum machine has made a new generation of musicians much better players. Now, nearly every musician has the benefit of a steady timekeeper to play with in a realistic setting, without the dreary drone of yesterday's metronome or the wandering meter of novice colleagues.

But MIDI giveth, and MIDI taketh away. The public soon complained about the "sameness" of music made by the MIDI musician. Everything seemed too accurate, too perfect, due to all the sequenced parts being quantized. Something in the rhythmic movement seemed lacking because of the one or two robot-like drum machine patterns within the song. Dynamics were missing because the velocities of the synths were a bit too even. The same tonal colors began showing up on record after record, because the "hit sounds" were only all too easy to copy; just buy the same synth and dial up the patch! This caused a new level of technique and technology to develop, both in the hardware and software, and in the programming.

Technology has come quite far in recent years. Thanks to Large Scale and Very Large Scale Integrated chips (LSI and VLSI), it is now possible to pack a tremendously powerful synthesizer into a relatively small package. This newly developed density and the availability of custom-designed chips have greatly decreased the cost of the average synthesizer, while the power has increased similarly. For this reason, not only has the

synth/sampler/computer come down to a price within reach of the serious user, but it has now become a necessary tool for the audio professional, regardless of the area of specialization. As a result, mid-priced synthesizers and samplers can now be found in production studios specializing in records, advertising, radio, television and film scoring.

To counter the proliferation of home and personal-use studios, most commercial recording facilities began to add synthesizers and samplers as permanent fixtures to the studio, and they have moved from their former station in the recording area to a full-fledged position in the control room. This move has proved to be not only an attractive amenity for the client, but also a major selling point for the studio.

Today, many studios even have an in-house MIDI setup in the form of a separate MIDI programming room. The programming room has become both a boon and a necessity. This is because of client demand to have the appropriate gear available at all times for last-minute fixes, to select sounds before laying sequenced tracks, to curtail the need for the musician to bring his entire MIDI rig in order to lay tracks, and to keep the client from going to another studio that already has the available MIDI facilities. The programming room is a boon because a dedicated MIDI room really doesn't cost much, relative to what a new control room would cost. The return on investment can be fairly quick (providing that only mid- and low-cost synth/samplers are used); the room doesn't require much space and is an additional source of cash flow for the studio.

At last, it was possible for a studio of any size to turn out a product that previously could only be captured in a major facility. This was partly due to the development of digital samplers, which now puts many

Bob Owsinski is a Los Angeles-based musician/producer/engineer and freelance writer.

well-recorded, high-quality digital samples of acoustic instruments and sound effects at everyone's disposal.

Samplers have also created new, exciting options for the engineer/producer/musician/programmer that were not available in the early days of synthesis. Now, the player has the ability to create new sounds that don't occur in nature, or to use natural sounds for things in ways that Mother Nature never dreamed of.

Samplers, in particular, are fast becoming one of the most-used devices in the modern studio. Since a sampler is, in reality, a digital recorder with a finite recording time, samplers are now being used to replace the analog tape recorder for such things as fly-ins and voice-overs. Plus, the latest batch of samplers allows many production tricks that either are not possible or normally are too time consuming on an analog recorder. These include replacement of sounds via a triggered sample (as in the case of replacing a kick drum with a better-sounding sample), editing, looping and crossfading the samples.

Digital sample recorders have found a home on the stage, as well as in the studio. Besides the samples that a keyboard player may use in a live situation to

reproduce the "studio tracks," an increasing number of drummers now use their live drum kit to trigger sets of samples. And why not? The advantages are many. First, the sound is consistent from gig to gig, auditorium to auditorium. Why mess with success when the sounds from the record can be reproduced exactly? Second, setup time is cut down tremendously. Since the sound is the same every night, the sound man knows what to expect and can make short work of the sound check (of which the drums are usually the longest part).

Although trigger pads for totally electronic drums were quite the rage for a few years, most drummers now choose to trigger their electronics via a pickup attached to their drums. This gives the added advantage of mixing both acoustic and electronic drums together as needed. A few pads are used to trigger samples other than drum sounds, such as sound effects and, occasionally, cymbals.

Synthesizers and samplers are no longer the private domain of keyboard players and percussionists. Recent advancements in digital control have now allowed both wind players and guitar players to become part of the technological crowd. Guitar

and wind controllers are no longer the novelty items that they once were, but are fully functioning instruments that are being used on an equal basis as their acoustic counterparts.

And, finally, the new technology of sampling has found its way into production environments that its designers may never have envisioned. Broadcast applications replacing cart machines and industrial applications, such as sampling heartbeats, are becoming more and more commonplace as the technology becomes cheaper and, consequently, falls into more hands. And it is inevitable that we look forward to even better and less-expensive devices tomorrow. Who knows what new uses are to come?

This supplement covers MIDI-based systems and their applications in the professional audio environment. The concentration is on mid-priced (\$1,000 to \$5,000) synthesizers, samplers, drums and other triggering devices, digital wind controllers and guitar controllers. These units are now common to most recording facilities, and nearly all audio professionals come in contact with them frequently. In short, these MIDI-based devices are now an integral part of the audio professional's life.

Also for your YAMAHA® C1 Music Computer

MAGNETIC MUSIC, sequencer experts for the IBM® Personal Computer family, now gives you a choice of *three* music composition programs for MIDI!

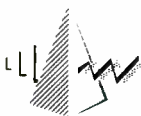

PRISM™

□ Sophisticated sequencing power at a breakthrough price! High-resolution graphics/windows/mouse interface with on-line help make it a snap to use! **16-Tracks \$99**



TEXTURE™ Classic

□ The premier MIDI sequencer for PC's written by synthesizer pioneer Roger Powell. Original Modular Architecture and legendary speed. Includes *Live!* for stage use. **24-Tracks \$199**



Texture™ for Windows®

□ High-performance for demanding applications. Fully utilizes Microsoft's® multi-tasking, graphics-based operating system and supports enhanced MIDI hardware. **32-Tracks \$299**

★ Hear TEXTURE featured on recent albums by Stevie Wonder, Suzanne Ciani and Bob James! ★

The Musician's Touch In MIDI Software

6 Twin Rocks Road
Brookfield, CT 06804
TEL 203-775-7832
FAX 203-775-6909

MAGNETIC
MUSIC

Circle (23) on Rapid Facts Card

SOUND QUEST

ATARI, PC / XT / AT, C1, AMIGA
Editor / Librarians

M1	QUEST	\$190
DXII/TX802	QUEST	190
D-10/20/110	QUEST	165
DX	QUEST	165
D-50	QUEST	165
MT-32	QUEST	165
DX11/TX81Z	QUEST	165
MATRIX 6/1000	QUEST	165
K1	QUEST	165
SQ-80/ESQ	QUEST	165
FBO1	QUEST	150
CZ	QUEST	150

For More Information:

Sound Quest Inc.
1573 Eglinton Avenue West, Suite 200
Toronto, Canada, M6E 2G9
416/256-0466
In US 800/387-8720

Circle (24) on Rapid Facts Card

Synthesizers and Samplers

The most common electronic music components have as many approaches as there are players.

In doing this survey, it quickly became apparent that there were several approaches commonly taken when using synthesizers and samplers in the studio. Many users are purists, preferring their MIDI sound sources simply to emulate the normal acoustic sounds of a band or orchestra, while a whole other segment uses the same devices in an ongoing search for new, artificial timbres. Many of the users principally employ their digital and/or analog synthesizers to achieve this end; for many, the friendly sampler was the device of choice. Although most engineers/producers/musicians/programmers seem to have no conscious choice in how they go about creating the sounds that they hear in their heads, their methodology primarily leans either toward synthesizers or samplers.

Synthesizers

Sir Gant, co-producer, arranger and keyboardist on Madonna's first album, Anita Baker's last two LPs and the latest

by Peabo Bryson, has in his keyboard arsenal a Roland D-550 and a Super Jupiter, an Akai S900, an Oberheim Matrix 12, a Yamaha TX816 and a DX-7, two MiniMoogs, an old Arp 2600 and a Macintosh SE with 2Mbytes of RAM and a 40Mbyte hard disk for his program libraries.

Gant finds that layering analog with digital synths helps him to achieve the best tonal colors. "I will frequently take an attack of an FM synth like a DX-7 and the sustain portion of a different sound from the Matrix 12," he says. "This gives me the best of both worlds with the warmth of the analog sound from the Matrix and the brightness from the DX. Combinations with the D-550 and DX or TX also work well together."

Although the owner of a Synclavier, Gant finds that he uses it mostly for sequencing. "I've had it happen a lot of times where people will say that the Synclav sounds great when it isn't even playing anything. The sounds are actually coming

from the other synths."

Despite the assortment of high-tech devices by which he's frequently surrounded, Gant takes care not to forget his acoustic roots. "I like combining the technology of today's electronic instruments with yesterday's acoustic instruments," he says. "That way, I get the best of both worlds."

At somewhat the other end of the spectrum is Steve Lindsay, who maintains a studio at the Village Recorder in West Los Angeles and who counts Luther Vandross, Joni Mitchell, Elton John, Michael McDonald, Manhattan Transfer, the Pointer Sisters, Randy Travis and Marvin Hamlisch among his clients.

"It's kind of a MIDI and anti-MIDI setup that I have here," states Lindsay. "I almost always go for the old synthesizers first because they sound thicker to me. I record mostly live onto tape with no sequencing for most stuff."

Lindsay's array of MIDI gear includes an Akai MPC60 sequencer/drum machine and an S1000 sampler; a Korg EX8000 and an M1; three Roland D550s, a D110, a P330, a TR808, a Jupiter 8, a MKS20 and a Super Jupiter; an Oberheim DPX1 sample player and Expander, an OB8 and an old 4 voice; a Yamaha TX816; a PPG Wave; a Prophet 5; an Arp Quadra; a Mini Moog; two Mellotrons; three Kurzweil model 1000 string expanders, two model 1000 guitar expanders, one model 1000 horn expander, and one model 1000 piano expander; and a Forat F16. A Mesa Boogie and vintage Fender and Magnatone guitar amps are frequently used to process the many synths and samplers, as are Groove Tube and ADA pre-amps.

It can be said that Lindsay takes a tradi-



The S1000 MIDI stereo digital sampler from Akai.

tional approach when making records. "I'm definitely into the older style of recording. I go more for the feeling than perfection. Contrary to the trends, I cut with a live drummer most of the time. On the occasions when I do happen to use a drum machine, I really want it to sound like a machine, so I purposely don't try to program it like a drummer."

"I like to create combination patches that feature some voices from later high-tech gear, and from some 'vintage' gear," Lindsay says. "One of my favorites is to sandwich all three Kurzweil string expanders together, using one for violins, another for violas, and still another for cellos, with a bit of D50 Arco strings added in. I'll sometimes add a bit of Mellotron to thicken it up a bit."

Mike Lang usually doesn't have the luxury of experimenting with new sounds. As a busy session keyboard player in Los Angeles, with recent credits on "Knots Landing," "Dallas," "A Fine Romance," "Jake and the Fat Man" and "McGyver," he almost always has to get the right sound on-line as quickly as possible.

Lang uses an Elka MK88 master controller with a Roland D-50, a Jupiter 8, a MKS50, a Super Jupiter, an MKS 80, and

an MKS 20 digital piano; two Yamaha DX-7s, a TX81Z and a DX-7FD; a Korg M1; an Oberheim Matrix 12; an E-mu Emulator II; and a Prophet VS.

"I've tried to choose instruments that have a unique character, almost like assembling an orchestra with different instrumentation. I try to find instruments that have as many different characteristics as possible, so that I can get sounds that all come from different points of view."

Although he has a Macintosh with Performer, Vision, Passport Mastertracks Pro and Dr. T's sequencing software, Lang frequently resorts to the dedicated Roland MSQ 700 for stressful situations. "In most situations where there are other musicians involved in the session, the MSQ 700 is the fastest for step recording—and speed is everything sometimes."

Wendy Carlos is certainly no stranger to the world of synthesis. Having taken music synthesis from the laboratory to the commercial masses with "Switched On Bach" in the 1960s, she has been not only a pioneer but a leader in the use of synthesizer technology.

An avid supporter of traditional synthesis over sampling to create new tim-

bres, Carlos feels that "synthesis, done properly, has none of the objections that samplers have, with seams between the notes where the timbres don't match, or having a limitation on what happens dynamically between the softest and the loudest notes. With synthesis, you can have a continuum of variability both in the dynamic dimension up and down and in the pitch domain. Those two dimensions are far more successfully handled with real synthesizers than they will ever be by samplers, except in the case of a huge overkill in memory and money."

Carlos currently has numerous pieces of synthesizer gear in her studio, ranging from some of the latest in technology to some of the oldest. Of particular interest are the main sound sources that Carlos relies on, which are two Synergys and three GDS Slave 32s, both of which are no longer made. These are augmented by two Kurzweil 150s, a 1000PX, a 1000SX and a MidiBoard; a Yamaha TX802 and an RX-5; a Synton Vocorder; and an old, modular Moog 904, which recently saw service on the "Peter and the Wolf" soundtrack that Carlos recorded for CBS. It was used to simulate the cat meow and duck quack sounds. An Aphex Aural Exciter is

smpte gets smarter.



J.L. Cooper's PPS-100 is a SMPTE/EBU to MIDI Synchronizer and Event Generator with smarts. The PPS-100 converts all SMPTE formats to MIDI Sync and Song Position Pointer with programmable tempo changes. The PPS-100 also generates MTC (MIDI Time Code), DIN sync, Direct Time Lock, and PPQN sync.

Need to generate time code as well? The PPS-100 generates all formats, starting at any time. And the PPS-100's "event generator" is even smarter! Any kind of MIDI commands (notes, program changes, even systems exclusive messages) can be output at any SMPTE time.

Two independent on-board relays and two pulse outputs may be programmed to turn on and off at any SMPTE time. Unlimited uses include auto punch-in and automated effects bypass.

Optional software "desk accessory" for the Atari ST and Macintosh allows for cue list entry of events.

Smart price, too. Just \$295. Optional disk only \$49!

Ask for it now at your music and pro audio dealers!

JL COOPER ELECTRONICS

13478 Beach Ave., Marina Del Rey, CA 90292 (213) 306-4131

Circle (25) on Rapid Facts Card

used to enhance the high frequencies of some of the units that have a frequency response only to 10kHz or 12kHz, and Phase Linear Auto Correlators are used to alleviate some of the digital noise from the digital synths.

For sequencing, Carlos uses a Macintosh with a Prodigy Prime modification and Mark of the Unicorn Performer software. A Mac 2X is used for music engraving with Finale software, the program of choice. Although she uses an extremely powerful sequencing program like Performer, Carlos says that she uses no quantizing. "I go into the note list and edit if I find that I played something a little late. I'd rather capture a performance and touch up any little kluges that might happen than play a phrase to death in hopes of getting a perfect take and lose the soul for the sake of the accuracy."

While back in the primal days of synthesis, an entire project was done with a single device containing a minimal number of oscillators, Carlos now says that "having to get the resources for a full orchestra requires at least 40 timbres on-line at all times." She has not, however, become a slave to technology.

"I think that it's a combination of taste and the background of the people who are using the gear that drives the type of results that you get," she says. "My background is traditional orchestration and instrumentation, which stimulates my appetite for making interesting ways of combining instruments and timbres together."

About to begin recording on a project marking the anniversary of "Switched on Bach," Carlos will be using the authentic tunings that Bach originally used, which were not of equal temperament. "The difference with my perspective is that I want passionately to get out of the clichés that define most of the music being made by these devices (current synthesizers and samplers), which is rhythmically simple, melodically diatonic, and harmonically

nothing but triads or fusion, like flatted ninths or sevenths," she says. "There are so many wonderful opportunities available with many of the new synthesizers, such as developing any alternative tunings that we might want."

"It's time to let go of the limitations within ourselves as musicians and realize that there is no need to *follow* any tradition, except that you really have to *respect* all tradition. The laws of acoustics, physics, musical balance and attention span never go away."

Samplers

With a different approach to obtaining a similar end product, David Orin uses the synthesizers and samplers in his studio to re-create traditional orchestral sounds when making tapes for planetariums. "Planetariums don't really have big budgets, so they can't afford to pay the fees for large orchestras. I supply them with simulations and sound effects. Planetariums need themes, so I provide them with a space shuttle, moonwalk or space probe theme; whatever they require," he says.

Reproducing Mozart's last six symphonies, Orin plays some of the parts into the sequencer directly without quantizing, while some of the music is step-entered directly from the score. Special sound effects are also supplied, which are sampled from a Sound Sensations tape library or created with the Matrix 1000, which Orin says is "fabulous for designing analog weirdness, sound effects and strange space pads."

Orin's studio "orchestra" consists of a Kurzweil MidiBoard, acting as the main controller, a Kurzweil 1000PX; an Ensoniq EPS with expanded memory; a Roland S-550 and a D-50; an Oberheim Matrix 1000; and a trusty old MiniMoog. He uses a Mac Plus with Mastertracks Pro software for sequencing.

Also attempting to replicate a full orchestra via the use of multisamples is Paul

Derek Mason of Sync Tank Productions, who recently completed the music for 20 episodes of "Shining Time Station" (a children's show starring ex-Beatle Ringo Starr) on PBS.

"On a tight budget, I needed a way to get as full an orchestration as possible using acoustic-sounding samples," says Mason. "Even though it's a children's show, it's not like 'Mister Rogers Neighborhood,' where you're listening to just an electric piano and train noises. I've used everything from timpani to full brass to strings with full woodwind sections. I use this gear more as a composer in search of an orchestra. I can't afford to hire the London Symphony Orchestra, but I can score it and have it played that way with my setup. I'm not looking to do anything esoteric, since it's well beyond the scope of the show."

Scoring a weekly show means that a lot of work must occur in a relatively short time. Says Mason, "It's evolved from 30 seconds of music per show to upward of 10 minutes per show. I'm scoring to picture on the fly so that I have a chance to play back the different sounds and orchestrate with frame accuracy. This enables me to meet my deadlines and get a show out in three or four days and save a lot of time later when they lay it back to picture."

Mason uses a Mac Plus with Performer software for sequencing, and two Casio FZ-1s with expanded memory and an Oberheim OB-8 as sound sources. He uses both Soundwaves and Casio libraries as sample sources.

Also under the gun of the weekly TV-series deadline is composer Tim Truman, who has taken over the music chores for this season's "Miami Vice" and must create 44 minutes of music in three days—every week.

Truman relies on an Akai MPC60 sequencer/drum machine, two S900s and two S1000s; a Prophet VS; a Yamaha DX-7; and a Roland Super Jupiter and a D-50 for the rock 'n' roll textures that have come to be the trademark of the show. In most cases, Truman will sequence approximately 10 tracks and free-play three tracks to improve the feel of the music. A live guitar player is later overdubbed for additional enhancement.

Because his is one of the few shows broadcast in stereo, Truman makes use of many techniques more commonly found in record production than in television. "For mono samples," Truman says, "we'll print it twice and delay one side, or detune one side. We also use a lot of creative panning, either manually or auto. Many times we'll pan the sample to the left but make the effect just as loud on the right." Stereo



The Ensoniq EPS performance sampler.

Bose® ProFiles

“When I went after this job, I looked at several manufacturers. But when I examined cost vs. performance and considered ease of installation, Bose was the clear choice.”

*—Phil Thorne
Taft Broadcasting Company*

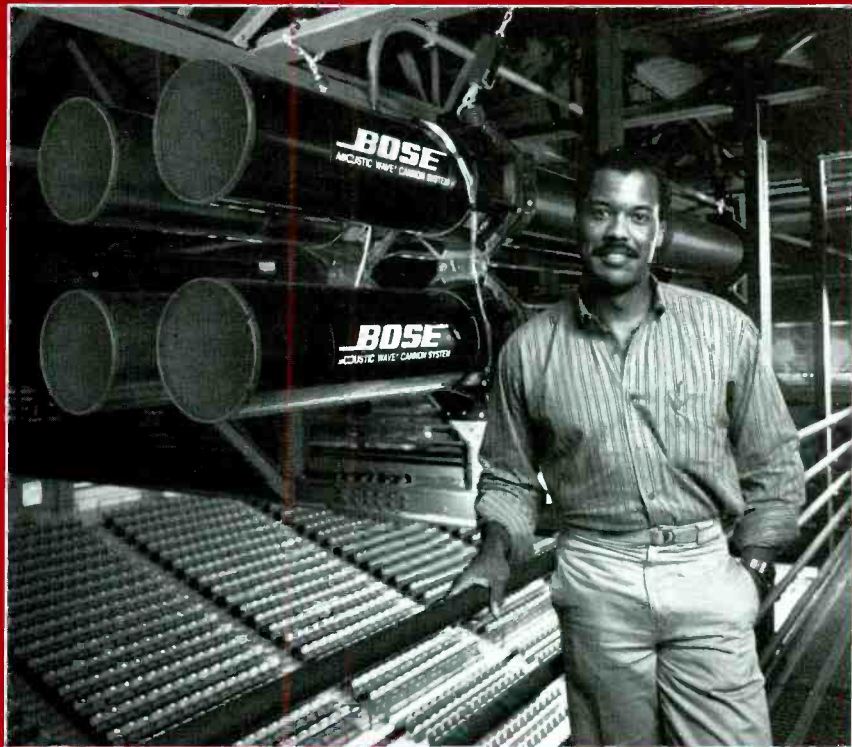

The Site: Health & Physical Education Building
Texas Southern University, Houston, Texas

The Challenge: Provide a quality sound installation for 12,000 seat enclosed basketball arena with anticipated crowd noise level exceeding 95dB

The Contractor: Phil Thorne—Taft Broadcasting Company

The Tools: Bose® Sound System® Software

The Products: Bose 802®-II/Acoustic Wave® Cannon Central Speaker Cluster
Bose 802-II Distributed-Delayed Speaker System

The Result: “Using Bose Sound System Software, I was able to show my customer a graphic representation of what their system would look like, and a computer projection of how it would perform. My customer was very impressed with the professionalism and in-depth analysis of the presentation, and they’re just as impressed with the final product. When you first look at the size of the Bose 802-II speakers, you wonder if they’ll really produce enough sound to fill an area as large as an arena effectively. When you use them the sound is complete and sound pressure levels are consistent over the whole area. My end users are happy I chose Bose products.”

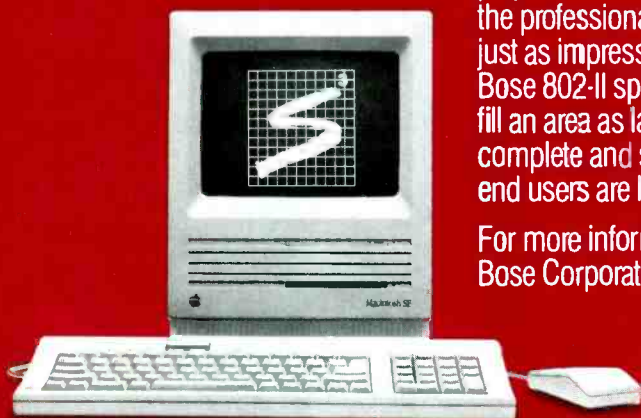

For more information on Bose products, call 508-879-7330, or write:
Bose Corporation, Dept. REP, The Mountain, Framingham, MA 01701-9168

BOSE
Better sound through research.

Circle (26) on Rapid Facts Card

samples, such as those from the S1000s, may be treated the same as a mono sample.

"In my opinion, most things are not really stereo anyway," says Truman. "But the strings samples from the Musicsoft library are exquisite and quite the exception."

Despite the short time frame required to put the "Miami Vice" score together, Truman has no qualms about altering any of his samples to achieve a particular sound or effect. Reversing samples or modifying attacks are some of the frequently used techniques to make the generic samples different. "I'll either play some samples backward, then combine it with a different sample," he says. "Or sometimes I'll use it just as an attack to another sound. I'll try anything to make it sound better."

A different approach to combining samples is taken by former Moody Blues keyboardist Mike Pinder, who prefers to combine samples from different machines to obtain the desired results. Says Pinder, "I switched from using a lot of FM-type synths to sampling. I found I enjoyed it more because it was such a logical extension of the Mellotron, which is the original analog sampler. I haven't had time to make up my own samples, except for combining various ones as needed. I use the Casio FZ10Ms as a left and right for stereo samples, and cross-echoing for some of the things that we did on the old Moody Blues records. I also like combining the warm, organic sound of the Prophet 3000 with the crystalline, clear sound of the Casio. They complement each other nicely."

Pinder does all of the Atari Computer commercials, as well as his many other production projects, from his private studio equipped with an Atari 1040 with a 60Mbyte hard disk and 4Mbytes of RAM; C-Labs Notator software; a Casio FZ1 as a master controller, two FZ10Ms, and a VZ10M; a Prophet 3000; a Yamaha DX-7; and a Roland S-330.

Neil Jason, of JSM Studios in New York,

is not only an advocate of combining samples to create a new timbre, but also of trying radically altered samples in place of some common sounds. "None of my hi-hats or snare drums are ever really hi-hats or snare drums," says Jason. "I screw around unmercifully with drum sounds. At times I have tuned up horn hits four octaves too high, then used that for a hi-hat. I once took wind chimes, cut the decay, and pitched it up real high to use it as a hat."

"I frequently will combine four or five different sounds to get one dynamite snare drum sound. I'll take the sound of breaking glass, a super-high-tuned rim-shot snare, a gated snare drum tuned down half an octave, and a gunshot. I'll put them together in one sample and then use that as the snare drum. I've used the slam of a car door in place of a bass drum. All of these altered sounds are mysteriously close to the real thing; they just have this other-worldly attitude when you hear them."

Jason has done sessions for Cyndi Lauper and Paul McCartney, and commercials for Goodyear, Certs and Club Med. He has a variety of sound sources at his disposal. In his studio, which is one of three located at the facility, he has two Korg M1s; two Yamaha DX-7s and a TX802; two Akai S900s; a Casio FZ10M; a Roland D-550; two Alesis HR-16 drum machines; and an Oberheim Matrix 1000. Sequencing is handled by a Mac 2X with a variety of software, an Alesis MT-8 or a Roland MC500. "I actually use the MT-8 more than anything because it programs like a drum machine, and it's the fastest sequencer that I have," he says. "I'm not crazy about computer-based programs that give me too many options. I like every piece of equipment to be dedicated, if possible."

Jay Rose owned and operated an advertising studio for 12 years in Boston, winning several Clios and Emmys along the way. When he finally sold the studio in a

real estate deal, he decided to set up a small studio in the attic of his home, keeping some of the clients from the days of his larger commercial facility.

One of his clients is hamburger giant McDonalds. He does all of its national TV spots and recently required a most unusual, but effective, use for a sampler. As Rose tells it: "About a year ago, a certain well-known actress narrated a spot for McDonalds, and they didn't like the way she said 'Happy Meal' (putting the emphasis on *Meal* instead of *Happy*). They asked her to fly back to Boston to dub in 'Happy Meal.' She was not very happy about having to do that, so it showed in her read. She did exactly what they asked her to do, but it was terrible. So I took the original read, loaded it into the FZ, took it apart syllable by syllable (putting each syllable on a separate key), and played it back in the intonation that they wanted. I gave them my Casio version as an alternative read, and that ended up being the one that they ran with."

Another spot that Rose created was a piece for a science museum that featured samples of Eskimo chants processed to sound like rock-and-roll. "I built all of the harmonies up on a \$300 Ibanez pitch shifter. That spot got me a first-place Clio," he says.

Rose uses a Casio FZ-1 with 30 seconds of memory, a CZ101; a Roland MKS-80; a Kurzweil K1000; and a Mac SE with Midi-Paint software for sequencing.



The 1000 PX Plus professional expander from Kurzweil Music Systems.

It's Not Just A Phase We're Going Through.

The tremendous success of the Tannoy PBM series of reference monitors is by no means coincidental. Since the introduction of the world renowned NFM-8 nearfield monitor, much time and effort has been spent on discerning the needs of the mixing engineer and the applied requirements of "playback monitors". The PBM Line exemplifies this commitment to excellence in reference studio monitoring. These compact loudspeakers sport robust poly cone mid-bass transducers utilizing efficient long-throw, high power voice coils. The low frequencies are carefully controlled by optimally tuned ports located on the rear of the loudspeakers. Hi frequencies

are provided by Hi Power ferro fluid cooled polyamide dome tweeters which extend H.F. bandwidth beyond 20KHZ. The driver accompaniment is knitted together by means of a precision hardwired crossover unit, utilizing robust low loss components, and heavy-duty input terminals which will accept standard 3/4" spaced banana plugs and the majority of high quality, specialist audio cables. Transducers and crossover assemblies are neatly housed in a stylish, high density, partial wrap cabinet,

specially designed to minimize unwanted cabinet resonance, and high frequency reflection. In summarizing, we have left the best feature of all for last "price versus performance."

TANNOY
Professional Products

Tannoy North America, Inc.
300 Gage Ave., Unit 1
Kitchener, Ont.,
Canada, N2M 2C8
(519) 745-1158
Telex 069-55328
Fax (519) 745-2364

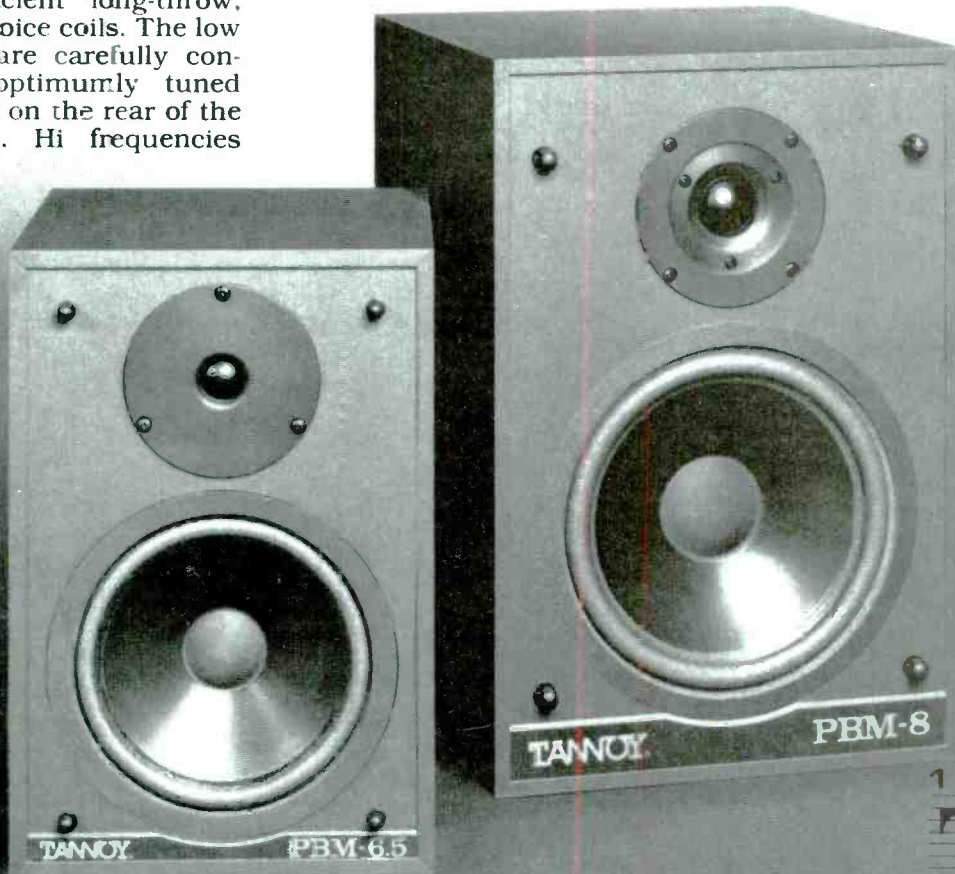

Circle (27) on Rapid Facts Card

TANNOY®

1 9 8 8
TEC

TECHNICAL EXCELLENCE & CREATIVITY
**AWARD
WINNER
TRANSDUCER
TECHNOLOGY**

Electronic Drums and Triggering Devices

Why should keyboardists have all the fun? With the right equipment, MIDI's possibilities are open to almost everyone.

Synthesizers and samplers are no longer the domain of the keyboardist, as controllers and triggering devices become more reliable and drummers, guitarists and wind players become more at ease with the technology. Drummers have been especially quick to embrace electronics as a way to supplement their existing acoustic kits. Nowhere is this more evident than in the case of John "JR" Robinson, studio drummer on Michael Jackson's "Bad" and "Thriller" albums.

Robinson is a Los Angeles-based studio drummer whose credits include Jackson, Lionel Richie, Kenny Rogers, John Fogarty, Kenny Loggins and the Pointer Sisters. Besides bringing his acoustic set to a ses-

sion, Robinson also sports a formidable array of electronics.

According to Doug Getschal, who designed and built the system, each drum contains a Barcus Berry pickup that has its output split four ways. A snake containing all trigger and drum pad cables is then connected to a rack containing a Simmons SD5, Simmons SD9 and a MIDI Expert trigger-to-MIDI converter. A second rack containing a Yamaha PMC drum brain turns the trigger signal into MIDI on Channels A and B. Channel A then feeds a Yamaha TX816 rack containing factory and custom drum sounds. Channel B feeds an E-mu SP12 drum machine. Each rack contains multipin connectors for minimal

setup time. All MIDI Ins and Outs, as well as audio ins and outs, are broken out to the rear panel of each rack for easy access. The trigger snake can be plugged into either of the two racks, if necessary.

During a studio session, all outputs are connected to the console, and the acoustic kit is miked as well, giving up to five sound sources per drum. The engineer and/or producer then has the option to decide which sounds to use, since all of the electronic drum sounds are now at their disposal. Most sessions usually end up with at least some live kick, snare, hi-hat and cymbals, while toms are triggered from the pads. The actual sound of the stick hitting a pad is picked up by the open mics, which, surprisingly enough, sometimes helps the overall sound by adding some acoustic attack to the processed sound.

Having a sequencing drum machine available can make the session go a bit easier if only a repetitive pattern is required. Sometimes after a tune is laid down with a drum pattern first, Robinson goes back and recuts the song live, triggering whatever sound is needed. Sometimes only tom fills with live cymbals are required after the initial pattern is recorded.

Digital wind controllers

Fairly new to the electronic scene are wind instrument players, who only recently have been able to perform via a digital controller/synthesizer. Applying the many nuances previously available only on their acoustic instruments, Tom Scott, Ernie Watts and Steve Tavaglione all are avid users who have made this new technology part of their everyday studio and concert experiences.



Tom Scott (left) with a Yamaha WX-11 on the "Pat Sajak Show."

Tom Scott, session sax player and recording artist, has found a place for the Yamaha Electronic Wind Instruments in his daily musical chores while composing in his home studio and while playing live as the band leader of "The Pat Sajak Show."

Scott's MIDI studio consists of a Yamaha KX76, a TX802 and a TX81Z; a Roland MKS-20 and a D-550; an Akai S900; a 360 Systems MidiBass; and a Yamaha MJC8 MIDI Switcher. His sequencer is a Mac SE with Mark of the Unicorn Performer and Composer, Opcode Sequencer 2.5 and Cue, and Graphic Notes Music Publisher software. Although he uses the KX76 keyboard controller to input most music into the Mac, Scott frequently uses the Yamaha WX7 for horn parts that require feeling. "I use it primarily as a solo instrument, or sometimes for doubling parts," he says. He recently completed the score for the remake of Disney's "Absent-Minded Professor," on which he used the WX7 extensively for flugal horn and trumpet sounds.

On "The Pat Sajak Show," Scott uses a Yamaha WX11, which he employs at least once a night because of the good sax and french horn sounds he gets.

Sax player Ernie Watts also finds that he uses his Yamaha electric wind instrument on a daily basis. "When I get a call for a session, it's becoming quite common for them to say 'Bring your saxophone and your wind thing,' because they don't know what to call it," Watts says.

He uses a Yamaha WX7 connected to a rack that contains a Yamaha TX81Z, a TX802, a SPX90 and an MFC2 when touring large venues, but finds carrying a Yamaha WX11 and a WT11 tone generator is sufficient for most other touring situations—because they're small enough to carry on a commercial airplane as hand baggage. "The WX11 is perfect for practice in a hotel since, internally, it contains the equivalent of a TX81Z and an SPX90, and the playing technique is very indigenous to the sax," Watts says.

Instead of trying to simulate an existing acoustic instrument, Watts instead chooses to take the electronic wind driver to its limits. "I'm looking for a creative sound on it so that people recognize me the same way they do on the saxophone," he says. "When I do a session, I work mainly as a solo or featured artist, so we experiment quite a bit with other synths, looking for a sound. There's always a certain amount of experimentation required anyway, because certain sounds are more conducive to the tracking of the wind driver."

On the question of triggering samples, Watts has strong views. "I have friends who have copies of oboe, bassoon, harmonica or english horn sounds that they use on sessions. I have an ethics problem with that. It bothers me to use an electronic instrument to substitute for an acoustic sound, so I have not become involved in that. When I use the electronic instrument, it's to create electronic sounds

that could not possibly be created by acoustic instruments. Eventually, I'd like to do a record that features the WX, to establish that sound as a solo voice," he says.

The electronic wind driver has opened up new options for Watts that were not formerly possible from a purely acoustic instrument.

"Besides being a solo voice, it has so many other possibilities," he says. "When I'm touring, during the time that I'm not playing the saxophone when I used to be playing hand percussion, I'm now doubling up bass lines, adding strings lines or helping out the keyboard player.

"And there are other possibilities, as well. I have some programs called 'Performances' where I can hold a chord and play a solo voice over it. This opens up the possibility of an unaccompanied, orchestrated performance, which was something that was previously impossible with just a saxophone."

Although Scott and Watts use their electronic wind drivers primarily for solo applications, Steve Tavaglione takes a much different approach, simulating not only a full horn section, but duplicating many keyboard functions as well. Currently preparing for the Diana Ross world tour, Tavaglione will be replacing five horn players with samples from an Akai 950. For the tour (which will be entirely MIDI for the keyboards, drums and percussion), Tavaglione will use two Akai S950 samplers; a Korg MIR; an Oberheim Matrix 6; a Roland D50; and a Yamaha TX81Z—all of which will be controlled from an Akai EWV 2000 electronic wind instrument.

Besides using the EWV2000 live, Tavaglione finds numerous opportunities to use it for sessions. "I use it every day, at least equally as much as the acoustic and sometimes more."

Because samplers don't respond to breath control or aftertouch amplitude information—parameters so important for a wind player—Tavaglione resorts to several tricks to augment the realism. "I like to run strings, horns and reed sounds through the external input of the EWV2000. I use a submixer to group all of my synth sounds other than the EWV2000, and connect the output of the submixer into the external input of the EWV2000. I then take the output of the EWV2000 and connect that to a regular mixer. This greatly increases not only the realism, but the control of the sounds, as well," he says.

Guitar controllers

Ever since synthesizers first came on the market, it's been the dream of guitarists to be able to control keyboards from their



The Roland D-50 linear synthesizer.



The Korg M1 workstation.



Akai Professional's MPC60 MIDI production center.

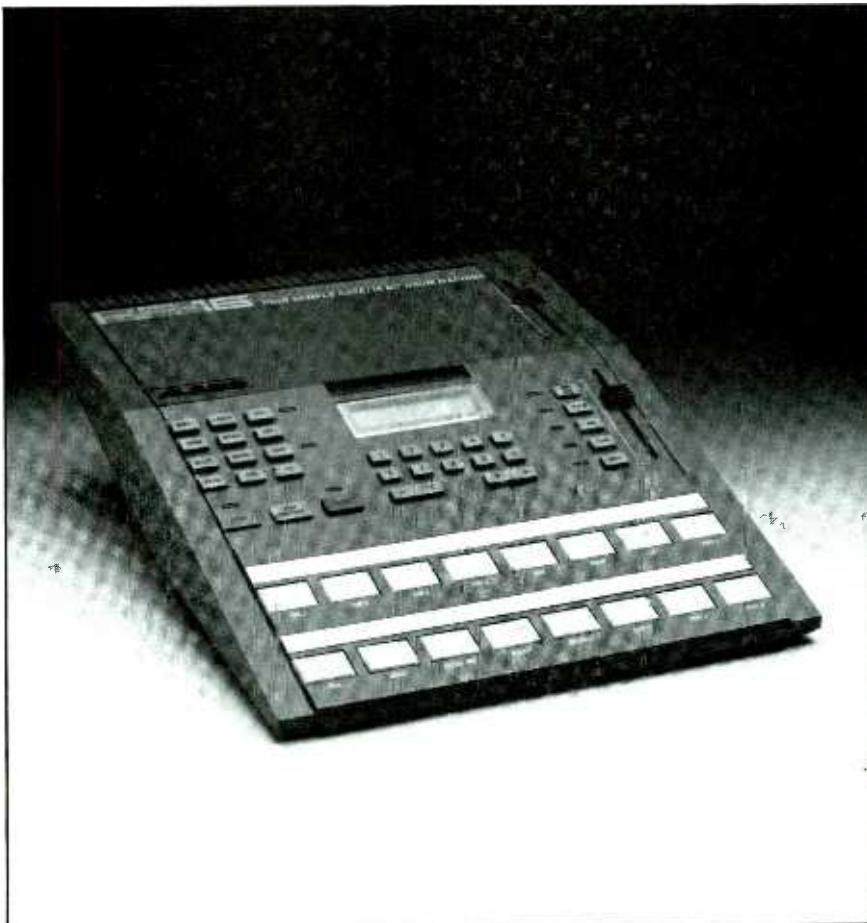

The Alesis HR-16 drum machine.

instruments. Although guitar synthesizers and controllers have been around for some 15 years, only recently have they become reliable enough to be used consistently. Guitarist Lee Ritenour has been there from the beginning.

"I've used every guitar synth, or at least tried them, since they first came out in 1976. So I've been through the lot of them and they've really been horrible until the last couple of years. The Yamaha G10 is the current state-of-the-art digital controller, and it's the easiest one to play. I find that with guitar synths, each manufacturer's synths work best with their own controllers in terms of tracking, sustain and bends. The guitar synth is not as generic as a keyboard because of the nuances of the player. Sometimes there's a double attack problem with the left hand hitting the fretboard and the right hand picking the strings. Yamaha is aware of this and has cleaned it up better than most.

"Synthesizers were not designed to be controlled by a guitar, because guitar players have so many different kinds of techniques," Ritenour says. "It's so much more than a note-on, note-off kind of situation with a guitar player than for a keyboard player. So many guitar players play with slurs, hammers, bends, slides, muting with the right hand, combination of the pick and the fingers, or sometimes just finger-picking. Some players pick real hard; some players pick real light. All these things are a factor in trying to make a guitar synthesizer play properly."

Despite these admittedly tough observations, Ritenour is still an enthusiastic user. "I use it all the time in my studio for composing by feeding it into an Atari computer with Hybrid Arts sequencing. In January, when I was writing for my new record, I used it every day. I would trigger the drums from the G10, all of the chordal parts and the synth bass. Sometimes I would quantize stuff. Sometimes I wouldn't. But I was creating my whole rhythm section with the G10."

"I do all the demos for my albums on the synthesizers," Ritenour says. "Everything is written out from the demos, and then I'll bring live players in to actually do the record. On the new record, I plan on using the G10 quite a bit as a solo instrument."

Ritenour, who connects his G10 to two Yamaha TX802 sound modules, also points out, "Most players will have not only a digital controller (which doesn't make any guitar sounds itself and is not a pitch-to-voltage converter), but also some kind of pitch-to-voltage converter. I've found that I've needed both."

New Applications

Electronic instruments have expanded beyond their original applications.

Synthesizers and samplers are now not only an integral part of the studio and concert stage; they have found new homes in broadcasting and the performing arts, as well. The following are examples of unique, exciting uses for samplers in those realms.

John Debela, of radio station WMMR-FM in Philadelphia, uses an Ensoniq EPS sampler both for production and as a replacement for a traditional cart machine.

"We use the gear in two different applications. One is obvious—in production. We create a lot of our own music, and we do a lot of live radio using the EPS extensively in the traditional manner of generating music," he says.

"We also use the EPS in place of a cart machine for sound effects to accent the show. There's a way to section off the keys so that a different sound will play on each section. This means that there are now up to eight cart machines that I don't need."

John Greenland, a former Ensoniq sound designer who was responsible for the ESQ-1 and ESQ-80 libraries, has found an extremely unique and unlikely use for a pair of Ensoniq EPS samplers—as sound sources for a "MIDI Sculpture."

"I'm working with a sculptor, Charles Emland, who makes pneumatic, mechanical sculptures, one of which is a 12-cylinder air dog," Greenland says. "The EPS is used to provide the music for the sculpture. The sculptures are choreographed from the sculptor's computer, an IBM clone, which also orchestrates the music. The EPS is controlled by the movements of the sculptures via the computer, which is linked to a Mac Plus using Performer software.

"I have sampled the sound that the sculptures actually make. We spent a lot of time banging on them with a lot of different materials. Because the sculptures are substantial bronze, iron and steel structures, they make beautiful noises when

they are struck. I've turned these sounds into playable instruments and blended them with other sounds so that the sculptures themselves are actually going to be making the music."

When the sculptures' choreography is complete, they will be videotaped, with Greenland's two EPSs supplying the score. "Our ultimate aim is a grant," Greenland states. "We're not after anything other than notoriety. We'd like to get some really good sculptures out, together with some really good music."

It's evident that keyboards, samplers and a growing number of other devices have become an integral part of the normal (and the not-so-normal) production environment. Where at one time it was unique to find these units as a permanent part of an audio facility, they are now often an expected element of a studio's audio arsenal.

And what of the future for the genre? In the coming years, we can expect the lines between audio products and musical instruments to become increasingly blurred as more power, features and sophistication are incorporated into these types of products. Operators will also evolve as the technology spawns a whole new generation of musicians who must be capable as programmers and engineers, and engineers who must be capable as musicians and programmers.

The future is, in many ways, actually here today, with products like the Synclavier and AudioFrame providing many of the traditional mixing, storage and signal-processing capabilities normally found in the average recording studio.

REP

PATCH-BAY PRODUCTS



- 1/4" Long-frame and Mini Telephone Jacks

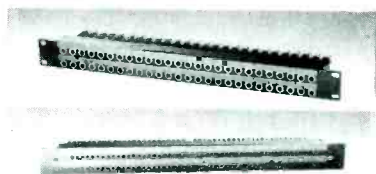

- Jack Panels with Jacks in both sizes
- A variety of Row and Jack Hole Spacings available

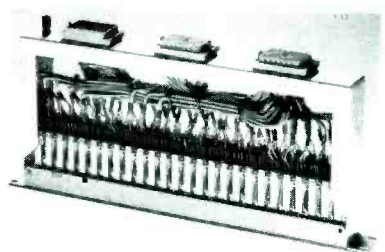

- Standard line of Pre-wired Panels
- Custom Wired Panels



- 1/4" & Mini Patch Cords
- Patch Cord Holders
- Polysand



- Video Panels

audio accessories 
audio line

AUDIO ACCESSORIES, INC.
Manufacturer of Audio Line Products.
Mill Street, Marlow, NH 03456
603/446-3335 Quote Line: 603/446-3336

Circle (28) on Rapid Facts Card

Computer Software for the Audio Industry

By Lynn Hedegard

A report on the audio-related software available for the Amiga, Atari, IBM/compatibles and Macintosh computers.

As the progress of technology marches forward, the presence of computers in the audio industry is ever-increasing. It has reached the point that a computer is no longer a luxury in the recording studio; it is now often a necessity.

The software available for the audio industry is plentiful. More than 70 vendors supply software applications, and some of them provide a large selection of products.

Human interface

Today's computers provide for various ways of data entry, including a mouse, typewriter keyboard, synth keyboard, analog sensing devices (for sensing the position of slide pots) and even voice recognition.

Clearly, one of the features that should be considered before purchasing software is the command interface. For the audio industry, the most popular interface probably is the mouse. But that is just the tip of the iceberg. Beyond the interface are a number of operational features that make one software package more suitable to your tasks than another. Find out how many menus must be pulled down before

you can accomplish the task at hand. How easy is moving from one section of the software to another, and how long does it take to complete the transition? Can commands that destroy data be undone? Does the program provide an expert interface to eliminate annoying "Are you sure?" messages? Can you construct "command macros" or customize the interface to your taste? Eventually, you will either love or hate the interface to your software, so evaluate it carefully before you buy.

The survey

This survey is intended to present the reader with a listing of current audio-related software and provide general application information. The software has not been reviewed. The various types of software have been categorized as follows:

1. Voice editor/librarians.
2. Sample editor/librarians.
3. DSP editor/librarians.
4. EDL/machine control.
5. Music library/EFX database.
6. Film-composing tools.
7. Mixing automation.
8. Sequencers.
9. Scoring/notation.
10. Composing tools.
11. Hard disk systems.
12. Miscellaneous.

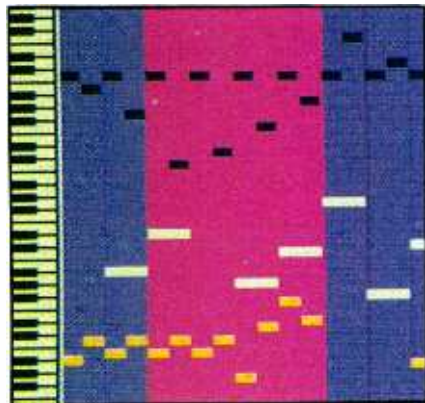

Lynn Hedegard is president of HED Productions in Encinitas, CA, and a free-lance producer, computer programmer and writer.

NEW MUSIC SEMINAR 10 JULY 15-19, 1989 MARRIOTT MARQUIS HOTEL NEW YORK CITY

"LAST YEAR AT THE NEW MUSIC SEMINAR I LICENSED PUBLISHING AND MASTERS FOR OVER \$60,000. FOR PEOPLE WHO ARE ALREADY IN THE MUSIC BUSINESS OR JUST GETTING STARTED, THE NEW MUSIC SEMINAR IS THE BEST PLACE TO LEARN EVERYTHING ABOUT IT. COMPARED TO THE NEW MUSIC SEMINAR ALL THE OTHER CONVENTIONS ARE JUST PARTIES." TOP PEOPLE FROM AROUND THE WORLD DEPEND ON THE NEW MUSIC SEMINAR.

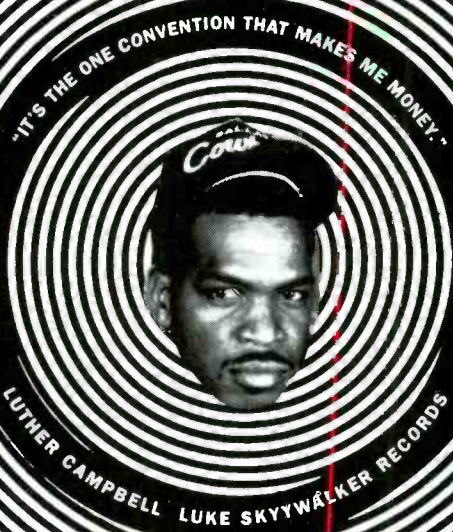

I WANT MORE INFORMATION ABOUT NMS 10!
PLEASE ADD ME TO YOUR MAILING LIST.

NAME _____

COMPANY _____

ADDRESS _____

CITY _____

STATE _____ ZIP _____

COUNTRY _____ POSTAL CODE _____

TELEPHONE NO. _____ OCCUPATION _____

Return This Form To:

NEW MUSIC SEMINAR, 632 BROADWAY, NY, NY 10012
TEL: 212-473-4343 FAX: (212) 353-3162
TELEX: 448737 NMS NYK E-MAIL: 62758238

RE _____

FOR AIRLINE DISCOUNTS CONTACT AMERICAN CORPORATE TRAVEL, TEL. 1 800 448-9494 or (212) 353-3408, FAX (212) 353-2876.

FOR MARKETING OPPORTUNITIES CALL THE SALES DEPARTMENT AT NMS, (212) 473-4343. PRESS CONTACT: INPRESS, TEL. (212) 751-9852, FAX (212) 644-8746.

SAVE \$100, REGISTER BEFORE MAY 19 AND PAY ONLY \$195. REGISTER NOW BY CREDIT CARD, CALL 1 800 888-8596, AND MAKE YOUR MARRIOTT ROOM RESERVATIONS AT THE SAME TIME.

NEW MUSIC SEMINAR 10 JULY 15-19, 1989 MARRIOTT MARQUIS HOTEL, NEW YORK CITY INCLUDING NEW YORK NIGHTS: THE INTERNATIONAL MUSIC FESTIVAL, JULY 14-19, 1989. FOR ARTIST SHOWCASE INFORMATION CALL THE NYN A&R COMMITTEE, (212) 473-4343.



Circle (29) on Rapid Facts Card

Symbols used to denote hardware in tables:

AL = Alpha Micro
 AM = Amiga
 AT = Atari
 I = IBM/compatible
 M = Macintosh

"—" Indicates information was incomplete or not available at the time of publication.

NOTES:

A. Many of the products listed have applications in categories other than the one in which they are listed.

B. In many cases, only the most recent product name and/or version is listed.

C. Version numbers are omitted for reasons of sanity. Check with the company of interest regarding which program is most suited to your applications.

TABLE 1
Sample Editor/Librarians

Company Name	Product Name	Computer	Comments	Rapid Facts #
Blank Software	Alchemy	M	—	(200)
Digidesign	Turbosynth	M/AT	—	(201)
Digidesign	Sound Designer	M	1	(202)
Dr. T's	(various)	AT//AM	1	(203)
Drumware Inc	Genwave	AT	—	(204)
Hybrid Arts	Oasis	AT	—	(205)
Music Services Software	Music Service	AT	—	(206)
Steinberg	Soundworks	AT	—	(207)
Turtle Beach Softworks	Sample Vision	I	—	(208)

1. Supports many samplers.

TABLE 2
Voice Editor/Librarians

Company Name	Product Name	Computer	Comments	Rapid Facts #
Altech Systems	—	—	—	(209)
Bacchus	Voice Man	I	1	(210)
C&M Research Group	GEN ESQ	I	2	(211)
Digidesign	SoftSynth	M	—	(212)
Digital Music Services	DX7, TX802, FB01 Pro	M	3	(213)
Dr. T's	(various)	M//AT/AM	4	(214)
Hybrid Arts	GenEdit	AT	4	(215)
Imagine Music	Master Series	I	4	(216)
Magnetic Music	Pyramid DX/TX	I	5	(217)
Musicode	Voice Devel Sys	AT	6	(218)
Opcode	(various)	M	4	(219)
Playroom Software	MVP	I	4	(220)
Prelude	MIDIEdit	I	4	(221)
Sonus	(various)	M//AT	4	(222)
Sound Quest	Sound Quest	AM/I	4	(223)
Steinberg	Synthworks	AT	4	(224)
Valhala	(various)	M	4	(225)
Voyetra	(various)	I	4	(226)

1. TX81Z, TX802, DX/TX.

2. Ensonic ESQ.

3. DX-7, TX802, FB01.

4. Supports many synths.

5. DX/TX

6. TX81Z, DX11

TABLE 3
DSP Editor/Librarians

Company Name	Product Name	Computer	Comments	Rapid Facts #
Digidesign	FX Designer	M	1	(227)
Dr. T's	—	AT	1	(228)
Marshall Electronic	XLC	M	2	(229)
Opcode	(various)	M	3	(230)
Snap Software	MEP4 Companion	I	4	(231)
Snap Software	PCM70 Companion	I	1	(232)
Voyetra	—	I	5	(233)

1. PCM 70

2. Quantec XL

3. PCM 70, REV-5, SPX 90

4. MEP4

5. AK6 ADR 68K

The most common type of software is the *voice editor/librarian*. This software typically groups sets of voices into banks that can be downloaded to a synth via a MIDI interface. Many of the librarians also provide the ability to edit the voice.

Voice editor/librarians have existed for many years and have evolved into rather elaborate pieces of software. Of course, you should expect to see graphic representations of parameters such as envelope, keyboard scaling and modulation. More advanced editors allow modification of these parameters with a mouse by pointing at the portion of the graph to be modified and "dragging" it to a new position. Copying similar substructures of one voice to a new voice is handy and saves time when trying to create new, similar voices. If it is a concern, determine if the parameter modifications are immediately sent to the synth or if the new patch must be transmitted manually. Some editors provide a facility to randomize the voice parameters for those times when "programmer's block" hits. (See Table 1.)

Sample editor/librarians are similar in nature to the voice editors, except they operate on sampled sounds. Creating a good sample is not a trivial task. One of the most important factors is the means by which the sample is looped. Look for software that provides assistance in determining the loop points and will perform "smoothing" functions at the loop points to make the sample seamless. Other features to consider: Are there any DSP functions that can be applied to the sample? Can two or more samples be combined to form a new sample? How many samplers are supported, and can future samplers be integrated?

Some software also provide for sample playback through custom hardware that is connected to the computer. Check to see if the sample editors support SCSI and RS-232/422 interfaces, which are not totally standardized, but are much faster than MIDI. Finally, support of the MIDI Dump Standard is desired. This allows you to give a colleague your latest sample without worrying about software compatibility. (See Table 2.)

Digital signal processing editor/librarians are similar to the voice editors—look for the same features in this type of software, including graphic representation of parameters, parameter modification by dragging the graph to a new location with a mouse, and immediate transmission of the modified parameters to the DSP, which saves time when auditioning sound effects. (See Table 3.)

Edit decision list and machine control software is most often used in audio post-

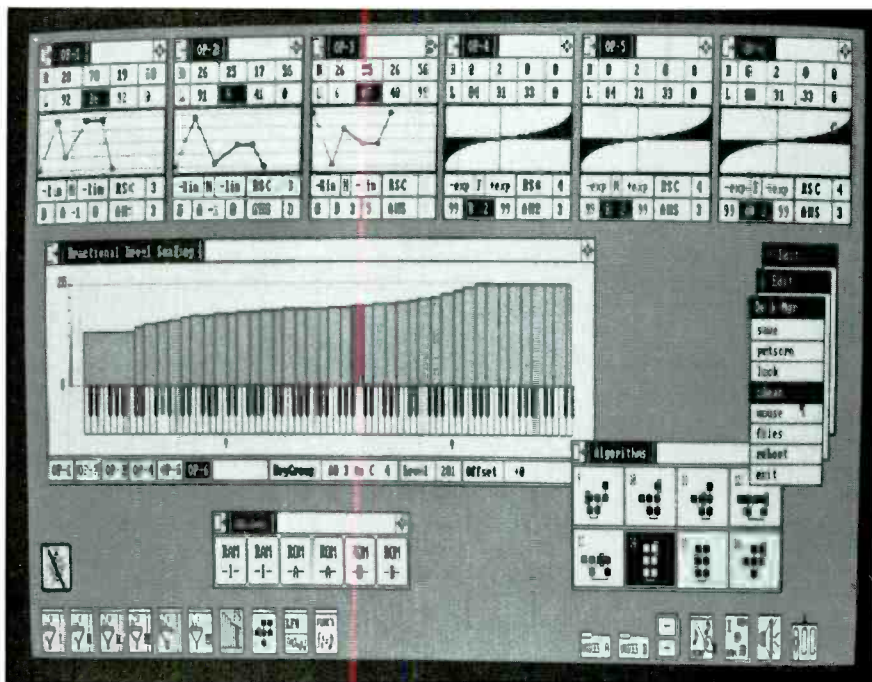

Photo 1. The TX802 Graphic Editing System from B&B.

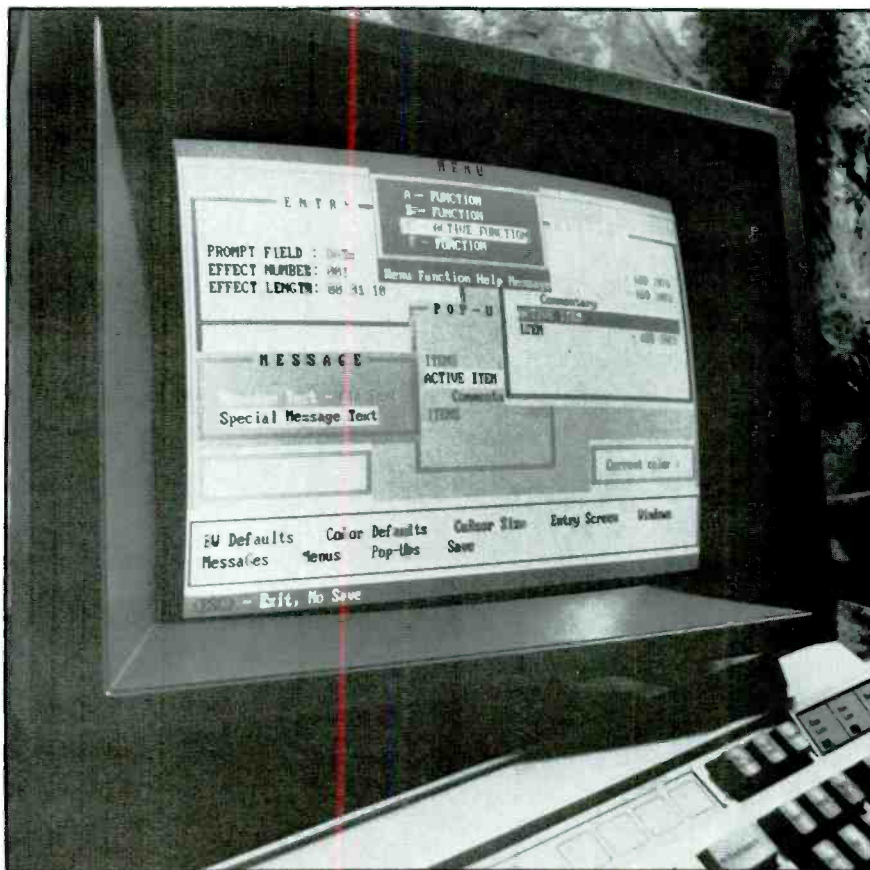

Photo 2. Leonardo Software's Professional Librarian Version 3.0 cataloging program.

TABLE 4
Edit Decision Lists/Machine Control

Company Name	Product Name	Computer	Comments	Rapid Facts #
AMTEL Systems	TRANSform LM	I	—	(234)
BCD Associates	Video Base	I	—	(235)
Cipher Digital	SOFTOUCH-PC	I	—	(236)
Digidesign	Q-Sheet A/V	M	—	(237)
Fostex	FAME	M	1	(238)
Julian Systems	Worx	M	—	(239)
Microillusions	Photon Video	AM	1	(240)
Microillusions	EDL Processor	AM	—	(241)

1. Transport controller.

TABLE 5
Music Library/EFX Database

Company Name	Product Name	Computer	Comments	Rapid Facts #
Gefen Systems	M&E Organizer	I	—	(242)
Leonardo	Professional Librarian	I	—	(243)
Rubber Dubbers	Compufix CD System	I	—	(244)
3AM Software	3AM Librarian	AL	—	(245)

TABLE 6
Film-Composing Tools

Company Name	Product Name	Computer	Comments	Rapid Facts #
Auricle Control Systems	Auricle III	I	—	(246)
Opcode	Cue	M	—	(247)
Passport	Clicktracks	M	—	(248)

TABLE 7
Mixing Automation

Company Name	Product Name	Computer	Comments	Rapid Facts #
Digital Music Services	DMP7 PRO	M	—	(249)
Opcode	Akai MPX820 editor	M	—	(250)
Sellmark	Cuedos/DMP7	AT	1	(251)
Soundcraft	Twister	AT	—	(252)
Steinberg	Desktop Mixing DMP-7	M/AT	—	(253)

1. Requires additional hardware.

TABLE 8
Sequencers

Company Name	Product Name	Computer	Comments	Rapid Facts #
C-Lab	Creator	AT	—	(254)
Dr. T's	KCS	M/AM/AT	—	(255)
Dynaware	Ballade	I	—	(256)
GFmusic	GF Music	I	—	(257)
Hybrid Arts	SMPTE Track	AT	—	(258)
Intelligent Music	RealTime	AT	—	(259)
Jim Miller	Personal Composer	I	—	(260)
Keller Designs	64 Track PC	I	—	(261)
Magnetic Music	Texture	I	—	(262)
Mark of the Unicorn	Performer	M	—	(263)
Microillusions	Music-X	AM	—	(264)
Mid West MIDI Consultants	Win Song	I	—	(265)
MIDISOFT	MIDISOFT	I	—	(266)
Opcode	Vision	M	—	(267)
Passport	Master Tracks Pro	M/I/AT/AM	—	(268)
Resonate	Portrait	M	—	(269)
Roland	Ease Sequencer	I	—	(270)
Sonus	Masterpiece	AT	—	(271)
Sonus	Cake Walk	I	—	(272)
Steinberg	PRO-24 III	AT	—	(273)
Voyetra	Sequencer Plus III	I	—	(274)

production work. Some of the software use the standard CMX format EDLs, and some use their own internal format. Combining MIDI TC with the EDLs allows precision effects generation from samplers. Look for software that maps a symbolic name with a sound effect. It is easier to think in terms of "gunshot" or "door slam" than middle C on sampler Number 2. Some of the software can randomize events such as "street noise." Determine if the EDL can be transported from the host computer to other computers (for example, via RS-232, floppy disk or other communication protocol), and, if so, how it is done. (See Table 4.)

The *music library/EFX database* group of software is a rather specialized group. This software indexes your collection of sound effects and library music. Many of these software packages can control the Sony CD jukebox. (See Table 5.)

Film-composing tools are used to assist film-music composers. They are also used during Foley and special effects recording. The software generally falls into two categories: those to which machine synchronization is very important and those that do not necessarily have to sync to machines in real time, but can be used off-line to generate hit lists, which are then sent into sequencers as MIDI Files. All SMPTE formats and MIDI TC should be supported. The software should then calculate and map out hit marks in the musical score. Determine if the software can handle meter and tempo changes as well as variable accelerandos and retards. Look for software that performs tempo searches that determine a "best fit" tempo for your set of hits. (See Table 6.)

Mixing automation software is also dependent on sync. Even if video is not a factor, the console must be synced to the audio tape. It's important to determine what type of sync you want to use and then ensure that the software you choose can handle the format. Some additional points to consider are: Can you set the rate at which the faders change? Can you copy settings, such as EQ, from one channel to another? Can "snapshots" of mix settings be saved and retrieved from disk? Can the software tell you the difference between two different snapshots? Can user-selected groups of parameters be moved in unison? (See Table 7.)

Another common type of software is the *sequencing package*. This software allows the user to enter notes and MIDI events via the computer or a master controller (synth keyboard). Once the MIDI data is entered into the computer, it can be modified and saved. When comparing sequencing software, several questions must be asked. Does it sync to MIDI TC, or MIDI Clocks and Pointers, which are the dif-

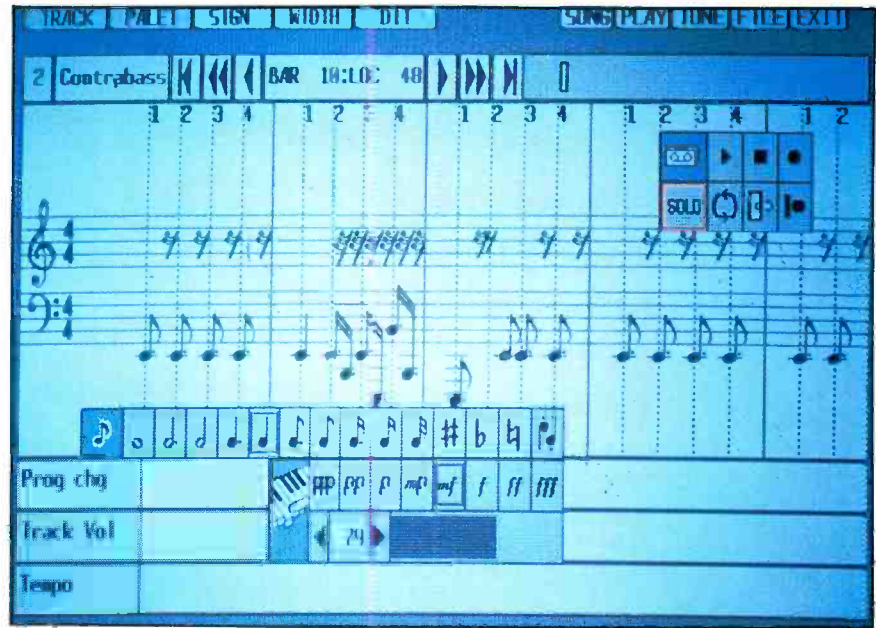

Photo 3. Ballade sequencing software from Dynaware.

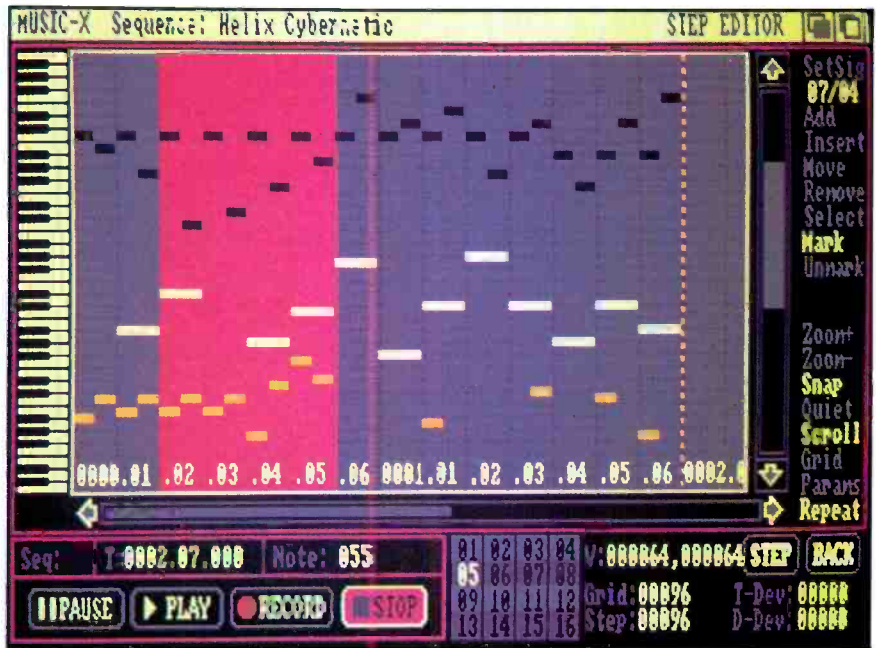

Photo 4. Music X sequencing software from Microillusions.

ferent protocols that the software addresses—or not at all? In slave mode, can the sequencer start anywhere in a song? Can the software display time code directly on the screen? What is the capacity of the sequencer in notes, tracks, measures and time code? Can the sequencer auto-correct to a predefined level of "swing?" Again, the interface can be very important. Do you think of music purely in terms of standard music notation

or do you want to get down to the MIDI Clock level, with the music displayed in tabular form? Do you want to work with "patterns" and "loops" or do you think of music purely in a "sequential" fashion? How easy is it to cut and paste pieces of the song? Does the software provide any form of artificial intelligence so you can specify a set of production rules that the software will use to generate original music? (See Table 8.)

TABLE 9
Scoring/Notation

Company Name	Product Name	Computer	Comments	Rapid Facts #
C-Lab	Notator	AT	—	(275)
Coda Music	Finale	M	—	(276)
Dr. T's	The Copyest	AT/I	—	(277)
Dynaware	DynaDuet	I	—	(278)
Hybrid Arts	EZ-Score	AT	—	(279)
Jim Miller	Personal Composer	I	—	(280)
Opcode	Sonata Font	M	—	(281)
Optronics Technology	Song Wright IV	I	—	(282)
Passport	Notewriter/Encore	M	—	(283)
Repertoire	Music Publisher	M	—	(284)
Resonate	Deluxe Music			
	Construction Set	M	—	(285)
Sonus	Super Score	I/AT	—	(286)
Steinberg	MasterScore	AT	—	(287)
Temporal Acuity Products	Music Printer Plus	I	—	(288)

TABLE 10
Composition Tools

Company Name	Product Name	Computer	Comments	Rapid Facts #
Aesthetic Engineering	Music Mouse	M/AT/AM	—	(289)
Dr. T's	Fingers	AT	—	(290)
Hybrid Arts	Ludwig	AT	1	(291)
Intelligent Music	Jam Factory/"M"	M/AT/AM	2	(292)
Intelligent Music	Up Beat/RealTime	M/AT	3	(293)
Mark of the Unicorn	Composer	M	—	(294)
Primera	Different Drummer	M	4	(295)
Voyetra	M/PC	I	1	(296)

1. Algorithmic composer.
2. Interactive composing/performing.

3. Rhythmic design.
4. Rhythm programmer.

TABLE 11
Hard Disk Systems

Company Name	Product Name	Computer	Comments	Rapid Facts #
Blank Software	Alchemy	M	1	(297)
Digidesign	Sound Designer II	M	1	(298)
Hybrid Arts	ADAP II	AT	1	(299)
IMS	Dyaxis	M	1	(300)

1. Digital recording/editing; requires additional hardware.

TABLE 12
Miscellaneous

Company Name	Product Name	Computer	Comments	Rapid Facts #
Altech Systems	MIDIBasic	M	1	(301)
Altech Systems	MIDIPascal	I	1	(302)
Dr. T's	MIDI Recording Studio	AT	—	(303)
HED Productions	MIDI Utility Package	I	2	(304)
Hybrid Arts	MIDIplexor	AT	—	(305)
Intelligent Music	OvalTune	M	3	(306)
Resonate	MIDI Pack	M	2	(307)
Roland	Desktop Music Studio	I	—	(308)
Savant Audio	Tweak It!	AT	4	(309)
Sonus	MIDI Tech	M/I/AT	2	(310)
Studio Master	Studio Master Plus	M	5	(311)
CNS Electronics	LEAP	I	6	(312)

1. Development tool.
2. SysEx edit/librarian
3. Audio/visual.

4. Desktop accessory.
5. Console log and reset.
6. Loudspeaker enclosure analysis program.



Photo 5. Auricle Control Systems' Auricle III film-composing software.

Some sequencer packages can also translate internal MIDI data into traditional music notation. But, although sequencing and scoring/notation software may seem similar, some of the notation software provide minimal sequencing capabilities.

The complexity (and cost) of *scoring/notation* software ranges from simple piano scores to elaborate notation with full orchestral scores, custom symbols, complex meters and laser-printed output. When shopping for this type of software, you should determine how data is input. Will it read standard MIDI Files? Is there support for custom input devices such as music notation keypads? A very important feature in this type of software is WYSIWYG (what you see is what you get). Does the software display the notation in scroll mode, page-layout mode or both? Can you zoom in and zoom out to inspect special symbols? Some of the notation software provide for a "linking" of separate but identical sections, such that editing one section affects the other.

The more-elegant software allows you to define custom values for such things as beam angle and width and rhythm spacing to name a few. Some software also provide special text control that links syllables with notes as the page is reformatted for use with vocal arrangements. Consider the means of output: Some of the common formats include Pure PostScript, QuickDraw, Encapsulated PostScript (EPS) and bitmap formats. (See Table 9.)

Composition tools are a category that

includes algorithmic composition programs, which provide melodic, harmonic and rhythmic variations on musical input. Also included in this category are rhythm-composing tools and interactive-improvisation tools. Rhythm composers aid drum-machine programming. Interactive-improvisation software uses "rules" and artificial intelligence to create original music. (See Table 10.)

Hard disk systems. These are special types of sample-editing systems. In most cases, they incorporate custom hardware for A/D and D/A conversion and can process many minutes of 2-channel digital audio. Once audio has been recorded into the system, it is manipulated entirely in the digital domain. Options to look for include precise cut and paste edit features, time compression and various DSP functions. (See Table 11.)

The remaining software under the *miscellaneous* heading includes MIDI System Exclusive editors (SysEx), development tools, a console-logging and reset program, and a loudspeaker modeling program.

SysEx editors allow you to get at the low-level MIDI data. Development tools provide a set of language-specific sub-routines, which form building blocks that can be used to develop custom MIDI applications. The console-logging and reset program is used to reset a particular mix, using the console's audio inputs and outputs. LEAP provides speaker enclosure and/or array modeling. (See Table 12.)

To compile the information contained in this survey, *RE/P* drew on a variety of resources. In many cases, a letter requesting product information (including a publication deadline) was sent. The companies listed below either did not respond or offer products that were not applicable to this survey. For more information about these companies' products, circle the appropriate number on the Rapid Facts Card.

DCI Music Video	(151)
Design Direct Sound	(152)
E-mu Systems	(153)
Erato Software	(154)
Eye and I Productions	(155)
General Parametrics	(156)
H.B. Imaging	(157)
Kawai America	(158)
Key Clique	(159)
Korg USA	(160)
Kurzweil Music Systems	(161)
Matao	(162)
MIDI Mouse Music	(163)
Music Solutions	(164)
Optical Media International	(165)
Player Software	(166)
Prosonus	(167)
QRS/MICRO-W Distributing	(168)
Quiet Lion	(169)
Soundmaster International	(170)
Soundware	(171)
Southworth Music Systems	(172)
360 Systems	(150)
Total Informations Systems	(173)
Triton	(174)
Tyler Business Systems	(175)
Yamaha	(176)

Conclusion

The current trend is toward standardization of data file formats such as the MIDI File and MIDI Sample Dump specifications, as well as open-system architecture. The ability to synchronize the activities of a multitude of dissimilar machines has also become important. Good software allows the user to process all of these facets for audio/video production. The best software processes all of these facets and makes the computer/human interface as transparent as possible.

This survey lists software that runs on the following hardware: Amiga, Atari, IBM/compatible, Macintosh and Alpha Micro.

RE/P

George Michael on Tour

By David Scheirman

**Sound system design
from Showco features
the Prism system.**

In 1988, singer George Michael, formerly a member of the English pop group Wham!, staged a world tour that featured the Prism sound system by Showco of Dallas.

Beginning in early 1988, a complex new stage set was designed for the upcoming tour. Production rehearsals were held, and crew selections made. Dates in Australia, Hawaii and Europe preceded the tour's mid-summer arrival in the continental United States, where all sound system pro-

David Scheirman is RE/P's live sound consulting editor and president of Concert Sound Consultants, Julian, CA.

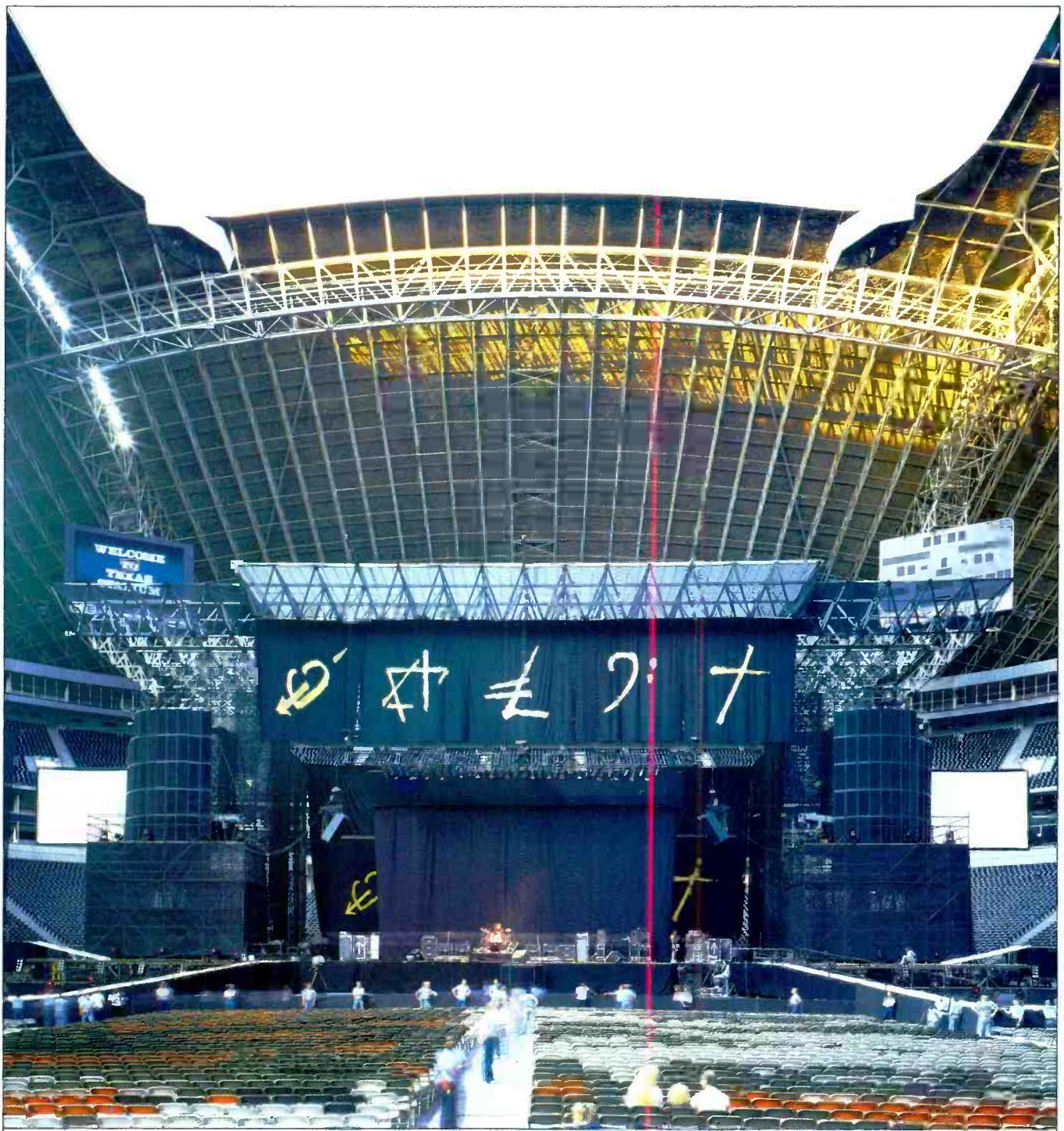

duction arrangements were handled from Showco's office.

The schedule covered a broad range of international and U.S. venues, including such indoor facilities as the Spectrum in Philadelphia, Madison Square Garden in New York and the Forum in Los Angeles. Outdoor venues included such sites as Fulton County Stadium in Atlanta, Texas Stadium in Dallas, the Citrus Bowl in Orlando, FL, and the Irvine Meadows and Shoreline amphitheaters in California.

Benji Lefevre was the house soundmixer for the tour. Lefevre has been working with rock-and-roll bands since 1968.

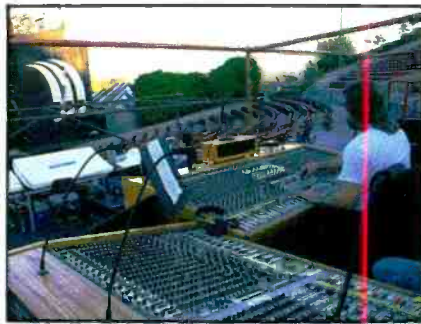

Figure 1. The front-of-house mixing position included a Harrison HM-5 and an SM-5 used as a submixer.

("That was in the pubs, mind you.") He first encountered Showco sound systems in the early 1970s.

"It was on a Led Zeppelin tour in the United States," he recalls. "Rusty Brutsche came out and provided us with a pretty good rig for the time. Since then, I've used every major company's gear somewhere along the line and let me tell you, there can be a big difference between P.A. systems. But Showco and I have an exceptionally good relationship. Since I'm an independent, I can take their gear and do with it what I want, which can be important when I work with a really critical per-



Figure 2. Digital musical equipment from Synclavier was used to re-create particular rhythmic sequences and sounds from the artist's recordings.

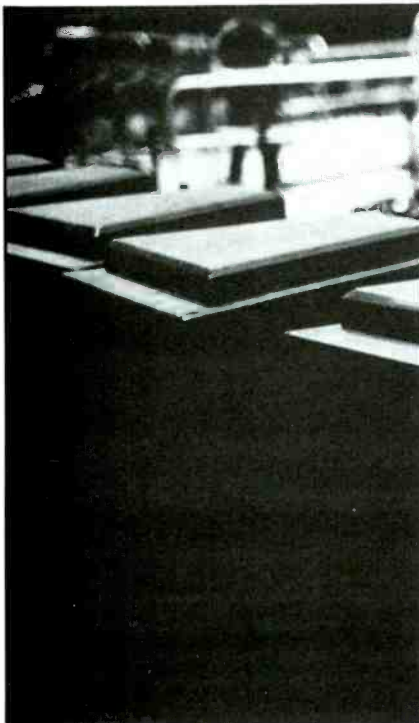

Figure 4. The top of each Prism enclosure has a rigid wooden form, allowing the boxes to be stacked and locked into place.

former. The success of a whole show can depend on whether the soundmixer can use a system in a way that is right for that particular show.'

Mixing the show

Lefevre has refined his mixing skills over the years by working with many of rock's classic male voices. "In the past, I've worked with singers such as Robert Plant, James Taylor, Peter Gabriel, Lou Graham and Paul Rodgers," he says. "George Michael has a very fine voice. Of course, all of the singers that I've worked with have had very fine voices, just ask them," he jokes. "Seriously, it's been quite a thrill



Figure 3. Showco technician Chris Lacoune (right) was responsible for the sound system and assisted Benji Lefevre.

and a challenge to work with George, because he has a young, powerful voice and he is aware of what he wants, and he's very demanding about getting the right sound."

The mixing gear included a 48-input Harrison HM-5 with a 32-input SM-5 as an extender. The pair of consoles, with associated signal-processing racks, carved out a large portion of real estate at the house mixing position. (See Figure 1.)

The HM-5 was produced several years ago by Harrison systems exclusively for Showco and features input group muting and VCA grouping capabilities. The SM-5, developed in conjunction with another

major concert sound company, was first fielded in 1983. It features 32 outputs (including re-assign buses), along with muting and VCA grouping. The SM-5 is normally used as a stage monitor console because of its extensive output capabilities. Both consoles share similar input modules.

The SM-5 is used primarily to receive inputs from a Synclavier digital music system located off stage, near the monitor mixing position. The Synclavier enables sequenced musical passages to be mixed into the sound of the live show. In this way, songs can be made more recognizable to the audience. (See Figure 2.)

"I have 24 inputs available for the Synclavier," explains Lefevre. "Sampled and sequenced material is used on perhaps 60% of the tunes in the show to help duplicate the rhythm tracks and special effects of the more popular album cuts. The technology is here—this is the way that hit records are being made. Concert artists will be bringing high-quality sequencer systems on the road more and more in the future."

Despite having access to this studio-quality technology as he builds a live mix, Lefevre finds live P.A. mixing is more challenging. "I'm fortunate to have had a live-sound background first and then to have gotten involved in studio recording," he says. "It's given me a good overall perspective. In a live situation, you can accomplish things, achieve really impressive effects that can't be done in the studio."

"When mixing live, you have an idea of what you need the show to sound like. You could say that it's in your 'mind's ear,' so to speak. This knowledge or vision is present before you even turn on the sound system for the day. After that, you have only a few hours to bring that vision into reality and before you know it, the crowd is walking in, ready to sit down and listen to what you've created."

A Yamaha DMP-7 was used as a post-mixer for the sequenced kick and snare drum sounds. With the DMP-7, EQ and level changes could be preset, and then called up as needed for each song. "The sound of the kick and snare drum varies a lot from song to song on George Michael's records," explains Showco system technician Chris Iacoue, the person responsible for setting up the sound system and assisting Lefevre at the house mix position. "Using the DMP-7 makes the changes quick, easy and consistent. It prevents a lot of fader-jockeying between songs on the main consoles during the show." (See Figure 3.)

Signal processing

At the house position, the signal processing equipment included Universal Audio 1176LN limiting amplifiers for the kick drum and the bass guitar, and dbx 160 compressor/limiters for all vocal microphone channels. dbx 900 series noise gates and compressor/limiters were also available for channel-insertion on drums, guitar and keyboard inputs.

Special effects devices from AMS included a pair of rmx16 digital reverbs and a dmx15-80S stereo digital delay. A pair of Yamaha SPX90s and a Yamaha REV-5 digital reverb were also available. "Some people call them toys," Lefevre says. "To me they are tools. The trick is to learn how each device works and what you can do with them on a repetitive basis to build

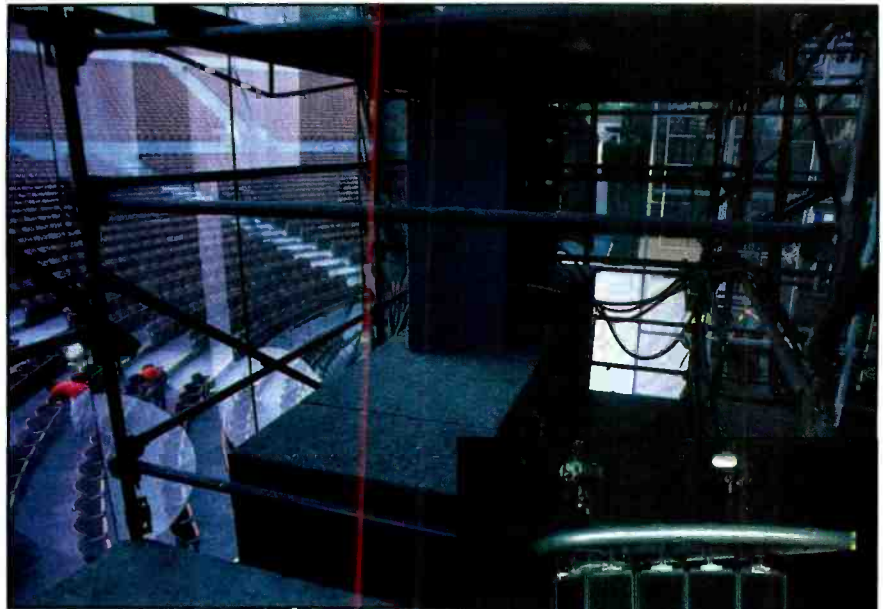

Figure 5. At Irvine Meadows Amphitheater, the Prism system was stacked vertically within the facility's scaffolding system on each side of the stage.

an exciting and accurate show mix. I call that a challenge. I work a lot with George to get an effect just right. The most important thing to me is to be consistent."

Prism loudspeaker system

Designed by Clay Powers and Jim Brawley, this loudspeaker package was introduced on a Genesis tour approximately two years ago. It has seen subsequent use on tours by such artists and groups as Eric Clapton, Peter Gabriel, Little Feat and Aerosmith, and has been featured at several special events. Showco has been secretive about the system and the design ideas behind it.

"You have to realize that it cost more than \$1 million to develop the Prism system," says M.L. Procise, senior sound department director for the company. "That was money that a concert sound company couldn't afford to spend, but we

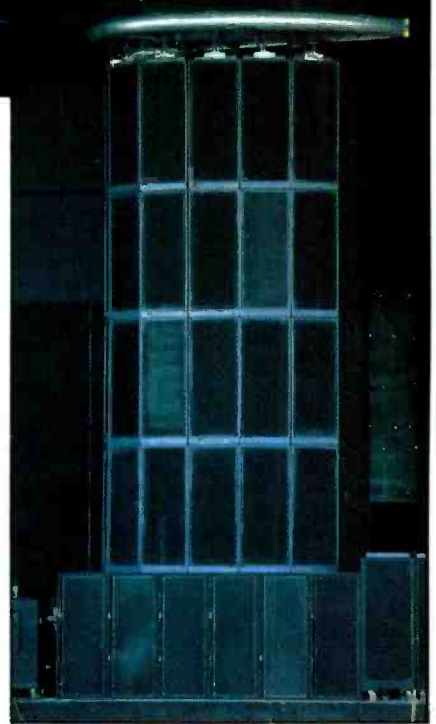

Figure 6. The Prism system is shown here stacked indoors, using the hanging form to align the array.

did it anyway. There were countless hours of research and development, of component examination, testing and prototype construction before there was a working system to show for our efforts. But we made a firm commitment to advance the state of the art in concert sound. We knew it would be expensive, but that it would be well worth the effort, if successful."

In attempting to penetrate the veil of secrecy that has surrounded the Prism system, different people have come up with widely varying, and sometimes amusing, descriptions regarding the use of unusual components and their arrange-

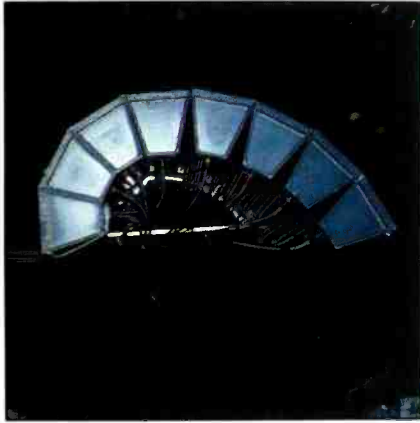

Figure 7. A bottom view of the aluminum hanging frame and Prism enclosures.

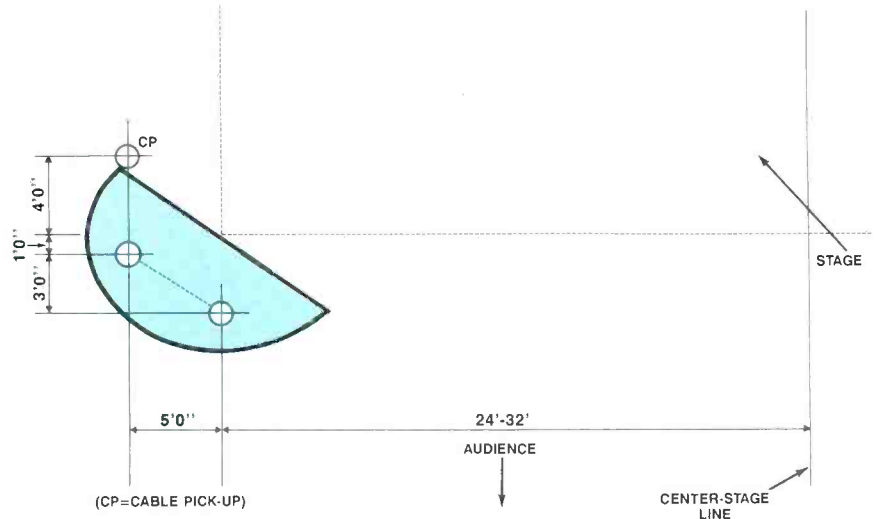

Figure 8. Prism hanging grid alignment. Typically each array is suspended from a pair of hanging points, with a third point used for cable pickup. This overhead view of the aluminum hanging form and the down-stage right corner of an arena performing area shows that the rigging points are not in alignment with the stage.



Figure 9. The Prism arrays shown in an arena setting. Note that the array appears vertical when viewed from nearly any angle.

ment within the cabinets. However, for sound reinforcement use, cone loudspeakers, horns and compression drivers are still the accepted way to convert electrical energy into acoustical energy. It usually takes 18-inch speaker cones to get powerful bass, and high-performance tweeters to get the highs.

Basically, the Prism system comprises multiples of a modular cabinet. Each cabinet is 60"x24"x22.5", with an enclosed volume of 22 cubic feet and an average weight of 208 pounds.

The enclosures are specified as having an average weight because they are not all the same. In fact, there are several dif-

ferent types of modular enclosures. Some are typical arena system setups, while others are long-throw-type enclosures constructed for use in large outdoor situations. Yet, all of the different trapezoidal enclosures are designed to stack together and form a single, cohesive array. The top of each Prism enclosure has a rigid wooden form, allowing the boxes to be stacked and locked into place. (See Figure 4.)

Additionally, a rectangular subwoofer enclosure is a companion piece to the various Prism enclosures. Each subwoofer enclosure measures 44"x56"x23" (including wheels) and weighs 250 pounds. The wheels are attached to a removable,

protective cover plate. This is done to eliminate audible hardware rattles.

"Perhaps the single most important thing to understand about the Prism system is that we designed the array first, then broke it down into modular boxes," says Procise. "This represents a significant change in the way concert systems are designed. Traditionally, the 'ideal' boxes would first be designed, then put together into a big array."

Regardless of internal componentry, each enclosure uses a single heavy-duty multipin connector for large-gauge speaker wiring. The connectors are recessed behind a protective metal back-plate. The

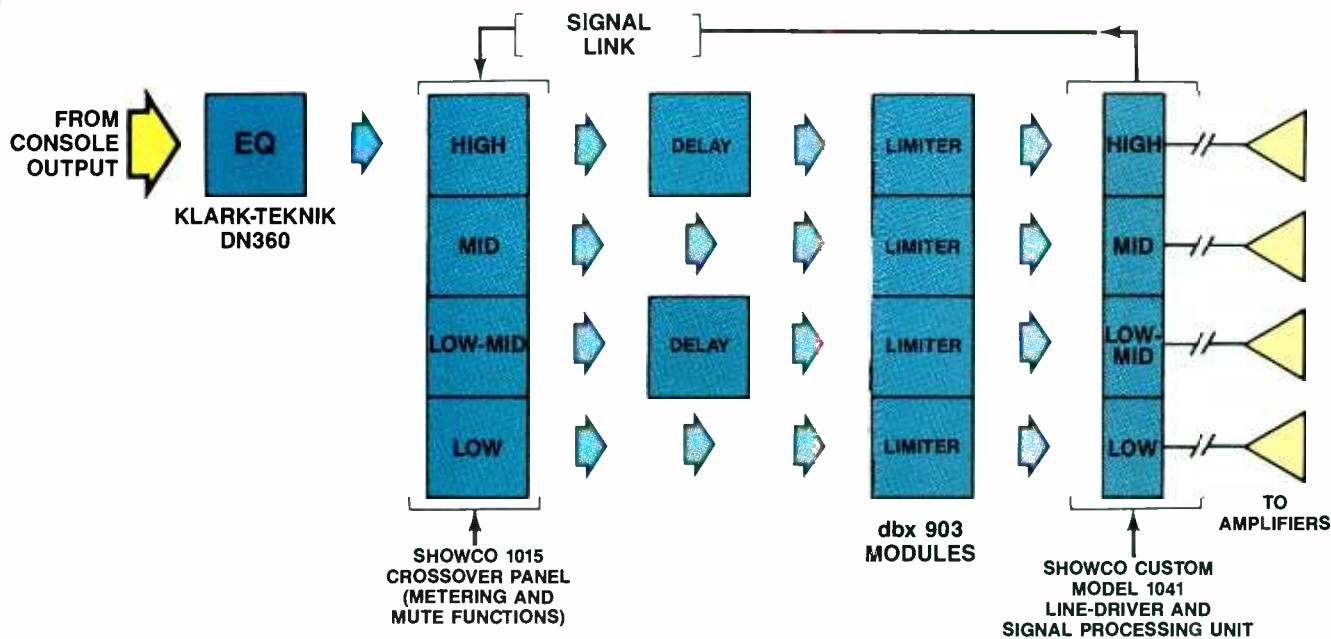

Figure 11. The Prism system drive configuration.

fronts of the enclosures are covered with a layer of acoustically transparent foam and shielded with metal grillwork.

The different boxes are color-coded (orange, yellow, blue and so on) on their back plates, so that attaching cable harnesses becomes a simple task. What might be a confusing jumble of identical boxes thus becomes a coherent system for stage hands to work with. Each color designates a different internal component arrangement, and depending on the needs of a particular venue, arrays vary in the number and placement of each type of enclosure.

On the road, technicians can test each section of each cabinet in an array. Using a "Prism checker" (speaker-line breakout assembly and ohmmeter), one person can test the resistance of every loudspeaker driver in a cabinet quickly and easily.

"We're into calibration," lacoune says. "We like to make sure that every single part of the system is working up to spec, so that when we look at the system as a whole, we know what we are dealing with. We calibrate each amplifier input channel, distribute our loads in a balanced manner and generally treat the system like a high-performance technical assembly."

Irvine Meadows

For the concert that was observed at Irvine Meadows Amphitheater, extra steel girders were added to the top of the amphitheater's regular scaffolding to accommodate the high vertical arrays. "We made it by an inch, after putting in an additional 8 feet of steel," says Thomas McClain, the

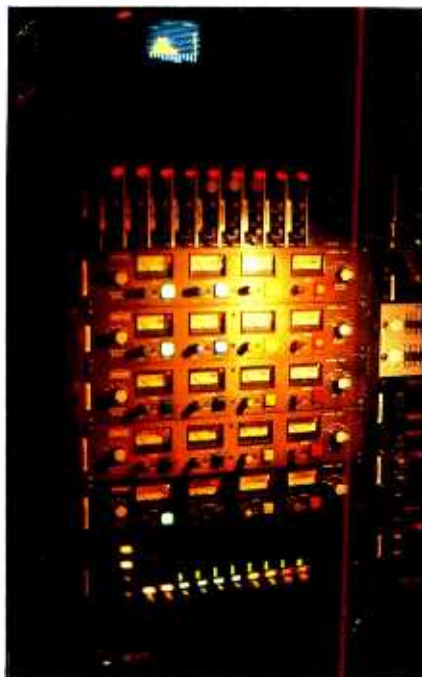

Figure 10. The system drive components include Showco crossovers. Compressor modules (dbx 903s) are used for each bandpass.

person in charge of the union stage crew's sound department at Irvine Meadows. "We've had the system in here on several occasions, but this show was probably the best-sounding I've heard using that system."

Lefevre explains one of his tricks for getting great sound: "If my employer has to spend an extra couple of grand for labor, or scaffolding, or whatever, I push them



Figure 12. Crown PSA-2 and Micro tech 1200 power amplifiers are used to drive the system. Note custom power distribution panel in background.

to do so. I want to do the best job I possibly can. And besides, it's good fun to ram a great idea down the pipeline, from the production manager to the artist to the promoter, and to have them see it my way. That's why they hire me: to be concerned about the sound of their show."

lacoune and the Showco crew used motor-driven chain hoists to stack the Prism enclosures in vertically oriented ar-

rays on either side of the stage. Arrays of 24 enclosures (six boxes wide, four boxes high) were built on the upper level of the scaffolding. (See Figure 5.) An additional four enclosures per side were placed in a tight group one level below and stacked on top of the eight subwoofers that were used for each side. In all, the 15,000-seat facility was presented with a 56-box system augmented by 16 subwoofer boxes.

"We needed to get the P.A. as high as possible at Irvine," Iacoune says. "The

seating area has a steep vertical rise, so most of the people are actually looking down on the stage. We had to get some gear up there on their level!"

In an arena situation, the system is typically flown leaving 26 to 30 feet between the bottom of the array and the floor. But the system is versatile and can be configured for use in just about any type of stacked, flown, or combination situation. (See Figure 6.)

One key to the system's ability to get

smooth, consistent coverage of audience space rests with the array geometry. The placement of the different-colored cabinets and the resultant coverage characteristics represent, possibly, the first uses of this array geometry for a touring sound system.

To execute the array design daily, a large, custom-fabricated frame made from aluminum pipe is provided for suspending the enclosures in vertical columns. These are level-adjustable so that each array can be tailored to the acoustical space it is intended to cover. Looking something like a large ear when viewed from below, the frame correctly positions the array and keeps it rigidly in position. (See Figure 7.)

With a full complement of 32 boxes (eight columns of four boxes each), the array weighs approximately 8,000 pounds, including frame and cables. This array is typically set up with 2-point suspension. A third hanging point is used to spot a cable pickup motor.

The placement of the aluminum frame is crucial to the proper coverage of an audience area. Typically, the two primary points are located 6 feet from each other and the aluminum frame is skewed at an angle from the stage line. The rows of cabinets are then hung from the frame, in increments appropriate to the particular setup. (See Figure 8.)

When the full system is assembled in an arena hanging format, the visual "footprint" of the arrays is relatively small. Because of the trapezoidal shape of the individual cabinets, a large array can be assembled offering direct, on-axis sound to nearly every part of the audience area. In fact, when viewed from the front, an array appears to be only 11 feet wide. For this reason, the system is reportedly quite popular with set and lighting designers, who never seem to get as excited about looking at loudspeaker arrays as sound system technicians do. (See Figure 9.)

Prism system drive configuration

Set up with a 4-way frequency dividing network and an additional low-pass filter for subwoofers, the system relies on a custom-tailored line-driving unit for operation. Showco's standard model 1015 4-way crossover panel is employed for metering and bandpass mute functions; the new 1041 line-driver and signal processing unit is specifically tailored for use with the Prism system. (See Figure 10.)

Currently, the signal path for the L/R main system feeds includes an Industrial Research DG4023 graphic equalizer (a 29-band unit with transversal filters) and dbx 903 compressor/limiter modules for each crossover bandpass. Using a Klark-Teknik DN716 digital delay unit, a slight amount of delay is employed on the low-



MOVING?

TAKE US WITH YOU.

Just peel off your subscription mailing label and attach it to the address change card inside this issue. Please allow 6-8 weeks to process your address change.

mid and high-frequency bands. (See Figure 11.)

Showco relies on power amplifiers from Crown to make the system sit up and "bark like a big dog," according to engineer Clay Powers. "We've been using Crown amplifiers for more than 10 years. There are a lot of amps out there, so you have to take your time and look into what they really do, compared to what the advertising says. We look at the basic construction of the chassis, the design philosophy and how that design has been executed, including choice of parts, grounding protection and the rest. Then we take it into the real world of rock-and-roll and see how well the ideas can meet that test."

Packaged in compact, rugged electronics racks for touring use, the amplifiers are typically formatted with three PSA-2s and a pair of Macrotech 1200s. A portable 400A power distribution system is used to get 3-phase electricity out to each rack; heavy-duty, front-mounted, standardized connectors link the racks to the power source lines. (See Figure 12.)

Total system power ratings can often be misleading. The 50kW or 100kW figures claimed for large arena systems are often nothing more than a tallying up of the per-channel best-case ratings from an amplifier company's sales literature. It is safe to say, however, that the typical Prism system is one of the most powerful integrated systems available for touring use. An arena-sized system has a total electrical output capability greater than 150kVA (kilovolt-amperes).

Iacoune checks the entire system daily. "I start with pink noise from the console," he says. "First I'll make sure that we have the speaker system set up correctly and all checked out at the stage end. Then I'll align the crossover sections by evening things out and getting the gain structures together. I'll have another person help me check out the different parts of the speaker arrays—somebody in front of the stacks with a walkie-talkie. Then we're ready to listen to some music."

At this point, Lefevre generally takes over and adjusts the system to suit his taste for the particular venue. And that job doesn't end with the house system. "The house and monitor systems have to work together, not fight each other. It has to be a complementary effort. If you don't get the stage sound right, you don't have a chance out front. I want to put musicians in an environment where they feel that the back line (band gear), the monitors and the main P.A. all work together."

Stage monitors

For the U.S. tour, Lefevre worked closely with stage monitor mixer Vish Wadi. (See Figure 13.) Wadi takes a total of 63



Figure 13. Benji Lefevre (left) and Vish Wadi compare great concert sound to a fine gourmet meal. "It's all in the seasoning."



Figure 14. Showco's BFM-100 floor monitors were used for most on-stage mixes. Shown here, the saxophonist position.

inputs into the monitor mixing system, combined from stage lines and the Synclavier system. He uses a 32-input Harrison SM-5 with a 16-channel extender and a pair of Yamaha DMP-7s for quick-change level and EQ settings between songs. "This SM-5 is modified so that I have eight VCA groups linked to the VCA master," Wadi says. "The DMP-7s handle all of the electronic percussion inputs from the Synclavier."

Klark-Teknik DN360 1/3-octave graphic equalizers are used for each mix output, with 20 separate channels available. Drawmer DS201 dual noise gates are used

for kick and snare drums and dbx 160s are inserted on each vocal microphone channel. A dbx 900 rack with noise gates and compressor/limiters is available for other inputs. Special effects devices used in the stage monitor system include five Yamaha SPX-90s, a Yamaha REV-7, and a pair of Roland SDE3000 digital delays.

"I'm actually using 17 mixes for this show," explains Wadi. "I have six down-stage mixes for George because he moves around a lot. In addition, there are eight for the band, stereo sidefills, and an additional subwoofer send for the drummer's monitor position. We place an enclosure

directly behind his seat, built into the riser."

Showco floor slants, the BFM-100—housing a 15-inch speaker, a horn with acoustic lens, and a compression tweeter—are used for most applications around the stage. (See Figure 14.) For the Michael shows, these floor slants were placed below metal grillwork panels built into the stage. The down-stage area had a very clean look, but the singer could still find coverage "hot spots" wherever he went.

As the singer moves around, Wadi does not change much at the monitor board. "It's mixed from the center out, you could say," he explains. "It is hottest there, and tapers out to the sides in terms of level. You don't hear as much of the house sound in the middle. If George wants to check up on what Lefevre is up to, he just moves out to the side a bit and he can hear more of the house mix."

Wadi's cue-monitor level is set at the same relative level as the house system; as the house sound changes with crowd noise variations, he can compensate on monitor levels for the featured artist and hear an accurate representation of what

Michael hears on stage, from his monitor position.

Assisting Wadi in his monitor system setup is Leon Hopkins. "Since this tour has a relatively large stage area and the coverage requirements for the sidefills are extensive, we use certain types of Prism

"The house and monitor systems have to work together, not fight each other."

enclosures as hanging sidefills," Hopkins says.

Summary and subjective comments

It was interesting to see and hear the Prism system on tour with George Michael. While I have heard it in different situations with other groups, this show in particular stood out as very good-sounding. Was it the new system, the engineer or the Synclavier and the all-star cast of musicians?

Most likely, it was a combination of them all. The obviously high production expenditures seemed to be justified, for the audience enjoyed the show. A large mechanized cage-like stage set, moving lights, lasers, fog machines, video screens and all the rest do not come cheaply. Seeing this production spend the extra dollars for an advanced sound system, as well, was an indication that somebody was concerned with the sound quality as much as with the bottom line—and that was refreshing.

From an electro-acoustic perspective, it was a finely tuned, no-compromise touring system, set up and cared for by technicians who really seemed pleased with both its packaging and its performance.

REP

HOLDS UP ON THE ROAD



CA COUNTRYMAN ASSOCIATES INC.
417 STANFORD AVE. - REDWOOD CITY, CA. 94063 - PHONE 415-364-9988

Circle (30) on Rapid Facts Card

RECORDABLE DAT's IN STOCK NOW

HOME D.A.T.		PORTABLE D.A.T.	
AIWA XD-999	995	SONY TCD-D10	2250
SONY DTC-M100	1400	Includes all factory accessories	
SONY DTC-300ES	1650	PROFESSIONAL D.A.T.	
SONY DTC-500ES	1750	PANASONIC SV-3500	CALL
SONY DTC-1000ES	1950	PANASONIC SV-250	CALL
JVC XD-2700	1750	FOSTEX D-20	CALL
JVC XD-21100	1850	SHARP SX-D100	CALL
JVC XD-2900	2250	SONY PCM-2500	CALL
AKAI D-9000	1800	SONY PCM-2000	CALL
PIONEER D-900	1800		

BLANK TAPE - ALWAYS IN STOCK
Maxell, TDK, Fujii, Panasonic

COMPLETE INVENTORY OF ACCESSORIES

FULL WRITTEN WARRANTY PLUS FREE LOANERS
IMMEDIATE DELIVERY
NO DEPOSITS REQUIRED
ENGLISH OWNERS MANUALS
A/C ADAPTORS INCLUDED

9 A.M. - 7 P.M. 7 DAYS
AMEX • VISA • MC SHIP VIA UPS/FED-EX
(213) 828-6487 FAX (213) 470-6176

The **DAT**
Digital Audio Tape
STORE

2624 Wilshire Blvd. Santa Monica CA 90403

Circle (31) on Rapid Facts Card

ENGINEER/PRODUCER INDEX

A

Conley Abrams (E): 13939 Oxnard, #4, Van Nuys, CA 91401; 818-782-4898. **Credits:** MCA Records/Funkadelic (MP-AT), Jugular (Sound Image); Warner Bros./Michael Cooper (MP-S), The Best (MJJ/American); Warner Bros./Michael Cooper (E-S), The Wild Side (American); CBS/Tyren Perry (MP-S), What's Up? (American); CBS/Tyren Perry (MP-S), I'm Sure It's Love (American).

William R. Aldrich (E/P): 4288 Veterans Drive, Holt, MI 48842; 517-694-7161. **Credits:** The Turn (MP-A), Maranatha (Windows Dream Productions); MRA (MP-A), Intercessor II (Windows Dream Productions); Venus Starr (MP-A), Aristocrats Smile (Windows Dream Productions); WRA Video (CP-TV), Intercessor (Continental Cablevision); Venus Starr (CP-TV), Dancing Around/Oh Louisa (Continental Cablevision).

George Althaus (E/P): 14 Lullington Road, London SE20 8DF England; 01-659 0434. **Credits:** Stex (MP-A); Sugar Ray (MP-AT), Animated Characters; Zoe (MP-S); Diver Deep (MP-A), Diving Sessions; Unameus (MP-A), Hard Times.

B

Bruce Barrett (E/P): 1945 McDonald, Missoula, MT 59801; 406-542-2563. **Credits:** Billings Metropolitan Transit Authority (CP), Ride the Met (Recording Center); Spectrum (PP-MV), Spectrum Music Video (Barrett A/V Studios); Ariel (MP-S), Dayglo Red (Recording Center).

Carlton Batts (E): 1697 Broadway, New York, NY 10019; 212-582-5473. **Credits:** Loose Ends (MP-S), Life (Frankford/Wayne); Al B. Sure! (MP-S), Killing Me Softly (Frankford/Wayne); Marley Marl (MP-S), Symphony (Frankford/Wayne); M.C. Trump (MP-S), I Want KRS-One (The Bat Cave).

Key

Name (Title Code): Address; Phone Number. **Credits:** Client/Artist (Credit Code-Subcode), Project Title (Facility Used).

Title Codes:

E (Engineer); P (Producer); E/P (Engineer/Producer).

Credit Codes:

CP (Commercial/Advertising Production). Subcodes: R (Radio); TV (Television).

MP (Music Production).

Subcodes: S (Single); A (Album); AT (Album Track); AR (Album Remix); SR (Single Remix).

PP (Post-Production).

Subcodes: F (Film); MV (Music Video); CI (Corporate/Industrial).

Ron Burton (E): 6329 Sussex, Portage, MI 49002; 616-323-9380. **Credits:** Chapel Hill Methodist Church Choir (MP-A), Praise tape (Christian Life Center Studio).

Kevin L. Bentley (P): 2300 N.W. 135th St., #117; Miami, FL 33167; 305-953-1143. **Credits:** Whitman Ford (CP-TV) (KLB Productions); Ohio Citizens Bank (PP-CI), Teller Training Tape (KLB Productions); TV Weekly/Tadson's Jewelry (CP-TV), Tadson's Jewelry (KLB Productions); TV Weekly/Arlington Restaurant (CP-TV), Arlington Restaurant (KLB Productions).

Craig Bevan (E/P): 135 Montgomery St., 18-H, Jersey City, NJ 07302; 201-435-1651. **Credits:** Electra Records/Yazz (MP-AT), Wanted (Livingston, London); Select Records/Crush Nation (MP-S), It's All About Money (Bassment Studios); Bassment Records/Joey Kid (MP-S), Broken Promises (Bassment Studios).

Bob and Lola Blank (P): 1597 Hope St., Stamford, CT 06907; 203-968-2420. **Credits:** Vinylmania/LOLA (MP-S), Just Like High School (Blank Productions); Catawba/CBS/Angel (MP-A), Gospel Angel (Blank Productions/ Hip Pocket); Catawba/CBS/locelyne Jocyca (MP-S), La Vie en Rose (Blank Productions); Network/Carlos Franzetti (MP-A), Industry Library (Blank Productions); Lower Level Records/Under the Covers (MP-S/SR), Half (Blank Productions).

Paul Butterfield (P): 762 Baffle Ave., Winter Park, FL 32789-3377; 407-647-1177; 407-645-1111. **Credits:** Tucker Wayne/Luckie/Southern Bell (CP-TV/R), The Advertisers of the Real Yellow Pages (Rice Productions).

C

R. Alan Campbell (E/P): 60 N. Beretania, #1402, Honolulu, HI 96817; 808-955-8821. **Credits:** Ballet Hawaii (CI), Piano Recording (Hawaii Public Radio); Ed Moody (MP-A), Live Jazz Combo (Cafe 33); Honolulu Symphony (TV), Drum Roll; Riley Kelly Lee (R), Flute Recital (Honolulu Academy of the Arts); Corlino & Co. (CI), Art of Letting Go.

Robert Cap (E/P): 500 N. Sixth Ave., Virginia, MN 55792; 218-749-4056. **Credits:** Pepsi Cola (CP-R), Pepsi Challenge Cross-Country Race; Subaru (CP-R), Subaru Classic Cross-Country Race; FLS Sweedent (CP-R), FLS Races; Tuffy's Dog Food (CP-R), Dog Sled Races.

Stephen Carter (E/P): 3389 C Berchworth, Columbus, OH 43232; 614-837-8539. **Credits:** Little Rock (MP-A), Once in a Blue Moon (Thornapple Sound); John Doe & the Unknowns (MP-A), John Doe & the Unknowns (Thornapple Sound); Bros. Grimm (MP-S) (Thornapple Sound); Radio Snakes (MP-AT) (Thornapple Sound); B-4 Productions (PP-F), Road Meat (Thornapple Sound).

D

James A. Dias (P): 1852 Wythe St., Worthington, OH 43235; 614-395-5375. **Credits:** PBS-Marquette (CP-TV), Ask the Doctors (Cine-Q); Video Concepts, Marquette (CP-TV), Marquette Country (Cine-Q); CEN/PBS-Marquette (CP-TV), The Osborn Incident (Cine-Q); Coany Island Productions (CP-TV), The Continuing Adventures (Cine-Q); Michigan Department of Health (CP-TV), PSA (Cine-Q).

LISTEN

"It would be hard for the producers to imagine maintaining as refined and transparent a sound on the latest Little Feat album, "Let it Roll", without B&K microphones."

George Massenburg
Engineer, Producer
and founder of
GML



BRUEL & KJÆR
PRO AUDIO
THE INTERNATIONAL
STANDARD
IN MICROPHONES

1-800-445-1218, ID-04000#

Circle (32) on Rapid Facts Card

June 1989 *Recording Engineer/Producer* 63

ENGINEER/PRODUCER INDEX

E

Thomas W. Earl (E): 4 Park St. Ext., Greene, NY 13778; 607-656-8336. **Credits:** Bill Mackechnie (MP-AT), Two-Way Street (Random Bullet Studios); Bill Mackechnie (MP-A), Communion (Random Bullet Studios); Charlie Montgomery (MP-AR), Visiting Hours (Random Bullet Studios); Bill Mackechnie (PP-MV) Video Heresy (Random Bullet Studios).

Don Elliot (P): Box 662, Hollywood, CA 90078-0662; 818-762-3554. **Credits:** RCA (National Video Products) (CP-R/TV), RCA Video Products; New York Seltzer (CP-TV), The Original; Pan Am Air (CP-R), Pan Am Airlines; Wienerschnitzel (CP-R/TV), Wienerschnitzel Hot Dogs; Utah Honda Dealers (CP-TV), Honda Motor Cars.

F

Karl Falkenham (E/P): 6021 Willow St., Halifax, Nova Scotia B3K 1L8 Canada; 902-420-4470. **Credits:** Coconut Records/The Trees (MP-A), The Trees (Studio H); Revenant Records/Lenny Gallant (MP-A) Breakwater (Studio H); Canadian Broadcasting Corp./various artists (MP-A), various artists/Coast to Coast (Studio H).

Lynn Fuston (E): 2125 Bernard Ave., Nashville, TN 37212; 615-292-2283. **Credits:** Reunion Records/Prism (MP-A), Green—The Christmas Album (Hummingbird Studio); Reunion Records/Prism (MP-A), Red (Hummingbird Studio); Reunion Records/Billy Sprague (MP-A), Greatest Hits (Bennett House); The Sharks (MP-A) (Quad/Bennett House); Pepsi (CP-R), Today's Texas Taste (Omni Sound).

G

W. Doug Gent (E/P): 125 Miller Ave., Oak Hill, WV 25901; 304-465-5786. **Credits:** The Sears Family (MP-S), Let Me Praise Him (Media Productions); The Sears Family (MP-A), Solid Gospel (Media Productions); Bitter Creek (MP-S), Mountain Man (Media Productions); Bitter Creek (MP-A), Sweet Memories (Media Productions); Clear Creek Crossin' (MP-A), This Ol' Guitar (Media Productions).

Victor Giordano (E/P): 657 Bridgeman Terrace, Baltimore, MD 21204; 301-821-5084. **Credits:** Sweet Honey in the Rock (MP-AR), Live at Carnegie Hall (Sheffield A/V); Quality Inn/Comfort Inn (CP-TV), Man in Suitcase (Sheffield A/V); Trump Casino (CP-R/TV), Tyson/Spinks-Trump Castle (Sheffield A/V); Baltimore Orioles (CP-R/TV), '89 Promos (Alonso); NASA (CP-R), Space Stories (Rodel Audio).

Paul Goeltz (E/P): 1190 Santa Clara St., Santa Clara, CA 95050; 408-244-6662. **Credits:** KSW FM103, Live Band Production (Studio B); Daddy in His Deep Shop (MP-A) (P&G Sound); Fairmount Hotel/Ancha (PP-Cl), Show Production (Fairmont Hotel).

H

Bryan Haggerty (E): 2319 E. Stewart, #3, Las Vegas, NV 89101; 702-382-5680. **Credits:** Stephen Can-

nell/Jerry Lewis (CP-TV), Wise Guy (Soundworks); GLOW Inc. (CP-TV), GLOW Show (Soundworks); Beef Council/Reba McIntyre (CP-TV), Beef Council TV Spot (Soundworks); Arista/Four Tops (MP-AT), Indestructible (Soundworks); Royal Viking Line/Bob Siegler (MP), Cruise Line Production Show (Soundworks/Personal).

Kevin Halpin (E): 26 Oliver St., Brooklyn, NY 11209; 718-745-1046. **Credits:** Michael Franks (MP-A), The Camera Never Lies (Flying Monkey, Clinton Recording); Mike Stern (MP-A), Time in Place (Skyline Recording); Aztec Camera (MP-A), Love (Flying Monkey, Clinton Recording); Michael Franks (MP-A), Skindive (Automated Sound); JSM Music/HEA Productions/Crushing Entertainment (CP-R/TV), hundreds of commercials (various studios).

Paul J. Harris (P): Box 4222, c/o Reel Harmony Productions, Hollywood, FL 33083-4222; 305-756-7902; 305-966-3227. **Credits:** K-Tel/Fool House (MP-A), Running on Soft Ground (Criteria/MSM Dieteron); Word/Dion Dimucci (MP-A), Three Albums (Criteria); The Doors, Soft Parade.

Brent Harshbarger (E/P): Box 1702, Springfield, OH 45501; 513-323-2670. **Credits:** Miami Valley Christian TV (MP-TV), Look-Up (26 Productions); Miami Valley Christian TV (CP-TV), TV-26, TV-54 Station Promos (26 Productions); Springfield Local Schools (PP-MV), Chapter One Reading Group (Logo's Production Studio); Crisis Pregnancy Center (PP-Cl), Little Angels (Mount Zion Recording Studio); Robert Edwards (MP-A), All Things (Mount Zion Productions/Logo's Productions).

Stephen A. Hart (E/P): 1690 Creekview Circle, Petaluma, CA 94952; 707-762-2521. **Credits:** Windham Hill/A&M (MP-A), Winter Solstice II (Different Fur); EMI Italy/Vasco Rossi (MP-A), Liberi Liberi (Studio Logic/Heaven Studios); Windham Hill/A&M/Michael Manning (MP-A), Life in the Trees (Different Fur); Concord Jazz/Marcos Silva (MP-A), Marcos Silva (Fantasy Studios/Different Fur); Nova/Select/Uzeb (MP-A), Noisy Nights (Victor/Le Studio).

J

Leslie Ann Jones (E): Capitol Records, 1750 N. Vine, Hollywood, CA 90028; 213-462-6252. **Credits:** Capitol/Dave Edmunds (MP-A) (Capitol); Rackyo/John Warren (MP-A) (Capitol, Lionshare); David Benoit (MP-AT) (Capitol); Redwood/Holly Near (MP-AR), Sky Dances (Capitol).

K

Richard Kaye (E/P): 417 Teaneck Road, Apt. 2A, Ridgefield Park, NJ 07660; 201-440-8618. **Credits:** Steve Evans (MP-A), Mr. Spats—Dream Patrol (39th St. Music Productions); Hush Productions (MP-S), Eric 'Gable' Dixon (39th St. Music Productions (MP-S), Eric Music (CP-R), Signature Inns (39th St. Music Productions); ESPN (CP-TV), Scholastic Sports Gameday (39th St. Productions); Peggy Stern (PP-Cl), The Continuing Forest (39th St. Music Productions).

Arklay King (E): 25 Huntington Ave., Boston, MA 02146; 617-262-9289. **Credits:** National Geographic

Society (PP-Cl), Centennial Gala (Silver Linings); Arts & Entertainment Cable (CP-TV), Chronicle TV show (Silver Linings); National Park Service (PP-Cl), Lowell Mill Girls (Silver Linings).

L

James Lash (E/P): 143 Lloyd Ave., Springfield, MA 01119; 413-596-0264. **Credits:** WGBY/Rich Panter (PP-F), Fathers and Sons (Quacktracks Recording); Massachusetts Mutual Life Insurance Co. (PP-Cl), MMLISI Roundup (Mass. Mutual/Creative Services).

Greg Leach (E/P): 2102 Bayou Drive, Lake Jackson, TX 77566; 409-798-5462. **Credits:** Rokitt (MP-AT) (Lost Person Productions); Debbie Robertson (MP-S), Ms. Epie (Lost Person Productions); Joey (MP-S), Magic Fingers (Lost Person Productions).

M

Phil Magnotti (E/P): 119 W. Hill, Stamford, CT 06902; 203-358-0065. **Credits:** Ernie Watts with Gamolon (MP-A), Project Earth (Carriage House Studios); Gamolon (MP-A), Aerial View (Carriage House Studios); Gerry Mulligan (MP-A), Gerry Mulligan Quartet (Carriage House Studios); Tour De Force (MP-A) (Carriage House Studios); Arts & Entertainment Cable (CP-TV), Corporate Logo (Carriage House Studios).

John Mahoney (E/P): Atlantic Studios, Synclavier Suite, 1841 Broadway, New York, NY 10023; 212-484-6093. **Credits:** Ezo (MP), II (Atlantic Synclavier Suite); Hemdale Films (F), A Boy's Life (Atlantic Synclavier Suite); Stanley Jordan (MP-A), Flying Home (Atlantic Synclavier Suite); DDB Needham Worldwide (CP-TV), Michelob Dry (Atlantic Synclavier Suite); Mick Jones (MP-A), Law (Atlantic Synclavier Suite).

George Manton (E/P): 2228 Goddard Road, Toledo, OH 43606; 419-536-0454. **Credits:** Jeff Lynch Band (MP-S), The Jeff Lynch Band (Farmhouse Recording Studios); Lovestreet (MP-S), Take It or Leave It (Action City Records).

Joe Martin (E/P): 3655 Old Shell Road, #321, Mobile, AL 36608; 205-343-2023. **Credits:** Miss Universe Inc./CBS-TV (CP-TV), Miss Universe telecast (Location—Taiwan); Miss Universe/CBS-TV (CP-TV), Miss Teen USA telecast (Location—San Bernardino, CA); Miss Universe/CBS-TV (CP-TV), Miss USA Telecast (Location—Mobile, AL).

Jon Mathias (E/P): 11 Winona Trail, Lake Hopatcong, NJ 07849; 201-663-0990. **Credits:** Dickey Betts Band/Epic (MP-A), Pattern Disruptive (Pegasus Studios); Mark Place/CBS (MP-A), Third One From the Sun (Sountec, Sound Ideas); Zeno/Manhattan (MP-A), Zeno (Puk, Abbey Road); Elliot Easton/Elektra (MP-A), Change...No Change (Syncrosound, Electric Lady); Eurogliders/CBS (MP-AR), This Island (Record Plant).

Rennie Mau (P): 138 N. Main St., Suite 26, Sebastopol, CA 95472; 707-823-7072. **Credits:** Living Skills Press (CP-TV), Help Me be Good (Banquet/Live Oak); Family Media (CP), John (Banquet).

Donald McKinzie (E/P): 1430 Kimsey Drive, Atlan-

The Industry Standard For Excellence



Saki Ferrite Audio Replacement Heads

Hot-pressed, glass-bonded ferrite for superior sound and long life. Fully compatible with original manufacturer. 1/4" and 1/2", 2 and 4 track applications. For Ampex, MCI, Mincom, Otari, Revox, Scully, Studer, Technics, and others. Call now to order.



SAKI MAGNETICS, INC.

26600 Agoura Road, Calabasas, CA 91302

Phone (818) 880-4054 Telex 244 546 FAX (818) 880-6242

Circle (33) on Rapid Facts Card

ta, GA 30337; 404-991-2855. **Credits:** Coast-to-Coast Top Twenty (CP-R) (American Media Studios); McMix Productions (MP-A), Mike Ewbanks (McMix, ACMA); Atlantic Records (MP-AT), Anne G, On a Mission (2560 Studios).

Edward R. Minnich (E/P): 127 Huron St., Elyria, OH 44035; 216-322-3984. **Credits:** JEM Productions (CP-R), The Newest in Town (Track 1 Recording Studio); Neon Lytes (MP-S), Dazzler/Forced Love (Magic Moonlight Recording Studio); Baby Doll Band (PP-MV), Transatlantic Set Airliner (On Trak Productions/Magic Moonlight Recording Studio).

N

Richard J. Nagle (E/P): 3532 Washington Blvd., Indianapolis, IN 46205; 317-926-2025. **Credits:** A&S (CP-TV/R), One Day Sale :30 (Kamen Audio Productions); Maison Blanche (CP-TV/R), Nick of Time :30 (Kamen Audio Productions); Burdines (CP-TV/R), TGIF :30 (Kamen Audio Productions); Scali McCabe Sloves (CP-R), Life's Luxuries :60 Volvo (Kamen Audio Productions); British West Indies Air (CP-R), BWIA International :60 (Kamen Audio Productions).

James Roger Nelson (E/P): 2155 Bennett Creek Road, Cottage Grove, OR 97424; 503-942-5877. **Credits:** Jimmy Blue & DATA (PP-F), Welcome to the Future (Data Studios, Desitrek Recording); Jimmy Blue & DATA (PP-F), Calling Rock 'n' Roll (Data Studios, Gung Ho Recording).

P

Ross Pallone (E): 1762 Bates Court, Thousand Oaks, CA 91362; 805-496-0147. **Credits:** James Newton Howard (PP-F), Tap (Circle Seven); Olivia Newton-John (MP-SR/AR/AT), The Rumor (Hollywood Sound, Circle Seven, Sunset Sound); John Tesh (MP-AT/AR/SR), Tour de France (Tesh Studio); David Paich (PP-CI), Nissan World's Fair (The Manor); Patti Austin (MP-AR), The Real Me (Pack's Place).

Tom Phillips (E/P): Box 138, Westborough, MA 01581; 508-366-9585. **Credits:** Nova/WGBH (PP-F), The Light Stuff; WGBH (PP-F), Long Ago and Far Away theme; Aydelott Associates (CP-TV), NRA :60 spots; Adventure/PBS (PP-F), Into the Great Solitude; WBZ (CP-TV), Time to Care :30 spots.

R

Craig Raguse (E/P) and **JoAnn Raguse** (P): Box 470507, Tulsa, OK 74147; 918-250-9749. **Credits:** Tall Tales (MP-A), Your Analysis (Evolution); Picture This (MP-A), Demo (Evolution); Square Force (MP-A), Untitled (Evolution); Dresden Bombers (MP-AT), Bomb Us Back Into the Stone Age (Evolution); Tall Tales (MP-A), Tall Tales (Evolution).

Rick Reineke (E): 26 Hillside Ave., Suffern, NY 10901; 914-357-4176. **Credits:** Quatta Battou (MP-A), The Argument; War Zone (MP-A), War Zone I; Creative Connections (PP-CI), United Christian Ministries; Media Arts (PP-CI), Reed-Lain; Lynn Skinner (MP-A), Profile.

Al Reiners (E): 1431 NW 71st Ave., Plantation, FL

Recording Engineer/Producer presents a
GREAT DEAL!

in classified advertising...

Our New Lower Rates

-- \$35 an inch --

are the most cost-effective way
to communicate your message.

An ad in RE/P's PRO AUDIO CLASSIFIED section
reaches the pro audio industry's highest
concentration of product buyers:
Professional audio engineers and producers.

And, our new format
makes your classified ad
easier to find for a greater response.

Recording
ENGINEER/PRODUCER

Call RE/P's Classified Advertising Manager, Renée Hambleton, at 913-888-4664 to reserve your classified space here.

Deadline for space reservations and materials is the first day of the month prior to issue publication date.

ENGINEER/PRODUCER INDEX

33313; 305-587-8258. **Credits:** IATSE Local 545, Miami (CP-CI) Caribiner Inc. Industrial Shows (Audio Facilities Inc., location).

Steven Remote (E/P): Box 6750, Fresh Meadow, NY 11365; 718-886-6500. **Credits:** WPIX-TV/Automat (TV), WPIX 40th Anniversary Special (ALS Mobile Audio/Video); Holographic Film/Public Enemy (MP-MV), Live from Nassau Coliseum (ACL Mobile Audio); Holographic Film/Jazzy Jeff and the Fresh Prince (MP-MV), Live from Nassau Coliseum (ASL Mobile Audio); WMJY-FM/Southside Johnny and the Asbury Jukes (MP-R), New Year's Eve Show (ASL Mobile Audio); HASC/various artists (MP-AT), A Time for Music—Live.

Rich Renik Jr. (E/P): 8446 S. Kenneth, Chicago, IL 60652; 312-598-9200. **Credits:** Bittersweet (MP-A) (Bayou Recording Studios); Cyndi (MP-AT), Freddy the Fickle Pickle (Bayou Recording Studios); Marjibo (MP-S), Oogie Boogie (Bayou Recording Studios); Scott Mantia (MP-S), Look at My -76 (Bayou Recording Studios).

Steven L. Rich (E): 226 Mohawk Drive, River Edge, NJ 07661; 201-342-5672. **Credits:** Laventhal & Horwath (PP/CI), The Hotel of the Future (R.J. Martin); Panasonic (PP-CI), Cellular Phone Instructional Video (R.J. Martin); Grand Union (CP-TV), commercial spots (R.J. Martin).

S

Hal Sacks (E/P): 16000 Septo St., Sepulveda, CA 91343; 818-894-5988. **Credits:** Word/A&M Records/Daniel Winans (MP-AT), Brotherly Love (Oceanway, Peace in the Valley); MCA/Larry Carlton (MP-AT/AR), On Solid Ground (Room 335/Monday to Sunday Recording/O'Henry's); Tappan Zee/CBS Records/Kirk Whalum (MP-AT/AR), The Promise (Oceanway/Peace in the Valley); Narada/MCA/Richard Souther (MP-A), Crosscurrents (Peace in the Valley/Royal Recorders); Carson Productions/NBC (PP-TV), Amen Show music cues (Oceanway/Sunset Sound).

Sooch San Souci (E/P): 146 Avenue Emile Zola, Paris, France 75015; 45-75-47-99. **Credits:** Hoche Films, CNAV Paris (CP-R/TV), French Social Security International; SYGNUM Communications (CP-TV), Institut National Polytechnique; Jacques Bogart (Perfume) Paris (CP-TV), Furyo; SON Productions (MP-S), various artists; FIEURY Communication (CP-R), various radio spots.

Vince Sanchez (E/P): Box 1634, Aptos, CA 95003; 408-373-3545. **Credits:** Scientific Cowboy (MP-S), Scientific Cowboy (Red Barn/VSO/Studiomasters); Jim Lee (MP-AR), Jimmy Joe Lee (Mars); Leon Patillo (MP-A), Brand New (LP/Conway/Encore/EMI/Sidney); Bo Capebiano (MP-A), Runaway (Fig Tree/LP).

Mark Seagraves (E/P): 623 W. Guadalupe Road, #137, Mesa, AZ 85210; 602-892-1024. **Credits:** GTE Communications Group (PP-CI), 2001 Imagine; Semper Rock Productions (MP-A), Jenifer Westmoreland project; Carmichael Productions (MP-A), J. Michael Chandler; Chris Spheeris (MP-A), Chris Spheeris; New West Productions (PP-F), Highway Man series.

John Seetoo (P): 853 Broadway, Suite 610, New York,

NY 10003; 212-219-3792. **Credits:** John Seetoo/Face of Another (MP-A), Face of Another (MMP Studios); Terry Watada (MP-A), The Art of Protest (MMP Studios); See-God Productions (PP-F), The Source of Power (Active Studios); Laser (MP-A); Bienvenue (Cereus Recording).

Dave Sell (E/P): 2175 Michael, Warren, MI 48091; 313-754-8200. **Credits:** Code Blue (MP-A), Code Blue (Hatchery Studios); Sony Corp. of America (PP-CI) 1989 New Product Layout (Hatchery Studios); Patten Advertising (CP-R), Chevy Dealer Ads (Hatchery Studios); W.B. Doner & Co. (CP-R), Shasta Softdrinks (Hatchery Studios).

Dan Shattuck (E/P): 145 W. Ave. Palizada, San Clemente, CA 92672; 714-361-1296. **Credits:** Scott Weimer Productions (PP-F), Tainted Love (Harrison Winter Studios); Harrison Winter (MP-A), Runnin' With the Wind (Harrison Winter Studios).

Gordon Shryock (E/P): 1007 E. 37th Place, Tulsa, OK 74105; 918-742-1302, 918-631-2577. **Credits:** Flying Fish Records/Larry Long (MP/A), Tribute to Oklahoma and Woody Guthrie (Remote unit, KWGS, Tulsa); Self Explosive Records/Steve Pryor & the Mighty Kingsnakes (MP-A), Steve Pryor & the Mighty Kingsnakes (Eiffel Tower, Tulsa); RCA/Vince Gill (MP-A/S), Victim of Life's Circumstance (United-Western, Hollywood); Light Records/Andrae Crouch (MP-A), I'll Be Thinking of You (United-Western/Sound Labs/Paramount); ACE Records/Ronnie Barron (MP-A), Bon Ton Roulette (United-Western).

Maurice Smeets (E/P): 1108 Elizabeth, West Chicago, IL 60185; 312-231-5018. **Credits:** Plank Road Folk Music Society (MP), Down the Old Plank Road (Studio A Recording); Last Band on Earth (MP), I'm Coming Home (Studio A Recording).

T

William S. Taylor (E/P): 110 Bedford St., Lexington, MA 02173; 617-861-1688. **Credits:** Bruce Hornsby & the Range (MP-S), Red Plains (Live Version) (Westwood One Mobile); Tank I Flip (MP-A), Lay Down (Inner City Sound/Normandy Sound); Sonny Thompson (MP-A), Inner City Sound/Normandy Sound; Airpote (MP-A), On the Edge (Blue Jay Recording); Steven Paul Perry (MP-A), (Normandy Sound).

Gene Tognacci (P): 12507 Nova Drive, Houston, TX 77077; 713-496-2358. **Credits:** Budweiser Battle of Bands/various (CP-R), Battle of Bands (Starstream Communications); FNN Business Radio (CP-R), Sounders/Audio Staging Red (Starstream Communication); Starstream Communications (CP-R), various sales demos; Budweiser/MAC Band (CP-R), Showdown.

Greg Trampe (E/P): 2322 Marconi, St. Louis, MO 63110; 314-773-1480. **Credits:** Monty Dale Luke (MP-S), Takin My Heart (Music Masters); Acousticity (MP-A), 11:59 (Music Masters); Linoi (MP-S), Cry in the Night (Music Masters).

V

Daniel Vaganek (E/P): 74 West St., Colonia, NJ 07067; 201-381-1861. **Credits:** 86 (MP-A), Provocation

(Axis Sound Studios); Guadalcanal Diary (MP-A), 2x4 (Axis Sound Studios); Arms Akimbo (MP-A), This is not the Late Show (Axis Sound Studios); Dash Rip Rock (MP-A), Mud (Musiplex); 86 (MP-A); Live Finale (Soundscape Studios).

John Vanore (P): 708 Ashland Ave., Eddystone, PA 19013; 215-328-9450. **Credits:** David Kuhn (MP-A), Fatherlike Sons (Alliance Records); One Alternative (MP-A), Take Note (Widener University).

W

Cal Walker (E/P): 1301 Briar Creek Road, Charlotte, NC 28205; 204-376-2949. **Credits** (all radio syndication): As It Was (2/Bop A/V); Sunday Night Jazz (2/Bop A/V).

Trent Walker (E/P): 167 S. Third East, Rexburg, ID 83440; 208-356-8705. **Credits:** Taryn Ivie (MP-A), Autumn (RHP Recording Studio); Lyle Bowen (MP-A), It Was for Me (RHP Recording Studio); Innovative Design (MP-A), 24-Hour Weight Loss (RHP Recording Studio); Carco Products (PP-CI), Introduction to Carco (RHP Recording Studio); Justin Tyme (MP-A), Open the Door (RHP Recording Studio).

Sam Wheelock (P): Box 88212, Dunwoody, GA 30338; 404-565-6695. **Credits:** Atlanta Journal & Constitution (PP-CI), Shades of Atlanta (Atlanta Journal & Constitution); Longview News Journal (CP-R), Good News (New Age Sight & Sound); Mesa Tribune (PP-CI), East Valley Access (Atlanta Journal & Constitution); Georgia Department of Education (PP-CI), Home & School (Sam Wheelock Productions); Waco Tribune-Herald (CP-R), Everyday (New Age Sight & Sound).

Craig C. White (E/P): 1901 Crested Butte, Edmond, OK 73034; 405-282-2729. **Credits:** Legacy (MP-AT), In My Tears (White Rose Studio); Woody Lingle (CP-R), Celco Safety Lights (White Rose Studio).

Sheniquia Whittle (P): 59 Old Mamaroneck Road, Box A, White Plains, NY 10601; 914-761-5718. **Credits:** Antiqua Records/Dennis (MP-A), Just Dennis (Antiqua Sound); Antiqua Productions/Timmy Hunter (MP-A), Slammin' (Antiqua Sound); D'Groove (MP-S), Feelin' D'Groove (Suite 28, Antiqua Sound); Calm Lab Music/Dynasty (CP-S), The Big Time (Calm Lab Music Studios); Antiqua Productions/Xzavier (CP-A), X Marks the Groove (Antiqua Sound).

Z

Zack Zaccaria (E/P): 16246 S.E. Salmon, Portland, OR 97233; 503-255-7122. **Credits:** Wayne Jackson (MP-AT) (Spectrum); Dan Reed Network (PP-MV), Ritual (Live at Starry Nite); various artists (MP-A) (Ace Tunnel Sound).

Greg Zaremba (E): 639 Main St., Metuchen, NJ 08840; 201-548-5316. **Credits:** Tico Torres/Uncle Funk & the Allstars (PP-MV), Uncle Funk & the Allstars (BMZ Mobile Recording).

RE/P

The Engineer/Producer Index is a monthly department. To be listed, fill out the reply card located in the back of this issue. Please note that the index is for individual engineers and producers; facilities should fill out the Tracks reply card.

TRACKS

A

American Media Services: 995 McMillan St., Atlanta, GA 30318; 404-873-3100; Kermit Bowen, manager. **Credits:** American Media (CP-R), Coast-to-Coast Top Twenty (RE/ME: Donald McKinzie; AE: Andy Williams/Charles Primerano); American Media (CP-R), Martin Luther King Scrapbook (RE/ME: Don McKinzie); American Media (CP-R), Jukebox Top 40 (RE/ME: Don McKinzie).

Appletree Productions: 248 S. Cole Road, Boise, ID 83709; 208-322-6155; Danny Jensen, vice president marketing. **Credits:** J.R. Simplot Co. (PP-Cl), Skin-credibles (RE: David Priest; AE: Gary Pickens); Hewlett-Packard (PP-Cl), Formatter Development (RE: David Priest; AE: Gary Pickens); Whiteman Manufacturing (PP-Cl), Power Trowel (RE: David Priest; ME: Danny Jensen; AE: Gary Pickens); Hewlett-Packard (PP-Cl), Laserjet IID (RE: Eric Malone; ME: David Priest; AE: Gary Pickens); Onati Restaurant (CP-TV), 30-second commercials (RE: Danny Jensen; ME: David Priest).

Key

Facility Name: Address; phone; contact name/title. **Credits:** Client (Credit Code-Subcode), Project Title (Recording Engineers; Mixdown Engineers; Assistant Engineers).

Codes

CP (Commercial/Advertising Production). Subcodes: R (Radio) TV (Television).

PP (Post-Production).

Subcodes: F (Film) MV (Music Video) CI (Corporate/Industrial).

B

Barrett A/V Studios: 1945 McDonald, Missoula, MT 59801; 406-542-2563; Bruce Barrett, owner/producer. **Credits:** Spectrum (PP-MV), Spectrum Music Video (RE: Ron Meisner; ME: Bruce Barrett); Montana Fiddlers' Competition (PP-MV), Centennial Fiddlers' Video (RE/ME: Bruce Barrett).

Bayou Recording Studios: 6328 W. 95th St., Oak Lawn, IL 60453; 312-598-9200; Rich Renik. **Credits:** Cyndi (CP-R), Freddy the Fickle Pickle (RE/ME/AE: Rich Renik); Siliker Labs (PP-Cl), Sanitization Process (RE/ME/AE: Rick Renik).

C

Carriage House Studios: 119 W. Hill Road, Stamford, CT 06902; 203-358-0065; Johnny Montagnese, manager. **Credits:** Turner Network (PP-F), Jacques Cousteau, The Bering Sea (RE/ME: Phil Magnotti; AE: Johnny Montagnese/Matt Lane); Arts & Entertainment (CP-TV), Network Logo (RE: Johnny Montagnese/Phil Magnotti; ME: Phil Magnotti; AE: Matt Lane); Chuck Norris Films (PP-F), Missing in Action, Invasion USA (RE: Alec Head/Phil Magnotti; ME: Alec Head; AE: Johnny Montagnese/Matt Lane); New World Films (PP-F), Tiger Warsaw (RE/ME: Phil Magnotti; AE: Johnny Montagnese/Matt Lane); New World Films (PP-F), Munchies (RE: Phil Magnotti; ME: Phil Magnotti; AE: Johnny Montagnese/Matt Lane).

Creative Media: 11105 Knott Ave., Cypress, CA 90630; 714-892-9469; Tim Keenan, operations director. **Credits:** NBC Technical Training/NBC Television (PP-Cl), NBC Halon Training (RE/ME: Tim Keenan; AE: Ed Berger); Stuart Anderson's Restaurants/The Hoppa Group (PP-Cl), Stuart Anderson's 1988 in Review (RE/ME: Tim Keenan); Orange County Register (CP-R), Spring Daily Campaign (CP-R), RE: Ed Berger/Tim Keenan; ME: Ed Berger; AE: Dan Pavelin); Disneyland/Delta Airlines (CP-TV), Disneyland/Delta California Fun Co-op (RE/ME: Tim

Keenan; AE: Dan Pavelin); Merrill-Lynch Realtors/Abracadabra Slide Prod. (RE/ME: Tim Keenan; AE: Ed Berger).

D

Data Studios: 2155 Bennett Creek Road, Cottage Grove, OR 97424; 503-942-5877; James Roger Nelson. **Credits:** Jimmy Blue & DATA (PP-F), Welcome to the Future (RE: Valerie E.C./James Roger Nelson; ME: James Roger Nelson/Jimmy Blue; AE: Bobby Weaver); Jimmy Blue & DATA (PP-F), Calling Rock 'n' Roll (RE: Bobby Weaver/Valerie E.C.; ME: James Roger Nelson/Jimmy Blue; AE: Mark Holliday).

F

Fox Farm Recording: 1431 Saundersville Ferry Road, Mt. Juliet, TN 37122; 615-754-2444; Kent Fox, owner. **Credits:** NSA (CP), Drip, Drip, Drip (RE/ME: Kent Fox).

Freedom Sound & Light: 1520 Ninth Ave. N.E., Owatonna, MN 55060; 507-451-1503; Ron Freiheit, owner. **Credits:** Owatonna Tool Co. (CP-Cl), New OTC Splitting Compression Tools (RE/ME: Ron Freiheit, Doug Smorek).

G

Giant Sound Recording: 1776 Broadway, New York, NY 10019; 212-247-1160; Douglas Pell, director. **Credits:** East/West Music (CP-TV), Buick (RE/ME: John Wolfson; AE: Mark Miller); Score Productions (PP-F), Dr. Seuss (RE/ME: Cynthia Danials; AE: Chris Hook/Eric Stollberger); East/West Music (CP-TV), Champion Spark Plugs (RE/ME: Keith Walsh; AE: Mark Miller); Vilinsky & Snyder (CP-TV), Elizabeth Arden (RE/ME: Doug Epstein; AE: Chris Hook); Jeff

What you see is what you get...

For a catalog and a list of over 60 dealers in the USA and Canada, contact

Magnetic Reference Laboratory, Inc.
229 Polaris Ave., Suite 4
Mountain View, CA 94043
(415) 965-8187

The MRL Calibration Graph is your proof of the quality control that goes into every MRL Reproducer Calibration Tape. We guarantee each one to exceed the performance requirements of IEC, NAB, AES, and EIA Standards.

MRL Calibration Tapes are designed and supported by experts in magnetic recording and audio standardization... we helped write the standards. Each tape comes with detailed instructions and application notes.

The MRL catalog includes tapes for all studio applications. In addition to the usual spot-frequency tapes, we make single-tone tapes, rapid-swept frequency tapes, wideband or 1/3rd octave-band pink random noise tapes, and difference-method azimuth-setup tapes. Most are available from stock.

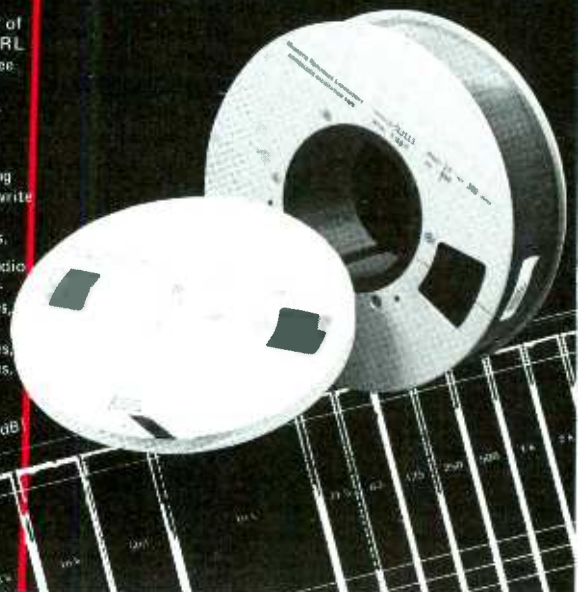

Circle (35) on Rapid Facts Card

TRACKS

Hest Productions (PP-Cl), Kawasaki One-Man Jam (RE/ME: John Wolfson; AE: Mark Miller/Chris Hook).

H

Hatchery Studios: 2175 Michael, Warren, MI 48091; 313-754-8200; Dave Sell, owner. **Credits:** Sony Corporation of America (PP-Cl), 1989 New Product Demo (RE/ME: Dave Sell/Kevin Allen); Reebok International (CP-R/TV), Reebok Spot (RE/ME: Dave Sell/Kevin Allen).

Heymac Productions: Box 6048, Federal Way, WA 98023; 206-838-1815; A.R. McPhail, owner. **Credits:** Vidicard Co. (PP-MV), Video Postcard (RE/ME: A.R. McPhail); Mike Lee (CP-R), The Air Bearing (RE/ME: A.R. McPhail; AE: Mike Lee); MacAd (CP-R), Azteca Demo (RE/ME: A.R. McPhail); RAFT Inc. (PP-F), Ride the Wild River (RE/ME: A.R. McPhail).

I

Informedia: Box 13287, Austin, TX 78711; 512-327-3227; Michael Sidoric, owner. **Credits:** Gambinus Importing Co. (CP-Cl), Corona: Quest for the Crown (RE: Brett Bunner; ME: Michael Sidoric); Southwestern Bell (CP-Cl), When Disaster Strikes (ME: Michael Sidoric; ME: Brett Bunner; AE: Joe Riordan); Institute of Texan Cultures (CP-Cl), The Texas Experience (RE: Brett Bunner; ME: Michael Sidoric).

L

Little Wing Recording: 154 Mallorca Way, #3, San Francisco, CA 94123; 415-563-8406; James R. Einolf, owner. **Credits:** GW Associates (PP-F), Glass Dreams (RE: James R. Einolf; ME: James R. Einolf/Brad Tompkins; AE: Phil Short); SG Productions (PP-F), Southern Gentlemen (RE: Alan Keeber; ME: Brad Tompkins/Phil Short); Mix Master (PP-MV), Lock and Key (RE: Alan Keeber; ME: James R. Einolf/Brad Tompkins; AE: Phil Short).

M

David Mark Audio: 3781 Silsby Road, Cleveland, OH 44118; 216-932-FUNN; David Mark, owner. **Credits:** Wizards' Conclave Come-in Music (PP-Cl), Conclave Come-ins (RE/ME: David Mark; AE: Adam Goldenberg); Gold Mountain Shows (PP-Cl), music for live shows (RE/ME: David Mark; AE: Adam Goldenberg/Mike Roberts); WERE Radio (CP-R), Whiz Quiz (RE: Jim Mehrling/Ted Kowalski; ME: Jay Burger; AE: David Mark); WEWS TV (CP-RV), Sports Scoreboard Music (RE: John Hansen; ME: David Mark).

N

National Video Center/Recording Studios: 460 W.

42nd St., New York, NY 10036; 212-279-2000; Caroline Lubber, public relations director. **Credits:** McCann-Erickson/East/West Music (CP-R/TV), The Great American Road Belongs to Buick (RE/ME: Gary Chester); Phoenix Communications (PP-TV), This Week in Baseball (RE/ME: Bill Ivie); Phoenix Communications (PP-TV), ESPN Baseball Magazine (RE/ME: Bill Ivie); VH-1 (PP-TV), Watch Bobby Rivers (RE/ME: Mike Ruschak); Chiat/Day (CP-TV), The Drexel Difference (RE/ME: Bill Ivie).

New York Audio Productions: 140 W. 22nd St., New York, NY 10011; 212-243-6826; Marianne Goldberg, manager. **Credits:** Random House Audio Books (CP), "Journey" by James Michener (RE/ME: Robert Kessler); Intercept Group (CP), Hudson River (RE/ME: John Fiscela); D.C. Heath & Co. (PP-Cl), Hola, Amigos! (RE/ME: Paul M. Barboza); Signs & Cities (CP), Pensacola (RE: Paul M. Barboza).

R

RAP Recording Studio: 167 S. Third E., Rexburg, ID 83440; 208-356-8705; Trent Walker, owner. **Credits:** Intermountain Film (CP-F), Boy Scouts of America Encampment '88 (RE/ME: Trent Walker); Carco Products (CP-Cl), Introduction to Carco (RE/ME: Trent Walker); International Dance Festival (PP-F), Idaho International Dance Festival (RE/ME: Trent Walker).

Reel Harmony: 3511 SW 35th St., Hollywood, FL 33024; 305-966-3277; Jules Lynn, president. **Credits:** Biotics Research (CP-R), Mineral Nutrition (RE/ME: Jules Lynn; AE: Ed Mashal); Consolidated Adv. & Mktg. Inc. (CP-R), Gerovitol-H3 (RE: Jules Lynn/Ed Mashal; ME: Jules Lynn); WLRN/Rock 'n' Roll Revisited (CP-R), Oldie Man (RE/ME: Jules Lynn).

Reel Hits: 15 Bridge Road, Weston, CT 06883; 203-226-4200; Dean Elliott, president. **Credits:** Brian & Shelly Morgan/MCA (PP-MV), Gimme Your Love (RE/ME: Dean Elliott; AE: Wayne Shulmister); Tuff Luck (PP-MV), Park Side Madness (RE: Dean Elliott; ME: Bill Finnerty/Dean Elliott; AE: Dodie Perez); Wee Men (PP-MV) (RE: Dean Elliott/Timmy Brannigan; ME: Dean Elliott; AE: Terry Brannigan/Wayne Shulmister); Cheap Jack's (CP-R), Get It at Jack's (RE: Bill Finnerty; ME: Doriane Elliott/Bill Finnerty); Park Place/Grey Ad., Park Place Rap (RE: Dean Elliott/David Hart; ME: Dean Elliott/Doriane Elliott; AE: Doug McKean).

S

Silver Linings: 25 Huntington Ave., Boston, MA 02146; 617-262-9289; Arklay King, president. **Credits:** National Geographic Society (PP-Cl), NGS Centennial Gala (RE: Arklay King/John Kusiak); Arts & Entertainment Cable (CP-TV), Chronicle TV Show (RE: Arklay King/John Kusiak/Mark Humphrey); Lotus Development Corp. (PP-MV), Magellan Video (RE: John Kusiak); National Park Service (PP-Cl), Lowell Mill Girls (RE: Arklay King); Massachusetts Lottery Commission (CP-TV), Aces High Jingle (RE: John Kusiak).

Sound Images: 602 Main St., Cincinnati, OH 45202; 513-241-7475; Jack Streitmarter, president. **Credits:**

ImageMatrix/Kentucky Fried Chicken (PP-Cl), Capture the Dream (RE/ME: Ric Probst; AE: John Murray); Fotino-Moriarty/WestMarc Cable (CP-R/TV), Cable TV Brings the World Home (RE/ME: Ric Probst); Procter & Gamble (CP-TV), New Zest Gel (Spanish Version) (RE/ME: Ric Probst); MultiMedia/Disney Films (PP-F), Good Old Boy (RE/ME: Jay Petach); Saatchi, Saatchi, DFS/Toyota (CP-TV), Truck Bashing (RE/ME: Ric Probst).

Studio 44: 4413 W. Reno, Broken Arrow, OK 74012; 918-250-2508. **Credits:** Dave Embry (PP-F), Gray Ghosts (RE/ME: Jack Brady).

T

Thornapple Sound: 3221 Thornapple, Columbus, OH 43231; 614-476-0233; Stephen J. Carter/Bryan Duple, owners. **Credits:** B-4 Productions (PP-F), Road Meat (RE/ME: Stephen Carter; ME: Bill Bragg); Little Rock (CP), Once in a Blue Moon (RE/ME: Stephen Carter); Midway Records (CP-MV), Saturdae (RE/ME: Stephen Carter; AE: Chris Dawkins); Bros. Grimm (CP) (RE/ME: Stephen Carter); John Doe & the Unknowns (CP) (RE/ME: Stephen Carter).

V

VSO Recording: 600 E. Franklin, Monterey, CA 93940; 408-373-3545; Vince Sanchez, owner. **Credits:** Monterey Life Magazine (CP-R), Life on Monterey Bay (RE: Vince Sanchez/Richard Bryant; ME: Vince Sanchez); Scientific Cowboy (PP-MV), Scientific Cowboy (RE/ME: Vince Sanchez).

W

The Wave Co.: 134-A Ashford Drive, Mt. Pearl, Newfoundland A1N 3L6 Canada; 709-364-8294; Lee Tizzard, owner/manager. **Credits:** SEACAM Productions (CP-TV) Newfoundland Light & Power Spots (RE: Lee Tizzard; ME: Lee Tizzard/Renee Flynn); NTV Broadcasting Co. (CP-TV), Station IDs (RE: Lee Tizzard; ME: Lee Tizzard/Renee Flynn); Agency 500 Advertising (CP-R/TV), Ches's Fish & Chips Spots (RE: Lee Tizzard; ME: Lee Tizzard/Renee Flynn), M5 Advertising (CP-R/TV), Purity Factories (RE: Lee Tizzard; ME: Lee Tizzard/Renee Flynn); Lens Master Optical (CP-R), :30 spot (RE: Lee Tizzard; ME: Lee Tizzard/Renee Flynn).

White Crow Audio: 19 Marble Ave., Burlington, VT 05401; 802-658-6475; Douglas Jaffe, studio manager. **Credits:** Tri-Star Pictures (PP-F), Sweethearts Dance (RE/ME: Todd Lockwood); Ben & Jerry's Ice Cream (CP-R), Two Real Guys (RE/ME: Todd Lockwood); Skis Dynastar Inc. (CP-R), National Radio Campaign (RE/ME: Todd Lockwood); Citizens for Responsible Growth (PP-MV), Back to the Pyramids (RE/ME: Todd Lockwood).

REP

Tracks is a monthly department. To have your facility listed, fill out the reply card located in the back of this issue. Please note that Tracks is for facilities only; individual engineers and producers should fill out the Engineer/Producer Index reply card.

During the past year, 18,889 audio production pros like you subscribed or renewed their subscriptions to RE/P.

With good reason(s).

Which one advertisement in this issue was of most interest to you?
Advertiser's Name TASCAM
Circle No. 128
Comments on this issue
THIS MAGAZINE ALWAYS HAS MORE INFORMATION ON NEW PRODUCTS WHICH I LIKE VERY MUCH

Which one advertisement in this issue was of most interest to you?
Advertiser's Name EAW
Circle No. 16
Comments on this issue
Very impressed by the detailed, technical fact of this magazine!

Which one advertisement in this issue was of most interest to you?
Advertiser's Name COMPRESSION
Circle No. _____
Comments on this issue
ANOTHER EXCELLENT ISSUE, WITH EXCELLENT INFORMATION. I REALLY APPRECIATE AND NEED THIS MAGAZINE!
THANK YOU. S.L.

Which one advertisement in this issue was of most interest to you?
Advertiser's Name Juice Gear
Circle No. 66
Comments on this issue
On this issue and as always I love it!

"Every issue of RE/P is must reading." G.S., Senior Producer.

"Your columns and advertisements are a constant source of information on new and improved equipment and procedures." C.V., Engineer

"The *Interconnecting Audio* article should be required reading for anyone with two or more pieces of gear." J.H., Production Manager

"RE/P's AES Show Directory was the most useful I've seen in any magazine!" F.W., Director

"Excellent articles on compressors, digital recording, microphones, studio wiring--everything!" K.V., Audio Engineer

"I especially appreciate your staying on the cutting edge of the digital technological advancements in the sound recording field." W.H., Sound Consultant

"RE/P is the only magazine I read cover to cover as soon as it arrives." R.G., Engineer/Musician

It's technical. It's operational. It's business. It's *now*. Recording Engineer/Producer--monthly "must reading" for the professional audio production industry.

Recording
—ENGINEER/PRODUCER—

P.O. Box 12901, Overland Park, KS 66212 (913) 888-4664

Where audio inspiration becomes sound reality.

STUDIO UPDATE

Northeast

New York Audio Productions (New York) has purchased an Otari MTR-12 recorder and Neumann TLM 170 microphones. *140 W. 22nd St., New York, NY 10011; 213-243-6826.*

Blank Productions (Stamford, CT) has purchased three Panasonic SV3500 DAT machines, modified to record at 44.1kHz; a Yamaha FC format converter, TX802 synth module, SPX90II effects module and a GC2020 compressor; a Korg MIR rack module; and a Brainstorm Electronics remote infrared talkback system. *1597 Hope St., Stamford, CT 06907; 203-968-2420; fax 203-329-7193.*

Sound Logic Studios (Silver Spring, MD) has appointed Mark Greenhouse as studio manager. Todd Morse has also joined the staff as an engineer. New equipment includes a Nakamichi real-time cassette duplication system, three Lexicon PCM 70s, a Hammond B-3 organ with Leslie cabinet, Sound Ideas series 2000 digital effects library and a variety of microphones. The facility has also opened a MIDI studio, featuring equipment from Apple, Yamaha, Oberheim and Emulator. *3209 Birchtree Lane, Silver Spring, MD 20906; 301-871-0200.*

Braidwood Studios (Metuchen, NJ) has named Sam Mack as chief engineer. New equipment includes a Commodore Amiga computer with Dr. T software and a J.L. Cooper PPS-1 tape sync controller, and a Toshiba DX 900 digital 2-track. *Box 4621, Metuchen, NJ 08840; 201-548-8542.*

Soundwave (Washington, DC) has purchased a New England Digital Direct-to-Disk recording system. *2000 P St. NW, Washington, DC 20036; 202-861-0560.*

Southeast

Patrick Creative Group (Nashville) received a 1989 Diamond Addy Award for musical concepts/advertising jingles for more than 30 seconds. The jingle for the *Arizona Republic/Phoenix Gazette* was engineered by Kent Madison and mixed by Todd Carpenter. *1719 West End Ave., Suite 300, Nashville, TN 37203; 615-329-4146.*

Digital ADR (Orlando, FL) has completed a major upgrade to its main film post-

production and screening room. A Neotek Elite 358 console with 58 mic and line inputs has been installed, as has a New England Digital 9600 with 48Mbytes of RAM and a 16-track Direct-to-Disk system.

Flood Zone Studios (Richmond, VA) has completed the construction of a new facility. The new room, totaling 1,900 square feet, features an 18' x 20' control room, Studer tape machines and a Soundcraft console. *Box 7105, Richmond, VA 23221; 804-644-0935.*

Studio Center Corporation (Norfolk, VA) has opened a new facility, Audio Studio C. The studio contains a Soundcraft 600B console, a Tascam MS-16 recorder, Otari 2-tracks, Crown power amps, and JBL and Auratone speakers. Room construction was by SCC personnel. Chuck Smith Audio, Windsor, VA, handled the audio and monitoring. *200 W. 22nd St., Norfolk, VA 23517.*

Midwest

Brookwood Studio (Ann Arbor, MI) has added an IMS Dyaxis digital audio workstation, said to be the first such system in Michigan. *1155 Rosewood, Ann Arbor, MI; 313-994-4992.*

Hatchery Studios (Warren, MI) has added Kevin Allen to the staff as second engineer. New equipment for the MIDI room includes a Yamaha SPX90, E-mu Emax, Akai S900, Apple Macintosh with Performer software, Valley Gate and Dynamite, Sony PCM 501ES digital mastering system, Roland M240 24-channel mixer, Roland A880 MIDI patcher/mixer and a Syncologic percussion signal processor. *2175 Michael, Warren, MI 48091; 313-754-1646.*

Tapemasters (Indianapolis) has named Randy Sipe as director of marketing and Grant Kattmann as engineer/producer. *3532 Washington Blvd., Indianapolis, IN 46205; 317-926-2025.*

Southern California

Sonic Images (Anaheim) has opened up a 3,400-square-foot complex featuring a New England Digital Direct-to-Disk PostPro system. The studio is designed with three primary work areas, for prelay audio, production and post-production audio sweetening. Additional equipment

includes a Tascam MS16 with dbx, a Tascam M600 console, a JVC 850 VCR and a JVC VP-101 PCM digital audio processor. *3164 E. La Palma, Suite B, Anaheim, CA 92806; 714-630-2494.*

Red Zone Studios (Burbank) has acquired new outboard gear for Studios A and B, including six Class A discrete Neve 1073 modules, four API 512 pre-amp/EQs, an Eventide H3000 Super Harmonizer and a Teletronics LA2A. New mics include a Neumann M-49 and an AKG C-24. *623 S. Glenwood Place, Burbank, CA 91506; 818-955-8030.*

The Post Group (Los Angeles) has named Rich Thorne as chief operating officer. *6335 Homewood Ave., Los Angeles, CA 90028; 213-462-2300.*

Tim Jordan Rentals (Los Angeles) has purchased a Sony PCM-3348 48-track digital recorder. *400 S. Citrus Ave., Los Angeles, CA 90036; 213-937-7354.*

Manufacturer and dealer announcements

Digital Audio Research has sold an 8-channel SoundStation II system to Gary Hedden Ltd., Nashville.

Soundmaster has installed Integrated Editing Systems at Films of Bristol, London; L.A. Studios, Hollywood; London by Night Productions, New York; CBC Television Studio 7 and Advanced Teleproduction Facility, Toronto; and Sonolab, Montreal.

Emmylou Harris and Paul Kennerley have taken delivery of a TAC Matchless console for their recording studio in Nashville. The console was supplied by Studio Supply.

Studer has sold a D820X DASH mastering recorder to Mix-o-lydian Studios in Boonton, NJ. Two A820-24 multitracks have been delivered to ABC-TV, New York. Arlyn Studios, Austin, TX, has purchased an A820-24.

George Massenburg Labs has installed automation systems at the following facilities: The Burbank Studios, Lorimar Films, Lions Gate Films, Lucasfilm, Electric Lady Studios, Manta Sound, Power Plant and Masterock.

REP

THE CUTTING EDGE

By Laurel Cash

The Road to CD Refs

Optical Media TOPIX workstation

Optical Media has just announced its TOPIX CD-R Audio Workstation. When utilizing this workstation, the company says you are provided with all the CD recorder control, PQ editing and generator functions required to record blank compact discs, using the TOPIX hardware/software package and the Yamaha Programmable Disc System.

This means there is now a system available for making on-off test or reference CDs from a properly formatted ¾-inch U-matic cassette—in real-time. In addition to being able to produce a compact disc, the system will also output to 1610/1630, SDIF-2 or DAT AES/EBU as long as they have a word-sync input. TOPIX is also capable of recording the table of contents (TOC) information in the lead-in area at the beginning of the CD.

The above configuration assumes that the user already has a Sony PCM-1610/1630 and either a DMR-4000 Digital Master Recorder or a ¾-inch videocassette recorder. Also required is an external SMPTE time code generator/reader. Optical Media does offer the above equipment as an option.

The basic system includes a TOPIX PC/AT CPU with at least 512K of RAM, a monochrome monitor, keyboard, internal hard disk of 20Mbytes or more, 360Kbyte and 1.2Mbyte floppy disk drives, PQ sub-code processor PC board, connection cables and system software, and Yamaha PDS Encoder and PDS Recorder units. Suggested retail price is \$49,900.

Of the available options, probably the hottest is the ability to use the TOPIX professional DAT recorder/player with SMPTE time code capability, built-in Sony SDIF-2 output and a built-in Yamaha PDS control port. This enables you to do complete CD-Audio disc recording (while using a SMPTE TC reader/generator) directly from a properly prepared DAT CD master without having to use a PCM-1610/1630 or DMR-4000.

Other kinds of professional DAT recorders could be used as the source. However, for it to work, correct TOPIX/Yamaha PDS control and SMPTE TC synchronization must be achieved.

Circle (181) on Rapid Facts Card



Another Road to CD Refs

Just a note that Meridian Data of Capitola, CA, is introducing a similar product to be delivered in June or July. Preliminary information was not available at press time.

Circle (182) on Rapid Facts Card

DCS announces A/D converter

Digital Conversion Systems, a British-based company making its entry into the professional audio industry, has announced its first product, the model 900 A/D converter.

An interesting claim of the product is its 128 times oversampling, which is said to give excellent distortion-free performance, particularly at low levels (typically 0.0003% @ 108dB below full scale), and a signal-to-noise ratio of greater than 105dB.

Two on-board crystal oscillators provide both 44.1kHz and 48kHz sampling rates, and the unit can be synchronized to an external AES/EBU clock or SDIF-2 word clock. The DCS 900 also has a conventional transformerless balanced input, and two serial outputs in both AES/EBU and SDIF-2 digital formats.

The 128 oversampling circuit uses no sample-and-hold techniques. It includes a linear phase digital filter and a gentle analog anti-aliasing filter, so it requires no

external filtering. Upon overloading, the converter simply clips and sets off an LED on the front panel. The company also says that any aliased artifacts within the audio band are at least 110dB down.

Circle (183) on Rapid Facts Card

Ariel DSP card for IBM PCs

Ariel has announced its new 2-channel DSP card for the IBM PC and compatibles, with complete dual-channel analog and digital I/Os. The company says this is the first product to be designed around the new Motorola DSP56ADC16 (first demonstrated and shown to developers at the last AES convention).

The DSP-56 is said to be the first and only DSP development system to include an integral SCSI port. Plus, the DSP-56 is supported by BUG-56, the symbolic debugger for Motorola's DSP56001.

As it now stands, the DSP-56 provides two 16-bit input channels, allowing simultaneous sampling of full bandwidth audio with software-selectable sample rates up to 100kHz per channel. Crystal generated rates of 32kHz, 44.1kHz and 50kHz are also provided. The system can also be configured to accommodate a single channel at up to 400kHz, while still maintaining 12-bit precision.

Standard features include 16Kbytes of 24-bit, zero-wait-state RAM; DSPnet (multiprocessing system for linking several DSP-56s together); and SCSI interfaces. Memory is expandable to fill the entire memory space of the Motorola DSP56001, totalling 576Kbytes (128K data and 64K program RAM).

Ariel also plans to offer a series of signal processing libraries for the DSP-56, including FFTs, digital filters and correlation/convolution programs.

Shipping of the first of these units was slated to begin in June.

Circle (184) on Rapid Facts Card

RE/P

Laurel Cash is RE/P's executive consultant and a free-lance writer based in Los Angeles.

NOTHING SOUNDS BETTER THAN OUR NEW SFX DATABASE SOFTWARE.



Introducing Version 3.0 Software of the M&E Organizer and the M&E Library.

(For IBM and Macintosh compatible computers.)

SEARCH METHODS FOR SOUND EFFECTS AND MUSIC LIBRARIES

- Look-up table to search by **Category** and **Sub-Category** words. This eliminates typing descriptions.
- Search by **Word, Synonym** or **Catalog #**. The program displays the sound description, CD track #, index location and library source.

FEATURES

- **Window** environment
- **New Editor** to add, delete and modify records
- **Print** your own catalog by category or by catalog #.
- **Search constraints** to search for "single" library, "except" words, "not less than" or "not more than" and media type.
- **Set colors** (IBM version)

CD CONTROL (CDK-006 & PX-240)

- Play, Pause, Cue, Loop, Autoplay
- External timecode trigger
- Network to all your rooms

LIBRARIES and CATALOGING

- Catalog listings from every production music and sound effect library is available and is included.
- **Free** library listing updates
- **New online Editor** to catalog your own libraries, tape, Dat, sampler and CDs.
- **Call us for a free demo disc or for more information.**



GEFEN SYSTEMS

5068 SAN FELICIANO DRIVE WOODLAND HILLS, CA 91364
PHONE: 818-884-6294 FAX: 818-884-3108

Circle (37) on Rapid Facts Card

NEW PRODUCTS

Audio-Technica AT853PM mic

The AT853PM is a miniature cardioid condenser mic designed to be suspended over choral and orchestral stages that demand unobtrusive appearances. Using low-mass fixed-charge technology allows the mic to have an ultra-thin, gold-vaporized diaphragm, which enhances frequency and transient response while reducing distortion. Other features include a 25-foot permanently attached miniature cable and a 3-position switch that allows flat frequency response or LF rolloff.

Circle (110) on Rapid Facts Card

Studer Revox A827

The 24-track analog recorder features an internal SMPTE time code synchronizer and parallel and serial RS-232/422 control ports. The recorder also offers 14-inch reel capacity; three tape speeds with an integrated varispeed controller; and phase-compensated, MDAC-controlled amplifiers with switchable Dolby HX Pro. Priced less than the A820-24, the A827 is designed to be a reliable, cost-effective machine.

Circle (132) on Rapid Facts Card



Hybrid Arts ADAP II

The ADAP II direct-to-hard disk digital audio recorder and editor, available in four models (77, 154, 380 and 760), features a SMPTE cue list and triggering functions for post-production and video sweetening, variable record and playback rates, and an ultra-fast operating system. Future software updates and hardware options include an AES/EBU interface, implementation of a flexible MIDI performer software page, time compression, pitch change, real-time digital EQ, crossfades,

triggered looping, scrubbing, CMX and VITC support. Retail prices range from \$9,250 to \$14,595.

Circle (112) on Rapid Facts Card

Librarian software from Music Service Software

S700/X-7000 Librarian is for use with the Akai X-7000 and S700 samplers and Atari ST computers. It allows users to store samples on hard disk or on 3.5-inch floppies. Features include the capability to store multisamples, accept samples from other 12-bit Sample Dump Standard samplers and perform elementary Visual Editing System capabilities. List price is \$79.95; the program is not copy-protected.

Circle (113) on Rapid Facts Card

Midia MIDIBOOST

Distributed by IMC, MIDIBOOST increases the power of MIDI signals and makes them immune to electrical noise so that they can be transmitted up to 4,000 feet on standard audio cables with XLR connectors. MIDI Ins and Outs are connected at each of the lines to one MIDIBOOST; standard low-impedance cables are strung between a second box. Using MIDIBOOST can allow users to wire entire installations with standard audio lines, to communicate with MIDI gear through the patchbay and to control onstage MIDI equipment at the house mix position. Suggested retail price is \$199.95.

Circle (114) on Rapid Facts Card

Turbosound TMW-20, TSE-112 monitors

The TMW-20 floor monitor is the latest addition to the TMW Series and consists of two 10-inch loudspeakers and an HF driver. The unit's smaller size allows it to be used in TV and film studios or in any situation where the preservation of sightlines is important. The TSE-112 is comprised of one 10-inch TurboMid device and a V-2 HF device, and is designed for installations that require a greater proportion of HF power with respect to the mid-band.

Circle (115) on Rapid Facts Card

Audio Logic X223 crossover

The X223 is a programmable, micro-processor-controlled crossover with three configurations: stereo 3-way, stereo 2-way with subwoofer and stereo 2-way. The crossover design uses 24dB-per-octave Linkwitz-Riley state variable filters with

the crossover points switched by the microprocessor. The unit provides exact distribution of audio to separate power amplifiers for the most efficient use of power and also protects drivers and transducers from damaging frequency transients.

Circle (111) on Rapid Facts Card

Soundtracs SPA console

The SPA sound reinforcement console is available in 32- or 48-channel configurations. The input channels feature a 4-band equalizer with fully parametric mid and frequency-sweepable high and low bands, switchable between bell and shelving response. Eight auxiliary sends, all switchable pre/post fader, and selectable pre/post equalizer are fitted. Although designed as a front-of-house desk, the SPA can be reconfigured to double as a monitor desk.

Circle (116) on Rapid Facts Card

Assistance pop filter

The Studio Pop Filter contains a one-piece plastic rim and run-resistant fabric that the

company says effectively controls consonant bursts without coloring the sound. It is available with a one-year warranty and retails for \$22.

Circle (117) on Rapid Facts Card

E-V FS-212 floor monitor

Electro-Voice's FS-212 is a 2-way, biamped concert floor monitor containing two DL12X woofers and one DH1A 2-inch compression driver mounted on an HP64 constant-directivity horn. The unit is capable of producing SPLs in excess of 130dB with full power input. ITT-Cannon EP-4-14 connectors are used for the power input; EP-4-13s are used for the loop-through connection.

Circle (120) on Rapid Facts Card

Ultimate Support studio organizer

Ultimate's HS26BP Studio Organizer was designed to be used in workstation applications where space is at a premium. The tabletop can be adjusted from 27 inches to 32 inches, and all tiers and surfaces are tilt-adjustable for individual needs. Custom additions include mic boom adapters, rails for rack-mount equipment, keyboard extensions and adapters for monitor speakers. Suggested retail is \$199.99.

Circle (121) on Rapid Facts Card

Nightingale music notation software

Nightingale, a professional music notation software program created by Don Byrd of Advanced Music Notation Systems, is designed for Apple Macintosh computers and is available from Opcode Systems. The program features full musical page layout capabilities, from piano to full orchestra; a transcription link to Opcode's Vision sequencer; use of the Adobe Systems Sonata postscript font; and the ability to record a live MIDI performance and immediately transcribe and display it in notation.

Circle (122) on Rapid Facts Card

Production Intercom LS-3 station

The LS-3 Loudspeaking Station is for 2-way communications. It automatically adjusts to one of three modes: press-to-talk, full duplex or as a headset handset station. Front panel controls may be overridden from anywhere in the system using the OG903 Override Generator. The

Another LTM Light?

Yes.



11646 Pendleton St.
Sun Valley, California 91352

Phone: (818) 767-1313 • Fax: (818) 767-1442

LOS ANGELES • MIAMI • ORLANDO
NEW YORK • DETROIT • CHICAGO

Circle (39) on Rapid Facts Card

A Light Mic Pole.

Carbon fiber for light weight and structural strength. Extends and extends. Available in a variety of lengths. And a shock mount and windscreens for all seasons.

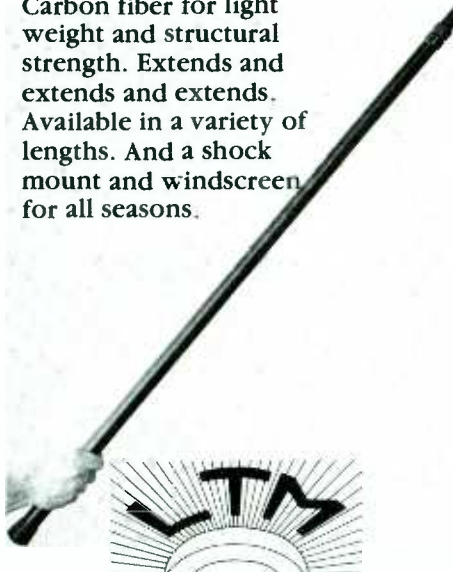

A subsidiary of LTM France

Other offices in London, Paris, Nice, Cologne and Toronto

LS-2 can be mounted in a 6-gang electrical rough-in box and is compatible with other 3-wire systems.

Circle (123) on Rapid Facts Card

Roland CD-5

The CD-5 storage unit is designed for use with the S-550 sampler module and W-30 workstation, and can be used for data storage or as a CD player. The unit, which incorporates the latest in CD-ROM storage technology, will hold as much data as 500 3.5-inch floppy disks, and can load an entire disk of data in 15 seconds. The CD-5 includes a factory disc containing the Roland Sound Bank Library (L-CD1). Other support discs, available from Roland, are optional.

Circle (124) on Rapid Facts Card

Carvin AudioCAD speaker software

AudioCAD is a loudspeaker design program for the Macintosh that calculates and displays the frequency response of any loudspeaker driver/box combination that is specified. A large library of drivers is included and can be expanded. The software uses the mathematical models of Thiele and Small for both vented and closed box loudspeaker systems. System requirements are a Macintosh with at least

NEW PRODUCTS

512K of memory and one 800K disk drive. The software and accompanying manual sell for \$95.

Circle (125) on Rapid Facts Card

Jensen Twin Servo 990 mic pre-amp

A new version of the Twin Servo 990 mic pre-amplifier has been designed with Jensen's 990C discrete op-amp technology. The model features improved dc servo-feedback circuitry, including dc offset nulling; input-bias injection with thermal tracking; and multi-LED metering. The 990 is packaged in a 1.75"×19" rack-mount chassis, which can be ordered with two or four channels. Suggested retail price is \$2,390 for the 2-channel model, \$4,240 for the 4-channel.

Circle (126) on Rapid Facts Card

ERA HFX processor

Available from RHODESystems, model HFX is designed to be used in situations where the use of a conventional noise gate is limited. Instead of turning on and off,

the unit subtracts noise and unwanted signals away from a signal, which produces a smooth transition. It is designed to be used with signals with an unpredictable nature, such as the human voice, stringed and acoustic instruments, and recordings made in locations that have acoustical problems. The unit uses Class A circuitry and discrete components to ensure audio quality.

Circle (127) on Rapid Facts Card

Peavey APB 32 audio patchbay

The 1/4-inch rack-mounted patchbay, available from Peavey's Audio Media Research division, provides 16 patch channels with 1/4-inch connectors, 1 3/4-inch rack-mount space-saving convenience, special screening for easy patch labeling and a deep patchbay chassis for unrestricted access to the rear jacks. The front panel jacks are normalled for direct feed-through when not patched. Suggested retail price is \$149.99.

Circle (128) on Rapid Facts Card

Renkus-Heinz stage monitor

This series of small, powerful stage monitors features a 12-inch woofer and a 2-inch throat HF driver, which provides less distortion at maximum output levels. As part of the Smart Systems product line, the monitors are used with Smart Processors. Two models are available. The W-121D was designed for clean mixing at high sound pressure levels. The W-121HD is configured with the horn above the woofer and is designed for small stages and as a high-level vocal monitor. Suggested retail price for both models is \$1,820.

Circle (129) on Rapid Facts Card

Studer Revox high-speed A807

The 1/4-inch 4-track recorder is the latest addition to the A807 line and is available in a 30ips version with overbridge metering. The model features MDAC-controlled audio electronics, Dolby HX Pro recording process, servo-controlled dc capstan

10,000 PERFECT CONNECTIONS — MINIMUM!

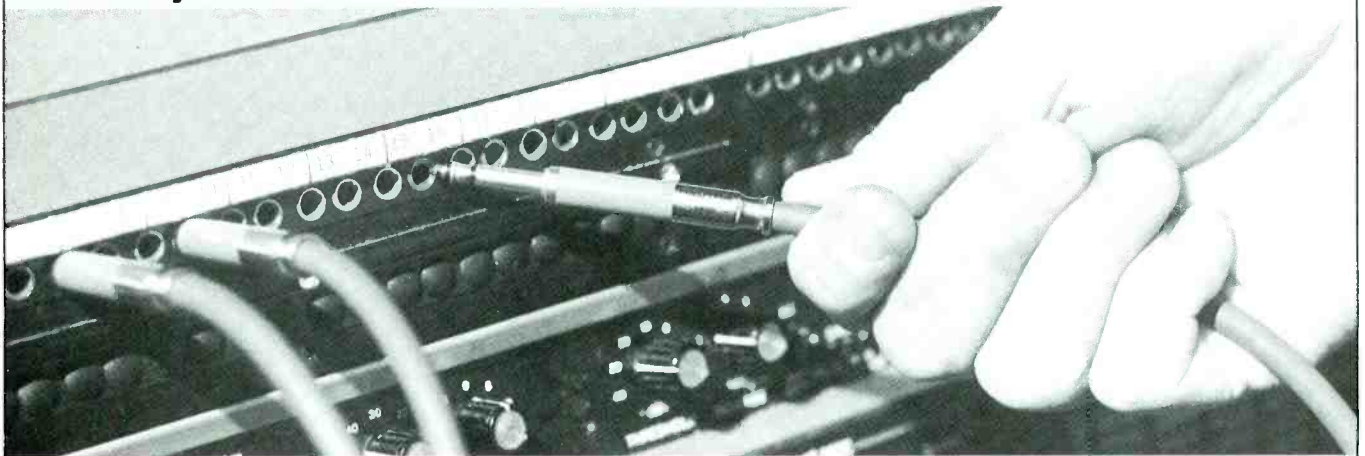

NEUTRIK PATCH BAY PLUGS — TESTED 10,000 TIMES

That's once a day for over 27 years before your Neutrik patch bay plugs would begin to show signs of wear.

The reason? Neutrik plugs have a new *Optalloy™* plating giving you more than 10 times the wear potential of unplated brass plugs. Of all the things you've got to worry about during a session, your patch bay plug doesn't have to be among them.

There's more. Neutrik's exclusive solder-or-crimp screwless connection and superior strain relief system are easy to assemble—every part fits with Swiss precision. The screw-on sleeves are even available in a wide range of colors for instant visual identification. It all adds up to the most functional and reliable patch bay plugs you can use.

Make the perfect connection...
Choose Neutrik.



Neutrik USA, Inc. • 1600 Malone Street • Millville, NJ 08322
TEL: 609-327-3113 • FAX 609-825-4804

CONNECTORS • PLUGS • JACKS • ADAPTERS • GOOSENECKS • TRANSFORMERS

Circle (40) on Rapid Facts Card

and spooling motors, a tape shuttle controller, and RS-232 and other control ports. The A807 is designed for quick response under synchronizer control.

Circle (130) on Rapid Facts Card

ASC production sound catalog

ASC has issued a catalog dedicated to production sound recording equipment and accessories. The 115-page catalog contains 500 original photographs, commentary, articles and other information. According to the company, the catalog is the industry's first that is devoted to production sound recording. The catalog is free.

Circle (131) on Rapid Facts Card

Offbeat Systems Streamline software

The Streamline System, which enables composers to create and edit click tracks, streamers, cues and timing notes while synchronized directly to picture via SMPTE code, has several updates. PAL compatibility is fully supported. Titling, print text, message and cue titles can now be located over source video.

Circle (186) on Rapid Facts Card

Korg M-1R rack module

The M-1R is a 2U rack-mount version of the M-1 music workstation and contains all the standard M-1 features. Additional features include MIDI Overflow, which allows users to combine M-1s and M-1Rs into 32-voice configurations. The front panel includes two card slots, which can accommodate both PCM ROM cards and ROM/RAM program/combo/sequence cards.

Circle (192) on Rapid Facts Card

Brainstorm Electronics TBS-4 talkback switch

The "remotable" talkback switch is designed for Trident consoles, series 65 through 80, and replaces the existing talkback switch. It allows a remote switch to activate the console's talkback. The switch can also be used with the Communicator, the company's infrared remote control. List price is \$98, or \$80 if purchased with the Communicator.

Circle (118) on Rapid Facts Card

Yamaha RX8 rhythm programmer

Designed for live or studio use, the RX8 has a sample library of 43 sounds, including five bass drums, eight toms and

five cymbals. The unit also contains Latin percussion, marimba, orchestra and two electric bass samples, allowing it to provide a bass/keyboard track to accompany the drum program. In addition to left and right outputs, two extra assignable outputs are included, allowing an individual instrument to be assigned for individual signal processing. Suggested retail price is \$495.

Circle (147) on Rapid Facts Card

QSC MX 700 amp

The MX 700 is the latest edition to the company's MX line of power amps. The 2U amp features a back panel that includes electronically balanced ¼-inch ring/tip/sleeve and barrier strip input connectors, and 5-way binding post speaker connectors. Power output is 150W into 8Ω, 225W into 4Ω and 350W into 2Ω. A 3-year parts and labor warranty is included; list price is \$598.

Circle (187) on Rapid Facts Card



Atlas/Soundolier MAC-1

The MAC-1 adapter is designed for close proximity in multiple-micing applications. It will accept all 5/8-inch 27-threaded microphone holders and standard adapters, including flexible goosenecks, twin-mount, extension tubes, snap-on/lock-on, shockmount and boom-arm extensions. The model is finished in non-reflecting ebony epoxy and is made of high-strength, extruded aluminum.

Circle (133) on Rapid Facts Card

AMS/Calrec M/S microphone

Developed from AMS/Calrec SoundField technology, the M/S microphone and stereo control unit have been designed for use in broadcast and recording applications. It can be used upright, inverted or end fire on a boom, and features coincident signals up to 10kHz, output signals L/R or M/S, and variable angle control from 0° to 180°. A stereo control unit is included, which can be powered from 100/240V mains, internal C cells or phantom powered, via two output connectors.

Circle (119) on Rapid Facts Card

Solve your monitoring problems with
THE STUDIO PSYCHOLOGIST
Remote Control Headphones or Stage Mixing System
from
intelix™
(608) 273-6333 • 6729 Seybold Rd., Madison, WI 53719

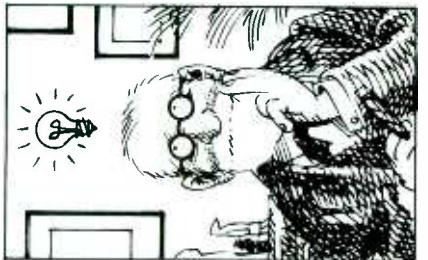
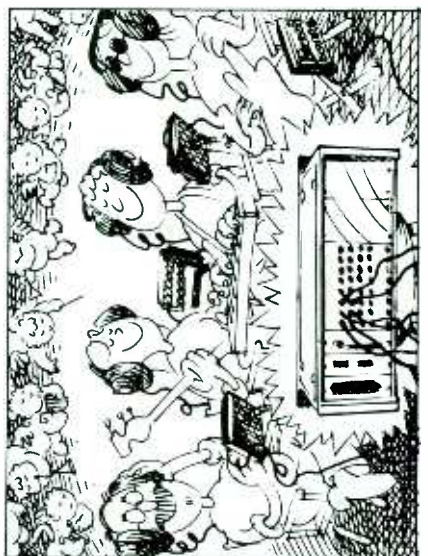

Circle (41) on Rapid Facts Card

NEW PRODUCTS

Software and hardware updates

Upgraded Clarity XLV software

The XLV effects interface has been upgraded to enable full automation of Lexicon 224XL, Lexicon 480L and AMS RMX-16 digital delay and reverbs. The software provides full MIDI control of performance parameters and features eight control-voltage ports for automating CV-equipped digital delays, VCAs and analog synthesizers. The software automates all page and machine changes available in the LARC controller used with the 224XL and 480L, in addition to the existing automation of fader moves.

Circle (136) on Rapid Facts Card

Studer A820-24 enhancements

Switchable Dolby SR and Dolby A noise-reduction systems on a single plug-in card are now available for the Studer A820-24

multichannel recorder. The model can accommodate all currently used noise-reduction systems, including the Dolby systems and Telcom C4, C4 DM and C4 E. Also, Studer has introduced a new software release for enhanced operation of the A820-24 in the TV/video post environment.

Circle (138) on Rapid Facts Card

Log detector circuit for Aphex 612

Aphex Systems now installs a new log detector circuit in its model 612 expander/gate units. The circuit provides more consistent decays over a wider dynamic range and a predictable "hold" resetting, especially with pulse-like waveforms. The update has been incorporated into all units with serial numbers beginning with #5371. For earlier Model 612s, Aphex is offering two circuit replacement options: a retrofit kit, \$25, or in-house replacement, \$50.

Circle (139) on Rapid Facts Card

Adams-Smith Zeta-Three update

Several features have been added to the audio-video-MIDI synchronizer. Tempo maps can be uploaded and downloaded in the standard MIDI File 1.00 format through the MIDI port. Multiple tempo maps can be stored in additional memory, and the unit can learn tempos from analog signals such as click-tracks.

Circle (180) on Rapid Facts Card

Soundtracs update for FMX consoles

Soundtracs has introduced an audio-follows-video controller for the FMX console, enabling up to eight channels of audio to be interfaced with video editors with BVE or GPI outputs. Internal selection on each of the audio channel VCAs may be either BVE, GPI or both simultaneously. The option is available factory-fitted or as a retrofit to existing consoles.

Circle (187) on Rapid Facts Card



TIMECODE EDITING... LIVING DANGEROUSLY?



Not if you have the new ADx-02 Timecode Analyzer. This is a sophisticated test instrument, as well as a fully functional reader-generator with video Key and L.E.D. displays. It can save you time and money. Finding timecode errors on tape before an edit is attempted, or matching color frames and ScH phase, or tracking on a Betacam is easy. For the engineer, it can be the quickest way to set tape speed, realign video play-back heads or check an audio synchronizer for wow. Each timecode bit is displayed graphically.

The ADx-02 is being used around the world in a variety of environments and applications. But the diagnostics function is not the end of the story, the ADx-02 is a very versatile timecode reader-generator-insert, with multiple screen displays, selectable fonts, three jam-sync modes, stable code generation, full speed range read and much more. So why buy just a timecode reader-generator?

The ADx-02.

The only timecode unit that can safely save you money.

ADx Systems Inc.
274 Madison Avenue, New York, NY 10016
The World Leader in Timecode.

For more information contact your local dealer or call us at 1-800-444-4-A-D-X.

Circle (42) on Rapid Facts Card



SONEX kills background noise beautifully.

Tom Hannaford, Dixieland Productions, Atlanta, GA

SONEX is a special acoustic foam that absorbs noise four times better than acoustic tile or carpeting. It makes you sound like a pro — inexpensively — because your voice comes across clear, clean, and intelligible. Use SONEX for video, remote conferencing, voice-overs, radio communications, audio production, or anywhere else you need to sound crystal clear. Kill background noise beautifully — and save the true sound — with SONEX. Send for all the facts. SONEX is manufactured by Illbruck and distributed exclusively to the pro sound market by Alpha Audio.

Alpha Audio.
Acoustics

2049 West Broad Street Richmond, Virginia 23220 USA
(804) 358-3852 FAX: (804) 358-9496
Acoustic Products for the Audio Industry

See us at NAMM, Booth #1964
Circle (43) on Rapid Facts Card

CLASSIFIED

FOR SALE

STUDIOWORKS

Recording & Broadcast Equipment

FACTORY DIRECT PRICES ON 3M & AMPEX TAPE

AKG	DBX	LEXICON
ART	DRAWMER	RAMSA
BBE	EV	OTARI
BEYER	JBL	OTHERS

SONY

Professional Audio
(800)438-5921/(704)375-1053

Circle (47) on Rapid Facts Card

FOSTEX RECORDING EQUIPMENT
MACINTOSH & IBM Computers
& compatibles
MUSIC SOFTWARE
Monitors & Printers

DISCOUNT PRICES DATAWARE INC.

(we ship world wide)
P.O. Box 1122
Hollywood, Ca 90078-1122
(818) 996-1161

Circle (48) on Rapid Facts Card

PRODUCTION TRUCK

Fully equipped 16 TK, 3 camera audio-video production truck. Three years old, like new. Over \$200,000 invested. A bargain at \$95,000! Ask for John - 704-487-7012.

MAGNETIC RECORDING HEADS—RELAP/REPLACE-
MENT for Audio, Video, Time Code, Duplication. 29 years of head design experience. IEM, 350 N. Eric Dr., Palatine, IL 60067; tel. (312) 358-4622.

HOUSE SPEAKER SYSTEM

8 Hill M-3 Speaker Enclosures System comes w/8 Hill TX-1000 Tri-amps, Racks, Speaker Cable, Crossover & Flying Hardware. System will cover 5,000 people. Cost \$25,000. Also for Sale: 1 Hill J-Series 32x8 Console w/case, \$6,000. 1 Emulator 2 w/case, \$2,750. **Seriously Sound 404-872-0346**

Brand New 19" ADC tt Patchbay Panels

Balanced/normalled, 144 points each. Cost \$300—Sell \$175 each, 2 for \$300 or 3 for \$400.

Call Roger Cordell
(816) 763-8301

Circle (49) on Rapid Facts Card

NEW, USED, DEMO EQUIPMENT

Trident consoles, Soundcraft 6000 28x24 w/bay, Aries mixers, Ampex 16TK, Soundcraft 762MKII 24TK w/locator, Studer A810 2TK, Panasonic SV-250, SV-3500 RDAT's, Tascam 122MKII, Eventide H3000, Tascam MSR-16, TSR-8, MS-16, ATR-60 Recorders, Dolby 363SR, Sony 1" 8TK xInt cond., experienced staff/factory service - equipment leasing specialists.

EAR Professional Audio-Video
(602) 267-0600

BLEVINS AUDIO EXCHANGE INC.

"The South's Largest Pro Audio Broker"

"Your unused equipment is requested for our Nashville, TN showroom."

We have in stock consoles, tape machines, outboard equipment, microphones, etc. Available immediately, the following items:

Sony JH24's EMT 250 Reverb
MCI JH400, JH500 and JH600 consoles
Otari MRT 90's Studer 24's

And lots more.
(615) 391-0429
(615) 391-0456 FAX

Our Commitment to Quality

At RADIAN, we believe that professional Compression Drivers must meet high standards:

• Uncomprised Performance

accurate reproduction,
low distortion, and
high efficiency.

• High Reliability

dependable under the
most demanding
conditions.



• Excellent Value for Your Investment

Professional performance and reliability are not accidents. They are *deliberately engineered* into every RADIAN product. Innovative designs using superior bonding technology and advanced metallurgical techniques are *standard* in all RADIAN products.

We invite you to examine, compare and prove RADIAN's performance to yourself.

RADIAN

AUDIO ENGINEERING, INC.

162 E. Orangethorpe • Placentia, CA 92670 • 714-961-1213 • FAX: 714-961-0869

Circle (21) on Rapid Facts Card

CLASSIFIED

FOR SALE

NEW & USED EQUIPMENT

Speakers

Gauss Co-Ax (used), \$900 ea;
Fostex 765 (demo), \$300 pr;
Fostex 780 (demo), \$400 pr.

Recorders

Otari MTR 90-II, \$35,000;
Ampex AG-440, \$1,500 ea. (3);
Otari MTR-12C (like new), \$7,000;
Fostex E-22, 1/2", 3 head, \$3,200;
TEAC 3-head cass. V570, \$249.

Microphones

AKG 414s new & used as low as \$500;
E-V PL20s (new), \$299;
Shure SM58 (new), \$105.

Consoles

Studiomaster V 24x4 (demo), \$3,200;
Soundtracs MR 24x4, 6 aux., \$4,995.

Call for complete list.

OPUS

RECORDING & EQUIPMENT CO.
4262 Grand Avenue, Gurnee, IL 60031
"The Midwest Recording Center"
(312) 336-6787 FAX (312)336-6895

Circle (50) on Rapid Facts Card

STUDIO MONITORS and OTARI TAPE RECORDER

Meyer 833 studio reference monitor system including processor, Tannoy SGM-1000 15" super gold monitors, Tannoy SGM-15B reference monitors, Otari MTR-12-I 1/2 inch 4 track.
Call TekCom at 215-426-7354 for details.

FOR SALE

BASF Cr02
In SHAPE MK-10 shell C-90 99¢
100 LOT

AGFA MAGNETITE-12
in SHAPE MK-10 shell C-90 1.05
100 LOT

ALSO... A/V supplies/equipment/parts, STUDIOFOAM acoustic foam (\$19.99/sheet, 2+ lot), cleaning fluids, HI-DEFINITION speaker cable, DAT, Switchcraft, CD jewel boxes, editing blades, MRP computers, Hewlett Packard Laserjets/Plotters, HOSA patch cords & MORE! Air personality voice talent available, too.

CARTUNES

PO Box 20384, Indianapolis, IN, USA 46220 (317) 257-6776
Serving professionals since 1977

*COD price, tax/S&H extra. Other lengths/types available at similar savings.

Circle (52) on Rapid Facts Card

DO YOURSELF A FAVOR

If you're ready to buy any type of recording gear or musical instrument, do yourself a favor and call us before you buy. We have most name brands at some of the lowest prices you'll find anywhere. Call us before you buy, you won't regret it. (318) 989-1000.

Circle (53) on Rapid Facts Card

New, Used & Demo NEOTEK, dbx, Trident, Otari, Lexicon, Neumann, Soundcraft Series IV 40x8 stereo w/pb, case and extras demo \$45,000. Soundcraft 800B 32x8 custom version new \$16,000. Used Cipher System \$2,400.

Pyramid Audio Inc. (312) 339-8014.
CALL US LAST!

EMPLOYMENT

AUDIO/VIDEO ELECTRONIC MAINTENANCE ENGINEER

Minimum 3 years experience maintaining professional audio, video, and editing system equipment. Evening and night hours required. Hi-tech facility in New York City with latest equipment. Good working environment. Send resume to: Al Hale, Sync Sound, 450 W. 56th St., New York, NY 10019.

EQUIPMENT WANTED

WANTED: PULTEC EQ's

We will pay \$1,000 for almost any Pultec program EQ models. Also wanted: Fairchild 670's and 660's any tube or ribbon microphones and limiting amps. Please call or write to:

Dan Alexander Audio
2944 San Pablo Ave.
Berkeley, CA 94702
(415) 644-2363
FAX: (415) 644-1848

STUDIO ACCESSORIES

"The Milli-Chart"

A handsome, plastic coated, wall or table top reference chart measuring 11" x 17". Cross references the relationship between tempos and digital delay time settings. Designed to alleviate the tedious process of computing delay times with a stop watch and calculator.

Contains the following cross reference material:

- Beats per minute (from 60 to 250)
- Seconds per beat
- Milliseconds per quarter note, eighth note, sixteenth note, eighth note triplet, sixteenth note triplet. All millisecond references are rounded to the nearest tenth (or 10,000 of a second).

Send \$15.95 post paid to:
J.S. LoBianco Enterprises
36 Park Ave., Oyster Bay, NY 11771
Satisfaction Guaranteed

AVR

AUDIO VIDEO RESEARCH THE STUDIO STORE (617) 924-0660

The Only Call You Have To Make For:

AKAI	BBE	MARK OF THE	SHURE
AKG	BEYER DYNAMIC	UNICORN	STUDIOMASTER
ALLEN & HEATH	BIAMP	MRL	SUMMIT
APHEX	CANARE CABLE	MILAB	TANNOY
SYSTEMS	CROWN	NADY	TC ELECTRONICS
ARIES	DIC DAT Tape	OPCODE SYSTEMS	TELEX
ART	EVENTIDE	ORBAN	US AUDIO
ASHLY	HYBRID ARTS	PANASONIC	WHIRLWIND
ATARI		RAMSA	

Exclusivamente para o Brasil, oferecendo instalacao e assistencia tecnica:
dbx JBL/UREI LEXICON

HARRISON KURZWEILL OTARI TRIDENT

AUDIO VIDEO RESEARCH 106 Main St. Watertown, MA 02172

Circle (51) on Rapid Facts Card

EMPLOYMENT

AUDIO OPERATOR

Now accepting applications for an audio operator. Must have knowledge of studio and remote broadcasting equipment, general electronics, various musical instruments, SMPTE time code synchronization of audio/video equipment. Minimum of three (3) years experience in television and/or professional 16/24 track recording. Must have excellent hearing, consistent temperament, able to work in pressure situations, and be emotionally mature. Must be willing to work various shifts, holidays, and weekends. Send resumes to:

CBN Employment Department
Box A2
CBN Center
Virginia Beach, VA 23463



SERVICE/REPAIR

Technical Service Specialists Inc.

Affordable nationwide design and/or construction of audio/video studios and facilities. Full line of electro-acoustical consulting, installations, and CAD/CAM services. Custom racks, cabinetwork, and tuning devices. Just completed turn-key project for Big Guy. For information call (914) 876-3999.

Circle (54) on Rapid Facts Card

RCA MICROPHONES—Repair

service on all models. Complete sound and cosmetic restoration. 35 yrs. experience with RCA. ENAK Microphone Repair, 420 Carew Avenue, Pitman, NJ 08071. (609) 589-6186.

SERVICE/REPAIR

STUDER REVOX FACTORY AUTHORIZED SERVICE CENTER "SUPERLATIVE SERVICE"

Swiss trained in servicing A77, B77, A700, PR99, A67, B67, A810, A807, B710, A710 & C270. Fast 48-72 hour service w/90 day warranty. Huge parts inventory. VISA/MC. New & used machines available.

SS STUDIO-SONICS CORP.
2246 N. Palmer Dr. #100
Schaumburg, IL 60173
(312) 843-7400

MISCELLANEOUS

A U D I O

Cassettes

AS EASY AS...

- 1 REAL TIME DUPLICATION
- 2 HIGH SPEED DUPLICATION
- 3 CUSTOM BLANKS

ESP MEANS QUALITY FULL SERVICE PRINTING AND PACKAGING. FRIENDLY PROFESSIONAL SERVICE. COMPETITIVE PRICES. FAST TURN-AROUND AND HIGHEST QUALITY RAW MATERIALS.

ESP EASTERN STANDARD PRODUCTIONS, INC.
26 Baxter St. Buffalo, NY 14207
1-716-876-1454

**CALL TOLL FREE:
1-800-527-9225**

Circle (80) on Rapid Facts Card

DISC MAKERS

MONEY SAVING PACKAGES

COMPLETE MANUFACTURING

CASSETTES CD'S, LP'S & VIDEOS

PROFESSIONAL DESIGN DEPT.

**CALL FOR CATALOG
1-800-468-9353**

Circle (81) on Rapid Facts Card

Electro Space effects processors—"Spanner", "Pressor", "The Gate". Audio Kinetics Pacer synchronizer. Call TekCom at 215-426-7354 for details.

Caution DAT Buyers!

Some dealers are offering DAT equipment that is not designed for use in the U.S. and is not covered by a legally binding written warranty. You need to know the facts on DAT - Call the DAT hotline today! 609-888-4414.



THE REEL DEALS ARE IN DC.

Otari MTR-10CT Recorder- \$9.9K
Otari MTR-12CT Recorder- \$10.9
Otari MK-III & BQ Series Recorders
TAC Matchless 36 x 24 Patchbay- \$25K
TAC Scorpion 40 x 8 w/ 8 Aux- \$17K
Soundtracs ERIC w/ Auto-Call
Soundcraft 8000 40 Input PA- \$20K
AHB Sigma Series 36 x 24- \$26K
Quad 8 Coronado Console- \$22K
Dolby 361SR- 1.4K

UREI & Crest Power Amps
Sony, Sharp, Ramsa R-Dat in Stock
Washington Professional Systems
11157 Viers Mill Rd. Wheaton, MD 20902

301-942-6800

CASSETTE TEK, INC.

SPECIALISTS IN PROMOTIONAL
CASSETTES FOR
ARTISTS—PRODUCERS—AGENCIES

- Highest quality custom blanks audio and video VHS cassettes
- Duplication of audio and video
- EMBOSSSED on-cassette printing using the PRINT RITE system
- Direct mail services
- Reasonable pricing
- Fast service

1605 THOMASTON AVE.
WATERBURY, CT 06704
TEL. (203) 757-4848

Circle (82) on Rapid Facts Card

Transformers, Plus:

- Twin Servo Mic Preamps • 990 Opamps
 - Boulder Power Amplifiers • Phono Preamps
 - Direct Boxes • Circuit Design Consulting
- Deane Jensen's Leading Edge Technology

jensen transformers
INCORPORATED

10735 Burbank Blvd. • North Hollywood, CA 91601
FAX (818) 763-4574 Phone (213) 876-0059
TELEX 6502919207 MCI UW
(Mon-Thurs, 9am-5pm Pacific time)

Circle (83) on Rapid Facts Card

ACOUSTIC FOAM

**GIANT
54" x 54"
\$19.99
Per Sheet!!**

KILL NOISE QUICK! Soundproof studios, vans, rooms with super-effective, E-Z mount, 2" thick studio gray Marker-foam. Immediate shipping. Add \$3.50 sheet shipping. NYS residents add 7% tax. MC Visa Amex COD Check Terms 3" sheets also available at \$29.99.

800-522-2025 America's most unique
(In NY 914-246-3036) catalog for the professional!

MARKERTEK
145 Uster Ave Saugerties
New York 12477 U.S.A. **VIDEO SUPPLY**

Circle (88) on Rapid Facts Card

THE MOST COMPLETE
SELECTION OF

AUDIO TEST TAPES

All formats including cassettes
Write or phone for free catalog

STL

STANDARD TAPE LABORATORY, INC.
26120 Eden Landing Road #5, Hayward, CA 94545
(415) 786-3546

Circle (85) on Rapid Facts Card

AUDIO AFFECTS

STUDIO EQUIP. FOR HIRE
Technician on staff 7a.m.-1a.m.
Open 7 days a week
Digital Tape Machines,
Synclavier Systems,
Effects Processors, Reverbs
(213) 871-1104 (818) 980-4006

Circle (84) on Rapid Facts Card

VELCRO CABLE WRAPS

Quick, safe, neat, never lost
Use them in Studio, Remote & Mtce Shop
Call or write for sample
VIDEO PARTS CO.
POB 25
SHENOROCK, NY 10587-0025
212-713-5757

ENDLESS WORD™
ADVERTISING PROMOTIONS
VOLUME IN STORE P.O.P. and TELEPHONE
ON HOLD MESSAGES
IDEAL FOR HI-SPEED or REAL-TIME
DUPLICATING



- Made in U.S.A. & Quality tested before shipping.
 - Lengths from 20 sec. to 20 min.
 - Special non-stretch tape.
 - Plays vertical or horizontal.
 - Clear case permits visual cueing.
 - Ask about our new volume discount pricing & low cost endless cassette promotional players and new F.C.C. approved multi-line telephone adapter for messages on hold tape players.
- MANN ENDLESS CASSETTE INDUSTRIES**
P.O. Box 1347 • San Francisco, CA 94101
(415) 221-2000 Ext. 2
Fax: (415) 387-2425

ADVERTISERS' INDEX

SALES OFFICES

	Page Number	Rapid Facts Number	Advertiser Hotline
Advanced Music Systems	15	12	
ADX Systems	76	42	212/532-5576
Agfa Corporation	9	8	201/440-2500
Alesis Corporation	5	6	
Allen & Heath Brenell	77	45	203/795-3594
Alpha Audio	76	43	804/358-3852
American International Audio Video	27	19	609/888-4414
Aphex Systems Ltd.	29	20	818/765-2212
Applied Research & Technology	23	18	716/436-2720
Atlas/Soundolier	13	11	314/349-3110
Audio Accessories, Inc.	45	28	603/446-3335
Bose Corporation	39	26	508/872-6541
Bruel & Kjaer — Denmark	63	32	
Carver	12		818/442-0782
Cooper, J. L. Electronics	37	25	213/306-4131
Countryman Associates	62	30	415/364-9988
The DAT Store	62	31	213/828-6487
DIC Digital Supply Corporation	19	16	800/DAT-1DIC
Everything Audio	33	22	818/884-6294
Fostex Corp. of America	17	15	213/921-1112
Full Compass Systems	75	41	800/356-5844
Gefen Systems	72	37	818/884-6294
Jensen Transformers, Inc.	79	83	213/876-0059
Kaba Research & Development	16	13	800/231-TAPE
LTM Corp. of America	73	39	818/767-1313
Magnetic Music	35	23	203/775-7832
Magnetic Reference Laboratory, Inc.	67	35	415/965-8187
Markertek Video Supply	79	86	800/522-2025
Neutrik U.S.A., Inc.	74	40	609/327-3113
New Music Seminar	47	29	212/473-4343
Otari Corp.	3	5	415/341-5900
QSC Audio Products	21	17	714/645-2540
Radian Audio Engineering, Inc.	77	21	714/961-1213
Rane Corporation	11	9	206/774-7309
Saki Magnetics, Inc.	65	33	818/880-4054
Sam Ash Professional	16	14	212/719-2640
Sony Broadcast Products Co.	25		800/635-SONY
Sound Quest, Inc.	35	24	416/256-0466
SoundCraft USA	BC		818/893-4351
Soundtracs Division/Samson Technologies	1	4	
Standard Tape Laboratory, Inc.	79	85	415/786-3546
Studer Revox/America	IFC	1	615/254-5651
Tannoy North America, Inc.	41	27	519/745-1158
Telex Communications, Inc.	7	7	612/887-5531
Trident USA, Inc.	IBC	2	213/533-8900

CLASSIFIEDS

Renée Hambleton
913-888-4664
9221 Quivira Road
Shawnee Mission, KS 66215
Telefax: 913-541-6697

SANTA MONICA, CA

Herbert A. Schiff
213-393-9285
Jason Perlman
213-458-9987
Chris Woodbury Leonard
213-451-8695
501 Santa Monica Blvd.
Santa Monica, CA 90401
Telefax: 213-393-2381

CHICAGO, IL

David Ruttenberg
312-435-2360
55 East Jackson Blvd.
Chicago, IL 60604
Telefax: 312-922-1408

NEW YORK, NY

Stan Kashine
212-702-3401
29th Floor
866 Third Ave.
New York, NY 10022
Telefax: 212-702-7802

OXFORD, ENGLAND

Nicholas McGeachin
Roseleigh House
New Street
Deddington, Oxford
OX5 45P England
Telefax: (0869) 38040
Telephone: (0869) 38794
Telex: 837469 BES G

FREWVILLE, SOUTH

AUSTRALIA

John Williamson
Hastwell, Williamson, Rep.
Pty. Ltd.
109 Conyngham Street
Frewville 5063
South Australia
Phone: 799-522
Telefax: 08 79 9735
Telex: AA87113 HANDM

TOKYO, JAPAN

Mashy Yoshikawa
Orient Echo, Inc.
1101 Grand Maison
Shinomiyabi-Cho, 2-18
Shinjuku-ku, Tokyo 162, Japan
Telephone: 03-235-5961
Telex: J-33376 MYORIENT

■

G R E A T C O M P A N Y



Since the early seventies, Keith Olsen has been creating for the best. He's produced for the likes of Fleetwood Mac, Foreigner, Pat Benatar, and Whitesnake. His efforts have sold over *65 Million records.*

After working on every console imaginable, his response to the DI-AN was "It's the best sounding and most advanced console ever." And for his own facility, he bought one.

After all, one must consider the company they keep...

The DI-AN from TRIDENT

TRIDENT AUDIO USA
2720 MONTEREY ST. #403
TORRANCE, CA 90503
(213)533-8900 / Fax (213)533-7072



GREAT COMPANY

Photo Courtesy of Goodnight LA Studios
Van Nuys, CA

Circle (2) on Rapid Facts Card

If Only More Expensive Consoles Performed As Well.

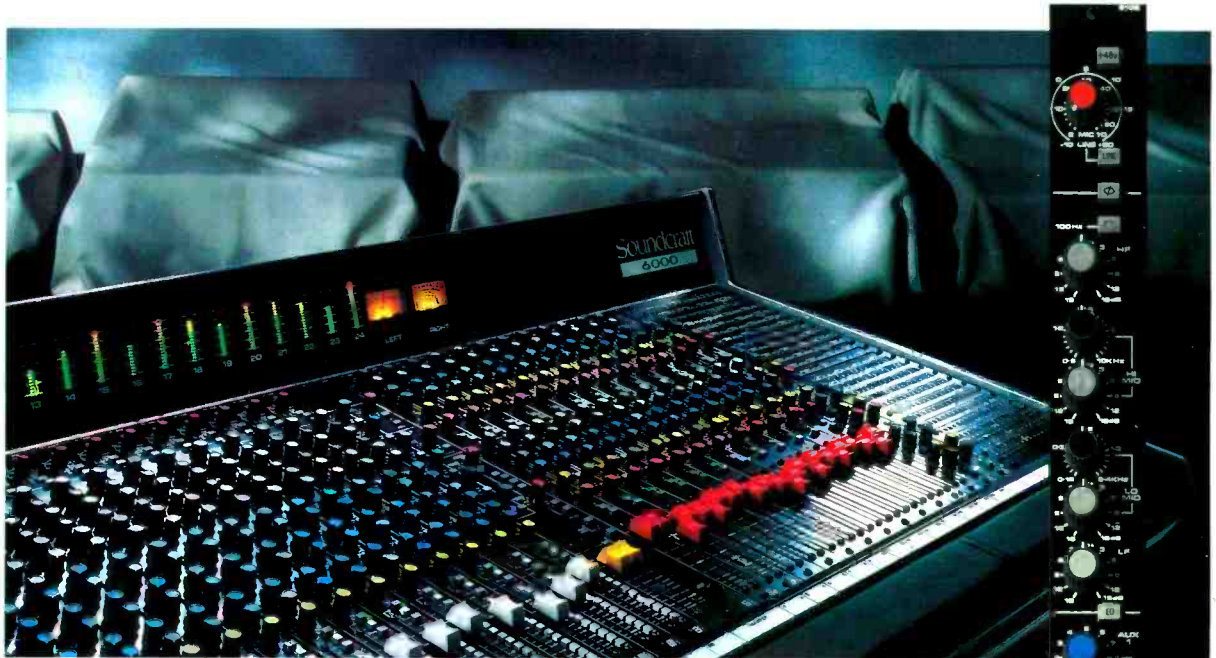

For a 16 or 24 track studio owner, the future looks very good.

With MIDI systems and digital outboard gear, you're faced with extremely sophisticated productions. But it's very hard to find a recording console to match the requirements without spending a small fortune.

That's precisely why we've developed the new Series 6000, an evolutionary design that clearly demonstrates the forward thinking of Soundcraft. Behind the classic layout is a revelation in performance and capability.

For one thing, it's equipped with enough busses and routing options to make adventurous productions a pleasure, not a nightmare. The 6000 is a full 16 or 24 buss console with six auxiliary sends per channel. The split format of the 6000 means each of the tape returns will double as extra inputs, with EQ.

We've also provided each input with push-button routing, EQ by-pass, and programmable electronic muting that eliminates the clicks produced by ordinary switches. You even get true solo-in-place, sadly lacking on more expensive consoles.

But it's the 6000's sonic performance that really sets it apart from the competition. Our revolutionary input design gives you 2dB to 70dB gain without a pad and virtually unmeasurable distortion, crosstalk, and noise.

Our new grounding system yields superb hum immunity and a routing isolation of 110dB (1kHz). And our active panpot comes close to theoretical perfection, exceeding our competitor's performance by a full 25dB.

The Series 6000 input module gives you programmable electronic muting under optional MIDI control, solo-in-place to get a clear picture of your progress, and a patented active panpot with isolation of 90 dB (1kHz).

To give you the subtle control it takes to achieve dramatic results, you also get four-band EQ with mid sweeps on each input channel.

When you specify Soundcraft's Series 6000, with options including 16 to 56 channels, stereo input modules, and built-in patchbay, you'll find it an affordable slice of progress. Series 6000, simply the most comprehensive production console in its class.

Soundcraft 6000

Soundcraft USA/JBL Professional
8500 Balboa Boulevard
Northridge, CA 91329

© 1988 - JBL Incorporated, A Harman International Company