

\$2.50  
FEBRUARY 1979  
VOLUME 10 — NUMBER 1

# Recording engineer producer

INCLUDING: CONCERT SOUND REINFORCEMENT



Studio Update:  
**The Digital Recording  
age  
arrives at L.A.'s  
RECORD PLANT,  
A&M  
studios...**

RELATING RECORDING SCIENCE • TO RECORDING ART • TO RECORDING EQUIPMENT

# Versatile...

is the word for Everything Audio. We have a wide range of clientele because we satisfy a wide range of needs. From the most elaborate studio design and installation to the smallest equipment need, we are ready to serve you.  Pictured at left is one of our



installations, **Spectrum Recording Studios** in Venice, California. Our involvement in this project was limited to that of design—to maximize their available funds, the owners had their own builders handle construction.  Pictured at right is **Compact Video Systems** in Burbank, California, an advanced

audio/video facility utilizing computer assistance in the post production audio room. It is one of our newest and most elaborate installations. We designed this facility in an existing structure, supplied the audio equipment, and assisted their crew during construction, clarifying and modifying the plans as the work progressed. The combined effort of the Compact Video crew and the Everything Audio staff resulted in an installation that is innovative in its technology as well as its finish and materials.

Another of our recently completed studios is the **Record Star** in Hamburg, West Germany. (We have representation in Great Britain, Germany, Australia, and Mexico.) We

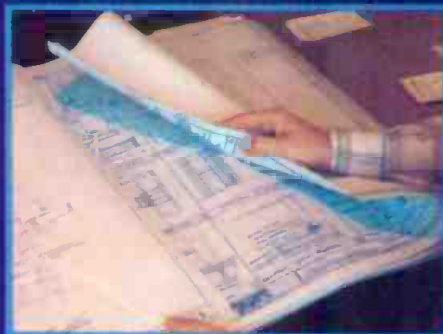

supplied the plans in metric measurements and, through local representation, kept involved in the project until its completion. In all of our projects—anywhere in the world—the home office keeps abreast of everything with on-site inspections.

If you are contemplating upgrading or building a new facility, we'd like to show you what we can do for you. Or if you're just looking for a new piece of equipment—let us help.  From total design and installation, to supplying the smallest equipment need—we do it all.

## EVERYTHING AUDIO

16055 VENTURA BLVD., SUITE 1001 • ENCINO, CALIFORNIA 91436 • (213) 995-4175

Versatility: Let it work for you.

# AMEK M3000



Favourably comparable with any console available today, the standard 36-input desk offers simultaneous quad, stereo and mono mixes from 32 tracks, with DC subgrouping of VCA-assisted channel and echo return faders.

The M3000 only has excellent performance specifications and is purpose-built to allow the engineer total control of the many advanced signal development and flow functions available in the desk.

Some of the outstanding facilities include: one mic and two differential line inputs; 4-band parametric equalization (variable frequency and Q on all 4 bands) with swept pass filters; four mono and one stereo send addressable to 8 busses; in-place, groupable quad solo; programmable and groupable muting; automation ready VCA channel faders with LED display in 'read' mode; 8 dedicated submasters; 24 assigns with panning odd-even between live busses, and direct assigns; additional audio subgrouping in remix; 32 track monitoring; in-line construction; comprehensive studio and control room monitoring systems; talkback; oscillator; 8 automated echo returns, 4 assignable to multitrack; overall status commands for main operation modes; comprehensive patchfield; phantom power; Penny and Giles conductive plastic faders.

Also available are the M2000, our most cost-effective 24 track desk, shortly also with automation option; the M1000, our ten buss console intended for 16-track and sound reinforcement work; the X series, our small console useful for 8-track, broadcast and reinforcement applications.

**EVERYTHING  
AUDIO**



Contact Brian Cornfield at, EVERYTHING AUDIO, 16055 Ventura Blvd. Suite 1001, Encino, Los Angeles, CA 91436, Tel: (213) 995 4175.

## MARTIN AUDIO

East Coast distribution, Courteney Spencer or Bruce Martin, MARTIN AUDIO, 423 West 55th, New York 10019, (212) 541 5900.  
AMEK SYSTEMS AND CONTROLS LTD, Islington Mill, James St. Salford M3 5HW, England. Tel: (061) 834 6747.

[www.americanradiohistory.com](http://www.americanradiohistory.com)

# BUILDING A STUDIO CAN SIERRA'S EXPERIENCE

Yes, it's expensive to build a recording studio today — and, unfortunately, it's going to become



more expensive with increases in the cost of everything; materials, labor, and especially the almost hidden cost of time delays. Plumbers and electricians can't be expected to stand around without being paid while waiting for

an on-site decision . . . and the costs of "working it out when we come to it", can certainly be catastrophic. Once the cement truck arrives there is no turning back.

We offer the kind of planning and preparation available only from professionals who have built studio after studio. And, how many times have you heard about a room having to be rebuilt (at even greater cost) because of poor design?



The lesson: experts in studio design and construction aren't found in your local equipment store, where studio design is merely a hobby or sideline. It is impossible to build a truly professional studio from a textbook.

**Excellent results can only be obtained by using proper materials in a proven plan.**

# BE EXPENSIVE — CAN MAKE IT PROFITABLE.

Profit from a plan developed by the people who build studios strictly for the professional.

**KENT DUNCAN** — utilizing keen insight gained from his years of experience working with some of the world's most famous artists, producers, and engineers, has developed a systems approach to the technical, financial, and human aspects of studio design. Now, you can buy the experience that made Kendun (Sierra's best effort to date) one of the World's best-known studios.



**TOM HIDLEY** — universally respected acoustician who has refined the knowledge gained in evaluating the results of over 185 studios constructed from his drawings into an



acoustic environment as advanced as tomorrow's recording techniques. And a guaranteed design that assures your success costs about the same as a four track machine.

**SIERRA AUDIO**, as exclusive representative of Tom Hidley's acoustic design services in North and Central America, Asia, Australia, Japan, and the Pacific, can provide the only acoustic design with performance guarantee, years of construction

expertise, and business acumen to make your studio an artistic and financial success. Whether you're planning a new facility from the ground up, or renovating your present studio, we are anxious to make you part of our story.



621 South Glenwood Place  
Burbank  
California 91506  
Phone (213) 843-8115  
Telex 691138

*We won't promise the World,  
but we will deliver what we promise!*

# RECORDING engineer/producer

— the magazine to exclusively serve the Recording Studio market... all those whose work involves the recording of commercially marketable sound.

— the magazine produced to relate... Recording ART to Recording SCIENCE to Recording EQUIPMENT.



Editor/Publisher ..... MARTIN GALLAY  
 Managing Editor ..... TOM LUBIN  
 Consulting Editor ..... PETER BUTT  
 Operations Manager . D. KEITH LARKIN  
 Traffic Manager ..... KEN McARTHUR  
 Business Manager ..... V. L. GAFFNEY  
 Circulation Manager .. PATTY COLLINS



"RECORDING Engineer/Producer"  
 (USPS 768-840)

is published six times a year by GALLAY COMMUNICATIONS, INC., 1850 N. Whitley Avenue, Hollywood, California 90028, and is sent to qualified recipients in the United States. One year (six issues) subscriptions for other than qualified individuals and companies may be purchased at the following rates:

United States (surface mail) .. \$10.00  
 United States (air mail) ..... \$17.00  
 All Other Countries ..... \$19.00

Foreign subscriptions payable in U.S. funds only by bank check or money order.



RECORDING Engineer/Producer is not responsible for any claim made by any person based on the publication by RECORDING Engineer/Producer of material submitted for publication.

Material appearing in RECORDING Engineer/Producer may not be reproduced without written permission of the publisher.



Controlled Circulation Postage  
 paid at  
 Los Angeles, California

Postmaster: Send form 3579 for  
 address correction to:

RECORDING Engineer/Producer  
 P. O. Box 2449  
 Hollywood, California 90028  
 (213) 467-1111

FEBRUARY 1979  
 VOLUME 10 — NUMBER 1

## Contents

- page 24 — **GEORGE MARTIN Revisited**  
 by Tom Lubin
- page 40 — **(LEDE) Live End - Dead End Control Room Acoustics**  
 ... (TDS™) Time Delay Spectrometry ...  
 (PZM™) Pressure Zone Microphones ...  
 by Chips Davis and Don Davis
- page 60 — **A HIGH PERFORMANCE, LOW-COST  
 TRANSFORMERLESS MICROPHONE PROJECT PREAMP**  
 by Dave Baskind and Jon Sanserino
- page 65 — **IMPULSE ALIGNMENT OF LOUDSPEAKERS  
 AND MICROPHONES — Part II**  
 by Gary Leo and Don Pearson
- page 72 — **VCAs ... the promise of  
 ELECTRONIC GAIN CONTROL**  
 by Harvey Rubens, Dave Baskind and Marvin Caesar
- page 76 — **Response on behalf of dbx, inc.**  
 by David Blackmer
- page 78 — **Response on behalf of Allison Research**  
 by Paul Buff
- page 101 — **1978 INDEX OF FEATURE EDITORIAL ARTICLES**

**The Cover —**  
 (Top photo) Mr. 'A' of A&M  
 with their new 3M Digital  
 Recording System. (Bottom  
 photo) Same day, 3M's John  
 McCracken with Record  
 Plant's Penn Stevens after  
 installation tests.

**Departments:**  
 Letters — 12  
 News — 108  
 Studio Update — 18  
 New Products — 88  
 Classified — 102

### THIS ISSUE OF R-e/p IS SPONSORED BY THE FOLLOWING LIST OF ADVERTISERS

AKG .....	92	Harrison .....	107,109,111,113	Quantum Audio Labs .....	21
Allison Research .....	65	Invonics .....	68	SESCOM .....	102
Altec Corporation .....	5	Interface Electronics .....	70	Shure Brothers .....	bk cvr
Amek .....	1	JBL .....	61,107	Sierra Audio .....	2-3
Atlas Sound .....	33	Jensen Transformer .....	109	Sound Workshop .....	19,32,97
Audio Associates .....	44	Klark-Teknik .....	31	Spectra Sonics .....	10-11,81
Audio & Design Recording ..	71	Lexicon .....	77	Stanton Magnetic .....	100
Audio Industries Corp. ....	29	Loft Modular Devices .....	91	Studer ReVox .....	63,10*
Audio-Technica, US .....	49	MCI .....	13	Studio Supply Company .....	5*
Audioarts Engineering .....	67	MXR .....	27	Symetrix .....	2*
Auditronics .....	73	Magnetic Reference Labs ..	20	Tangent Systems .....	1*
Auratone .....	21	MICMIX Audio Products ..	35,99	TEAC/Tascam .....	50-5*
BGW Systems .....	75	Rupert Neve, Inc. ....	16-17,59	Telex Communications ..	37,71
BTX Corporation .....	93	Northwest Sound .....	39	3M Companies .....	2*
Rudi Breuer .....	103	Omnicaft .....	98	UREI .....	4*
ClearCom .....	34	Orange County Electronics .	45	URSA MAJOR .....	6*
Countryman Associates .....	108	Orban Associates .....	43	Valley Audio .....	8*
dbx, inc. ....	6	Otari Corporation .....	46-47,83	Valley People .....	8*
DeltaLab Research .....	69	PML .....	96	Wakefield Manufacturing ..	10*
Eastern Acoustics .....	38	Peavey Electronics .....	53	Westlake Audio .....	56-5*
Electro-Voice, Inc. ....	81	QSC Audio Products .....	95	White Instruments .....	6*
Eventide Clockworks .....	90	Quad-Eight .....	9,94	Windt Audio Engineering ..	10*
Everything Audio .....	cvr 1			Yamaha International .....	2*

# IF YOU THINK ALTEC LANSING ONLY MAKES GREAT SPEAKERS...



## ...Meet The Great Power Behind Them.

At Altec Lansing, we've been making high-quality loudspeakers for over forty years. And we're very proud of the reputation that they've earned during that time. But perhaps it's because we're so well known for our speakers that some people tend to forget that we also make a full line of professional electronics. Equipment that's built with the same quality and reliability that our speakers are famous for.

Case in point: The Altec Lansing 9440A power amplifier.

The 9440A is a dual-channel power amp that delivers the high performance standards that today's audio professional needs. It produces more than 200 watts per channel into 8 ohms of highly reactive loudspeaker load. At 4 ohms the power is typically greater than 400 watts. And even at these levels the 9440A has less than 0.25% THD or IM distortion and a frequency response that's flat  $\pm 0.25$  dB from 20 Hz to 20 kHz.

Of course high performance must be matched with high reliability. The 9440A is designed to meet the most demanding conditions. Day-after-day. Year-after-year. Reliability provided by sixteen 250-watt home-

taxial power transistors backed up by a massive die-cast aluminum heat sink. Reliability ensured by an efficient VI limiter, a unique 40% power-limiting circuit and an output relay that protects against dangerous turn-on/turn-off transients. Reliability good enough to earn both UL and CSA approval.

And because we think that an amplifier should do more than just amplify, we've incorporated some features in the 9440A's design that will help make life a little easier. Features like lighted VU meters, meter range switches and provisions for adding plug-in input transformers. Features like a front-panel-mounted switch that converts the 9440A into a single-channel amplifier with a true balanced output. Features that help make the 9440A a versatile addition to any sound system.

But perhaps the best feature of the 9440A is that it's from Altec Lansing — a leader in quality audio products for over four decades.

So if you're thinking about power amps, think about Altec Lansing. Check the Yellow Pages under Sound Systems for the name of your local Altec Lansing sound contractor. And meet the great power behind our speakers.



1515 So. Manchester Ave., Anaheim, Ca. 92803 • 714/774-2900  
ALTEC CORPORATION

for additional information circle no. 1

[www.americanradiohistory.com](http://www.americanradiohistory.com)

# HUSH MONEY.

The dbx 208 tape noise reduction system is a new product that will impress both your engineering staff and your accountant. The 208 features 8 channels of simultaneous noise reduction on plug-in modules, plus a spare, all in a compact 5¼" rack mount package.

dbx noise reduction is rapidly becoming the new industry standard because it provides 30 dB noise reduction and 10 dB headroom improvement, from 20 Hz to 20 kHz, without the problems of other systems. The dbx system does not require critical and time-consuming level-match adjustments. Its true RMS detectors are not sensitive to tape recorder phase shift. Its voltage-controlled amplifiers (VCAs) operate over a 100 dB range. Overall the dbx system provides a level of performance and a simplicity of operation that is unsurpassed.

But the 208 is also a great value. It is priced at \$3300. That's \$6600 for your 16-track and \$9900 for your 24-track.\* And no matter how complex the future becomes, the 208 system expands simply and economically.

The dbx 208. The easy solution to your noise problems, today and in the future.

dbx, Incorporated,  
71 Chapel Street  
Newton MA 02195  
617-964-3210

# dbx

## UNLOCK YOUR EARS



\*Nationally advertised value.  
Actual prices are set  
by dbx dealers.

for additional information circle no. 2

[www.americanradiohistory.com](http://www.americanradiohistory.com)



**USE THIS CARD FOR MORE FACTS ON ITEMS SEEN IN THIS ISSUE**

Name \_\_\_\_\_ Title \_\_\_\_\_

Company \_\_\_\_\_

Address \_\_\_\_\_

City \_\_\_\_\_ State \_\_\_\_\_ Zip 

--	--	--	--	--

**PLEASE CHECK APPROPRIATE CATEGORY:**

- |   |  |  |                                   |   |                                      |  |  |  |                                   |                                |                                      |   |   |  |  |   |  |                                      |  |
|---|--|--|-----------------------------------|---|--------------------------------------|--|--|--|-----------------------------------|--------------------------------|--------------------------------------|---|---|--|--|---|--|--------------------------------------|--|
| <p>1) Was this copy addressed to you personally?    <input type="checkbox"/> Yes   <input type="checkbox"/> No</p> <p>2) Are you professionally involved with magnetic recording?    <input type="checkbox"/> Yes   <input type="checkbox"/> No</p> <p>3) Which of the following best describes your primary relationship to the professional audio business? (Circle One)</p> <table border="0" style="width: 100%;"><tr><td><input type="checkbox"/> Recording Studio</td><td><input type="checkbox"/> Sound Reinforcement</td></tr><tr><td><input type="checkbox"/> Producer</td><td><input type="checkbox"/> Sound Contractor</td></tr><tr><td colspan="2"><input type="checkbox"/> Other _____</td></tr></table> | <input type="checkbox"/> Recording Studio    | <input type="checkbox"/> Sound Reinforcement | <input type="checkbox"/> Producer | <input type="checkbox"/> Sound Contractor | <input type="checkbox"/> Other _____ |  | <p>4) Which of the following describes the functions you regularly perform?</p> <table border="0" style="width: 100%;"><tr><td><input type="checkbox"/> Owner/Manager</td><td><input type="checkbox"/> Producer</td></tr><tr><td><input type="checkbox"/> Mixer</td><td><input type="checkbox"/> Disc Cutter</td></tr><tr><td><input type="checkbox"/> Maintenance Engineer</td><td><input type="checkbox"/> Remote Recording</td></tr><tr><td><input type="checkbox"/> Video Movie Recording</td><td><input type="checkbox"/> Sound Reinforcement</td></tr><tr><td><input type="checkbox"/> Production Quantity Tape Duplicating</td><td></td></tr><tr><td colspan="2"><input type="checkbox"/> Other _____</td></tr></table> | <input type="checkbox"/> Owner/Manager | <input type="checkbox"/> Producer | <input type="checkbox"/> Mixer | <input type="checkbox"/> Disc Cutter | <input type="checkbox"/> Maintenance Engineer | <input type="checkbox"/> Remote Recording | <input type="checkbox"/> Video Movie Recording | <input type="checkbox"/> Sound Reinforcement | <input type="checkbox"/> Production Quantity Tape Duplicating |  | <input type="checkbox"/> Other _____ |  |
| <input type="checkbox"/> Recording Studio   | <input type="checkbox"/> Sound Reinforcement |  |                                   |   |                                      |  |  |  |                                   |                                |                                      |   |   |  |  |   |  |                                      |  |
| <input type="checkbox"/> Producer   | <input type="checkbox"/> Sound Contractor    |  |                                   |   |                                      |  |  |  |                                   |                                |                                      |   |   |  |  |   |  |                                      |  |
| <input type="checkbox"/> Other _____  |  |  |                                   |   |                                      |  |  |  |                                   |                                |                                      |   |   |  |  |   |  |                                      |  |
| <input type="checkbox"/> Owner/Manager  | <input type="checkbox"/> Producer            |  |                                   |   |                                      |  |  |  |                                   |                                |                                      |   |   |  |  |   |  |                                      |  |
| <input type="checkbox"/> Mixer  | <input type="checkbox"/> Disc Cutter         |  |                                   |   |                                      |  |  |  |                                   |                                |                                      |   |   |  |  |   |  |                                      |  |
| <input type="checkbox"/> Maintenance Engineer   | <input type="checkbox"/> Remote Recording    |  |                                   |   |                                      |  |  |  |                                   |                                |                                      |   |   |  |  |   |  |                                      |  |
| <input type="checkbox"/> Video Movie Recording  | <input type="checkbox"/> Sound Reinforcement |  |                                   |   |                                      |  |  |  |                                   |                                |                                      |   |   |  |  |   |  |                                      |  |
| <input type="checkbox"/> Production Quantity Tape Duplicating   |  |  |                                   |   |                                      |  |  |  |                                   |                                |                                      |   |   |  |  |   |  |                                      |  |
| <input type="checkbox"/> Other _____  |  |  |                                   |   |                                      |  |  |  |                                   |                                |                                      |   |   |  |  |   |  |                                      |  |

**SEND INFORMATION ON ITEMS CIRCLED BELOW:**

1	2	3	4	5	6	7	8	9	10	11	12	13	14	15	16	17	18	19	20
21	22	23	24	25	26	27	28	29	30	31	32	33	34	35	36	37	38	39	40
41	42	43	44	45	46	47	48	49	50	51	52	53	54	55	56	57	58	59	60
61	62	63	64	65	66	67	68	69	70	71	72	73	74	75	76	77	78	79	80
81	82	83	84	85	86	87	88	89	90	91	92	93	94	95	96	97	98	99	100
101	102	103	104	105	106	107	108	109	110	111	112	113	114	115	116	117	118	119	120

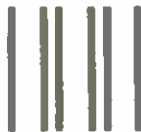

---

**FIRST CLASS**  
Permit  
No. 59188  
Los Angeles CA

---

**BUSINESS REPLY MAIL**

No Postage Stamp Necessary if Mailed in the United States

---

Postage will be Paid by

**RECORDING**  
**engineer/producer**

**BOX 24B80 \***  
**LOS ANGELES, CA 90024**

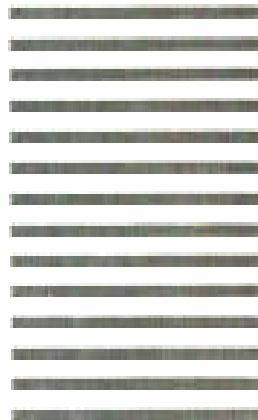

\* Please Note: This address is for Reader Service only.

Address other correspondence to P.O. Box 2449, Hollywood, CA 90028.

[www.americanradiohistory.com](http://www.americanradiohistory.com)

# From Quad/Eight:

**The forty by forty,  
totally modular,  
fully automated,  
feature-packed,  
super-spec'd,  
recording and mixdown system  
that you thought you couldn't afford.**

**The way you've always heard it should be.**



Shown as Coronado Model MS4024CX.



For the Artist in Every Engineer

Quad/Eight Electronics  
Quad/Eight International  
11929 Vose Street, North Hollywood, California 91605  
(213) 764-1516 Telex: 662-446

For additional information circle no. 3

[www.americanradiohistory.com](http://www.americanradiohistory.com)

# NEW!



## A NEW "STATE OF THE ART" DC POWER AMPLIFIER . . .

from **SPECTRA SONICS**,  
the pioneer and leader in bi, tri, quad, and  
*five-way* professional amplification  
systems!

As the most experienced manufacturer  
of multi-way amplification systems,  
**SPECTRA SONICS** has consolidated over  
seven years of field experience into the  
design of a second generation DC modular  
power amplifier, the Model 701.

With such improvements as increased  
power output, lower noise, higher  
damping factor, LED fuse indicator, and  
less susceptibility to physical abuse, the  
new Model 701 warrants consideration as  
the most advanced power amplifier  
available today.

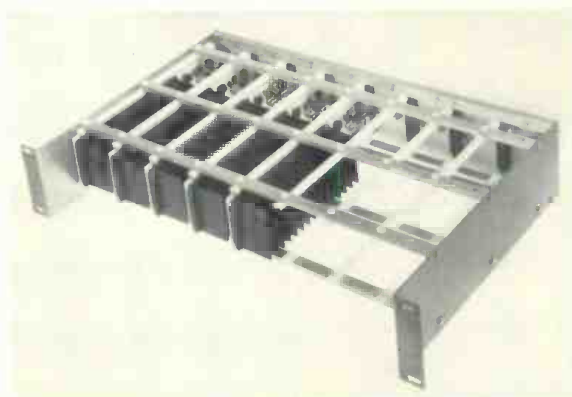

If you have not heard the new  
**SPECTRA SONICS** Model 701 Power  
Amplifier, it just might mean that you are  
missing the privilege of listening to the  
best. For complete specifications, see your  
Professional Audio Dealer, or contact:

# SPECTRA SONICS

LEADER IN ADVANCED TECHNOLOGY



3750 Airport Road ■ Ogden, Utah 84403 ■ (801) 392-7531

# NEW!

**SPECTRA SONICS** modular DC power amplifiers have been utilized by such top performers\* as Paul Anka, The Carpenters, Earth, Wind & Fire, The Jacksons, Wayne Newton, Donny and Marie Osmond, Debbie Reynolds, and by such prestigious performing arts facilities\* as Concord Pavilion, Denver Symphony Hall, Harrah's Club Tahoe, Hollywood Bowl, Ontario Place Forum, Scottsdale Center for the Arts, Stardust Hotel, and St. Louis Municipal Opera.

Now you, personally, may listen to the new **SPECTRA SONICS** Model 701 Power Amplifier in *tri-amplified* systems at any of the following participating **SPECTRA SONICS** dealers:

**ACCURATE SOUND CORPORATION**

114 5th Avenue  
Redwood City, California 94063  
(415) 365-2843

**AMERICAN ELECTRONICS**

313 South 36th Street  
Phoenix, Arizona 85034  
(602) 275-5496

**AUDIO CONCEPTS, INC.**

7138 Santa Monica Boulevard  
Hollywood, California 90046  
(213) 851-7172

**AUDIO INNOVATORS**

216 Boulevard of the Allies  
Pittsburgh, Pennsylvania 15222  
(412) 391-6220

**BARATH ACOUSTICS, INC.**

1925 South Rosemary, Suite C  
Denver, Colorado 80231  
(303) 750-6474

**CABLE BROTHERS, LTD.**

7915 Argyll Road  
Edmonton, T6C 4A9, Canada  
(403) 465-9731

**COLLMUS SOUND, INC.**

627 North Bend Road  
Baltimore, Maryland 21229  
(301) 747-6339

\*Partial Listing Only

**EXCEL AUDIO**

1819 Crook Avenue  
Cheyenne, Wyoming 82001  
(307) 638-6433

**JEFFERSON AUDIO**

9701 Taylorsville Road  
Louisville, Kentucky 40299  
(502) 267-9658

**KLOPF AUDIO/VIDEO COMPANY**

3381 Successful Way  
Dayton, Ohio 45414  
(513) 236-5500

**MULTI-SONUS, INC.**

168 Durnan Street  
Rochester, New York 14621  
(716) 544-8024

**SOUND SYSTEMS, INC.**

10254 Page Industrial Boulevard  
St. Louis, Missouri 63132  
(314) 428-1033

**SPECTRA SOUND PRODUCTS, INC.**

2245 South West Temple  
Salt Lake City, Utah 84115  
(801) 467-2842

**UNITED AUDIO RECORDING**

8535 Fairhaven  
San Antonio, Texas 78229  
(512) 690-8888

# SPECTRA SONICS

LEADER IN ADVANCED TECHNOLOGY



**3750 Airport Road ■ Ogden, Utah 84403 ■ (801) 392-7531**

**MCI** Professional  
Recording Equipment.  
Available through these  
dealers:

**USA.**

- California, Hollywood  
Audio Industries Corp.
- California, San Diego  
Pacific Recorder and Engineering
- Connecticut, Stamford  
AudioTechniques Inc.
- Florida, N. Miami Beach  
Recording Studio Equipment Co.
- Illinois, Pekin  
Milam Audio Corp.
- Minnesota, Minneapolis  
Sound 80
- Tennessee, Nashville  
Audio Consultants
- Texas, Austin  
Southwest Professional Audio

**Worldwide:**

- Africa, Rep. of S., Johannesburg  
Vitaphone Pty. Ltd.
- Argentina, Buenos Aires  
Platten S.R.L.
- Australia, S. Melbourne  
Klarion Enterprises Pty. Ltd.
- Belgium, Dilbeek  
N.V. Trans European Music S.A.
- Brazil, Sao Paulo  
Intersom
- Columbia, Bogota  
Ingeson, Ltda.
- England, London  
MCI, Ltd.
- France, Paris  
Studio Equipment S.A.
- Germany W., Hamburg  
R. Barth KG
- Holland, Eindhoven  
Pieter Bollen Geluidstechniek b.v.
- Italy, Milano  
Roje Telecomunicazioni S.P.A.
- Jamaica W.I., Kingston  
Professional Sound Equipment
- Japan, Taito-Ku, Tokyo  
Continental Far East Inc.
- Korea, Seoul  
Yushin Company Inc.
- Malaysia, Kuala Lumpur  
Dagang Teknik SDN.BHD.
- Mexico, Mexico D.F.  
Audio Y Consultoria
- New Zealand, Wellington  
Cepak Automation Ltd.
- Peru, Lima  
Schleusner, Heinz O.
- Puerto Rico, Old San Juan  
Hope, Bennet, Blackburn Inc.
- Spain, Barcelona  
Singleton Productions Inc.
- Sweden, Goteborg  
Tal och Ton A.B.
- Taiwan, Taipei  
Phoenix & Co. Ltd.



4007 N.E. 6th Avenue  
Ft. Lauderdale, Florida USA 33334  
Phone: (305)566-2853 Telex: 51-4362

# Letters

from: **Brad S. Miller**  
**President/Executive Producer**  
**Mobile Fidelity Sound Lab**  
**Olympic Valley, CA**

A fascinating interview with Geoff Emerick (*R-e/p*, December, 1978 by Howard Cummings.) Now, if we could only convince every producer and every engineer, that sound engineering practices will contribute more to the quality of their final product than all of the gimmicks and gadgets combined, the need for noise reduction systems (in most cases) could be eliminated altogether.

It is a sheer delight for us to receive an original stereo master tape recorded at 30 ips, no limiting, compression, mastering EQ or noise reduction encoding, for half-speed audiophile mastering.

While our approach cannot accommodate the mass media market, due to AM radio and large volume pressing requirements, there certainly is a growing need for the alternate approach. Speaking from a purist point of view, I hope that producers and engineers will prepare two stereo master tapes, simultaneously mixed of course, with one of the masters destined solely for "audiophile" quality mastering and pressing of limited quantities.

In this way, we can accommodate producers and engineers such as Geoff Emerick, where those music fans with the hi-fi systems to match, can truly hear and appreciate what was actually recorded, rather than some facsimile made to accommodate KHJ or WLS.

Thanks again to Geoff and Howard!

from: **Peter Butt**  
**Audio Diagnostic Measurements**  
**Los Angeles, CA**

The article entitled "Impulse Alignment of Loudspeakers and Microphones," by Don Pearson and Tom Lubin, contained some techniques that I found quite valuable in the examination of sound reproduction systems that I had previously taken for granted.

In the course of my experiments with Messrs. Pearson and Lubin's methods, it occurred to me that the relative phase and polarity of the various components of the audio signal chain are not the only matter for serious consideration. As has been apparent to others, Doug Sachs and Richard Heyser, to name two, the absolute polarity of the signal paths have a very significant impact on the acoustic experience of reproduced sound. Anyone having doubts about the audibility of differences in absolute signal polarity is invited to invert both pair of

speaker leads of his sound system and compare percussive program material in the inverted and erect polarity conditions.

As far as I am aware, there are no standards whatever for conventions concerning what response any audio system or component shall have to a positive-going transition. There are none for analog magnetic recorders and reproducers; none for disk mastering systems, phonograph reproducers, long distance transmission lines, broadcast transmitters, broadcast receivers, or amplifier components. The relative phase for the stereo or quad channels is a matter of standard convention. Conventions for preserving the absolute polarity of the audio signal chain have somehow escaped attention by standardizing organizations until even now.

I propose to the audio community at large that the possibilities of establishing some such absolute polarity convention be considered as well as methods and devices for determination that any polarity convention is, in fact, adhered to.

The areas requiring particular attention are the electrical/acoustic, electrical/magnetic, and electrical/mechanical interfaces in the audio signal chain.

Until some universal conventions are adopted, I suggest that all serious audiophiles install polarity reversing switches in their program channels as Doug Sachs has at the Mastering Lab.

I commend Messrs. Pearson and Lubin on a useful and thought provoking contribution. I'm looking forward to the second part of their discussion and hope they will include a description of the computer program they use to characterize their clients' audio systems.

from: **Bruce Lowell**  
**Helen Rowe & Associates**  
**West Los Angeles, CA**

In reference to the article *The Agony of Success*, (locating a new studio), in the December issue: As a person who is primarily involved in real estate and also has done consulting in numerous recording projects, I can personally relate to the agonizing problems Mr. King faced because I have had to find specialized facilities for former clients.

I have also faced problems with leased facilities for my own 4-track studio, because they were meant for various other purposes.

My commendation to you, Mr. King, for holding out to find perfection.

— continued overleaf

THANK YOU  
FOR LETTING MCI  
SHARE YOUR  
PLATINUM EXPERIENCE

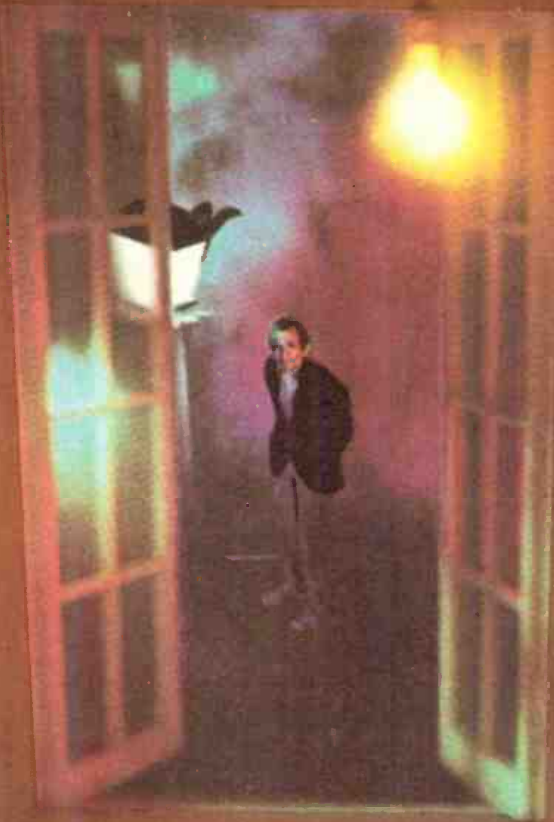

# NIGHTWATCH

KENNY LOGGINS

ON COLUMBIA RECORDS

PRODUCED BY  
ENGINEER

BOB JAMES  
JOE JORGENSEN  
WITH JOHN PACE

RECORDED AND MIXED AT

SOUNDMIXERS NYC

A TAPPAN ZEE PRODUCTION



4007 N.E. 6th AVE. FT. LAUDERDALE, FLA. 33334

for additional information circle no. 5

[www.americanradiohistory.com](http://www.americanradiohistory.com)

## Your original sound is at the nearest Tangent Dealer!

### **Martin Audio**

New York/(212) 541-5900  
Bruce Martin

### **Express Sound**

California (Southern)/(714) 645-8501  
Jerry Smith

### **Banana's At Large**

California (Northern)/(414) 457-7600  
J.D. Sharp

### **Lebow Labs**

Massachusetts/(617) 782-0600  
Peter Engle

### **Creative Audio**

Tennessee/(615) 331-3247  
Allen Rumbaugh

### **Paul Westbrook Audio**

Texas/(512) 578-4401  
Paul Westbrook

### **E.A.R.**

Arizona/(602) 968-8675  
Mike King

### **B.S.C.**

Illinois/(312) 453-5551  
Paul Bergetz

### **Sedco**

Missouri/(417) 883-6373  
Mark Morton

### **Pro Audio Seattle**

Washington/(206) 622-6984  
Craig Ingle

### **Stereo Sonics Laboratories**

Florida/(305) 831-2575  
Allan Smith

### **AVC Systems**

Minnesota/(612) 729-8305  
John Borman

### **Listen Up**

Colorado/(303) 778-0780  
Bill Rollin

### **Ford Audio**

Oklahoma/(405) 525-3343  
Jim Ford

### **Arnoldt Williams**

Michigan/(313) 453-6586  
John Williams

### **Veneman's**

Maryland/(301) 762-5100  
Andy Fantin

from: **Bert Frilot**  
**Manager & Chief Engineer**  
**Gilley's Recording Studio**  
**Pasadena, TX**

The letter in the December, 1978 issue from Mr. Jack Hunt, Mastering Engineer for Alshire Mastering Studios, is typical of the attitude of most mastering companies. He states that, "To make a disk that is identical with a good master tape is not really a challenge."

How can he justify a statement like that?

Mr. Hunt states, "Make a record better than the master tape." What is better? Is there a published book that states the rules as to what is better? Of course not! "Better" is entirely up to an individual. Why should anyone, completely detached from the producer and the studio engineer, take it upon himself to make the record "better" than the tape. He can make it sound *different*, but is it better, just because he thinks so!

Why do we spend hours and hours getting the sound the producer, or customer wants, just to have it changed by the mastering company? Any mastering company can make a record sound different, (most do), but it takes one hell of an engineer and good equipment to make the record sound just like the tape.

I've been a recording engineer for 17 years and I have certainly done a number of what I consider "bad" sessions, but the customer left with what he wanted and was happy.

I have cut master records for about four years, so I can appreciate the problems, but if I could make the record sound like the tape, no one could complain. If, however, I was asked to do what I could to better the tape, then fine! Then they were accepting my ear and capabilities.

My problem as a studio engineer and producer (9 million sellers and 26 top ten national records) is getting my sessions on record just as it sounds on the master tape. I spend hours working on tones and levels, only for someone to decide on their own that they are going to make it "better."

I don't appreciate it, and ask any other studio engineer or record company what they think and Mr. Hunt will find that all of us will shop for the mastering company that makes our records sound like our tapes — good, bad, or indifferent.

---

*Because of scheduling problems, Ray Kimber, author of "Speaker Wire" in the October, 1978 R-e/p, was unable to respond to points raised in letters by Ken Dickensheets and Henry L. Brooks published in the December, 1978 issue.*

reply from: **Ray Kimber**

First of all, let me say that I'm a bit perplexed that anyone can take a strong position on a product without ever being

exposed to the said product. To my knowledge, neither Mr. Dickensheets nor Mr. Brooks have ever purchased or asked for a sample of the braided cable with fine pure copper conductors that I wrote about.

In responding to the published comments, let me focus on Mr. Dickensheets' letter, which was the longer, more involved and covered the same points as Brooks.

Regarding the parameter of DC resistance in the damping factor formula, let me say it was left out on purpose. It's an erroneous assumption that the DC resistance at the voice coil greatly affects damping.

The damping factor is only useful at the time when a speaker is acting as a generator . . . for those of you not familiar with this phenomena, let me explain. Anytime the cone of a speaker is moving away from center, it is acting as a motor with the voltage being supplied by the amplifier. When the cone is moving from one extreme of excursion toward the center (the opposite direction), then it's acting like a generator and the amplifier should act like an electromagnetic brake by applying a short. Damping factor is the ability of the amp to present a short to the speaker at the time the speaker is acting as a generator.

The voltage that the speaker produces is determined only by the number of turns, the strength of the magnetic field, and the velocity of the voice coil. The resistance of the voice coil determines how much power it will produce at those voltage levels and nothing else. For instance, if you were to have a voice coil with, say, 100 turns of #20 and another voice coil with 100 turns of #40, they would generate virtually identical amounts of voltage, if they were moved in identical magnetic fields at identical velocities. The only difference would be the amount of power available; the 100 turns of #20, obviously, has lower source impedance and, hence, will match a lower impedance termination. So one can use the voice coil resistance or voice coil impedance, but not both in the same formula. I chose to use impedance since that information is more readily available.

One additional significant point is in order about the damping factor formula used by Mr. Dickensheets. The copper voice coil, such as the one used in his example, will increase in DC resistance at a rate of .22 per cent for every degree Fahrenheit increase in temperature. The example he uses states 6.5 ohms resistance. That value is valid only at room temperature. Since the temperature of the voice coil will rise to in excess of 200 degrees Fahrenheit at normal operating levels, a doubling of the resistance is predictable. This, obviously, invalidates the formula in "real world" applications.

... continued on page 107 -

**tangent**



# Why settle for a copy . . .



## when Tangent gives you the original?

Why settle for an imperfect copy of your sound, when Tangent will give you the original?

Tangent's crystal-clear transparency allows your original sound to flow cleanly to the tape, with only the coloration that **you** add.

And beyond this foundation of solid quality, Tangent invites comparison on these features:

### **Automation**

Automation from Tangent uses the innovative and widely-respected Allison 65K programmer and Fadex designs. Tangent chose the Allison system because it is the proven-in-the-field system.

### **VCA Grouping**

For those not needing full automation, Voltage Controlled Amplifier (VCA) Grouping utilizes up to **nine** VCA groups, while other manufacturers normally use fewer.

### **Sub-Group Solo**

Programmable Sub-Group Solo allows the engineer to solo an entire sub-group in place by pushing only one button. This convenience is not found in all competing VCA grouping or Automation systems.

### **Semi-Parametric EQ**

Three-band sweepable frequency equalization on each channel is a standard Tangent feature. Not an expensive option as with some competing systems.

### **Transformerless Balancing**

Transformerless Balancing keeps your original sound pure with incredible transient response. Noise is within 3 dB of the theoretical limit.

Transformerless Balancing is suddenly a big deal among the other console manufacturers. It should be. Tangent's been doing it for years.

### **16 Submasters**

Tangent's 16 submaster busses plus "Direct" allow tremendous flexibility for 16 or 24-track work.

### **FET Switching**

Electronic FET switching silently rearranges the signal flows for maximum convenience and minimum repatching.

### **Lots of Extras**

Penny & Giles faders, multiple Echo and Cue send, Phase Reverse, Tape Return Gain, and many other features on each channel give full professional control and reliability.

Compare Tangent's features to consoles costing twice as much and you'll see what a value Tangent is.

As for comparing Tangent's quality, well, you just can't get better than the original.

## Tangent Model 3216

**tangent**  
MUSICAL ENGINEERING

2810 South 24th Street/(602) 267-0653  
Phoenix, Arizona 85034

for additional information circle no. 6

[www.americanradiohistory.com](http://www.americanradiohistory.com)

R-e/p 15

The Neve Model 8088.  
The ultimate music recording console with  
in-line monitor. 44 inputs/32 tracks.  
Designed and built to the highest standards.



Picture shows custom made Neve console,  
similar to model 8088, at Eastern Sound —  
Toronto. One of three studios at Eastern  
equipped with Neve. Join Eastern and the  
other leading studios in the Neve world  
of excellence.  
Please call or write.

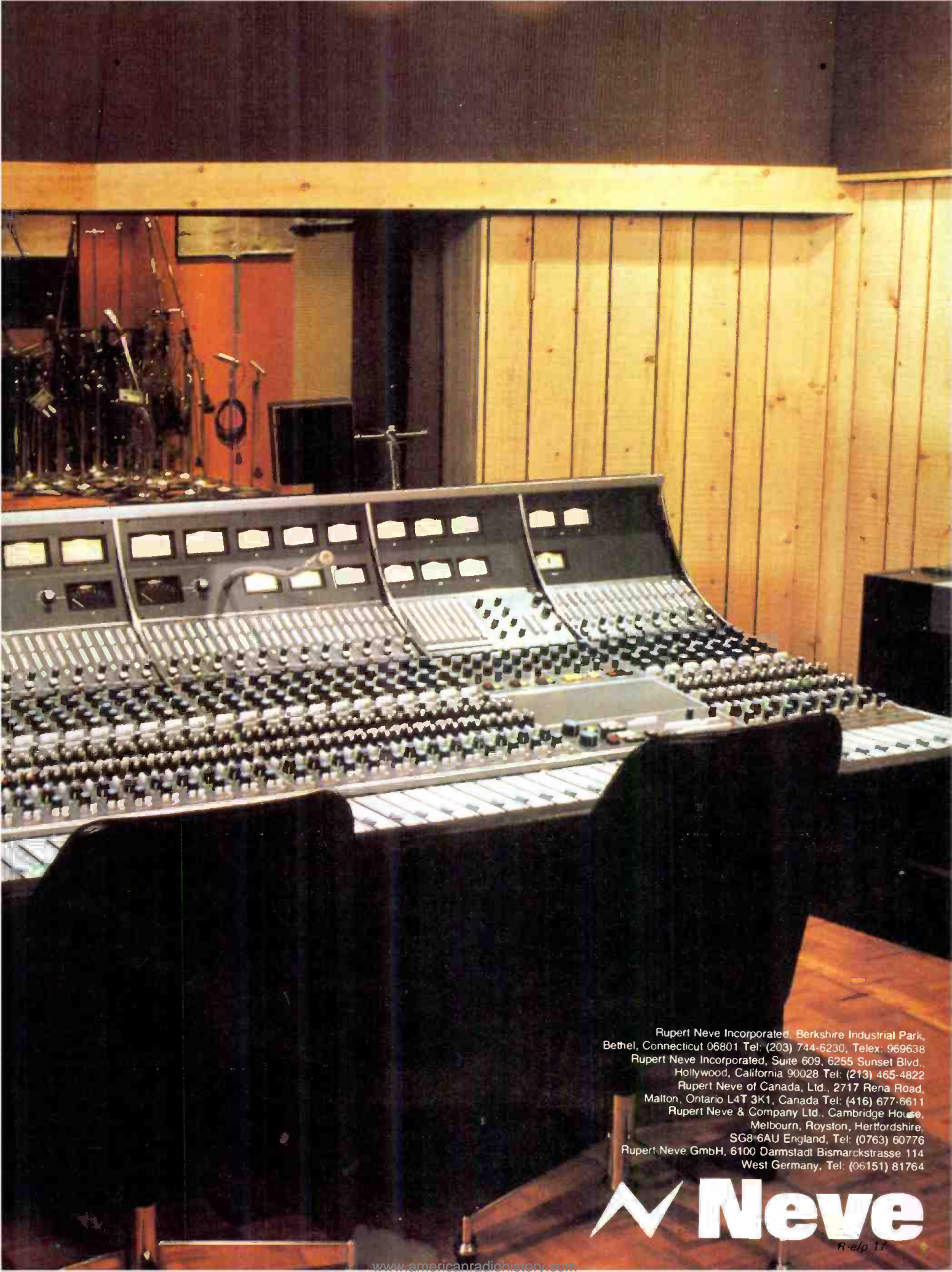

Rupert Neve Incorporated, Berkshire Industrial Park,  
Bethel, Connecticut 06801 Tel: (203) 744-6230, Telex: 969638  
Rupert Neve Incorporated, Suite 609, 6255 Sunset Blvd.,  
Hollywood, California 90028 Tel: (213) 465-4822  
Rupert Neve of Canada, Ltd., 2717 Rena Road,  
Malton, Ontario L4T 3K1, Canada Tel: (416) 677-6611  
Rupert Neve & Company Ltd., Cambridge House,  
Melbourn, Royston, Hertfordshire,  
SG8 6AU England, Tel: (0763) 60776  
Rupert Neve GmbH, 6100 Darmstadt Bismarckstrasse 114  
West Germany, Tel: (06151) 81764

 **Neve**

R-elp 17

# STUDIO UPDATE

**Northeast:** □ **SOUNDMIXER STUDIOS (NYC)** complementing its facilities for record recording has installed new equipment to enhance its capability as a film post-production studio, according to **HARRY HIRSCH**, president. A Dolby/BTX/ SMPTE code package consisting of generator, synchronizer, reader and microprocessor/programmer has been installed. "In essence, it means that Soundmixer may now function as a film-post-production center, complete with Capstan Servo and SMPTE interlock," explained Hirsch.

□ **STUDIO 0741 (Philadelphia)** has been established by the **MUSICOR Entertainment** firm. Equipment includes an eight track TEAC/Tascam recorder, a four track Toshiba, a Sony 2-track machine with other equipment including AKG and Shure microphones, Ashley Audio parametric equalization and peak limiting, and dbx noise reduction. 2539 E. Columbia Avenue, Philadelphia, PA 19121. (215) 763-0741.

□ **HALLMARK FILMS (Owings Mills, MD)** formerly a 4-track studio specializing in film scores and audio visual shows, announces its expansion to a new 7,000 square foot, 16-track facility. New equipment includes an Ampex 1200, 16-track recorder, Op-Amp Series II console, EMT 140 reverb, Scully 280-B mixdown machines and JBL monitors. The new facility also includes a 2,000 square foot drive-in film stage. 51-53 New Plant Ct., Owings Mills, MD 21117. (301) 363-4500.



Ron and Howard Albert, Criteria

**Southeast:** □ **CRITERIA (Miami)** is putting the finishing mixes on the **OSMOND BROTHERS** new LP with **MAURICE GIBB** and **STEVE KLEIN** producing. Klein is also the engineer for the album with **MIKE GUERRA** assisting. Other groups in the studio include the **ALLMAN BROTHERS**, with **TOM DOWD** producing and **STEVE GURSKY** engineering, the **HENRY PAUL BAND** and **FOXY**. Criteria also announced the naming of **RON** and **HOWARD ALBERT**, best known in the recording industry for their production success with **CROSBY, STILLS AND NASH**, as vice presidents of Criteria Recording Studios.

□ **BEE JAY RECORDING STUDIOS (Orlando, FL)** is recording **GODDO**, a Toronto-based group, now working on their third album for Polydor. Produced by **GREG GODDO**, this album is being engineered by **TIM SADDLER** with **BILL VERMILLION** assisting. Also at Bee Jay are **AL NALLEY** and **HENRY WECK** (drummer of Brownsville Station) mixing **BLACKFOOT** for an upcoming **ATCO** release. 5000 Eggleston Avenue, Orlando, FL 32810. (305) 293-1781.

□ **ECHO SOUND STUDIO (Pensacola, FL)** started off the New Year by adding a 16-track recorder to its facilities. The studio has been operating over six years — first as a four-tracker, then eight and now sixteen. A variety of recording packages are available, according to **RANDY SHELNUIT**. All tracks are equipped with dbx noise reduction and Echo Sound offers a plate echo unit, Yamaha grand piano, Rhodes, and Wurlitzer electric pianos, and Yamaha drums. Route 3, Box 194 T-15, Pensacola, FL 32504. (904) 477-6391 or 453-2051.



Tom Jung, Sound 80

**North Central:** □ **SOUND 80 (Minneapolis, MN)** has released the first two albums recorded using 3M Company's new Digital Mastering System. The albums are by the **SAINT PAUL CHAMBER ORCHESTRA** and the jazz group, **FLIM AND THE THE BB'S**. The studio used the digital prototype experimentally as backup during several direct-to-disk recording sessions. The prototype produced digital tapes from these sessions were judged superior to the direct-to-disk masters and the digital albums resulted. 2709 East 25th Street, Minneapolis, MN 55406. (612) 721-6341

□ **KAJAC RECORDING STUDIOS (Carlisle, IA)** **LEE MACE**, owner of Lee Mace's Ozark Opry, Osage Beach, Missouri, announced the purchase of Kajac Record Corporation, which includes the firm's 16-track recording studio facility. The purchase includes land, building, recording equipment, two music publishing companies and record distribution company. The 16-track recording studio will continue to operate in Carlisle until a new studio complex is completed at the Ozark Opry in the Spring of 1979. **HAROLD L. LUICK**, past president of Kajac Record Corporation, has been appointed general manager of the Ozark Opry, Inc., recording complex and will be in charge of all recording and publishing operations. 115 First Street, Carlisle, IA 50047. (515) 989-0876.

have you?  
 • increased track capacity - gone 24, 16, 8 •  
 • added key people • won awards •  
 • moved or expanded • added important equipment •  
 these are the interesting news items that can be announced in the next  
 available issue. Write:  
 R-e/p STUDIO UPDATE  
 Box 2449, Hollywood, CA 90028

# After spending so much money on a *state of the art* digital delay, why must you still use a tape deck when you need more than 300 milliseconds?

Because even today's *state of the art* digital signal processors are restricted.

**Introducing the Shared Access Memory System, by Audio Machinery.** The Shared Access Memory System is a modular computer controlled system that takes away the restrictions from digital signal processors.

The Shared Access Memory System consists of a mainframe and up to 8 plug in modules. The mainframe houses the Random Access Memory (RAM) and a computer that allows you to control the distribution of the RAM space to suit any particular

processing requirements. The mainframe comes with 400 milliseconds of RAM, however up to 6,000 milliseconds (6 seconds), may be installed.

The mainframe accepts up to 8 plug in modules. Each module has one or more designated functions including: Delay, Pitch Shift with Delay, Reverberation and Output. The modules determine the in/out configuration. The maximum delay time is only restricted to the amount of

RAM available in the mainframe. And with a possible six seconds available, that's not much of a restriction.

Shared Access Memory achieves 16 bit resolution, which means it is cleaner and quieter than the others. No analog techniques such as companding or pre/de-emphasis are employed, which means that the 16 kiloHertz bandwidth of Shared Access Memory is 16 kiloHertz, even at full

level! Proprietary algorithms are employed which allow the Pitch Shift Module a new level of performance.

The Shared Access Memory System is manufactured by Audio Machinery and is distributed exclusively by Sound Workshop Professional Audio Products, Inc. For more details please see your professional audio dealer or contact us directly.



**AM**

The Audio Machinery Shared Access Memory System  
distributed by Sound Workshop Professional Audio Products, Inc.  
1324 Motor Parkway / Hauppauge, New York 11787 / 516-582-6210

for additional information circle no. 7

www.americanradiohistory.com

R-e/p 19

# STUDIO UPDATE

**Mid-Central:**  **JACK CLEMENT RECORDING STUDIO B (Nashville)** recently re-opened after a two-month shutdown. Designed by **TOM IRBY**, of **STUDIO SUPPLY COMPANY**, and directed by Clement manager **JIM WILLIAMSON**, Studio B underwent complete renovation and remodeling to expand its facilities from 16 to 24 tracks. New equipment includes a 28-input, 32-output Harrison console with the new transformerless mike preamps, a 24-track Studer tape machine with 16-track capability, 24 tracks of Dolby noise reduction, a Studer mixdown machine and THE-1 monitors. **DOLLY PARTON**, **DON WILLIAMS** and **PAL RAKES** have already been in to use the new facility. 3102 Belmont Boulevard, Nashville, TN 37212. (615) 383-1982.

**TRACKING STATION (Nashville)** A 24-track Studer with dbx noise reduction and a Sphere 40-in, 40-out console have been installed at the Tracking Station, a just-completed facility built by country/pop artist **RONNIE MILSAP**. **VALLEY AUDIO** did the design work and **RUDI BREUER** supervised the construction. One interesting feature is a string loft above the control room, according to **BEN W. HARRIS**, chief engineer. The Tracking Station is accepting no outside bookings at the present time. 12 Music Circle South, Nashville, TN. (615) 256-7575.

**Mountain:**  **MOUNTAIN EARS RECORDING (Boulder, CO)** has recently updated to 24-track MCI electronics. Studio engineer **JOHN ALDRIDGE** describes space at the studio as "substantial," with a control room measuring 22' x 22' by 10' and the main "live room" measuring 50' x 60' x 22'. Mountain Ears' facilities also include a drum booth, a separate anechoic type isolation booth and a remote listening lounge. Outboard equipment is by Orban, Marshall, UREI and dbx. Monitors offered include JBL 4333 and 4311 as well as Auratones. Box 2240, Boulder, CO 80306. (303) 444-3277.

**Northwest:**  **SEA-WEST STUDIOS (Seattle, WA)** has added a second Ampex MM-1200 16-track recorder, which has been sync-locked with their original 16-track Ampex machine using the BTX/SMPTE time code generator and synchronizer. The first project in the new format is the new **HEART LP**, "Dog and Butterfly," according to **RICK KEEFER**, president and chief engineer. 319 North 85th Street, Seattle, WA 98103. (206) 783-2524.

**Southwest:**  **OVERLAND RECORDING STUDIOS (Costa Mesa, CA)** owner/producer **PAUL FREEMAN** announced the installation of an MCI 24-track recorder along with a Sound Workshop Series 1600 at Overland Recording Studios, a division of Freeman & Haws, Inc. Joining Freeman as co-owners are former KIIS radio producer, **MICHAEL ANTHONY**, and **TONY BRITO**, former producer for **HERB ALPERT** in Madrid. Anthony has been named director of promotion and Brito will collaborate with Freeman as co-producer on current projects being prepared for their in-house label. The studio also accepts outside clients. 3176 Pullman Avenue, Suite 123, Costa Mesa, CA 92626. (714) 957-1466.

**A&M STUDIOS (Los Angeles)** has completed the installation of its new 3M Digital Mastering System. A&M was chosen as one of four studios throughout the country to receive the first digital recorders marketed by 3M. The system consists of a 32-track digital recorder and a complementary 2/4 track mastering recorder. A preliminary session took place on February 8th, and regular sessions are scheduled to begin almost immediately with A&M's **HERB ALPERT** considering the possibility of cutting a digital LP to be released on A&M Records. 1336 N. La Brea Avenue, Hollywood, CA 90028. (213) 469-2411.

— continued overleaf

**What  
you see  
is what  
you  
get...**

For a catalog and a list of over 60 dealers in the USA and Canada, contact J. G. (Jay) McKnight at:

Magnetic Reference Laboratory, Inc.  
229 Polaris Ave., Suite 4  
Mountain View, CA 94043  
(415) 965-8187

Exclusive Export Agent: Gotham Export Corp.  
New York, NY

The MRL Calibration Graph is your proof of the quality control that goes into every MRL Reproducer Calibration Tape. We guarantee each one to exceed the performance requirements of IEC, NAB, AES, and EIA Standards.

MRL Calibration Tapes are designed and supported by experts in magnetic recording and audio standardization... we helped write the standards. Each tape comes with detailed instructions and application notes.

The MRL catalog includes tapes for all studio applications. In addition to the usual spot-frequency tapes, we make single-tone tapes, rapid-swept frequency tapes, wideband or 1/3rd octave-band pink random noise tapes, and difference-method azimuth-setup tapes. Most are available from stock.

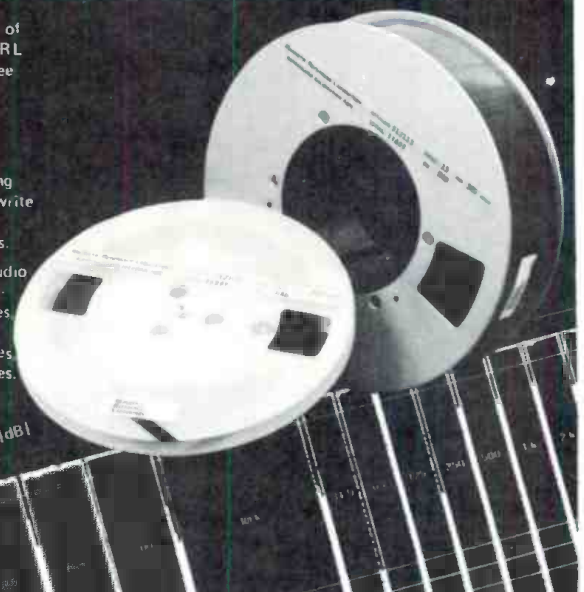

Quincy Jones knows quality . . .



**NOW THERE ARE FIVE LITTLE AURATONES . . .**

Same clean sound, but five different configurations for your special professional requirements.



5C



5PC



5W



5RC



5S

RECORDING MONITORS FOR THE REAL WORLD™

**AURATONE CORPORATION • P.O. BOX 698 • CORONADO • CALIFORNIA 92118 • U.S.A.**

for additional information circle no. 9

[www.americanradiohistory.com](http://www.americanradiohistory.com)

R-el/p 21

# STUDIO UPDATE



Baker Bigsby, Kendun

□ **KENDUN RECORDERS (Burbank, CA)** held its first sessions in their new Studio D using the recently installed Soundstream Digital System. **KENT DUNCAN** estimated that the equipment for the new studio would be valued in the one million dollar range. The console, built by Solid State Logic, Ltd., of Oxford, England, is 40-in and 32-out and incorporates an automation system which provides automated editing of an unlimited number of mixes. In addition, the computer provides printed track sheets and tape legends from information stored on a floppy disk. Tape machines include Studer 24-track machines. The studio utilizes TM-3 tri-amped monitors, the first ever tri-amping of the Hidley system. 621 Glenwood Place, Burbank, CA 91506. (213) 843-8096.

□ **RECORD PLANT (Los Angeles)** has recorded its first major rock artist on its newly installed 3M Digital Mastering System. **STEPHEN STILLS** wrote a special song for the occasion which was engineered by **MICHAEL BRAUNSTEIN** with Stills producing the session himself. The 3M system puts 32-tracks on a one-inch tape with mixdown to a 2/4 track machine using half-inch tape. The Record Plant was one of four studios selected by 3M to receive the first systems under a special leasing arrangement. 8456 West Third, Los Angeles, CA. (213) 653-0240.

□ **WESTLAKE RECORDING STUDIOS (Los Angeles)** on January 15 announced the completion of its new "super-studio," Studio B. The new studio is complete with a 3M 24-track master recorder, 3M/Studer/Ampex 2-track recorders, and a Harrison 4432 C console. The control room uses the new "Westlake" HR1 monitors. The HR1 is a high power, phase coherent, four-way quad-amped unit.



Foreign: □ **LITTLE MOUNTAIN SOUND (Vancouver, BC, Canada)** has installed a 24-track Studer tape recorder which becomes the second 24-track recorder acquired in the last 18 months, announced general manager **BOB BROOKS**. In addition, Little Mountain Sound recently added a three-story townhouse to its list of client services. "When a group comes to town for a long session, hotel rooms and food can get pretty dull, not to mention expensive," said Brooks. "Our condominium makes them feel at home." The full-furnished townhouse has three bedrooms, two-and-a-half baths, fireplace, full basement and a large patio. 201 West 7th Avenue, Vancouver, BC V5Y 1L9, Canada. (604) 873-4711.

□ **BARCLAY RECORDING STUDIOS (Paris, France)** has increased its capacity to 24 tracks according to **GERHARD LEHNER**, chief engineer. In November, 40 per cent of the studio was acquired by Philips and another 40 per cent by the French National Bank Company, while **EDDIE BARCLAY** retained a 20 per cent interest. Studios Barclay 9, Avenue Hoche 75008, Paris, France. Phone: 924.81.30/267.05.61. Telex: Barclay 62693F.

to be represented in the next available issue write:  
R-e/p STUDIO UPDATE  
P. O. Box 2449 • Hollywood, CA 90028



The Symetrix CL-100 represents a major step forward in versatility and cost-effectiveness.

Consider these features: D-essing, Independent attack and release controls, Side chain insertion which allows an equalizer to be patched into the control loop for frequency dependent threshold, and LED gain reduction and threshold indication. CL-100: \$299, CL-100B (Balanced): \$349.

**Symetrix, 109 Bell Street, Seattle, Washington 98121 (206) 682-3076.**



# WHY SETTLE FOR THEIR BEST, WHEN OUR SECOND BEST IS BETTER.



You see, the Series 79 Professional Audio Recorders may not be 3M's new digital sound, but you'll be hard-pressed to find more dependable analog sound.

Start with an unusual way to have lower wow and flutter and keep head contact. It's our patented 3M Isoloop differential capstan-drive. Which cuts unsupported tape length down to  $3\frac{1}{2}$ "

Then design it all into a no-warp metal deck base plate.

Finally, choose from expandable 8, 16 and 24-channel models.

For more information, phone R. J. Brown at (612) 733-1262 or write Mincom Division, 3M Company, St. Paul, MN 55101.



**3M**

10 years  
later -

# George Martin

revisited

by  
**TOM LUBIN**  
photos by  
**Henry Diltz**

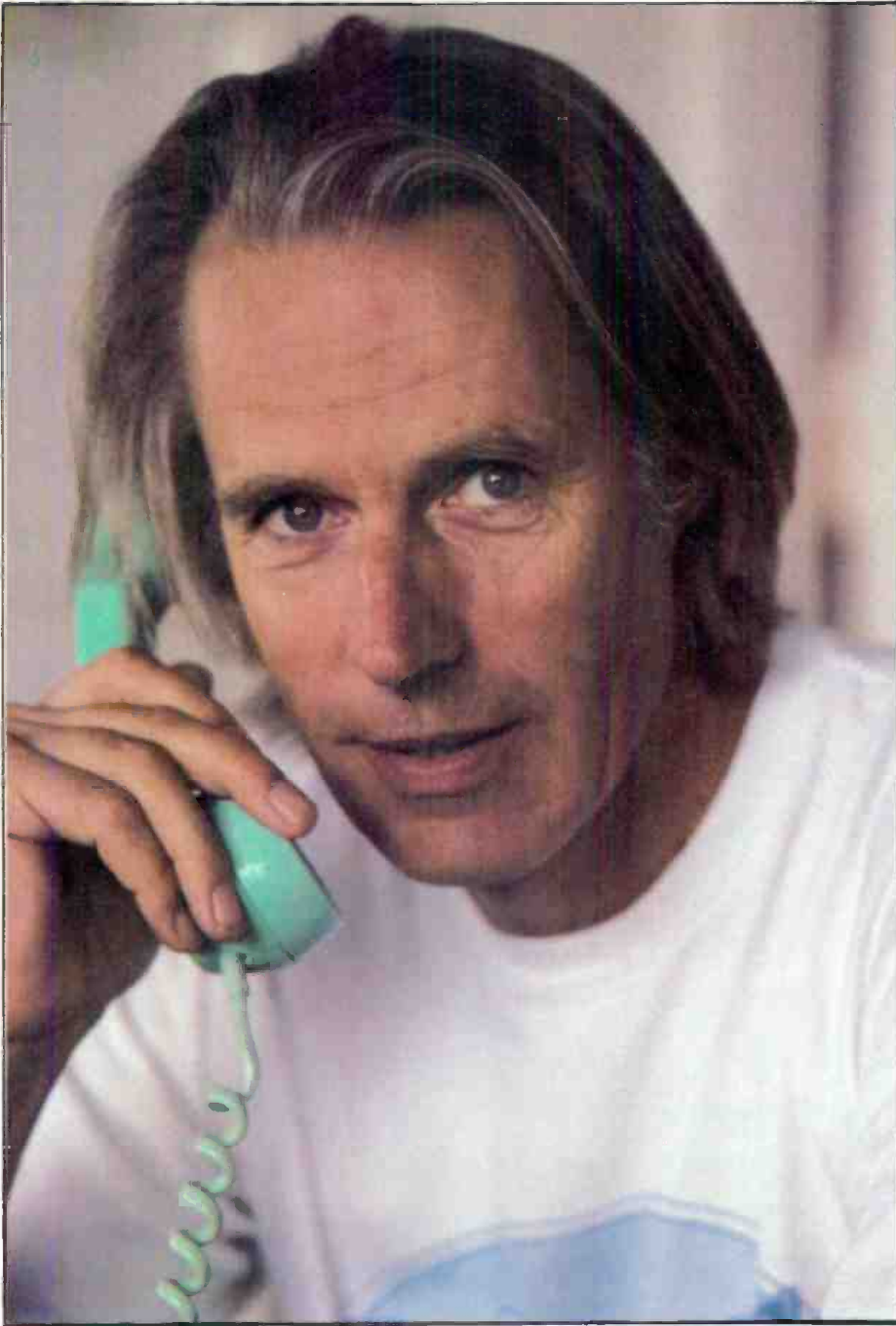

*Tom Lubin: What do you think the role of a producer is?*

**George Martin:** Big question isn't it. It's changed. It changes with the time. I guess the role of a producer is to produce a record as well as he possibly can, using the best of the talent available to him, which means that he has to get more out of the artist than the artist is capable of getting by himself. There's been a tendency in recent years for the artists to want to produce his own record because the role of the producer has become too important, it's been kind of self-defeating. The 'cachet,' "produced by" has become such a coveted title that the artist themselves have become jealous of it. So they say, well, I'd much rather not have you around, I think I can produce it by myself. I'd

like to have "produced by" not just "sung by."

In the main I think it's to their disadvantage, because the problem with a certain produced piece of work is that the artist can't be completely objective and a prime role of a producer is to be objective. He needs to step back and look at the whole of the painting instead of just concentrating on the brush work in the corner. It's one of the most important parts of making a record. He must also contribute, and be creative. He must see within the raw material, both the song and the voice, something which can be brought out that other people may not see. He has various ways of doing that. Some people do it by taking their ideas and giving them to the

artist to carry them out. Then the better ones do it in such a way that the artist feels he could have easily done it himself.

*Tom Lubin: How do you get an artist to think he had a particular idea?*

**George Martin:** It's not very difficult since most of them think they did anyway. I'll give you an example. If I want a particular ending to a piece of music and the guy, the composer, goes to the piano and I say, "That's fine, but I don't like the ending very much. I think you might do something about that." And he'll say, "What kind of thing do you mean?" And I'll say, "Well, I think you ought to go to a kind of unrelated mood, finish up some pattern you're doing." He'll say, "Like this?" "No." He'll try something

# YAMAHA'S NEWEST TOURING PROFESSIONAL.

Yamaha's new PM-2000 Mixer. Ideal for professional sound reinforcement, it's the kind of full production console pros have always had in mind, but never in hand.

The PM-2000. The touch is solid, smooth, consistent. It feels like the professional console that it is.

The knob, switch and slider placement anticipate where your hands will naturally fall.

With 5-position, 4-band equalization and six independent sends on all 32 inputs, plus a full function, 14x8 matrix, the

PM-2000 has everything you would expect from the consummate professional console.

And if the PM-2000 looks and feels like a custom console, and seems to have read your mind, it is no accident. Because Yamaha spent two years on intensive research

and prototypes based on input from professionals. One touch and you'll realize: the PM-2000 feels how you think.

Available soon on a limited basis, through select Yamaha dealerships.



P.O. Box 6600, Buena Park, CA 90622  
Write for complete information on the PM-2000.



else and I'll say, "No." Well, pretty soon he'll get it.

I knew all along what it was I wanted, but instead of taking his hands off the piano and doing it myself I had him try it, and about the third time around he had it. Because later he'll say, "You know George said something about the ending so I made this change at the end and it really works great." That's really how it works. It's a very subtle thing.

*Tom Lubin: What we're talking about is diplomacy.*

**George Martin:** Absolutely, it's essential. Though it can rebound on you. If you take it to its logical conclusion sometimes the artist will say, "So what the hell do I need him for, I did it all myself anyway." That is the danger. On the other hand most people do have pretty big egos, and it is necessary to pander to it in order to get the best out of them.

*Tom: Diplomacy is as much a part of producing as making musical decisions.*

**GM:** There's an awful temptation if you're good at something to show off because

everyone wants to have people say how clever you are. Everyone wants to be able to do something that people say is great. That's a thing that a producer must always resist. He really is subservient to the artist. He is not the talent that is being promoted, he really isn't. If that were the case he could then make his own records and be done with it. He is there to serve, to guide, and encourage the artists. And at all times he's got to be careful to not push too hard. He's got to lead rather than drive.

*Tom: At what point do you think a producer should become involved with a project.*

**GM:** From the very beginning when the material is first played. Before the Beatles, the role of the producer, who wasn't called a producer in those days, was very much a role of song picker. The day of the singer/songwriter hadn't really arrived. The tendency in those days, pre-1960, was to find really good professional singers who didn't necessarily write their own songs, though sometimes they tried. But generally there were songwriters who wrote really good material. But they couldn't perform. It was the wedding of those two.

The producer's main role in those days was to pick really great songs for really great artists and put them together; choose an arranger or whatever, and produce the record in that fashion. That's what we all did. And then came along the Beatles. And things started changing because the Beatles started writing their own material. Other people wanted to do the same thing. A lot of singer/songwriters came along. And the producer's role changed. Since the songs were already there, it became more a question of shaping the songs; of helping the songs along. Saying, "Right, I think you ought to go into the middle eight a bit earlier," or whatever.

That role lasted for quite a while. Now, I think we're coming back into the other phase, because there is no doubt that albums are selling because of singles. You've got to have a hit single if you're going to be a success, and the selection of the raw material is absolutely crucial. And so we have the situation where the producer has a very, very important role of picking songs.

*Tom: His role seems to have been broadened as well by the extensive use of orchestration.*

**GM:** Yes, but there's a lot of records without heavy orchestration; the group does the sweetening themselves. Use of synthesizers have made it that much easier.

*Tom: What do you think the role of the engineer is?*

**GM:** To make a good technical record is the simple answer. Again, over the past fifteen years there have been changing elements within the roles of these two people.

## Dr. Les Remsen has faith in Quantum Mixers!

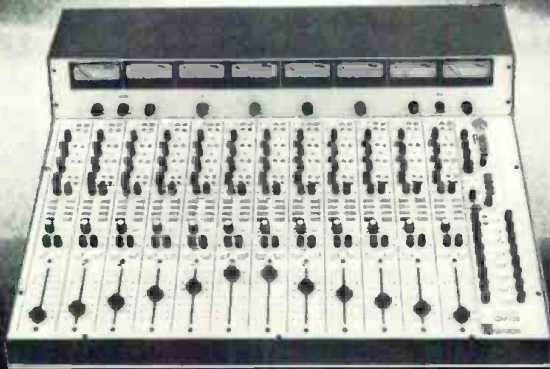

QM-128 — 12 In, 8 Out

### WHO IS LES REMSEN . . . AND WHO CARES?

A while back, Les Remsen bought a Quantum QM-168 mixing board and set up a small studio in his church. Since that time, he's made over 100 classical music albums for about half a dozen labels, plus assorted demos and audition tapes. Incidentally, Les holds a Dr. of Music in performance, was formerly first trumpet in the L.A. Philharmonic, and heads Avant Records.

### LES CARES

He may not be recording the Bee Gees or Peter Frampton (they have their own Quantum boards), but Les Remsen wants every track he lays down to be the best. That's why he chose Quantum.

### WE CARE

Because every artist wants his demo and master recordings to meet the highest professional standards, we build small Quantum boards with the same care that goes into our large studio consoles. We also sell our mixers at a price young artists and engineers can afford. Dr. Les Remsen puts his faith in Quantum, and so do a lot of others on their way up. How about you?



**QUANTUM**

AUDIO LABS, INC.

1909 RIVERSIDE DR., GLENDALE, CALIFORNIA 91201 • (213) 841-0970

# More Than Great Specs, Great Ideas.

For the past three years we've been telling you about the benefits of using graphic equalizers; now we've made it even easier to appreciate them. Introducing the MXR Dual Fifteen and Thirty-One Band Equalizers. Two equalizers designed with the imagination and understanding to solve your toughest equalization problems. Designed for use in either studios or sound reinforcement situations, our new eqs offer features not previously available at any price.

The Dual Fifteen Band Eq features two channels of equalization with the bands set two-thirds of an octave apart. By breaking the frequencies down further than conventional octave equalizers, you now have the flexibility to contour your music with much greater selectivity. As most musical information occurs in the midrange, this is where you need even more definition, and the Dual Fifteen Band Eq gives you six bands of contour in this area rather than the usual four. In addition, each channel has its own level control.

The Thirty-One Band Eq divides the frequency spectrum even further. A single channel unit, the Thirty-One Band features frequency bands set one-third of an octave apart, generally regarded to be the optimum amount of resolution.

When used in conjunction with any PA system, our equalizers can make a bad environment sound good, and a good performance sound great. Unlike parametric equalizers, the frequency response change is immediate and easily visible, so that when you shape a response curve you know what it's going to sound like.

Both units feature a range of -12 to +12 decibels on each band, standard 19" rack mount, and the rugged construction you always get with an MXR product. Both units also feature phone plug input/output connections, (the Thirty-One Band also features Cannon type XLRs), high slew rate (7V/microsecond), and incredibly low noise (better than -90 dBm). But not only do we offer great specifications, we produce great ideas... you wouldn't expect any less from us.

MXR Innovations, 247 N. Goodman Street, Rochester, New York 14607, (716) 442-5320.

**MXR** Professional  
Products Group

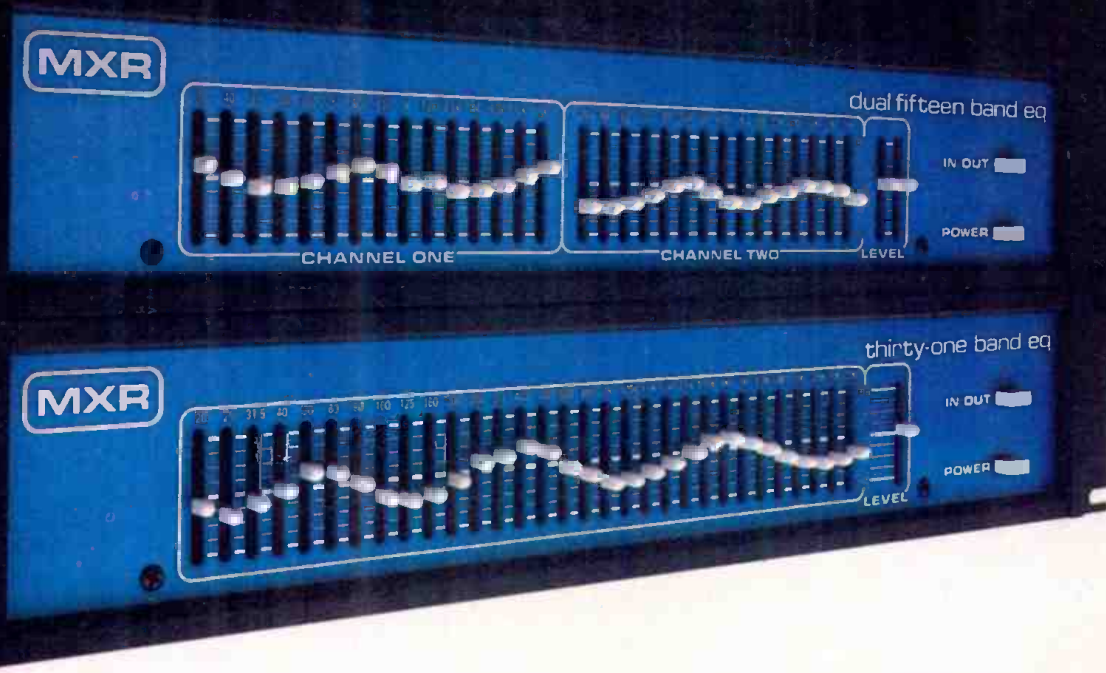

Many times they've become immersed in each other's way. In fact, the role of the engineer/producer has become very important. I should think of all the records produced in this country, half of them are produced by engineer/producers; a great many are. Obviously, I'm an old-fashioned type of producer, and obviously I think it's better to have two heads rather than one, if they work in good harmony. The complementary roles of a top engineer working with a top producer produces a better result.

When I'm working with someone — like Geoff Emerick, who I've worked with for years since I tossed him in the deep end and now one of the great producers of all time — we know each other so well we don't have to talk. He knows what I'm thinking; I know what he's thinking. I know the kind of sounds he can get. He knows the kind of sounds I want. Consequently, we don't get



Rehearsing vocals for "America",  
Hollywood Bowl.

in each other's way; we don't waste time. He concentrates like mad to get a really great technical sound. If I say, "Geoff that bass drum sounds a bit flabby," he'll say, "Okay, I've got it." He goes off. I literally forget that problem, because I know that he'll give me a great bass drum sound. In the meantime, I'm working on the music. He might say to me equally, "Do you think that chord works there, George?" And I might say, "Yes, Geoff, I think it does," and I fume a bit. Or, I might say, "You know, maybe Geoff is right about that; I hadn't thought about that."

And that's as far as our roles overlap. We stick to each others' work. And the result is

we come up with something that an engineer/producer would take longer to do, if he does it as well, because he's having to think of all things at once. He has to think of keeping the band happy, of looking after the technical side of it, running around to all the instruments, and so on. And at the same time thinking of the music. And I frankly think it's too much for one person to do.

*Tom: Do you think your production style has changed with the advancement of the recording technology?*

**GM:** It's bound to have changed because of the years I've been in the business and the way it started. In the beginning it came out of a tiny little hole, and that was all the sound you got. That was a mono sound. It was really restricted. The equipment you had to play with was extremely limited. If you wanted to be *avant-garde* in any way you had to make your own tools. It was literally like living in the Stone Age.

If I wanted an electronic sound there was just no such thing as a synthesizer. I'd have to make it myself, bang on the piano wires, and speed the tape down or double it up, or whatever. The most elementary way of doing concrete music. As the techniques changed, the development of records made that little hole in the middle a big, panoramic wall of sound. I see that wall not as a line, but if I can be a bit pretentious, I see it as a painting; if I could think in terms of sight in relation to sound. I'm thinking of putting bits here and there, and hearing things coming out, and going back so that there is depth as well as breadth. I think three dimensionally, where something is way back behind. A hundred yards back. And I can hear things right in front. As I started developing that process, that was when mixing became fun. "Pepper" became an ego trip, and a hobby as well. I used movement. I found when panning it not only went left-to-right, but it seemed to go above me.

Later on, when we had quad, we had the facility to bring the sound out in front of the speakers. Ah, well! But that died a death.

*Tom: Do you think quad will ever make a comeback?*

**GM:** It may do it, but the improvement of stereo over mono was enormous; let us say it was 100 per cent better. The improvement of quad over stereo wasn't as much, maybe 20 per cent better. And the encumbrance of it all didn't make it worthwhile for the average listener in the home. Mrs. Jones will put up with two speakers, but when it comes to four she's going to put her foot down.

*Tom: The texture of the echo on the original Sgt. Pepper is quite different than the film.*

**GM:** I think the answer is that plate echoes have become better. In the old days at Abbey Road we used to have a great chamber, and we would use a combination

of chamber and tape. We called it Steed. We would vary the amount of tape going into the chamber, and so on; sometimes using it straight. In the end we'd get a combination of all things.

Nowadays the EMT plates have become so good that they almost sound like a live room. Today we use EMT and tape together. In fact, we don't have live chambers at Air. We built one but it didn't sound as good as the one at Abbey Road and it took up too much space. EMT's work better anyway.

*Tom: I'd like to go back before the Beatles.*

**GM:** I was running a label. I was running Parlophone Records. It was a pretty small label, but I was responsible for all the music on it and, as I was responsible for the success of that label, I had to decide what records to sell. During the time that I was doing that, the British market was dominated by the American charts. The best sellers were all American. A label that didn't have any American product was bound to be unsuccessful, and my big brothers at EMI — which were Columbia and HMV — had people like Elvis Presley, Guy Mitchell, Doris Day, Frankie Laine and Frank Sinatra. Coming in on that Parlophone was never a very successful label. We had no American artists at all; we had to make our own.

The British rock and roll industry didn't exist, then. Rock was just beginning in the late fifties in England. What we did have was skiffle. Have you heard of Lonnie Donegan?

*Tom: No.*

**GM:** No! He had quite a bit of success. Ha! I guess it's too far back. Lonnie Donegan was about 1958.

We had a pseudo rock and roll star, who didn't really become a rock and roll star at all, but became a general entertainer named Tommy Steele. That was after the start of Presley. Lonnie Donegan started skiffle, which was kind of a mixture of bluegrass music, but an English version. And I had a skiffle group called the Viper Skiffle Group that did very well, and a rock and roll star named Jim Dale that was not as successful as Tommy Steele. He eventually gave it up because he wanted to be a comedian. He now appears in Walt Disney movies and such. We had a bit of success with him.

And then along came Columbia with a new guy that was different than anybody else but fairly anonymous in his sound, and, of course, he's still there after twenty-one years — that's Cliff Richard.

During this time I got into comedy records. I did an awful lot of it and became sort of the comedy king in England. I recorded people like Peter Sellers and Spike Milligan; shows like "A Drop of the Hat" and "Beyond the Fringe." There was a whole string of comedy records. It was a

# Smoketree Ranch

"AIC and MCI lived up to their reputations."

"IT WORKS"

*Doug Parry*

President



SMOKETREE Studio's Automated MCI 528 console and JH 24 Multitrack.

*Systems design and installation  
by Audio Industries Corporation.*



*The people  
and the products —  
We have them both.*

Smoketree Ranch  
9752 Baden Avenue  
Chatsworth,  
CA 91311

(213) 998-2097



**MCI**

**audio industries corporation**

1419 N. LA BREA AVE. • HOLLYWOOD, CALIFORNIA 90028 • (213) 851-4111 • TELEX 67-7363



Working out vocals.  
Caribou Studio.

breakthrough in England because nobody else was doing it at that time.

During the same time that Stan Freeberg was a big success over here, Parlophone became sort of an oddball success for a small label, and I got the reputation for doing weird things, but which happened to come off. I was producing every record on the label; kind of one man band. I was handling the business as well, you had to in those days.

I was very envious of the ease with which Columbia had hit records with Cliff Richards because this guy was a kind of sex symbol. All he had to do was find a fairly reasonable song and it became number one. Whereas, there I was sweating my guts out trying to find a really clever funny song for Bernard Cribbins to follow up "Hole in the Ground," as each one was a one-off job.

I was looking and looking for something like that. And it was at that stage in my life when I heard a tape that Brian Epstein brought in.

I met them [The Beatles] in April of 1962 and signed them in June or July to Parlophone. We issued our first record in November, 1962, which wasn't enormously successful. The first record that became number one was really the second release, which was "Please, Please Me," which was issued in February of 1963.

So began the whole she-bang that became just one golden treadmill. It never stopped. I nearly had a nervous breakdown in the balance. I was producing an awful lot at that time. Too much.

*Tom: In 1965 there was a definite American sound and a British one. It's become very much one in the same. You've seen quite a change in studios.*

**GM:** We always thought we were way behind and, of course, we were.

Around 1955 when British recording was fairly primitive, I paid a visit to America. Capitol by this time had been bought by EMI. I visited the Capitol tower where Frank Sinatra reigned supreme. I went to one of his sessions and was enormously impressed with the studios. They had things like limiters, which we didn't have. They did things to sound which we couldn't get. And they had three-track recording on half-inch. We were still in stereo. We had twin-track.

That's all we had. It wasn't just the facility or tape; the whole approach was much more as it is today. It was the beginning of the electronic revolution. Their monitoring was better. The handling of the whole thing was very impressive, very modern.

So I went back to England saying, "For Christ's sake, we've got to pull our socks on!" I started beating around the EMI people telling them they had to have better machinery and better studios otherwise we couldn't compete.

It so happened that during that same time a new generation of recording engineers were developing at EMI. I will say this much for EMI: It was a breeding ground for talent and, though they didn't provide us with very many good tools, they didn't stop us from experimenting. It was almost like a laboratory. It was generally done on a shoestring. We'd listen to other people's records and try to figure out how they were done and try to do them ourselves, though not very successfully.

We had very limited technology, but eventually we got it — the beginnings of multi-track. EMI made their own tape machines, and then we started getting machines from Germany and limiters from America, and new kinds of microphones from the Continent. And the whole thing started moving along.

By the time The Beatles had made their success we were getting pretty good sounds. The studios had a tradition of good acoustics and once they were coupled with the modern technology they were as good as any studios in the world.

When I went back to America in the heart of The Beatles thing, I went back to the same studios that I had seen years before at Capitol and I found that they hadn't changed and were now very old-fashioned. I was shaken. We had reversed places.

*Tom: That was about 1965. At that time the acoustics of English studios seemed to be quite different in design than their American counterpart.*

**GM:** Well, it's very difficult to generalize because studios vary like hell wherever you go. It's still true to say that most American studios are deader than most English studios or Continental studios. Here they seem to like wrapping the drums up in a soundproof box so the sound doesn't go out too much. The Hidley designs always provided a drum box in the corner with a bass trap overhead to soak up sound. The obvious thing of having that kind of treatment is you get very good separation which we tended not to get in our English studios because of the very nature of our livier rooms. But we used to get a better string sound and generally more "air" around our recordings. I think that's still true, but as you say . . . like the rest of the world we've tended to become less different.

I mean it's in everything; in our way of dress, our lifestyles. The world is shrinking.

There are one or two studios in Los Angeles that are like British studios. There is still a difference between a British and an American studio, and it's obvious I prefer the British ones.

*Tom: Do you think there's a difference in engineering attitude between the British studios and the American ones?*

**GM:** I think the engineers in England are trained more to pay attention to detail. I don't mean to sound like carping, after all American studios are very good; but we tend to line up things with a greater degree of accuracy and consciousness.

For example: Dolbys. We tended to use Dolbys before America. In the early days Dolby got a bad reputation in the States because people said they colored the sound. I think they do, actually, but that's neither here nor there. There was a very strong feeling against them but we preferred the coloration of the Dolbys to the hiss. Now, granted, we spent a long time before each recording making sure that every one of those Dolby units were really right, really tuned properly. I found that when I came over here I was getting bad results from them so I started using 30 ips without Dolbys.

In England where I could control them and I knew what I had, I used them. Now, curiously enough, Americans are tending to use Dolbys more whereas we are thinking of dropping it all together. I have Dolbys in Montserrat only because I have to. When I'm working there I won't use them.

*Tom: Why do you think there is such a difference between English and American engineers?*

**GM:** I think there are different pressures on English engineers. I think they're not as well paid, which is cutting across my own argument while on the other hand I don't think they have the internal pressure that American engineers face. Here in the States we seem to grind the engineers into the dust and expect them to be there the following morning at 8:00 a.m. when they've just finished a session at 4:00 a.m. They're expected to work around the clock, and weekends are an automatic rule.

You question one of them here, "What do you mean you didn't have a holiday this year?" and he'll answer, "I haven't had a whole day for the past five years." I think we treat engineers a bit more humanly in the U.K. even if we do pay them worse.

*Tom: Who are you influenced by? So many people listen to George Martin records.*

**GM:** I don't listen to much more. Obviously, I listen to the records that are high in the hit parade or anything that's been brought my way as being interesting, but I don't really



# The new DN34 analogue time processor.

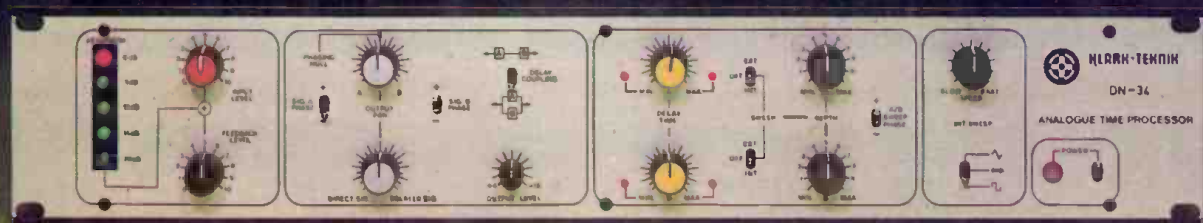

## Think of the effect you'll have.

The new DN34 analogue time processor is an exceptionally versatile signal processing and special effects unit, designed around two discrete, independently controllable delay sections.

Like other Klark-Teknik products, the DN34 is the result of intensive research and development - the best there is in state-of-the-art analogue delay technology.

With a product of this stature you can achieve all these effects cleanly and noiselessly.

- Positive flanging.
- Negative flanging.
- Double tracking.
- Resonant flanging.
- Triple tracking.
- Loudness enhancement.
- Pitch detune.
- Pitch shifting.
- True vibrato.
- Chorus.
- 'Cardboard tube' echo.
- Doppler/Leslie effects.

And, if this isn't enough, the DN34 can give you such new effects as:-

- Crossover flanging.
- Time-related frequency synthesis.
- Complex Doppler effects.

The DN34 analogue time processor also offers you:-

- A dynamic range better than 90dB.
- A time sweep range of 70:1.
- T.H.D. at less than 0.3%.
- Numerous exclusive features including full 'on board' mixing and phase reversal facilities.
- Amazing performance and value for money.

The DN34 is unequalled in the signal processing field today.

And we're not just saying that for effect.



## KLARK-TEKNIK

You know it's the best.

For further information about the DN34, our new DN70 digital time processor, and also our DN27 and DN22 graphic equalisers:

**Hammond Industries Inc.** 155 Michael Drive,  
Syosset, New York 11791 (516) 364-1900; West Coast  
Office (213) 846-0500; Canada (416) 677-0545

listen to a great many records. I don't really get all that much time to just listen. I do most of my listening in the car.

*Tom: I'd like to talk about the Jeff Beck "Blow by Blow" album. That album stands alone as being quite different from all the other records that you've produced.*

**GM:** A lot of people told me I shouldn't do it before I did it. The combination of Jeff Beck and myself was an unlikely one; for that reason I wanted to do it. I've always admired his guitar playing which is fantastic. We got on fine; we were both prepared to do something different.

*Tom: The guitar sound on "Blow by Blow" has a great deal of space around it.*

**GM:** We used a big room to record. With Jeff I set out to get what he wanted to do and what his sound was. Jeff is not a very technical person. He's the kind of guitar player that plays by the seat of his pants. When we were doing "Blow by Blow" he had pretty rotten equipment. I think he had two guitars and, at any given time, only one of them would be working. He'd be cursing the thing and flinging it across the room saying it was no good and he wanted another one.

When he played he would generally bring a small amp and we'd use number one at Air as a kind of ambient chamber. The guy who engineered "Blow by Blow" was Denny

Bridges. He doesn't do too much engineering these days but is helping John Burgess with Air Studios. Dave Harries, the manager at Air, is out at Montserrat developing that. Denny did get a good guitar sound because it was a fairly natural one. We didn't use very much direct insertion, we did it mostly through an amp, using the studio.

*Tom: Did you have Jeff working in the studio or was he working in the control room with lines run out to his amp?*

**GM:** When we were working with the group we had him in the studio. When he was overdubbing we had a line running to the studio and he was playing in the control room.

*Tom: Do you like working that way — with the player in the control room?*

**GM:** Sometimes, but sometimes it doesn't work. I've seen an artist get awfully inhibited with everyone sitting around waiting for him to produce a work of genius. Jeff found that very inhibiting. Jeff is essentially a guy who does his best work when he's blowing to a crowd. Within the confines of the studio he found it very difficult to play anything inspired. The only difficulty I had with Jeff was that he would play something I would try to encourage him by saying, "Yes, that's great . . . now try it again." And he'd turn around and say, "You know damn well that's

not great, it's absolute crap." That was the kind of problem one would get.

*Tom: Were Jeff's guitar parts pretty much complete takes or was there a lot of punching-in or multiple takes?*

**GM:** Generally we had a number of takes.

*Tom: On one of the America records — particularly "Hideaway" — the brass sound is excellent. Do you happen to recall how you recorded them? Do you use a small brass section and then double- and triple-track them or use a large one, much like an orchestra?*

**GM:** I'm smiling because I get this quite often, and I'm always somewhat embarrassed about it because the truthful answer is that to most of these specific questions I have to think very hard because I can't remember. When I've done records in the past I just do what I think is right for the time. I certainly don't make notes about it. I think we did the brass on "Hideaway" back in Los Angeles, at Western. I like Western. We did some in that big room in Burbank. I think that was the orchestral things. I don't think the brass were done there. To my memory we didn't use anything special on the horns. It was Geoff again, and he was just using the microphones he always uses. I use a large section, or at least on those recordings I did. I wrote it like it would be a performance.

# The Series 1600 Recording Console.

VCA grouping, Automation, Spectrum Analyzer.  
Available with  
Trans-Amp LZ\*.

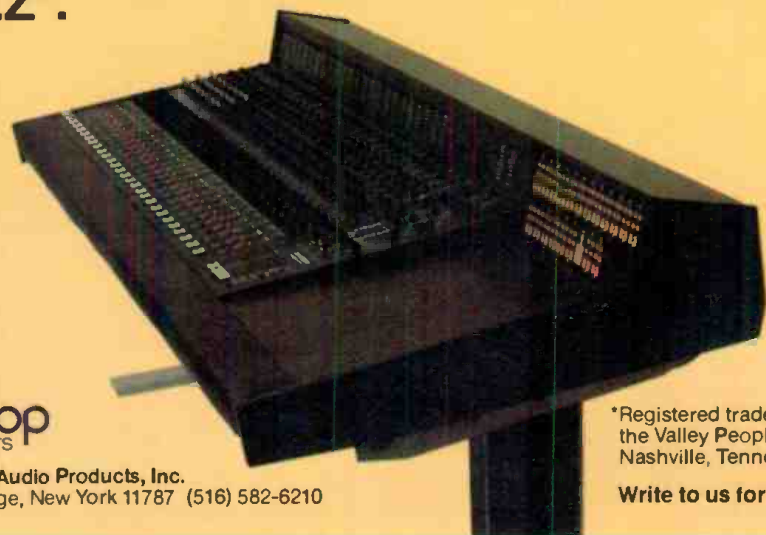

**Sound Workshop**  
PROFESSIONAL AUDIO PRODUCTS

Sound Workshop Professional Audio Products, Inc.  
1324 Motor Parkway, Hauppauge, New York 11787 (516) 582-6210

\*Registered trademark of  
the Valley People, Inc.,  
Nashville, Tennessee.

Write to us for details.

**Tom:** Do you approach it like it was a classical recording using, say, a stereo pair of microphones.

**GM:** Yes, we do use that on strings quite a bit. It's a combination of that and direct miking as well. I mean if you can get away with just a stereo pair on an orchestra and your using a good room, it's a lovely sound. But it's very difficult to do that when you need things brought out; they need a certain amount of help. I try to write most of my score so they sound naturally right without having to artificially raise the volume of any particular one section.

**Tom:** Do you write your score before the basics are cut?

**GM:** No, generally the score is the last thing to be done.

## The SGT. PEPPER MOVIE

**Tom:** For the Pepper movie was it completely scored before being recorded?

**GM:** It really depends on what part of it we're talking about. There was an enormous amount of work involved. There's about 200 minutes of music. I was scoring right up to the film dubbing. Little background bits here and there. Sweetening, for example, on the Alice Cooper tune, "Because," was basically very similar to the original except for his spitting out the words. But, in fact, it wasn't because there was a lot of sweetening on it that was not on the original; strings and such. They were rather weird strings that were done to fit the picture.

Have you seen the picture?

**Tom:** I tried seeing it, but it wasn't playing in San Francisco.

**GM:** I don't suppose you've missed very much. It wasn't the best picture in the world, but neither was "Grease." So on one hand you have an enormous success and on the other a bomb. I can only presume that people weren't prepared to accept a third Stigwood film. I think the public had a reaction to it. The fact that The Beatles were being played by the Bee Gees and Peter Frampton must have incurred some sales resistance before the word go.

**Tom:** I would assume that you were given which song would be done and who would sing them.

**GM:** Yes.

**Tom:** Were you able to pick your players?

**GM:** Yes.

**Tom:** You must have put quite a lot of thought into who would re-play those basic tracks.

**GM:** Well, I was in an impossible situation anyway having to make a soundtrack of

that. So I decided that what I would do would be to make the music sound fairly authentic where in the picture the group is supposed to be an up-and-coming group. Then make the music a little more sophisticated as they became more successful. We started off with the original sound and then brought it up to date.

You might say what The Beatles would have tended to do if they were still working today. I wanted something where the basic rhythm tracks could be a little bit more hip than the basic rhythm tracks of 1964 . . . which weren't very clever, you know; just sort of a bashing noise, really. They were

good records, but there was nothing particularly hip about them. So I wanted something a little jazz oriented. It was slightly watered down because of the songs themselves. There's only so much you can do without destroying a song.

**Tom:** I wondered if you used any processing on the Alice Cooper vocal.

**GM:** That was just him. I got him to speak it or hiss it more-or-less. You see, it was a nasty bit of work in the film. The sort of cloying vocal effect on the original was duplicated by the Bee Gees, which was countered by the nastiness of Alice Cooper.



There's a  
new group  
in town.

Professional performers for stage and studio...from ATLAS SOUND, the world's leading manufacturer of microphone stands and booms.

Take these Porta-Stand headliners, for example. For today's artist there's Model PS-C, America's first floor stand with spring-action telescoping legs, most practical where mobility or transportation costs are a consideration.

For acts that have their ups and downs, Model PS-S features our exclusive touch-control clutch that makes height adjustment so easy, you can raise and lower the microphone with one hand tied behind your back.

There is Model PB-1, one of a series of new easy-adjustment microphone boom attachments which fit all ATLAS SOUND microphone floor stands.



And, for choir or studio, the mobile model SB-100W Boom, 9 ft. long, with its unique flexible drive balance-control and 350° microphone-follower.

There are even two new desk-top microphone stands — one of decorative Carrara marble, the other with a vibration-isolating base for sound-absorption no matter how strong the beat.

For details on these and other microphone stands/accessories headliners, Contact: ATLAS SOUND, Division of American Trading and Production Corporation, 10 Pomeroy Road, Parsippany, NJ 07054; Tel. (201) 887-7800.



George Martin with engineer Geoff Emerick.

*Tom: On "A Day in the Life" — the last piano chord. I was wondering if you had gone back to EMI to get the same piano.*

**GM:** No. To begin with, on the original we used three pianos: two grands and an upright played three times. In other words, I played one and John and Paul played the others. We all played the chords. As a matter of fact we had several people on a piano. We'd count and hit the chord together, and then overdub a couple of times with lots and lots of percussion.

This time we were working in Cherokee Studios and I just used one piano. What I did there was to do it about nine or ten times on 24-track; each time I did it in a different key to give me different overtones. So if the basic chord was in F, I put one chord down in F. And then I would speed up or slow down the tape and play the chord in a different key to

change the timbre. I used ten completely different keys at different speeds. When it was put back to normal speed it was monstrous. I did something similar with the strings.

In fact, I had to explain what I wanted done. I divided the cellos and gave half of them just the root note. They were to play very softly to give me a sense of tonality to the whole chord. To the violin, viola and the rest of the cellos I told, "These are the notes you play. Let's say it's an E minor seventh chord, so you play E, G, E and D, and you can also play — if you want — an A. What I want you to do is play any of those notes ultra-pianissimo at any time in the sequence you feel like; but they must be in this tempo." The tempo was a very quick rhythm pattern. Every person was to do something different than the player who was next door to him. They all looked at me as though I was crazy and deaf. So! . . . what we got was this kind of shimmer of any minor seventh chord. And it sounded good. It was just an effect. I did that seven times over with seven different chords and kept it going for about twenty seconds.

Then we made loops of each one, put them on machines and played them through faders and dubbed them over to seven tracks of one 24-track. I had a continual sound of whatever the chord was, and then I just mixed in where I wanted it. As the song went through I would play the fader like an

organ, fading up the strings as a background for the song. It doesn't sound like strings, but it doesn't sound like a synthesizer either.

*Tom: Do you use a conductor so that you can be in the control room and hear the results, or do you stay in the studio and listen to just playbacks?*

**GM:** Sometimes I just get the first violin to take it.

*Tom: On the new version of "Good Morning," the phasing effect on the drums . .*

**GM:** Yes, we phased just the overheads, not the whole set, though undoubtedly some leakage of the rest of the kit got phased as well.

*Tom: There was quite a lot of phasing on "Lucy in the Sky."*

**GM:** Yes, that was a weird one, too. A lot of synthesizer stuff on that. Michael Schultz wanted a very psychedelic effect. He wanted it to be a dream-like sequence, so we did rather over-do it.

*Tom: You worked off the script?*

**GM:** Yes. I worked very closely with the director.

*Tom: Is that why you did it here in Hollywood?*

## THE STATE OF OUR ART

- New "series II" improved headsets
- 50 station capability with up to 8 channels using SB8 switchboard monitor
- External program feed with volume control
- Wide frequency response (200Hz to 12kHz) for exceptional intelligibility
- Designed for high noise environments
- Visual signalling uses bright amber lights
- Adjustable sidetone reduces feedback and background noise

- Mic on-off feature standard with headset and remote stations
- Single and two channel systems virtually immune to RF and SCR dimmer noise
- Remote stations available in portable, wall mount and rack mount versions including speakers for paging and monitoring
- Catalogue with complete specifications available upon request



**Clear-Com**  
intercom systems

759 Hamson Street  
San Francisco, CA 94107  
(415) 989-1130



**GM:** They insisted that I do it here because they were so late with their cutting. Ordinarily when you do a film you get measurements from the director. You get a rough cutting and then when the picture is finished, or almost finished, you'll get a fine cutting or editing. You can't really start scoring while the director is still chopping the film around and altering the length of things so you don't really know what you've got to write to until you have the fine cut.

Well, I was promised the fine cut on April the twelfth and was geared up to leisurely do the scoring after that. As it turned out, we didn't get the fine cut until two weeks into dubbing. He'd actually finished some of the reels and started dubbing while others were still being cut.

**Tom:** How much was recorded before the film was shot?

**GM:** I did the basics first and all the sweetening was left until afterwards.

**Tom:** The vocals were also later?

**GM:** No, the vocals were done before shooting. They had to sing without any of the strings and such. But it wasn't quite as simple as that because quite often he would cut a song. For instance, George Burns' vocal on "Fixing A Hole." Although I had done all the vocal that song was cut in half and whole phrases were taken out. Michael

would come back and say, "Look I want to get rid of this sequence, would you mind him not singing this line." And I'd say, "Sorry, you can't alter the song that much." In the case of "A Day in the Life" he wanted to cut out the complete middle of it. I put my foot down and said, "No, you just can't do that."

**Tom:** While doing this project you must have had a number of moments that took you back ten years. *Deja vous . . . there must have been a measure of sentimental feelings.*

**GM:** I got over my hangups when I decided to do it because I thought that if I had hangups about it, I'd never be able to do it. For a start I didn't look at it as though I was making a record. I had made the record in 1965; this was making a film, and that was how I got past it. I really didn't relate to what had happened before except as a basis from which to start. It was like being involved with Gershwin's "Porgy and Bess" on the New York stage and then having to do a film some fifteen years later.

That was my justification for sticking fairly close to the originals. I really didn't view it as a duplicate of the record.

**Tom:** On the live America album Elmer Bernstein conducted. How did you like his conducting of your score?

**GM:** Real nice. Very good musician. I

couldn't do the conducting myself, so they got Elmer to do it. Well, some of the scores that I had originally done had got lost, and I didn't have a copy myself. So Elmer, though I don't think he did it himself, got someone to listen to the record and take down the scores so they could be reproduced with the live orchestra.

When I heard the scores they sounded different. They were written in a way I never could possibly have written them. The notes and chords and lines were right, but the way they were disposed over the orchestra was different than my style of scoring. The guy had listened to the records and had figured out that I'd done things that I really hadn't done, which was interesting. Elmer hadn't seen the difference either. There was a lot of dividing of the string lines which I rarely do. I guess they thought it made things sound fuller.

**Tom:** That album was cut live at Greek Theater, in Los Angeles. Did you have any particular problems working there?

**GM:** No, it's a good place, one of the best around. It's a damn sight better than Hollywood Bowl.

**Tom:** America's "Harbar" record was cut in Hawaii. You cut all the basic and vocals there and sweetened it back at Air?

**GM:** That's right. We did absolutely

# DYNAMIC VERSATILITY

## TO ACCENT ANY TYPE OF PROGRAM MATERIAL

### IS YOURS WITH

# DYNAFLANGER

FEATURING TRUE AUTOMATION — WITH PROGRAM CONTENT AUTOMATICALLY CONTROLLING PROGRAM CONTENT IN ACCORDANCE WITH PARAMETERS THAT YOU ESTABLISH.

**MIX** MICMIX-Audio Products, Inc.

(214) 352-3811

2995 Ladybird  
Dallas, TX 75220

everything that could be done without an orchestra because it was a pretty expensive process just recording out there. You know we had built our own studio in a house. I had done that before a number of years ago while I was recording *Sea Train* in Massachusetts. But in Hawaii it was the only thing to do because there wasn't a studio there. The only studio in Hawaii was on the island of Oahu, which was a 16-track. The boys wanted to go to Hawaii, so we found an old, large house on the seashore that had a good room in it and we made that our recording studio.

I did a kind of reconnaissance with Geoff. We gave the realtor the specifications as to

what we were looking for, and then had carpenters build what we needed, batten screens and things. We hired a Yamaha piano from Japan, and brought in Record Plant's mobile truck. Geoff used the same desk later on the boat with Paul McCartney. We had our own little studio right there . . . very cozy.

### The AIR MONTSERRAT STUDIO

*Tom: Tell me about the new studios.*

**GM:** The new studios are on Montserrat, which is a small island 27 miles from Antigua.

Antigua is in the middle of the chain of Caribbean Islands. Antigua is kind of a focal point because it's an international airport. You can get to New York, Toronto and London on direct flights. So it's quite convenient. We've got a thirty-acre site there. It's a lovely island, very green.

We chose the island because I wanted to build a total environment studio. I'd been looking for a long time. In fact, Hawaii was very appealing. When I did that album with America on the island of Kawaii, I was sorely tempted to try to do a studio there, but decided against it when I found out how expensive property was on that island. Also, the cost of living is very expensive, and it's

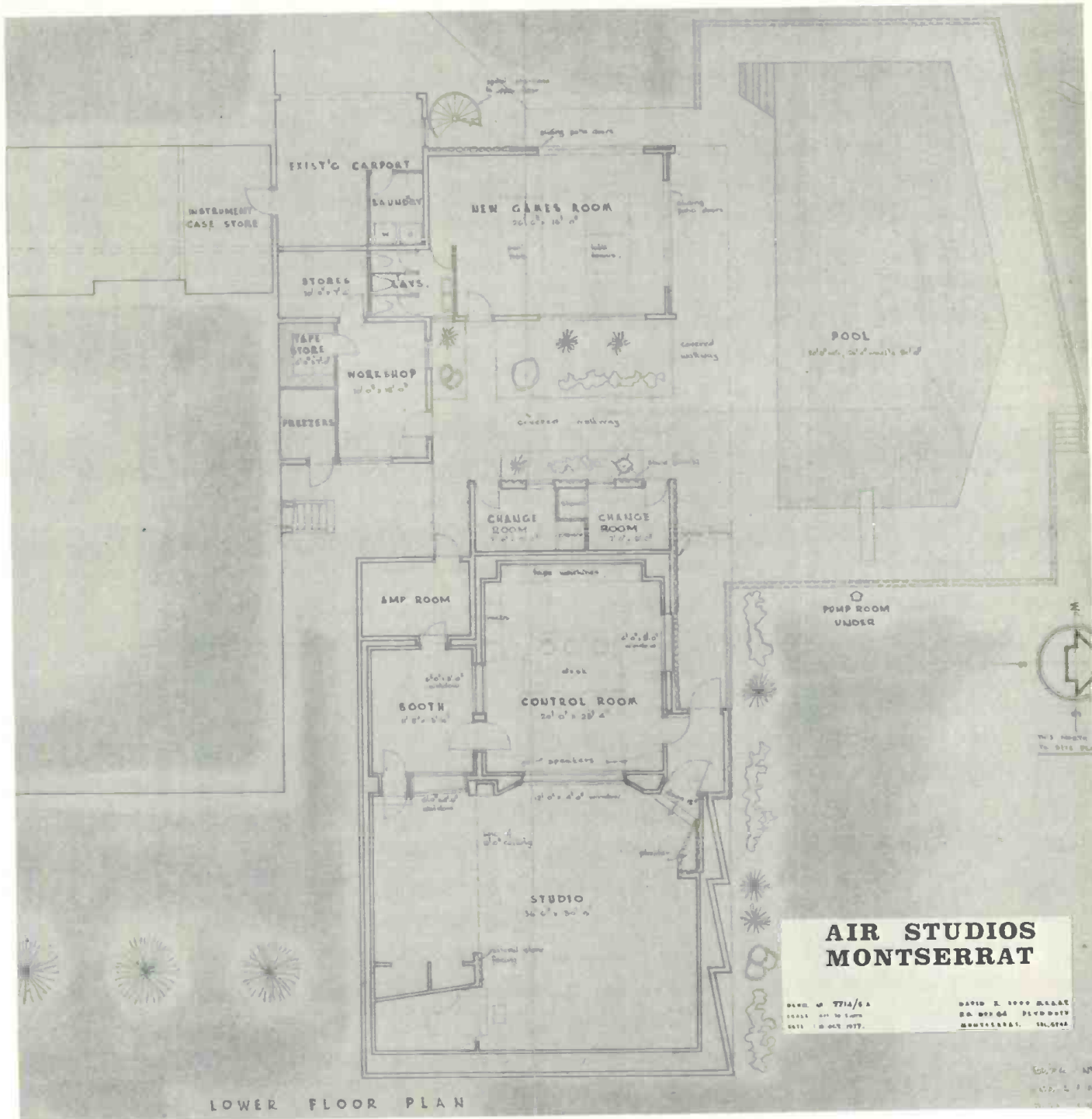

one *HELL* of a way from London. Lastly, it's American soil, which didn't make very much sense for a British citizen. So I was looking to building a studio which would be within easy reach of London and most of the places in America. Antigua certainly fits in with the East Coast. But admittedly it's more difficult to get to from Los Angeles than it is to get to Hawaii, but it suits my bill very well.

We were able to build a studio from the ground up, which we hadn't done before. As you know, Air studios was built in a department store banquet room 65 to 75 feet long and 45 feet wide. We had a lot of problems inherent in the site due to the fact that it was on the fourth floor of a department store, in a steel frame structure, over three underground railways, and a lot of traffic noise outside. We had to be very careful in our design of Air. We used Ken Shearer for that one. We designed the studios ourselves but the acoustics were worked out by him. Once we got in there we did some changes to tighten it up a bit.

*Tom: It has a control room window that overlooks the street?*

**GM:** That's right.

*Tom: I love a studio that has a window that opens to something besides another room.*

**GM:** So do I. Funny thing when we first built it we had a certain amount of comment from

the rock groups who on seeing the outside didn't like the daylight. They found the outside distracting. But they're coming around to it. At the new studio there's windows. I have this picture window giving me a view of the bay and the mountains going down to the sea. I shall sit in a complete daze and not make records at all!

*Tom: Who designed the new studio in Montserrat?*

**GM:** Well, we've done it literally ourselves. We used an architect, of course. But Dave Harries, who's the studio manager at the London Studio, is a great technical influence. He's very good on sound. He designed our own speaker. I got him very heavily involved in the design of the new studios. He knew what I wanted so he worked out the acoustics for me.

*Tom: Describe it.*

**GM:** It's pretty typical. It's rectangular and looks pretty normal. There's no point in having butterfly winged studios, or conical shapes or tetrahedron for the sake of it. It's better with it rectangular with a corner cut off for a piano trap. The piano disappears into its own trap. There's a bass trap and a guitar trap for the heavy instrument. There's also a live area for the others, but it's basically a fairly large studio. I like having a bit of air around the drums and not locked away in

some box. There's also an overdub room next to the control room.

*Tom: Is the control room window in front of the console or to one side, as typical in many English studios?*

**GM:** It's in front. And you have one into the vocal booth. I guess the control room's emphasis is on size. I like plenty of space in my control room as well as the studio. My main criticism of most of the studios I've been in is that their control rooms are much too small. When you have a group coming to listen to their record, and there is only three feet of space where it's good to listen to, then everyone has to huddle around on each others' shoulders. The control room we have in Montserrat is 24 by 20 feet. It's almost the size of the studio.

*Tom: How high is the ceiling?*

**GM:** Not too high. It's about ten to twelve feet high.

*Tom: What are the speakers like? You mentioned that they were custom made.*

**GM:** They're basically Tannoy Gold units which have their own tweeters built in them. The enclosure is Dave's design, rather like the Lockwood cabinets, but a bit better than that. They're very flat. So we have two kinds of speakers, our own and the JBL 4311, which I find to be a very good speaker.

## At Last, a Cart Machine that Keeps its Cool

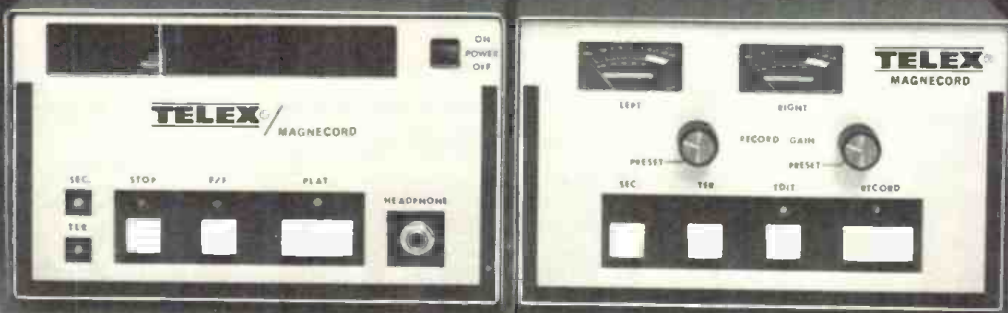

Telex/Magnecord broadcast cart machines run cool and steady. So cool no ventilation is required, so steady not even voltage or frequency fluctuations will alter their speed. Thanks to our dc servo flutter-filter drive.

The MC series offers broadcasters a host of options, including field convertability from mono to stereo or play to record and, of course, end of message, secondary/tertiary cue tones.

Designed for type A or B carts, the MC series meets all NAB specifications, offers full immunity to EMI and RFI, is remote controllable and automation compatible with CMOS digital logic. Audio muting, air damped low voltage

dc solenoid and fast forward are standard features on every MC unit.

Four broadcast cart machines to choose from in the Telex/Magnecord MC series. Running cool and steady. With a pleasant surprise—they're affordable.

For detailed information please write:

PRODUCTS OF SOUND RESEARCH  
**TELEX**<sup>®</sup>  
COMMUNICATIONS, INC.

9600 ALDRICH AVE. SO. • MINNEAPOLIS, MINN. 55420 U.S.A.  
Europe: 22 rue de la Legion-d'honneur, 93200 St. Denis, France  
Canada: Telak Electronics, Ltd., Scarborough, Ontario



Conducting at rehearsal . . .

*Tom: What equipment have you chosen for Montserrat? Are you going to have digital recording?*

**GM:** Well, all my life I think I've been in the forefront of studios while trying to make Air the best, always trying to be better than anybody else. I looked at digital very closely; I'm very aware of it all. And I've been aware of the growing complication of analogue recording, and the growing expense of it. A point is going to be reached where someone is going to say, "Halt! This is enough!" I think I've gotten to that point now. But in making the studio in Montserrat I wanted to have the very best facility not just in the Caribbean, but in the world. That didn't mean that I had to go into digital, because if I went into digital I wouldn't have the best recordings in the world, I might have the most avant-garde ones, but it certainly wouldn't cope with the majority of recordings being done today.

*Tom: What board do you have there?*

**GM:** A Neve, 52-input, 32-output with separate monitoring systems. Not an in-line desk. I like to have my own monitoring section.

*Tom: Automated?*

**GM:** No. We have automation at Air. The new board could be automated if I ever need it, but since automation is only really used for mixing, and since I don't anticipate at this time that we will do too much mixing. At Montserrat I didn't get it.

It's much more likely that people working there will concentrate on basic tracks for three or four weeks, and then go back to Los Angeles or New York, or wherever, and do the rest of it — sweetening and mixing.

It's a new transformerless system of Rupert Neve's design and will be the only one of its kind. It's got completely new EQ facilities. It's very expensive and very good. In fact, the figures on the tests are just incredible.

*Tom: What sort of tape machines are you going to use?*

**GM:** We use Studer in England and I was sorely tempted to get the new Studer 32-track, 3-inch machine. But, frankly, I don't like 32-track or 3-inch tape; but it's got to be provided at the facility. Because we're so near Florida and they're very good machines, we've ordered the new MCI 32-

track machines. We haven't gotten delivery on them yet, but we'll be the first to get them. The new ones will be optional 24/32 with interchangeable head blocks.

I personally will never use 32-track. I think 46-track using two 24-track machines in sync makes much more sense. However, if you're a tidy producer you shouldn't really need more than 24. If you do need more than 24, which I did on the Pepper film, there is no sense going to 3-inch tape. It's different technology; more flapping problems; more storage problems, and so on. What you should do is whatever you've got on the first 24 mixed it down to a rough stereo and put it on a second 24. To do overdubbing, let's say you'll work five weeks on one particular tape. The amount of spooling back-and-forth, to-and-fro is enormous. The tape wear is fantastic. Why should you keep wearing down the original tracks that whole time?

You're not wearing them out at all if you're working on a second reel. When it comes to mixing, what you've got to do is sync the two together and away you go. That seems to me to be a lot more logical than running a 32-track thing back-and-forth a few thousand times just to get one vocal or some other equally time-consuming overdub.

*Tom Lubin: In 1971 you were interviewed by R-e/p. Many things which you felt would be a part of the future of recording have come*

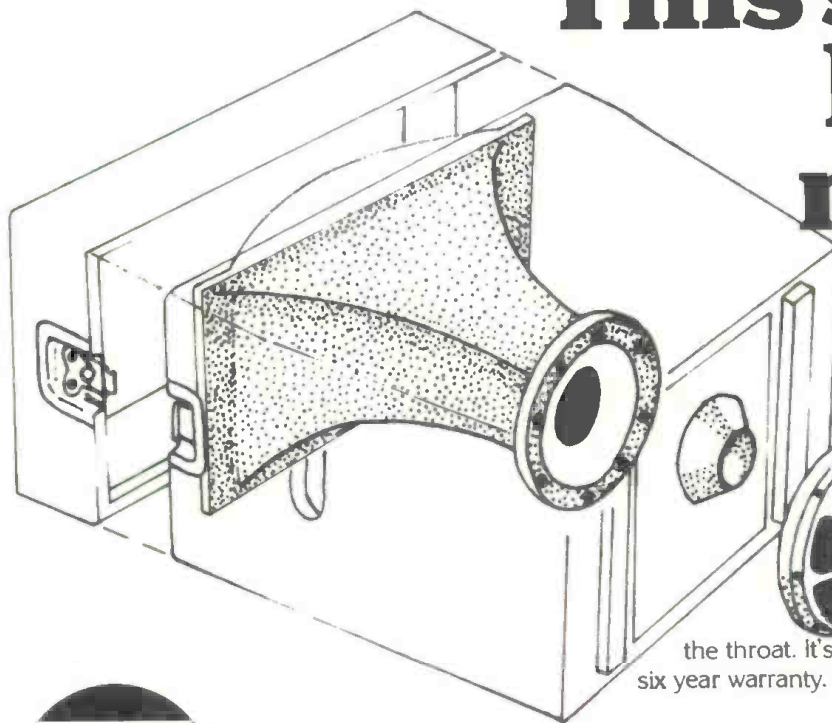

# This singular lower midrange system

improves intelligibility in the voice frequencies to a new order in high power sound reinforcement. The exciting new ATC 9" driver connects to a straight exponential horn using an integral phasing plug for enhanced dispersion. The hand-laminated fiberglass horn is lead-sheeted and polyurethane damped to eliminate resonances, even at 130 dB SPLs at the throat. It's built for the road and has an unprecedented six year warranty. Call or write for the "works".



**Eastern Acoustic Works, Inc.**

59 Fountain Street, Box 111, Framingham, Massachusetts 01701/(617) 620-1478



to pass. One of them was the emergence of video as an integral part of a musical presentation.

**George Martin:** Sure, it was bound to happen. I must confess that if I said that seven years ago I was being a bit premature. It hasn't been all that fast. It's a question of economics rather than the arts. And what people are prepared to pay for it.

**Tom Lubin:** Air was the first studio in London to have the capabilities to do both recording for records and for video.

**George Martin:** That's true.

**Tom:** Where do you see the direction of technology?

**GM:** Well, digital is going to be here. When we were talking about Montserrat, the reason I said I didn't want to go digital . . . I think the degree of sophistication on our new Neve is about as complicated as I want to go on a desk and about as big as I want to go before I go to digital.

Digital is now in its infancy and we've been guinea pigs for an awful lot of years. We're letting other people be the guinea pigs this time. In three or four years we'll take all the hard lessons learned by other people and use it where it's properly used.

In any case I think digital recording will only come into its own when it becomes completely integrated with the desk. I think just having a digital machine connected up to an analog desk doesn't make too much sense to me. That's just cutting down on your noise a little bit; but that isn't a major problem. I think when the tape machine is an integral part of the console, and it's a completely computerized unit which can do things that you can't do now, like synthetically process an echo sound that imitates "Heartbreak Hotel" without an echo unit . . . that kind of thing. Then it will make sense. But that's always off.

I heard the Soundstream stuff about two years ago, but I'm afraid I haven't kept up with the latest developments in digital technology. I've obviously read about them, but there isn't all that much development. I'm a bit surprised that the development hasn't been quicker.

### 「The Record Pressing Problem?」

**Tom:** Would you care to comment on the quality of pressings?

**GM:** It's a hell of a problem 'cause you never know about it. We spend hours in the studio getting a great sound. We take a lot of trouble, and because we don't want it to go into the hands of an idiot, we go along and we have it cut by someone we like and know well. We know what he does, so we spend more hours with him in the cutting room to get the lacquer right and then we approve them.

Then we hear a test pressing and it sounds

good . . . fine. But what we don't hear is what happens to the thirty-second run at the Scranton plant, or what happens in Turkey. Or what happens when the tapes are shipped to Japan. We do hear eventually. I've heard some ghastly reproductions of something I've done. Christ! How'd that ever get out!

And I know for a fact that an awful lot of records that get out in this country bear no resemblance to the record we've made. They're issued that way and people buy them because they don't know the difference. I never hear them because I don't buy records at a store in Pennsylvania to see if my "Blow by Blow" is good enough, and I'm sure it isn't. Quality control is a hell of a problem because we don't know how good or bad it is. The record manufacturers really don't know. And I guess when it comes down to it the economics of the thing are pretty paramount.

**Tom:** What can artists, producers, engineers, or even the consumer do about it?

**GM:** They can only make noises to the record companies. The record companies can only make sure that their quality control is stepped up so that they don't issue too many duff records. But, then, there are always alibis. The record company can give the artist a perfect copy, saying that it just came out of the Scranton plant and there's no way that they'll ever get any better than that. Though the company knows perfectly well that all the records being pressed are full of carbon dust, or whatever.

**Tom:** Are their reasons legitimate — or are we expecting too much?

**GM:** I don't think we're expecting too much, no. But in relation to today's civilization it's just like buying a car. You'll get your Friday one as well as good ones. You buy a car from Ford and the advertisements look great. Then you take it on the highway and you find that the throttle cable is sticking. There's no way that you can do it except by attention to detail all the way down the line. Those people doing those terrible, boring jobs just have to do it a bit better. It's a big problem, and I don't think that it can be overcome very easily.

**Tom:** What do you say to people who write you letters. "Mr. Martin: How do I get into the business?"

**GM:** Don't. Too many people want to get into the business, that's one of the problems. An outside viewer of our business really has no idea what he's getting into. You don't have football pools in this country, do you? You have some kind of gambling?

# Boilermaker

PRESENTS THE  
**\$100**  
MICROPHONE  
STAND

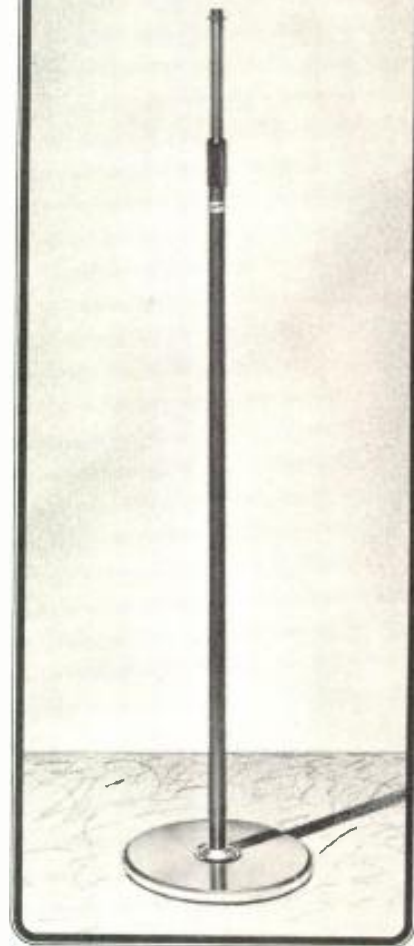

Sure, they come cheaper. But only Boilermaker gives you all these top quality features: 6061 aluminum alloy, machined steel base . . . a choice of five show-stopping colors to choose from.

If you can tolerate only the best in your act, act now and call us for all the details.

# Boilermaker

BY NORTHWEST SOUND

3497 N.W. Yeon Avenue  
P.O. Box 3586  
Portland, Oregon 97205  
15011221-1924

... concluded on page 100 —



**Congratulates  
Martin Audio  
on their  
move to new  
and modern  
quarters at**

423 West 55th Street  
6th Floor  
(Between 9th & 10th Ave.)  
New York, NY 10019  
(212) 541-5900

•

Martin Audio  
continues to be  
one of our  
top dealers  
for  
UREI Products  
which can now  
be seen in their  
new expanded demo  
and display rooms

•

**LOOK TO UREI  
FOR ALL YOUR  
AUDIO SIGNAL  
PROCESSING AND  
SPECIAL  
INSTRUMENTATION  
NEEDS**

■ Active Equalizers and Filters ■ Com-  
pressors ■ Limiters. ■ Crossover Net-  
works ■ Digital Metronome ■ Digital  
Delay Lines ■ Preamps and Program  
Amps ■ Sonipulse ■ X-Y Plotters ■  
Broadcast Consoles ■ Monitor Loud  
Speakers

The first  
Time Aligned™  
Control Room  
Speaker System

**Unbelievably  
Clean...from  
a whisper, to  
the threshold  
of pain.**

The UREI 813 Monitor Loudspeaker System brings impressive new realism and clarity to recording control room listening. This first Time Aligned™ professional monitor employs the efficient Altec 6048-G duplex 15" driver with a UREI custom horn for extended and more uniform H.F. response, plus an added 15" direct radiating driver for extended L.F. response and higher power handling. Add to this the UREI 3-way TA™ network in a unique pressure controlled enclosure and you have unbelievably clean reproduction from low levels to the threshold of pain! Bring your aspirin and hear it at your UREI dealer.



8460 San Fernando Road  
Sun Valley, California 91352 (213) 767-1000

Exclusive export agent: Gotham Export Corporation, New York

 Time-Align and its derivatives are trademarks of and licensed by E. M. Long Associates

for additional information circle no. 25

[www.americanradiohistory.com](http://www.americanradiohistory.com)



**(LEDE) LIVE END - DEAD END CONTROL ROOM ACOUSTICS . . . (TDS) TIME DELAY SPECTROMETRY . . . (PZM) PRESSURE ZONE MICROPHONES**

by CHIPS DAVIS  
Las Vegas Recording

My original reason for attending Don Davis' Syn-Aud-Con class in February, 1978 was to learn about TDS (or time delay spectrometry). Little did I know at the time that I would take Don's findings on the early order reflections in hard-front control rooms and expand on the theory and make Las Vegas Recording, Inc., the first Live End - Dead End (LEDE) control room.

**TDS**

TDS was invented by Richard C. Heyser (U.S. Patent #3466652) and requires a special license to practice.\* Heyser conceived and patented this vast improvement on pulse testing which had been in extensive use for 40 years, and called it time delay spectrometry. Briefly described, the receiver or tracking filters are delayed in time and do not start the receiver sweep until the signal reaches the microphone. This time delay sweep can then see the direct wave without having any interfering room reflections. (60 dB of signal-to-reflection.) It can delay the receiver and open the receiver window for longer periods of time until the first reflection is shown on the screen of the analyzer. The frequency, the depth in dB, can be seen and the time delay can be calculated to determine the surface from which the reflection came. Tuning can continue out in time until there are no other reflections, or the window is so wide only the total sound of the room can be seen. TDS can also show the amount of

*continued on page 44 . . .*

\* Those wishing a license to practice TDS should send a check for \$100.00 made out to California Institute Research Foundation, but mailed to Syn-Aud-Con, and a check for \$25.00 made out to Syn-Aud-Con, for a set of "how to" notes on TDS. Syn-Aud-Con, P.O. Box 1134, Tustin, California 92680.

by DON DAVIS  
Synergetic Audio Concepts

There are a series of fundamental "first principles" that underlie the LEDE concept. When Chips Davis undertook the redesign of his control room at Las Vegas Recording, I had only discussed the first of these principles — that of creating narrower anomalies. What is of great interest to me is that Chips in working out each new detail of the concept had "felt" what we are now actually measuring and mathematically developing. It is our belief that artist-engineers like Chips, when exposed to acoustical training, fulfill the promise inherent in recording technology.

**First Principles**

What are the "First Principles" underlying the success of the "Live end - Dead end" (LEDE) technique of recording studio control room design? The answer to this query lies in understanding how sound spectra propagate, reflect, undergo absorption or transmission, and combine. This is why you always see Time Delay Spectrometry (TDS) involved wherever a LEDE control room is engineered.

**Time Delay Spectrometry**

TDS was developed (and patented) by Richard C. Heyser in 1968. TDS allows the user to observe the direct sound level as if in an anechoic room with a 60 dB reduction of the signal from any surface. Since conventional anechoic chambers of first quality can only provide a 20 dB reduction it can be seen that TDS is an extremely powerful analytical tool of unprecedented resolution.

In observing the direct sound level with the TDS analyzer it is easily seen that no "room modes" are involved, even though the loudspeaker is indeed indoors because there are,

*continued on page 52 . . .*

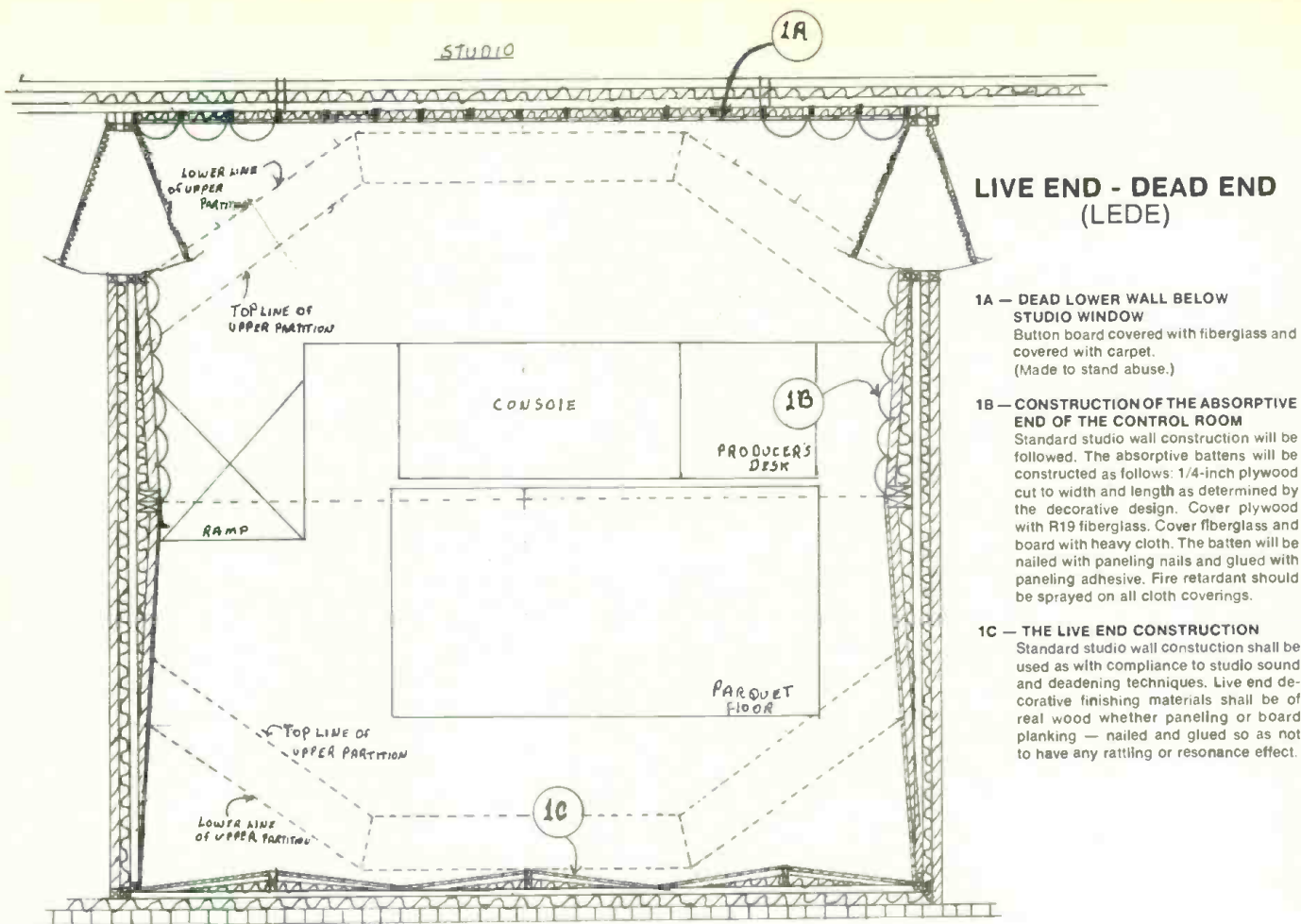

## LIVE END - DEAD END (LEDE)

- 1A — DEAD LOWER WALL BELOW STUDIO WINDOW**  
 Button board covered with fiberglass and covered with carpet.  
 (Made to stand abuse.)
- 1B — CONSTRUCTION OF THE ABSORPTIVE END OF THE CONTROL ROOM**  
 Standard studio wall construction will be followed. The absorptive battens will be constructed as follows: 1/4-inch plywood cut to width and length as determined by the decorative design. Cover plywood with R19 fiberglass. Cover fiberglass and board with heavy cloth. The batten will be nailed with paneling nails and glued with paneling adhesive. Fire retardant should be sprayed on all cloth coverings.
- 1C — THE LIVE END CONSTRUCTION**  
 Standard studio wall construction shall be used as with compliance to studio sound and deadening techniques. Live end decorative finishing materials shall be of real wood whether paneling or board planking — nailed and glued so as not to have any rattling or resonance effect.

absorption various materials provide, the effectiveness of splays and not only acoustical problems but anechoic displays of speakers and microphones. An anechoic chamber only has about 20 dB of signal-to-reflection; TDS has 60 decibels of signal-to-reflection. Polar response of speakers and front-to-back ratios of microphones can thus be easily viewed with TDS. TDS is probably one of the most useful tools available to us today to find and analyze problems in our audio industry.

### Live End - Dead End (LEDE) Control Rooms

Live end - dead end (LEDE) refers to the newly conceived acoustical design for control of rooms. It seems to me that this is the first real advance in recording studio control room acoustics in quite some time. To quote Don Davis, of Synergetic Audio Concepts, whose theoretical concepts of LEDE developed through his work with time delay spectrometry, those which compelled me to build the first live end - dead end control room: Don wrote, "Pick up any book with pretensions of knowledge about recording studios and almost without exception the material on the internal acoustics exhibits an enormous void of accurate or useful information. Implied is that all you have to do is add absorption with the aid of some devil's apprentice with info from the dark domain and all is well."

LEDE is basically the complete opposite of all other control rooms. That is, the rear of the room is hard and reflective while the front is as absorptive as possible.

Let's start with the front of the control room, and explain the reasons behind the absorptive half. Davis found, through TDS, that mixing of early reflections from the hard ceilings and walls of conventional control rooms with the direct wave

causes very deep anomalies in the order of 25 to 30 dB. (Anomalies are any deviation from the original response, therefore, distortion.) These anomalies are broadband and very deep when generated by very early reflections. They occur from the low mid to the uppermost frequencies beyond the audible range. The anomalies, from improper acoustical design, are caused by addition and cancellation of signals arriving at the mixing position out of phase, the phase depending on the time interval or the distance of the early order reflections.

The acoustical anomalies and anomalies due to improper speaker design cannot be equalized into a smooth, flat reproduction spectrum. To equalize a control room under these conditions with the equalizing microphone at one position (in the mixing position), you could obtain a reasonably flat response. Move the microphone two inches and the curve becomes a gross, mis-adjusted, unequalized mess. Try this in your control room. Move the microphone in the area of the mixing position and watch the response curve change.

LEDE acoustical design minimizes this effect and helps keep a uniform frequency response in the mixing position. These anomalies are real and do exist in hard-front control rooms. We can see these effects and mathematically study their cause and effect with the aid of time delay spectrometry.

### The Live End of LEDE

The live end of the control room is, I think, the most important part of the room. Davis gives a demonstration of the Haas effect in the Syn-Aud-Con class. It is a simple, but

# Announcing the new 672A Equalizer

8 bands + tunable filters  
+ electronic crossover = \$499\*

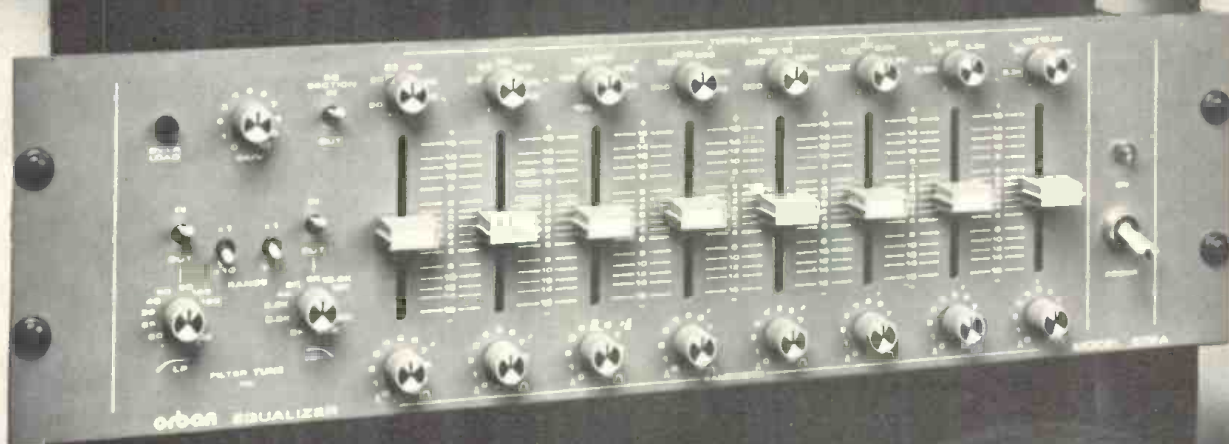

The 672A is a fully professional 8-band single-channel parametric with extra tunable highpass and lowpass filters. The filters can be used to shape the response at the ends of the spectrum — Or, the 672A's *split output* lets you use the filters as a full electronic crossover cascaded with the 8-band parametric.

At \$499\* it's an unbeatable machine for sound reinforcement, monitor tuning or general-purpose program equalization in recording, broadcasting, cinema, theater, and disco.

Despite its attractive price, the 672A contains no quality compromises. Balanced input (with output transformer option), RFI suppression, and state-of-the-art specs are all there, as are Orban's traditional industrial quality, serviceability, and comprehensive software. Orban's advanced engineering and manufacturing expertise are the keys to this extraordinary value.

Discover more about this remarkable, easy to use equalizer. See your Orban Dealer or contact us directly.

**orban**

**Orban Associates Inc.**  
645 Bryant St.  
San Francisco, CA 94107  
(415) 957-1067

\*suggested list

## LAS VEGAS RECORDING "LIVE END - DEAD END"

Hardwood  
Live End

Front View (from back wall)

sound absorbing battens →



Side View

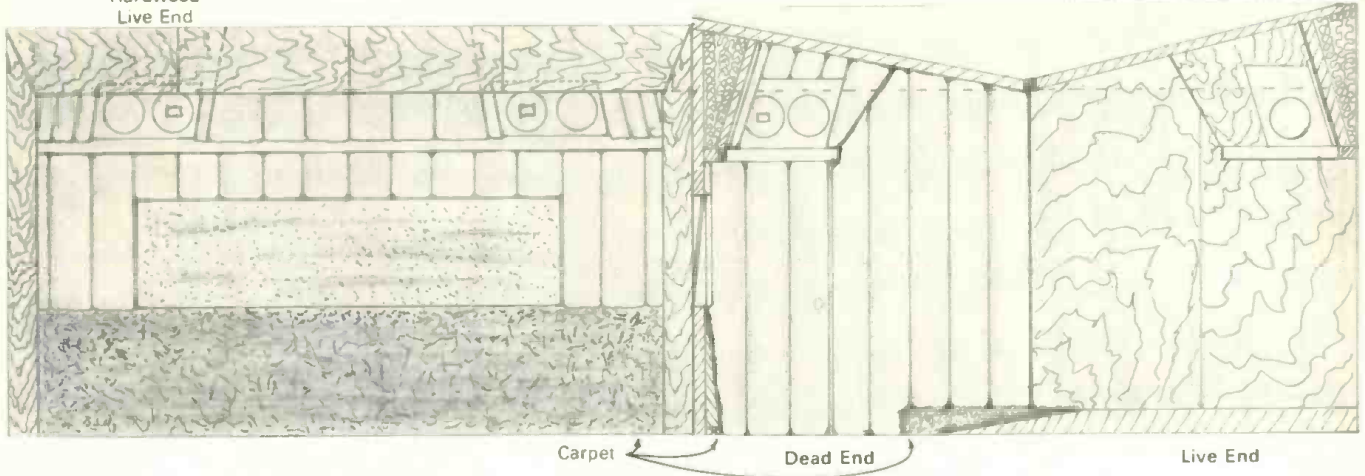

very important fact of the LEDE control room. The Haas effect is the ability of the brain to discriminate against echoes and delays of sound that arrive approximately 10 to 20 msec after the original waves. The sound is still present but psychoacoustically does not exist so far as the listener is concerned. If the listener is 10 feet or less from a wall, the sound wave travels past him to the hard wall and back — a total of 20 feet — and he will not be aware of its origin. This is called the Haas effect. At greater distances the listener hears echoes or flutter. A hard-backed wall that is 10 feet or less away does not acoustically exist in our brains. The brain doesn't recognize or receive it. Again, this is the Haas effect. Therefore, we have, for the listener, eliminated the back wall, an infinite distance in space, psychoacoustically, and all we can hear is the front speakers.

Control rooms with very dead back walls compound other problems: room acoustics, speakers, and sloppy studio construction. Now that we have a disappearing back wall, we have to treat it acoustically, and this is where everything becomes like a game of acoustic pool at 1,130 ft. per second.

We splay, angle, direct and bounce the sound that strikes the rear wall back to the mixing position. This stacking of the immense number of reflecting paths from the back wall is very precise and is figured extremely close as to time interval.

What we are trying to achieve is a very dense and diffuse total sound spectrum by combining the paths off the back wall into a series of controlled narrow band comb filters. Successfully done, the overall result is a very smooth total sound spectrum without any broadband anomalies. This procedure also masks console reflections, tape machines, people, etc., so that what is heard by the mixer is true, extremely accurate sound.

If the back wall is designed incorrectly, the possibility of having reflections arrive outside the 20 msec time interval would be disastrous. Inside the 20 msec range, an initial time delay gap of a much larger room is present at the mixer's position. You can turn and face the rear wall, cup your ears, and none of the sound from the monitor speakers ever seems to come from anywhere but the monitor

# NEOTEK-eastern & s.w.; u.s.

No matter what console you are considering, you can't get a cleaner board or a better dollar value than a Neotek SERIES III.

The fully professional SERIES III is available configured up to 40 inputs with 32 track assignment. Each module contains a full 4 band quasi parametric equalizer & light meter level indicator. Neotek is the pioneer & leader in transformerless console design.

a full line studio design-construction company.

**A** Audio Associates

319 Bonnaview Dr.  
Nashville, TN 37076

Call Bill Wilson and let us put our years of experience to work for you.

615-883-1405

# Stressing Quality

Orange County Electronics, creators of fine professional audio products for over a decade, introduce the new VS-1 Stressor. The VS-1 combines the separate functions of a compressor with adjustable ratio, threshold, and attack and release times, a fast peak limiter with 250:1 slope, and a highly functional expander/noise-gate, and a full parametric equalizer, all in one beautiful 3½" rack mount.

This complete signal processing system gives you the power to handle problems such as level control, noise, and equalization in one package. These necessary processing functions are designed to work independently or in tandem with one another. For example, with the selection of one button which handles routing chores, the parametric equalizer can be inserted before, after,

or in the side-chain of the compressor. When in the side-chain mode, you have a frequency-sensitive compressor or dynamic equalizer, which can deal with sibilance problems on vocal tracks as a "de-esser."

The Orange County VS-1 Stressor is built to high technical standards and offers switchable balanced/unbalanced operation, with fully modular construction for easy service and performance flexibility, and noise and distortion specs equal to the best in the industry.

Applications for the VS-1 Stressor include recording studios, AM broadcasting, TV and broadcast production, film sound, and sound reinforcement. Quiet, powerful, and extremely versatile, the VS-1 Stressor belongs in your studio or station today. And for smaller studios or stations who want the fine sound of the VS-1 but don't need the full flexibility, try our VS-2 Stressor, which offers internally pre-set functions.



ORANGE COUNTY ELECTRONICS  
INTERNATIONAL INC.

Exclusive Sales & Marketing:

**Parasound**

680 Beach Street, San Francisco, Ca. 94109 (415) 673-4544

Dealer Inquiries Invited

# THE BEST VALUE IN A PROFESSIONAL TAPE RECORDER

When you compare a tape recorder, here are the most important areas to consider for value, quality, and sound.

## PERFORMANCE:

Overall Signal-to-Noise: 66 dB unweighted at 520 nWb/m (30 Hz to 18 kHz audio filter).

Playback Signal-to-Noise (electronics): 72 dB unweighted (with audio filter).

Headroom: +24 dB. Maximum Output: +28 dBm.

Overall Frequency Response (15 ips): 30 Hz to 22 kHz  $\pm 2$  dB.

Playback Frequency Response (MRL test tape): 31.5 Hz to 20 kHz  $\pm 2$  dB.

**RELIABILITY:** An unmatched 4-year track record of on the job performance for the original compact professional recorder. Day in, night out. Just ask someone you trust.

**ALIGNABILITY:** Any tape recorder must be aligned to achieve maximum performance. With the MX-5050-B, all primary alignments including record bias and level are on the front panel. So is a 1-kHz test oscillator. Secondary alignments are inside the bottom panel. You or your maintenance people can align it fast and easy. This saves you time, money, and enhances your reputation.

**INTERFACEABILITY:** With a flick of the output switch you can plug-in to any system: +4 dBm 600 ohm or -10 dB high impedance. No line amps or pads to mess with. A perfect match everytime.

**ADDITIONAL BENEFITS:** Three speeds, dc servo  $\pm 7\%$ ,  $\frac{1}{4}$  track reproduce, full edit including indexed splicing block, over-dubbing, noise free inserts, XLR connectors, NAB/CCIR switching, unique 3-position alignment level switch.

**PRICE:** Suggested retail price \$1,945 (USA).

## MX-5050-B: THE CHOICE IS OBVIOUS

The OTARI logo consists of the word "OTARI" in a bold, sans-serif font. Each letter is contained within a rectangular box that has a 3D effect, with a dark shadow on the bottom and right sides, making the letters appear to be floating or stacked.

Call Ruth Pruett on 415/593-1648 for the name of your nearest Otari professional dealer.  
Otari Corporation, 981 Industrial Rd., San Carlos, CA 94070 TWX 910-376-4890  
In Canada: BSR (Canada, Ltd.), P.O. 7003 Sta. B, Rexdale, Ontario M9V 4B3 416/675-2425





speakers. It is totally undetectable in direction but audible in level. Careful diffusing of the rear wall and a very soft, nearly anechoic front wall are what makes an LEDE an incredible mixing environment. You have complete control of placement, depth and locality.

### Time Alignment of the Monitors

LEDE and TDS are what we have put together so far. Now we will add time align™ (trademarked by E. M. Long Associates) monitor speakers invented by Ed Long and Ron Wickersham — the UREI 813s.

The 813s give a realism in the LEDE control room like we have never encountered. Before having installed the UREI 813s, we had a very popular, well known monitor. After looking at this speaker with TDS (See Figure #1) we decided

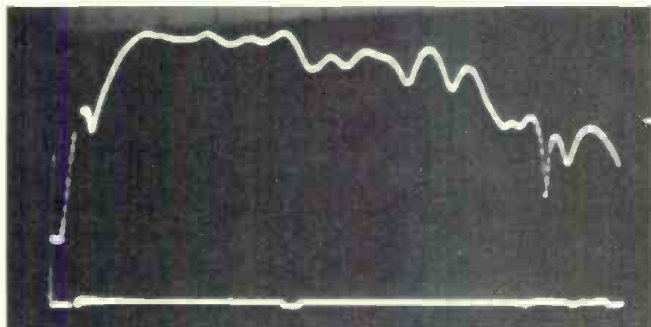

Figure 1. Studio monitor which exhibits a series of severe acoustic anomalies. Measurements made with TDS.

to go to the 813s. Comparisons proved the 813s far superior due to the problems of mis-time alignment caused by mis-design of the crossovers. The problem cannot be easily eliminated acoustically or electrically. This distortion in the old monitor speaker could readily be heard by placing your hand over the tweeter and hearing the anomalies that we were seeing on the analyzer disappear. (See Figure #2) This

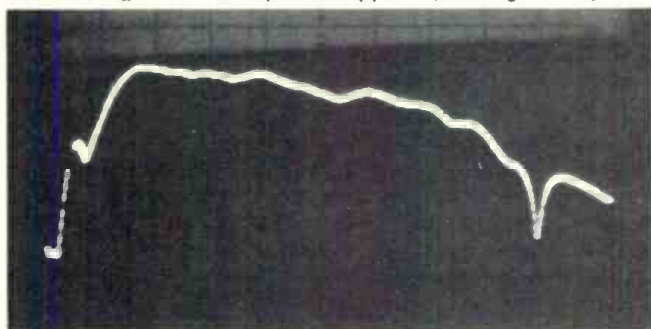

Figure 2. Studio monitor response when the H.F. unit is covered with a hand.

distortion is due to two elements emitting the same frequencies from different planes — the mid-range and the tweeter — with the crossover not cutting the mid-range off but allowing it to share a mutual portion of the spectrum with the high frequency. The effect is readily detectable and the ears can hear the distortion on cymbals and mid-range upper spectrum. You can hear the crackling of the anomalies as they phase in and out, causing the distortion feeling in your ears after you know it is there and focuses your attention on that particular section of the spectrum.

### PZM™ — Pressure Zone Microphones

Having eliminated the problems of the speakers and the distortion of the early order reflections that caused anomalies we then added another improvement to our medium: The Pressure Recording Process (PRP™ — trademarked by E. M. Long Associates) is a new type of microphone and miking technique developed by Ron

Wickersham and Ed Long and manufactured under license by Ken Wahrenbrock, under the trade name PZM™ (trademarked by Syn-Aud-Con).

If you don't have an LEDE control room, or 813 monitors to A - B any mike in your arsenal, don't worry. The PZMs will give you a realism that will really make you a believer. Try it on anything. A - B it with any mike, in any situation — a piano is the most startling. Lay the PZM on a hard surface, on the floor, tape it to a baffle, tape it on a wall or under the lid of a piano — or tape two, one above the "f" holes and one down by the bass strings. This is the most incredible stereo piano you have probably ever heard. Horns, drums, vocals — all take on new realism. Some of the comments that I have received from some of the very fine trumpet players and musicians is that it is like playing against a solid concrete wall and hearing themselves come back, or a direct disk recording of themselves. Put your favorite vocal mike up for vocals and put the PZMs on a flat surface up to 3 or 4 feet away. (See Figure #3) Run one to one track, the other to

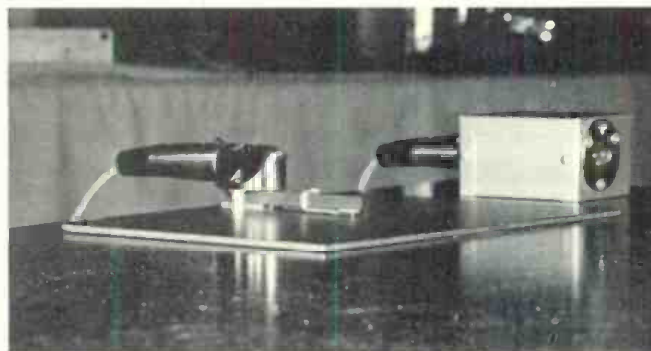

Figure 3. Pressure Zone Microphone (PZM™). A pair of Pressure Zone Microphones sells for \$225 with power supply.

another. When you get through, A - B them. See which one the performer likes and see which one you like. If you don't believe the sound that you're hearing, go out in the studio and put your ear exactly where the mike is — exact realism.

### Putting It All Together

When LEDE, TA, PZM and TDS are put together we have produced the most accurate mixing environment that we have had in the studio to date. It is so clear, and free of distortions caused by anomalies, mis-designed monitors, and general smearing of bad control rooms that your ears start to rebel. Where is that old sound of distortion, problems that everyone has accepted for many years? Your ears have learned a new realism that you can only experience from live performances — naturalness of drums, tympanies, trumpets, English horns, oboes. I have a good comparison for that — it's live orchestras, 40 weeks a year, seven days a week.

A large number of engineers have been through the new LEDE room at Las Vegas Recording. If you're near Las Vegas, I'll be happy to have you stop in.

What we have to look forward to now is an LEDE mastering room, digital recording and improved record processing. It is extremely difficult to put into words what these advancements can do for our industry, but I'll sum it up by answering the question that has been asked of me many, many times by the people who have come through our facilities: "What have you gained, if the material is to be played over AM radio, cheap hi-fi sets and television?" My answer to this has always been the same, "Every problem is additive, all problems add together — they never subtract from each other. They combine to make larger problems. Any problems that you can eliminate anywhere in the chain and make your product better will always be better, played anywhere, anytime, over any system." □ □ □

# Audio-Technica rewrites the book on professional phono cartridges.

## Introducing The Professionals

### The new Audio-Technica ATP Series Dual Magnet™ Stereo Phono Cartridges

What do you really need from a professional phono cartridge? Impeccable quality. Reliability. Uniformity. And reasonable cost. The goals we've met with the new ATP Series cartridges.

The new ATP Series are flat, smooth, low distortion performers that will do your station, studio, disco, library, or commercial installation proud. They are also very tough... the next best thing to "bullet proof". Because we know that "needle drop" isn't just a way to pay for music or SFX. It's a fact of life!

Both ATP cartridges and styli are *uniformly* excellent. When you at last need to replace a stylus, you always get "like new" performance again, and again, and again.

Don't confuse the ATP Series with other "professional" cartridges that are merely modified home units. ATP units don't have to be treated with kid gloves. And yet we haven't sacrificed tracking ability to make them rugged.

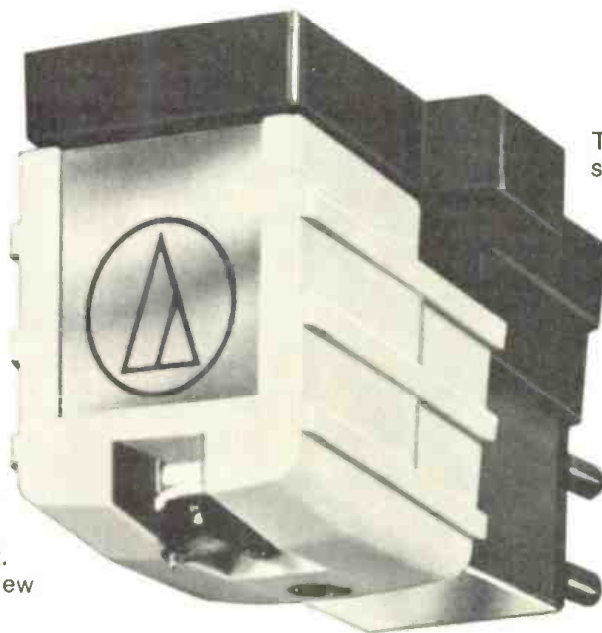

The all-new ATP cartridges were specially developed for the working environment. Three models provide a choice of either spherical or elliptical styli. Each cartridge is hand-tuned for optimum performance, with stereo channels matched within 1.5 dB to eliminate balance problems.

All ATP cartridges feature tapered cantilever tubes that combine high strength with minimum moving mass. There's no problem with back cueing, and the brightly colored cantilever tip is readily visible so that you can spot an LP cut quickly and accurately.

ATP cartridges are priced from \$30.00 suggested professional net. Write for complete specifications. Try the ATP Professionals on your own turntables. We know you'll be pleased with what you hear. From the thoughtful pros at Audio-Technica.



Upgrade your entire record-playing system with new ATP tone arms. Rugged and precise, like ATP cartridges. Professional in every respect. Model ATP-12T or ATP-16T just \$125.00 suggested professional net.



**audio-technica**  
INNOVATION □ PRECISION □ INTEGRITY

AUDIO-TECHNICA U.S., INC., Dept. 19RE, 33 Shlwassee Avenue, Fairlawn, Ohio 44313 • In Canada: Superior Electronics, Inc.

for additional information circle no. 29

[www.americanradiohistory.com](http://www.americanradiohistory.com)

R-e/p 49

# **OUR VARIABLE SPEED CONTROL WILL MAKE YOU CHANGE YOUR TUNE.**

If you're already working with an 80-8 or 40-4, our Variable Speed Control is a very cost-effective addition. For just \$350\* you'll adjust 15 ips to the tune of  $\pm 20\%$ .

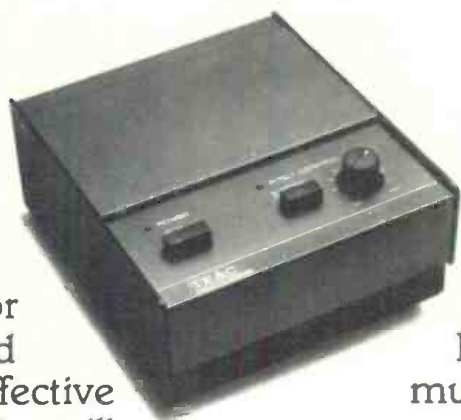

And you'll get a brand new single speed servo-controlled DC motor in the deal. Your multichannel recorder becomes more versatile. And it ends up lasting longer. Remember trying to over-

dub a piano only to find it out of tune with the track? Or sweat-

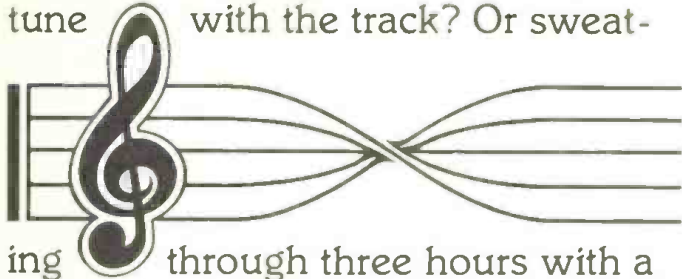

ing through three hours with a singer who flatted the last note of an otherwise flawless performance? You'll turn these late-night horror stories into lullabies with Variable Speed Control.

Try it for adding a "tunable tom" effect to your song. Then experiment with other rhythmic twists.

Turn two singers into a chorus of eight. Add harmonies. Transpose from A up to C, or back down to

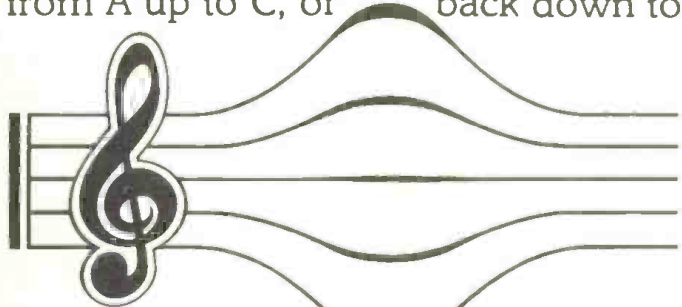

F#. With the 80-8, you have eight tracks to build your song.

When you're working with synthesizers, you can spend hours experimenting. Or seconds repairing an out-of-tune tone. Try creating your own special effects, bending and shaping other instruments to fit your ideas. Whether you have an 80-8 or 40-4, you have the capability to turn basic music into complex arrangements.

As a production aid, our Variable Speed Control becomes Executive Producer when that beautiful radio spot comes in at 32

seconds. Just rewind the tape, set the control and 28 seconds later you're right on the money.

For audio-visual soundtracks, slide or filmstrip audio tracks, Variable Speed Control lets you solve tough cueing and timing problems. Without re-recording, wasting time and losing money.

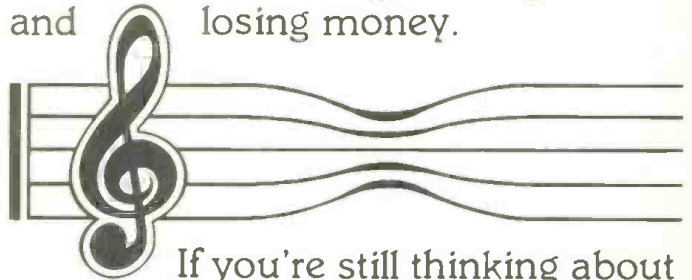

If you're still thinking about buying your 80-8 or 40-4, now is an ideal time because you have the option of taking it home with Variable Speed Control and new DC motor completely installed.

Let your Tascam Series dealer give you a hands-on demonstration. You'll hear how our new Variable Speed Control lets your 80-8 or 40-4 sing a new tune.

\*Suggested list price, optional with dealer; installation required.



## TASCAM SERIES

### TEAC Professional Products

TEAC Corporation of America, 7733 Telegraph Road, Montebello, CA 90640.

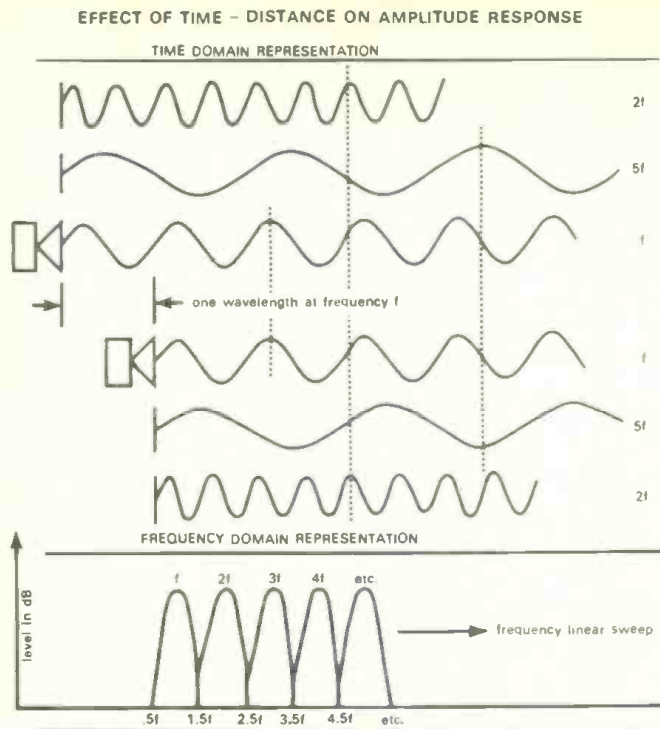

as yet, no reflections. Room modes are the resultant amplitude variations by frequency as measured at a given position of the complex additions of time varying reflected spectra with each other and the direct sound. In other words, "modes," or more properly, eigen-wavelengths (for it is their wavelengths that remain consistent as, for example, when the temperature shifts) are frequency response anomalies generated by reflected spectra. Figure #1 illustrates simple combinations that can occur. TDS allows the easy observation of this phenomenon because of the linear frequency response scale of TDS in distinction to the "log" scale universally used on standard frequency response charts. The anomalies generated by two spectra arriving at the same point in space are "out of phase," that is, displaced slightly in time, are linearly spaced nulls and peaks in frequency. See Figure #2.

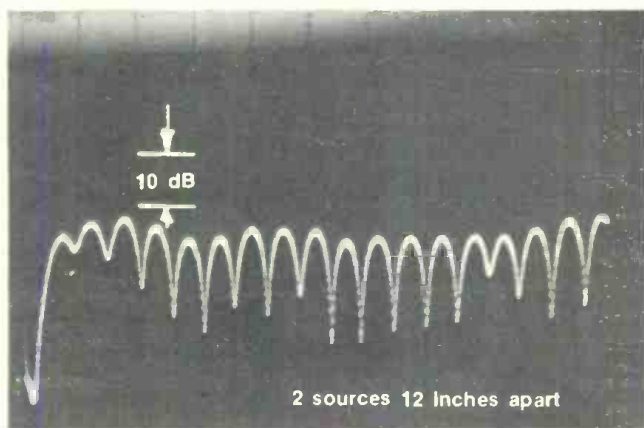

Figure 2: The anomalies generated by two spectra arriving at the same point in space "out of phase", that is, displaced slightly in time, are linearly spaced nulls and peaks in frequency (0-20kHz)

**A Short Primer on Phase and Polarity**

Many audio engineers accept the statement that "reversing the polarity of a speaker shifts its phase 180°."

If you examine the statement for a moment you will see that the signal emits from the same point in space with either polarity. The difference being that in one case it starts

with a compression and in the other case it starts with a rarefaction. So let's clarify the terms "polarity" and "phase." (No Charlie — you don't "phase speakers" by reversing the connection to one of them.) Polarity is not frequency dependent; Phase is frequency dependent. A polarity reversal is instantaneous in time where a phase difference involves a time difference. In fact, there is a simple equation for translating phase difference into time difference

$$T_D = T_p \theta / 360$$

Where:

- $T_D$  is the time delay, or difference, in seconds
- $T_p$  is the time period of frequency  $f$  ( $T_p = 1/f$ )
- $\theta$  is the phase delay in degrees

Then, of course,

$$\theta = T_D / T_p (360)$$

For deliberate displacements of "acoustic center"

$$T_D = ((1 \text{ sec}/1130 \text{ ft}) \cdot (1 \text{ ft}/12 \text{ in})) (\text{displacement in inches})$$

Using these concepts we can calculate that two sources emitting the same spectra but with one of the units one inch behind the other.

$$T_D = (1/1130) (1/12) (1") = .0000737 \text{ secs, or } 73.7 \mu\text{secs.}$$

The temporal integration window of the ear has an effective width of about 10 to 15 msec. Therefore, it might be argued that such a slight time delay should not be audible. What is forgotten is what this "phase shift" (which is what time delay is) causes the amplitude response to do.

Figure #3 illustrates a frequency response from 0 to 20,000 Hz of the summation of the acoustic output of two loudspeakers (1" apart) at the measuring microphone. Please believe that the hole created is audible when program material falls in that region of the spectrum.

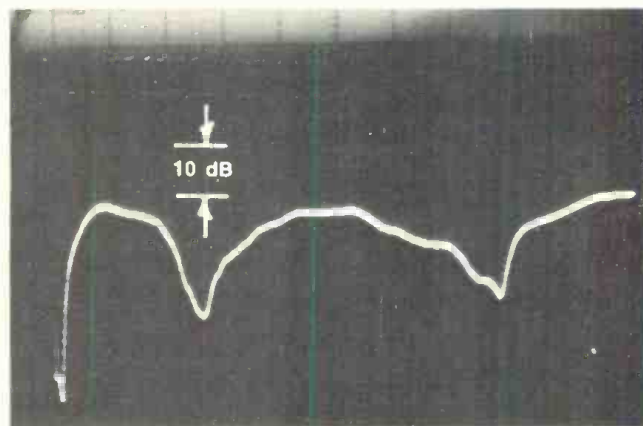

Figure 3: Illustrates a frequency response from 0 to 20kHz of the summation of the acoustic output of two loudspeakers (1" apart) at the measuring microphone.

**Back To LEDE**

Whenever the sound source and a pseudo source (such as a virtual image generated by a solid reflective surface) come together with a time difference of 73.7 μsecs or at a frequency of 6780. Hz, a phase difference of

$$\theta = ((.0000737)/(1/6780)) \times (360) = 180^\circ$$

Thus, you will have a large null in the response.

Now, let's place the two sources 10" apart. That is, one source reaches your ears 10" ahead of the other source. See Figure #4. We now have peaks at 1356, 2712, 4068, 5424,

These are the "big guns" in "professional" power amplifiers. Each of these amplifiers has individual features and abounds with specifications to impress potential buyers and to satisfy the professional user but they are not created equal... especially in reliability under professional (rack mounted) conditions.

Some of these "big guns" have been talking about everybody else being "behind", others are talking about comparator LED's, while others depend mostly on their good looks. The Peavey CS-800 comes out on top when you consider the features, the specifications (which are as good or better than anybody's), total power output, and price per watt of professional power.

Some companies have recently "discovered" LED's and comparator circuitry that Peavey pioneered and has been using for years. These recent "converts" were most vocal in the past against LED's...that is, until they updated their "plain Jane" units. Some of the

other companies spend a lot on cosmetics but not much on built-in forced air cooling and large numbers of output devices to enable reliable rack mounted operation under

continuous professional use.

Each channel of the Peavey CS-800 features 10 output devices and 2 TO-3 drivers bolted to massive modular heatsinks that are forced

cooled by a 2-speed fan, has special distortion detection circuitry and LED indicator (not simple overload), as well as a functional patch panel on the rear to facilitate the use of plug-in balanced transformer modules, electronic crossover modules and speaker equalization modules custom tailored to Peavey's SP-1 and SP-2 speaker systems.

In comparing pro amplifiers, one should apply the old commercial sound "dollar-per-watt" rule. The CS-800 is again "on top" at 81¢ per professional watt. The fact is...Peavey is not behind anyone in power, durability, features or performance.

Below are the respective published specifications of the "heavies" in pro amps. Check for yourself to see how we all stack up. You might be surprised.



Peavey Electronics  
711 A Street  
Meridian, Miss. 39301

## HOW DO THE "BIG GUNS" STACK UP?

	OUTPUT TRANSISTORS POWER @ MFRS. MIN. RECC. LOAD	COOLING SYSTEM	SPEAKER PROTECTION	GENERAL CONSTRUCTION	TURN ON DELAY	OUTPUT CIRCUITRY	T.I.M.	LIST PRICE	DOLLARS PER WATT	
Peavey CS-800	800 W Total 400 Watts/Ch. @ 4 Ohms  260 Watts/Ch. @ 8 Ohms (Both Ch driven)	20	2 Speed forced air cooling	Yes	Totally Plug-in Modular	None Required	Quasi Complimentary All rugged NPN Silicon Outputs	Not given. No accepted Measurement standards Presently exist.	\$649.50	\$0.81 per Watt Based on 4 Ohms/Ch. min. load
Crown DC-300A	310 W 155 W/Ch. @ 8 Ohms  500 W 250 W/Ch. @ 4 Ohms	16	Conventional Passive Airflow Only	No	Hard Wired	None Required	Quasi Complimentary. All rugged NPN Silicon Outputs	.0035% (NTIM) Crown Is Quoting Noise Transfer Intermodulation Distortion	\$899.00	\$1.79 per Watt Based on 4 Ohms/Ch. min. load (recently revised specs)
BGW 750 B	720 W Total 360 Watts/Ch. @ 4 Ohms  225 Watts/Ch. @ 8 Ohms	20	2 Speed forced air cooling	Yes	Modular	Relay Circuit	Collector drive Complimentary using PNP & NPN Silicon	.02% No measurement details given.	\$1099.00	\$1.53 per Watt Based on 4 Ohms/Ch. min. load
Yamaha P 2200	700 W Total 350 Watts/Ch. @ 4 Ohms  200 Watts/Ch. @ 8 Ohms	12	Conventional Passive Airflow Only	No	Hard Wired	None Required	Emitter follower drive complimentary using PNP & NPN Silicon	Not given. No accepted Measurement standards Presently exist.	\$1095.00	\$1.56 per Watt Based on 4 Ohms/Ch. min. load

All above figures based on manufacturers' published specifications and minimum recommended load impedances as of 11/1/78

for additional information circle no. 31

www.americanradiohistory.com

R-e/p 53

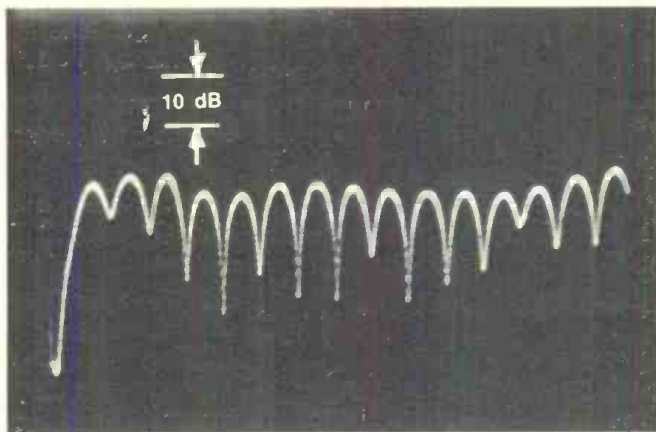

Figure 4: Two loudspeakers 10" apart. One source reaches the ears 10" ahead of the other source.

6780 and 8136 Hz, and nulls at 2034, 3390, 4746, 6102, 7458 and 8814 Hz.

What is of fundamental interest is the fact that the greater the time difference (or distance) between two combining spectra, the narrower the response anomalies generated. I'm sure we are all familiar with the concept that the wider the bandwidth of signals (at the same level) the greater the power. For example, one hundred watts as a sine wave will reach a far higher level on the analyzer than a 100 watt pink noise signal as the filter reads each spectrum. Thus the familiar caution, "the wider the bandwidth, the more likely to cause problems."

Only a short period of time is required before the investigation of response anomalies leads to an understanding that small time differences are not desirable in control room acoustics. How do we get rid of such early differences? Put the sound source in as nearly anechoic space as you can achieve, but in a manner that insures that the reflected sound travels 15 to 20 feet further than the path taken by the direct sound from the source.

### Making a Physically "Small" Room Into An Acoustically "Large" Room

When the "source" end of the control room is made nearly anechoic it insures, so far as excitation by the sources located in the anechoic end are concerned, that the earliest reflection the ear will hear now has the time dimension of a much larger room. So, too, the diffusion at the "live" end is able to be manipulated so as to approach both the narrow band characteristics as well as the density characteristics of a much larger space than actually is on hand. In other words, all clues, acoustically speaking, have been removed or masked that would allow aural identification of the physical size of the environment. Beranek has written in *Music, Acoustics and Architecture* (page 26):

Persons trained in listening — for example, blind people, who receive all their cues about the environment around them through the senses other than the eye — can "measure" the size of a room or judge the distance to a wall behind them by the length of the time interval between the direct sound and the first reflected sound.

Beranek goes on to note that this capability is not restricted to the unsighted but that

Experienced music listeners . . . sense the approximate size of a hall . . . by the length of the "initial-time-delay gap."

The LEDE technique, by virtue of the distance the direct sound must travel to encounter a first reflection has

adjusted the initial time delay gap to the same figure that Beranek judged as desirable in the best concert halls in the world, namely 20 msec. It is no coincidence that the same 20 msec is the optimum delay for the maximum Haas effect in good diffuse semi-reverberant spaces. See Figure #5.

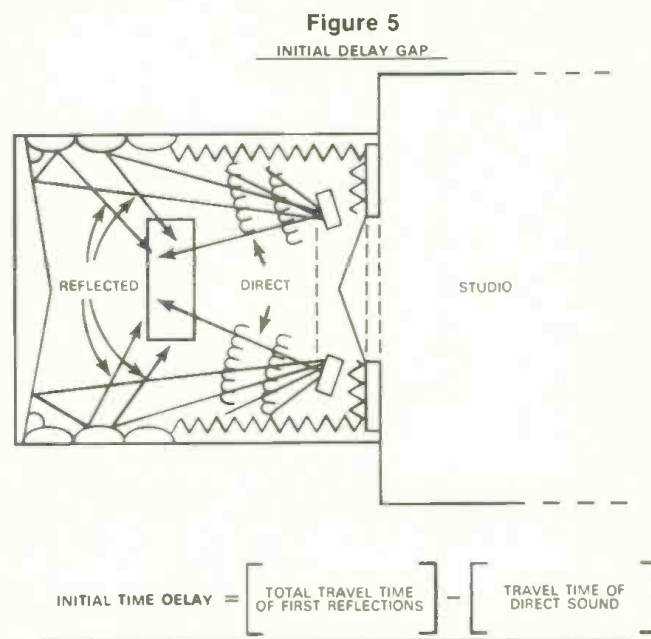

There are two important factors both in the control room and in the concert hall. They are:

1 - The first substantial reverberant energy when in the Haas precedence zone does not distract the listener with "directional" information but merely raises the acoustic level.

2 - This early arriving reverberant energy must be well diffused if the aural mechanism is not to fasten on a specific clue. That is, the energy should arrive over a spread of time that does not allow identifiable broad band anomalies to be formed by only a few discrete reflections combining with extremely short differences in travel time. A mixture of a goodly number of reflections spaced over, say a time interval from 15 or 20 msec to 300 or 400 msec — the  $RT_{60}$  of the "live" end of the room — is the design goal in a really high quality control room.

All enclosed spaces theoretically have a reverberant sound level. Figure #6 illustrates the sound fields theoretically present in a control room. First, there is the direct sound level from the source. Second, there is the total reflected — reverberant sound level. This reverberant level may consist of merely a few discrete reflected spectra or it may be a well-established diffuse field. Third, there is the total sound level — the direct and reflected sound levels combined. Finally, there is a sound field not generated by the sound source under consideration, called the ambient noise level. All of these sound fields require consideration when discussing any part of the total sound individually.

In control room work, because of a mistaken use of a technique useful in large rooms (arenas, etc.) but incorrect in small rooms, many control rooms do not have a reverberant sound level capable of influencing the total sound level. In other words, for all practical purposes there is no reverberant sound field present because the total sound field level is identical to the direct sound field level.

*continued on page 58 . . .*



Nashville

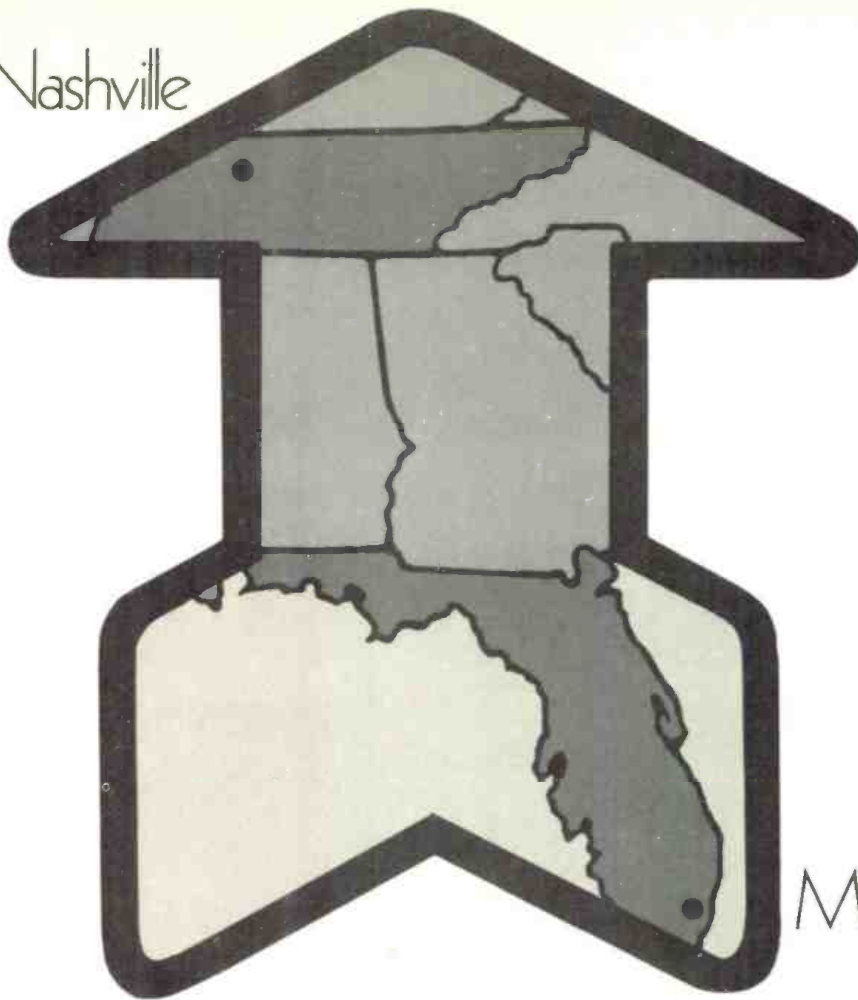

Miami

# Studio Supply Won't Stay In One Place!

They are in Nashville! Now they are in Miami! They are on the move to better serve you! And have they got a new line — Sound Workshop Professional Audio Products! STUDIO SUPPLY is where you need them with the best equipment!

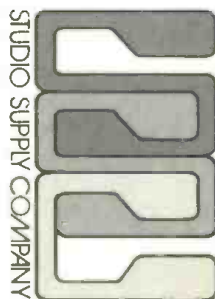

for additional information circle no. 32

[www.americanradiohistory.com](http://www.americanradiohistory.com)

R-e/p 55

# What do you look for in a Recording Studio?

Whether you are looking for studio  
time, equipment or design, you owe  
it to yourself to find out what  
"The Gold Record People"  
can offer you.

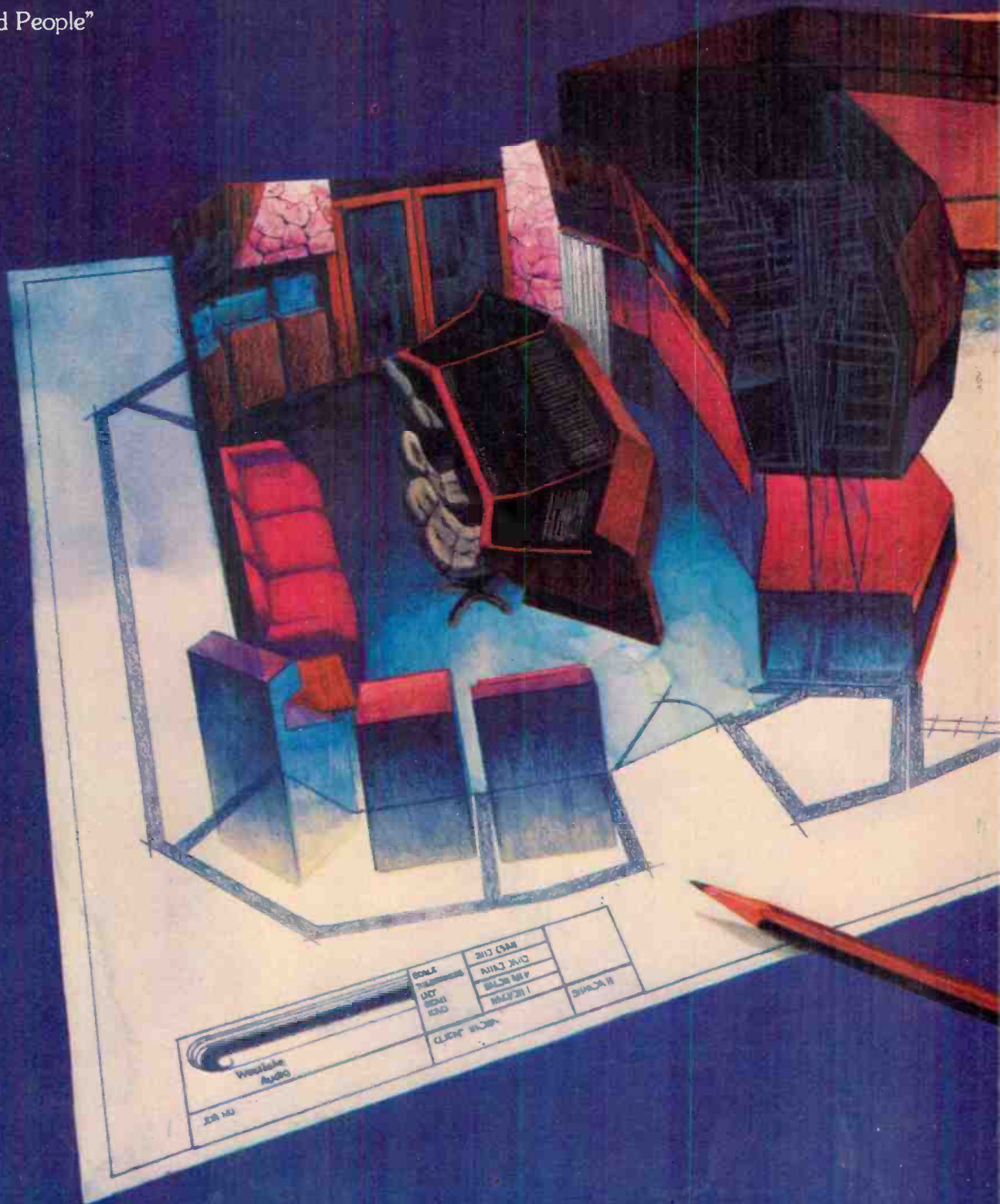

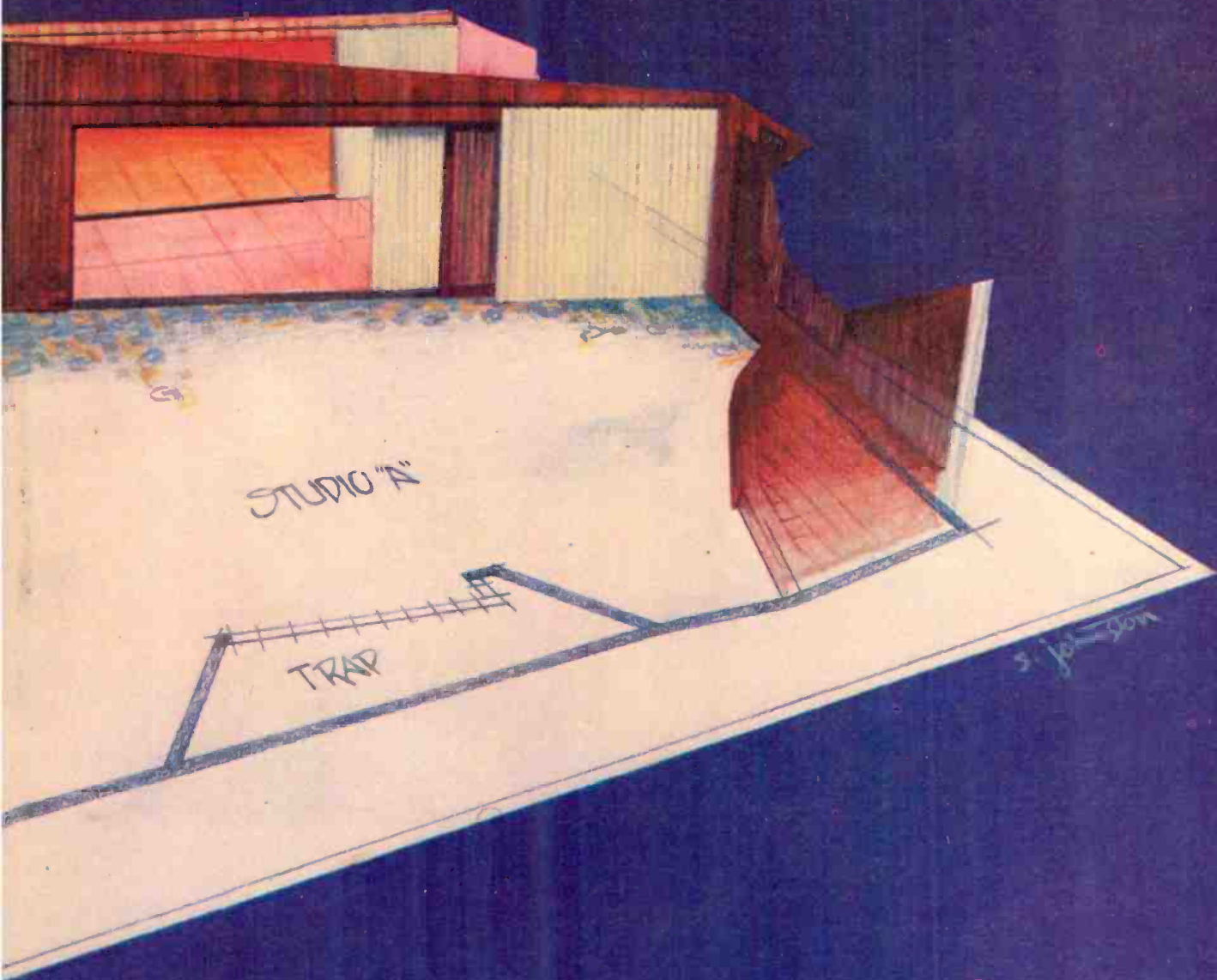

from acoustic design  
to down beat...

**Westlake  
Audio**

6311 Wilshire Blvd.  
Los Angeles, California 90048  
(213) 655-0303

8447 Beverly Blvd.  
Los Angeles, California 90048  
(213) 654-2155

**DEFINITION OF ACOUSTIC TERMS**

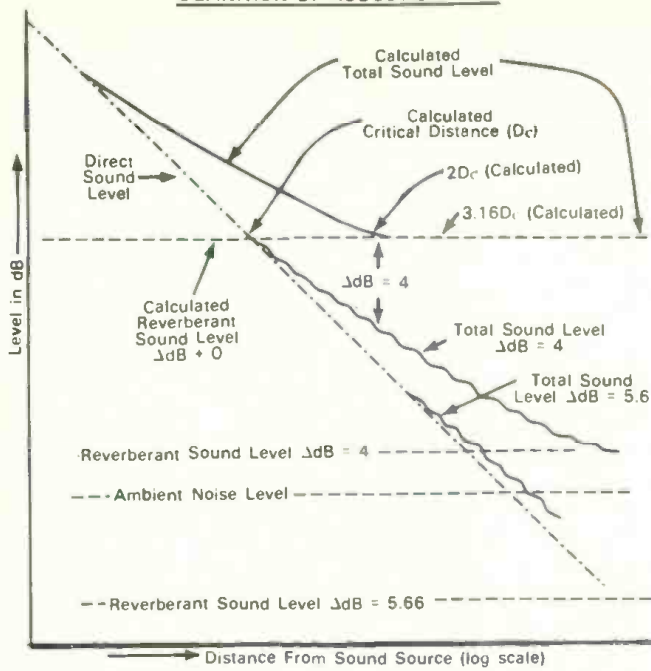

**Figure 6**

**How A Control Room Can Be Anechoic To Its Monitor Loudspeakers While Remaining "Live" To The Mixer's Ears**

First, consider if an anechoic chamber would make an acceptable control room. This question is easily answered by trying to mix in a chamber; a really horrible mix results. Or it can be seen theoretically by considering the massive anomalies that would be generated every time you moved your head from precisely between two monitors. Experience reveals that you wouldn't want to "mix" in a reverberation chamber either. Thus we have eliminated the two limits available. Obviously, the answer lies somewhere inbetween and is called the semi-reverberant sound field.

A semi-reverberant sound field is characterized by a reverberant level capable of influencing (favorably) the total sound level without having to be the predominant level. Figure #6 illustrates the effect.

One way to thwart the establishment of a semi-reverberant sound field that is quite often done without realizing the severe consequences is to make the wall behind the mixer "dead." See Figure #7. If, for example, there were a total absorption of 440 sabins (S<sub>a</sub>) in the control room, so far as the loudspeaker is concerned, there are 440 x 64.9 = 28,556 S<sub>a</sub>, while the mixer continues to hear a semi-reverberant space for any of the sounds he makes. At mid-frequencies a UREI 813 has a Q in excess of 10 (which, by the way, is nearly optimum — but that's a discussion longer than this article). A "live" talker has a Q ≈ 2.5 at mid-frequencies. Therefore, in this case the loudspeaker will not generate a useable reverberant level.

In large rooms (auditoria, arenas, etc.) we attempt to increase M<sub>a</sub> (architectural acoustic modifier). In control rooms, we attempt to eliminate M<sub>a</sub> and concentrate on maximizing diffusion in the "live" end of the room.

**Some Comments On Reverberation**

The above mentioned "diffusion" constitutes the heart of LEDE design and is a subject that, from the evidence in the literature of control room design, is not sufficiently understood. To properly cover the subject of diffusion requires more time and space than this article affords. For

**Figure 7** EFFECT OF 'DEAD' REAR WALL

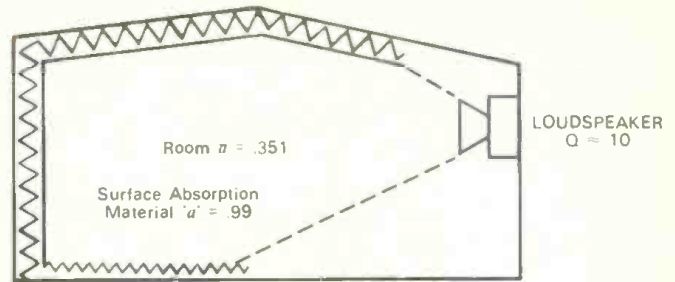

$$M_u = \left( \frac{1 \cdot .351}{1 \cdot .99} \right) = 64.9$$

If total S<sub>a</sub> = 440 then loudspeaker will generate a reverberant sound field level comparable to that which would appear in a space having 440 X 64.9 = 28.556 S<sub>a</sub>

those with pressing needs, the writings of A. M. Legendre and C. F. Gauss on quadratic-residue sequences of elementary number theory have been found germane by the most qualified of modern researchers into the problem.

Much confusion attends the term "reverberant sound field" in the control room. Theoretically speaking, any enclosed space has a reverberant sound field. The only difference between one space and another space is the sound level of the reverberant sound field.

To again look at "limits," an anechoic chamber has a "reverberant sound field" that is, by specification, down 20 dB below the direct sound field level. In any practical case, using the best of the currently available acoustic measurement equipment, an accuracy of 0.5 dB is exceptional; therefore, any reverberant sound field level found to affect the total sound field level by less than 0.5 dB may, with justification, be treated as not present. This is particularly true whenever the measurement of the total sound field level is being taken at a distance from the sound source that exceeds twice the calculated critical distance, D<sub>c</sub>. See Figure #8.

We have found that the desired ΔdB falls between 3 and 4 dB. An extremely simple but highly effective estimator of ΔdB is the Peutz equation

$$\Delta dB = .22 ((\sqrt{V}) / (h \cdot RT_{60}))$$

Where:

- V is the internal volume of the space in ft<sup>3</sup>
- h is the height of the ceiling
- RT<sub>60</sub> is the reverberation time for 60 dB of decay

We use the equation in the form of

$$RT_{60} = .22 ((\sqrt{V}) / (h \cdot \Delta dB))$$

**Advantages of the LEDE Concept**

What LEDE accomplishes acoustically can be enumerated as:

- 1 - Frequency response anomalies generated by the interaction of the direct sound and first reflections are high density narrow band (less than 1/6-octave at 500 Hz and 1/12-octave at 1,000 Hz, etc.).
- 2 - The initial time delay gap (as defined by Beranek) may be adjusted to provide the psychoacoustic effect of a large space.

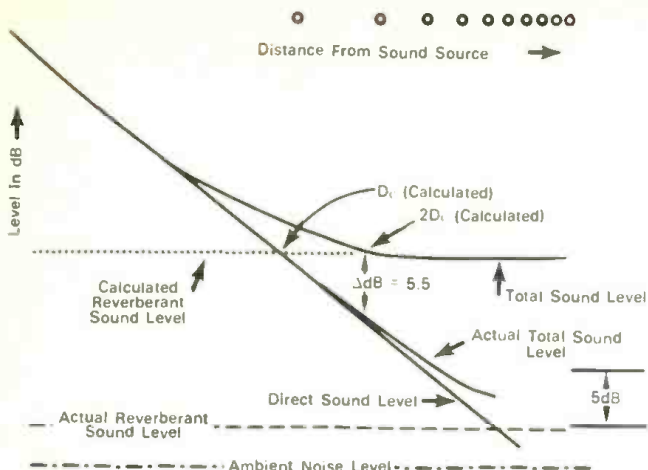

Figure 8

Figure #8: Sound Levels

The sound levels normally measured with a sound level meter are:

- 1 - Direct sound level
- 2 - Reverberant sound level
- 3 - Ambient noise level
- 4 - Total sound level.

Expressed mathematically the non-coherent addition of the first three constitutes the fourth.

$$T_{SL} = 10 \log (\exp(D_{SL}/10) + \exp(R_{SL}/10) + \exp(ANL/10))^*$$

The addition of individual frequencies can be accomplished by

$$T_{SL} = 10 \log \sqrt{(\exp(SPL_1/10))^2 + (\exp(SPL_2/10))^2 + 2(SPL_1)(SPL_2)(\cos(a_1 - a_2))^*}$$

\* exp = base 10

Where  $SPL_1$ ,  $SPL_2$  is the relative sound pressure associated with a sound level

$$10(D_{SL}/20) = SPL_{rel}$$

$a_1$ ;  $a_2$  are the phase angles in degrees associated with  $SPL_1$  and  $SPL_2$ .

It is important when using sound level meters, spectrum analyzers, etc., that the operator knows how to detect which of these levels or combination of levels he is measuring and knows how to calculate the others from the ones measured. Quite often the total sound, including ambient noise, is mistaken for the reverberant sound level. On occasion critical distances are discovered in essentially non-reverberant spaces and incoherent signals are summed as coherent signals.

Figure #8 helps define some of these terms and illustrates their relationship. The case chosen is a control room which for all practical purposes may be considered without a reverberant sound field. The actual reverberant level is so low as to make the total sound level at  $2D_c$  (calculated) less than .5 dB different than the direct sound level at that same distance. Since the room is only 40 feet in its longest dimension, the reverberant sound level, though theoretically present, does not affect any measurement undertaken.

3 - All first order reflections fall within the Henry-Haas effect precedence zone.

4 - Substantially more acoustic energy can be developed without incurring the penalty of "small space" coloration.

5 - Symmetry need not be as rigorously enforced provided no repetitive reflection paths are established (control of flutter, echoes, etc.).

6 - A sufficiently reverberant sound field may be developed to generate a  $\Delta dB$  of 3 to 4 dB while maintaining traditionally accepted reverberation times.

7 - Spatial geometry is not degraded by the control room environment and therefore remains dependent upon:

A - Loudspeaker spacing and orientation (10 to 20 feet are suggested separation distances).

B - Time alignment of loudspeakers.

C - Pressure Zone Microphony, PZM™. Suggested microphone spacing just slightly wider than playback loudspeaker spacing used.

D - One fundamental advantage of LEDE that can be overlooked is the fact that equipment racks, tape machines, etc., when placed in a soffit flush with the upper rear wall now provide useful diffusion of the higher frequency energy.

### Conclusions

The LEDE concept of control room design is part of a chain of events that leads to "coherent sound reproduction."

- 1 - TDS analysis of direct and reflected spectra.
- 2 - Enlightened use of actual Time Aligned™ (E. M. Long Associates) transducers. (Be very wary here as a majority of the devices claiming TA are not so aligned.)
- 3 - Enlightened use of the PZM™ system.
- 4 - Creation of a desirable "acoustic size" control room free of uncontrolled response anomalies.
- 5 - Creation of a diffuse "live" end adjusted to an effective  $\Delta dB$ .

6 - Use of combinational geometry in the creation of eigen wavelengths of the desired spacing and density.

7 - Use of the psychoacoustic effects of precedence (Henry, Fay-Hall, Haas, et al) and initial time delay gap (Beranek).

Chips Davis is the first recording engineer to use PZM™, TA, and LEDE, in a control room analyzed by TDS. □ □ □



### DEALERSHIPS AVAILABLE FOR NEVE — LYREC

Neve, the world leader in professional audio consoles and computer assisted mixing systems, is seeking dealer representation in the following areas:

**MIDWEST • SOUTHEAST  
SOUTHWEST • ROCKY MOUNTAIN**

Applicants should be experienced in selling professional audio equipment to sound recording and broadcast fields, and should have first-line service facilities. This is an excellent opportunity for a hardworking dealer to increase its yearly turnover potential significantly. Please reply in strict confidence with brief details of your sales area, turnover, growth history and current products carried. Sorry, NO dealerships available in the Northeast, Nashville area, or West Coast.

Reply to:

**Tore B. Nordahl, President  
Rupert Neve, Inc.  
Berkshire Industrial Park  
Bethel, CT 06801**

## A HIGH PERFORMANCE, LOW-COST TRANSFORMERLESS MICROPHONE PRE-AMP PROJECT

by  
*Dave Baskind and Jon Sanserino*

One of the longest standing necessary evils in mixing consoles is the mike input transformer. As good as some are made, they are still prone to all kinds of problems such as low frequency distortion, transient distortion and sensitivity to changes in source impedance, not to mention cost and size (for a good one). But we can't do without them, because the voltage gain they provide gives us a few precious extra dB of signal-to-noise ratio, and they isolate the preamp from the phantom power supplies used with condenser mikes. However, if you can put up with a few more dB of noise, especially on higher level tracks such as drums and percussion where it can't be heard anyway, here is a low cost solution that offers greatly improved performance in terms of

transient response and overall sound quality, and still allows phantom powering to be used.

### CIRCUIT DESCRIPTION

This transformerless mike preamp is an adaptation of an instrumentation amp configuration. The front end network of R1, R2 and C3 form an RF rejection (low pass) circuit with the -3 dB point at 100 kHz and around 20 dB of rejection at 550 kHz (the bottom of the AM band). In areas with high RFI problems, C3 can be doubled in value with a very slight audio high end rolloff. D1-D4, C1, C2, R1 and R2 form a protection circuit which protects the preamp from phantom power in two ways: a) C1 and C2 block the DC voltage, and b) the

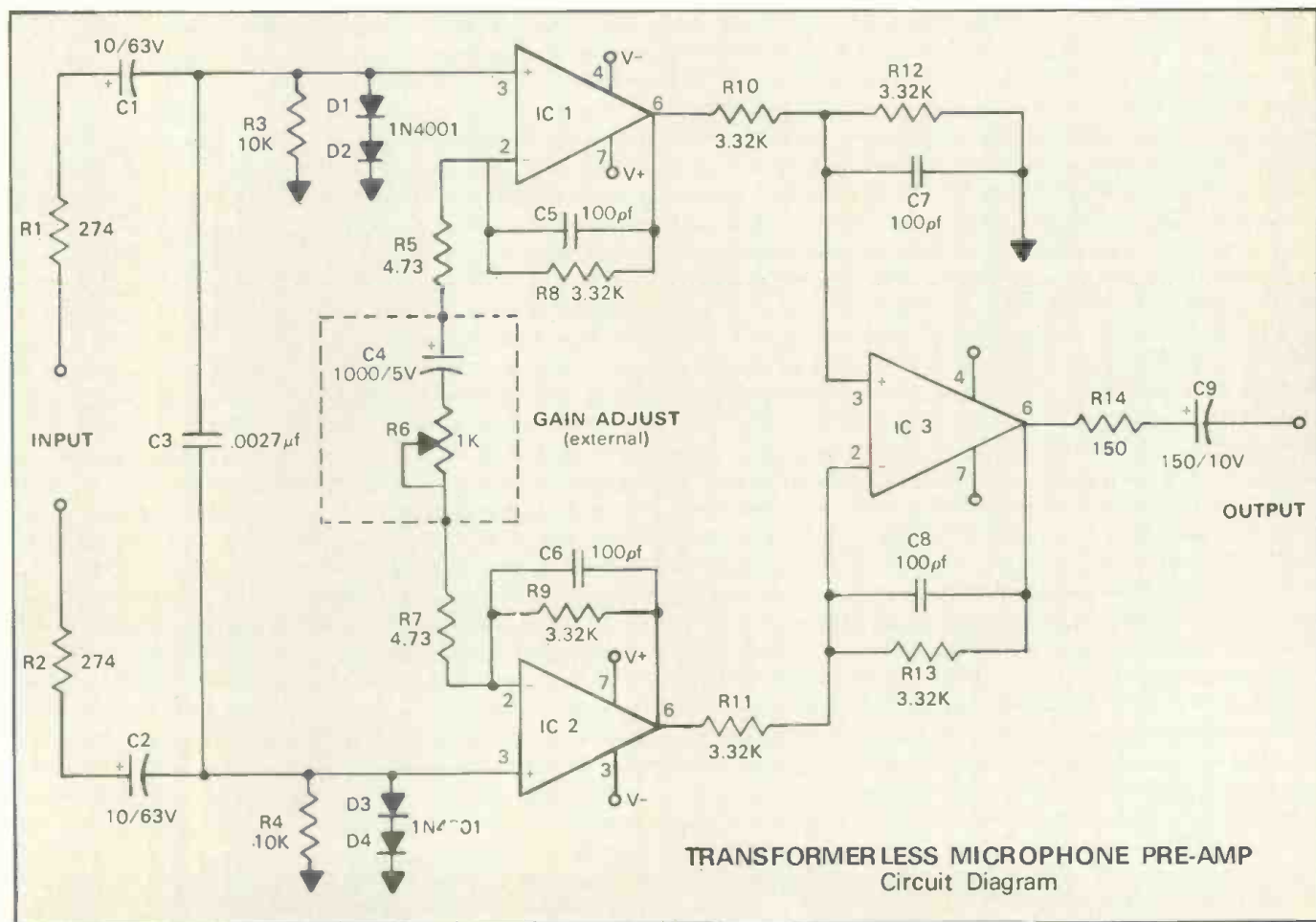

# Studer A-800



When performance is  
more important  
than price

... demanding recording engineers and studio managers choose Studer. And when the requirement is multi-track, their choice is likely to be the new Studer A-800 with 14" reel capability, 1/2 horsepower spooling motors and microprocessor controlled deck functions for the smoothest, fastest tape motion you've ever seen. It also includes new phase compensated amplifiers, a self-contained Autolocator function and numerous other convenience and quality features that make Studer's slightly higher purchase price less costly in the long run. For complete information on the Studer A-800-16 and A-800-24, please write to us.

**STUDER**

Studer Revox America, Inc., 1819 Broadway, Nashville, Tennessee 37203 / (615) 329-9576 • In Canada: Studer Revox Canada, Ltd.

for additional information circle no. 35  
[www.americanradiohistory.com](http://www.americanradiohistory.com)

R-e/p 63

# IMPULSE ALIGNMENT OF LOUDSPEAKERS AND MICROPHONES

## PART TWO

by Gary Leo and Don Pearson

Part one of this article (*R-e/p*, December, 1978) described a method for observing the electrical polarity of speakers and microphones with respect to a known source. It included a circuit and a test setup for making these observations. It then went on to show how to determine the polarity between drivers in a multiband speaker system and how the frequency response

### ABOUT ULTRA SOUND:

In addition to consulting and design engineering, Ultra Sound offers custom construction of one-of-a-kind electronic projects for sound reinforcement applications and rental of electronic equipment.

A recent project was construction of the six-way stereo electronic crossover used during the final shows at San Francisco's Winterland Arena on December 31, 1978. It was designed for Bill Graham's F.M. Productions as specified by the Grateful Dead. Ultra Sound is supplying a monitor system to the Jefferson Starship, presently rehearsing in San Francisco.

Currently, Ultra Sound is in the process of interfacing its custom test equipment to its computer.

A partial list of Ultra Sound's better-known clients include WAH Sound, Sacramento, California; Starline Sound, Hard Truckers Speakers, and The Grateful Dead, all San Rafael, California; and Hot Tuna, San Francisco, California.

would suffer if the drivers were connected improperly.

There are a couple of additions and corrections to Part One of Impulse Alignment. First, picture 4A had no explanation. It shows the signals generated by the circuit shown. The top trace is the signal for the oscilloscope sync input, while the bottom trace shows the signal after it has gone through the bandpass filter (pulse output). When using this circuit, adjust the oscilloscope so that it is being triggered on the negative edge of the pulse.

The circuit itself needs one minor correction. The jumper connecting the output of Op-Amp #2 to the wiper of the 5 kilohm potentiometer going to the pulse output should be omitted. The final addition is the calibrations on all the frequency response measurement photos and they are identical to those in Figure 3 of this article.

To begin this, the final article on impulse alignment, a few points are in order. If your oscilloscope does not have sufficient sensitivity to view the microphone signal directly, then a microphone preamplifier should be used. It should be pointed out that there is no general rule to follow with regard to consistency of phase polarity or whether there should be alternating polarity between crossover outputs. This is determined by the taper and slope of the crossover in use.

There are several things that can be done to improve a sound system. First, in a testing situation, test the components and make improvements, get rid of rattles and vibrations. Then find the proper alignment and mark the speaker locations relative to each other so that the system can be returned to this configuration every time it is installed.

When the sound system is in use:

1 - Use an impulse test to verify that all of the drivers are connected in their proper

polarity, and optimize the alignment. This may be omitted if nothing has changed since the last use or alignment.

2 - Use pink noise and a real time spectrum analyzer to adjust the system for flat response by adjusting crossover output levels and polarity. Then adjust the system equalizer.

3 - The system is then adjusted to sound good by the person mixing. This is most critical and someone with proven experience will be able to please the greatest number of people. It is not uncommon for a sound system to be hired because of the ability of the personnel operating it rather than its hardware.

Part two will discuss the observation of and problems associated with enclosure resonances and some of the corrective measures that can be taken using the same basic test set-up. It will also demonstrate a method for observing and adjusting the arrival time of the signal from each of the speakers in a multi-driver system.

### Common Applications

Figure 1 depicts a typical waveform that should be received at a microphone. Figure 2 shows the impulse response of a woofer in a badly braced speaker cabinet. Note that audible ringing is demonstrated.

Figure 3 is the frequency vs. amplitude response of this woofer/enclosure combination. The peak in the frequency response at 4 kHz is a result of cabinet resonance. The peak in the frequency response plot is due to the resonances that the impulse generated in the enclosure. Figure 3 shows that the acoustic output of the cabinet resonances can be almost as loud as the signal coming from the speaker. The crossover network can be partially responsible for some of the ringing as demonstrated in Figures 4 and 5. Figure 4 is a three-pole Butterworth bandpass (18 dB/octave) filter (800 - 7 k) while Figure 5 is

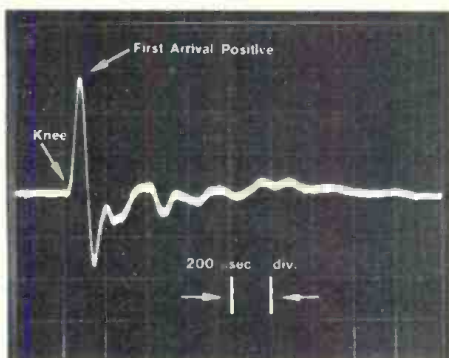

Figure 1. Typical Impulse received at microphone. Horizontal scale = 200 microseconds/div.

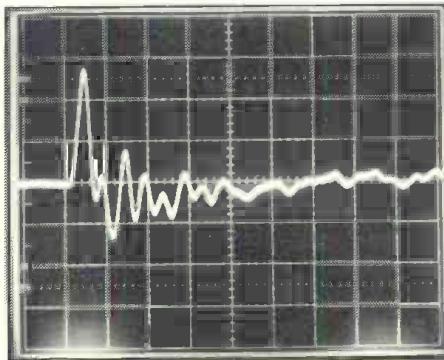

Figure 2. Impulse response of badly braced cabinet.

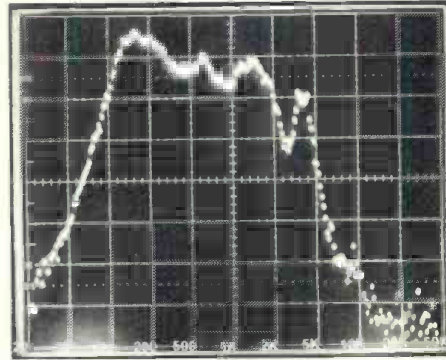

Figure 3. Frequency vs. Amplitude Response of Figure 2.



# FADEX GIVES YOU GREAT AUTOMATION

## VCA-5M GIVES YOU GREAT AUDIO



The FADEX promise is very straightforward. Easy retrofit of the finest automation available, into just about anybody's console.

Of course, console designers, and users have varying psychologies concerning the importance of certain audio performance parameters to their "sound." Some, for instance, go for lots of headroom and gain reserve. Others insist on wide frequency response and very low noise levels.

Some emphasize the importance of transient response, T.I.M., twin tone I.M. and square wave response. What separates *great consoles* from the run of the mill, obviously, is strict attention to *all* audio parameters, rather than just the designers favorites.

### THE VCA-5M IS DESIGNED FOR GREAT CONSOLES!

It has to be. When you automate YOUR console with FADEX, our reputation for excellence is on the line. The audio performance cannot be degraded, in any way, in any installation. Our VCA-5M insures this sort of audio integrity, by offering superb performance in all known parameters of performance.

The real proof of performance, of course, lies in the ears of the user. Whenever we FADEX a console, we ask "Well, how does it sound"? We always get the same monotonous answer: "It sounds just like it did before."



**allison research, inc.**  
2817 ERICA PL., P.O. BOX 40288  
NASHVILLE, TENNESSEE 37204

Figure 4. Impulse response of 18 dB/oct Butterworth bandpass crossover 800-7 kHz.

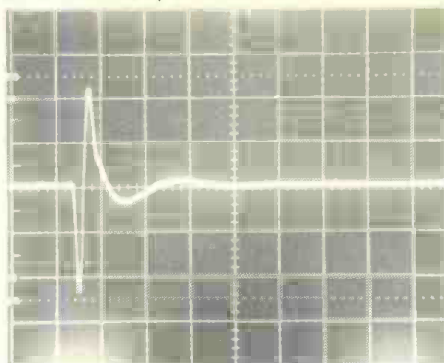

four-pole Chebyshev (24 dB/octave) filter (250 - 4 k).

Sweep the pulse output control of the signal generator to different settings and observe the received waveform. The amount of ringing will vary with different settings. The place where the waveform is modulated the most is where the cabinet resonances (ringing) is maximized. Leave the generator set and feel the cabinet with your hands. You should be able to feel the actual panel vibrations. At this point an accelerometer may be substituted for the microphone and placed against the speaker cabinet and walls. The test system is now like a stethoscope for the speaker system.

Much can be inferred by striking the cabinet in different places. You should hear a dull thud. If you hear vibrations, rattles or

Figure 5. Impulse response of 24 dB/oct Chebyshev bandpass crossover 250-4 kHz.

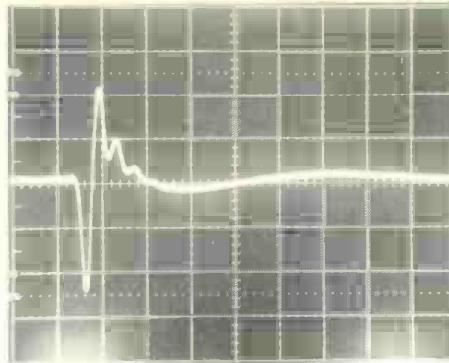

gong type sounds (extended decay time), then some corrective action must be taken. The air pressure inside the cabinet normally couples the speaker cone to the side walls. As the speaker functions, the cabinet side panels start to vibrate. These vibrations, unlike acoustic resonances, can be different from the passband frequencies generated by the speaker. Acoustic resonances play a part in the ringing problem, since a great deal of power in the bass region will generate sympathetic resonances in an improperly constructed or braced cabinet. Horn-type transducers also exhibit bell type sounds which can be excited with a mallet or similar object.

#### Enclosure Construction and Bracing

There is no standard procedure for

Figure 6. Impulse response of the system shown in Figure 2, after bracing.

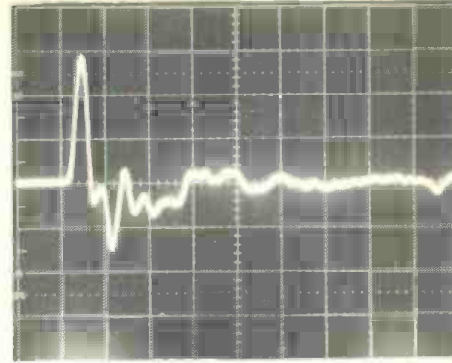

solving the enclosure ringing problem. Bear in mind, though, that if a surface can move it will resonate at certain frequencies. Constructing a properly braced cabinet usually reduces this problem significantly. Ultra Sound has researched the ringing problem with Hard Truckers Speakers, of San Rafael, California, to improve enclosure construction and bracing.

Some of the indications used are as follows:

- Any surface with a span greater than two feet should be braced with a piece of wood across the surface; cross bracing should also connect opposing walls.
- If there are any removable panels, they should be screwed down around the perimeter and also to cross bracing.
- The thickness of the enclosure wall is

## The most versatile digital reverb ever made...



for only \$1995.

Ursa Major's new SPACE STATION is a true breakthrough in audio technology—a digital reverb so versatile that it can create virtually any pattern of direct sound, early reflections and reverberation, yet costs only a third of what you would pay for a single-function reverb system. This easy-to-use unit will take your dry tracks and put them into an endless variety of reverberant spaces, from tiny rooms to concert halls to parking garages to sci-fi locales. And the SPACE STATION can do even more. Multi-Tap Delay and built-in mixer give you totally new pure delay effects, while feedback of a single tap provides simultaneous echo or resonance effects.

**KEY SPECS:** Delay Mode: 80dB dynamic range, 0.1% T(N+D), 7kHz, 256ms delay, 16 programs of delay times for 8 Audition Taps; Reverb Mode: decay time 0 to 3.5s, EQ +0/-10dB at 20 Hz and 7kHz, two programs of reverb taps; Echo Mode: delay time 1 to 255ms, decay time 0 to 13s. Mono In/Stereo Out, LED Peak Level Indicator at 0, -6, -15 and -30dB. Manufactured in USA. URSA MAJOR, SPACE STATION and Multi-Tap Delay are trademarks of Ursa Major, Inc.

**URSA MAJOR**  
Box 18  
Belmont, MA 02178  
(USA) (617) 489-0303

USA, Hollywood CA  
AUDIO CONCEPTS  
213 851 7172  
USA, Pekin Illinois  
MILAM AUDIO  
309 346 3161

USA, New York NY  
MARTIN AUDIO/VIDEO  
212 541 5900  
USA, San Rafael CA  
BANANAS AT LARGE  
415 457 7600

USA, Stamford CT  
AUDIO TECHNIQUES  
203 359 2312  
USA, Strongsville OH  
PI CORP  
216 238 0644

England, London  
FELDON AUDIO  
01 580 4314  
USA, Cleveland TN  
BROADCAST DISTRIB.  
615 472 8200

Canada, Toronto  
J-MAR ELECTRONICS  
416 421 9080  
Japan, Tokyo  
ELECTORI CO.  
(03) 950-6266

Figure 7. Frequency response of the system shown in Figure 3, after bracing.

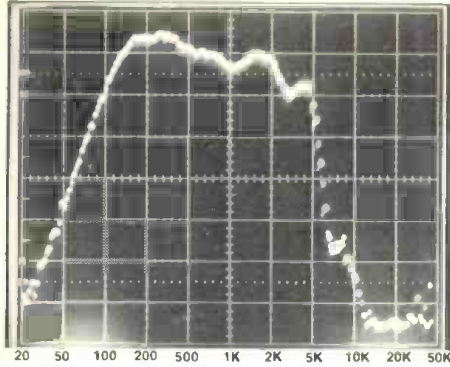

dependent upon the actual size of the cabinet, larger cabinets need thicker walls. In all cases, high quality wood should be used. If plywood is used, only accept wood with plys made of solid laminations with no gaps or filler. Filler, consisting of sawdust and glue, is added to the gaps in cheap plywood. The price of proper materials is much more expensive than ordinary woods. If there are any gaps in the layers, they will start vibrating and breaking up the filler between the plys causing buzzes and other sounds. Hard Truckers only uses imported 14-ply Finnish birch three-quarter-inch marine plywood in their construction and bracing. All of their products make extensive use of these materials and techniques. High quality particle board may be substituted, but it will not be as durable.

Figure 8. Arrival time difference — showing both woofer and mid-range pulse. (Difference = 1.6 divisions  $\times$  0.5 milliseconds/div = .8 ms or 10.8 inches)

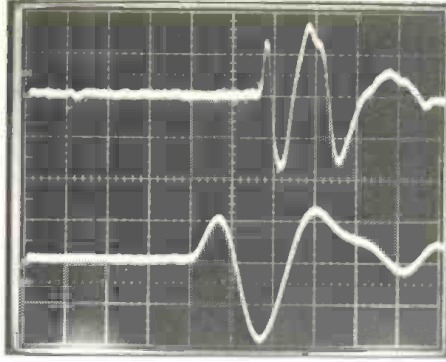

- An enclosure made with cheap plywood may superficially resemble a high quality cabinet, but after a short period of time it will sound like a "rattle trap."
- It is necessary to isolate the speaker from the cabinet with a gasket. The gasket serves two purposes; one is to insure an airtight seal and the other is to provide some shock isolation.
- The impulse response can be dampened by changing the amount of stuffing inside the cabinet. Increasing stuffing should stop the high frequency reflections within the enclosure from radiating out through the port or through the cone material.
- Ringing in horns can also be suppressed to some degree. One approach to the problem involves the utilization of some carpet under-padding (waffled horse hair covered

Figure 9. Same as Figure 8 with speakers adjusted for equal arrival time.

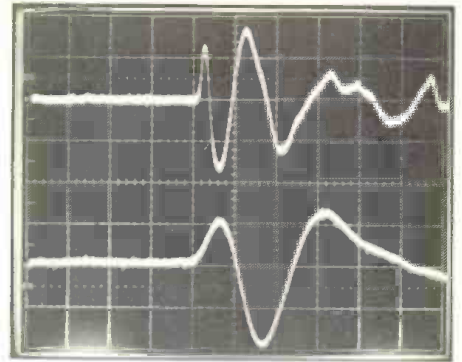

with jute). This material also works well as cabinet stuffing. Hotels and theaters usually throw it away when they replace their carpets. Coat the outer surfaces of the horn with plastic resin or similar adhesive, and press the padding into the adhesive and allow it to harden. Make sure that all fittings and connections are airtight and that any mounting plates or adapters cannot rattle against any other surface.

Figure 6 shows the impulse response of the same system as depicted in Figure 2, except that bracing and stuffing techniques have been applied. Figure 7 is the frequency response of the same system shown in Figure 3 after bracing.

#### Background Information

In the 1920's, researchers at Bell Labs

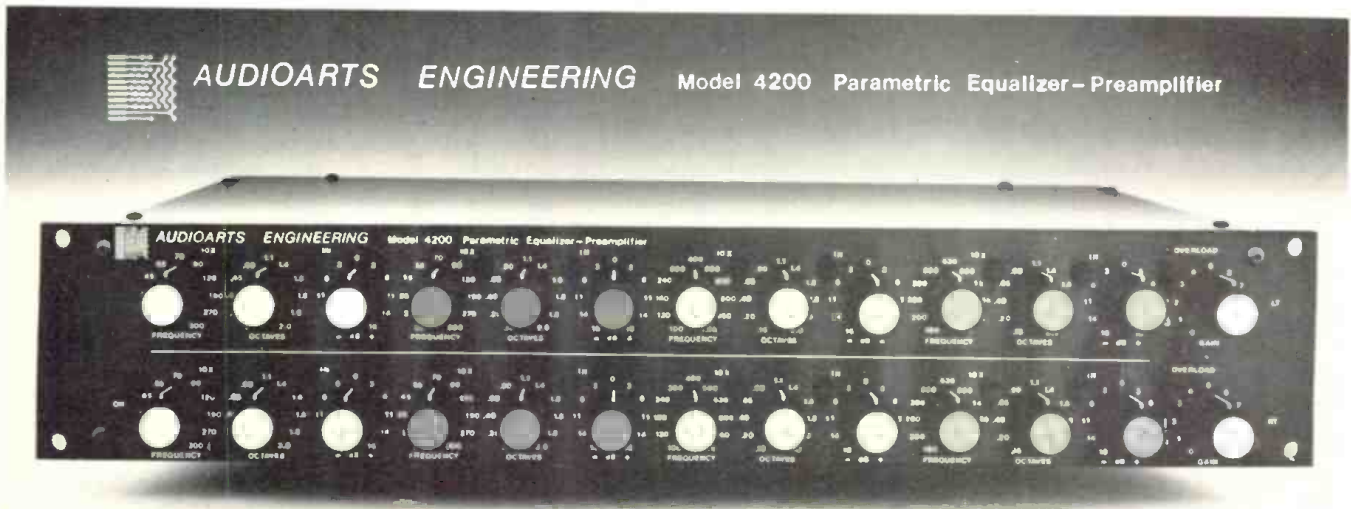

**CONSIDER THIS:** A parametric equalizer without low, mid and high band restrictions. The Audioarts Engineering Model 4200 is a four section stereo parametric equalizer; each section is a dual range filter. **CONSIDER** an equalizer that can handle full +20 dBm studio levels, regardless of equalization setting, but which also has a low-noise preamp input to allow musical instruments to plug directly into those same studio effects. The Audioarts Engineering Model 4200 is a professional no compromise parametric equalization system.

- four dual range filter sections
- EQ bypass switch for each section
- Master Equalization bypass switch
- LED overload indicator
- input gain control
- line level input jack (+20 dBm)
- instrument preamp input jack
- line output jack (+20 dBm into 600  $\Omega$  load)
- reciprocal equalization
- 3/2 inch rack mount
- Model 4200 (stereo) price: \$599
- Model 4100 (mono) price: \$335

**AUDIOARTS ENGINEERING®**  
286 DOWNS ROAD, BETHANY, CT. 06525 • 203-393-0887



Designed and built in U.S.A.

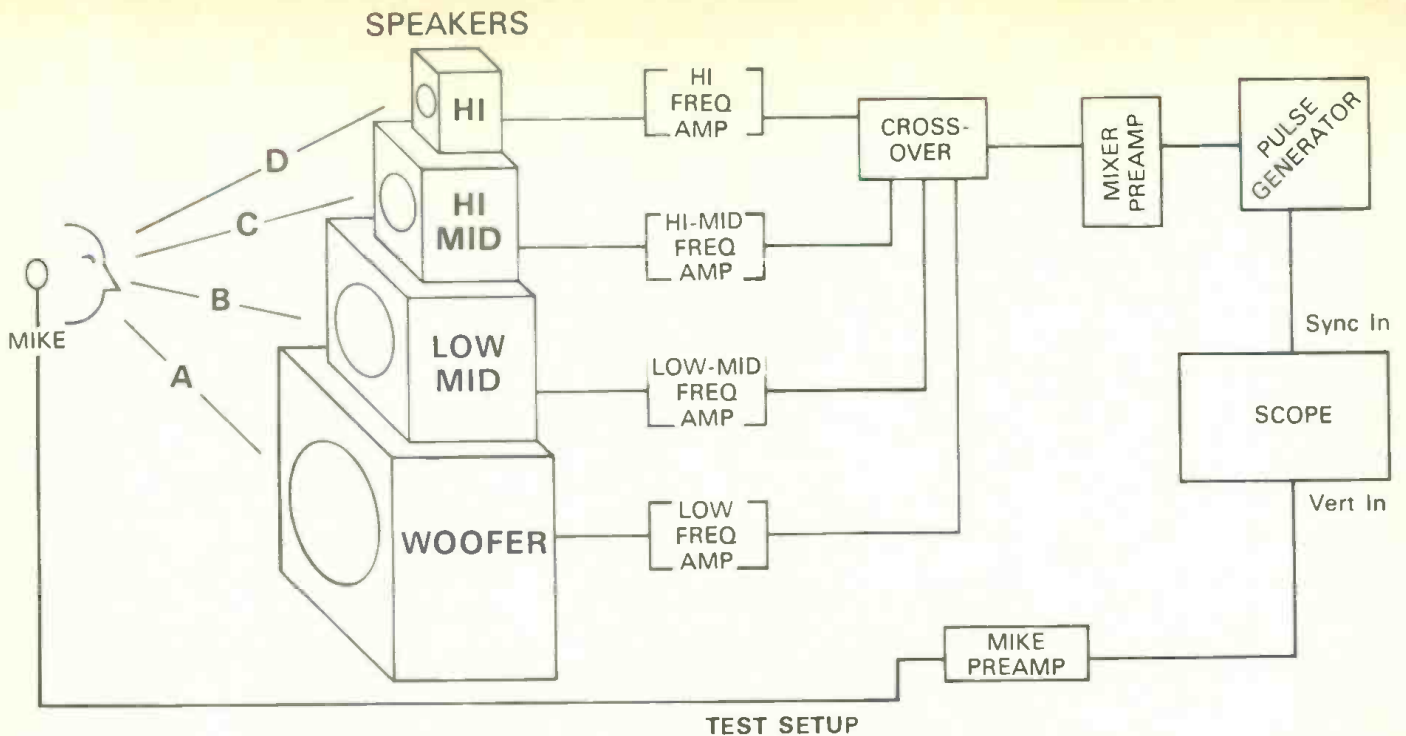

TEST SETUP

discovered that the arrival time of the sound from speakers reproducing different frequency components of the same signal was important if high intelligibility was to be maintained. Until recently, these concepts have not been applied in the design of commercially available systems. UREI offers Time Aligned™ Studio Monitors

(Time Aligned is a trademark of E. M. Long and Associates). Other products are also marketed under various tradenames.

Using the same impulse system setup previously mentioned, it is possible to observe the arrival of the impulse with respect to time. For test purposes, consider a four-way sound system containing an

active crossover and a separate amplifier for each speaker component (see diagram).

#### Preparation Before Testing

In the following discussion, it is important that the crossover be included in the tests for two reasons: first, the crossover prevents out of range signals from damaging the speakers and; second, the crossover exhibits a frequency dependent time delay which needs to be considered in the measurements.

The test microphone should, within reason, be closer to the sound system than the first reflective surface and should be pointed towards the system at approximately ear level. Since we are going to make high-frequency measurements, the microphone needs to be on-axis. If the speaker is on the floor, place some carpet or other absorptive material on the floor between the speaker and the microphone to help minimize reflections.

When a single broadband impulse is injected into the system, it is divided into four separate bandpass outputs by the crossover, and then each output goes to a separate amplifier and speaker (array). The signal that was once a single impulse to the input is now being reproduced by the four separate speakers. If these signals do not arrive at the listeners ears at the same time, the coherence of the sound is reduced. The results may be an auditory double image, a smearing of the sound and a general reduction in intelligibility. This is particularly noticeable in the high frequencies because the psychoacoustic properties of the ear are much more sensitive to mid and high frequencies.

The arrival time of the four signals from the speakers is also controlled by the physical location of each of those speakers.

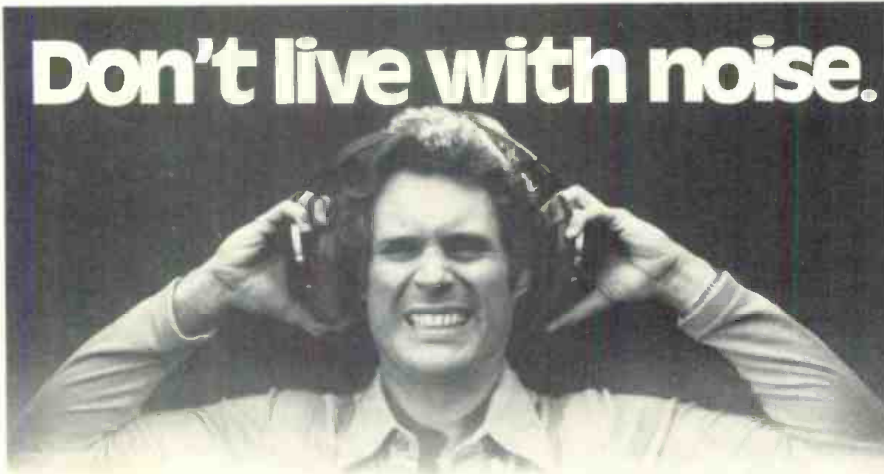

The DYNEX Noise Suppressor helps get rid of electronic and environmental background noise without sacrificing program clarity.

Choose low-frequency, high-frequency or wideband noise suppression. As legitimate program energy in the suppressed band increases, suppression is progressively reduced. The result is a cleaner sound for broadcasting, location

filming or studio recording and production.



You don't have to live with noise. Find out more about the DYNEX. Call or write us today. Model 241, DYNEX — \$300.

### Inovonics Inc.

503-B Vandell Way  
Campbell, CA 95008

Telephone  
(408) 374-8300



In the past, many people have lined up the voice coils in a vertical plane. This is a step in the right direction, but not a complete solution. The problem of mis-alignment may be observed fairly easily. If all of the components are mounted in separate enclosures, moving them forwards or backwards relative to each other will help bring the system into closer alignment.

Most large portable reinforcement systems are built in a modular fashion, so moving individual sections is not too difficult. In the studio, however, the system speakers are usually fixed into a particular place so they are not easily moved.

It should be noted that the speakers should not be tipped or tilted as this

movement will alter the polar response. Also, too much movement could put a reflective surface in the path.

### Testing Process

The procedure for observing alignment is similar to that used for checking polarity. First, set the generator's output filter to a low frequency setting and adjust the oscilloscope so that the knee or breaking point of the received impulse lines up with one of the vertical lines on the scope graticule (continue to trigger on the negative edge of the waveform).

Now slowly move the generator's frequency control to a higher setting. The amplitude of the low frequency speaker will

decrease and the mid-range speaker's impulse will appear and increase in amplitude. This impulse knee will then be either to the right or left of the noted graticule line. If it is to the left, then the speaker is too close to the microphone and needs to be moved back. Conversely, if it is to the right then it needs to be moved closer.

Again move the generator to a higher frequency and reposition the speaker accordingly. Continue until all speakers have been observed and adjusted. If you move any speaker, then you may have to adjust its level to compensate for the increase or decrease in SPL since it is now closer or farther from the microphone.

The aforementioned procedure can also

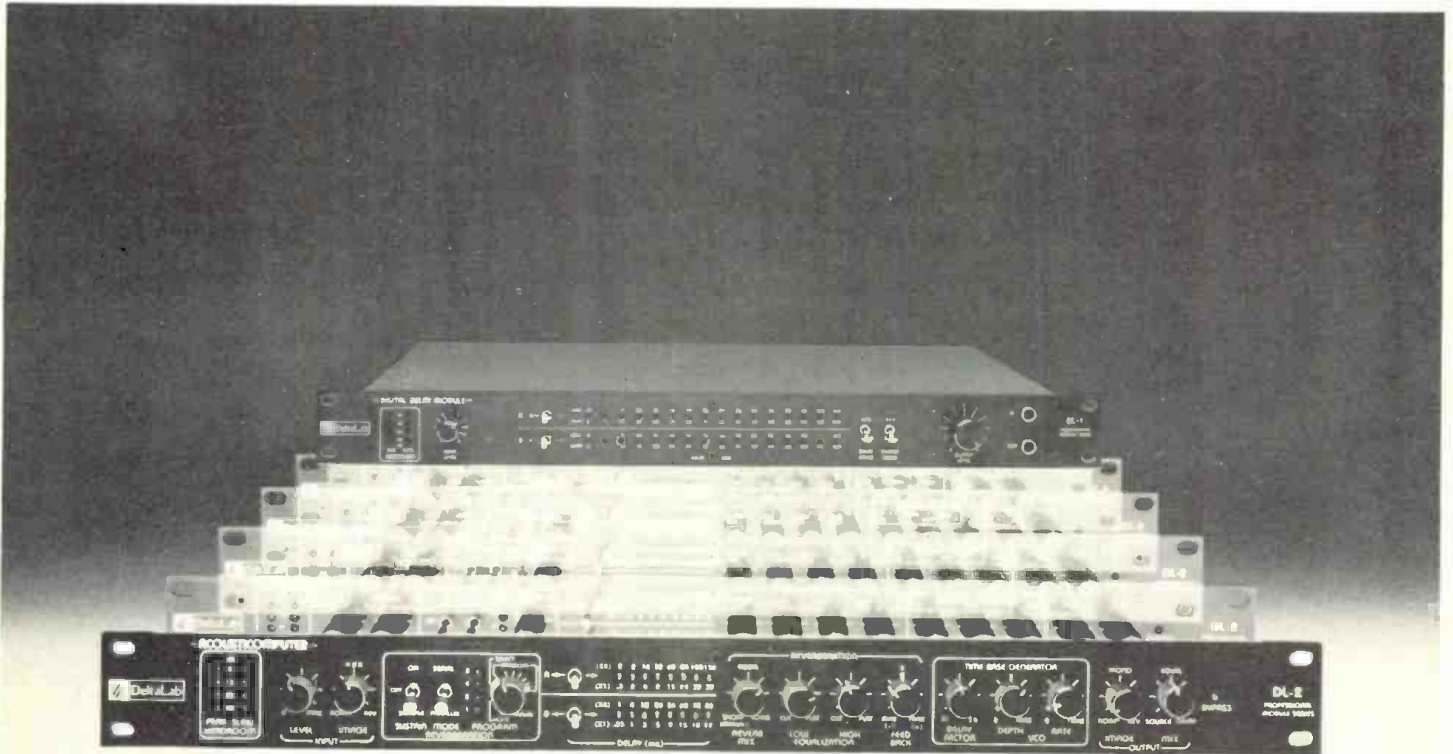

## How's THIS for an encore?

Modern Recording called our DL-1 Delay "probably the best we have encountered" . . . a tough act to follow.\* Now after more than a year in development DeltaLab introduces its encore - the ACOUSTICOMPUTER® - a combination digital-delay and special-effects processor designed for use both on-stage and in the studio, providing well-known functions (echo, doubling, chorusing, vibrato, flanging, etc.) plus new effects not available in any other device.

- Pre-reverb delay with two independent delay channels, variable from 0.25ms to 152ms with LED display.
- Delay up to 240ms in serial (mono) mode.
- Built in VCO with external control input at rear.
- Same no-compromise sound quality as in our DL-1 Digital Delay: Full 20-15 kHz bandwidth at all delay lengths with 90 dB dynamic range.
- Computer-synthesized acoustic space with 16 selectable reverb programs plus a new special effect in which the ACOUSTICOMPUTER scans the 16 programs.
- Two channels in and out. Built in reverb mixing and stereo imaging controls.
- Foot-switch controlled by pass.

It's impossible to describe in this space everything the ACOUSTICOMPUTER does; you'll have to experiment with it yourself. By carefully minimizing the number of separate controls and grouping them logically, we've made it easy for non-engineers to operate the ACOUSTICOMPUTER.

For further information call or write Phil Markham at DeltaLab Research, Inc., 25 Drum Hill Road, Chelmsford, MA 01824 Tel. (617) 458-2545.

\*See Modern Recording "Hands On Report," Sept. 1978.



DeltaLab Research, Inc. 27 Industrial Avenue, Chelmsford, Mass. 01824

Available at Quality Dealers

for additional information circle no. 40

[www.americanradiohistory.com](http://www.americanradiohistory.com)

**Rugged high  
performance  
low cost mixers**  
For studio  
or sound system  
For remotes  
For stage monitor



**New Model 12X4A mixer**

Over 500 INTERFACE ELECTRONICS mixers are now in use in recording studios and sound systems and wherever high performance at low cost is needed. These mixers have been used in making gold records and they are also specified by many rock groups for road use because of their ruggedness, reliability, flexibility, immunity to stray fields, and high performance — equal to or better than that of consoles costing many times more. Mainframes are available for 8 to 32 inputs, and modules can be ordered as needed.

- SERIES 200:** two track stereo
- SERIES 104:** four mono or stereo tracks or submixes
- SERIES 108:** eight mono or stereo tracks or submixes
- SERIES 316:** sixteen tracks

Included are echo sends, cue sends (four on the 104-108-316), solo, equalizers, pan pot, six step input gain adjust with two input pad positions, conductive plastic sliders, fully modular plug-in construction using plug-in integrated circuits throughout, balanced transformer inputs, output transformers optional. New high slew rate IC's assure full output to 20 KHz.

**MANY OPTIONS AND CONFIGURATIONS—ALLOW YOU TO HAVE IT JUST AS YOU WANT IT.**

**STAGE MONITOR mixer Model 104L** makes eight independent mixes, uses color coded knobs and large lighted VU meters, optional headphone monitor, intercom.

**"American quality at Japanese prices."**

**INTERFACE  
ELECTRONICS**

3810 WESTHEIMER  
• HOUSTON, TEXAS 77027 •  
(713) 626-1190

be used to calculate the mis-alignment. This is accomplished by observing the relative time interval between break points, then convert the measured time delay to distance. The time delay between the drivers may be found by multiplying the scope horizontal sweep switch setting in milliseconds times the number of divisions separating the impulse break points. Then, since sound travels at 1130 ft/sec @ 70 degrees F, multiply 1130 times the time interval in seconds. The result is the distance of separation in feet.

$$D = C \times T = 1130 \times .001 = 11.13 \text{ ft/ms}$$

Where:

- D = distance in feet
- C = sound velocity (1130 ft/sec @ 70°F)
- T = time in seconds

The idea is to get all of the knees to line up on or near the same vertical graticule line. For further adjustment, tune the generator's output frequency upward, and then downward while observing the received waveform. As you follow this procedure you should observe the familiar impulse. This would be a good time to experiment with different polarities between crossover outputs. Reversing polarity will cause a change in the amplitude and the wave shape.

**Listening Evaluations**

Before you start your listening test be sure to adjust the levels — using pink noise and a spectrum analyzer — on the crossover outputs or on the power amplifiers for your preferred listeners curve. Use these controls as if they were broadband equalizers, which they are.

Recently, many articles have been written on the pro's and con's of impulse alignment. Some have observed that there is no value in making these adjustments and that there will be no audible effect. The authors offer the following experiment which allows the reader to independently judge for himself.

Using two identical speaker systems, optimize the impulse alignment on only one of them. While you are standing between the two, have someone rattle a set of keys into a microphone which is connected to both systems. The authors have observed that the adjusted side will retain its intelligibility as you walk towards it while the sound from the non-adjusted side seems to get lost shortly after moving off center.

Other effects the authors have observed are that as you make the original sound more coherent, the reverberation will become less apparent. In the case of stage monitors, the gain level may be reduced slightly due to improve intelligibility, thus effectively lowering the feedback threshold.

One of the worst mis-alignments measured was of a four-way system and totaled

approximately 14 feet. This was a portable reinforcement system whose components consisted of RCA type W horns, a closed box array of 16 twelve-inch speakers, compression drivers on radial and long-throw horns, and ESS Heil Blue Ox Air-Motion Transformers. The mis-alignment was so great, that no corrective action could be taken.

In some commercially-available speaker systems, the alignment is achieved through a combination of driver placement and special delay networks added to the passive crossover. On a multi-amp system, delay would be required at each of the crossover bands prior to the power amplifier. At the present time, Ultra Sound has been unable to locate a commercial delay which operates satisfactorily while achieving the desired alignment. Some of the available delays tested could be used in the lower frequency ranges, but none were acceptable in the high frequency range where "birdies and chirps" from the sampling processes were objectionable. Some of the new generation delays becoming available may resolve these problems.

Another observation that may be made from the impulse is the study of reflections. To illustrate this effect, place an album cover near the microphone and observe the scope while changing the position of the album cover. Now place some foam or other absorptive material near the microphone, between it and the nearest reflective surface. This will reduce some of the reflections. Thus, by manipulating the acoustic environment — that is, by covering or hanging things on the walls or other hard surfaces or by moving furniture — you may be able to minimize or control the reflections arriving at the microphone.

Readers who do not have access to an oscilloscope or circuit construction facilities should still verify that all speakers sharing the same signal are correctly connected with respect to polarity. This applies to all sound systems.

A commercial product is available for determining polarity both electrically and through the air from Sounder Electronics. This device consists of a sending unit and a receiver. The receiver has an internal microphone and various input capabilities. Indicator lights signify whether the received pulse is positive or negative. For further information, contact Sounder Electronics, at 21 Madrona Street, Mill Valley, California 94941. An article showing a hand-held audio phase detector was published in *Audio*, January, 1978.

**In Conclusion**

Because every system is made up of different combination of speakers, enclosures, crossover networks and power amplifiers, it is difficult to establish a standardized set of rules to follow with

which to "properly" adjust the impulse response of a sound system. The authors' suggestions here are offered as a relatively simple means of observing speaker and microphone connections and placement. Such studies are otherwise limited to those with access to complex and expensive equipment such as spectrum analyzers, wave analyzers and Fourier analyzers.

Many subjects in this discussion were just briefly mentioned since the purpose of this article was to offer a basic measurement technique. It is hoped that interested readers will investigate the references listed in the bibliography that follows. Copies of these references are available at most public libraries.

The important information to be seen from the received waveform is the polarity of the first arrival and its time relationship to a similar first arrival from another speaker. The ripples following the first impulse sometimes can be seen to have a regular, periodic structure. This may be an indication of resonances within the speaker or cabinet. The waveform also contains signals from reflections of other objects near the speaker, microphone, or in the path between them, so an exact interpretation is difficult. This interpretation of the received waveform could be accomplished with Fourier analysis to derive a frequency vs. amplitude plot, for example. □ □ □

## BIBLIOGRAPHY:

- 1 - **The Application of Impulse Techniques to the Detection of Linear Distortion** — Alfred Schaumberger, JAES, September, 1971, p. 664.
- 2 - **A Catalog of Frequency and Transient Responses** — D. Pries, JAES, December, 1977, p. 990.
- 3 - **Linear Distortion** — D. Pries, JAES, June, 1976, p. 346.
- 4 - **Acoustical Measurements by Time Delay Spectrometry** — Richard C. Heyser, JAES, October 1967, p. 370.
- 5 - **Loudspeaker Phase Characteristics and Time Delay Distortion, Part One** — Richard C. Heyser, JAES, January, 1969, p. 30; **Part Two** — April, 1969, p. 130-137.
- 6 - **Determination of Loudspeaker Signal Arrival Times, Part One** — Richard C. Heyser, JAES, October, 1971, p. 734-743; **Part Two** — November, 1971, p. 829-834; **Part Three** — December, 1971, p. 902-905.
- 7 - **The Response of Loudspeakers to Tone Bursts** — V. Kaminsky, JAES, April, 1965, p. 119-123.
- 8 - **Delay Effects in Loudspeakers** — Paul Klipsch, JAES, October, 1972, p. 634.
- 9 - **A Shuffleboard Experiment of Time-Delay Effects in Loudspeakers** — Gary Gillaum, JAES, May, 1978, p. 361.
- 10 - **Active and Passive Filters as Loudspeaker Crossover Networks** — Ashley and A. L. Kaminsky, JAES, June, 1971, p. 494.
- 11 - **On the Transient Response of Ideal Crossover Networks** — J. R. Ashley, JAES, July 1962, p. 241.

- 12 - **Op-Amp Implimentation of Ideal Crossover Networks** — J. R. Ashley and L. H. Henne, JAES, January, 1971, p. 7-11.
- 13 - **Electronic Crossover Network and Their Contribution to Improve Loudspeaker Transient Response** — A. P. Smith, JAES, September, 1971, p. 674-679.
- 14 - **Network with Maximally Flat Delay** — W. E. Thompson, Wireless Engineer, October, 1952, p. 256-263.
- 15 - **Butterworth Filters as Loudspeaker Frequency Dividing Networks** — J. R. Ashley, Proc. IEEE, 1970, vol. 58, p. 959.
- 16 - **Notes on How Phase and Delay Distortions Affect the Quality of Speech, Music and Sound Effects** — J. K. Hilliard, IEEE Trans. Audio, vol. AU-12, p. 23-25, March-April, 1964).
- 17 - **Phase Distortion** — P. Tappan, IEEE Trans. Audio, vol. AU-12, p.22 (March-April 1964).
- 18 - **Plain and Fancy Test Signals for Music Reproduction Systems** — Ashley, Matson, and Saponas, JAES, April, 1971, p. 294-305.
- 19 - **Time Alignment in Loudspeakers** — E. M. Long, Audio, August, 1977.
- 20 - **Crossover Network Design** — E. M. Long, Audio, March, 1972, p. 34-36.
- 21 - **Loudspeaker Damping** — Nelson Pass, Audio, March, 1973, p. 52-54.
- 22 - **Dividing Networks for Loudspeaker Systems** — John K. Hilliard and H. R. Kimball, reprinted JAES, November, 1978, p. 850-855.
- 23 - **Audio Cyclopeda** — Howard Tremaine, Howard Sams & Company, 1959.
- 24 - **How to Build Speaker Enclosures** — Alexis Badmaeff and Don Davis, Howard Sams & Company, 1966.

# Have VOCAL STRESSER WILL TRAVEL!

.....says Tony Visconti\*

*"As a successful record producer, I am continually travelling to studios all over the world, recording such people as David Bowie, Thin Lizzy and Mary Hopkin. I have to deal with a wide variety of equipment in various studio settings; so in order to ensure that I have the best Compressor-Limiter equipment to hand, I invariably pack a Vocal-Stresser in my suitcase*

*In my opinion, Audio & Design make the finest range of auxiliary processors available and their equipment offers the producer/engineer ultra flexibility in the creation of good music*



\* Managing Director of Good Earth Productions and freelance producer of many hit records by illustrious pop stars, whose own solo album "Visconti's Inventory" was released in mid October '77.



The Audio & Design Vocal Stresser uniquely combines a multi-ratio compressor with overall peak limiter and low level noise expander/gate with a parametric type equaliser in one package. The combination provides most facilities necessary for improving and processing programme material whilst retaining maximum operational flexibility. The equaliser is simple to operate and can be switched before (pre), or after (post), the compressor-limiter, as well as into the side-chain (s.c) of the compressor section for frequency modulation effects and changing spectral energy balance.

## audio & design recording

P.O. Box 23047, Honolulu 96822, Hawaii.

Tel: (808) 845 7226



*Editor's Note: The following article was submitted for publication in R-e/p by Messrs. Rubens, Baskind and Caesar on behalf of a product designed, manufactured and sold by their company.*

*R-e/p's publishing policy dictates that where sponsored, direct, competitive references and comparisons are made the manufacturers of the products named should be offered the right of comment in the same issue.*

*In keeping with that policy, responses by David Blackmer, of dbx, and Paul Buff, of Allison, follow the B & B/Aphex presentation.*

# VCA's

## The Promise of Electronic Gain Control

by

Harvey Rubens  
David Baskind  
Marvin Caesar

In our fantasies as engineers, producers, and musicians most of us have marvelled at what could be done with voltage controlled amplifiers (VCAs).

In the studio, those six channels of carefully EQ'd, balanced and panned voices, each with its own set of effect sends, could be easily controlled with one group fader or mute switch. In automated mixing, that elusive, almost "perfect" mix, with only the last two bars of a guitar solo too loud, too soft, or even in need of an EQ change, could be endlessly repeated, changing only the errant track while retaining all other mix dynamics — and all on first generation tape so that we could, theoretically, go directly from multi-track tape to disk master, skipping the intermediate two-track (or quad) generation losses.

In the field, in sound reinforcement applications, an entire stage-full of mikes, effects and monitors could be balanced and EQ'd via one coax cable or wireless system plus an intercom merely by multiplexing all the necessary control signals, thus eliminating expensive multi-conductor snakes.

It all seems so desirable. Yet, even though VCAs and automation control systems have been available for several years, the industry's response has been less than enthusiastic for one major reason — inadequate performance by previously available VCAs.

We human beings are possessed of an unusual set of audio measurement equipment — our ears. If we can't quantify distortion like a meter, we are quite capable of perceiving changes that seem to defy detection using "standard" techniques. This leads to an obvious conclusion — if it measures good, but it sounds bad, we're measuring the wrong things. Despite impressive manufacturers' specifications, signals passed through previously available VCAs have been subjectively colored by them. What is worse, as we shall see, is that the perceived coloration itself varies with (1) attenuation setting, (2) signal frequency, and (3) thermal conditions within the VCA, all of which make fixed compensation impossible. Finally, the noise performance of some VCAs does not always match what is specified or even measured with conventional techniques.

To better understand this discussion it will be helpful first to examine the basic concepts of operation of VCAs offered to the professional audio market.

### About the Authors:

Harvey Rubens and David Baskind have spent the past two years developing a new, class A VCA which is being manufactured by Baskind, Bissot and Associates (B & B Audio) in Los Angeles, of which Mr. Baskind is president.

Marvin Caesar is president of Aphex Systems, Ltd., which handles worldwide marketing of the VCA and other B & B products, as well as the Aphex Aural Exciter.

Until recently, the only successful technique for achieving high slew rate, wide dynamic range electronic gain control has been the log-antilog technique typified by dbx and Allison Research VCAs. These products differ from each other in their actual realizations, but the basic computational technique and the same general limitations apply to both. The operation of these devices is based on the identity

$$\log^{-1}(\log A + B) = (\log^{-1}B) \times A,$$

where A = the audio input, and B = the control voltage. Electronically the circuit computes the log of the audio input, sums in the control voltage, and computes the antilog or exponent of that sum, giving the desired dB/volt multiplication or division of the audio signal.

What does this mean to the non-math-oriented person behind the console? First, electronic logging circuits can only operate on signals of one polarity (positive or negative). Therefore, to work on audio, the log-antilog VCA must separate the positive and negative going portions of the input, operate on them separately, then re-combine them (see Figure 1). One obvious limitation to this class B mode of operation is the precision with which one can match the dynamic behavior of two separate circuits. This specific problem is potentially greater in the dbx VCA than in the Allison, since the former relies on the ability to match discrete transistors of opposite polarity, while the latter uses an all NPN monolithic array.

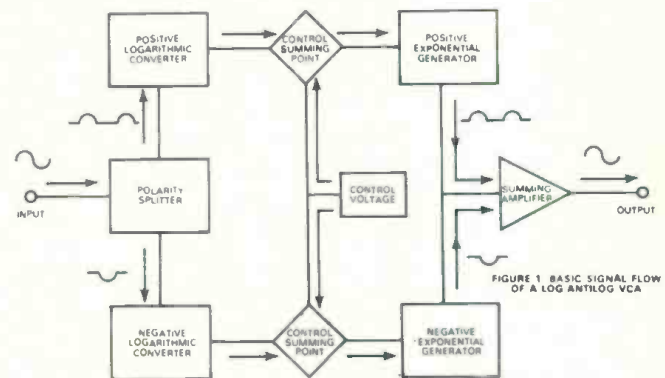

FIGURE 1 BASIC SIGNAL FLOW OF A LOG-ANTILOG VCA

Inaccuracies are inherently greater in logging circuits at higher frequencies and at high and low signal levels<sup>1,2</sup>. Even with well-matched transistors, the log-antilog behavior of these circuits is only accurate over approximately a 40 dB gain range with optimum performance centered at a specific, trimmed operating point with respect to gain (usually near unity) and input level (typically 0 dBv in the dbx and maximum input in the Allison VCA-5A/5M).

In the dbx 202 both THD and IM distortion vary widely over





## Some people buy us for our fader

because ours is better than any you can buy elsewhere. Ours has all the features you need, like smooth action, accurate tracking, long life and low noise, plus a full 85 dB attenuation. And ours is coffee proof. It's just one more reason an Auditronics mixer is a better investment for the long haul. To learn more, circle reader service number or write to us for complete information.



*It's coffee proof*

**auditronics, inc.**

3750 Old Getwell Road, Memphis, Tennessee 38118 / (901) 362-1350

for additional information circle no. 43  
[www.americanradiohistory.com](http://www.americanradiohistory.com)

R-e/p 73

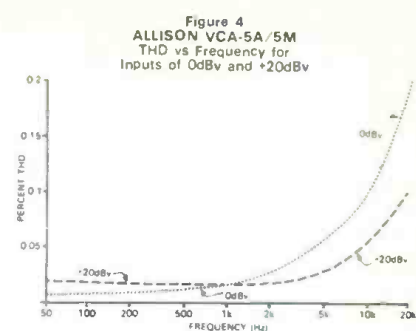
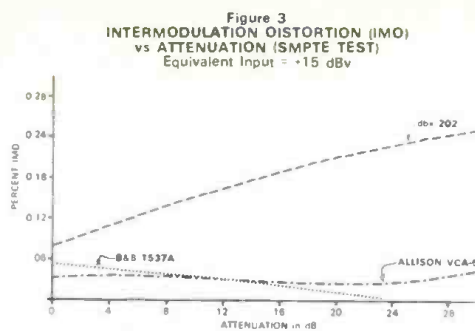
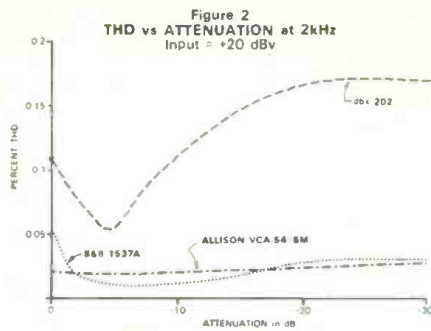

FIGURE 5a

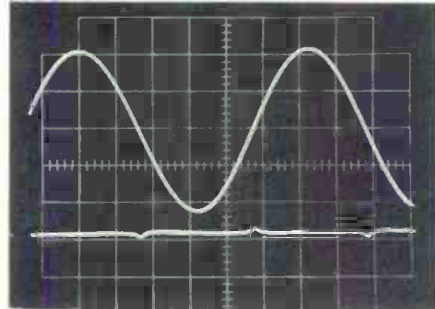

FIGURE 5b

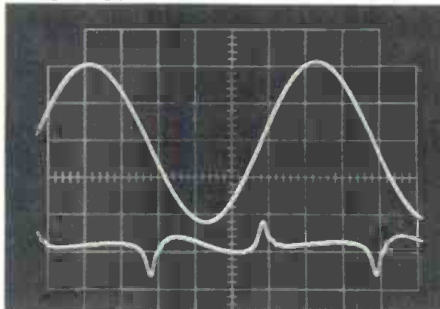

FIGURE 5c



attenuation as is shown in Figures 2 and 3, due mainly to transistor mis-matches. On the other hand, Allison's all NPN transistor array exhibits very stable performance over attenuation. To accomplish this, Allison employs precision rectifiers to separate the positive and negative portions of the signal. The accuracy of such rectifiers depends on the open loop gain of the Op-Amps used to realize the circuit (Allison uses Texas Instruments TL074). A quick check with any IC catalogue shows that, in any Op-Amp, open loop gain falls at higher frequencies. Predictably, the Allison VCA exhibits considerably higher crossover or notch distortion at higher frequencies with respect to any given input level and at lower input levels with respect to any given frequency (see figure 4). The scope photos of Figures 5A and 5B show that in the Allison VCA the amplitude of the crossover notch, as a percent of the input signal, is substantially greater at 20 Hz than a 2 kHz at the given input level (0 dBv). Photos 5B and 5C show that this notch is greater at lower input levels at the given frequency (20 kHz at 0 dBv and +20 dBv, respectively).

The distortion products generated by the above circuit behavior include disturbance of the balance of overtones in the signal and the generation of false overtones. These changes are perceived in playback as changes in timbre, presence, perspective and location. This can be likened to the differences perceived with a change in mike placement which changes overtone balance and phase relationships. Note that in both of the log/antilog devices distortion actually rises as the input level (Allison) or gain (dbx) is reduced. Since our senses tell us that distortion usually rises with rising signal, rising distortion with lower signal seems unnatural and, therefore, subjectively more noticeable.

Thermal changes in transistor circuits may be caused by environmental conditions or by the signal itself. Environmental changes are not usually critical in studio installations since, typically, these changes are slow and affect a whole system uniformly. Such is not the case with signal transients which may quickly heat either side of a class B circuit, thereby generating changes in transistor matching. What this implies is that under such conditions, whether or not you already like (or have accepted) a given sound through the circuit, that sonic quality is itself subject to change with transient heating when, for example, you un-mute a hot bass

or drum track.

The last of the nasties in this rogues' gallery of VCA behavior is noise performance. Typically, noise specifications are determined with no input signal present. What this gives us is not necessarily a true signal-to-noise specification, since log-antilog VCAs are literally gated off when no signal is present.

In a paper presented to the Audio Engineering Society convention in March, 1978<sup>3</sup>, the authors discussed methods of analyzing dynamic noise behavior (i. e. actual noise levels occurring in the presence of a signal). We called this phenomenon "modulation noise" since it is noise modulated in amplitude by the input signal. Modulation noise has been shown to be psychoacoustically more detectable than similar steady-state noise levels<sup>4</sup>. It is perceived as an undesirable fuzziness in the sound, most notably on transient peaks. A similar phenomenon has long been known in magnetic recording.

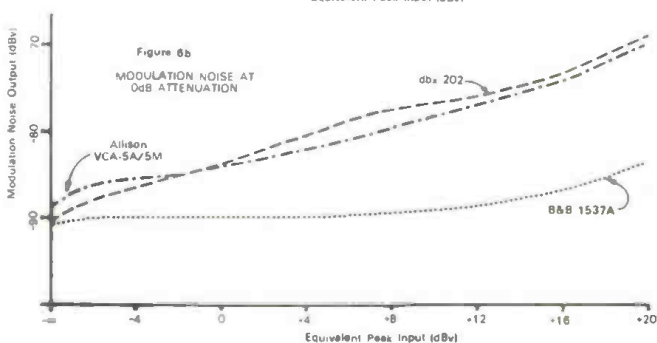
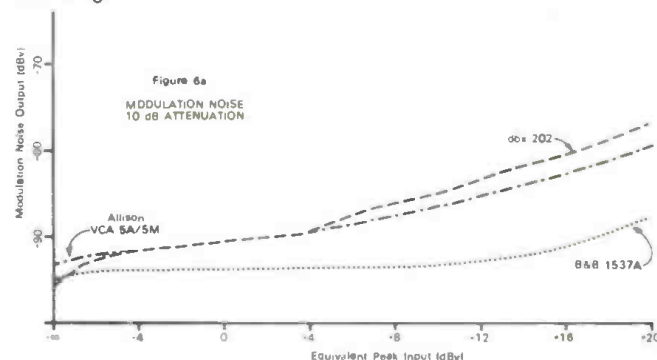

**GO FOR THE BEST**

**GO FOR THE 100B, 250D & 750B/C**

They're the BGW amps. The Industry Leaders. Four different models with only one philosophy: The Best. The best engineered and designed; the best and most sophisticated electronic test equipment available; the best the dreams of an audio engineer's imagination; the best support for an engineer that money can buy - from complex computer modeling to the back-up personnel who refine and distill the inventor's visions.

In every BGW product there is a lot you can relate to. Like the quality of every component. Every one meticulously selected for uncompromised reliability - a simple resistor or a complex semiconductor. Hand-wired teflon harnesses and precision soldered modular assemblies are built to exacting standards. From our imitated front panels to our imitated back panels, you'll find a heavy steel chassis and massive heatsink modules.

These are things you'd expect from a company that has built an enviable reputation as being the best money can buy. Recording engineers and artists alike have recognized that the BGW name is performance and is innovation. The best specs and the most versatile and reliable amp you can buy. Absolutely. A BGW is equally at home on a grueling road tour or in the demanding environs of a studio control room. Super-high power to super-low noise and distortion, a BGW works with any high quality speaker or mixer. Year-in and Year-out a BGW delivers the kind of incredible sound that has made the careers of many an artist and engineer. Check-out the new 100B and 250D. Both are the result of continuing evolution based upon experience. These two new amps are worthy partners of our industry standard 750 series.

A BGW may be priced a bit more initially, but you need the best. So, when you're ready, Go For The Best.

**GO FOR A BGW**



BGW Systems, Inc.  
13130 South Yukon Avenue,  
Hawthorne, California 90250  
In Canada: Omnimedia Corp.,  
9653 Cote de Liesse  
Dorval, Quebec H9P 1A3

Figure 7a: Allison Modulation Noise

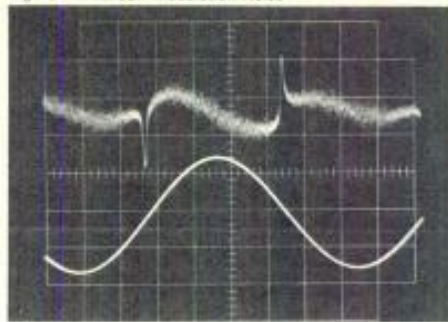

Figure 7b: dbx Modulation Noise

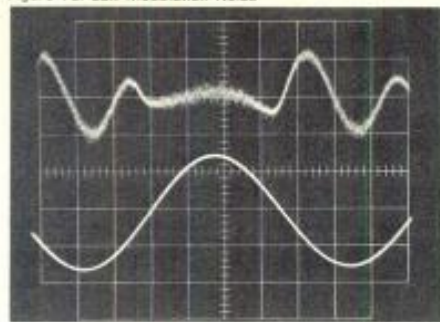
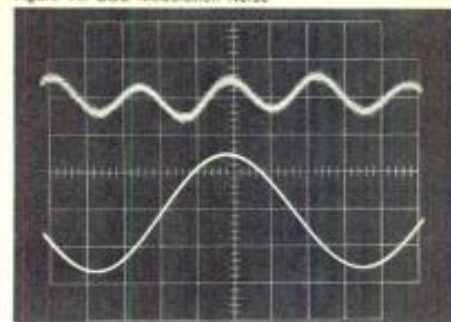

Figure 7c: B&B Modulation Noise



All at 500 Hz, +10 dBV.

To their credit, Allison Research now at least partially specifies modulation noise for their VCA-5A/5M. However, examination of their specification (92 dB below peak signal level) only confirms our observation, since 92 dB below +20 dBV (typical peak signal level on  $\pm 15$  volt supplies) yields a noise level of -78 dBV — 17 dB worse than is specified for the same circuit with input shorted at unity gain. This performance is roughly equal to our measured data at this one point for the dbx VCA (and is much better than Allison's previous model VCA-5 — see graphs, Figures 4A and 4B, and scope photos, Figures 5A and 5B). The scope photos are of magnified distortion traces from the named VCAs throughout our harmonic distortion analyzer (Sound Technology model 1710A) and clearly show noise gated around the zero-crossings of the associated sine waves. Note also in the Allison photo (which required less amplification to show the noise) that the residual distortion trace exhibits the classical B wave form. Those little peaks at the zero-crossings are cross-over or notch distortion.

Now that you know what has been wrong with VCAs, you might ask, "Who's doing something about it?"

As noted at the head of this article, authors Baskind and Rubens have developed a new VCA which is a radical departure in design from log-antilog and other, earlier VCAs. Its basic design is specifically addressed to overcoming the basic performance limitations just discussed.

This new VCA is a true class A circuit employing a balanced differential configuration which cancels most of its own internal distortion products (see Figure 6). Also, residual distortion (0.1% THD worst case at +20 dBV input) falls both with lower input level and with attenuation to a typical .004% THD at +10 dBV input with 10 dB attenuation.

The heart of the system is built into a custom monolithic IC which gives it excellent transient thermal stability with respect to both distortion and gain. The combination of monolithic construction for good transistor matching and differential configuration gives the circuit added immunity to outside interference. Lastly, since the circuit is class A, there can be no cross-over distortion, and modulation noise is restricted to the inherent noise of a current flowing across an impedance, which is characteristic of any active circuit (see scope photo, Figure 7C).

Our research has given us new criteria useful in evaluating not only VCAs but audio circuits in general. It is clear that we can no longer be content to evaluate dynamic circuits under a

few specified static conditions and expect to obtain meaningful data. A happy result of this research is a truly professional quality VCA whose performance is consistent with the best of contemporary audio design. With this a reality, the promise of electronic gain control can, at last, be fulfilled. □ □ □

#### BIBLIOGRAPHY

- 1 - Graeme, Jerald G. — *Applications of Operational Amplifiers — Third Generation Techniques*, McGraw-Hill Book Co., 1973, p. 94.
- 2 - Wong, Yu Jen and Ott, William E. — *Function Circuits: Design and Applications*, McGraw-Hill Book Co., 1976, ch. 2.
- 3 - Baskind, David and Rubens, Harvey — *Techniques for the Realization and Application of Voltage Controlled Amplifiers and Attenuators*, Preprint No. 1378 presented at the 60th Convention of the Audio Engineering Society, 1978.
- 4 - Minifie, Hixon and Williams — *Normal Aspects of Speech, Hearing and Language*, Prentice-Hall, 1973, ch. 9.

*response on behalf of*  
**dbx VCA 202**  
 David Blackmer  
*President, dbx, Inc.*

It seems that Baskin & Rubens, in their eagerness to turn the audio world upside-down, have used erroneous data and questionable logic to arrive at their conclusion.

B & B shows a lack of understanding of the log/antilog VCA when they claim that it is more difficult to match transistors of opposite polarity (the dbx VCA) than an all NPN array. In fact, the dbx VCA relies only on matching between devices of the same polarity, not of opposite polarity. The use of all NPN transistors in a log/antilog VCA requires greater attention to matching between transistors and results in increased circuit complexity. The superiority of the dbx approach is demonstrated by the fact that the dbx VCA has superior voltage offset vs. attenuation characteristics when compared to either the Allison or the B & B VCA. This is of particular importance when summing several channels together as the offsets may add together and produce a noticeable thump during rapid gain changes.

B & B's contention that log/antilog VCAs are only accurate over a 40 dB gain range is also quite misleading. The accuracy of the VCA is quite good over a range of 100 dB or more at normal input levels. The distortion shown in Figures 2 and 3 was derived using very high input levels and is not representative of the distortion encountered during normal use. Perhaps a quick glance at our applications note might have prevented this problem.

Another misleading statement is the one concerning thermal distortion. There is no detectable thermal distortion in log/antilog VCAs unless one uses input currents above 1 ma. If the VCA is used properly, the peak input currents are five times lower than this value.

Now we come to the last of the imaginary nasties in our rogues gallery, modulation noise. Certainly modulation noise at significant levels, such as found in magnetic tape recorders, is objectionable, but it is highly unlikely that

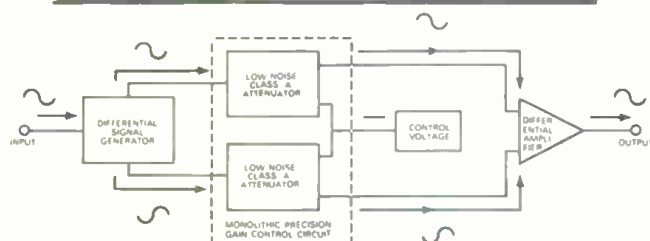
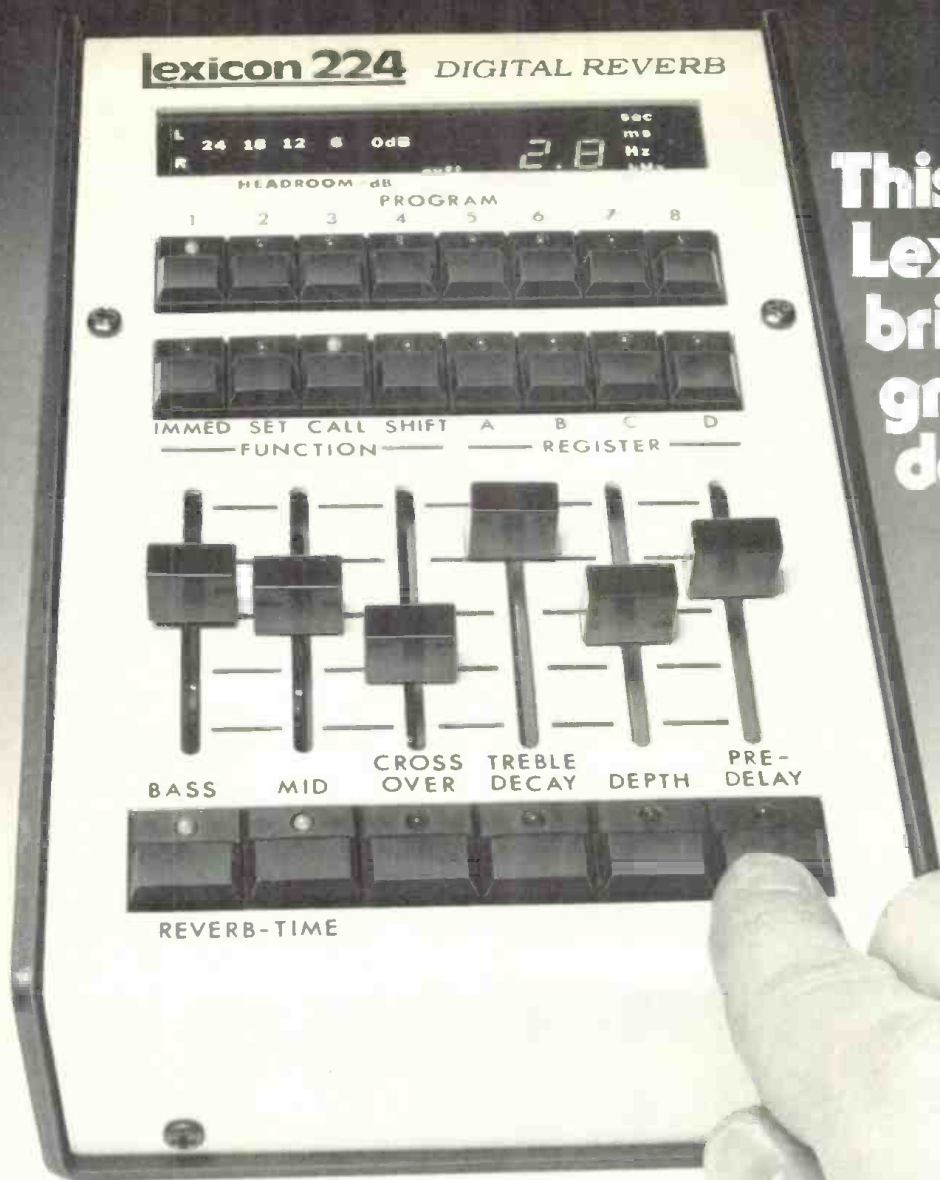

FIGURE 8 BASIC SIGNAL FLOW OF B&B VCA



**This new  
Lexicon reverb  
brings  
great sound  
down to size.**

**Model 224 reverberation system  
has the sound, the controls,  
the compactness you've always wanted.**

The remarkable — and remarkably compact — Lexicon 224 digital reverberation system gives you superb sound unmatched by any other system available today — electronic, digital or mechanical. You get smooth, natural decay without coloration, "twang" or "boing".

And you get unprecedented control over all significant reverberation parameters. It's industry's first reverb with a built-in control memory that provides instant push-button recall of previously set effects.

Model 224 saves studio space and is fully portable. Its 5½" x 8" remote control console puts reverb control right at the producer's fingertips. The system's high speed digital processor holds up to eight different programs and requires only 7 inches of rack space.

Currently available programs include: concert hall programs with stereo input and four outputs that create the space and depth of a live performance with decay times of 0.6 seconds to 70 seconds; acoustic chamber programs that provide sound equal to the best reverberation chambers; plate programs that outperform the highest quality reverberation plates or other mechanical devices with full control of all parameters including pre-delay of up to 256 milliseconds.

Model 224. A major advance from Lexicon. Once you've heard it, you'll never want to do another session without it.

for additional information circle no. 45

modulation noise that is 80 dB below the peak signal is psychoacoustically objectionable. Our tests, with a panel of trained listeners, indicate that there is no audible signal distortion or noise modulation effects when the VCA is compared to a straight wire. The B & B VCA, which claims to solve all of these "problems," has a few nasties of its own. First, the unit is capable only of gain reduction as compared to the dbx VCA which is easily capable of 30 dB of gain. If we follow the B & B VCA with a gain of 20 dB, its output noise becomes unacceptably high. This is certainly more of a "problem" than the miniscule amounts of noise modulation caused by the dbx VCA.

One of the important characteristics of a VCA is its voltage control characteristic. The dbx VCA has a control characteristic that is linear in dB; that is, equal changes in control voltage produce equal decibel changes in gain. This is very important in automated consoles and makes it very easy to program the gain of a channel and to produce natural-sounding fades. The B & B VCA, however, has a control characteristic which departs significantly from this linear control curve making it difficult to accurately program the gain of the VCA.

These problems seem to indicate that the B & B VCA will find little use in the professional recording field. The charges leveled at the dbx VCA are based on misleading data that is not representative of actual-use conditions.

It is interesting to note that the B & B article devotes almost all of its space to discrediting the dbx VCA and gives very little information about the B & B VCA. When choosing a VCA for professional use, it is necessary to examine all of the specifications of the device, not just a narrow few as B & B has done.

dbx has introduced a new VCA called the 202C. This VCA features all of the advantages of the 202 plus distortion correction circuitry which will reduce distortion by a factor of 5 or more at the gain extremes. This VCA should satisfy the most spec conscious console designer. □ □ □

---

*response on behalf of*  
**Allison VCA 5A/5M**  
by Paul Buff  
*President, Allison Research*

I wish to thank R-e/p magazine for the opportunity to comment on the material submitted by Messrs. Rubens, Baskind and Caesar. Unfortunately, I have had but a few days to review this material and put together my comments, but I shall do the best job I can.

While the authors have presented some interesting views on their new product, I am of the opinion that they have been a bit over-enthusiastic in comparing their device to VCAs of previous manufacturers, particularly those offered by my company and dbx, Inc.

If a manufacturer is to draw comparisons of this sort, it is of paramount importance that he be factual, both with regard to his competition as well as to his own product. It must be remembered that the promise offered, by a publication such as R-e/p, is to the reader, in the form of material which he may use to better his understanding of the art. The privilege extended to producers of new equipment, in the form of editorial space, dictates that the authors present a true picture of the subject matter presented, free of blatant commercialism.

I do not believe that B & B has adhered to these fundamental rules of journalism. I found their material to contain unfounded insinuations, errors, half truths and omissions, of a magnitude, I believe, sufficient to seriously

mislead the reader.

Since the bulk of the article serves as an attempt to discredit my product, as well as that of a respected competitor, I find it necessary to devote a good deal of effort to setting the facts straight. I shall attempt to do this on the most factual basis possible.

Before getting to the heavy stuff, allow me to make one point of clarification. B & B made numerous remarks about a device of our manufacture, specifically the "VCA-5." This device was never put into full production, and served only as an interim step to the production of our current VCA-5A and VCA-5M. Last spring, under the guise of preparing a "scientific paper" on the current state of VCA technology, Mr. Rubens requested an evaluation sample of this device. We gave it to him, explaining that the device had some bugs and was to be superceded by a new series. At the time, Mr. Rubens acknowledged that he would clarify the circumstances involved in any printed comment, explaining that the device was not to be taken as typical of marketed product.

Since that time, I have made several requests of B & B to provide samples of their product, for my evaluation. Since I have been unsuccessful in this attempt, I have consequently obtained a marketed sample, and data sheet, from a customer here in Nashville, only yesterday.

#### THE HEAVY STUFF — ERRORS

1 - B & B claims to have developed a "New, Class A VCA." The fact is that B & B has not created a VCA at all! In accepted industry terminology, the statement "VCA" means Voltage Controlled Amplifier, and denotes a device which is capable of both gain and attenuation. The B & B device is not capable of gain, but only attenuation. It is therefore a Voltage Controlled Attenuator, VCATT. This category of device is in no way a substitute for a true VCA, as I shall point out later.

2 - B & B claims that both the dbx and Allison VCAs are "Class B" devices. They then go on to extoll the virtues of Class A, while claiming all sorts of bad nasties associated with Class B.

Neither the dbx VCA, nor the Allison VCA are Class B devices. They are Class AB devices, as are essentially all Op-Amps, power amps and nearly all circuits to be found in any audio console built in the last 15 years. In fact, the B & B data sheet suggests the employment of no less than 6 Class AB Op-Amps as external circuitry for support of their IC. I think with this information we can dismiss the insinuation that Class A is great, and everything else stinks.

3 - B & B implies that, while dbx and Allison utilize Log/Antilog techniques, B & B has developed a new and revolutionary process to obtain multiplication. When you have worked with bi-polar transistors as long as I, you begin to realize that all methods of obtaining multiplication via bi-polar transistors are the effect of the log/antilog transfer function of the base-emitter junction of the transistors. For instance, in the use of a transconductance multiplier type of circuit, the mechanism which directs the diff-amp currents is hidden away from obvious view, but is indeed the log/antilog base-emitter characteristic, complete with all its small non-linearities. While these non-linearities may show up in different parameters, from one design to the next, they are always there.

4 - B & B suggests that the log/antilog characteristics are "only accurate over approximately a 40 dB gain range," inferring that Allison and dbx VCAs are accurate only over this range. They further indicate that these VCAs exhibit optimum performance only at a specific trimmed operating point near unity gain. B & B continues by stating that "transistor mismatches cause rising THD and IMD as the VCAs are attenuated away from this point."

# A duplicating system ready to grow with you.

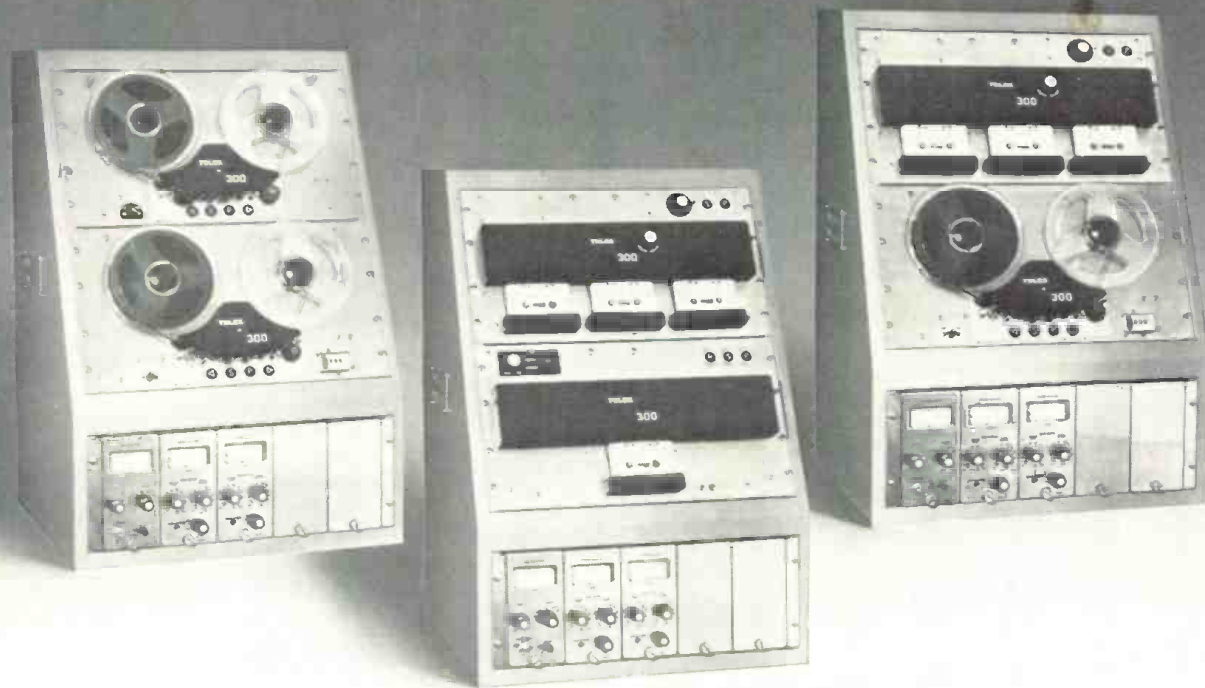

**Telex Series 300 Duplicating System is versatile and expandable and fits most duplicating requirements.**

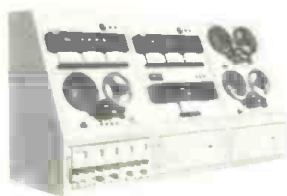

**A Building Block System:** A modest capital investment gets you started whether in cassette-to-cassette, reel-to-reel, in two or four channels. Start with a basic unit and later add modules to suite your growing requirement.

cassette, reel-to-reel, in two or four channels. Start with a basic unit and later add modules to suite your growing requirement.

**Modular Electronics:** Individual plug-in modular electronics permit fast easy service and minimum downtime. Since the system is made in the U.S.A., parts and service are readily available, through a coast-to-coast dealer network.

**Now Long Life Heads at No Extra Cost:** Cassette slaves with new long life heads last 10 times longer than conventional heads, reducing downtime and replacement cost.

Telex also has available desk top cassette copiers.

PRODUCTS OF SOUND RESEARCH  
**TELEX**  
COMMUNICATIONS, INC.

9600 Aldrich Ave. So., Minneapolis, MN 55420 U.S.A. EUROPE: 22 rue de la Legion-d'Honneur, 93200 St. Denis, France. CANADA: Telak Electronics, Ltd., Scarborough, Ontario.

R-e/p 1/79

Mail To: **TELEX A-V DEPT.**  
9600 Aldrich Ave. So.  
Minneapolis, MN 55420

Yes, I'd like to know more about the Series 300 high-speed tape duplicating systems.

Name \_\_\_\_\_

Title \_\_\_\_\_

Organization \_\_\_\_\_

Address \_\_\_\_\_

City \_\_\_\_\_ State \_\_\_\_\_

Zip \_\_\_\_\_

Telephone \_\_\_\_\_

Best time to contact \_\_\_\_\_

It is obvious to me that the authors have only a partial knowledge of the behavior of log/antilog multipliers — enough to sound like experts, but not enough to explain their true behavior. Particularly, as it applies to the differences between the dbx and Allison designs.

The Allison VCA-5A and M are, indeed, extremely accurate over a gain range of 140 to 160 dB. Gibbons and Horn showed that 9 decades (180 dB) of accurate log/antilog function can be obtained, using bi-polar transistors, in the early 60s. B & B seems confused by, or unaware of, the distinction between the actual conversion of audio to log form, and the logarithmic response of the control circuit, as it applies to the dbx and Allison VCAs.

If one were to attempt to configure either of these VCA designs in "Class B" fashion (as B & B erroneously suggested), it would be necessary to perform the full log/antilog conversion on the entire magnitude spectrum of the audio signal. This approach is impractical since, at very low audio levels, the logging current would become exceedingly small, resulting in severe limitations to bandwidth and other parameters.

Consequently, both dbx and Allison employ "Class AB," in two differing structures. This approach removes the necessity of logging the entire audio level spectrum, via the inclusion of a bias current. Thus, the log amps only actually operate over about a 40 dB current range, maintaining excellent bandwidth and extremely low errors.

The logging restrictions which apply to the circuits which pass the audio itself, however, are not nearly as stringent in their application to the logarithmic transfer function of control volts vs. gain. Here, a full 160 dB of gain control range is easily obtainable, with a typical error from true log conformity of around 1% (1 dB per 100 dB).

Furthermore, the rising distortion vs. attenuation curve exhibited by the dbx VCA is not caused by "Transistor mismatch." This characteristic is caused by a very predictable parameter of the log/antilog transistors, namely the error from true log conformity introduced by the finite resistance associated in the base/emitter junction. At the operating gain where the log currents exactly equal the antilog currents, the two error signals oppose each other, and cancel the effect. At any other gain point, the two errors are unequal, and manifest themselves as distortion products which are directly proportional to the signal level. The effect is entirely predictable, and has nothing to do with "Transistor mismatch," as B & B suggests. Three methods of dealing with the error are:

- A. Reduce the operating current to the point where the distortion products are acceptable.
- B. Increase the geometry of the log/antilog transistors to minimize the resistances which cause the error.
- C. Introduce an error cancelling signal which removes the effect.

In the dbx design, methods A & B are used. The discrete transistor approach allows the employment of large geometry transistors to minimize the base/emitter resistances.

As far as the choice of operating currents, in the dbx design, this is left up to the customer. The choice of signal

---

#### About the Author:

Paul C. Buff, in his capacity as president and design engineer of Allison Research, Inc., Nashville, Tennessee, has been involved in the art of voltage control of audio equipment since 1970. Allison Research is a recognized pioneer in the field of automated mixing techniques and hardware.

---

current is, of necessity, a trade-off between noise and distortion. Fortunately, the mechanics of the situation are favorable, since a 6 dB reduction of distortion products may be obtained at a cost of only 3 dB noise increase. (Or 12 dB for 6 dB, etc.)

It is unfortunate that B & B, in an overzealous attempt to make dbx look bad, chose to depict the distortion curve realized at very high signal currents, and conveniently chose to imply that this was typical at all operating currents.

As for the Allison VCA-5A and M, we chose to use the approach outlined in "C" above, namely that of removing the effect entirely, via the introduction of an error cancelling signal. This technique is a very important attribute of our design, since it allows the use of small geometry monolithic transistors (with their inherent close match and thermal stability), while effectively removing the restraints of noise vs. signal current vs. distortion.

The effectiveness of this proprietary technique can be seen by referring to the noise and distortion curves for the VCA-5A and M.

5 - B & B makes a disaster of attempting to explain the VCA-5A and M circuitry, and cites references which have absolutely no bearing on the circuit used.

The Allison VCA-5A and M do not employ "Precision rectifiers" in splitting the signal. The type of circuit to which B & B makes reference is an active rectifier which, indeed, provides usable precision only to around 3 kHz.

The polarity divider employed in our VCA design is a proprietary passive design which provides extreme accuracy to beyond 1 MHz. None of the aspects of this circuitry are to be found in reference books, but, rather, only in the claims of our pending U.S. Patent.

6 - B & B claims that the VCA-5A and M exhibit optimum performance "Only at a trimmed operating gain and input level." I call the readers attention to the measured performance graphs of my Figures 13 through 18, wherein the performance of the worst of two VCA-5Ms (randomly selected from production), is plotted against that of a B & B VCATT. As can be seen, the Allison VCAs exhibit superior performance at essentially all combinations of level and attenuation, or gain.

7 - B & B sets themselves up as experts on psychoacoustics, and make claims which have no basis in fact, and which are in direct conflict with all known principles regarding the perceptive qualities of the human ear. These statements are no more than blatant libel, and only serve to prove that B & B has not actually listened to the devices in question. Because of the immense magnitude of presenting a meaningful discussion on the perceptability of various distortions produced by electronic equipment, I have committed a full length article on my views of this subject, to appear in the next issue of R-e/p magazine.

Suffice it to say, for the moment, that the Allison VCA-5A and M offer excellent performance on all parameters known to induce coloration or perceptable difference between input and output signals. These parameters include the full spectrum of THD, SMPTE IMD, Twin Tone Intermodulation Distortion, TIM, Slew Induced Distortion, Square Wave Response, Phase Response, Frequency Response and Modulation Noise.

The proof of the pudding, of course, is in the listening. We communicate with our customers and solicit their comments regularly. How come they don't hear all that garbage that B & B claims they ought to? I should be happy to submit a list of our VCA customers to anyone who would like to hear their comments.

In commenting on the "crossover glitch" portrayed by B & B in their scope photos, I must state that:

*continued on page 82*



# Studio quality microphones that don't need a studio to survive.



## The CS15P condenser cardioid

microphone is equally at home in a recording environment or broadcast studio. When hand-held it puts sex appeal in a voice with its bass-boosting proximity effect. With shaped high-frequency response and its ability to handle high sound pressure levels (140dB with 1% THD at 1kHz), the CS15P is ideal for close-up vocal or solo instrument miking applications.

When boom mounted, the CS15P has better gain-before-feedback and a better signal-to-noise ratio than most shot-guns. It's phantom powered and it's rugged.

The CO15P condenser omni extends frequency response to the very limits of audibility, 20 to 20,000 Hz. Unlike other "omni's," the CO15P maintains its omnidirectional polar pattern at the very highest frequencies.

Perfect for the distant miking of an entire orchestra as well as up close on individual instruments. And like the CS15P, it's phantom powered and it's rugged.

**The Electro-Voice warranty**  
Electro-Voice backs up these two microphones with the only unconditional warranty in the business: for two years we will replace or

repair your CS15P or CO15P microphone, when returned to Electro-Voice for service, at no charge – no matter what caused the damage!

We can do this because we build these microphones to meet our standards for performance, ruggedness and durability. We accept nothing less, and if you're a professional, buying a professional quality microphone, you shouldn't either.

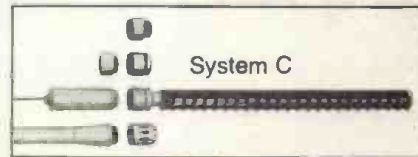

**EV** **Electro-Voice**  
a gulton company

600 Cecil Street, Buchanan, Michigan 49107

for additional information circle no. 47

[www.americanradiohistory.com](http://www.americanradiohistory.com)

R-e/p 81

A - These photos are of the residual components of the audio, after filtering out the original signal, and are highly magnified.

B - The actual energy contained in the glitches is in the vicinity of 60 dB below the signal, and is in the frequency spectrum of 100 kHz to 1 MHz.

My Figure 21 shows the distributed energy of the residuals, as obtained by spectrum analysis to 100 kHz, while my Figure 22 shows the appearance of the residuals when the THD analysis is performed on a Sound Technology using the 80 kHz signal bandpass filter.

If anyone at B & B can hear these effects, or any of their dogs, for that matter, I would suggest a career with the CIA or NASA. I understand that they both have openings for superhumans.

8 - B & B implies that VCAs of the type made by Allison and dbx are subject to thermally induced transient distortions, which are produced by doing such things as "un-muting a hot track." I believe, if given the task, I could design a device with such poor thermal engineering as to cause such a problem. This, however, does not mean that I have designed such a creature. The monolithic transistor array used in the Allison VCAs, together with symmetrically balanced circuitry assures freedom from such effects. This may be readily verified by lab measurement, or by critical listening tests. It should also be noted that our data sheet contains a specification for dynamic temperature sensitivity.

9 - B & B makes a very big deal about modulation noise, claims to have discovered the phenomenon, and shows irrelevant scope photos on the subject.

Firstly, I call your attention to the un-retouched scope photo, as taken from the VCA-5A and M spec sheet. (Figure 1) Note the absence of visible (or audible) modulation noise amidst the distortion residuals (.03%). The reason the noise is neither visible, nor audible is the fact that it is 22 dB below the distortion residuals, and 92 dB below the signal itself. I further call your attention to the fact that this spec sheet (and photo) were in B & B's hands at the time of their writing, yet they chose to use the irrelevant photo of the VCA they borrowed for "scientific purposes," without explaining its origin.

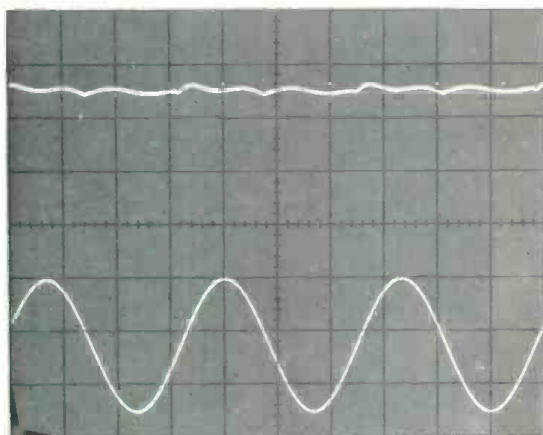

10kHz THD, byproducts <.03% +20dBv in Unity Gain

Figure 1  
VCA-5M Residual Distortion Products Showing  
Absence of Noise Modulation

While it is widely known that modulation noise can be perceived as causing fuzziness, it comes down to a matter of severity, in the same manner as do other parameters such as THD, IMD, TIM, and etc. In tape machines, we are accustomed to modulation noise in the broad range of 30 to 50 dB below signal level. (.3% to 3%) It is not difficult to perceive a disturbance signal of this magnitude. However, when a

modulation noise accompanies a signal at a level beyond 70 dB below the signal level, the ear is unable to perceive the noise, through masking effects, in the same manner as it is unable to perceive distortion products of similar magnitude. (.03%)

The modulation noise produced by the VCA-5A and M is 92 dB (.0025%) below the signal level, and is totally inaudible.

B & B made comments regarding the perceivability of modulation noise on transient material, and I think this statement needs some clarification. In some equipment, such as typified by tape noise reduction chains, a transient signal can trigger a noise signal which persists considerably beyond the removal of the transient. This type of modulation noise, indeed, becomes more detectable on transient material than on steady-state material. However, there is no basis of comparing this type of gated modulation noise to the type produced by a VCA. Figure 2 shows examples of the two types of modulation noise. The noise shown in Figure 2B has been triggered by the signal transient, and lingers long after the signal. The human ear perceives the very short duration signal transient as having a very low energy content, due to its short duration. The actual electrical energy level of the transient, however, is considerable. Thus, the expander portion of the noise reduction system has raised its gain, as dictated by the high signal level. Since the dynamics of a noise reduction system do not allow it to actually follow the signal waveform, there is a delay, or release time involved in recovering from a burst of signal energy. During the time, after the removal of the signal transient, that the expander remains at high gain, the tape noise is passed through at a higher than normal level. Since there is no signal present to mask the noise during this time, the noise, following signal removal, is perceivable as a swishing or pumping sound.

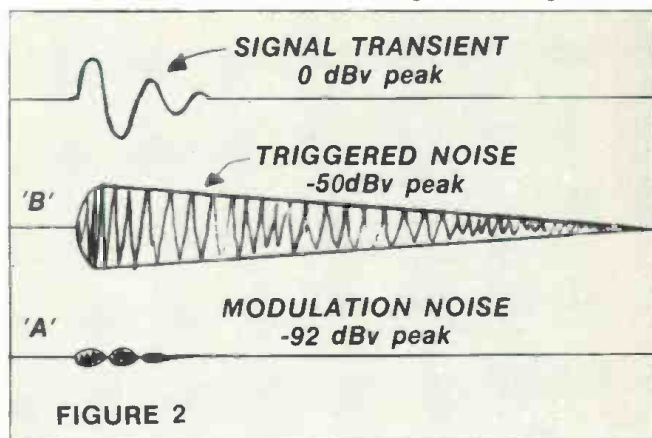

### DEPICTION OF TRIGGERED MODULATION NOISE vs VCA MODULATION NOISE

In the VCA type noise modulation of Figure 2A, the noise is neither triggered, nor does it linger. It is actually impressed on the signal, at a level some 20 to 30 dB below the point of perceivability. If the signal is transient, so is the noise. Thus the 92 dB separation between signal and noise remains effective and unchanged, regardless of the nature of signal transients. Critical listening tests will confirm both cases.

### THE REAL HEAVY STUFF — OMISSIONS

This section will deal with the important parameters which B & B chose to omit, in reference to the various VCAs available. Beside other less important parameters, the biggies are: **Gain Control Range, Control Signal Rejection and the Implementation of Practical Circuits.**

# The full-function one-inch eight-track. Otari MX7800.

The sophisticated machine sets the new standard for one-inch eight-track master recording. It comes with the latest electronics and every function indispensable for heavy-duty applications. Designed with ruggedness and extra easy operation in mind.

DC-servo 30/15 ips direct drive with minimum wow/flutter and  $\pm 12\%$  pitch control for variable speed playback. Constant-tension reel servo

with motion-sensing control logic plus new dynamic braking system for minimized tape shock and tighter timing. Built-in 700Hz/5kHz test oscillator for alignment convenience.

And it features perfect remote controllability. Full remote selective synchronous reproduce on all eight tracks. Automatic monitor switching to the pre-set mode—record, reproduce or synchronous. Remote coarse/fine two-stage pitch control for the



full  $\pm 12\%$  range. Precise remote timing with return-to-zero memory for mix-down convenience. Remote position locator with automatic click-free punch-in/punch-out function.

Easy-to-access transport and plug-in electronics for improved serviceability, and thorough heavy-duty design for utmost reliability.

If you've been looking for a full-function one-inch eight-track machine, this is it. For the full story about the ingeniously designed masterpiece, contact your nearest Otari dealer.

## **OTARI**

U.S.A: Otari Corporation,  
981 Industrial Road, San Carlos, California 94070.  
Phone: (415) 593-1648

Japan: Otari Electric Co., Ltd.,  
4-29-18 Minami Ogikubo, Suginami-ku, Tokyo 167.  
Phone: (03) 333-9631

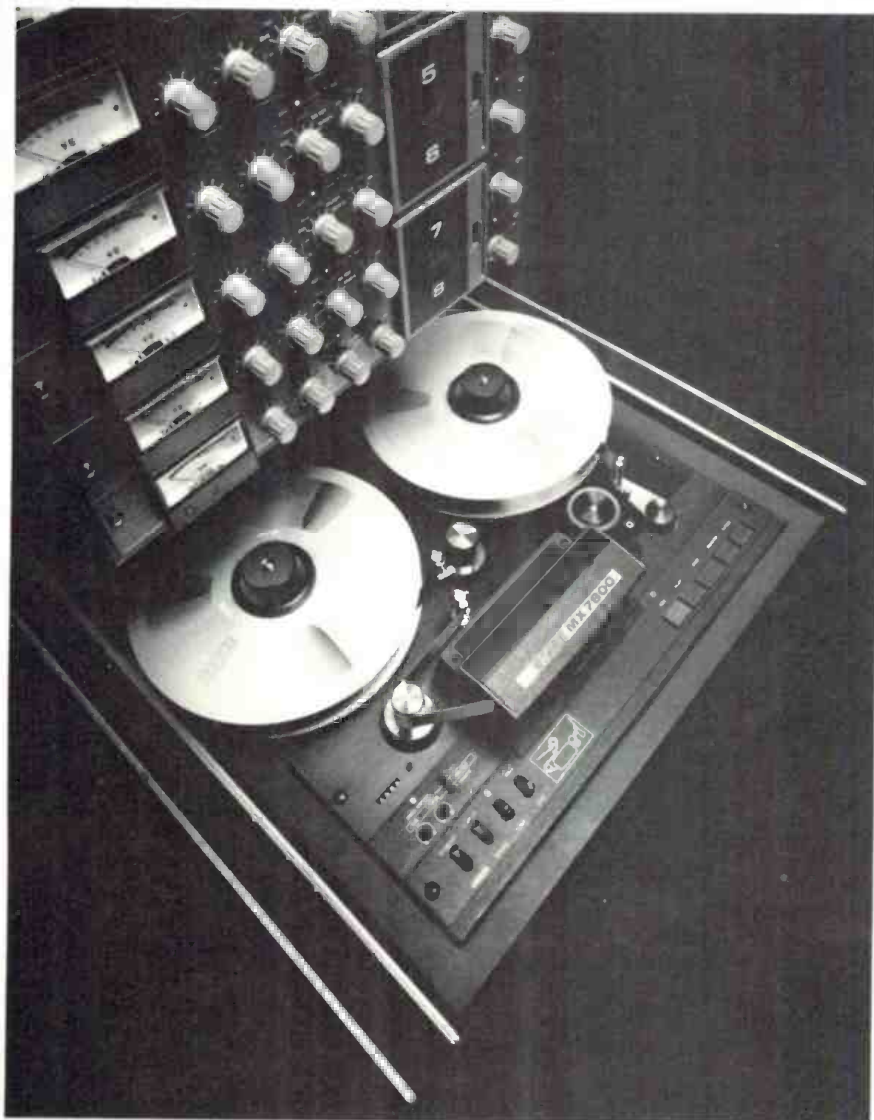

As I stated previously, the B & B device is not a VCA, but a Voltage Controlled Attenuator. The obvious conclusion one might draw is: "Who cares? Gain or loss is relative. We'll follow it with an Op-Amp and it will effectively become a VCA." In fact this is what B & B suggests in their spec sheet, as they show up to 15 dB of gain being obtainable in the Op-Amp which follows the attenuator element. Unfortunately, this does not make the device a VCA, it simply becomes a VCATT followed by gain.

The act of following the device with gain simply raise all components of its output by the amount of gain inserted. These components, of course, include noise, modulation noise, power supply noise (not specified), control signal crosstalk, etc. Additionally, the maximum attenuation is reduced by the amount of inserted gain. Putting gain before the VCATT element is no better, since it only serves to reduce its input overload point.

As for control signal rejection, allow me to quote from the B & B data sheet. "DC shift vs. attenuation = less than 5 mv." (No test conditions given.)

Now let us look at the performance of the VCA-5A and M, for the related parameters, as taken from our data sheet:

**Gain Control Range =**

+35 dB to -120 dB (155 dB) @ 1 kHz

+35 dB to -105 dB (140 dB) @ 10 kHz

**Control Circuit Rejection =**

Less than 1 mv output level shift with gain modulated from -100 dB to +20 dB @ 1 kHz (No input)

**Output Noise:** -96 dBv @ Max. Attenuation (20 - 20 kHz)  
-89 dBv @ Unity Gain  
-73 dBv @ 20 dB Gain

**Power Supply Rejection =** 54 dB @ 120 Hz (Referred to input)  
46 dB @ 1 kHz

(The stated gain control range for B & B is 0 dB to -103 dB @ low frequencies; 0 dB to -99 dB @ 10 kHz.)

**PRACTICAL IMPLEMENTATION**

As a model for the utilization of VCAs in audio consoles, I will typify the configuration, in basic form, as employed in the following equipment:

- The Allison Fadx System
- The Harrison Console
- The API Console
- The Allison Designed Sphere Console Automation
- The Allison Designed Auditorics Console Automation
- The Allison Designed Trident Console Automation

All of the above named equipment employs either dbx or Allison VCAs, in either conventional or automated formats. These systems gain enormous benefit from the ability of the VCAs, located in each input module, to be gain controlled by the sum of control voltages produced by the channel faders, the group faders, VCA Grandmaster, mute and solo systems, compress/expand detectors and, of course, automation. The configuration is, contrary to B & B's comments, very enthusiastically received, and is rapidly becoming an Industry Standard configuration.

As one might guess, the VCAs employed must have a very wide gain control range, in order to accept the numerous controlling sources, and must have a precise log (dB vs. Volts) control response, for accurate grouping.

In typical service, the channel faders will be nominally placed around unity VCA gain, but will have reserve gain (top of fader) of around 15 dB. The group masters have a similar gain structure, that is to say they can direct an additional gain of up to 15 dB to the VCAs which are assigned to the group fader. The VCA Grand master will have a similar structure.

It can be readily seen that a soft passage can be brought up to as much as 30 dB of gain by operating the associated channel and group faders to their maximum.

Since today's quieter recording mediums allow placing a greater dynamic range on tape, this sort of gain reserve is necessary in structuring a flexible mixing console. In Figure 3, I show the typical configuration of such a system, using the VCA-5M. Figure 4 shows the implementation of a circuit having a similar gain reserve, using the B & B device.

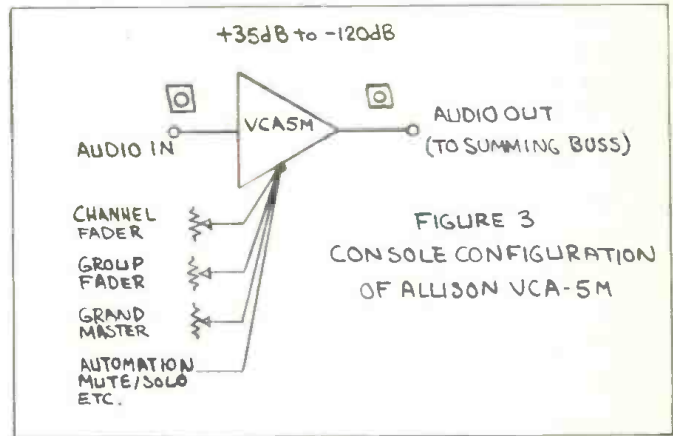

FIGURE 3  
CONSOLE CONFIGURATION  
OF ALLISON VCA-5M

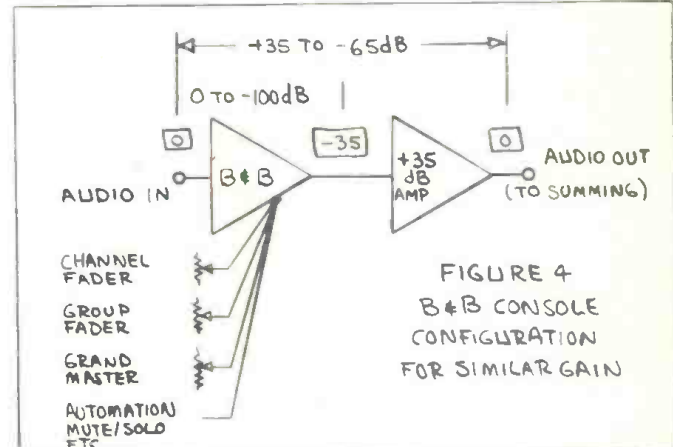

FIGURE 4  
B & B CONSOLE  
CONFIGURATION  
FOR SIMILAR GAIN

Beginning to get the picture? Yes, I am being cruel to B & B, but these are real configurations of modern consoles being mass produced. In short, this is the type of equipment which B & B proposes to have a miracle fix for. Remember their closing words: "A happy result of this research is a truly professional quality VCA whose performance is consistent with the best of contemporary audio design. With this reality, the promise of electronic gain control can, at last, be fulfilled."

Let us proceed to Table 1 to see just how well they fulfill that promise!

TABLE 1

PARAMETER	Figure 3 (ALLISON VCA-5M)	Figure 4 (B&B VCATT)
CHANNEL GAIN RANGE	+35dB to -120dB	+35dB to -65dB
SHUT-OFF (Max Attenuation)	-120dB @ 1kHz -105dB @ 10kHz	-68dB @ 1kHz -64dB @ 10kHz
OUTPUT NOISE AT SHUT-OFF (1 channel)	-96dBv	-65dBv
OUTPUT NOISE AT NOMINAL MIX POSITION (Per channel)	-89dBv	-64dBv
OUTPUT NOISE AT +20dB CHAN. GAIN	-73dBv	-61dBv
OUTPUT NOISE @ NOMINAL MIX POSITION (Based on 32 mixed channels)	-74dBv	-49dBv
OUTPUT NOISE @ MAX ATTENUATION (32 channel console)	-81dBv	-50dBv
CONSOLE NOISE w/31 FADERS @ NOMINAL & 1 @ 20dB GAIN	-70dBv	-48dBv
CONSOLE NOISE w/32 FADERS @ 15dB GAIN	-62dBv	-47dBv
CONTROL SIGNAL FEEDTHROUGH @ 1 FADER CHANGE FROM -100 to +20dB GAIN	<1mv (60dB below signal)	<300mv (10dB below signal)
CONTROL SIGNAL FEEDTHROUGH UPON ADJUSTING VCA GRAND MASTER FROM -100 to +20dB GAIN	<5mv (45dB below signal)	<1.5 volts (5dB above signal)

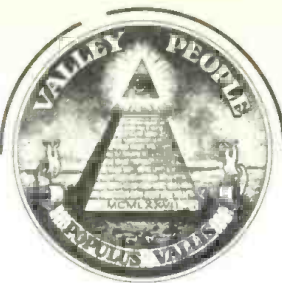

# DISTORTION 101

Harmonic and intermodulation distortions have negative effects on more than just your ears. Ever sit down at a synthesizer for an hour and after the third ring modulation of half a dozen frequency modulated square waves (stirred, not shaken), you're searching for your roll of Tums? This peptic phenomenon isn't caused by lack of musical ability (hopefully), but rather the richness of all those bizarrely intermodulated, triangularly squared, complex waveforms, harmonically grating on your stomach. Bad sneakers!

Transient distortion is another indiges-

tion which might put an annoying edge on the vocal (that 40db of good old padding won't cure) or make an excellent cymbal sound as if it might be an incarnation of a garbage can lid.

EXAMPLE: Good transient response, adequate slew rate and low distortion products, all work to retain the luster of a fine piano, allowing it to function or "work" in a mix... compatibility, if you will... (won't you?—humor me, OK!)

Anyway; note the illustrations, memorize the text, and there will be a quiz on Monday.

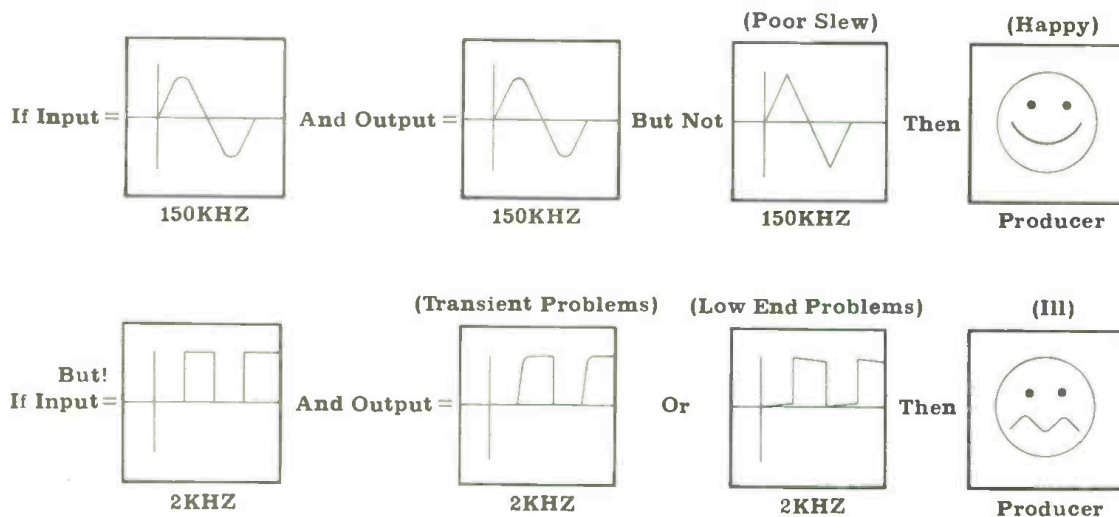

## TRANSAMP™ LZ

A transformerless mic preamp of respectable quality!  
Available in plug in (15 pin edge connector) or as a retrofit for MCI consoles.

A product of the  
**Valley People, Inc.**

P. O. Box 40306/2821 Erica Place/Nashville, Tennessee 37204/615-383-4737

## FURTHER ANALYSIS AND TESTS

Thanks to a studio operator here in Nashville, I was able to procure (just yesterday) a B & B #1537A. The unit came mounted on a board provided for retro-fit into an MCI 528 console. In reading the B & B literature, I noted the claim that this module would "greatly upgrade the performance," by simply plugging in the new module.

Since I had recently done a very exacting study of the signal and noise parameters of this console, I decided to find out what improvement, if any, could be derived by substituting the B & B module for the existing dbx #202 VCA. The original basic console structure, to the best of my knowledge as based on MCI schematics, is as shown in my Figure 5.

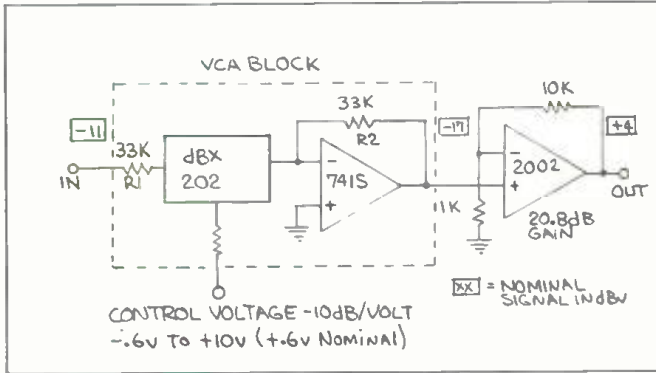

FIGURE 5  
STANDARD MCI 528 VCA CONFIGURATION

At the normal operating point of the fader (control voltage = +.6 V) the nominal -11 dBV dBV audio input level is attenuated 6 dB within the VCA block, then given 20.8 dB of gain in the MCI 2002 Op-Amp, to provide the nominal +4 dBV output level. The MCI 2002 is a high voltage IC (bi-polar 36V) device, and clips at an output level of +28 dBV. I believe the console can deliver a maximum of +13 dBV to the input of the VCA block, thus giving a respectable 24 dB of headroom in and out.

The control voltage range allows a modest 12 dB increase over the nominal fader position (control voltage = -.6 V), and a 94 dB increase at maximum attenuation (control voltage = +10 V). This agrees with the fader scales on the console itself.

As I had stated earlier, the distortion and noise contours of the dbx 202 VCA are a function of the signal currents, as established by the user-selected input and current to voltage converter resistors, R1 and R2. For the values shown, the nominal input current (@ -11 dBV in) is 10  $\mu$ a peak, and rises to 100  $\mu$ a at an input 20 dB over nominal. At the maximum signal deliverable to the input, (24 dB over nominal) the current rises to about 160  $\mu$ a peak. The VCA output current is nominally 5  $\mu$ a peak, and can rise to a value of 80  $\mu$ a, beyond which the 2002 Op-Amp clips at its +28 output level.

At this point, I'm going to estimate the IMD and THD contours for the dbx 202, at worst case fader positions, at these operating currents. I believe my estimates will be found to be at least 80% correct. I would, however, suggest that the reader either make measurements, or contact dbx, should he desire more accurate information.

The results of my estimates are to be found in Figures 6 and 7. Note that the distortion products rise proportional to the input level, and that the THD is consistently around 1/3 the IMD. This is the characteristic contour of error caused by the resistive component of the base/emitter junctions of the log/antilog transistors, as discussed earlier. I must warn that the reader not yet jump to the conclusion that the dbx VCA is at fault for the relatively high distortion. There are other factors.

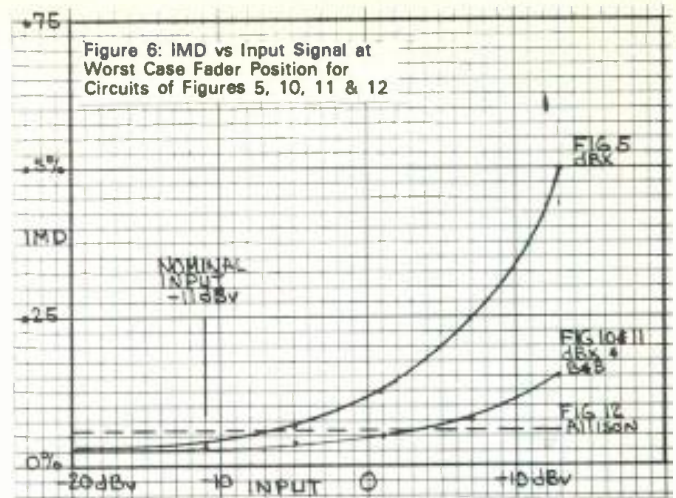

Figure 6: IMD vs Input Signal at Worst Case Fader Position for Circuits of Figures 5, 10, 11 & 12

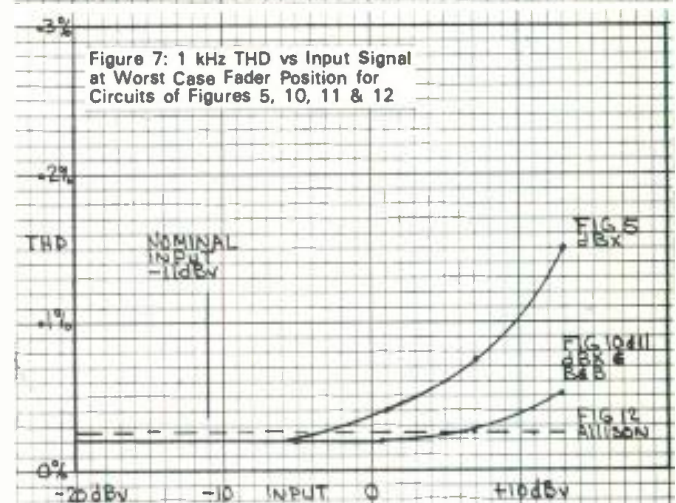

Figure 7: 1 kHz THD vs Input Signal at Worst Case Fader Position for Circuits of Figures 5, 10, 11 & 12

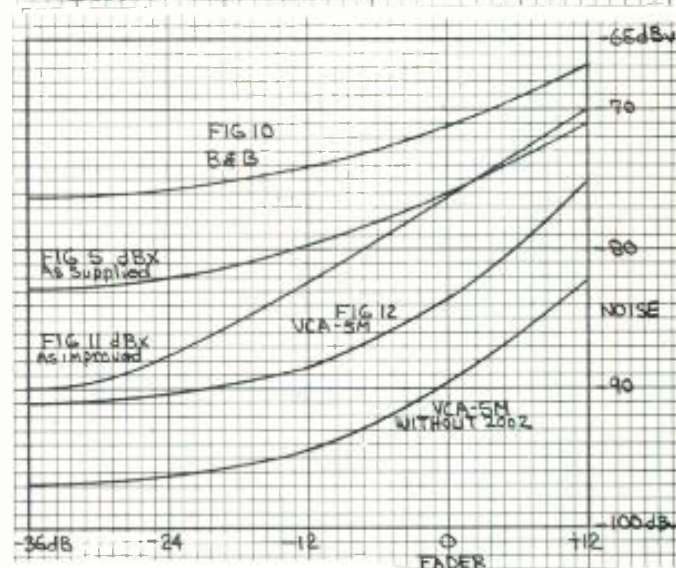

Figure 8  
Output Noise vs Fader Position Relative to Nominal Operating Fader Position for Circuits of Figures 5, 10, 11 & 12

## NOISE ANALYSIS OF FIGURE 5

The 2002 Op-Amp is specified to have an input noise voltage of 14  $\text{nv} \sqrt{\text{Hz}}$  (per input), and is operated at 20.8 dB gain. Its output noise, with no input, comes to -88 dBV, using these parameters. To this must be added the amplified noise of the 741s and the 202 VCA. For the sake of not getting overtechnical, I will refrain from the ritual of stating the noise formulas, and just provide the results.

The 202 VCA/741S combination yields an output noise of -106 dBv @ maximum attenuation, -98 dBv @ nominal gain (-6 dB) and -92 dBv at maximum gain (+6 dB). When amplified by the 2002 stage, and added to its noise, the final noise analysis comes out as shown in the contour of Figure 8.

### THE B & B/MCI CONNECTION

Now, let's find out what the B & B/MCI replacement module can do. Figure 10 depicts the circuit involved.

Since the B & B device is incapable of gain, 6 dB of gain precedes the VCATT element. A +.6 V offset is introduced at the control terminal to compensate for the additional input gain. The net result is to trick the VCATT into thinking it is a VCA. The cost of doing this is the reduction of the maximum input level by 6 dB, to +14 dBv. In this application the loss is of no real consequence since the console can deliver only +13 dBv to the circuit.

### SCALE FACTOR NON-LINEARITY

When I started to test the B & B/MCI module, the first thing I noticed was that, although the gain vs. control voltage was correct at 0 control volts, it was off by 2 dB at -6 V (maximum gain). This had the effect of reducing the console's 12 dB gain reserve by 2 dB. Upon examining the situation further, I found that the presumed 10 dB/volt relationship was non-linear to the extent shown in Figure 9.

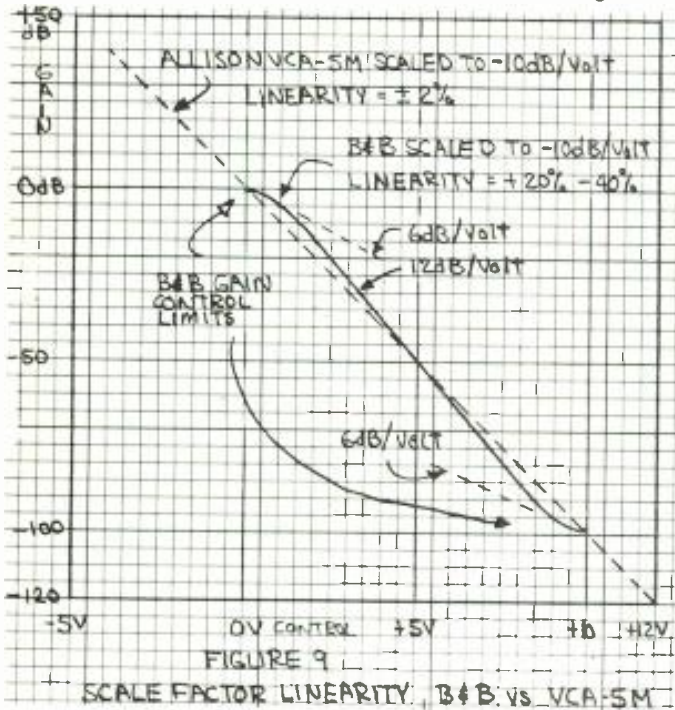

The scale factor log conformity error of Figure 9 was confirmed by a close scrutiny of the B & B data sheet, but the consequences are not explained. Note that the scale factor is around 12 dB/volt in the center region, but falls to 6 dB/volt at the extremes. This degree of error makes accurate grouping impossible.

Let us make the assumption that two drum tracks were assigned to one VCA group master. Let us further assume that, in order to achieve a pleasing mix, that one drum fader were near the top of its range, while the other were down by 15 or 20 dB. (A very common mixing situation.) Now let us assume that the group master is moved up or down 10 dB (1 volt).

One drum track changes by only 6 dB, while the other moves by 12 dB. The result, of course, is that the mix is

destroyed, since a 6 dB error has been introduced in the relative balance of the two drum tracks.

As you can see, for successful grouping, the VCAs must have excellent scale factor log conformity.

The Allison VCA-5A and M exhibit no more than 2% error in log conformity, over the gain range of +35 dB to -100 dB. In a similar mixing situation to the one above, the tracking error would be a maximum of 2% of the 10 dB change, or .2 dB. If still greater accuracy is required, the scale factor can be trimmed with a 50-cent trimpot, to provide an essentially unmeasurable error over the normal working range.

Getting back to the B & B/MCI retrofit, I measured good distortion parameters, as shown in Figures 6 and 7. Definitely an improvement over the original performance.

### B & B/MCI NOISE

The noise performance of the B & B/MCI retrofit, however, was a different story. Although the B & B module met its published specs, the net result of the total circuit was a disaster. The original noise performance of the console had been degraded by from 5 to 7 dB, as shown in Figure 8. If 32 such channels were summed, at the nominal fader positions, the buss noise would come to -56 dBv from this source alone. If all 32 signals had passed through these circuits twice (once in miking and once in mixing), the buss noise comes out -53 dBv, giving an output signal-to-noise ratio of 57 dB! You might as well take the dbx noise reduction off the tape machine and put it on the console!

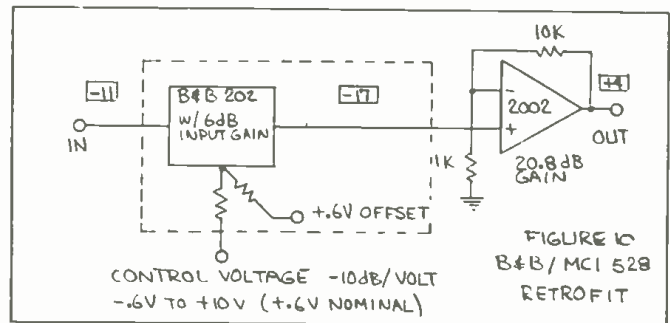

### BACK TO DBX

Maybe we should give dbx another chance. Let's configure it more in keeping with the ways its designer intended, and see what happens. Starting with a criteria of no more than .15% IMD for maximum input levels of +13 dBv, its input resistor should be around 100 k. Next, the double Op-Amp output stage is an unnecessary source of noise, as the dbx VCA can couple directly into the 2002 Op-Amp, using it as a current to voltage converter, using a 500 k feedback resistor. Offsetting the control voltage by -.6 V allows the VCA to take more of the gain load, and places the VCA's unity current gain point at the console nominal operating point, for minimum distortion at the typical use point.

The improved circuit is shown in Figure 11. Now refer back to the noise and distortion contours of Figures 6, 7 and 8 and Voila!, not only is the distortion performance every bit as good as the B & B/MCI, the noise has been improved by up to 14 dB over the B & B, and 7 dB over the original configuration. Can this be magic? Perhaps it is just a matter of applying good engineering principles.

### THE VCA-5M CONNECTION

Finally, the Allison VCA-5M VCA is plugged into the same set of requirements. (Figure 12) In most applications, the 2002 following amp would not be required, since the VCA-5M has a voltage output capable of delivering +23 dBv without additional circuitry. Since, in this case the console

... continued on page 111 —

# New Products



## LEXICON ANNOUNCES LOW-COST DELTA-T MODEL 91

Lexicon's Delta-T 91 is a new low-cost professional audio digital delay for small sound reinforcement installation and pre-reverb use in recording studios. It provides a delay adjustable from 0 to 120 milliseconds.

Delta-T 91 has all the performance specifications and features of the more expensive Model 92 including: muting of audio outputs during power up/down sequences; automatic bypass; audio input and output transformers, etc. The only difference being a single output in the Model 91 versus two outputs in the 92.

The audio quality of Delta-T 91 meets the highest professional standards. Total distortion and noise is typically 0.06% at 1 kHz. Dynamic range is 90 dB and response is from 20 Hz to 12 kHz,  $\pm 1$  dB. Modular construction, including pluggable ICs and

power regulators, plus diagnostic aids for rapid field service. Five-level headroom indicator simplifies and verifies correct level setting. XLR connectors are standard. Delta-T Model 91 professional net price is \$985.00.

**LEXICON, INCORPORATED**  
60 TURNER STREET  
WALTHAM, MA 02154  
(617) 891-6790

for additional information circle no. 50

## JBL ANNOUNCES THE 4313 PROFESSIONAL SERIES CONTROL MONITOR

James B. Lansing Sound, Inc., announces the 4313 designed for control rooms, mixdown facilities and any other professional applications in which a compact unit is required. Features of interest include a new low frequency driver, especially developed

for the 4313, and a system design incorporating in-line mounting of all transducers for excellent stereo imaging. In combination with the system's exceptional transient response, these elements, according to JBL, make the 4313 a product capable of outstanding accuracy, clarity and openness.

JBL engineers designed the powerful 10-inch low frequency loudspeaker specifically for accuracy and distortion-free performance in the 4313 enclosure. Features of this component include a 3-inch edgewound copper voice coil and a heavy 1.5-pound cast magnetic assembly. The rear surface of the cone is coated with an exclusive damping formulation that provides the precise mass and density necessary for optimum bass performance.



The 5-inch mid-range loudspeaker is housed in an isolated sub-chamber to prevent interaction with the low frequency driver. Powered by a 7/8-inch copper voice coil, the extremely stiff cone provides clear sound reproduction with minimum distortion even at the highest volume levels. The magnet assembly in this component weighs 1-5/8-pounds.

Constructed of phenolic-impregnated linen coated with a thin film of aluminum, the one-inch dome radiator provides high acoustic output with great clarity. The entire surface of the dome acts as a radiating area, resulting in exceptional dispersion characteristics. This component is powered by a one-inch copper voice coil energized by a 1-1/2-pound magnet assembly.

The crossover network has special phase-correcting conjugate circuitry to ensure that the drivers operate in a manner approaching the theoretical ideal through

# NEW!



## Model 1100

### Line/Microphone Audio Mixer

Six Line/Microphone Inputs • Phono Preamplifier, RIAA Equalization  
Monaural Output • Monitor Output  
Rack Mountable • Transformer Isolation  
Equalization • VU Meter

**OUTSTANDING GUARANTEED PERFORMANCE**  
**IMMEDIATE DELIVERY — ECONOMICALLY PRICED**

Specifications may be obtained from:

# SPECTRA SONICS

LEADER IN ADVANCED TECHNOLOGY



3750 Airport Road • Ogden, Utah 84403 • (801) 392-7531



# Take an inside look at GroundStar Laboratory Ronnie Milsap's new facility in Nashville.

Studio (view from conductor's balcony)



Studio (view into control and string room)



Control Room



String Room

## Ronnie had a dream. Call us about yours!

Consultation, Design, Equipment,  
Custom Electronics, and Installation by

### VALLEY AUDIO

P.O. Box 40743 · 2821 Erica Place · Nashville, Tenn. 37204 · 615-383-4732

Special credit goes to Rudi Breuer of Palm Dale, California for his invaluable design help and superior construction work on Ronnie's facility.

## MASTERS OF AURAL GRATIFICATION

the transition frequencies. Built expressly for use in dividing networks, the capacitors are non-inductive and non-polarized types with high AC current capacity. Level controls allow individual adjustment of mid-range and high frequency output.

The 4313 is available with a contemporary-styled walnut enclosure, constructed of dense 3/4-inch stock throughout to prevent unwanted resonance; internal padding absorbs spurious reflections and standing waves. All components mount directly to the baffle panel and are removable from the front of the enclosure.

Weight of the 4313 is 42.5 pounds. The dimensions are 22 3/4" x 14 1/4" x 9-15/16" deep.

**JAMES B. LANSING SOUND, INC.**  
**8500 BALBOA BOULEVARD**  
**NORTHRIDGE, CA 91329**  
**(213) 893-8411**

for additional information circle no. 53

### TANGENT MODEL 1602a

Tangent Systems, Inc., announces the introduction of the Model 1602a stereo mixing console — a board designed to offer professional capabilities at a moderate price.

The 1602a features include:

A solo function — thanks to electronic FET switching, a sound engineer can monitor any input or preview an entire grouping, according to the manufacturer. Pushing any solo button automatically puts that channel into the headphones, no matter what was present before.

100 mm Faders — Tangent's use of long-throw 100 mm slide faders provides a greater degree of control and more accurate visual feedback.

Three effects sends — effects, reverb, and monitor sends on each channel offer the



flexibility a sound person needs by acting as three independent mixers-within-a-mixer.

Channel patching — each input has a pair of access jacks for patching external effects into a single channel.

Modularity — the 1602a mixer line is totally modular for ease of servicing and greater versatility.

Reverb — an internal option, the Tangent reverb features a three-spring Accutronics Type 9 chamber.

Variable gain control — Rather than relying on pads, this control actually varies the gain of the microphone preamp over a 40 dB range.

Numerous other features, such as balanced inputs and outputs, expandability, auxiliary inputs, transformerless mike inputs and a phantom power capability are standard.

The performance characteristics of the 1602a are reportedly impressive. The unit

delivers a typical noise level of -128.5 dBv and total harmonic distortion checks in at less than 0.004% at 1 kHz. The slew rate, measured at any point in the audio chain, is a minimum of 10 volts per microsecond.

The 1602a, engineered to meet professional standards at a moderate price, is marketed through an exclusive network of dealers, qualified in sound reinforcement.

**TANGENT SYSTEMS, INC.**  
**2810 SOUTH 24TH STREET**  
**PHOENIX, AZ 85034**  
**(602) 267-0653**

for additional information circle no. 55

### SOUND WORKSHOP ANNOUNCES NEW 262 STEREO REVERBERATION SYSTEM

Utilizing the latest in spring design for professional studio applications, the 262 is said to bring new performance standards to reverb systems in the under \$1,000

**HELLO !**

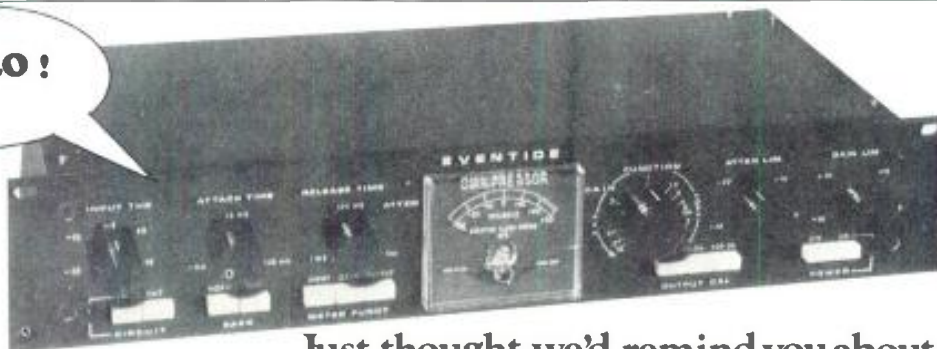

### Just thought we'd remind you about the Omnipressor

**Eventide**  
 the next step

The versatile unit which combines the characteristics of a compressor, expander, noise gate, and limiter in one convenient package. Its dynamic reversal feature makes high level input signals lower than corresponding low level inputs. Musically, this reverses the attack-decay envelope of plucked string and similar instruments, and gives the effect of "talking backwards" when applied to a voice signal.

EVENTIDE CLOCKWORKS INC 265 WEST 54TH STREET NEW YORK, NY (212) 581-9290 CABLES EVENTIDE N Y  
 (Omnipressor is a trademark of Eventide Clockworks Inc.)

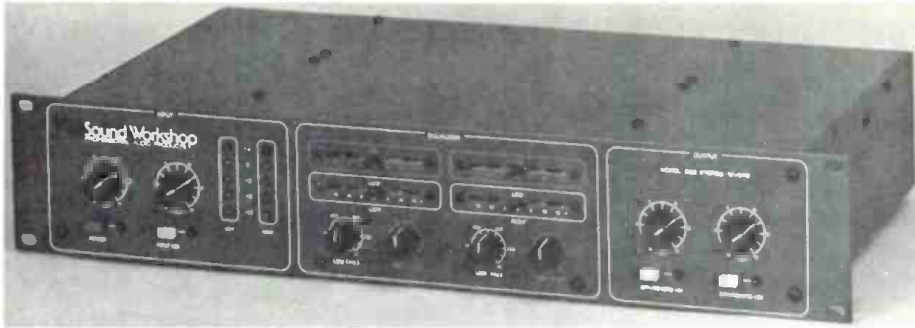

category. The 262 features extended high and low frequency response and a fullness of sound associated previously only with systems of substantially higher cost.

The 262 Stereo Reverb features an extremely versatile and competent equalizer section. Two channels of EQ are provided, with each channel allowing a plus and minus 15 dB range over the high and low frequency bands. Frequency selection is fully sweepable from 50 Hz to 1 kHz (low band) and from 500 Hz to 10 kHz (high band). The EQ bandwidth is optimized for proper contouring of the reverberant signal.

The 262 also allows dry/wet mixing (for broadcast and disco applications), full drive level into 600 ohm loads, LED level indicators (for optimum dynamic range,) active balanced inputs, and matched bi-FET preamps for ultra-low noise performance.

The 262 Stereo Reverb mounts in a 3½-

inch rack space and sells for \$700.00. It is also available with transformer balanced outputs and XLR connectors at \$750.00.

**SOUND WORKSHOP  
PROFESSIONAL AUDIO  
PRODUCTS, INC.  
1324 MOTOR PARKWAY  
HAUPPAUGE, NY 11787  
(516) 582-6210**

for additional information circle no. 57

### NEW MUSICAL SOUND SPEAKER FROM ALTEC LANSING

A speaker system which offers portability and high performance levels was Altec Lansing's aim in designing the new 934, according to Irwin Zucker, vice president market development.

The 934's performance is indicated by the efficiency level. With one watt of power the 934 can produce 101 dB SPL at four feet.

Zucker also pointed out that the 934's directivity control is improved over traditional designs by the inclusion of the Mantaray™. As a component of the 934, the Mantaray constant directivity horn eliminates one of the most common problems in all types of speaker designs — beaming, or a narrowing of dispersion at higher frequencies. "The resultant benefit to the musician is much greater latitude in speaker location with more uniform audience coverage and freedom from feedback," Zucker said.

An additional feature of the 934, the company states, is the inclusion of the Tangerine™, radial phase plug in the high frequency compression driver. This phase plug enhances high frequency response, a critical factor in high quality sound reinforcement.

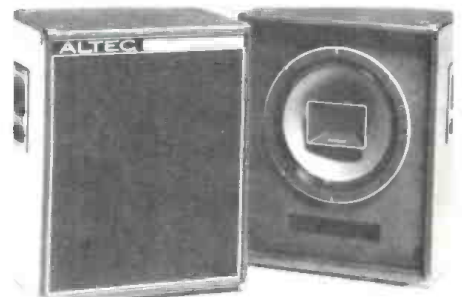

The new 934 also includes a unique crossover network which features a built-in dual-band variable equalizer. The equalizer

## Time-Based Effects . . . Without the Side-Effects. Introducing the 440 Delay Line/Flinger from Loft Modular Devices.

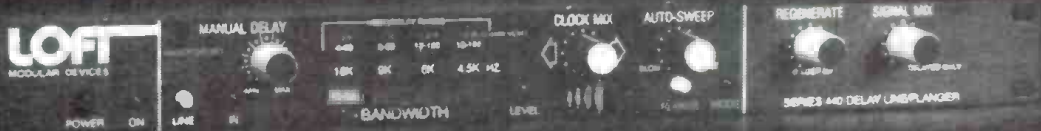

There is a new solution for time-based effects. Filling the gap between expensive digital lines and low cost 'black boxes', the Series 440 Delay Line/Flinger delivers the amazing depth and dramatic realism rightly associated with analog delay effects. Yet it avoids so many unwanted side effects you expect from analog and even some digital systems.

Now, you don't have to sacrifice the dimensional impact of your music to severely limited bandwidths, nor lose that bright crisp edge to compromised electronics. Gone too, are the 'thumps', 'whistles', background oscillations, quantizing noise, 'grainy' digital audio, and other strange distortion you may have noticed before. Even headroom, a problem with so many units, is no problem with the Series 440 Delay Line/Flinger.

All you get is great sounding delay combined with the creative flexibility of VCO time based processing. Mixed to any degree with straight delays from .5msec all the way out to 160msec., VCO processing permits such effects as resonant flanging, Leslie-type sounds with different 'rotation' speeds, vibrato, double tracking with realistic pitch and timing errors, or a wide range of more subtle effects to control the spatial perspective of your music. In addition to the built-in VCO feature, control voltage jacks allow further modification of the system's special effects capability. Impressive? We think so, but there is more. Why not check out the details at a representative dealer near you.

The Series 440 Analog Delay Line/Flinger is in stock and ready for immediate delivery.

**LOFT**  
MODULAR DEVICES

LOFT MODULAR DEVICES, INC. 91 Elm Street, Manchester, CT 06040 (203)646-7806

can be defeated by means of a panel-mounted switch, converting the equalizer to a full-range attenuator for the high-frequency driver. The result is a new level of flexibility in network design for sound reinforcement applications.

Built to meet the portable requirements of a road tour, the 934's cabinet measures only 22" x 26" x 17". The cabinet is finished in black leather-grained vinyl and is equipped with a durable black knit grille. It is also "bi-amp ready", capable of receiving the Altec 1224A bi-amp in a pre-fabricated panel.

"The 934 is engineered for use in concert halls, nightclubs, or discos," Zucker said, adding, "but it's versatile enough to handle any sound requirement."

**ALTEC CORPORATION**  
**1515 S. MANCHESTER AVENUE**  
**ANAHEIM, CA 92803**  
**(714) 774-2900**

for additional information circle no. 58

### TECHNICAL CHANGES IMPROVE TONE AND TOUCH OF YAMAHA GRANDS — 6'6" CONSERVATORY MODEL INTRODUCED

Yamaha has improved the tone and touch of its grand piano line with a variety of technical changes, and has introduced a 6'6" conservatory piano, the C-5.

Foremost among the technical advances is a revolutionary new frame casting method

called the vacuum shield mold process, or "V-Pro," which involves placing a thin plastic film over the green sand mold used in piano frame casting. In the Vacuum-Process, by using vacuum pressure, the sand fills even the finest details of the mold for a perfect casting. Contours are exact, and the internal structure of the casting is more uniform so there is less vibration loss. This advanced method permits the reproduction of design dimensions and shapes to more accurate tolerances than ever before.



The "scale," defined as the engineering and design that creates the sound, has also been improved in the new Yamaha grands. Major components of a piano's scale include such things as string length, bass string

construction and bridge shape.

The bass and mid-range areas of the new pianos, excluding the G1-J and C7-D which were recently improved, will feature longer strings for improved bass volume and sustain and a smoother transition to mid-range. Bass strings are made by wrapping plain music wire with copper wire — a method which results in muddiness if the wire is wound too tightly, or buzzes and rattles if the winding is too loose — are now made through a more precise technique. Winding tension can be adjusted more exactly to maintain string elasticity and achieve clearer sound, improved volume and sustain.

The bridge, which transfers the string vibrations to the soundboard, will be more efficient in that task, thanks to a new shape and a greater contact area. The soundboard itself has also been improved. In all grand piano models, the apex of the soundboard crown is now located at a more centralized point under the bridge to enhance tone quality and sustain.

The touch of the new Yamaha grands stays smooth indefinitely because a new method for plating the action center pin surfaces prevents roughness even after long-term use. The nickel-plated tuning pins, which were so highly appreciated in the previous C-series, are used in all of the new grand pianos. Hard steel insets in the frame capo bar section of the plate prevent wearing of the bearing by the strings, and assures a more precise string support point for a clearer tone with less unwanted noise.

As exciting as the technical changes in existing Yamaha models is the addition of the 6'6" conservatory piano, the C-5, to the line-up. The plate is made by the new "V-Pro" and the C-5 features such case embellishments as a bevelled topboard and spade legs on the bench.

**YAMAHA INTERNATIONAL CORP.**  
**P.O. BOX 6600**  
**BUENA PARK, CA 90622**

for additional information circle no. 60

## Meet AKG's "New Professionals"

AKG is a research, development and manufacturing organization specializing in electro-acoustic technology. Our designs have been awarded over 600 transducer related patents, and our products have earned the highest degree of user respect for quality and dependability.

The AKG line of various microphone models is considered to be the most sophisticated available for applications ranging through the spectrum of professional uses. From studio, to in-concert recording and reinforcement, to location film sound...our products can be called on to solve the most difficult situations you may encounter. AKG has developed a broad range of products to meet your varying creative requirements and, as new audio frontiers evolve, our engineers will lead the technological pioneering.

We set our goals rather high



and turn every stone to live up to, and improve upon, self-imposed challenges. We constantly strive to advance beyond state-of-the-art developments. Some of these advancements you see illustrated below. Loaded with practical, innovative features, AKG's "New Professional" microphones are intended to further build upon the remarkable results achievable with the other AKG "Professionals." Ask your dealer or write:



**PHILIPS AUDIO VIDEO SYSTEMS CORP.**  
A NORTH AMERICAN PHILIPS COMPANY  
 81 McKee Drive, Mahwah, N.J. 07430 • (201) 529-3800

The Mark of Professional Quality.  
 in microphones, headphones,  
 phonocartidges, reverb units.

### MCI'S JH-600

#### STOCK AUTOMATED CONSOLE

Said to be the first stock automated console, the JH-600, like the predecessor JH-400 and JH-500, is an in-line console with each I/O module containing one complete mike channel and one complete remix channel. On the JH-600 the VCA fader assemblies have been mechanically separated from the rest of the module. It comes in two frame sizes, the JH-618 (18 inputs) or JH-636 (36 inputs).

Some of the features designed into the new desk include differential line inputs, and optional differential mike preamps. There are up to 36 channel outputs, high and low pass filters, 24 channel busses with panning, and six sends. The console also has momentary short travel mute switches,

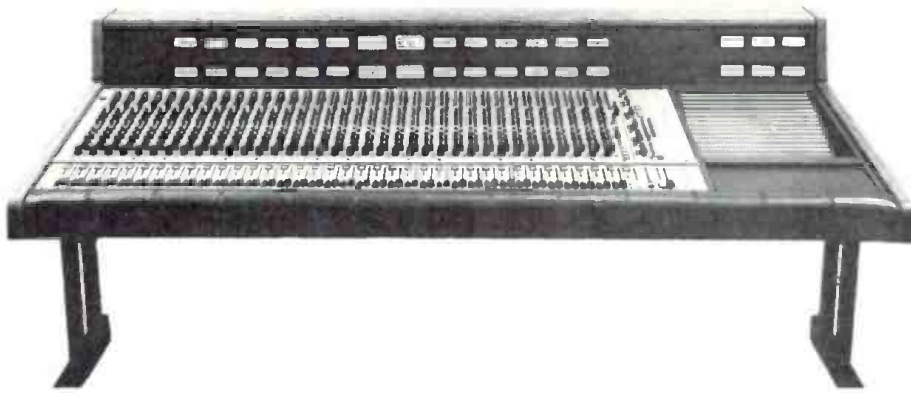

balanced push/pull output, and multiway connectors for all rear panel connections. Another highlight of the JH-600 is the optional true parametric equalization. This means that there are three separate controls for frequency, amount of boost, and Q (sharpness) that are not interactive.

The JH-600 features MCI's JH-50 Automation as standard equipment. The automation gives the console such capabilities as discrete grouping and Stereo In Place Solo, as well as the automation functions. Basic automation modes include READ, WRITE and UPDATE as well as an independent command for MUTE WRITE, and REWRITE capability. Automation is controlled by sets of three buttons and three LEDs for each I/O, Master and Group fader

and each Echo Return. Smooth transfer between modes of operation is automatic.

The standard JH-600, as an automated full-featured desk is available at \$28,000.00 for a Model JH-618-18-VU.

**MCI**  
**4007 N.E. 6TH AVENUE**  
**FT. LAUDERDALE, FL 33334**  
**(305) 566-2853**

for additional information circle no. 61

**TRACK AUDIO**  
**LM-1R COMPRESSOR/LIMITER**

The LM-1R features extremely low noise and distortion figures. The unit is rack mountable and was designed with flexibility in mind. Variable functions include compression 2:1 to infinity, attack times .2

to 20 msec, release times .1 to 2 sec. The unit features a switch whereby the user may select the function of the VU meter. You may see the actual output level or see the amount of gain reduction. With zero gain reduction the needle would point to zero level. At 3 dB of gain reduction the needle would point to -3 dB, indicating a cut of 3 dB. The meter is illuminated, and uses special ballistics for better movement. Rear connection is made via barrier strip.



Professional net price has been set around \$350.00. Dealer inquiries are invited.

**TRACK AUDIO, INC.**  
**33753 9TH AVENUE SOUTH**  
**FEDERAL WAY, WA 98003**  
**(206) 838-4460**

for additional information circle no. 63

**KLARK-TEKNIK DN-34**  
**ANALOG TIME PROCESSOR**

Hammond Industries, Inc., the exclusive United States distributor for Klark-Teknik, announces the DN-34 Analog Time Processor is now available for delivery.

The DN-34 is described as being capable of producing numerous time related effects. Among others, these effects include

**btx presents**  
**the 30-track**  
**audio recorder**

The btx 4500 SMPTE interlocking system lets you operate any two multi-track recorders in tandem for 14, 22, 30 or 46-track capability. Using standard SMPTE time code written on one track of each machine, any two recorders may be synchronized, including video to audio. You can even mix makes, formats, speeds, and numbers of tracks, with or without servo controlled capstan drive. The btx 4500 is a micro-processor-based system capable of tracking within 50 microseconds of an actual mechanical lock. It's an economical direct plug-in system that's easy to use and ultra-reliable.

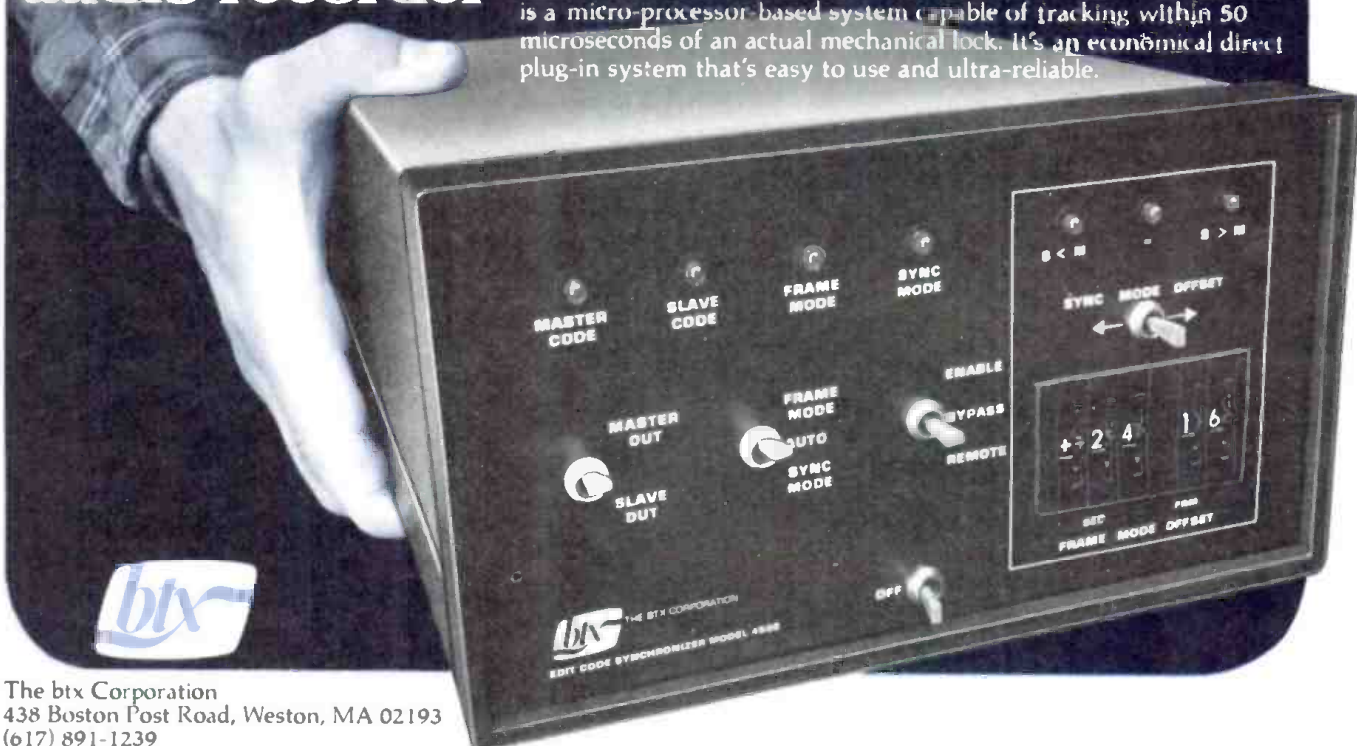

The btx Corporation  
 438 Boston Post Road, Weston, MA 02193  
 (617) 891-1239

for additional information circle no. 62

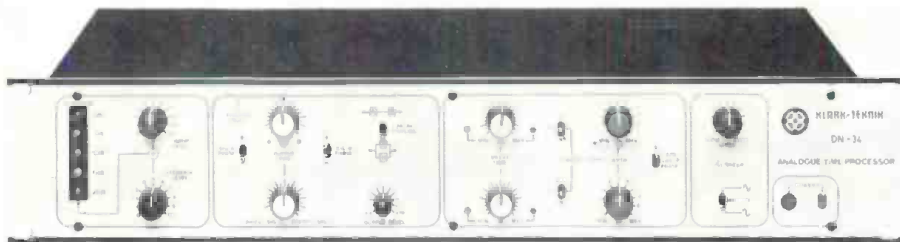

flanging, phasing, double and triple tracking, vibrato, doppler/leslie and chorus.

The design of the DN-34 incorporates a compander and peak limiter so the effects can be achieved cleanly and noiselessly. All of the effects can be achieved without the need for additional outboard equipment and/or mixer console facilities.

The DN-34 is available from Klark-Teknik franchised dealers and has a suggested retail price of \$1,600.00.

**HAMMOND INDUSTRIES, INC.**  
**KLARK-TEKNIK DIVISION**  
**155 MICHAEL DRIVE**  
**SYOSSET, NY 11791**  
**(516) 364-1900**

for additional information circle no. 64

**NEW SONY HIGH-PERFORMANCE  
 MONITOR HEADPHONES**

Sony's new DR-6M dynamic stereo headphones are uniquely suited to sound monitoring while recording live perform-

ances or off-the-air.

The lightweight, folding headphones, which will fit in a coat pocket, provide



accurate sound clarity and wide frequency response for critical recording sessions.

Large 50 cm diameter cone type drivers have a sensitivity of 110 dB/mW, impedance of 28 ohms at 1 kHz and frequency response of 20 - 20 kHz. Rated output is 10 mW, with a maximum of 100 mW. The DR-6M weighs 350 grams.

Suggested retail price of the DR-6M is \$55.00.

**SONY INDUSTRIES  
 PROFESSIONAL AUDIO  
 PRODUCTS DIVISION**  
**9 WEST 57TH STREET**  
**NEW YORK, NY 10019**  
**(212) 371-5800**

for additional information circle no. 66

**CORRECTION**

Unfortunately, a typographical error in our December, 1978 issue resulted in an incorrect price listing on a New Products item.

The new Shure Monitor Speaker, Model 703, should have been shown with a user net price of \$370.00.

**NEW SHURE MONITOR  
 SPEAKER FEATURES UNIQUE  
 VARIABLE DISPERSION CONTROL**

The new stage monitor speaker with a unique high frequency variable dispersion control allows the user to tailor the horizontal sound pattern to a variety of coverage requirements.

# The Quad-Eight Story You've Never Heard.

Introducing the precision Quad-Eight Equalizers. Three and four-band configurations with integral Hi and Lo-Pass filters. Each available in 19" rack and standard console 1-1/2" mountings. Contact us for all the juicy details.

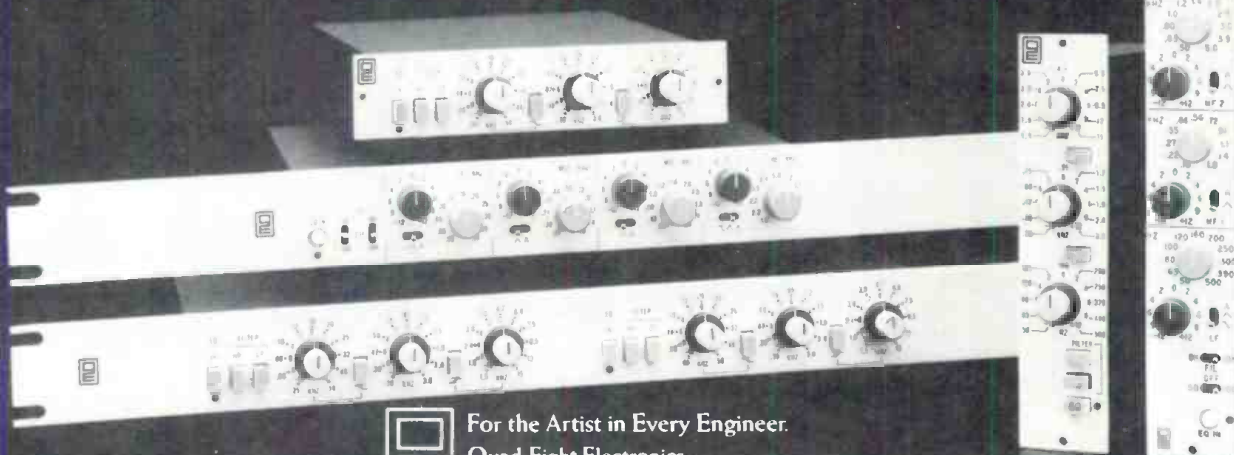

For the Artist in Every Engineer.  
 Quad-Eight Electronics  
 Quad Eight International  
 11929 Vose Street, North Hollywood, California 91605, (213) 764-1516 Telex: 662-446

This versatile, compact two-way monitor speaker is called the Shure Model 703 and is designed to provide control of high frequency dispersion through the use of removable acoustic wedges. This feature, in conjunction with the capability of two tilt angles, provides the user with four possible coverage selections.

Sound can be dispersed over a wide 120° angle to cover several performers or to permit greater freedom of movement on stage, or a tight 60° angle for narrow, "personalized" coverage and minimum sound spillover. The speaker can also be set on its back at the front of the performer for short throw (close use) or placed upright for long throw coverage when the performer is farther away.

Another important feature of the Model

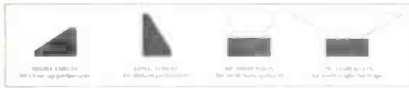

703 is its shaped frequency response, which properly emphasizes the presence range and effectively eliminates undesirable bass boominess. This feature not only enables the Model 703 to cut through intense ambient sounds on stage, but also provides a very natural sound to the performer.

The Model 703's high frequency driver and two eight-inch heavy-duty speakers provide excellent sound reproduction. Power handling capacity is 100 watts of continuous program material. The speaker is an eight-ohm system and can produce 97 dB SPL with a one-watt input at four feet.

Overall dimensions of the speaker enclosure are 283 mm (11-1/8 in.) H x 587 mm (23-1/8 in.) W x 438 mm (17-1/4") D. Weight is 14.3 kg (31-1/2 lbs.). User net price for the Model 703 is \$370.00

**SHURE BROTHERS, INC.**  
222 HARTREY AVENUE  
EVANSTON, IL 60204

for additional information circle no. 67

### FURMAN SOUND STEREO PARAMETRIC EQUALIZER/PREAMP MODEL PQ-6

The Furman Sound PQ-6 is the equivalent of two Model PQ-3s in one chassis, resulting in substantial savings to those users needing two channels of parametric equalization. Among its uses are: a stereo musical instrument preamp for use with



either a stereo power amp or conventional musical instrument amps; in a P.A. system for feedback suppression; as general

purpose patchable equalization for recording studio or broadcast applications; or for room equalization in studio control rooms

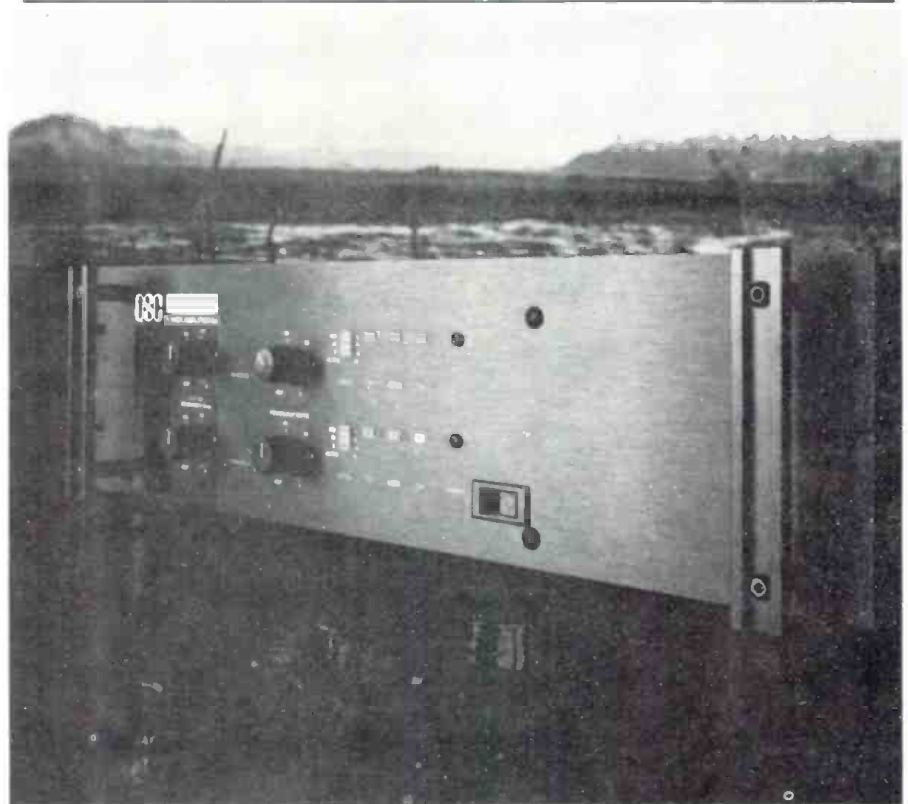

# LOADED... THE 600 WATT NO-OPTION AMP.

People kept asking us "How about a high-power amp with low distortion that's loaded with options and doesn't cost an arm and a leg?" We listened to them and set out to build "The Complete Amp" with reliability, power, specs, features, and price. We've succeeded. Our reputation has been built on the design and construction of cost-effective gear combining maximum performance with simplicity and reliability. Now QSC offers a package you can't find in any other amp. REGARDLESS OF PRICE OR OPTIONS. The A 8.0 delivers 300 watts of clean power to each channel (20-16kHz with less than .09% THD

rising gradually to 0.2% THD at 20 kHz into 4 ohms) and 600 watts into 8 ohms with the same specs in the bridged-mono operation.

Features include: PowerLimit Controls: Fan Cooling; 3-way Load Protection; LED displays for level, distortion, and limiting indicators; Balanced Inputs with XLR type 3-pin connectors; and Outputs with 5-way binding posts, phone jacks, and speaker protection fuses. Ask your Pro-Audio

Dealer about the A 8.0 or write directly to us for a free brochure detailing the incredible features and specifications of this exceptional new power amplifier from QSC.

**QSC**

AUDIO PRODUCTS  
1926 Placentia Avenue  
Costa Mesa, CA 92627  
714/645-2540

for additional information circle no. 68

R-e/p 95

# SWEDISH STEAL.

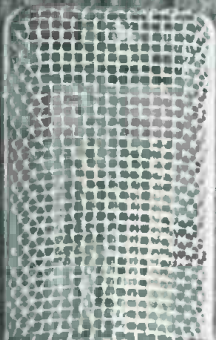

Actual size

## THE PML DC-63 CONDENSER.

More Performance. Less Money. Just one in a tough, practical & precision line of professional mikes. Handcrafted in Sweden since 1941.

PML Worldwide Marketing:  
Creative Trade, AB, Knutsgatan 6,  
S-265 00, Astorp, Sweden, Tel: 4642/51521

U.S. Distributor:  
Cara International Ltd., 4145 Via  
Marina, No. 120, Marina Del Rey, CA 90291,  
(213) 821-7898

or even in home living rooms.

Parametrics are not limited by a fixed number of frequencies as are graphic equalizers. The Furman PQ-6 has three continuously variable and broadly overlapping frequency controls per channel so you can zero-in EQ exactly where you want it. Each band can be boosted by up to 20 dB or cut to complete cancellation (more than 40 dB). Bandwidth controls adjust the extent to which surrounding frequencies are affected, from 1/10 of an octave to over four octaves with any band. Other features include: Bypass switches, high and low level inputs and outputs, 1/4-inch phone jacks, and a detailed instruction manual. The PQ-6 is 19-inch rack-mountable, and is available in 115 V, 60 Hz and 230 V, 50-60 Hz versions.

Specifications include:

Frequency Ranges: Bass 25-500 Hz, Mid-range 150-2,500 Hz, Treble 600-10,000 Hz. Equalization: +20 dB boost, - dB cut, all ranges. Bandwidth: Boosting, 1/3 to 4 octaves; Cutting, 1/10 to 1 octave ("Q" adjustable from 0.2 to 3.8). Input: 100 kilohms unbalanced, with maximum input level before clipping at 1 kHz, 4.9 Vrms for High Level In; 430 Vrms for Low Level In. Output: 10 ohms unbalanced, with maximum output level of 8.3 Vrms (+21 dBm) into minimum terminating impedance of 600 ohms. Total Available Gain: Low Level In 26 dB; High Level In 6 dB (with EQ set flat or bypassed).

Frequency Response:  $\pm 1/2$  dB in Bypass or with all Equalization controls set to 0, from 20 Hz to 20 kHz. Signal-To-Noise Ratio: 109 dB in Bypass; 99 dB with EQ in and set flat (noise measured with High Level Input shorted to ground, unweighted, from DC to 80 kHz). Distortion: .015% in Bypass; .025% with EQ in and set flat (THD measured at 1 kHz at +20 dBm output and 600 ohm termination).

Distributed by:

**ROTHCHILD MUSICAL  
INSTRUMENTS  
10 IVY LANE  
ENGLEWOOD, NJ 07631  
(201) 871-3366**

for additional information circle no. 70

### OTARI ANNOUNCES 8:1 IN-CASSETTE DUPLICATOR WITH CASSETTE MASTER AND FIVE SLAVES, THE DP-4050-CCF

Otari has announced the availability in the U.S. of a second version of its DP-4050 in-cassette duplicator which features a cassette master and five slaves with ferrite heads. Designated the DP-4050-CCF, this version complements the DP-4050-OCF, which has an open-reel master and six slaves, and has gained wide acceptance for its rugged reliability and ease of operation by non-technical personnel.

Duplicating speed ratio is 8:1 and all

tracks are copied simultaneously. Thus, five C-30 copies, for example, can be made in under two minutes.

A major benefit of the DP-4050 duplicator, according to the manufacturer,



is that each plug-in slave unit is completely independent of the others and contains its own servo-controlled capstan motor. The advantage of this approach is that if one of the cassettes should jam during duplication, that slave can be stopped while the other slave units continue duplicating without interruption.

Other major DP-4050-CCF benefits are:

Professional quality and reliability; duplicates C-30, C-60 and C-90 cassettes; and master and slave transports have long-life hot-pressed ferrite heads.

Cassette formats duplicated are 1/4- or 1/2-track mono or 1/4-track stereo. All tracks are recorded in one pass — cassettes don't have to be turned over. Bias adjustments are conveniently located behind a panel on the front. Photocell sensing provides automatic rewind of master cassette.

**OTARI CORPORATION  
981 INDUSTRIAL ROAD  
SAN CARLOS, CA 94070  
(415) 593-1648**

for additional information circle no. 71

### MXR FLANGER/DOUBLER

The MXR Flanger/Doubler is a versatile signal processing device which produces a wide variety of time delay effects, and is instantly switchable between the Flanging and Doubling modes. The time delay in the Flanging mode is from .25 to 5 milliseconds, and the time delay in the Doubling mode is from 17.5 to 70 milliseconds.

The MXR Flanger/Doubler features Manual Control over the delay time, a Mix control (between the dry and undelayed signals), Sweep controls over both width and speed, and a Regeneration control for additional intensity. The Flanger/Doubler can produce many varieties of flanging, hard reverberation, and numerous types of doubling which include subtle chorus effects.

The unit is rack mountable, and features instrument level inputs and outputs on the front, and line level inputs and outputs on the rear, making it equally adaptable to both stage and studio use. The Flanger/Doubler





also features LED sweep indicators as well as power on and effects in/out indicators. Voltage control terminals on the rear panel provide external delay control, and the ability to gang two units together for stereo.

**MXR INNOVATIONS, INC.**  
 247 N. GOODMAN STREET  
 ROCHESTER, NY 14607  
 (716) 442-5320

for additional information circle no. 72

**POLYFONICS PY-10 and PY-5S  
 ACOUSTIC SIMULATORS  
 ANNOUNCED**

Designed to be used for room simulation and sound enhancement their application can vary from correcting overly close microphone techniques in studio use to creating an ambience effect on too dry sounding tapes. In live applications the

units are used to vary the apparent room environment acoustically.

The units are said to improve on



previous methods used to accomplish similar kinds of tasks by enabling the user to control the frequency spectrum tonally and spacially at one time, from the same piece of equipment. By combining the functions of equalization and delay in one piece of equipment the user has the ability to vary the delay rates of several frequency bands as compared with other delay devices which provide a single selected rate of delay over the entire frequency spectrum.

**POLYPHONIC SOUND INDUSTRIES**  
 104 RIDGE ROAD  
 NO. ARLINGTON, NJ 07032  
 (201) 997-6666

for additional information circle no. 73

**Should you buy the new Sound Workshop 262  
 Stereo Reverb or should you retile your bathroom?**

That's a tough decision to make. Perhaps you stay up nights pondering this very question. But please take the time, right now, to consider this important matter.

Think how great your voice sounds when you're lathering up in the shower. It's because the hard, ultra-smooth surface of the tile takes your normally lifeless voice and bounces it

back and forth adding depth and magnitude. It's called natural reverberation.

There are, and have been, devices available which simulate natural reverberation. But a professional quality studio reverb (that sounds as natural as your bathroom) used to cost well over a thousand dollars.

Sound Workshop introduces the new 262 Stereo Reverberation System... for well under a thousand dollars. We thought you'd like to know.



**Sound Workshop**  
 PROFESSIONAL AUDIO PRODUCTS

**Sound Workshop Professional Audio Products, Inc.**  
 1324 Motor Parkway, Hauppauge, New York 11787 (516) 582-6210

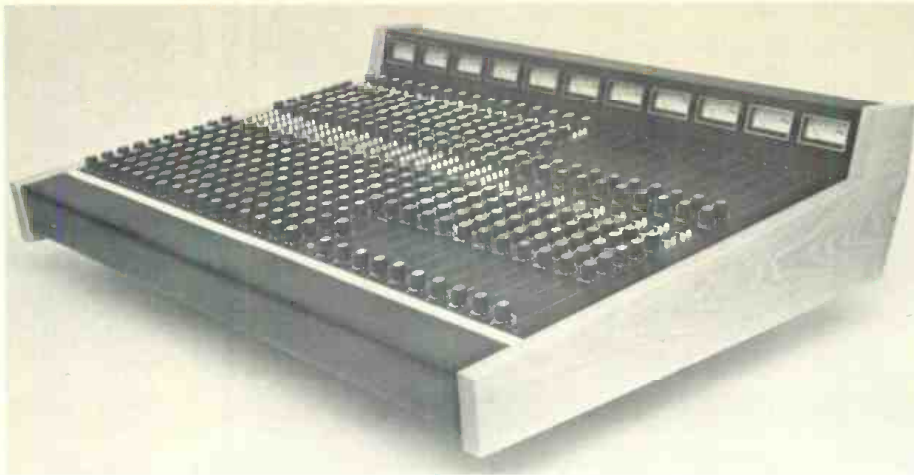

### THE AUDIOARTS MONITOR 10 SYSTEM

This newly announced product is a professional stage monitor mixing and distribution system which was designed to maximize flexibility while maintaining logical flow of operation. The Monitor 10 has been carefully engineered to assure that reliability and performance have not been compromised. Special attention has been paid to achieve high speed, low noise electronics with excellent overload recovery characteristics and artifact free operation.

The Monitor 10 system features five subgroup busses, ten mix busses, 26 inputs, 26

outputs (16 channel configuration), five knob EQ, modular design, direct output control on each input (for spot monitors, effects send, etc.), meters for all output channels and separate solo meter.

**AUDIOARTS ENGINEERING**  
286 DOWNS ROAD  
BETHANY, CT 06525  
(203) 393-0887

for additional information circle no. 75

### SOUNDCRAFTSMEN SIGNAL-PROCESSOR/PREAMP

A new preamplifier with front panel pushbutton switching facilities for outboard

processing loops, as well as for internal circuitry providing octave-wide equalization, sub-sonic filtering, and three-way tape recorder dubbing and monitoring, has been announced by Soundcraftsmen. The new model is called a Signal Processor/Preamplifier, model SP 4002, with rack-mount front panel, handles, and walnut-grained decorative side panels.

Two ultra-sensitive phone preamps with variable cartridge loading 50 to 800 pf, and variable impedance 100/47 k, will accept any type cartridge with output from 0.28 millivolts to 300 millivolts. Each stereo phono preamp is completely separate, with its own inputs, outputs, and its own independently variable  $\pm 20$  dB gain stage, 300 millivolts overload capability, and a phenomenal 97 dB signal-to-noise ratio. Either or both stereo phono preamps may be driven by variable reluctance, moving magnet type cartridges or moving coil cartridges with 0.28 millivolt or higher output.

The signal path is logically routed via clearly labeled pushbutton switches from any one of six input sources sequentially through a sub-sonic filter, two external processing loops, an equalizer, and a mono A + B mixer, to either the two tape outputs or the two line outputs. Tape dubbing and tape monitoring may be switched in and out with equal facility, and any source may be listened to normally during the tape dubbing process. All processing facilities may be inserted into the tape dubbing circuitry as desired by pushbutton as labeled. Dubbing can also be accomplished without processing, while listening to a different, fully processed source signal at the user's option.

Built into the new preamp is a professional quality octave-wide graphic equalizer with 15 dB minimum boost or cut per octave, and up to 22 dB per octave boost or cut with all octaves full, LED indicators for precise input-to-output balancing, precision-made wire wound passive inductors for optimum bandwidth curve formulation and consistency, separate spectrum-level control for precise control of the input to output gain of each channel, and EQ signal-to-noise ratio better than 114 dB at full output.

Headphone amplifiers for two headphones from 80 ohms to 200 ohms impedance provide excellent monitoring facilities, with one headphone muting the speakers by interrupting Line 1 output. Also, front panel jacks are provided for a third tape recorder in parallel with tape recorder 2 for easy input and output access when desired.

The volume control is a high precision click-stop resistance notched stepped potentiometer, to control total system gain from infinity to maximum 71 dB. The click stops have been selected in varying degrees,

## NOISE GATE

### OMNI CRAFT'S MODEL GT-4



READY TO MOUNT - SELF POWERED.

FOUR CHANNELS IN ONLY 1-3/4 INCHES OF SPACE.

60Db OF ATTENUATION.

DIRECT AND KEYED INPUTS.

ADJUSTABLE THRESHOLD AND RELEASE.

CONTRIBUTES NO NOISE OR DISTORTION.

\$395.00 FOR 4 CHANNELS.

**OMNI CRAFT INC. RT. 4 BOX 40**  
**LOCKPORT, IL. 60441 815 838-1285**



from approximately 1 dB upward, so that the audible output level increase or decrease from 1 click stop to the next remains constant. Each click stop has its own separate resistance network so that a precise percentage of output can be consistently applied at the user's preference, with specific and repeatable variances in level.

The signal processing paths have been carefully plotted to enable the user to take full advantage of the flexibility of the pushbutton patching capabilities of the signal processing preamp. The source signal, coming from either Tape 1, Tape 2, Tuner, Aux., Phono 1 or Phono 2, is immediately routed to the sub-sonic filter, thence forward to External Loop 1, Loop 2, Equalizer and Mono A & B mixer. At that point a selection is made as to the Tape Outputs or the Line Outputs. The selection of "Tape Record" applies the processed signal, (if processing is desired, and according to which buttons are depressed), to the Tape Outputs only. Line Outputs remain live, but provide an unprocessed source signal only. If Tape Record is not pushed in, Line Outputs receive the processed signal automatically. Thus, during tape dubbing processing, it is possible to listen to an unprocessed source signal as it is put out on the Line Outputs. During tape recording or tape dubbing, by depressing Tape Monitor 1 or Tape Monitor 2, as appropriate, the recorded processed signal can be listened to through the Line Outputs or Headphones.

**SOUNDCRAFTSMEN, INC.**  
2200 S. RITCHEY STREET  
SANTA ANA, CA 92705  
(714) 540-4961

for additional information circle no. 77

**BELDEN DEVELOPS NEW SERIES OF SHIELDED MICROPHONE CABLES**

A new series of single and multi-conductor shielded microphone cables has been introduced by Belden Corporation's Electronic Division.

Two single-conductor designs for out-

side, cold-weather applications in high impedance systems are included. The 18- and 20-gauge neoprene-jacketed constructions feature an inner conductive-textile wrap shield and a tinned-copper serve shield for 100% coverage. The 20-gauge construction (No. 9394) is 0.190 inch diameter; the 18-gauge version (No. 9395), 0.235 inch. Nominal capacitance between conductor and shield is 55 pF/ft. for both.

For low impedance systems, three vinyl-jacketed configurations, offering low capacitance, low loss, light weight, and small diameter, also are available in the new line. Single-conductor design No. 9396 uses a 25-gauge stranded cooper/copper-covered vinyl-insulated conductor with a tinned-copper serve shield and a gray jacket. Diameter, 0.100 inch; nominal capacitance 75 pF/ft.

Two- and three-conductor 24-gauge designs feature stranded tinned copper vinyl-insulated conductors with bare copper spiral shield and matte white and matte gray vinyl jackets. The two-conductor design (No. 9397) is 0.176 inch diameter; the three-conductor (No. 9398), 0.186 inch. Both have a nominal capacitance between conductors of 40 pF/ft.

Single-conductor neoprene constructions are offered in lengths of 500 to 1,000 feet. Vinyl-jacketed designs come in lengths of 100 and 250 feet (No. 9396) and 100, 500, and 1,000 feet (Nos. 9397 and 9398).

**BELDEN CORPORATION**  
2000 S. BATAVIA AVENUE  
GENEVA, IL 60134

for additional information circle no. 78

**E-V INTRODUCES TWO BASS GUITAR SPEAKER SYSTEMS**

The two new systems, designated the B115-M and B215-M, are both two-way systems with the B115-M having a single EVM-15B speaker while the B215-M has two. Both systems utilize the vented-cone mid-range driver. The VMR is said to offer a much improved high end over that normally found in single driver enclosures. The effects of the VMR can be tailored to the bass player's requirements via a rotary

**THE WORD FOR TODAY IS "NATURAL" [More or Less]**

For years, all reverbs were just that - simply reverbs - until development of the MASTER-ROOM.

MASTER-ROOM claimed Natural Sound and demonstrated what is meant by that with its unique, full ambience properties of:

- Natural delay prior to first echo
- Natural group of first order echoes
- Natural build-up in amplitude
- Natural pattern random diffusion
- Natural build-up in echo density
- Natural proportioned decay
- Natural flat frequency response
- Natural smoothness without limiting

As a result of MASTER-ROOM, "NATURAL" is now the key word in reverberation equipment, but a word that is too often used without regard to its true meaning.

So thanks to all who have helped to make "NATURAL" the word in reverberation devices.

From the originator... the one who backs it up with performance.



**MICMIX Audio Products, Inc.**  
2995 Ladybird, Dallas, TX 75220  
(214) 352-3811

for additional information circle no. 79

**We are pleased to announce that these studios have already chosen the new Studer A800 multitrack tape recorder.**

Studio	Location	Qty	Model
Air Studios	London	4	A 800 24
Bayrischer RDF	Germany	1	A 800 16
CBS Sony	Tokyo	4	A 800 24
Canyon Records	Tokyo	4	A 800 16
	Tokyo	4	A 800 24
	Tokyo	2	A 800 24
EMI	London	1	A 800 24
Easy Sound	Copenhagen	1	A 800 16
Fuji TV	Tokyo	1	A 800 24
Filtroson	Montreal	1	A 800 16
Hessischer RDF	Germany	2	A 800 24
Kitty Records	Tokyo	1	A 800 16
Life Records	Hong Kong	2	A 800 24
	London	2	A 800 24
London Weekend	London	2	A 800 24
Marcus Studios	Tokyo	5	A 800 24
NTV		1	A 800 16
		1	A 800 24
		1	A 800 24
Philips	Netherlands	2	A 800 24
Rockfield Studios	Wales	4	A 800 24
Sierra Audio	Burbank	1	A 800 16
TBS	Tokyo	2	A 800 24
Trident Studios	London	2	A 800 24
Wessex Studios	London	1	A 800 8
Eastern Sound	Toronto	3	A 800 8
CSSR	Prague	2	A 800 24
Radio Transamerica	Rio De Janeiro	1	A 800 24
Studio 55		1	A 800 24
Dawnbreaker	Los Angeles	1	A 800 24
Studios	San Fernando	1	A 800 24
PAC-3		1	A 800 24
Paragon Recording	Detroit	1	A 800 24
Sterling Sound	Chicago	1	A 800 24
Suntreader Studios		1	A 800 24
Glixman Productions	New York	1	A 800 24
	Sharon, VT	1	A 800 24
	Atlanta	1	A 800 24

for additional information circle no. 81

**STUDER**

control mounted on the front of the enclosure.

The B115-M, according to the company, has the cleaner sound preferred by many jazz bassists, and is also quite at home in the studio. The B215-M has a heavier sound, and its increased power handling capacity (400 watts vs. 200 watts for the B115-M) make it the logical choice for the rock musician.

Both speaker systems are constructed of 3/4" plywood covered with durable black vinyl. All edges are aluminum trimmed, and the metal mesh grille protects the drivers



from accidental damage. The B215-M is equipped with the heavy-duty casters and both systems have integral handles for easy set-ups and tear-downs.

Suggested prices for the B115-M and B215-M are \$650 and \$930 respectively.

**ELECTRO-VOICE, INC.**  
600 CECIL STREET  
BUCHANAN, MI 49107  
(616) 695-6831

for additional information circle no. 82

**ATLAS SOUND PORTA—SERIES MICROPHONE STANDS IMPROVEMENTS ANNOUNCED**

Improvements in its recently-released Porta-Series include the addition of a grooved cam, machined into the tube assembly, providing for positive-locking and non-rotational brake action, while new tempered springs within the tripod assembly guarantee increased stability.

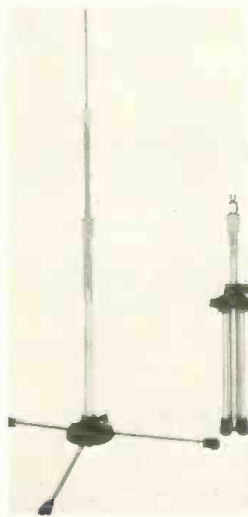

The popular and economically-priced Porta-Series models PSC and PSC-3 acknowledge the trend among performers to use a single-unit microphone stand with foldable base. Each offers instant set-up and compactness for minimum transportation expense.

The PSC and PSC-3 feature die-cast baked epoxy bases finished in non-reflective black. In addition, the stands' vertical tube assemblies are chrome-plated with all-metal "grip-action" clutches and the industry's standard 5/8"-27 male thread termination,

making them suitable for use with all microphone holders, flexible connectors or microphone attachments.

Model PSC-3 is specifically designed for use by seated performers or in instrument miking, and extends from 26 inches to a 66-inch height. It telescopes to a space-saving 22 inches for transportation.

Model PSC extends from 35 inches to 63 inches, and folds into a 32-inch length for compact shipping. It weighs 4 1/2 pounds.

**ATLAS SOUND**  
10 POMEROY ROAD  
PARSIPPANY, NJ 07054  
(201) 391-8298

for additional information circle no. 83

**-concluded from page 39- GEORGE MARTIN**

**GM:** The kid who wants into it thinks he has a chance of being number one. He thinks he's going to buy that ticket, too. The other problem is that standards have gone up generally, so it's very hard to break through.

**Tom:** It is getting to the point a garage band can't break into recording?

**GM:** I don't think so. I think there is always room, particularly now. Trends reach plateaus; we're in a plateau now. There's a great deal of very good music, but nothing is utterly fantastic. Obviously it's difficult to break through because the level of quality is so high.

**Tom:** What do you think of disco?

**GM:** It's super. I love it, I love dancing to disco... well, I better put 'moving to disco,' I really can't dance. As a body propellent I think it's great.

**Tom:** Do you see it being with us for a while?

**GM:** Like all things it has an influence on music. And like all things it will have an effect on all kinds of music. It's a good tool to use.

**Tom:** Are you interested in someday becoming the president of your own record company again?

**GM:** Oh, God! Well, what do you do when you get too old and sick and tired to make records? I think it's obvious I have a role to play in the record business somewhere. I'm quite happy doing what I'm doing at the moment. □ □ □

**R-e/p BACK ISSUES AVAILABLE**

*Limited Quantity — While They Last*

April, 1975	Volume 6, #2
June, 1975	Volume 6, #3
December, 1975	Volume 6, #6
February, 1976	Volume 7, #1
June, 1976	Volume 7, #3
August, 1976	Volume 7, #4
February, 1977	Volume 8, #1
June, 1977	Volume 8, #3
August, 1977	Volume 8, #4
October, 1977	Volume 8, #5
December, 1977	Volume 8, #6

\$2.50 each  
Mall orders to: R-e/p  
P.O. Box 2449 • Hollywood, CA 90028  
Foreign orders payable in U.S. funds only by bank check or money order.

**RECORDING**  
*engineer / producer*

1978

**INDEX OF FEATURE EDITORIAL ARTICLES**

TITLE	AUTHOR	ISSUE	DATE
<b>INTERVIEWS</b>			
Geoff Emerick, Grammy Winner	Howard Cummlngs	9-6	December, 1978
The Bee Gees, Albhy Galuten and Karl Richardson	Tom Lubln	9-5	October, 1978
Bill Szymczyk, Ed Mashal, Joe Walsh and The Eagles	Tom Lubln	9-4	August, 1978
The Motown Sound, Al Stewart	Howard Cummings	9-3	June, 1978
Fleetwood Mac's "Rumours," with Richard Dashut, Ken Caillat	Howard Cummings	9-2	April, 1978
Fred Catero at San Francisco's Automatt	Jim Furman	9-1	February, 1978
<b>STUDIOS:</b>			
<b>DESIGN/ACOUSTICS/OPERATION</b>			
Soundcastle Recording	Bob Marlch	9-6	December, 1978
San Francisco Area Small Studios	Tom Lubin	9-5	October, 1978
Studio Acoustic Design	Woody Smith	9-3	June, 1978
<b>RECORDING TECHNIQUES</b>			
Re-Orchestrating	Paul Laurence	9-6	December, 1978
Recording the Cathedral Pipe Organ	Michael Nemo	9-2	April, 1978
<b>STANDARDS, SPECIFICATIONS AND TESTS</b>			
IHF Amplifier Standards	Bill Isenberg	9-6	December, 1978
Magnetic Reproducer			
Equalization Accuracy	Peter Butt	9-5	October, 1978
Mathematics for Sound Systems, Pt. II	Chris Foreman	9-2	April, 1978
Noise Index Measurements	John G. McKnight	9-1	February, 1978
A Standard Digital Interface for Peripheral Equipment	Richard Factor	9-1	February, 1978
Console Noise Specifications, Part II	Paul C. Buff	9-1	February, 1978
<b>TROUBLESHOOTING</b>			
<b>ALIGNMENT, MAINTENANCE</b>			
Impulse Alignment of Loudspeakers and Microphones	Don Pearson and Tom Lubin	9-6	December, 1978
Speaker Wire	Ray Kimber	9-5	October, 1978
Stabilizing Op-Amps	Deane Jensen	9-3	June, 1978
Audio Shielding, Grounding & Safety	Ken Fause	9-3	June, 1978
<b>CONCERT</b>			
<b>SOUND REINFORCEMENT</b>			
The Doobie Brothers Touring System	Stan King and Bob Marich	9-5	October, 1978
Time Delay In Sound Reinforcement Systems	Chris Foreman	9-2	April, 1978
<b>MASTERING TAPE</b>			
Your Studio Mastering Tape	J. Talmadge Ball		
	Jeffry Dahl	9-5	October, 1978
Mastering Tape Compatibility	John Robinson	9-1	February, 1978
<b>RECORD PRESSING/MASTERING</b>			
The Record Pressing Problem	Bill Szymczyk	9-4	August, 1978
Disk Mastering	Howard Cummings	9-4	August, 1978
The Buchmann-Meyer Light Pattern Technique	R-e/p Staff	9-4	August, 1978
<b>SIGNAL PROCESSING</b>			
Small and Miniature Reverberation Chambers	Michael Rettinger	9-4	August, 1978
<b>DIGITAL RECORDING</b>			
Digital Audio Report	R-e/p Staff	9-6	December, 1978
Digital Audio Standards	R-e/p Staff	9-3	June, 1978
The Soundstream Digital System In Use	R-e/p Staff	9-3	June, 1978
Digital Report	R-e/p Staff	9-2	April, 1978
The Crystalab Programmable Parametric Attenuator and Digital Logic Control System	Andrew Berliner	9-2	April, 1978
A Standard Digital Interface For Peripheral Equipment	Richard Factor	9-1	February, 1978
<b>MISCELLANEOUS</b>			
A Control Room/Studio Communications System	Bob Todrank		
	Gary Carrelli	9-3	June, 1978
The Band's "Last Waltz"	Ed Lever	9-4	August, 1978
1977 Grammy-Winning Engineers and Producers	R-e/p Staff	9-2	April, 1978
Microcomputers/Microprocessors	Jack Wiener	9-1	February, 1978

**PROFESSIONAL**  
**Nashville, the Center of Country Music, is Stanton Country, too!**



Kitty Puckett checks out 45 rpm stamper, while auditioning one at 33 1/3 rpm.

The Nashville Record Production Inc., uses Stanton exclusively throughout its two Disc Cutting Studios. Naturally, they are mostly involved with Country Music, but they also get into Pop and Rock.

John Eberle states that they use the Stanton Calibrated 681A "for cutting system calibration, including level and frequency response" ... and they use the Calibrated 681 Triple-E in their Disc Cutting operation ... with plans to soon move up to the new Professional Calibration Standard, Stanton's 881S.

Each Stanton 681 series and 881S cartridge, is guaranteed to meet its specifications within exacting limits, and each one boasts the most meaningful warranty... an individually calibrated test result is packed with each unit.

Whether your usage involves recording, broadcasting, or home entertainment, your choice should be the choice of the Professionals... the Stanton Calibrated Cartridge.

© Stanton 1978

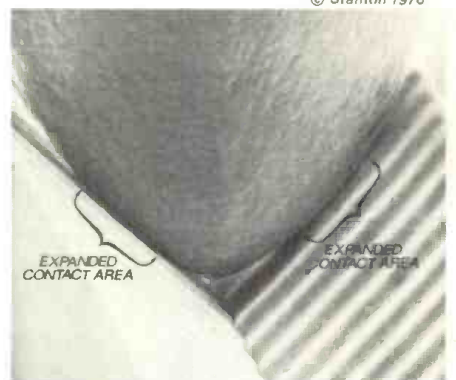

Scanning Electron Beam Microscope photo of Stereo-hedron® stylus. 2000 times magnification; brackets point out wider contact area.

For further information write: Stanton Magnetics, Terminal Drive, Plainview, N.Y. 11803



**STANTON!**

R-e/p 101

for additional information circle no. 85

**Direct Boxes & "Mic-Splitters"**

Passive Direct Box SM-1A Active Direct Box SM-2  
 Deluxe Active Direct Box SM-3 Single "Mic-Splitters" MS-1A  
 Quad "Mic-Splitter" MS-4 8 x 2 "Mic-Splitter" MS-8  
 12 x 2 "Mic-Splitter" MS-9 16 x 2 "Mic-Splitter" MS-10

**Direct Boxes:** Both active and passive SM-1A for guitars SM-2 and SM-3 for keyboards and electronic instruments.

**"Mic-Splitters":** Low impedance in and out. Will handle +6 dBm. Will pass phantom voltage. Isolated grounds.

**Thousands in use around the World!**  
 We also manufacture audio transformers, snakes, audio modules

**SEND FOR YOUR FREE COPY OF OUR NEW CATALOG**  
 P.O. Box 590,  
 12931 Budlong Ave.,  
 Gardena, CA 90247 U.S.A.  
 (213) 770-3510, (800) 421-1828,  
 TWX (910) 346-7023

Quality Engineered Sound Products

for additional information circle no. 86

**SNAKES & CABLES**

Orders processed same day  
 COD's accepted

Write for free catalog and price list, with full information on other assorted goodies in little black boxes.

**WA** Windt Audio Inc.  
 1207 N. Western Ave.  
 Los Angeles, CA 90029  
 (213) 466-1271

**SYNTHESIZER PATCH CHART COLLECTION AVAILABLE**

Said to be the largest collection of music synthesizer patch charts ever assembled in one volume, The Source is available from Polyphony at a cost of \$4.00, postpaid.

To allow adaptation to a wide variety of models of synthesizers, all of the patch charts are shown in block diagram/flow chart type of notation. The variety of types of patches included can serve the synthesist directly, or through inspiration in aiding the musician to develop original patches.

**POLYPHONY**  
 P.O. BOX 20305  
 OKLAHOMA CITY, OK 73156  
 (405) 842-5480

**TAPE EDITING BOOK AVAILABLE**

Joel Tall, the inventor of modern tape splicing blocks, probably knows as much or more than anybody about the art of splicing audio and video tapes. Now he has written a book, "Tape Editing," which not only explains the basics of tape splicing and editing, but gives a flock of helpful hints that can benefit both novice and professional tape editors. One intriguing trick, for example, is running the tape backwards. Listening in reverse helps the editor to more sharply recognize certain speech sounds.

The 32-page tape editing "bible" will be sold through retail stores handling tape equipment. "Tape Editing" carries a suggested retail price of \$2.00.

**ELPA MARKETING INDUSTRIES**  
 THORENS & ATLANTIC AVENUES  
 NEW HYDE PARK, NY 11040

**CLASSIFIED ADVERTISING RATES**

— \$45.00 Per Column Inch —  
 (2 1/4" x 1")

One inch minimum, payable in advance. Four inches maximum. Space over four inches will be charged for at regular display advertising rates.

**BOOKS**

*theory and working information and emphasis on practical uses*

**"MICROPHONES — HOW THEY WORK AND HOW TO USE THEM"**

by Martin Clifford  
 224 Pages — 97 Illustrations  
 \$8.95 Hardbound; \$5.95 Paperback  
 Postpaid  
 R-e/p Books  
 P. O. Box 2449 • Hollywood, CA 90028

**SOUND RECORDING**

by John Eargle. JME Associates  
 "The best book on the technical side of recording... thoroughly recommended"

— Studio Sound  
 338 Pages, illustrated with 232 tables, curves, schematic diagrams, photographs, and cutaway views of equipment.  
 \$16.95 each  
 R-e/p Books  
 P. O. Box 2449 • Hollywood, CA 90028

**SOUND SYSTEM ENGINEERING**

by Don & Carolyn Davis

□ 296 Pages □ 8 1/2 x 11  
 Hardbound — \$19.95  
 R-e/p Books  
 P. O. Box 2449 • Hollywood, CA 90028

When you subscribe to R-e/p... you'll be starting a useful reference library pertaining to the recording industry.

We will be delighted to enter your subscription to R-e/p upon receipt of your order and payment (check or money order must be included with your order — we cannot bill for subscriptions). Your subscription will begin with the next published issue. (Sorry! We cannot start with back issues.)

Foreign subscriptions are payable in U.S. funds only and must be by bank check or money order.

Please provide the information below and mail with your payment to: **Recording Engineer/Producer, P.O. Box 2449, Hollywood, California 90028.** Since R-e/p is published six times per year, please allow ample time to receive your first issue.

**ONE YEAR (SIX ISSUES)**  
 United States (surface mail) \$10.00  
 United States (air mail) \$17.00  
 All Other Countries \$19.00

I have enclosed \$ \_\_\_\_\_

Name _____		Title _____	
Station/Company _____		<input type="checkbox"/> New <input type="checkbox"/> Renewal	
Address _____		<input type="checkbox"/> Home <input type="checkbox"/> Office	
City _____	State/Province/Country _____	Zip _____	

## HANDBOOK OF MULTICHANNEL RECORDING

by F. Alton Everest

320 pages - 201 illustrations

The book that covers it all... a comprehensive guide to all facets of multi-track recording... acoustics... construction... studio design... equipment... techniques... and much, much more.

Hardbound \$10.95 - Paperback \$7.95

R-e/p Books

P.O. Box 2449 Hollywood, CA 90028

## CONSULTING SERVICES

Consulting in Performance and Presentation Technology



- ARCHITECTURAL ACOUSTICS
- ENTERTAINMENT SOUND SYSTEMS
- TIME DELAY SPECTROMETRY
- AUDIO-VISUAL SYSTEMS

1887 Tipperary Lane • Newbury Park • CA 91320 • (805) 498-4006

## EQUIPMENT FOR SALE

### FREE CATALOG & AUDIO APPLICATIONS



CONSOLES  
KITS & WIRED  
AMPLIFIERS  
MIC, EQ, ACN, LINE,  
TAPE, DISC, POWER  
OSCILLATORS  
AUDIO, TAPE BIAS  
POWER SUPPLIES

OPAMP  
LABS INC.

1033 N. SYCAMORE AVE.  
LOS ANGELES, CA. 90038  
(213) 934-3566

for additional information circle no. 87

ONE STOP FOR ALL YOUR  
PROFESSIONAL AUDIO REQUIREMENTS  
BOTTOM LINE ORIENTED

F. T. C. BREWER COMPANY

P.O. Box 8057 • Pensacola, Florida 32506

### FOR SALE

Neumann 24-channel recording console; 3M Series 56 16-track machine; 2 - 3M Series 56 2-track machines; Allison Research 24-channel Memory's Little Helper computerized mixing; 5 - dbx 187 units (4 channel per unit). A perfect 16-track studio set-up.

Package price \$40,000.00.

For more information and individual prices, call Tom -

(205) 871-4221

**FOR SALE:** MCI JH-114/24 24-track master recorder, MCI Auto Locator for 24-track recorder, MCI JH-428 master console 24x24 and producer's desk. Contact Chgo.

(312) 785-3838/9

The **EXR EXCITER** will do more for your recordings than onboard EQ could ever do. If you don't agree, we'll buy it back. We also have Marshall, Lexicon, Eventide, Delta-Lab and Loft. Call us.

ASI Pro Audio  
(512) 824-8781

### CONCERT SOUND/LIGHTING

**SYSTEM:** Portable with road cases, major auditorium capabilities. Retail value \$123,000. Will consider reasonable offers. Call (816) 531-4305 or (816) 361-9114.

**FOR SALE:** MCI - 24-track with 16-track heads. Well maintained work horse. Reasonable.

Call M. GUTHRIE  
(212) 581-6505

### NEW! AUDIO OP-AMP'S



- Standard 7 Pin Pkg.
- Highest Professional Quality
- Lowest Possible Price

PROTECH AUDIO CO.  
P.O. BOX 638 LAKE RONKONKOMA, NY 11779

### TRACKS!

Total recording systems, specializing in the semi-pro studio. Tascam, TEAC, Neotek, BGW, dbx, MicMix, Sennheiser, TAPCO, MXR, Shure, S.A.E., and many others.

COMPLETE STUDIO PACKAGES  
AVAILABLE

### TRACKS

9520 - 47th Street

Brookfield, IL 60513 (312) 485-0020

### CROWN CX-844

Four channel with trac/sync, remote, balanced, anvil case, two years old, but new condition. \$2,000.00 firm.

Señor Sound, Inc.  
(412) 921-7744



C-24 vs. C422  
run side-by-side.  
We have our opinions.  
Call Wes, Ron or Dick.



Types 104aB and 105  
Reference Series  
for classical  
monitoring.



Ivie  
Electronics

production  
devices

Portable Audio Test Equipment

## REVOX SERVICE & MODIFICATION TO PROFESSIONAL STANDARDS

15 ips B-77s in stock!

### CLEAN USED EQUIPMENT

Neve BCM 10/2 mixing desk; pair of AKG C-60 tube microphones; Balantine 310 ACVTVMs; HP412AR; Interstate F-44 Sweep-Marker function generator, recommended by Don Davis for TDS work; ReVox A-77 Mark IV. Dolby. 15 ips. 2-track.

Want an EMT 140 type sound without the drawbacks? The new ECOPLATE is studio proven in L.A. Great reverb at a good price!

(213) 798-9127

85 ARROYO ANNEX  
Pasadena, CA 91109

AUDIOENGINEERINGASSOCIATES



# WANTED!!!



For the very best Studio Construction and Design available...

He is also known for doing work all over North America, giving firm estimates, exacting dates of completion and...

NO BULL!!!

He pleads guilty of constructing the following studios:

- Century 21, Winnipeg, Canada, new studio
- Sound Interchange, Toronto, Canada, new studio
- Superscope, San Fernando, California, new studio
- Chicago Recording Company, Chicago, Illinois, Studios 1, 2 and 3
- Bill Szymczyk's Bayshore Recording Studios, Inc., Coconut Grove, Florida, new studio
- The Shade Tree Playboy Club Lake Geneva, Wisconsin new studio
- Group Four, Hollywood, Calif.
- KBK Earth City Studios St. Louis, Missouri
- Village Recorders, Los Angeles, California new studio
- Record Plant, Los Angeles, California new studio
- Ronnie Milsap, Nashville, Tennessee new studio

Call for information and details  
RUDOLF A. BREUER

805 / 273-3792

Lic. No. 238315

## EQUIPMENT FOR SALE

Two DATA-MIX Consoles for sale. Excellent condition. Now in use. Both are 24-track and-wired for 36-input and 36-output. Complete with modules. Many gold and platinum albums made on these consoles. Original price, \$96,000.00; asking price, \$15,000.00.

Call Hal Selby  
Electric Lady — (212) 477-7500

Tascam, TEAC, Scund Workshop, Otari dbx, Nakamichi, MXR, Dynaco, ADS, E-V, Eventide, Shure, Maxell, Ampex, AKG Pro, Beyer, UREI, Stax, Sennhelsler, TAPCO, Crown, and more!

SEND FOR PRICE QUOTES

ZIMET PRO AUDIO

Dept. REP  
1038 Northern Blvd. • Roslyn, NY 11576

### FOR SALE

LIKE NEW HARRISON 3232 RECORDING CONSOLE WITH 26 I/O MODULES, SPARE POWER SUPPLY, PRODUCER'S DESK, AND EXTRA PATCH BAY. \$61,000.00. CALL CHICAGO RECORDING COMPANY, (312) 822-9333. ASK FOR CLEON WELLS, OR ALAN KUBICKA.

## MAGNETIC TAPE

BEST NAMES IN TAPE  
AT THE BEST PRICES.

- AGFA
- AMPEX
- 3M-SCOTCH



call toll free  
800-531-7392

ABADDON SUN, INC.

P.O. Box 6520, San Antonio, Texas 78209

### FOR SALE

MCI JH-114-24 24-track with auto locator and flux track; \$23,900.00.

SOUND 80  
(612) 721-6341

### ★ RECORDING STUDIO ★

For Sale! Newly remodeled and equipped plush Early American decor with video and 24-track capability. Located in booming Orange County. Motivated owners.

C & I PROPERTIES  
(213) 598-6852 • (714) 894-3377

### FOR SALE

Mobile 16 Track Studio. Completely customized Chevalier 16' van, fully equipped with brand name gear. In service. Inspection by appointment. Three years old, mint condition. Original cost \$70,000.00.  
(205) 871-7328

## EQUIPMENT WANTED

### WANTED

RECORDING EQUIPMENT  
OF ALL AGES AND  
VARIETIES

Dan Alexander • 6026 Bernhard  
Richmond, CA 94805 U.S.A.  
(415) 232-7933 or (415) 232-7818

## EDUCATION

Short Intensive summer courses in recording techniques, electronics, electronic, jazz improvisation, contemporary songwriting, popular and jazz harmony, musical instrument repair and Instrumental workshops in saxophone, clarinet, flute, trombone, and percussion, with Allard, Oberbrunner, Rascher, Goebel, Purcell and Strohmman. Write or call Frank Stachow, Summer Workshops, (717) 867-4411, ext. 275.

LEBANON VALLEY COLLEGE  
Annville, PA 17003

## EMPLOYMENT

WE ARE LOOKING FOR THE TWO BEST

# DISC MASTERING ENGINEERS

WE CAN FIND

WAKEFIELD MFG., INC., P.O. Box 6037  
Phoenix, Arizona 85005 Phone 602-252-5644

## REAL ESTATE

### L.A. BROKER

Specializes in Business Ops/locations for studios. Former background in mixing and recording. Let us help you sell your studio business or expand it to new location. PLEASE CONTACT:

BRUCE LOWELL  
HELEN ROWE and ASSOCIATES  
(213) 934-8444

## OPPORTUNITIES

### ESTABLISHED MIDWEST RECORDING STUDIO

seeks business investor. Excellent profit potential. Call (515) 972-4924 or write:

Box FDI, c/o R-e/p  
P.O. Box 2449 • Hollywood, CA 90028

## EMPLOYMENT

### WANTED

Experienced disk mastering engineer to operate a Neumann Lathe and associated equipment. Tech/maintenance capabilities desired. Contact:

I. A. M.  
17422 Murphy Avenue  
Irvine, CA 92714 • (714) 751-2015

### MAINTENANCE ENGINEER

Top San Francisco studio has opening for qualified maintenance engineer. Send resume and specify salary requirements to:

Box DSF, c/o R-e/p  
P.O. Box 2449 • Hollywood, CA 90028

## FIELD ENGINEERS

New York — Toronto — Los Angeles

Rupert Neve, Incorporated, the world leader in professional sound consoles and computer assisted mixing systems, is seeking qualified technical personnel to fill one or more Field/Service Engineer position(s) in New York, Toronto and Los Angeles. Our technical staff work with the most sophisticated audio equipment, including Neve consoles, NECAM minicomputers and Lyrec studio recorders. We offer excellent salary according to experience and ability; liberal vacation, holiday and fringe benefits, and the opportunity to work with a true industry leader. Relocation expenses paid. If you would like to join a dynamic and successful company in rapid growth, please forward your resume in confidence, or call (203) 744-6230.

Mr. Barry Roche  
Executive Vice President  
Rupert Neve, Incorporated  
Berkshire Industrial Park  
Bethel, CT 06801





### SUPERVISING ENGINEER

BONNEVILLE PRODUCTIONS has an immediate opening for an electronic engineer to supervise technical operations of our tape duplication operation. Qualifications necessary include a BSEE (or equivalent training plus experience), thorough experience in magnetic tape theory and recording techniques (professional systems), an excellent troubleshooting background and the ability to supervise a staff of four engineers and technicians. Experience with Cetec/Gauss tape duplication equipment is preferred. Tape production and engineering areas are designated no-smoking. Please reply with resume, references and salary requirements to:

Lorna van Komen  
Bonneville Productions  
130 Social Hall Avenue  
Salt Lake City, Utah 84111

Give  
Heart  
Fund



American Heart Association

### -LETTERS-

Ray Kimber's reply continued from page 16 . . .

I fully realize that the formula which I used also has some error in it. But I stand firm that the degree of change in the result of the formula I used approximates perceived

audible changes in real life.

For the record, a spot check of three manufacturers of speakers and/or amplifiers in the Los Angeles area supported the formula used. The formula, by the way, is not one I made up, but rather one which is commonly used by the industry.

Mr. Dickensheets has supplied us with a summation of his position and, since the letter is on Boner & Associates letterhead, I can assume also the position of Boner & Associates on the importance of wire size for speaker runs. Mr. Dickensheets word-for-word summation is as follows:

Until the damping factor of an amplifier reaches a value below 20:1, this damping factor does not have a significant effect on the actual damping factor of the amplifier/speaker combination and until the resistance of the wire approaches a value of several ohms, it too has little effect on the actual damping factor of the circuit.

According to his viewpoint, as long as an amplifier has an output impedance of .4 ohms or less, it does not have a significant effect on damping factor. The .4 ohm figure is reached by dividing 8 by 20. This means that virtually all currently-manufactured amplifiers meet this level of acceptability.

Mr. Dickensheets then states that you

## PROFESSIONAL AUDIO SALES MANAGER

Market expansion has created a new position for a take-charge individual with solid experience in sound contracting and/or consulting. The person we seek will have outstanding verbal and written communication skills and will be able to work with architects, consultants, contractors and their clients. He/she will have responsibility for JBL and UREI professional sales through sound contractors in all parts of Canada. The winning candidate will be based in Montreal and will travel as required to support his/her dealers. English/French bilingual fluency is not required but is desirable.

Send resume (including salary history):

**H. Z. GOLDSTEIN  
GOULD MARKETING CO., LTD.  
109 MONTEE DE LIESSE  
ST. LAURENT, QUEBEC H4T 1S9  
CANADA**

# GREEN BACK

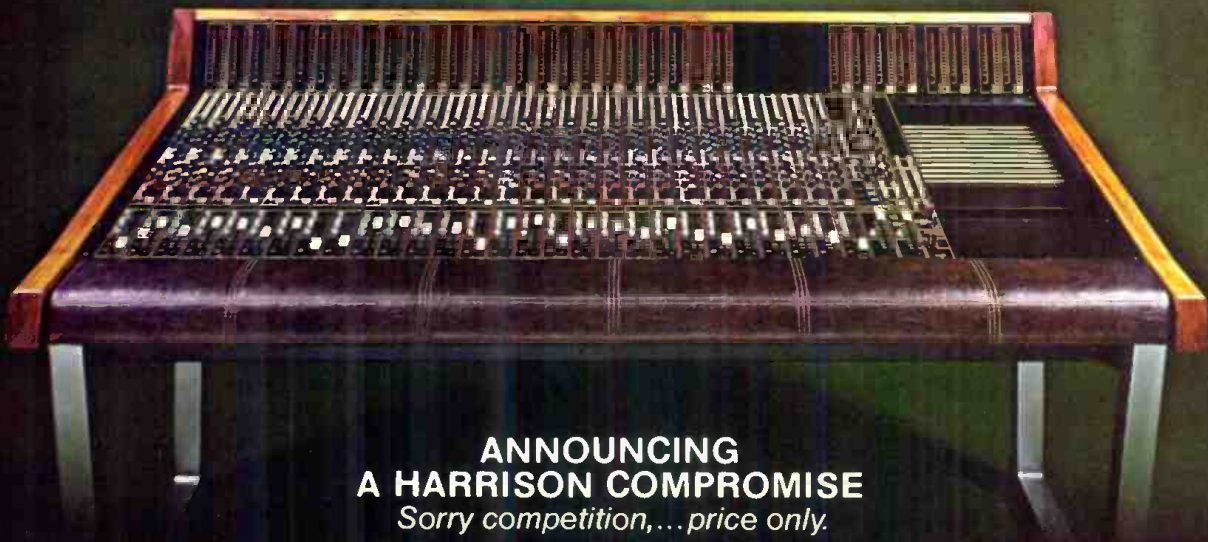

## ANNOUNCING A HARRISON COMPROMISE

*Sorry competition, ... price only.*

Affordable automation is now even *more* affordable.  
The Harrison 3624 and 2824 are now available at 10% off  
for a limited time. Not a quality cutback, but a price rollback  
so you can put some of the long GREEN...BACK in your pocket.

Almost  
NO COMPROMISE

**Harrison**

Outside it's  
**BLACK**  
Inside it's  
**TRANSPARENT**



- **INDESTRUCTIBLE EXTRUDED HOUSING**
- **RECESSED CONNECTORS AND SWITCHES**
- **BATTERY OR PHANTOM POWERED**
- **INTERNAL PAD FOR SPEAKER BRIDGING**
- **TRUE GROUND ISOLATION—EVEN WHEN PHANTOM POWERED**
- **R.F. FILTERED ON INPUT AND OUTPUT**
- **ACTIVE CIRCUIT—DOES NOT LOAD PICKUPS**
- **LESS THAN 2 $\mu$ V NOISE**
- **RESPONSE  $\pm$ .5dB 20 Hz TO 20 KHz**
- **.05% HARMONIC DISTORTION**

**COUNTRYMAN ASSOCIATES**  
424 Stanford Avenue  
Redwood City, CA 94063  
Phone (415) 364-9988

for additional information circle no. 89

may then couple speaker wire approaching "a value of several ohms with little effect." We find by looking at a wire resistance chart that 100 feet round trip of number 22 gauge is approximately 2.7 ohms. I find it difficult; no, impossible, to believe that Mr. Dickensheets and/or Boner & Associates can't hear a difference between 100 feet of number 22 gauge and 100 feet of a much heavier gauge using just about any amplifier/speaker combination he pleases.

Let me conclude with a little warning for all. "The natural scatter of data in the mental world exceeds the number and nature of differences we are able to perceive in the physical world." (pace Petrov contra Lorenzo)

## News

### CLARENCE C. MOORE AUDIO PIONEER AND INNOVATOR PASSES

Clarence C. Moore, founder and president of Crown International, Inc., passed away on January 24, 1979, at the age of 74.

Mr. Moore's primary impact in the field of audio was the development of the first tape recorder which included a power amplifier, the invention of the cubical quad antenna system, the creation of the first 1/4-inch 4-channel recorder and the introduction of the first solid state power amplifier.

Though Clarence Moore's formal educa-

tion included a bachelor's degree from Marion College with majors in English, chemistry and music and graduate study at the University of Notre Dame in clinical psychology, he never stopped his drive for additional knowledge. His life was characterized by a strong religious faith, a striving to improve himself and the desire to be of utmost use to his friends and his God.

### AKG ESTABLISHES WESTERN SERVICE CENTER

AKG Acoustics has recently established a service center for AKG microphones and reverb units at 3940 Higuera Street, Culver City, California 90230, in the Los Angeles area.

West Coast consumers are advised to send their AKG units to the address above for repair. Twenty-four hour turn-around time is normal for most units.

The phone number is (213) 204-1952.

### BRUNO HOCHSTRASSER NAMED PRESIDENT OF STUDER REVOX AMERICA, INC.

Effective in January, 1979, as announced by Willi Studer, Mr. Bruno Hochstrasser will be responsible for all U.S.A. activities of both the Studer line of professional tape recorders and associated equipment, and the ReVox brand of audiophile components. A ten-year veteran at Studer, he was previously vice-president of sales for Studer International in Regensdorf. No stranger to the North American market, he served as vice-president of Studer ReVox of Canada, Limited, for four years until his return to the home office in 1977.



*"OK", so I accidentally erased your lead vocal, but NOW we've got an open track for AUTOMATION!"*

Mr. Hochstrasser will be based in Nashville, and will be assisted in sales and engineering support activities by Tom Jenny and Heinz Schiess. Jenny comes from field sales in Switzerland and previously held engineering and sales positions with Studer in South Africa and Switzerland. Schiess previously served Studer in both sales and engineering positions in France, Switzerland and Canada. Also reporting to Mr. Hochstrasser will be Rob Robinson, newly appointed ReVox sales manager.

## BOOK REVIEW

### AUDIO IC OP-AMP APPLICATIONS

by Walter G. Jung

Price: \$7.95, 208 pages

Publisher: Howard W. Sams & Co., Inc.

The application of the new IC operational amplifier to the field of audio signal processing has been slow to develop. One reason for this is the fact that the problems the audio designer encounters when he attempts to incorporate IC op-amps in his circuits have been insufficiently treated in technical books and papers. This book examines the various pitfalls in detail and discusses methods for realizing the full potential of the op-amp in a

wide variety of audio circuits.

The book is organized into six chapters. Chapter 1 introduces and briefly discusses the IC op-amp types under consideration, and covers general operating procedures and precautions to be observed in using the various devices. Chapter 2 discusses IC op-amp parameters that are important in audio applications, while Chapter 3 deals with the basic op-amp configurations as they are applied to audio use.

Chapter 4 covers a wide variety of practical *audio amplifier* circuits in which specific IC types are used. Equalized amplifiers and active filters are dealt with in Chapter 5, while Chapter 6 discusses a miscellaneous assortment of special purpose audio circuits. The appendixes contain a data sheet on the Signetics 5534 op-amp and a list of manufacturers' names and addresses and the audio IC op-amps that they manufacture.

Readers already familiar with basic op-amp theory will find this book a valuable addition to their technical libraries.

Reviewed by Peter Butt

### AUDIO IC OP-AMP APPLICATIONS

May be ordered directly from  
R-e/p BOOKS

P.O. Box 2449 • Hollywood, CA 90028

\$7.95 each

Include money order or check with your order.

## jensen transformers

By REICHENBACH ENGINEERING

Wide Bandwidth  
Minimum Transient Distortion  
Low Noise

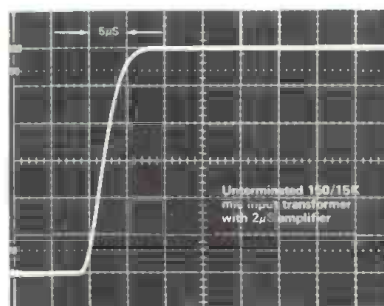

Years of transformer manufacturing and design experience, combined with computer assisted technology, have enabled us to make a *significantly audible improvement* in the performance of audio transformers.

Write or call for information  
1617 NORTH FULLER AVENUE  
HOLLYWOOD, CA 90046  
(213) 876-0059

(Visitors by appointment only.)

for additional information circle no. 90

## I know this sounds impossible...

but I want the intro from the second mix,  
pull up the horns in the turn-around from the last mix,  
fade the background vocals at "B" like the third mix,  
and give me the number one mix on the electric piano at the bridge...

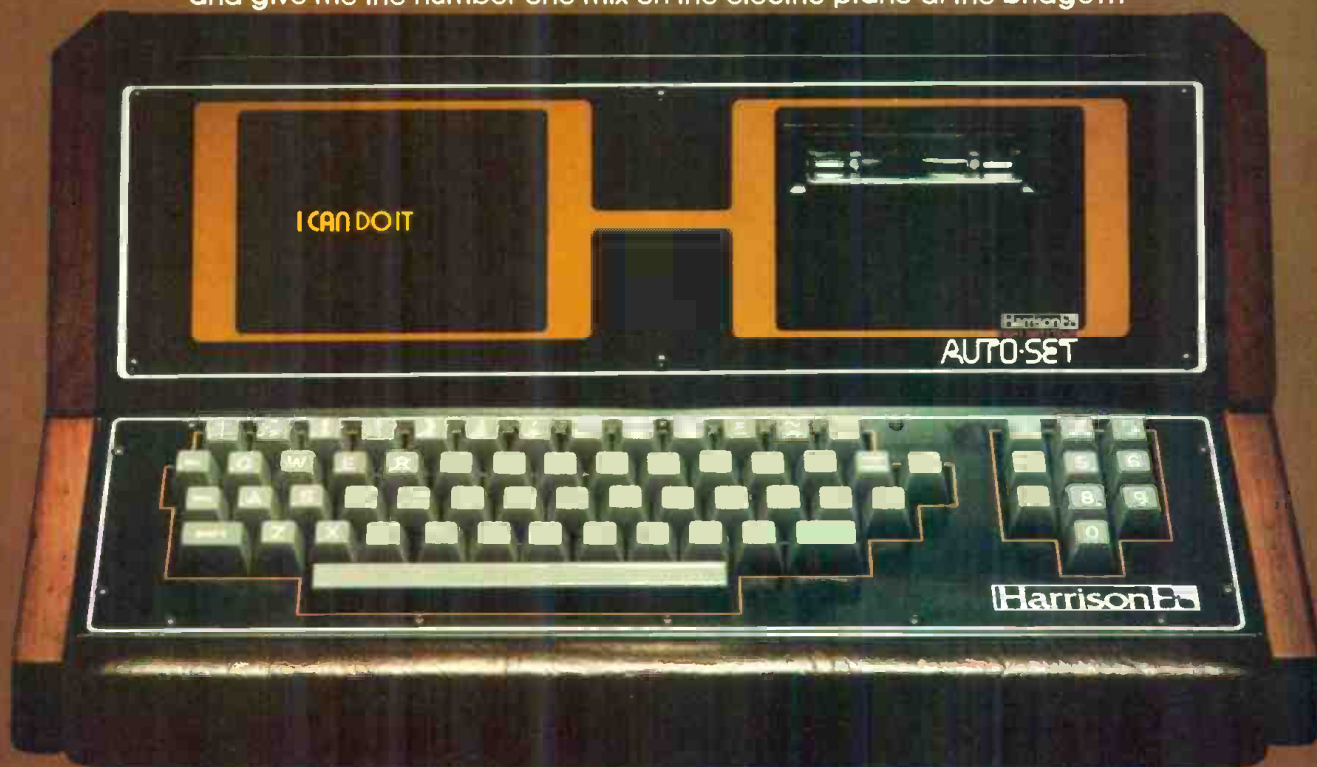

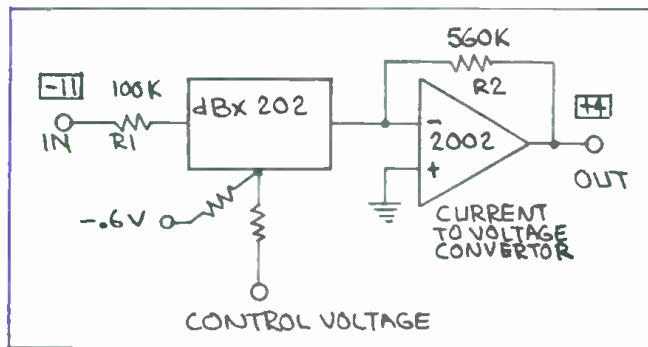

FIGURE 11  
IMPROVED dBX/MCI CONFIGURATION

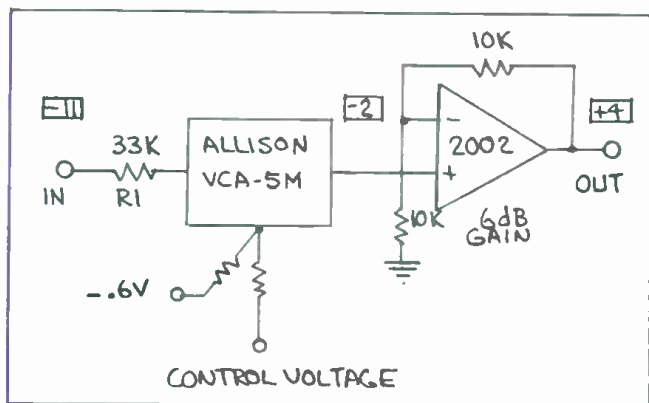

FIGURE 12  
ALLISON/MCI CONFIGURATION

structure requires a +28 dBv output, the 2002 Op-Amp is re-configured to raise the output (and noise) of the VCA-5M to provide this elevated output level.

In properly employing the VCA-5M, the value of the input resistor is adjusted to cause the maximum signal deliverable by the preceeding stage to coincide with the VCA's input clipping point. The control voltage is offset to accommodate the range produced by the console, and to optimize the dynamic range of the circuit. Please refer again to Figures 6, 7 and 8 for the noise and distortion contours produced by this circuit.

It should be noted that in both the dbx and Allison configurations, up to 20 dB of additional reserve gain is available, over and above that gain range provided by this particular console. On the bottom end, another 10 to 20dB of shutoff is also available. The B & B deployment, conversely, is pushed to the limits of its gain control range, and is operating in a region of serious scale factor non-linearity.

### CONFIRMING MEASUREMENTS

While making the measurements on the B & B VCATT, I also did a series of side-by-side measurements (using a Sound Technology) on two randomly chosen production VCA-5M modules. In making the B & B measurements, I compensated for the 6 dB input gain by stating the input levels 6 dB higher on the graphs than what I had used in making the tests. Thus, both devices were measured and charted with the same relative input levels. The results of the B & B vs. the worst of the two VCA-5Ms are shown in the graphs of Figures 13 through 18.

### SUMMARY

In closing this paper, I would like to present my personal

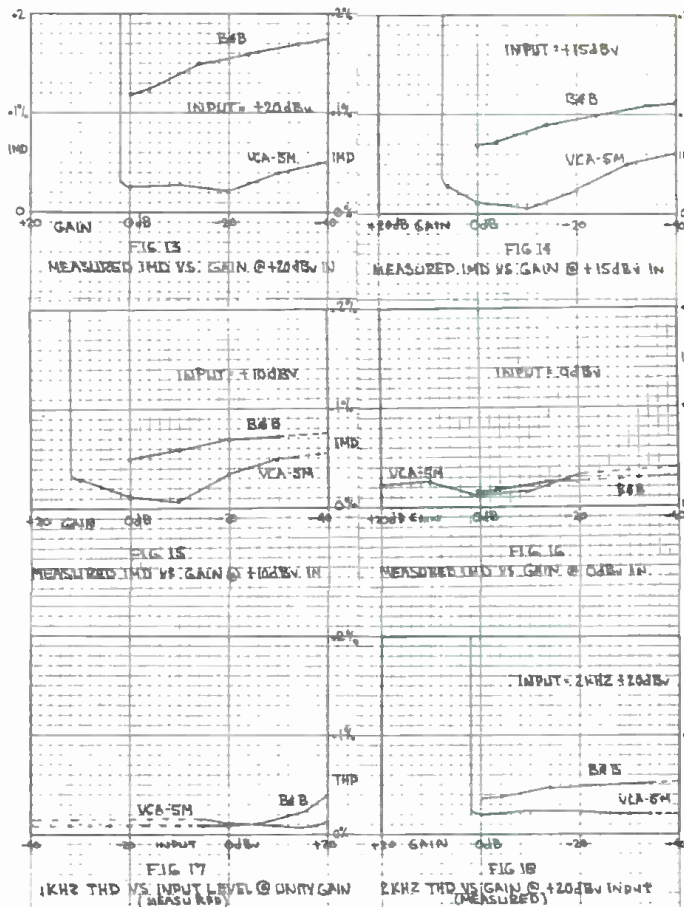

assessment of the advantages and disadvantages of the three voltage controlled devices mentioned herein. I will try to do so in a subjective and unbiased manner.

### DBX 202

The dbx 202 is a true VCA, capable of a gain control range in excess of +30 dB to -100 dB. It offers excellent scale factor linearity, control rejection, noise levels and distortion levels. Its operating parameters are user definable. Perhaps the biggest problem with the 202 is a lack of understanding, on the part of its users, on the selection of proper operating parameters. There are compromises in the selection of input current and output coupling methods, which may have a profound bearing on the distortion and noise parameters. When these parameters are properly defined, there is no excuse for serious audio degradation in most applications. Thus defined, the device has valuable application in all situations requiring a true VCA.

### B & B 1537A

The device is not a VCA, but rather, a VCATT, or voltage controlled attenuator. As such, it offers excellent noise, distortion and temperature immunity. It exhibits a good scale factor linearity over the range of -20 dB to -80 dB gain, and it has a maximum gain control range of 0 dB to -100 dB. By careful employment of temperature compensated non-linear corrective circuitry, its scale factor linearity could be improved.

Thus defined, the device should find application where Voltage Controlled Attenuation is required, but its usefulness is limited in most applications requiring a wide range, true VCA.

### ALLISON VCA-5A and VCA-5M

The VCA-5A and M are two derivatives of the same basic

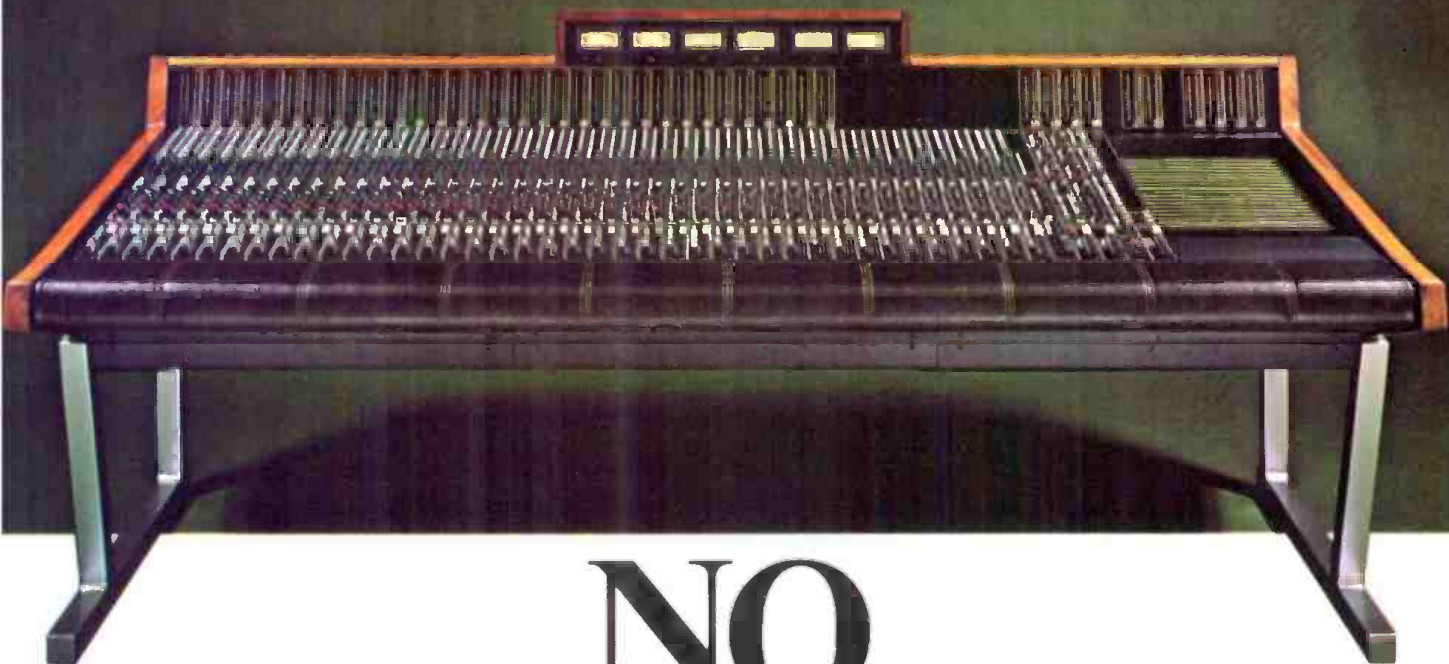

# NO COMPROMISE

Two nice sounding words, just like a lot of other nice sounding words that manufacturers and suppliers use to describe their products and services.

Talk is cheap and so are words, so in order for words to have any true value they must stand for something of value.

At Harrison Systems *No Compromise* means something very real to us, to our dealers, and to our customers. *No Compromise* is a way of doing business, a philosophy that we believe in, a standard by which we can measure our every decision and endeavor, not just pretty words.

The *No Compromise* philosophy is with us every minute of every day. It is the dominant factor in the design, the manufacture, and the after sales support of every piece of equipment that we build.

To our dealers it means that they are representing and delivering the very best recording consoles available in the world. They are proud of the fact and we are proud of them. Without exception Harrison dealers world wide are the finest, most knowledgeable, most honorable audio professionals to be found.

Harrison customers have the *No Compromise* philosophy, also. In most cases the decision to purchase a Harrison console has not been made on price, for there are many consoles that sell for less. Harrison owners know that they have purchased the finest consoles for their studios. That goes a long way toward the making of a *No Compromise* studio. Interestingly, most Harrison owners have found that the choice of a Harrison console has in the long-run been the most profitable for their operations. The care and expertise in the design of the consoles have made their clientele very happy and supportive. The quality of construction and check out have meant minimum down time and start up problems. Harrison consoles have a history of very good retained value which means that the cost of ownership can be quite reasonable.

Many years ago one of the smartest men I have known told me that if you take care of business, then business will take care of you. Taking care of business... I guess that is what *No Compromise* is really all about.

*David Harrison*

**Harrison** 

circuit. The 5M is a minimum size VCA module featuring current inputs for the audio and control circuits, and a voltage output. It has all necessary operating circuitry in-built, with the exception of the current establishing audio and control input resistors.

The VCA-5A is a card frame mounting device which features differential voltage inputs for the audio and control circuits. It has a voltage output, and requires no external parts.

The devices are true VCAs, and employ an all npn monolithic gain control element, in a balanced differential arrangement under current application to the U.S. Patent Office. Of particular importance to the design, is the proprietary employment of trimmable compensating loops, which cancel the inherent error of log/antilog elements at the higher operating currents. The result is a very low production of distortion products, under all conditions of signal level and gain control.

The devices are accurate over a gain control range in excess of +35 dB to -105 dB, and feature excellent parameters of noise, distortion, temperature immunity, scale factor linearity and control circuit rejection.

The design has one inherent difficulty which manifests itself in the form of a gently rising high frequency THD characteristic. (See Figure 19) It should be noted that the production of harmonics is still quite low at 10 kHz, being typically under .15%, and that harmonics produced for frequencies above 10 kHz are of little concern since they are out of the range of normal hearing. One must differentiate between the gentle distortions shown in Figure 19 and the severe distortion often produced by slew rate induced triangulation of some modern circuits in the 20 kHz to 50 kHz region. The latter forms of distortion can be audible since the spurious products rapidly exceed 20% once triangulation begins.

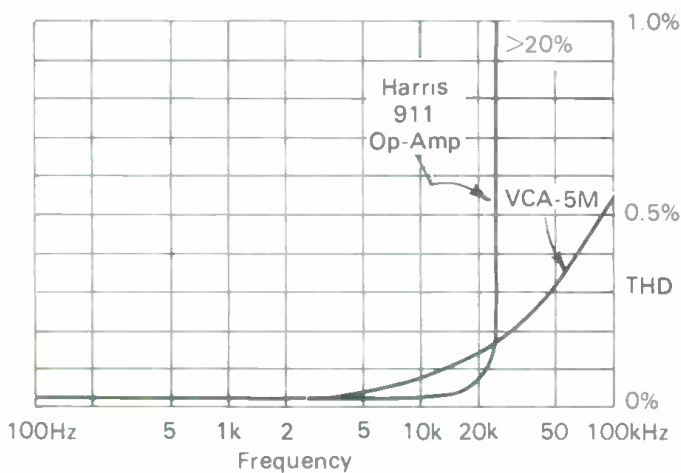

Figure 19

### Gentle Rise in THD vs Frequency VCA-5M VS Slew Induced THD for Harris 911 Op-Amp

The VCA-5A and M exhibit an excellent slew rate of 13 volts/ $\mu$ sec, and can deliver, or accept, full power signals at frequencies in excess of 150 kHz, as indicated by the scope photo of Figure 20.

#### PRECAUTIONS FOR ALL VCAS

It must always be remembered that any VCA or VCATT is a multiplier, and is capable of producing severe distortion, or modulation, if any audio signal is allowed to become

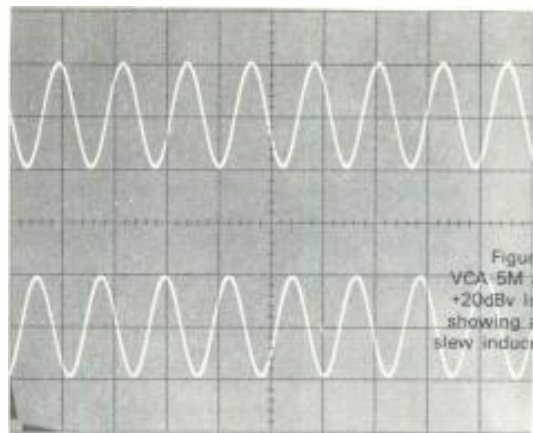

Figure 20  
VCA-5M at 150kHz  
+20dBv in and out  
showing absence of  
slew induced distortion

### 150kHz, Full power Bandwidth 20vp-p in and out

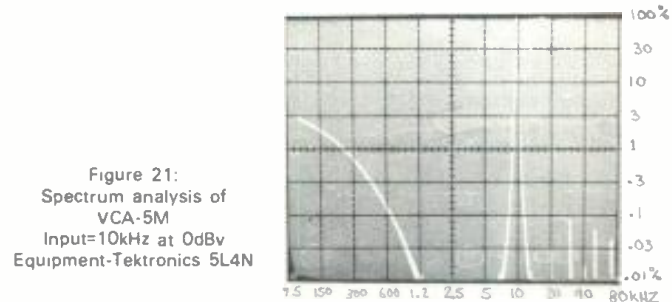

Figure 21:  
Spectrum analysis of  
VCA-5M  
Input=10kHz at 0dBv  
Equipment-Tektronics 5L4N

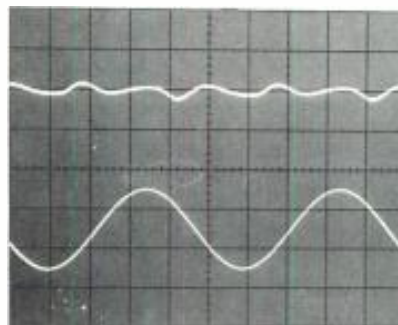

Figure 22:  
Residual products of  
VCA-5M  
Input=20kHz at 0dBv.  
Equipment-  
Sound Technology 1710A  
with 80kHz filter in.  
THD=0.16%

impressed on the control signal input. This is particularly true at high frequencies where the chance of capacitive coupling between the two ports is increased. Always ground any unused control voltage inputs. (Do not ground current mode inputs.) Keep impedances low, and observe every precaution to isolate the control port from interference.

#### CLOSING

The use of Voltage Controlled Elements, not to mention Digitally Controlled Elements, offers important advances to the art of audio control. As with any relatively new science, however, the successful employment of such devices must be accompanied by a keen understanding of the principles involved, the limitations, and the engineering disciplines required to make the implementation truly effective and beneficial.

It is the responsibility of the creators of these new techniques to educate the users, and to make certain that the product offered truly advances the art, rather than merely serving as a means to enrich the manufacturers bank account, at the ultimate expense of the consumer and the industry. □ □ □

# COME

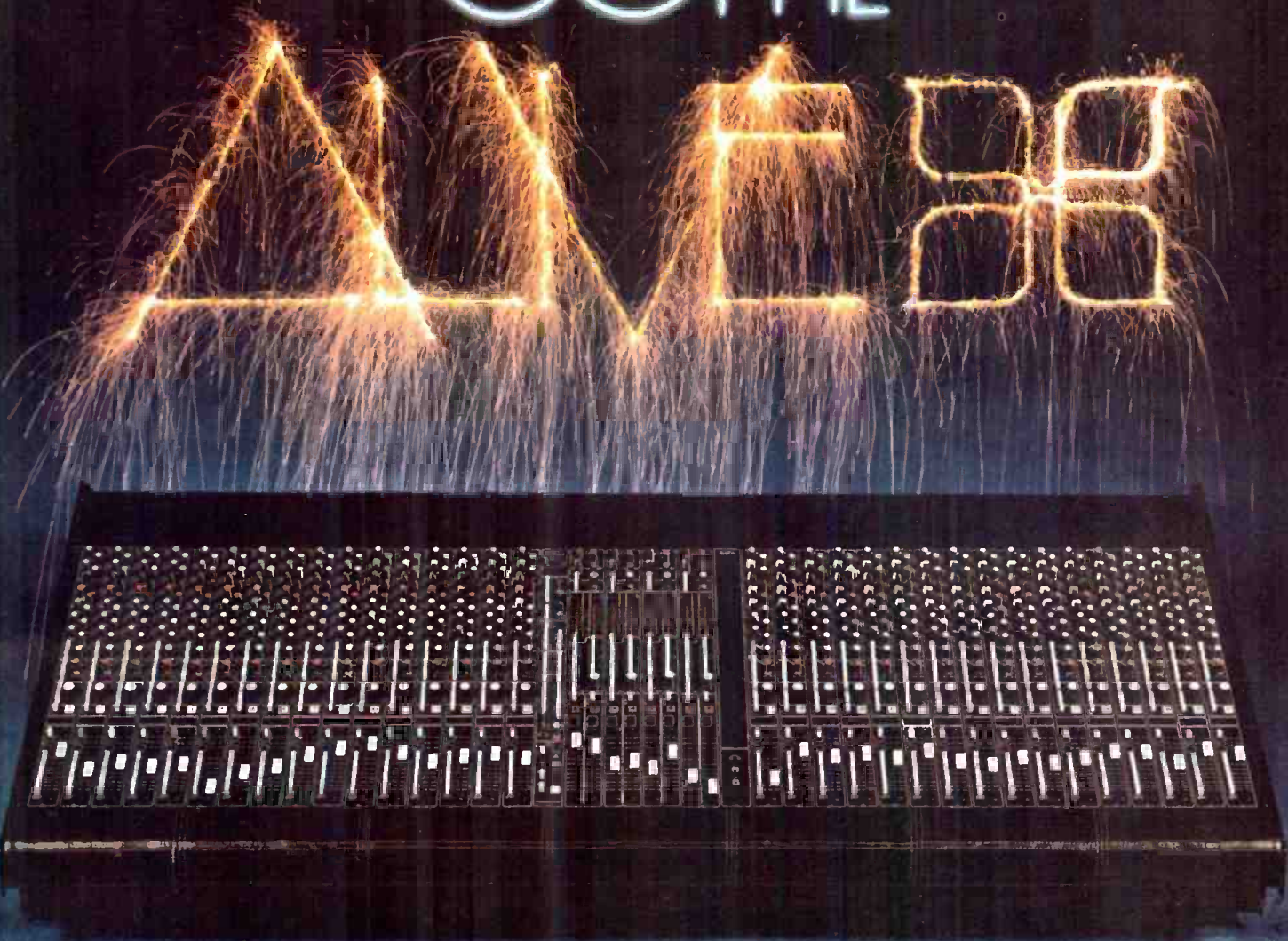

Now, a high performance studio quality Harrison console designed for LIVE PERFORMANCE. The Harrison NO COMPROMISE philosophy has been carried through every aspect in the design of the ALIVE console. Standard features:

- Harrison transformerless microphone preamplifiers.
- Automated VCA Faders with Groupers.
- 8 VCA matrix sub groups.
- 3 band parametric EQ with high-pass.
- Direct communications interface.
- 4 main stereo output pairs.
- 8 auxiliary send busses.
- 8 built-in 16 segment electronic LED VU meters.
- 32 or 24 channel mainframes and extender frames.
- 3 point overload LED indicator on each I/O module.
- Road proof lightweight aircraft aluminum frame.





# fact: you can choose your microphone to enhance your productions.

Shure makes microphones for every imaginable use. Like musical instruments, each different type of Shure microphone has a distinctive "sound," or physical characteristic that optimizes it for particular applications, voices, or effects. Take, for example, the Shure SM58 and SM59 microphones:

## SM59

**Mellow, smooth,  
silent...**

The SM59 is a relatively new, dynamic cardioid microphone. Yet it is already widely accepted as a standard for distinguished studio productions. In fact, you'll often see it on TV . . . especially on musical shows where perfection of sound quality is a major consideration. This revolutionary cardioid microphone has an exceptionally flat frequency response and neutral sound that reproduces exactly what it hears. It's designed to give good bass response when miking at a distance. Remarkably rugged — it's built to shrug off rough handling. And, it is superb in rejecting mechanical stand noise such as floor and desk vibrations because of a unique, patented built-in shock mount. It also features a special hum-bucking coil for superior noise reduction!

**Some like it essentially flat...**

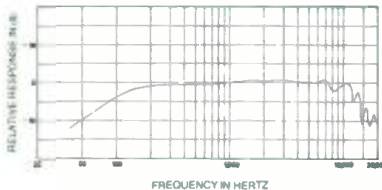

## SM58

**Crisp, bright  
"abuse proof"**

Probably the most widely used on-stage, hand-held cardioid dynamic microphone. The SM58 dynamic microphone is preferred for its punch in live vocal applications . . . especially where close-up miking is important. It is THE world-standard professional stage microphone with the distinctive Shure upper mid-range presence peak for an intelligible, lively sound. World-renowned for its ability to withstand the kind of abuse that would destroy many other microphones. Designed to minimize the boominess you'd expect from close miking. Rugged, efficient spherical windscreen eliminates pops. Lightweight (15 ounces!) hand-sized. The first choice among rock, pop, R & B, country, gospel, and jazz vocalists.

**...some like a "presence" peak.**

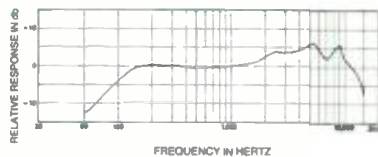

professional microphones...by



# SHURE

®

Shure Brothers Inc., 222 Hartrey Ave., Evanston, IL 60204, In Canada: A. C. Simmonds & Son Limited  
Manufacturers of high fidelity components, microphones, sound systems and related circuitry,

for additional information circle no. 91

[www.americanradiohistory.com](http://www.americanradiohistory.com)