

\$1.00



RECORDING engineer/producer

relating recording science • to recording art • to recording equipment



11201PMEBL 93DC
DOUG POMEROY
COLUMBIA RERDS
193 BAL TIC ST
BROOKLYN
NY 11201

RECORDING "SHAFT" AT STAX PAGE 15

**AUTOMATION
FOR
AUDIO
RECORDING
PAGE 23**

**TODAY'S
MAGNETIC
RECORDERS
PAGE 39**

SYSTEMS ..

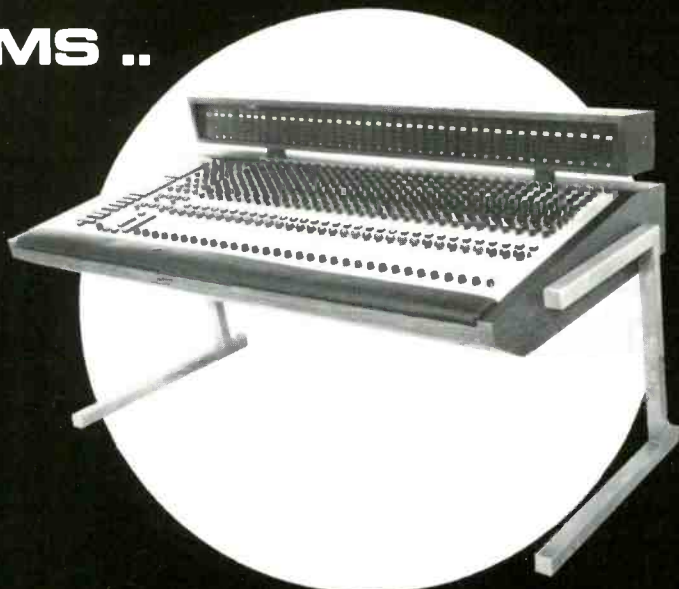

MOD-N-32

- REMOTE ACCESS AND PROGRAMMABLE SOLID STATE SWITCHING
- DC CONTROL FOR AUTOMATION
- FULL 32 INPUT ASSIGN TO ANY TRACK
- 32 OUTPUT PLUS SIMULTANEOUS QUAD-STEREO-MONO OUTPUTS
- SOLID STATE 32 TRACK PROGRAMMABLE BOARD & MONITOR MASTERS
- AUTOMATIC SYNC SWITCHING
- PREVIEW PUNCH-IN MONITOR CONTROL
- QUAD-PAN ON ALL INPUTS
- SELECTABLE PROGRAMMABLE MUTING
- 3 RANGE STEPLESS RECIPROCAL AND SHELVE EQ
- FULL PLUG-IN CONSTRUCTION
- SOLO INPUT-SOLO MONITOR-MUTE INPUTS
- PEAK OR RMS LEVELITES
- FOUR CUE SYSTEMS
- 68 INCHES WIDE

...AND COMPONENTS

SOLID STATE
ELECTRONIC SWITCHING MODULE

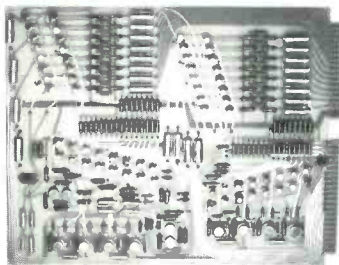

LEVELITE VISUAL
VU METER

MULTI RANGE
CONTINUOUSLY
VARIABLE EQUALIZER



PRECISION
NOISELESS
ATTENUATOR

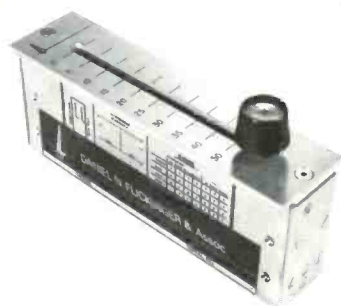

DANIEL N. FLICKINGER & ASSOCIATES, INC.

40 SOUTH OVIATT STREET

HUDSON, OHIO 44236

(216) 655-2400

New Tools for Professional Monitoring

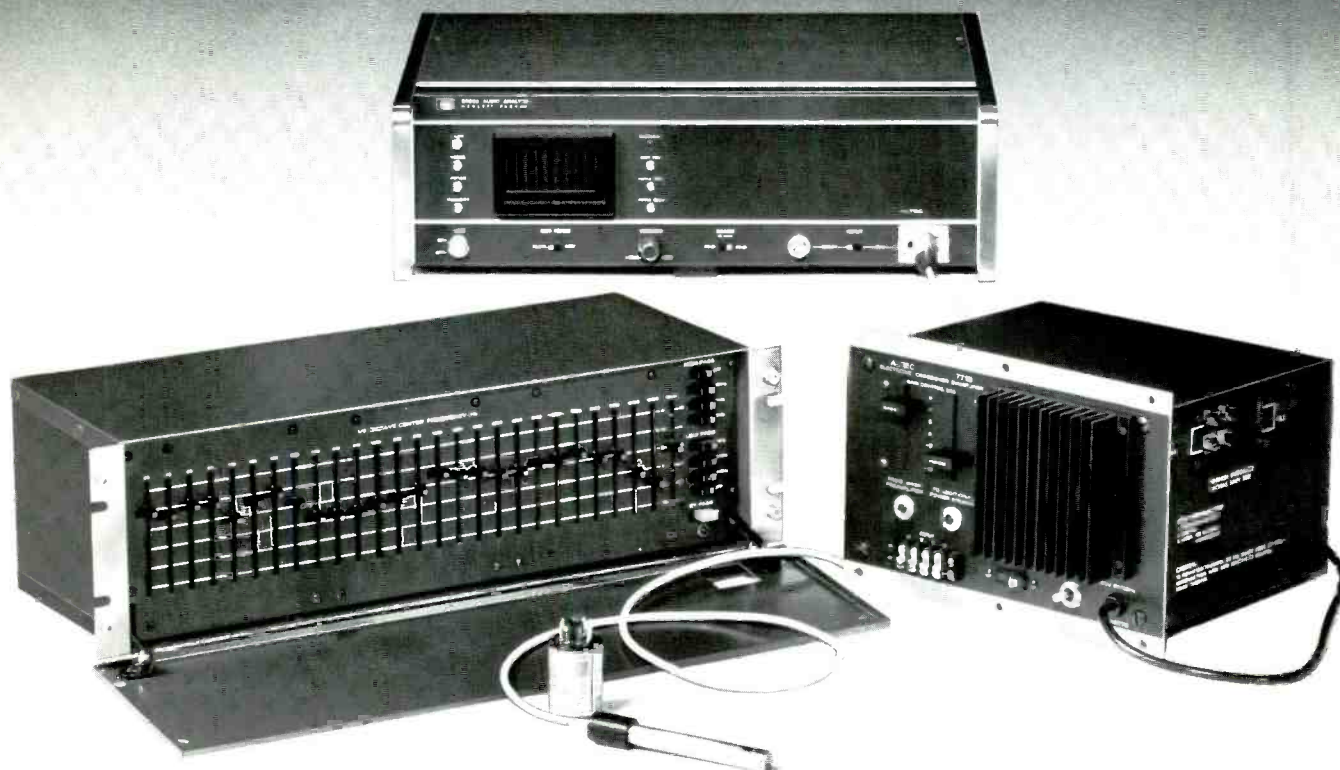

THE 8050A REAL TIME ANALYZER provides continuous audio spectrum scanning every 30 ms, 40 Hz to 16 kHz on ISO center frequencies. Has *fast* RMS response for visual program monitoring and *slow* RMS response for room equalization. Cost is about 1/3 of competitive models.

THE 9860A ACTIVE EQUALIZER has phase and amplitude transfer characteristics identical with those of the Altec passive equalizer. Permits detailed equalization from 40 Hz to 12.5 kHz. High and low-pass functions, 18 dB/octave, permit more precise finishing of frequency extremes. Cost is about 1/2 of comparable passive devices.

THE 8030A PINK NOISE GENERATOR plugs into standard Altec mixers. An ideal flat and stable noise source for room/speaker equalization with 24V power supply or battery. Cost is about 1/5 of standard noise generators.

THE 771B BIAMPLIFIER has a switchable 12 dB/octave crossover at 500, 800, and 1500 Hz. Can be adapted to most studio monitoring systems and coaxial speakers. Acoustical balances can be exactly controlled by separate HF and LF gain controls. The LF section delivers 60 Watts and the HF section 30 Watts continuous sine wave power.

For more detailed data and specs write Altec, Professional Studio Products, 1515 S. Manchester Ave., Anaheim, Calif. 92803.

ALTEC

← Circle No. 101

Circle No. 102



How good is the new Electro-Voice RE20 studio dynamic microphone?

Here's proof from the new scoring stage at Glen Glenn.

Ey The fine reputation of Glen Glenn Sound Company rests on their knowledge of sound... their ability to turn a full symphony orchestra into a perfect sound track for TV, the movies, or a new album. And their desire to be first with the finest.

So for their new scoring Studio M, Glen Glenn engineers asked to see the latest products in every category... tape, film, electronics, and — of course — microphones. Especially a new E-V dynamic cardioid microphone which they had seen in prototype form earlier.

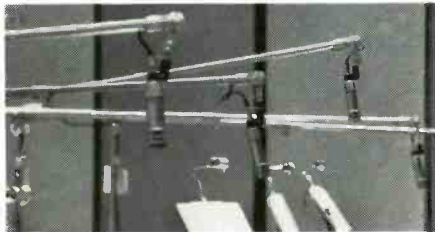

Glen Glenn put the RE20 to the test. Including days of studio experiments and actual sessions that pitted the RE20 against every type of musical instrument. Plus a searching critique by the musicians themselves. The RE20 passed every test with flying colors.

As a result, when Studio M was completed, RE20's were on the booms... almost four dozen of them from our first production run.

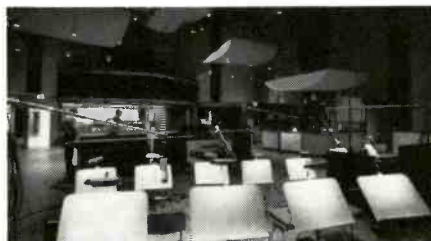

Since then, Glen Glenn has scheduled a number of major recordings with RE20's. And the RE20 has often been used where previously an expensive condenser was the automatic choice. Why? Because the RE20 has proved itself a significant advance in microphone design. With wide-range, peak-free response on axis (even the off-axis response is better than many other studio microphones on axis). Transient response rivals any other studio microphone, regardless of design. Directional control is uniform and predictable from every angle. Yet proximity effect is virtually eliminated (a problem that plagues almost every cardioid — except E-V Continuously Variable-D[®] microphones).

In short, the RE20 does everything a good condenser does, and some things better. Without the complication of power supplies. Or special cables. Or shock mounts or windscreens (they're both built in). Or the need for equalization just to overcome design faults.



It's simple. It's flat. It's rugged. It's clean. With a 2-year performance warranty unmatched in the industry (it's spelled out completely on the spec sheet). The RE20. For the studio looking for better sound. Your E-V microphone specialist will gladly loan your studio an RE20 to make any tests you like. Call him today.

P. S. For full technical data on the RE20, write us today. To find out more about Studio M, write Joe Kelly, VP, Engineering, Glen Glenn Sound Company, 6624 Romaine St., Hollywood, Calif. 90038

ELECTRO-VOICE, INC., Dept. 821RP,
674 Cecil Street, Buchanan, Michigan 49107



MODEL RE20
dynamic cardioid studio
microphone \$454.00 list,
less normal trade discounts.

Electro-Voice[®]

A SUBSIDIARY OF GULTON INDUSTRIES, INC.



RECORDING

engineer/producer

—the magazine to exclusively serve the recording studio market . . . all those whose work involves the recording of commercially marketable sound.

—the magazine produced to relate . . . RECORDING ART to RECORDING SCIENCE . . . to RECORDING EQUIPMENT.

Editor/Publisher . . . MARTIN GALLAY

Engineering Editors . . . RON MALO
WILLIAM ROBINSON
CHUCK DAVIS

Business/Circulation
Manager . . . V. L. GAFFNEY
Art Director . . . GERRY SADOWSKI

RECORDING engineer/producer is published bi-monthly and is sent free to qualified recipients in the United States. Subscriptions for other than qualified individuals or companies may be purchased at \$5.00 per year. (All foreign subscriptions: \$6.00 per year.) Material appearing in Re/p may not be reproduced without written permission of the Publisher.

RECORDING engineer/producer is not responsible for any claim made by any person based upon the publication by RECORDING engineer/producer of material submitted for publication.

Controlled circulation postage paid at Los Angeles, California.
RECORDING engineer/producer
6430 Sunset Boulevard
P.O. Box 2287
Hollywood, CA 90028
(213) 461-7907

an Re/p interview with the 1971
'GRAMMY' winning engineers; SHAFT's
DAVE PURPLE
HENRY BUSH
RON CAPONE 15 RON MALO

NATIONAL COUNCIL OF
RECORDING ENGINEERS
ANNOUNCED 19

AUTOMATION FOR AUDIO RECORDING
Allison Research 23
Audio Designs 24
Automated Processes 24
Daniel Flickinger 26
MCI 26
Olive Electro Dynamics 31
Quad-Eight Electronics 32

TODAY'S MAGNETIC RECORDERS 39 BILL WILSON

Letters & Late News 10
New Products 49
Classified Ads 55

A POWERFUL PAIR EXPOSED BY MCI!

TALKBACK MIKE

METERS LIGHT

Activates if track meters 9-16 are being used to monitor tracks 17-24. (See tracks meter select.)

TRACK METERS

Tracks 17-24 share meters with 9-16 (See tracks meter select)

CONNECTOR BLOCKS

On rear covered by metal back panel provides hidden connections for all inputs and outputs

SUBMASTER TRACK GAIN

Provides track attenuation during recording when many inputs are mixed together and mix must be held while the group is attenuated.

TRACK SELECT

Permits each input to be fed into any of the 16 summing busses which then feed the first 16 tracks. The direct button on each strip feeds the module input directly to its track output.

CUE AND ECHO LEVELS

These 4 busses are identical and may be used interchangeably. (See also master echo and cue levels.)

ECHO SWITCH

This button connects echo to the output of the equalizer (thus only the single input can be used.) Instead of the monitor booster. (any signals entering the track are used.)

O DUB SWITCH

Defeats board status command and places module in mike status. A red light indicates use of this button. (See status switches.)

SOLO SWITCH

Routes its track signal to the control room monitor without disturbing program circuits. It can be used during recording.

MONITOR AND PAN CONTROLS

The monitor fader controls the percent of track output sent to quad busses. In remix status the fader controls tape return level. The pan control provides L-R panning through a front-back mute switch.

EQUALIZER

H. F. EQUALIZATION is through a 2 frequency select push button and 11 position $\pm 12\text{db}$ shelf with center off.

MID RANGE EQUALIZATION is through a 12 frequency select switch and an 8 position $+14\text{db}$ shelf with an off position.

LOW FREQUENCY EQUALIZATION is through a 2 frequency select push button and an 11 position $\pm 12\text{db}$ shelf with center off.

MIKE TRIM

Provides 24-50db mike gain through an extremely low noise amplifier with balanced transformer input.

ILLUMINATED CONDUCTIVE PLASTIC FADER

Is in front of the equalizer circuit and will accept its input either from the mike preamp or tape. (See status buttons)

PLEATED AND ROLLED 6" ARMREST

SOLO LIGHT

Activates if any solo buttons are pushed.

4 ECHO RETURNS TO QUAD MIX

Each channel has 20db boost, level control and pan controls identical to an input strip. They feed directly into the quad mix busses and each also has a solo button.

SUBMASTER CUE AND ECHO

These permit adjustment of cue mix levels and echo mix levels.

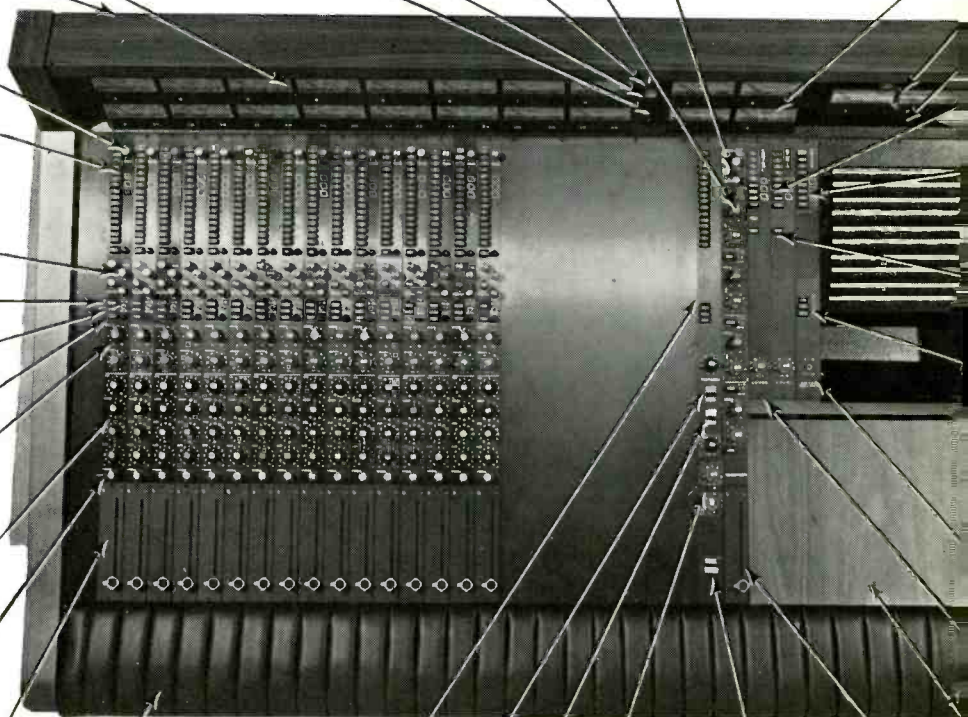

ECHO RETURN TO TRACKS

Provides level control on 20db boost amplifier 16 track selects, solo, and cue feeds for one echo return.

OSC. SELECT

Permits oscillator feed from patch bay to the 16 track busses or the quad mix busses.

SLATE SELECT

Permits slating signal to be fed to 16 track busses, or quad mix busses.

MIKE LEVEL CONTROLS

For talkback, slating, and communicate.

TB MIKE BUTTONS

Conveniently located near arm rest and just off center of console. The **TALKBACK BUTTON** feeds slating and the studio monitor while muting the control room to prevent feedback, the **COMMUNICATE BUTTON** feeds only the cue busses. It can be used during recording.

When you buy MCI's new JH-416 mixing console—priced at a phenomenal \$19,500 for the 16-track model — you'll have enough money left over to buy our JH-16 recorder (\$16,500) . . . and still be paying less than what you'd expect for a comparable mixing console alone. Expandable to 24 tracks (total: \$25,100), the JH-416 makes possible a complete studio package of heavy hardware at

unheard-of savings. And to save even *more* consider starting out with an 8-track version of the JH-416 (\$13,900), which you can build on later.

We'll match our console—its specifications and functions — with any competitive model, even the \$40,000-and-up jobs.

Recorder and mixer — together, a powerful pair from MCI.



4007 N.E. 6th Avenue
Ft. Lauderdale, Florida 33308

QUAD METERS
Continuously monitor the quad mix busses.

2 TRACK METERS
(See meter selector)

POWER SENSE LIGHTS
Sense any bipolar voltage imbalance or failure and gives warning to operator.

MONITOR SELECT
The studio and control monitor have independent selectors, both given the choices of: Mono Tape; 2 TK Tape; Aux 1,2; Cue 1,2; Echo 1,2; 2 Track Mix; Quad Mix; and Quad Tape Return.
The control room monitor has quad output. The studio monitor comes with 2 TK output. A quad studio monitor is also available. The studio also has automatic muting when 2 TK or Quad Mix is monitored while the console is in mike mode.

2 TK METER SELECT
Feeds the left and right channel meters. The selection is: Mono Tape; 2 TK Tape; Aux 1, 2; Cue 1, 2; Echo 1, 2; 2 TK Mix; Quad Tape Front; and Quad Tape Rear.

240 JACK PATCH BAY
Provides interface for inputs, outputs, and inner electronics.

MONITOR MODE SELECT
These determine whether the monitor acts as mono, 2 channel or quad output. In addition, the control room monitor also has a 1-2 speaker switch used in mono mode.

STATUS BUTTONS
Three buttons which feed transistor drivers providing non-transient operation of status and mix relays in each module thus programming the console in 3 conditions. (The following gives electrical flow through 1 input module.)

MIKE STATUS — Mike signal routed through preamp, patch bay, conductive fader, equalizer booster, solo and assignment buttons, submaster level control, track summing amplifiers to the patch bay and out to tapes and also to the monitor level quad mix and echo, cue busses.

TAPE STATUS — identical to the first except tape return signal is routed to the monitor level by a status relay. This allows a multi track master to be played through the same mix circuits used to monitor track feeds during recording.

REMIK STATUS — routes the tape return from patch bay through the main fader, equalizer, quad pan, and cue, echo feeds. (Also see o-dub button)

TRACKS METER SELECT
Switches track meters 9-16 to tracks 17-24.

MONITOR LEVEL CONTROLS
The **CONTROL ROOM MONITOR** comes with a 4 channel rotary fader. The **STUDIO MONITOR** comes with a rotary 2 channel or 4 channel fader.

REMOVABLE PANEL
Acts as writing surface but can be removed and replaced by optional metal insert for your custom electronics.

QUADMASTER FADER
Fades quad mix, stereo mix and mono mix.

LOG RESET BUTTON
Sets beginning of tape location at position of tape when pushed.

AUTO-LOC BUTTON
Activates auto-locate function.

REMOTE CONTROL
This unit is furnished with the recorder. It houses 16 sets of illuminated mode switches — ready, overdub, & safe. The remote also houses a complete set of deck motion controls. The entire remote-auto-locator package is less than 8"H X 12"W X 5"D
Sophisticated logic activates automatic individual/master input monitor switching.

THREE TAPE HEADS
Are quickly removable for easy 8-16 conversion. All connectors are on top of the deck.

AUTOMATIC SHIELDS & TAPE LIFTERS
Can also be manually controlled.

CONSTANT TAPE TENSION
Electronic control maintains constant tension at all reel loading situations

FOLD-OUT ELECTRONICS RACK
Permits easy access to all wiring and rear of card connectors.

ALL METAL CABINET
Finished with mar-resistant poly — urethane paint and woodgrain vinyl. The front, top, and back open for servicing.

CASTERS
Designed for use on thick carpeting of recording studio floors

MCI AUTO LOCATOR
An optional accessory which can be connected to any JH-16 in the field. The auto locator permits automatic return to any two starting points. A 99 minute, 59 second clock is also contained in the auto locator.

DISPLAY BUTTONS
LOG — Brings Log count into auto locator counter after using "0" or clock functions.

"0" — Resets auto locator counter to current tape position while not affecting log count.

CLOCK BUTTONS
ON — Turns on clock and switches digital display from auto-loc to clock.
RUN — Starts and stops clock.

RECORD AND INPUT LIGHTS
Over each track meter.

16 VU METERS
Furnished on all machines. All mainframes are fully wired and tested regardless of head configuration.

CONTROL CARDS
House adjustments for reproduce, overdub, and record levels.

NOISE GATE
An optional accessory which plugs onto Control Cards. The noise gate reduces channel noise to >80 dB when program material is not present.

VU METER SWITCH
Switches VU meter to read bias level.

REPRODUCE AMPLIFIER CARDS
House a plug in equalizer with adjustments for fast & slow speed, high & low frequency equalization.

RECORD AMPLIFIER CARDS
House a plug-in equalizer with adjustments for fast & slow high frequency equalization and record calibration.

BIAS AMPLIFIER CARDS
House the adjustments for erase, bias and bias calibrate.

1176 LN limiting amplifier

Cool-aid for hot sounds

Cool and reliable, the 1176 is the Industry's most popular limiter for controlling today's hot sounds. It has ultrafast attack time independent of peak duration or frequency, adjustable from front panel. Release time is also adjustable from front panel. Push button selection of four compression ratios, of 20:1, 12:1, 8:1, or 4:1. It is a compact 19" rack mount size — 3½" high.

Available from better professional audio dealers everywhere or send for complete technical details today!

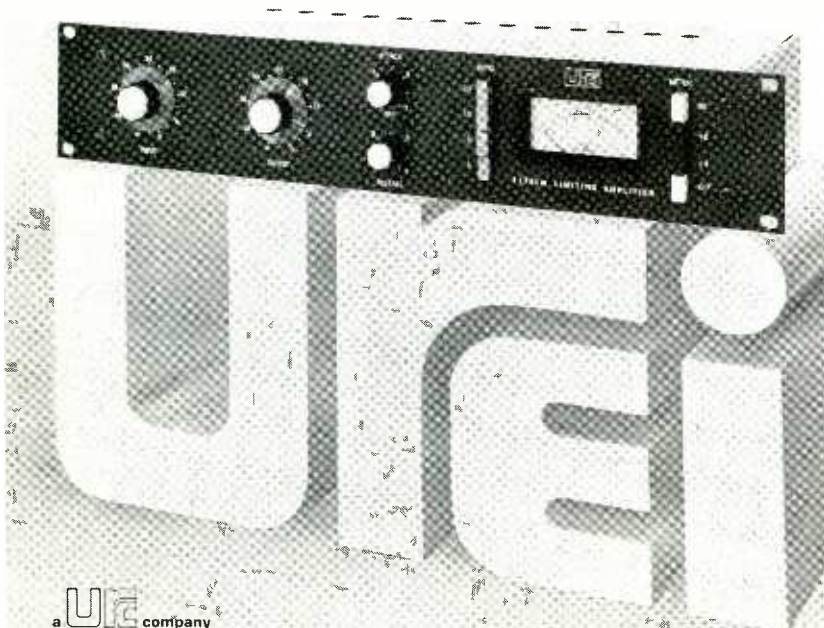

11922 Valerío Street, No. Hollywood, California 91605 (213) 764-1500

Exclusive export agent: Gotham Export Corporation, New York

From: M.T. Putnam
The URC Companies

In the May/June 1972 issue, you published an article by my good friend, Don Foster, concerning the construction of an echo chamber. I consider this to be a very constructive article since too few such articles are published covering the practical aspects.

There are a couple of items which Don covers which I think should be clarified for the sake of accuracy. He infers under the paragraph entitled "An Analysis" that the decay time is a function of the amount of electrical drive to the chamber, and of course this is not true since the reverberation time parameters are determined solely by the well known "Sabine" formula concerning only volume and the total amount of absorption. However, the signal to noise ratio which defines the usable amount of reverberation envelope of course does relate to the SPL in the chamber environment.

Secondarily, in the table showing frequencies ranging from 125Hz to 4000Hz, he shows the comparison between the absorption coefficient between Terrazo and Plaster. In this connection, it is important to remember that the figures given at the lower frequency, i.e., 250 cycles and below, is a function of not only the porosity of the reflecting surface, but also the mass and rigidity of the Boundary structures. Also, the absorption coefficients between construction "plaster" are somewhat misleading since in common practice "Keene" cement is used which is an extra hard non-porous surface that gives absorption coefficients equal to that of Terrazo Tile at a fraction of the cost.

As a mere comment concerning the general guide lines for the construction of an echo chamber, I would like to emphasize the importance of the geometric ratios, i.e., incommensurate numbers for height, width and length, the importance of geometric diffusion. The emphasis of Don's article has to do with achieving long reverberation time and ignores the fact that the ideal chamber would be one in which no change or coloration is added to the original sound other than perhaps a longer decay time at low frequencies.

One last note in this connection concerning geometry. Don uses for an example a room 10'x10'x10', constituting a cube which of course would be fraught with coincidental axial modes and would have a characteristic sound predominantly that of the resonant dimension.

I realize your vast experience in echo chamber design — especially your great Studio Three and its associated chamber where so many of our now famous people started! Also, your beautiful chamber of Studio A which really gives the best concert hall realism that I have ever heard — just beautiful.

As for the decay time in my article, I was going by the usable signal to noise and comparing the untiled to the tiled chamber. I must admit that I am no expert, but this chamber is considerably better than before. I am not certain as to the original type of cement used, but whatever, it didn't sound right.

The geometric ratios are very important as you point out, but my chamber area was already built, so I could not change this, hoping that the longer reverb time would also add to the coloration. This apparently has happened, as I now want to do a second one.

As for the 10x10x10, I hope no one tries to build this. I merely used this as a figure for calculation. I mention this is not of the right proportion in my article. I wish someone would build a chamber like the old time water cistern. This gives great coloration. The best one I ever heard is down in the Caribbean on the Island of Antigua in the West Indies. This is the water cistern used for Lord Nelson's soldiers way back in the 1740's. It is still there, at Fort Charlotte.

DON FOSTER

From: Ronald A. Slusser
Environmental and
Dynamic Testing Section
Jet Propulsion Lab
Pasadena, California

Here at JPL we are actively engaged in high intensity acoustic testing of spacecraft components. Since we want to be at least a little friendly with our neighbors, we do our testing in a reverberation chamber (echo chamber). Inasmuch as our levels reach as high as 156dB sound pressure level, the chamber must be pretty sturdy. When our chamber was built, we wanted the most "reverberant" possible walls because it's pretty hard to get 156dB of shaped random noise from anything — even a rock group! Our chamber is constructed of slip formed concrete walls, doubly reinforced, 18 inches thick. None of that wall "give"

Don Foster talks about in his "Ceramic Tile Echo Chamber" article. The walls of our chamber are painted with a hard epoxy paint. I think I would go this route (whether over concrete or cement block) rather than tile. It is easy to apply and I'm sure less expensive. Of course Mr. Foster had an additional problem of getting stiffer walls which we surely did not have.

Our chamber which is 18x24x26 feet (about 10,000 cubic feet) has a measured reverberation time of 17 seconds at 125Hz to about 10 seconds at 500Hz. Air absorption takes over above that fre-

quency to substantially reduce the reverberation time. Since the absorption is mostly due to moisture in the air, when we run a test, we "tweak" it a bit by filling the chamber with gaseous nitrogen. This gives us better high frequency performance.

I'd like to point out that our chamber is rectangular. The walls are parallel. Our chamber was designed for smooth response throughout the room which I'm sure is the goal for any echo chamber. We found that it just wasn't worth it to skew

continued on page 37

INDUSTRY STANDARDS

The MKH 415. A new kind of microphone.

The MKH 415 fills a gap in many broadcasting, recording and filmmaking applications. A gap created by longer- and shorter-than-normal miking distances, high wind and crowd noise levels, and more demanding engineers. To meet these often conflicting needs, we devised a unique combination of pressure-gradient and interference principles.

The result is a condenser microphone equally at home in recording studios, onstage, in reporting and on location.

Neither cardioid nor shotgun, the MKH 415 behaves as a super-cardioid

below 2 kHz; at higher frequencies its pattern narrows to a beam. Besides reduced leakage, this higher on-axis conversion efficiency yields improved wind-noise resistance and virtually no proximity effect, permitting close miking of performers and interviewers, without bass attenuators.

Beyond these advantages, and the added "reach" provided by the microphone's 10" length, the MKH 415 offers extremely wide response, high output and overload resistance—traditional Sennheiser characteristics. Once you try it, we're sure you'll call it indispensable. For more information, please write, or call us.



SENNHEISER
ELECTRONIC CORPORATION

10 West 37th Street, New York, N.Y. 10018 (212) 239-0190
Manufacturing Plant: Bissendorf, Hannover, West Germany



~~ALLISON RESEARCH, INC.~~
~~7100 SUNSET BOULEVARD~~
~~HOLLYWOOD, CALIF. 90046~~
~~(813) 874-8815~~

→ we've moved
2817 Erica Place
P.O. Box 40288
Nashville, Tenn. 37204
(615) "ALLISON"

Automated Processes, Inc.
80 Marcus Dr.
Melville, New York 11746

Dear Mr. Processes,

A funny thing happened to us while we were on the way to creating the nifty-neat kind of equipment that audio land looks to Allison Research for. We have created a device that falls into the "MAJOR BREAKTHROUGH" category. WE HAVE MADE AUTOMATED MIXDOWN REALLY POSSIBLE.

You know how everybody wants to make an automated mixdown system, but hasn't discovered how to process and store enough mixing information to create a really complete system? (not just gain, but equalization, echo, panning and the whole bit). Well, our memory processor can.

1. It can process and store as many as 256 separate mixdown functions on a single track of the master tape, a cassette machine or, in fact, anything that has a 5kHz bandwidth and a 35dB signal to noise ratio.
2. It features a 90dB range of highly accurate, infinite resolution control.
3. Fast update speed of 800 microseconds per function (it can scan 128 functions at the rate of 10 times per second).
4. Its failsafe system renders immunity to dropouts, splices or level changes.
5. Simple and trouble free circuitry requiring no alignment tone or tricky adjustments.
6. Separate encoder/decoder which can be built up from as few as 16 to as many as 256 functions, by simply plugging in cards.

Now then, Mr. Processes, why are we telling you all these things? Well, we didn't just happen to find your name in the yellow pages. It happens that we think your company is swell. In short, let's make beautiful automation together. (Call me at (615) "ALLISON")

Love,
Allison
XOXOXOXOX



AUTOMATED PROCESSES, INC.
80 MARCUS DRIVE, MELVILLE, NEW YORK 11746 - 516-694-8212

Dear Allison,

Great! Your memory processor is just what the industry is looking for. Let's get together and create a total AUTOMATED MIXDOWN SYSTEM that will knock the audio world on its ears!

Sincerely,

Low Lindauer

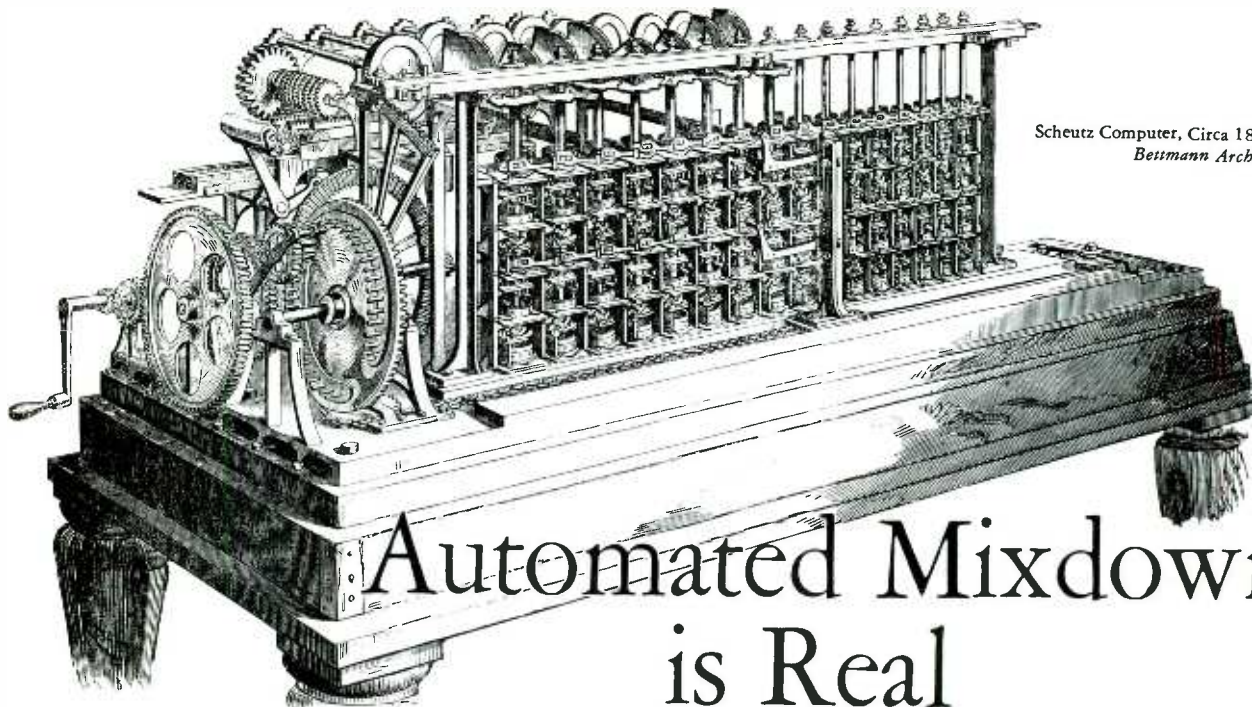

Automated Mixdown is Real

Automated Processes proudly announces The Automation System. The one that's available today, yet is capable of satisfying tomorrow's needs. Capable because we've engineered into it the capacity to automate virtually all mixing functions instead of just a few.

Let's face it, when you get into automation, you won't want to replace your system in a few months or years because of insufficient capacity to store and control all necessary functions.

Here is what we have to offer:

- **256 function capability.** The significance of this will become apparent when you consider the following suggested utilization format:

- Function 1-16, individual channel gain
- Function 17-32, individual channel echo send
- Function 33-48, individual channel stereo panning (left/right)
- Function 49-64, individual channel quad panning (front/rear)
- Function 65-128, individual channel equalization (four functions per channel)
- Function 129-144, master levels, echo returns, etc.
- Function 145-256, 24 track and other future functions

The system may be purchased with as few as 16 or as

many as 256 functions. It is user-expandable in blocks of 16 functions, simply by plugging-in additional cards.

- **Fast update speed of 800 microseconds per function.** This allows rapid changes in mixing parameters. For instance, a 128 function system will update 10 times per second. The updating rate automatically changes to accommodate the number of functions being stored. If you expand the system in the future, it will still automatically accommodate the tapes made before the expansion.

- **Stepless, highly linear control over a 90 dB range.**
Accuracy: ± 2 dB over the first 40 dB
 $+0, -2$ dB from -40 to -60 dB

- **Failsafe circuitry.** This prevents adverse reaction to drop-outs, splices or level changes. Splicing and "punch-in" are possible, as is quasi splicing by switching from one encoded track to another. Internal memory circuits even protect against dropouts in excess of 60 seconds.

- **All encoded information may be contained on one track of the master tape,** or on any other medium capable of a 5 kHz bandwidth and a 35 dB signal-to-noise ratio. Ideal for storage on a cassette, etc.

- **The system and its components is available for retrofit into existing consoles,** as well as for inclusion in new equipment.

This is only the beginning. See us at Booths 40 and 41 at the AES Convention for a live, real-time demonstration, or write for details.

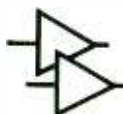

AUTOMATED PROCESSES, INC.
80 MARCUS DRIVE, MELVILLE, NEW YORK 11746 • 516-694-9212

LARGE CONSOLES



SMALL CONSOLES

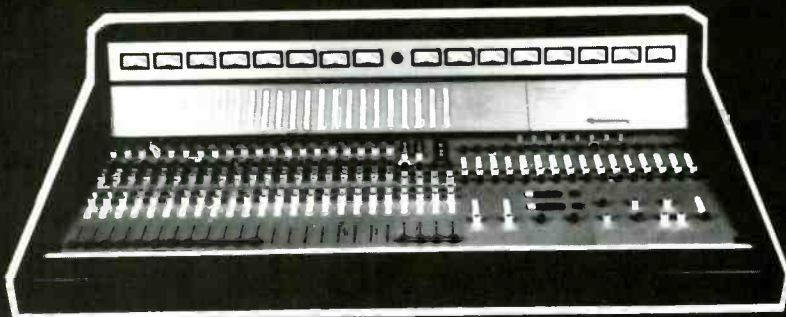

CUSTOM CONSOLES

Before you purchase your new console, think first of SPECTRA SONICS

QUALITY

Guaranteed to outperform any console in the world in noise, distortion, frequency response, and peak overload.

RELIABILITY

The Model 101 Audio Amplifier, the heart of all consoles, is guaranteed in writing by SPECTRA SONICS for a period of two full years against any defect.

For guaranteed performance and reliability in professional audio consoles contact SPECTRA SONICS at:

770 Wall Avenue
Ogden, Utah 84404
(801) 392-7531

6430 Sunset Blvd., Suite 1117
Hollywood, California 90028
(213) 461-4321

SPECTRA SONICS

LEADER IN ADVANCED TECHNOLOGY





an R-e/p report of conversations with the STAX engineering team, winners of the NARAS Grammy Award for 1971's BEST ENGINEERED RECORDING (non-classical): Isaac Haye's THEME FROM SHAFT.

BUSH CAPONE PURPLE

ENGINEERS OF THE YEAR:

**DAVE
PURPLE**

**HENRY
BUSH**

**RON
CAPONE**

by RON MALO

TOTAL CONCEPT SOUND

"Straight ahead engineering . . . you can really dig the hell out of Isaac's arrangements . . . the music is just a gas . . . the ultra clean, bright top end . . . the bottom end that's good and fat, and just kind of pushes up to the top end . . . like it's just a perfect blend . . ."

These were the initial comments of Dave Purple, Ron Capone and Henry Bush, when R-e/p visited STAX in Memphis to analyze the success of their recording of SHAFT.

To start the interview R-e/p made the observation that it was pretty unique that three guys, individually, had such a good idea of how the end product was going to sound, as they each laid down certain tracks.

Speaking for all, Dave Purple retorted, "We didn't."

There was unanimous agreement, as Ron Capone stated, ". . . Isaac writes and arranges so that everything follows in place . . . even though he might use a lot of instruments, and there are

lots of things happening . . . everything has got a spot in the recording."

As was further explained, the LP release of SHAFT was independent of the film score recording.

DAVE PURPLE: ". . . the film score was already done, and Isaac was not happy with the film score recording to be used as the record release. He wanted to do an actual record version of the same material. After having seen the film and listened to the movie track it sounded, to me, really sterile . . . but there were some things on it we didn't have on the record . . . like, at the end they had a cymbal that just came whooshing up out of nowhere; that really knocked me out. You could hardly hear it being struck . . . almost like it was being hit by a mallet. It just came up and over everything and faded out again.

"But, the idea was to get the LP version done fast . . . it had to be out quick."

R-e/p: Henry, you cut the rhythm tracks first?

HENRY BUSH: "The musicians knew all the tunes from the flick, that's why we wrapped it up so quickly. They were laying down the same songs they did for the movie. It was a head arrangement based on the movie score, but they didn't try to copy the sound track at all; just set the same tempo, though. They did use a metronome on every tune."

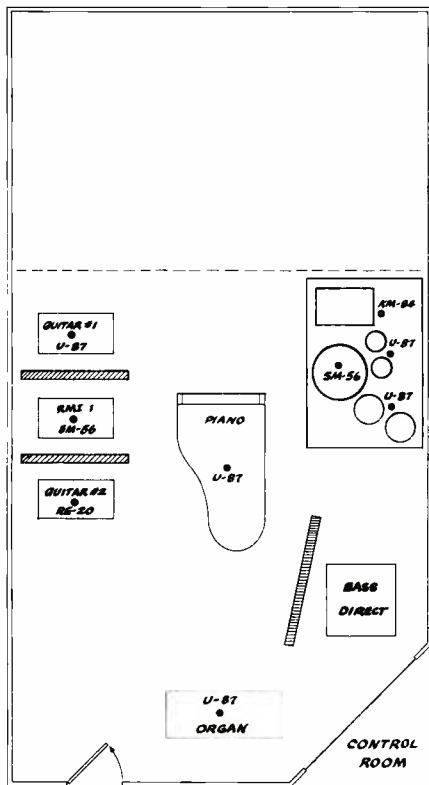

"We used two guitars, a piano, RMI, a bass and drums. On guitars I used an SM-56 on one and a U-87 on the other. Piano was a U-87. A KM-84 on the snare. Bass drum was an SM-56. A U-87 on the tom-toms; between the two small toms. Also a KM-84 on the high-hat. I miked the high-hat and the snare with the same mike . . . picked up with that one KM-84."

"Basically, on the whole album we used 8 tracks for the rhythm. Bass on one, guitars on two and three, RMI on four, snare on five, tom-toms on six and seven, bass drum on eight. We went back and overdubbed the piano. It came up, I think, on track eleven."

"On the SHAFT THEME cut there were three pianos; one live track, and two overdubbed tracks."

DAVE PURPLE: "Yes, on every cut but the SHAFT THEME we put Isaac's vocal on right after the rhythm tracks, and after that we put the vocal group on. But on the SHAFT THEME we had to do Isaac and the group together because they had those answering kind of lyrics on the vocal."

RON CAPONE: "Right, on the SHAFT THEME, that was after everything else was done. Isaac had done a lot of overdubbing, tympani, vibes, tree bells, whatever . . . he played all the miscellaneous stuff himself . . . he did it all. That night he asked me how many tracks we had left. I told him, just one. One was just enough to finish the cut, because we cut Isaac and the group together."

R-e/p: What microphones did you use on Isaac and the group?

CAPONE: "I always used the same mike on Isaac, an AKG-451 . . . riding him constantly . . . on every breath . . . without a limiter."

R-e/p: What qualities do you see in that mike?

CAPONE: "The presence that we got out of it. The good low-end; I could back it off him a pretty good distance over his head, and wouldn't have to worry about him puffin (poppin). Nobody else could sing on that mike, Isaac was the only one. He really learned how to work it."

R-e/p: Does he have a tendency to work up closer to the mike as he really gets into a song, or does he stay back?

CAPONE: "We used earphones . . . he knows when he is going to do the low things, and he can feel me riding him, I'm sure, as he is going down for the low points; 'cause I ride every breath. That's another reason I use that AKG, 'cause the top end is so good, and we get a lot of his sexy breath on there. That's one of his gimmicks, I guess. So we ride him pretty close and he learned to work the mike to where he wouldn't puff it. I guess the mike is a good 12" over his head."

"You remember, Henry, we really put it up over his head, and yet really got presence. It just proves a point; you don't have to be working 3" from a mike to get presence."

BUSH: "That's right. Isaac's voice is just so resonant, the low end is so beautiful on it, it really picks up."

R-e/p: What about the background voices, how many are there?

CAPONE: On the LP, generally, there are 3 voices, doubled; with limiting. Although you almost don't need limiting with them; they are almost hung right in there without limiting. Isaac does some background, too, with the group; he gets in there and takes a part sometimes."

R-e/p: Dave, you did the sweetening sessions?

PURPLE: "Yes, it was one of the most unusual set-ups I ever ran into, 23 instruments. Nine violins, three celli, an electric string bass, three flutes, two french horns, three trumpets and two trombones . . . all at once."

"I think Johnny Allen, the arranger, could have been writing some of the viola parts into the second strings. It was beautiful."

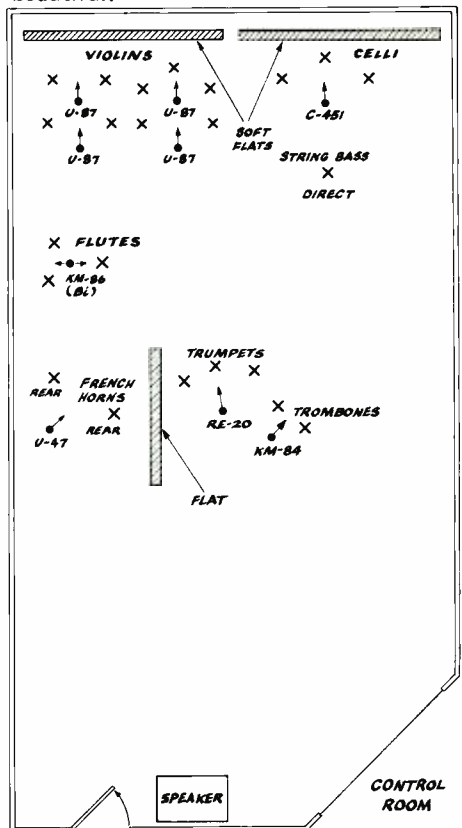

"I wound up putting U-87's on the violins; using an AKG 451 on the celli, and it really surprised me how well it picked up the three of them. On the trumpets we used an RE-20. The trombones were picked up by a KM-84, with the french horns on the old reliable U-47. The flutes were on a KM-86, bi-directional; two guys on one side and the other guy on the other side. With this set-up I was getting strings on the horn"

HENRY BUSH: "I have been here at STAX since 1969. I had been working in a record shop and I used to run in here all the time asking Ron Capone all kinds of dumb questions about recording. They finally gave me a job here, cleaning-up. After about 6 months I got a chance to do a couple of sessions for Isaac; the first was a Christmas song "Mistle-toe & Me" and since I have been working regularly on his things."

MIX MASTERS

The virtues of Yamaha Grands can be heard on hundreds of thousands of feet of tape. Clarity. Power. Rich, full tone. Textural versatility. Dynamic versatility. Yamaha Grands (like this C-7) will help you get it all down, exactly the way you and your talent want it.

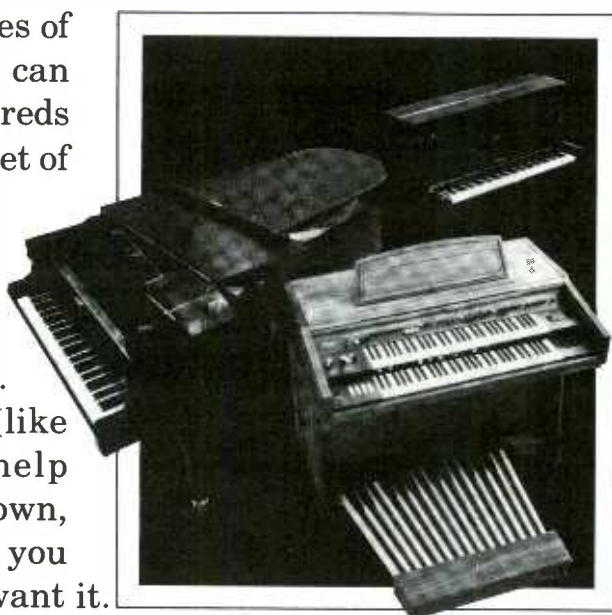

The Yamaha Electone E-3 is more than a complete professional organ. It's literally a control center for hundreds of colors, rhythms, sound effects, and textures—some unavailable in organs costing twice as much. It can help keep unexpected problems or surprises in a session from turning

into glaring holes.

Yamaha Verticals are the closest you can come to grand pianos without grand pianos. The U1-D, for instance, has impeccable tone quality and response quick enough to please the most finicky talent. And Yamaha Verticals are made to endure, session after session, year after year.

 **YAMAHA**

Yamaha International Corp., P.O. Box 6600, Buena Park, Calif. 90620

C7 Grand Piano Name _____

U1-D Upright Piano Business _____

E-3 Organ Address _____

Other City _____ State _____ Zip _____

Send for complete specifications and dealer information.

mikes, not the other way around. In other words, the two string tracks were recorded in stereo; celli on the right – violins on the left, and I split the bass in the center. The horns were done the same way; trumpets left, trombones right and, I think, flutes and horns in the center.

“Everything was cut dry, with echo added on the re-mix. Just recently though, as I began to know his things better, we have been doing all his strings and horns, cutting with echo.

CAPONE: “Cutting dry, I really believe in that . . . putting echo on it . . . you can’t take it off.”

PURPLE: “Well, there is another way to look at it, too. On certain instruments I like more echo than on others. By adding echo later, you are adding blanket echo, whereas, if you do it tastefully; I’m not saying go overboard to put too much on – granted you can goof – say, if you put a tasteful varied amount on your different instruments, then you can still go back and add more blanket echo to get what you need.”

R-e/p: What type of echo did you use?

PURPLE: “EMT . . . one stereo EMT for the whole thing, with a lot of EQ. We were hearing a pretty bad low frequency boom coming back from the EMT, which is kept in a room next to Studio B. At that time there was a wailing rhythm section being cut in ‘B’. The input I wasn’t worried about because we’ve got them rolled off all the way, so I think we were dumping about -6 at 300Hz and boosting +4 at 10kHz on the top end to get it a little brighter on the EMT returns.”

R-e/p: Any tape delay?

PURPLE: “No, on this album I didn’t use any.”

CAPONE: “I don’t know if you guys used any. I did on some of the stuff I did. I can’t remember if I did it at 30 or 15 ips. I think it was 30 ips because . . .”

PURPLE: “. . . if you did it on a Scully, you did it at 30. The difference between 15 and 30 tape delay on some machines is not that one speed is different than the other, it’s that the spacing between the *record* and *play* head is different. On the 3-M machines 30 gives you about the same delay as the old Ampex did at 15 ips. It becomes

confusing to some people because they think that you use 30 because 30 gives something different than 15. It all depends on the machine. You can use a VSO on the machine to get exactly the right amount of tape delay. . .”

MIXDOWN

R-e/p: Let’s talk about the mix-down?

PURPLE: “You have to remember that the whole thing had to be done in a hurry. The whole SHAFT LP was mixed in 3 1/2 days. SHAFT really was sort of a one take mix. We ran it through once, of course, positioning the string and horns as noted on the box, and then added the echo we felt was necessary.”

R-e/p: Did you do the mix, monitoring in stereo?

PURPLE: “Yes, at quite high levels; too, on JBL 4320’s. It was a super bright mix – especially in retrospect. Then there were a few things that Isaac wanted to pop-out in the rhythm section, at various places that had to be mixed. They were laid in, I think, kind of at 0 on the track. But the rest was mixed on the fly as each of us recorded. The musicians played most of the dynamics.”

CAPONE: “You just get a nice level, and let him rip, and the musicians take care of the necessary dynamics.”

PURPLE: “Like you, Ron, (Capone), I think three people should not play dynamics – bass – piano – organ. They have a habit of going from too soft to, too loud. . .”

R-e/p: What happened on the cut of “DO YOUR THING?”

PURPLE: “Ike had this tune, “DO YOUR THING;” it started at the head of a 16 track reel and went from the head to run-out, a 31 minute side. He said we’ll use as much of it as we need on the fourth side and then just get out of it. I had this idea for a dramatic way to get out of it. After about 10 minutes of the tune I just stopped the recorder and inter-cut a piece of tape about 18” long I had recorded of a phonograph needle being raked across a record. From there we just faded into the end theme. That needle scratch really snaps the listener around.

“The only technical thing I want to mention about that needle scratch was that I thought we might run into some

really bad problems in disc transfer with all that real high level high frequency energy. So, I used a 70Hz cut-off, and a low-pass at 5kHz, I also recorded it through a Dolby in play mode, which would tend to reduce it even more. It still scares hell out of me everytime I hear it .

“We had a hell of a time convincing people that we meant for the scratch to be there. Every one of the pressing plants called to tell us they had bad sets of *stampers* with a great scratch on one of the sides.

R-e/p: How did you use noise reduction in the production?

PURPLE: “It was mixed to the two-track using Dolby. On 3M 202 tape . . . that was before we switched to 206.”

CAPONE: “You know, we mixed several versions of the SHAFT THEME because of the curse words. They were mixed further into the track; or just punched out on the mix.”

PURPLE: “A lot of pop stations wouldn’t have gone for the LP version.”

CAPONE: “I think the one that did not go for it, and the reason the single was started that way – we had not intended on releasing the single in that way at all – was that WABC in New York told us to give them a version without certain words and they would play it. So we made that especially for WABC in New York.”

PURPLE: “Also we had to edit the SHAFT THEME single to cut it down from over 4½ minutes to 3½ minutes, so we were able to dump a couple of the words there. One guy who wrote us was highly incensed about the fact that the single didn’t match the LP.”

R-e/p: Are you saying that the version of SHAFT played during the Oscar and Grammy shows were the record version, not the movie version.

PURPLE: “That’s right. That’s another trip in itself. The version I sent to whatever TV station did the production for the Oscar ceremony, I re-equalized the 45 version using a 6”x9” cue speaker for them.”

R-e/p: You mentioned that the LP was a son-of-a-gun to disc master, why?

PURPLE: “Yes it was . . . because of the brightness. The whole album was very bright. There was an incredible amount of

RON CAPONE: “I came into Memphis as a drummer for a jingle company (Pepper Tanner) and was there for 9½ years; 3 years as a player, mostly. About a week after I started, I got into editing and was taught recording step by step by Welton Jetton who now owns MASTERCRAFT and AUDITRONICS. Eventually I got pretty good at track sessions and after 3 years went full time into engineering. I came over here to STAX (when it was still part of Atlantic) and watched this place grow for 5½ years.

Now I’m over at Trans Maximus; (TMI Records, distributed by RCA) where I am producing TOWER OF POWER (whose “YOU’RE STILL A YOUNG MAN” was 47 with a star on Billboards August 12, chart), and engineering Jeff Beck and ose’ Feliciano albums at TMI.”

DAVE PURPLE: "As a kid I got involved with ham radio, and that is where I began to have an interest in electronics. I also played keyboard for 18 years and went to college not knowing whether I wanted to be a classical pipe organist or an E.E. Got discouraged with college, joined a band — Crying Shames — and played bass with them a couple of years. The guy who cut our hit record, Stu Black; the only engineer I have known who could consistently make a bad group sound good, got me into the recording business. After a couple of years working in small Chicago studios I ended up working with Stu and Ron Malo at Chess for 3 years. That was until Ron Capone hired me down here.

high frequency excursion on the disc, especially on the first cut.

"For example, the high-hat cymbal on the intro was laid in somewhere between — 20 and — 10, there was an incredible amount of high frequency excursion. This caused a tracing distortion condition on the disc . . . where the frequency and level causes the groove radius to become smaller than the tip of the playback stylus, so rather than tracing the groove evenly, it sort of slides over the mountain tops, as it were. You get distortion. The same thing can be caused by vocal sibilance, tamborines, closed high hat cymbals . . .

"When I mixed the SHAFT THEME down I had only been here at STAX a short time, and I had come from a studio using different monitor speakers. So, I really wasn't sure what I was getting on the tape . . . I didn't realize it was so bright."

CAPONE: "Having been here as long as I had, I did think it was a little bright . . . but it sounded good, and naturally after that I had to go with Dave's mixes, on the ones I did, to keep the LP sounding the same. — So I played his mixes and matched them."

PURPLE: "It sounded good to me on those speakers, and I figured, well, let's go with it. Boy, that thing sure sounded super over the radio.

CAPONE: "Sure did."

R-e/p: Generally in the mastering channel you add more brightness, usually due to the record being played back at lower level than you mixed it at, and you

lose some of the apparent brightness.

PURPLE: "We didn't have to add much brightness to this one."

R-e/p: Who did the disc cutting?

PURPLE: "It was done at MASTER-CRAFT here in Memphis by Howard Craft; no pun intended. They did all of our discs until we got our own channel."

R-e/p: What were your instructions when you sent it over to MASTER-CRAFT?

PURPLE: "I went over with it. The first cut was done, actually, I think, with a -2dB roll off at 15kHz plus the usual 18dB per octave hi-lo pass filter, and, I think, we chopped the hi and low end. 70Hz at the low end and 15kHz at the top end. With the exception of the first cut, all the rest was boosted +2 to +4 at 10kHz, and the low end was cut flat.

R-e/p: Did you use a low frequency crossover?

PURPLE: "Yes, we used a 250Hz low frequency rollover because, primarily — I had them do that because most of the low frequency information was mixed in the center anyway. I just wanted to pull, in terms of mechanical compatibility, playback compatibility, I wanted to pull the other existing low frequency material a little more into the center."

R-e/p: Would you say that in the recording process the greatest variable is in the monitoring — what the engineer himself thinks he is hearing?

PURPLE: "Face it, the loudspeaker is the final link in the recording process, whether it's tape mastering or playback in the home — what sounds so great on your

studio monitors can easily sound so bad on someone's Magnavox, TV Stereo Console in their home — it's incredible."

R-e/p: Do you feel possibly that the record has a good feeling, and sound, because it was not over-produced — that it had that natural live feeling — and that's substantially why it won the Grammy, in addition to your opening comments?

CAPONE: "I think that's part of it. I also think the nice bright top end had a lot to do with the listener. The listener put that record on and it's brighter than the rest he is playing — he'll dig it — and that's what you've got to look at, the final product — he's gonna imagine it sounding better."

PURPLE: "After having heard the other Grammy nominees, that WINGS thing, done by Larry Levine at A&M, and Armin Steiner always does a beautiful job on the Neil Diamond stuff — and the others, that's damned stiff competition."

R-e/p: How do you feel about the brightness of the mix now? . . . is it too bright?

PURPLE: "I still don't think it was too bright — it was just very bright . . . and it wasn't, as I've said, the easiest tape to transfer to disc — but it wasn't the hardest I've done either."

R-e/p: Had you known about the problem, would you have toned it down a bit?

PURPLE: I don't think so — in retrospect . . . HELL NO! IT WAS A HIT RECORD.

Ron Malo

Total Concept Sound

NATIONAL COUNCIL OF RECORDING ENGINEERS (NCRE) FOUNDED

With formative meetings already having been held in Los Angeles and New York, and with a Nashville meeting scheduled shortly, NCRE has been launched by a number of well known recording engineers.

An interim board of directors representing a national cross section of the industry has been elected:

Larry Levine A&M (temporary chairman)

Gary Blum, Columbia

Chuck Bronier, Sun West
Dave Gold, Gold Star
Shelley Herman, Artist's Recording
Jerry Ragovoy, Hit Factory
Phil Ramone, A&R
Pen Stevens, Record Plant
Allen Ballentine, RCA

The council, it was stated in their release, was formed to provide recording engineers with a voice in the development of new equipment. It is felt by the council that this will prove beneficial to both the engineers and manufacturers.

In an initial action the Association voted unanimously to discourage the advent of 24 track recording machines.

The group feels, according to their statement, that the ability to interlock tape machines is already existent, and that the recording industry would be better served by refinements of the interlock techniques.

The next Los Angeles meeting is scheduled in Hollywood at the A&M Recording Studios, at 8:00 PM on September 6. All professional recording engineers are invited to attend and to apply for membership.

Inquiries can be directed to Larry Levine at A&M Records, 1416 North LaBrea, Hollywood, CA 90028.

PRICE BREAK

FOR THE FIRST TIME IN THE INDUSTRY

16 CHANNEL CONSOLE FOR \$29,950

(. . . it used to cost \$40,000)

**We just got rid of \$10,000 in wiring
and now offer the most trouble-free
console in the business**

We've cut costs dramatically in redesigning this total 16 channel full-featured console . . . without sacrificing quality and performance. Use of trouble-free printed circuitry let us eliminate literally miles of costly hand wiring. In this new NRC Series Console you still get the high reliability Audio Designs engineers into its custom consoles, with such features as three Cue Busses, two Solo Systems, complete Sync System, complete Tip, Ring and Sleeve Patching, Full Quadraphonic Capability with four Joy Sticks, and many more features. And you get the flexibility and convenience of interchangeable plug-in modules. But now you get these deluxe features for thousands of dollars less. There are no other consoles on the market like the NRC Series for anywhere near the price, whether you require an 8 or 16 channel model. And all have expansion capabilities of up to 24 inputs. Write or call collect today for the complete money-saving story. (Unless, of course, you're willing to pay for wiring you don't need.)

**AUDIO DESIGNS
CONSOLES
FEATURE
PLUG-IN
MODULES
TO PROVIDE
COMPLETE
FLEXIBILITY**

THROUGH!

YOU CAN BUY A FULL-FEATURED

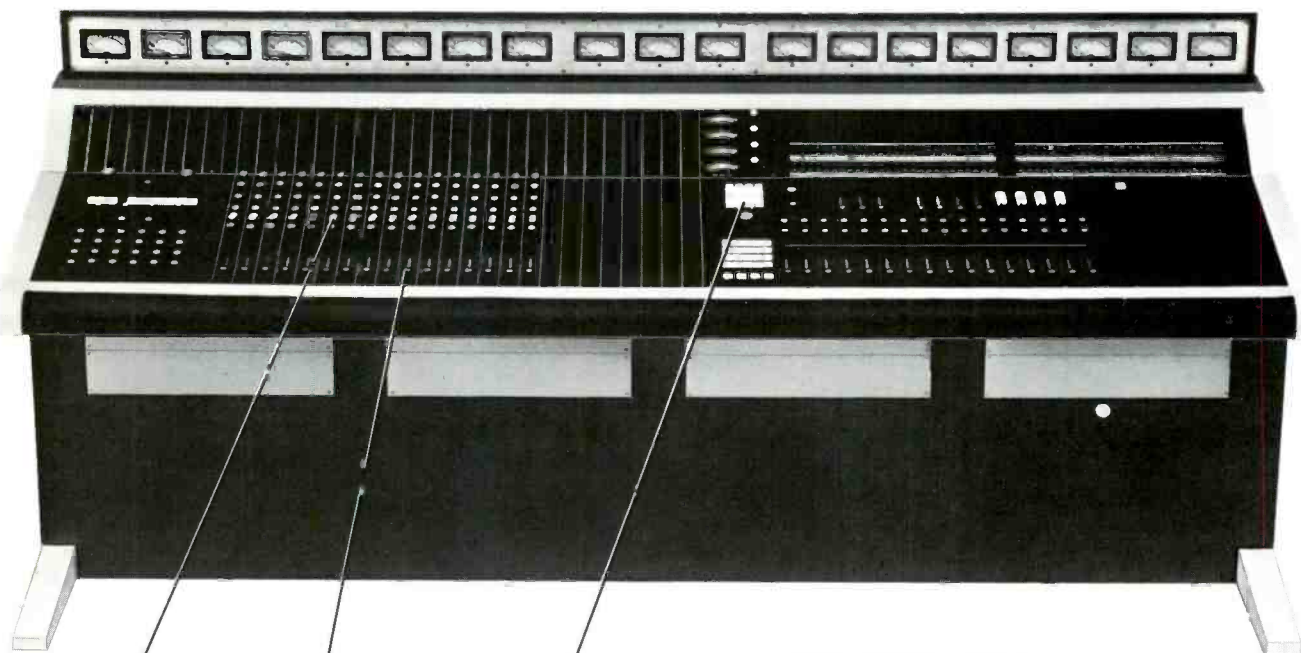

Model NRC-1616



INPUT MODULES

Versatile input strip features op-amp circuitry and four-section equalizer. Input overload light and Solo button are also included. Everything required at an input is in one convenient plug-in module.



SLIDEX

Unique, noise-free attenuator uses sealed elements. No contacts to clean. Even spilled coffee won't cause noise problems. Guaranteed free from noise or other defects for five years.



AUDEX*

Ultra-reliable switching system uses magnetic reeds governed by this compact control panel. Switch modules, mounted above inputs, include illuminated readouts for instant reference.

*U.S. Patent Nos. 3626097, 3631470

COMPONENTS & CONSOLES
for audio control



AUDIO DESIGNS
and Manufacturing, Inc.

**AUDIO DESIGNS and
MANUFACTURING, INC.**

16005 Sturgeon
Roseville (Detroit), Michigan 48066
Phone (313) 778-8400

New from Dolby

The M16: a compact sixteen-track noise reduction unit

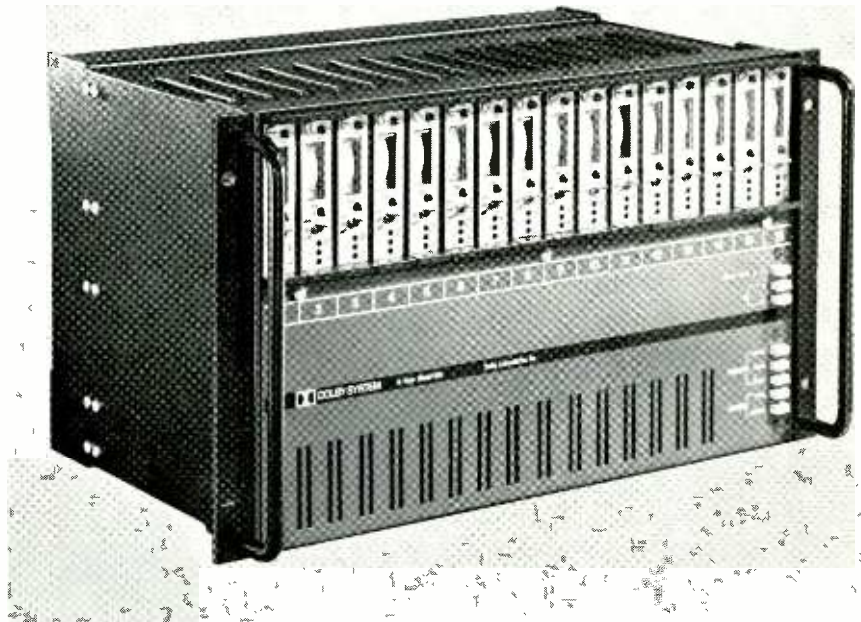

New monitoring facilities in record, play, and recorder rest modes.

All solid-state control logic and signal switching.

Simple remote operation of all functions from console and recorder.

Standard Dolby A-type noise reduction characteristics.

New, simplified line-up procedure.

Complete self-contained power supply and interface circuitry.

Add-on A8X provides simple expansion to 24-track operation.

Only \$8,000 for full sixteen-track capability.

The Dolby system has become an integral part of modern multi-track professional recording practice. A new unit, the M16, has been developed for these applications and is now in production.

In addition to the obvious economy of space, installation time, and maintenance which the M16 offers, its cost per channel is substantially lower than that of other Dolby noise reduction units.



Dolby Laboratories Inc

1133 Avenue of the Americas
New York NY 10036
Telephone (212) 489-6652

346 Clapham Road, London SW9
Telephone 01-7201111

Tiger Building 30-74-Chome Kuramae
Taito-Ku Tokyo
Telephone 03-861-5371

Circle No. 112

Full information about the M16, including accessories, auxiliary and independent eight-track units, and prices, available upon request.

'Dolby' and the double-D symbol are trade marks of Dolby Laboratories Inc.

*What is AUTOMATION expected to do?
When will AUTOMATION be available?
How does AUTOMATION work?
What is AUTOMATION going to cost?*

THESE ARE THE PARAPHRASED QUESTIONS WHICH R-E/P HAS ENCOUNTERED IN VIRTUALLY EVERY STUDIO WE HAVE VISITED DURING OUR TRIPS ACROSS THE COUNTRY, THESE PAST FEW MONTHS.

TWO THINGS ARE READILY APPARENT. FIRST, THAT THE RECORDING INDUSTRY'S INTEREST IN AUTOMATION IS INDEED GREAT. SECOND, THAT THERE CLEARLY HAS BEEN A LACK OF HARD LINE INFORMATION GENERALLY AVAILABLE TO ANSWER THE RECORDING INDUSTRY'S QUESTIONS ABOUT AUTOMATION.

WHAT FOLLOWS, ARE THE SOLICITED, UNEDITED, STATEMENTS OF SEVEN MANUFACTURERS WHO WERE KNOWN TO HAVE AUTOMATION ENGINEERING DEVELOPMENT PROJECTS UNDER WAY. THESE LETTERS PUBLISHED IN ALPHABETICAL ORDER MAY VERY WELL FORM THE CORE INFORMATION AROUND WHICH THE CONTINUING AND VITAL DISCUSSION OF AUTOMATION (WHAT MANY ARE CALLING THE NEXT TECHNICAL REVOLUTION IN AUDIO RECORDING) WILL CENTER.

R-E/P



ALLISON RESEARCH, INC.

We, at Allison Research, Inc., are very happy to announce the introduction of our Automated Mixdown Memory Processing device. To set things straight, the device will not be marketed through normal Allison channels, but will be exclusively available from Automated Processes, Inc., in conjunction with their line of peripheral automation equipment.

In designing the device, we placed extreme emphasis on the eventual system, rather than on satisfying today's needs. Our research, in the area of Automation Feasibility, has led us to two primary conclusions:

1. The eventual automation system will require a memory which is capable of processing and storing enough mixing information to automate essentially all variable functions on the board. (Gains, echo sends, panning, equalization, master levels, echo returns and etc.)
2. The ideal storage medium will be one that is permanent, inexpensive and convenient. This would tend to rule out

disc memories, integrated circuit memories and other computer peripherals. Two logical media remain: (A) Unused tracks on the master tape itself. (B) An external cassette type machine.

It is my opinion that initial automation systems will use the master tape as a memory, while systems developed in the near future will likely employ a cassette machine.

Further conclusions which we arrived at were:

3. Any memory processing device marketed today should be engineered so that it is readily expandable to fulfill future needs, without format or "code" changes. Future expansion should be accomplished without the necessity of "throw away" parts or other purchaser headaches.

4. Separate encoder/decoder packaging would be nice for such applications as remote controlled consoles, etc.

5. Thorough, dependable fail-safe circuitry is a must, to prevent inaccuracy from causes such as drop-outs, splices and level changes. The device must be capable of operating satisfactorily on moth-eaten

master tapes.

6. Updating times must be fast enough to faithfully follow the manipulations of the mixing engineers real time performance.

7. Dynamic range, or range of control, must be in excess of 80dB, must be extremely accurate and should be stepless in order to achieve smooth control.

8. Accuracy of the system should be independent of levels recorded, and should be compatible from unit to unit, and from studio to studio.

In the creation of the Allison Programmer, we were able to meet all of the requirements above, but not by totally conventional means. It would seem that a purely digital approach, although quite attractive, suffers certain limitations in some of the areas listed above, these being primarily:

1. Difficulty in obtaining the desired density of information on audio bandwidth recorders.

2. Difficulty in achieving the desired resolution over the required range of control.

3. Extreme sensitivity to drop-outs and splices.

4. Inordinate cost and complexity.

We settled on a unique combination of both digital and analog techniques in the final design of our programmer. The end result is that IT WORKS.

Sincerely,
Paul C. Buff
President/Allison Research



AUDIO DESIGNS

and Manufacturing, Inc.

Automation? Why is it necessary? How complex should it be? What features need to be automated?

The above are many of the questions that Audio Designs and Manufacturing's management and engineering personnel had to answer before proceeding with the research and development of such a system. The first question to be answered is why. With multi-track recording in its present form of 8 and 16 track and the hushed whispers of 24 track around the corner, it has become increasingly more difficult for today's mixer to produce a finished product in a reasonable amount of time. In the average remix session of today, the mixer is faced with 16 level pots from the recorder, echo send from each track echo return, masters, quadrophonic positioning, and possibly one through four "joysticks." This, of course, does not include any special effects such as phasing, delay echo, etc. It is inconceivable that one human mind is capable of remembering the position of all these controls. The only answer in such a case is some assistance offered to the mixer. We have coined a phrase at Audio Designs called "CAM." "CAM" stands for *computer assisted mixing*. With the system to be outlined, the mixer is now free to put his creative talents to work and permit a machine to remember the creativity that has been put into the original mix.

How complex should an automated system be? A recording console can be broken into a few major areas; attenuator settings, equalization, and delegation. Looking first at equalization and delegation, most would agree that these are readily pre-settable and are not often quickly changed in a remixing session. On the other hand, attenuator settings (track level, echo, quadrophonic panning, etc.) are constantly being changed and it is in this area that the mixer needs "CAM."

Although there are many engineering approaches to "CAM" it must be readily agreed that the ultimate objective of such a system should be to remember, and

repeat without error, any attenuator setting in a mixing console.

Looking at some of the basic prerequisites for such a system we concluded the following: The system should have 100 attenuator capability. The fastest change that can be made from full off to full using a slide attenuator is 10 milliseconds. If we wish to have 100 attenuator capability we then need a 100 microsecond scan rate, i.e. an attenuator position will be interrogated every 100 microseconds. Although there are a variety of methods that can be used in storing and processing the encoded attenuator output, the one that lends itself to the best repeatability is a digital word system. The "CAM" system will use both slide and rotary attenuators that generate digital words, and the controlled element will be a digital voltage controlled amplifier (DVCA). Either two channels of a master recorder or a slaved stereo recorder will be necessary for storage and up-date of the system.

The front panel controls of the automation system will include only three additional pre-select buttons associated with each attenuator. These buttons will have the call outs, *playback* (playback of pre-recorded automated signals), *record* (recording of an automated signal), *preview* (listening to some number of pre-recorded automated signals, while rehearsing the changes required on some additional tracks). In addition to the pre-select buttons associated with each attenuator will be two master buttons; record and playback. These buttons will control both the tape recorder and the attenuator pre-selects. One important aspect of any new system is how it will effect both end product and revenues? Obviously, such a system will require a capital expenditure. This investment will pay off by producing a superior product in less time and permitting fuller utilization of the studio facilities to a larger clientele.

Sincerely,
AUDIO DESIGNS AND
MANUFACTURING,

Robert A. Bloom
President



AUTOMATED PROCESSES

Automatic control of switching functions is becoming routine in the broadcasting industry to the extent that some stations now operate virtually

unattended. The control equipment involved varies all the way from simple timing motor sequencers to complete general purpose digital computers, but in all instances the desired functional sequences are known in advance and are pre-programmed to occur upon initiation of appropriate commands.

Automation of this type is not of major importance to the recording industry since it is virtually impossible to pre-program the required mixing functions, and it would be artistically undesirable even if it were technically feasible.

However, recent conversations with recording studio operators and sound mixers indicate a developing sophistication and awareness in their consideration of automation techniques applied to routine studio operations. While most studios continue to maintain a "wait and see" attitude, many have indicated that there is a genuine need for automatic assistance, particularly with respect to re-mix or mixdown from multitrack masters. Studios having complex and costly consoles for 16 or 24 track recording and quad mixdown find much of this equipment is seldom if ever utilized to the full extent possible. Mixers, being mere human beings, just can't manage to operate all the controls which have been made available to them, and as a result either ignore certain functions, make compromise settings, or rehearse mixes to the point of exhaustion.

The increased demand for mono, stereo, and quad master tapes for disc manufacture and tape duplication frequently results in the production of 3rd generation masters with consequent degradation, or in time consuming re-mixing from the multitrack master. Automation permits the recording of any number of exact 2nd generation masters, all conforming precisely to the original master artistically derived in the mix-down room. In fact, tapes and disc masters can be produced from the equivalent of a 1st generation master by copying directly from the original multi-track tape.

People who, only a short time ago, would have gladly settled for a means to automatically duplicate and update fader levels, now feel that provision for echo send, panning, "punch-in", track switching, equalization, etc., must also be available in any viable system.

Meaningful automation in the recording industry, whether music, film or commercial production, requires that

Everything you always wanted in a multi-track tape recorder...



The Custom Fidelity
"PRO MASTER 16" *
By Pak Associates

Total Price \$16,500.00
F.O.B. Hollywood, Calif.

* 24 Track Model Also Available

But never expected to find!

FERRAFLUX HEADS

Producing extremely low phase shift; long life due to all-metal face and large radius/deep gap configuration. Fixed azimuth and zenith. Dual gap erase heads assuring in excess of 64DB erasure.

DUAL CAPSTANS

Full servo controlled dual capstans provide precision tape delivery at all speeds, combined with a reversing idler for a closed loop system assures minimum flutter and short unsupported lengths of tape across the heads. No tape lifters required.

TAPE SPEEDS

15 and 30 IPS, with a variable speed control (Allowing approximately 50% variation above and below both 15 IPS and 30 IPS).

COUNTER

A five place digital counter reads out in feet and tenths of feet.

IPS COUNT

In the variable speed mode of operation the counter will display the exact speed in inches per second of the tape when the IPS count button is depressed.

AUTO REWIND

When the "play" mode is initiated, a zero reference is established and registered on the counter. Upon the "rewind" command the tape will automatically return to the zero reference and stop. An "auto rewind defeat" switch defeats this function if desired. There is also a manual "reset" switch to establish the zero reference at any time or in any mode.

EXTERNAL SYNC

Built-in resolver permits syncing with any external sync source or pulse.

THE CUSTOM FIDELITY COMPANY INC.
7925 Santa Monica Blvd., Hollywood, CA. 90046

NATIONAL MARKETING DISTRIBUTOR DEALER INQUIRIES INVITED

Circle No. 115

Phone (213) 654-7267

Page 25

the mixing console be equipped to self-program all relevant control functions in real time. In other words, the console and associated equipment must be capable of normal manual operation, but with the additional capacity to remember what was done, when it was done, and how it was done. It must then be able to precisely re-create the original mix any number of times without degradation while individual controls are re-adjusted to alter or improve any portion of the recording. Several techniques to accomplish this end have been proposed, and working prototype units have been demonstrated by a number of manufacturers. While none of the previously demonstrated devices were able to satisfy all potential requirements, they did serve to stimulate sufficient interest within the industry to make the development of a totally successful system inevitable.

All current and proposed systems have a great deal in common. Typically they employ some form of voltage controlled amplifier or voltage controlled attenuator (VCA) in each of the audio channels to be controlled. The VCA responds to a DC level obtained from the appropriate manual control, i.e., channel fader or panner, such that the audio output is proportional to the control setting. Each VCA in the system therefore, has a DC control voltage present at all times which corresponds with the front panel control settings. These DC levels are sequentially sampled and encoded in a programming unit which converts this level information into a signal which is compatible with conventional audio recorders. In a mixdown from multitrack tape, all encoded level information is recorded on one unused track or on a synchronized tape machine. In playback, the programmer decodes this data track to re-establish the DC voltages which were previously recorded. Updating or re-recording controls are provided to permit alterations to the mix to be recorded on a second data track, and this revision process is continued until a satisfactory mix has been accomplished.

We at Automated Processes Inc. believe that our recently developed Automation System has what it takes to become the industry standard. At the heart of this system is the Allison Programmer which avoids obsolescence by being capable of encoding any number of channels up to 256 for recording on any conventional tape recorder. Highly reliable error free playback is assured by a combination of analog and digital

techniques. The encoder and decoder units automatically expand the channel format in groups of 16 as additional cards are inserted. No other adjustment is necessary on either the programmer or the tape machine. In fact all tapes and programmers are interchangeable without adjustment so that tapes made in one studio may be played in any other studio having similar equipment.

The Fader Unit contains a standard API conductive plastic slide attenuator and all controls necessary to record, meter and update. This module fits in the space normally occupied by a conventional fader so no additional console panel area is required when converting to automatic control. During multi-track recording, an in/out switch allows the fader to operate as a conventional audio control, bypassing the VCA entirely. This switch also assures that the console can be operated manually in the event of a malfunction in the automation system.

Additional control modules and read-out devices are under development and will be available soon.

Who needs automation? The chances are you do. There is no longer a reason to delay the introduction of automation into current studio operations. A system is now available, at a realistic price, which can satisfy all present requirements and can be easily expanded to meet the needs of the future.

Sincerely yours,
AUTOMATED PROCESSES
Saul Walker
V.P. Engineering



FLICKINGER

The *Flickinger* Automated Remix Console is DIGITAL:

Digital programming with 8 bit control of Digitally Controlled Attenuators, thereby avoiding the noise and distortion problems associated with analog voltage controlled amplifiers.

Digitally Controlled Attenuators with 16 bit Digital/Analog accuracy and 8 bit access. 96dB of control range in 256 steps. Amplifier characteristics of overload recovery, distortion, and noise identical to *Flickinger* program amplifiers.

Unlimited digital memory with external tape system: each memory unit will hold 80 Digitally Controlled Attenuator words or 640 switch

functions for equalizer programming. Additional memory units can be added as required.

Parallel digital information in the memory units which permits digital word punch-ins eliminating the necessity to start from the top to revise and up-date.

Automatic digital tape rewind control and access to sections; pre-programmable punch-in controls which can also be used for over-dubbing.

Installation and maintenance simplicity with parallel digital information.

Constant accuracy of Digitally Controlled Attenuators after hundreds of transfers as stored digital information is never converted to analog during stored transfer.

Sincerely yours,

DANIEL N. FLICKINGER

MCI

In response to your request for information about MCI's plans for automation I will try to define our plans for you and your readers.

The term automation requires definition first. MCI has been "automating" control functions for multi-track magnetic tape recorders for some time and the status control system in the MCI JH-416 console is "automated" in a sense. However, what we feel is the immediate future of automation techniques in audio is what we will call *mixdown automation*.

With the growing acceptance of 24 track recording as indicated by our sales of the JH-24 recorders and 24 channel consoles, the burden placed on the engineer doing the final mixdown has finally exceeded the relative benefits of the additional track complement. Modern recording console systems which allow a full range of equalization, echo or reverberation effects, quadrasonic or stereo panning, and level control for each of 24 tape track returns present even the most talented audio mixers with a staggering array of knobs, switches, and faders. We feel that providing an automation system capable of sensing mixing operations related to level and panning performed in groups by the mixer and storing that information in digital form on a track of the recorder and then recovering the data and controlling those same functions directly, will allow the mixer adequate flexibility

continued on page 31

3M Introduces the Series 79 Professional Audio Recorders.

With Servo Control. And an Optional Synchronizer.

**They're the first
audio recorders that
won't become obsolete.**





Series 79,
24 track model.
Also available in
16 and 8-track models.

3M combines IsoLoop® differential drive with a unique package design to produce the smallest, lightest 24, 16 and 8-track professional recorders you can buy!

Standard Transport Features.

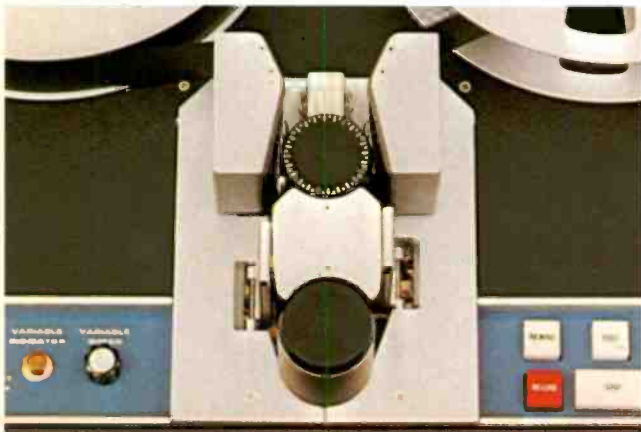

DC servo capstan with external control capability • Selectable 7-1/2, 15, 30 ips speeds • 5 to 45 ips variable speeds • Complete mode-to-mode logic • 50-60 Hz. 110V or 220V input for easy adaptation to domestic or overseas applications • Power failsafe • Edit capability • Remote transport control • Selectable wind mode tensions.

Standard Signal Electronics Features.

Separate equalization for synch • Broad equalizer ranges • NAB or CCIR equalization • Equalized for three standard speeds • Remote control for individual mode selection of any and all tracks •

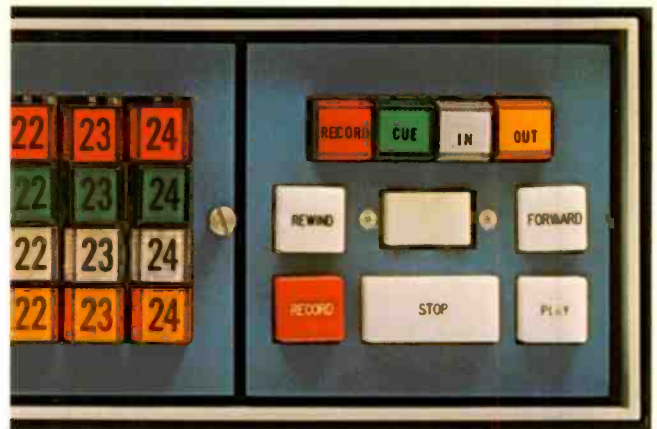

Single electronics card per channel • Signal electronics card is designed for noise reduction interface • Individual channel record failsafe warning.

Packaging Features.

Updatable: Recorder will not become obsolete. Space provided for state-of-the-art noise reduction circuitry.

Expandable: 8 and 16-track recorders can be quickly and easily expanded to 24 track.

Maintenance: Quick accessibility from front is provided to all systems for easy maintenance.

Styling: Design is sophisticated and elegant for harmonious studio color coordination.

Flexibility: Packaging allows for remote to be used as an integral part of machine or at console.



Series 79 Synchronizer.

Rack-mounted synchronizer is an optional accessory. It provides synchronizing capability to quadruplex or slant-track VTR, sprocketed machine such as mag track, or to audio tape recorders. SMPTE time code is utilized by the synchronizer to phase-lock the master and slave machines. Configuration of synchronizer is such that the audio tape recorder will always be the slave unit. SMPTE time code reader is included as part of the synchronizer system.



Regional Sales Offices

Western
6023 South Garfield Avenue
Los Angeles, California 90040
(213) 726-1511

Midwestern
220 East 21st Street
Chicago, Illinois 60616
(312) 225-7900

Eastern
4701 Lydell Avenue
Cheverly, Maryland 20781
(301) 773-9033

PROFESSIONAL AUDIO PRODUCTS
Mincom Division **3M**
COMPANY

300 SO. LEWIS RD., CAMARILLO, CALIF. 93010 • TEL. (805) 482-1911 • TWX 910-336-1676

to perform such other operations necessary for an artistically creative mix.

Automated control of level and panning alone will reduce the load on the mixer for direct manual control of mixdown functions. Automation of other console functions is possible although the complexity of the overall system would become reason for concern from both cost and reliability standpoints.

Considerable engineering development time has been spent on design of the analog/digital hybrid circuitry required to encode level and pan position data and to decode the digital data and control these functions. This circuitry is the key-stone of the mixdown automation system described. We have developed some novel circuitry for this. This engineering effort has been expended due to the noise and distortion problems associated with available analog hardware (VCA's multipliers, etc.) Problems of channel to channel tracking, and long term amplitude repeatability necessitates the use of digital technique. Also, if repairs are necessary the repaired module must track accurately to the control signals generated by any module. Due to these engineering complications, the lack of input from potential users, and the absence of any industry agreement on features or standardization of systems, MCI does not consider it prudent to market an automation system at this time.

Direct correspondence from customers desiring any type of mixdown automation system would be of great value and should be sent to:

Mr. Claude Hill
MCI Marketing/Engineering
MCI, Inc.
1140 North Flagler Drive
Ft. Lauderdale, Florida 33304

Sincerely,
MCI, INC.

Claude Hill
MCI Marketing/Engineering

The logo for Olive, featuring the word "olive" in a bold, lowercase, sans-serif font, followed by a stylized circle that resembles an olive.

Automation implies many things to many people. Automation is most commonly thought of for its use in industrial control processes where it replaces manual operations in the interests of more economic and more efficient production.

Automation in the recording industry, however, requires a different outlook.

The human input is mostly a creative or artistic one. While some work has been done to stimulate creative "thinking" using computers, in general automation in this industry plays the role of an assistant.

Automation in recording can be used to perform routine operations, provide a memory for information or simplify the man-machine interface problems. To do this, we must introduce new technology to existing equipment. One of the most logical locations to implement automation is in the console as this is center of the technical operations of the control room.

It is Olive's philosophy to provide automation in two basic areas — one assists during original recording and the other during mix down. During recording automation is used to simplify or eliminate as many of the routine operations as possible. As every mixer knows, during most sessions much of his time is devoted to non-creative, yet essential operations. This is particularly true when changing from one mode of operation to another, such as overdub to playback. Numerous controls, mostly on the monitor section of the console and the multi-track tape recorder must be operated.

Using sophisticated logic circuitry, most of these switching operations can be reduced to a simple choice of a few controls. Such things as Dolby or DBX switching, individual track mode selection on the multi-track tape machine and monitor and cue system selection can readily be handled by a small "computer" which analyses the status of all equipment, interrogates the panel controls, makes decisions and performs the routine operations. In this way, the mixer can be freed to concentrate on artistic input.

This form of automation is available in varying degrees from many manufacturers. It has been our intention to provide as complete a system as possible and use contemporary logic circuits and techniques which offer the most function for the least dollar.

The second area of automation involves programming certain functions of a console as an aid during complex mix downs. We, in effect, create a console with a memory. This differs from the previous form of automation in that it simply permits the artistic or creative input to a mix to be repeated automatically. It does not make any of its own "decisions." It presumes human

input for its program.

To implement this form of automation, Olive has developed a programmable console and an Automated Remix Programmer. The console differs from a conventional console in that several of the level functions, such as faders, pan controls and rotary level controls are voltage controllable. The actual physical controls process only DC signals which in turn drive special voltage controlled attenuators.

This key feature permits the DC voltages from the controls to be interrogated to determine what the human input is or, in other words, where the faders and controls are set. By the same token DC voltages may be used to establish these same fader and control settings. To put it another way, these DC voltages permit a form of electronic communication with the console.

The Automated Remix Programmer is a device which will monitor several of these DC control voltages [up to 64] and generate a single digital code which contains all the information about these voltages. It does this by using a multiplex or time sharing principle in which it rapidly scans all the voltages pausing long enough at each to convert its absolute value into a digital word. This continuous digital code is preserved in a memory during the first mix down. In all subsequent mixes the digital signal is decoded by the programmer to recreate the individual DC control voltages which then drive the voltage controlled attenuators.

In order to ensure that the memory information is synchronous with the audio, one track of the master multitrack tape is used to store the digital signal. Thus, the mix information is permanently stored in the master itself and available at any time.

A key feature of the system is its ability to build up a mix section by section. As each section is accepted it is preserved intact in the memory while new sections are mixed. The final result is a composite of the exact mix desired. This is accomplished by using two tracks of the master tape and bouncing the digital information between these two tracks adding changes each time. This also means that at any time, both the last mix and the second to last mix are available for comparison.

Occasionally, there is a requirement at some later date to slightly modify a mix for a different application — for example, a film mix to be released in album form,

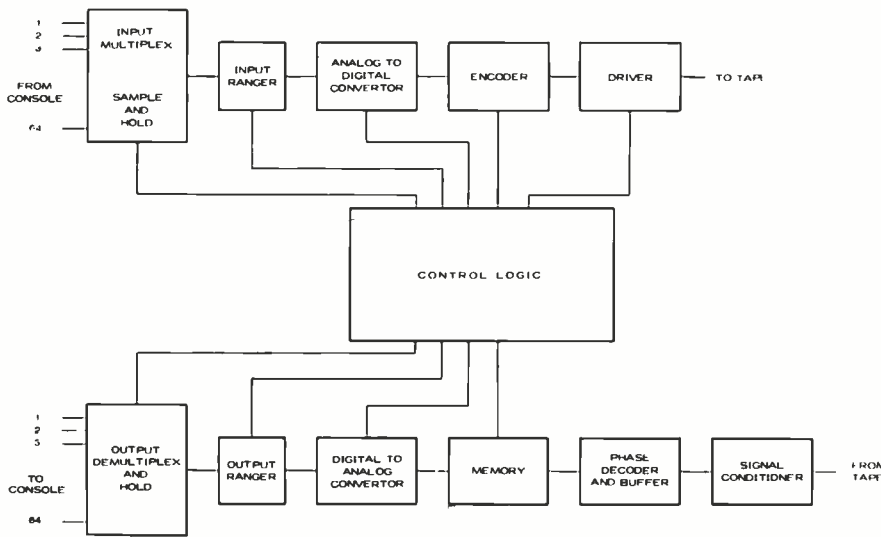

AUTOMATED REMIX PROGRAMMER
SYSTEM BLOCK DIAGRAM



an L.P. mix in a 45, a re-release with more strings and so forth. This becomes very simple as the initial mix is available and only the changes need be made — either manually or in memory form.

The Olive Programmer was developed as a tool for the creative mixer or producer to enable him to capture his artistic efforts, to free him from the constraints imposed by time and to improve the final quality by reducing the need to pre-mix a tape and thereby add a generation.

The functional diagram shows the circuits in the programmer itself. Although most of the blocks are self explanatory, certain features should be explained in greater detail.

The memory block should not be confused with the tape track used as the permanent memory. The internal memory is a circulating buffer memory used to bridge the gap presented during tape dropouts or any other hiatus in digital signal flow. When this occurs due to faulty tape, noise or transients on the digital line, low level or any other cause the DC voltages at the output are preserved at a fixed level until good digital information returns. Furthermore, a parity checker ensures that false digital information will not damage a mix by presenting incorrect or erratic DC voltage levels to the console. When a parity error is sensed as when digital input is interrupted the buffer memory continuously recirculates the previous correct information until a valid signal is present. The sophistication of these circuits ensures a near foolproof system.

These automated systems represent only the start of automation. As electronic hardware costs go down and logic expertise goes up, more sophistication will be found in consoles. This will actually make consoles seem simpler as panel controls are replaced by internal functions. The man/machine communication will improve to present an even greater freedom to the artist.

Specifically, improvements in automation will include programming of equalization, compression and other console functions, a wider range of audio processing functions without increasing the panel density and a lower cost per function for automated features. One need only look at the sophistication used in some video tape editing systems to see some of the technical possibilities of computer based automation systems.

Contrary to the practice in industry, continued introduction of automation into recording will never endanger the human contribution — it will simply improve the end product.

Sincerely yours,

OLIVE ELECTRO DYNAMICS
Wayne Jones,
President



**quad/eight
electronics**

11929 Vose Street □ North Hollywood, California 91605 □ 213/764-1516

COMPUMIX™: The realization of a programmable automated mixing system for professional audio recording.

Considering the withstanding knowledge, claims and speculations regarding the advantages in utilizing EDP

techniques as applied to audio-mixing data entry and retrieval, Quad-Eight Electronics will hopefully illuminate, by way of describing the hardware in their COMPUMIX system, the method and implementation of a practical, low-cost solution to automated mixing.

THE BASIC CONCEPT AND THE RELATED HARDWARE

By addressing (recording on) any conventional audio tape machine which has a minimum reproducible bandwidth of 8kHz with a digital encoding format, a repeatable, reliable and variable amount of digitized audio data can be entered into a memory condition. This data can be used to perform modulation and switching functions as related to the pertinent analog information concurrently recorded. Simply stated, a complete record of all level and switching operations performed during a conventional multi-track mixdown can be remembered, recalled and altered at will with the COMPUMIX mixing system. Although one might implement any number of varying formats of computer peripheral devices to store the digitized audio mix-data, none of these approaches are necessary as the Quad-Eight system will allow the use of a standard 2, 4, or 8 channel spare tape machine to record the mix-data. Certainly, the mix-data can be entered onto the master multi-track audio tape machine, however, a limitation is imposed which defeats the purposes of automation. Since "updating" (rerecording) the mix-data is of crucial importance, one must transfer the recorded digital data with new instructions to another vacant channel. This, by necessity, implies at least two audio tracks with perhaps the only limitation being the engineer's and producer's paucity to add additional "ping-ponged" mix generations. This directly relates to the number of tracks available to perform the entire recording operation; standard analog audio data and the digitized control information. Although Quad-Eight would recommend the use of an auxiliary tape machine for data storage only, the integral approach on the master can be utilized with COMPUMIX. A separate magnetic tape containing only mix-data would allow the creative process to be more fruitful with many mixes.

Having defined some basic storage approaches to automation, what are the devices and methods necessary to process and enter the mix-data into this "computer" memory?

continued on page 36

Crown

PROFESSIONAL STUDIO EQUIPMENT

| Specs | 15ips | 7½ips |
|---------------|---------------|---------------|
| w. & fl. | 0.06% | 0.09% |
| f. resp. +2dB | 40Hz to 30kHz | 20Hz to 20kHz |
| S/N | -60dB | -60dB |

3 speeds - 15, 7½ & 3¾ips; hysteresis synchronous drive motor

computer logic controls for safe, rapid tape handling and editing; full remote control optional

torque reel motors

"capable of providing the most faithful reproduction of sound through the magnetic recording medium to date" -Audio magazine, 4/68

optional Trac-Sync

individual channel equalizers

third head monitor with A/B switch; meter monitoring of source, tape, output and source+tape; sound-with-sound, sound-on-sound and echo

2 mixing inputs per channel

individual channel bias adjust

"construction rugged enough to withstand parachute drops" -Audio magazine, 4/68

\$1790 for basic rack mount half-track stereo deck, about \$2300 with typical accessories, Formica floor console \$295, rugged portable case -\$69

modular construction with easy access to all 10 moving parts and plug-in circuit boards; deck rotates 360° in console locks at any angle

CX822

RECORDERS & REPRODUCERS

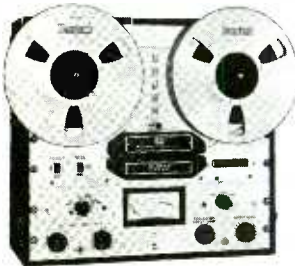

SX711 Claimed by its pro audio owners to be the finest professional tape recorder value on the market today - price versus performance

- Frequency response at 7½ips ±2dB 20Hz-20kHz, at 3¾ips ±2dB 20Hz-10kHz
- Wow & flutter at 7½ips 0.09%, at 3¾ips 0.18%
- S/N at 7½ips -60dB, at 3¾ips -55dB

Facilities: bias metering and adjustment, third head monitor with A/B switch, sound-with-sound, two mic or line inputs, meter monitoring same as CX822, 600Ω output

Remote start/stop optional, automatic stop in play mode

- \$895 for full-track mono deck as shown, \$995 for half-track stereo deck



SP722 Ideal reproducer for automation systems

- Meets or exceeds all NAB standards
- Remote start/stop optional, automatic stop in play mode
- \$595 for half-track stereo reproducer

Crown tape recorders and reproducers are available in 42 models with almost any head configuration, including 4 channels in-line. Patented electro-magnetic brakes maintain ultra-light tape tension and never need adjusting. They are made by American craftsmen to professional quality standards, with industrial-grade construction for years of heavy use.

All Crown amplifiers are warranted three years for parts and labor. They are 100% American-made to professional quality standards. All are fully protected against shorts, mismatch and open circuits. Construction is industrial-grade for years of continuous operation.

For more information, write CROWN, Box 1000, Elkhart, Indiana 46514

STUDIO MONITOR AMPLIFIERS



D60

Delivers 30 watts RMS per channel at 8Ω

- Takes only 1¾" rack space, weighs 8½ lbs.
- IM distortion less than 0.05% from 1/10w to 30w at 8Ω
- S/N 106dB below 30w output
- \$229 rack mount



D150

Delivers 75 watts RMS per channel at 8Ω

- IM distortion less than 0.05% from 0.01w to 75w at 8Ω
- S/N 110dB below 75w output
- Takes 5¼" rack space, weighs 20 lbs.
- \$429 rack mount



DC300

Delivers 150 watts RMS per channel at 8Ω

- IM distortion less than 0.05% from 0.01 w-150w at 8Ω
- S/N 110dB below 150w output at 8Ω
- Lab Standard performance and reliability
- "As close to absolute perfection as any amplifier we have ever seen" - Audio magazine, 10/69
- \$685 rack mount

look who's going

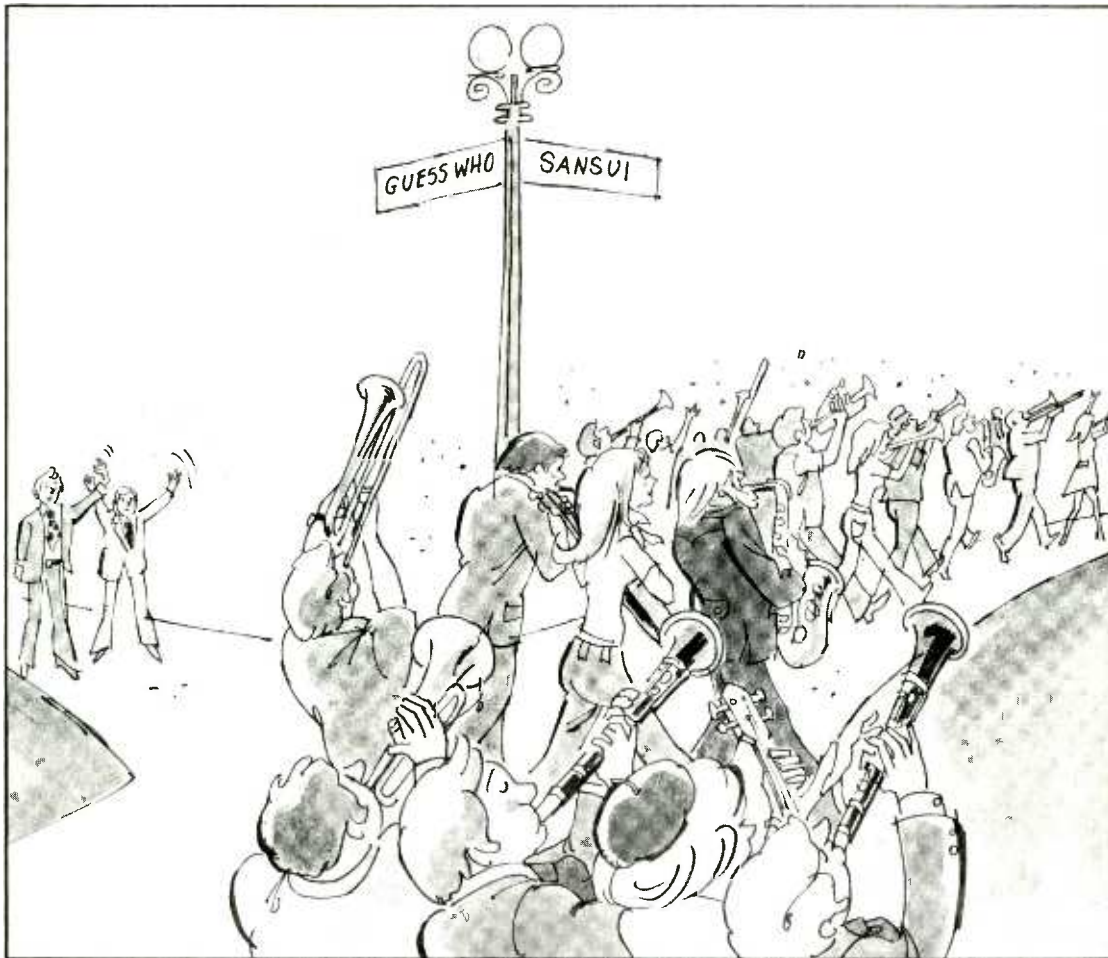

You may have heard it already—or you may not have—but more and more recording artists, more and more recording labels, and more and more engineers and producers are using Sansui's QS four-channel technique to encode their records in the four-channel mode. The list, growing from week to week, is quite impressive. But more important than the list itself is the fact that all these independent artists and companies have conducted extensive testing and actual use procedures before they made up their minds. What speaks for Sansui's QS System is not the pressure of a major software company nor exaggerated statements and promises; it's simply the performance.

Whether it is such an outstanding artist as Carole King or Joan Baez; or perhaps eminent musicians and producers like Enoch Light or Dick Schory add to the list such a beloved figure as B. B. King—they all are going Sansui's QS way because they think it is the best way. Some of these artists have actually produced with other matrix four-channel encoding methods, but have found that the most satisfactory results, in terms of the freedom of the producer and the artistic results, are in the one and only balanced and symmetrical system—that is, Sansui's QS method.

the QS way — and why

(Report on the Sansui QS Coding System)

There are now almost three hundred — yes, three hundred — Sansui-type matrixed four-channel record albums available all over the world, most of them encoded with Sansui QS encoders. In this country alone, almost 30 albums are already on the market. And we hate to hold anything back from you, but there are a number of artists who will, in the very near future, be on the market with their QS four-channel recordings. Also, major labels.

While we do not know the particular reasons each of these artists and producers selected Sansui's QS System, we know that it could be any or all of those enumerated here. These are the qualifications that make Sansui's QS matrix system uniquely efficient and effective and musically satisfying. In fact, we believe Sansui's QS System is the only matrix system that can claim that it has no known major drawbacks, that are not subject to refinement. These are the features of Sansui's QS system:

TOTAL, ACCURATE SOUND-SOURCE LOCALIZATION in every direction and at any point *inside* the sound field. No dropouts, cancellations or irritating shifts in position. The "overhead" effect, with a performer in the dead center,

is readily achieved. This means there are no problems about having to place performers in some positions and avoiding other areas. It means that the total acoustic perspective is the same as that for discrete tape.

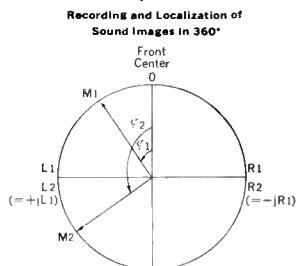

TOTAL COMPATIBILITY. Sansui's QS Coding System is compatible with two-channel stereo playback of encoded recordings. With four-channel playback (ambience synthesis) of conventional two-channel recordings. With other matrix decoders. With all existing home hardware and with all existing

Location of Various Sound Components in Left and Right Channels

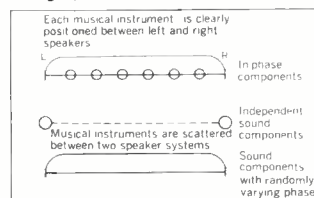

professional equipment. With present broadcast standards and equipment.

There are many important implications in this comprehensive situation. For

example, when QS-encoded material is played back in conventional two-channel stereo, it produces an entirely correct stereo perspective. The rear-channel information serves to produce a broadened and enhanced stereo perspective instead of jamming rear-channel information unnaturally into the wrong places to confuse directionality and obscure the stereo effect.

We believe that it is in the interest of the entire industry that the very best system be selected, regardless of politics, regardless of cross-currents and undercurrents, regardless of alliances and pride or even some dent in someone's reputation.

We have no other ax to grind than to play the fiddle that will make the best music for the industry. If you care to know more about Sansui's QS System, please contact our New York office for a demonstration and materials. It may interest you that the RIAJ (Record Industry Association of Japan) has adopted the Sansui system under the name of Regular Matrix to be the standard for recordings in Japan. An application for acceptance of our standards is now with the Recording Industry Association of America.

It's no wonder, then, that everybody who is anybody in the four-channel medium is going the QS way. Why not join the trend? The QS encoder is very simple to adjust, easy to use and reliable. Try it. Check out our claims with your own material, in your own way. Learn for yourself what the present members of the Sansui QS bandwagon have already discovered.

Labels Using Sansui QS Encoding

A&M • Audio Treasury/ABC • Black Jazz • Command • Impulse • Ode • Ovation • Project 3

Artists Encoded with Sansui QS

The Awakening • Count Basie • Doug Carn • Ray Charles Singers • Alice Coltrane • Henry Franklin • Free Design • Urbie Green
John Lee Hooker • Sammy Kaye • B. B. King • Carole King • Bonnie Koloc • Enoch Light • Tony Mottola • Doc Severinsen • Beverly Sills



For full details, contact your nearest Sansui office now.

SANSUI ELECTRONICS CORP.

Sansui Electronics Corp.

New York

32-17, 61st Street, Woodside, N.Y. 11377. Tel.: (212) 721-4408. Cable: SANSUIELEC NEW YORK. Telex: 422633 SEC UI.

Sansui Electric Co., Ltd.

Los Angeles
Tokyo

333 West Alondra Blvd. Gardena, Calif 90247. Tel.: (213) 532-7670.
14-1, 2-chome, Izumi Suginami-ku, Tokyo 168. Japan. Tel.: (03) 323-1111. Cable: SANSUIELEC.

Sansui Audio Europe S.A.

Belgium

Diaceem Building Vestingstraat 53-55 2000 Antwerp. Tel.: 315663-5. Cable: SANSUIEURO ANTWERP. Telex: ANTWERP 33538

Vernitron Ltd.

Germany, W.
U.K.

6 Frankfurt am Main, Reuterweg 93 Tel.: 33538
Thornhill Southampton S09 5QF. Southampton 44811. Cable: VERNITRON SOTON. Telex: 47138.

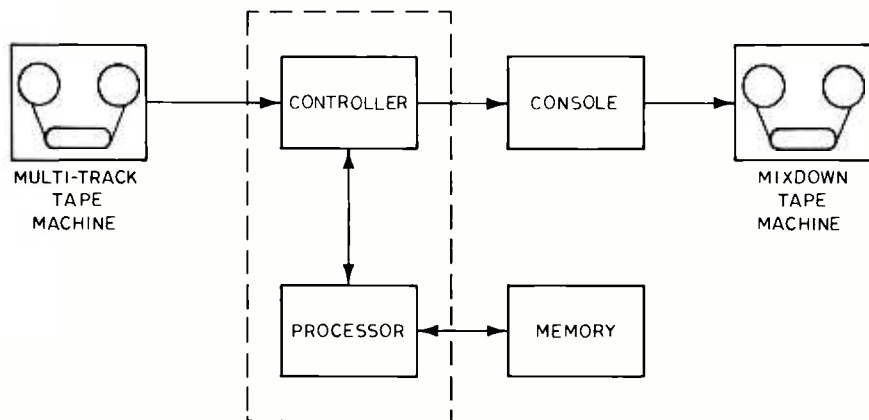

COMPUMIX™

quad/eight electronics
 11920 Vona Street North Hollywood California 91605 213/764 1516

continued from page 33

There are only two component system parts: a controller and a processor. With COMPUMIX, the controller is a portable mixing control station, containing within a very small area all of the level, switching, and logic functions for interfacing any existing mixing console and multi-track master recorder to the storage machine(s). The controller's input is line level signal from the multi-track master machine; the output enters the conventional console inputs and also interfaces to the processor which simultaneously reads the audio information for storage. In addition to the basic 24 input level and 6 sub-mix grouping facility, this "desk" will also program 54 switch functions. Its linear faders, whose signals appear as D.C. control voltages, are connected to Voltage-Controlled Attenuators. Noiseless mixing and numerous grouping control combinations are possible due to the utilization of the VCA's. A multiplexing approach to scanning fader positions will allow a complete data renewal rate of one-tenth of a second. The resolution of the level function shall be within .25dB and no degradation to the audio signal will be tolerable in the system. In order to effect changes to a recorded mix, the controller incorporates a unique and simple updating scheme. There is no level matching problem. For changing an existing recorded mix or any portion of the mix, a light emitting diode indicator above each input and sub-mix fader automatically signals "level match" when

a fixed electrical reference point of -15dB is set on the fader. No previous knowledge of the original signal level need be "matched" by a "comparator" indication. Since the update approach is additive (additional dB's) or subtractive (minus dB's) from this reference point, any subsequent fader motion will change the new update information correspondingly. Fading-in or fading-out can be accomplished with this simple update comparator display. There is no reason for "hunting" to match levels and the fade feature completes the update arrangement for maximum flexibility.

This controller can be used in a self-standing mode with detachable legs that adjust its height. Or, the compact dimensions of this unit will allow the engineer to place the controller directly over his existing board, leaving the pan and equalization controls exposed.* Expansion to a 32 input or various configurations of pan or quadrasonic control has been provided on our controller. The wiring and the connectors are built-in to permit this expansion of extra programming capability. The unit is lightweight and is designed to be moved between studios. (Automation should happen in Studio B sessions too!)

The controller's associated processor is housed in a 42" high, 19" wide EIA rack enclosure mounted on casters. An "umbilical cord" connects the controller to this rack. Contained in the enclosure are all VCA's, power supplies, the digital processor and signal-conditioning electronics. Provisions for future

electronic packages are built-in and a master system "bypass control" is included. This control permits removal of the system electrically from your mix without tedious unpatching and downtime due to control and signal cable modifications. Simple alternation between mixdown and real time recording is possible without dismantling the equipment, yet it retains its portability! Due to the composition of the digital code, sync-timing, time coding and a 50% expansion capability are incorporated for future automation needs.

Any console or standard tape system can use the COMPUMIX format. In applying automation hardware to an operating recording studio, there should be no necessity for obsoleting or rewiring present systems. Neither should there be a requirement to purchase a large, expensive "computerized" console to gain the benefits of automation.

*The basic 24 input controller measures 48" long, 13" wide and 3" deep. The equalization and pan functions with COMPUMIX remain in real-time control with the operator.

For approximately \$18,000 the complete COMPUMIX system — controller and processor can start automating present mixes in any audio recording environment. This includes film-sound applications.

It is the adaptability to existing equipment (much of this capital equipment new and recently purchased for growing track requirements) that Quad-Eight Electronics has designed into their COMPUMIX approach. Granted, no definitive standards for automation are yet established and their evolution may be slow. If the much talked-about advantages of digital techniques as applied to audio are to really have impact on both the technical and artistic aspects of the professional recording community, then let someone provide a system that is understandable, operationally succinct, complete and affordable. As manufacturer's complete recording systems, we are confident that our COMPUMIX will provide an important and long-awaited inroad to the simplification of complex and routine mixing procedures. An important step, we feel, to free the creative engineer's mind for more exciting and interesting activity.

Ron A. Neilson
 Marketing Director
 Quad-Eight Electronics

continued from page 11

the walls in terms of cost and performance. There is no theoretical prediction of performance for non-parallel wall rooms, so you get pot luck when you build one.

Finally, I would expect an odd reverberant sound from the arrangement shown for the Bolic Sound Chamber. It seems to me that by putting the microphone and the speaker so close together, one would get a very quick direct sound wave followed by a quiet delay, then all the reverberant sound. Wouldn't this delay be annoying?

Thank you for your comment on my article about tiling an Echo chamber.

Sounds like you have a great chamber, but I believe too long reverb for musical application.

You should hear the Taj Mahal. I was there for CBS News in 1959 with President Eisenhower, did all the video taping. When our guide showed us the reverberant time around 25 seconds with a loud shout, I couldn't resist, so I blew my police whistle. I just about woke up the dead. It's a wonder they didn't cremate me on the spot!

In the tiled chamber the speaker is actually projecting away from the

microphone, as the speaker is placed slightly in front of the microphone. The diagram in the article did not show the exact relationship between the speaker and the mike. So the sound travels to the far end before being picked up by the mike. Incidentally, the chamber is actually sounding better each day, quite reverberant. I may do a second one, if the building doesn't collapse.

DON FOSTER

AUDIO DESIGNS IN NEW BUILDING

Necessitated by the continuing growth of the firm's console business, as well as rapidly expanding sales of components Audio Designs has occupied their new building.

Located at 16005 Sturgeon, Roseville, Michigan 48066 in suburban Detroit, the new building to house all company activities is approximately three times larger than their former plant.

Also headquartered at the new address is PAN, the Professional Audio Newsletter, published by Audio Designs, and available to qualified recipients by writing to Audio Designs' president, Bob Bloom.

NEW HOLLYWOOD OFFICE OPENED BY RUPERT NEVE, INC.

Rupert Neve, Incorporated announces the opening of its Hollywood office and

the appointment of Mr. John Marston as Los Angeles Sales Manager.

Rupert Neve has installed a number of audio control consoles throughout the United States and Canada and has been expanding its capability to provide the customer service for which it is so well known. It now adds Hollywood to the Connecticut and Toronto locations.

The office is located at 1800 North Highland Avenue, Suite 616 — literally in the heart of the Hollywood recording and film industry.

From the READERS

An editorial material rating of the most useful feature article, as gathered from the Reader Service Cards received prior to press time.

MAY/JUNE ISSUE:

| | |
|--------------------------|-------|
| SIMULTANEOUS OVERDUBBING | 35.10 |
| TILE ECHO CHAMBER | 20.51 |
| \$5.00 LINE AMPLIFIER | 13.97 |
| TAPE MACHINES IN SYNC | 28.42 |

Neve

*the sound of Neve
is world wide*

Now In
Six West Recording
New York, N.Y.

16 track facilities
by Neve S24/8 console . . .
24 input, 8 busses
16 track monitor



Professional Audio Control and Distribution

Rupert Neve Incorporated
Berkshire Industrial Park
Bethel, Conn. 06801
Tel: (203) 744-6230

Rupert Neve & Co. Ltd.
Cambridge House
Melbourn, Royston
Herts, England

Rupert Neve of Canada Ltd.
P.O. Box 182
Etobicoke, Ontario
Canada

Now, another step forward
by the leader.

Ampex MM-1100

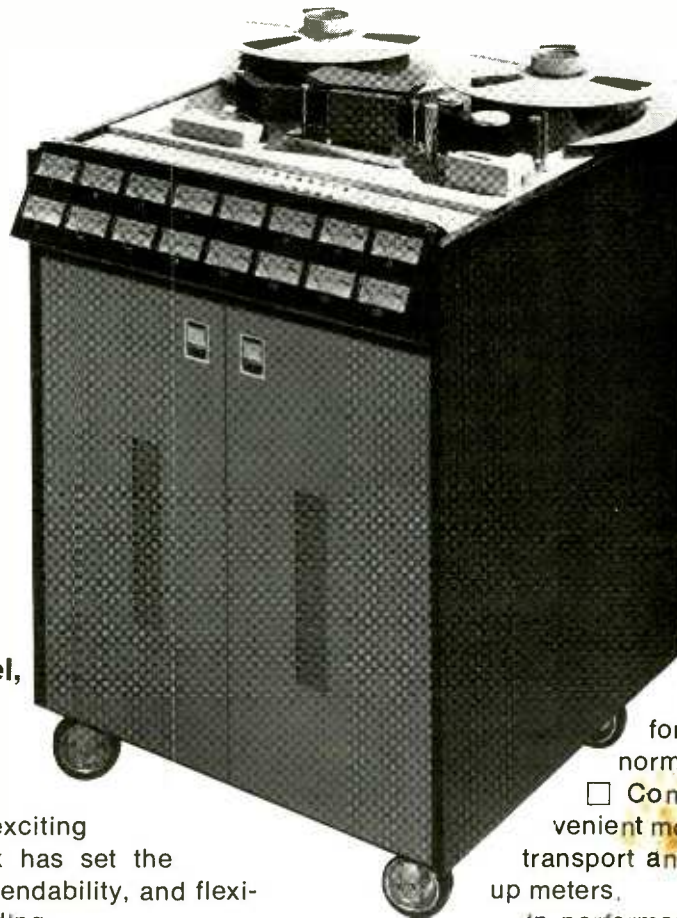

An economical, compact, multichannel, high performance audio recorder/reproducer.

As the leader in today's exciting sound revolution, Ampex has set the standards for fidelity, dependability, and flexibility in imaginative recording.

Now the MM-1100 fits solidly into the matchless Ampex family of multichannel recorders and reproducers.

For the budget-minded user there is the reliable AG-440-8, the lowest priced 8-channel recorder available.

The new MM-1100 fits the need in more demanding 8-channel applications, and also offers an entry into 16 or 24-channel recording at a cost much lower than for recorders of similar capability. Outstanding features include:

- Stable tape motion in 0.5 sec. from precision capstan servo.
- Tape tension servo

for smooth handling of 10½" and 14" reels.

Identical playback performance in both sel-sync and normal reproduce.

Compact packaging for convenient mobility; functionally grouped transport and electronics controls; tilt-up meters.

In performance, the MM-1100 is a no-compromise companion to the MM-1000.

Where very sophisticated mastering is the rule, the MM-1000 is unchallenged for flexibility and versatility. Capstan servo accessories for the MM-1000 allow precise locking to either film or video; permit variable speed control; and offer tape lock for absolute pitch stability.

There's an Ampex recorder/reproducer for any of your innovative ambitions. For complete information write: *National Sales Manager, Audio-Video Systems Division, Ampex Corporation, 401 Broadway, Redwood City, CA 94063.*



MM-1000 The ultimate audio recorder/reproducer. Available in 8, 16 or 24-channel models.



AG-440-8 Long known as the quiet professional. Lowest priced 8-channel recorder available.

AMPEX

There has been a great deal published by design and R&D engineers concerning the *state-of-the-art* technology found in today's magnetic recorders. Unfortunately, much of this literature is too circuit oriented for studio personnel. Another source of information is the recorder manufacturers own instruction manuals. Many of these, too, fall short in supplying complete information on how the recorder can be best aligned, and very few of these manuals investigate the principles involved, so that studio personnel can understand the reasons for certain procedures.

We believe there is a need for something in between the two approaches. It is our hope that these articles answer that need.

Specifically, in this article we will try to cover the subject of *distortion* in the magnetic recorder. Wherever possible, references will be made and appendices added to assist in finding additional information.

TODAY'S MAGNETIC RECORDERS

by BILL WILSON
B. W. ASSOCIATES
CHICAGO, ILLINOIS

TYPES OF DISTORTION

During the last 'AES' convention there were magnetic recorders displayed offering an impressive and wide range of *state-of-the-art* options and improvements. There were:

- dc reel and capstan servo systems
- video and film sync units
- new multi-track signal electronics; up to 40 tracks
- built-in noise reduction units
- automatic data locators
- computer type 'go-no-go' test systems
- complete solid state electronics and switching
- even, a transport without a capstan or pucks

An impressive list contrasting greatly to the recent past when all of the tape recording equipment offered had simple open-loop transports and very similar signal electronics.

What has evolved from these expanded R&D efforts are greatly improved machines at very competitive pricing. Distinct advantages, yes. But, along with the advantages, new problems as well, for both studio maintenance engineers and recording engineers (mixers), who each should fully comprehend the principles involved, in order to maintain and fully exploit the capabilities of their recorders.

DISTORTION

The term distortion has many different definitions normally based on the type of distortion being described. For the purposes of this article we believe the following definition would be best; 'Distortion is either the creation or elimination of any spurious components in a signal when comparing the input to the output of an amplifier, recorder, etc., as a result of some form of non-linearity in the input/output characteristics of the system.' Noting this definition and realizing that a magnetic tape recorder is basically one of the most non-linear pieces of equipment in a studio, a high percentage of distortion would appear to be an unavoidable by-product of recording. This is not the case however, since many recorders are equipped with circuits designed to minimize or completely cancel any distortion, (and all recorders can be aligned and operated to at least minimize distortion.)

The two major types of distortion found in tape recording are Harmonic Distortion and Intermodulation Distortion. Harmonic distortion is the creation of spurious components which are harmonics of the fundamental input signal. Intermodulation distortion (IM) is the creation of spurious components when two frequencies are put through a non-linear device. With IM these components are not harmonics but represent the sum and difference between the two signals and the effects of amplitude and frequency modulation, one of the signals has on the other.

We have used the term ". . . creation or elimination of spurious components . . ." while normally talking about distortion we refer only to the creation or addition of these components. In music and voice recording however, some forms of natural intermodulation and harmonic distortion are present in the original signal. For a recorder to cancel or eliminate these *natural distortions* would be just as bad as creating new ones. As an example, if we record a signal known to contain 1.5% harmonic distortion with a recorder known to contain 1% harmonic distortion, the signal played back could have anywhere between 0.5% to 2.5% harmonic distortion, depending upon the phase relationship and individual amplitude of each harmonic in the distortion of the original signal and that of the recorder. The same relationships and percentages could hold true for IM distortion as well.

MEASURING DISTORTION

Harmonic distortion can be measured two ways either by measuring discret harmonic levels or by measuring total harmonic distortion. Discret harmonic levels are measured with a Wave Analyzer or tunable AC VTVM. With this method a pure sine wave is used as a signal source and the output of the system under test is put through a tunable narrow band-pass filter, the filter is tuned to one of the harmonics and its output is measured with the AC VTVM. Using the amplitude of the signal output to equal 100%, the level of the harmonic signal is measured as a percentage of the fundamental. (Appendix 1a).

Total Harmonic Distortion (THD) is measured with a distortion analyzer. With this method a pure sine wave is again used as a signal source. The output of the system is put through a band reject filter, to filter out the original fundamental, and what remains are the harmonic components plus the system's noise. As with discrete harmonic distortion the level of the fundamental equals 100% and the level of the remaining harmonics plus system noise is measured as a percentage of that fundamental. (Appendix 1b) Intermodulation Distortion is commonly measured by one of two methods. The SMPE method is the one form of IM measurement commonly used in the United States while the CCIF method is very common in Europe. With the SMPE method, two pure sine waves (60Hz and 6000Hz) are mixed in a 4:1 ratio. This combined signal is recorded and the output put through a high pass filter to eliminate the 60 Hz; the remaining signal is amplitude modulation detected to see how much amplitude modulation effect the 60 Hz had on the 6000Hz. The output of the detector is again filtered to be sure no high frequency components remain, and the remainder is measured with an AC VTVM. Using the amplitude of the original 60Hz to represent 100%, the amplitude of the residual 60Hz is measured in percentages and represents the percentage of IM distortion. (Appendix 1c)

While the SMPE (now known as SMPTE) method measures the amplitude modulating effect of IM distortion, the CCIF method measures the effects of IM distortion in creating components not harmonically related to either of the two original signals being used. A typical CCIF test would use two pure sine waves of 8000Hz and 8100Hz each of equal amplitude. Putting them through a non-linear system would create an output containing each of the input frequencies, the sum and difference between them, their harmonics and the sum and difference of their harmonics. Depending on created and the sum of the two frequencies could be beyond the response of the system being tested, while the difference frequency (100Hz in this example) is in the systems bandwidth where the system will add it as a spurious component in its output. This difference frequency is also normally the first noticed IM distortion when listening to the output. CCIF measurements can be made with a standard CCIF IM distortion analyzer or a wave analyzer. The object

of either of these test set-ups is to measure the amplitude of the known difference and compare its level to that of the original input frequencies and note the level of the difference as a percentage of the original. (Appendix 1d and 1e)

None of the methods of measuring distortion commonly used today is ideal, each of them have their limitations, but their measurements are relative to the actual condition of a recorder with respect to distortion. For the many causes of distortion in a magnetic recorder each test procedure has its merits. For SMPE IM distortion a Heathkit model IM-48 is more than adequate and is available in kit or pre-wired form, both at good prices. For total harmonic distortion one of the best pieces of reliable and inexpensive test equipment is the Ferrograph RTS-1. Besides containing a distortion analyzer it also has a signal generator, AC VTVM, and flutter and wow test set. For a Wave Analyzer, the Hewlett Packard HP-302A is best for audio. However, it is very expensive. Ampex Corporation has done some work in designing a Wave Analyzer using 500Hz as the fundamental frequency, but there is no word yet as to when and if it will be put on the market. The Mincom Division of 3M Company also has a piece of test gear, the 6100 Test Set. The 6100 is a signal generator, 2nd and 3rd harmonic wave analyzer (Automatically tuned to the 2nd or 3rd harmonic of the generator's frequency) and an AC VTVM. The last word heard from 3M is that they are still improving the original design and necessary ruggedness of this test set after their purchase of its design from Data Measurements Corp.

DISTORTION IN THE RECORDER

Distortion within a magnetic tape recorder is generated in several places. The following basic block diagram points out some of the major causes:

- A. Non-linear and phase shift characteristics of transformers. (Input & Output)
- B. Non-linear characteristics of amplifiers.
- C. Frequency discriminating equalizers causing phase shift distortion.
- D. Bias Trap, when tuned prevents bias frequency from feeding back into record amplifiers and causing distortion.
- E. Non-linear transfer characteristics of magnetic heads.
- F. Distortion (harmonic) in output of bias and erase oscillator.
- G. Harmonic distortion in bias and erase tuning circuits and amplifiers.
- H. Distortion caused by rectifier circuits found in monitoring meters.
- K. Non-linear transfer characteristics of magnetic tape.

Introduced in this outline of a recorder but not previously mentioned is phase shift distortion due to frequency discrimination of some components and circuits in the recorder. Equalizers and transformers are two examples.

Graphic examples of phase shift distortion and the other types of distortion already discussed might be helpful now before we get into the circuits found in a recorder to minimize distortion, and an alignment procedure based on distortion readings.

continued on page 42

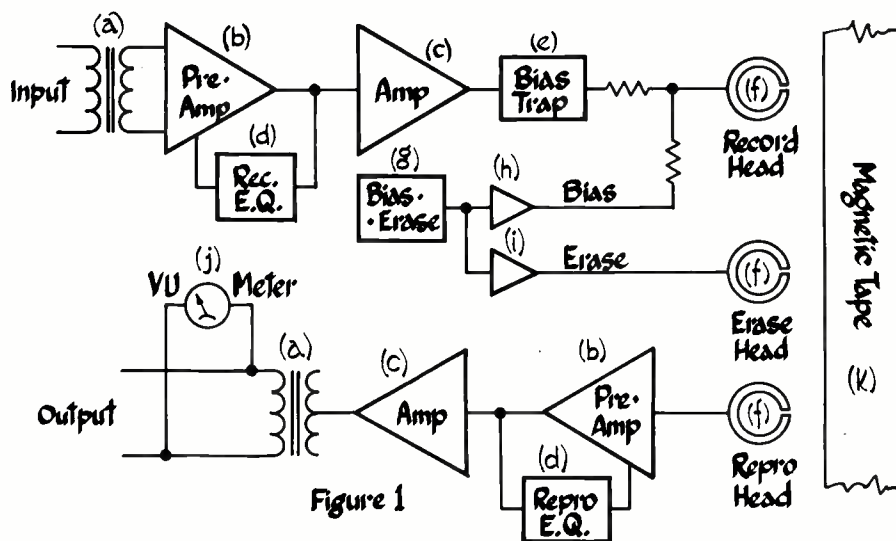



INTRODUCING THE FINEST PERFORMER ON ANY STAGE. THE TURNER TC10.

We've got it! A great new multi-port cardioid dynamic microphone. The TC10. It's the best you can buy, and we can prove it. In a series of carefully controlled tests, we ran the TC10 mike-to-mike against the top professional entertainment microphones in the industry. We got what we wanted—documented evidence that TC10 specifications meet or exceed those of any equivalent model. Results of these tests are available from Turner or the representative nearest you. See them and you'll agree. It's time for a change. It's time to try this remarkable new Turner microphone.

You'll get a multi-port cardioid dynamic with each component individually selected. Featuring: —26 db front-to-back discrimination on an axis of 180°, a frequency range of 50-15,000 Hz with an extremely flat response. —55 db output level. 150 ohm impedance. A unique acoustic cartridge mount which virtually eliminates shock and handling noise. Each TC10 is numbered, registered and packed in a handsome metal carrying case with its own individual response curve. Find out more about the TC10 and the rest of the high-quality TC series. Write for details. Turner Division, Conrac Corporation, 909 Seventeenth Street N.E., Cedar Rapids, Iowa 52402.

TURNER
DIVISION OF CONRAC CORPORATION

A linear recorder or amplifier has a straight transfer curve. For every incremental change in input current or voltage there is a proportionate change in output current or voltage. FIG 2

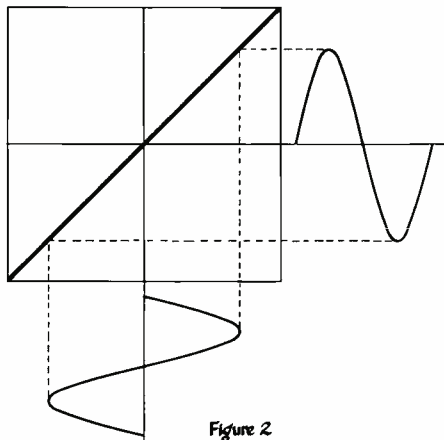

Figure 2

This type of transfer curve would result in symmetrical distortion evidenced by odd harmonic distortion (3rd, 5th, . . .) FIG 3

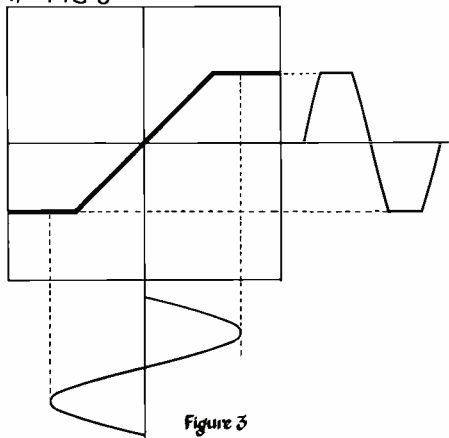

Figure 3

This type of transfer curve would result in asymmetrical distortion evidenced by even harmonic distortion (2nd, 4th, . . .) and first order IM Distortion. FIG 4

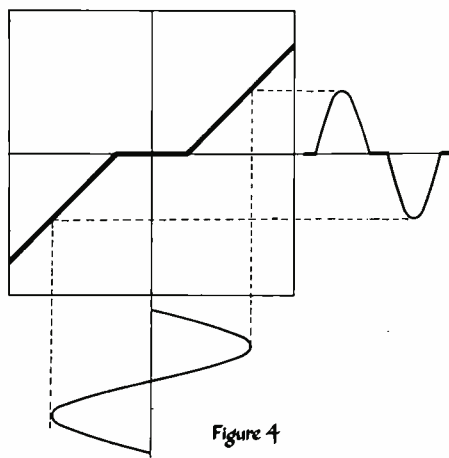

Figure 4

FIG 5a shows a transfer curve for a circuit having linear phase shift distortion. The output of a circuit having this

type of distortion will be asymmetrical since the positive and negative components of a signal will not coincide. FIG 5b shows non-linear phase shift distortion. Depending on the degree of phase shift and the non-linear characteristics this waveform could have any possible non-elliptical pattern.

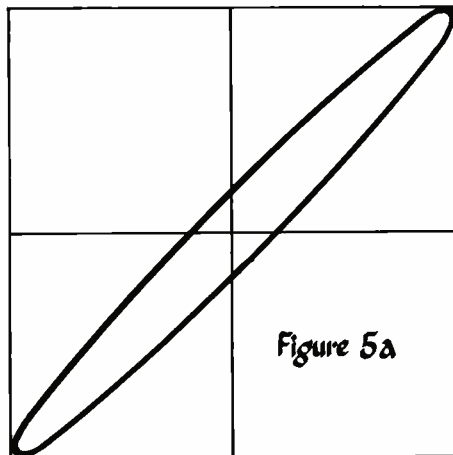

Figure 5a

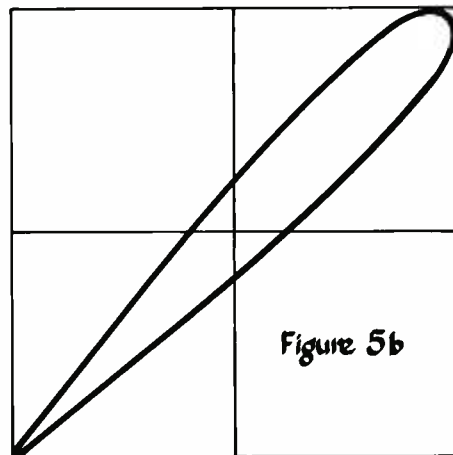

Figure 5b

FIG 6a shows a magnetic transfer characteristic curve with a sine wave input and the resulting output distortion. FIG 6b shows how the addition of high frequency bias transfers the input signal to the linear portion of the magnetic transfer curve.

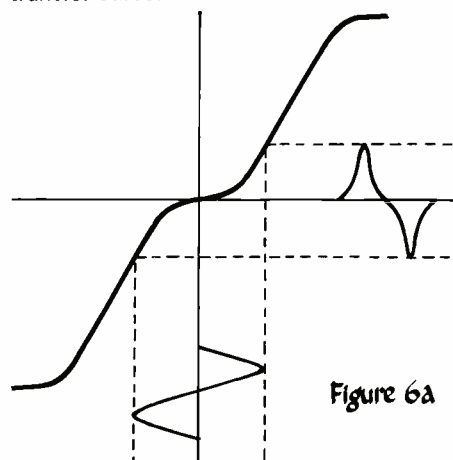

Figure 6a

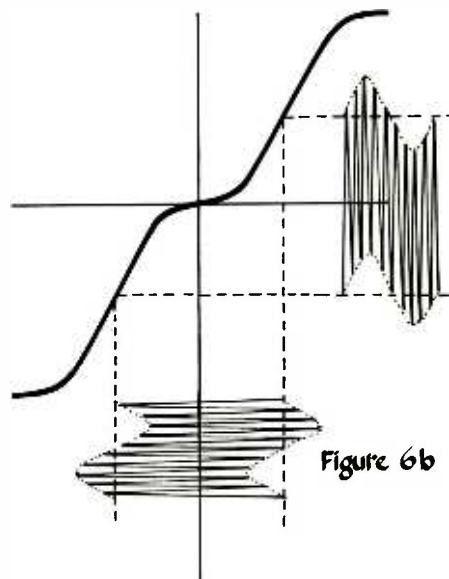

Figure 6b

CIRCUITS TO MINIMIZE DISTORTION

Now that we have built the recorder up as a distortion creating monster, let's look into the circuits designed to cancel or minimize all this distortion. Among the circuits available in today's recorders are, high frequency bias, adjustable tuned circuits for bias and erase currents, noise balance circuits, linerization controls, and phase shift compensation networks.

BIAS:

In our block diagram we showed bias as a distortion creating circuit, and it can be. However the intended purpose of high frequency bias in a recorder is to minimize distortion created by non-linear magnetic transfer characteristics, and to increase the signal-to-noise ratio. For the intended purpose of bias to be realized, the bias signal must be a pure sine wave at least five times the frequency of the highest frequency to be recorded (to prevent beats with harmonics of the recorded signal); it must be combined with the audio signal by a linear mix (so no sum and difference frequencies are created); and it must be at the proper ratio of bias to signal current to get the most out of the linear portions of the magnetic transfer curve.

The application of bias is not an amplitude modulation process. Bias does not get into the recording or playback process, but is used for the signal to 'ride' on it to the linear portion of the magnetic transfer curve. The amplitude of the bias is very important and will vary with the type of recording head and magnetic tape being used. Bias current affects the sensitivity of the tape at both the high and low frequencies, as well as frequency response, distortion, output, and signal-to-noise ratios. The relationship between

continued on page 44



convention

You'll find the Olive Series 2500 multi-track recording console in the AES Convention at the Waldorf Astoria September 12-15. But you won't find any convention in the Olive Series 2500 Console. In creating the Series 2500 we threw out the ordinary. By rejecting conventional routes, Olive engineers made possible a console in the popular price range loaded with custom features. For instance, the 2500 is ready for automation when you buy it; attach the Olive Automated Remix Programmer and it remembers every single operation of your multi-track mixdown.

We believe the Olive Series 2500 is the finest console in its price range.

There's only one better at any price and we make that too — the Series 2000.

Drop in at the Waldorf and talk with the people who designed and built the 2500 and the 2000. Take a look at the Olive line of modular components like the equalizer and the compressor/limiter, all aimed at complementing the imaginative producer.

Olive. The unconventional at the convention.



Olive Electro Dynamics Inc.
2670 Paulus
Montréal 386, Québec
Canada
(514) 332-0331
Cable Olivet, Montréal

Westlake Audio Inc.
6311 Wilshire Blvd.
Los Angeles, California
90048
(213) 655-0303

Studio-Technique
4 avenue Claude-Vellefaux
Paris (10e) France
206-15-60/208-40-99

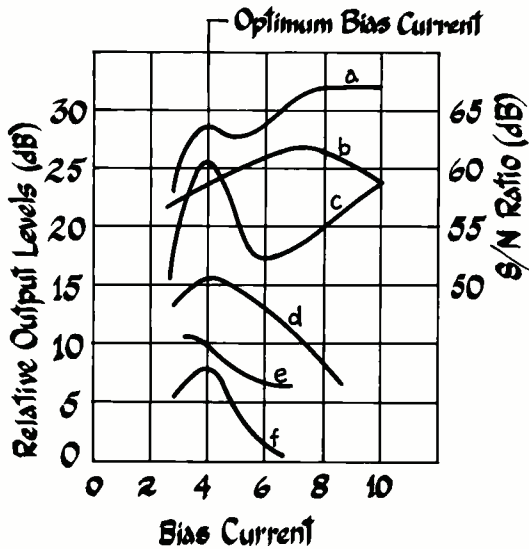

Figure 7

- a HF S/N Ratio
- b Undistorted Output
- c LF S/N Ratio
- d LF Sensitivity
- e Frequency Response
- f HF Sensitivity

these factors and proper bias level is shown in FIG 7.

BIAS & ERASE TUNABLE CIRCUITS AND AMPLIFIERS

Many recorders use tunable circuits between the bias & erase oscillator and the various stages of bias and erase amplification. These tuned circuits are employed to minimize harmonic waveform distortion in the bias and erase signals. Harmonic distortion of the bias or erase waveform could create IM distortion by beating these harmonics with the harmonics of the signal being recorded. Nonsymmetrical bias or erase waveform causes magnetization of the record and erase heads and greatly increases even harmonic distortion of the recorded signal (2nd & 4th, . . . harmonics).

NOISE BALANCE

The purpose of the noise balance circuit in a recorder is to inject a variable small dc component into the record head to compensate for nonsymmetrical bias waveforms, even harmonics in the record signal, external magnetic fields crossing the record head gap and dc components on the tape due to nonsymmetrical erase waveforms. FIG 8 shows a typical noise balance circuit.

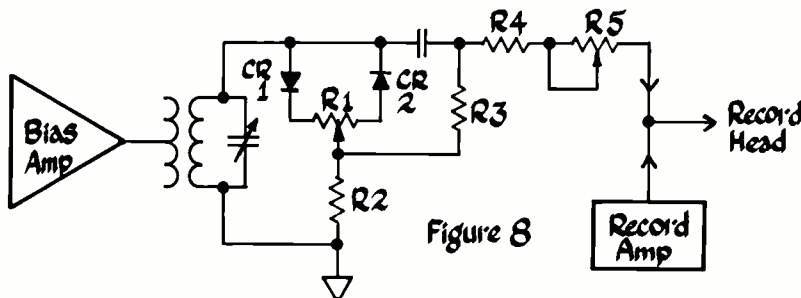

Figure 8

distorted 180° out of phase with the type of distortion the nonlinear magnetic transfer curve would create. The net result is a clean distortion free signal on tape. FIG 9 shows an example circuit.

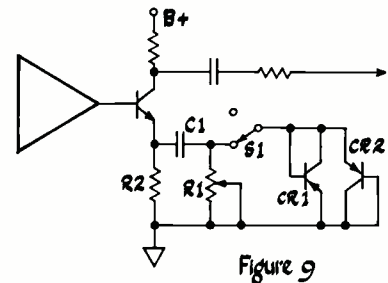

Figure 9

When the linearizer switch is 'off,' degenerative feedback for the record amplifier is supplied by the emitter circuit of Q1. (Through C1 and R1 with R2.) With the switch 'on,' CR1 and CR2 (Transistors wired as diodes) come into the circuit. R1 is set so that the current level, at a point just before tape saturation occurs, is not enough to overcome the contact potential of CR1 & CR2. In this manner signal level great enough to cause tape saturation will also cause CR1 & CR2 to conduct. Their conduction decreases degenerative feedback, and causes predistortion as described above. The setting of R1 is critical for proper operation.

PHASE COMPENSATION NETWORKS

Considerable rotation of phase (Phase Shift) normally occurs in the overall process of magnetic tape recording. The amount of phase shift varies with the frequency being recorded; higher frequencies have a greater amount of phase rotation. A phase shift compensation network in the playback amplifier will vary the phase shift of the playback signal between 0° and 180°, depending on frequency, to correct the inherent shift. The end result would cancel any phase shift distortion. FIG 10 shows a sample circuit.

A paraphase signal output condition exists between the emitter and collector of Q1; that is, equal amplitude with 180° phase difference. C1, which couples the collector signal to the base of Q2, presents a high impedance to the low frequencies. R1 feeds the emitter signal directly to the base of Q2. As a result of this action, the low frequency phase components of the recorded signal, present at the emitter of Q1 predominate at the base of Q2 and are 180° out of phase with the same signal at the col-

continued on page 46

WE HAVE IT, IT WORKS,

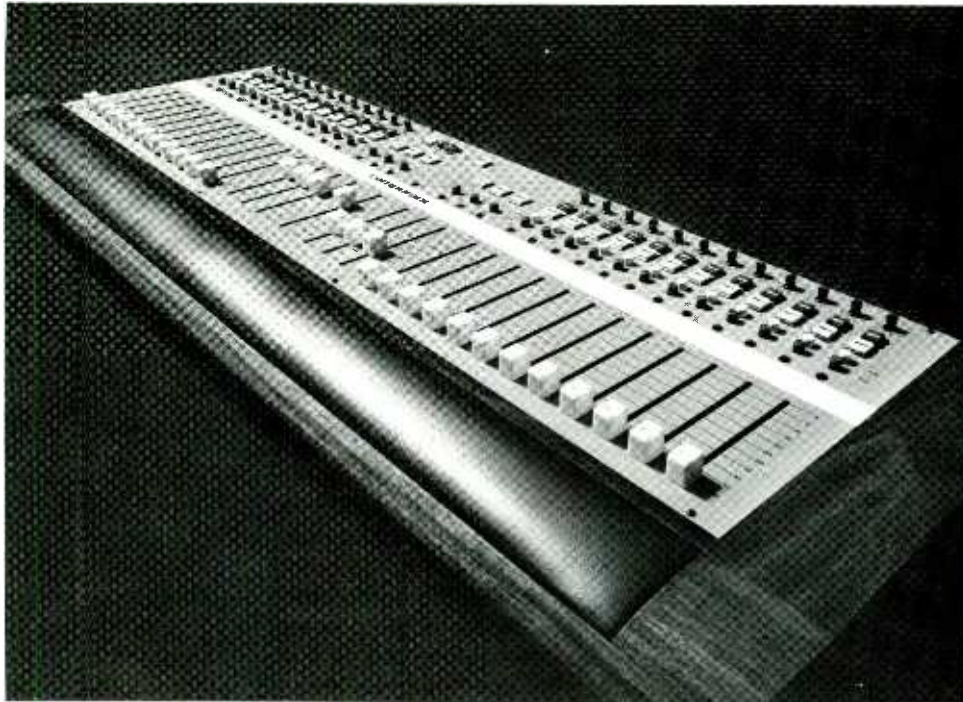

COMPUMIX™

The first expandable automated mixing system that makes sense. It's designed to augment your *present* mixing console... large or small.

Even if you're not ready to address a memory with your mix information*, our controller will give you the flexibility of an extra pair of helpful hands: to make those exasperating mixing gymnastics more comfortable.

COMPUMIX™ makes sense because you can utilize your existing equipment to add the benefits of automated mixing. It's ready for all the progressive thinkers to become doers.

COMPUMIX™ is noiseless voltage-controlled sub-mix grouping and switching control. Think about that, when you decide... simply interface our digital processor for that memory feature.

COMPUMIX™ won't let you forget the good mixes. Little things make a big difference, however, *big things make a bigger difference.*

THE COMPUMIX™ CONTROLLER • 24 inputs (expandable) to 32 • 6 sub-mix groupings • master fade • 54 program auxiliary switch functions • complete read, write, update control with our exclusive digital VCA-800.

*With COMPUMIX™ the memory mix-information can be stored in the following ways • 2 channels of the multi-track master, any peripheral multi-track audio recorder, cassette or cartridge recorder with minimum recording bandwidth requirements.



**quad/eight
electronics**

11929 Vose Street • North Hollywood California 91605 • 213/764 1516

Circle No. 121

Re/p 45

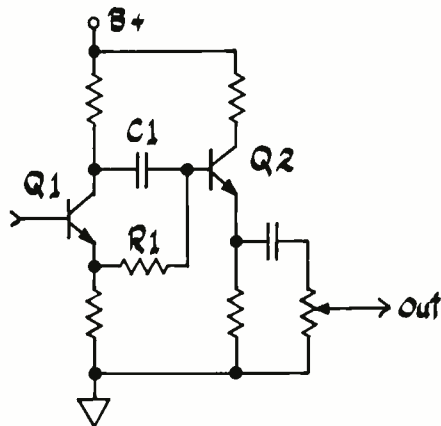

Figure 10

lector of Q1. Conversely, capacitor C1 presents a very low impedance to the higher signal frequencies allowing them to pass readily to the base of Q2. At intermediate frequencies, the vector sum of R1 causes the signal to be applied to the base of Q2 at some intermediate phase angle between 0° and 180°, while the amplitude remains constant throughout the entire frequency range. The result of this frequency/phase shift action cancels the inherent phase distortion on a signal caused by magnetic transfer characteristics when the signal was recorded on tape.

The value of R1 is normally changed for different tape speeds for the proper amount of compensation.

RECORDER ALIGNMENT PROCEDURE

Like all recorder alignment procedures the first two steps should be automatic; the complete cleaning and proper demagnetizing of the entire tape path. Any residual magnetization along the tape path and especially the heads will result in increased even harmonic distortion and a decrease in the final signal/noise ratio. For those using 3M 206 or 207 tape a special cleaning of the tape path and heads is recommended. With all the good qualities of this low noise, high output tape, it does create a problem for many studios who have found it to leave a hard residue, suspected of being bonding compound, on the heads. As a result of this there is poor tape to head contact. When not corrected the end result is higher than necessary record current to get the proper level on the tape, improper high frequency equalization settings, increased distortion and poorer S/N ratio.

Only those alignment steps and procedures aimed at lowering the distortion within your recorder will be reviewed; this does include however, most alignment steps.

If the recorder has transport problems

they should be taken care of first. Check flutter and wow to be sure these are within specs. Excessive flutter makes any distortion checks difficult for two reasons. The first being the tuning of a distortion analyzer since flutter will put the analyzer in and out phase tuning. Secondly, flutter creates FM modulation which can cause false true distortion readings.

Getting into the electrical alignment, the reproduce alignment is first. If 206 tape is to be used we have a choice in alignment; maximum S/N or minimum distortion. We do not however, have a free choice, some recorders when using 206 tape for maximum S/N create additional distortion problems. Manufacturers of different recorders have made modifications available, based on the use of 206 tape. A check with your local manufacturers field rep is suggested, plus some trial and error steps with your particular recorder.

All recorders can use 206 tape when aligned for minimum distortion or additional headroom. Using 206 in this manner, set alignment tape playback levels for 0 VU at 700Hz and playback equalization for 0 VU at 10,000 Hz. Next in line is head azimuth adjustment. The reproduce head can be set with the alignment tape, and so can the record head if the recorder is equipped with sel-sync playback. Azimuth adjustment and level adjustments are done in conjunction with each other, after azimuth is aligned be sure your levels are still set at 0 VU.

All signal sources being used in the alignment of a recorder should be of the lowest possible distortion. We certainly do not want to align our recorder to the distorted waveforms of a poor signal source. Virgin or bulk degaussed tape should be used whenever possible.

In the alignment of the record electronics a check of the bias and erase

APPENDIX 1a

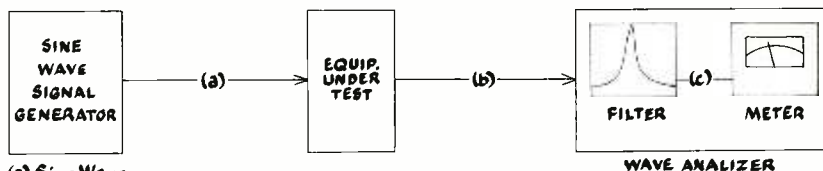

- (a) Sine Wave
- (b) Output Sine Wave with Harmonic Components
- (c) Harmonic Component Tuned To With Filter

APPENDIX 1b

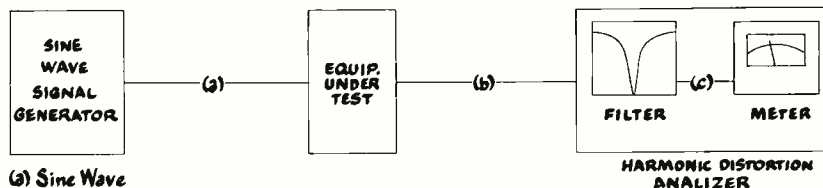

- (a) Sine Wave
- (b) Output Sinc Wave With Harmonic Components
- (c) Output Signal Including Harmonics And Noise, Less Original Signal

APPENDIX 1c

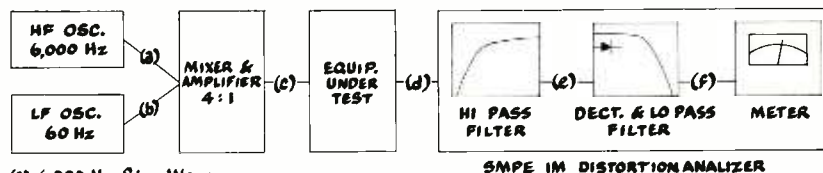

- (a) 6,000 Hz Sine Wave
- (b) 60 Hz Sine Wave
- (c) 60 & 6,000 Hz Mixed 4:1
- (d) Mixed Signal Plus IM Distortion Components
- (e) 6,000 Hz AM Modulated Due To IM Distortion
- (f) IM Components of The 6,000 Hz Signal

APPENDIX 1d

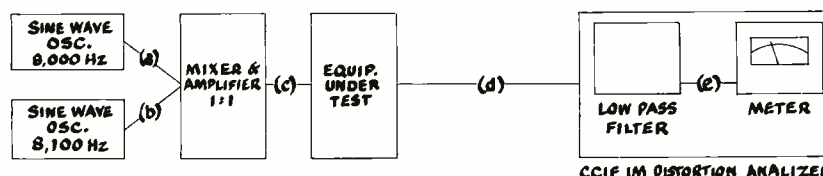

CCIF IM DISTORTION ANALYZER

waveforms is the first step. If the recorder has a bias or erase amplifier equipped with tunable coupling circuits, these circuits have to be tuned for the least distorted waveform. This can be done several ways:

- 1) If distortion analyzers are not available these circuits can be aligned for maximum output which will normally be the point of least distortion, since maximum output is the same point as the best possible impedance match. (Impedance mismatch being a cause for distortion.)
- 2) Again if distortion analyzers are not available, a scope can be used to observe the waveform as it is adjusted for minimum distortion.
- 3) Using a harmonic distortion analyzer to check the waveform, the goal is again to adjust the tank circuits or coupling circuits for minimum distortion.
- 4) If an IM analyzer is available, bias waveform can be aligned for minimum distortion of a recorded IM signal. Using this, one must be sure that bias level is also adjusted properly.

After the bias and erase waveforms are checked and aligned the next step is record and bias level adjustments. As shown in FIG 7, there is one point of bias current that is best for distortion and signal to noise readings. This point, however varies with each recorder and type of tape being used. The point can normally be found between peak bias and 1 dB over-bias of a recorded 1000Hz signal. Normally we start by setting bias for 1/2 dB over-bias at 1000Hz and check the distortion of the output. Excessive bias current can deteriorate the high frequency response of the recorder, and this has to be checked and avoided while setting bias level. That point between peak and 1 dB over-bias which is best for your recorder will have to be determined by you. The best bias setting being a compromise between minimum distortion and best frequency response.

The next adjustment will be a re-check of record level and record high frequency equalization after the bias level is set.

Noise balance is next and this too can be done several ways:

- 1) With the absence of an input signal place the recorder in the record mode and monitor

the output at a very high listening level, noise balance is then set for minimum popping and 'grotzel' type noise.

- 2) If a wave analyzer is available noise balance should be set for minimum second harmonic distortion of a 1000Hz signal. This is a finer tuning than the steps shown in No. 1 and should be done only with a wave analyzer tuned to the second harmonic. Total harmonic

distortion cannot be used since some recorders will show a minimum total harmonic distortion where there is not a minimum second. Noise balance should be set only for minimum second harmonic which is the exact point of minimum record noise.

Linearization adjustment is sometimes the most difficult. Not all recorders can be adjusted the same way due to slight

continued on page 48



"The Silencer"

WIPES OUT TAPE SOUND



TABERASER

WIPES OUT sound from all magnetic tapes, cartridges, cassettes, magnetic film stock too. Up to 2".

WIPES OUT sound with minimum residual noise because the field automatically diminishes at the end of each 30-second cycle.

NO OVERHEAT because internal blower activates automatically to keep unit below 71°C.

BUDGET PRICED at only \$395.00.

For the distributor in your area -
Call or Write: **TABER** MANUFACTURING & ENGINEERING CO.
 2081 EDISON AVE. • SAN LEANDRO, CALIF. 94577 • PHONE: (415) 635-3831

differences in their linearization networks. While the 3M recorder can best be set up for minimum third harmonic distortion using the linearizer, a Scully should be set up for minimum IM distortion at higher input levels. With the goal being the best possible alignment for each recorder, again a little trial and error with your recorder may be best. At last report Scully is modifying their linearizer network however the final modification kit is as yet unavailable.

- 1) On a 3M machine using a wave analyzer record a 1000Hz tone and monitor the output with the analyzer tuned to the third harmonic.
- 2) Increase the input level (with the linearizer turned off) till the output from the recorder shows 3% third harmonic.
- 3) Turn the linearizer on and adjust for minimum 3rd harmonic, it should be at least 0.8%.
- 4) Since the linearizer is a feedback path, overall record level may now have to be re-adjusted.

- 5) Repeat steps 1 through 4 so the end results are: proper record level, 0 VU *in* equals 0 VU *out*; and with the linearizer turned off the same input level that gives you 3% third harmonic distortion gives you less than 0.8% when the linearizer is turned on.

On a Scully recorder inject an IM signal at plus 9 dBm in, and adjust the linearizer for minimum IM distortion out. Again there is interaction between record level and the linearizer, the end result should be the proper record level for 1000Hz in and minimum IM distortion at plus 9 dBm (plus 5 VU) in.

For the best results with your recorder both tests should be tried to see the best results for minimum harmonic or IM distortion at both normal and higher than normal input levels.

CONCLUSION

No two recorders are alike and each has to be checked out and aligned differently. Aligning your recorder for minimum distortion does take a little

more time, but normally only when you're trying it for the first time. Most recorders have the ability to hold their alignments fairly well after they have been set up properly, and future distortion alignments should only be a fine tuning of the levels set up after a distortion alignment is completed the first time. It has been our experience that the time taken to complete this type of alignment is well worth it since the sound quality of your recorder both in terms of S/N ratio and distortion can really be heard. The additional cost of the test equipment is a sound investment to align your \$17,000, and up, multi channel recorder. Axiomatically, your equipment can only be as good as the test equipment you use to align it with. For the smaller studio where such an investment is still too much, most of this equipment can be rented on short terms at reasonable rates, or consider the idea of several small studios joining together, in that each studio can obtain one good piece of equipment, to create a pool of good test gear.

BILL WILSON
B.W. ASSOCIATES

"What I need is a recording console that's expandable to 26 in., 16/24 out; with full quad capability; and FET logic automatic rec./play mode switching. But it would cost me \$36,000 or more."

"What you need is Auditronics!

"Son of 36 Grand"

It's got everything you need for about half the cost."

For more information on the Son of 36 Grand, write Auditronics, P.O. Box 12637, Memphis, Tenn. 38112. Or visit our display at the Fall AES Convention, Waldorf-Astoria, New York.



auditronics, inc.
MEMPHIS TENNESSEE

NEW PRODUCT NEWS

TASCAM 8 IN - 4 OUT MIXING CONSOLE; \$1890.

An 8-in, 4-out TASCAM Model 10 Mixing Console developed by TEAC Audio Systems is now available at \$1,890. The floor-standing unit includes eight input modules, four sub-master modules, a master module with a straight-line fader, and four 4" VU meters with fast-acting LED peak indicators.



Each of the eight input modules provides a 3-position input pad, a feedback-type mic attenuator, a line attenuator, a 3-position input selector, hi- and lo-pass filters, hi-, mid- and lo-band equalizers with frequency selection, complete echo-send and receive circuitry including pre- and post-selection, channel and pan assignment pushbuttons, a pan pot, and a unique straight-line fader.

Each of the four sub-master modules provides a straight-line fader, source/tape monitor control, and separate monitor level controls.

The board is pre-wired to accept four additional input modules for a 12-input capability, and other optional plug-in modules including talkback, remote transport control, quad panner with joy stick controls, and a headphone monitor panel.

TASCAM CORPORATION (TEAC AUDIO SYSTEMS CORPORATION OF AMERICA), 5440 MC CONNELL AVENUE, LOS ANGELES, CALIF. 90066.

Circle No. 124

SHURE INTRODUCES BOOM MICROPHONE THAT SOLVES THE PROBLEM OF SUBSONIC TRANSIENTS.

Shure Brothers has introduced an improved version of its Model SM5A unidirectional dynamic microphone, that includes features designed to minimize subsonic low frequency transients resulting from rapid boom movement or wind.

Called the SM5C, the new model incorporates a 100Hz hi-pass filter in the cartridge assembly that significantly reduces subsonic transients. Although these transients often occur at frequencies below audible levels, they can overload the input stage of some recording channels and result in momentary blocking or distortion.

The SM5C Model also includes a hum-bucking coil that improves the signal-to-noise ratio when used in high-magnetic fields, such as power transformers or lighting dimmers.



Like other models in the SM5 series, the SM5C offers wide range smooth response and a near perfect cardioid pattern. It is ideal for boom applications involving narration, vocals, dialog, and orchestration pickup.

Professional net price of the Model SM5C Microphone is \$267.00.

SHURE BROTHERS INC., 222 HARTREY AVENUE, EVANSTON, ILLINOIS 60204.

Circle No. 125

FREE from AKG

48-page technical brochure on Field Effect Transistor condenser microphones and describing in detail:

- A. Structural details of new type miniature condenser microphone capsules with various pick-up pattern, complete with performance and comparison charts.
- B. F.E.T. condenser microphone preamplifier technology, including schematics and specifications.
- C. Modern powering techniques of F.E.T. condenser microphones.
- D. Application hints, including illustrations and descriptions of recording accessories.



This booklet is of interest to every innovative recording and broadcast engineer. Please fill out coupon below or send us your request on your organization's stationery. AKG-113

NAME _____

TITLE _____

FIRM _____

ADDRESS _____

CITY _____

STATE _____ ZIP _____



MICROPHONES • HEADPHONES

DISTRIBUTED BY
NORTH AMERICAN PHILIPS CORPORATION
510 EAST 42nd STREET, NEW YORK, NEW YORK 10017

AKG CANADA • DIVISION OF DOUBLE DIAMOND ELECTRONICS • SCARBOROUGH, ONTARIO

Circle No. 126

Re/p 49

Prevent

NOISE

Pollution with the Model 2000 Noise Eliminator



A record-play signal processor which extends the dynamic range of a studio tape machine or transmission link to as much as 110 dB.

The Noise Eliminator can also be used to produce program material to be played through special consumer equipment with 35 dB improvement in dynamic range or through conventional equipment. It is applicable to prerecorded tapes, cartridges, cassettes, records, and FM.

Features

110 dB Dynamic Range @ 15 ips

105 dB Dynamic Range @ 7½ ips

35 dB Improvement in FM, Tapes, and Records

Less than .1% Total Harmonic Distortion RECORD and PLAY Modes for Each Channel

Silent Manual or Automatic Mode Switching

Output DC Coupled, ±11 V Open Circuit Delivers 18 dBm Into 600 ohms or 16 dBm Into 150 ohms

Response ±.2 dB 20 cps to 20 kc at all times

Compensation for Tape Recorder Response

Equalization for Future High Resolution Tapes

Insensitive to Tape Recorder Errors 1 or 2 Channels Available on 1¾" Rack Panel

Plug-in Channel Cards and Modules for Ease of Servicing

Active Transformer Input, 100k or 600 ohms

Highest Quality Materials and Components Guaranteed for Two Years

For full information write:

BURWEN T.M.
LABORATORIES

12 Holmes Road
LEXINGTON, MASS. 02173
(617) 861-0242

Re/p 50 Circle No. 127

AUDIOTECHNIQUES INTRODUCES NTP STEREO MONITOR OSCILLOSCOPE.

The NTP Model No. 177-500 Stereo Monitor Oscilloscope is designed for monitoring stereo recordings and stereo disc mastering. When recording compatible stereo programs, the engineer should know the phase and amplitude ratio between the two channels. This device is a method of controlling the phase, stereo width and balance during mixing of multi channel recordings into two track. Stereo signals with correct balance will show circular patterns while crosstalk or prevalent center will show elliptical figures oriented NE-SW. Phase error is indicated by an elliptical figure oriented NW-SE.



Price \$410.

AUDIOTECHNIQUES, INC., 121 HAMILTON AVE., STAMFORD, CONN. 06902.

Circle No. 128

FROM ELPA MARKETING, SINGLE UNIT MEASURES ALL MAJOR PARAMETERS OF MAGNETIC RECORDING SYSTEM.

Equally appropriate to the professional studio as to the smallest service shop, the Ferrograph Recorder Test (RTS-1) consists of four sections: variable frequency audio generator, millivolt meter with associated attenuator, wow and flutter unit and total harmonic distortion measuring unit.

Independent access to the inputs and outputs of the various sections ensures the greatest flexibility for general purpose

work. The interconnecting of these sections in the correct sequence for any particular test, or for calibration checks is carried out by an array of clearly labelled push buttons. Only two leads are necessary from the test set to the equipment under test.

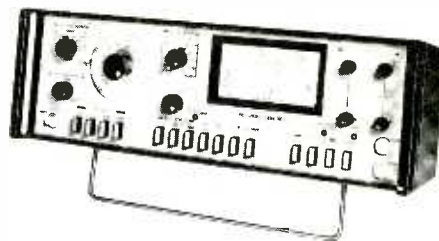

In addition to magnetic recorders, the Ferrograph Test Set is equally applicable to disc reproducers, dictating machines, tele cine and film apparatus and audio amplifiers. The unit weighs only 13 lbs. and is 17 - 3/8" wide x 10" deep over a stand 5 - 5/8" high. A portable carrying case and rack mounting provisions are available as options.

Price is \$1200.00.

ELPA MARKETING INDUSTRIES, INC., NEW HYDE PARK, NEW YORK 11040.

Circle No. 129

SPECTRA SONICS ANNOUNCES THE MODEL 904P QUADRAPHONIC PAN CONTROL TO THEIR LINE OF PROFESSIONAL AUDIO PRODUCTS.

The Model 904P is a joy stick, continuously variable control of superior electrical and mechanical design. It provides variable panning action of a single audio signal to four channels of audio, as utilized in quadraphonic recording, or sound reinforcing applications, and for the first time this control is available on 1-1/2" centers for custom installation in any audio application.

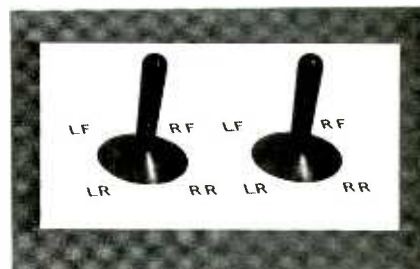

Price is: \$165.00.

SPECTRA SONICS, 770 WALL AVENUE, OGDEN, UTAH 84404 or 6430 SUNSET BLVD., SUITE 1117, HOLLYWOOD, CALIFORNIA 90028.

Circle No. 130

ELECTRODYNE CORPORATION AN MCA TECHNOLOGY CO., INTRODUCES A NEW QUADRAFONIC PAN POT AND CHANNEL SELECTOR, FOR CONSOLE INSTALLATION, IN A PLUG-IN MODULE, MODEL NO. SML-516094P.

The unit utilizes switches with numerical readout for channel selection in 16 track recording applications. Two selectors assign to channels 1 – 8 and two selectors assign to channels 9 – 16. This allows signal delegation to any of the 16 channels with two assignments to the first 8 tracks and two assignments to the second 8 tracks, simultaneously. On-Off buttons are provided for each switch so that the selection may be punched in or out individually. A separate selector and On-Off button is provided for echo selection of any of eight echo send channels.

Quadrafonic panning and positioning is accomplished with four pan pots providing any angular placement within 360 degrees. Concentric controls are used for individual program and echo panning. Two sets of these controls are used. One for left – right, and the other for front – rear positioning.



Panel size is 1 1/2" x 9", overall depth including mating connector is 4 3/4". Front panel is black matte formica, special colors and finishes are available upon request.

MCA TECHNOLOGY INC., 13035 SATICOY ST., NO. HOLLYWOOD, CA 91605.

Circle No. 131

AMPEX ANNOUNCES DELIVERIES OF NEW MODEL MM-1100 AUDIO RECORDERS

The new Model MM-1100 is priced at \$16,500 in its standard 16-track version and features a servo capstan not usually included in recorders in this price range.



The MM-1100 is designed for heavy duty studio or remote recording use by master recording studios, rock and other musical groups and production houses. It will allow studios small and large to enhance their multichannel capability economically.

The MM-1100 is a companion recorder to the MM-1000, which remains in the Ampex line as the premium machine for recording and studio production work.

The MM-1100 has a removable control box for remote control operation. Additional remote control units can be accommodated. The MM-1100 can handle up to 16-inch reels, which permit more than two hours of recording at 15 ips.

An automatic tape tensioning system permits fast conversion from 1-inch to 2-inch tape widths. Tape tension is automatically adjusted when head assemblies are changed. Full digital control of all transport functions virtually eliminates the possibility of tape damage or spillage caused by operator error or power failure.

The recorder features improved Sel-Sync performance, which enables recording artists to listen to a previously recorded track while recording in perfect synchronization on another track.

AMPEX CORPORATION, 401 BROADWAY, REDWOOD CITY, CA 94063.

Circle No. 132

Sound pressure levels up to 137 dB.



Sony's new condenser microphones; ECM-64P (Uni) and ECM-65P (Omni) handle sound pressure levels up to 137 dB, with less than 1% distortion.

Both microphones shield the capsule with a unique double windscreen to reduce pop susceptibility when close miking is employed. In addition, they're designed to filter out unwanted extreme low frequencies, all but eliminating the proximity effect that can severely impair the performance of a hand-held microphone. Primarily designed for Phantom power the ECM 64P/65P operates equally well from a self contained battery.

SONY SUPERSCOPE

©1972 Superscope, Inc., 8132 Vineland Ave., Sun Valley, Calif. 91352. Send for free literature.

Circle No. 133

Re/p 51

Sony's award presenting microphone.*

*Used at Academy Award and Emmy Award T.V. presentations 1972.

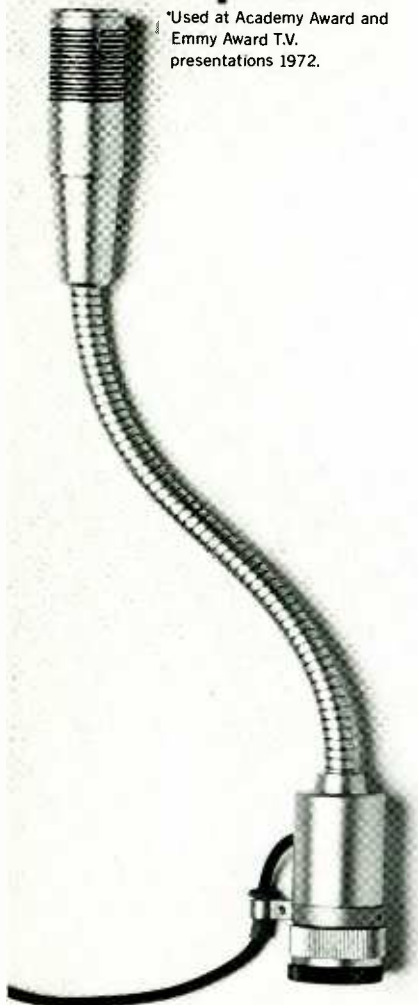

Featuring a high-performance condenser capsule of electret design, the ECM-53 is specifically designed for broadcast, recording studio, public address and similar applications.

The cardioid capsule assembly contains a permanently charged condenser capsule and FET/IC amplifier. A Cannon connector houses the battery supply.

- Frequency Response: (Frontal ± 3 dB): 40 Hz to 16 kHz
- Output Impedance (at 1 kHz $\pm 20\%$): 50, 250, 600 ohms Balanced
- Maximum SPL (1 kHz): 134 dB

Also Consider:

Tie-tack/lapel condenser mic ECM-50.

Telescopic (from 7 $\frac{3}{4}$ " to 17 $\frac{1}{2}$ ") condenser mic ECM-51.



©1972 Superscope, Inc., 8132 Vineland Ave., Sun Valley, Calif. 91352. Send for free literature.

STEPHENS CAPSTANLESS DRIVE RECORDERS

Stephens Electronics announces a breakthrough in the state of the art of multi-track professional studio recorders. The Stephens 811D-103 Recorder is a Capstanless Drive Machine, thus virtually insuring safe handling of expensive wide-width tape. The patented servosystem provides smooth, effortless tape control in all modes of operation, assuring that it cannot accidentally destroy tape.

Speed is maintained to within the accuracy of external A.C. line frequency, or to a built in variable speed oscillator, which can vary speed from 10 ips to 80 ips, while maintaining .03% flutter average, not exceeding .05%. Remote V.S.O. package, which is included, reads phase reference for locking to tape, film, or 60 cycle line frequency.

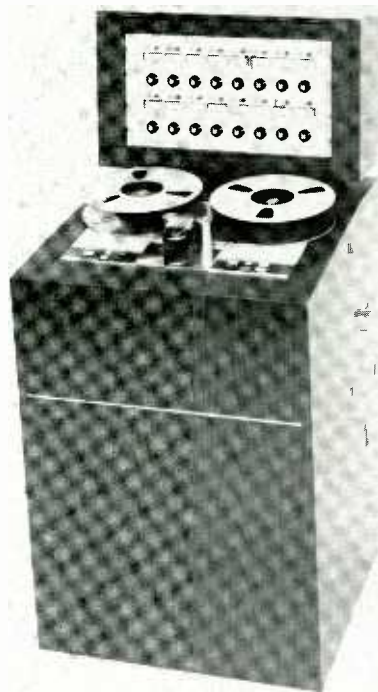

Recorder is provided with digital tape speed readout. Standard tape speed is 15 ips/30 ips; other speeds are available at additional cost. Controlled instant starts and stops are only one of its many features, including a 60 ips "SCAN SPEED" to locate takes, reel size handled on standard machine is 10 $\frac{1}{2}$ " NAB hub. Other large reel capabilities can be supplied on special order.

Any number of decks can be synchronized by a rear connector, and an external servo signal can be introduced to lock the machine's speed to exterior control devices. Electronics are modular, highly reliable, and quiet.

Overall size of 16 track recorder in cabinet is 24" wide x 30" deep x 51" high. Optional additional equipment available: remote control; tape counter and tape locator, and noise reduction system.

Price of 16 track recorder in cabinet is \$19,500. 16 track unit convertible to 8 track, \$21,000. Delivery is approximately 6 weeks from receipt of order. Also available in 8 track, 24 track and 40 track configurations.

STEPHENS ELECTRONICS, INC.,
3513 PACIFIC AVE., BURBANK, CA
91505

Circle No. 135

JBL PREMIERES NEW STUDIO MONITOR

The 4350 speaker complement consists of two 15" low frequency transducers, one 12" mid-bass reproducer, a 4" diaphragm compression driver with horn and slant-plate acoustic lens, plus an ultra-high frequency slot-loaded horn driver for reproduction of upper harmonics and overtones. The new monitor loudspeaker system is designed for bi-amplification — one amplifier driving the low frequency transducers and another powering the balance of the speaker complement. JBL recommends that an electronic crossover be used which provides a crossover point of 250Hz with an attenuation rate of 12dB per octave.

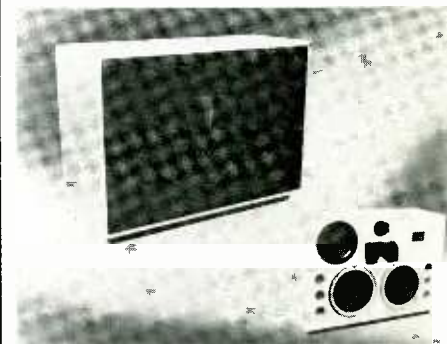

Additional crossover points of 1200Hz and 9000Hz are internally controlled. Rated at a continuous power capacity of 200 Watts RMS below and 100 Watts RMS above 250Hz, the JBL 4350 Studio Monitor is capable of generating intense sound pressure levels while retaining flat response, exceptional instrument definition and exceedingly low distortion.

JAMES B. LANSING SOUND, INC.,
3249 CASITAS AVENUE, LOS
ANGELES, CALIF. 90039

Circle No. 136

Circle No. 137

A professional 6 channel stereo mixer at a price everyone can afford. Noise -127 dbm. Output -120 dbm into 600 ohms. Integral VU meters. Switchable mic preamp gain, IC circuitry, 117 VAC or battery operation. Switchable low frequency rolloff. A-B pots. Beyer and Triad transformers. See your dealer or order direct postpaid from Prokit.

\$24900 KIT
\$49900 WIRED

PROKIT DIVISION, GATELY ELECTRONICS
57 WEST HILLCREST AVE. • HAVERTOWN, PA. 19083 • 215-446-1415

there will be a slight delay

(two of them, in fact)

UREI's unique Cooper Time Cube gives you TWO completely independent audio delay lines, at less than one-third the cost of a single channel digit unit.

The Time Cube is the ideal creative tool for: recovery of hidden ambients to produce Quadriphonic product; loudness enhancement; delaying reverb send; and changing apparent source-to-mike distances.

Model 920-16 Time Cube is the only acoustical delay line system of professional quality. It is designed specifically for recording studio applications and for anticipatory noise reduction in optical film recording.

See your dealer or write for complete specifications



UREI company

11922 Valerio Street, No. Hollywood, California 91605
(213) 764-1500

Circle No. 139

CLASSIFIED

Send for FREE Catalog and Audio Applications



OPAMP LABS
172 S. Alta Vista Blvd.
Los Angeles, Calif. 90036
(213) 934-3566



Circle No. 138

EQUIPMENT AVAILABLE

America's Largest Selection of New and Used RECORDING EQUIPMENT

Bought, Sold, Traded — Write for Free Listing

THE MAZE CORPORATION

P. O. Box 6636, Birmingham, Alabama 35210

ONE STOP FOR ALL YOUR PROFESSIONAL AUDIO REQUIREMENTS. BOTTOM LINE ORIENTED.

F. T. C. BREWER COMPANY

P. O. Box 8057, Pensacola, Florida, 32505

PROFESSIONAL NATIONWIDE STUDIO DESIGN, INSTALLATION, AND SERVICING. PLAN BEFORE YOU SPEND!

THE MAZE CORPORATION

P. O. Box 6636, Birmingham, Alabama 35210

AMPEX 351-2-X. Especially built high performance machine with many extras. Includes portable cases plus walnut vertical cabinet, spare motor, etc. \$1400. Also Altec 1567A mixer, G-R650A Bridge, MDC300 scope and two Schoeps CMT46 mics. Francis Daniel, 201 West 89 St., N.Y.C. (212) 874-0590.

AUDIO DESIGNS CONSOLE — 16 input, 8/16 output. Audex program and echo buss assignment. Quad monitoring both studio and control room with Audex tape track to speaker assignment. Quad outputs. 16-track monitor mix. 4 equalized echo busses. 2 cue busses. \$16,000. Sound 80, (612) 721-6341.

EMT PDM 156 Limiter-Compressor-Expander. Excellent condition. Price: \$2500.00. Call (213) 478-8227. Ask for Rob or Mike.

ASSUME PAYMENTS
QUAD-EIGHT 1682 10-in 8-out
AG-440-8 Write for details
c/o P.O. Box 40603
Nashville, Tenn. 37204

FOR SALE
Professional 8-track recording console
\$6,500 or best offer
Call 213-848-9004 any time

Variable-directivity condenser studio microphone provides 130 dB dynamic range.



Dynamic range (130 dB)
+ noise level (24 dB)
= max. spl (154 dB)

Sony's variable-directivity (Omni-Uni) C-37P* contains an advanced FET amplifier. A switchable attenuator is placed between the capsule and amplifier to prevent distortion even at extreme sound pressure levels.

The combination of proven excellence in sound quality, and the very latest in semiconductor technology makes the Sony C-37P indispensable in today's quality-oriented recording studio.

Also Consider:
Studio standard condenser microphone model C-500.*

SONY SUPERSCOPE

*Must be powered by Sony AC 148A or equivalent power source.

©1972 Superscope, Inc., 8132 Vineland Ave., Sun Valley, Calif. 91352. Send for free literature.

Circle No. 140

Re/p 55

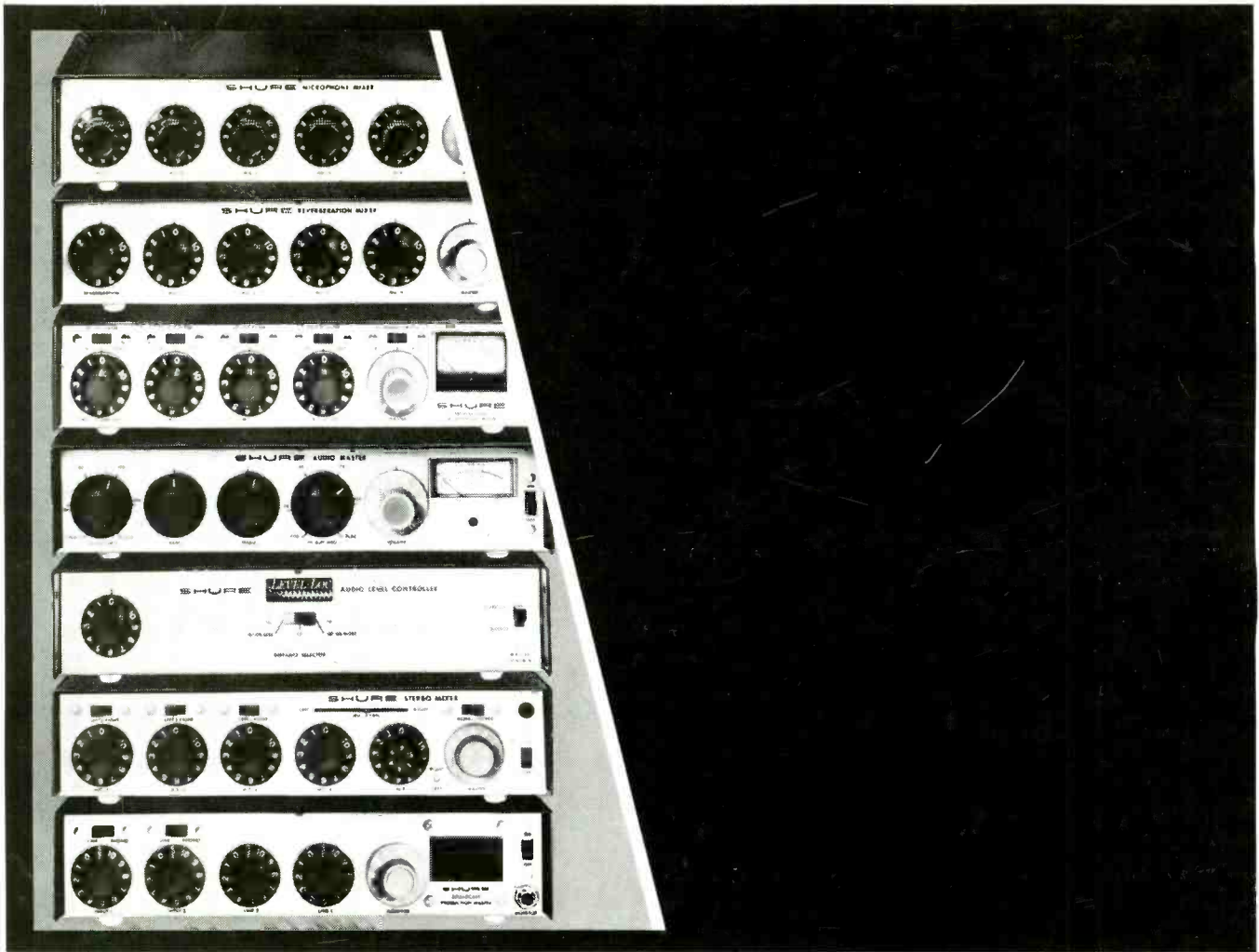

The Magnificent Seven



We've been hearing unsolicited rave reviews from soundmen across the country concerning our seven ingeniously versatile problem-solving audio control components (1) *M68 Microphone Mixer*, vanguard of the low-cost, high-performance portable mixers; (2) *M68-RM Mixer*, with built-in reverb for vocalists and special effects; (3) *M67 Mixer*, the trail-blazing low-cost professional mixer; (4) *M63 Audio Control Center*, that gives you variable response shaping; (5) *M62V Level-Loc*, the audio level controller that automatically limits output level; (6) *M688 Stereo Mixer*, made to order for stereo recording and audio-visual work; and finally, (7) *M675 Broadcast Production Master*, that teams up with our M67 to give a complete broadcast production console (with cuing) for under \$325. Write for the new Shure Circuitry catalog that shows them all:

Shure Brothers Inc.
222 Hartrey Ave., Evanston, Ill. 60204



Circle No. 141

www.americanradiohistory.com