

Profile:
Engineer/Producer
RON MALO

ICD 08560
\$1.95

MODERN RECORDING & MUSIC

Vol. 6 No. 12
September 1981

a session with:
**TEDDY
PENDERGRASS**



LAB REPORTS:

**Hitachi D-1100M
Cassette Recorder**

**Sonic Rainbow
Accusonic Tuner**

**TEAC 22-4
Open-Reel Recorder**

HANDS-ON REPORT:

**BGW Model 10
Electronic Crossover**

NOTES:

**Electro-Harmonix
Model EH-3060 Graphic Fuzz**

AP0MED193BAL99
D P0MEROY
193 BAL TIC ST
BROOKLYN
NY 11201
83/05 09
MR

**UCTS
:VIEWS**

The Unlimited Limiter.



In keeping with MXR's expanding commitment to the professional recording industry, our engineers have designed and built the Dual Limiter. A world class mono-stereo limiter offering total flexibility and ease of operation, the Dual Limiter produces a musically natural response in any compression-limiting application. All of this versatility is built into a compact, rack-mountable package.

The totally unique VCA's at the heart of the Dual Limiter provide an exceptionally wide dynamic range with low levels of distortion. Continuous bass distortion is much lower in level than typical compressor-limiters, allowing more freedom in setting release characteristics.

The Dual Limiter is also a forgiving limiter. Attack and release characteristics dictated by the front panel controls are modified by program dynamics and compression requirements. The slope increases smoothly past the threshold point, allowing a *gradual* transition into compression. Varying the Dual Limiter's threshold region produces a variety of intermediate slopes with the primary slope being that chosen by the slope switch. These features permit apparent dynamics to be maintained even though the dynamic range is being controllably limited.

The Dual Limiter's remarkable versatility is based on the fact that it can be viewed as two independent mono limiters that can be patched together via front panel switches for stereo limiting applications. Each channel has an In/Out switch, Slope switch, Input, Output, Attack and Release controls and an LED display, showing the amount of gain reduction. On the rear are

both XLR and 1/4" phone jack (ring-tip-sleeve) input and output connectors. Each channel's detector is accessible via rear panel phone jacks to permit external tailoring of the detectors' frequency response. This feature allows for de-essing (reduction of vocal sibilance) and a wide variety of frequency dependent limiting needs.

Because virtually every form of musical signal was used to evaluate the Dual Limiter's response during the initial stages of development, its sophisticated internal circuitry enables it to sound musically *natural* — even at extreme compression settings.

Balanced inputs, the ability to drive 600 ohm loads, +19 dBm input and output and standard rack dimensions (1 3/4" high) allow the Dual Limiter to be easily integrated into any professional system. With an extremely rugged case, metal knobs and reliable internal construction, the new MXR Dual Limiter reflects the highest professional standards and has been fully designed and built in the U.S.A.

The Unlimited Limiter — MXR's natural response to the question of performance and versatility in a space-efficient and cost-effective package. See the MXR Dual Limiter at your nearest MXR dealer.

MXR Professional Products Group

MXR Innovations Inc.
740 Driving Park Avenue
Rochester, New York 14613
(716) 254-2910

MXR



thirty-one band eq

IN/OUT

POWER

MXR

dual fifteen band eq



Studiomixer II

Now You Can Get What You Want

The next time you walk into your local audio store and listen to the salesman try to tell you what you want, turn the tables on him. *You* tell *him* what *you* want, instead.

Explain to the salesman that you have a studio and you need a mixing console with the finest components and specifications available to give trouble free performance and produce high quality tapes. Mention that your band also works gigs, and that your new mixer must have equalized, balanced sends for stage amps, too.

Next, convince him that you need some basic features like individual input channel patching, phantom power, input attenuation and padding, two effects sends, and overload indicator lights. Remind him that you would like at least a four-way, independent mix for headphones in the studio or for monitors on stage. Tell him that you would like the mixer's submasters to be an independent mix from that of the masters, so that a tape can be made of a live gig without disturbing the P.A. mix.

Don't forget to tell the salesman that you must have a full parts and labor warranty for at least two years . . . one which enables you to deal

directly with the factory if you like when your band is not near a local dealer.

Then demand more features. Tell him that you would like the board to have a built-in pink noise generator, a lineup oscillator, VU meters for all output functions, and cueing buttons for just about everything you can think of. And, of course, tell him that you expect all this for an unbelievably low price!

But, most importantly, put the final icing on the cake by saying that you need a 10X2 mixer today, but that your needs may dictate as large as a 35X8X4X2 console for your expanded facility, tomorrow.

By this time, if your local audio dealer is prepared for someone with needs as complex and sophisticated as yours, he will be directing you to the Studiomixer display in his store. If he's not prepared, then maybe you had better find a dealer who is.

If you need help finding a dealer, or just plain want some more information, please write to us, Amerimex Co., Inc., 10700 Katella Ave., Anaheim, California, 92804.

CIRCLE 83 ON READER SERVICE CARD

RSS

**Professional
Product
Series**

**Subject:
The Breakthrough
of Accessible
Automation**

CPE-800

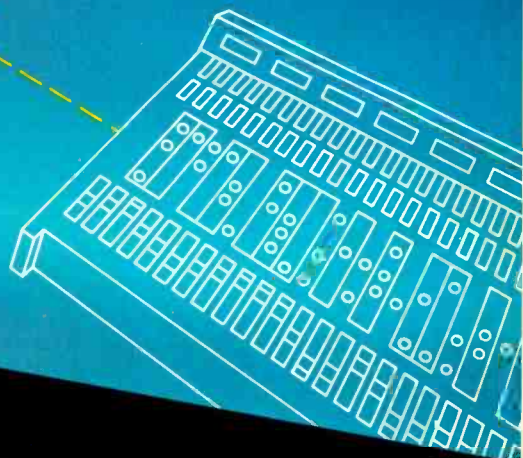
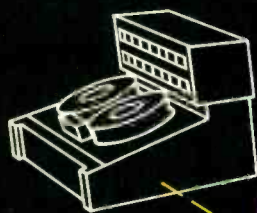

Now, for the first time, automation is within the reach of any professional. Roland Corporation, for years a leader in advanced microprocessor-based musical electronics announces a breakthrough in automation with the introduction of the CPE-800 Compu Editor from our professional division—Roland Studio Systems.

The CPE-800 has been designed to provide automation in a simple, economical format for many uses from recording to live performance and lighting. The CPE-800 and its companion unit the VCA-800 Voltage Controlled Amplifier provide automated fader

and mute control when inserted between any multitrack deck and mixing console. The CPE-800 can also be used to expand existing automation systems to include echo send, cue mixes and special effects control.

The CPE-800 provides 15 channels of simultaneous fader and mute control, and allows individual channel updates at any time. All motions are timed off a self-contained SMPTE generator/reader, which also allows the CPE-800 to interface with any other system using a SMPTE time base.

The 32k bytes of on-board data storage prevents the punch-in delay caused in

automation systems using tape storage. The entire memory can be dumped and re-loaded at any time to facilitate multiple uses. Software includes in addition, a scene-by-scene cue automation system, and internal clock programming for non-recording applications.

The Outputs of the CPE-800 allow the connection to any X-Y oscilloscope for a visual indication of all fifteen fader positions. Fader level comparator LEDs indicate the difference between data and current fader positions to enable smooth punch-ins. Two CPE-800 units can be coupled together to control 30 individual channels or functions.

If you've found the high cost of conventional automation systems to be prohibitive, you're going to like the CPE-800. You'll find that automation is a lot more accessible than you think.

Roland Studio Systems Inc.
1022 S. La Cienega Blvd.
Los Angeles, CA 90035

RSS

We Design the Future

MODERN RECORDING & MUSIC

SEPTEMBER 1981

VOL. 6 NO. 12

THE FEATURES

CONSTRUCTION PROJECT: BUILDING A MICROPHONE CABLE TESTER **38**

By *Jerry Whaley*

No one would dispute the importance of the microphone in this business, but when did you last hear a kind word for the *cable*? This simple D-I-Y circuit will check for shorts, continuity and proper pin wiring. Isn't it about time you did something nice for your cables—and your sanity?

A SESSION WITH TEDDY PENDERGRASS **44**

By *Sam Moses*

Five consecutive platinum albums are proof that "Pendergrass, Gamble, Huff and Tarsia, Inc." have hit on a winning formula, but this time out they are experimenting with new instruments, new techniques, new music. *MR&M* got a chance to talk with this award-winning team as they worked on the new album at Philadelphia's Sigma Sound.

PROFILE: PRODUCER RON MALO **52**

By *Tom Lubin*

80 gold records and sessions with—among others—The Rolling Stones, Muddy Waters, the Yardbirds and Chuck Berry have made Ron Malo somewhat of a legend in this business. Add to this his experience building studios, including the original Motown Hitsville studio, and you'll understand why *MR&M* felt this chat with Ron was way overdue!

COMING NEXT ISSUE!

A Session With Ron Wood
Profile: Producer Jack Douglas
Studio Notebook, No. 3

Modern Recording & Music (ISSN 0273-8511) is published monthly by Cowan Publishing Corp., 14 Vandeventer Ave., Port Washington, N.Y. 11050. Design and contents are copyright 1981 by Cowan Publishing Corp., and must not be reproduced in any manner except by permission of the publisher. Second class postage paid at Port Washington, New York, and at additional mailing offices. Subscription rates: \$14.00 for 12 issues; \$26.00 for 24 issues. Add \$3.00 per year for subscriptions outside of U.S. Subscriptions must be paid in American currency. Postmaster: Send Form 3579 to Modern Recording & Music, Cowan Publishing Corp., 14 Vandeventer Ave., Port Washington, N.Y. 11050.



THE STAPLES

LETTERS TO THE EDITOR **5**

TALKBACK **16**

The technical Q & A scene.

THE PRODUCT SCENE **30**

By *Norman Eisenberg*

The notable and the new, with a comment on tuning in to the new ways of tuning out noise.

MUSICAL NEWSICALS **34**

By *Fred Ridder*

New products for the musician.

NOTES **60**

By *Craig Anderton*

The Electro-Harmonix Graphic Fuzz

AMBIENT SOUND **64**

By *Len Feldman*

The introduction of the Compact Digital Audio Disc by Sony and Philips: is tomorrow's industry standard here now?

LAB REPORTS **66**

By *Norman Eisenberg*

and *Len Feldman*

Hitachi D-1100M Cassette Recorder
Sonic Rainbow Labs Accusonic Tuner
Teac/Tascam 22-4 Open-Reel Tape Deck

HANDS-ON REPORT **80**

By *Jim Ford and John Murphy*

BGW Model 10 Electronic Crossover

GROOVE VIEWS **84**

Reviews of albums by Gary U.S. Bonds, Cris Williamson, Alberta Hunter, Pharoah Sanders, Jay McShann, Sammy Price and Wray Downes.

ADVERTISER'S INDEX **92**

Cover Photo: Bernie Moser/Dufor
Teddy Pendergrass Photos: Bernie Moser/Dufor
Ron Malo Photos: Jill Jarrett
Mic Cable Tester Photos: Jerry Whaley

WHY SPEND \$200 MORE ON A BETTER TAPE DECK WHEN ALL YOU NEED IS \$2 MORE FOR A BETTER TAPE.



No matter how much you spend on a tape deck, the sound that comes out of it can only be as good as the tape you put in it. So before you invest a few hundred dollars upgrading your tape deck, invest a few extra dollars in a new Maxell XLI-S or XLII-S cassette.

They're the newest and most advanced generation of oxide formulation tapes. By engineering smaller and more uniformly shaped oxide particles, we were able to pack more of these particles onto a given area of tape.

Now this might not sound exactly earth-shattering, but it can help your tape deck live up to its specifications by improving output, signal-to-noise ratio and frequency response.

Our new XL-S cassettes also have an improved binder system, which helps keep the oxide particles exactly where they're supposed to be. On the tape's surface, not on your recording heads. As a result, you'll hear a lot more music and a lot less distortion.

There's more to our XL-S tape than just great tape. We've also redesigned our cassette shells. Our new Quin-Lok™ Clamp/Hub Assembly holds the leader firmly in place and eliminates tape deformation. Which means you'll not only hear great music, but you'll also be able to enjoy it a lot longer.

So if you'd like to get better sound out of your tape system, you don't have to put more money into it. Just put in our new tape.

maxell
IT'S WORTH IT.

Maxell Corporation of America, 60 Oxford Drive, Moonachie, N.J. 07074

LETTERS TO THE EDITOR

The Job of the Producer

I would like some clarification of the term record producer. I've heard it used so often, but often, I cannot be sure if it is actually a broad category or a specific term, or if, in the instances I've seen it used, it is actually being misused.

—Michael Stone
Oklahoma City, OK

The job of a record producer does not consist entirely of recording, mixing, and editing. There are three basic categories of record producers. There is the staff producer, the executive producer, and independent producers.

A staff producer works for a record company. The company's Artist and Repertoire (A&R) department usually has him listen to the artists who are with that company's label. He receives a salary. Also, most staff producers receive incentive production royalties.

The executive producer usually heads the A&R departments of record companies or are administrators at major record companies. They approve production budgets, settle disagreements between artists, producers, and studio personnel. They make roster decisions for the label as well, determining how many artists of different types should be included, i.e., R&B, jazz, rock, etc.

Independent producers usually don't work for a specific company, but may have an agreement with a given label to make a certain number of records for them in a certain period of time. They earn their money through a combination of advances against royalties, and independent production royalties.

Hope this clarified, at least somewhat, the job of the record producer.

Unintentional Anonymity

In the June 1981 issue of Modern Recording and Music, in *Letters to the Editor*, we printed a letter entitled "There is No Frigate Like a Book."

The person who wrote that letter was interested in correspondence. We printed his address, but omitted his name. His name is Rick Weston, and the address remains the same: 121 Westview St., Scarborough 6019, Perth, Western Australia.

Half of What You've Asked

Can you please tell me in what issues you might have published reviews of the David Hafler DH-101, and DH-200? I am interested in your opinion on these products.

—Chuck Coronato
Paterson, NJ

In the October 1979 issue of Modern Recording and Music we published a review of the DH-200 in the Product Scene column. In the December 1979 issue, in the Lab Reports column, we also did a review of the DH-200. Unfortunately, we have not published any material on the DH-101.

Two Types of Enclosure

I am preparing to build speaker enclosures and want to build either a closed box enclosure or a reflex enclosure. I am undecided, and don't know what the relative advantages and disadvantages are. Thanks in advance for any information you can give me.

—Charles Peterson
Norwalk, CT

Well, one of the advantages of the closed box design is that it is easier to design and build than the reflex. It has a more gradual cut-off rate of 12 dB per octave. It's also good for use with sub-miniature enclosures. It can be used with higher powered amplifiers because of the fact that it doesn't unload the speaker at the lowest frequencies. Another advantage to using the closed box enclosure is that any variability in the speaker has less ef-

Harmony... Instantly!

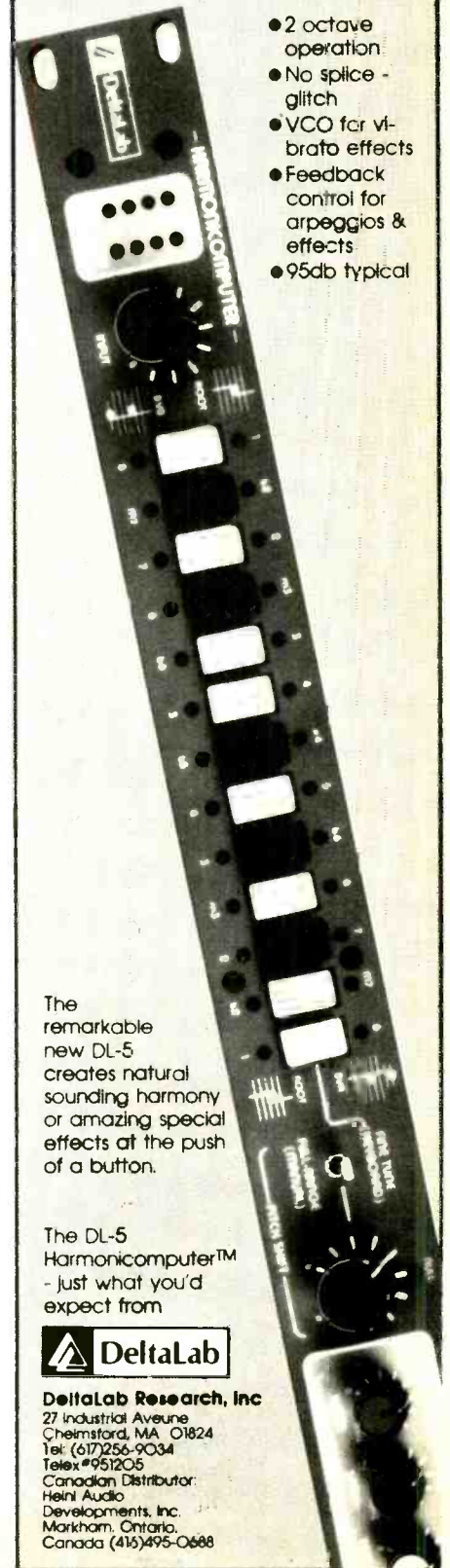

- 2 octave operation
- No splice - glitch
- VCO for vibrato effects
- Feedback control for arpeggios & effects
- 95db typical

The remarkable new DL-5 creates natural sounding harmony or amazing special effects at the push of a button.

The DL-5 Harmonic Computer™ - just what you'd expect from



DeltaLab Research, Inc
27 Industrial Avenue
Chelmsford, MA 01824
Tel: (617)256-9034
Telex: #951205
Canadian Distributor:
Heini Audio
Developments, Inc.
Markham, Ontario,
Canada (416)495-0688

CIRCLE 114 ON READER SERVICE CARD

H. G. La TORRE
Editor/Publisher

PAM HIGHTON
Managing Editor

GENE SCARAMELLINO
Assistant Editor

NORMAN EISENBERG
LEONARD FELDMAN
JIM FORD

JOHN MURPHY
BRIAN ROTH
Technical Editors

CRAIG ANDERTON
ROBERT ANGUS

NAT HENTOFF
DAVID MOYSSIADIS
FRED RIDDER
PETER WEISS

Contributing Editors

MIKE DEREVLANY
ROBERT HENSCHEN

JOE KLEE
ALLAN KOZINN

STEVE ROW
RUSSELL SHAW

JEFF TAMARKIN
Music Reviewers

LORI RESSA
Production Supervisor

BILL TRAVIS
Art Director

ELIZABETH BAILE
Assistant Art Director

EILEEN NOFI
Circulation Manager

JANICE KERNER
Advertising Assistant

MYLES GROSSMAN
Associate Publisher
Advertising Director

Editorial and Executive Offices
Modern Recording & Music
14 Vanderventer Ave.
Port Washington, N.Y. 11050
516-883-6200

Cowan Publishing Corp., Richard A. Cowan, Chairman of the Board & President; Cary L. Cowan, Vice President; Jack N. Schneider, Vice President, Marketing; Amy C. Gilman, Secretary/Treasurer; Sanford R. Cowan, Founder & President Emeritus.

Editorial contributions should be addressed to The Editor, Modern Recording & Music, 14 Vanderventer Ave., Port Washington, N.Y. 11050. Unsolicited manuscripts will be treated with care and must be accompanied by return postage.

fect on the performance.

The advantage of the reflex type of enclosure are that it has higher output and lower distortion in the octave above f_B. With a reflex enclosure you'll get greater bass range or higher efficiency from equal box volume. With a reflex enclosure you can use a single cone speaker with reduced phase problems. This makes it lower in cost. A problem with the reflex enclosure is that a speaker in such an enclosure is damped at resonance, and also damped for a band of frequencies above resonance by the air piston in the port working in phase with the cone. For more information you should look at How To Design, Build, and Test Complete Speaker Systems by David B. Weems, published by TAB Books, Blue Ridge Summit, Pennsylvania 17214.

We Have Methods To Help You Comply

I want to increase the compliance of my speakers, but I am not sure how to go about it, nor whether or not it is feasible for me to try and do so with the speakers I've got. Would you have any information about increasing compliance?

—John O'Connell
Middletown, NY

We've found that a strong whip is usually effective.

As for your speakers, you can make compliance changes if they have simple cones, ones with no surround except for the cone material's corrugations. Don't try to alter speakers with separate surrounds like treated cloth, foam roll or butyl roll, unless, of course, the surround material has deteriorated.

You can increase compliance by taking a sharp knife and slitting the cone surround. Make the slits in pairs, the two slits in a pair being opposite to each other. This is best for 8-12 inch speakers, though sometimes it will work with smaller speakers. This technique lowers the frequency resonance by about 15% to 30%. You'll probably need to cut 16 or 32 slits for this.

First slit the corrugated edge at one side of the cone and then make a slit opposite the first one. Rotate the cone one-quarter of a turn and then do the same. When you've totalled four slits, make slits halfway between each of these. Then make slits again, halfway between those eight slits, so that you wind up with 16 slits. You might want to make another round of slits to make a total of 32.

Put the speaker in a closed box. This will add a restoring force to the cone. The bass response will probably be improved despite leakage. You can seal the slits by treating them with silicone rubber. (The sealer may raise the frequency resonance a bit, but you're actually better off with a sealed cone.)

Another method of increasing compliance is by cutting out your outer corrugation and replacing it with something more flexible. Soft chamois cloth can be used. It has the advantage of damping the high frequency waves that can travel out through the cones. This keeps them from reflecting back into the cone and interfering with the waves that follow.

To use this method, first remove the speaker gasket. If the cone has a felt dust cover in its center, remove it by grasping it with tweezers and pulling it away. Below the dust cover will be the pole piece within the voice coil. With strips of photographic film, shim the voice coil, locking it in place on the pole piece. (Skip this if the cone has a dome center or a flat center made of the same material as the cone, or any center other than felt. The spider will probably hold the voice coil in place.)

Cut out four sections on the surround (at 3, 6, 9 and 12 o'clock). Make each cut-out two to three inches wide. This will depend on the size of the cone. For a twelve inch cone, cut about two inch sections of chamois to suspend it. The sections should be wide enough to go from the edge of the cone to the frame. Rubber cement can be used to glue the chamois to the lip of the cone. Stretch the chamois to the frame, and then glue it to it when the first strip has dried. These strips will suspend and center

The Electro-Voice PL91A...

the entertainer's choice.

Incredible sound! Superb performance!
Electro-Voice reliability! Set after set,
show after show, night after night. That's
what has made the PL91A the working
entertainer's vocal microphone.



EV **Electro-Voice**[®]
a gulton company

600 Decil Street, Buchanan, Michigan 49107

In Canada:
Electro-Voice, Div. of Gulton Industries (Canada) Ltd.,
345 Herbert St., Gananoque, Ontario K7G 2V1.

CIRCLE 82 ON READER SERVICE CARD

CAVEAT EMPTOR. Let the buyer beware.

All multi-cable connectors are not created equal. Some of them may look alike on the surface, but a closer examination of the design and components will show a marked difference. A professional will know the difference; if not now, then in time to come. The Whirlwind Medusa will hold up under abusive day in and day out treatment.

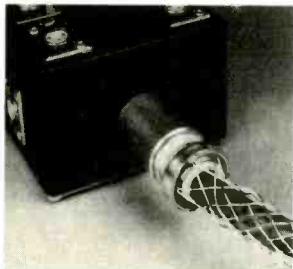
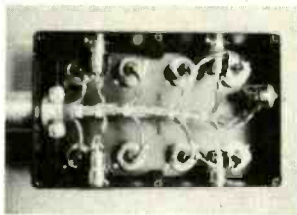

This could save you time and aggravation. Only Whirlwind uses cable custom made to our specifications by Belden for increased life and versatility. We individually hand stamp the plug ends for easy identification; We don't use wrapping which can come off. We've designed our Medusas with independent grounds to eliminate ground loops.

But we're not telling you all this to scare you. We feel confident in the way we design and build our products. Besides using the best possible cable and connectors, we back our Medusas with the Whirlwind full two year guarantee. That should ease your mind and let you concentrate on your music. So don't worry, beware and buy Whirlwind.



Shown above is the standard Medusa 15 with 100' cable, 12 mikes in, and 3 sends.

whirlwind

Whirlwind Music Inc.
P.O. Box 1075
Rochester, New York 14603

CIRCLE 110 ON READER SERVICE CARD

the cone. Then test the speaker. (Do not drive it too hard.) If there are no problems, then cut out the rest of the surrounds and replace them with chamois. The large pieces should be folded, not stretched. Leakage can be minimized by putting the speaker in a compact closed box.

Try to Remember

I remember reading a book on building recording studios in your magazine, but I'm afraid that the titles, authors, and all those other important details elude me. Could you dig up that information?

—Jack Phillips
Jersey City, NJ

Sure thing. We've actually mentioned at least two, both of which we'll give you the details on. One of them is: Building a Recording Studio, by Jeff Cooper, published by The Recording Institute of America Press, Inc., New York, NY, 1978. The other book is: How to Build a Small Budget Recording Studio from Scratch...With Twelve Tested Designs, by F. Alton Everest. It is one of the TAB series of books, number 1166 in the series. You can send for it by writing to TAB Books, Blue Ridge Summit, Pennsylvania, 17214. We hope that these books suit your needs, and that one of them is the one your memory half lost.

A Little Background

Could you give me some information on the development of multichannel recording, such as when it began, who started it, etc.? If you could provide this bit of historical information, I'd be most appreciative.

—Don Nathan
Parsippany, NJ

Stereo recording began in 1931, with the experiments of A.D. Blumlein, who was then the chief engineer for England's Electrical and Musical Industries, Ltd. He was the first to experiment with recording two separate channels simultaneously. In 1940 stereo was first put to use commercially in the soundtrack of Walt Disney's Fantasia. But it took quite a while until stereo was used for the recording of popular music. In 1957 Westrex began cutting left and right stereo channels in one record groove. Magnecord

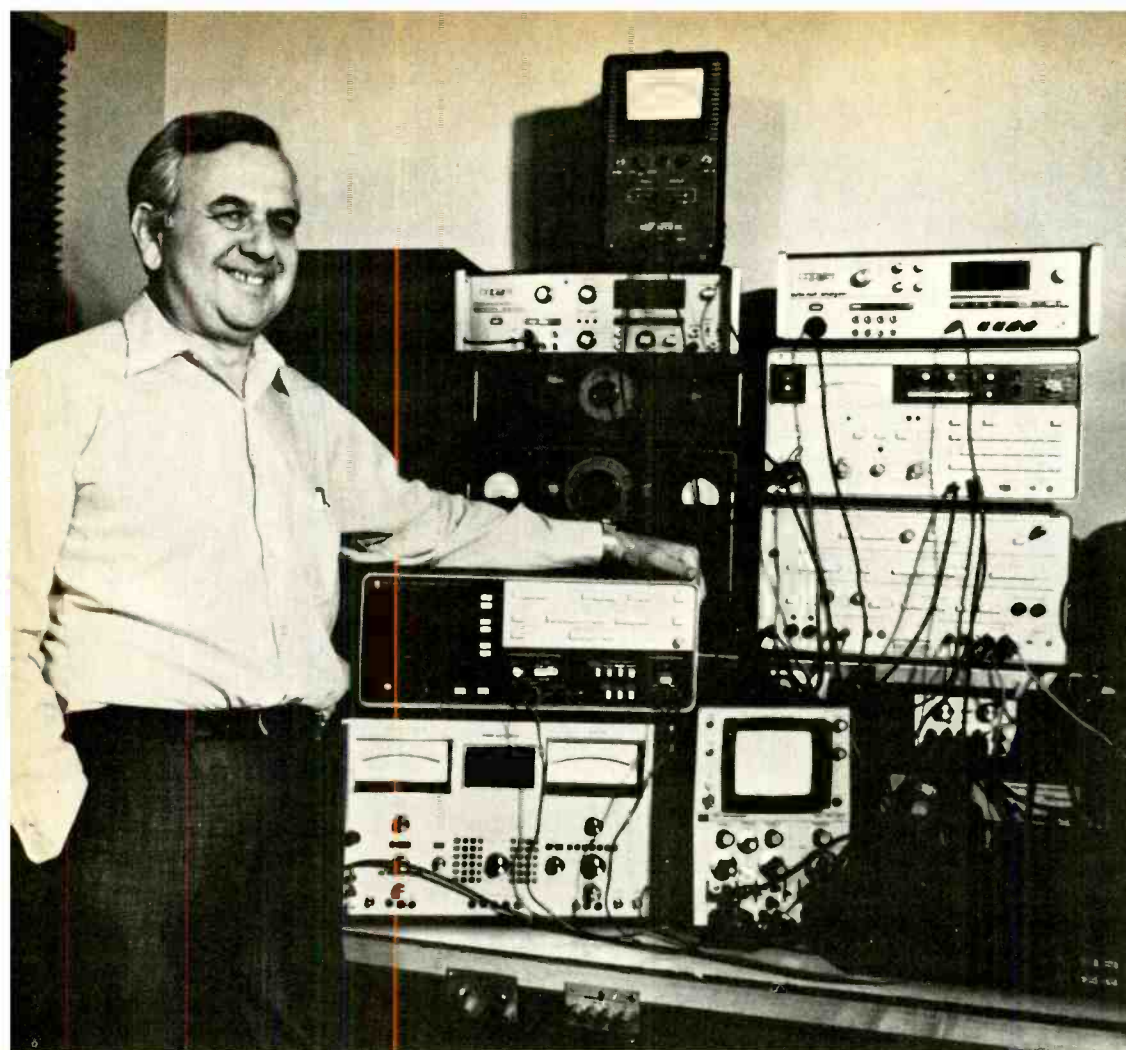

**Len Feldman on the
Sound Technology 1500A Audio Test Set:**

**“To my mind, a brilliant
combination of audio,
video and computer/
microprocessor technologies
and applications.”**

“When I first saw the first 1500A’s, I knew I had to have one . . . because I knew it would cut down my test time considerably. When it came, it exceeded my expectations. It not only increased the accuracy of the measurements I was making, but it cut down on the time involved by 75%. With the 1500A I could actually do a test in ¼ the time, with greater accuracy!

“My laboratory is involved strictly in product testing, for both publications and for manufacturers’ proposed new products. Everytime we turn on the lab,

we’re using Sound Technology products . . . and I’m finding more and more ways of using the 1500A in applications that I’m sure Sound Technology never intended. I feel rather proud that I recognized some of its potential perhaps even before they (Sound Technology) did.

“I also own the hard printer and use the printouts in my test reports in the magazines because of the credibility it gives the reader of the reports. The idea of getting a hard copy readout from whatever is on the screen of the 1500A is just incredible!

“The people at Sound Technology have been marvelous to me. My unit was one of the first shipped and Sound Tech has been very cooperative by updating the software on my unit as they made production changes. I just happen to love those people, and my 1500A.”

Len Feldman tests products for various professional and consumer publications, and performs product testing for numerous manufacturers. Mr. Feldman purchased the second Sound Technology 1500A Audio Test Set manufactured. For information on how the 1500A can increase your testing accuracy while reducing testing and set-up time, call today. It will clean up your act.

**S SOUND
T TECHNOLOGY**

1400 Dell Avenue, Campbell, CA 95008
(408) 378-6540 Telex: 357445

Please send me full information on the Sound Technology 1500A Audio Test Set.

NAME _____
COMPANY _____
ADDRESS _____
CITY _____ STATE _____
ZIP _____ PHONE _____

**S SOUND
T TECHNOLOGY** Department 9006105

© Sound Technology 1981

CIRCLE 94 ON READER SERVICE CARD

www.americanradiohistory.com

**Only
the strong
survive.**

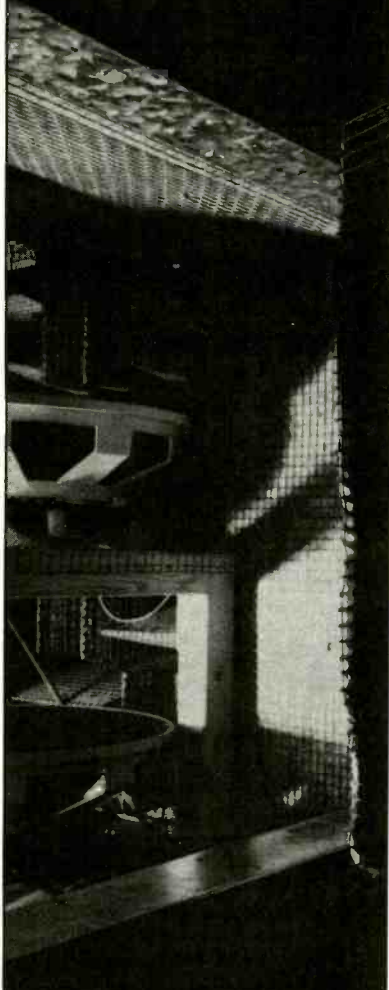

While others spot test their loudspeakers with minimal test procedures, we test them all. Every one. Our method of testing is like the entire hand going flat out on every note applied simultaneously at full rated power for 10 minutes. The most demanding of test procedures.

Procedures that mean a Gauss will be more cost effective for you.

This expensive testing means a Gauss will cost more. It also means that every one will deliver more dBs per dollar, more efficiency and last longer.

Before every Gauss goes out the door, we know it's going to work. And work. And work. You can stake your reputation on that.

GAUSS
Your reputation's worth it.

Cetec Gauss 9130 Glenoaks Blvd.
Sun Valley, CA 91352

CIRCLE 112 ON READER SERVICE CARD

created the first stereo tape recorder in 1949. They added a second record head below the first and multichannel recorders now utilize the same principle by adding however many record heads and then widening the tape to suit the number of tracks.

In the late 1940's, stereo radio broadcasts began with one AM and one FM station. In 1961 the system of stereo broadcasting from one station was developed. This system was developed by Zenith and General Electric. FM's inventor, Major Edwin Armstrong and Murray Crosby did work that contributed to this multiplex system of stereo broadcasting from one station.

M.R. to MR&M

We received this letter from Max Rudolf. In it he clarifies, among other things, the fact that he is still alive.

A friend of a friend mailed me a copy of your review in *Modern Recording & Music* [April, 1981—Groove Views, p. 94] of two reissued recordings played by the Cincinnati Symphony Orchestra during the last quarter of 1964. I appreciate your interest, also your efforts to find out if I am still of this world. In a recent concert review in the *Boston Globe* I was listed as "the late M.R."

I have been living in Philadelphia, since I moved here in 1970 to teach at

Curtis, which I did for three years. Since then I have been guest conducting and rewriting my text "The Grammar of Conducting" which, I am happy to say, is still a bestseller in the field after 30 years.

During the 1980-81 season I have been appearing with the Philadelphia Orchestra, the National Symphony, and the orchestras in Detroit, St. Louis, Houston, New Orleans, and Nashville. With traveling getting tedious, I have decided to retire from the podium after 1982, with the exception of Philadelphia and Washington where I am already invited for 1983.

This coming November I shall conduct five performances of *Die Zauberflöte* for the Washington Opera Co.

Enclosed is a list of all the recordings I conducted with the Cincinnati Symphony Orchestra. MCA should have reissued the Mozart record which was probably the best we did. George Szell thought it was good. Unfortunately, I hear that MCA is discontinuing the project.

Someone told me that the reissued Bruckner record was praised in a California publication last year.

—Max Rudolf
Philadelphia, PA

The following is the list mentioned above.

		Recorded On:
Gutche: Symphony No. 5	CRI 189 SD	5/27/64
R Paganini & Saint-Saens: Violin concerti	Decca	
	DL 710106	10/13/64
R Haydn: Symphony No. 86 & Symphony No. 57	DL 710107	12/17/64
R Nielsen: Symphony No. 4 & Maskarade		
Overture	DL 710127	12/20/65
Brahms: Symphony No. 4	DL 710128	12/21/65
Mozart: Serenade No. 9 & Symphony No. 28	DL 710129	12/22/65
R Bruckner: Symphony No. 7	DL 710139	12/6/66
Mendelssohn: Symphony No. 5 & Berwald:		
Symphony No. 5	DL 710144	12/7/66
Beethoven: Symphony No. 3	DL 710149	12/20-22/67
R R. Strauss: Rosenkavalier-Suit & J. Strauss:		
Fledermaus—Overture, Wein, Weib, und Gesang,		
Unter Donner und Blitz	DL 710158	12/20-22/67
Bizet: Symphony No. 1 & Roussel: Suite & Indy:		
Ishtar Variations	DL 710162	12/20-22/67
Tchaikovsky: Symphony No. 6	DL 710166	1/14/69
Dallapiccola: Variations & Mennin: Canto &		
Schuman: New England Triptych & Webern:		
Parascaglia	DL 710168	1/15-17/69
Haydn: Symphonies Nos. 91 & 102	DL 710173	1/15-17/69

R = reissued by MCA (1980)

Digital Description Desired

I'd like an understandable explanation of digital recording if you could possibly provide me with one. Most of the information I've gotten so far has me confused. I'd be most appreciative if you could help me out with this matter. Thank you.

—David Goldstein
Nyack, NY

In analog recording, music is represented by continuous signals that are analogous to the sounds that are heard. In digital recording, any continuous event such as a pattern of music can be represented by a number or a numerical code. In digital work a binary number system consisting of 0's and 1's is used. (Zero is represented by "000," one is represented by "001," two by "010," three by "011," and four by "100." An analog musical tone, represented by cycle or alteration of a sound wave, is sampled in terms of its amplitude. The amplitude is sampled at nine points, and the amplitude at each of these points is represented by a digital number. In order to then ex-

press these numbers in electronic circuitry, "0" is represented by no voltage, and "1" is represented by a positive pulse of voltage. These pulses are recorded onto tape as long as baseline zero-voltage and the positive voltage pulse are above tape-hiss level and below the maximum recording level of the tape. The noise and distortion which are usually part of the tape recording process don't play a part in digital tape recording.

The more points at which the waveform is sampled, the greater is the faithfulness of the representation of the original signal. In new digital tape recorders, this is what is done. A sixteen-out digital system can express 32,000 levels or amplitudes of a tone in zeroes and ones.

Some Light Summer Reading

I have been reading your magazine for several years now and I must offer my compliments on your fine effort.

In many of your past issues you have given the titles and publishers of books on sound recording and the

associated audio equipment. I plan on reading some of these books but my interest now is in finding information on speaker enclosures/system design.

To be more specific, I am looking for publications which cover the following topics:

1. Principles and design equations for sealed enclosure acoustic suspension systems giving the relationship between enclosure volume, resonance and speaker parameters.

2. Principles and design equations for bass reflex systems giving relationships between enclosure volume, resonance, port volume and speaker parameters.

3. Principles and design equations for the larger non-acoustic suspension type ported enclosures giving the relationships between enclosure volume, resonance and speaker parameters.

4. Principles and design equations for horn loaded systems.

5. Principles and design equations for crossover and attenuation networks for two and three way systems.

6. Enclosure construction techniques.

Total control-with verification-

At one location — the crossover — Crown's new mono electronic MX-4 controls bandwidth for four outputs (high, mid-range, low and sub-woofer), with separate level control for each output and for input.

The MX-4 includes signal-present and overload indicators for each band. At a glance it tells you how well it's working. Precision stepped rotary switches select 18 dB/octave Butterworth filters. Easy to set. Easier to reset.

XLR balanced, or phone-jack unbalanced, input/output. Extra XLR input connector for "daisy-chaining." Built-in polarity switches on XLR outputs.

Total control. Total convenience. Totally Crown.

at the CROSSOVER.



 **CROWN**®

1718 W. Mishawaka Road, Elkhart, IN 46517

...WHEN YOU'RE READY FOR REAL!

Please write us, or call 219/294-5571 for further information.

7. Methods of matching components and testing procedures to determine system frequency response, sensitivity and power handling capacity.

I realize this is a lot of information, but I am sure it is available somewhere. Can you help?

Thanks for your help and keep up the good work!

—Wayne W. Hovis
Gorapopolis, PA

Again we recommend referring to the TAB series of books. One of their series in particular, No. 1064, How to Design, Build & Test Complete Speaker

Systems, by David B. Weems. You can obtain a free catalog of their books by writing to: TAB Books, Blue Ridge Summit, PA 17214. Their catalog lists a multitude of other books which you would probably find useful.

Building Cabinets

In response to Rick Bogas' request for information and plans for rear (horn) loaded LF bins, etc. (page 34 of the July, 1981 issue), let me inform you that I have complete plans, construction details, etc., for such cabinets as well as other classic cabinets (Voice of

Theaters, floor spot monitors, folded horns) and several amazing "state of the art" designs. I've been planning to print either a book or individual plan sets and haven't reached the point where a price has been set, so let me estimate that per cabinet design the basic plans will probably sell for \$20 to \$30. This fee encompasses research, drawing, and my ten years of experience in achieving optimum techniques. Let me give you a word of warning. To construct a cabinet that will perform and/or out-perform "factory-built" units, it is necessary to employ some standard wood-shop tools such as a table saw, router, drill press and either air nailer or screw shooter. In my opinion it is wasted time to attempt to construct these cabinets with only a \$15 circular saw and a lot of sweat, glue, and plastic wood putty. There are many home craftsmen that have satisfactory equipment that one should be able to gain access to.

My plan package includes the following:

- Complete plans
- Construction techniques
- Finish suggestions
- Finishing materials and techniques
- Historical notes and theory of operation
- Estimated specs (accurate)
- Materials suggestions/comparisons
- Hardware options and sources

Available plans are for approximately ten to twelve bass-reflex horns (front-loaded), three scoop-style (rear loaded), dozens of bass-reflex and/or intimate baffle (flat baffle), six to ten floor monitors and approximately six folded horns. I'm certain that there are many readers who will benefit from "doing it themselves." I can be reached at 203-575-9786 or DPCS, 171 Moreland Avenue, Waterbury, Ct. 06705.

—T. Young
Waterbury, CT

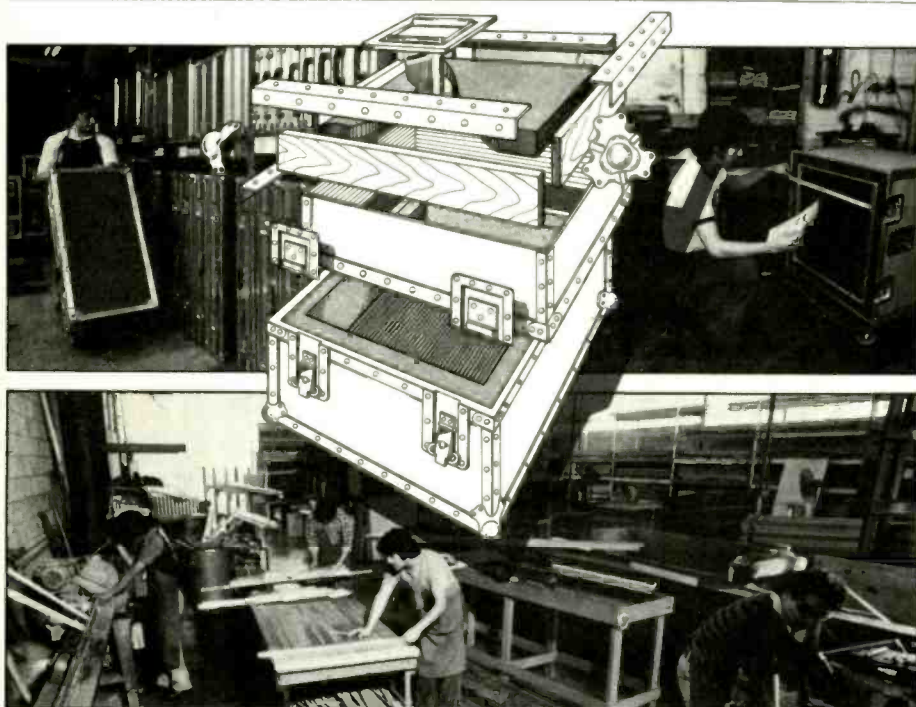

IF IT DOESN'T HAVE AN ANVIL®... you don't have a Case.

It takes a lot to build a top quality Case worthy of the ANVIL® brand name. ANVIL® utilizes only the finest raw materials which must conform to exacting specifications. ANVIL® stocks these materials in huge quantities, so even the largest orders can be produced without delay.

The machinery used to manufacture ANVIL® Cases is the finest in the Travel Case industry. The result is a Case that stands up to the bumps and grinds of life on the road—so your delicate equipment doesn't have to.

But Cases don't build themselves. People do. And ANVIL® has the most highly-skilled and dedicated designers, assemblers and Customer Service people you'll find anywhere.

CIRCLE 45 ON READER SERVICE CARD



So if your delicate equipment has to get there and back in one piece, every time, just take our word for it—ANVIL®:—The # 1 name in Travel Cases for almost three decades.

ANVIL® CASES, INC., 4128 Temple City Blvd.
Rosemead, CA 91770 • (213) 575-8614

Situation Wanted

I am interested in a possible career in the field of audio systems designing. I have designed monitor systems, racks, etc., and am currently enrolled in Pennsylvania State University in the College of Engineering, majoring in mechanical design engineering technology. I have also been a sound

technician for two different rock bands since the age of 16. What do companies such as Showco or Clair Brothers usually look for in prospective employees? Your reply will be most appreciated.

—Gregory Sloditskie
Sunbury, PA

We couldn't tell you very specifically what these companies do look for. For a clear and thorough answer we suggest that you write directly to Showco and Clair Brothers, and others like them, or, perhaps, call them. The address of Clair Brothers is: P.O. Box 396, Lititz, Pennsylvania 17543. Their phone number is (717) 733-1211. Showco's address is: Showco Manufacturing Corporation, 9009 Governor's Row, Dallas, Texas 75247. Their phone number is (214) 630-7121.

My Old School

Some years ago, while a student at the University of Texas at Austin, I sampled many courses from different programs of the School of Communications, before finally specializing in communication disorders. I fondly recall two courses in particular, from the Radio-Television-Film department, both dealing with radio production. Although I don't remember the equipment we used, the class assignments are still vivid—mixing sound effects, music, and voice to produce PSA's, commercials, sound cartoons, radio dramas, etc. My interest in this area never really dwindled, but I was uncertain as to how to pursue it on a professional level. Apparently radio dramas are occasionally still produced, as is evidenced by the recent adaptation of *Star Wars* via NPR. And judging from the class D entry of the 5th annual Roland synthesizer/tape contest, whose application form appears in your recent issue, so are sound cartoons, sound effects and poems, etc. Are there training institutes, books, manuals, etc., that focus on these areas? How exactly does one become a professional in this field?

—Robert Graziano
Brownsville, Texas

We are disinclined to publish lists of schools, as we cannot pass judgement on the relative merits of each. We do recommend several paths for you. One is to refer to the Contemporary Music

Almanac, 1980/81, by Ronald Zalkin, published by Schirmer Books, a division of MacMillan Publishing Co., 866 Third Ave., New York, N.Y. 10022. This will give you much information and addresses of some Music & Audio Engineering Schools. We also recommend going back to your alma mater for help. Their School of Communication could give you much needed information and advice, and their library would give you further leads.

TAB is More Than a Soft Drink

In a past issue of *Modern Recording & Music* magazine (June 1980) I read an article that appeared in the Talkback column entitled, "Sound Studio Ideas, Dead or Alive," and found that I am having much of the same problems with studio design.

In that column you mentioned *Acoustic Techniques for Home and Studio*, by F. Alton Everest, and *How to Build a Small Budget Recording Studio from Scratch*, also by F. Alton Everest. Where can I purchase these books?

—Chip Zaloga
Philadelphia, PA

Both are TAB publications. TAB Books are located at: Blue Ridge Summit, Pennsylvania 17214. The first book you mention is No. 646 in their series. The second one that you mention is No. 1166. I recommend that you mail a request to TAB Books for copies of those particular titles. They will also send you a free TAB catalog if you request it. They publish many other books that you would probably find very useful.

Direct-to-Disc

Could you explain what direct-to-disc recording is, and what its advantages are over other types of record production? I know that a lot of smaller recording companies have been using this method, and I'd like to know why they've taken this turn.

—Robert Clement
Toledo, OH

Multi-track studio tape recording enables engineers and artists to exercise a great deal of freedom in the recording process. But the many changes that are often made in the "dubbings" can add a lot of noise to the master

A NEW concept in MICROPHONES

I'm Carl Countryman and I'm so excited about the EM-101 I must tell you why no other microphone offers you such fantastic performance and why the EM-101 is the most versatile mike you can own!

125 dB DYNAMIC RANGE

In terms of raw performance alone, the EM-101 is in a class by itself. The 25 dB noise level of the EM-101 is one of the lowest in the industry. With the EM-101 you can hear sounds in a quiet room that you can't hear with your own ears, yet it easily handles 150 dB sound levels without distortion or pad switching. That's over 300 times the threshold of pain! The EM-101 will completely eliminate microphone overload.

LABORATORY FLAT RESPONSE

The EM-101 is GUARANTEED to have an incredibly flat frequency response; within 1.5dB of perfection over the entire audible range from 20Hz to 15kHz and we back that guarantee by shipping each EM-101 with its own individual computer verified frequency response curve. Listening tests cannot distinguish the EM-101 from precision laboratory microphones costing TEN times more!

VERSITILITY

The EM-101 is about the size and shape of a stick of Dentyne chewing gum and has a non-reflective, black surface. It is also the most perfectly non directional microphone you can buy for recording or sound reinforcement. That makes it the ideal choice for stage, TV, motion picture, or conference work where variations in quality caused by motion and position around the microphone must be minimized. Unlike conventional microphones or "plate mounted" microphones, the EM-101's unique flat design allows it to be placed as close to the surface as desired to take full advantage of this traditional microphone placement technique.

FEEDBACK AND LEAKAGE REDUCTION

The unique design of the EM-101 makes it almost completely insensitive to conducted vibration so it can be placed directly on or even inside an instrument where the sound level is high and you will obtain remarkably improved rejection of unwanted sound and reduction of feedback. Because PA systems feed back on response peaks, the EM-101's ultra flat response allows you to use more gain without feedback and will reduce or even eliminate the need to notch filter or equalize a system.

YOU MUST TRY THE EM-101

I want you to have the experience of using a microphone with performance that rivals the human ear! I'm convinced that once you hear a truly accurate, uncolored microphone in your facility, with your kind of program material, for the affordably low price of \$234.50 U.S. you will never want to be without one!

Please call Countryman Associates or your favorite professional sound dealer to arrange a no risk trial of the incredible EM-101 microphone.

**COUNTRYMAN
ASSOCIATES INC**

417 STANFORD AVE - REDWOOD CITY, CA 94063 (415) 364-9988

CIRCLE 61 ON READER SERVICE CARD

CARVIN

FREE!

1981 Pro-Line Guide

- A comprehensive 64 pg. color guide to all Carvin Pro-Line equipment including illustrations, technical information and specifications with Special Direct Prices.
- Carvin's new products for the 80's include; double neck guitars, modular power amps up to 700w RMS. Recording and road mixing boards, JBL Pro speakers, bi-channel tube guitar amps, Parts, plus much, much more.
- As we introduce you to the finest Pro Equipment available, you'll appreciate Carvin's policy of selling Direct for exceptional values.

Write: CARVIN Dept. MR80, 155 Industrial Ave., Escondido, CA 92025 • Phone: (714) 747-1710

CARVIN FREE CATALOG

Name _____
 Address _____
 City _____
 State _____ Zip _____ MR80

CIRCLE 85 ON READER SERVICE CARD

INSTITUTE OF AUDIO/VIDEO ENGINEERING

OFFERING DIPLOMA PROGRAMS IN:

- RECORDING ENGINEERING
- VIDEO ENGINEERING
- CONCERT SOUND REINFORCEMENT AND MAINTENANCE

Two In-House State-Of-The-Art
24-Track Recording Studios

Faculty Members Are Leading
Recording Industry Professionals

Internship/Placement Assistance

Professional Working Environment

Write or Call for Brochure

INSTITUTE OF AUDIO/VIDEO ENGINEERING
1831 Hyperion Ave.
Hollywood, California, U.S.A. 90027
(213) 666-3003



CIRCLE 150 ON READER SERVICE CARD

tape, from which is cut the master disc.

Direct-to-disc recording pre-dates the tape recorder method. There is no intermediate taping process in this method of recording. When a mistake is made the whole side of the disc must be redone. But, by avoiding using the taping process, lower background noise levels can be achieved and greater extremes of dynamic range can be achieved. Because the processing from the lacquer master disc to the final vinyl disc must be done carefully, a limited number of copies are usually available. Direct-to-disc recordings are usually made as limited edition recordings. These records usually cost more than twice as much as the conventionally produced discs. There are more than one hundred titles produced in that format, but it is considered unlikely that it will ever replace the tape-mastered discs. The easier to produce tape-mastered discs are what have been responsible for the last ten years of rapid growth of the contemporary music industry.

Heavier Than the Goodyear Blimp

Has *Modern Recording & Music* ever done an article on the group Led Zep-
pelin? If so, in what back issues can I find them? Also, if you know, how did they get their name? I'd appreciate anything else you could tell me about them. I am a fan of theirs from "way back."

—Greg Thomas
Portland, OR

No, we have never done an article on Led Zeppelin. Sorry. But, we can tell you some things about them. The members of the band are: Robert Plant, John Bonham, John Paul Jones, and Jimmy Page. Page had received an offer to replace Eric Clapton in the Yardbirds. A year later he did join them, though. He stayed with them until they disbanded in 1968. He then formed his own band, called the New Yardbirds. The late Keith Moon made a joke to him about the band "going down like a lead balloon," and that answers your question as to their name. Their music is a combination of blues and rock. Originally they played a lot of Page's original songs and modifications of Yardbird music. Page's mystical interests show in much of their work, e.g., "Stairway to Heaven."

SEE THE DIFFERENCE IN YOUR SOUND



- Full 3 year transferable warranty
- Frequency bands: 25HZ-16KHZ
- Over and under range meter
- 209 L.E.D. - resolution
- 3 dB scale, 1 dB scale on vu meter
- 4-position decay rate
- Pink noise & white noise output variable output levels from 80-110 dB with automatic return level to 80 dB
- 3 mic & 2 line level inputs with continuous attenuation on all inputs
- Oscilloscope hook-up in back of unit
- S.P.L. meter - digital display with adjacent L.E.D. display. Yellow L.E.D.'s are used for flat response level, digital display is variable from 50-125 dB.
- Adjustable voltage switch for overseas use
- Anvil road case standard
- Accuracy .4 dB from slope center
- Analyzer can be adjusted to its own pink noise to maintain accurate flat response
- Each frequency can be individually calibrated. This allows any mic. to be used and yet guarantees accurate response
- Scan function
 - Variable left to right by single tap of the scan button or hold for continuous scan.
 - Frequency being scanned automatically becomes brighter for easy reading.
 - Frequency being scanned will react in a much faster decay rate to assure proper peak attenuation.
 - Scanned frequency will also appear on vu meter in peak average to enable adjustments within 1 dB.
- Spectrum analysis can be used in bar graph or dot mode

TODAY'S GREATEST DOLLAR VALUE IN REAL TIME ANALYZERS

BUILT LIKE A TANK!



PULSAR LABORATORIES
3200 GILCHRIST ROAD
MOGADORE, OHIO, 44260
(216) 784-8022

FOR YOUR FREE
RTA 150 TECHNICAL
BULLETIN:

WRITE OR CALL TODAY

© Copyright Pulsar Labs 1981

CIRCLE 179 ON READER SERVICE CARD

Much of their music, though, is somewhat heavy-metal. "Whole Lotta Love," for example. Supposedly they signed a contract with Atlantic Records on the strength of their reputations, as their manager, Peter Grant had no demo tape at the time. Feisty guys, those Zeps.

Music Therapy

I am in high school now, and am thinking of studying music therapy in college. But right now I don't know what schools I should think about applying to, or how one actually gets to be a music therapist. Please help me out.

—Janice Jones
New London, CT

We cannot recommend individual schools to you. But you can write to the National Association for Music Therapy for information regarding different schools, their curricula, tuition fees, etc. We can tell you that to become a music therapist you will most likely have to follow a four year program with the major emphasis in music. There will also probably be required courses in biological sciences,

anthropology, sociology, psychology, and music therapy. The Bachelor of Music Therapy will probably also require general studies in English, history, speech and government. After college there is a six month traineeship during which you must complete an internship under the guidance of a registered music therapist.

You then become a registered music therapist by applying to the National Association for Music Therapy mentioned above. If you belong to this association you receive the Journal of Music Therapy. In this you can find job openings listed. Also try your local library for catalogs of schools that offer programs in music therapy.

Noise Rainbows

Can you distinguish between random noise, pink noise, and white noise for me? I have never gotten these terms straight, and I feel that it's about time that I got the definitive answer!

—Margery Rudolph
Meriden, CT

Well, I hope this proves to be a definitive answer. Noise, as you prob-

ably already know, is a signal that is not wanted. It can be in the form of a hiss, crosstalk, hum, or rumble.

Random noise is heard as a hiss, and is a blend of all audio frequencies. It can be caused by irregularities on the surface of the tape, or by tiny fluctuations in the resistance of electronic components, which would be called thermal noise.

Pink noise is random noise that has been modified so that it has an equal amount of energy in each octave. The octave between 10,000 Hz and 20,000 Hz takes up 10,000 Hz in bandwidth. The octave from 5,000 Hz to 10,000 Hz occupies only 5,000 Hz bandwidth. Because of a 6 dB/octave roll-off, though, both these octaves have an equal amount of pink noise energy.

White noise is random noise which has equal energy for any equal bandwidths (as opposed to equal energy for each octave, as in pink noise). For example, the 5,000 Hz bandwidth between 5,000 Hz and 10,000 Hz or between 10,000 Hz and 15,000 Hz would have equal amounts of white noise energy. Total energy per octave increases by 6 dB/octave as you increase frequency.



AKG

The design objective of our new D300 series was to put the world's most advanced microphone technology right into the palm of your hand. The patented suspension system shown here, allows for the first time ever, a combination of the famous AKG studio quality sound with the ruggedness and dependability expected from an "on-the-road" vocal microphone. And, this is just one of the many unique design features you'll find exclusively in our D-330BT, D-320B and D-310 microphones. Once your AKG dealer puts all the advanced features which distinguish the D300 series into the palm of your hand... we're confident you'll decide to go on-tour with AKG.





AKG ACOUSTICS INC.
A NORTH AMERICAN PHILIPS COMPANY
77 Selleck Street, Stamford, CT 06902
(203) 348-2121

© AKG 1981

AKG Akustische und Kino-Geräte GmbH, Austria

TALK BACK

"Talkback" questions are answered by professional engineers, many of whose names you have probably seen listed on the credits of major pop albums. Their techniques are their own and might very well differ from another's. Thus, an answer in "Talkback" is certainly not necessarily the last word.

We welcome all questions on the subject of recording, although the large volume of questions received precludes our being able to answer them all. If you feel that we are skirting any issues, fire a letter off to the editor right away. "Talkback" is the Modern Recording & Music reader's technical forum.

A Springboard for Inventive Ideas

After reading Craig Anderton's "Hot Springs" reverb project [see October 1980 issue, pages 38-48], a question came to mind for him: On an existing spring reverb, is it possible to add another spring unit (or replace with two of the same), connecting it as in the article and obtain the desired cancellation effect? I own a Tapco 6100 RB/EB mixing board and have found that there is room in the unit to mount another spring unit. Can I make this conversion without too much difficulty? If so, I believe your reply will also prove most insightful to guitarists who have prayed for a more realistic sounding reverb for their amps. Might even revolutionize the industry. I'd greatly appreciate your reply.

—Terry Benander
East Greenwich, R.I.

Unfortunately, there's more to the Hot Springs than just connecting up the springs in the proper manner. Much of the strength of the circuit involves the input stage "tuning" provided by C1 and R9; this tuning is pretty critical, as

putting two coils in series can produce some interesting frequency response effects. The trick is to peak the highs as much as possible, without overloading the springs at those frequencies and avoiding oscillation. The Hot Springs input stage was designed around a specific set of springs, and tuned to those springs. As a result, I cannot vouch for the performance with other springs or other input and output stages, although the principle could very well work in other applications. If you go ahead and try adapting something else to a Hot Springs configuration, let us in on the results.

By the way, if you're into my construction projects, you might be interested to know that the next scheduled project is a rack mount flanger/choruser with built-in noise reduction and some other goodies; watch for it in a future issue.

—Craig Anderton
Contributing Editor
Modern Recording & Music

Noise Reduction for "Purists"

I have a small recording business which caters to classical and religious music, as well as the production of soundtracks for slide shows and such. My equipment consists of Teac 6100, 2340SX and 2300S recorders, a Teac Model 2 mixer and mics by Teac, Beyer, Electro-Voice and Sony.

I want to get some form of noise reduction for the 4-track to use while overdubbing, ping-ponging, etc. I have considered the ETI Ultima IV (similar to dbx) and the Integrex Dolby kit systems. However, in playing with a dbx unit a while back, I found that it tends to accentuate background noises in the material being recorded. So, in checking out literature on the Integrex, I find that Dolby is critical in setting levels and that the frequency

response specs are not necessarily as good as my reel-to-reel recorders are capable of.

How does dbx and/or Dolby work when dubbing for several generations? Can you recommend either format for "purist" results with my Teac 2340SX, or am I stuck with eventually having to invest considerably more money for a Teac 3440 and still be without these add-on noise reduction units?

—Paul F. Becker
Accurate Sound Productions
Bismarck, N.D.

When you say the word "purist" you open a can of worms—which for some reason seems to please the palate of a lot of audiophiliac types. These folks used to be thought of as "technofreaks," but since the advent of digital recording and Dick Heyser, they have had to accept the rank of mere "technoids."

I've spent considerable time discussing with Mr. Heyser, that most recon-dite human ability: perception. Perception (of sounds) it seems, is the *deus ex machina* that pops up at the end of every argument between audiophiles, when they have exhausted every "what about," and "have-you-heard," and both instinctively know that the fight is a draw.

In my cynical old age (speaking, of course, in audio terms) I have learned to walk away from these dialogues without feeling that I must replace all my gear in favor of more state-of-the-art. This, then, is reinforced each time I see a rented Neumann or Telefunken "tube" microphone hung during an expensive recording session. The very idea of a hissy old fire bottle being fed to a \$150,000 digital recorder appalls me, or would if I were not open-minded. To a lot of folks, "the sound" is everything, and any knob will be

twisted to any degree to get that sound—purism be damned! I know of one electric guitarist who insists his Brand X 300 watt/channel amp is better than Brand Y, or Brand Z, because the distortion is .008% and the slew rate is 200 Volts per microsecond, and then plugs 10 or 12 "effects" pedals into its inputs to get his "sound"; and the insanity goes on and on.

Your perception of a loss of high-end, and the apparent accentuation of background noises when using dbx, is a result of lowering the "noise floor" to a point where the tape hiss is no longer "masking," or covering up the background noises that were really there all along, and haven't changed level at all.

I refer you to a very relevant article by William Anderson in the December, 1980 issue of *Stereo Review*, entitled: "Necessary Noise," wherein issue is taken with those self-appointed "golden ears" who find fault with digital recording. As a musician, I find that I am constantly faced with arguments from people who do not attend "live" (acoustical) music events, and thus have no frame of absolute reference on which to build valid comparisons or to evaluate their listening experiences with objectivity.

Noise reduction devices are useful when used properly, and can yield very misleading results when used improperly.

In my experience, a Dolby system capable of delivering performance approaching dbx, is much more expensive (Dolby "A") and still falls short of actual overall "specs" offered by the dbx. It should be noted, however, that there is no free lunch, so to speak, and you must pay a price for low-cost noise reduction. The dbx system will, by the very nature of its 2:1/1:2 companding format, exaggerate any frequency response anomalies by a factor of 2, so ping-ponging capability may be limited and you may need to search out a tape type for your machine, that gives less bass "bump."

The Dolby A, on the other hand, is a very expensive and complex device which requires more alignment than does dbx, and in general requires a bit more care to use.

Level matching is critical with both dbx and Dolby (A or B), and a good regimen should be developed when using either.

The dbx level matching scheme is

HOW TO BE QUIETLY SUCCESSFUL FOR \$350.*

Now that you're committed to making it in the pro world, give yourself some professional advantages. Like dbx noise reduction. The new dbx Model 150 gives your tape machine the dynamic range of digital. Perfect punch-ins and decoded monitoring without special switching. In a slim-line, rack mountable 1³/₄" package, it fits in easily with other studio equipment. And, it's expandable to grow as you grow. Professionally. See your dbx Pro dealer, or write for complete technical information.

*Manufacturer's suggested retail price.



Model 150 Type I Tape Noise Reduction System

dbx, Incorporated, Professional Products Division,
71 Chapel St., Newton, Mass. 02195 U.S.A.
Tel. (617) 964-3210, Telex: 92-2522. Distributed in
Canada by BSR (Canada) Ltd., Rexdale, Ontario.

dbx®

CIRCLE 92 ON READER SERVICE CARD

SONY LOWERS THE PRICE OF FAME.

Not just once, but twice.

The advanced Sony F-520 Vocal Mic and the ECM-23F Instrument Mic are both priced at about one-third to one-half the cost of anything comparable.

Made for the stage, the rugged F-520 has a tailored vocal response and a smooth cardioid pattern to prevent feedback.

Among other features, the ECM-23F offers condenser sound quality that lets your instrument come through uncolored, and convenient AA battery operation to eliminate phantom power needs.

The Sony Mics. They allow a lot of struggling musicians to finally be properly heard.

Professional Audio

© 1981 Sony Inc., a Div. of Sony Corp. of America, 9 W. 57th St., N.Y., N.Y. 10019. Sony is a registered trademark of the Sony Corporation.



CIRCLE 75 ON READER SERVICE CARD

really pretty simple, although many seem confused and dbx, for their part, hasn't "gone public" with the simple procedure required:

1. Set dbx input level adjust (or mixer output) so meters show no shift in level when dbx is switched in and out with 1 kHz tone fed through.

2. Record 1 kHz tone *directly* onto tape, then set tape output control to "zero" deck's meters.

3. Play taped 1 kHz tone back through dbx unit and adjust "play" adjustment to obtain the same results as item 1, using an external meter.

[Note: dbx crossover frequency = 1 kHz.]

If you calibrate your recording rig with a 1 kHz signal anyway, this should be a snap. Just remember that all you need is the same level in and out at 1 kHz for encode and again for decode (the encode and decode levels can be different). There is only one other item to watch out for with dbx: record level. You will want to record lower on the VU meters when using dbx, say around -3, because—although dbx compresses signals on the way onto the tape, and in theory you should therefore be able to cram more energy

up closer to zero—tape recording physics can compress dynamics when you are near the electrical limits of the record amp/tape/head system, and this slight compression being inside the dbx loop, can cause some decoding error resulting in "pumping" or "breathing" sound along with recorded signal.

Finally, on frequency response specs: I spent three years at JBL, a very large and well-endowed company with almost \$1M worth of test equipment I was involved with every day. Part of my job was testing. Testing reveals that almost everybody suffers from some wishful thinking at least part of the time, and that some manufacturers lie about their specs. One speaker manufacturer, who will go unnamed, had the guts to claim their product was flat to 18 kHz when in fact all samples tested showed they were 60 dB down at 18 kHz! That's a factor of a million!

The best advice I can give is to get your hands on a representative unit of each type long enough to give them a try to see for yourself which one will be less audible and easier to use and calibrate. You are definitely not stuck

with upgrading as a means of achieving good (commercial quality) recordings: the Beatles' *Sergeant Pepper* album was done on a 4-track, and all the sound effects and voices in *Star Wars* were done on Teac recorders and mixers! Good mic placement techniques such as coincident pair M-S, among others, and the choice of the right microphone for the job will allow enough flexibility to get the sound you are after, in most cases, without any noise reduction. The careful use of either dbx or Dolby should give significant improvement in the hiss and noise department, careful mic placement will help further, and also use of the least amount of signal processing during and after recording will all help to ensure highest quality recordings.

—Drew Daniels
Applications Engineer
Teac/Tascam Professional
Products Group

Making All the Right Connections

I have been reading *MR&M* with great interest for over three years. Now, however, the time has come for me to

ASHLY INNOVATION

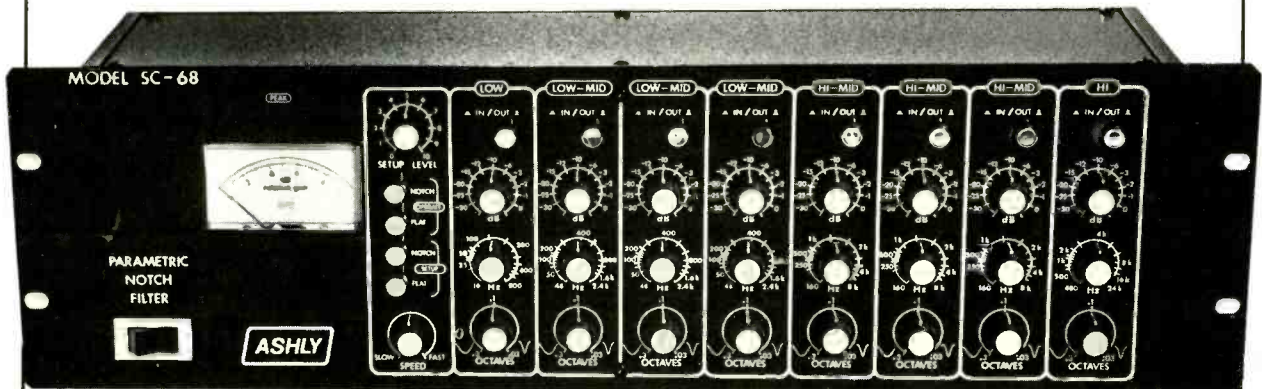

Equalization of sound systems can now be faster and more accurate. The new SC-68 Parametric Notch Filter combines cut only filter sections with a unique operator assisted setup procedure. During setup the SC-68 will hold sound system feedback at a steady controlled level while feedback frequencies are selectively "notched" out. Progressive improvement in gain

before feedback can be read directly on the SC-68's linear db Meter. Control over filter shape and notch depth guarantee that your most difficult feedback problem can be quickly and easily solved. Another unique product to solve your everyday problems. From the innovators at ASHLY.

ASHLY

Ashly Audio Inc.

100 Fernwood Ave. • Rochester, N.Y. 14621

(716) 544-5191 • Toll Free (800) 828-6308 (except N.Y.S.)

CIRCLE 84 ON READER SERVICE CARD

seek some qualified advice from you. My questions pertain to sound reinforcement rather than recording. I will briefly describe our sound system and its signal flow and then explain my problems.

We use eight dynamic, low-impedance mics and six condenser mics on stage. These signals flow through a Medusa 19 snake to a Tangent 1602ax board. The mixed stereo line signals leave the board unbalanced and go to a Soundcraftsmen TG 3044-R equalizer located just below the board. From there, the stereo balanced signals travel back through the Medusa to a Crown VFX-2A crossover located in a rack mount, together with power amps, on the stage. We use the balanced jacks with adjustable gain on the crossover. At this point, we use two Shure A15 BT line transformers before the signal enters the crossover. (Should the transformers be used here? Is this practice correct?) We also have a separate mono monitor mix traveling from the Tangent, through the snake, to a Yamaha P-2200 power amp. This signal is also balanced, low-level, XLR at the board. We also put this signal through a Shure A15 BT transformer before it enters the Yamaha's balanced input. Is this correct?

The crossover frequencies are set at 450 Hz as recommended by Electro-Voice. At this point, we take Crown's advice and run the high frequencies of Channel One from the crossover through one side, and the low frequencies through the other side of a Crown DC300A power amp. The same is done with the high and low frequencies of Channel Two where they feed another Crown DC300A amp. Crown states that the amp will be under less of a load and won't heat up as much.

At this junction, the signals go to two Electro-Voice Sentry IVB loudspeakers via 16 AWG wire. We substituted the original Sentry 1823M driver with a new 1824M driver rated for 100 w at 8 ohms. The original SM 120A mid-horns, a 120-degree wide-angle, we retained.

The setup I have just described worked just fine until we started playing outdoors and in large, reverberant halls. We noticed then that we needed more directional sound. However, instead of changing or substituting the basic loudspeakers, a task financially prohibitive for us, we added two more

Electro-Voice HR60/DH1012 horn-driver combinations. The horns are of a medium throw design with 60 degree coverage and the drivers take 30 watts at 8 ohms. The minimum crossover point for these units is at 500 Hz.

What I need to know is how to connect this mess. How do we connect the new drivers to the old ones? In the original Sentry setup, the high frequency signal went to a passive crossover which subdivided it into very high which fed the ST300A tweeter horn. Do we now need a protective circuit for the added drivers? If we connect the two drivers together the

total impedance will drop to 4 ohms and the Crown DC300A power amp is rated at 155w/C into 8 ohms, and 250 w/C into 4 ohms. Would we use the same power amp setup as recommended above by Crown or do we need another power amp for drivers with less power?

Are the main balanced outputs on the Tangent board or the Soundcraftsmen equalizer proper to drive the Crown DC300A or Yamaha power amps directly? Should the Shure A15 BT transformers be inserted at this point? The board and equalizer owner's manuals are very vague about this.

© 1980 Rhythm Tech Inc.

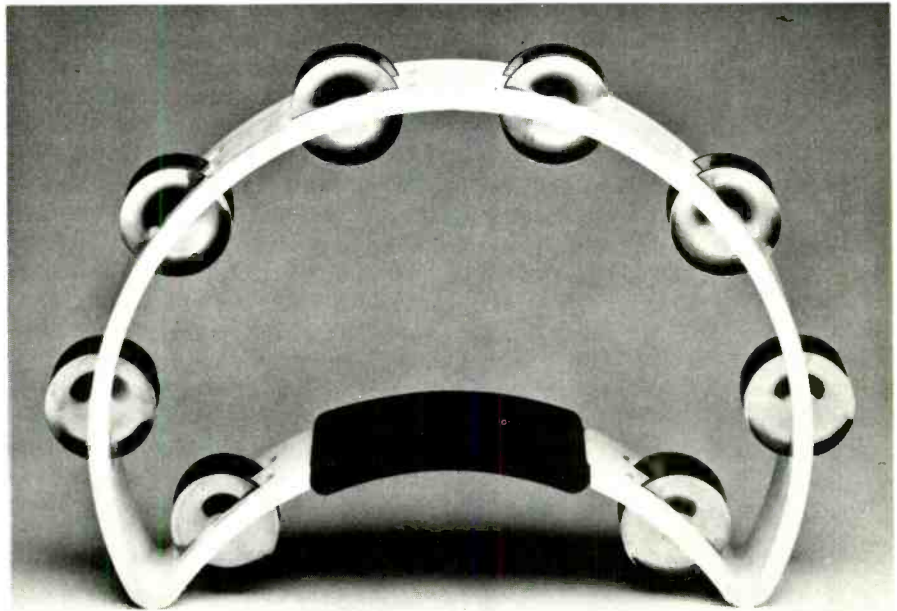

THIS IS THE RHYTHM TECH TAMBOURINE.

It looks different because it's designed to feel different. The difference is the location of a cushioned grip within the frame's overall center of gravity. This patented design puts more perceived mass where it belongs: in your hand. That makes a big difference in control and response, and that's the important difference to you, the player. The Rhythm Tech Tambourine requires less effort to play, which conserves your energy and enhances your technique and endurance.

Our sound is different, too. Stage and recording professionals helped us develop an optimal jingle formula. As a result, the Rhythm Tech Tambourine creates a clear distinctive sound that holds its own in today's multi-track environment.

Professionals like Ralph MacDonald, Steve Gadd, Jeff Porcaro and Lenny White appreciate the difference of this instrument. It's not your standard tambourine... but it will be.

 **RhythmTech**

511 CENTER AVE. MAMARONECK NY 10543

CIRCLE 167 ON READER SERVICE CARD

Can the main balanced line outputs on the Tangent board or the Crown crossover be split via a regular "Y" adaptor and drive inputs for the two different power amps without a loss of signal?

Please be so kind as to offer some advice. The local pro sound shops are not staffed with people qualified to answer these questions.

—Mark Logan
Detroit, Mich.

Don't feel alone in your confusion over the proper wiring of sound reinforcement systems. A large percentage of our sales people's time is spent with bands and musicians who purchased their system from M.I. stores and do not know how to properly tie it together.

To get to your specific questions, there are two ways to wire your current system. I recommend the second method, but you should try both to determine the most advantageous method for you.

Method Number One: If you raise the crossover frequency to 500 Hz, you can wire the 1824M/DH1012 combo in parallel. By going to a crossover fre-

quency of 500 Hz, you are protecting your horns. Even though the box is rated at 400-500 Hz, it is better to push the twelves a little and live with phase distortion of the folded horn at that frequency rather than to cross your horns too low and run the risk of damage to those units.

As you know, the 1824M is a phenolic diaphragm designed for midrange. Therefore, its power handling is greater and its low-end cut-off point is extended. The DH1012 is an extended range driver using an aluminum diaphragm. Although I do not have a data sheet on the 1824, Electro-Voice confirmed my suspicion that the 1824 is less efficient, especially on a 120° horn. In parallel, not only will the DH1012 produce over a much wider bandwidth, but for the same input voltage, it will produce a "hotter" output level. This situation may or may not suit your application. Should you decide to go this route, you should put a non-polar polypropylene capacitor in series with the hot side of the DH1012 driver to protect them from DC and misplaced low end. A value of 50 uf/50 v should work fine. This is not meant as a crossover, but

only as a low frequency/DC protector.

Method Number Two: I assume your system is run in stereo presently. Using plan Number One, you could continue with a "stereo" set-up. With this wiring, your system would be mono, but your overall flexibility will increase.

If you run the E-V IVB as you have, same crossover frequency, same gain, etc., but parallel your two horn sections on one side of a DC300A and use only one side of the VFX-2 to drive this system, you will have two horns, one crossover channel, and one side of DC300A unused.

Now, parallel the full range input to the second channel of the VFX-2. Set your crossover at approximately 1200 Hz and feed the high output to the spare DC300A channel. The low output will remain unused at present. Tie your two DH1012 drivers in parallel to the DC300A. Now you have two horns that you can tailor to the needs of each room. Since they are highly directional, they should be aimed to areas of the room not covered by the IVB cabinets. Since you have separate level controls, adjust their output level for smoothest coverage, i.e., matching them up to the

SIX SIMULTANEOUS DELAYS



The A/DA Stereo Tapped Delay (STD-1) is the only voltage controlled analog delay capable of producing six different delays simultaneously, making it the most powerful time processor available for "stereo" flanging, doubling, and multi-voice chorus effects.

Conventional delays take one input signal and produce one output signal at one delay length. When a signal enters the STD-1, it is delayed, then tapped at six different non-harmonically related points ranging from 1.3 to 55 ms. This produces six variations of the signal, each capable of being assigned and mixed into two output channels. The non-harmonically related taps create a natural sounding time delay, while other units at best, are multiples of some fixed delay time, creating predictable sounding effects.

The extensive delay section provides a 1 - 5x continuously variable delay range from each tap. The delay time can be swept at rates varying from 0.1 to 25 seconds. As the Sweep speed is increased, the Sweep range automatically tapers so you perceive a change in rate only without an accompanying change in

range as is common with other units. (You're not forced to compensate by backing off the CV Mix when you increase the Sweep speed.) Further, the Sweep Modulation control superimposes a higher frequency sweep pattern over the regular sweep. This allows effects like a "vibrato sweep" to sweeps which appear to move randomly like "sample and hold" on synthesizers.

The regeneration section has been carefully tailored to achieve mechanical to natural sounding ambiances by providing separate Level, High Cut equalization, and Tap select controls that can be switched in or out from the front panel or remotely via the rear panel jack. The Level control determines the decay time at long delays (up to 20 seconds), and the amount of resonance at short delays (< 12 dB). Since a reverberant signal primarily consists of bass and lower midrange frequencies, the High Cut feature in the STD-1 reduces the high-frequency content in the program material as it recirculates through the system for a more natural sounding echo. At longer delay times,

echoes can be textured from a hard reverb to a soft spacious drone. At short delay times, the resonance can be shaped from a sharp "metallic ringing" sound to "boomy" bass peaking.

All these features working independently and in conjunction, allow such effects as high flanging, low flanging, voice doubling, multi-voice chorusing, echo, reverberation, machine gun reverb, singular to multiple "doppler" effects, "doppler" pan, vibrato, and highly resonant flanging. All at full bandwidth—all in stereo! Never before has such an unlimited number of delay combinations been available to the musician, engineer, or concert sound technician.



A/DA
2316 Fourth Street
Berkeley, CA 94710
(415) 548-1311

CIRCLE 187 ON READER SERVICE CARD

PEAVEY ADVANCES TRANSDUCER TECHNOLOGY. AGAIN.

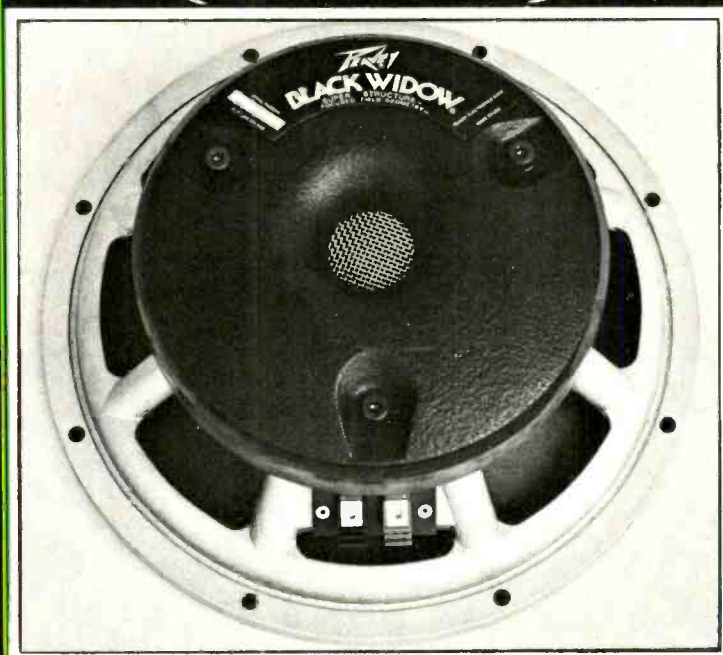
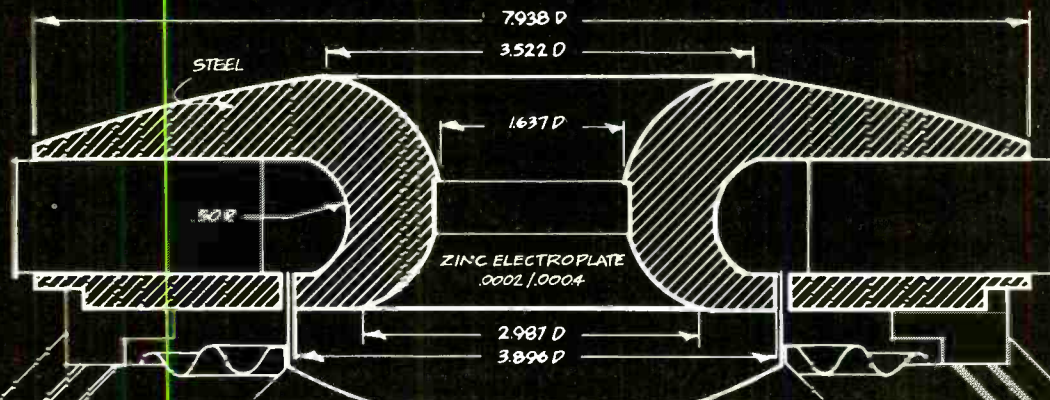

THE BLACK WIDOW® SUPER STRUCTURE™

Our Black Widow® loudspeaker program was initially conceived because we felt there was substantial room for improvement in the design and construction of premium grade loudspeakers. Since the loudspeaker is the last and typically the weakest link in the audio chain, any improvement, no matter how small, will significantly upgrade the overall performance of any system.

We developed many new design innovations (i.e., one-piece coil form/dome assembly and field replaceable basket assembly) that have helped to make the Black Widow® the choice of engineers and performers the world over.

Our ongoing research has recently developed a more sophisticated product featuring what we consider to be superlative performance! The Black Widow® now features our unique Super

Structure™ magnetic assembly — a totally new concept in the optimization of magnet structure design. The development of FFC™ (Focused Field Geometry) allows for the most efficient use of magnetic energy and increases the already high efficiency of the Black Widow® by at least 2 dB, in a way that totally offsets the cost of the much larger magnet.

The Black Widow®/Super Structure™ is the most technologically advanced core type transducer available.

PEAVEY ELECTRONICS CORP
711 A Street/Meridian, MS 39301
© 1981



IVB enclosure, use a 20 uf/50 v non-polar capacitor in series to protect your drivers.

By crossing-over at 1200 Hz or above, the driver's power handling capacity will increase and its subjective sound quality will improve also.

As far as the output power of the DC300A's is concerned, you must determine how hard you are driving your system. Typically, it only takes a few watts into a horn to produce ear piercing levels. If you constantly drive your system into the red on the low end, you will probably end up damaging the horns. Simply tie your horns in series; this will give a 16 ohm load, and the power output will drop significantly.

Regarding the use of line level isolation with matching transformers, I would recommend:

1. Move the VFX-2 to the house electronics rack. Crossover adjustments are the first place to start in making your system sound good, especially if you use option #2.

2. Run unbalanced lines between the output of the VFX-2 and the DC300A's, the signal will still pass through your snake in the same pairs, but without the A15BT transformers

in the line. You have 3 return lines for the house P.A.—low (left and right) high (450 Hz and out) and high (1200 Hz and out)—and one for monitors.

3. Run a signal from the monitor output of your console to the now spare side of the Soundcraftsmen equalizer, then run the output to one channel of the P2200 unbalanced. (The P2200 has unbalanced inputs even though 3 pin plugs are used). Then jump the two P2200 channels together with a short unbalanced jumper. Now you have equalization for your monitors.

By jumping the two P2200 inputs together you have effectively "Y"ed the input. This is acceptable, so long as the total load impedance is greater than or equal to the stated output impedance of the source unit.

Your use of the A15BT transformer was correct and I suggest you keep them for future troubleshooting applications. However, for line level returns to the amplifier rack the use of transformers is not a necessity. I believe the disadvantages outweigh the advantages in this case:

Transformer advantages:

1. Proper loading of input/outputs.
2. Isolation of signal producing

devices, especially useful in alleviating ground loops and RF from dimmers and other sources, which is why I suggest you keep them.

In many instances, a transformer isolated balanced line is the only way to quickly alleviate these problems. So set up your transformer in convenient little boxes with 3-pin Cansons for input and output. Then they can be patched in whenever needed.

Transformer Disadvantages:

1. Gain loss, depending on design and usage.
 2. Higher harmonic distortion in low end. This distortion tapers off rapidly as frequency increases, but is a significant factor below 100 Hz, typically resulting in a "less tight" low end.
 3. Saturation distortion as the maximum operating level is reached—a transformer will saturate causing an unpleasant distortion.
 4. Expensive—especially the very best—which are necessary to keep items 1, 2 & 3 to an absolute minimum.
- I hope this guidance will help you.

—Will Parry

General Manager

Maryland Sound Industries, Inc.
Baltimore, Md.



LOFT Professional Products
are manufactured by
Phoenix Audio Laboratory, Inc.
91 Elm Street
Manchester, Connecticut 06040 (203) 649-1199

CIRCLE 63 ON READER SERVICE CARD

the entertainer™ by TAPCO

A lightweight, portable powered mixing system for entertainers on the move

The Tapco ENTERTAINER powered mixing system was designed with portability in mind. The three-piece system, a powered mixer and two speakers, weighs less than 100 lbs. — total! But the ENTERTAINER is no performance lightweight.

Both the mixer and the speaker systems have handles that are positioned at the center of gravity making the units lighter to carry. That means that more high-performance features can be built in without adding to your burden at set-up and tear-down time.

Some of these "performance plus" features include 12 inch, two-way constant directivity speakers that can be placed on stands, hung from walls, stacked and

used as stage or side-fill monitors — and all can be accomplished using optional mounting brackets and fittings that are integrated into the cabinet.

The mixer has 8 feature-loaded channels, plus two auxiliary channels complete with monitor sends. The two 150-watt power amps can be changed from stereo mode to a mono-monitor configuration with the flick of a switch. You also get two graphic equalizers, phantom powering capability for your condenser mikes, fluorescent bargraph metering that you can read from across the stage, and a connector panel that isn't in front, (where you could break connectors) but on a slanted rear panel where it is both visible and out of the way.

The ENTERTAINER is "performance plus" in a portable package. If you're an

entertainer on the move or one just in need of a top notch sound system, the ENTERTAINER is your answer. Audition the ENTERTAINER at your EV/TAPCO dealer.

EV **TAPCO**
a gulton company

TAPCO
2810 148th Ave. N.E.
Redmond, WA 98052
(206) 383-3510
TWX 310-449-2594

In Canada:
Gulton Industries, Ltd.
Box 220, 34E Herbert Street
Gananoque, Ontario K7G 2V7

In Australia:
Electro-Voice Australia PTY-LTD
59 Waratan Street
Kirrawee, N.S.W. 2202

In Europe:
E.V.S.A.
Romestrasse 3
253C Nidau
Switzerland

In Japan:
Electro-Voice Ltd.
6F No. 2 Taro Building
2-10 Yotsuya Shinjuku-ku
Tokyo, Japan 16C

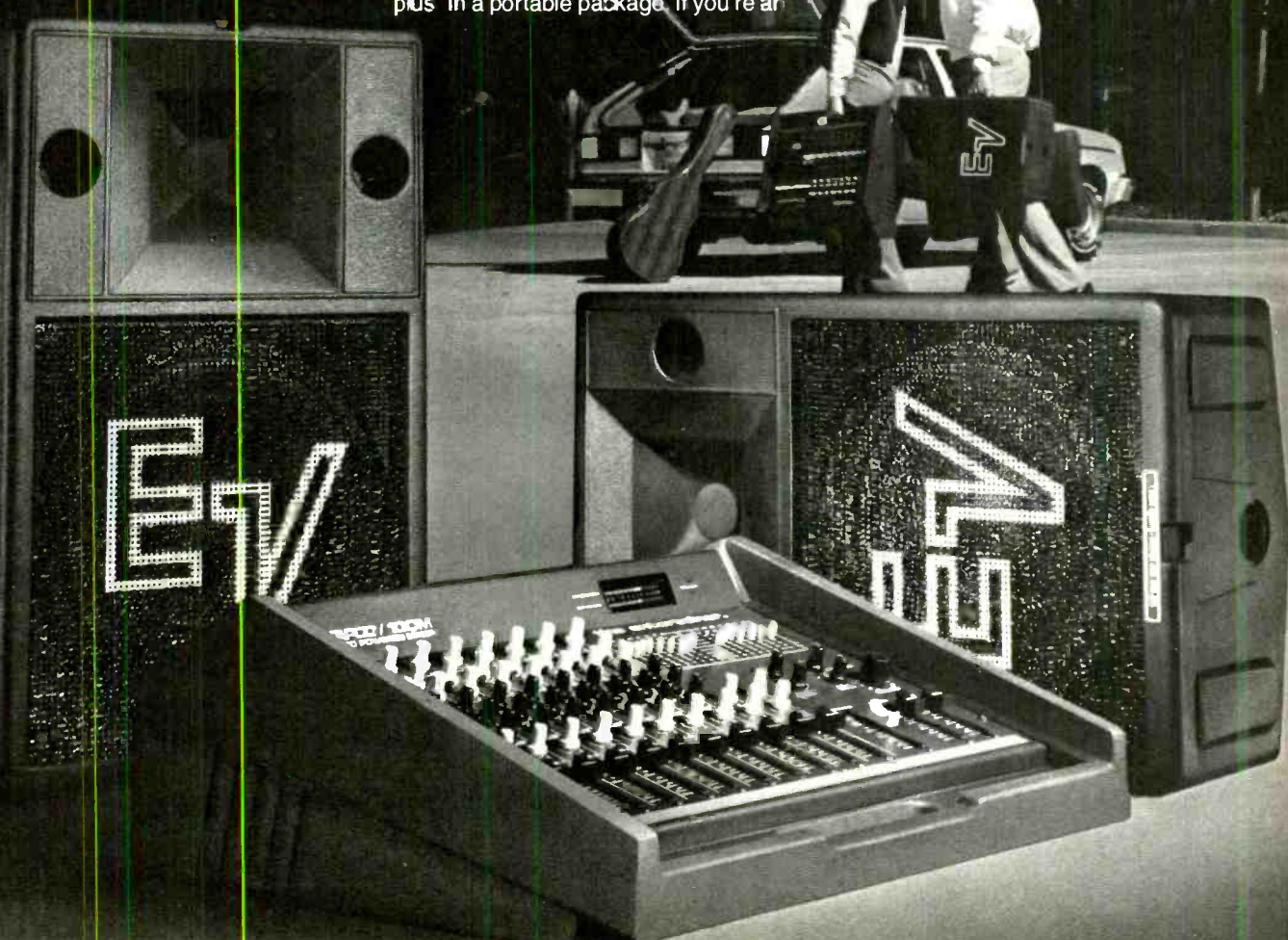

CIRCLE 189 ON READER SERVICE CARD

www.americanradiohistory.com

A SINGER'S DREAM!

TVE

REMOVES VOCAL FROM MOST STEREO DISCS

The Thompson Vocal Eliminator can actually remove most or virtually all of a solo vocalist from a standard stereo record and yet leave most of the background music untouched! Not an equalizer! We can prove it works over the phone. Write for a brochure and demo record below. COST: \$249.00

YOU SHOULD SEE US

- For:
- Studio Echo/Reverb
 - Tape Noise Reduction
 - Parametric Equalization
 - Electronic Crossovers
 - Comp/Limiters

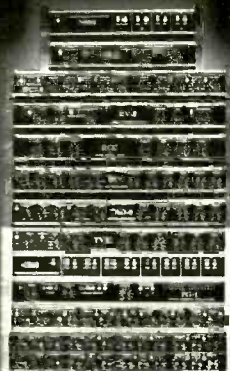

We manufacture a full line of high quality audio and recording equipment. You will probably have to pay twice as much elsewhere to obtain comparable quality. Only Direct Sales make our prices and quality possible. Send \$1 for a 24 page brochure and 20 minute demonstration record.

Write to: **LT Sound**, Dept. MR, P.O. Box 338, Stone Mountain, GA 30086 (404) 493-1258



...in a

REVERB

- Peak limiter in front end
- Quasi-parametric equalization
- Wet and dry mix controls
- Foot switch operation
- Quality construction, dependable, easily serviceable
- For use in studio, PA or instrument applications
- The right price!

Model RV-1

FURMAN SOUND

616 Canal Street
San Rafael, California 94901
(415) 456-6766

CIRCLE 74 ON READER SERVICE CARD

Eliminating the Leaky Basement Blues

My question concerns acoustic isolation. I am converting a house into a recording studio. My control room is in the living room and one bedroom is being converted into a "live" sounding studio. The main studio and a drum room are in the basement.

My major problem is that the low frequencies leak from the basement to the upstairs rooms more than I would like. Presently there is carpeting on a wooden floor on the main floor, and the floor is supported by 2" x 6" beams. The basement ceiling is simply drywall tacked to the 2" x 6" 's. The best idea I can come up with to eliminate the leakage would be to remove the drywall, insert glass wool insulation, replace the drywall and attach a layer of cork to that. Do you think this will work? I realize my problem would be solved if I used sandbags instead of the insulation, but in this case I don't want to risk bringing the house down around my ears. Is there a lightweight alternative to sandbags that would supply me with the same acoustic properties?

—Nate Stelton
Lemont, Ill.

THE WEDGE...



...is constructed out of a special high-density, open-cell acoustic urethane which is then formed to shape for optimum sound absorption and noise reduction, making it a useful tool in the recording studio.

When properly applied WEDGE products will:

- Eliminate slap echo
- Reduce standing waves
- Lower noise levels
- Smooth frequency response
- Reduce room flexure

In the recording studio, where proper room treatment is essential, WEDGE products can fulfill a number of recording needs.

WEDGE products are available in a variety of attractive styles, such as our room dividers (shown here) wall paneling, portable sound barriers, and in sheeting for ease of application anywhere.

Best of all, WEDGE products are finished products, and can be custom made to fit your individual studio.

For more information and a free brochure contact:

Esotech Inc.

7778 Mitchell Road
Minneapolis, Mn 55344
(612) 934-5790

CIRCLE 188 ON READER SERVICE CARD

We believe the following to be a practicable and economically feasible solution to your dilemma:

1. Remove the carpet from the main floor and the drywall at the basement ceiling.

2. Fill the spaces between the 2" x 6" joists at the basement ceiling with batt insulation: R-11 foil-backed glass fiber insulation (available from Owings-Corning).

3. Wrap ¼"-thick felt around the bottoms of the basement joists and up 2 to 3 inches on each side of joists. Staple.

4. Apply to layers of ½" drywall to basement joists, setting layers at right angles to each other.

5. Install 2 layers of carpet underlayment to main floor; 2 layers of ½" plywood on underlayment, setting plywood layers at right angles to each other.

6. Lay carpet on plywood.

Where plywood and drywall meet partitions, install ¼" felt between partition and drywall and plywood.

—Herbert Schwartz, R.A.
John M. Storyk and Associates, Inc.
New York, N.Y.

MODERN RECORDING & MUSIC

No Shortage of Circuits Here

For the past several years, I have been using a Teac Model 2 mixer to mix down tapes. However, it falls short when it comes to mixing "live" music due to its lack of bass and treble controls; it has only high- and low-cut switches. Is there a circuit available

which will allow the replacement of these switches with active tone controls as in the Model 2A?

The serial number of my mixer is 10041, if that's of any use. Thank you for your time.

—Gary M. Gorsky
Alden, N.Y.

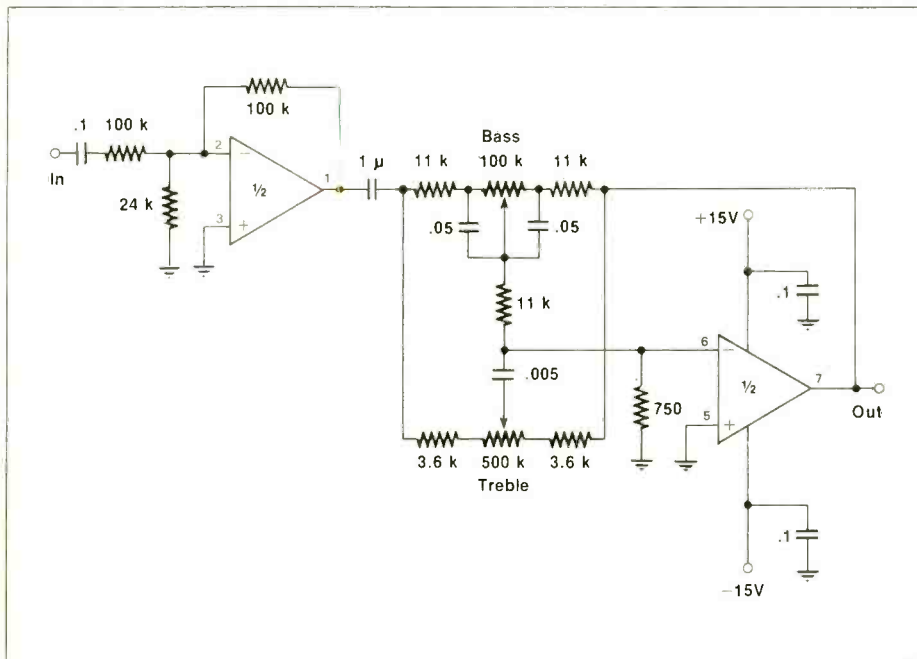

Fig. 1A: The Baxandall tone control.

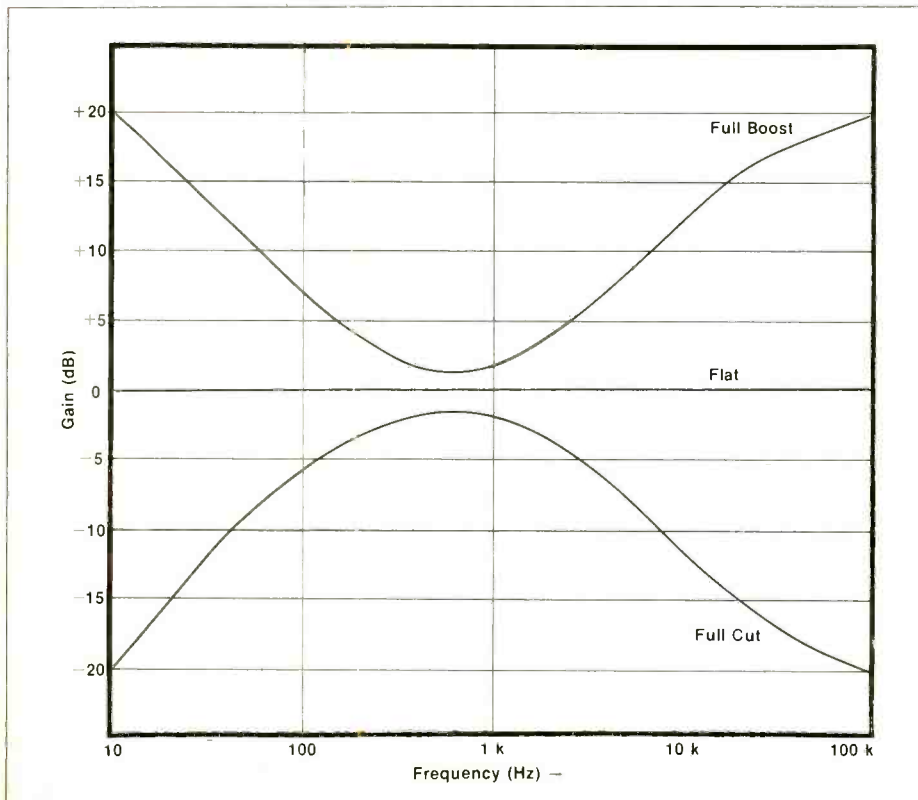

Fig. 1B: Frequency response of the Baxandall circuit at full boost, flat and full cut.

Quincy Jones... demands quality

AURATONE®



Photographed at RECORD PLANT, Los Angeles, CA
"...I mix with AURATONE® 5C Super-Sound-Cubes® the little powerhouse speakers. They tell me exactly what will be in the grooves. You hear it all with AURATONE®!"

Join "Q" and other seasoned music world pros, top record company executives,



engineers, producers, and artists who lay it on the line with AURATONE®.

Durability, flat full-range response, amazing power handling, and portability have made AURATONE® 5C's the Record Industry's favorite "mixdown monitors,"... for comparison and final mixes, auditioning, remotes, and reference standard speakers.

See your Dealer or order Factory Direct (30-day return privilege, one-year guarantee). \$75.00 per pair. Shipping and handling add: U.S.: \$5.00 pair; Foreign: \$15.00 pair. Calif. residents add sales tax.

Mail to: AURATONE
P.O. Box 698-R21, Coronado, CA 92118
Ship ___ pair 5 C's. Amount Enclosed \$ _____

Name (Please print) _____ Date _____

Shipping Address _____

City _____ State _____ Zip _____

Please send additional information.
CIRCLE 142 ON READER SERVICE CARD

There is, of course, the circuit of the Model 2A mixer (included below), but if you are going to be that clever, why not go the next step and build in parametrics? It is possible to breadboard very small circuit modules on perfboard, which can then be neatly

tucked inside existing chassis spaces and wired in place. Given here are three circuits for equalizing that will do the job if you care to do the layout. Just a hint—it's a whole lot easier to make yourself a number of small printed circuit boards when you are about to

duplicate a number of channels as in a mixer. The first circuit here is a generalized Baxandall tone control "Americanized" with opamps, and may be the simplest to breadboard. This one comes directly from the National Semiconductor Audio Handbook.* Any good dual, such as an N package type, can be used with minimum parts count and provide a very small module. The second circuit is the Model 2A tone controls, and the third circuit is the quasi-parametric E.Q. section of the Tascam Model 35, which will require triple-ganged pots and many more parts, but will impress you with its flexibility.

—Drew Daniels
Applications Engineer
TEAC/Tascam Professional
Products Group
Montebello, Ca.

* Used with permission from National

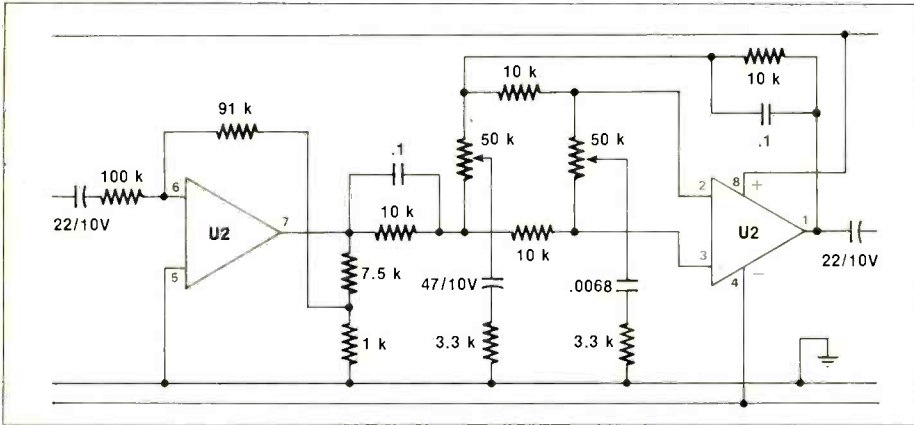

Figure 2: Teac Model 2A mixer.

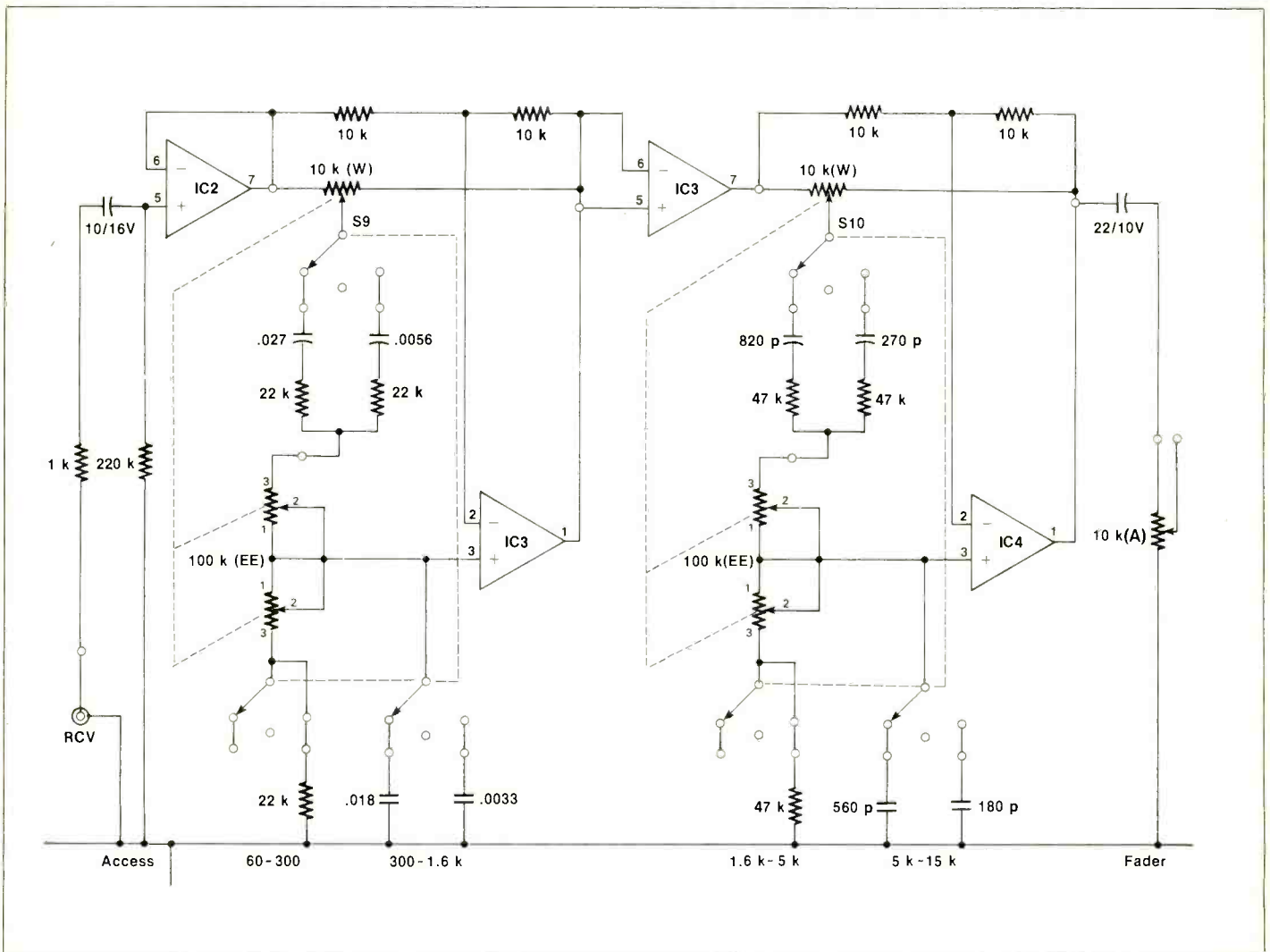
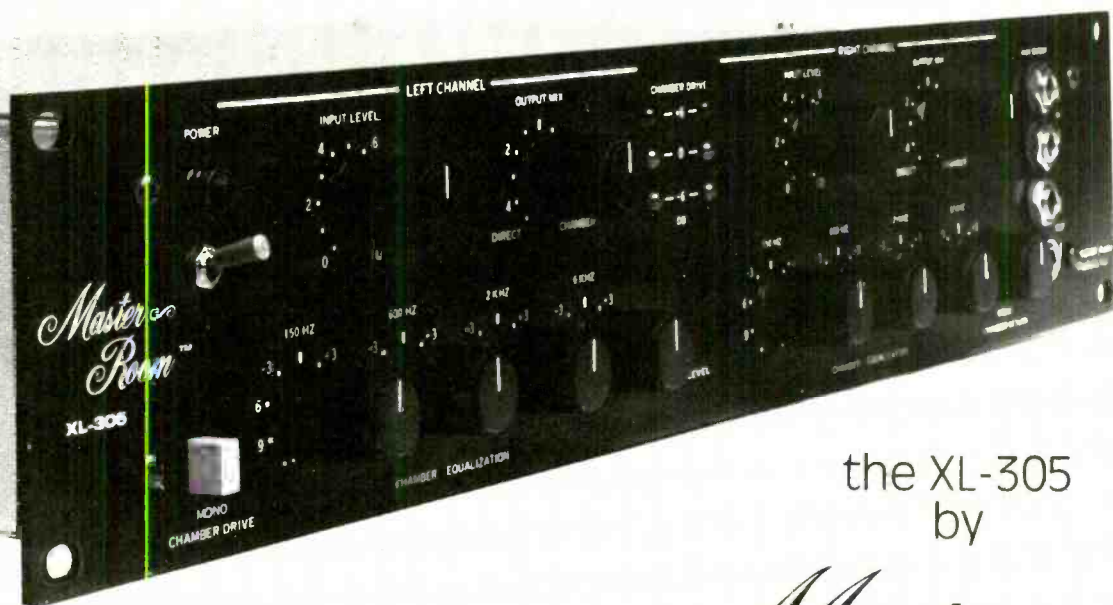

Figure 3: Tascam Model 35.

Incredible...

the "Acoustic Chamber Synthesizer"™



the XL-305
by

*Master
Room*™

- Totally new design approach
- The sound of a live acoustic chamber
- Natural sound, even on percussion
- Self-contained rack mount unit
- Full two-channel stereo

The Master Room XL-305 is a totally new design approach in reverberation technology. For the first time, the qualities and properties of a live acoustic chamber are available in a rack mount unit at an affordable price. There is a natural sound on percussion, as well as voices and all other musical instruments. This quality has not been obtainable from other compact reverberation devices. The XL-305 exhibits no unwanted side effects; it's as natural as a live chamber itself.

To hear this new advancement in reverberation, see your professional audio dealer and ask for a demonstration of this exciting new unit. Hear the XL-305 "Acoustic Chamber Synthesizer" for yourself, and you too will agree... It's INCREDIBLE.

MICMIX Audio Products, Inc.

CIRCLE 48 ON READER SERVICE CARD

Dallas, Texas 75220

2995 Ladybird Lane

www.americanradiohistory.com

(214) 352-3811

THE **PRODUCT** SCENE

By Norman Eisenberg

SHURE MIXER

Designed for professional broadcast and recording use is the M67 audio mixer just announced by Shure. New features include a fast attack limiter; simplex (phantom) power on all mic inputs; built-in battery pack; LED peak indicator; headphone level control; headphone amp/line selector switch; automatic muting circuit. Improved features include the mic/line switch on all four XLR inputs; higher power for driving headphones (up to three, or using this power to drive a tape deck or power amplifier); active gain controls; front-panel headphone jack and tone-oscillator switch; battery check function; electronic power supply regulation; lower distortion (less than 0.5 percent at line level output). The M67 also retains familiar features such as transformer balanced inputs and outputs; XLR and binding post outputs; a mix buss; VU meter; low-cut filters; low RFI and line noise susceptibility; frequency response within ± 2 dB, 30 Hz to 20 kHz; small size and lightweight. Price is "under \$400."

CIRCLE 1 ON READER SERVICE CARD

UPDATE ON LORAN CASSETTES

The new line of Loran cassette tape is now available in four formulations. Ferric-oxide cassettes in C-46, C-60 and C-90 sizes will sell, respectively, for \$4.55; \$5.55; and \$7.65. Chrome cassettes in C-60 and C-90 sizes are priced, respectively, at \$5.75 and \$7.95. Prices for Loran's metal and ferrichrome cassettes have not yet been announced. Loran has emphasized the high degree of environmental stability of its cassettes, a factor which—among other things—is held to be responsible for continued reliable service in vehicle dash cassette systems which are particularly subject to extremely high heat.

CIRCLE 2 ON READER SERVICE CARD

DIGITAL REVERB SYSTEM STORES THIRTY-TWO SET-UPS

A new digital reverberation system, the model 8X32, has been announced by Ursa Major Inc. of Belmont, Ma. Effects suitable for studio, broadcast, "live" performance and other applications are provided. The microprocessor-based front panel has a separate LED read-out and control for each adjustable reverb parameter. Says Ursa Major: "These displays and controls make the 8X32 an exceptionally 'friendly' system to operate despite its sophistication."



Also featured is a bank of thirty-two non-volatile (they retain their contents even when power is turned off) storage registers that allow the user to store and recall thirty-two complete reverb set-ups and to edit them at will. Four basic programs are available with the 8X32, from a small, fast-diffusing "plate" to a large, echoing "space" simulation. Within each of these programs, sixteen decay times can be selected (0.25 to 19.9S, depending on program). The level (eight steps) and delay time (about 6 to 9 ms in sixteen steps) of both the early reflection pattern and the initial reverb may be independently controlled. LF and HF decay also may be individually trimmed (four values each). Especially useful effects for performing artists are provided by two unique controls called "Input Mute" and "Reverb Clear." The 8X32 takes 3½ inches of rack space. Controls and displays are available on the front panel, or in a remote unit suitable for use on consoles, or both. Suggested price is \$5995.

CIRCLE 3 ON READER SERVICE CARD

DISTRIBUTION AMPLIFIER

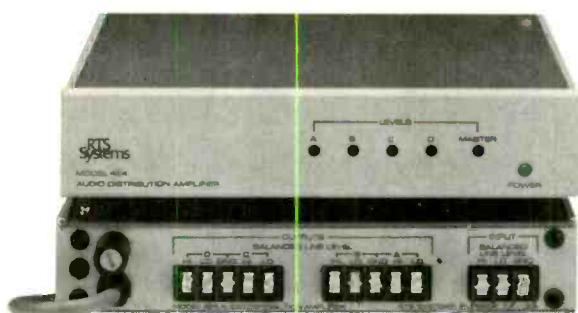

RTS Systems has introduced its model 424 Distribution Amplifier with one balanced input and four independent, active, transformer-isolated outputs. The use of a separate amplifier for each output is credited with providing an output channel-to-channel isolation of better than 60 dB at all frequencies, far greater than can be achieved with multiple transformers or resistive fan-outs from a single amplifier. This high isolation in turn is said to prevent shorts, opens or unusual reactances or voltages on one or more lines being coupled through the amp to other lines. This design also offers independent gain adjustment of 33 dB for each channel without any change in source impedance. Maximum output level from the model 424 on any channel is 22 dBm with all channels terminated in 600 ohms, or 25 dBu unterminated. Dimensioned for one standard rack-unit space, the model 424 costs \$354.

CIRCLE 4 ON READER SERVICE CARD

ATI'S "EMPH' A SIZER"

The "Emph' a Sizer" is a new audio processing system from Audio Technologies, Inc. (ATI) of Horsham, Pa., which combines the functions of a program-controlled input gate; a switchable four-band parametric equalizer; and a wide-range, very low-distortion compressor/limiter. Designed for use in the recording studio as well as in sound-reinforcement work, the device accepts direct microphone or line-level inputs and it provides both low- and high-level balanced outputs to +24 dBm. It mounts singly or two across in 3½ inches of rack space, and may be ganged for stereo use.

CIRCLE 5 ON READER SERVICE CARD

PRO VIDEO TAPE SPLICING KIT

Designated as a professional video tape splicing kit is the new VE-9 from Bib, the well-known accessory manufacturer. The VE-9 kit comprises a half-inch video tape splicer, two stainless steel razor blades, splicing tape, instructions and a permanent storage box. The splicer holds the tape under clamps, while diagonal or butt splices are made. Price is \$39.95.

CIRCLE 6 ON READER SERVICE CARD

AMPLIFIER HAS REAL-TIME SPECTRUM DISPLAY

An integral part of the model RA7503 power amplifier from Soundcraftsmen is a 100-LED real-time frequency spectrum bar-graph display. Said to be highly accurate, the display enables continuous monitoring of the actual output of the amplifier in discrete octave bands. When crossovers are used (for bi-amping or tri-amping), and/or when equalization has been introduced into the system, the display may be analyzed for octave-by-octave spectrum performance indication. A pink-noise test record is included to facilitate spectrum output monitoring as desired.

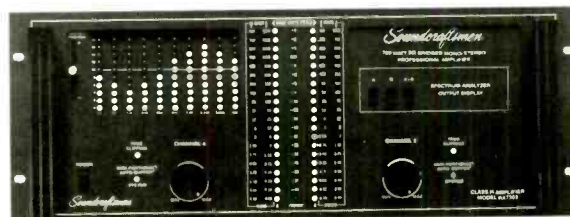

Output of the amplifier is rated at 250 watts per channel stereo, or 750 watts bridged mono, into 8 ohms from 20 Hz to 20 kHz, with THD under 0.09 percent. Into 4-ohm loads, the stereo output becomes 375 watts per channel across the audio band. Balanced and unbalanced inputs are provided. TIM is listed as less than 0.02 percent (unmeasurable). S/N is stated as better than 105 dB. Slew rate and rise times "far exceed all present and future source signal requirements, including direct-to-disc and digital recording techniques," says the manufacturer.

In addition to the 100-LED spectrum display, the RA7503 amplifier has a 20-LED metering system for displaying output power on each channel.

CIRCLE 7 ON READER SERVICE CARD

BASF SORTS IT ALL OUT

BASF is offering new cassette tapes for different recording needs, and here is how the company sorts it all out:

Their "flagship" tape is Professional II, made with an improved chrome formula, and claimed to be "the world's quietest tape, for the most demanding recordings."

Next down in the line is Professional III, a ferrichrome tape, which BASF claims is ideal for car stereo systems.

The tape known as Professional I, normal bias, is offered for "loud recordings without distortion."

Finally there are "Performance" cassettes for "quality music and voice recording on any cassette recorder."

According to a company spokesman, BASF Professional II tape has less noise than "any other formulation, including metal."



CIRCLE 8 ON READER SERVICE CARD

VIDEO "SUPER ISOLATOR"

Designed to curb problems caused by severe AC power line spikes, surges, noise and hash—which are responsible for many unexplained flashes and picture jitters during video viewing and recording—is the new Model ISO-3 "Super Isolator" from Electronic Specialists, Inc. of Natic, Ma. The box incorporates three individually dual-balanced-Pi filtered 3-prong AC sockets. Capable of handling an 1875-watt load, with each socket capable of handling 1000 watts, the "Super Isolator" is credited with eliminating equipment interactions and controlling line spikes and hash. The price of the box is \$94.95.

CIRCLE 9 ON READER SERVICE CARD

PIONEER HEADPHONES



Three new headphones have been added to Pioneer's product line. The Master-IS is a lightweight model with rated sensitivity of 103 dB/mW; frequency range of 16 Hz to 22 kHz; maximum input of 200 mW. It weighs 5.2 ounces less its 10-foot cord.

The SE-L5 is an "open air" super lightweight headset with rated sensitivity of 101 dB/mW; frequency range of 20 Hz to 22 kHz; maximum input of 200 mW. Weight, less its 10-foot cord, is 2.5 ounces.

The SE-L3 is similar to the SE-L5 except for a sensitivity rating of 98 dB/mW and a weight of only 2.1 ounces less its cord.

CIRCLE 10 ON READER SERVICE CARD

DECK DEMAGNETIZES ITSELF

The latest feature in cassette decks is an automatic demagnetizing system (ADMS) found in the new Aiwa AD-3600. A special oscillator, which is activated when power is switched on (there also is a manual switch), automatically cancels out built-up magnetization and also prevents slips in manual demagnetization. The new recorder features dual capstan drive with Aiwa's new tension stabilized dual capstan (TSD), credited with reducing wow-and-flutter to only 0.029 percent WRMS.

A three-head unit, the AD-3600 incorporates the Dolby HX system, a bias fine-adjust control, 12-point LED indicators, an automatic tape slack cancellor, record-mute, auto repeat and feather-touch IC logic controls. For metal tape, response is rated as 20 Hz to 20 kHz; S/N with Dolby on is stated as 68 dB. Price is \$460.

CIRCLE 11 ON READER SERVICE CARD

OTARI MASTERING MACHINES

First models announced in the new MTR-10 series of "world class" production/mastering professional tape recorders from Otari are the MTR-10-2 and the MTR-10-4. The MTR 10-2 uses the quarter-inch, two-channel format. The MTR 10-4 employs the half-inch, four-channel format, and it also may be converted to half-inch, two-channel. Both recorders feature DC, PLL, servo tape-transport operation governed by microprocessor; real-time tape counters; hinged-top transport deck-plate; adjustable phase compensation, bias, record and play levels which are aided by an internal multi-frequency square/sine wave generator; optional tape locator with 10-position memory and shuttle; direct-coupled outputs; active balancing on inputs and outputs (optional transformers are available); rear-panel interface to the transport and time-base functions for SMPTE interlock; desk-height console on casters; conveniently located audio and transport electronics card frame for ease of adjustment and servicing; and more. Speeds are 30 and 15 ips. Prices start at \$6,450.



CIRCLE 12 ON READER SERVICE CARD

NEWS ABOUT NOISE

Among other items unveiled at the recent Chicago C.E.S. (May 31 to June 3) is a noise reduction system from Bang & Olufsen. Known as HX Professional, it appears to be an extension of Dolby HX—the main difference being that in the B & O system tape bias remains virtually constant. Further, HX Professional does not depend on the control signal used for Dolby B, which, says B & O, is not optimally suited for varying the bias. And, the changes introduced by the B & O system are applied to both stereo channels separately, rather than by the same amount as in Dolby HX.

The result, claims B & O, is a "dramatic increase in high-frequency headroom: up to 7 dB at 10 kHz..." which "...means that ferric tapes recorded with the HX Professional system give essentially the same performance as normally-recorded metal tapes."

In discs, CBS has announced its CX system, which "virtually eliminates surface noise...and dramatically extends dynamic range" (by 20 dB, for a maximum of about 85 dB). CX-encoded records, which will cost the same as standard discs, may be played "as is" on conventional stereo equipment, although the full benefits of CX do require the addition of a decoder to the playback system. Obviously a challenge to the dbx disc system, CX mastering encoders already have been licensed for manufacture to UREI, while interest in the system has been expressed by several labels including WEA, A&M, RCA, MCA, Capitol-EMI, Teldec and others. Manufacture of decoders already has been announced by MXR, Sound Concepts, Phase Linear and Audionics. Second-generation decoders, says CBS, can be incorporated as circuitry to be built into new playback equipment.

For its part, dbx now has an integrated circuit on two tiny chips for its system which can be applied to tape recording as well as to the decoding of dbx-processed discs. The dbx decoding capability also is being introduced for car stereo players. Among dbx licensees are such names as Matsushita (Technics and Panasonic), Teac, Marantz, Trio Kenwood, Nikko, Nippon Electric and others.

It is still too early in this new phase of the anti-noise contest to form any long-range opinions, and we hope to gain insight into these systems in the coming months as both hardware and software became available. Stay tuned to this station.



MUSICAL

NEWSIGNALS

STAGE MONITOR SPEAKERS

Recently added to the Crate line from St. Louis Music are two models of compact personal stage monitors. The UPM-1 is a compact enclosure housing two 5-inch speakers which can be placed on the floor (at one of four different angles) or mounted to a mic stand. The unit is housed in a ponderosa pine cabinet with a steel face plate and a perforated steel speaker grill. The UPM-1 has paralleled input jacks for daisy-chaining several speakers together. Rated power handling for the unit is 100 watts RMS. The other new model from Crate is the PM-20, a powered monitor in a similar ponderosa pine enclosure. This model has a single 5-inch speaker and a 20-watt RMS power amp for self-contained versatility. The amplifier in the PM-20 has a specially designed preamp section with volume and tone controls to give the performer control over his own monitor sound. The unit has a line output jack to feed other PM-20s and an extension speaker jack to connect additional speaker cabinets such as the UPM-1.

CIRCLE 18 ON READER SERVICE CARD

American Acoustics Labs has announced the Road Systems line of sound reinforcement and stage monitoring loudspeakers. The Road Systems line includes three models so far, all of which feature solid, non-resonant construction and rugged black vinyl finish. The RS-450 is intended primarily as a sound reinforcement or high-power monitoring loudspeaker system. The RS-450 features two 15-inch woofers and a wide dispersion horn with compression driver. The system is rated at 10 watts minimum, 250 watts maximum (RMS); frequency response is given as 38 Hz to 15 kHz

± 6 dB. The RS-350 is a system designed for keyboard amplification, and features a single 15-inch woofer and a wide dispersion horn with compression driver. Power handling rating for the Road Systems RS-350 is 150 watts RMS maximum. The RS-250 is the



smallest of the Road Systems models and is designed primarily for stage monitoring applications. It boasts a 12-inch woofer plus horn/compression driver, and is a compact 21 $\frac{1}{4}$ "x 16"x16".

CIRCLE 19 ON READER SERVICE CARD

MUSICAL INSTRUMENTS

Probably the most sophisticated electronic drum box is the LM-1 Drum Computer from Linn Electronics. The unique aspect of the Linn is that it is *not* a drum synthesizer, but rather uses the sounds of real drums which have been digitally recorded and stored in read-only computer memory chips. Thirteen basic drum sounds are furnished with the LM-1, five of them available with normal and accented dynamics. The sounds include bass, snare, open and closed hi-hat, two toms, two congas, cabasa, tambourine, cowbell, clave and handclaps. Each

sound may be tuned over a wide pitch range using controls on the back panel of the unit. Thirteen slide faders and left-center-right assign switches comprise a stereo mixer to control the balance of the various drum sounds as they are played, either in real time or from memory. Separate outputs for each of the drum sounds are provided on the back panel of the unit for multi-track recording or external mixing. The LM-1 is fully programmable in real-time using building-block units which are typically two bars in length. For use with other synthesizer or sequencer equipment, the LM-1 has clock output and external clock input jacks on its rear panel.

CIRCLE 20 ON READER SERVICE CARD

A very versatile drum box is the Roland TR-808 Rhythm Composer, which is a rhythm synthesizer combined with a comprehensive digital sequencer and memory system. The TR-808 has eleven basic sounds including bass, snare, low-, mid- and high-pitch tom/conga, rim-shot/clave, handclap/maracas, cow bell, cymbal, open hi-hat and closed hi-hat. Each of these sounds has a level control for the mixed output and a direct output connection, and some of the sounds have timbre controls. Using the eleven basic sounds plus accents, the musician is able to program up to thirty-two different rhythm patterns. A step pro-

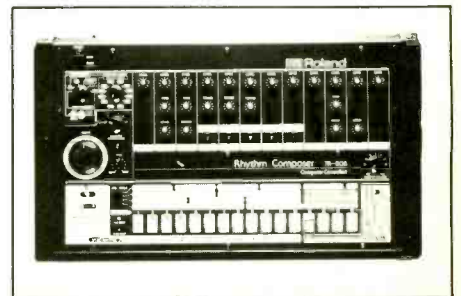

programming mode is used which breaks each beat within the measure-long pattern into a series of steps which may be grouped in different ways to accommodate intervals as short as 64th notes or incorporating triplets. Odd time signatures such as 5/4 or 7/8 are accommodated by using less than the full 64 steps per measure, and a Pre-Scale feature insures that the various rhythms are in relative time with each other regardless of odd or even time signatures. A Compose function is included in the TR-808 to make a complete tune from the component patterns which have been programmed. The Compose function will store twelve segments of sixty-four basic patterns each to accommodate songs of typical length, or the entire Compose memory may be used to store one long 768 measure composed track.

CIRCLE 21 ON READER SERVICE CARD

E-mu Systems recently announced the introduction of a new polyphonic digital keyboard instrument called the Emulator. The computer-based Emulator allows the musician to digitally record any sound from either a microphone or a line-level source and then to play that sound back at any pitch with up to eight note polyphony. The unit includes a built-in floppy disk drive to allow the user to store his recorded sounds on a diskette for later recall. The Emulator is furnished with a library of pre-recorded sounds and E-mu plans to make available a continuing series of additional sounds and special function software including a realtime multi-track sequencer. Opera-

tionally the Emulator is very simple and requires no special programming skills or knowledge of computers. The four-octave keyboard of the Emulator may be split to allow simultaneous control of two different sounds. Two conventional mod wheels are provided with the unit to control vibrato and realtime pitch bending. Two switches and two sliders are included among the front panel controls to vary the sustain of the recorded notes, and a unique feature of the Emulator is the loop function which allows indefinite sustain of any note regardless of its original length or decay.

CIRCLE 22 ON READER SERVICE CARD

St. Louis Music Supply Co. recently introduced a new line of electric basses known as the Phoenix series. So far, the Phoenix line has two models available with a number of common features. Both Phoenix models feature Canadian ash bodies with a deep heel cutaway for easy access to the upper register of the neck. The body is beveled and is carefully designed to balance the neck for long hours of comfortable playing. The neck is hard rock maple with maple fingerboard and features an adjustable truss rod and magnesium U-channels. The neck is finished in a clear satin finish while the body is available in a natural or sunburst open-pore finish. Hardware on the Phoenix basses includes extra-heavy duty machine heads, brass bridge and a solid brass neck nut. The two models differ in terms of their pickups and associated electronics. The X630 is a straightforward model

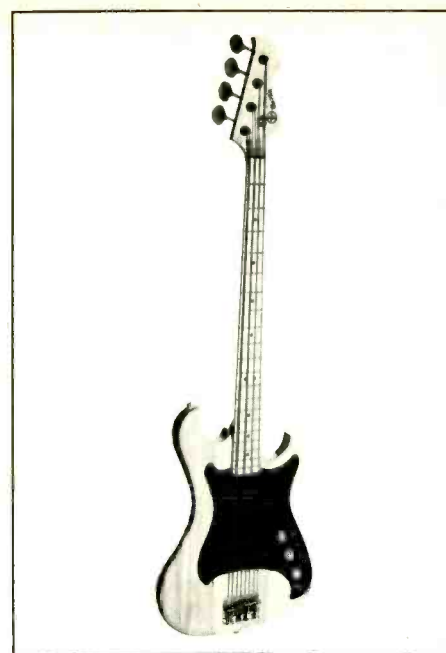

with a single split-coil pickup mounted in the conventional position and connected to passive electronics. The X640, on the other hand, has two split-coil humbucking pickups with series/parallel and out-of-phase wiring selectable and active electronics giving the musician parametric equalization for extreme versatility of sound.

CIRCLE 23 ON READER SERVICE CARD

MUSICAL INSTRUMENT ACCESSORIES

Anvil Cases recently formally introduced its new line of Anvilite Cases. This new line uses .085" thick plastic material in place of the traditional fiber material in a line of drum and trap cases. The new Anvilite material is mar-resistant and more rugged than the comparable fiber material. Heavy-duty steel handles are used in the Anvilite cases to insure reliable service. Anvilite cases are available in blue and black and have optional foam linings for added protection of equipment.

CIRCLE 24 ON READER SERVICE CARD

The EZ Cord Control is a simple but very useful item, namely a spool for winding and storing wires and cables neatly. The spool is made from orange high-impact plastic and is available in three sizes: the 9" long Model 300 which will hold up to 25 feet, the 16" Model 200 which will hold up to 100 feet and the 19" Model 100 to hold up to 150 feet.

CIRCLE 25 ON READER SERVICE CARD

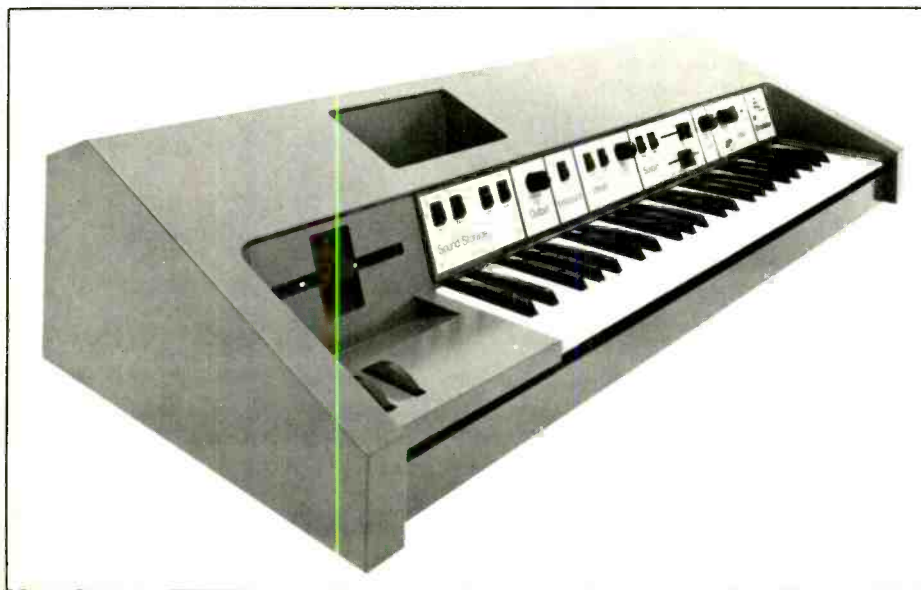

Interfax has introduced a new harmonic distortion device known as the Harmonic Percolator. This new device is not just another fuzz box, however, as the harmonic content has been carefully tailored to yield some ten times more even harmonics—which sound rich and musical—than harsh-sounding odd harmonics. Additionally, the harmonic enrichment occurs at all input signal levels rather than cutting in at some arbitrary signal level as in conventional fuzz-tones. Another interesting feature of the Harmonic Percolator is that its frequency response changes at low input signal levels to improve the subjective noise perfor-



mance; at normal signal levels, the frequency response is within ± 2 dB from 20 Hz to 20 kHz, but at low signal levels the low frequencies are attenuated by as much as 10 to 15 dB to reduce the amount of low frequency noise and hum heard in quiet passages while still maintaining a bright tone. The Harmonic Percolator has a maximum gain of 55 dB and has an equivalent input noise of -125 dB. It is powered by a single 9-volt battery which will last for over a month of continuous operation thanks to the low-noise, low current circuit design. Two slide-type controls, one for the amount of added harmonics and one to set the effect's output level, and a bypass footswitch are provided on the unit.

CIRCLE 29 ON READER SERVICE CARD

News comes from The Music People, Inc. of a line of retrofit electronics for guitars to be known as the TMP Network. The idea behind the TMP Network was to provide a way for owners of older and vintage instruments to achieve the higher output levels, and wider tonal range they desire without

the necessity of changing pickups which would change the tonal characteristics of the instrument and which may be undesirable from an esthetic standpoint, as well. The Network currently comprises three models, two with active circuitry and one passive, which may in many cases be installed in a guitar or bass by the musician himself. Sure Energy is a pre-amp module with very flat frequency response to boost the output level of the instrument and increase the dynamic range without changing the tonal character.

Act One is an active equalization module which replaces the guitar's tone control. Existing tone controls with their limited range are replaced by two knobs to control bass and treble independently over a ± 15 dB range. The final product in the TMP Network as it now stands is a passive tone control network called the Equalizer. This unit gives improved control over the 30 Hz to 7 kHz range, replacing the conventional tone controls with a master bass/treble control and a master mid-range control.

CIRCLE 30 ON READER SERVICE CARD

Schecter Research recently published a new, full-color catalog of its line of accessories and replacement components for guitars and basses. This 16-page book shows an almost overwhelming range of items from the company's well-known replacement pickups and brass bridges, to replacement knobs and strap buttons (in brass, chrome or black chrome finishes, no less), to complete Fender-style bass and guitar necks in a choice of ten different woods, to custom Allen-Bradley Mod-Pots designed for sophisticated electronics packages. Schecter even offers Fender-style guitar and bass bodies (in eighteen common and exotic woods) which would make it possible for the do-it-yourselfer to assemble a total instrument down to the last screw from items listed in the catalog.

CIRCLE 31 ON READER SERVICE CARD

Another interface product is the Mojo Bone, new from ElectroSonics, Inc. The Mojo Bone is a multifunction interface device which will accept inputs from a hi-fi type source (phono preamp, tuner, tape deck) and a musical instrument source (electrified instrument, contact pickups or high impedance mics), mixes them together and

delivers the output to headphones or to additional audio stages such as a stereo amplifier or a tape recorder. The Mojo Bone has 46 dB of available gain with flat frequency response for either clean or overdriven sounds. An additional function is that the Mojo Bone will deliver $1\frac{1}{4}$ watts of power when connected directly to a hi-fi type loudspeaker. The unit is powered via a single 9-volt battery or the included AC adapter.

CIRCLE 32 ON READER SERVICE CARD

EJA is a company which features an assortment of unusual guitar accessories. Among the items listed in its catalog are earplugs for rock guitarists, a guitar circles poster and stainless steel and brass guitar picks. Probably the most unusual product listed is the Acoustifuzz, a mechanical device which gives a fuzz-tone like sound when attached to an acoustic guitar. Acoustifuzz mounts in the sound hole of the guitar with plastic supports and vibrates in sympathy with the guitar to produce its effect.

CIRCLE 33 ON READER SERVICE CARD

News comes from Peterson Electro-Musical Products about the Node Type 7000 strobe tuner for which Peterson will be the exclusive North American distributor. The unique aspect of the Node 7000's design is that it has twelve separate strobe windows, one

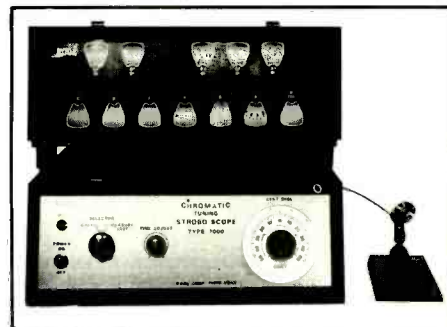

for each note of the equi-tempered scale to eliminate the selector switch. The only controls on the unit are the power switch, a calibrate/measure switch, a cent dial and a fine adjust knob. Beyond that, the unit is virtually foolproof, displaying tuning wheels with markings for a 7-octave range from $C=32.703$ Hz through $B=3951.07$ Hz, with a specified accuracy of 1/100 semitone (less than .05%).

CIRCLE 34 ON READER SERVICE CARD

WHEN YOUR WORK BEGINS AT 8.

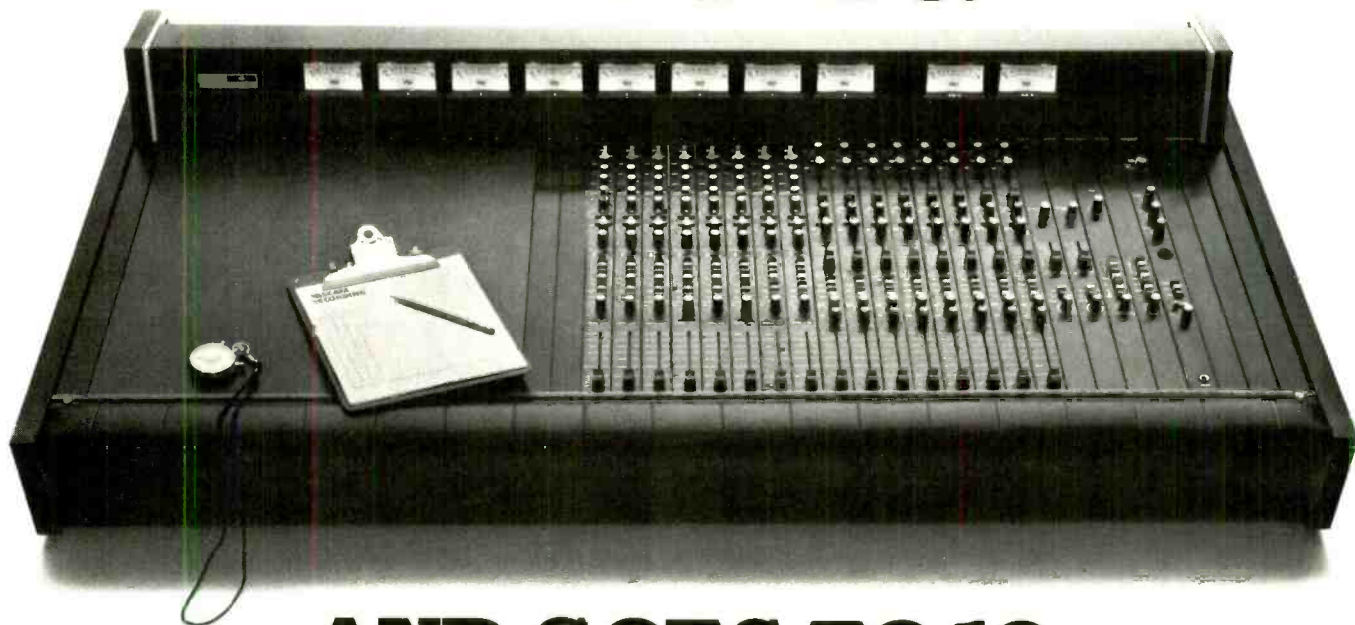

AND GOES TO 16.

The New Model 15SL.

Today it's 8-tracks. Tomorrow 16. And unless you have a pile of money stashed somewhere, you'll need hardware that can grow to fit your future.

Enter the Model 15SL. An 8-in/8-out configuration with a double 8-track monitoring system and 6-position EQ on all inputs. Expandable to 24 inputs with full 16-track monitoring. It's the "short load" version of our renowned Model 15.

The Model 15SL gives your ears an almost unlimited mixing and monitoring repertoire. For example, you can punch up a 8 x 2 or 8 x 4 output monitor mix without affecting what goes onto

tape. Or solo one or several monitor channels. You can listen to a performer's headphone cue, hear the echo buss, add external signal processing to the monitor or tape. You'll easily satisfy your musicians, your producer and yourself, with an amazing amount of flexibility and control.



The model 15SL is the perfect studio mate for the world's most popular 8-track recorder, the Tascam 80-8. Put both to the test at your Tascam dealer today.

And the Model 15SL does all this very quietly. The mic preamps are all discrete FETs (not chips) for lower noise and distortion. The power supply is housed separately for remote mounting to keep heat and hum away from the amplifiers. Mic input S/N is greater than 76dB (1 channel, WTD). And overall distortion (Mic In to Line Out) is 0.03% THD @ 1,000Hz.

So listen to the Model 15SL. Examine its extraordinary flexibility. You'll find everything you need to start work at 8. And go to 16. At your Tascam dealer right now.

TASCAM STUDIO SERIES
TEAC Production Products

Construction
Project:

BUILDING A MICROPHONE CABLE TESTER

By Jerry Whaley

Neglect me! Reject me! Use me! Abuse me! Throw me on the floor and walk all over me! If cables could talk they would say this and much more. How many times have you untangled microphone cables that were literally in knots? How many times have you rolled heavy equipment over your cables? How many times have you sat down in a chair to do some recording, then noticed that one leg of your chair is smack-dab on top of your mic cable?

Microphone manufacturers choose the most flexible, durable cable they can get their hands on, but it is not indestructible. We repeat: *not* indestructible. A little tender loving care can go a long way in extending the life of a mic cable, or any other cable for that matter. Although, even with the best of care there are times when these slender workhorses develop problems.

After all, they are only so flexible and only so durable. When that time comes, one cable tester is worth a thousand guesses about where the trouble is.

This simple, inexpensive tester will check a microphone cable for CONTINUITY. What's all that crackling and popping? It will check for SHORTS between conductors. Why does this mic have no output? It will also check for proper PIN WIRING between the connectors. Why is this mic out-of-phase with the others? By this time you should be getting the picture as to why a properly functioning cable is so important. This tester is a real lifesaver if you have lots of cables to check and you are tired of fumbling with ohmmeter leads. Try holding two connectors and touching two probes to two pins with only two hands. It is a real blast! Let's not even mention the part

about remembering which pins have and have not been done. Cable testing can be done quickly and easily with the tester. It also allows a free hand to flex the cable in order to check for intermittent shorts and open conductors.

Understanding the Test Circuit

The schematic diagram for the cable test circuit is shown in *Figure 1*. The circuit consists of a power supply switched via S4 to two different circuit configurations. One section checks for shorts. It also contains switches which in conjunction with the second section check for continuity and proper pin wiring. A schematic diagram of a microphone cable is provided in *Figure 2*. The diagram will help to visualize the cable problems outlined in this article.

When S4 is put in the SHORT position, the two LEDs in that section should light. If one or both of the

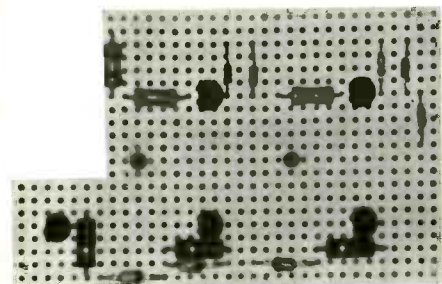

Photo 1

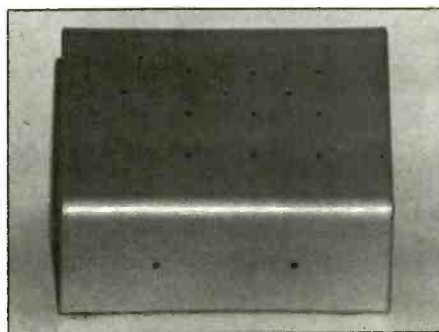

Photo 2

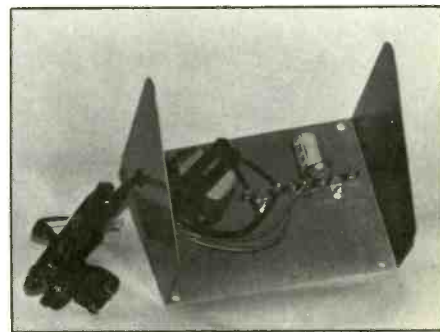

Photo 3

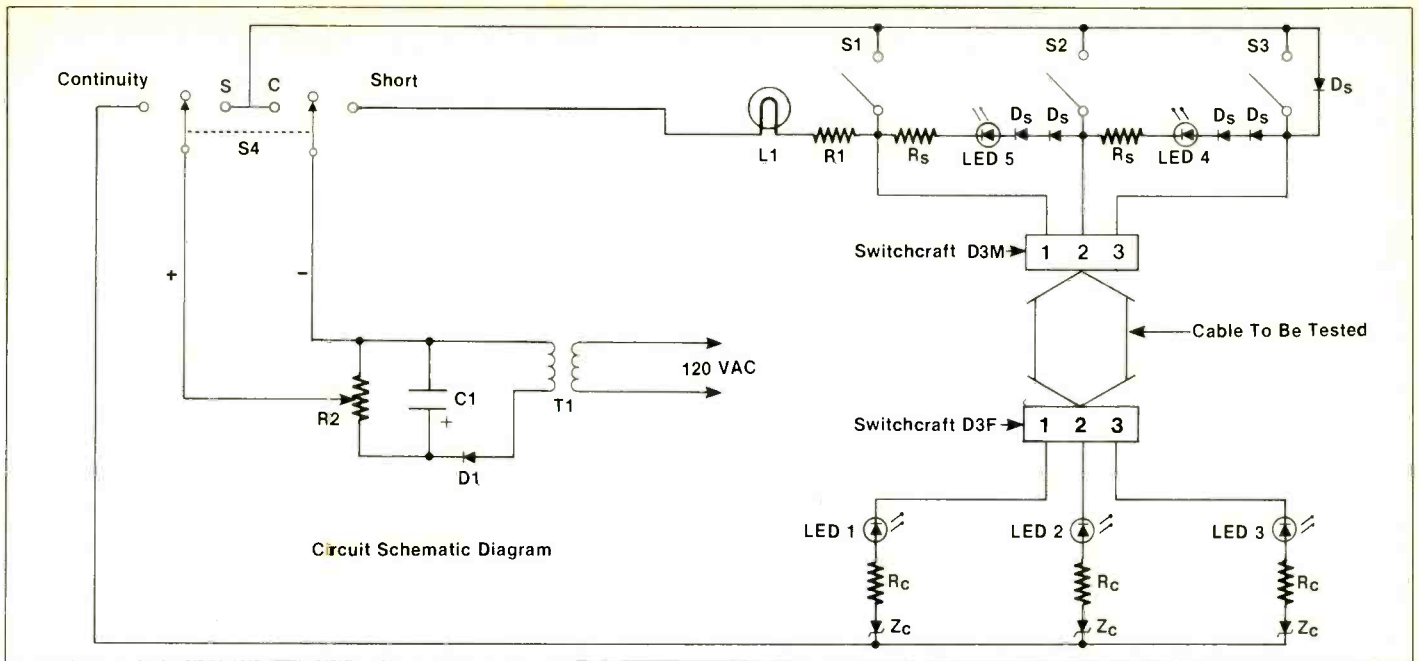

Figure 1

LEDs fail to light this indicates a short. They fail to light because their section of the circuit has been bypassed by the short. The incandescent lamp should remain off due to the current limiting of the R_s resistors. If there is a short between pins one and three the incandescent lamp will then light. The lamp current is controlled by R_1 .

When S_4 is put in the CONTINUITY position no LED will light until its corresponding switch (momentary contact) is pushed. Each switch is mounted near the LED that corresponds to the particular pin number the switch controls on the opposite end of the cable. This allows each conductor to be individually tested, and assures proper pin wiring between connectors. For example, if S_2 is pushed and LED 3 lights, this indicates improper pin wiring. If S_2 is pushed and no LED lights, this indicates a lack of continuity in the cable or an open connection at the connector pins.

The 12-volt zener diodes provide a voltage drop which in addition to the

R_c , R_s , D_s , D_s combination keeps the LEDs in the unactivated sections of the test circuit from lighting. The D_s , D_s diode pairs provide a slight voltage barrier (approx. 1.4 v). In conjunction with the limiting resistors they provide enough isolation of the unactivated LEDs to enable the current in the activated LED to be high enough to provide adequate brightness. R_2 in the power supply circuit is provided to allow maximum brightness adjustment of the continuity LEDs. This will be just below the point where the unactivated LEDs begin to faintly glow.

The power supply consists of a 12-volt transformer; a rectifier diode (D_1) which provides half wave rectification; and a capacitor (C_1). The capacitor smoothes the half wave DC signal provided by D_1 , thereby supplying a more constant voltage to the LEDs. At this point let us point out that a regulated 15-volt power supply, such as the supply outlined in the October 1978 issue of *MR&M*, can be used instead of the supply shown. This

will cut out some expensive parts (the power transformer will probably be the most expensive part of the circuit) and simplify the construction.

Building the Cable Tester

Building this circuit should present no great difficulties. Very simple components are used. However, the inexperienced builder should take care to

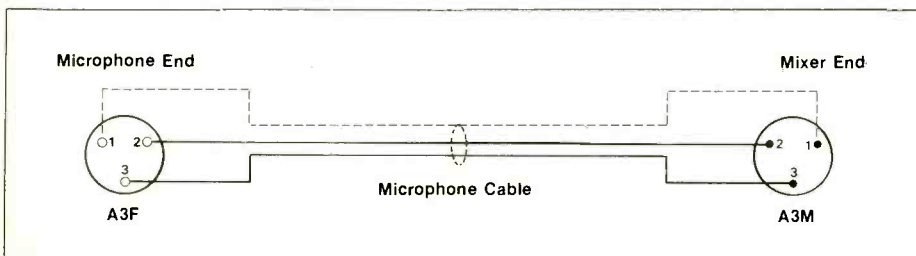

Figure 2

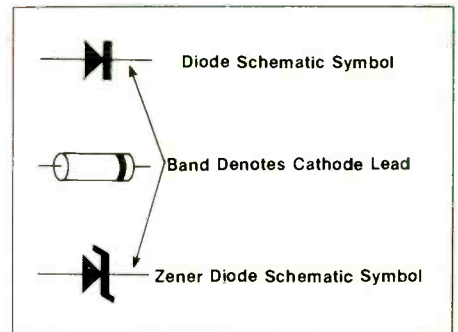

Figure 3A

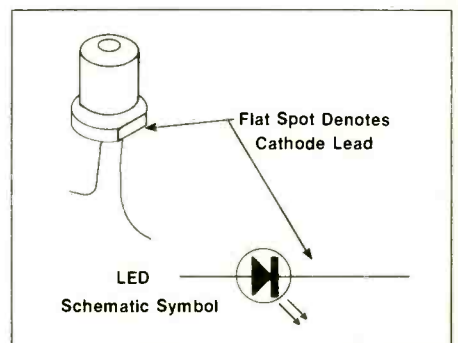

Figure 3B

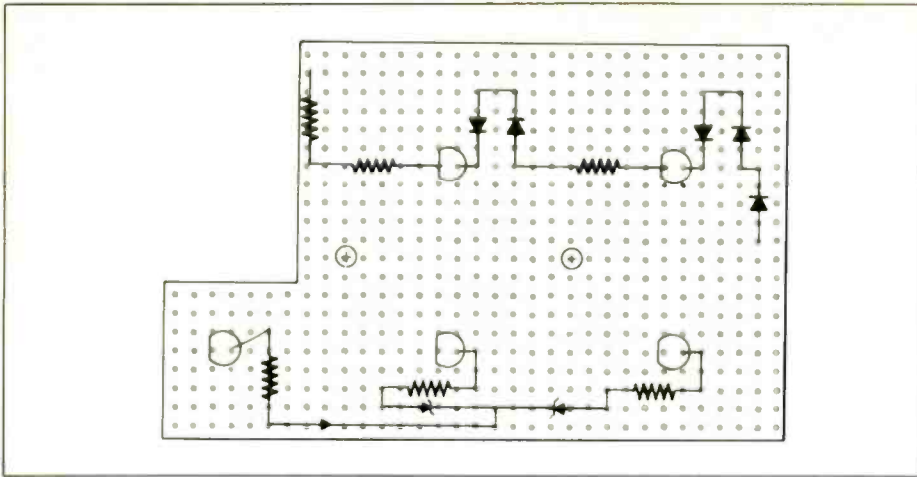

Figure 4A

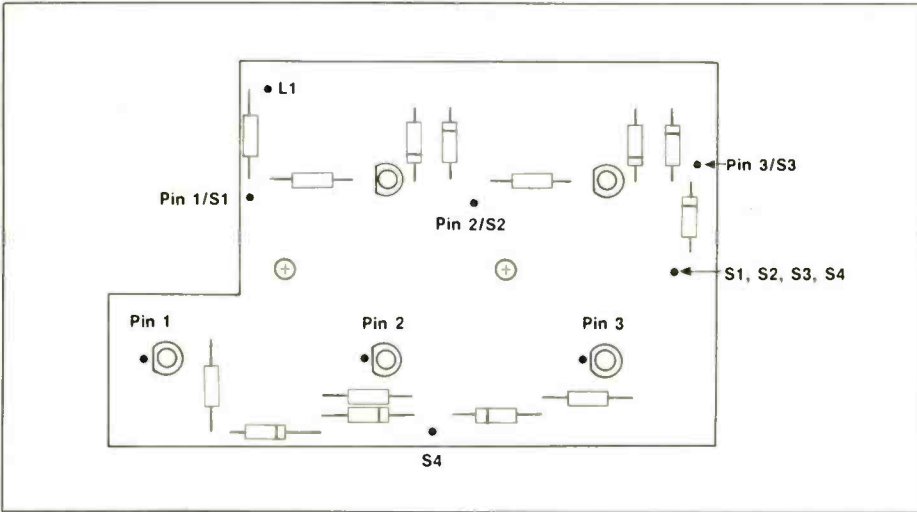

Figure 4B

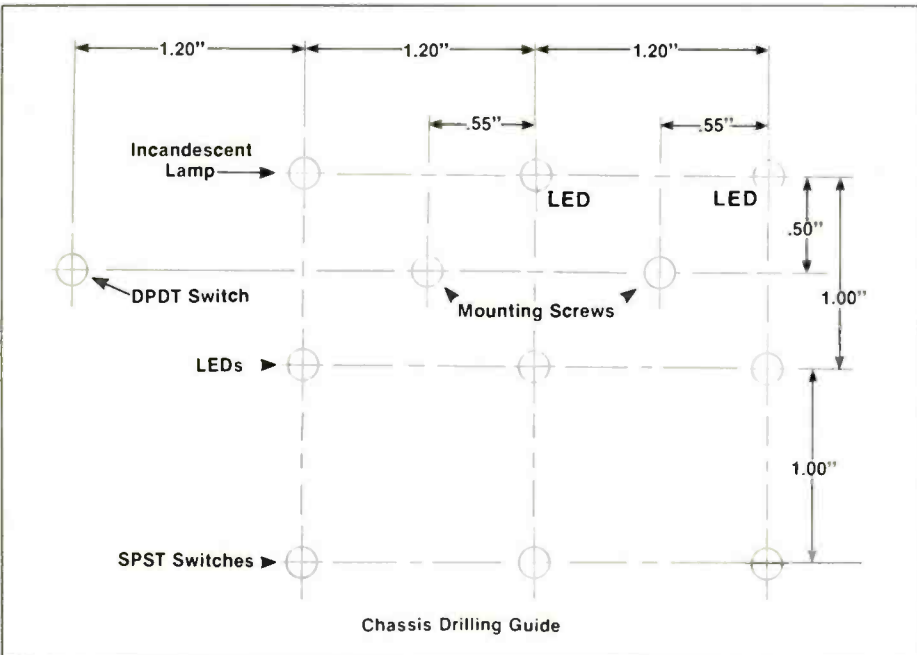
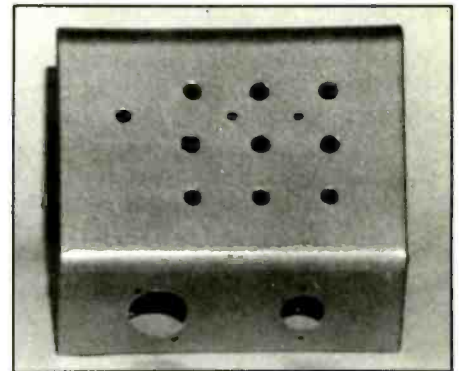

Figure 5

observe the polarity markings on the diodes and the capacitor. The cathode is marked on the diodes by a band around the body which is closer to one end than the other as shown in *Figure 3A*. The LED cathode is determined by the flat area on the rim as shown in *Figure 3B*.

For the sake of simplicity the circuit was built on a piece of vectorboard with holes on a .1 inch x .1 inch grid (see *Photo #1*). All the components are mounted on the vectorboard except the power supply parts, the switches and the incandescent lamp. If the LEDs are mounted on the board as shown in *Figures 4A* and *4B*, the drilling guide, *Figure 5*, can be used to locate hole centers in the chassis (see *Photo #2*). LED mounting clips can be used and wires run to the circuit boards, but be sure to connect them properly, according to polarity.

The power supply can be mounted on the chassis bottom with C1, D1 and R1 mounted on a terminal strip as shown in *Photo #3*. The transformer used here was a Triad #F-216X (12 volt/350 ma). By all means, observe the polarity of C1 and D1. When electrolytic capacitors are reversed they have a tendency to swell and explode. The danger is obvious, so please be meticulous about observing polarity



Unit with holes drilled.

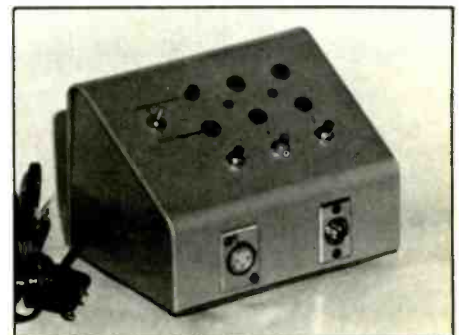

Finished unit.

THE SUPER-BOSE[®] FALL SPECIAL.

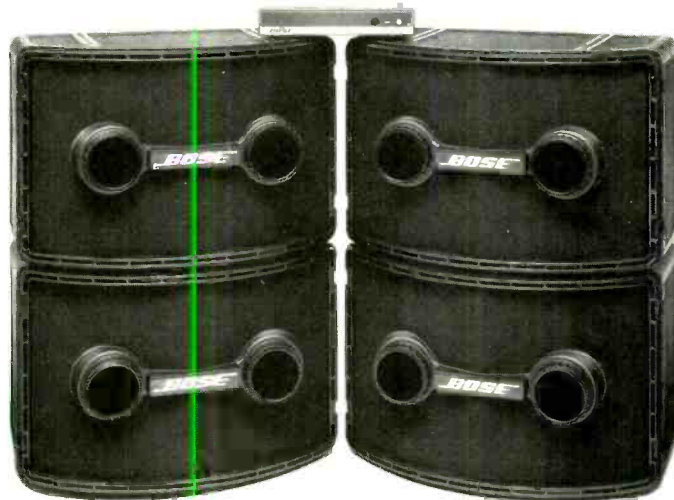

Now is the time to invest in a Super-Bose System. Because if you purchase your System before October 31, we'll send you a coupon worth \$150 towards the purchase of any other products at your authorized Bose Professional Products dealer.

The Super-Bose System consists of two stacked pairs of Bose 802 Loudspeakers with a matched 802-E Active Equalizer. Together, they give you twice the projection and four times the bass of a single pair of 802s. And you get lifelike clarity, exceptional ruggedness and portability unmatched by any conventional speaker system.

Don't miss this chance to get the outstanding performance of stacked Bose 802 speakers *plus* \$150 worth of free merchandise!

Bose Corporation, Dept. MR
The Mountain
Framingham, Massachusetts 01701

Please send me a copy of the Bose Professional Products Catalog and a complete dealer list.

Name _____

Address _____

City _____ State _____ Zip _____

Telephone () _____

BOSE[®]

Better sound through research.

This offer applies only to complete Super-Bose Systems (four 802 speakers with 802-E Equalizer) purchased at participating authorized Bose Professional Products dealers between September 1 and October 31, 1981. All sales subject to verification. Void where prohibited.

Covered by patent rights issued and/or pending. 802 speaker design is a trademark of Bose Corporation. © Copyright 1981 Bose Corporation.

www.americanradiohistory.com

SIMPLIFY YOUR LIFE

ANYONE can now align a tape machine accurately! The Accusonic Tuner, a novel piece of test equipment, allows you to obtain 100% performance from your recorder every day. Perform basic recorder alignment without expensive or complicated test equipment.



Name _____
Address _____
City _____
State _____ Zip _____
Phone _____

Send Free Descriptive Literature
 Send Copy of Owner Manual—\$5.00 each

Sonic Rainbow Labs
112 Space Park Drive • Nashville, Tennessee 37211
(615) 832-2646

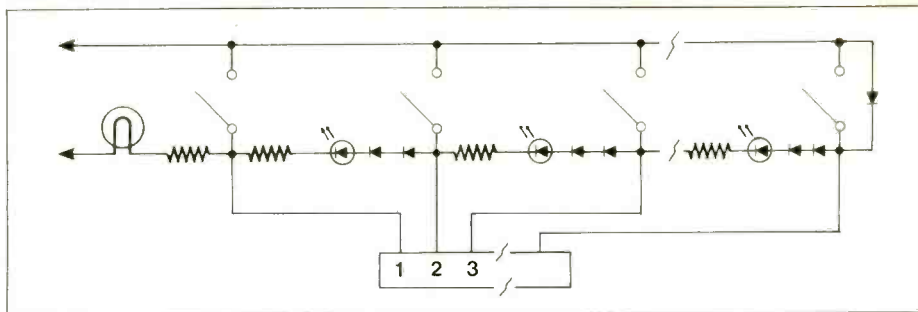

Figure 6

markings on components.

All the parts should be easily obtainable at any electronics parts distributor. This article's cable tester was assembled in a Bud Box #AC1612 which has a sloping front panel. This makes the LEDs clearly visible in a normal work position. S4 should be a DPDT switch preferably with a center-off position.

Checkout and Adjustment

After the circuit is completely wired and mounted you are ready for that moment of truth commonly known as the "Smoke Test." (People in electronics have a bit of warp in their sense of humor due to massive doses of Murphy's Law.) Anyway, if you plug your cable tester in and after a few seconds see no smoke, it has passed the first hurdle. With switch S4 in the center-off position no LEDs should be on. If none are on, connect a known good microphone cable to the tester and proceed. Put S4 in the SHORT position. If the two LEDs light and the incandescent lamp does not light, this is normal so

proceed to the next step. Put S4 in the CONT position. Push S1 and adjust R2 until the #1 continuity LED lights brightly. If you adjust too far, the other continuity LEDs will begin to light. Optimum R2 adjustment is at the point where the faint glow of the unactivated LEDs disappears. Again, if a 15-volt regulated supply is used this adjustment will be unnecessary.

The circuit can be modified to check cables with more conductors if desired (see Figure 6). It is also possible to wire other connectors in parallel with the 3-pin mic connectors, such as phone jacks for checking patchbay cables and guitar cables. Be sure to isolate them from the chassis so both conductors will be checked.

Conclusion

Readers should find this cable checker a very useful device to have around the studio. Anyone involved in P.A. work also will find it most useful. You probably won't use it every day, but it will make cable troubleshooting a pleasure when it is necessary.

PARTS LIST

Part	#	Description
Rs	2	470-ohm 1/2 w resistor
Rc	3	150-ohm 1/2 w resistor
R1	1	68-ohm 1/2 w resistor
R2	1	1 K-ohm trimpot
C1	1	220 uf/25 v electrolytic capacitor
D1	1	1N4002 rectifier diode or equiv.
Ds	5	1N914 signal diode or equiv.
Zc	3	1N4742 12-volt zener diode or equiv.
L1	1	12 volt incandescent lamp
LED	5	Red LEDs
S1,S2,S3	3	Momentary contact SPST switch (normally open)
S4	1	DPDT switch w/center-off position
T1	1	Triad #F-216X 12 v/350 ma
D3M	1	Switchcraft #D3M male mic connector
D3F	1	Switchcraft #D3F female mic connector
MISC.		Bud #AC-1612 chassis Rubber grommets or LED mounting clips Power cord Vectorboard Terminal strip Mounting hardware

THE CHALLENGER: MORE FOR LESS

MCI, the best selling "mid-range" console maker in the United States issued the challenge: "If you can find professional recording equipment that does more for less, buy it." Soundcraft, the best selling mid-range console maker in Europe wants you to accept the challenge.

A lot of people would like you to believe their console will give you all the performance and features of a Neve or SSL for less money. We don't expect you to buy that. But, a Soundcraft console will give you more of the features you want... more quality... more transparent sound... and more reliability than other consoles in our price class. And, in less room and frequently for less money.

The 'top' of the Soundcraft line is the Series 2400 with full automation. The same design philosophy that

went into the 2400 goes into every Soundcraft console. In fact, the same components go in, too. Best of all, every Soundcraft console sounds great because they don't sound at all.

Take the challenge. Work with a Soundcraft. Listen to a Soundcraft. Price a Soundcraft. At one of these selected Series 2400 professional audio dealers:

West Coast: Westlake Audio, Los Angeles

Midwest: AVC Systems, Inc., Minneapolis
Chicago

Rocky Mountain: Barath Acoustics, Inc.,
Denver

Southwest: Abaddon Sun, Inc.,
San Antonio

New England: Lake Systems, Inc., Boston

New York: Harvey Pro Audio

Mid-Atlantic: Audio Innovators, Pittsburgh

Soundcraft, Inc.
20510 Manhattan Place, Suite 120
Torrance, CA 90501
(213) 328-2595

Soundcraft Electronics Limited
5-8 Great Sutton Street
London EC1V 03X England
01-251-3631
Telex: 21198

Soundcraft

THE CHALLENGER

Phi Dudderidge • Graham Blvth

Soundcraft
Series 2400



a session with:

TEDDY PENDERGRASS

By Sam Moses

Sunglasses on and smiling, Teddy Pendergrass walks into the control room of Philadelphia International's "309" studio with a local newspaper folded underarm. This writer has been waiting with producers Kenny Gamble and Leon Huff while a photo session for Pendergrass is being set up in the adjacent studio. Like a proud father showing off snapshots of his child's first steps, Teddy opens his daily paper to a teletyped photograph of himself and a mutually beaming Stevie Wonder. Wonder appeared on stage with Pendergrass in London to the frenzied appreciation of an SRC audience. The mutual smiles are contagious.

Exploring New Directions

In spite of the recording industry's cautious atmosphere—one fearful of departure from high paying formulas—Pendergrass, along with a number of producers (including Kenny Gamble and Leon Huff), is exploring new musical directions on his next album, including a venture into the Country and Western format! Now celebrating ten successful years with Philadelphia International Records, including five consecutive platinum solo albums, Teddy Pendergrass is taking a critical look back and an even sharper assessment of the challenge of the Eighties.

The pressure to achieve successful artistic expression has always been a fire that encourages, but occasionally consumes.

"I look at every album as though it's my first," says Pendergrass "and yet each project is more and more intense because it asks for more. With my first solo album, everyone said I was lucky. With the second and third—they said 'OK.' Eyes opened up on the fourth and after *TP*, now they say I can't do it again." Aside from the fact that each one of Teddy's albums has sold over a million copies, he welcomes the sometimes self-imposed pressure. "The pressure from inside and outside is better for me," he indicates. "If I become too lax, I'll lose the instinct, the killer instinct." There's a no-fun-and-games attitude behind Teddy's grin and all present know it.

Kenny Gamble adds his own positive comments about the pressure. "It's a known fact that the business is competitive," he says, "but we continue to work as we always have, doing the best job we can and as has been proven in the past, we will be successful." As Leon Huff paraphrases, "The pressure is the fire that creates success."

Referring to Gamble and Huff, Teddy continues: "As a result of an upward career shift, we are more critical now. These gentlemen are perfectionists, as I



am. We know that a track is never finished until it's out and even then, you always hear things, but the responsibility for it has to be taken. A 360-degree awareness is required and the only compromises that exist are in working details out together, never in the quality of the product."

Huff adds, "We may sometimes disagree, but our roots are similar and constructive criticism brings about the

behind the sound is too reflective to be ignored. With Pendergrass, Gamble and Huff the feeling is never ignored."

In the Studio

Joe Tarsia admits, "There are times when I almost feel guilty about being paid for engineering these sessions. The excitement and feeling of accomplishment is sometimes satisfying enough." As chief engineer of Sigma Studios in

Philadelphia, Tarsia is experimenting in the recording process of Teddy's album. "With the luxury of forty-eight tracks, I've been exploring stereo miking a little more on this project," he says. "I fill up the tracks quickly with both stereo and mono recording of some instruments, then burning one of the versions as production develops. I've even recorded tambourine in stereo," Tarsia laughs. "The beauty of forty-eight tracks, even in smaller productions, is in the development of truer spatial perspective."

Attached to the ceiling of the "309" studio are large mirrors angled at 45 degrees to which Tarsia had attached pairs of PZM microphones. "There's an unexplainable 'openness' to the PZM's," Tarsia relates. "On occasion, I've taped PZM mics to the corner of two walls, which added a bottom that was lacking in other positions."

The customary lush strings and horns common to Pendergrass' previous albums are being reconsidered. "At one time," Joe Tarsia comments, "I automatically anticipated saving tracks for strings and horns with Teddy's projects, but that practice is being reevaluated." As a result, other instruments have opened up the possibility for exploring different musical formats, for example, the Casio keyboard, a Hammond B-3 organ and an assort-



Teddy Pendergrass (c) with producers Leon Huff and Kenny Gamble going over arrangements for the next album.

better product. Every one of Teddy's songs are composed specifically for him. We'll come up with an idea for him to hear; he'll listen and turn it down [which makes Teddy laugh], so, we go back and write some more."

Although the subject of pressure is being discussed, an impression of a relaxed working process exists and is acknowledged by all three men. Huff states that, "Spontaneity is a great part of our process. A loose, highly creative feeling is needed in the studio. If the feel isn't there or a track doesn't flow, we'll stop and come back another time." Quoting himself, Huff concludes, "Your body won't move, if you can't feel the groove!" Joe Tarsia, the LP's chief engineer, later adds that "The atmosphere is usually organized, but the importance of the *feeling*

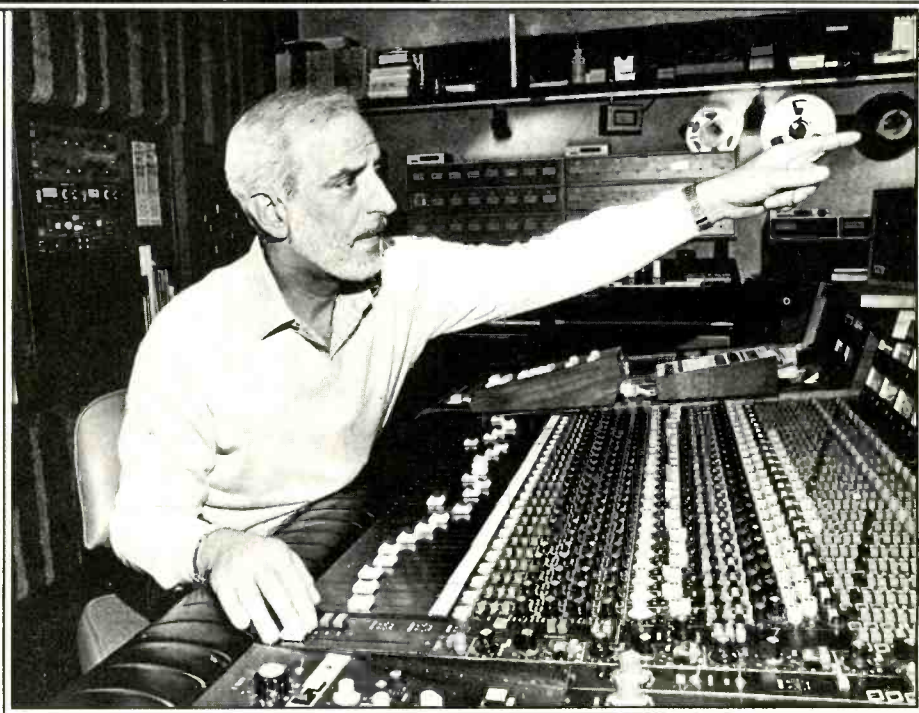

Chief engineer Joe Tarsia seated behind the console in Sigma's "309" studio.

ment of other electronic keyboards are being considered. A self-contained horn section, developed by Huff, has been recorded. Rather than the usual Rhythm and Blues use of guitars, electric guitars with rock orientation are in experimentation. Possibly as a result of Huff's recent visits to a Country and Western club, a dobro has also been used to tape Mr. Pendergrass' next album. In light of format and instrument experimentation, Leon Huff emphasized a "back to basics" approach to the songs and cautioned that "to the uninitiated, Teddy's style wouldn't change radically."

"Neumann U-47 mics with Gainbrain limiting has been the proven standard for recording Pendergrass' vocals," Joe Tarsia comments. "Of course, the register of the song will change equalization needs, but in a close-miked ballad, I roll off 2 dB at 400 Hz for clarity. Teddy's voice tends to record warmly with the 47. So, in order to boost the highs and lows, I subtract a little of the middle," the engineer states. "In addition, Teddy's voice is one of the world's greatest "S" generators, which has caused problems for adding high frequencies. Normally, I wait until mix-down to add a last measure control. In the past, due to sibilance problems, I had to go as far as bringing Teddy's voice back without Dolby, then rolling 10 dB off the top."

Tarsia finds Pendergrass extremely easy to work with in the studio. "Many artists require a completed mix in their headphones, when recording," Tarsia says. "Being a percussionist, Teddy, however, asks for a strong rhythm mix for the feel." In fact, Teddy told me earlier that he has performed as a percussionist on his previous albums, but hadn't asked for credit. Comically, Pendergrass noted, "No credit, please, just the check."

"An attempt is made to keep Teddy's vocal recording punchless," Tarsia says. "Consequently, a number of vocal tracks are recorded, then scrutinized for possible combinations at a later date. The ad libs, which Pendergrass is well known for, are usually added following the formation of a completed vocal track."

Many times, the mixdown process of Teddy's albums, as Tarsia suggests, is left to the engineer's hands and ears alone. After mixing a song, Mr. Tarsia presents the product to Pendergrass and the producers for approval. Because of a relationship spanning

years, Tarsia's knowledge and suggestions are well-received by the artist/producer team. "Not always agreed with, however," Joe Tarsia admits with a laugh. If necessary, changes are made in the mix, the mention of which brings a sparkle to Joe Tarsia's eyes. He expects to mix the newest Pendergrass' product in the soon-to-be-completed "dream" room now being constructed at Sigma Studio's Philadelphia operation. As Tarsia explains, "The abilities of the console will make remixing virtually painless." Tarsia is having, among other recording/mixing delights, the new Sphere console installed in Sigma's new room to his specifications. The Datalog system in the Sphere console will store and return positions of board controls, down to the slightest echo setting. Upon which, Tarsia comments, "If I had my way and was able to call the shots completely, I would mix every record twice. Out of the mixing environment, at my leisure, I make notes on things I like and dislike about a particular mix. Unpressured listening to a tape with the option to go back in and make adjustments should be standard operating procedure." With carpenters and technicians busily working, Tarsia and I visited the new recording/mixing facility that afternoon. The innovations and renovations to the remaining spaces clearly are fanning the same "fires" I'd seen earlier in Pendergrass, Gamble and Huff. The parallel movement of creativity and technology is reflected in their smiles.

In addition to the new facility, Mr. Tarsia voiced excitement for the new Pendergrass product. "The direction

for this project is definitely upward and outward. I believe a wider audience will appreciate the 'new' Pendergrass. Ultimately, no matter how technologically equipped a studio may be, or how proficient the arranger, or credited the producer, the quality that turns a hit into a classic lies within the song."

Looking Ugly

"There's a fine line between 'live' performance and performing in the studio," according to Pendergrass. "Each time I record I look for that small space which allows me to combine 'live' and recorded aspects of my singing. Each time I record, that space becomes easier to find."

For certain songs, Teddy may request a small audience of close friends to create the medium for finding the space where both worlds combine. However, the similarity of past experiences between him and his writers is, usually, incentive enough.

"I saw a photograph of myself while recording, recently, and I looked like I had some kind of disease or something," Pendergrass remembers. "My hands were all curled up. I'm convinced, you can't sing good and be pretty! You gotta get ugly, ugly uglier! The first time Stephanie Mills and I sang 'Feel the Fire,' we were two ugly suckers! The emotional intensity was incredible!"

Barbra and Teddy?

The successful pairing of Teddy and Stephanie Mills should not be expected on Pendergrass' new album, though Teddy is pleased to see a resurgence of

MIC LIST

Room Mic:	Crown PZM (2)
Guitars:	Neumann U47 FET Shure SM57 Direct
Bass:	AKG C14 (overheads)
Drums:	E-V RE-15 (5 rack toms) KM-86 (floor tom) Direct (2, active)
Fender Rhodes (stereo):	U87 (2)
Yamaha Grand:	770X (top)
Hammond B3:	RE-20 (bottom)
Acoustic Guitar:	Beyer M 160
Casio Keyboard:	Direct (in control room)

Guitars utilized Fender Twin Reverb amps and Mesa Boogie amps; bass guitar, Ampeg B-15 amp; organ, Leslie speaker cabinets.

female performers. On the subject of duets, Teddy half-jokingly suggests, "Wouldn't it be great if I was to do a duet with Streisand? Who would you say is left for her to do a duet with?" We tossed the possibility around and Pendergrass concluded, "I'm really serious!"

I Was a Waiter

Teddy Pendergrass stepped into national attention with Harold Melvin and the Blue Notes, recording well-known hits such as "Wake Up, Everybody," "If You Don't Know Me By Now," "The Love I Lost" and

"Bad Luck." Rather than pursue the already well-documented subject of his stint and subsequent break in 1976 with the Blue Notes, we went back further to a time Teddy remembers as his big break.

"Years ago, I worked in a club as a waiter and the band that was scheduled to perform didn't show up. Fortunately, the guys in my group also worked as cooks and busboys at the same club," he recalls. "So, we all got up on stage and sang 'Stay in My Corner' by the Dells. A standing ovation followed and we were on our way. Goodbye busboy!"

In addition to the impact of gospel music on his early years, Teddy Pendergrass speaks of another musical influence on his career. "The powerful lead voice of the Dells' Marvin Junior is still close," says Teddy. "To this day, he calls me 'son' and I call him 'Dad.' Marvin has the most powerful voice I've ever heard. In 1977, I witnessed that man's voice shake the walls of a club over in Jersey. All I could think was 'what is this man doin'!' The influence of black music," he adds, "is wide. Knowing that music belongs to everyone, I find the 'certain sound' of black-influenced music to be more fashionable, now. Although black music has always been fashionable to me, the public awareness is increasing."

The Challenge of the Eighties

The future signals more potential activity than Teddy Pendergrass ever imagined. Return engagements in Europe are on the books. Due to public demand, his recent appearance in London was expanded from one to three sold-out performances. Kenny Gamble insists that, "Soon, they'll have to put Teddy up in the Columbia space shuttle!"

While his next album nears completion, Pendergrass' ability to self-produce is ever increasing. Joe Tarsia remarks: "As reflected in 'Can't We Try' on the last album, Teddy displayed an objectivity in producing, which is rare among self-producing artists." There's that smile again.

The only potential medium Teddy is reluctant to tackle is video recorded concerts. "Music is a social gathering," he comments. "Many are picking up on the money of video discs but I'll be the one you can still see from the front row. My performances are all different, changing as life does. I wouldn't want to be a part of making music move into any type of isolation." He notes, "The experience of playing with Stevie Wonder in London is a major step for me. A moment that can't be captured or that money can't buy.

"At one time," Teddy Pendergrass chooses his words carefully, "I thought I could see my goals. Living day-to-day seems to lead to a successful long term. But now, the possibilities are larger than I can see. I'm aware of the areas in which I'll be moving, but how far, I can't imagine." But the smiles keep growing.

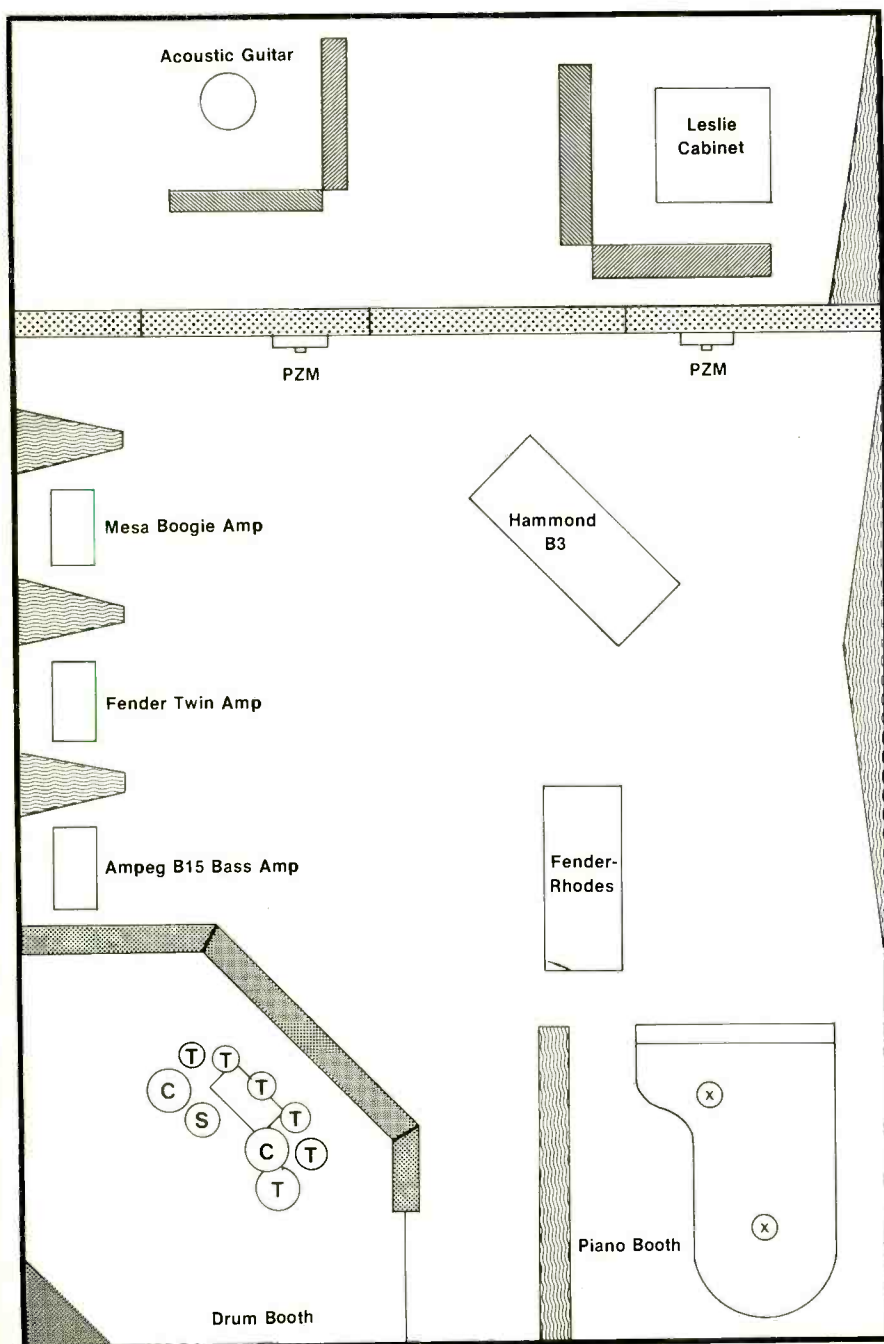

Two delays, one price.

Since flanging and doubling are important effects derived from time delay, we put them both in a single, cost-effective unit and called it the Flanger/Doubler.

As a flanger, the MXR Flanger/Doubler can add a variety of tonal colors and vibratos, from the subtle to the bizarre. As a doubler, it can thicken textures, broaden stereo images, make a single instrument or voice sound like many, and create spatial illusions.

Many time delay devices offer a time delay range that is enormous but impractical for certain applications. You end up paying for effects that are either inaudible, distorted, or extremely difficult to manage in performance.

By incorporating a concentrated time delay range of .25 to 5 milliseconds in its flanging mode and 17.5 to 70 milliseconds in its doubling mode, and by providing a variable sweep speed of .03 to 20 Hz, we've enabled the Flanger/Doubler to offer, without unnecessary expense, a tremendous range of time delay effects that are clean, musical, and expressive.

With the MXR Flanger/Doubler, you can create everything from fast frenetic quivers to slow pulsating throbs, including hard reverb and numerous chorus sounds, without sacrificing sonic integrity.

The Flanger/Doubler switches easily between flanging and doubling modes and provides presetting and LED monitoring of sweep speed and range, so musicians no longer have to hunt for correct flanging and doubling settings during performance. And the MXR Flanger/Doubler is an economical and effective way for engineers to free other delay devices (such as a Digital Delay) for longer time delay functions.

The Flanger/Doubler is designed for use in the studio and on stage, with line or instrument levels. Rugged construction and an optional road case enable it to readily handle the punishments of the road.

Like all MXR products, the Flanger/Doubler has been designed as a practical tool for both musicians and engineers. It has been built with the highest-quality materials and the most advanced American musical technology in order to provide creative artists with the freedom to make original and imaginative statements in today's electronic music. See your MXR dealer.

MXR Innovations, Inc., 740 Driving Park Ave., Rochester, New York 14613, (716) 254-2910

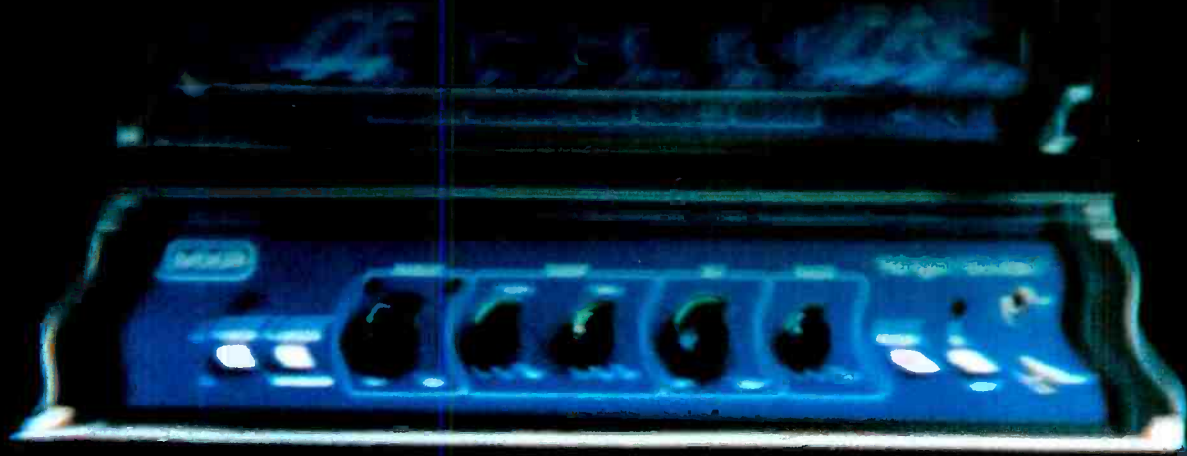

**SUPERB HANDLING.
PERFORMANCE
TO SPARE.**



THE NEW TOA RX-7 SERIES MIXING CONSOLES.

THE NEVER-ENDING CONSOLE RACE.

Year-in, year-out, it seems like there's never any clearcut winner. With dozens to choose from, it's been easy for the sound pro to make the wrong choice.

Until now.

Introducing the new TOA RX-7 Series machines: from 16 to 32 inputs (and anywhere in-between) to 4 or 8 program outputs. The RX-7's are completely modular consoles built to take the bumps along any road they travel. Whether you need an RX-7 for reinforcement or recording, or both—we designed them to be small and agile enough to move-out easily and big enough to handle just about any conceivable fixed or remote sound requirement. They give you incredible flexibility,



RX-5A

RX-6A

If you need a more humble mixer, but don't want to eat the pie, we make a few lower horsepower, two channel economy models patterned on the RX-7 Series.

Tascam—all the rest. We stripped down the look-alikes that think they're in the fast lane. We saw that a sound pro has a slim chance of seeing the winner's circle by spinning-out on yesterday's technology. So at TOA, we started from scratch. And here's why we're so confident:

DRIVER'S EDUCATION.

Because an RX-7 is fully modular, you create the board you need. Start with input modules that feature three band E.Q., two echo and foldback sends, long travel faders, peak indicators, stereo panning—and more. A lot more. Going in, you're transformer isolated via XLR from -60 to +10 dBm; insert any signal processing devices you want in the signal path; and, take a direct out for recording.

Add two foldback and echo return Buss Master modules. For your outputs, add either 2 or 4 modules that feature +4 dBm on XLR's. To complete your board, just plug-in a Phones module, a Talkback module and of course, a Power Supply module. A multipin plug connects the remote power supply unit which also

gives you switchable phantom power for your condensers.

GREAT VISIBILITY.

14 large, illuminated V.U.'s (Model 328) are easily seen as well as accessible on a hinged, low-profile meter pod. Easy to see, easy to use, easy to service.

EVEN A PADDED ARMREST.

And a lot more convenience and useful features make the TOA RX-7 Series the professional mixers that they are: for any critical and demanding sound environment.

THE FASTEST WAY TO SHIFT INTO FIRST GEAR.

Give us a call at (415) 588-2538. We'll rush out all the spec's and the name of your nearest qualified TOA dealer. We're confident you'll want to sit behind the superb handling of an RX-7. The one that has performance to spare—and the serious machines that won't drive you to the poorhouse while you're on your way to the top.



*Crafted in Japan,
Proven in the States.*



TOA Electronics, Inc.
1023 Grandview Drive
S. San Francisco, CA 94080
(415) 588-2538
Telex: 331-332



Every picture tells a story—like these fully professional, and easily accessible back panel interconnections.

copious features and the kind of performance you might expect from a board that can cost up to twice as much. Or more.

SIT BEHIND SOME REAL PERFORMANCE.

Before we engineered the RX-7's we looked at 'em all: Yamaha, Ramsa,

Profile: Producer



RON
MALO

by Tom Lubin

Through his quality work and experience in the recording field, producer/engineer Ron Malo has gained the attention and respect of the recording industry. Mr. Malo has built a number of studios over the years, including the original Motown Hitsville studio, and has engineered and produced albums and singles for Chuck Berry, Bo Diddley, Muddy Waters, the Yardbirds and Weather Report. He also

was involved with the legendary Chess record label during the period of the Rolling Stones' first major hit, "It's All Over Now," which was recorded at the Chess recording studios. Ron Malo has been awarded over 80 gold records for his work, and Modern Recording & Music was happy to be able to sit down and speak to him—and speak he did—despite his obviously busy schedule.

Modern Recording & Music: How did you get involved with recording?

Ron Malo: In 1948 I answered an ad in a little Detroit neighborhood newspaper for a radio repairman. I was just starting in high school. I went

over to the listed address. A handicapped kid needed someone to handle the equipment. He had a little radio repair business.

I got interested in recording and did a lot of records back then. Built a

studio called Esquire Recording Studios. We recorded Skeeter Davis, Eartha Kitt and a lot of national commercials. That was mono—four microphones, no equalization, no limiting, no nothing. However, things moved very

fast in the 60s—two channel, then three channel...Chess was the first studio to have four track. The standard was three track. The four channel was made for the four-track cartridge duplicators, so no one else was really using it in recording studios. It wasn't a standard, but it was around.

MR&M: The industry went to three track because they needed a hard center?

RM: Yeah. That was basically so that they could do a stereo and a mono mix and it would be essentially the same balance. You would do a left-center-right mix on three tracks. You could record a mono mix on one track and have a stereo mix on the other two channels. If you wanted anything in the middle you put up two microphones and you balanced it to get real stereo. You had a lot of leakage, but you didn't worry about separation because nobody said the drums had to be on the drum track. If the drums were on the piano mic, no one cared, as long as the sound was right. You recorded a fifty piece orchestra with some background singers and a lead singer all at the same time. You didn't overdub; you didn't have EQ; and you really didn't have much echo. When we did start using echo, we had separate microphones which were placed in the studio and fed a speaker over in some other room somewhere, or a hallway or a staircase or an elevator shaft, anything that would make echo and that was brought back on the console. You lose one mic pot. You might have to do a forty piece band with three mics or four mics instead of five or six.

MR&M: Talk about those early days at Motown.

RM: It is hard to say what records I did at Motown, since there actually was no Motown then. Motown was a non-entity compared to what it is now.

Berry Gordy was one of the first to do overdubbing. The studio had a four-input console, two quarter-inch Ampex 400s, a disc cutting Lathe, a couple of monitor amplifiers, a patchbay, half-a-dozen different microphones and some microphone cable. That was a \$2,000 investment to build a studio.

The acoustic treatment for the studio was theater drapes. You could buy them cheap. Old, worn out theater drapes that nobody wanted. Just drape them on the walls, and you have high-frequency/low frequency acoustic treating. We are talking about 25 or 30

years ago. The studio was built in '58, '59. Up 'til then, Berry didn't have a studio. He was leasing his records, going to Chicago or New York, or cutting them in Detroit; they were being released on other labels. I think "Money" was on Chess. Wherever he could get a deal. I think the Four Tops original records were with Mercury as the 4 Singing Aces.

MR&M: When did you move to Chess?

RM: In 1959. The original studio was on 63rd and Cottage Grove in Chicago, in the back of a printing shop. It was just a warehouse. They put a window in and built a studio and that is where they cut. When Leonard Chess had his first hit record he made a million dollars and went bankrupt. A hit record was usually the worst thing that could happen to an independent label. A good record was alright, but with a hit record you need to send out records, and distributors don't send you back the payment for those fast enough, and creditors wanted collection so you ended up going bankrupt. I think Leonard went bankrupt twice before he finally got his record company established to where he had the financial solvency and the cash flow to keep it going.

Literally, Leonard went around the country to promote his records. That was the era of the 50s when the independents put their records in the trunks of their cars and drove all around the country. They got their records played and delivered into the record stores in the areas that they could get to. It was mostly Black records and rock 'n' roll; the regular stations wouldn't play them. The only place you could get those records played was on underground stations, and in those days an underground station was Black or foreign language. Pop stations were playing the Lucky Strikes' "Hit Parade." Black records were usually covered by white artists. You had songs such as "Dance With Me Henry," which was originally "Roll With Me Henry." It was converted to clean up the lyrics. A tremendous number of Black records were actually covered, but almost everybody only remembers the cover, not the original Black record, which also was a hit, but only in the Black media.

MR&M: Much has been said about the early Detroit sound. How would you describe it?

RM: The Detroit sound was a condition; not having any proper equipment to make a good record, you created a sound not so different than Gary U.S. Bonds' "Quarter To Three." It was done on an Ampex 600 that had a bad flutter problem. It was cut in his garage. Chuck Berry's "Maybelline" and "Roll Over Beethoven" were cut at the same session with one microphone direct to a mono tape recorder. I mean, *that was the era.*

Larger record companies didn't want anything to do with rock 'n' roll, so you had these little record companies and little back room recording studios with less equipment than the average home recordist has today. The equipment was minimal, so people went in prepared because you knew you couldn't overdub. You did everything "live." You never miked the bass or drums because they were always bleeding all over the place. If you listen to early rock 'n' roll records, you don't hear a definite bass because it was an acoustic bass; you hear a *thud* on the records. And the drums were just leaking into everything, so you never miked them. You would set up a piano mic—because the piano was usually the weakest instrument—and that would pick up the bass, the drums and whatever.

The first hit record that I ever did was "Poor Boy" by the Royaltones, and that essentially was cut with one microphone. That was the beginning of the White teen rock bands. Johnny and the Hurricanes were also in Detroit; I did a couple things with them. We did "Flamingo Express" and "Poor Boy" with the Royaltones with just one microphone to pick up drums and everything else, a mic on the bass and the echo chamber was a hallway. We had another microphone out there in the hallway feeding a P.A. speaker in the hall and a microphone picking that up.

MR&M: What sort of microphones did they use?

RM: Altec 639s. The 639 was the ribbon/dynamic variable pattern mic. Altec ultimately came out with a smaller version of it that didn't work quite as well. RCA had the 77 DX, the junior velocity version of the RCA ribbon mics. They are worth their weight in gold. The 44 was the big one, the 77 DX was the later one.

MR&M: You've also done designs for several studios?

"Larger record companies didn't want anything to do with rock 'n roll..."

RM: Yeah, well...you create by learning. You can go to all the acoustic schools you want to and do everything perfectly by the books and your studio still won't work. Ultimately you have to go in there and fine tune it. I don't think anyone has built a perfect studio yet, except by accident, maybe.

MR&M: Right. There are a few in town here [Los Angeles] that, by accident, sound wonderful.

RM: Chess Records' 2120 South Michigan Studios were built in a standard 20-foot store front. But we needed a stairway, so that meant the studio could only be 15 feet wide. Fortunately it had a high ceiling; acoustically it was a good studio. It had a poured concrete floor over 2 inches of cork—the floor was floating—and multiple Pyro walls.

MR&M: What is a Pyro wall?

RM: Pyro is plaster, if you will. It is hollow poured plaster in 4-inch-thick blocks about 1 foot by 4 feet, or so. You would build two of these walls and separate them by an air space. On the inner surfaces you mounted spring clips and then attached gypsum board to the clips. You then had a spring wall for low-frequency absorption, while on the inner surface you just built some fiberglass traps, or something like that. Most of the RCA studios were built that way. But in California you can't do that. Earthquake requirements won't let you build a structural wall 4 inches thick without steel reinforcing. And if you reinforce the wall, then the wall is useless because it is not going to be a low frequency absorber. Your low frequency transmission loss in a wall is zilch.

The second Chess studio that I built was in the old 3M building, a building which we bought in the mid-60s. We used cinder block then to build all of the studios, with dead air spaces between the walls. We then proceeded to paint the outer surfaces of each of the two walls in order to close the pores, and then what we did was to leave the inner surfaces open. We were able to stagger cinder block walls on angles

so that we had dispersion and diffusion of the sound within the room. We put up some vertical splays because we couldn't lean a cinder block wall. We used 4 by 8 foot wood paneling and bowed it so it made a polycylindrical diffuser in a vertical direction. The ceiling was sprayed with asbestos material like you often see on acoustical ceilings, except we sprayed it four inches thick. It looked like a cave that was dripping downward, but it wasn't going to fall. Essentially we built up a nice porous open surface up there. We also sprayed the air conditioning ducts.

We built five studios in the new building for about \$80,000. We had 18,000 square feet of floor space combined with offices and studios, the big studio was 40 by 50 feet, or so. A lot of the rock 'n' roll acts didn't use any dividers. And all the studios had tile floors because we didn't want dead studios. One of the biggest problems that we have today—and are getting away from it now, you notice—are studios that are too dead. If it is very dead, people have a tendency to play louder and the louder they play the more they saturate the air.

MR&M: You have an interesting awareness of the acoustical evolution of the recording studio.

RM: Well, multi-tracking got to the point of being a crutch. In fact, it still is for some groups. Multi-tracking is great because it gives you flexibility. When the flexibility of recording becomes a crutch for allowing indecision or poor performance or whatever, then you worry that the guitar is only on the guitar track even though he is "live" in the same studio. You might as well build five studios and have each instrument in a separate studio, so that you have a nice, clean, isolated sound. A super dead studio doesn't feel right to a musician and isn't really conducive to performance. You lose all the presence.

We were able, in studio A at Chess, to take a trumpet player and, literally,

have him a foot from the microphone and then back him up the full 40 feet in the studio and just raise the gain. You started to hear some ambiance, but you didn't lose the presence. Forgetting about recording technique and everything, people are rediscovering something that we knew a long time ago—if you want emotional interaction between musicians, they have to record "live."

* * *

MR&M: When did you leave Detroit?

RM: In 1959, when I went to Chess; I was there until 1970. It was the "Chicago Sound." I left there for California when Leonard Chess died. I should have come out to California five years earlier, when I did the Rolling Stones. They came to Chicago because their idols recorded there. Muddy Waters, Bo Diddley and Chuck Berry had been recording at Chess, and they wanted to record where their idols had. At that time who had ever heard of the Rolling Stones or Jeff Beck and the Yardbirds. When the Stones came to the studio I didn't know who they were. They were an English group.

I did the English version of "(I Can't Get No) Satisfaction." The American version was done by Dave Hassenger in California at RCA with Phil Spector. Then the Stones came to Chicago on the same tour and they wanted to recut the British version which they wanted the Chess sound on. So there are, in fact, two versions of "Satisfaction" and I have heard both versions on record. Nobody seems to know which version is which anymore.

MR&M: Can you tell?

RM: Oh, yeah. You can play them side by side and hear the difference. Mine is this very straightforward, very simple five-piece group. The one that Spector did was basically the same tune, performed the same way and everything else, but there is a difference. There is a raw, raunchier sound on the version I did. I did twenty-one sides with the Rolling Stones, but nothing was ever released as an album, though *Between The Buttons* had many of the tunes. They were all singles. "It's All Over Now" was the first hit that they had that I did.

I did two sessions with the Rolling Stones, one year apart. We did thirteen sides in one day when they were on their first tour, and nine sides on the

second tour. They were completed, mixed and out the door with stereo masters, which somebody combined to mono. All the releases of those records are synthesized stereo even though they were originally stereo.

MR&M: So you just mixed them straight to stereo?

RM: No, they were recorded on four track, but the four tracks were cut up and thrown in the wastebasket. In fact, they didn't want me to mix it in stereo because, to quote somebody in the band, "If London Records got a hold of anything they could change, they would try to make it sound like a Mantovani record." London was not willing to release distorted records, so they would try to remix it.

MR&M: Up to that time you had really done a lot of recording with Black acts.

RM: Yes, because Chess was predominantly a Black label. Etta James, Muddy Waters, Chuck Berry, Bo Diddley, Little Walter, Howlin' Wolf, Ramsey Lewis and Ahmad Jamal. We had 175 acts over a period of time on that label.

I also was engineering artists other than those on Chess. I did the Yardbirds' "Shape of Things to Come." They came to me and said, "We want you to do one tune for us. We want you to record it and we will do anything that you say." We did one tune, and I believe it was the only hit record that Jeff Beck ever had with the Yardbirds. It still is a classic. I listen to it and I don't know how we did it. There were no microphones on the guitars. So the only open microphones on the sessions were for the vocalist, drums and piano. I recorded the guitar by putting leads across the speaker terminals so I was getting all of the distortion and sound of the amplifier, but eliminating the speaker and a microphone. I was getting all the noise and distortion and garbage on the amplifier.

On "Shape of Things" Jeff literally took the neck of his guitar and placed it against the speaker board on the little Vox amplifiers that were used. He put the neck of the guitar against it to get that feedback solo. Jeff had little metal funnels that went in front of the speaker so he could control the tone and pitch of the thing; we didn't have phasers or flangers or anything like that. Also, the song was recorded on four track. The drums, the bass and any rhythm instruments were on track

one. Then any melody instruments like a guitar or piano on track two. The vocal or solo went on three. So you had drums and bass on the left side, lead instruments on the right side and the vocals and solos would go center. We didn't worry much about putting the bass and drums in the center, that wasn't primary and we were more concerned about the mono mix. A lot of the stuff we did in stereo was monitored totally in mono; track four would contain a mono mix.

MR&M: So you left Chess in 1970 and came to California to find your fortune and fame?

RM: To find my fortune and fame. When I came out here I worked on "Double Loving" with the Osmond Brothers. Those big hits that Rick Hall did. Rick Hall is an old friend of mine from the Chess days. I did all of his L.A. work. I did the sweetening and mixing on "Baby Don't Get Hooked On Me" with Mac Davis. Rick would cut the tracks in Muscle Shoals and bring them to L.A. In the case of the Osmonds, the records that are out are my 7½ ips rough mixes that were done right after a recording date. There have been quite a few records where that has happened over the years. Weather Report has used a rough mix. In fact, one tune on one of the Weather Report albums has a tune from a cassette.

Sometimes when you start over-producing a mix you lose your initial gut feeling.

* * *

MR&M: Do you think that digital audio in pro audio has come of age?

RM: I believe that eventually everything will be digital and tape will not be the medium. The consoles will be digital. You will convert from analog at the diaphragm directly to digital, and then mix, equalize and process everything digitally. Ultimately, that will happen. Today, I don't think that we are at the point, or we are at the threshold of the point, where the realistic quality of digital recording is that good. Analog tape does something. It smoothes things out. A 30-inch per second tape of a "live" performance sometimes will sound better coming back than what was put in because it has smoothed out some of the irregularities and idiosyncrasies of nature or whatever. Digital seems to exaggerate the idiosyncrasies and makes things harsher, harder and brighter. But ultimately I think everything will be digital.

MR&M: How do you see the role of the engineer and producer?

RM: Up until just recently I engineered a lot of records that I also actually produced, unofficially, and that is not to



Ron Malo, arm in air, with jazz artist Stefano Sabatini (seated at keyboard), Eric Ajaye playing bass, and Carlo Stogel, Sabatini's manager (standing).

slight some of the producers that I have worked with. I like to refer to this as sort of co-production. Production assistance in some cases. There are producers that are making a lot of money, who are very famous, that I have done records for, where I produced the records and they got all the money. I also have worked with some great producers that no way would I ever say that I could come up with some of the stuff that they would.

MR&M: There is a running line about if it is a good record it was a great producer and if it is a bad record it was a lousy engineer.

RM: Sometimes we had hit records in spite of the producers. In spite of the artists in some cases. At Chess, I remember an incident with Chuck Berry. We would do a mix and Chuck would say that was the way he wanted it. He would leave and then Leonard Chess would say, "Ah, he doesn't know what the hell he wants. This is the way to do it," and he would tell us to go ahead and give it a little more here and a little less there. Then, when he would leave I would mix the record and give them all the dubs of my mix, and they would say, "See, I told you that was the way to do it."

MR&M: In the last year or so you have gotten much more involved in production.

RM: Only because I wanted to. My whole concept is that with a given artist, who is self-produced, there has to be someone in that room during the session that is production oriented. The only one left is the engineer because they [the artists] resent record company producers. And as most people know, the engineer probably has more experience producing than most producers. Whether or not the engineer is musically inclined, he has the ears in the room. Therefore, my primary desire is to co-produce with an artist. Get together and work things out.

Even at Chess the whole idea was you had the opportunity to get together with the artist and the songwriters and everyone before the recording session. You determined what they wanted it to sound like *before* you went into the studio. You made suggestions that would help from a technical standpoint to give you more of what you wanted in the end product. I have always tried to do that. I mean, we had control. One is constantly requesting changes so that the total qualities of the recording don't

conflict with each other. You say, well look, let's transpose that and play the same note an octave higher and that will hold in. But when you work ahead of time with the artist you have a chance to tell him what they can do to help you.

When I do things with Jimmy Haskell quite frequently he will ask me, "What do you think we can get away with on this particular project?" We have done an awful lot of hit records with just four violins, or let's see... "Baby Don't Get Hooked On Me"

"I believe that eventually everything will be digital..."

was 4, 1 and 1—four violins, one viola and one cello. No doubling, no nothing. Paul Anka's hit, "Having My Baby," was four, two and one. A very minimal string section, but you listen to that and you are not aware of the small size of the section. It wasn't doubled or delayed or anything. Just straightahead sound with just a little reverb.

Devonshire [recording studios] has probably one of the best echo chambers in town [Los Angeles area]. It has 5500 cubic feet, a tile-lined chamber with two 635 Electro-Voice microphones and a speaker that was built out of whatever parts were available. It sounds good. They have three "live" chambers at Devonshire. One of the few studios that still has them.

MR&M: With the tighter budgets today, do you see the use of an engineer/producer as an economic decision?

RM: Certainly can be. Again, part of what I have been telling people for 15 years is that I can get the session done cheaper and more efficiently and end up with a better product by having that control. If you have an artist who knows what he is doing and has his own material, and an engineer who knows what he is doing, and you put the two together, you can operate extremely ef-

ficiently. Now, if you have an engineer that is more of a flake than some artists, then you have got a problem. Some engineers get off in some area of trying to develop a sound and they forget about the music, but if the combination is working, you can save time. That includes being realistic about the time it takes to do something, being the ears for the artist and realizing when it is good enough. We don't have to create something new. I mean, at some point someone has to make a realistic people decision about what the public would be willing to go along with. If later on it doesn't sound good enough we can go back and do it again, but let's not get hung up spending 40 hours on eight bars of a tune.

I always work in a mixed configuration whenever I can. That way I can maintain my perspective of the finished product all the way through the record process. A record that has one sound in it when you start off may have another sound when you get through. But at least you are hearing it in a realistic perspective with the artist or the producer. Everyone is able to come in and hear a record and say, "Well, we can fix it in a mix." Bullshit. You can't fix it in a mix if it isn't correctly performed. And you can't tell if the performance is correct unless you can hear it in the proper perspective of a mix.

A guitar player can play a note with more emphasis, but there is no way that you can mix it with more emphasis. Raising the note's intensity won't get it. Amplitude is a lot different than when a guitarist picks a string or a drummer hits a drum. Raising the drum level won't make the drum fill sound bigger. You can't raise sonic perspective that way.

In order to get an idea of what a client wants I ask them if they have a favorite record that has the particular sound that they want. It doesn't even have to be the same type of music, just the same sound. Then we play that in the control room so that the artist can hear it on the particular studio's monitor speakers. So now, I know what that sounds like on these speakers, in this room, at that time and on that day, and now we can make our sound sound like that. Remember, though, your mind plays tricks on you. You might say, God there was a great drum sound on Chuck Berry's so and so record, but if you actually got that record out and played it in that studio, you probably would say,

“...if you want emotional interaction between musicians, they have to record “live.”

God that is terrible; that's not what I want.

Recently somebody was saying that there were great drum sounds on Fats Domino's records. I defy you to play a Fats Domino record and tell me you even hear the drums. You hear mostly piano and saxes, and yet people say there are drums on it. I mean, there certainly *are* drums playing, but it is not as your mind remembers. It is good to hear the comparison. That's how I learned to mix—by playing records. I used to go to the radio stations and get the DJ copies of the 78s—which were on vinyl as opposed to the “molded mud”—and I would play those on earphones, then on speakers. I would work at getting my sound as good as the commercial record. And you can't pick off-the-wall records; I picked the popular records of the time.

* * *

MR&M: When you are co-producing and engineering, do you get a percentage for your production as well as your normal engineering fee?

RM: Depending on the engineering... depending upon the deal. If I'm the producer or co-producer I ask for an advance against royalties, a percentage and to be paid as an engineer. I would have to pay an engineer if I were the producer. However, my production fee is usually about half of what a producer who does not engineer would ask for, because he is not getting this hourly fee on the side. It usually averages out to about the same thing; it is a very fair way. I have a set fee that I start with, and sometimes I get a bigger production fee and less on mixer fees or vice versa. For instance, is part of that production fee directly related to, or allocated out of, that production budget? Say it happens to be a \$10,000 advance against royalties. That can be payable and due half before you start and half on delivery of the master. That is one way it works, and that is yours no matter what. When you deliver the masters, even if it is the worst thing in the world, you get that money. That is guaranteed. The percentages certainly are negotiable.

We start at 3½ percent and work around that.

MR&M: Three-and-a-half percent of what?

RM: Well, that is also flexible because 3 percent of wholesale [price] is not three percent of list. If it is 3 percent of the list price, then it is after promotion. The percentages constantly move around. It depends upon what the record company is going to charge back against production budget. Are they going to charge for promotion? Are they going to charge rental of the limousine? Things like that. All of it gets charged into your budget; you have to know all of the possibilities before getting involved.

MR&M: How much do you get involved in picking the tunes?

RM: I like to screen them depending upon the musical styles. When I do jazz albums I obviously have little to do with picking of the tunes. I have a lot to do with how the final tune might sound, but if I am co-producing with an artist then I don't want to interfere with that artist's musical way of doing things. All I want to do is to interpret that music the best way I can—to get across what the artist is trying to say musically. It feels better to me if we do it that way. Can we use a little different sound in the synthesizer or whatever, but always working with the music. Not changing it.

Now, if we are picking tunes together I'll be much closer to the actual selection. A lot of times some artists will bring in a group of tunes that you have no control over. At this point you are hearing it for the first time and some of them are really bad. You are very polite and record them and do the best you can on them, but you concentrate on the important tune. Sometimes you become a psychoanalyst, a psychologist and a therapist in the process of many, many albums. How you approach musicians on the subject of their production is extremely important. How well an engineer works with a particular artist or group depends upon how well he can guess what is going to happen and how he can interpret

what they are saying. So sometimes you are a translator. I mean, music is nothing more than a human interpretation. It is interpreting one person's feelings to a mass audience, and you want to try and do that as successfully as possible, because the idea is making money, not just making records.

Art in its pure form is one thing, but if nobody wants to buy the record then the artist will not be successful. He can be the greatest piccolo player in the world, but if the world doesn't want to listen to his records, for one aesthetic reason or another, then what good is it?

I never let technicalities get in the way. I don't think that an artist should be aware that he is recording. I've seen engineers spend hours getting a drum sound. The drums are not that important to a record. They are important... but they don't warrant that much time. There have been recording sessions where there were eighteen or nineteen microphones on a drum set and considerable time taken to balance them and it's discovered the drummer only plays snare and a high-hat the whole record. Great. I mean that isn't really productive. All I want is for the listener to have an emotional reaction to the music. You may not be copying anything on that record except the “state of mind” of the record—the way that record has been interpreted. Maybe the snare is a little louder than normal, or there is a lot of high-hat and no snare. A big broad sound as opposed to a tight sound...and that is the feeling that you are going for. When someone says he likes the sound of this particular record, it may not be the sound, but the way that it was interpreted. So you go for that.

MR&M: Do you prefer to record “live” as much as possible?

RM: I love “live.” The business needs more “live” performances. I don't necessarily mean “live” in-person, but performing “live” in the studio. I know there is a difference in making a hit record between a mechanically-concocted, layered record and a “live” performance. The odds are in your favor in a “live” performance. For one thing,

"If I am co-producing with an artist I don't want to interfere with that artist's musical way of doing things."

you find out if notes work. It is terrible to be doing string overdubs and discover there is a note played by the guitar that doesn't fit. You made a mistake and you didn't really notice it, and then all of a sudden you put strings on and the chord's wrong. The arranger then has to change the chord to fit. Or you have to go back and replace the guitar.

I have done studio albums that ultimately sounded like "live" albums. We did a "live" Chuck Berry album, and the world didn't know that Chuck Berry was in jail at that time. We actually were releasing previously unreleased tapes that were in the can. Then we thought we'd come up with a remote which would let us release old tunes that were supposedly "live." So I found the original takes with the count-offs and the dumb endings and everything

else, and I cut it all together and created a performance. Then we sweetened it, but the audience sounded phony. However, the Beatles were doing some concerts during the same time period, and the kids were screaming all the way through their concerts. So I used those audience screams, and had a continuous roar during the whole album...at the ends it got real loud. I even had the audience singing with Chuck Berry—if you ride the control along with the words it sounds like the audience's reaction is singing the words.

* * *

MR&M: Chess was very AM oriented. Do you still have that view?

RM: Yes. Most records are made hits by being played on a mono AM radio station. Working for Chess Records we geared the whole sound to making a hit

AM radio record. Leonard Chess' philosophy was that he didn't care what it sounded like when the people got it home. They bought it based on what they heard on the AM radio. If it didn't play well on the record player, it was the record player that was screwed up. As long as it sounded good on the radio; that is very practical advice.

Leonard Chess was a very astute man as far as this business is concerned. He held Chess Records together. When Leonard died, Chess Records ended. There is no Chess Records today. Some of the masters are still floating around, but there is no Chess Records. He was the key element in a very successful one-man corporation. He had good ears; he knew what was commercially successful; and he was able to produce it. He was a good guy. I think that he was shrewd, but I don't think he was

THE WEAK LINKS.

A power amplifier is only as good as its mechanical integrity.

Here, the transformer is mounted outside the chassis. Exposed to knocks and damage. Its rear mounting may cause rack weight imbalance.

The transformer and support bracket here is mounted to the outside cabinet. The transformer is located poorly for direct impact on the cabinet bottom.

Also, it takes 20% more rack space than ours. (Left output module removed to show transformer.)

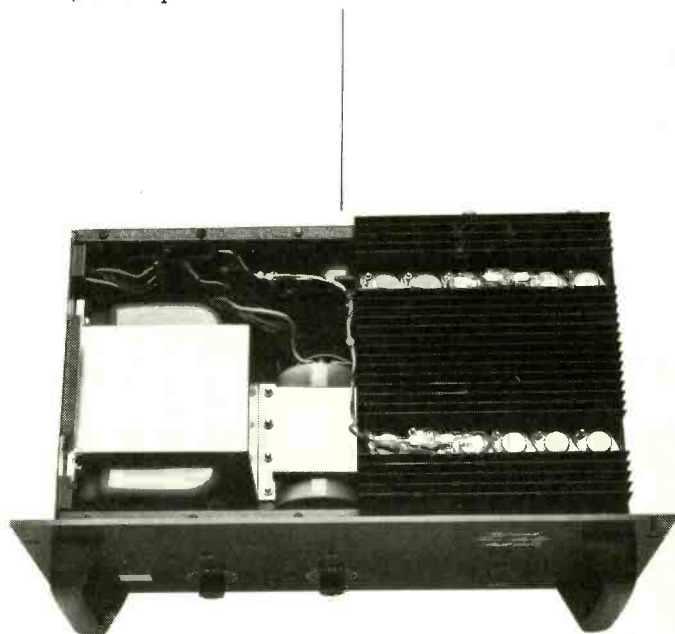
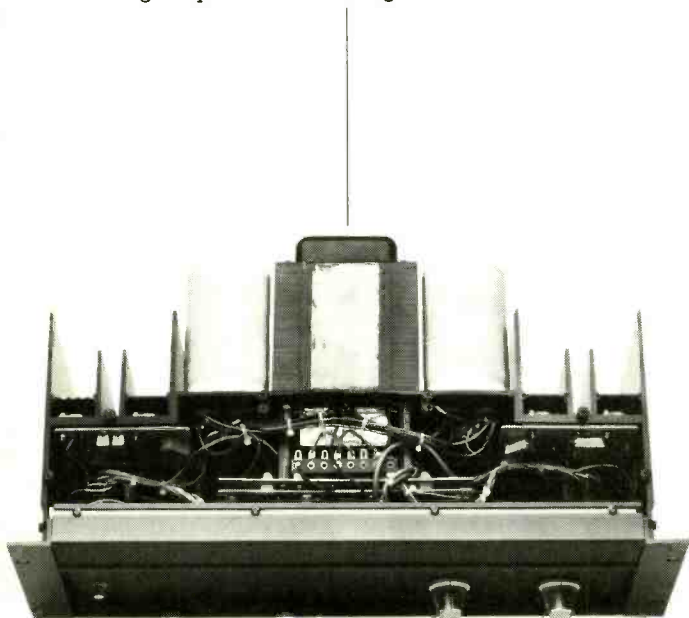

PHASE LINEAR TAKES THE

You can see the advantages of the new Phase Linear A60 and A30 pro amps. Now listen to them. For the name of your nearest

dishonest. In fact, somebody once told me that the best way to get screwed working with Leonard Chess was to ask for a contract and then negotiate it. If you negotiated you'd come out on the short side. His pencil was sharper than yours and he had better control. But if it was an agreement and a handshake you'd probably come out fine.

Today, of course, your contrasts have to be down [in writing]. There are so many outside things involved with contracts today. There are percentages for records, percentages for cassettes, percentages for video use of your recording. Do you have Oriental, Near East, Far East control? Do you have European control? Do you have individual areas of Europe control... tape rights? All of these things are involved in contracts and the percentages are different. Nothing is simple today.

Production budgets have really been cut back. Some groups were really blowing a lot of money in the studio. A lot of albums that cost \$100,000 or \$125,000 were never released. They were not releasable. The group didn't sell any records, so they got dropped and the record company had to eat it. It is cheaper for a record company to can a

record and buy out the contract than to promote the record. You may spend \$100,000 on an album, but it may cost \$250,000 to promote it. We used to be able to record a single for \$2,000 or \$3,000—a big single—but it cost \$6,000 to promote a single. Just to release it. You need disc jockey copies, promotion...and payola or whatever. It is easily \$6,000 to \$10,000 for a \$2,000 or \$3,000 record. So, if a record didn't work, a record company would buy it. They would come out ahead by just paying it off. Or by pressing 400 records, sending them out to the disc jockies and letting it die a slow death. That satisfies the contract; they did release the record.

The artists do the same thing. They have delivered albums to record companies to satisfy a two-record deal knowing that the record company would never release the albums. Go into a demo studio and just cut an album of B-flat blues or something.

MR&M: Just to satisfy the requirement so they can move on to another deal.

RM: Not totally bad albums—good enough that the record company was willing to accept it as a record, but then

the company would realize that it wasn't good enough and kill it.

MR&M: Then it's definitely killed once they jump to another label...?

RM: Yes, if you have to get off the label. You will try and get out of the option. The record company will shelve it because they don't want to release an album when they don't have follow up material available.

A lot of the problems of today's record industry are the result of the increasing number of non-musical people at the companies. The legal department wants to be the tail that wags the dog, and the accounting department wants to wag the production department. That has been going on for a few years. The bigger the company, the harder it is. And usually the least musical person, the one with the worst ears, is usually president. They move people up and make them chairman of the board and things like that. I have seen that happen. Believe me, I have been very close to record companies. I have seen the inside and the outside. That is another advantage for someone who works with me: they buy a production aid that has seen a lot of the business.



Here, the power transformer is bolted directly to the chassis. Every time the chassis takes a knock, so does the transformer.

Also, there are no detachable cords, no flexibility.

A STRONG ARGUMENT FOR PHASE LINEAR.

The new Phase Linear pro amps have a separate structural member designed solely to support and protect the entire assembly from damage. It's a chassis within a chassis. Virtually shockproof. A carefully designed environment for all the electronics your sound depends on.

There are also detachable cords. And die-cast handles.

Phase Linear
The Professional Connection

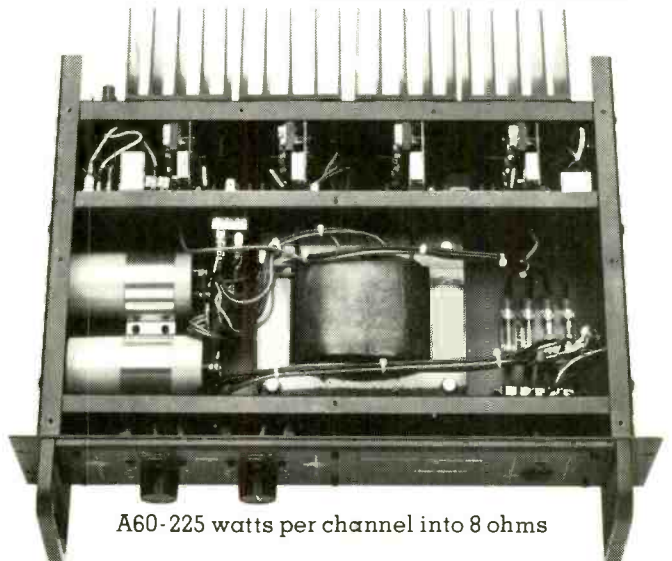
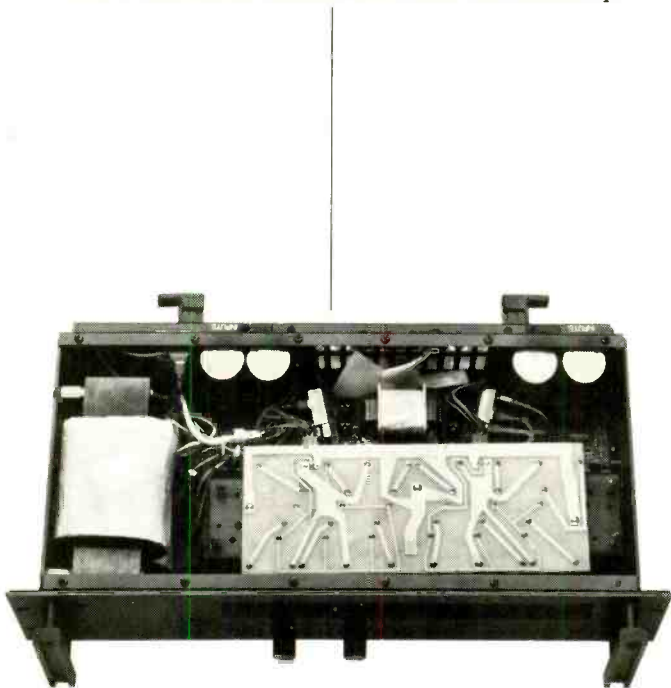

A60- 225 watts per channel into 8 ohms

LID OFF PRO AMPLIFIERS.

dealer, contact Phase Linear at (206) 774-3571, 20121 48th Avenue West, Lynnwood, WA 98036.

CIRCLE 153 ON READER SERVICE CARD

www.americanradiohistory.com

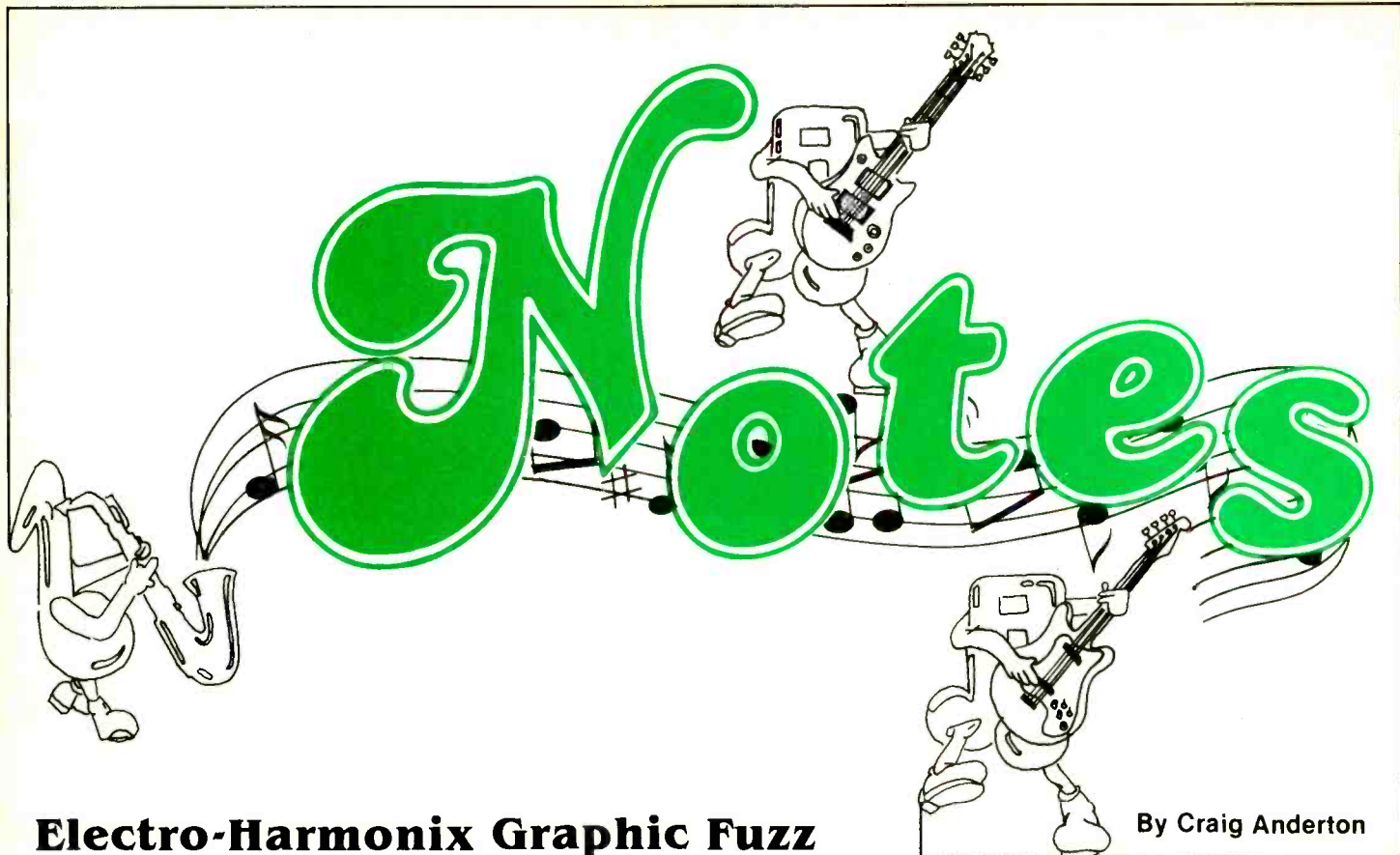

Electro-Harmonix Graphic Fuzz

By Craig Anderton

Considering that commercial fuzz boxes have been around for well over a decade, it's surprising how few musicians I've talked to are really happy with their fuzzes. Most seem to be of the opinion that their fuzz is "OK," but they'd rather be getting the distortion sound associated with a vintage tube amp. As a result, fuzzes are still in a state of evolution. My stab at an improved fuzz used CMOS inverters biased linearly to get a "soft distortion" effect, and this technique was picked up by at least one other manufacturer; MXR, whose "Distortion +" has been one of the industry's best received fuzzes, has brought out a new fuzz which incorporates filter-related controls to modify the basic fuzz sound; and other approaches to the "perfect" fuzz have ranged from slightly eccentric to downright baroque (like lugging around a studio tape recorder because its preamp happens to fuzz in a "nice way").

So why even bother with fuzzes—why doesn't everybody just use an overdriven vintage tube amp? One of the main reasons is volume. With a fuzz, you can get distorted sounds at relatively low levels. A tube amp, on the other hand, might not distort in just the right way until you're blasting the thing at maximum volume, thereby shredding your ears and possibly the speakers at the same time. Another reason for using a fuzz is consistency of sound. As tubes age, their characteristics change; but a solid-state fuzz box always sounds the same from one day to the next (until your batteries start to go, but that's another story). A final reason is flexibility. An overdriven amp might sound exceptionally nice at a certain setting, but it will generally only give one particular sound. A fuzz has additional controls that allow you to tailor the sound a bit more.

Which brings us to the E-H Graphic Fuzz. It seems that

E-H has decided to go the route of maximum flexibility; rather than try to make one sound that will please all guitarists. The Graphic Fuzz includes enough controls and options so that the sound you're looking for is bound to be in there somewhere...it's just a question of figuring out which dials to turn. And what do those dials do, you might ask? Read on for the answer.



WHAT IS IT? The Graphic Fuzz (GF for short) is built in a standard E-H sheet metal box that's the same size (approximately 8 x 6.75 x 1.5 inches) as other boxes in its newest line of effects. Actually, the unit includes two separate effects in one case: a fuzz section with three slide pot controls (overdrive, dynamics and sustain); and a six-stage graphic equalizer (with slide pots located at 125 Hz, 250 Hz, 500 Hz, 1 kHz, 2 kHz and 4 kHz). There's also a master output control, in/out footswitch, LED status indicator, a switch for selecting graphic-only or fuzz-with-graphic when the effect is selected and input/output jacks. The unit is AC powered, with a two-conductor line cord. It has no on-off switch. As a result, this is one unit that would best be plugged into some kind of barrier strip along with other effects; that way, turning off the barrier strip would turn off AC power to all the various effects. The GF lists for \$139.

GRAPHIC FUZZ CONTROLS: Let's consider the fuzz controls first, and then move on to the graphic's controls.

Overdrive is similar to the "attack" or "sensitivity" control found on other fuzzes. The higher you set the slide pot, the "grunchier" the sound. Extreme amounts of overdrive

seem to emphasize the octave-above components of the sound somewhat, which is a phenomenon that also occurs occasionally with other fuzzes.

The *Dynamics* control is basically an envelope follower sensitivity control. For those of you who associate the term "envelope follower" exclusively with filters, remember that any voltage-controlled device may be "envelope followed" and thus be synchronized to your dynamics. In the case of the GF, I assume that there is some kind of voltage controlled amplifier after the fuzz section whose gain corresponds to the amplitude envelope of your guitar. With the dynamics control at minimum, the GF responds like a regular fuzz—namely, whether you play loudly or softly, everything comes out at about the same relative level. Turning up the dynamics control gives an accenting effect, where as you play louder, the overall level gets louder. No matter where you set the dynamics control, however, there is always a certain amount of envelope following. As a result, when you aren't playing, the fuzz quietly shuts down and awaits your next note. This is distinctly unlike most fuzzes that keep putting out noise and hum (and occasionally, local radio stations) when you aren't playing. I feel that this ability to respond dynamically is probably the most important feature of the GF, as the end result is a fuzz that is truly quiet and well-behaved.

However, many guitarists specifically buy a fuzz because they want extra sustain; in other words, they *don't* want the fuzz to follow the dynamics of their playing, but rather, to extend those dynamics to create the desired sustain. Not to worry; the GF includes a *Sustain* control which does just what it says. I assume that this pot boosts the control voltage going into the VCA that follows the fuzz section, thereby keeping the VCA open longer yet still allowing it to shut down when the guitar signal reaches an unuseably low level.

Playing with these controls gives a wide range of dynamic responses to your signal. I can easily imagine jazz players using minimum sustain and maximum dynamics for a punchy, dynamic sound, while rock and rollers might instead bring the dynamics back a touch and boost the sustain to the max.

There is one quirk of the fuzz, however. Envelope followers have an inherent attack time *under certain conditions*, and the envelope follower in the GF is no exception. The only time this is a problem is when the dynamics control is at maximum and there has been a long pause (more than a second or two) between notes. If you play a loud chord right

after the pause, there is a very slight attack time. This problem is not really noticeable with single notes, only with chords. By simply trimming the dynamics control back to about the $\frac{3}{4}$ mark, this quirk will go away and you'll still have plenty of dynamic range.

GRAPHIC EQ CONTROLS: If you've seen a six-stage graphic equalizer before (and I can't imagine someone reading this magazine who hasn't!), then you've seen the GF's graphic EQ section. The only real difference is the inclusion of an output level control and a switch that allows you to select fuzz followed by the graphic, or the graphic alone. This allows the GF to do double-duty as a fuzz or as a graphic. The graphic's resonant frequencies are placed on one octave intervals and are calibrated for a boost/cut of ± 15 dB. However, I wouldn't take those markings too seriously. Which brings us to the next section.

EVALUATING the EQ: First, a little background. Some companies take a very specsman-oriented approach to equipment design—which follows in the footsteps of the hi-fi tradition of emphasizing low distortion, predictable (specifiable) operation and flat frequency response. Other companies, and I feel E-H belongs in this category, seem more concerned with musical effectiveness than specs. For an example that illustrates the difference between these two approaches, a long time ago I was hired by a particular company to design a fuzz for them. I was very careful to work towards a nice, clean, wide-range response, since the company I was working for was fairly specs-conscious. The guy in charge loved the sound, but then he took it around to some musicians and dealers. The verdict: the fuzz was "too bright." So, I changed a couple of compensation capacitors around, and just about killed the high frequencies above 5 kHz. The fuzz was then taken to the same people, and lo and behold, they loved it. This taught me an important lesson: When you're dealing with something as subjective and non-hi-fi as distortion, you have to forget the traditional rules and go for what sounds good rather than what specs out well or follows traditional rules of design.



On a related topic, when I test a device, I always listen to the device *first* before I even turn on my test equipment. That way, I won't be influenced by the specs into hearing something differently from what it really is. For example, if you measure something and you see that the low frequency response is off a little bit, you might start listening for that loss of lows and end up attaching more importance to this phenomenon than you would otherwise. I also begin the testing process by playing guitar or keyboards (which one depends mostly on the nature of the device) rather than putting a sine wave generator through the box, because, after all, very few people play sine wave oscillator for a gig.

The reason for all this preface is that as I played the GF, I really liked the range of sounds I could get out of the graphic in conjunction with the fuzz. In fact, putting the graphic in there really adds a necessary degree of flexibility to the straight sound of a fuzz. Trying the graphic on its own also yielded good results, although there were a few aspects of its sound that didn't seem quite right. So, I then started testing, and was surprised to find out several things.

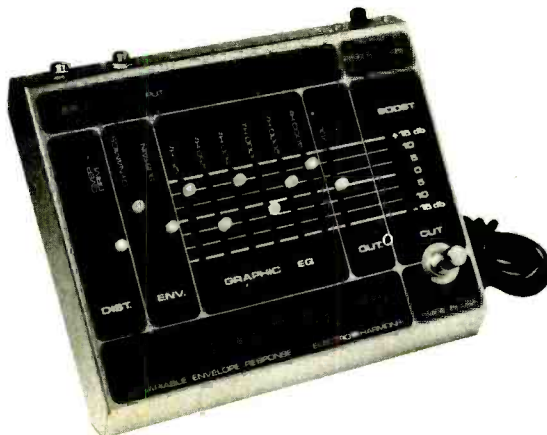

First, the graphic is definitely a non-precision device. Setting all the controls for flat response produced a curve that was far from flat—it was down 6 dB at about 10 kHz and down 12 dB at about 20 kHz. There was also quite a bit of ripple in the lower range of the filter, indicating some overlapping and interreaction between the various controls. To get as flat a response as possible required setting the 1 K slider to +5 dB and the 4 kHz slider all the way up (+15 dB, in theory; more about these calibrations later). This resulted in a response that was virtually flat up until about 10 kHz, finally ending up around -6 dB at 15 kHz (still a bit of high frequency loss).

Except for the 4 K slider, all frequencies were within about 10% of the panel markings, and most were better than 10%. The 4 K slider I couldn't figure out at all; I think it gives more of a shelving response that progressively boosts high frequencies rather than accenting one specific frequency. With all the other sliders at minimum, advancing the 4 kHz slider gave a response hump at about 8 kHz. Also, this slider influenced the response at frequencies which, theoretically, would have been out of its nominal range; none of the other sliders exhibited this peculiarity.

As far as the ± 15 dB markings go, that only applies vaguely to the reality of the situation. Measured amounts of maximum boost/cut with a 2 V peak-to-peak input signal were:

125 Hz: +14.4 dB; -13.5 dB.

250 Hz: +12.6 dB; -14 dB.

500 Hz: +11.8 dB; -14 dB.

1 kHz: +9.8 dB; -14 dB.

2 kHz: +5.1 dB; -18 dB.

4 kHz: Difficult to measure with any degree of certainty.

So, if you're looking for a precision EQ, this is not your baby. But, the qualities that make it imprecise—ripple in the passband and diminished high frequency response—are exactly what make the unit so suitable for use with fuzz. Either the people at E-H sent me a defective unit (in which case they should build all of them this way), or they set about to make a graphic that was specifically designed to make a fuzz sound good. Whichever is the case, the unit I tried certainly had the EQ well-matched to the fuzz.

This is not to imply that the EQ is useless for normal applications; far from it. However, you should be prepared to realize that some of the control markings don't really mean what they say, and act accordingly.

One simple, yet highly useful, control is the master output. While it's surely necessary to have this control with fuzz, it's also useable with the EQ. As a result, if you end up pushing the sliders up for a lot of boost, the output control allows you to trim the overall level back to prevent any signal mismatches.

EVALUATING the FUZZ SOUND: Fuzz sounds are so subjective. Basically, the GF gives a more or less standard semiconductor fuzz sound; overall, I would say that the tone of the fuzz (*without* EQ) is comparable to the sound of other solid-state fuzzes on the market. However, the fact that this basic sound is so alterable via the built-in EQ means that it's possible to obtain just about any type of solid-state fuzz sound desired. I did notice that moving the 125 Hz slider up a bit produced some pretty dissonant low end fuzz sounds, but that's to be expected.

However, the ability to respond dynamically also makes

some timbres available that are quite novel. For example, most fuzzes don't work with chords, right? Well, by setting the distortion control for minimum, dynamics up about $\frac{3}{4}$, and sustain at minimum, chorded riffs (*a la* Keith Richards) come out sounding just fine. Lead lines can also be made more expressive, and the fact that the fuzz unobtrusively decays rather than dissolving into hiss is a real plus.

INSIDE the BOX: It's not hard to get at the insides of the GF once it's unplugged: simply remove the six bottom screws, remove three more Phillips head screws on the top panel that hold the circuit board in place, and pop the knobs off the sliders so that you can push the circuit board away from the case. This gives you access to anywhere in the circuit, so I'd say the GF is pretty easy to service should something go wrong. The parts are reasonably good quality; tantalum and mylar capacitors are used in strategic places, the op amps are Texas Instruments 4558's (along with one of what appears to be some kind of proprietary E-H chip that resembles a CA3080) and the pots look sturdy enough. In short, the insides are typical state-of-the-art for consumer-oriented electronics equipment. That just about covers everything, with the exception of some remaining technical points: the input impedance of the device is about 230 K; the maximum input before distortion starts occurring is about 4 V peak-to-peak; and switching the effect in and out produces no annoying pops or clicks.

OVERALL EVALUATION: Of course, anybody can go out and stick a graphic EQ after a fuzz, but this would not be the same as playing through the GF. As mentioned earlier, the EQ seems specifically designed to work with fuzz, and the ability of the fuzz to respond dynamically is most welcome in light of the current emphasis on expressiveness in musical electronics. Considering that you're also getting AC power, the price of the graphic fuzz certainly seems reasonable. Unless you don't like the sound of the fuzz itself—remember that subjective factor again—the GF represents a very flexible fuzz device.

My biggest problem with the device is that the panel graphics are easily scratched, so if you want to protect your GF's finish, here's a tip. First, remove the screws, knobs, and circuit board as described earlier, then unscrew the footswitch and push it away from the top panel. Cut a piece of clear contact paper (well, contact *plastic* actually) large enough to cover the top panel, and put it in place starting at the left hand side of the panel.

Another somewhat minor complaint (which applies to numerous other boxes) is that the footswitch is held in place with only a nut, and no lockwasher. I've seen lots of effects with loose footswitches, and simply adding a lockwasher would correct that problem.

If you think I'm reaching for complaints, you just may be right; I found very little to dislike about the GF. I'll admit to being kind of disappointed when I first got the thing to review—"Gee, a fuzz...too bad I didn't get something more exciting to play with"—but when I actually sat down and played through the box, I really had a good time. For me, that says something about a box, especially one as common as a fuzz. If you're interested in trading up to one of the new fuzzes on the block, check out the GF—it's unique and it's fun.

CIRCLE 16 ON READER SERVICE CARD



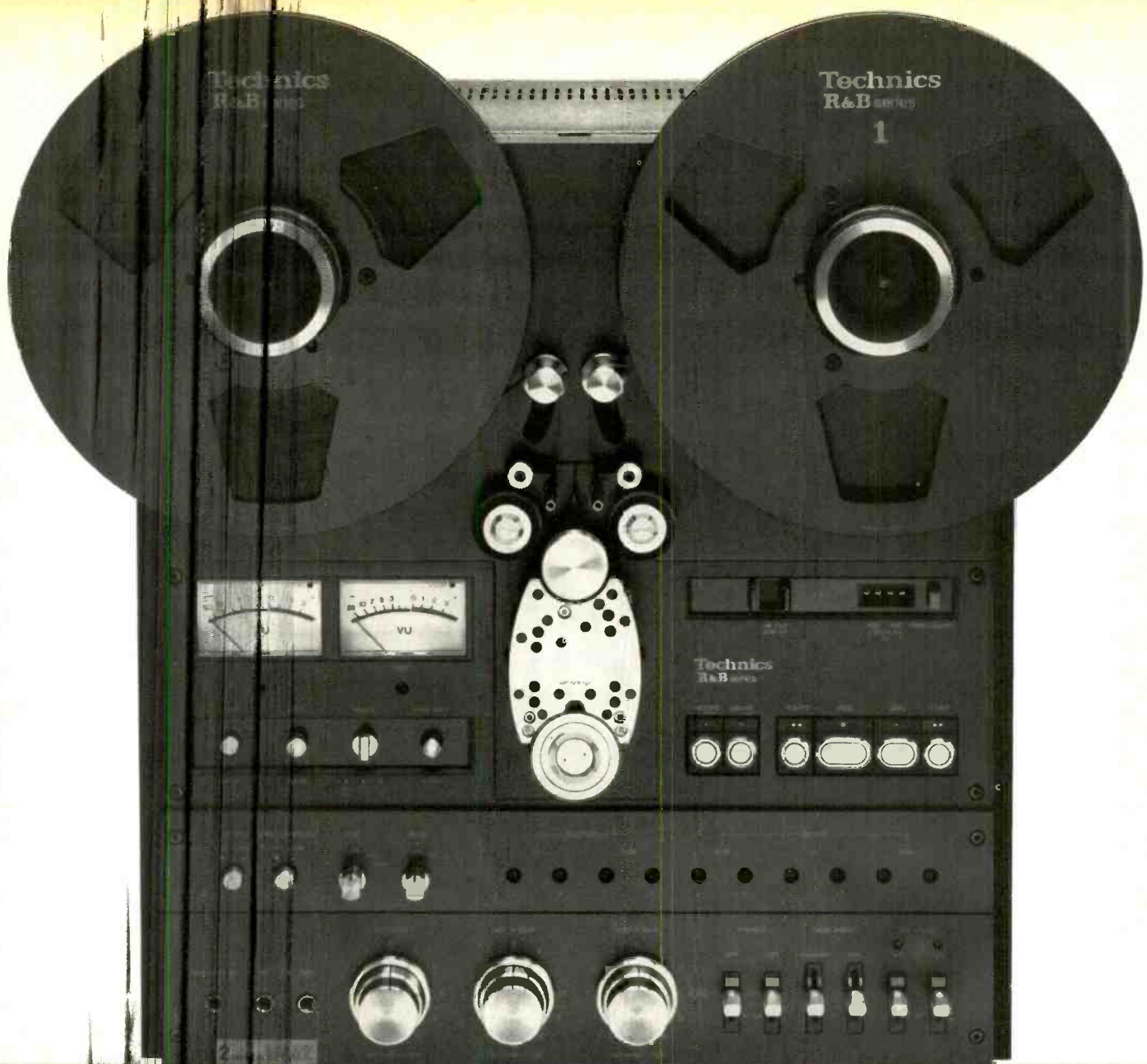

The technology that made Technics turntables the No.1 choice will make this Technics deck your No.1 choice.

You'll choose Technics RS-10A02 tape deck for the same reason 85 of the top 100 radio stations choose Technics turntables: The performance and reliability of Technics' quartz-locked direct drive.

Like our turntables, the RS-10A02 gives you the precision of a quartz-locked direct-drive motor. But you also get Technics' isolated loop tape transport system which optimizes tape tension to virtually eliminate signal dropout while reducing modulation noise and wow and flutter.

Studio pros will appreciate the RS-10A02's full complement of ten front-panel controls. Like playback and recording EQ adjustments, bias controls, and playback and recording level calibrators. When used with the built-in test-tone oscillator, these controls will give you optimum recording performance no matter what kind of tape you use.

The RS-10A02 also has extremely durable SX Sendust heads, IC logic controls and just about everything else you could want in a professional 2-track deck.

So before you buy any reel-to-reel deck, audition the RS-10A02 and see why it's your No. 1 choice.

For more information on the Technics R&B Series, call 201-346-7470.

CIRCLE 93 ON READER SERVICE CARD

Technics
R&B series

Ambient Sound

BY LEN FELDMAN

Getting Ready for Digital Audio Discs

Until now, everything I've been telling you about the possibilities for audio discs—the timing, the technology and even possible pricing—has been gleaned from bits and pieces which we of the audio world have had to put together from overly optimistic business journal reports, company press releases (with lots of axes to grind) and general industry rumor mills. Late in May, just before we went off to Chicago for yet another CES show (about which I'll have more to say in my next "Ambient Sound" column), a joint press conference took place in New York in which a great many questions about the future of digital audio were answered, with only a very few remaining unanswered.

The press conference was jointly sponsored by Sony Corporation and North American Philips Corporation, and the spokesmen for these two prestigious firms were none other than Mr. Akio Morita (a founder and now Board Chairman of Sony) and Mr. Frank L. Randall, Jr., Vice Chairman of North American Philips. If my earlier columns on the subject of digital audio disc standardization seemed to vacillate between favoring a totally dedicated digital audio disc and one that can be played on a video disc player, let me state, here and now, that I think the dedicated, digital audio disc is going to win, hands down. More specifically, I am now convinced that the disc that was introduced to the press of this country in late May by Sony and Philips and is called the Compact Digital Audio Disc is going to become a world standard within the next decade.

In his remarks to the press, Mr. Morita pointed out that ever since the invention of the phonograph cylinder recording by Edison way back in 1877, there has been a major breakthrough approximately every twenty years. Among these major innovations have been the transition from the cylinder to the flat, 78 rpm shellac disc; the change from acoustic recording to electrical recording and reproduction; the development of the microgroove LP record; the transition from monophonic record to stereophonic recordings; and most recently, the digital mastering of tapes for use in making high-quality sound recordings. I haven't bothered to figure out whether we are at a twenty-year point again, but the sound demonstrations that I heard

at that press conference told me that what I was listening to was the most significant advance in recorded sound since the whole thing began in 1877.

Here was a disc which measured 12 centimeters in diameter—approximately $3\frac{3}{4}$ inches—with enormous digital storage capacity. One side of this new Compact Disc will contain enough stereo sound information for a full hour of uninterrupted playing time. In digital recording, of course, the original sound wave-form will be sampled at an agreed-upon rate of 44.1 thousand times per second, and samples will be quantized and converted into 16-bit "words" using Pulse Code Modulation (PCM). An hour's worth of recording is made up of six *billion* bits, linearly encoded along a helical track of "pits" (which measure about 0.6 microns in width and about 0.2 microns deep) and flats. These pits and flats represent "1s" and "0s" in binary computer language.

A solid-state laser pickup will scan the sequence of pits and flats. Scanning rate is around 4.3 million bits per second. Since there will be no contact between the pickup and the disc surface, record wear is effectively eliminated and discs should last indefinitely. The compact disc rotates *counterclockwise* and is played from the inside outward. Furthermore, disc rotation speed is variable (so as to keep *linear* scanning speed constant) and ranges from around 200 rpm near the outer edge of the disc to about 500 rpm near the center of the disc. Theoretically, the Compact Disc may be recorded on both sides, for a total of two hours playing time. It can even support 4-channel recordings, though playing time would necessarily be cut in half if quad "returns."

Now that Sony and Philips have pretty well described how the disc works, here's the kind of performance it will deliver. Frequency response will be ruler-flat from 20 Hz to 20,000 Hz. Signal-to-noise ratio, dynamic range and even stereo channel separation will all be in excess of 90 dB! Harmonic distortion will be less than 0.05%, while wow-and-flutter will be unmeasurable. Digital audio is subject to errors caused by dropouts or inability of the reader or scanning device to catch every single "bit" that makes up the "words" stored in the recording medium, be it tape or

discs. In the case of the new Compact Digital Audio disc championed by Sony and Philips, a remarkably efficient correction code (Sony's major contribution to the disc which was originally developed by Philips) known as CIRC (Cross Interleave Reed-Solomon Code) is capable of correcting a burst error as great as 3,548 "bits," or 2.38 millimeters of laser linear tracking distance. Errors greater than this, but less than 14,000 bits in length can be compensated for by means of linear interpolation.

Towards a New World Standard

While other competing digital audio disc systems may well make an appearance on the marketplace in the near future (in particular, JVC has announced its intention to produce discs using its AHD capacitance pickup system—the same system used in its VHD Videodisc System which will also be introduced later this year or early in 1982) the advantages inherent in the Compact Digital Audio Disc have prompted many companies to come out in favor of the Sony-Philips disc format. Among those who have indicated their intention to back this disc are Bang & Olufsen, CBS/Sony (no great surprise), Crown, Dual, Matsushita, Nakamichi, Nippon Columbia, Onkyo, Polygram, Studer/Revox, Thomson and Trio Kenwood. By the time you read this—and other firms have had a chance to review the merits of the system—there will be more firms committed to the Compact Digital Audio Disc.

Another element which bodes well for the possible standardization of the Compact DAD is the recognition by both Sony and Philips that a new type of playback system with no software to be played back has little chance of success. Accordingly, both companies have been actively engaged in the development of software programs for the new system. In Europe, the well known Polygram group of recording companies plans to release a variety of discs at the same time that the players become available. Similarly, in Japan, where Sony will first market its DAD players, CBS/Sony, the largest record company in Japan, plans to have 100 album titles ready when the players hit the market in the autumn of 1982.

As for marketing in the U.S., distribution here will probably begin shortly after distribution is established in their home territories. That suggests early 1983 as

the earliest date that we can expect the American phase of the audio revolution to begin.

How Much Will It All Cost

We still cannot quote a suggested retail price to you for the DAD player. About the best we can tell you is that the new player (which could easily be adapted to a form suitable for use in a moving vehicle) is expected to cost "no more than a high-quality audiophile analog turntable system with cartridge." That, I suppose, could mean anything from about \$500 up! Information regarding the possible price for Compact Digital Audio Discs was a bit more definite. It was suggested that a disc will cost about as much as a present day audiophile (direct-to-disc or digitally mastered) analog vinyl LP costs today, but that as mass production and high volume demand takes over, prices for discs could come down substantially. If nothing else, material costs will certainly be lower, since the disc contains about one-seventh the volume of material as a conventional 12-inch LP!

One last point which I've overlooked in my enthusiasm over the actual sound quality delivered by this disc. The data storage capacity of the Compact Disc is actually much greater than is needed to record an hour of music per side. This additional capacity allows the Compact Digital Disc system to offer many additional programming and convenience features. For example, number, length, titles and even texts of songs could be encoded for print-out on an associated luminescent display or on a TV monitoring screen. It will be possible to play individual selections in any desired sequence, to skip certain songs or repeat others at the touch of a button. The Compact Disc, in addition to its sonic virtues, provides enormous latitude and flexibility for imaginative audio equipment designers in the future, and I suspect that we will see everything from a very "basic" Compact DAD player, to very elaborate models with all sorts of programming capabilities and readout displays.

Technically speaking, an important breakthrough in the whole system has been the development of low-power, solid-state, laser units which are such a vital part of this record playing system. Earlier conventional lasers were much costlier and more difficult to work with in a system of this kind. Fortunately, too, for this new system, recording artists have been making their master tapes on digital studio equipment for some time now, so there is an ample supply of master tapes that are suitable for making software per the new digital disc format. In short, everything seems right for the introduction and speedy acceptance of this latest breakthrough in sound recording. Mr. Morita of Sony believes that ultimately the familiar LP record will be completely replaced by the new Compact Digital Disc. I'm not quite that optimistic. I think that LPs and Compact Discs may coexist for a long time, but someday we'll think of the 12-inch LP in much the same way that we look upon old shellac 78s today—with just a bit of disdain and a measure of nostalgia.



Sony's prototype Compact Digital Disc Player with disc in place (pictured here next to a conventional LP for size comparison purposes).

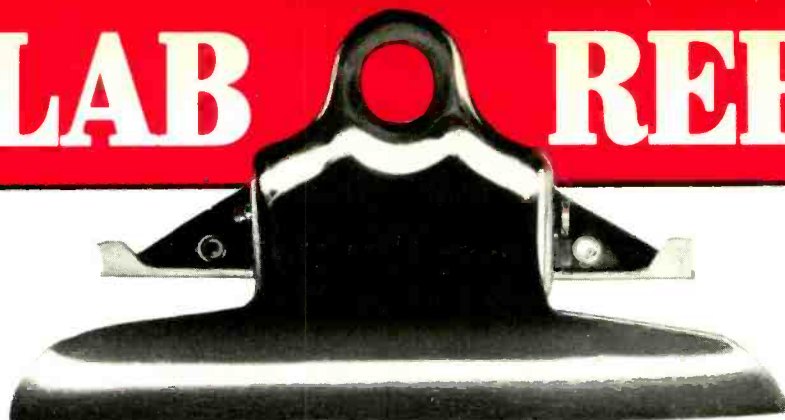

NORMAN EISENBERG AND LEN FELDMAN

Hitachi D-1100M Cassette Recorder



General Description: The Hitachi D-1100M is a three-head cassette recorder, with the record and play heads electrically separate but sharing a common housing. The transport uses two motors and a dual capstan system. Logic-control feather-touch transport buttons permit fast buttoning to and from all modes, including going into record from play or either fast-wind mode. The deck is equipped with a microprocessor which may be used to automatically set the bias, equalization, and recording level for any tape, as selected on the four-position switch (ferric-oxide; chromium dioxide; ferrichrome; metal). Known here as ATRS (for automatic tape response system), this option may be bypassed if desired. The built-in computer also handles the memory/rewind feature as well as an automatic rewind at the end of a tape. Another option provided by the computer is automatic recording mute whereby it is possible to introduce a non-signal mode for approximately four seconds, when desired. Unattended record and play are possible via an external timer, and remote control is available with the use of an optional accessory. The built-in Dolby-B system operates on both

record and play (monitor) simultaneously ("double Dolby"), and it has a MPX filter option. Signal metering is done on a two-color horizontal bar graph (one per channel) that shows peak levels, and is equipped with a peak-hold switch. Calibration across the sixteen bars on each graph runs from -30 to $+10$ dB.

The deck is laid out in conventional fashion, with all controls and features logically placed and clearly marked. The cassette door contains a large transparent panel which may be removed for cleaning heads and so on. To the left are the power off/on switch, the timer switch, an output level control, and a headphone jack. The output level control handles playback volume through the headphone jack and the line-out jacks at the rear.

To the right is the large meter panel. Above it are the buttons to select ATRS or "fixed" (ATRS is bypassed), and an ATRS function indicator. To the right of the meter panel is the peak-hold switch.

Below the meters are the tape index counter and its reset button, the eject button, and the transport controls. The group includes buttons for rewind, play, fast-

forward, record, pause, record mute, and stop. When the record and pause buttons are pressed simultaneously, the deck is placed in standby to enable setting recording levels by monitoring the source on the meters. Just below the stop button are the auto/memory rewind switches. To the right are the tape selector and the Dolby selector. Just above the Dolby switch is the tape/source monitor selector. At the far right of the panel are the controls for recording level (concentric and handling each channel separately); the input selector (mic or line), and two mic input jacks.

Line in and line out jacks are at the rear along with the remote-control socket and the deck's AC power cord. The Hitachi D-1100M comes in a metal case finished in soft brown matte and fitted with small feet.

Test Results: On most counts, the Hitachi D-1100M confirmed published specs, providing fine performance for all three tapes with which it was tested (normal bias, high bias, and metal), although there is no unequivocal verdict here for any one kind of tape. For instance, its response exceeded the 20-kHz mark with metal tape, but it also had the highest distortion with metal tape. At that, the rise in HD was not so much as to cause alarm. Signal-to-noise without Dolby was almost a standoff between normal bias and metal tape; with Dolby, S/N became definitely best for metal tape although still under spec.

Plots of frequency response (for the entire record/play cycle) are shown in *Figs. 1, 2, and 3*. Upper traces show response at "0 dB" record level (for this machine,

0 dB equals 200 nWb/m). Lower traces depict the response at -20 dB below that level. We used TDK AD and SA respectively for normal and high bias settings, and Fuji metal for the metal position. In *Figs. 1, 2, and 3* we allowed the machine's ATRS to adjust parameters automatically. While results for ferric and metal samples were better than claimed, the SA tape came up a bit short at the high end, but not seriously so.

Figs. 4, 5, and 6 are plots of third-order distortion

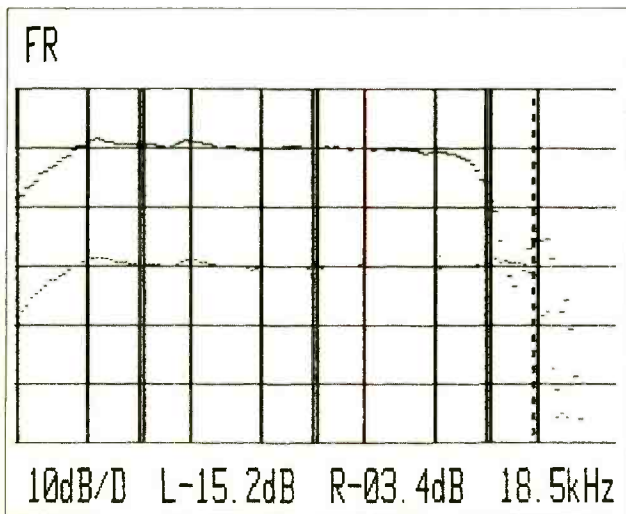

Fig. 1: Hitachi D-1100M: Record/play frequency response, at 0 dB and -20 dB, TDK-AD tape.

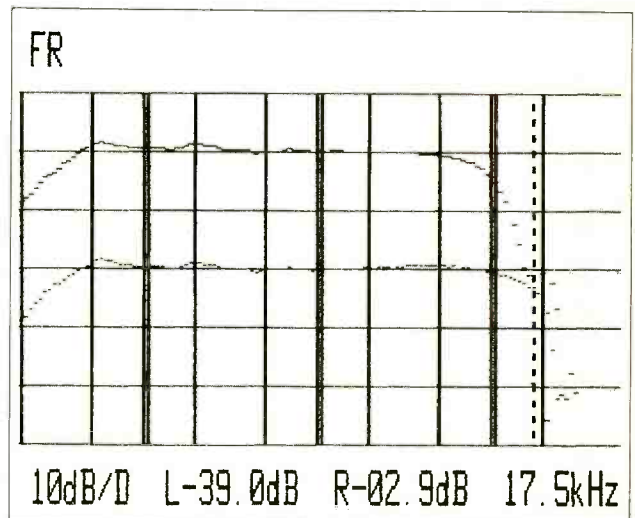

Fig. 2: Hitachi D-1100M: Record/play frequency response, 0 dB and -20 dB, TDK-SA tape.

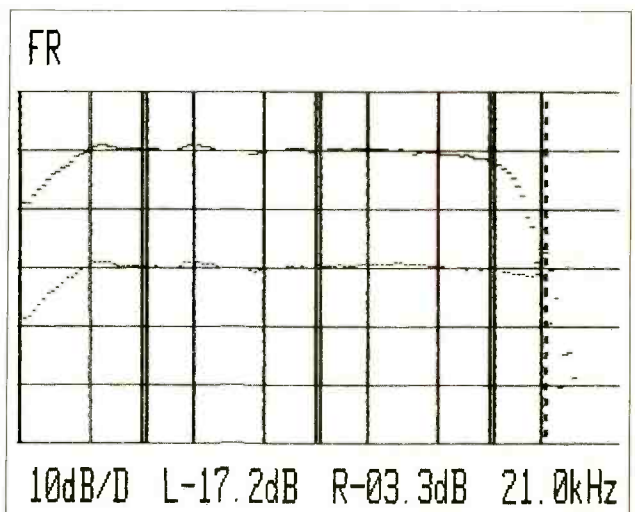

Fig. 3: Hitachi D-1100M: Record/play frequency response, 0 dB and -20 dB, Fuji metal tape.

versus record level. In each of these plots, the dotted line "cursor" has been set to show the headroom available for a distortion level of approximately 3 percent. The ATRS obviously adjusts bias so that this headroom remains fairly constant, regardless of tape type, at a level between +4 and +5 dB. Third-order distortion at 0-dB record level for all three tape types is listed in the "Vital Statistics" chart.

As an experiment, we decided to see whether frequency response would change for one of the tape samples if we used the "fixed" mode instead of the ATRS. Results of this comparison are shown in the two plots of Fig. 7. The upper response curve (L), obtained in the "fixed" mode, actually did a bit better at the

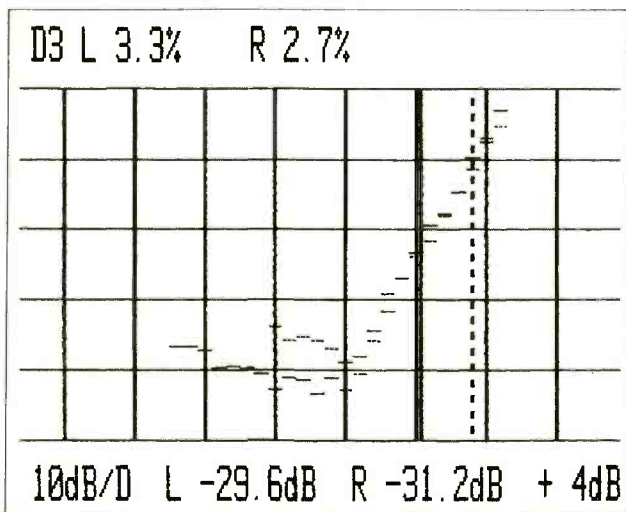

Fig. 4: Hitachi D-1100M: Third-order distortion versus record level, TDK-AD tape.

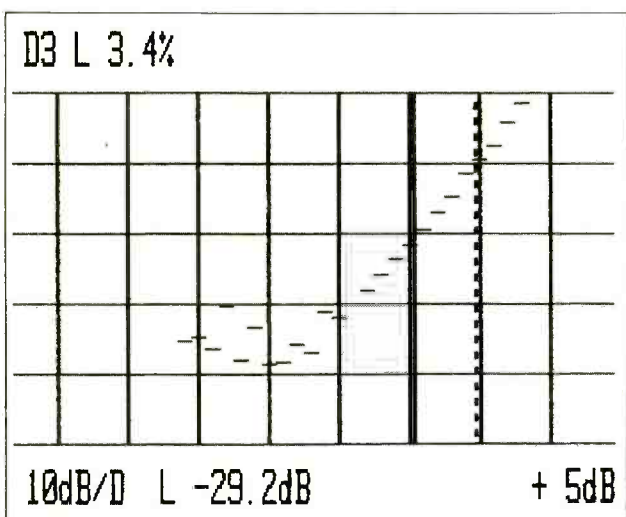

Fig. 5: Hitachi D-1100M: Third-order distortion versus record level, TDK-SA tape.

high end. In all fairness, however, we must quickly add that without ATRS the S/N ratio was decreased by 2 dB (54.5 instead of 56.5 dB without Dolby). Thus, as we have said many times in the past, it all depends on which parameters are deemed most important by an individual user. In general, the microprocessor-controlled ATRS did favor the best S/N and lower distortion—a wise choice in our view.

Fig. 8 shows another double plot of frequency response—this time with and without Dolby—made in order to determine how well the Dolby calibration is adjusted with respect to the ATRS. As can be seen from the two curves, calibration is excellent, with differences in response at the high end coming to no more than 0.2 dB between the Dolby on and Dolby off curves.

Playback-only response is shown in Fig. 9, measured with our standard 120-microsecond test tape. Fig. 10 is a plot of speed accuracy (deviation from 1 7/8 ips). The plot is of time (horizontal axis) versus speed error. Each vertical line represents a time span of 1 second. With line voltage set at a nominal 120 volts for the first three minutes, speed accuracy of the Hitachi D-1100M was better than for any deck we have ever measured, averaging +0.03 percent. At the 140-second point, where the cursor was stopped, speed actually was perfect, as indicated by the notation of +0.000%. After three minutes we lowered line voltage to 105 V and—much to our surprise—the speed actually increased, although it still was within 0.2% of precisely 1 7/8 ips. Conversely, after 5 minutes we increased line voltage to 130 V only to find that now the speed decreased slightly, but again remaining within one vertical division on the graph, or less than -0.2% below perfect speed.

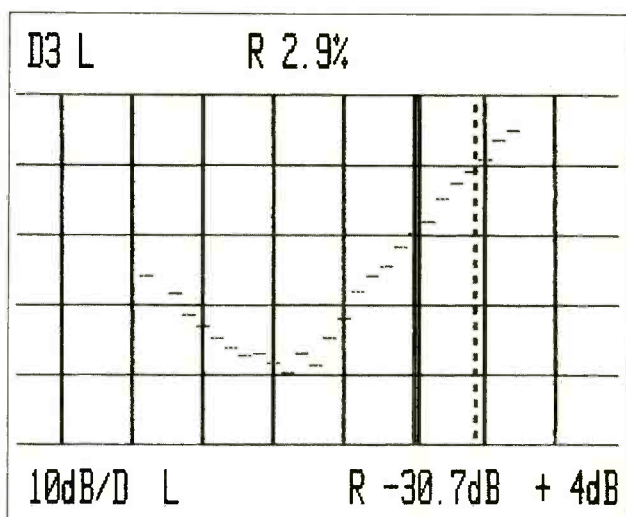

Fig. 6: Hitachi D-1100M: Third-order distortion versus record level, Fuji metal tape.

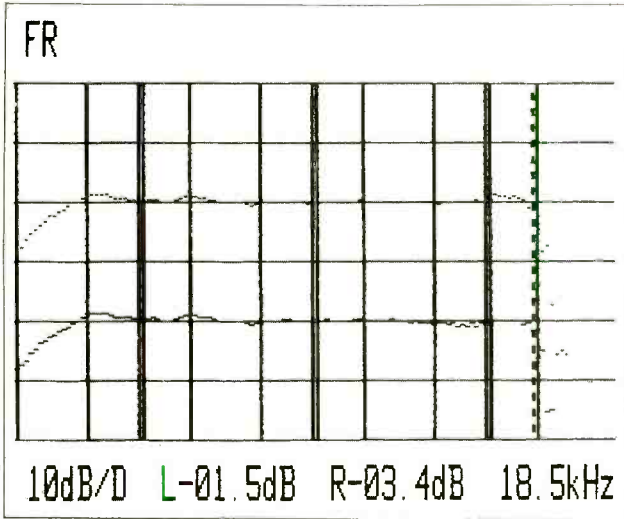

Fig. 7: Hitachi D-1100M: Effectiveness of ATRS feature. Upper trace (L) is without ATRS; lower trace (R) is with ATRS.

Overall, we feel that the Hitachi D-1100M combines many convenience features with good basic performance at a fair price.

General Info: Dimensions are 17 $\frac{1}{8}$ inches wide; 5.12 inches high; 10 $\frac{1}{2}$ inches deep. Weight is 16.5 lbs. The price is \$599.95.

Individual Comment by L.F.: While this is certainly not the first cassette deck tested that automatically adjusts its own bias and EQ to match the tape used with it, the Hitachi D-1100M is probably

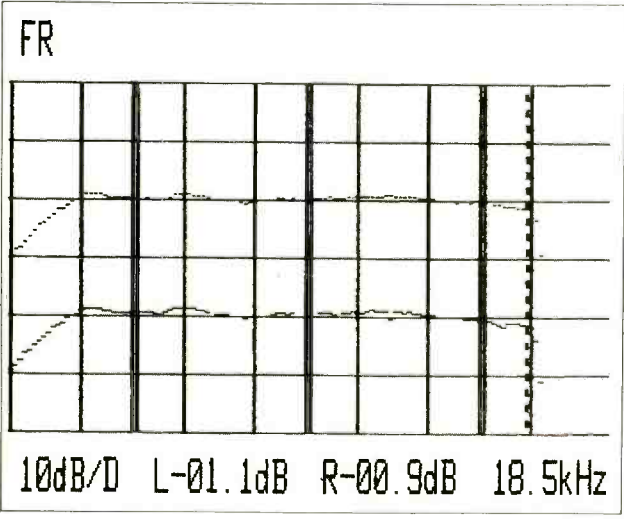

Fig. 8: Hitachi D-1100M: Accuracy of Dolby calibration. Upper trace (L) is with Dolby "on"; lower trace is with Dolby "off."

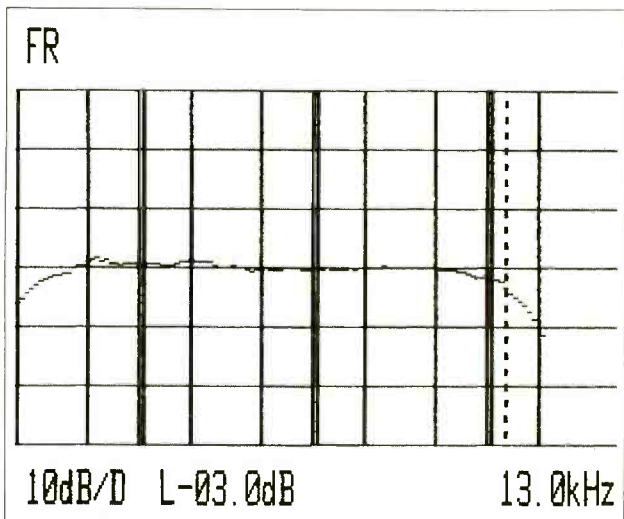

Fig. 9: Hitachi D-1100M: Playback-only response (120 usec EQ).

the lowest-priced unit that incorporates such micro-processor-controlled functions. As one might suspect, while the basic self-adjusting functions are there, some of the frills associated with more expensive units of this type are absent. Specifically, although the deck has tape parameter "memory," it will store only the operating points for one tape in each basic tape category (ferric-oxide, chrome, ferrichrome, and metal). Furthermore, such storage is kept only so long as power is applied to the deck (power turned on, not merely line-cord plugged in). Finally, if you don't like the results obtained automatically, you can switch to "fixed" bias and EQ settings (determined at the factory), but then there is no way you can "trim" these

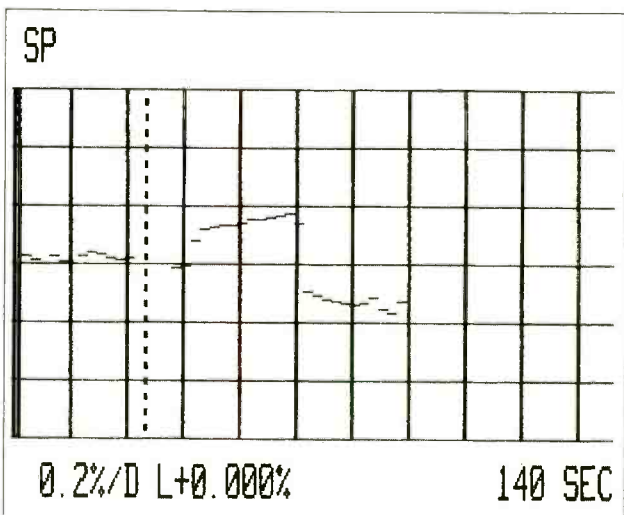

Fig. 10: Hitachi D-1100M: Speed accuracy versus time and line voltage.

fixed settings to your liking.

The foregoing is in no way intended as a criticism of this deck. Quite the contrary, I was amazed at just how much automatic adjustment capability Hitachi was able to build into what must be considered a "medium priced" three-headed deck. And bear in mind that besides the ATRS, there are such features as logic-control transport functions, memory rewind and auto-rewind, automatic record mute, peak reading LED meters, a dual-capstan drive system, and facilities for remote-control operation. For all of that, though, Hitachi decided not to provide front panel line/mic mixing.

Adding it all up, there's a great deal offered in this new cassette deck. It is easy to use, although the owner's manual contains some some awkward language and sentence structure which often requires a re-reading for full understanding. I have always maintained that a good editor could make a fortune rewriting owner's manuals for products that are imported from the Orient—but I suspect that it would mean relocating in Tokyo, so I don't plan to apply for the position.

Individual Comment by N.E.: Occasional departures from published specs notwithstanding, the Hitachi D-1100M strikes me as a very good buy in cassette recorders on today's market. It does have separate record and play heads for off-the-tape

monitoring while recording, and it does have a very smooth transport with very low wow-and-flutter, and the facility for unrestricted fast-buttoning. Metering is both convenient and accurate, and headphone monitor volume—while not mind-blowing—is ample for normal use. I suppose Hitachi felt that they had to include some form of microprocessor automation these days, and so they have—and it obviously works as intended, which is to say, it provides quite ample high-end response while keeping distortion low and S/N fairly high. Certainly these characteristics seemed well enough suited for dubbing one of Telarc's latest digitally-mastered sonic blockbusters—this was the Gershwin *Rhapsody in Blue*, and *American in Paris* played by the Cincinnati Symphony led by Erich Kunzel with Eugene List at the piano (Telarc DG 10058). The intriguing thing about these two Gershwin pieces is that they abound in percussives: the big bass drum Telarc is so fond of recording in all its impact, as well as more subtle percussives—all of them combining to lend the music a dramatic intensity that often is overwhelmed by the pure sentiment (schmaltz?) in the scores. Except for an occasional traffic jam in the *American in Paris*, this modest little Hitachi caught it all, when operated as per instructions.

Speaking of which, those supplied with the deck are complete and amply illustrated. The English is not always the smoothest, but I have seen worse. All told, at \$600, this deck has a lot going for it.

HITACHI D-1100M CASSETTE RECORDER: Vital Statistics

PERFORMANCE CHARACTERISTIC	MANUFACTURER'S SPEC	LAB MEASUREMENT
Frequency response, normal tape	± 3 dB, 30 Hz to 17 kHz	± 3 dB, 28 Hz to 18.5 kHz
high-bias tape	± 3 dB, 30 Hz to 18 kHz	± 3 dB, 28 Hz to 17.5 kHz
metal tape	± 3 dB, 30 Hz to 19 kHz	± 3 dB, 33 Hz to 21 kHz
Signal-to-noise, Dolby off, re: 3% THD record level		
normal; high bias; metal	NA; NA; 60 dB	56.5; 54.2; 56 dB
Same, Dolby on,		
normal; high bias; metal	NA; NA; 69 dB	61.8; 61.7; 64.3 dB
Record level for 3% THD (0 dB = 200 nWb/m)		
normal; high bias; metal	NA; NA; NA	± 4.0; ± 4.5; ± 4 dB
Third-order distortion at 0 dB rec. level		
normal; high bias; metal	0.8; 0.8; 0.8%	0.68; 0.84; 1.00%
Line output at 0 dB	500 mV	715 mV
Headphone output at 0 dB	NA	70 mV/8 ohms
Microphone input sensitivity for 0 dB	0.3 mV	0.3 mV
Line input sensitivity for 0 dB	60 mV	81 mV
Bias frequency	1.5 kHz	105 kHz
Wow-and-flutter, WRMS	0.038%	0.030%
Speed accuracy	NA	+ 0.03%
Fast-wind time, C-60	NA	72 seconds
Power consumption	36 watts	30 watts

CIRCLE 13 ON READER SERVICE CARD

Teac/Tascam 22-4 Open-Reel Tape Deck



General Description: The Tascam 22-4 from Teac is a four-channel open-reel tape recorder/reproducer. The track format is quarter-track on 1/4-inch wide tape. Speeds are 15 and 7.5 inches-per-second; maximum reel size is 7 inches. Designed for professional use, the model 22-4 is capable of recording on each, or any combination, of its four tracks, with built-in options for overdubbing, sync-recording and punch-in recording. The cue facility permits hearing the signal during fast-forward or rewind, as well as by manually "rocking" the reels. A pitch control may be used to vary tape speed during both record and playback. Output signals as well as input signals with regard to the deck's four channels are completely selectable. The model 22-4 is well suited for "final" mixing-down operations in conjunction with an external mixer and a half-track recorder, and also for mix-downs while recording since it is possible to combine up to three synced tracks with the unused track.

The upper portion of the front panel is given over to the tape spools and head assembly. The tape path includes swinging guides (on both sides) in addition to rotating and fixed guides. The head cover is easily removable for access to the heads. Above it are the four-digit index counter and reset button.

Below the heads and to the left are the controls for power off/on; speed selection; memory-rewind; variable pitch; and cue. To the right are the transport buttons (rewind; stop; play; fast-forward; pause; and record). Pressing both the pause and record buttons puts the deck in record-standby.

The actual tracks to be recorded on are selected by the four switches below and to the left, labeled "function select." To their right are the output-select buttons (source, sync, and play). Monitoring of the input signal is selected by the source button; monitoring what is actually on the tape is chosen by the play button; monitoring the tape by picking off the signal from

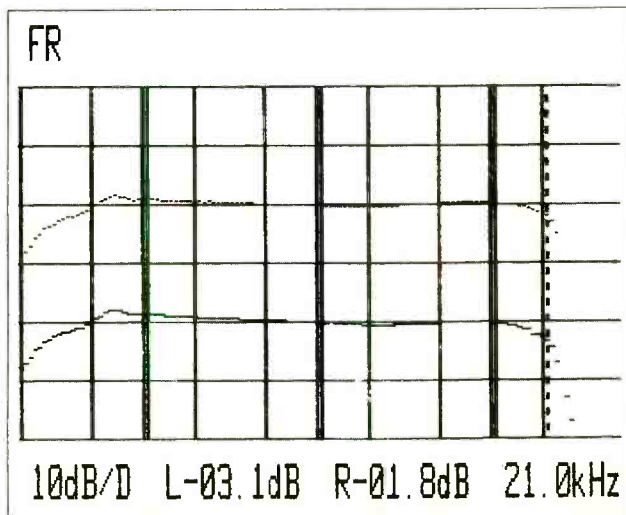
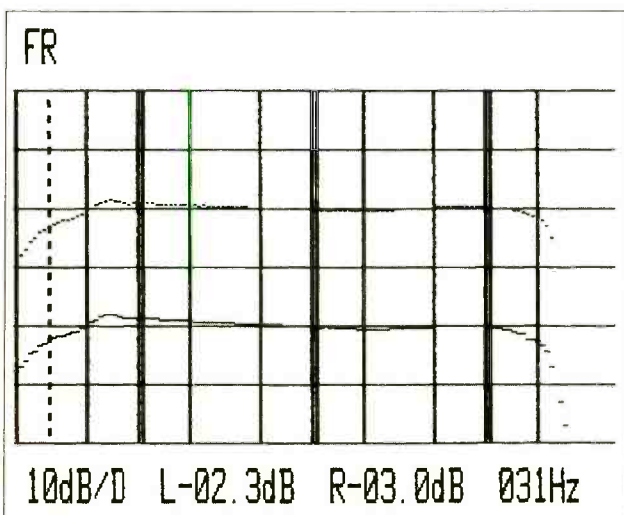

Fig. 1: Teac/Tascam 22-4: Record/play response at 7½ ips for channels 1 and 3 (ref: 0 VU = 185 nWb/m).

the record head is, of course, what the sync button does, which permits making perfect overdubs.

Below these controls are the four VU meters, one per channel. These are amply sized, lit during use, and calibrated from -20 to $+5$. Under each meter is a pair of knob controls for input and output level on that particular track. The latter controls adjust level for both the line output jacks at the rear, and for the monitor panel on the front. The monitor panel consists of an additional output level control; four pushbuttons, one for each track, and a headphone jack. The buttons permit monitoring any or all of the tracks via headphones. In addition to normal monitoring via headphones, this arrangement facilitates multi-track recording since it can monitor what already is on a tape together with new material being recorded.

The rear of the model 22-4 contains the pin-jack connectors for line in and out for each track. In addition there are special sockets for a remote-control accessory, and a special panel for use with an external dbx system.

The Tascam 22-4 uses three motors (two AC induction motors for the reels, and a frequency generator DC servo motor for capstan drive). The erase, record, and play heads are physically and electrically discrete. The machine may be installed upright or horizontally.

Test Results: As may be seen by reading the "Vital Statistics" chart, the Tascam 22-4 readily met or exceeded all of its specifications. Response at either speed went well beyond the stated limits; distortion was at least twice as good as claimed; ditto for wow-and-flutter; S/N was higher than spec'd.

We have included a fair amount of graphic data (derived from our Sound Technology 1500A Tape Tester) to supplement the statistics. *Fig. 1* shows a graphic plot of record/play frequency response for two channels (1 and 3) of the model 22-4 operated at its slower speed 7.5 ips. Note that both sets of curves are identical, and are repeated only so that we could show the dotted line "cursor" at the low and high frequency points at which at least one of the two channels' response has rolled off by the customary 3 dB. Overall response, therefore, ran from 31 Hz to 21 kHz, measured at a -10 dB VU level. On this machine, by the way, "0 VU" corresponds to 185 nWb/m, a rather low reference point that makes the headroom look remarkably good.

Total harmonic distortion plus noise came to only 0.4 percent for the 0 VU recording level at both speeds. This is, of course, very low—but the third-order distortion was even lower, a mere 0.09 percent at 7.5 ips and a negligible 0.03% at 15 ips. In fact, headroom measured 14.3 dB above 0 VU reference level at 7.5 ips, and ± 15.4 dB at the faster speed. *Fig. 2* shows the third-order distortion vs. record level for 7.5 ips. *Fig. 7* shows it for 15 ips. *Fig. 3* shows playback-only response at 7.5 ips which was down only 2.8 dB at 20 kHz. *Fig. 4* shows two identical plots of record/play response for 15 ips, with

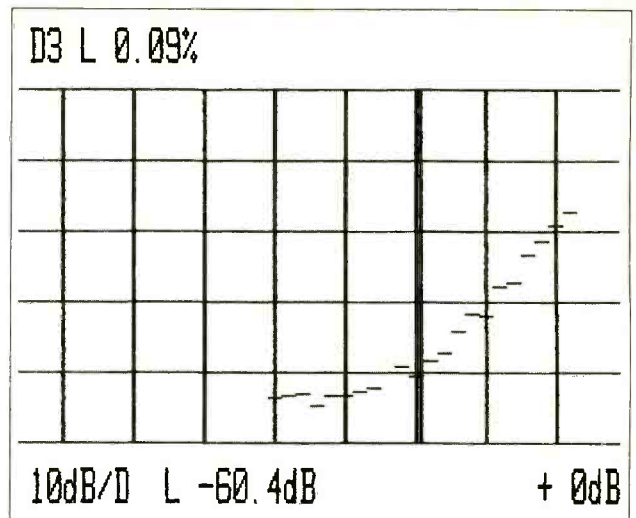

Fig. 2: Teac/Tascam 22-4: Third-order distortion at $7\frac{1}{2}$ ips.

response of two stereo channels (1 and 3) plotted. Again, the duplication of curves is solely to show the cursor (dotted line) close to the low-end and high-end -3 dB points which, for the worst case in this instance, occurred at 40 Hz and a bit above 27 kHz. For reasons we have not been able to determine with certainty, playback-only response at 15 ips (*Fig. 5*) was a bit off, with the -3 dB point occurring at 13.5 kHz. We suggest that the playback EQ may not have corresponded to that required for our test tape, at least at the 15 ips speed.

Since this Tascam deck is equipped with individual channel simul-sync capabilities (for synchronizing add-on tracks with those already recorded, by using the record head as a playback head for those channels already on that tape), we decided to check out the response of the record head when it is used for this pur-

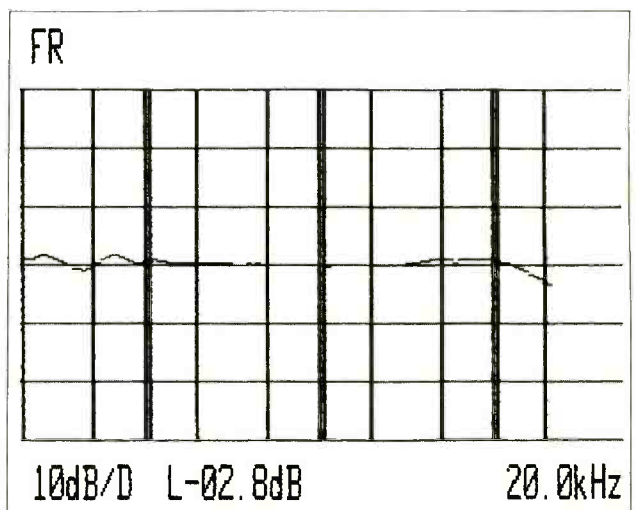

Fig. 3: Teac/Tascam 22-4: Playback-only response at $7\frac{1}{2}$ ips.

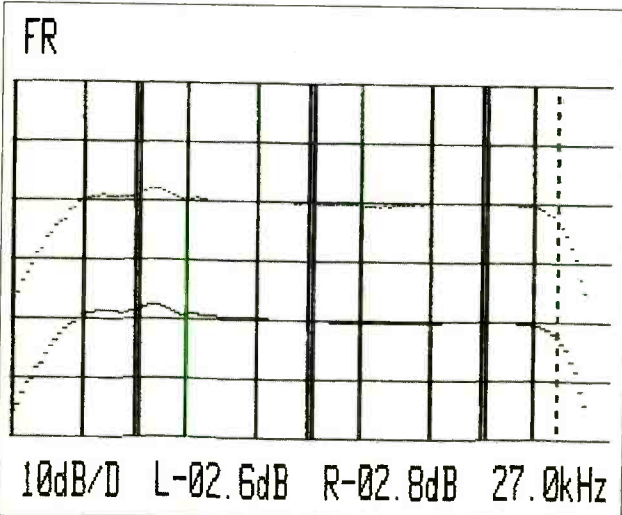
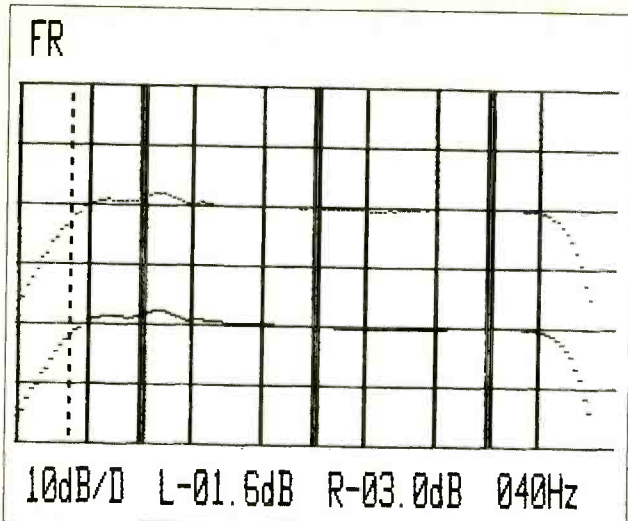

Fig. 4: Teac/Tascam 22-4: Record/play response at 15 ips for channels 1 and 3.

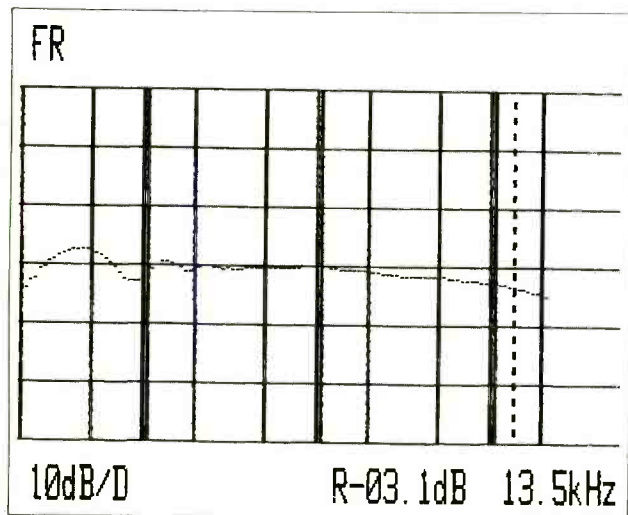

Fig. 5: Teac/Tascam 22-4: Playback-only response at 15 ips.

pose. The results are plotted in *Fig. 6*, and they show a slight rise, peaking at around 10 kHz and then a -3 dB rolloff just beyond 11 kHz. Tascam never claimed that this sort of playback would yield high-fidelity response and we were, in fact, surprised that it was as good as we measured. The remaining plot in *Fig. 8* shows separation versus frequency and, in this instance, we purposely chose tracks 1 and 2 (which are adjacent to each other) to obtain worst-case measurements. They turned out to be very good indeed, with the 1 kHz separation coming to 52 dB.

General Info: Dimensions are 16 $\frac{1}{8}$ inches wide; 16 $\frac{1}{8}$ inches high; 10 $\frac{1}{4}$ inches deep. Weight is 40 pounds. Price: \$1,425.

Individual Comment by N.E.: This is one sweet deck for the creative recordist who does not need NAB-size reels but who can do "his thing" on 7-inch reels. Everything on the deck is devised and arranged for the main purpose of making multi-track recordings whose sonic character and options go well beyond those of a conventional stereo deck. Once the recorder's features and controls have been learned, they prove to be both easy to use and effective for their intended applications.

The model 22-4 also is sturdily built. From its large tape rollers to its feather-touch transport buttons, one gets a feeling of professional quality and reliability. Controls are amply proportioned and clearly labeled. The deck seems to be one that could appeal to the newcomer to creative recording while at the same time offering the kind of performance and handling that would find favor with the seasoned pro.

Teac, incidentally, is one company that believes in the power of the printed word. The owner's manual for the 22-4 is a model of completeness and clarity. It seems to have been prepared with some insight into the user's likely reaction to the equipment, and not as an after-

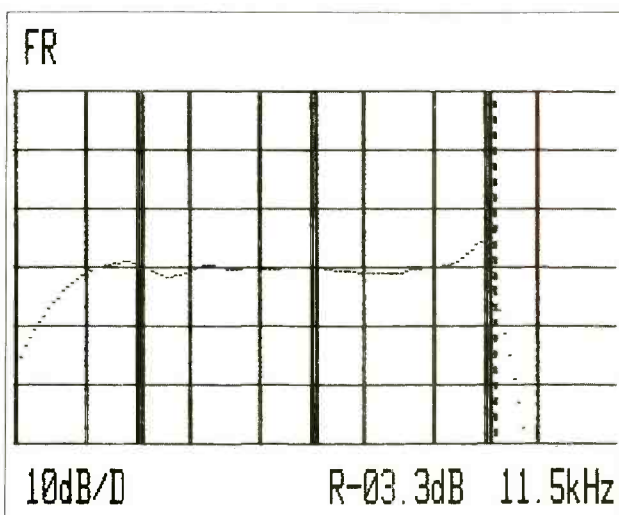

Fig. 6: Teac/Tascam 22-4: Playback response of record head used during sel-sync at 15 ips.

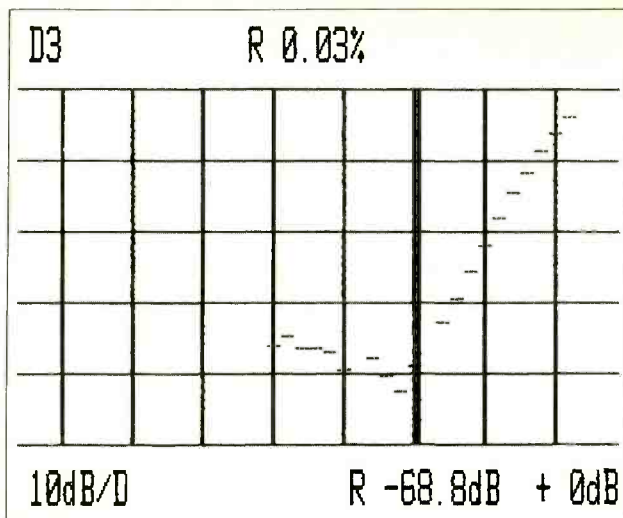

Fig. 7: Teac/Tascam 22-4: Third-order distortion at 15 ips.

thought. The added Information Supplement included here is virtually a primer on open-reel tape recording theory and practice.

One quirk on my sample: The meters on unused channels danced somewhat even when their gain controls were turned down. Sympathetic vibrations with respect to the channels being used?

Individual Comment by L.F.: I think that most readers of *MR&M* are familiar enough with Tascam equipment so that comments from me regarding the high level of quality that can be achieved with the model 22-4 are hardly needed. I have always liked the feel of Teac/Tascam tape deck controls as well as their front-panel layouts, and the model 22-4 is no exception. The connection facilities for an external noise reduction system are a handy addition, though why Teac limits their description to dbx I cannot imagine, even though I think the dbx NR system is a great one. However, you

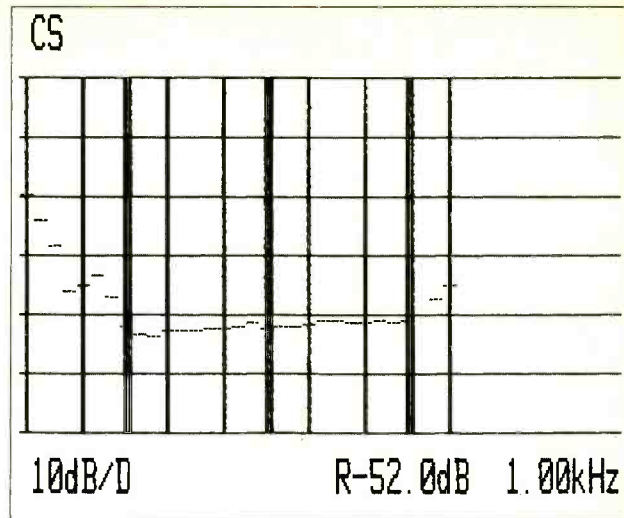

Fig. 8: Teac/Tascam 22-4: Separation versus frequency at 15 ips.

could just as easily hook in a Dolby noise-reduction encoder/decoder, or a Nakamichi High-Com unit. The absence of direct microphone inputs will, of course, not trouble the typical user of this machine who would no doubt couple it to a good multi-mic mixer. In the event that Teac's own dbx unit (model RX-9) is used with the 22-4, a special control signal socket on the deck's rear accepts an appropriate plug from that noise reduction unit.

For the record, we used Maxell UD-XL tape for our lab measurements. Also for the record, I cannot justify the fact that this otherwise beautifully engineered machine accommodates only 7-inch reels instead of the usual 10½-inch variety. This seems to me especially odd in view of the fact that the deck operates at 15 ips as well as at 7.5 ips. I could have accepted the smaller reels for a machine whose two speeds were 7.5 and 3.75 ips more readily. After all, Tascam is supposed to be the pro division of Teac, isn't it?

TEAC/TASCAM 22-4 OPEN REEL TAPE RECORDER: Vital Statistics

PERFORMANCE CHARACTERISTIC	MANUFACTURER'S SPEC	LAB MEASUREMENT
Frequency response, 15 ips, 0 VU 7.5 ips, -10 VU	± 3 dB, 40 Hz to 22 kHz ± 3 dB, 40 Hz to 20 kHz	± 3 dB, 40 Hz to 27 kHz ± 3 dB; 31 Hz to 21 kHz
THD at 0 VU, 15 ips; 7.5 ips	1.0%	0.4%; 0.4%
Record level for 3% THD 15 ips; 7.5 ips	+ 10 dB	+ 14.3 dB; + 15.4 dB
S/N ratio, 15 ips, NAB "A" wtd 7.5 ips, NAB "A" wtd	61 dB 60 dB	66 dB 65.6 dB
Line input sensitivity	0.1 V	0.086 V
Line output level	1 V	1 V
Headphone output level	100 mW/8 ohms	110 mW/8 ohms
Bias frequency	100 kHz	Confirmed
Erase ratio	70 dB	Confirmed
Wow-and-flutter, 15 ips; 7.5 ips	0.04%; 0.08%	0.03%; 0.045%
Speed accuracy, 15 ips; 7.5 ips	± 0.5%	Adjustable

CIRCLE 14 ON READER SERVICE CARD

Sonic Rainbow Labs Accusonic Tuner



General Description: The device known as the Accusonic Tuner, from Sonic Rainbow Labs, Inc. (Nashville, Tennessee) is not—as the title suggests—a radio receiving device or guitar tuner, but rather a sophisticated piece of test gear for performing aural alignment of tape recorders. It also may be used for checking electrical phase of studio equipment and cables, and for making frequency response measurements.

Basically, the Accusonic Tuner consists of a user-adjustable oscillator plus circuitry and connections for feeding signals out and accepting signals in, and a small built-in speaker for aural monitoring of test tones. By using the signal meters on a given tape machine together with LED indicators on the Tuner, the system also provides visual indications.

Nominal operating levels are selected on one of three pushbutton switches. The first switch selects -8 dBm or 0.3 volt which applies to the -10 level used in the Tascam professional series of decks. Switch no. 2 selects $+4$ dBm (1.23 volts), the nominal level used in most other professional recorders. Switch no. 3 selects $+2$ dBm (1 volt), but this level can be changed by changing some resistors inside the device; instructions are included in the owner's manual.

The sloping topside of the Tuner contains the signal connectors, oscillator controls, the slotted opening for the internal speaker, and a speaker level control. Signal connectors require banana plugs, and the leads from each pair ("hot" and "common") may be wired for balanced or unbalanced termination with respect to the recorder or console used in the system.

Controls for the internal sweep oscillator include a frequency selector (1 through 10) and a frequency multiplier (X 10, 100, 1K, and 10K), and a level control.

The input level switches mentioned earlier are located on the front panel. Also found here are additional switches. The level switch permits the Tuner to analyze signals entering input no. 1. The azimuth switch permits the Tuner to compare the phase relationship of signals coming into both of its inputs; in

this mode, the Tuner generates its own frequency which indicates the phase condition. The oscillator switch activates the internal oscillator. The calibrate switch permits the operator to calibrate the device by means of a screwdriver-adjustable pot on the left side of the unit. A power off/on switch and indicator complete the lineup here. An additional LED at the top of the sloping panel indicates when two audible tones are "in tune."

Using the device requires that the operator have a test tape (for playback alignment) as well as a service manual for the particular recorder being "tuned" since the process involves working with the adjustment screws of tape heads, as well as the trim pots for bias equalization and recording level.

Test Results: Specs for this device were readily confirmed in bench tests, and its effectiveness also confirmed in a run-through of use-tests. The key to the "aural alignment" of which this device is capable lies in the fact that audio oscillators are now available which can be tuned by varying the voltage applied instead of changing the circuit components such as discrete inductors or capacitors. Thus, once the operator has calibrated the Tuner itself so that reference level corresponds to a "zero beat" between two built-in tones, any change in input level from a tape deck under test corresponds to a departure from flat response.

In similar manner, an out-of-phase condition (as between the tracks of a given record or playback head) can be indicated aurally—the tones read by the heads will not add up to their maximum value unless they are in phase. This shift in level, therefore, can also show up as a change in pitch of an oscillator.

Actually, any level shift—caused by misadjustment of bias, of sensitivity, of EQ, or whatever—can be translated by this instrument into an audible shift in pitch of its oscillator(s).

Both playback and record alignments were performed using the Sonic Rainbow device—including

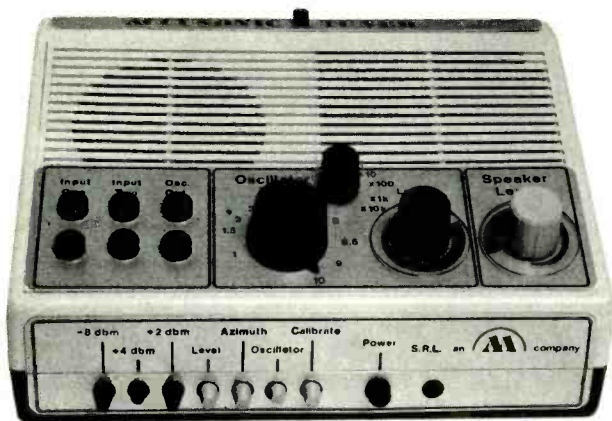

Front panel view.

azimuth alignment, EQ adjustment and sensitivity adjustment, following which frequency response was measured. The instrument also lends itself to phase measurement of other studio equipment including cables, and to frequency response measurements of any piece of audio gear.

General Info: Dimensions are 8¾ inches wide; 4 inches high; 6¾ inches deep. Weight is 3 lbs., 2 oz. The price is \$650.

Individual Comment by N.E.: This ingenious device functions as both "source" and "monitor" for test signals, and its electrical interface characteristics suit it for a wide range of tape machines in terms of signal levels and hookup methods. Its accuracy is well documented by our lab test data. The Accusonic Tuner is, emphatically, a professional-grade tool for use by the serious or advanced open-reel tape recordist who has a service manual for a given recorder, or at least sufficient-

ly detailed information regarding the trim adjustments for bias, EQ, and recording level. He (or she) also should know what banana plugs are (it is surprising how many self-styled "audio types"—including more than one sales clerk in a radio retail outlet—do not know what a banana plug is).

Using this "tuner" for the first time takes some care and patience, and one is urged to follow the step-by-step instructions supplied with it rather than try to second-guess or jump ahead. And if the owner opts for a nominal operating level that differs from those supplied, a willingness to go inside the chassis and wield a soldering iron also is required.

Individual Comment by L.F.: I never thought I'd see the day when I would be able to align a piece of equipment—especially one as complex as a tape deck—by ear, and obtain accuracies that are within a quarter of a dB. But that is exactly what this cleverly engineered little test device allowed me to do. What's more, once you understand its operating principles, it is hardly any trouble at all to go through a fast calibration process whenever you want to use your tape deck, be it a simple cassette model or an elaborate open-reel multi-channel deck.

My only criticism of the equipment is the fact that its own output level varies with frequency (referring to the built-in variable frequency oscillator), so that if you want to do a multi-point frequency response check, it is necessary to calibrate the instrument itself for each frequency to be used. Considering the ease with which other, more complex functions can be performed, and the fact that everything can be done without an actual meter movement in sight, that is a small criticism indeed, and—from my point of view—the manufacturer is to be commended for coming up with a brilliant solution to an everyday alignment problem faced by so many small, medium, and large recording studio operations.

SONIC RAINBOW ACCUSONIC TUNER: Vital Statistics

PERFORMANCE CHARACTERISTIC	MANUFACTURER'S SPEC	LAB MEASUREMENT
Oscillator range	10 Hz to 100 kHz, ± 10%	Confirmed
Oscillator THD	Less than 1.0%	0.5% (worst case)
Maximum output level	± 21 dBm/600 ohms	+ 23 dBm
Input impedance	10 ohms, unbalanced	Confirmed
Accuracy of level mode	± 0.25 dB (worst case)	Confirmed
Accuracy of oscillator calibration mode	± 0.25 dB (worst case)	Confirmed
Nominal levels		
Switch 1	- 8 dBm	Confirmed
Switch 2	+ 4 dBm	Confirmed
Switch 3	+ 2 dBm (modifiable)	Confirmed
Power consumption	With 115VAC, 1 amp	Confirmed

CIRCLE 15 ON READER SERVICE CARD



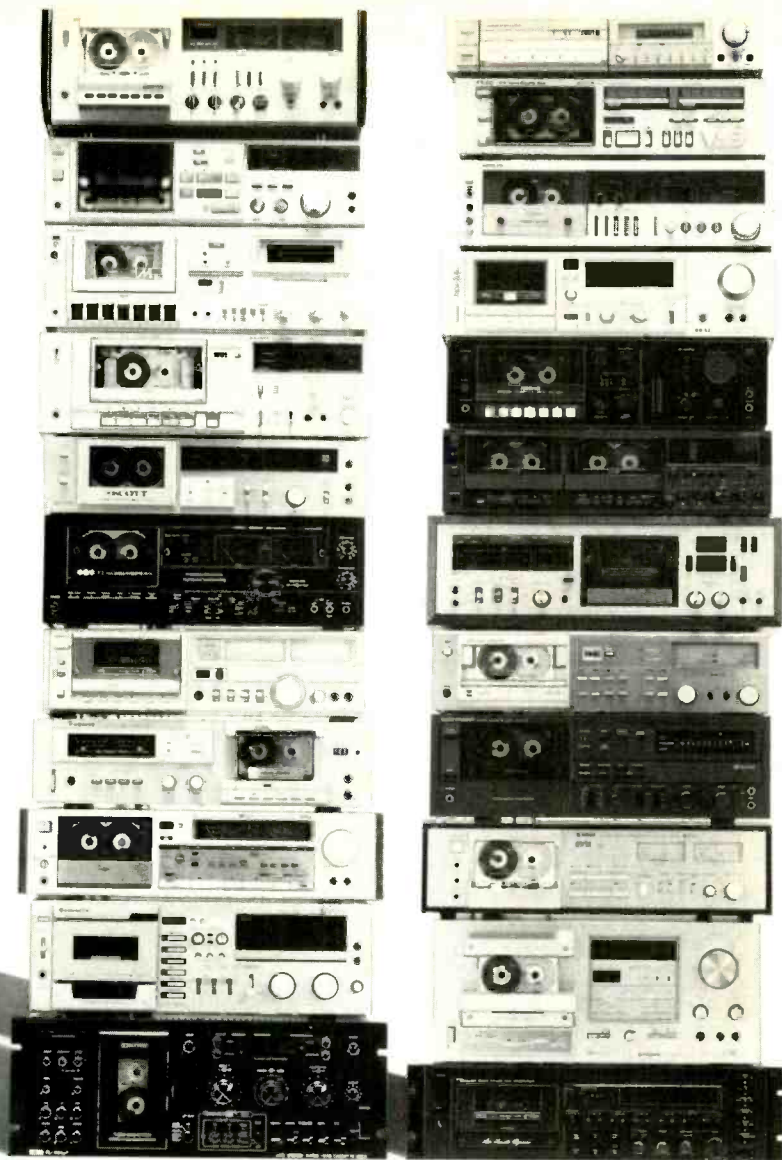
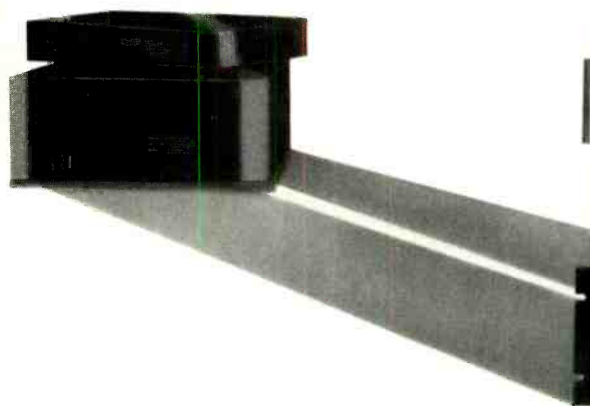

23 deck makers bias with TDK metal. That doesn't leave many for the competition.

When it comes to the critical bias adjustment, the vast majority of manufacturers won't use anything but TDK Metal Alloy cassettes. TDK metal excels in two different cases. The MA-R has the Reference Standard Mechanism, with a unique metal unibody frame. MA uses the Laboratory Standard Mechanism, designed to deliver the smoothest possible flow of music.

Both MA-R and MA incorporate TDK's remarkable tape formulation, FINAVINX, a metal particle with extremely high coercivity and remanence for high frequency response and low distortion. TDK metal has the widest frequency range and highest MOL of all cassettes rated in an independent test.

It's not easy to get 23 quality deck makers to reach the same conclusion. If you use TDK metal, you'll be in good company.

 **TDK**
The machine for your machine



BGW Systems Model 10 Electronic Crossover

By John Murphy and Jim Ford

The BGW Model 10 electronic crossover has been on the market for a couple of years now. It is a single channel 2-way crossover with a variable frequency subsonic filter. Although the electronic design of the crossover is fairly conventional (18 dB/octave Butterworth filter pairs), the interface with the user is quite different from any other crossover we've reviewed. There are no front panel controls. Hi- and low-frequency output signal levels are adjustable from the front panel, but only through the use of a small screwdriver. The crossover and subsonic filter frequencies are adjustable (via BGW's clever "switchset" technique) only after the unit's top cover plate is removed. This arrangement might seem like a catastrophe to an audio marketing person since it sometimes seems to be the front panel "bells and whistles" that sell audio equipment, but to knowledgeable end users and system designers we expect the BGW Model 10 will be a very appealing crossover because of the inherent protection of critical one-time control settings. Packaged in a standard single width (1 $\frac{3}{4}$ " high) rack mounting chassis, the unit is only 5 $\frac{1}{2}$ inches deep and sells for \$239.

General Description: In past reviews of electronic crossovers we have indicated our concern over readily accessible front panel controls for crossover frequency selection, signal levels, etc. BGW's Model 10 is the first crossover we've reviewed which gives these controls the foolproof protection which we feel they should have. About the only situation where crossover frequency needs to be easily adjustable is where the crossover is used in a variety of different loudspeaker systems (as in a loudspeaker design laboratory, for example). Most often, electronic crossovers are used with a particular loudspeaker system and it is only necessary to select an appropriate crossover frequency when the crossover is initially purchased. Providing access to crossover frequency controls after that time is only asking for trouble.

On the front panel of the Model 10 there is a push-button power on/off switch with an LED indicator, and, to the left, a pair of screwdriver access holes for adjusting the high- and low-frequency output signal levels. Crossover frequency adjustment can be made only after removing the six screws which hold the unit's chassis cover in place. Instructions for selecting various crossover frequencies are conveniently provided on the inside of the cover. Actual frequency selection is made



by setting nine miniature slide switches (for each filter) according to the instructions provided. The available crossover frequencies are: 300, 500, 800, 1000, 1200, 1400, 1700 and 1900 Hz. The unit's 18 dB/octave subsonic filter is similarly programmed by a set of nine switches for any of the following frequencies: 0.66, 10, 20, 30, 50, 60, 70 or 80 Hz. The inclusion of the sub-sonic filter is a very good idea considering that sub-sonic noise can present a real problem in some sound reinforcement situations.

All signal connections to the Model 10 are made at the rear panel. Both $\frac{1}{4}$ -inch phone jacks and 3-pin XLR-type connectors are provided, the phone jacks for unbalanced signals, the 3-pin connectors for either balanced or unbalanced signals. An octal socket is located adjacent to each 3-pin connector and it must have a jumper plug (provided) inserted for unbalanced signals, or a balancing transformer (optional purchase) inserted for balanced signal connections.

Also located on the rear panel are an AC line fuseholder and voltage selector (120 or 240 VAC, 50-60 Hz). There is also a terminal strip with a removable jumper which ties the unit's power supply ground to the chassis. This is a nice feature from a systems point of view because it allows the user to implement an optimized approach to system grounding which might otherwise require isolating the crossover's chassis from the equipment rack in order to break a noisy ground loop.

Listening/Handling: We performed our usual listening test on the BGW crossover by patching it into a tape

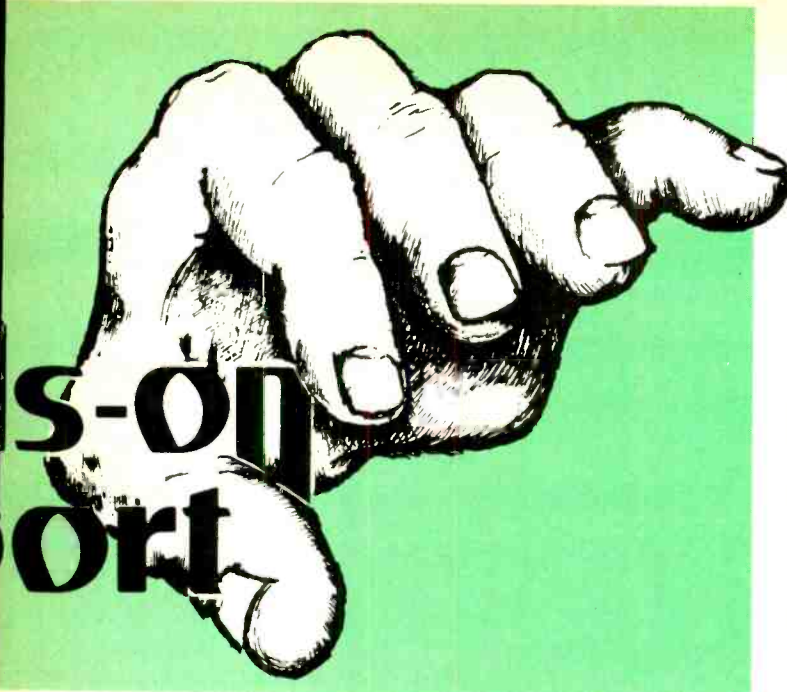

monitor loop of the preamplifier in our reference monitoring system. The high- and low-frequency outputs were summed using a precision summing amplifier so that the full spectrum signal was returned into the preamp. With this arrangement we could alternately listen through the crossover and then bypass it. An ideal crossover would be totally inaudible when switched in and out of the listening chain. The Model 10 performed very well in this test in that we could hear no significant changes in sonic quality when the unit was switched in or out of the system as we listened to several different high-quality discs.

Crossover frequency selection on the Model 10 is not as simple as turning a front panel knob, but it is not difficult, either. The user must set a total of eighteen slide switches to the prescribed positions (on or off) for the desired crossover frequency. For example, in order to tune the unit for a 1 kHz crossover the instructions indicate that switches 1, 2, 4, 5, 7 and 8 should be set to the "on" position while switches 3, 6 and 9 should be "off." The switches for the low-pass and high-pass filters are set the same. Similarly, the sub-sonic filter requires that nine switches be set according to the recipe for the selected frequency. Because there is rarely much "music" below about 40 Hz, any signal components below this frequency are most likely noise. This sub-sonic noise has several bad effects on a sound reinforcement system. It can waste a lot of valuable amplifier power while causing large excursions of the woofer cones. The large woofer excursions result in increased distortion over the woofer's operating range and a

general tendency for the system to sound "muddy." By setting the Model 10's sub-sonic filter to cut the response of the system below the 30-50 Hz range these problems can be greatly reduced.

We were a little disappointed that the range of crossover frequencies available on the Model 10 is only from 300 to 1900 Hz as it is not unusual that crossover frequencies outside this range are required. For those loud-speaker systems where the required frequency is within the range of the Model 10, however, this would appear to be an excellent choice for a crossover.

The owner's documentation supplied with the unit is very complete. Besides the basic information on setup and operation there is a thorough discussion of how to wire various balanced and unbalanced lines for connection to the crossover. The manual also includes detailed schematics, a wiring diagram and a parts list. This should be enough service documentation to insure that the unit could be repaired readily in the event it should fail while on the road away from your dealer's service department.

Lab Test: We performed our standard lab evaluation on the Model 10 and have provided the detailed results in the "Lab Test Summary" below.

The unit's maximum input and output levels are in the area of +20 dBv and are therefore appropriate for professional audio work; the output is also capable of driving a 600-ohm load. Noise at the unit's output was very low at about -90 dBv. We observed total harmonic distortion (THD) levels below .005% from low frequen-

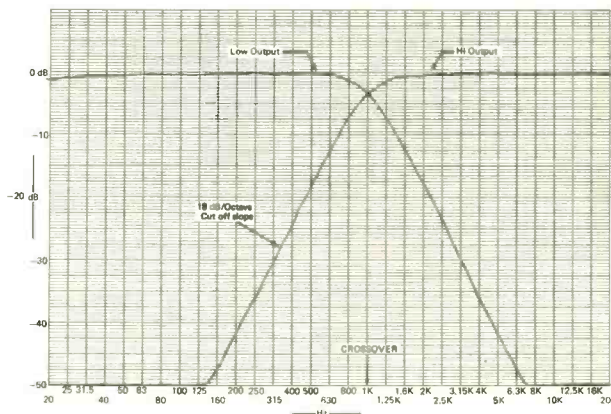

Fig. 1: BGW Model 10: High and low output frequency response curves.

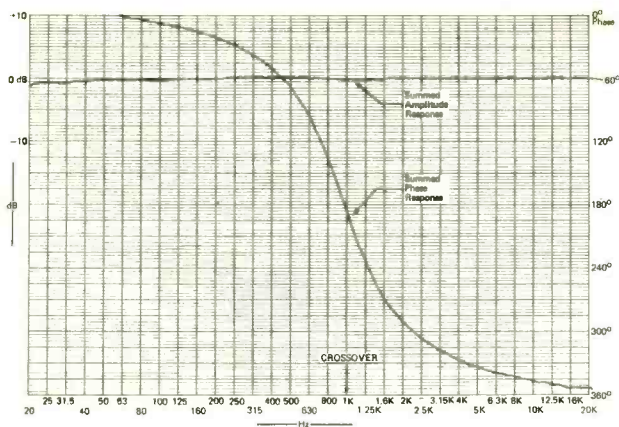

Fig. 2: BGW Model 10: Amplitude and phase response when the high and low outputs are summed (no polarity reversal).

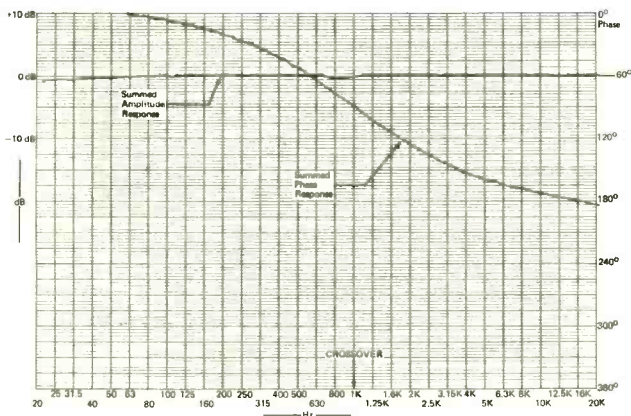

Fig. 3: BGW Model 10: Amplitude and phase response when the high and low outputs are summed (with external polarity reversal).

cies up through the middle of the spectrum with the THD increasing at higher frequencies to about .02% at 20 kHz. It would be nice if the unit's small signal bandwidth (570 kHz) were limited to a frequency no higher than the power bandwidth (150 kHz) as this would have made the unit virtually "slew proof." Don't be misled by this statement, however, because the Model 10 has excellent slewing headroom at 13 Volts per microsecond. The normalized slew rate limit of 0.96 is well in excess of the recommended minimum (0.5) for freedom from slewing induced distortion.¹

The most important characteristic of a crossover is the frequency response that results when the separate high- and low-frequency outputs are recombined, that is, the summed frequency response. In *Figures 1, 2 and 3* we have provided the amplitude response curves of the high- and low-crossover output signals, as well as the

summed amplitude and phase response curves for the cases of non-inverted and inverted polarity connections. We recommend the use of inverted polarity connections for 18 dB/octave Butterworth crossovers as this option provides the least phase distortion, the least time delay distortion and the least waveform distortion. The difference between the two polarity options is typically inaudible except in a carefully controlled laboratory situation. So, in practice, which phase response curve is obtained is not nearly as important as the fact that *either* polarity connection results in a flat amplitude response.

Conclusion: The Model 10 electronic crossover from BGW Systems has been evaluated and found to be an excellent general purpose crossover. It shares with many of the crossovers on the market the accurate amplitude summing characteristics of the 18 dB/octave Butterworth filter pair. However, the Model 10 provides an unusually high degree of protection for critical crossover frequency adjustments and signal level controls. This *lack* of front panel controls makes the Model 10 especially practical in our opinion.

LAB TEST SUMMARY

(Note: 0 dBv is referenced to .775 Vrms)

Input/Output Levels

Maximum input level before clipping: + 22.1 dBv
 Maximum output level before clipping:
 20 K-ohm load + 22.1 dBv
 600-ohm load + 17.5 dBv

Noise Performance

(Note: 20 kHz filter, unweighted, output level controls set for unity gain)
 Noise at "Hi" output: - 89.8 dBv
 Noise at "Low" output: - 91.2 dBv

Distortion Performance (+ 10 dBv output level)

Frequency	THD plus noise
100 Hz	.0027%
500 Hz	.0027%
2 kHz	.0052%
10 kHz	.010%
20 kHz	.022%

Small Signal Bandwidth (- 3 dB points):
 3 Hz to 570 kHz

Power Bandwidth: 150 kHz

Slew Rate Limit: 13 volts per microsecond

Normalized Slew Rate Limit: .96 volts per microsecond per volt.

1. W.G. Jung; M.L. Stephens; C.C. Todd, "An Overview of SID and TIM, Part II," *Audio*, 38-47 (July 1979).

CIRCLE 17 ON READER SERVICE CARD



Grow with the best...



Tapco's expandable, versatile C-12/ Series Two Mixing System.

Whatever your requirements, the C-12/ Series Two is versatile enough to meet them... on the road or in the studio. The C-12 is the first moderately-priced twelve-channel stereo mixing console to offer you the flexibility of subgroup mixing. You can route any input signal directly to any of the four subgroups or the main outputs. For example, by putting the drums on one subgroup, lead vocals, background vocals and the rhythm section on each of the others, you can change any subgroup level independently of the master balances you've set or the main channel inputs. You can also use the subgroup outputs to feed a four-channel tape deck,

or as separate monitor sends, and still use the main outputs to feed your sound reinforcement system. It also has versatile features such as sweepable midrange EQ, a convenient patch bay, and transformer-balanced inputs. Plus, the C-12 has 48 VDC regulated power available, giving you the capability of using any phantom-powered condenser mike currently on the market.

A factory installed transformer-balanced option on all 10 outputs allows you to interface the C-12 with other balanced equipment, such as recording, broadcast, production and fixed installation systems. And the C-12 is expandable. When your needs grow beyond a twelve-channel console, C8E/ Series Two Expander modules can increase your capacity to 20, 28, 36 - even 44 channels.

You no longer have to buy more mixer than you need or less mixer than you require. The C-12/ Series Two mixing system will take you as far as you want to go. Grow with the best. Audit the C-12/ Series Two at your EV/TAPCO dealer.



TAPCO
381C 148th Ave N.E.
Redmond, WA 98052
(206) 883-3516
Telex: 990-449-2594

In Europe:

EVSA
Römersstrasse 3
5500 Nidau
Switzerland

In Canada:

Custom Industries Ltd.
Box 520, 345 Herbert Street
Gananoque, Ontario K7G 2V1

In Australia:

Electro-Voice Australia PTY-LTD
59 Waratah Street
Kirrawee, N.S.W. 2232

In Japan:

Electro-Voice Ltd.
6F No. 2 Taro Building
2-10 Yotsuya, Shinjuku-ku
Tokyo, Japan 69

GROOVE VIEWS

Reviewed By:
ROBERT HENSCHEN
NAT HENTOFF
JOE KLEE
NORMAN WEINSTEIN

POPULAR

GARY U.S. BONDS: *Dedication*. [Miami Steve, Bruce Springsteen, Gary Talent, Lanny Lambert, Rob Parissi, and Gary U.S. Bonds, producers; Neil Dorfsman, Bob Clearmountain, Tony Bongiovi, Larry Alexander, Randy Mason, and Bill Sheinman, engineers; recorded at Power Station and Sound Mixers, New York, N.Y.] EMI America SO-17051.

Performance: **Add Springsteen and simmer**
Recording: **Overshadowing influences**

It was a shock to see U.S. Bonds suddenly come out of the woodwork after 20 years of near oblivion. And pleasantly adding to the surprise is the entire E Street Band (including The Boss on guitar) toiling as his hot little backup band.

Two decades after "Quarter To Three" roared to #1 with what was a very Black, streetwise sound for the early '60s, the time seems strangely right for a singer with Bonds' reputation for sheer energy. So-called experts in the music biz are saying that New Wave is history, and if they're right, we'll soon be in need of intense, soulful rock & roll without having to put up with dumb funk or heavy metal.

"Jole Blon," with its cranking accordion (by Danny Federici) and stomping hoarse vocals (by both Bonds and Springsteen), hints immediately at R&R salvation. The band has seldom

sounded stronger, seeming to seize subsequent cover tunes by Dylan ("From A Buick 6"), Jackson Browne ("The Pretender"), and The Beatles ("It's Only Love") as a chance to get back to their days of playing Jersey bars (which is where, incidentally, Springsteen recently rediscovered Bonds).

The band's concentration of fire seems particularly focused in "Jole Blon," but it's actually the second cut, "This Little Girl," that became the first successful single from the album...there may be more. The rest of the album has many Good to Very Good moments, as on Springsteen's title composition where Clarence "Big Man" Clemons screams on tenor sax and Bonds recaptures his "School Is Out" sound of



GARY U.S. BONDS: R 'n' R salvation.

yore. Two of Bonds' singing cronies from that earlier era, Chuck Jackson and Ben E. King, join in for "Your Love," a momentous meeting that should sound more special. Still, Bonds does a great job of selling most of his lead vocals.

But does Gary U.S. Bonds fulfill here the promise that his return seemed to offer? Well, his voice seems a little ragged at times ("Daddy's Come Home"), and his TV appearances on "Fridays," "American Bandstand" and elsewhere seem to find him healthy and happy in his re-starring role...if looking maybe a bit tight and awkward out in front of his contrastingly young musician friends.

But this is definitely an album worth having. If Bonds' dusky vocals are overshadowed in the mix, that's due in part to the "live" feel achieved by Miami Steve & staff. Gary U.S. Bonds is back. Given this kind of material (half inked by Springsteen and band), Bonds can't help but rise to the top all over again. R.H.

CRIS WILLIAMSON: *Strange Paradise*. [June Millington, producer; Leslie Ann Jones, engineer; recorded at The Automatt, San Francisco, Ca., additional recording at Jennifundy Studios, Los Angeles, Ca.] Olivia Records (no stock number listed).

Performance: **Uplifting and elegant**
Recording: **A little too lush**

In one of his more acerbic moments Keith Richards of the Rolling Stones complained about "Judy Collins and all those other *fruity* women folk singers."

While I don't share Keith's disdain for Collins, I have listened to dozens of folk cum rock female vocalists who have sent me into comatose reverie. Cris Williamson is the kind of folk/rock vocalist Keith Richards would probably like—not that she would give a particular damn about what Keith or any man might think of her. Cris Williamson is simply the most significant new female vocalist to emerge in the last few years in any genre AND she has become a powerful spokeswoman for music that communicates feminist consciousness.

This is quite a feat for a young woman who not too many years ago earned her living singing for small change at any number of clubs lining the outskirts of numerous university districts. For over a decade she has carefully refined her singing style. She has learned all there is to learn from the holy trinity of women folk/pop vocalists (Collins/Baez/Mitchell) and has gone on to forge a wholly individual voice. Her voice is a perfect vehicle for conveying warmth, empathy, the personal touch. Yet...she transcends the "fruity" by keeping a subtle edge and bite in both her vocal style and songwriting. These qualities have made her records on the small Olivia record label underground best sellers.

Strange Paradise is not my favorite Williamson release (that honor would have to go to her best selling *The Changer and the Changed*) but there are numerous pleasures for any listener to enjoy. "Strange Paradise," the album's opening cut, features Cris' exquisite, soaring voice belting out rather metaphysical lyrics while her Prophet II Synthesizer fills the studio with great chordal washes. Very haunting beginning. "Twisted Love" sounds like an early sixties Carole King rocker and reveals a harsher side of Cris' vocalizing and songwriting. Another tough minded song is "When Anger Takes the Wheel," dedicated to Lowell George of Little Feat. The album closes with a touching self portrait entitled "Native Dancer" which closes the session with a refrain of "And so far, she's holding her own." She certainly does. Her program of songs reflects the mind and soul of a contemporary woman celebrating the many strange landscapes of love. Her songs resonate with the thrill of love realized, the agony of love misplaced, love that transcends death. The obvious compassion and conviction that laces her voice and colors her material is ex-

Professional Grade Recording Tape

Stocked for Immediate Shipment

1/4" & 1/2"

**Audio
Tape
ALL TYPES**

AMPEX
3M
TDK

CASSETTES
ACCESSORIES

ASK FOR OUR CATALOG
OF PROFESSIONAL
RECORDING SUPPLIES

Polyline
Corp.

1233 Rand Rd. Des Plaines, IL 60016

312/298-5300

25

CIRCLE 126 ON READER SERVICE CARD

AS GOOD AS THE BEST FOR A WHOLE LOT LESS

Better Compression Drivers
and Exponential Horns for
unsurpassed natural sound
with big power delivered
exactly where you want it.



RENKUS HEINZ

Follow the lead of the Pros
in-the-know who have com-
pared the quality, the rugged
reliability... and the price.

Ask for a demo, or write us

RENKUS-HEINZ, INC.

17851AB Sky Park Circle • Irvine, CA 92714
(714) 540-3154

CIRCLE 129 ON READER SERVICE CARD

FEEDBACK PROTECTION. WITHOUT SACRIFICING RESPONSE.



Our remarkable MD 431 lets
performers work with amplification
as loud as they wish—up to
6 dB over other microphones—without
feedback. And without sacrificing
the clarity of full rich response.

SENNHEISER

ELECTRONIC CORPORATION

10 West 37th Street, New York, NY 10018
(212) 239-1190

Manufacturing Plant: Bissendorf/Hannover, West Germany

CIRCLE 166 ON READER SERVICE CARD

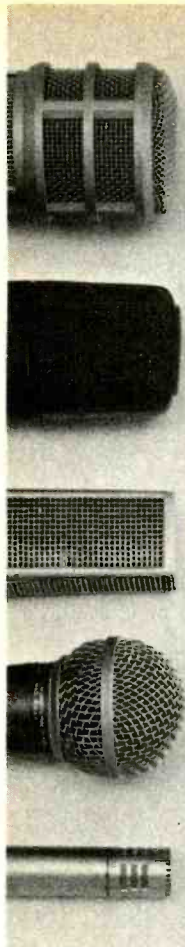

**mikes
by mail?
for less?
why not!™
and much
more!**

Now, we're offering mixers, reverbs, sound reinforcement systems™, amps, DDL's and much more.

And, because we maintain a mail-order only policy, we haven't the high overhead, no store-front, no salesmen... that means lower prices to you.

Write or call us for a prompt price quote or for our price sheet.

The Mike Shop™... mikes and audio equipment by mail, for less... Why not!

The Mike Shop™
PO Box 366V,
Elmont NY 11003
516/437-7925
A Division of Omnisound Ltd.

CIRCLE 136 ON READER SERVICE CARD



**HOT STUFF FROM
SESCOM**



PM-100

\$180.00
THREE BAND PARAMETRIC EQUALIZER

**Great For Live
Performance
And Recording**

FEATURES:

- Instrument Pre-amped Input
- Transformer Balanced Inputs And Outputs
- 15dB Of Boost And Cut
- Variable "Q" Control
- Variable Frequency

Available At
Local Music Stores



SESCOM, INC.
MUSICAL PRODUCTS DIVISION
Las Vegas, NV 89101 U.S.A.

CIRCLE 116 ON READER SERVICE CARD

tremely stirring, uplifting, stately.

I wish I could be so flattering about June Millington's production. I have the impression that she wanted to simply "pull out all the stops." You know what I mean: put the synthesizer high in the mix, push the vocals a bit back, closely mike the cymbals. Lots of flash, bombast, echo, color. Funny thing is—Cris Williamson's voice doesn't need this polished treatment. A much simpler production would have showcased her voice far more successfully. Instead, one of the most distinctive vocalists of our time has to contend with all of the other voicings in the mix. Frankly, I'd like to hear her produce her next record herself and record it in a simple studio. She could make my heart skip a beat if she recorded in the downtown New York City bus terminal—she's that entralling.

Production reservations aside, listen to *Strange Paradise* and discover the beauty of this woman's soul. N.W.



PHAROAH SANDERS: *Rejoice.*
[Pharoah Sanders, producer; Allen G. Pittman, assistant producer; Mark Needham, engineer; recorded at the Power Station Studios, New York, N.Y. and Bear West Studios, San Francisco, Ca.] Theresa Records TR/112/113.

Performance: **Jumping with jubilation**
Recording: **Clear as a mountain stream**

Poor Pharoah Sanders has suffered ignobly in the hands of various jazz critics over the years. His tenure in the Coltrane band resulted in numerous charges after Coltrane's death that Sanders was merely a shadow of the late great sax master. The various recordings on the Impulse label were a mixed lot and certainly didn't contribute to his reputation in certain jazz circles. A curious rift in his musical personality was evident in these releases: the man could blow the sweetest notes imaginable on his tenor sax—or could create wildly atonal bursts of grating sound. He was either ALL Apollonian or ALL Dionysian, a dragon or a cooing dove. Paradoxically, he has often utilized chanted lyrics celebrating the glories of peace and



800-645-3518

WHAT'S BEHIND THIS TELEPHONE NUMBER?

There's a whole world of service behind the Sam Ash telephone number.

Like quick delivery. We know that once you've made up your mind on an item, you want it NOW. So we keep \$5 million dollars worth of merchandise on hand to insure that almost everything is in stock.

Another plus: Sam Ash telephone sales people are all professional musicians. They know what they're talking about and you can trust their advice. Even our packers are specialists in musical gear, quality checking every shipment before it goes out. What a pleasure to get service like this! Call the Sam Ash Hot Line—and enjoy.

IN NEW YORK STATE CALL 212-347-7757
TWX 510-222-1630 SAM ASH HEMP



Since 1924
Sam Ash
MUSIC STORES

124 Fulton Avenue, Hempstead, New York 11550

CIRCLE 124 ON READER SERVICE CARD

love while his horn has sung the glories of conflict and pain.

Rejoice marks a radical turning in Sanders' career. He has finally linked up with a record company that understands how to accentuate his many strong points and knows how to down-play his weaknesses. This two record set represents the most refined and consistent effort I've ever heard from the veteran tenor man and can be recommended without qualification.

"Rejoice," the album's opening cut features another old voice from the Coltrane band, Elvin Jones, on drums. Jones is his usual thunderously brilliant self and provides an active rhythmic setting for Sanders' colorful horn work. Joe Bonner plays gorgeous piano while Bobby Hutcherson's vibes provide delicate tonal shadings. There's one unfortunate reminder of the old Sanders: B. Kazuko Ishida recites some of the most trite "peace and love" type cosmic doggerel I've ever suffered. Luckily, the recitation passes in a few moments and the music succeeds splendidly from that juncture on.

Side two features Sanders exploring the African roots of his music by working several improvisations on African dance motifs. He cuts loose with his wildest blowing of the session—but he also maintains enough coherence and clarity in his solos to remain highly listenable. Babatunde shines on drums and shaker and someone named "Big Black" shines on congas. This is music that makes you feel glad to be alive, music vibrating with thrilling cross rhythms and hummable melodies.

The remaining sides feature Sanders at his most romantic. His dolce tone makes the old Benny Carter chestnut "When Lights Are Low" glow and his silky treatment of Coltrane's "Central Park West" is an unexpected treat. There's not a bad cut on this record and every sideman plays with intuitive charm, sensitivity and sympathy.

The recorded sound is lovely. The mix is transparent and spacious. Too bad that *Impulse* never gave Sanders such a royal treatment in the studio a decade ago. Even the packaging is attractive and the album actually comes with informative liner notes. Theresa Records is a small operation located in Berkeley, California with only a dozen recordings in print. If all of their other recordings echo the quality of *Rejoice*, the company will have an exceptionally bright future.

N.W.

ALBERTA HUNTER: *The Legendary Alberta Hunter: The London Sessions, 1934.* [Beth Greenberg, production coordinator; no engineer listed; recorded at the Dorchester Hotel, London, England, September through November, 1934.] DRG SL 5195.

Performance: **One of America's best singers with one of Britain's top dance bands: need I say more?**

Recording: **A superb example of British 78 sound of the '30s**

Such are the foibles of time. When these recordings came out originally on HMV in the thirties, Alberta Hunter was recording as vocalist with Jack Jackson and His Orchestra. Never mind that she was already a cabaret singer who was part of the show at the Hotel Dorchester where Jack Jackson's band played for dancing and accompanied the show. Alberta Hunter got one vocal chorus on the record in between opening and closing choruses by Jack Jackson's Orchestra. Today Alberta Hunter is still a top star on the cabaret circuit and

Compress/Limit/De-Ess and Noise Gate/Key/Duck
-Two Channels/Push Button Stereo/Independent Tracking-



The CLX-2 is the most versatile two channel compressor/limiter/expander you have ever seen. We use the BEST Voltage Controlled Amplifier available; the EGC-101 and the latest Feed Forward design technology to produce the most natural and musical sounding compression and noise gating obtainable at any price. Knee type compression switchable in or out. Price: \$595.00

Write for a 24 page brochure on our full product line and a demo record.
Send \$1 to: **LT Sound**, Dept. MRX, PO Box 338,
Stone Mountain, GA 30086 Phone: (404) 493-1258

**SOUND BOX
SELLS ONLY THE
REAL THING
IN
PROFESSIONAL
AUDIO GEAR
AT
DON'T PANIC
PRICES**

**Order Your Free
1981 Catalog
Call Toll Free For
Orders and Info**

1-800-638-6050
MD RESIDENTS (301) 881-2663



**PHONE ORDERS
ACCEPTED**

COUNTDOWN
P.O. BOX 2094
ROCKVILLE, MD 20852

CIRCLE 59 ON READER SERVICE CARD

**DON'T MISS OUT
on back issues
of MR&M!**



Just send \$2.20 plus \$.65 for postage and handling per issue to:

**Modern Recording & Music
Back Issues Dept.
14 Vanderventer Avenue
Port Washington, NY 11050**

Check Box:

<input type="checkbox"/> April 1981	<input type="checkbox"/> July 1981
<input type="checkbox"/> May 1981	<input type="checkbox"/> August 1981
<input type="checkbox"/> June 1981	<input type="checkbox"/> Sept. 1981

Sorry! All other back issues are out of print.

Name _____

Address _____

City _____

State _____ Zip _____

NOISE GATE GT-4

The remarkably simple optical noise gate that contributes no noise or distortion to your signal, occupies only 1 3/4" of rack space and costs only \$395.00 for four channels.

To get the full story and a list of dealers call or write

OMNI CRAFT INC.
RT. 4 BOX 40
LOCKPORT, IL
60441
815-938-1285



CIRCLE 64 ON READER SERVICE CARD

BUY CLASSIFIED
SELL
TRADE

- PRODUCTS
- EQUIPMENT
- SERVICES

Classified Rates
75c per word

Minimum 10 words. Copy must be received at Modern Recording & Music, 14 Vandeventer Ave., Port Washington, N.Y. 11050 by the 1st day of the 2nd month prior to cover date (for example, the April issue closes February 1st). Payment must accompany order. Phone numbers count as 1 word. Zip codes are free.

DISPLAY ADVERTISING

\$115.00 per column inch.

PIANO TRIPTYCH: JAY McSHANN, SAMMY PRICE, WRAY DOWNES

By Nat Hentoff

In Toronto, there is a jazz complex that, among other activities, produces the invaluable magazine *Coda* and a consistently first-class record label, Sackville. The label, like the magazine, is concerned only with authentic jazz—but that means the entire spectrum from hardy survivors to current frontiers-breakers. The Canadians who produce the sessions are, in the best sense of the word, true fans. For instance, the notes usually include this line: "Produced cooperatively by Bill Smith and John Norris, who wish to thank the musicians for the privilege of being able to record their music."

Sackville's newest releases focus on pianists. In *Tuxedo Junction*, that long-time Kansas City jazz force, Jay McShann, who in recent years has flourished on the international circuit, is heard with the unusually attentive bassist, Don Thompson. It's like being in a club after hours, listening to a musician playing for himself and maybe a few other colleagues at the bar. In such tunes as "Gee Baby Ain't I Good to You" and his own "One Sided Love," McShann creates deep, mellow moods, laced with the blues. Every note is hit with authority, but it is the infectious easeful authority of a man who long ago transcended the instrument so that he could play himself.

Texas-born Sammy Price has been a landmark on the New York jazz scene since 1937; but, as Julian Yarrow points out in the notes to Price's album, *Sweet Substitute*, Sammy has long been labeled, too narrowly, as a specialist in blues and boogie-woogie. There is, however, a lot more to Price's imaginative scope and this set indeed presents Sammy's solo style "fully and properly for the first time"—as Yarrow says.

To be sure, the blues touches everything he plays, but it is a revelation to hear Sammy's lyrical, meditative grace in "A Hundred Years from Today" and in a gently probing medley of "Memories of You," "As Times Goes By," and "Misty." I can't think of another label but Sackville that would have made this album.

Wray Downes, whose name will be new to most American listeners, has had a long, distinguished history as both a classical and jazz musician. That the classical training has not diminished his spontaneity and rhythmic resiliency is enliveningly clear in *Au Privave*, with bassist Dave Young (joined on one side by guitarist Ed Bickert). Downes is a continually inventive, crisply disciplined improviser who is as persuasive on swift swingers as on delicate ballads.

On all three albums, the sound—as has been true of Sackville releases from the label's beginning—is so justly balanced that you're not aware of the engineering. And that, of course, signifies the very best engineering.

For more information about Sackville, and catalogue, the address is: Sackville Recordings, Box 87, Station J, Toronto, Ontario M4J 4X8, Canada.

JAY McSHANN: *Tuxedo Junction*. [Bill Smith, John Norris, producers; Phil Sheridan, engineer.] Sackville 3025.

SAMMY PRICE: *Sweet Substitute*. [Bill Smith, John Norris, producers; Phil Sheridan, engineer.] Sackville 3024.

WRAY DOWNES: *Au Privave*. [John Norris, David Young, producers; Don Thompson, engineer.] Sackville 4003.

Ladies and Gentlemen....

Please Meet the New Chairman of the Boards!



The SOUNDPRISM Series

Our Other Board Members Include:
The Pro Club + 3, Pro Tour 8/3,
Pro 4/3 and Stagemix + 4 Series

Kelsey

Boards are products of

DMI INC.

150 Florence Avenue
Hawthorne, NJ 07506 (201) 423-1300

CIRCLE 88 ON READER SERVICE CARD

www.americanradiohistory.com

few, if any, nostalgia buffs remember that Jack Jackson certainly had one of the best dance bands in Great Britain of the '30s, if not the absolute best.

The material, as was usual with dance bands of the '30s, varied from such excellent songs as "Stars Fell On Alabama" and "Miss Otis Regrets" to such less memorable material as "Where The Mountains Meet The Sea" and "Two Little Flies On A Lump Of

Sugar." Give it to the credit of Alberta Hunter that she doesn't slough off the not so hot material as quickly as possible but gives the same effort and energy to the near impossible task of making sense of "A Lonely Singing Fool" as she does to something as wonderful as Noel Coward's poignant and sensitive tune, "I Travel Alone."

I guess there's no need to tell anyone about the merits of Alberta Hunter. Her

many TV appearances, her engagements at New York's Cookery and other clubs and her recent recordings for Columbia are impressive enough to captivate any audience. A bit more background is needed in the case of Jack Jackson. As a trumpeter he worked with some of England's best dance bands including the Hotel Savoy Orpheans and Jack Hylton's Orchestra and the Jack Payne BBC Dance Orchestra. When he took his own band into London's Hotel Dorchester it was immediately recognized as one of the best around and started making records for HMV. Surprisingly few of these were picked up by Victor for American issue. If we can believe the listing in Brian Rust's *Jazz Records 1897-1942* only "I Travel Alone" of the sides issued on this DRG LP was issued on Victor as a 78. I guess it was easier for Victor to get Richard Himber's Ritz-Carlton Orchestra over to their studios and to record "Stars Fell On Alabama" than to go through the channels of international export and issue the Jack Jackson/Alberta Hunter version. Also given Jackson's near-anonymity on this side of the Atlantic and the fact that Alberta Hunter hadn't recorded in America for years, they probably felt more commercially secure with Richard Himber's band and Joey Nash on the vocal.

Well, buddy, Alberta's outlasted them all. Himber has long since passed away. Joey Nash is in retirement. Jack Jackson quit the band business to become a disk jockey after WW2 and subsequently retired to the peaceful life in the Canary Islands. I've been unable to find out if he's still living (if so, he'd be 74 years old), but Alberta Hunter at eighty plus is still going strong. Such are the changes that fate and time play on the world.

As to the sound, HMV had an early lead on fidelity in the days of 78 RPM and these were considerably better sounding than what the record companies on this side of the Atlantic were putting out in the thirties. The engineering on these sides holds up just as well as Jack Jackson's band and Alberta Hunter's singing.

The album notes are voluminous and informative and they include photographs from Alberta's collection including the 1928 London cast of *Show Boat* with Paul Robeson and Alberta Hunter standing there in the front row.

J.K.



MODERN RECORDING & MUSIC

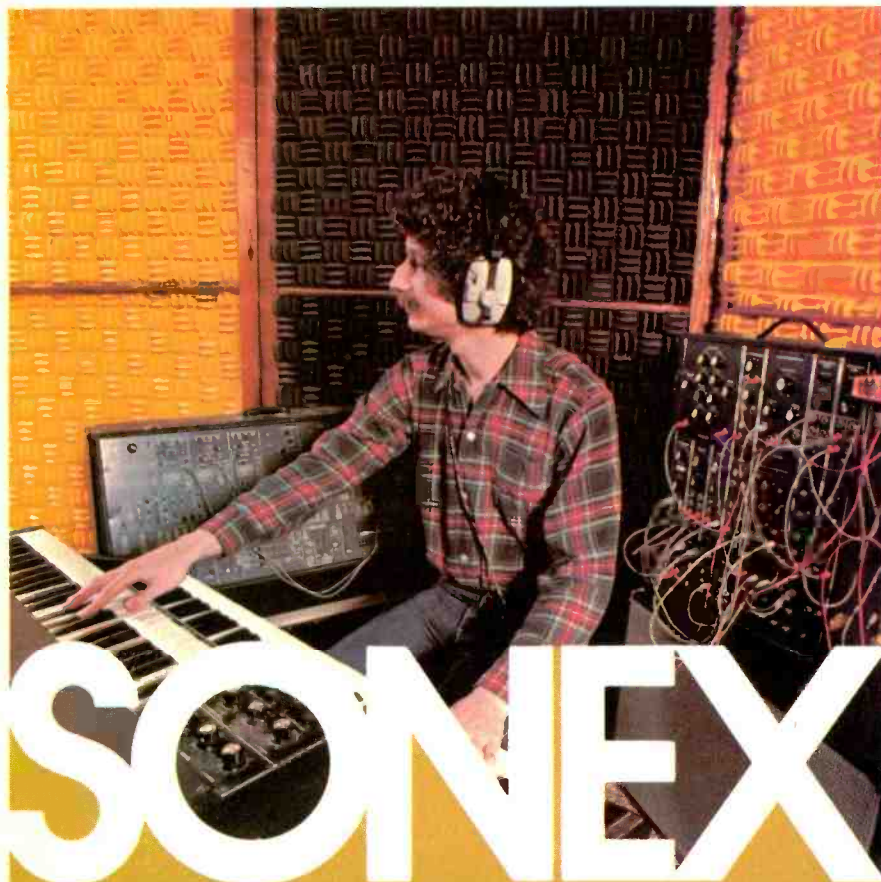

SONEX

FOR PURE SOUND

SONEX introduces the new era in effective sound engineering. With SONEX acoustical foam, you hear only the true sound of the performance. SONEX absorbs sound uniformly with no peaks or valleys so you can control reverb times, eliminate stray reflections, and kill standing waves. Easy, economical construction. Apply adhe-



SONEX's special geometric shape, the "anechoic wedge," optimizes noise dissipation.

sive and put SONEX in place. SONEX is available in 15 inch square silver Audiotiles or 48 inch squares in silver, green, blue, yellow, or brown colors to match your decor. When you need to eliminate noise and hear pure sound, go with the best. SONEX, made only by Illbruck/usa. Distributed through Alpha Audio. **Get the clean sound today. Call:**

Alpha Audio

2049 West Broad Street
Richmond, Virginia 23220 (304) 358-3852

CIRCLE 131 ON READER SERVICE CARD

CLASSIFIED ADS

ATTENTION SMALL STUDIOS! Independent label LP and 45 releases wanted for review and inclusion in feature article in *Modern Recording & Music*. The article will highlight the best recordings from small studios *only*. Send sample disc, studio name, address and phone as well as story behind record to James F. Rupert, c/o The Audio Associates, 2820 N. 48th, Lincoln, Nebraska 68504. There will be *no* monetary compensation for samples sent; samples cannot be returned.

BLANK AUDIO & VIDEO CASSETTES: Direct from manufacturer: Below wholesale: Any length cassettes, four different qualities to choose from. BULK & REEL MASTERTAPE: From 1/4" to 2". Cassette duplication also available. BROCHURE. ANDOL AUDIO PRODUCTS, INC., 4212 14th AVE., DEPT. MR, BROOKLYN, N.Y. 11219. TOLL FREE #: 1-800-221-6578/N.Y. RES. 212-435-7322, ext. 2.

Professional Sound Labs
 110 N. Franklin St., Hempstead, N.Y. (516) 486-5813. Over 70 major lines of Pro Audio Products including: Urei, dbx, Otari, AB Systems, Ramsa, Sound Workshop, Audioarts, JBL Pro, Altec, AKG, Orban, Tascam 8516, Fostex and more. Large stocking inventory on Altec, JBL and EV diaphragms. Full repair and re-coning center in house. Authorized warranty service for Altec, JBL, EV, PAS. Get your best deal and then call us.

WOULD YOU LIKE TO LEARN THE GUITAR from the most respected teachers and performers playing today? Folk, Blues, Jazz, Bluegrass and many other styles are taught on cassette taped lessons. The teachers include John Renbourn, Stefan Grossman, Duck Baker, Dick Fegy, Eric Thompson, Barry Solomon, Ton Van Bergeyk, and Larry Coryell. For your free catalog please write to Stefan Grossman's Guitar Workshop, Box 804, Cooper Station, NY 10003.

AGFA MASTERTAPE AND CASSETTES. Super prices. Example: 1/4" x 2400' bulk = 9.82 and C-60 for 86¢ (case quantities). Send for wholesale price list. Solid Sound, Inc., Box 7611, Ann Arbor, Mich. 48105 (313) 662-0667.

QUALITY AUDIO COMPONENTS, MULTI-TRACK EQUIPMENT, PROGRAMMABLE CALCULATORS, ACCESSORIES. Competitive Pricing! Prompt Delivery! Knowledgeable Staff! Service Facility! Credit Cards Accepted. FREE Catalog. SOUND IDEAS, Dept. MR, P.O. Box 340, Cary, NC 27511. Call 919-467-8462.

Ecoplate, Master Room XL210, XL305, Symetrix, Valley People, Top Dollar on trades. Audiohouse 303-751-2268.

I'll buy your Tascam, Teac, UREI, Neumann, dbx, etc. 303-751-2268.

TASCAM MODEL 15 16 CHANNEL MIXING CONSOLE, MINT COND. FULL WARRANTY, \$6375. EAR PROFESSIONAL AUDIO. 602-968-8675.



ACOUSTIC TEST INSTRUMENTS
 USE TO ADJUST EQUALIZERS. OPTIMIZE SPEAKER PLACEMENT, ETC.

Complete Test Set	\$399
Calibrated Sound Level Meter	\$169
Fractional Octave Pink Noise Generator	\$299
Handbook on Acoustic Testing	\$6

Free broch. HALL ENGINEERING, Dept R4
 P.O. Box 506, Martinsville, NJ 08836
 (201) 647-0377

FOR SALE NEW: Beyer M600 \$165; M260 (2 ea) \$125; Shure SM59 (2 ea) \$110; SM56 (2 ea) \$110; JBL E120 (6 ea) \$107, E130 (2 ea) \$110, E140 (4 ea) \$112; 2220 (4 ea) \$115; 2402 Bullet (6 ea) \$88. Barney O'Kelly (614) 268-5643.

USED MINT CONDITION: Ashly SC80 4-way crossover \$235; JBL 2405 tweeter (12 ea) \$88; JBL 4602 stage monitor (4 ea) \$325; JBL 4680 columns w/2-2402, 4-E110 (2 ea) \$700. Barney O'Kelly (614) 268-5643.

Are you console hunting? How about a 16 into 4 matrix-mix board with 5 band input EQ, 2 monitor 8 2 effects sends, 3-way LED's on inputs, great internal reverb, phantom power, modular input, output AND effects modules, with optional plug-in compressor or stereo 10 band EQ? For around three grand? Cook Christian Supplies, 219 Prospect, Alma, Michigan 48801.

RECORD PRESSING, Fast quality service, package prices. King-Pin Record Pressing, 212 Roswell, Marietta, Ga. 30060. 404-428-5336.

WHY PAY MORE! CROWN PRESSURE ZONE MICS \$289. ELECTRO-VOICE, AKG AND SENNHEISER MICS AT DISCOUNT PRICES. CALL OR WRITE, ISLAND SALES, P.O. BOX 242, CLARKSBURG, MD. 20734. 301-972-1653.

RECORDING ENGINEER WANTED for midwest studio. Experience a must. Please send demo reel and resume to: TRIAXE, 2416 S. Walnut, Springfield, Ill. 62704.

WOW! THEY'RE GOING FAST! RUPERT'S COMMANDMENTS OF TAPE RECORDING-SECOND EDITION, AVAILABLE ON CASSETTE TAPE. STRAIGHT POOP FROM THAT BIG STUDIO IN THE SKY! SEND \$5.95 TO AUDIO CLOSET, 2820 NORTH 48TH, LINCOLN, NEBRASKA, 68504.

(Continued on page 92)

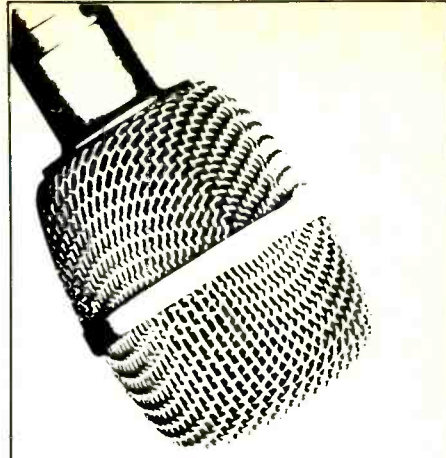

MODERN RECORDING & MUSIC

Because you are... creatively involved in how sound is produced and reproduced, and are serious about creating & recreating music both live & recorded.

Modern Recording & Music can help you develop your talent.

Subscribe Now.

MODERN RECORDING & MUSIC
 14 Vanderwater Ave. Port Washington, NY 11050
 (516) 883-5705

I wish to subscribe
 renew today and save up to \$20.80
 \$15.00 for 12 issues - Save \$8.40
 \$26.00 for 24 issues - Save \$20.80
 check money order
 enclosed for the amount of \$ _____

My account number is:
 VISA MASTERCARD

Exp. Date ---/---/---

NAME _____
 ADDRESS _____
 CITY _____
 STATE _____
 ZIP _____

(Foreign subscribers add \$3.00 for each year Foreign subscriptions payable ONLY in U.S. funds by international draft or money order)

Advertiser's Index

R.S. #	Page #
No # . . . AKG	15
131 . . . Alpha Audio	90
187 . . . Analog/Digital Associates	20
45 . . . Anvil	12
84 . . . Ashly Audio	18
142 . . . Auratone	27
No # . . . Bose	41
85 . . . Carvin	14
112 . . . Cetec Gauss	10
61 . . . Countryman	13
104 . . . Crown	11
88 . . . Dallas	89
92 . . . dbx	17
114 . . . DeltaLab	5
82 . . . Electro-Voice	7
188 . . . Esotech	26
74 . . . Furman Sound	26
150 . . . Institute of Audio/Video Engineering	14
No # . . . LT Sound	26
No # . . . LT Sound	87
79 . . . Maxell	4
79 . . . Mic Mix	29
136 . . . Mike Shop	86
No # . . . MXR	Cover 2
No # . . . MXR	49
64 . . . Omni Craft	88
156 . . . Otari	Cover 3
98 . . . Panasonic/PAD	63
89 . . . Peavey	23
153 . . . Phase Linear	58, 59
63 . . . Phoenix Audio Laboratories	24
126 . . . Polyline	85
179 . . . Pulsar	14
129 . . . Renkus Heinz	85
167 . . . Rhythm Tech	19
71 . . . RolandCorp US	2
124 . . . Sam Ash	86
166 . . . Sennheiser	85
116 . . . Sescom	86
No # . . . Sonic Rainbow Labs	42
75 . . . Sony	17
59 . . . Soundbox	87
No # . . . Soundcraft	43
94 . . . Sound Technology	9
83 . . . Studiomixer	1
189 . . . Tapco	25
77 . . . Tapco	83
67 . . . TDK	79
125 . . . Teac	37
190 . . . TOA Electronics	50, 51
110 . . . Whirlwind	8
99 . . . Yamaha	Cover 4

Use MODERN RECORDING & MUSIC

Classified Ads- They Get Results!

CATHEDRAL SOUND STUDIOS sells the best in Professional Recording and Reinforcement Sound Equipment. AB SYSTEMS, AKG, AMPEX (tape and recorders), ANVIL CASES, BEYER DYNAMIC, CLEAR-COM, COMMUNITY LIGHT & SOUND, dbx (150's in stock), ELECTRO-VOICE, FURMAN, HME WIRELESS SYSTEMS, KLARK-TEKNIK, OTARI, SOUNDCRAFT, SOUNDCRAFTSMEN, SYMETRIX, TAPCO, and a full line of bulk tape and cassettes, reels and boxes. We are also a full service duplicator facility. Call or write for a quote. 1575 5th Street, Rensselaer, New York 12144. (518) 465-5689.

Teac 3300SX-2T, Orban 111b, Orban 418A, rack mount unit for AKG BX10, DX4, dbx unit for 40-4. 303-751-2268.

FOR SALE JBL: 2420 (4 ea) \$155; 2470 (4 ea) \$165; 2482 (2 ea) \$315; 2441 (4 ea) \$345; 2231 15" (4 ea) \$117; 2202 12" (6 ea) \$108; 2105A 5" (16 ea) \$35; K-110 \$69. UREI 525 Crossover \$550; PHASE LINEAR X-20 Crossover \$250. MOST UNITS NEW. Barney O'Kelly (614) 268-5643.

Recording Engineer T-Shirts!!! 100% Cotton T-Shirts. Black with white letters that say, **Recording Engineers Always Get Knob Jobs.** State size (S, M, L, XL). Send \$5.95 + \$1.25 shipping and handling to: E-Shirts, P.O. Box 50556, Columbia, S.C. 29250. Money back guarantee.

FOR SALE: Yamaha M916 board with Anvil case, Yamaha equalizer and E1010 delay, JBL Cabaret (2) 4690, (2) 4695. Everything like new. (315) 262-2576.

WANTED: RECORDING EQUIPMENT OF ALL AGES & VARIETIES. Microphones, outboard gear, consoles, tape decks, etc. Dan Alexander, 245 Hyde St., San Francisco, CA 94102. (415) 441-8912.

JBL AND GAUSS SPEAKER WARRANTY CENTER. Fast emergency service. Speaker Recong and Repair. Compression driver diaphragms for immediate shipment. NEWCOME SOUND, 4684 Indianola Avenue, Columbus, OH 43214. 614-268-5605.

WANTED: McINTOSH, MARANTZ, AUDIO RESEARCH TUBE EQUIPMENT. MAURY, 713-728-4343.

SATIN PANTS, ETC. FOR ENTERTAINERS, ETC. WRITE-CALL FOR FREE CATALOG. SATIN SALES, DEPT. 7, 7 SOUTH 5TH STREET, MINNEAPOLIS, MINNESOTA 55402. 612-333-5045.

QUALITY RECORD PRESSING! JACKET PRINTING and FABRICATION. We do it all from your master tape! VP Records, Drawer 10-RM, Ville Platte, Louisiana 70586. (318) 363-2104.

YOU BUILD/WE BUILD - Inexpensive. Professional Quality, Mixers, Consoles, Outboard Equipment. Plans, Parts of Finished Product! MCP/DaviSound, Box 521, Newberry, S.C. 29108.

ALLEN & HEATH Mixers, FERROGRAPH recorders, pro-studio supplies, ICB AUDIO, Box 2752, Erlanger, KY 41018, 606-491-2421.

RECORDING ENGINEERING CORRESPONDENCE COURSE. An intense and comprehensive correspondence course based on the new, acclaimed textbook, "Sherman Keene's Practical Techniques for the Recording Engineer" is now available from the author. The course includes textbook study, additional reading, thought provoking homework assignments and question and answer dialog via cassette. There are eight lessons per level, three levels (Basic, Intermediate and Advanced) - \$250 per level. For complete information write to Sherman Keene Recording Course, 1626 N. Wilcox No. 677, Hollywood, Ca. 90028.

SUBSCRIBER SERVICE CHANGE OF ADDRESS

Planning to move? Please let us know six weeks in advance so you won't miss a single issue of Modern Recording & Music.

Attach old label and print new address in space provided. Also include your mailing label whenever you write concerning your subscription to insure prompt service on your inquiry.

Modern Recording & Music
14 Vanderverter Avenue
Port Washington, NY 11050

Attach
Label
Here

New Address Here

Please print

Name _____

Address _____

City _____ State _____

Date _____ Zip _____

"The performance and technology sold me. The sound of the '90 sold my clients."

Guy Costa, Vice President and Managing Director, Motown/Hitsville Studios

"When we first got our hands on the Otari MTF-90 we were impressed. The tape handling is superb. The production features are all there. The electronics and logic are to the highest standard we've come across in all the years of Motown's recording history.

But, as I've learned over the past nineteen years in this music recording business, it isn't just specs that count. The producers and artists have to like the way it sounds. A mastering multitrack machine has got to have a "musical" sound. Transparent. Clean. Performance that has to deliver everything possible — right up to the limitations of the tape.

I'd say that judging from the reactions of the creative people who record at Motown/Hitsville,



Otari's got a platinum record coming up for their New Workhorse.

And one added thing. We bought two because a lot of the music product is going 48 track. The '90 synchronizes beautifully through the AudioKnetics controller and interface. Now, all we have to do is figure out how we can juggle this year's budget to get four more!

If you use your ears for a living, use your head too. Listen to the Otari MTR-90. I did."

OTARI

Otari Electric Co., Ltd.
4-29-18 Minami Ogikubo
Suginami-ku-Tokyo 167
Phone: (03) 333-9631
Telex: OTRDENKI J26604
CIRCLE 156 ON FEEDER SERVICE CARD



HOLD IT BEFORE YOU BUY A COMPRESSION DRIVER.

Before you choose one of the "old standard" compression drivers, consider this — Yamaha's advanced technology and years of experience have produced a new standard — the JA-6681B high frequency compression driver. Engineered with subtle improvements that make a not-so-subtle improvement in performance and durability.

Yamaha's exclusive suspension consists of beryllium-copper fingers bonded to a rigid, pneumatically

formed aluminum diaphragm whose low mass yields optimum response and low distortion. Since extreme excursions cannot cause the suspension to "take a set," sound quality remains excellent throughout the driver's lifetime.

To deliver more sound per watt and long-term reliability, we use a very powerful ferrite magnet which retains the driver's high sensitivity through thousands of hours of severe use. An aluminum shorting ring prevents

magnetic flux modulation at power levels, further reducing distortion.

These are just a few of the reasons Yamaha outperforms and outlasts the others. For the whole story, write: Yamaha, P.O. Box 6600, Buena Park, CA 90622* Or visit your Yamaha dealer and hear the difference. You'll be glad you held out for a Yamaha.

Because you're serious.

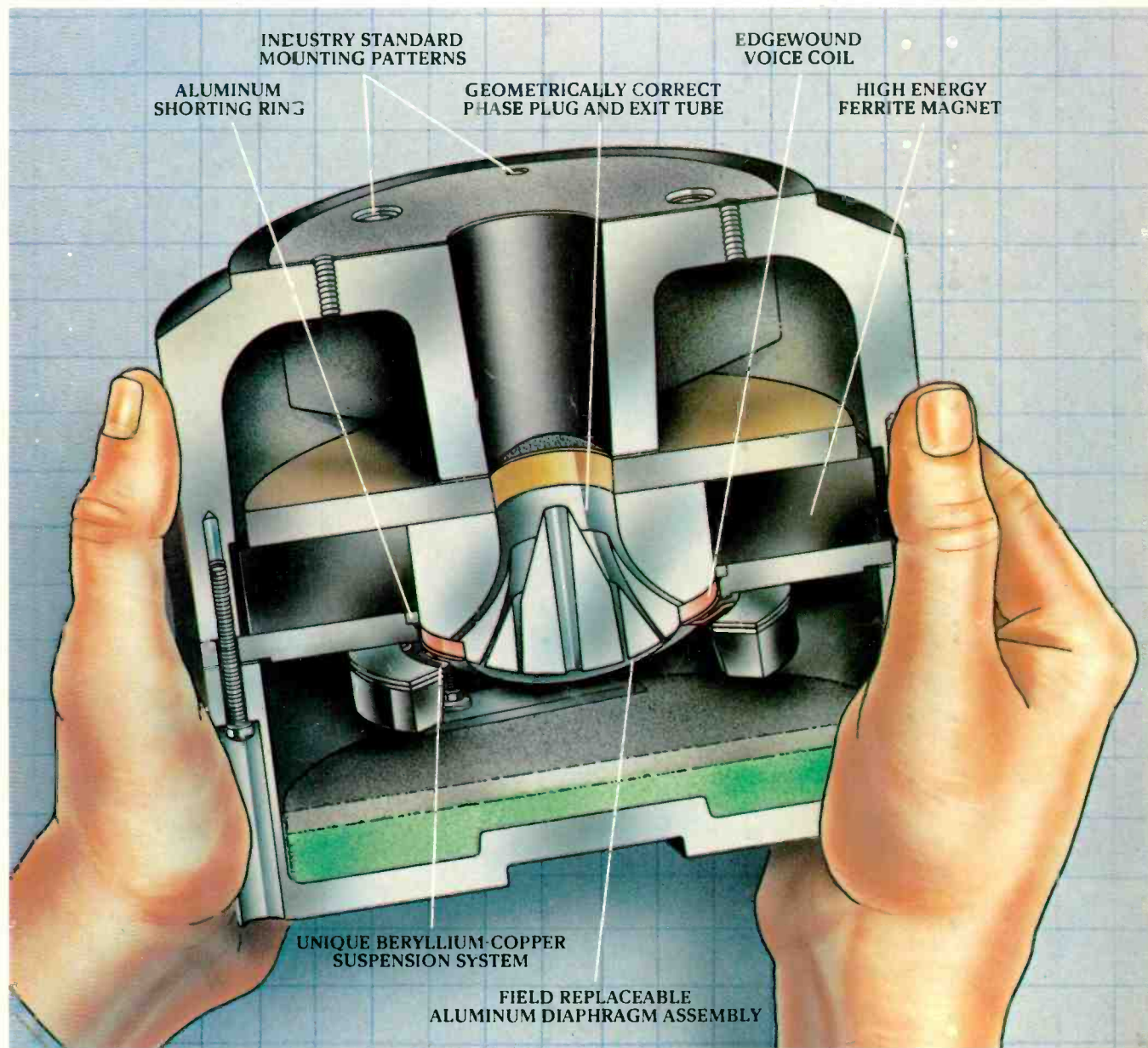

*Or Yamaha Canada Music Ltd., 135 Milner Ave., Scarborough, Ontario M1S 3R1.

