

Profile:
Boston's
Tom Scholz

MODERN RECORDING

#06691 (F)
\$1.50

SERVING TODAY'S MUSIC/RECORDING-CONSCIOUS SOCIETY

VOL. 4 NO. 10
JULY 1979

A Session with **KANSAS**



MUSICIANS:
Special Effects
What Goes Where
Negative Feedback
in Amplifiers

LAB REPORTS:
Pioneer CT-7800 Cassette Recorder
Scott 830Z Audio Analyzer
Yamaha M-4 Power Amplifier

HANDS-ON REPORT:
Studiomaster 16/4 Mixing Console

NEW PRODUCTS
RECORD REVIEWS

NY 11201
BROCKLYN
193 BAL TIC ST
D POMEROY
APOMED193BAL99
81/04/0

Imagination fuses two powerful illusions.

**Experimentation leads to the
discovery of new realities.**



Introducing the MXR Flanger/Doubler.
For more information see your MXR dealer or write us.

MXR Innovations, Inc., 247 N. Goodman Street,
Rochester, New York 14607, (716) 442-5320



**Professional
Products Group**

CIRCLE 94 ON READER SERVICE CARD



Fidgety

Well, fidgety really isn't the right word for it. What we're trying to say is that *Studiomaster* hasn't exactly been *sitting still* since we introduced our ultra-successful 16X4 mixing console over a year ago. So we've posed for a "group portrait" so that you can see what we mean.

As you can see, we now have a strong support team of professionally designed mixers for our 16X4 pioneer. They include a 12X2B with 5-way quasi-parametrically equalized *balanced* outputs for the master and monitor sends. A 20X8 monitor mixing console that allows any of the 20 input signals to be fully or partially assigned to any of the eight equalized output channels. And a 16X8 recording console with the same features as our 16X4, although with an 8 channel format. All of our mixers are *expandable*, of course, and come packed in aluminum flight cases.

We even have a rugged new fancooled stereo power amplifier which puts out 450 watts per channel into 4 ohms *all night long*, without a whimper. This amp has four protection circuits, is completely plug-in card serviceable, and is breathtakingly clean.

So now that makes *two* of us fidgety. We are . . . in spite of the new products we have, we're coming out with still more. And you are . . . because by now you can't wait to visit your closest dealer listed below and see them.

ALABAMA Nancie's Music 1917 5th Ave. No. Birmingham 35203 205-252-4498	(California) Guitar Center 7402 Sunset Blvd. Hollywood 90046 213-874-1060	COLORADO Solid Sound 1638 Pearl St. Boulder 80302 303-444-1738	(ILLINOIS) D.J.'s Music 5055 W. 31st St. Cicero 60650 312-865-7400	MINNESOTA Marguerite's Music 2419 10th Street Minnetonka 55660 216-235-7546	(NEW JERSEY) M&M Music 6600 Uchua Dr. Vineland 08360 609-691-9668	OKLAHOMA Driver Music 6600 N.W. 39th Expwy Bethany 73008 405-789-4711	TENNESSEE Strupp & Things in Memphis 1492 Union Memphis 38134 901-278-0500	(VIRGINIA) Rolls Music 1065 W. Broad St. Falls Church 22046 703-533-9500
ARIZONA Bill Fry's Music Center 8522 N. 7th Street Phoenix 85020 602-997-6293	Guitar Center 928 Van Ness Ave San Francisco 94109 415-441-4020	CONNECTICUT East Coast Sound 440 Candlewood New Milford 06776 203-354-1369	INDIANA I.R.C. Music Stores 5911 East 82nd St. Indianapolis 46218 317-849-7963	AVC Systems 1517 E. Lake St. Minneapolis 55407 612-729-8305	NEW YORK Whirlwind Music 100 Bomer St. Rockster 14612 716-683-8020	OREGON Portland Music 520 SW 5rd Portland 97204 503-226-3719	TEXAS Daan's Band Box 4305 Montana El Paso 79903 913-866-6675	WASHINGTON American Music Retailers 1459 Fremont No. Seattle 98105 206-633-1774
ARKANSAS Strum and Hum 7515 Geyer Springs Little Rock 72209 501-562-4731	Guitar Center 96 N. 2nd Street San Jose 95115 408-298-6336	FLORIDA Music City 311 W. Robinson Orlando 32801 305-423-4204	J.B.O. Productions 1701 N. Harrison St. Fort Wayne 46808 219-422-1976	GMS Music Cook Center, Terry Rd. Jackson 39212 601-573-1604	Audion by Zimet 1038 Northern Blvd. Roslyn 11576 516-421-0138	PENNSYLVANIA Cintoli Music Center 5359 Oxford Ave. Philadelphia 19124 215-742-4115	River City Music 6716 San Pedro San Antonio 78215 512-826-4101	WASHINGTON D.C. Washington Music Center 11131 Viers Mill Rd. Weston 20502 301-946-8806
WALL Sound 1115 R Street Sacramento 95814 916-444-8481	K&K Music 1904 W. San Carlos St. San Jose 95128 408-249-3760	WICHITA E.M. Shorts Guitars 2425 E. Douglas Wichita 67211 316-684-6252	KANSAS E.M. Shorts Guitars 2425 E. Douglas Wichita 67211 316-684-6252	GMS Music 1883 Jenny Ave. Pasadena 39567 601-769-2638	Musical Instrument Outlet 2511 Middle Country Rd. Greenshank 11720 516-485-7776	D.C. Short Sound Systems 239 Center Ave. Elsworth 15202 412-761-2724	Fasker Music Co. 5005 Gulf Freeway Houston 77025 713-923-9026	WEST VIRGINIA The Pied Piper 1200 3rd. Ave. Huntington 25701 800-642-3446 800-624-3498
California Musical Instrument 1019 E. Vermont Anaheim 92805 714-533-8610	WALL Sound 1115 R Street Sacramento 95814 916-444-8481	LOUISIANA Sound City 506 N. Carrollton Ave. New Orleans 70119 504-482-7891	MISSISSIPPI GMS Music 1883 Jenny Ave. Pasadena 39567 601-769-2638	Kubera Music 910 Fillmore Buffalo 14211 716-394-5190	Musical Instrument Outlet 2511 Middle Country Rd. Greenshank 11720 516-485-7776	Markham Music 1651 W. 26th St. Erie 16508 814-452-3340	Billy's Band Aid 150 Hamlet Shopping Cent. Amarillo 79107 805-383-3232	UTAH Guitar City Studios 470 N. 1100 W. Centerville 84014 801-292-3461
Audible Sound Systems 7858 Midfield Ave. Los Angeles 90045 213-670-1719	Skip's Music 2324 Florio Rd. Sacramento 95814 916-444-8481	MASSACHUSETTS K&L Pro Audio 28 Acton St. Watertown 02172 617-926-6100	MISSOURI Big Dude's Music City 3817 Broadway Kansas City 64111 816-931-4638	Specialized Audio Rd. 5, Rte. 50 & Hutchins Rd. Karatoga 12866 918-885-8966	Howard Early Music Center 217 L. Glendale-Milford Rd. Cincinnati 45241 513-569-0900	Swinsale Music 2035 Noble Pittsburgh 15218 412-351-5882	VERMONT Uncle Bob's Music 6633 W. Capitol Milwaukee 53216 414-462-2700	
Music City 1715 S. Low Ave. Tampa 33609 813-879-8327	Music City 2588 Atlantic Blvd. Jacksonville 32207 904-389-5789	NEW JERSEY Rondo Music Hwy. 22 at Vauxhall Rd. Ann Arbor 48104 913-994-0934	NEVADA Sovik Music 2854 N. High St. Columbus 43202 614-363-1991	Ohio The Music Connection 14512 Peck Strongsville 44136 916-238-6966	NEW YORK Whirlwind Music 100 Bomer St. Rockster 14612 716-683-8020	South Carolina Smith Music House 120 Magnolia St. Spartanburg 29301 803-582-4108	VERMONT Uncle Bob's Music 6633 W. Capitol Milwaukee 53216 414-462-2700	
Music City 2588 Atlantic Blvd. Jacksonville 32207 904-389-5789	Ace Music 13670 W. Dixie Highway N. Miami 33161 305-891-6201	MICHIGAN Hij James Enterprises 216 Catherine Ave. Ann Arbor 48104 913-994-0934	NEVADA Sovik Music 2854 N. High St. Columbus 43202 614-363-1991	OHIO The Music Connection 14512 Peck Strongsville 44136 916-238-6966	NEW YORK Whirlwind Music 100 Bomer St. Rockster 14612 716-683-8020	SOUTH CAROLINA Smith Music House 120 Magnolia St. Spartanburg 29301 803-582-4108	VERMONT Uncle Bob's Music 6633 W. Capitol Milwaukee 53216 414-462-2700	
AAA Swing City Music 1312 Vandusia Collinsville 62234 618-345-6700 914-421-1558	ILLINOIS AAA Swing City Music 1312 Vandusia Collinsville 62234 618-345-6700 914-421-1558	NEW JERSEY Rondo Music Hwy. 22 at Vauxhall Rd. Ann Arbor 48104 913-994-0934	NEVADA Sovik Music 2854 N. High St. Columbus 43202 614-363-1991	OHIO The Music Connection 14512 Peck Strongsville 44136 916-238-6966	NEW YORK Whirlwind Music 100 Bomer St. Rockster 14612 716-683-8020	SOUTH CAROLINA Smith Music House 120 Magnolia St. Spartanburg 29301 803-582-4108	VERMONT Uncle Bob's Music 6633 W. Capitol Milwaukee 53216 414-462-2700	
AAA Swing City Music 1312 Vandusia Collinsville 62234 618-345-6700 914-421-1558	ILLINOIS AAA Swing City Music 1312 Vandusia Collinsville 62234 618-345-6700 914-421-1558	NEW JERSEY Rondo Music Hwy. 22 at Vauxhall Rd. Ann Arbor 48104 913-994-0934	NEVADA Sovik Music 2854 N. High St. Columbus 43202 614-363-1991	OHIO The Music Connection 14512 Peck Strongsville 44136 916-238-6966	NEW YORK Whirlwind Music 100 Bomer St. Rockster 14612 716-683-8020	SOUTH CAROLINA Smith Music House 120 Magnolia St. Spartanburg 29301 803-582-4108	VERMONT Uncle Bob's Music 6633 W. Capitol Milwaukee 53216 414-462-2700	
AAA Swing City Music 1312 Vandusia Collinsville 62234 618-345-6700 914-421-1558	ILLINOIS AAA Swing City Music 1312 Vandusia Collinsville 62234 618-345-6700 914-421-1558	NEW JERSEY Rondo Music Hwy. 22 at Vauxhall Rd. Ann Arbor 48104 913-994-0934	NEVADA Sovik Music 2854 N. High St. Columbus 43202 614-363-1991	OHIO The Music Connection 14512 Peck Strongsville 44136 916-238-6966	NEW YORK Whirlwind Music 100 Bomer St. Rockster 14612 716-683-8020	SOUTH CAROLINA Smith Music House 120 Magnolia St. Spartanburg 29301 803-582-4108	VERMONT Uncle Bob's Music 6633 W. Capitol Milwaukee 53216 414-462-2700	
AAA Swing City Music 1312 Vandusia Collinsville 62234 618-345-6700 914-421-1558	ILLINOIS AAA Swing City Music 1312 Vandusia Collinsville 62234 618-345-6700 914-421-1558	NEW JERSEY Rondo Music Hwy. 22 at Vauxhall Rd. Ann Arbor 48104 913-994-0934	NEVADA Sovik Music 2854 N. High St. Columbus 43202 614-363-1991	OHIO The Music Connection 14512 Peck Strongsville 44136 916-238-6966	NEW YORK Whirlwind Music 100 Bomer St. Rockster 14612 716-683-8020	SOUTH CAROLINA Smith Music House 120 Magnolia St. Spartanburg 29301 803-582-4108	VERMONT Uncle Bob's Music 6633 W. Capitol Milwaukee 53216 414-462-2700	
AAA Swing City Music 1312 Vandusia Collinsville 62234 618-345-6700 914-421-1558	ILLINOIS AAA Swing City Music 1312 Vandusia Collinsville 62234 618-345-6700 914-421-1558	NEW JERSEY Rondo Music Hwy. 22 at Vauxhall Rd. Ann Arbor 48104 913-994-0934	NEVADA Sovik Music 2854 N. High St. Columbus 43202 614-363-1991	OHIO The Music Connection 14512 Peck Strongsville 44136 916-238-6966	NEW YORK Whirlwind Music 100 Bomer St. Rockster 14612 716-683-8020	SOUTH CAROLINA Smith Music House 120 Magnolia St. Spartanburg 29301 803-582-4108	VERMONT Uncle Bob's Music 6633 W. Capitol Milwaukee 53216 414-462-2700	
AAA Swing City Music 1312 Vandusia Collinsville 62234 618-345-6700 914-421-1558	ILLINOIS AAA Swing City Music 1312 Vandusia Collinsville 62234 618-345-6700 914-421-1558	NEW JERSEY Rondo Music Hwy. 22 at Vauxhall Rd. Ann Arbor 48104 913-994-0934	NEVADA Sovik Music 2854 N. High St. Columbus 43202 614-363-1991	OHIO The Music Connection 14512 Peck Strongsville 44136 916-238-6966	NEW YORK Whirlwind Music 100 Bomer St. Rockster 14612 716-683-8020	SOUTH CAROLINA Smith Music House 120 Magnolia St. Spartanburg 29301 803-582-4108	VERMONT Uncle Bob's Music 6633 W. Capitol Milwaukee 53216 414-462-2700	
AAA Swing City Music 1312 Vandusia Collinsville 62234 618-345-6700 914-421-1558	ILLINOIS AAA Swing City Music 1312 Vandusia Collinsville 62234 618-345-6700 914-421-1558	NEW JERSEY Rondo Music Hwy. 22 at Vauxhall Rd. Ann Arbor 48104 913-994-0934	NEVADA Sovik Music 2854 N. High St. Columbus 43202 614-363-1991	OHIO The Music Connection 14512 Peck Strongsville 44136 916-238-6966	NEW YORK Whirlwind Music 100 Bomer St. Rockster 14612 716-683-8020	SOUTH CAROLINA Smith Music House 120 Magnolia St. Spartanburg 29301 803-582-4108	VERMONT Uncle Bob's Music 6633 W. Capitol Milwaukee 53216 414-462-2700	
AAA Swing City Music 1312 Vandusia Collinsville 62234 618-345-6700 914-421-1558	ILLINOIS AAA Swing City Music 1312 Vandusia Collinsville 62234 618-345-6700 914-421-1558	NEW JERSEY Rondo Music Hwy. 22 at Vauxhall Rd. Ann Arbor 48104 913-994-0934	NEVADA Sovik Music 2854 N. High St. Columbus 43202 614-363-1991	OHIO The Music Connection 14512 Peck Strongsville 44136 916-238-6966	NEW YORK Whirlwind Music 100 Bomer St. Rockster 14612 716-683-8020	SOUTH CAROLINA Smith Music House 120 Magnolia St. Spartanburg 29301 803-582-4108	VERMONT Uncle Bob's Music 6633 W. Capitol Milwaukee 53216 414-462-2700	
AAA Swing City Music 1312 Vandusia Collinsville 62234 618-345-6700 914-421-1558	ILLINOIS AAA Swing City Music 1312 Vandusia Collinsville 62234 618-345-6700 914-421-1558	NEW JERSEY Rondo Music Hwy. 22 at Vauxhall Rd. Ann Arbor 48104 913-994-0934	NEVADA Sovik Music 2854 N. High St. Columbus 43202 614-363-1991	OHIO The Music Connection 14512 Peck Strongsville 44136 916-238-6966	NEW YORK Whirlwind Music 100 Bomer St. Rockster 14612 716-683-8020	SOUTH CAROLINA Smith Music House 120 Magnolia St. Spartanburg 29301 803-582-4108	VERMONT Uncle Bob's Music 6633 W. Capitol Milwaukee 53216 414-462-2700	
AAA Swing City Music 1312 Vandusia Collinsville 62234 618-345-6700 914-421-1558	ILLINOIS AAA Swing City Music 1312 Vandusia Collinsville 62234 618-345-6700 914-421-1558	NEW JERSEY Rondo Music Hwy. 22 at Vauxhall Rd. Ann Arbor 48104 913-994-0934	NEVADA Sovik Music 2854 N. High St. Columbus 43202 614-363-1991	OHIO The Music Connection 14512 Peck Strongsville 44136 916-238-6966	NEW YORK Whirlwind Music 100 Bomer St. Rockster 14612 716-683-8020	SOUTH CAROLINA Smith Music House 120 Magnolia St. Spartanburg 29301 803-582-4108	VERMONT Uncle Bob's Music 6633 W. Capitol Milwaukee 53216 414-462-2700	
AAA Swing City Music 1312 Vandusia Collinsville 62234 618-345-6700 914-421-1558	ILLINOIS AAA Swing City Music 1312 Vandusia Collinsville 62234 618-345-6700 914-421-1558	NEW JERSEY Rondo Music Hwy. 22 at Vauxhall Rd. Ann Arbor 48104 913-994-0934	NEVADA Sovik Music 2854 N. High St. Columbus 43202 614-363-1991	OHIO The Music Connection 14512 Peck Strongsville 44136 916-238-6966	NEW YORK Whirlwind Music 100 Bomer St. Rockster 14612 716-683-8020	SOUTH CAROLINA Smith Music House 120 Magnolia St. Spartanburg 29301 803-582-4108	VERMONT Uncle Bob's Music 6633 W. Capitol Milwaukee 53216 414-462-2700	
AAA Swing City Music 1312 Vandusia Collinsville 62234 618-345-6700 914-421-1558	ILLINOIS AAA Swing City Music 1312 Vandusia Collinsville 62234 618-345-6700 914-421-1558	NEW JERSEY Rondo Music Hwy. 22 at Vauxhall Rd. Ann Arbor 48104 913-994-0934	NEVADA Sovik Music 2854 N. High St. Columbus 43202 614-363-1991	OHIO The Music Connection 14512 Peck Strongsville 44136 916-238-6966	NEW YORK Whirlwind Music 100 Bomer St. Rockster 14612 716-683-8020	SOUTH CAROLINA Smith Music House 120 Magnolia St. Spartanburg 29301 803-582-4108	VERMONT Uncle Bob's Music 6633 W. Capitol Milwaukee 53216 414-462-2700	
AAA Swing City Music 1312 Vandusia Collinsville 62234 618-345-6700 914-421-1558	ILLINOIS AAA Swing City Music 1312 Vandusia Collinsville 62234 618-345-6700 914-421-1558	NEW JERSEY Rondo Music Hwy. 22 at Vauxhall Rd. Ann Arbor 48104 913-994-0934	NEVADA Sovik Music 2854 N. High St. Columbus 43202 614-363-1991	OHIO The Music Connection 14512 Peck Strongsville 44136 916-238-6966	NEW YORK Whirlwind Music 100 Bomer St. Rockster 14612 716-683-8020	SOUTH CAROLINA Smith Music House 120 Magnolia St. Spartanburg 29301 803-582-4108	VERMONT Uncle Bob's Music 6633 W. Capitol Milwaukee 53216 414-462-2700	
AAA Swing City Music 1312 Vandusia Collinsville 62234 618-345-6700 914-421-1558	ILLINOIS AAA Swing City Music 1312 Vandusia Collinsville 62234 618-345-6700 914-421-1558	NEW JERSEY Rondo Music Hwy. 22 at Vauxhall Rd. Ann Arbor 48104 913-994-0934	NEVADA Sovik Music 2854 N. High St. Columbus 43202 614-363-1991	OHIO The Music Connection 14512 Peck Strongsville 44136 916-238-6966	NEW YORK Whirlwind Music 100 Bomer St. Rockster 14612 716-683-8020	SOUTH CAROLINA Smith Music House 120 Magnolia St. Spartanburg 29301 803-582-4108	VERMONT Uncle Bob's Music 6633 W. Capitol Milwaukee 53216 414-462-2700	
AAA Swing City Music 1312 Vandusia Collinsville 62234 618-345-6700 914-421-1558	ILLINOIS AAA Swing City Music 1312 Vandusia Collinsville 62234 618-345-6700 914-421-1558	NEW JERSEY Rondo Music Hwy. 22 at Vauxhall Rd. Ann Arbor 48104 913-994-0934	NEVADA Sovik Music 2854 N. High St. Columbus 43202 614-363-1991	OHIO The Music Connection 14512 Peck Strongsville 44136 916-238-6966	NEW YORK Whirlwind Music 100 Bomer St. Rockster 14612 716-683-8020	SOUTH CAROLINA Smith Music House 120 Magnolia St. Spartanburg 29301 803-582-4108	VERMONT Uncle Bob's Music 6633 W. Capitol Milwaukee 53216 414-462-2700	
AAA Swing City Music 1312 Vandusia Collinsville 62234 618-345-6700 914-421-1558	ILLINOIS AAA Swing City Music 1312 Vandusia Collinsville 62234 618-345-6700 914-421-1558	NEW JERSEY Rondo Music Hwy. 22 at Vauxhall Rd. Ann Arbor 48104 913-994-0934	NEVADA Sovik Music 2854 N. High St. Columbus 43202 614-363-1991	OHIO The Music Connection 14512 Peck Strongsville 44136 916-238-6966	NEW YORK Whirlwind Music 100 Bomer St. Rockster 14612 716-683-8020	SOUTH CAROLINA Smith Music House 120 Magnolia St. Spartanburg 29301 803-582-4108	VERMONT Uncle Bob's Music 6633 W. Capitol Milwaukee 53216 414-462-2700	
AAA Swing City Music 1312 Vandusia Collinsville 62234 618-345-6700 914-421-1558	ILLINOIS AAA Swing City Music 1312 Vandusia Collinsville 62234 618-345-6700 914-421-1558	NEW JERSEY Rondo Music Hwy. 22 at Vauxhall Rd. Ann Arbor 48104 913-994-0934	NEVADA Sovik Music 2854 N. High St. Columbus 43202 614-363-1991	OHIO The Music Connection 14512 Peck Strongsville 44136 916-238-6966	NEW YORK Whirlwind Music 100 Bomer St. Rockster 14612 716-683-8020	SOUTH CAROLINA Smith Music House 120 Magnolia St. Spartanburg 29301 803-582-4108	VERMONT Uncle Bob's Music 6633 W. Capitol Milwaukee 53216 414-462-2700	
AAA Swing City Music 1312 Vandusia Collinsville 62234 618-345-6700 914-421-1558	ILLINOIS AAA Swing City Music 1312 Vandusia Collinsville 62234 618-345-6700 914-421-1558	NEW JERSEY Rondo Music Hwy. 22 at Vauxhall Rd. Ann Arbor 48104 913-994-0934	NEVADA S					

**Whichever half-inch 8 track machine you choose,
the Sound Workshop 1280 remains the
most together recording console in its field.**



The 1280B-8EQ with optional Meter Bridge



the Sound Workshop 1280 recording console

Sound Workshop
PROFESSIONAL AUDIO PRODUCTS

CIRCLE 95 ON READER SERVICE CARD

1324 Motor Parkway, Hauppauge, New York 11787 (516) 582-6210

It sounds better.

MODERN RECORDING

JULY 1979
VOL. 4 NO. 10

SERVING TODAY'S MUSIC/RECORDING-CONSCIOUS SOCIETY

THE FEATURES

THE GREAT PEDAL PUZZLE

By Brian A. Roth

52

The proliferation of special effects pedals for the musician has brought a bit of bad news along with all that capacity to create new sounds: mainly, what the heck do we do with them all!?! Which ones do we plug into which ones?

A SESSION WITH KANSAS

By Murray M. Silver, Jr.

58

A quietly successful group, Kansas has made a name for itself as a quality outfit. This session covers some of the new techniques that the group is utilizing in an attempt to explore fresh ground.

THE IMPACT OF NEGATIVE FEEDBACK ON THE TONE QUALITY OF AMPLIFIERS

By Robert E. Furst

66

Modern Recording and Mr. Furst look at how the use of negative feedback in amplifier circuitry has created new specifications for audio equipment.

PROFILE: TOM SCHOLZ

By Gil Podolinsky

72

Rock's Boston generated an almost unheard of amount of popularity for a new act on the scene when it first broke out. Tom Scholz, Boston's founder and lead guitarist—and non-stop workaholic—is a low profile sort who has problems understanding his label as “rock 'n' roll's boy wonder.”

COMING NEXT ISSUE!

The J. Geils Band “Live!”

What to Do With Those Studio

Special Effects



THE STAPLES

LETTERS TO THE EDITOR

6

TALKBACK

The technical Q & A scene.

28

THE PRODUCT SCENE

By Norman Eisenberg

The notable and the new, with a comment on so-called “bookshelf” speakers.

42

MUSICAL NEWSICALS

By Fred Ridder

New products for the musician.

46

AMBIENT SOUND

By Len Feldman

Some new and follow-up thoughts on “time delay, reverb and other reflections.”

82

LAB REPORT

By Norman Eisenberg

and Len Feldman

Pioneer CT-F800 Cassette Deck

Scott 830Z Audio Analyzer

Yamaha M-4 Power Amplifier

84

HANDS-ON REPORT

By Jim Ford

and John Murphy

Studiomaster 16/4 Mixing Console

92

GROOVE VIEWS

Reviews of albums by Chick Corea & Herbie Hancock, Gary Burton, Charlie Parker, the Grateful Dead, the Bliss Band, Rory Gallagher and Jiva.

98

ADVERTISER'S INDEX

126

Cover photo: Neil Preston
Kansas photos: Murray M. Silver, Jr.
Tom Scholz photo: Courtesy Epic records

Modern Recording (ISSN 0361-0004) is published monthly by Cowan Publishing Corp., 14 Vanderventer Ave., Port Washington, N.Y. 11050. Design and contents are copyright 1979 by Cowan Publishing Corp., and must not be reproduced in any manner except by permission of the publisher. Second class postage paid at Port Washington, New York, and at additional mailing offices. Subscription rates: \$12.00 for 12 issues; \$22.00 for 24 issues. Add \$3.00 per year for subscriptions outside of U.S. Subscriptions must be paid in American currency. Postmaster: Send Form 3579 to *Modern Recording*, Cowan Publishing Corp., 14 Vanderventer Ave., Port Washington, N.Y. 11050.

H.G. La TORRE
Editor

**PAM HIGHTON
AUDREY KURLAND**
Assistant Editors

**NORMAN EISENBERG
LEONARD FELDMAN
JIM FORD
JOHN MURPHY
BRIAN ROTH**
Technical Editors

**ROBERT ANGUS
NAT HENTOFF
DAVID MOYSSIADIS
FRED RIDDER
PETER WEISS**
Contributing Editors

**SEDGWICK CLARK
JOE KLEE
RUSSELL SHAW**
Music Reviewers

LORI RESSA
Production Manager

**BONNIE BRENNAN
CHRIS KELLY
KIM SMITH**
Production Staff

BILL TRAVIS
Art Director

**KAREN JENSEN
HAROLD PERRY
LIZ RYAN
BARRY SIMON**
Art Staff

JANET KURTZ
Circulation Manager

MELANIE DEUTSCH
Assistant to the Publisher

BILL SLAPIN
West Coast
Advertising Representative

MYLES GROSSMAN
Advertising Director

VINCENT P. TESTA
Publisher

Editorial and Executive Offices
Modern Recording
14 Vanderventer Ave.
Port Washington, N.Y. 11050
516-883-5705

COWAN PUBLISHING CORP.
RICHARD A. COWAN Chairman of the Board & President
CARY L. COWAN Vice President
JACK N. SCHNEIDER Vice President, Marketing
RICHARD A. ROSS Vice President, General Manager
MARC L. GILMAN Credit Manager
AMY C. GILMAN Secretary/Treasurer
SANFORD R. COWAN Founder & President Emeritus

Editorial contributions should be addressed to
The Editor, Modern Recording, 14 Vanderventer
Ave., Port Washington, N.Y. 11050. Unsolicited
manuscripts will be treated with care and must be
accompanied by return postage.

LETTERS TO THE EDITOR

Historical Perspective, and More

We couldn't let the overwhelming response to Keith Evans ("Talkback," Modern Recording, March 1979, page 22) go without further acknowledging the letter-writers, one of whom gives detailed perspective to the workings of this industry, and two others, whose input may be helpful to Mr. Evans, who is, by now, quite a celebrity—in these columns, at least. The letters:

More than any other company in the world, Presto was responsible for introducing and developing the lacquer recording disc, without which high quality disc cutting would be far more difficult. It's a shame that the industry's memory is not longer.

Presto did not merely "produce a line of budget-priced lathes even before the mass manufacture of tape recorders." They had a full line of machines which included some fully professional stationary units which could be found in a large percentage of recording studios and radio stations. It was originally founded by Morris Gruber and Aaron Benjamin as Presto Machine Products Co. in the 1920's to make phonograph parts. In 1927 they advertised kits to build radio-facsimile receivers using Austin G. Cooley's Ray-Foto system. They were introduced to recording when Edgar H. Felix of *Radio Broadcast Magazine* made recordings of these pictures on a wax cylinder dictating machine. By 1930, Presto was selling kits and machines to make recordings on discs of bare aluminum with a diamond embossing stylus. The company went under when the depression ruined the economy, and for a while the partners became the Duall Engineering Co., but in October, 1933 they reformed as the Presto Recording Corp. with an additional partner. George Saliba had written a series of articles in *Radio-Craft* in 1930 and 1931 describing all the current systems of instantaneous recording, and when he joined Presto he was in the process of developing an improved system.

Discarding the use of gelatin and celluloid sheets for various reasons, Saliba developed discs with lacquer coated on an aluminum base. They were introduced in October 1934, and by July 1936 Presto could announce that "87% of all instantaneous station recordings are made on Presto Green Seal Discs" and "92% of all stations using instantaneous recording installations are Presto equipped." The first Presto discs were hand-sprayed in their Manhattan plant and are identifiable by the lacquer extending all the way to the center hole. The Green Seal discs were made in the Newark plant by dipping, and these do not have any lacquer coating near the center of the disc. A green label was painted on. A new lacquer formula, known as the "Q lacquer" was introduced in July 1938, and in 1939 they set up a new plant in Paramus, New Jersey to coat the discs by passing them on a conveyer belt through a falling curtain of lacquer. It is this system they used through the time the company was sold to Bogen on July 1, 1956. That building is now a furniture store on Route 4, right next to the Lear-Siegler building—the company which has since taken over Bogen-Presto.

There are indications that Pyral in France and Cecil Watts of Marguarette Sound Studios in England were also doing experiments using coated discs in the early 1930's, but I have been

Why settle for a copy...



when Tangent gives you the original?

Why settle for an imperfect copy of your sound, when Tangent will give your audience the original?

Tangent's crystal-clear transparency allows your original to flow cleanly to your listeners, with only the coloration that you add.

And beyond this foundation of solid quality, Tangent's "a" series mixers give you these features found previously only on recording consoles:

SOLO

Listen to any input by itself, or preview an entire group. Pushing ANY solo button automatically puts that channel into the headphones, no matter what signal was there before. Electronic FET switching makes this possible.

MODULARITY

Tangent consoles are totally modular for servicing ease. Take a spare module on the road for no down time.

100mm SLIDERS

Tangent uses 100mm long-throw faders for extra control and visual feedback. Compare these to the competition's usual 45mm or 60mm length.

THREE SENDS

Effects, Reverb, and Monitor sends on each channel act as three independent mixers-within-a-mixer. Compare Tangent's three send busses to other mixers having typically just one or two.

CHANNEL PATCHING

Each input has a pair of access jacks for patching external effects into a single channel or sending a direct feed to a multi-channel tape machine.

LOTS OF EXTRAS

Tangent also has totally balanced inputs and outputs, buss access jacks for slave mixer expandability, and an optional reverb that is one of the smoothest sounding spring units available.

Compare these features to those on consoles costing twice as much and you'll see what a value Tangent is.

As for comparing the quality, well, you just can't get better than the original.

Write or call for your nearest dealer.

tangent 
musical engineering

2810 south 24th street
phoenix, arizona 85034
602-267-0653

CIRCLE 75 ON READER SERVICE CARD

www.americanradiohistory.com

WHEN YOU KNOW HOW THEY'RE BUILT, YOU'LL KNOW WHY THEY'RE BETTER.

Specially designed compliance to insure full linear travel without fatigue or cracking.

Rigid-spoke cast aluminum frame.

Unique double-spider system guarantees centering of the voice coil, and, coil alignment in the gap during high power operation at all frequencies.

Machine edgewound copper or aluminum voice coil.

Anodized aluminum voice coil support to transmit and dissipate heat in high power operation.

Voice coil wire terminates at flex lead on the voice coil tube to eliminate breakage.



If you're a professional, you look for clean sound, more sound pressure, and speakers that will stand up to 200 watts of continuous sine wave power. That's what you get from Gauss. Performance.

What's more, Gauss now offers you a full line of professional speakers and monitors, compression drivers and tweeters. Plus studio and disco monitors and horns. Built the Gauss way. For professionals.

Our unique "double-spider" system is just one example. By positively centering and aligning the voice coil, we virtually eliminate the blowouts that are common with less expensive speakers. And yes, you'll pay more for Gauss. But you'll get two things you won't get with those other speakers, the Gauss Warranty... and peace of mind.

Ask your professional sound equipment dealer why Gauss travels with the biggest names on the road. He'll tell you how they're better speakers. And why.

gauss by Cetec

CETEC GAUSS
13035 Saricoy Street
North Hollywood, CA 91605
(213) 875-1900
TWX: 910-499-2669

CETEC INTERNATIONAL LTD.
16 Uxbridge Road
Ealing, London W5 2BP, England
01-579-9145
TLX: 935847
Divisions of Cetec Corporation

CIRCLE 112 ON READER SERVICE CARD

unable to *authoritatively* place the exact dates of their experiments. Apparently no patents were issued on the basic lacquer disc because all of the individual provisions of the system are based on prior techniques. There also were several German systems of coated discs known as the Simplat and Permarec, but these apparently needed chemical softening before recording and/or baking after recording. All of Presto's American competitors postdate Presto in the introduction of coated discs, and some were even founded by Presto's ex-employees.

As I indicated earlier, there was a great diversity in the types of machines manufactured by Presto. The earliest was merely an embossing head that rested on a feedscrew device. By the mid-1930's they had a line of single case portable units for amateurs, multi-case professional portable machines, and a very large (and ugly) studio machine costing over a thousand depression dollars. Presto machines were installed by NBC in 1935 and WOR/Mutual in 1936. It was a Presto professional portable machine which was on the scene in Lakehurst, New Jersey in May 1937 to record Herbert Morrison's eyewitness description of the Hindenburg disaster. (It was *not* a live broadcast.) The four original Presto Green Seal 16" discs made on the scene that evening are now safely tucked away in the National Archives.

I have made a microfilm of a large collection of Presto catalogues, brochures, and instruction/repair manuals. Many of the pre-war manuals were reprinted in slightly altered form in John F. Rider's *Automatic Record Changers and Recorders* which went to press the week before Pearl Harbor day. The 1C cutter head was introduced about 1939 and had a frequency response to 8,000 cycles per second. The 1D came just after the war and was designed to drop off above 12,000 cycles per second. I have not been able to fully identify Keith Evans' machine from the letters GN CSE. It could be the amateur Model G, but more likely it is a misreading of the professional models 6N or 8N. These were available uncased, in a portable case, or in a console, thus the letters CSE might have been a casing designation.

I hope that this has been of interest and of help to you.

—Michael Biel
Assistant Professor
Morehead State Univ.
Morehead, Ky.

MODERN RECORDING

0.05%
NAB WRMS

0.05%
NAB WRMS

Neatness counts.

You are looking at graphic measurements of wow and flutter in two different cassette decks. The nice, neat one is ours. The one with the funny spikes is the competition. What is really interesting about this comparison is that the numerical specification for wow and flutter for both machines is identical: 0.05 percent.

How can that be?

The reason is that conventional measurements do not account for some kinds of disturbances caused by momentary tape speed variations. Many manufacturers simply ignore or overlook the spikes. We don't. Because we can hear them. And

if we can hear them, you can hear them. So we build tighter tolerances into our parts—such as our precision-machined reel tables and shafts that prevent cogging of the cassette hubs. The fact is that we use a lot of unconventional methods of getting rid of a lot of conventionally ignored distortions.

We figure our most important test instrument is our ears. You can build good cassette decks in the laboratory. But you build great ones in the listening room. That's why our engineers listen, under dynamic test conditions, to every single electrical and mechanical component of our cassette decks

that can affect the texture of the sound you hear.

You'll find that every one of the new Harman Kardon cassette decks has the features, specifications, the look and the feel you'd expect from equipment made by one of the world's great high fidelity manufacturers.

But you'll find something else too.

The clean, open sound that comes on only when a company listens and pays attention to details that others tend to overlook.

That's what makes us so neat.

Come listen soon.



harman/kardon
Hear all the music.

55 Ames Court
Plainview NY 11803

CIRCLE 71 ON READER SERVICE CARD

Pictured: The new hk3500 Dolby® cassette deck. Not shown: Models hk1500 and hk2500.

The wave of tomorrow.

There's one consistently great performance after another in your future. Because Fender® introduces new Studio Bass Strings.

You can put your fingers right on the advantages—an unmatched continuity of tonal response from first string to fourth, greater sustain, added brilliance and superb attack.

That's not just a claim. Any scope will confirm what your ears already tell you.

You can put your fingers on the reasons why Studio Bass Strings will open up a whole new age in bass playing, too. You see, they're made a new way—with *double-reverse* nickel windings on a Swedish Steel hex core. The wrapping holds tighter for a sound that's brighter.

So treat yourself to a couple of sets of flat wound or round wound Fender Studio Bass Strings in light, medium or heavy gauges. Also available for 30" *short scale* basses.

They'll never let you down. Because nothing else measures up. See your Fender Strings dealer today.

Fender®
Strings

make any bass more bass

CIRCLE 56 ON READER SERVICE CARD

©1979 CBS Inc.



In response to the "Talkback" column headed "Golden Oldie," the following info might be helpful.

First off, I believe the lathe is incorrectly identified. It is not a Presto GN, but a model 6N. The lathe was generally available in a portable case, which made it useful for both studio and remote sessions. Its cost was about \$1200.00. There was hardly a radio station that didn't have a lathe back in those days before tape recorders. The big stations usually had a Scully in the control room and used the Presto for field recording. The smaller stations were all using the Presto. Similar lathes were available from RCA, Fairchild, Van Epps, Arcturus, and Rec-O-Cut.

The Presto 6N is similar to the model 8N and 8DG, the main difference being the drive system for the feedscrew. The 6N had a pedestal which contacted the center of the record, and through a gear system caused the feedscrew to turn. The model 8 lathes made no contact with the center of the record, but had a flexible shaft which ran from the overhead support post to a power takeoff on the turntable drive motor. The other difference between the two was that the 6N had two round bars for

the carriage to ride on, while the 8N had one flat engine-turned bar for the same function.

These two lathes use the same feedscrew, which was available in pitches of from 96 to 240 lines per inch, the 96 being a coarse 78 rpm pitch and the 240 for microgroove.

The 6N lathe was a two speed machine, 78 and 33-1/3 rpm. It could be converted to 45 rpm by removing the 78 rpm drive puck and replacing it with one for 45 rpm.

Now for the cutters. You mentioned that the lathe included both the type C and type D heads, so you obviously don't need the Audak 8H head that Mr. Porterfield suggested. It was quite inferior to the Presto heads anyway. Both Presto heads you have are similar in construction; the type D being the last and most refined of the Presto monophonic cutters. Both are "non-feedback" heads, in that they had only drive coils and no feedback windings. To control frequency response without feedback windings, Presto employed a synthetic rubber damping material called Presto-flex. It was placed on the back of the cutter under a metal plate which had adjusting screws. You would

cut a band of frequencies to check the response of the cutter, and tighten the various screws on the back of the cutter 'til the "Christmas tree" light pattern indicated flat response.

For cutting styli, a standard microgroove with 87 degree angle will take care all of your cutting. The #20 stylus was the number system used by Audio Point back when they made styli. Your lathe probably isn't set up for hot stylus cutting, which would require a vacuum pump, chip jar, and chip pickup tube. These are easy to implement and are advised, as hot stylus recording provides both lower noise and increased stylus life, as well.

It is not advised to try cutting any discs with hot stylus unless you do have a vacuum system to remove the chip. You don't know what fun is until you've had the experience of having a disc go up in smoke due to the chip getting caught up in the heater wires!

As to the fate of the Presto firm, I believe they merged with the Bogen Co. to become Bogen/Presto. The last lathe they made was in about 1958, when they came out with the model 8DG, which was similar in looks to a Scully with an overhead. The last cut-



Finally, full-range compacts that deliver

concert reinforcement SPLs with frequency linearity comparable to the finest studio monitors. Our new MK series compact systems sound great in any near-field application, and we optimize driver selection from among the world's best to meet your needs for portable PA; stage, keyboard or instrument monitor; or disco use.

The MK compact systems survive the long-term rigors of the road with their 18 ply-per-inch genuine hardwood structure, scuff and water resistant exterior, extruded edge rails with roadie type corners, large recessed handles and latching tour cover.

For complete information and dealer list on the MK compact systems, call or write us for the "works".

Eastern Acoustic Works, Inc.

59 Fountain Street, Box 111, Framingham, Massachusetts 01701/(617)620-1478

CIRCLE 42 ON READER SERVICE CARD

The TDK machine because it moves

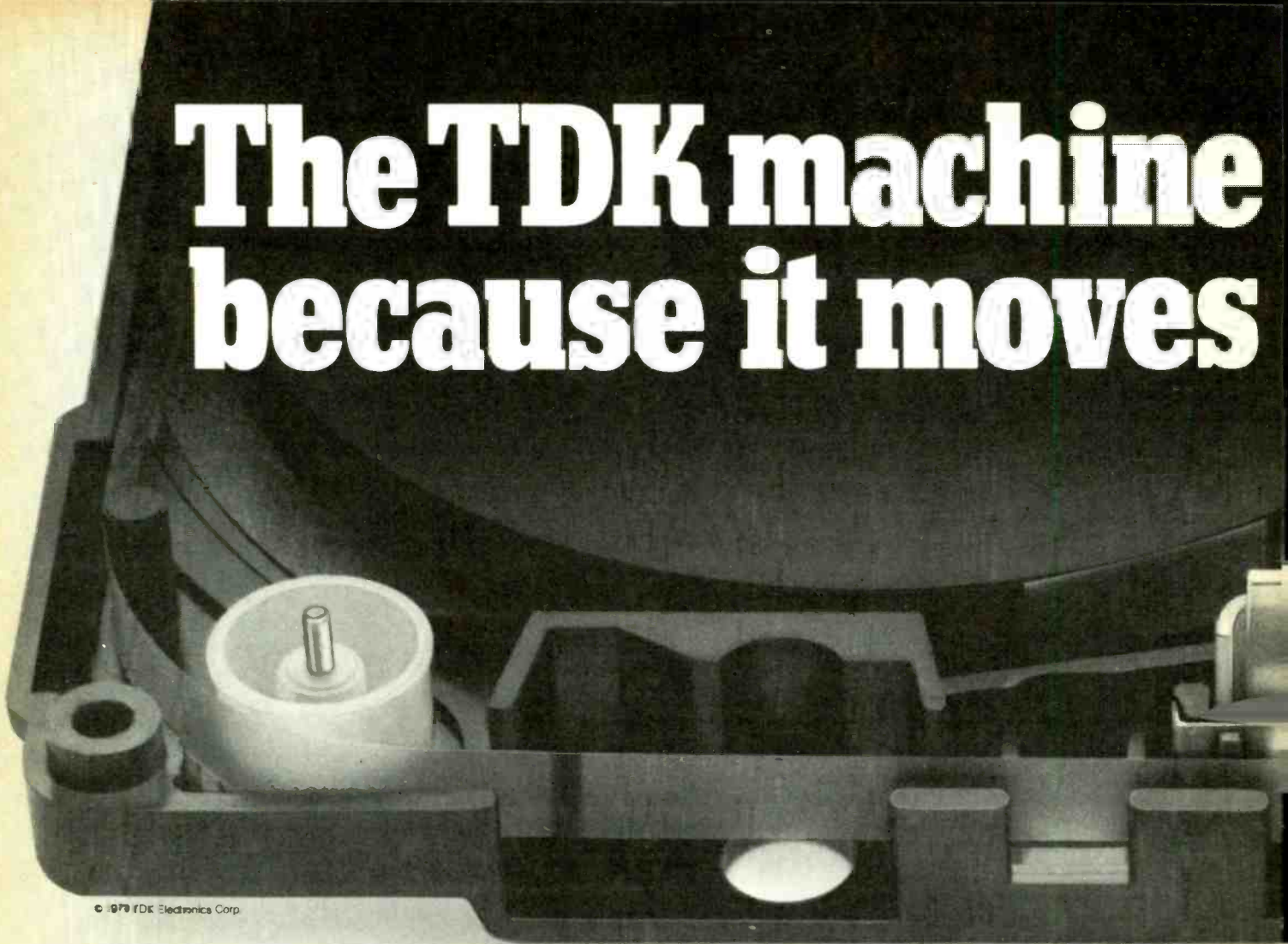

© 1979 TDK Electronics Corp.

At TDK, we're proud of our reputation as the leader in recording tape technology. We got that reputation by paying attention to all the little details other manufacturers sometimes skim over. But there's more to a cassette than just tape. There's a shell to house that tape, and a mechanism that has the function of transporting the tape across the heads. Unless that mechanism does its job evenly and precisely, the best tape in the world won't perform properly, and you won't get all the sound you paid for.

The TDK cassette shell and mechanism are every bit as good as our tape. And when you begin to understand the time and effort we've spent in perfecting them, you'll appreciate that our engineers wouldn't put TDK tape in anything less than the most advanced and reliable cassette available.

The Shell Our precision-molded cassette shells are made by continuously monitored injection molding that creates a mirror-image parallel match, to insure against signal

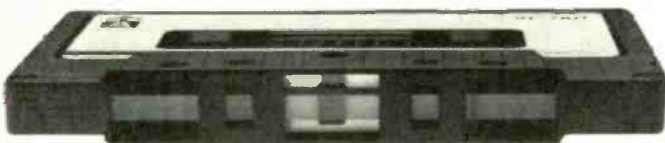

overlap, channel or sensitivity loss from A to B sides. We make these shells from high impact styrene, which resists temperature extremes and sudden stress better than regular styrene or clear plastic.

The Screws Our cassettes use five screws instead of four for warp-free mating of the cassette halves. We carefully

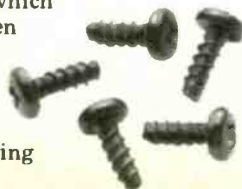

torque those screws to achieve computer-controlled stress equilibrium. That way, the shell is impervious to dust, and the halves are parallel to a tolerance of a few microns.

The Liner Sheet Our ingenious and unique bubble liner sheet makes the tape follow a consistent running angle with gentle fingertip-like embossed cushions. It prevents uneven tape winding and minimizes the friction that can lead to tape damage. Also our cassettes will not squeak or squeal during operation.

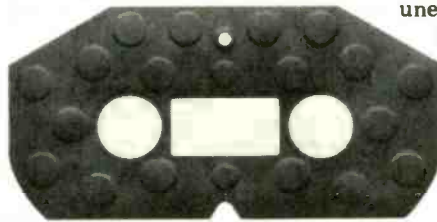

The Rollers Our Delrin rollers are tapered and flanged, so the tape won't move up and down on its path across the heads. This assures a smooth transport and prevents tape damage.

The Pins In every cassette we make, we use stainless steel roller pins to minimize friction and avert wow and flutter and channel loss. Some other manufacturers "cheat" by using plastic pins in some of their less expensive cassettes. We don't.

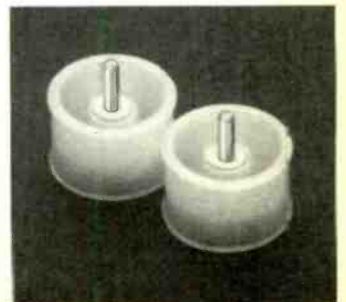

sounds better better.

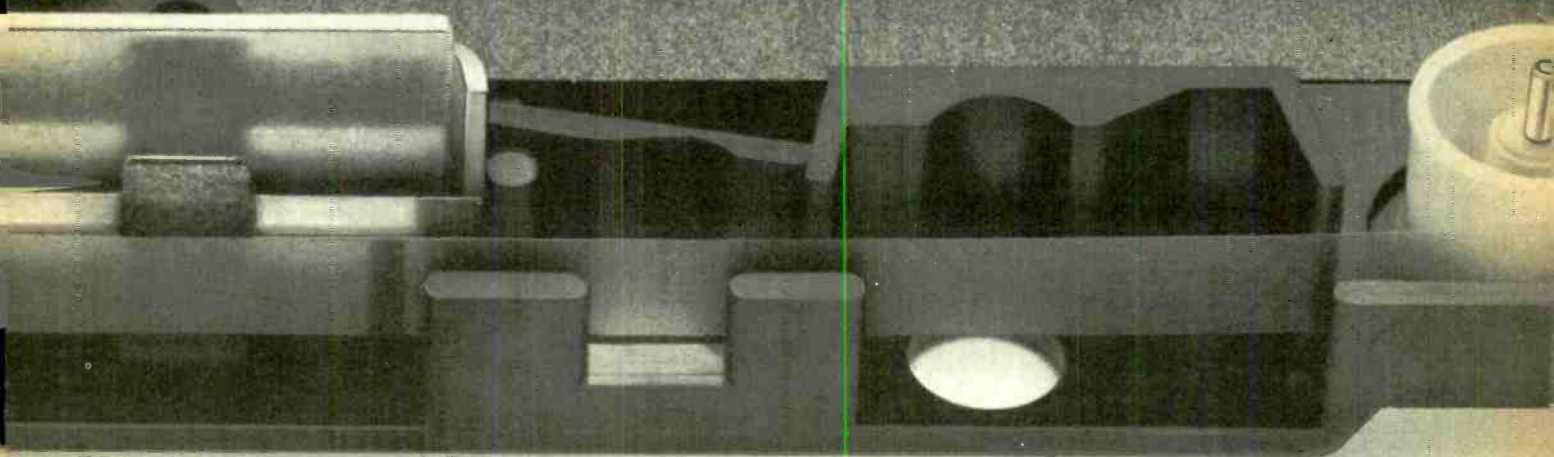

The Pressure Pad

Our sophisticated pressure pad maintains tape contact at dead center on the head gap. Our interlocking pin system anchors the pad assembly to the shell and prevents lateral movement of the pad, which could affect sound quality.

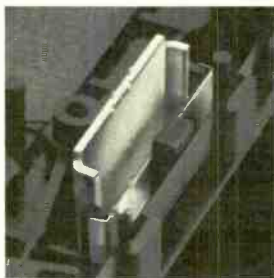

The Shield We use an expensive shield to protect your recordings from stray magnetism that could mar them. Some manufacturers try to "get by" with a thinner, less expensive shield. We don't.

The Window Our tape checking window is designed to be large enough for you to see all the tape, so you can keep track of your recordings.

The Label We've even put a lot of thought into the label we put on our cassettes. Ours is made from a special non-blur quality paper. You can write on it with a felt-tip pen, a ballpoint, whatever. Its size, thickness and placement are carefully designed and executed so as not to upset the cassette's azimuth alignment.

The Inspections When it comes to quality control, TDK goes to extremes. Each cassette is subject to thousands of separate inspections. If it doesn't measure up on every one of these, we discard it. Our zeal may seem extreme, but it is this commitment

to quality which allowed us to offer the first full lifetime warranty in the cassette business—more than 10 years ago: In the unlikely event that any TDK cassette ever fails to perform due to a defect in materials or workmanship, simply return it to your local dealer or to TDK for a free replacement. It took guts to pioneer that warranty, but our cassettes have the guts—and the reliability—to back it up.

A Machine for All Your Machines Now that we've told you how we move our tape, let us remind you about our tape. SA, the first non-chrome high bias cassette, is the reference tape most quality manufacturers use to align their decks before they leave the factory. It's also the number one-selling high bias cassette in America. For critical music recording, it is unsurpassed. AD is the normal bias tape with the "hot high end." It requires no special bias setting, which is why it is the best cassette

for use in your car, where highs are hard to come by, as well as at home. Whatever your recording needs, TDK makes a tape that offers the ultimate in sound quality. But it's our super precision shell and mechanism that make sure all that sound gets from our tape to your ears, year after year. TDK Electronics Corp., Garden City, NY 11530



 **TDK**
The machine for your machine.

CIRCLE 67 ON READER SERVICE CARD

www.americanradiohistory.com

ter was the model S-1 which was a rather crude copy of the Westrex 3A recorder. Several sources exist that handle parts for the Presto lathes. One is Wiegand Audio Labs, in I believe Walton, N.J. and the other is Boynton Studios in Morris, N.Y.

Something else I found interesting in the March Issue in "Groove Views" was the review of the Sonics: *Original Northwest Punk*. Back in the sixties, Jerry Dennon was a very busy producer. There was hardly a group in the Northwest that he didn't demo at one time or another, and he is probably best remembered for all the big hits the Kingsmen had. When he wasn't in the studio, he was generally out boat racing with his hydroplane.

The Spanish Castle between Seattle and Tacoma was the "in" music niteclub back then, and when the Wailers weren't there, other groups like the Sonics were.

Etiquette Productions was the label owned by the Wailers and on which most of their records came out. The Sonics' song "Psycho," which was originally on Etiquette Records, featured a scream at the end of the song which must be heard to be believed! Most likely caused by the vocalist being electrocuted by a hot mic.

Most all the recording back then was done at Audio Recorders, on 5th Ave. in Seattle, and Kearney Barton was the owner/engineer. It was a 2-track studio then, and 8-track now. If it sounds like it was recorded on a portable cassette recorder (which weren't even around then), it is due to the style of recording which was prevalent then. Close miking was not the style, and basically, most engineers were trying to figure out how to mike rock music. I guess we have come a ways in technique since then.

I will close with wishes that you maintain the same high quality of your magazine in the future.

—James H. Zuehsow
Chief engineer
Arctic Studio Productions
Anchorage, Alaska

In regard to Keith Evans' question in "Talkback," March 1979 concerning his Presto disc recorder: I am into old audio equipment and I collect a lot of old catalogs and Hi-Fi books. I have just about looked through all of them trying to help this guy out. I have come up with just about every Presto disc recorder except his.

From a 1947 Allied Radio catalog he

could have bought a Presto 1-D cutting head for \$188.00, Presto blank discs (12 inch) were \$1.80 each and Presto recording needles, long shaft, were \$8.00 each. Makes you sick, doesn't it?

Maybe someone out there could help me. I am looking for the front door to an Ampex 300 metal studio cabinet and the overhead bridge that houses the electronics. I am also looking for the manuals to Magnecorder PT63-J with P63-A transport and PT6-R with PT63-AH transport.

—Alan Wolf
Ellicott City, Md.

Splitter Variation

I hope it's not too late to offer a variation on the splitter circuit described in the December 1978 issue by Peter Weiss. This design utilizes a more common IC; the LM318, manufactured by National Semiconductor. It is a low noise, high slew rate (70 Volts per μ sec) op amp that is excellent for studio use. The splitter is unique in that it uses a single +V supply. All three ICs are operated as voltage followers, which characteristically have a gain of unity. The voltage divider resistors at each op amp input bias the amps to $1/2$ Vcc. As

long as the input signal is kept below $1/2$ Vcc, the output will "follow" the input with very little distortion. The high value of divider resistors on IC1 determine the input impedance of the splitter and should be kept high for minimal loading of the input signal. Input impedance is on the order of 1 megohm and the output impedance is 100 ohms. The frequency compensation capacitors were chosen to reduce the unity gain bandwidth to audio frequencies and help the overall stability of the op amps. 1μ f tantalum caps were used on the supply lines of each amp to shunt radio frequencies. The input and output coupling caps block any DC offsets that would affect the signal.

I have breadboarded this circuit and found it to work perfectly. I would like to add that much of the information used for the design of this splitter may be obtained from Walter Jung's excellent book, *Audio IC Op Amp Applications*, a Howard Sams & Co., Inc. (4300 West 62nd St., Indianapolis, In.) publication. On a final note, your magazine is a great source of information to those of us in the audio industry. Keep up the continuing good work!

—Robert C. Bradshaw
Gardena, Ca.

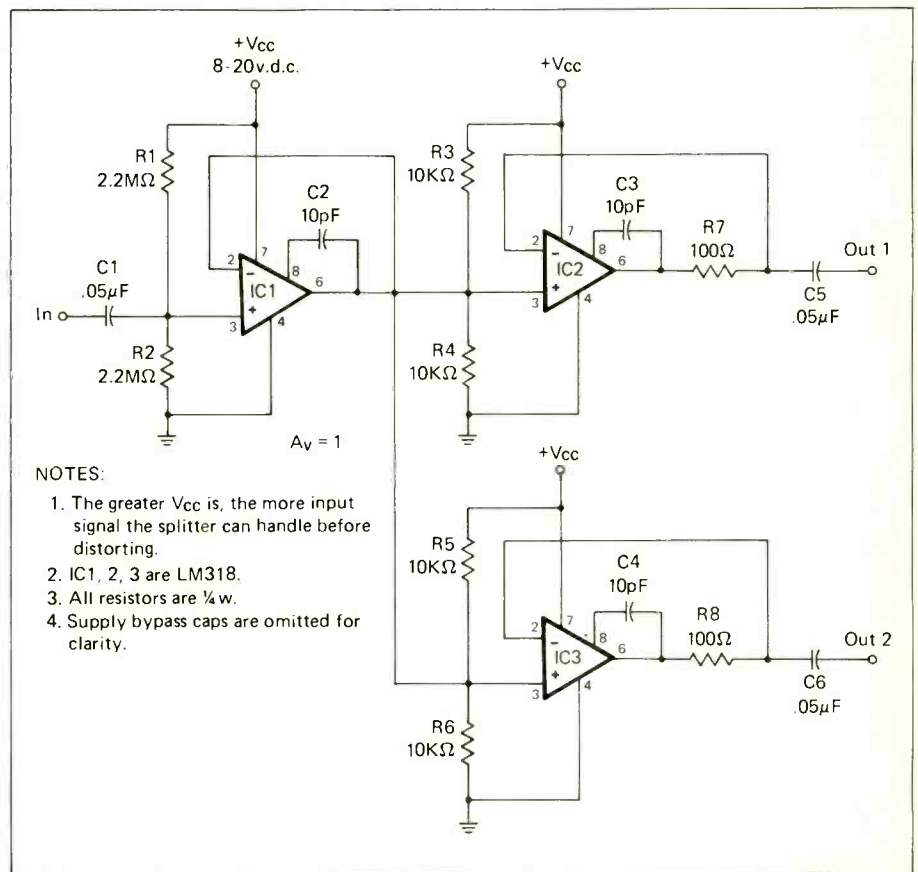

Schematic of variant Mic Splitter design offered by reader

AFTER DEVELOPING THE WORLD'S MOST PRECISE METERING SYSTEM, SUCCESS WENT TO OUR HEADS.

Most any audio manufacturer today would be completely content with a cassette deck that offered the incredible Fluroscan metering system found in Pioneer's CT-F950.

But Pioneer isn't just any audio manufacturer. And the CT-F950 isn't just any cassette deck.

Instead of slow-to-react VU meters that give you limited resolution, the CT-F950 has a Fluroscan metering system that gives you a far more accurate picture of what you're listening to. It even has Peak, Peak Hold, and Average Buttons that let you record without

music. More clarity. Less distortion.

A DIGITAL BRAIN WITH AN ELECTRONIC MEMORY.

Pioneer's CT-F950 has a digital brain with a memory that performs four different functions. Memory Stop. Memory Play. Counter Repeat. And End Repeat.

And while many cassette decks let you monitor during recording, what they don't let you do is control what you monitor.

The CT-F950 allows you to bias by ear. So you have as much control over your tape deck as you would over any musical instrument.

Of course, these are just a few of the virtues of the CT-F950. But there are also features like a Double Dolby noise reduction system. And direct function switching.

Obviously, all that went into Pioneer's CT-F950 sounds impressive. But it's not half as impressive as what comes out of it.

So we suggest you go to your Pioneer dealer and listen to it. You'll hear what's really made the CT-F950 an instant success.

PIONEER®
We bring it back alive.

©1979 U.S. Pioneer Electronics Corp., 85 Oxford Drive, Moonachie, N.J. 07074.

Rack mounting handles optional.

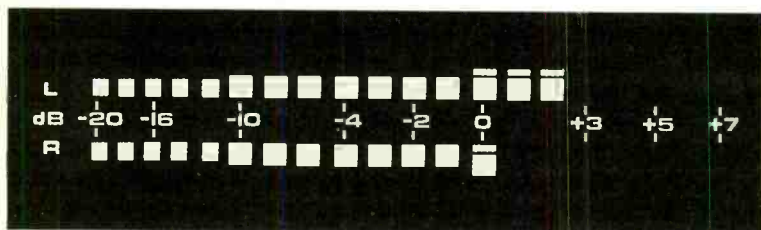

The first cassette deck with Fluroscan metering *and* an erase head for metal tape.

fear of overload.

But our meter is only a small measure of our worth.

If you examine our heads you'll find the CT-F950 is different from most cassette decks. Instead of record and playback heads made of permalloy or ordinary ferrite, our heads are made of a newly developed Uni-Crystal Ferrite composition that gives you greater frequency response, lower distortion, and better wear-resistance.

METAL TAPE CAPABILITY FOR HIGHER HIGH FIDELITY.

But it's our third head that keeps us further ahead of the competition. This new Alfex/ferrite erase head permits the CT-F950 to accept one of today's great audio advancements. Metal tape. Though its technology is incredibly complicated, its benefit is incredibly simple. More



CIRCLE 119 ON READER SERVICE CARD

Mic Beef

Let me start out by saying that you have an excellent magazine and that I enjoy all of the articles presented.

Now for my beef!

Most of us who are recording in our basements have limited space and capital. We can't afford MCI boards and machines. We are presently stuck with semi-pro gear such as Otari and Tascam 40-4 and 80-8 complemented by dbx, of course. And to make matters worse, how can any of us afford Neumann U-87 and U-47 mics by the truckload? We are a large number, but *small* studios, and can't afford these high-priced mics.

So how about some articles on using mics such as Shure SM57s and SM58s and Sennheiser MD421s, or say the Electro-Voice RE 15, 16, 20, and the CS-15 condenser model. These are more in our price range and there must be a way of incorporating these in recording without the expense of the Neumann or AKG microphones.

Keep up the good work and thanks for your great magazine.

—Mark Paulick
Green Bay, Wisc.

I think your magazine is tops. I have a question that arises from reading your monthly interviews.

It seems that all your engineer and producer interviews state that in sessions they use U-87s, U-47s, and a host of other mics that cost around \$1000.

I have a small studio, and really do not want and have no intention of getting into the 16-track variety. Now, about those mics—I do not have any U-87s, U-47s and the super expensive type. Is there any way you could have an interview with someone who uses, or run some articles concerning any mics like the C451, SM81 or DM421 for the growing small studio that is ever increasing in number and cannot afford the \$1000 mics?

—Bill Montella, Jr.
Warwick, R.I.

While we will admit that the Neumann and AKG mics are often referred to in our interviews and recording sessions, there are plenty mentions of Beyer, Sennheiser, Shure, Sony, Audio-Technica, Electro-Voice and others (to wit, the "Dingle") in the stories we cover. Our Tom Scholz "Profile" (this issue) finds Tom making extensive use of Shure SM57s and the Electro-Voice RE 20, for instance.

Recording artists (including producers and engineers) and studios that



**BSC Sells All Major
Brands Of Recording
Equipment.
Package Pricing
Available.**

System 700 SERIES III

© 1978 BSC, INC.



**Sometimes It's Better To Have
All Your Eggs In One Basket...**

Several years ago enclosures for semi pro recording gear were as rare as hens' teeth. The manufacture left it all in your hands. As a result, our System 700 approach to packaging the semi pro studio was hatched. System 700 became the only logical answer. However, high cost and long lead times limited availability of these early units.

Now for as little as \$800.00, you can turn that maze of cables, tables and chairs into a first class studio. Our System 700 Series III enclosures come to you as illustrated. Ready for quick assembly, modular construction allows easy updating. Best of all, they are available from stock! Hens' teeth have finally come of age.



**SERIES III ENCLOSURES
ARE AVAILABLE FOR
ALL TASCAM, TANGENT
AND SOUND WORKSHOP
CONSOLES.**

**2932 RIVER ROAD
RIVER GROVE, ILLINOIS 60171
PHONE NO. 312-452-5551**

**BSC
INCORPORATED**



CIRCLE 41 ON READER SERVICE CARD

The Orban 526A Dynamic Sibilance Controller:

the single channel de-ess specialist

Introducing the Orban 526A — an improved, single-channel version of our internationally-accepted Dynamic Sibilance Controller. It features a mike input, fully-balanced input and output, LED level display, and GAIN control.

The 526A performs the de-ess function only without the compromises inherent in multi-function processors. It's clean, quiet, stable, and easy to use. So it's invaluable anywhere speech is processed professionally: recording studios, cinema, broadcasting, cassette duplication, and more. It's a simple time-saver and problem-solver — and at \$399* you can't afford to be without it.

The Orban 526A De-Ess Specialist is available at your Orban pro-audio dealer.

*suggested list



orban

Orban Associates Inc.
645 Bryant Street
San Francisco, California 94107
(415) 957-1067

CIRCLE 100 ON READER SERVICE CARD

receive critical and public acclaim as well as our editorial attention are often in the position of affording the most highly-priced equipment—the relationship of price to specific performance is a matter, often largely, of opinion.

Music in Venezuela

I am very interested in subscribing to your magazine. I've seen your December 1978 issue, and would like to receive free additional information on some of the products advertised, so I'm sending the

card corresponding to the aforementioned issue with the numbers circled.

The book by John M. Woram advertised on page 99 in that issue, *The Recording Studio Handbook*, commanded my attention for its marvelous contents, as advertised. My case is that I have a musical group and we perform in big churches, theatres or any possible large place. We have two electric guitars, drums, bass, piano, synthesizer, percussion elements and a chorus of eight women. We have trouble with the use of microphones, PA system, voice

speakers, monitors, echo, equalizers, delay and all those major problems a group like this has on stage, because our knowledge of these subjects and those covered in Woram's book is very little. Therefore, we'd be extremely thankful if you could recommend to us, if possible, a book or books that contain more information on all these matters. As you see, our case involves performing and not really actual recording.

If you think that the Woram book is not only the best but also essential, we would buy it together with any other one you recommend. Please let us know any other address we should write to. Thank you for your time and attention.

—Ian Achong
Caracas, Venezuela

One book that gives much more attention to your particular situation and needs than John Woram's book is: Practical Guide For Concert Sound, by Bob Heil, published by Melco Publishing, P.O. Box 26, Marissa, Illinois 62257, price \$10.

John Woram's book is not essential for your needs, but it is largely considered a "bible" of the recording industry. Should you ever get more heavily into recording, we'd strongly recommend your obtaining it.

Out of the Lights With His "Pride and Joy"

I enjoyed reading Mr. Ketteler's and Mr. Ridder's article, "Meat Loaf 'Live' and Recorded" in the January 1979 issue of *MR*. Large scale, high-quality sound reinforcement is a feat which falls between out-running a state policeman and space travel.

Other than absorbing all printed material on recording and "live" sound mixing and having viewed over a hundred professional groups, I have been doing little toward attaining my goal of becoming a sound or recording engineer. I play multi-keyboards for a local semi-professional band, but instead of being "in the lights," I'd rather sit quietly in the back with the board and my "pride and joy" sound processors. Equipment must be "just right" or I throw fits! Is there any hope for me?

I have been buying *Modern Recording* off the newsstand monthly, but now my subscription is in the mail. More "Live" situation" articles would be appreciated, but your mag is great the way it is. Good work! Thank you,

—Robert Sohmer
State College, Pa.

AND NOW, A WORD ABOUT OVERLOAD, FROM SENNHEISER'S MD 421:

NONE.*

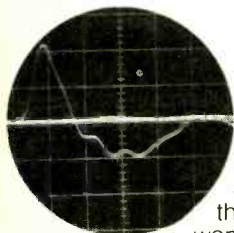

A lot of musicians are worried about overload these days. And no wonder: special

effects, high amplification and combinations of acoustical and electronic instruments all make it more necessary than ever for microphones to be overload-free as well as accurate.

Like our tough MD 421 cardioid dynamic.

In a test beyond what any musical instrument or voice can produce, we used a starter pistol to produce an instantaneous sound-pressure level of 175 dB, which the MD 421 handled with no trace of distortion.

*Outdoor test with Tektronix scope, set for 10V/division vertical, 01. μ sec/div. horizontal. 22 cal. starter's pistol mounted 15 cm from MD 421 measured pressure of 111,000 dynes/cm² (175 dB SPL). Smooth, rounded scope trace indicates total lack of distortion.

SENNHEISER

ELECTRONIC CORPORATION

10 West 37th Street, New York 10018 (212) 239-0190

Manufacturing Plant Bissendorf/Hannover, West Germany

Whatever your application—sound reinforcement, recording or broadcasting—consider our MD 421. Besides freedom from overload, you'll discover its precise cardioid directionality, rugged design and wide, smooth response give you superb results. Even under difficult conditions.

The price won't overload you, either.

CIRCLE 39 ON READER SERVICE CARD

12x4x2x1.

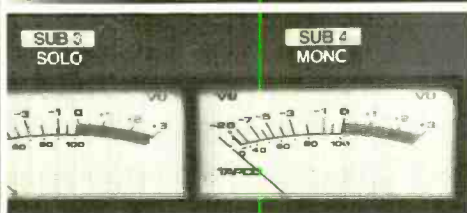
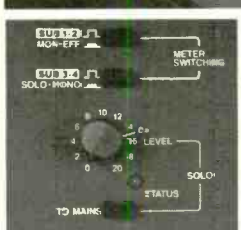

...with
features
you need
and the
performance
you demand...

under \$2000.

See your TAPCO dealer and get acquainted with the CATALINA — a logically-designed, ruggedly-built multi-purpose mixing console.

CIRCLE 77 ON READER SERVICE CARD

the **C-12** from **EV TAPCO** 3810 148th Ave. NE
Redmond, WA 98052

Purchase before Aug. 31 to receive a limited edition condenser vocal mic free. *Hurry!* Mic supply limited.

The DIGITAL DELAY LINE That Doesn't COST "DIGITAL"



When a new product wins universal acceptance from audio professionals, it must be very good indeed. The DL-1 is. Modern Recording called its sound quality "the best we have encountered in any digital delay unit." Dozens of DL-1s are providing unobtrusive sound reinforcement in Broadway theaters, hundreds have been purchased by large and small studios for pre-reverb delay and special effects, and many more are appearing nightly on stages and on the road, producing consistently reliable doubling, echo and other effects.

With its 3 independent outputs, enormous dynamic range, wide bandwidth, startlingly musical sound, and modest \$1200* price, the DL-1 is clearly the best buy in digital delay today.

But not for long...



Your dealer is now accepting orders for the astonishing new DL-3, a digital delay line intended for sound reinforcement and studio applications where just one delayed output is needed. The DL-3 gives you:

- True digital delay.
 - Delays from 5 to 120 milliseconds.
 - 20 - 15 kHz bandwidth, independent of delay.
 - Dynamic range better than 90 dB.
 - The same great reliability and sound as the DL-1.
 - Tamper-proof hidden controls.
 - A new low price for genuine digital delay: only \$775!*
- * Suggested retail price

Call your dealer now — the DL-3 is going to move quickly. For details and the name of your nearest distributor, write or call Phil Markham at DeltaLab Research, Inc., (617) 256-9034.



DeltaLab Research, Inc.
27 Industrial Avenue, Chelmsford, MA 01824

Available at Quality Dealers

CIRCLE 114 ON READER SERVICE CARD

Being picky and throwing fits, that's fine. And the experience you're getting while working is valuable. There's definitely hope for you.

As to your request, our mail is evenly divided: Half of our readers want more "live" articles, half want more recorded. We try to keep you both satisfied.

The Best Getting Better

In regard to the letter ("Letters to the Editor," page 8, May 1979) from Jeff E. Heyl about tests in the "Lab Reports" column, I'd like to support his criticism about power amp tests. I feel it is important that the consumer who reads these reports knows how much power the amp can deliver into 8-, 4-, and even 2-ohm loads, and for that matter, whether or not the manufacturer recommends a load below 4 or 2 ohms.

I subscribe to this magazine because it gives me the best equipment test reports for pro sound reinforcement. I feel that the majority of your readers would agree; the best can be *better*. The "Hands On" report is very complete, but only one piece of equipment is tested per month. By adding these few extra specs, I believe you can better satisfy your subscribers. I do not agree with Mr. Heyl, of course, that an "abuse test" (dropping an amp thirty or forty feet) would accomplish anything — except, of course, destroy perfectly good equipment.

And on another note, hail to your excellent and informative articles on "PCM digital recording techniques."

— Muff Hill
Together SoundSystems
Atlanta, Ga.

Point well taken. In the future, we will be testing power amps with attention to operation into 4- and 2-ohm loads wherever possible.

Dished Discs

Being pretty much of an amateur audio addict, I don't know a whole lot about the engineering aspects of recording music. I do know how much equipment (and consequently money), skill and hard work it takes those concerned to put an album together.

What bugs me, is after all the effort, the tracks are pressed into poor quality warped vinyl. It's sickening! I have a growing collection of albums, but one out of every three I've purchased has been inferior. I've returned scads of warped or "dished" records, bad press-



It can turn you into a group.

You've heard about this little Gizmotron.

You've read that it was invented by Lol Creme and Kevin Godley.

You've heard that McCartney has recorded with it, and loves it.

And you may be wondering what it is, and how it works and how you can get your hands on one.

Well, it is a device that bows the strings of an electric guitar, and turns it into a new instrument which is capable of reproducing virtually every orchestral string sound. It turns an electric guitar into an entire group of string instruments.

By pressing a few keys on the Gizmotron you can add dimensions never before possible on the guitar.

You can get infinite sustain with complete control over any note or chord you play.

If you're also a composer you can write a string arrangement on the guitar.

It doesn't make electronic sounds (unless you run it through an effects box).

It makes pure string sounds.

In short, the Gizmotron is the most impressive development in guitar technology since the amplifier.

And if you can play an electric guitar, you can play it with the Gizmotron.

All it does is turn your fingers into bows.

What does the Gizmotron cost?

Less than \$250.

A couple of gigs should pay for it.

Gizmo Inc.

For dealer nearest you, write: Gizmo Inc., P.O. Box 139, Dept. G, Rosemont, N.J. 08556, or call 609-397-2000.

CIRCLE 121 ON READER SERVICE CARD

ings and off-center or misaligned pressings. I've found bits of paper in the grooves, and later discovered that unsuccessful albums are melted down, label and all, and then made into "new" records. It just doesn't seem logical that all of the time and effort going into an album should be wasted on such lousy, low quality pressings.

Imported records such as Decca are thick, clean-sounding discs packaged in dust-resistant inner sleeves. Real deluxe! Why can't America have albums of decent quality, like Europe? Obviously, consumer bitching has had no effect, but complaints never reach the source of the problem, do they?

—L.J. Russell
Pullman, Wa.

The source of the problem, we expect, will be saying something along the lines of "Well, we could, but we'd be forced to raise our prices accordingly," adding, "We'd rather make the product available to more who could afford it."

Comparison of any products from the Old with those of the New World traditionally has demonstrated the former's quality, care and craft, and the latter's profitability. (There are, of course,

many exceptions.) Overall, this generalization appears to apply to records, although what we see from Europe may actually be imported largely because of quality: discs we don't get stateside could be just as inferior as domestic inferior discs.

We intend to approach disc manufacturers for responses on this matter.

Final Touches

Page 68 of our April 1979 issue, the opening page of Modern Recording's "Profile: Producer/Artist Allen Toussaint," complained loudly when it glanced in the mirror: We had forgotten to byline Murray M. Silver, Jr. on the page. Mr. Silver wrote the article.

Enjoyed Mac Much

Just a note to let you know how much I enjoyed your March issue cover story on Fleetwood Mac. It isn't too often that I see the supergroups in Modern Recording, and since they recorded just about one of the greatest albums of all time, I was especially glad to read the article. Especially the parts about the band's background and the fact that the article

was more like a story or a conversation than just technical info.

So I just wanted you to know how much I liked the issue and that I hope there will be more like it. I would also like to suggest that you print more articles such as the "Profiles" because I like to read about musicians' lives along with their recording techniques. Keep up the good work.

—Charlie Chodorow
Hollywood, Fla.

Dynamite, with Reservations

The March '79 issue of *Modern Recording* was absolutely dynamite from the front cover to the back. The Fleetwood Mac story was about the most entertaining I have read and for once the article did not read like an instruction manual. Also, the photographs were much better than usual, although it would have been nice to have seen more in the article. One more issue like that and I may subscribe. Could we see an article on Electric Light Orchestra or an article on Genesis?

—Scott Barker
Atlanta, Ga.



AUDIOARTS ENGINEERING

Model 1500 Tuneable Notch Filter - Feedback Suppressor



CONTROL FEEDBACK

THE MODEL 1500 was engineered to solve the problems of feedback where conventional filters fail:

- (1) **TUNEABLE** — Meaning you tune the filters exactly to the offending frequency, while leaving adjacent frequencies unaffected;
- (2) **NARROW BAND** — 1/6 octave; much narrower than any graphic equalizer, so you remove only feedback, without disturbing tonal balance in program material;
- (3) **SPECIALIZED DESIGN** — The Model 1500 has five identical filter sections, each covering 52 Hz to 7.3 KHz, thus eliminating the "low-mid-high" band restrictions imposed by other general purpose equalizers. This ensures plenty of control, no matter what frequencies you need to process.

- Five identical tuneable full range filters 52 Hz to 7.3 KHz, 0 to -16 dB notch depth
- Front panel gain control
- Overload LED
- IN/OUT switch
- Separate color-coded controls (no concentrics or sliders)
- Balanced input (accepts unbalanced sources)
- 7 pushbutton switches (each w/LED indicator)
- Direct rack mount
- +20 dB output
- Optional transformer balanced output
- No test equipment required



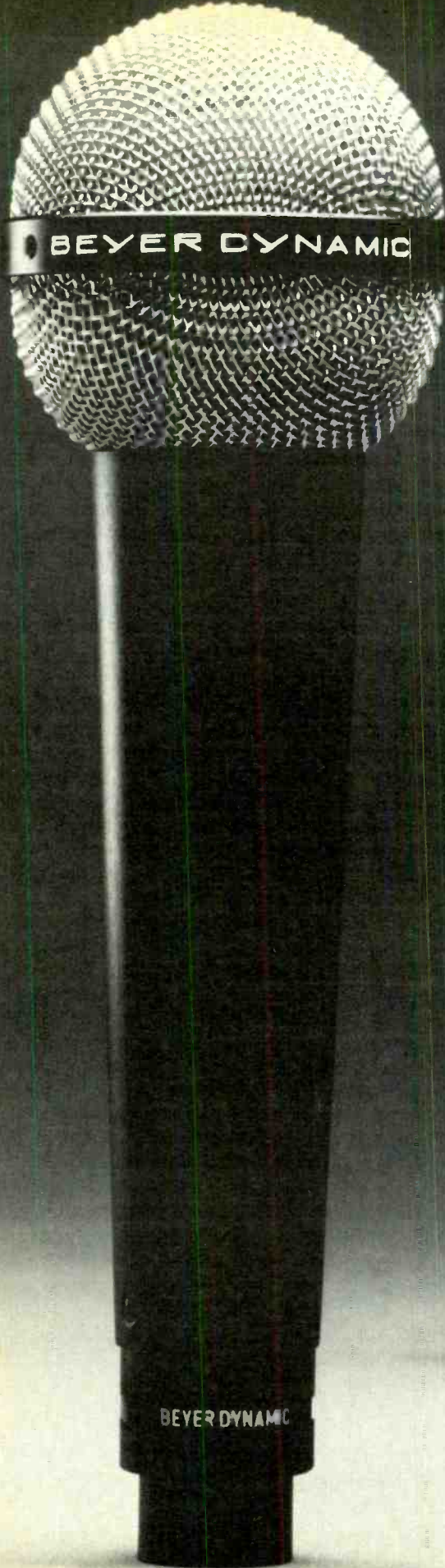

A RIBBON FOR THE ROAD

Beyer thinks the ribbon microphone is too good to be left behind. So we designed our M500, which comes with a protective carrying case, to stand up to the rigors of the road. It's a true handheld performer's mic that's ruggedly constructed for touring and remote recording, without sacrificing superior sound.

The heart of the M500 is Beyer's exclusive corrugated aluminum ribbon. Its extremely low mass not only makes it highly responsive to transients, but puts less strain on the points where it is attached to the transducer to stand the high SPL's of live performance. The transducer is in a protective subassembly, isolated by a resilient suspension system. And a special four-stage pop filter limits the sound pressure on the ribbon when a performer is working close to the mic.

We don't recommend the M500 for hammering nails or fighting off groupies. But it can do anything a mic has to do, anywhere it has to be done. We've made tens of thousands of them, and 99.5% are still on the road.

THE BEYER M 500



M500 carrying case

Beyer
Dynamic

BURNS AUDIOTRONICS, INC.
5-05 Burns Ave • Hicksville, NY 11801 • (516) 935-8000

CIRCLE 122 ON READER SERVICE CARD

Don't let your speakers control your sound...

Electro-Voice stage systems put you in control.

Why should a musician allow his creativity to be limited by his speaker system? With amplifiers, pre-amps and the myriad of other state-of-the-art electronic devices available, why should a musician limit his sound by playing his equipment through a speaker system that hasn't changed in design since 1957? The answer is he shouldn't, and with Electro-Voice Stage Systems he doesn't have to. These three new instrument speaker systems let you hear all the sound your instrument is capable of producing, the way you want it to be heard, by choice not by chance.

The S18-3 lets you hear all the notes you never heard before from your keyboard or synthesizer from below 40 Hz to above 16,000 Hz. The famous EVM-18B delivers the bass. The Electro-Voice

exclusive vented midrange driver delivers the midranges as efficiently as a horn, but without the typical "honky" small horn sound. The ST350A tweeter gives you clean highs over a solid 120° angle, eliminating the high-frequency "beaming" that limits the enjoyment of your performance to the few people sitting directly in front of the speaker.

The two new bass guitar systems also incorporate the VMR™ vented midrange. It can be controlled from the front panel, thus giving the bass player total control over the midrange harmonics missing from "standard" bass enclosures. The B115-M uses a single EVM-15B in an optimally vented enclosure. The result is the tight sound preferred by many jazz bassists and studio musicians. The B215-M has two EVM-15B's for a bass sound with more "carry"; perfect for the larger venue or

for the rock musician who wants more low-frequency "punch." In both cases, the VMR brings out sounds you may have heard before only on studio recordings.

All systems have identical styling. Black vinyl covered 3/4" plywood construction for durability, further protected by extruded aluminum trim on all edges. A metal mesh grille screen protects the drivers from accidental abuse.

If you want to have control over your sound, these are the speakers for you. See and hear these superb instrument speaker systems at your Electro-Voice dealer.

EV **Electro-Voice**
a gulton company

600 Cecil Street, Buchanan, Michigan 49107



Hear the S18, B115-M and B215-M at any of these Electro-Voice dealers

ALABAMA

Anniston
Radio Distributors & Supply
Birmingham
Matec, Inc.
Music Alley
Sonics Assocs, Inc.
Dothan
Shalimar Sounds
Gadsden
Carl Greene Music Co.
Huntsville
Robbins Music Center
Sheffield
Powell Electronics, Inc.
Sumiton
Music Center

ARIZONA

Phoenix
Axe Handlers & Co.
Tucson
Chicago Store

CALIFORNIA

Anaheim
California Musical Instr.
Concord
Mau's Music
Culver City
Creative Audio
El Cajon
Valley Music
Fresno
California Musician's
Service
Garden Grove
Stonebridge Music
Hollywood
Ametron
L.A. Sound Co.
Nadine's
Lakewood
Al Kalie Music
Lawndale
Hogan's House of Music
Long Beach
Guitar's Afire
Los Angeles
Audio Concepts, Inc.
RPS Electronics
Sound Foyer
North Hollywood
Filmway's Audio Services,
Inc.
Sacramento
Skip's Music, Inc.
San Bernardino
Parker Music
San Diego
Apex Music
Sound West
San Jose
K & K Music
San Rafael
Bananas at Large
South San Francisco
Bronstein Music
Sun Valley
Speaker City U.S.A.
Torrance
V.J. Electronics
West Covina
Hanich Music

COLORADO

Boulder
Solid Sound, Inc.
Denver
Pro Sound Music Center

CONNECTICUT

Danbury
Danbury Electronic Music
New London
Caruso Music Store, Inc.
North Haven
Ludwig Sound & Stage
West Hartford
LaSalle Music Shop

DELAWARE

Wilmington
Music Museum
East Coast Music

FLORIDA

Dania
Hollywood Music Center,
Inc.
Ft. Lauderdale
Modern Music, Inc.
Ft. Walton Beach
Playground Music Center
Gainesville
Lipham Sound
Hialeah
Musik Korner, Inc.
Jacksonville
Music City
Lake Park
Music Mart
North Miami
Abe Music
Orlando
Discount Music Center
Music City
Pensacola
Grice Pro Sound
Pinnellas Park
Aesop Music Center
Sarasota
Interworld, Inc.
Tallahassee
Bryan's Music Center
Tampa
Thoroughbred Music

GEORGIA

Atlanta
Metro Music
Augusta
Jay Music Center
Schneider's Music Center
Decatur
Maestro Music Center Inc.
Marietta
Marietta Music Center, Inc.
Norcross
Concert Music Co.
Savannah
Ben Portman Music Center
Smyrna
Music Mart

HAWAII

Honolulu
Harry's Music Store, Inc.

ILLINOIS

Arlington
Ray Bauman Music
Chicago
Biasco's
Cicero
D.J.'s Music
Granite City
John Fornaszewski
Harvey
Pyramid Sound Co.
Highland Park
Gary Gand
Mt. Prospect
Sound Post
Peoria
Byerly Music
Wheeling
Soundz Music Shack

INDIANA

Anderson
Top In Sound
Indianapolis
JRC Music, Inc.
Jeffersonville
Far Out Music
South Bend
Drumville Guitarland

IOWA

Davenport
Greg's Music
Des Moines
Victor's House of Music

KANSAS

Hays
Sunshine Sound
Topeka
Steam Sound
Wichita
Superior Sound Rental
& Service

KENTUCKY

Lexington
Carl's Music

LOUISIANA

Baton Rouge
Sound City
Eunice
Savoy Music Center
New Orleans
Sound City

MAINE

Bangor
New England Music Co.
Portland
New England Music Co.

MARYLAND

Baltimore
Gordon Miller Music
Rockville
Veneman Music Co.
CMG Sound
Wheaton
Washington Music Center

MASSACHUSETTS

Boston
EU Wurlitzer Music
Sid Stone Laboratories, Inc.
Watertown
Distronics Sound &
Lighting Co.
Wendell
Klondike Sound Co.
West Springfield
A & M Sound/Divn.
of Accordion Art

MICHIGAN

Ann Arbor
Al Nallie Music Co.
Canton
Arnoldt Williams Music
Saginaw
Watermelon Sugar
Warren
Gus Zoppi Music Center

MINNESOTA

Burnsville
La Vonne Wagner Music
Moorhead
Marguirite's Music

MISSISSIPPI

Cleveland
Morrison Bros. /GMS Music
Hattiesburg
Communication Sound
Jackson
Morrison Bros. /GMS Music
Pascagoula
Morrison Bros. /GMS Music

MISSOURI

Columbia
Music Village
Kansas City
Irish Music
Springfield
Mr. Music's Rock Shop

MONTANA

Billings
Hansen Music

NEBRASKA

Omaha
Rainbow Recording
Sound Show

NEVADA

Las Vegas
Professional Music Center
& Drum Shop
Sun Valley
Bazaar Guitar/dba
Star Sound Audio

NEW HAMPSHIRE

Manchester
Ted Herbert's Music Mart
Salem
The Music Workshop

NEW JERSEY

Belleville
Muscara Music
Edison
Lou Rose Music Center, Inc.
Englewood
Gilonite Music City
Flemington
Nolde's Music Box
Manville
Manville Music Center
Moorestown
East Coast Music
Parsippany
Long & McQuade Musical
Instr.
Phillipsburg
Dave Phillips Music
& Sound

PITMAN

Musica Museum
Red Bank
Red Bank Music
Ridgewood
Victor's House of Music
Union
Rondo Music

NEW MEXICO

Albuquerque
Multi Media
Ft. Collins
Appleyway Music Center
Audio Video Consultant

NEW YORK

Brooklyn
Big Barry's Music
Buffalo
Kubera Music
Franklin Square
Mario's Sound Room
Hempstead
Gracin's Music
Kenmore
Power Supply Co.
Nanuet
Gamma II Music Center,
Inc.

New York
Manny's Musical Instr. &
Access., Inc.

Patchogue
Square Deal Radio &
TV Inc

Rochester
Michael's Music

NORTH CAROLINA

Charlotte
Carolina Audio, Inc.
Joseph A. Cohen, Inc.
Music Scene
Reflection Sound Studios
Matthews
Theatre Equipment Co.
North Wilkesboro
North Wilkesboro Bible
Bookstore & Music
Center, Inc.

Raleigh
Coliseum Sound Systems,
Inc.
Associated Sound Products
Whetstone Music, Inc.
Shelby
Apple Tree Music
Statesville
Blackwelder's

OHIO

Canton
Gattuso's Music Center
Cincinnati
Swallen's Inc.
Columbus
Swallens, Inc.
Coyle Music
Dayton
Bernie's Music Store
Defiance
Plaza Music Center
Fairfield
Don's Music Center
Kent
Woody's Music, Inc.
Mansfield
Swallen's Inc.
Gattuso's Music Center
McKees Rock
Urich Rock
Middleton
Swallen's Inc.
Richmond Heights
Sodja Music, Inc.
Strongsville
The Music Connection
Toledo
Penquinn Music
Hayday Sound
Youngstown
New York Music

OKLAHOMA

Altus
Southwestern Music
of Altus
Bethany
Drive Music Co.
Muskogee
Rickett's Music
Oklahoma City
Ford Audio
Tulsa
Music Sound World

PENNSYLVANIA

Bryn Mawr
Medley Music
Philadelphia
Cintioli Music Center
Medley Music
Eighth Street Music
Schnecksville
Sight & Sound
Womelsdorf
Dimension Five
Rhode Island
Cranston
Viscount Records

SOUTH CAROLINA

Anderson
Mr. Music
John Brookshire Music
Machine
Columbia
Bob Dunn Music
Florence
Whitstone, Inc.
Greenville
Dixieland Music
Bob McGinnis Music Co.
Pecknel Music Co. Inc.
North Charleston
Wayman Music Store
Orangeburg
Williams Music & TV
Spartanburg
Alexander Music House,
Inc.

TENNESSEE

Chattanooga
Sound Post
Hendersonville
The Hi Fi Man
Hi Fi Labs
Knoxville
Lynn's Guitars
Memphis
Strings & Things
Murfreesboro
Bellcon Systems, Ltd.
Murfreesboro Music Center
Nashville
Corner Music
Electra Dist. Co.
Musician's Flea Market
Tullahoma
Tennessee Audio

TEXAS

Austin
Heart of Texas Music
Corpus Christie
Sound Vibrations
El Paso
Audi Consultants
Music Den
Garland
Arnold M. Morgan Music
Houston
Parker Music Co.
Texas Tom's Music
Lubbock
Al Music Machine
San Antonio
River City Music

UTAH

Centerville
Guitar City Studio's
Wagstaff
Salt Lake City
D.M. Music
Progressive Music

VIRGINIA

Arlington
Zavarellas Music
Charlottesville
Recording Sound
Falls Church
Rolls Music
Harrisburg
Ace Electric Co.
Martinsville
Mountain Top Music
Norfolk
Ambassador Music
Richmond
Virginia Music Co.
Don Warnes Music

WASHINGTON

Seattle
American Music
Mitcho of Seattle, Inc.

WISCONSIN

Eau Claire
UMS Audio



600 Cecil Street, Buchanan, Michigan 49107

CIRCLE 82 ON READER SERVICE CARD

TALK BACK

"Talkback" questions are answered by professional engineers, many of whose names you have probably seen listed on the credits of major pop albums. Their techniques are their own and might very well differ from another's. Thus, an answer in "Talkback" is certainly not necessarily the last word.

We welcome all questions on the subject of recording, although the large volume of questions received precludes our being able to answer them all. If you feel that we are skirting any issues, fire a letter off to the editor right away. "Talkback" is the Modern Recording reader's technical forum.

Component Combinations for Small Sound Reinforcement Systems

You have a fine magazine and I enjoy all facets of it—just as I enjoy (and play) all types of music. I am a musician (drums, guitar, bass, mandolin) and also have a great deal of interest in sound reinforcement applications, hence my two questions.

I am planning to construct a small sound reinforcement system for a solo act and I am currently planning on using either a Bi-amp or Tapco six-channel board, a Bi-amp M2/V crossover and a Bi-amp TC/60 (60 RMS/channel) amplifier into JBL components. Here's where the questions arise. I would like to use a twelve-inch woofer to conserve space—either a 2202 or a K120 in a modified cabinet similar to the JBL 4530. I plan to build the cabinets myself, and they will be considerably smaller than the JBLs with the horns built in. Which driver do you recommend, and is it a mistake to try and get by with twelve-inchers?

For the horns, I plan on using the JBL 2391 horn/lens combo with either the JBL 2470 or 2420 driver. The ad-

vantage of the 2420 is its increased frequency response. Is this necessary for my two-way system, or would the 2470's greater power handling capacity be better suited for biamping?

Secondly, a friend and I have been having a congenial argument about crossover points. His system is composed of JBL K130s in 4560 cabinets, JBL 2345 horns with 2470 drivers, and 2405 tweeters all tri-amped with Yamaha F1030 crossover and Yamaha power amps. The low end of the horns is crossed at 500 Hz, which I contend is too low for compression drivers, especially with the relatively "mid-range-y" quality of the K130s. I recommend an 800 Hz, possibly even a 1000 Hz crossover point to avoid any distortion in the horn drivers, as the band using the system is obviously very "distortion conscious." With whom do you side?

—Kirk R. Higgins
Flagstaff, Az.

Your basic choice of components for a small solo act sound reinforcement system is very good. The compression driver/horn/lens combination will give excellent efficiency, transient quality, and dispersion control. The use of a 12-inch woofer, instead of a 15-inch, will provide almost the same mid-range efficiency and a smoother transition to the high frequency transducer at a considerable savings in necessary box volume. The only disadvantage will be less deep bass, and even this can be compensated for somewhat with low frequency equalization. For the enclosure, however, I would not recommend a scaled down 4530. The 4530 is a rear loaded folded horn, and a smaller version would not have a large enough mouth size to make the horn useful, among other problems. I would suggest a vented box design of about 2 cubic feet in volume. This will make a small, easy to construct, highly portable box

that will provide the best performance for the available space. A simple hole in the baffle panel of 4 inches in diameter will tune an enclosure of this size to about 60 Hz, which will provide proper acoustic loading for the bass driver and enhance the low frequency performance of the system.

As to the specific choice of components, the 2202 12-inch is an extremely linear driver, both in terms of frequency response and cone excursion capability, whereas the K120 is designed as a lead guitar transducer with somewhat less low frequency linearity and a rising response in the mid-range. A similar comparison can be made between the 2420, an aluminum diaphragm compression driver with smooth, wide bandwidth response, and the 2470 with a phenolic diaphragm, sacrificing some smoothness, and response above 10 kHz, for increased power handling. The optimum match-ups for a bi-amped system would be the 2202/2420 combination for extremely smooth, accurate, low distortion reproduction, and the K120/2470 combination for maximum perceived loudness and power handling. Both these combinations have been used very successfully as stage monitor systems in large professional touring sound reinforcement systems, and hence will provide excellent results as a small sound system. Since you intend to use the system for a solo act with a variety of instruments and tonal characteristics, and hence will want accurate, low distortion sound that need not be tremendously loud, I would recommend the 2202/2420 combination.

Concerning the choice of crossover points, as a general rule only the largest compression drivers should be crossed over at 500 Hz, and then only with second-order (12 dB/octave) crossover slopes or greater. This prevents low frequency energy from causing diaphragm excursions, which

can create high distortion and destroy the devices. For most compression drivers, 800 Hz is the lower usable limit, again requiring steep transition slopes. These rules of thumb are for aluminum diaphragm compression drivers. Drivers with phenolic or hybrid diaphragms can be used lower with less risk of damage, but they will also suffer from increased distortion. Higher crossover points may provide even better performance, but the other characteristics of the system must be taken into account. For instance, the 4560 bass enclosure will only control the dispersion of a K130 or other 15-inch woofer up to 800 Hz, above which the coverage pattern will begin to narrow quite rapidly. There may be some situations, such as in a highly reverberant hall, in which crossing over at 1200 Hz could use this narrowing to advantage, by increasing the direct-to-reverberant sound ratio and improving intelligibility. In general, however, systems with 15-inch woofers crossing over to compression drivers will have to have their transition at 800 Hz. With a 12-inch woofer, 1200 Hz will probably provide optimum results.

—Mark Gander
Transducer Engineer
JBL
Northridge, Ca.

Matchmaker

What are line amps and what are they used for technically?

—Cathy Weidner
Bayside, N.Y.

A line amplifier is a low or medium gain amplifier (typically unity to 18 dB of gain) with a maximum undistorted output of about +20 dBm into rated termination. A line amp is used following the output of a mixer, tape recorder, preamplifier, etcetera, to drive a low impedance line input of another circuit, a bridging buss (a number of high impedance inputs connected to one source) or a long transmission cable such as a telephone line.

In simple terms you may think of a line amplifier as a power-boosting device used to "match" the output of a device, such as a high impedance -10 dBm output found on many of the small mixers available, to the low impedance (600 ohm) line level (+4 dBm) input of a professional tape deck or power amp.

—Norm Cleary
President
Audio Innovators, Inc.
Pittsburgh, Pa.



Synare STRIKES AGAIN...

Electronic sounds from Any DRUM.

Synare Sensor \$140.

You've come to expect innovations in electronic percussion from Star, and we've never let you down. Now, check out our latest

The Synare Sensor.

Our new Sensor turns any drum into a synthesizer. Tom, snare, bass, bongo: If you can drum on it, we can synthesize it. Picking up the vibrations through the drum's rim, the Sensor's not in your way and doesn't interfere

with the drum head or normal drum sound. And there's no simpler, less expensive way to produce a wide variety of popular synthesizer sounds right on your own drum.

Not only that you can use a Sensor on every drum and control them all with an optional Synare foot pedal. Clamp the Sensor to the rim and plug the little beauty into any amplifier; your drum is automatically synthesized.

\$140 for all this magic? Sure, and Star super durability and reliability, too.

Get on down to your local music store and give a listen to the new Synare Sensor. You won't come home without one. Or write us for more information.



STAR
INSTRUMENTS, INC.
Dept MO
P.O. Box 145
Stafford Springs, CT 06076
(203) 684-4258

See Us At Booth No. 7013 NAMM Show
CIRCLE 113 ON READER SERVICE CARD

Scoping In on Azimuth

In David Moyssiadis' article "The Care and Feeding of Your Multi-track" (March 1978 issue, page 32), he mentioned a way to adjust azimuth using an oscilloscope. Can he describe that method to me now?

While I've got your attention, I'd just like to add that I really enjoy the articles in your magazine!

—Glen Pedersen
Fargo, N.D.

Using an oscilloscope is probably the most accurate way to check and adjust azimuth. Here's how to do it, assuming that the 'scope itself is properly aligned.

Set the recorder for equal output from each channel. Set the horizontal and vertical gains on the 'scope for equal gain, that is, for each volt input you should get an equal number of centimeters of deflection on each axis. Set the other controls—focus, position, brightness, etc.—for proper operation. Connect the left channel of the recorder to the vertical input of the 'scope and the right channel to the horizontal input. Adjust both gain controls equally (either on the recorder or the 'scope) so as to have the display fill about 50% of the CRT face. If everything is hooked up and working properly—usually a grossly optimistic assumption—you will see a display similar to one of the five drawings included here. This is what they mean:

Figure 1a shows the display we are trying to achieve — 0° phase shift.

Figure 1b and 1d show 45° and 135° phase shift respectively.

Figure 1c shows 90° phase shift.

Figure 1e shows 180° phase shift (complete cancellation).

Adjust the azimuth so that you get a display that looks like figure 1a and that's it. Figure 1a, as you can see, is a straight line that crosses the x and y axes at a 45° angle on the horizontal and slants upward to the right. If there

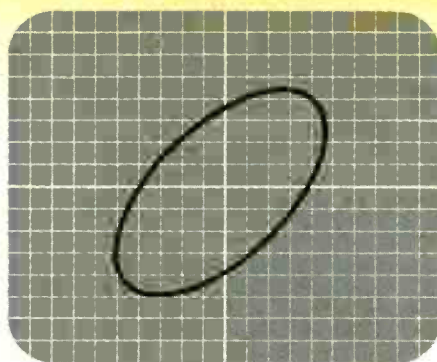

(B)

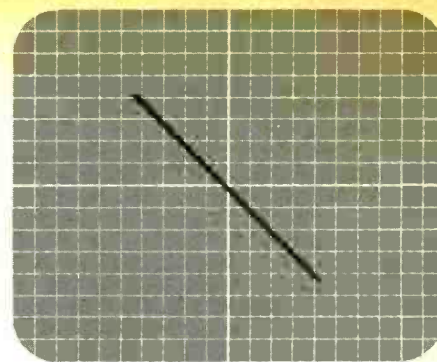

(E)

is a difference in level or gain between the two channels but the azimuth is right on, the angle will be different on the display. That is, for example, if the right channel is hotter, the angle with the horizontal will be less and vice-versa. This is not too important as long as the line is a straight line inclined to the right and not an ellipse or circle. But if both settings are equal, it will make this observation easier to read.

move up to 10 kHz or higher. Or adjust azimuth with the recorder's VU meters for maximum output and then go to the 'scope method. If you have experience with a 'scope you don't need the VU meters; you can go entirely by the size of the display—look for the longest line in figure 1a.

—David Moyssiadis
Contributing Editor
Modern Recording

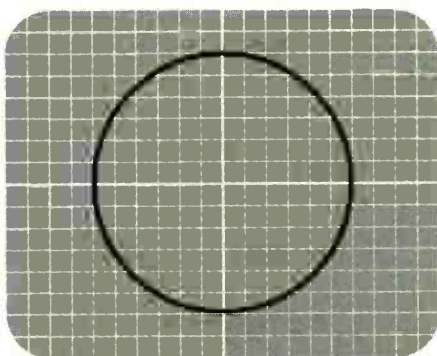

(C)

One word of caution: Since this is a highly precise method of setting azimuth, if you are using a very high frequency (15 kHz or higher) it is quite possible to be more than 360° out of phase which would give a proper reading and azimuth would be incorrect. This is a side peak. To avoid falling into this trap, the suggestion is to make a coarse adjustment with a lower frequency such as 7 or 8 kHz and then

Gauging Wire's Importance

In regard to wire gauge for a basic "live" sound reinforcement system, is 18-gauge wire used? What is the standard size utilized, if one exists? What happens to the power if too small a gauge wire is employed?

—Cathy Weidner
Bayside, N.Y.

First, consider what an amplifier does. A modern, 250 watt at 8 ohms per channel solid state amplifier produces an alternating current varying from 20 to 20,000 Hertz and at full power puts out about 6 amps at about 40 volts. Zip cord and other popular speaker cords are Underwriters' Laboratories (U.L.) rated for use at 60 Hz and 115 volts, according to an acceptable voltage drop with lighting, heaters and motors.

Generally, a sound system's speaker leads are 25 feet to 75 feet. 18 gauge is rated by U.L. to carry 10 amps at 115 volts and drop a maximum of 10 volts or 8.7% at 75 feet. 14 gauge wire is rated at 8 amps; 12 gauge at 25 amps. On the surface, it would seem that 18 gauge is okay. However, we like to think that the relationship between an amplifier and a speaker is a bit more critical. Any design engineer considers headroom of at least a factor of two. The difference between 18 gauge and 14 gauge is less than that. More important is the effect on power transmission and damping factor. 18 gauge has a resistance of 6½ ohms per 1000 feet; 14 gauge, 2.6 ohms

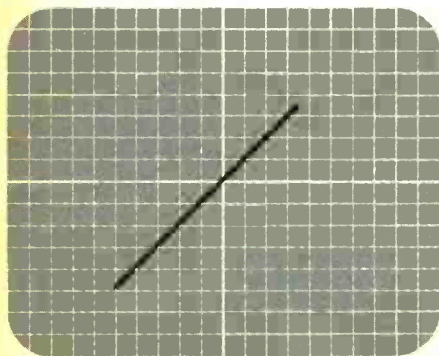

(A)

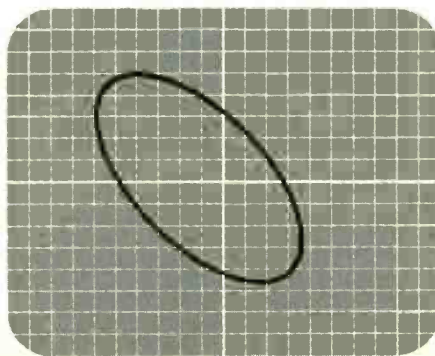

(D)

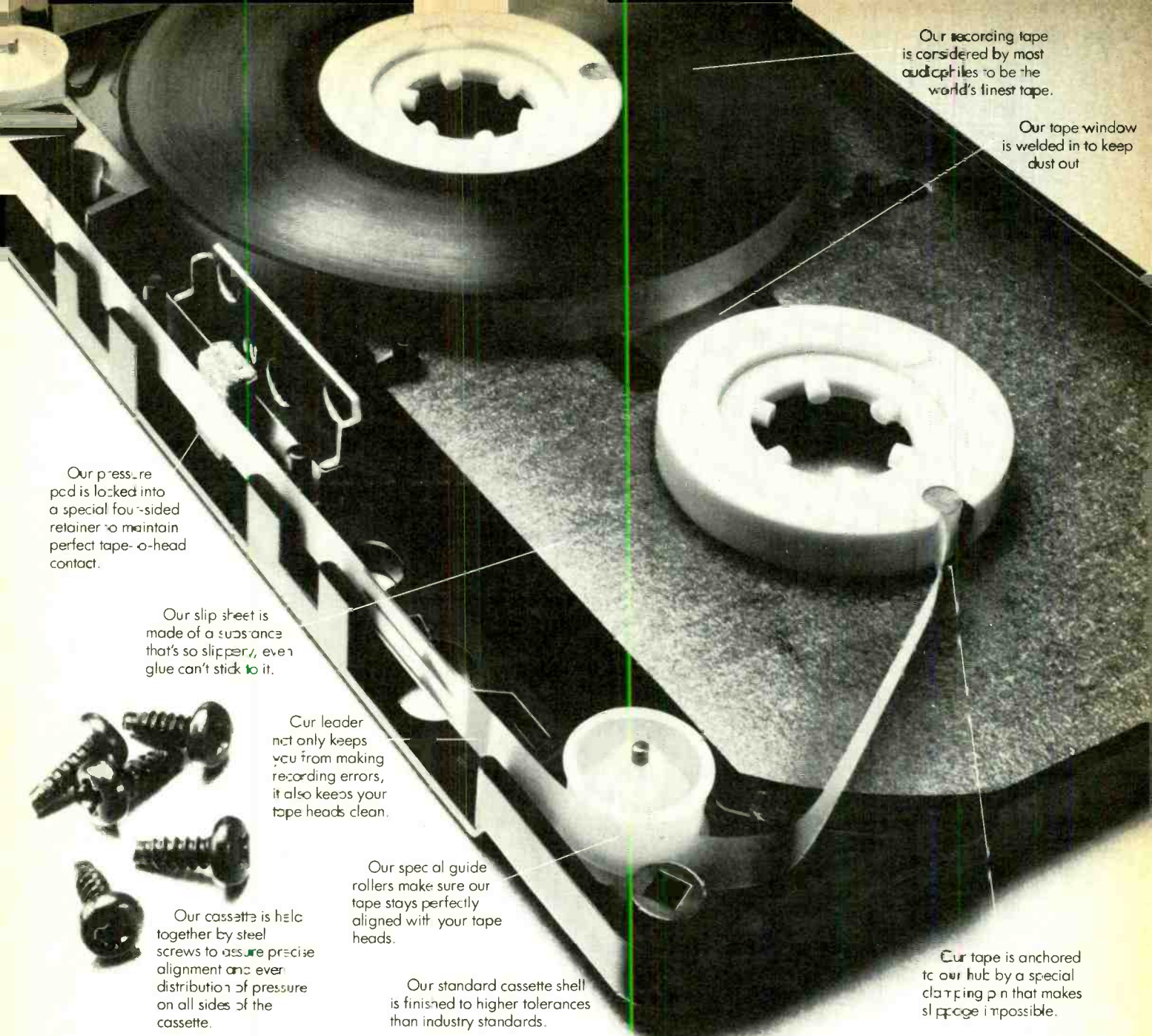

Our recording tape is considered by most audiophiles to be the world's finest tape.

Our tape window is welded in to keep dust out.

Our pressure pad is locked into a special four-sided retainer to maintain perfect tape-to-head contact.

Our slip sheet is made of a substance that's so slippery, even glue can't stick to it.



Our leader not only keeps you from making recording errors, it also keeps your tape heads clean.

Our cassette is held together by steel screws to assure precise alignment and even distribution of pressure on all sides of the cassette.

Our special guide rollers make sure our tape stays perfectly aligned with your tape heads.

Our standard cassette shell is finished to higher tolerances than industry standards.

Our tape is anchored to our hub by a special clamping pin that makes slippage impossible.

There's more to the world's best tape than the world's best tape.

Our reputation for making the world's best tape is due in part to making the world's best cassettes.

In fact, we put more thought

and more work into our cassettes than most manufacturers put into their tape.

We do all this, because at Maxell

we believe in a simple philosophy.

To get great sound out of a cassette takes a lot more than just putting great tape into it.

maxell

Maxell Corporation of America, 60 Oxford Drive, Moonachie, N.J. 07074.

CIRCLE 79 ON READER SERVICE CARD
www.americanradiohistory.com

and 12 gauge, 1.6 ohms per 1000 feet. Thus, two leads of 75 feet compute to 1 ohm for 18 gauge, .4 for 14 gauge and .25 for 12 gauge. This value of extra resistance is placed in series with the speaker load, thus *raising* the total load impedance and *reducing* the power transmitted. This can be a significant factor at low impedances. A typical 250 watt at 8 ohms amplifier might produce approximately 500 watts at 4 ohms, *but* if 1 ohm is now placed in series with the speakers, the total load would raise to approximately 5 ohms. (Of course, resistance is only one component of impedance. Values might vary slightly.) This would lower the current flow by about 60-70 watts or about one decibel — not a very significant figure, but still, why give up any power?

Perhaps most important is the effect on damping factor. Damping factor is the measure of how the amplifier dissipates the back E.M.F. (electromotive force or, simply, voltage) generated by the speaker. The more speakers in parallel or series, the more complex this inductive/reactive phenomenon. Damping factor is directly related to the internal impedance of the power amp. This is *not* as critical at

higher frequencies or in horns where there is very little speaker movement, but is very important at low frequencies, especially in ported-type cabinets where speaker excursion is large. The audible effect is a muddy, ill-defined bass. Some claim this is insignificant, as well it is, with amplifiers having normally low damping factors, such as tube-type amplifiers or solid state amplifiers with output transformers. However, state-of-the-art, direct-coupled, solid state amps have *high* damping factors which can be affected by thin cable.

Like anything else, we compromise between theory and cost. Our 75 foot speaker leads are 12 gauge, while shorter leads for stage use are 14 gauge. Specialized multi-cord is used for large systems. This is expensive for small users. Smaller systems generally use two-conductor type SO (Six hundred volt, Neoprene covered) or SJO (three hundred volt, Neoprene covered) or SJ (three hundred volt, rubber coated) power cordage. (N.B.: SO, SJ and SJO are standard U.L. codes which refer to the different jackets used on wire.) They are easy to coil, are readily available and extremely rugged.

Continuing the same logic, we recommend a connector capable of handling at least 10 amperes, such as 15-amp Twist-lok, as opposed to Cannon or 1/2-inch connectors. Too often these can be improperly patched and really were not designed to handle high current; rather they were designed to handle a low current, low voltage signal.

—Harold Blumberg
Audiofreqs Sound Service
Cincinnati, Ohio

Disco Sessions Simplified

I read with great interest Bruce Swedien's article, "Miking Strings and Horns" (February 1979, page 36) and found it very informative. However, I would like answers to some questions concerning the production of a 24-track recording session that is disco oriented, using an orchestra.

With reference to what point in the recording chain the vocals and various instrumentals are added, could you supply me with answers to the following:

Are lead guitar parts recorded during basic tracks?

At what point are synthesizer parts recorded?

Time-Based Effects . . . Without the Side-Effects.

Introducing the 440 Delay Line/Flanger from Loft Modular Devices.



There is a new solution for time-based effects. Filling the gap between expensive digital lines and low cost 'black boxes', the Series 440 Delay Line/Flanger delivers the amazing depth and dramatic realism rightly associated with analog delay effects. Yet it avoids so many unwanted side effects you expect from analog and even some digital systems.

Now, you don't have to sacrifice the dimensional impact of your music to severely limited bandwidths, nor lose that bright crisp edge to compromised electronics. Gone too, are the 'thumps', 'whistles', background oscillations, quantizing noise, 'grainy' digital audio, and other strange distortion you may have noticed before. Even headroom, a problem with so many units, is no problem with the Series 440 Delay Line/Flanger.

All you get is great sounding delay combined with the creative flexibility of VCO time based processing. Mixed to any degree with straight delays from .5msec all the way out to 160msec., VCO processing permits such effects as resonant flanging, Leslie-type sounds with different 'rotation' speeds, vibrato, double tracking with realistic pitch and timing errors, or a wide range of more subtle effects to control the spatial perspective of your music. In addition to the built-in VCO feature, control voltage jacks allow further modification of the system's special effects capability. Impressive? We think so, but there is more. Why not check out the details at a representative dealer near you.

The Series 440 Analog Delay Line/Flanger is in stock and ready for immediate delivery.

LOFT
MODULAR DEVICES

LOFT MODULAR DEVICES, INC. 91 Elm Street, Manchester, CT 06040 (203)646-7806

CIRCLE 76 ON READER SERVICE CARD



Music by Matrix. Sound by Bose.

Matrix. Warner Bros. recording artists. A hard-driving fusion group with lots of brass, percussion and electronics. And all 32 channels, including a wide variety of mics, pickups, and line feeds, are amplified by Bose 1800 power amps and Model 802 loudspeakers.

Matrix. A group with talent and taste. "A band that cannot fail," says the LA Times.

Matrix chooses Bose for all their needs. Main PA, electric bass, synthesizers, acoustic and electric piano, and all stage monitors.

Why?

Because with Bose, Matrix

sounds like what they really are. Trumpets sound like trumpets. A flute sounds like a flute. Even the drums

sound live, not canned. The sound is clear. Clean. Natural.

And the modular nature of their Bose system gives Matrix the versatility and flexibility of performing virtually anywhere. From clubs, auditoriums and gyms to outdoor festivals with audiences of 10,000 people.

If you're interested in a system that sounds like the band that's using it, check out Bose.

BOSE[®]

Bose for Pros

Stage courtesy Berklee Performance Center. Model 802 patent rights issued and pending.

Bose Corporation Dept. MR
100 The Mountain Rd.
Framingham, MA 01701

Please send me a copy of the Bose Professional Products Catalog and a complete dealer list.

Name _____
Street _____
City _____
State _____ Zip _____
Tel. () _____

Here are some of the reasons why **GLI** sound equipment is #1 in disco throughout the world:

• FLAMINGO • MARRIOTT'S • ZACHARY'S • GIORGIO'S • CC REGINE'S • INFINITY • THE LIBRARY • 2001 CLUBS • POOH'S • LA FOLIE • CRAZZ • BREESIE'S • HOLIDAY INNS • GIRARD MARAKESH • SKATE UNIVERSITY • TOBY HANNA OFFICER • NEWPORT BEACH RESORT HOTEL • EMPIRE ROLLERDROM • AMERICA ON WHEELS • UNITED SKATES OF AMERICA • RC • FLYING SAUCER • THE FUN HOUSE • L'AMOUR • STADIUM RAMADA INNS • SHEZATON INNS • HYATT REGENCY HOTEL • PIERCE ST. ANNEX • CLUB INTERNATIONAL • SKATERS PARK • BURGUNDY WOODS • MARMALADE MAX • SOUTHTOWN • BEAUCONTE • SKATE-A-WAY U.S.A. • M

MANUFACTURERS OF DISCO SOUND SYSTEMS, POWER AMPLIFIERS, MIXERS AND PROFESSIONAL SPEAKERS. FOR MORE INFORMATION, SEE YOUR GLI SOUND DEALER.

GLI INTEGRATED SOUND SYSTEMS, INC.
29-50 Northern Blvd., Long Island City, N.Y. 11101
(212) 729-8400
A Subsidiary of The VSC Corporation
SPEAKS FOR ITSELF

CIRCLE 46 ON READER SERVICE CARD

Now... a rack system as flexible as your equipment.

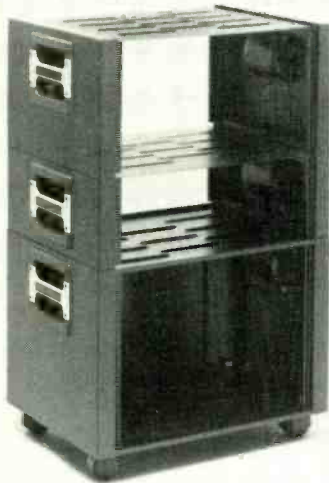

All Stak-Raks have a scratch-resistant finish, heavy duty handles, louvered tops for ventilation and are 16" deep. Three sizes — 7", 10" & 14". The 14" comes with a removable hinged door, casters, and will support up to 880 lbs.

The new Stak-Rak modular interlocking case system allows you to safely stack equipment as high as you like, yet lifts apart for easy transportation. 6' of loaded Stak-Raks fit into any compact car. Exclusive mounting rails front & rear, with slots instead of pre-drilled holes, allow installation of any type of 19" equipment, even those with non-standard heights.



STAK-RAK ... THE MODULAR ALTERNATIVE

Distributed exclusively by **AUDIO-VIDEO SUPPLY**
1129L DOMINGUEZ ST., CARSON, CA 90746 - 213/632-7119

CIRCLE 34 ON READER SERVICE CARD

When are congas, bongos, timbales, and other such drums recorded?

Are all horn solos added during overdubs?

When are orchestra bells, chimes, vibes, cowbells, wood blocks, and various other special effects added?

Are lead and backup vocals recorded simultaneously?

Are vocal overdubs recorded before or after strings and horns?

Is it better to add special effects during recording or mixdown?

I would like to know the best way to organize a disco session. It seems to me that such sessions, with all the instruments and parts (and breaks) involved, would be confusing affairs!

— William G. Piper
Bridgeport, Ct.

The approach to recording disco music is basically the same as one would take to any modern recording. A reasonable amount of isolation between instruments is desirable for control, and unless it is a "live" session (all instrumental sections recorded simultaneously in the same room), most lead and special effect instruments are actually overdubbed.

In the more common overdub approach, the entire rhythm section is recorded first, with lead and background vocals being added next (usually lead vocal first). The arranger then gets a reference mix of the track and vocals. At this point, he hears where the "holes" are, learns the hooks and melody, and writes his arrangement accordingly. Strings and horns are then overdubbed and the song is basically complete. The producer will then add any additional percussion and lead instrument lines that he feels are needed. The tune is now ready to be mixed. It is here where the real distinction in the "disco sound" will be made. It is here that the heavy rhythm instruments (bass, bass drum and snare) are featured, most special effects added, and any breaks "added" via editing in special rhythmic mixes of various parts of the tune.

Please note that with the disco format preferred over the years, many producers and arrangers now incorporate all the breaks and instrumental sections into the basic arrangement of the song, thus eliminating the need to edit them in.

— Carl R. Paruolo
Chief Engineer
Sigma Sound Studios
Philadelphia, Pa.

The Audio-Technica philosophy:

EQ should be used to improve the sound... not to fix the mike!

Introducing affordable smooth sound. The remarkable AT801 and AT811 Electret Condensers. With curves so smooth you would have to pay a bundle to match them anywhere else.

Response like this has a number of benefits. First, your EQ is used only to touch up the sound, not to correct built-in errors of the microphone. Which leaves more leeway to control the overall sound.

And without unwanted peaks you have more usable headroom. That's vital when you're working near the dynamic limit of a preamp or line amp. Sound stays clean and sharp. Compressors or limiters sound less forced, because they are controlling peaks in the *sound*, not peaks in the *mike!*

But perhaps the biggest advantage is the versatility of these A-T condensers. Because they have just the right amount of presence for today's recordings, they're not limited to just one kind of instrument...just one type of voice. Put them *anywhere* in the mix: brass, reeds, percussion, chorus, or strings. Then listen. What you hear in the studio you'll hear at the console. Which is a great place to start in miking any session.

At their highly affordable prices, these are two of the best bargains you'll find these days. Reliable, clean-sounding, and the most predictable microphones you can use. Make them a mainstay in your studio today. Write for spec sheets and dealer list.

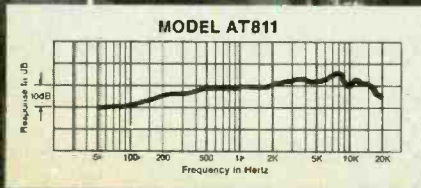
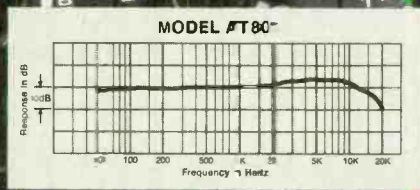

Model AT801 Omnidirectional Electret Condenser

Model AT811 Unidirectional Electret Condenser

Great sound, right from the start!



audio-technica
INNOVATION □ PRECISION □ INTEGRITY

AUDIO-TECHNICA U.S., INC., Dept. 79MR
33 Shiawassee Avenue, Fairlawn, Ohio 44313

CIRCLE 132 ON READER SERVICE CARD

Laborious Process Pays Off

I am curious as to how cross-fades between album tracks can best be achieved. The most obvious way is to re-record the stereo mixdown from two separate recorders onto one two-track tape, but this results in a stereo master three generations removed from the original multi-track tape. I have read that what is often done is that the two segments that are to be cross-faded are done so in the above manner, and the resulting fusion of the two cuts is then spliced into the second generation master at strategic points in the songs so as to disguise the splice. The theory here is that no more of a song is marred by worsened signal-to-noise and degraded quality than is necessary, but it seems to me that you would be in quite a bind if the spliced section didn't match the rest of the tape in volume. It seems like quite a laborious process anyway. Is it possible to obtain cross-fades while mastering? I find the effect very pleasing aesthetically (it really added class to Dave Mason's last album) and it certainly didn't hurt the Moody Blues to get three of four cuts played at one time on FM (thanks to cross-fading); another group might only have had one aired!

—Roman W. Pawlyszyn
Woodstock, Ontario

It is quite ironic that when the phone call came from *Modern Recording* with this inquiry, I was just finishing off an album session using the technique in question.

Yes, I agree with you that the cross-fade transition can be very effective, particularly with certain types of material. The object of course, would be to listen to the album as a continuous entity with much the same dissolve continuity as is used in motion pictures.

You are quite well informed as to the various methods of achieving the cross-fade and the implications involved. It is possible to achieve cross-fades while mixing with a lot of preplanning, a large computerized board, and two multitrack machines, but this involves a lot of hassle and expense. It could also be possible at mastering, using two two-tracks, the material edited onto opposite reels—for example, machine one would have cuts 1, 3, 5, etc., and machine two would have cuts 2, 4, 6, etc. However, this is quite impractical and if the cross-fade wasn't perfect each time, you would end up wasting a lot of lacquers. Also, if a recut was necessary, the whole cross-fade process would have to be repeated.

So, the most sensible method remains to assemble a master after all mixes are complete. You are correct in saying it would be three generations down from

the multitrack. However, with good professional and well-maintained tape machines, and great care, the loss and added tape noise is insignificant. Editing back into the master as suggested in the letter should be no problem, providing equipment and engineer are together. Yes, it is a laborious process, but so are all stages of recording art if it is to be done properly.

—Roger Monk
Recording Engineer
The Little Mountain Sound
Company, Ltd.
Vancouver, British Columbia

Comparisons and Compromises in Horn Design

For low-frequency reproduction involving large-mouth, straight (low frequency) horns (such as the JBL 4550) versus medium-length folded horns, which is the more important aspect of the horn design—the final mouth diameter or the length of the horn flare?

—Linda Bialous
Hillsdale, N.J.

All portable LF horns involve compromises—if they didn't, they wouldn't be portable. To illustrate: with our HF

LAND VOICE PRODUCTIONS PRESENTS

Your own recording studio with an exclusive franchise for your city!*

- A complete, portable, professional 12 channel recording studio for on location recording of everything from church groups to rock bands and theatrical events!
- Brand name equipment! TEAC, Tapco, Superscope, MXR and more!
- All equipment is supplied by Mars Music and Electronics, one of the east coast leaders in quality components!
- Album pressing and tape production at very reasonable rates!
- Marketing plan and promotional services!
- Complete quality control of album production by Land Voice Productions!
- Professional mixing services!

Write or call Land Voice Productions for more information on how you can operate your own recording company! A complete package designed for initial recording through the final album release! Unlimited recording possibilities and profit potential!

Land Voice Productions

401-E Philadelphia Pike
Wilmington, Delaware 19809
(302) 764-7046

* Availability limited to one franchise per U.S. city, depending upon population and location.

@All rights reserved



CIRCLE 115 ON READER SERVICE CARD

FOR THE SMALL STUDIO OWNER WITH BIG IDEAS.

If you're a small studio owner, you may have a problem: your ideas are far beyond your present equipment.

Maybe you're an engineer, dreaming of an automated 24-track studio. Maybe you're a producer, searching for "the next big thing." Maybe you're an artist, trying to land a record contract. What you need is something that will get you from where you are to where you'd like to be.

Sound impossible? Not to us. At dbx, we're committed to make professional recording technology available to anyone with the determination to make use of it. We make a line of rack-mountable signal-processing devices designed and priced especially for the small studio.

Our tape noise reduction systems, the 155 (4-channel, switchable), the RM-155 (8-channel, switchable) and the 158 (8-channel, simultaneous), all offer the same 30 dB noise reduction and 10 dB headroom improvement as our state-of-the-art units and are fully compatible with them. They enable you to make master quality tapes, instead of demos, on your present equipment.

Our 161 and 163 compressor/limiters feature true RMS signal detection, which closely resembles the response of the human ear, and feed forward gain reduction, which allow for infinite compression capability. The 163 employs "Over Easy" compression, the most natural-sounding you've ever heard, and its "one knob" operation is the simplest around.

We can't guarantee our products will make you a star. But if you've got the talent, they'll take you as far as you want to go. dbx, Incorporated, 71 Chapel Street, Newton, MA 02195 617-964-3210.



dbx
UNLOCK
YOUR EARS

CIRCLE 92 ON READER SERVICE CARD

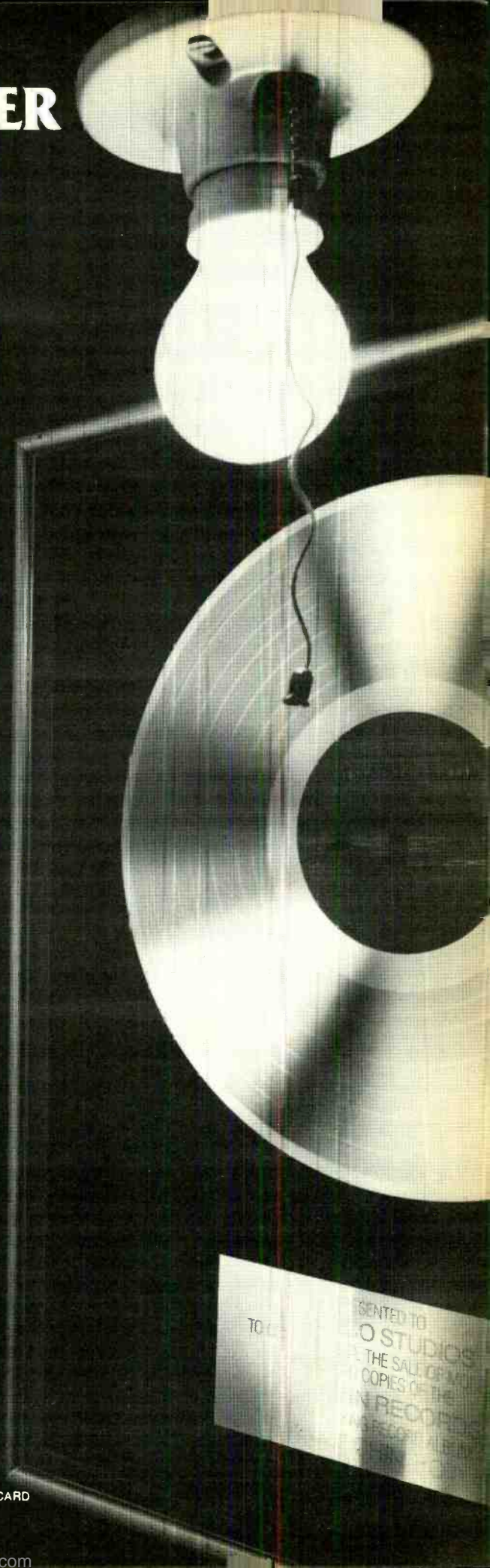

SENT TO
TO
O STUDIOS
THE SALE
COPIES OF
RECORD

horns we usually recommend operation above a frequency which is twice the flare rate of the horn, or a frequency at which the mouth height is one-half the wave length, whichever is higher. Applying that rule to a bass horn at 50 Hz, we would have a mouth height in excess of ten feet and a horn length in the vicinity of fifteen feet—not exactly portable unless you were to put an engine on it and drive it to your gig. Practical LF horns are compromised in both flare rate and mouth size, but the compromise can be shifted one way or the other as your question suggests.

The flare rate of a horn sets the lower limit at which it will operate as a horn—below that point the piece will not, of course, cease to make sound; it simply will not be a horn. Units such as the JBL 4550, which incorporate horns of rather high flare rate, operate well below their flare rate, but in that range they are functioning as sealed (or ported) cabinets, not horns. With a lower flare rate, horn operation is extended to lower frequencies, but only if there is sufficient mouth size to support the wave front at those frequencies. The flare frequency simply relates to the rate of expansion of the horn—one could easily construct a 25 Hz horn that

was six inches long and 6" x 6" at the mouth. It would indeed be a 25 Hz horn, and of course it would not work at all.

I have not done much testing of folded horns, but in detailed comparison of our straight LF horns with pieces such as the 4550, the straight horn, with its lower flare rate will show superior efficiency and pattern control down to a particular frequency, usually around 60 Hz (depending on the specific device) and below that output drops off rapidly. The higher flare unit will have a less sharp drop-off and in the very low regions will show higher output than the straight horn in question. The primary reason for this is that units like the 4550 actually use a large part of their bulk as a sealed cabinet, and fifteen-inch drivers in a large sealed enclosure are capable of going quite low. The straight horn, on the other hand, is entirely optimized for horn performance—its back cavity is quite small to provide maximum efficiency in the region in which it can operate as a horn, and below that region it really can't do much at all. A folded horn of equivalent dimensions to the straight horn would be likely to exhibit similar performance on the low end, although its midrange would suffer because of the folds.

As far as which approach is preferable, it depends on your application. If you need solid horn efficiency and control at 70 Hz, you would be better off with the lower flare piece. If you need some amount of output at 35 Hz, the higher flare horn-enclosure system would be indicated. It also might be a practical solution to employ both types in a large system.

—Bruce Howze

President
Community Light & Sound, Inc.
Philadelphia, Pa.

Instrumental Advice

I need some information regarding pianos and drums for studio use. Must you have a grand piano or could a reconditioned upright or even something like a Yamaha electric grand take its place? What about piano pickups such as Barcus-Berry and Frap, etc.; can these devices still be utilized?

On the subject of drums, what about clear acrylic and metal shells? Any quality loss experienced here?

—Q. Carley Roberts III
Mountain Music Inc.
Gulfport, Miss.

Whirlwind's Medusa helps fight spaghetti.

If you do music professionally, you can appreciate the importance of getting your equipment together, as well as your act. At Whirlwind, we know what this means because we've been through it for many years. As a solution to many of the problems resulting from multiple-wiring situations, we have designed a line of multiple cable systems, or "snakes," called Whirlwind Medusas. They are among the most highly respected systems in the world for their ruggedness, reliability, and their ability to pass noise free signal consistently for years and years.

Medusas feature cast steel boxes, riveted chassis mounted jacks, and wire mesh strain reliefs. They are available in nine basic configurations or custom wired to your specs. We provide many options including Medusa Wheels, Road Cases, Ribbon Connectors (for easy detachment and added flexibility), and Split Audio Feeds (for stage monitor mix or remote recording). If you've got a special job we'll build you a custom Medusa.

Whirlwind also manufactures a complete line of Instrument Cords, Mic Cords, Speaker Load Protection Systems, Speaker Cordsets, Cable ties, AC Cords, Stage Tape and an assortment of the world's finest connectors.

See your Pro Sound Dealer or write us for our catalog.

Medusas are the only snakes with color coded sends and inputs (by subgroups).



Many of today's top touring acts and recording studios have chosen Medusas.

whirlwind

Whirlwind Music, Inc.
P.O. Box 1075/Dept. MR
Rochester, New York 14603

CIRCLE 110 ON READER SERVICE CARD

THE BEST VALUE IN A PROFESSIONAL TAPE RECORDER

When you evaluate a tape recorder, here are the most important areas to consider for value, quality, and sound.

PERFORMANCE:

Overall Signal-to-Noise: 56 dB unweighted at 520 nWb/m (30 Hz to 18 kHz audio filter).

Playback Signal-to-Noise (electronics): 72 dB unweighted (with audio filter).

Headroom: +24 dB. Maximum Output: +23 dBm.

Overall Frequency Response (15 ips): 30 Hz to 22 kHz ± 2 dB.

Playback Frequency Response (MRL test tape): 31.5 Hz to 20 kHz ± 2 dB.

RELIABILITY: An unmatched four-year track record of on the job performance for the original compact professional recorder. Day in, night out. Just ask someone you trust.

ALIGNABILITY: Any tape recorder must be aligned to achieve maximum performance. With the MX-5050-B, all primary alignments are on the front panel. So is a 1-kHz test oscillator. Secondary alignments are inside the bottom panel. You or your maintenance people can align it fast and easy. This saves you time, money, and enhances your reputation.

INTERFACEABILITY: With a flick of the output switch you can plug-in to any system: +4 dBm 600 ohm or -10 dB high impedance. No line amps or pads to mess with. A perfect match everytime.

ADDITIONAL BENEFITS: Three speeds, dc servo $\pm 7\%$, 1/4 track reproduce, full edit capability, over-dubbing, noise free inserts, XLR connectors, NAB/CCIR switching, unique three-position alignment level switch.

PRICE: Suggested retail price \$1,945 (USA).

MX-5050-B: THE CHOICE IS OBVIOUS

OTARI[®]

Call Ruth Pruett on 415/593-1548 for the name of your nearest Otari professional dealer.
Otari Corporation, 981 Industrial Road,
San Carlos, CA 94070 TWX 910-376-4890
In Canada: BSR (Canada, Ltd.),
P.O. 7003 Station B, Rexdale, Ontario M9V 4B3
416/675-2425



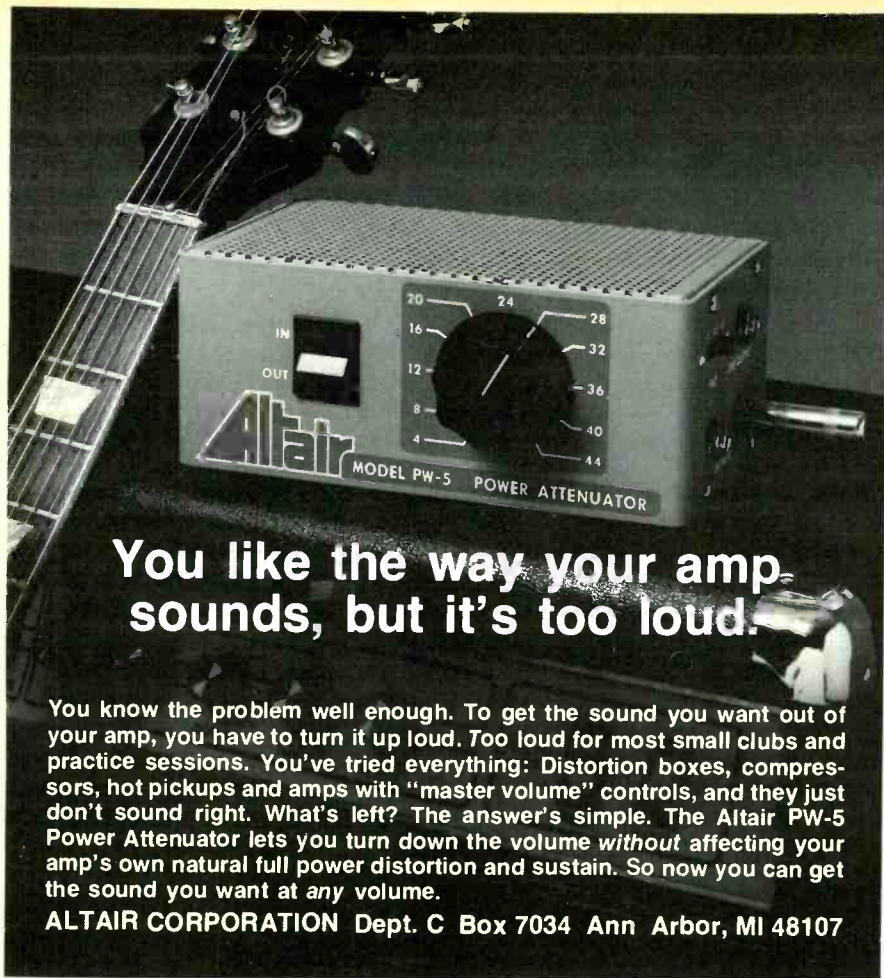

You like the way your amp sounds, but it's too loud.

You know the problem well enough. To get the sound you want out of your amp, you have to turn it up loud. Too loud for most small clubs and practice sessions. You've tried everything: Distortion boxes, compressors, hot pickups and amps with "master volume" controls, and they just don't sound right. What's left? The answer's simple. The answer's simple. The Altair PW-5 Power Attenuator lets you turn down the volume *without* affecting your amp's own natural full power distortion and sustain. So now you can get the sound you want at *any* volume.

ALTAIR CORPORATION Dept. C Box 7034 Ann Arbor, MI 48107

CIRCLE 116 ON READER SERVICE CARD

THE GREAT ONE...



Announcing our all new 1979 Buyer's Guide. 112 pages offering a tremendous selection of professional sound equipment and musical instruments at the lowest discount prices.

MUSIC EMPORIUM USA

P. O. Box 34441 West Bethesda, Md. 20034
(301) 340-1480 (301) 424-1696

NAME _____

ADDRESS _____

CITY _____

STATE _____ ZIP _____

Our catalog is yours —

FREE!

Just fill in the coupon at right and mail it to us today.

CIRCLE 51 ON READER SERVICE CARD

You should have a grand piano in your studio. Nothing is going to replace the sound of an acoustical instrument. The Yamaha or Steinway "B type" grand is a lot more practical for studio use than the regular large grand. The "B type" grand is only 7 1/2 feet long and is very suitable for today's hard percussive playing styles.

The three most used keyboards at MediaSound are the grand piano, Fender Rhodes and Clavinette. We also have Hammond organs and synthesizers available when the need arises. There is very little demand for a Yamaha electric grand. It's a lot more useful for road gigs.

We don't use piano pickups, but they may be useful as an effect or to help isolation. The use of a pickup for a percussive sound, along with the richness of a microphone, may give you an effect you're looking for. We advise good isolation by putting baffles around the piano and covering the open lid with heavy storage blankets.

I've been playing drums for a long time and my preference is wood drums, especially Pearl or Ludwig. I prefer Pearl for recording use because they have a clean sound. It's a good feeling bringing up a mic fader to a tom-tom and hearing a crisp unmuddy sound. Pearl makes some of their drums with fiberglass sprayed on the interior of the wood shell. The result is a clear, ballsy bottom that doesn't get lost in the record. Metal drums have too distinctive a sound and are not warm enough for my particular use.

Fibes makes a very good, clear drum. They sound best with double heads, but tuning them correctly is critical.

The type of head used is important in bringing out the best quality of the drum. If you have a drum that is too bright, try a hydraulic skin. Hydraulics are built using two heads separated by a thin film of oil. These heads are good for plastic shells. Be careful using them on wood shells. If you have double-headed toms, first try replacing the bottom with a hydraulic. Hydraulics are also very good on bass drums. I don't recommend them on shells smaller than eight inches in diameter. They deaden the overtones too much.

Bringing along a studio musician when you purchase your piano or drum set will also be very helpful.

—Michael Brauer
Engineer

MediaSound Recording Studio
New York, N.Y.



MODERN RECORDING

Jaco Pastorius | Acoustic Amps



photo: Gorm Valentin

Together
for over
a decade

acoustic

professional sound equipment

On stage: 330 top/408 enclosure/361 bass system
Off stage: 727 stereo amp/648 & 626 studio monitors

7949 Woodley Avenue
Van Nuys, California 91406

CIRCLE 54 ON READER SERVICE CARD

THE **PRODUCT** SCENE

By Norman Eisenberg

ELECTRONIC MICROPHONE SNAKE

JHD Audio of Costa Mesa, California, has announced the Mainliner ML-08 series, a multiplexing system for transmitting low-level signals from a stage to mixing or recording equipment. It utilizes time-domain multiplexing to transmit these channels over a length of standard microphone cable (8-channel model). There also are 16 and 24 channel models, each with four returns. Time-domain multiplexing involves sampling the inputs (encoding) and transmitting this information to a decoder where the data are reassembled at their respective outputs. Lo-Z mic inputs are standard, and Hi-Z inputs also are available. Intended primarily for instrument use (such as multiple keyboard setups, or direct feeding from guitars), the Hi-Z input snakes also may be used where the P.A. equipment consists primarily of Hi-Z microphone and mixer, without the signal loss and noise pickup of a conventional snake. Cable runs up to 700 feet are said to incur no signal loss.



CIRCLE 14 ON READER SERVICE CARD

ONE-SIXTH OCTAVE EQUALIZER

Designed by George Augspurger (Perception, Inc., Los Angeles) is a new active equalizer from White Instruments Inc. of Austin, Texas. The model 4240 is basically a one-sixth octave equalizer designed to be used in sound systems where speech is the pri-

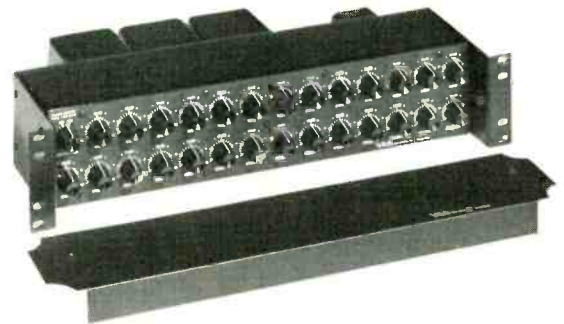

mary program material. The 4240 covers the range from 63 Hz to 10 kHz. Between 250 Hz and 2 kHz the device uses eighteen one-sixth octave controls. The frequency ranges below and above those points are adjusted with one-third, two-thirds, or full octave bandwidths.

CIRCLE 15 ON READER SERVICE CARD

CASSETTE DUPLICATOR

Mini-Max is the name of a new cassette-to-cassette duplicator priced at \$459 and capable of copying two tracks simultaneously at 15 ips. Mini-Max has automatic stop at the end of both the record and rewind cycles. Some specs include: frequency response of ± 3 dB, 30 Hz to 10 kHz; bias adjustment of 0.4 MHz; wow and flutter of less than 0.25 percent; S/N of 50 dB. Mini-Max is offered by Recordex Corp., of Atlanta, Ga., a firm that produces a broad line of tape duplicators.

CIRCLE 16 ON READER SERVICE CARD

TWO NEW ITEMS FROM SOUNDCRAFT

A one-inch eight-track tape recorder, the first from its Soundcrafts Magnetic subsidiary, has been announced by this British firm. Known as the SCM 381-8, the new machine employs a precision-engineered tape transport based on a thick cast-aluminum plate. A simple tape path features the capstan shaft on the outside of the tape to avoid tape oxide wear. Rated wow and flutter is 0.03 percent. The main control panel, for all audio and transport functions, may be removed and used as a remote control. Included is a tape counter that reads in real time (minutes and seconds), with a search-to-zero facility. Some specs: Reel size, 10½ inches; speed, 15 ips; r/p frequency response, 30 Hz to 20 kHz within +1 and -2 dB; unweighted playback S/N, 68 dB. Price for the 381-8 (allowing for the rise and fall of the U.S. dollar) has yet to be set, but will be approximately—professional net; available factory direct from the Michigan branch—\$10,500.

Also from Soundcraft comes word of its model EX4S electronic crossover, a stereo unit switchable for two, three or four-way applications. This device is said to be the only professional crossover employing 4th-order Bessel function filters which makes possible 24-dB-per-octave filtering with ultralinear phase response. The result, says the firm, is cleaner sound plus the possibility of attaining higher power levels without damage to compression driver diaphragms.



CIRCLE 17 ON READER SERVICE CARD

INFINITY "HYBRID" AMPLIFIER

Infinity Systems has introduced a new amplifier which employs vacuum tubes in the input stage, transistors in the output stage, and Class A operation. Power is rated at 150 watts per channel, RMS into 8 ohms with a total harmonic distortion of no more than 0.2%. Into a 4-ohm load, the power rating goes up to 280 watts, and into a 2-ohm load it



goes up to 400 watts. Characterizing the circuit design as offering the both of best worlds, an Infinity spokesman points out that tube amplifiers exhibit a "sweetness and sense of reality never achieved by transistor amplifiers." So tubes are utilized in the front end. However, transistors, Infinity admits, "make possible higher power without enormously increased amplifier size," so in the output stages they are using transistors. The suggested retail price of the new amplifier is \$4000.

CIRCLE 18 ON READER SERVICE CARD

TEAC MODIFIES FOR METAL TAPE

TEAC will modify its C-1 cassette recorder to record and play metal tape at a cost of \$150 which includes shipping costs both ways. A model C-1 owner can expect the unit to be out of service for two to three weeks while the modifications are made on it, says TEAC. The refit program involves replacing the unit's erase head, and modifying the bias circuitry. The record and play heads do not have to be replaced, explains TEAC, inasmuch as the existing C-1 heads are compatible with the new metal tapes as a result of TEAC's having been researching this area for several years. TEAC has three service stations for the modification, and suggests that the customer call first before sending the deck. One is at 63 Bergen Turnpike, Little Ferry, N.J. 07643. Another is at 539 W. Gold Road, Arlington Heights, Ill. 60005. The third is at 1824 Gage Street, Montebello, Ca. 90640.

CIRCLE 19 ON READER SERVICE CARD

DIGITAL TIMER FOR AUDIO USE

Amid all its other products Pioneer has introduced a precision digital timer said to be especially good for audio use. The new DT-400 is a noiseless device that may be used to turn on and off connected audio components at any preset time. The auto-on, auto on/off, sleep timer and other features are said to make the DT-400 more useful than ordinary mecha-



nical timers. Two AC outlets (500 watts maximum, each) permit connecting the power cords of various audio components—tape deck and tuner or receiver, for instance. In addition to the “cool blue” time indication, the device has a red LED for power-send indication, and a failure flash if power has been interrupted. Timer accuracy is said to be within +0.02 second.

CIRCLE 20 ON READER SERVICE CARD

METAL TAPE CASSETTE DECK

New from Aiwa is the model AD-6700 U, a front-loading cassette recorder with metal-particle tape compatibility. Features include solenoid-feather touch controls with cue/review operation; a nine-point multicolor peak LED indicator; a real-time tape meter that shows the minutes left before the end of a tape; adjustable bias for LH, FeCr, and CrO₂ tapes; and automatic rewind/replay facility. The unit also comes with a full-function wireless remote control accessory. Weighing 23 pounds, and 18¾ inches wide, the AD-6700 U has a rated frequency response of +2, -3 dB from 25 Hz to 15 kHz with LH tape, and to 17 kHz with CrO₂, FeCr and metal tapes. S/N ratio is given (with Dolby on) as 65 dB for FeCr tape, 67 dB for metal tape and 54 dB for LH tape. Wow and flutter is listed as 0.04 percent. Price of the Aiwa deck is \$750.

CIRCLE 21 ON READER SERVICE CARD

SUB-WOOFER AMPLIFIER

Designed for driving a sub-woofer is Ace Audio's new model 8000 amplifier. A direct-coupled, full complementary monophonic power amp, the 8000 is rated for an output of 70 watts RMS, and its response is spec'd as running within ± 0.1 dB from 15 Hz to 20 kHz. At low frequencies, it has a damping factor of at least 70. Full power output is available for both 8-ohm and 4-ohm speakers. The manufacturer points out that while the model 8000 was designed especially for subwoofer use, it does deliver a very clean signal throughout the entire normal audio band, with distortion remaining less than 0.1 percent at full power and also at low levels of 250 mW. Hum and noise spec is -90 dB. Price for one amp is \$189; for 2 or more, \$185 each.

CIRCLE 22 ON READER SERVICE CARD

FOUR-BAND PARAMETRIC EQ

From Parasound of San Francisco comes word of a new equalizer made by Orange County Electronics of Winnipeg, Manitoba, Canada. The device is the model PEQ, a four-band parametric equalizer with center frequencies variable from 20 Hz to 20 kHz in overlapping five-octave (32:1) ranges. Each section tunes over a 40-dB control range. Bandwidth is

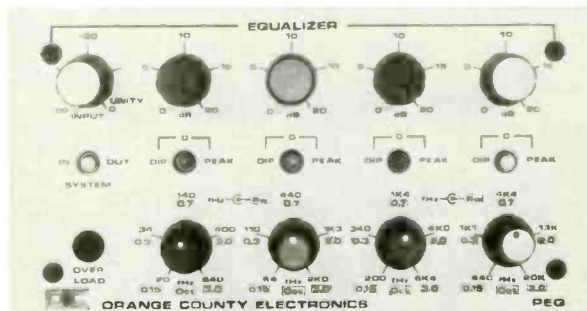

variable from 0.15-3 octaves. Said to be a unique feature of PEQ is the fact that all its controls are non-interacting, which is to say, for example, that when the bandwidth is varied, there is no change in level. Some specs are: S/N of 110 dB with all sections in 20-dB boost; THD of 0.05 percent at 18 dBm output; output capability of +30 dB for a 10-K ohm load, or +24 dB into a 600-ohm load. Balanced or unbalanced operation is available.

CIRCLE 23 ON READER SERVICE CARD

NIKKO TIME DELAY

From Nikko Audio comes word of a new addition to its product line, the ATD-1 Time Delay Synthesizer. The new unit "recreates the ambience of the concert hall, permitting the user to make an infinite combination of adjustments to duplicate virtually any acoustic environment," according to the manufacturer. In fact, says Nikko, the unique aspect of



the ATD-1 is that it can be programmed by the user, and Nikko plans to publish a listing of control settings to match the ambience of some of the most famous recording sites. Finished in black matte and mountable in a standard 19-inch rack, the new Nikko ATD-1 has adjustable input level with LED indicators and is said to be the only unit that permits connection through the tape or preamp outputs, whichever the user elects to use. This flexibility, which results from the adjustable input level, is not obtainable on other units, points out Nikko. The ATD-1 incorporates Nikko's transient elimination circuitry so that initial turn-on thumps are eliminated.

CIRCLE 24 ON READER SERVICE CARD

NEW POWER AMP SERIES

Four power amplifiers featuring the use of new power MOS FETs (field effect transistors) have been announced by H/H Electronic. Claimed to offer superior high frequency performance for both open-loop and closed-loop operation, the amps' slew rate of 60 V/microsecond is, says H/H, much faster than that of conventional bipolar transistor amplifiers. Thermal stability also is assured. The amplifiers have calibrated detented input attenuators, plug-in optional input transformers, XLR and jack connectors, 19-inch rack-mounting, and LED peak indicators—features which H/H feels will appeal to the professional user.

Included in the series are: the model V150-L, a single-channel amplifier rated for 100 watts output; the model V200, a two-channel model, 60 watts per channel; the model V500, a two-channel model, 150 watts per channel; and the V800, a two-channel model, 250 watts per channel; all at 8 ohms across the audio band for rated THD of 0.03 percent.

CIRCLE 25 ON READER SERVICE CARD

WHAT'S IN A NAME?

A recent entrant into the world of sound and recording stopped by the shop where I share space the other day and threw this one at us: "I have bookshelves in my studio," he said, "but I'll be damned if I can fit so-called bookshelf speakers onto them. Who's kidding whom?"

A legitimate question. His bookshelves (which were designed actually to hold books, believe it or not) are a bit over ten inches deep and at most eleven inches high. Okay for most books, some magazines and manuals, and of course for 7-inch tape reels or even NAB size reels placed horizontally. But a speaker system that is 25 by 12½ by 12½ inches? You need some special kind of "bookshelf" for a pair (or more) of those units.

The term "bookshelf" as applied to speaker systems is of course a relative term. It harks back to the days when the only reputable-sounding speakers were tall, floor-based types. The original air-suspension systems were, in contrast, much smaller—and someone started calling them "bookshelf" size. Even so, the concept of speaker system size was still a matter of one's frame of reference. I recall one audio show at which Edgar Villchur was proudly demonstrating his (then) new prodigies, with 30-Hz tones coming out of an unbelievable 2-cubic-foot box. The usually verbal inventor was struck speechless when one witness said: "They sound very good, but why must they be so big?"

The term "bookshelf" may have been (and still is) a bit of promotional hype, but over the years it has become apparent that it does contain a technically valid clue. And that is, simply, that such speakers do not belong on the floor. They need—in most installations (home stereo or studio monitor or stage reinforcement use)—to be raised some distance off the floor. Why? For one thing, to avoid overly heavy bass often with the attendant problem of exciting spurious room resonances. For another thing, the middles and highs have a better chance of getting out into the listening area, and at elevations more consistent with where most people's ears are located, while also avoiding the blocking effects of furnishings. A raised speaker of this type also will minimize the danger of acoustical feedback, not to mention the problem of bass thumping through the floor to those below (if that is also a problem).

Of course, with speakers raised to some height—especially on stands that tilt them back—it may become awkward to place ashtrays and coffee cups on them. Oh, the price we pay for clean sound!

MUSICAL

NEWSIGALS

MUSICAL INSTRUMENTS

Buddy Emmons, the noted steel guitarist, has been involved in the manufacture of steel guitars since he founded the Emmons Guitar Company in 1963. Emmons and former physics professor Ron Lashly, who heads the Emmons Guitar Company, recently announced the introduction of a new



model pedal steel guitar of their own design, which is said to incorporate the first major design advances in pedal steel guitars in over a decade. The Emmons LeGrande Custom pedal steel guitar was designed to allow greater chord flexibility and better tonal quality. Features include an all-pull system, split tuning, and quick-change bell-crank levers and pull rods.

CIRCLE 1 ON READER SERVICE CARD

Ibanez has once again expanded its model line with the introduction of two new bass guitar models in its Musician Series. The MC 800 bass guitar incorporates the latest thinking in guitar design for state-of-the-art performance. The neck of the instrument runs the full length of the instrument for rigidity and improved sustain. The neck is constructed from rock maple with walnut laminations and a tuned steel truss rod, and each neck is indivi-

dually tuned to eliminate "dead spots." The fingerboard has twenty-two Velve-Touch frets on a 34-inch scale length. The bridge on the MC 800 is the Accu-Cast B, a precision die-cast bridge/tailpiece assembly. This unit features machined bridge saddles which are independently adjustable for height and intonation, and a slotted tailpiece for quick string changes. On the electronic side, the MC 800 uses the wide-response Ibanez Super 4 bass pickups for a clean, full sound with excellent crispness. The Ibanez MC 900 has all the same features as the MC 800, but adds the Ibanez EQ tone system, which is an on-board preamplifier and equalizer. For use on a bass guitar, the frequencies of the three equalization bands were altered from their usual guitar equalization fre-



quencies; the EQ-B Tone System now features bass, mid and treble controls which act at 80 Hz, 500 Hz and 1.5 kHz, respectively for near-ideal control of the instrument's sound.

CIRCLE 2 ON READER SERVICE CARD

Tama Drums has announced a new wood shell snare drum, called the Superstar. As we all know, musical tastes have a habit of changing, and the sound of wood drums has been showing a resurgence in popularity. This new Superstar snare drum was designed to produce the desired sound of a wood drum without any sacrifice in strength and durability, and with the addition of modern features and hardware lacking in traditional wood drums. The wood shells are specially built to give the strength of laminated wood while retaining the vibrational properties of solid wood. Like all Tama snare drums, the Superstar features high-pressure, die-cast alloy hoops which are much stiffer than conventional stamped metal hoops. This results in better fit to both the drum head and the shell and in more consistent and accurate tuning and head tensioning because the hoop does not flex or distort under tension. Other features of the Superstar include the Tama One-Touch tone control and a choice of two special snare strainers. The Superstar snare drum is available in 5-inch and 6½-inch depths, both 14 inches in diameter, and the manufacturer offers a choice of custom mahogany or natural maple finishes.

CIRCLE 3 ON READER SERVICE CARD

SYNTHESIZER EQUIPMENT

Users of the Synare 3 electronic drums will be interested to learn that Star Instruments has announced the introduction of an electronic sequencer for use with their Synare 3 system. The unit is capable of storing up to four 32-note sequences of up to ten seconds duration each. These sequences are entered into the sequencer by selecting one of the four memory banks, hitting the "load" pad on the unit and then playing the desired sequence as usual on the Synare 3 drums with hand, stick or

mallet. The system memorizes the between-note intervals, the dynamics of each note and which one of up to four Synare 3 drums was hit to produce the note. On playback, the user selects one of the four sequences stored and hits the "play" pad; the unit then replays the sequence of notes stored at a



tempo which can be varied and repeats the sequence of notes stored at a tempo which can be varied and repeats the sequence until the "stop" pad is hit. While the sequencer is playing back, the Synare 3 drums are still active, allowing the drummer to add additional rhythm patterns or poly-rhythms over the stored sequence.

CIRCLE 4 ON READER SERVICE CARD

SYNTHESIZERS

Roland Corp US is now marketing a new, computer-controlled, 4-voice polyphonic synthesizer which has ten preset voices and eight programmable voices. The model is known as the Jupiter 4 and uses a single-panel control design which allows ease of operation without sacrificing versatility. The unit features a four-octave keyboard with bend/mod wheel, polyphonic portamento, and four keyboard assign modes. The ten preset voices include strings, bass, voice, piano, trombone, sax, trumpet, and several unusual voices, while the programmable voices are limitless. Sounds already programmed may be protected against erasure with a memory protect. All eighteen voices are instantly available while playing. Special



features of the Jupiter 4 include a wide-range, multiple-waveform LFO, 4-pole (24 dB/octave) VCFs and an arpeggiator.

CIRCLE 5 ON READER SERVICE CARD

The Aries Music Keyboard System III is a new performance-oriented model from Aries Music, Inc., featuring normal prepatching which can be easily overridden when other patches are desired. A "natural filter patch" gives a realistic quality to the timbre with footpedal control of brightness. Other features include voltage controlled phasing, VC stereo panning, independent reverb on each output channel, preamp and envelope follower, balanced modulator, and a 5-octave keyboard.

CIRCLE 6 ON READER SERVICE CARD

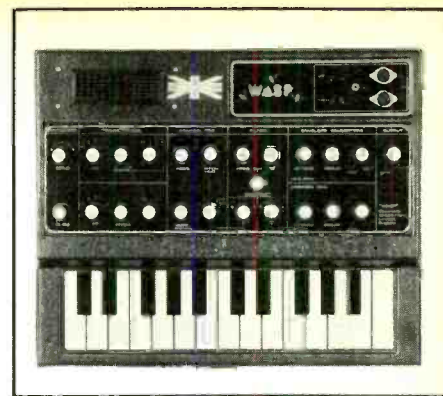

keyboard which is capacitance-triggered. The unit operates from six C-cell batteries or from household AC via a 9-volt adaptor. Main and headphone outputs are provided as well as a small built-in speaker.

CIRCLE 7 ON READER SERVICE CARD

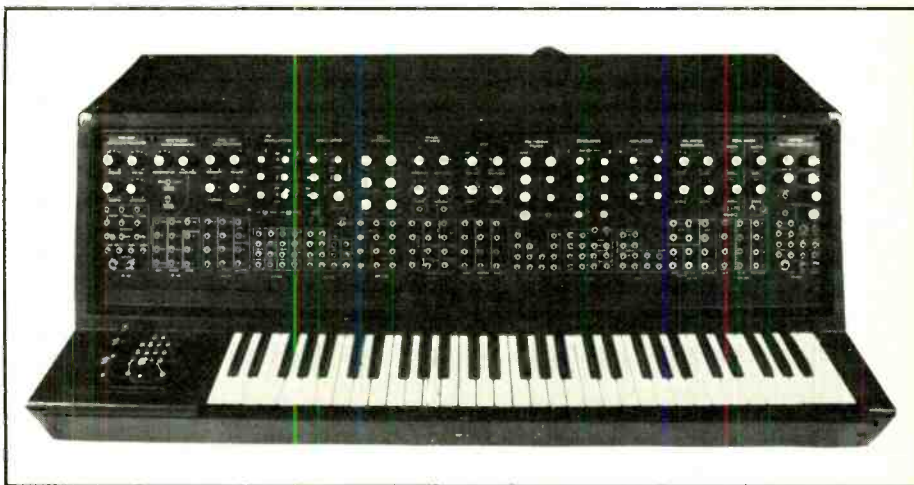

A.I.M. Ltd. has announced a new, low-cost synthesizer which uses all-digital internal circuitry. The new model is the WASP synthesizer, and among its features are two no-drift oscillators, an "adjustable three pass filter," and two envelope generators with envelope repeat and control envelope delay as well as positive or negative filter modulation. The WASP uses a two-octave, non-mechanical

SOUND REINFORCEMENT EQUIPMENT

Eastern Acoustic Works, Inc. manufactures a range of speaker system enclosures for use with drivers from any of the major professional manufacturers including ATC, Altec, E-V, Gauss, JBL and TAD. The MK-1512 and MK-1215 are the basic models of the line, combining an optimally-vented low frequency enclosure with an integral high frequency horn/lens assembly and a low-loss 12 dB/octave passive crossover. The MK-1512 is a 5.0 cubic foot enclosure for 15-inch drivers, while the MK-1215 is a 3.6 cubic foot enclosure for 12-inch speakers. Both systems use a horn/lens with a 1-inch throat for use with any 1-inch exit compression drivers bolted on directly, or 1 3/8" x 18 thread-on drivers may be used with a throat adapter. As an option, either system may be ordered for three-way operation in which case there will be a mounting for a professional type high-power tweeter and the

crossover will be three-way instead of two-way. For maximum versatility and optimum performance, the systems use interchangeable low frequency vent units to match any particular model of driver. Both models are available in permanent installation versions with plain, polyurethane-painted exteriors, or a road version complete with ABS-laminated surfaces, extruded metal edges, bumper corners, recessed handles and latch-on transport covers. Depending on the particular drivers used, frequency response is specified as 38 Hz-20 kHz for the MK-1512, and 40 Hz-20 kHz for the MK-1215. Standard crossover frequencies are 1500 Hz and 1200 Hz, respectively, with an optional 7000 Hz tweeter crossover.

CIRCLE 8 ON READER SERVICE CARD

A new alternative in professional quality stage monitor speakers is the Gollehon 150 SML. This system uses a 12-inch woofer in a compact vented enclosure plus a compression driver and horn to provide high sound pressure levels in a small package. The drivers are quite efficient, producing 99 dB SPL at 1 meter with a 1 watt input, and have high power handling capability at 100 watts RMS. Since the system was specifically designed for monitor applications, much attention was paid to matching the drivers for smooth frequency response and even dispersion at all frequencies as this will result in higher gain without feedback. Frequency response for the 150 SML is given as 70 Hz to 16 kHz, and dispersion is specified at 70° horizontally and 60° vertically to give the musician greater freedom of movement. The 150 SML weighs in at only forty pounds complete with a steel grille to prevent speaker damage.

Also new from Gollehon is the Penetrator 2 sound reinforcement loudspeaker. Recommended for short-throw applications or playback monitoring in the studio, the unit is said to utilize the advantages of both the vented and sealed enclosure princi-

ples to produce high efficiency and extended low-frequency response. The Penetrator 2 combines a 12-inch woofer with a high-frequency horn to develop a sensitivity of 98 dB SPL at 1 meter with a 1 watt input.

CIRCLE 9 ON READER SERVICE CARD

Audio Processing Systems, Inc. has introduced a new mixing console which was specifically designed for use in touring sound reinforcement systems. The APSI Model 2000 mixing console combines the flexibility and ease of operation of a studio console with the ruggedness and reliability necessary for use on the road. As many as thirty-

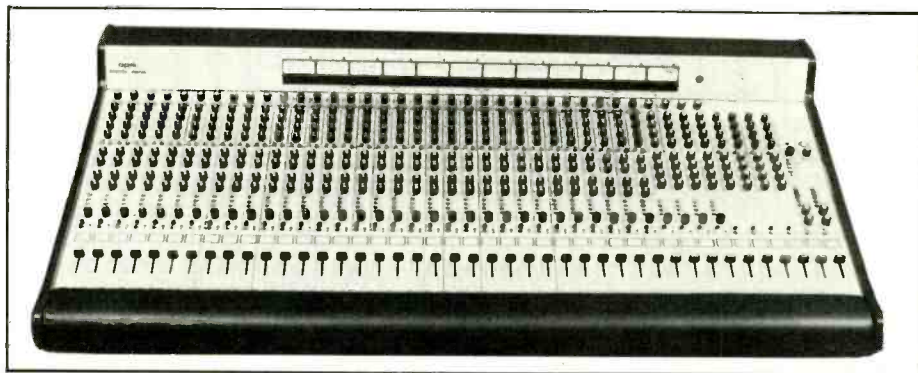

two input channels feed four submix buses, four master buses and a quad output channel in any combination. These twelve outputs may be used in a wide variety of configurations to provide effects send buses, subgrouping, tape mixes or stage monitor mixes as well as the main P.A. output. All controls are color-coded and logically arranged with indicators for easy operation and precise control of each signal in or out of the mixer.

CIRCLE 10 ON READER SERVICE CARD

MUSICAL INSTRUMENT ACCESSORIES

New from Peterson Electro-Musical Products is the Model 420 strobe tuner, a high-precision solid-state tuning device. The unit is insensitive to variations in line voltage, line frequency and temperature so that no calibration is necessary under any

operating conditions. The tuner uses an illuminated rotating disc as the visual indicator of tuning because this has proven to be the most accurate and easy-to-use of the various indicator types. The unit has a built-in condenser microphone so there is no separate mic to be lost or damaged, or electronic instruments may be plugged in directly. Notes that are rich in harmonics, such as the bass notes of a piano often present difficulties in tuning accurately with most tuners, but the Model 420 includes an image clarifier to eliminate this problem. A vernier pitch control, calibrated in hundredths of a semi-tone, is provided

to vary tuning as much as 1/2 semitone sharp or flat from A=440 tuning, while temperament from the 12-position note dial is accurate to 1/300th of a semitone (.0196%).

CIRCLE 11 ON READER SERVICE CARD

Ibanez has added a new phase shifter, the PT-909 to their line of electronic accessories. The PT-909 is a very compact unit which has controls for speed, width and feedback, making it one of the most versatile mini-phasers available. The width control is a new advance for mini-phasers, allowing the width of the sweep to be controlled for phasing effects ranging from the most subtle to very dramatic. The feedback circuit routes a portion of the phased signal back to the input so that it is "re-phased" adding dramatic depth to the phasing effect. A new, buffered output stage is an additional feature of the unit, providing a clean, undistorted sound free of the volume swells common to some phasers. An LED indicator is built in to the unit for visual setting of the unit and as a battery checker. The PT-909 phase shifter is housed in a heavy, die-cast aluminum enclosure complete with rugged footswitch.

CIRCLE 13 ON READER SERVICE CARD

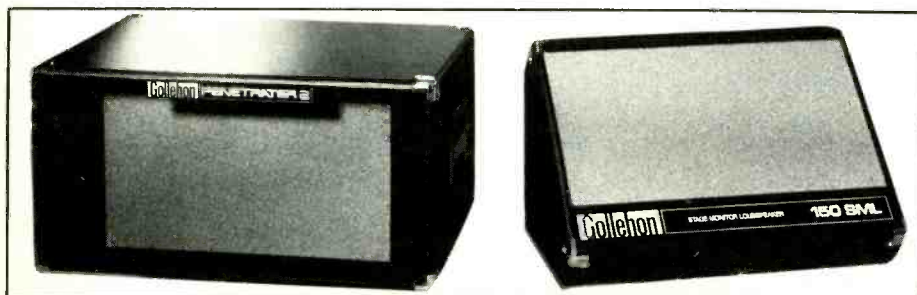

Yamaha's PM Series. A mixer to match every job.

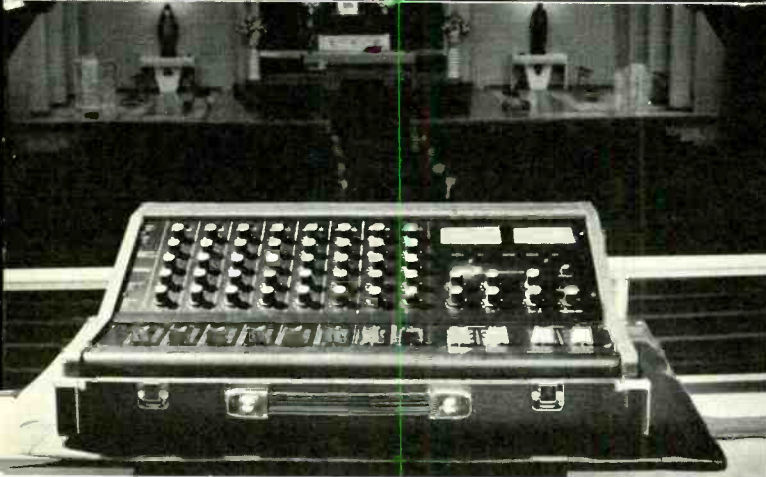
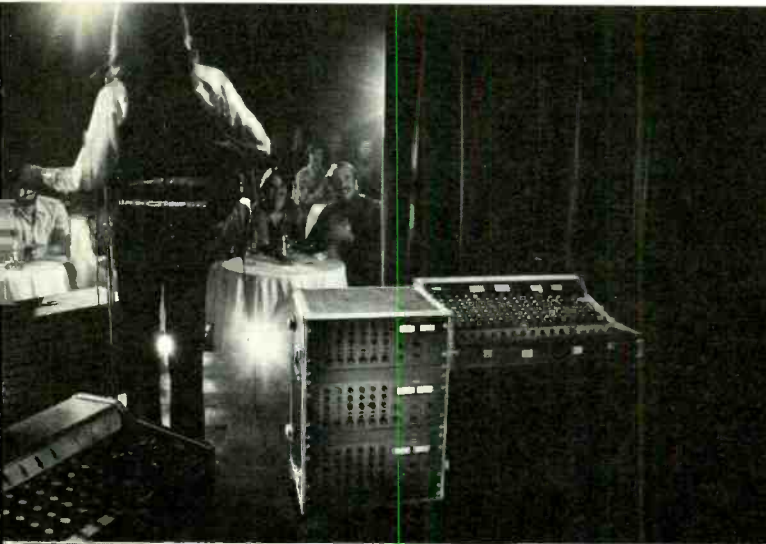

No matter what the application, or how tough the job, there's a Yamaha PM Series professional sound mixer that can handle it.

Think of the Yamaha PM mixers as business machines that insure your sound. The PM-170 and PM-180 are ideal as prime mixers for small clubs, discos, schools and the like. Or they're excellent submixers to extend the capability of larger consoles.

The Yamaha PM-430 and PM-700 are the portable heavyweights. They have the specs, power and flexibility to mix well in moderate to major events and concerts, broadcast production and recording studio applications.

Each PM mixer can be used as a complete sound system controller. Or they can be combined to solve your most complex reinforcement and production problems.

And all your mixes are well under control with balanced, transformer-isolated inputs* and +24dBm (12.3 volts RMS) stereo outputs for no-hum sound over long distances. Precision Yamaha engineered and manufactured long-throw, smooth-flow, dB-calibrated faders respond to your most subtle adjustments. And foldback and monitor functions that help you precisely feed the right mix to the right performer or technician.

Send six dollars, and we'll rush you an operating manual complete with schematics on our PM Series. (Please, certified check or money order only. No cash or personal checks.) Or better yet, see your Yamaha dealer and match a Yamaha PM mixer to your job.

*PM-170 uses unbalanced inputs, ideal as a keyboard mixer.

Yamaha International Corporation, Musical Instrument/Combo Division,
6600 Orangethorpe Avenue, Buena Park, CA 90620. Write: P.O. Box 6600, Buena Park, CA 90622.



CIRCLE 99 ON READER SERVICE CARD



THE BLACK WIDOW

...because the best wasn't good enough.

You're looking at one of the finest loudspeakers in the world...the Peavey Black Widow. They were created to fill a serious void,...speakers that could match the sophistication of today's sound reinforcement technology. For years we have employed the finest speakers from the most respected manufacturers in our equipment and through years of experience, have re-discovered the value of that

old cliché, "if you want it done right, do it yourself." We did.

Since its introduction several years ago, the Black Widow has been praised by sound experts and musicians for its excellent efficiency, bandwidth, and power handling capabilities in applications that range from high powered concert sound reinforcement to studio recording.

The Black Widow's unique

characteristics are the result of optimized procedures and concepts in design and manufacturing that provide a complete integration of form and function.

Unlike the other established manufacturers who are still building the speakers they designed back when a 100 Watt amp was a big deal, Peavey has designed the Black Widow with today's technology for today's high powered music.

The combination of a rigid cast-aluminum frame and high-efficiency magnetic structure is a feature found in many professional quality loudspeakers. What places the Black Widow Series far ahead of its competition is its field replacable basket assembly.

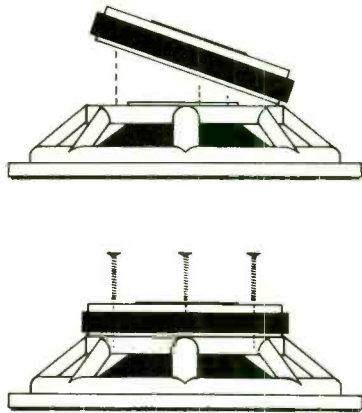

This feature, usually found only in high quality compression drivers, allows the user to be "back in business" in a matter of minutes, rather than days or weeks.

The high efficiency and high power handling capabilities found in the Black Widow make each model the best choice for its sound reproduction application. Again, what separates

the Black Widow from other high quality transducers is its unique integral coil form/dome structure. When a loudspeaker is subjected to very high power levels, the voice coil temperature rises very rapidly, causing the loudspeaker impedance to increase. The result of this increase is a loss of efficiency. The Black Widow Series provides a most effective method of minimizing any impedance increases due to heat by utilizing the one-piece coil form/dome as a heatsink. Just as high power amplifiers use aluminum heatsinks to dissipate heat, the Black Widow coil form/dome is produced with low mass, high rigidity aluminum.

Each Peavey Black Widow is subjected to extensive quality control procedures to insure long field life and high reliability. The manufacturing methods employed by Peavey, such as numerical and computer controlled machining equipment, allow the Black Widow to maintain the close tolerances necessary for previously unattainable levels of quality and consistency.

Each Black Widow has a four-inch edge-wound

aluminum wire voice coil to provide maximum energy conversion. The cone assemblies provide the required frequency response shapes with minimum weight and maximum structural integrity for high mechanical reliability. Each magnetic structure is fully removable and will provide minimum flux density of 12,000 gauss with very precise operating clearances. The magnetic structure uses a large rear vent to assist in further voice coil temperature control.

The Peavey Black Widow is now offered as standard equipment or as an option in most Peavey enclosures and will soon be available "over the counter" at selected Peavey Dealers.

The Peavey Black Widow...for those who can't accept less than maximum performance and reliability from their speakers.



PEAVEY ELECTRONICS
711 A Street
Meridian, Mississippi 39301

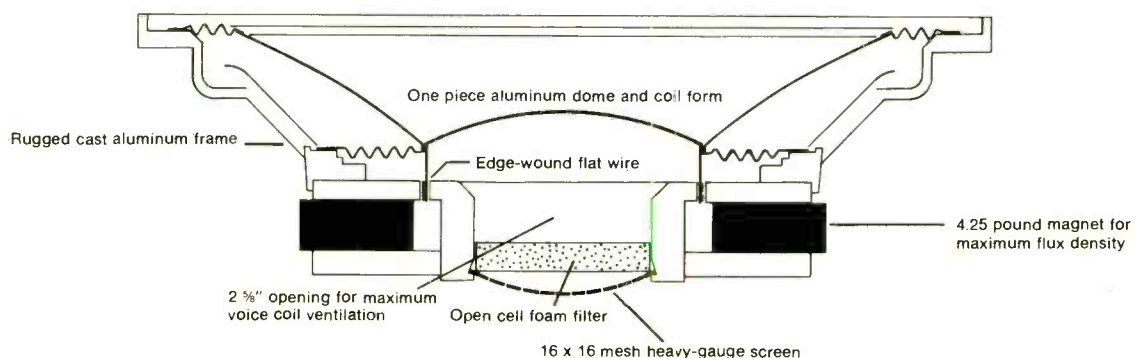

MODEL NO.	DIAMETER	NOMINAL IMPEDANCE	POWER HANDLING CAPACITY CONTINUOUS	PROGRAM	SENSITIVITY 1w, 1m on axis	VOICE COIL DIAMETER
1201	12"	4/8	150W	300W	101 dB	4"
1501	15"	4/8	150W	300W	103 dB	4"
1502	15"	4/8	150W	300W	101 dB	4"
1503	15"	8	150W	300W	102 dB	4"
1801	18"	4/8	150W	300W	99 dB	4"

CIRCLE 89 ON READER SERVICE CARD

THE GREAT PEDAL PUZZLE

By Brian A. Roth

"Should I connect my tape echo unit before or after my flanger?" "When I plug my fuzzbox ahead of my wah-wah I get a lot of noise. What should I do?" Many questions similar to these have been appearing in *Modern Recording's* mailbox. Consequently, this article will examine some of the variables involved with the interfacing of musical instrument signal processors.

There can be no absolute rules governing the sequence of effects units in the "chain" between the instrument and the amplifier input. Some arrangements may perform better than others, but that doesn't make them "right" in all instances. However, once the interactions are understood, the musician should have an easier time deciding upon the proper order of the devices in his or her situation.

Two areas require consideration: technical (noise, distortion, etc.) and aesthetic (is the final sound good or garbage?). First, the technical part.

Technical Department

Unfortunately, many of the shiny little gizmos which musicians use exhibit dismal performance in the noise department. Ask any recording engineer about these goodie boxes. Chances are that his face will turn lavender and he will start moaning about the times that a guitar amp sounded as if Niagara Falls had parked inside a speaker cabinet because of the guitarist's toys.

Why is this? It appears that some of

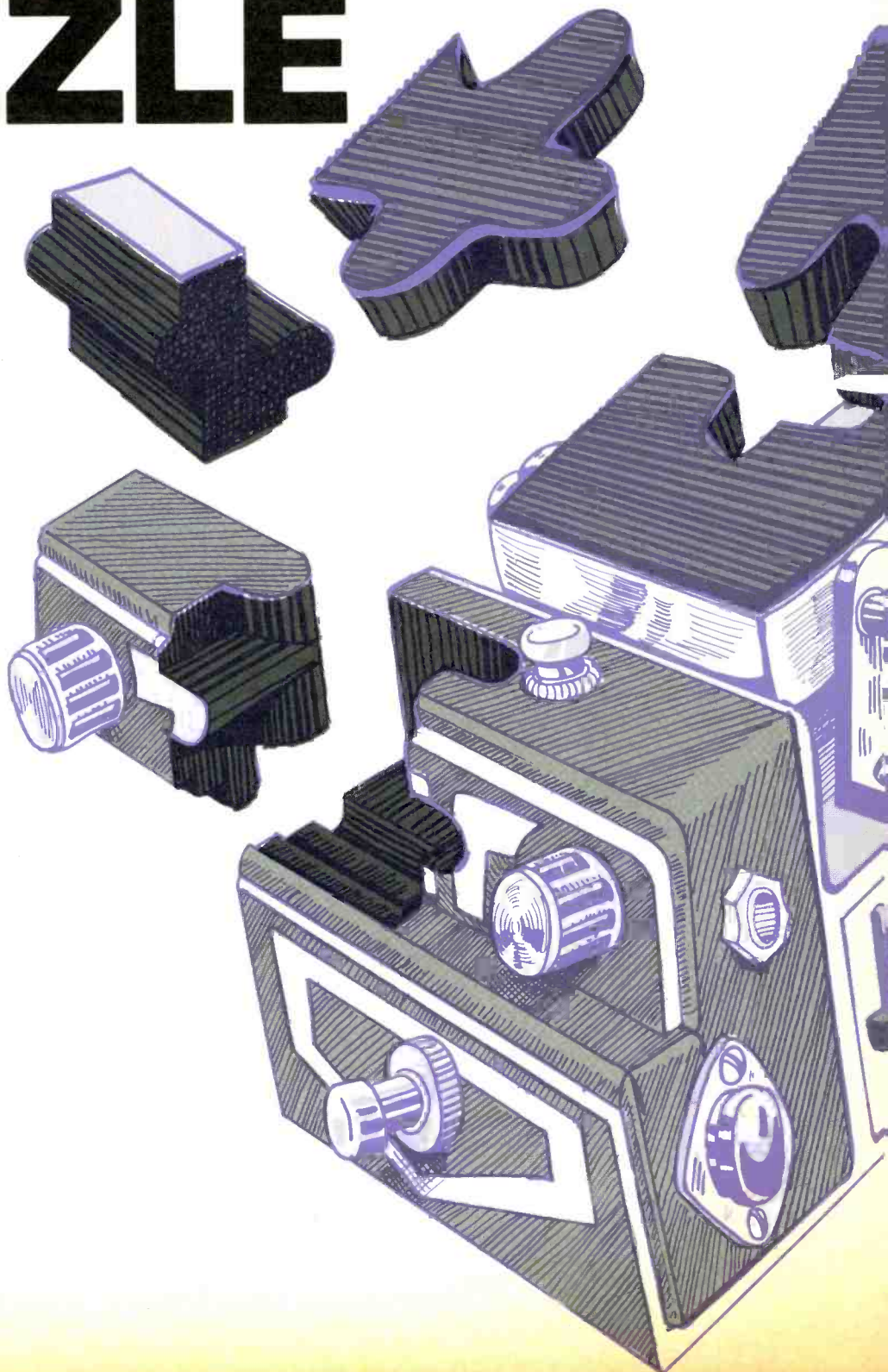

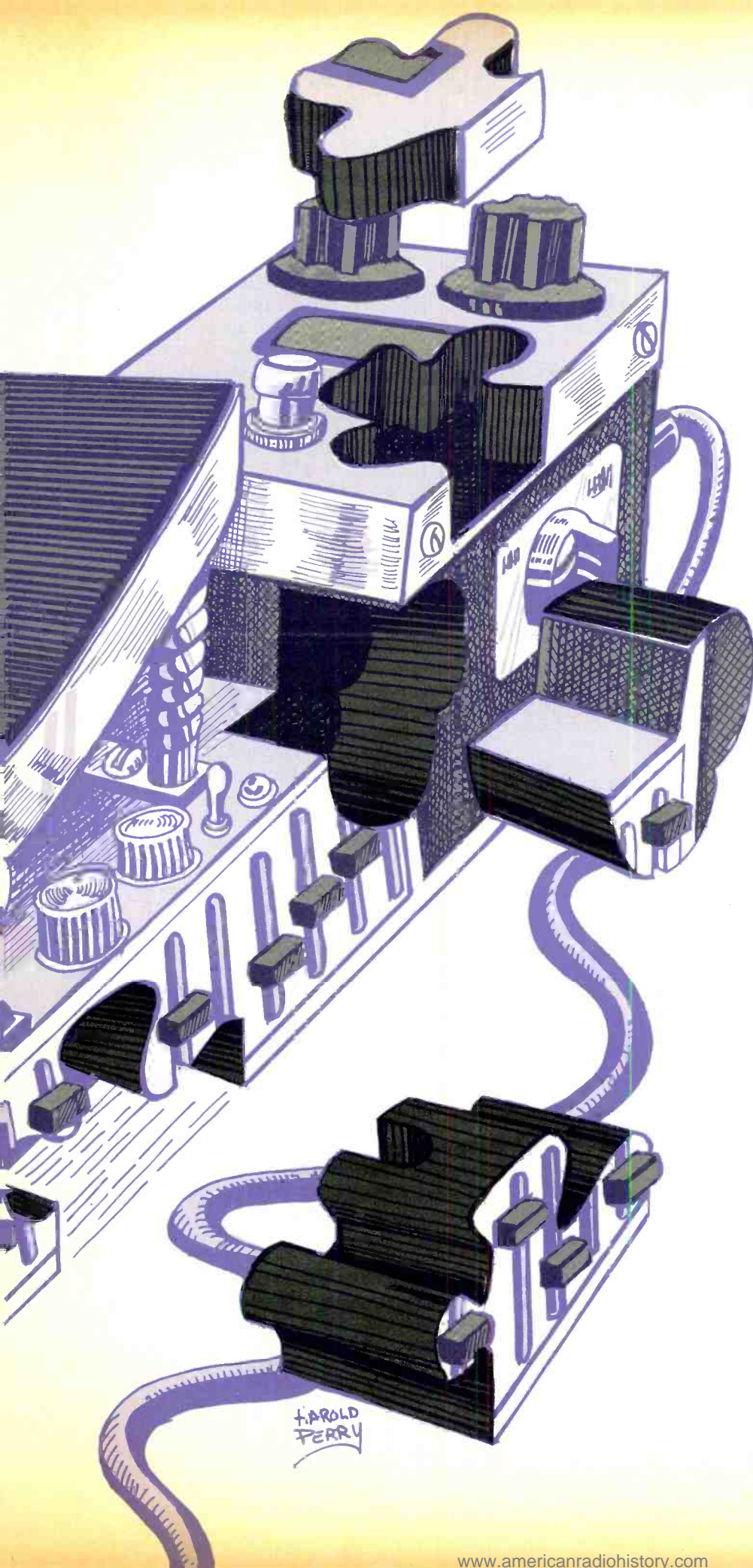

the manufacturers of these accessories are more interested in building the cheapest possible product rather than designing high performance circuitry. Happily, the latest generations of instrument signal processors have a *much* lower noise level than the units of previous years. Nevertheless, there is no way that a \$19.95 fuzzbox can have the noise figure of a \$50,000 console; things don't work that way!

Even if the musician uses only the latest and best designed worder boxes, it is still possible for a high overall noise level to exist. This can be due to the sequence of interconnections. This noise figure can be optimized by analyzing what is called the "gain structure" of the audio system.

There are three primary factors to be considered when studying the gain structure: 1) the input or output signal level at which overload occurs; 2) the gain (amount of signal amplification); and 3) the output noise level of each part in the "chain." These characteristics must be considered regardless of the type of audio system; they apply equally to instrument effects systems as well as P.A. or recording systems.

If the output of a device that has a comparatively high internal noise level is connected to the input of a second device that has a high amount of signal amplification, a high overall noise level will result. This happens because the second device not only amplifies the desired signal from the first device but also the undesired noise.

An example of this principle can be heard if a tape echo unit, which may be acceptably quiet by itself, is fed into a fuzzbox. The fuzz is actually a very high gain amplifier that can be easily overdriven, thus creating the desired (?) fuzzy effect. To make matters worse in this example, the desired signal will be "clipped" or limited to a specific output level by the intentional overdriving while the weaker noise signal will be merely amplified by the fuzz. This results in a poor ratio of the desired signal to the undesired noise.

Examine Figure 1. Notice that the desired audio's [guitar] signal strength is -40 dB (don't worry about what the dB reference is other than a unit of signal or noise strength; the more negative the dB figure is, the weaker the signal) at the output of the tape echo unit while the noise level is -90 dB at this same point. This represents a *signal-to-noise ratio* of 50 dB at the output of the tape echo device and is a fairly acceptable ratio in practice.

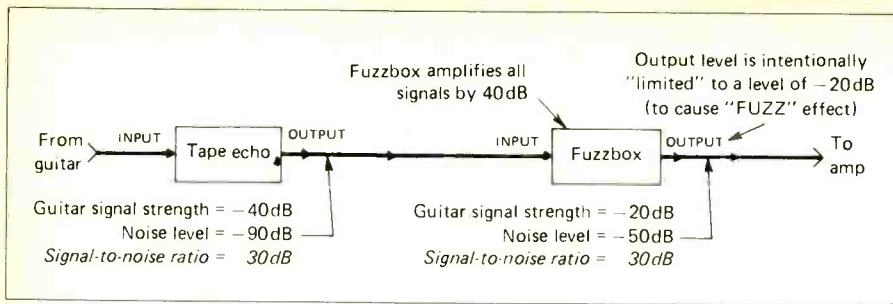

Fig 1: "Gain structure" of a guitar effects system. Note: Guitar waveforms and dB levels are given for clarification only.

Now, this [original guitar] signal is routed to the input of a fuzzbox, which has an amplification factor of 40 dB. If all goes according to Hoyle, that should increase the desired signal level to 0 dB (-40+40=0). However, the output level in this particular fuzzbox has been limited to -20 dB to intentionally distort the signal (see the waveform drawings in Figure 1). On the other hand, the -90 dB noise is also strengthened by 40 dB. The resultant noise at the output of the fuzz will be at a level of -50 dB (-90+40=-50) and will not be "limited" or "clipped" like the desired signal since the -50 dB output noise

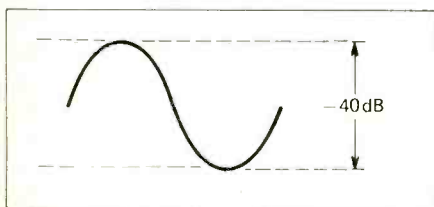

Fig. 2a: Guitar signal strength to the input of the fuzzbox = -40 dB.

level is far below the -20 dB level at which the fuzzbox clips. So, the result is a signal strength of -20 dB and a noise level of -50 dB, or a net signal-to-noise ratio of 30 dB. This is 20 dB worse than the ratio at the output of the tape echo, and the ear would interpret this as an apparent increase of noise of about four times! The noise would be particularly obvious during times when the musician was not playing or between individual notes.

Whew! Now, I realize that all of this may be mighty hairy to a non-technically-inclined person, so here's the real-life bottom line: put the fuzzbox at the beginning of the chain rather than in the middle or at the end. By doing this, you should optimize the signal-to-noise ratio.

What about combinations of other

types of effects units? Unfortunately, predicting the ultimate signal-to-noise becomes difficult since there are jillions of different types of effects boxes that each modify the instrument signal in their own particular fashion. Here are some of the very general rules to observe.

1) Put the quietest units at the beginning of the chain since each succeeding processor can amplify the noise in the system.

2) Use the minimum quantity of wonder boxes; each additional unit has the potential of adding undesirable noise. In most cases, the foot switch on the processors will actually bypass the

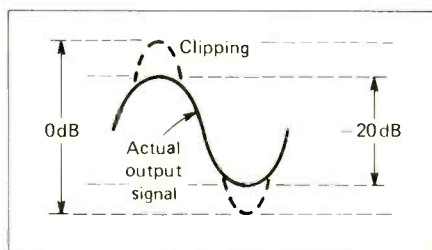

Fig. 2b: Guitar signal at the output of the fuzzbox "wants" to go to a level of 0 dB, but signal is limited to a level of -20 dB, thus clipping the guitar signal, making "fuzz."

internal circuit, thus effectively removing the unit from the chain. Even though there may be twenty modifiers in the chain, if nineteen are bypassed, this is usually the same as if only the activated one was present and the other nineteen were still on the shelf at the music store. Mash that bypass switch if the effect is not required at a particular time!

3) Buy the best. While they may be more expensive, just remember the old saying: "You can't get something for nothing." A high price doesn't guarantee high quality (sometimes a high price only means high profit for the manufacturer), but an unusually inex-

pensive unit will often give you what you paid for: el cheapo performance.

Here are a few comments on specific types of effects units before moving on to the aesthetic comments.

Wah-wah pedals can cause the impression of high-noise levels since they are a specialized tone control that amplifies certain frequencies (depending upon the pedal position). This means that the treble portion of the audio signal (which includes the undesired noise) can be strengthened while the bass frequencies are attenuated; the result is that hiss (high frequency noise) is amplified along with the signal. The treble-boosted musical signal will contain less bass energy and will appear to have been diminished in perceived volume while the noise (being primarily high frequencies) will be intensified. The result is an apparently high noise level. This is a simplified explanation, but is close enough to reality to explain why a wah-wah can appear to aggravate noise. So, it is probably best to put the pedal near the beginning of the chain where noise has not yet accumulated to a high level.

Phasers and flangers can usually be placed anywhere in the chain without affecting the overall noise floor. In fact, it may be desirable to connect these units after a device with a high hiss output level because the noise will be phased along with the music signal. The flanged noise can give the illusion of greater depth to the effect.

Tape echo devices should be connected at the end of the chain since they tend to have a relatively high noise output level. If a tape loop is patched in at the start of the sequence, the noise level can be intensified by the succeeding devices.

Beyond these suggestions there are a few specific "rules" to follow. Since the vast majority of accessory manufacturers do not publish any technical performance specifications, the consumers are "on their own" in the marketplace. Because of the possible interactions among the variety of effects units, it is almost impossible to predict the ultimate performance quality in advance. So, "try it before you buy it."

Aesthetic Considerations

Now we wander into a big grey area. No longer are we concerned with noise levels and similar technical performance. Rather, we start talking about



leads with MOS-FET Technology !

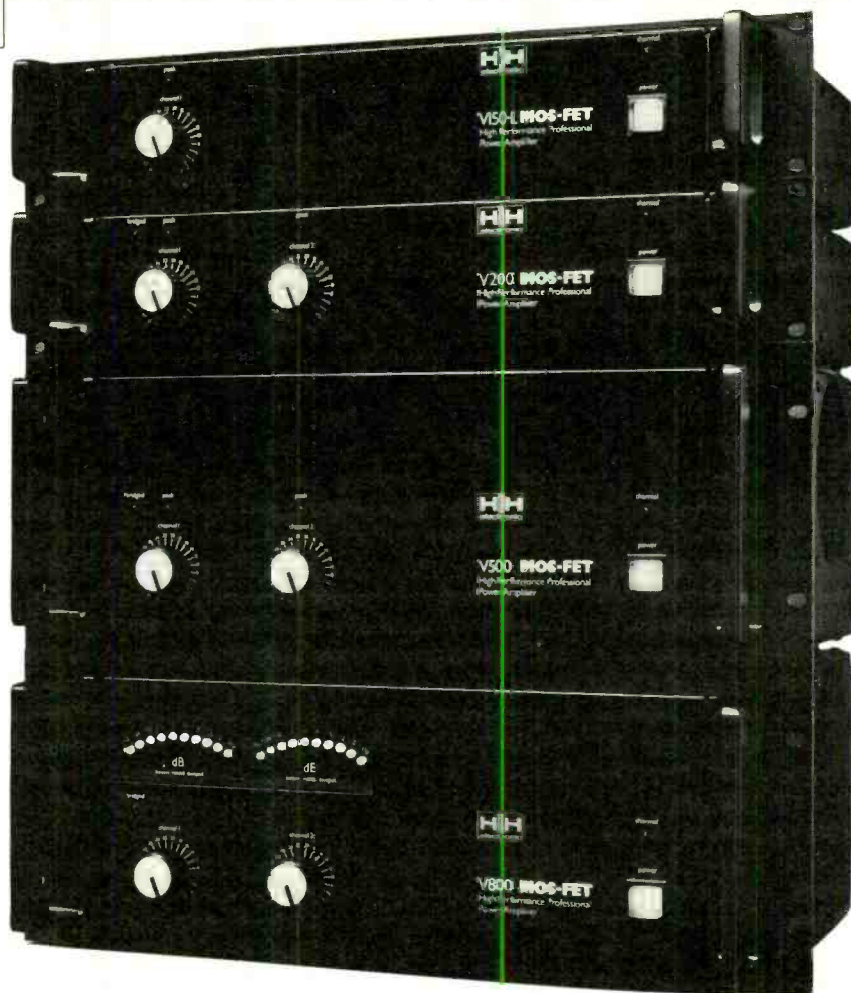

Power MOS-FETs

The development of the new Power MOS-FETs has opened up the possibility of audio power amplifiers that perform better than bipolar transistor designs. The characteristics of the Power MOS-FETs make them ideally suited for use in the output stages of linear amplifiers that must deliver distortion free power into a reactive load such as a loudspeaker or transformer.

Advantages

1. Ultra Low Distortion

The MOS-FET has a very high input impedance at audio frequencies which eliminates the need for high current gain driver stages—this circuit simplification enables the H/H Power Amplifiers to have ultra low distortion without the use of large amounts of negative feedback. The reduced negative feedback results in improved amplifier stability at high frequencies, as well as transient intermodulation distortion that is virtually immeasurable.

2. Superior Sound Quality

The new H/H MOS-FET amplifiers provide superior high frequency performance for both open-loop and closed-loop operation. The slew rate may be more than $60V/\mu\text{sec}$, which is much faster than that of conventional bipolar transistor amplifiers. The open-loop frequency response can be greater than 100kHz—an improvement by a factor of six.

3. Total Thermal Stability

In the new H/H power amplifiers, the MOS-FET devices are virtually immune from thermal runaway. A temperature increase has the effect of reducing device current, thereby decreasing power dissipation and pushing the temperature back down. No thermal feedback is required, and MOS-FETs easily operate at quiescent current five times higher than those of bipolar transistors. This higher operating current lowers signal distortion, especially at high frequencies.

H/H may be seen at the C.E.S show at Mc Cormick Place, Mall Level, Stand 424/16. Pick Congress, Suite 461 (the Dayton-Wright suite) and at the NAMM show Atlanta, CAT Toronto, MIAC Toronto.



Heinl Audio Developments Inc.

1001 Denison St., Unit 6, Markham, Ont. L3R 2Z2

416-495-0688

CIRCLE 123 ON READER SERVICE CARD

matters of personal taste. A jazz musician may abhor any type of effects units while a rock player may load up on three dozen different devices. In both cases, the musician is expressing his or her own preference. Who can say that one is right and the other is wrong? I won't even dare to broach the subject of personal taste.

However, it is possible to partially predict what will happen to the instrument's signal after it is subjected to a series of different modifications.

A good example is the interactions of a fuzzbox and a flanger (or phaser). If the instrument's signal is fed to the fuzz before the flanger, the depth or intensity of the phasing effect will be much greater. This occurs because the fuzz adds many harmonics to the original signal, and thus provides a thicker "texture" to the flanger input.

For similar reasons, a more intense phasing effect can be obtained by connecting a tape echo unit before a flanger. The "repeats" created by the echo unit add the extra texture.

If a flanger is connected prior to a fuzz, it is not uncommon for the flanging effect to be totally washed out by the fuzz.

The same type of reasoning will also apply to the sequence of connections between a wah-wah and fuzz. With the fuzz first in line, the wah-wah effect will usually be much more intense due to the added harmonics.

Very fortunately, it is advantageous to have the fuzz early in the chain to maintain the system signal-to-noise as well as generating a more complex signal for the later units in the sequence. Please don't accept this as the gospel truth, but rather as a suggestion. Shape the sound to suit your own tastes (and, of course, the tastes of your fans if you are so inclined).

Another factor to be pondered relates to both the technical and aesthetic angles. In some cases the output of one device may be strong enough to overload the input of the succeeding device. The result is that the distortion will be generated by the second unit, even though it was not intentionally designed to do this. This distortion is often added to the regular effect created by the device. Sometimes this added distortion may be desirable, but just as often it is unwanted. Due to the lack of published specs for the effects boxes, the purchaser is forced to try out the combination beforehand to determine if the distortion will occur.

Good Housekeeping Rules

- When using multiple effects units, keep the interconnecting cables *short* to minimize noise problems.
- Use the best grades of connection cable. It *must* be shielded. Preferably, it should have a rubber jacket for maximum reliability.
- Use connectors with metal shells. Plastic covers will break if you miss the footswitch and accidentally stomp on the plug.
- The vast majority of effects devices are designed to be used in line between the instrument and the amp's input. Never connect these devices between the amplifier's output and loudspeaker (unless you have a fire extinguisher on hand!).
- Keep batteries handy. Alkaline and mercury types usually last longer (for a price, naturally). Consider buying a set of rechargeable Nickel-Cadmium (Ni-Cad) batteries along with the proper charger.
- Try to keep the innards of the units clean. Use a soft, clean paint brush to tidy them up. Dirt can cause all sorts of noise problems, and since most effects units sit on the floor, they are very susceptible to dirt contamination.
- Use the minimum quantity of effects units in the chain. The more units, the more potential problems.

Volume pedals are very popular these days, so let's see where they "should" go in the chain. If the pedal is connected prior to a fuzzbox, varying the volume pedal will usually affect the depth of the fuzz effect. Remember that most fuzz units operate by intentionally "clipping" the signal. If the input to the fuzz is reduced by a significant amount, the fuzzbox circuitry will no longer overload but will act as a preamplifier with low or moderate distortion characteristics. Conversely, with the volume pedal connected after the fuzz unit, the depth of the distortion will not change. When the pedal is moved, only the overall volume will vary.

Most volume pedals are "passive"-type devices, which means that they do not contain any tubes or transistors that can distort and "clip." Short of plugging it into 440 volt power, you cannot overload the pedal. So, the

main concern is what effect the variable strength signal will have upon the units "downstream" from the pedal in the entire equipment chain.

Consider the Amplifier

Most musicians do not consider their instrument amplifier as an effects unit, but it most certainly is. Different types and brands of amp "heads," tone control and volume settings, and the loudspeakers will all significantly affect the overall sound.

It is very common for guitarists to operate their amplifier in a "clipping mode." This gives extra sustain and adds "balls" to the signal. It is rather humorous that a guitarist who disdains fuzzboxes will almost always adjust his amp so that it is distorting much like a fuzztone. Of course a guitar amp will generate different harmonics than a fuzz and thus will create a different effect, nevertheless, the guitar amp can be thought of as a 100-watt fuzzbox! And like a fuzzbox, the distortion generated in the amplifier can almost "wash out" the effects of flangers, phasers and equalizers that are connected between the instrument and the amp's input.

The strength of the input signal to the amp will affect the degree of distortion caused by the amp's circuitry; so will the volume and tone settings. If the amp doesn't have enough gain to create the desired amount of sustain (distortion) there are preamplifiers available that can be inserted before the input. These will boost the signal strength and cause higher amounts of distortion. Of course, the preamp will also indiscriminately amplify noise, so it is important that the input to the booster be as "quiet" as possible.

There are so many combinations that it is impossible to discuss each situation. So, experiment! Try it out and see how it sounds. If you decide that passing your instrument's signal through a loaf of moldy wheat bread gives a "hot" sound, do it, and everyone else be damned!

Try out the combinations well in advance of the actual performance. Don't dash into your local music emporium ten minutes before the gig and buy three new goody boxes. Unless you are very lucky, the chances are that the new additions to your system will hurt your sound rather than improve it. Play and experiment with the combinations before you actually go on stage (or to the studio).



designed and built
by people who still
care about quality
and reliability

More of **The**
ASHLY
Package

SC-22 \$290

SC-77 \$429

SC-70 \$249

SC-80 \$349

SC-66/A \$599

SC-63 \$369

SC-50 \$299

SC-55 \$499

SC-40
\$349

NEW
SC-44 Keyboard
Input Processor
\$499

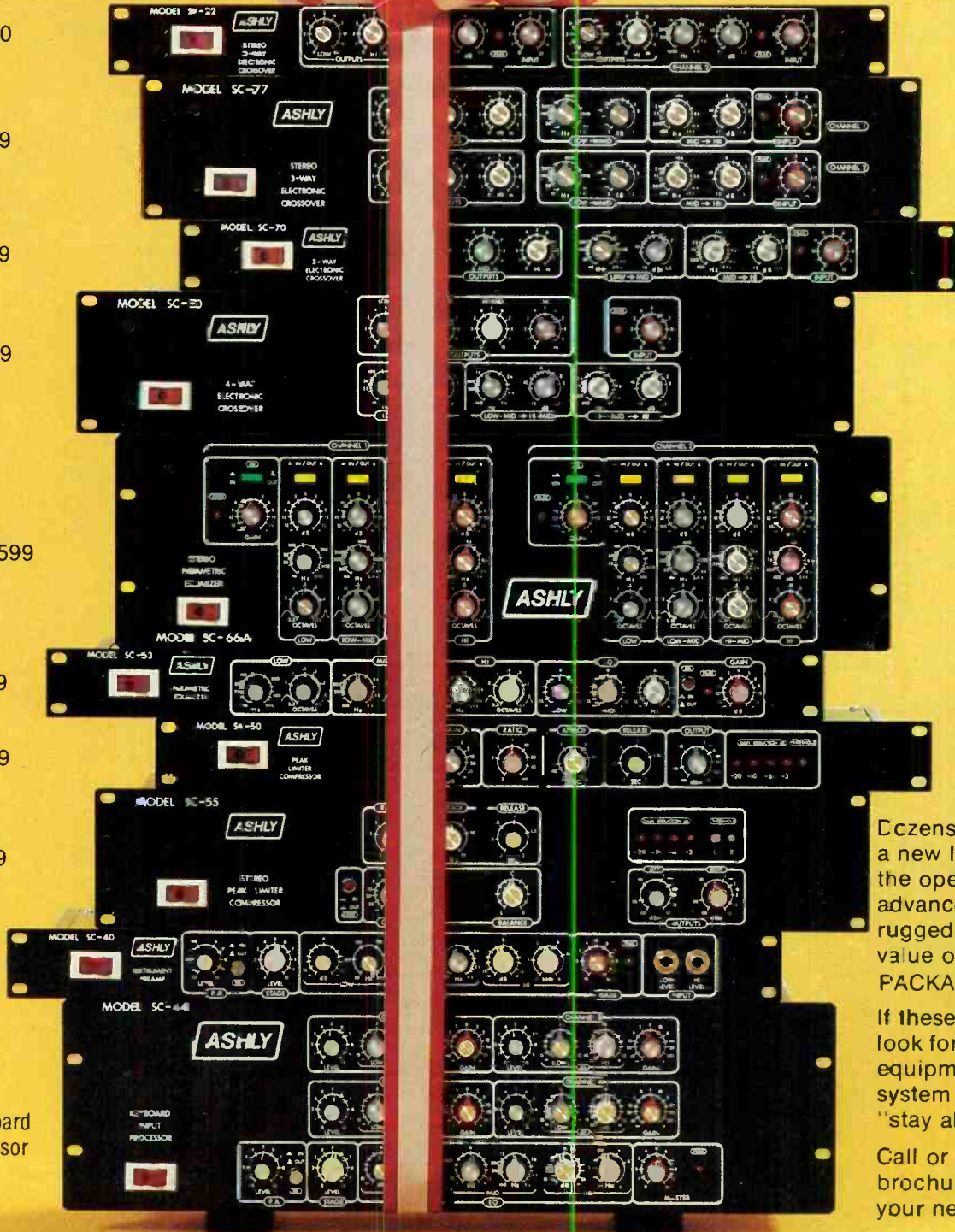

Dozens of new features and a new look are added to the operational flexibility, advanced design, reliability, rugged construction, and value of the ASHLY PACKAGE

If these are the things you look for in signal processing equipment plan your sound system around the ASHLY "stay ahead" PACKAGE.

Call or write for our new brochure and the name of your nearest Ashly dealer.

EXCLUSIVE DISTRIBUTION IN CANADA

Gerr Electro-Acoustics
365 Adelaide Street East
Toronto, Ontario, Canada M5B 4R9
#413-868-0528

ASHLY AUDIO Inc. 1099 JAY STREET
ROCHESTER, N.Y. 14611 (716) 328-9560

CIRCLE 84 ON READER SERVICE CARD

a session with:

KANSAS

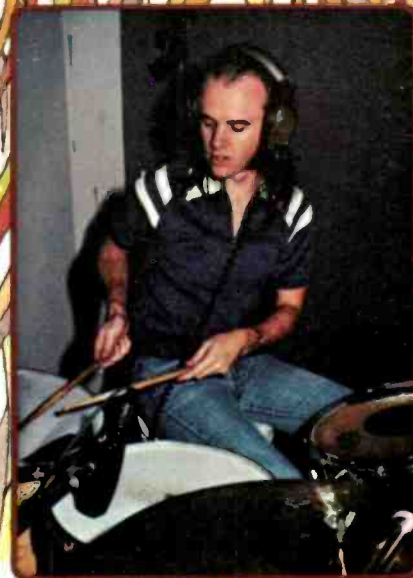
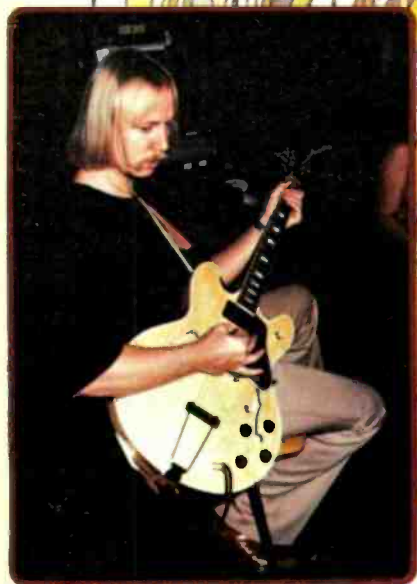



Since January 1 of this year, Kansas has been at work in Atlanta on lucky number seven, an album that signifies several major changes in a musical group that has thus far defied classification. Perhaps the pet peeve of this band of old friends has been the fact that critics have likened their music to everybody from Bach and Paganini to the Beach Boys, and more often to the English art-rock genre as typified by Genesis and Jethro Tull. "Just once," says [lead vocalist] Steve Walsh, "I wish I could have the chance to sit down with one of these critics with every album by Kansas and play them next to every Who album and demand that the

guy point out just one remotely similar passage. Just once."

Chances are that very few critics will take Walsh up on his offer, but just in case any of you experts decide to accept the challenge, do not attempt to prove your point with the new Kansas album. Wait until you hear what happens when this band is given the luxury of lots of time and the engineering talents of Frank Zappa's (of all people) knob twister and then throw away the blueprints and make way for some unique sounds.

To insure that Kansas would have sufficient time for this project, the group bought a year with the release of a double "live" LP and afforded them-

selves enough room to recuperate from a major tour before returning to the studio. Along the way, their longtime friend, engineer and producer Jeff Glixman tendered his resignation to begin new associations. Before his departure, Glixman gave the band the name of some groups and their producers and told Kansas that they would be in good hands with any of them. The list included: Genesis, Jethro Tull, Emerson, Lake & Palmer and Frank Zappa (of all people). Well, yeah Jeff, I suppose we would be in fine shape if ELP would lend us their producer, but it's highly unlikely. Robby Steinhardt, the band's violin virtuoso, opted for the only American

on the list, Davy Moire (pronounced Moore), who had been moontanning with Frank Zappa (of all people) for the past five years.

Moire coincidentally had decided that he wanted to mix sound for big outdoor gigs just for the fun of it, and the Kansas offer to engineer the summer tour of 1978 would provide many such opportunities. It was also a chance for Moire to exercise a creative control which Zappa never relinquishes and therefore both the band and Davy would benefit by the new collaboration. Midway in the tour, Kansas sought to make the relationship more permanent by inviting Davy into the studio for the next album.

At the first of the new year, Kansas moved into the studio for a month of rehearsals which they paid their engi-

his work on Bob Dylan's *Highway 61 Revisited* and *New Morning* and the *Super Session* albums of Al Kooper and Mike Bloomfield. The studio features triple floating walls and ceiling for complete noise isolation and a semi-floating floor that eliminates sound transfer. Davy Moire has found the studio's dozen moveable panels (twenty feet high) very useful in tuning and changing the EQ of the room.

By album's end, many of the innovations and surprises will largely be credited to engineers Davy Moire and Brad Aaron. Their individual backgrounds are impressive and their techniques unorthodox. Davy, in his youth, was part of several, relatively good, regionally popular bands in New York. Since his input was limited to that of a performer and not a writer,

stant gratification of thousands exiting from a concert with smiles on their faces and minds blown away."

In working with Kansas, Davy again sought to apply his studio techniques on the road. Even though he admittedly knows very little about acoustics, he claims [there is] a great advantage when the album's engineer also mixes sound on the road instead of employing someone who is unfamiliar with the music. Davy's partner in recording Kansas is Brad Aaron, a long time friend of the band who owes his involvement in the music business to Robby Steinhardt.

Brad was a disc jockey in the Midwest for eleven years and met the members of Kansas while they were still local residents of Topeka. Upon Robby's recommendation, Brad applied for work with Bill Evans at Studio In the Country in Louisiana. Although there were no positions open, Brad agreed to work without wages especially when he discovered that Stevie Wonder was working on a soundtrack at the studio. When work became sporadic, Brad occupied his time conducting sound experiments and variations in miking techniques. Again, with Robby's invitation, Brad gained his first major involvement as second to Jeff Glixman on *Point of Know Return*.

When the pair first met, it seemed that nearly everything in Davy's background clashed with Brad's. Secretly they were both wondering how they would survive the ordeal of recording an album side by side while avoiding a major conflict. It was decided that roles would be left open and the duties flexible. By the time that basic tracks were underway, the differences began to melt away leaving only one major factor unresolved: to what extent would special effects be included.

Davy's modus operandi at the Record Plant was gaining maximum efficiency out of a minimum amount of studio time. He was accustomed to being shuffled in and out of two sessions a day in three different studios where it was get in, get it down and get out. There was little time for experimentation until he was rescued by Zappa. Even then his practices would be unique. Many of Zappa's studio LPs would be derived from tapes made of concerts on a 4-track off the mixing console. The tapes would be transferred to multitrack in the studio and they would build the album from there.

However, recording Kansas is a very



(Left to right) Kerry Livgren, Steve Walsh, Brad Aaron and Davy Moire at Axis.

neers full salary to attend. When time came to record the basic tracks, Kansas chose a location close to home and moved into Axis Sound Studios in Atlanta during February. The Axis control room features a Neve 8068 24-track console with two Neve 32264A limiters and a Studer A-80 VU 24-track tape machine. The monitoring system contains two special design JBL monitors with two 2215 15-inch woofers, a 2440 mid driver and two 2405 high frequency units; four 4320 JBL monitors, two 4311 JBL monitors and two Auratone 5C monitors. Power amps include two White Filter Series 4000s, three Studer A68s, two Crown D-60s, a Crown D-40 and D-150A and one MacIntosh MC 2105 power amp.

Axis is managed by Harvey Brooks, a founding member of the Electric Flag, who is perhaps best known for

Davy gave up show biz to work the Record Plant's Mobile Unit at major concert events from 1969 through 1971. His move to L.A.'s Record Plant afforded him the chance to second for everybody in the profession and within a relatively short time his credits included Joe Walsh's *So What?*, The Eagles' *On The Border*, and Tommy Bolin's *Sleeper*.

Davy Loves the Road

Davy graduated from engineer's second when Frank Zappa promoted him to engineer and sound mixer on the road. It was an ideal arrangement because Davy loved the road and didn't want to give it up for the studio. Also, he relished the idea of attempting to duplicate his studio work in concert. "Making hit records is fine," says Davy, "but nothing can match the in-

methodical procedure. The first objective is getting down the perfect drum sounds and then carefully adding each individual instrument until, *Voilà*—album! Basically what happens in the early sessions is that depending on who wrote the song, Kerry Livgren or Steve Walsh will play keyboards, Dave Hope will play bass and Rich Williams will use a guitar fill to enable Phil Ehart to capture the sound that he is looking for on drums. By taking the bass direct and concentrating on the drums, leakage can be avoided from Marshall stacks playing at hemorrhaging volumes.

New Sound . . . Technically

The day to day feeling in the studio is one of a new direction. After seven albums in a row with the same production and crew the Kansas sound began to take on an unwanted sameness. Now Davy and Brad are striving for a new sound *technically*, not musically. It will still be good ol' Kansas. For Davy, there is plenty of time to prevent having to make sacrifices; he need only be concerned with tonality without making compensations for time and accommodations.

The key to the Kansas sound is actually the band [playing] as a whole. Each song either takes on a strong keyboard or guitar flavor and the focal point traditionally has been the vocals of Steve Walsh. Davy comments that Walsh has a dynamic range unlike any other vocalist in that he [his voice] gets stronger as the pitch rises. But for the first time, it is drummer Phil Ehart who will come to the front. Much more time has been devoted to recording a wide variety of sounds by changing the physical location of the drum kit in the studio and toying with the miking techniques. This newest album will be Phil's showcase.

If there is an internal problem with Kansas it may stem from the fact that each member of the band is accomplished in his own right. Presently, basic tracks have been recorded on a solo album by Steve Walsh, and Kerry, Rich and Robby all plan to do the same. Says Steve: "When you are in a band, you have to make band decisions, and that usually requires making compromises. There are a lot of songs that I have written that the band can't or won't do or there isn't room for. Those songs mean too much to me to just put on a shelf."

In making solo efforts, other members of the band are used and are sometimes featured, but sparingly, so the final product does not take on the appearance of a spin-off album. Steve wants to reveal more of a rock and roll sound, and to do so he has enlisted the aide of Steve Morse and Alan Sloan of the Dixie Dregs as well as old friends from bands that he played with in the old days. Kerry's intention is to feature one side of heavy guitars using friends from Ambrosia and perhaps create a contrast by making side two a symphonic work. Robby Steinhardt wants to sing and rarely gets the chance with Kansas. He secretly longs to croon ballads fashioned after the

Eagles, with country-western tinges resembling Poco, but does not want to exclude other modes such as progressive jazz. So what is the alternative? Well, Kansas could do what Emerson, Lake & Palmer did and allow each member control over an entire album side, but with six members the final product might turn out to be akin to a musical *War and Peace*.

Kansas collectively never invites outside participation in a studio effort. This new project is no exception. However, the listener will hear choirs and symphonies herein even though two voices do not a choir make nor one violin add up to a section, i.e., rather than employ a choir, Kansas has one in

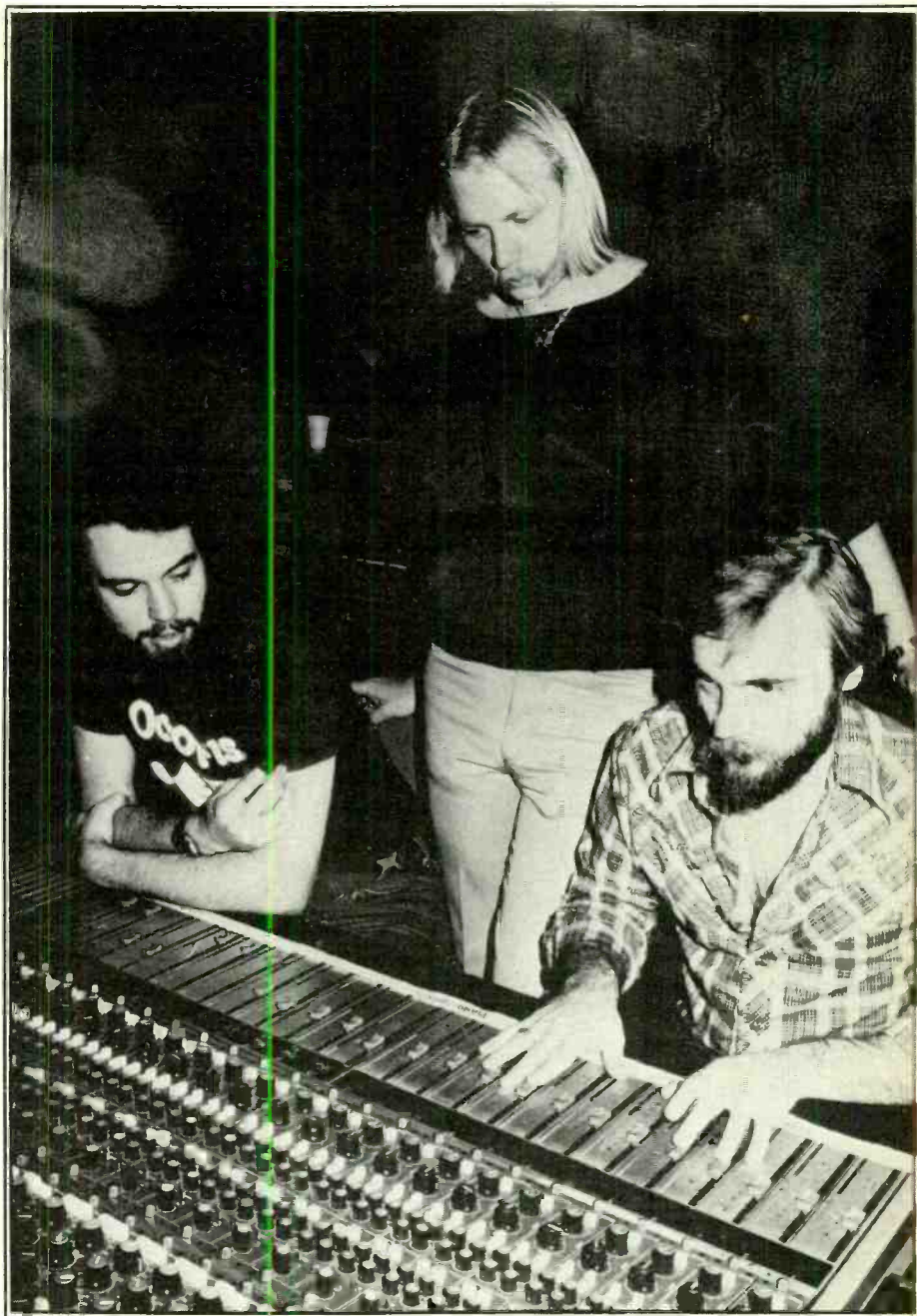

Brad Aaron and Kerry Livgren watch as Davy Moire takes the controls.

Steve Walsh whose vocals have been stacked ninety-six times for one particular cut. Robby was tracked nine times with varying amounts of delay, slightly differing EQ, varying tape speeds and at changing distances from the mic to create a violin section.

There are minor problems to be overcome in the early going. Setting levels for Steve Walsh is difficult because as mentioned earlier as he builds in pitch his voice gets stronger. Therefore it is essential that he is recorded with a compressor. Also, the EQ changes with drum kit location and changes in ambience dictate mic placements.

When talk turns to special effects, Davy [says he] prefers to use them

sparingly and then only to affect a passage and not for the effect alone. He attempts to avoid over-processing by a judicious use of stereo EMTs and digital delays—both of which happen to be Brad's very favorite toys. Essentially their differences are centered around their basic philosophies: Davy claims that the mark of a good engineer is his ears and Brad insists that it is the technical interpretation of the music. Brad likes to hear electronics breathe on a record while Davy strives for clarity in production.

"I like a Fleetwood Mac production," says Davy, "where there is a place for everything and everything has its place. As with Steely Dan, pro-

duction should be just enough. Queen's production is excellent but tends to be cluttered and overly self-indulgent. There is a method in their madness, but their panning assignments aren't even subtle anymore, just random."

"Yes, but Queen's production is a perfect enhancement to their type of music," argues Brad. And so it goes. The end result being the use of phlanging and the occasional use of a sweeping digital delay on some acoustic guitar lines. Davy and Brad decide to use phlanging to change normal guitar sounds into something unearthly, but Davy cringes when Brad cries out his familiar chorus, "Let's put digital on it."

Selection and Procedure

A computer track mix list oversees track assignments on this project. Tracks 1 and 24 are left open for the computer and drums are positioned at 3,4,5 and 6. The vocals are placed in the middle, from which guitars and keyboards are added at outer tracks. The bass guitar falls in on track 10.

Mic selection and placements will be the whole technical story on this album. Let's take the easy instruments first. As far as miking Robby's violin, two Neumann U-87s are placed at 45° angles a few feet in front of him and a KM-86 is placed in the center. Dave's bass is miked direct as well as by placing a Electro-Voice RE 20 on the bass amp very close with a Sennheiser 441 two feet back. These signals can be mixed together with the direct later being used as a filler or thrown out altogether.

Depending on the sound that Steve Walsh is looking for, his vocals may be aimed at any of the following: Neumann KM-86, U-87, Shure SM 57 or an Electro-Voice RE 20. The best results thus far have been obtained with a Neumann 47 tube-type.

When it comes to miking the guitars, take out your red pen and underline the following experiments because you ain't seen nothing like it. Simply done, the acoustic guitars such as Kerry's Martin can be miked by a Neumann U-87 two feet away without any EQ. One variation includes using an AKG C414 or a C452 back close to the bridge. A bizarre set up includes taking a direct, which sounds awful alone, and combining it with a Neumann U-87 in tight on the sound hole and with a Sennheiser shotgun MK 815 fifteen feet away pointed down the

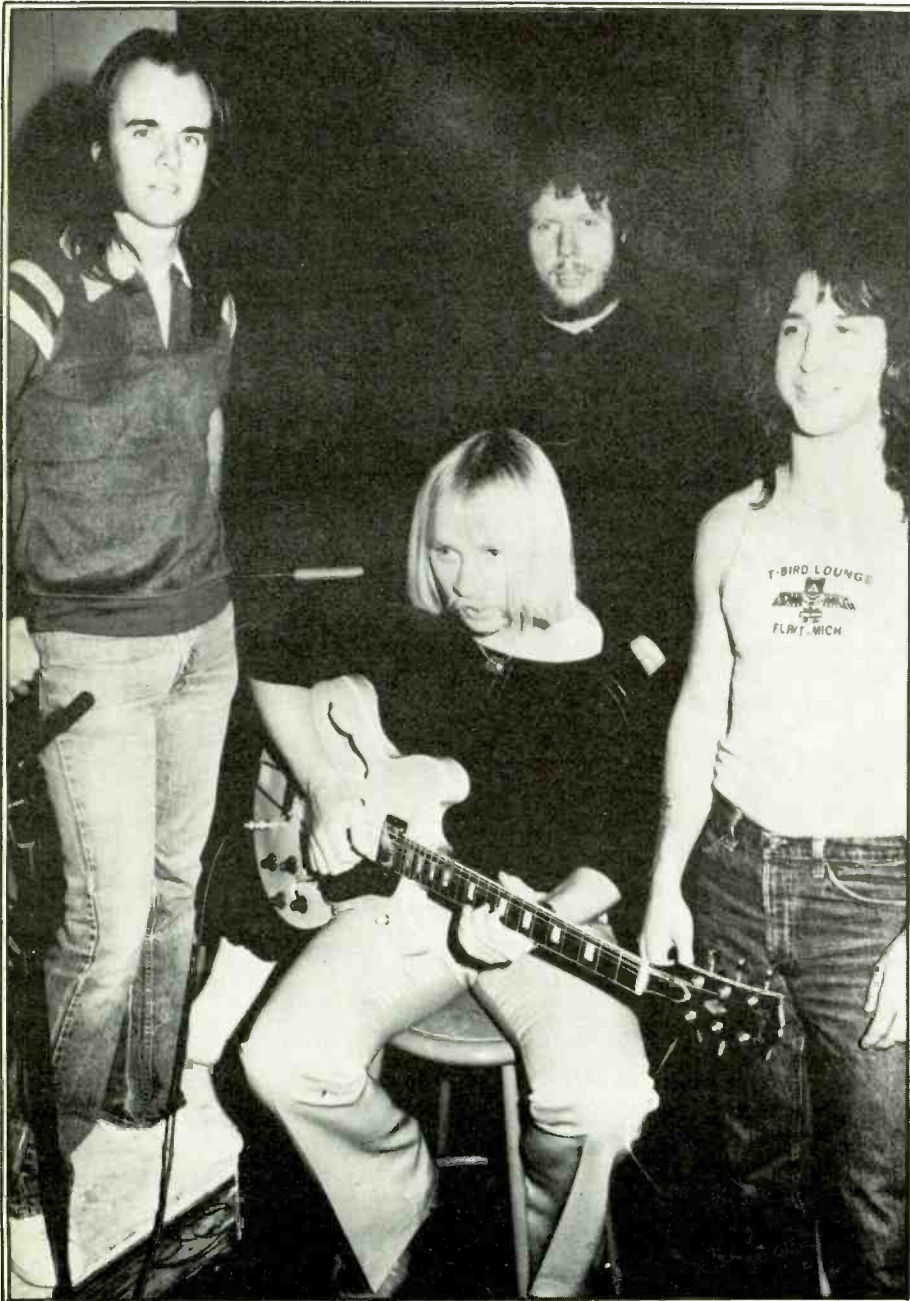

Phil Ehart, Rich Williams and Steve Walsh look on as Kerry Livgren plays.

neck of the guitar—the sound is magnificent. The newest technique from Davy's bag of tricks is using a stereo direct panned left and right whereby three strings go to the right channel and three strings go to the left channel with a mic signal to the center. The result: A "wall-of-guitars" sound.

There will be one particular favorite sound which many listeners will argue among themselves as to whether they are hearing harps, pianos, or guitars. Actually, it's a little of each. The technique is called "Pignose in the Piano," whereby a Pignose amplifier is mounted on top of a Sony ECM 50 mic which has been suspended in the base hole of a piano pointing towards the sound board. As the guitar is played through the piano, a sandbag is placed on the sustain pedal to create a lush harmonic effect on staccato guitar solos. Without the sandbag the same harmonics can be achieved only with a chordal effect, but this variation has a tendency to create some distortion.

When it comes to miking electric guitars, Davy and Brad pull out all the stops. The most remote innovation is setting up an amp in the hallway miked by two mics suspended from the top of a balcony. A more practical approach involves using one mic in close, a condenser ten feet away, another from the balcony for room ambience and a Sennheiser 421 pointed at the wall for bounceback. This technique was later modified to substitute an E-V RE 20 for the RE 15 in close and a Neumann U-87 on omnidirectional for the room sound.

A third technique for miking electric guitars involves using twenty-seven mics to cover every possible angle in the room, and sometimes Brad will set up a wall of three or four Marshall stacks and several mics to capture the sound of power.

Davy feels that many engineers concerned with miking a solitary piano overlook the one place which seems likeliest—the sound board. "That's where all the richness of a grand piano comes from," says Davy. So, in miking the piano, Davy places a Neumann 47 underneath the sound board, along with standard placements of two Neumann KM-86s and a Sony ECM 50 on the strings; Davy might use any or all four at any given time.

As previously mentioned, the physical location of the drums in the studio was used to vary the sounds. Brad devotes a lot of his time to assisting Phil Ehart in moving mics and seeking

different tones. The basic pattern involves miking the toms from above with a Sennheiser 421 and from underneath with Shure SM 57s. The SM 57s are used along with AKG C414s on the snare; an Electro-Voice RE 20 is placed inside the kick. Overhead mics vary in choice and distance. Where permissible, two Neumann U-87s are placed overhead at 45° angles and two Neumann KM 86s are placed in front of the kit. At remote corners of the room, ambience mics are established and moved in closer when a tighter sound is desired.

A basic technique for miking the organs involves staking two AKG 452s anywhere from three to six feet away with a Neumann U-87 placed on top of the Leslies for bouncebacks. An Electro-Voice RE 20 is placed in front of the Leslies.

Experiments in miking of other effects include placing a Pignose inside a conga drum. Instead of playing guitar in a "live" chamber, Kansas has put a Marshall in the chamber. One variation of "Pignose in the Piano" involves Kerry playing guitar through the piano while Rich plays the exact same chords at the exact same time on the piano, and the effect is incredible. All of these miking techniques are used freely and Davy makes mental notes for use in planning the forthcoming concert tour.

From Studio to Concert Hall

Davy's concert set-up is basically the same as his studio placements except that he uses only condenser mics for drum overheads. Mostly he chooses unidirectional dynamic mics to get as much isolation as possible in a situation where there is practically no isolation. He uses his favorite mics in his favorite placements, but if the results are not favorable, he will change mics instead of resorting to electronic processing. Rather than [immediately] turning to an equalizer to decrease certain frequencies, Davy will change mics or their placement.

Mixing a "live" concert requires that Davy shoot pink noise through the system during the sound check. Using a mic at the console he checks side-to-side frequency responses on both sides and then adds the two together. Yes, he is aware that his technique is somewhat unconventional, but he makes several EQ adjustments to bring it as close to

flat as possible without radically altering the EQ. "If I show a trough of 12 dB from 400 to 800 cycles, that doesn't necessarily mean I'm going to add 15 dB at those frequencies to bring it back to flat; that's unrealistic," says Davy. "The maximum dB I will use will be plus or minus 5 dB. Once I'm satisfied that the curve is coming up basically flat, I'll do a sound check.

"Some engineers conduct four hour sound checks by bringing the band onstage and EQ'ing each instrument," Davy adds, "but as soon as 15,000 people come into the hall, the EQ goes right out the window." Neither does Davy rely on a cassette tape to EQ the room as he considers that method the least scientific of all. And real-time analyzers are also rejected. He is only concerned that the system works. By the second song of the show, Davy has made all the settings he needs to make and thereafter his only real concern is closely watching the changing sound levels of the vocals and the guitars. Last year's tour incorporated all Midas consoles and Martin audio.

When asked to pass along tips to those of you owning home studios, Davy was caught short for a response. "I don't have a home studio," he said. "Hell, I don't have a home. I'm in the studio six months and on the road six months. But in building a system, start with amps and speakers first because they will tell you how good everything else is."

Moving the Music

As the sessions for recording basic tracks at Axis were concluded, Kansas moved across town to Apogee recording studios to record vocal, violin and synthesizer overdubs. The final mix was reserved for Capricorn Studios in Macon, Georgia. In creating the final mix, Davy and Brad will work towards self satisfaction and pleasing their clients before worrying about public critique. Although the band is not AM radio motivated, the success of "Dust In The Wind," has the band and its engineers cultivating two of the present cuts for airplay.

"Our design is that this Kansas album will sound good whether it is heard through car speakers, cheap stereos or state of the art units," claims Davy Moire.

"And the music," concludes Steve Walsh, "The music is the best we have ever done."

MXR on the use of multiple effects.

The use of special effects has become a major part of today's music. Contemporary musicians are able to reach new levels of self-expression by combining instrument and effect in the development of their technique. If multiple effects are used, not only is this expression enhanced, but a new world of totally unique sounds is provided.

Although many of today's knowledgeable musicians use multiple effects, this technique has not been exploited to its fullest. One reason for this is that the artist usually has a musical rather than technical background, and is more familiar with artistic expression than the concepts of signal processing. At MXR we feel that our knowledge as designers may be very useful to the artist. The information here has been gathered by our engineering and marketing staffs through customer feedback, research, and personal use.

The purpose of this paper is to be a comprehensive yet understandable guide for the musician who is using or planning to use effects devices. We feel that MXR products provide well designed, legitimate effects that easily interface between your musical instrument and amplifier, whether employed singularly or in multiples. The following information, however, applies to any device of the same generic type. These devices are organized into groups according to their effect on the signal.

In a hypothetical situation, where all types of devices are used simultaneously, the following groups may be distinguished. Note that the order given is for the general case. Later we will discuss some alternatives and specific applications which you can try. The first group is composed of level boosting devices and includes preamps and distortion units. They are generally placed in the front of the effects chain because they are capable of providing a higher signal level for the successive devices to work with. The second group, the dynamics dependent devices, vary their effect in relation to the level dynamics of the incoming signal. This group includes envelope filters and envelope generators. Next are compressors and limiting devices which provide a more uniform signal level. Next are phase shifters and flangers which alter different frequencies in differing amounts. Delay lines, including tape delays, analog delays, digital delays, and doublers, are the next group. Noise control devices such as noise gates

and noise filters would be next and would help to decrease the overall system noise. Equalizers belong in the last group and help to tailor the entire tonal character of the signal.

Let's examine a typical situation in more detail. It is beneficial to use a preamp or compression device such as our Dyna Comp first. The compression device sets up a more constant level for the next device, which might be a distortion device. Many additional harmonics are provided by the distortion device for later stages. Next a phase shifter would produce its characteristic frequency cancellation notches. If desired, a flanger would be used next to generate many more notches, especially at higher frequencies. Use a wah-wah pedal towards the end of the effects chain since it has the capabilities (in certain frequency ranges) of overdriving devices placed after it. If you are using a delay line, it should also appear near the end, regardless of what type it is (tape, analog, or digital), since it could potentially add noise to the signal. Use a volume pedal next. It can serve as a manual noise gate, a dynamics controller, or an envelope control. A Noise Gate/Line Driver, used at the end of the chain, can create a

impression, or sound, without losing control and without introducing unnecessary noise. An important idea to keep in mind is to make connections as short as practical, in the interest of a cleaner signal as well as neater physical organization. For instance, if you are using four different devices simultaneously, chances are it would be to your advantage to have them relatively close together. More noise can be introduced by the cables than by the circuitry within the devices. Most MXR effects devices have been designed so that when they are switched "out" the input and output jacks are effectively tied together to help maintain a clean signal when bypassed. The exceptions are our graphic equalizer pedals which are always "in" and our Noise Gate/Line Driver whose line driver function is always "in."

Buffering devices (preamps, compressors, etc.) establish a strong or uniform driving signal. In the beginning of a long chain (more than four devices), they can prevent the effects of "loading." The symptoms of loading are loss of highs and lows and the lowering of the "signal to noise ratio." The resulting sound is one of lost crispness. All MXR products have a relatively high input impedance so



threshold between unwanted noise and the musical signal. It can also serve as a signal splitting device for remote recording or P.A. amplification. The last device is usually an equalizer. This contours the sound or may be used to compensate for the acoustical response problems at a club, auditorium, or studio. The goal is to achieve a desired effect,

that more of them can be used with less loading effects.

Whether on stage or in a recording studio, a proper arrangement of signal levels must be set at all places along the signal path. In order for any electronic device to operate at its optimum it must be used within the specific level range for which it was designed. MXR devices have been designed to accept a wide variety of

input levels. These levels must be considered, however, since they can vary greatly, depending on where the signal is coming from. Keep the signal, at all points, below the clipping level and above the noise floor. Maintaining adequate "headroom" refers to having enough room at the signal peaks to ensure that they are not clipped or distorted by the unit. Maintaining a high "signal to noise ratio" refers to having enough signal level to prevent unwanted noise from being heard.

Until now we have been primarily concerned with dynamics and level, but frequency response is also important. It is generally not advised to limit the frequency response in the beginning of the effects chain. An exception to this is the use of an equalizer at the beginning in order to purposely alter the apparent tonality of a particular instrument. An example of this is a guitarist who wants to make his guitar with humbucking pickups sound as if it had single coil pickups. Equalizers can also be used at the end of the chain to filter out unwanted high and low frequency noise.

Something to consider when using several devices is the level difference which can result from the device being switched in and out. Usually there will be a gain or output level control on the unit which enables adjustment of the modified signal's level in relation to the original or dry signal. A recommended method for achieving uniformity between signals is to play a note or chord with the device "out" then switch it "in" and play the same note again. Rotate the output control to the place where the signals are in their proper relationship according to your needs. Remember that the first devices have the potential of overloading all the rest, so be aware.

Another factor to consider is the harmonic character of the material and how it affects subsequent signal processing. To illustrate a point, consider a situation in which we can use either a compressor or a distortion device to feed a flanger or phase shifter. Theoretically, a compressor should not change the harmonic character of the signal, while the distortion unit adds many harmonics. The thickened frequency spectrum of the distortion unit offers more signal for the flanger or phase shifter to act on. The result is a more intense sound.

A compressor or limiter should generally not be used at the end of a signal chain. By definition, a

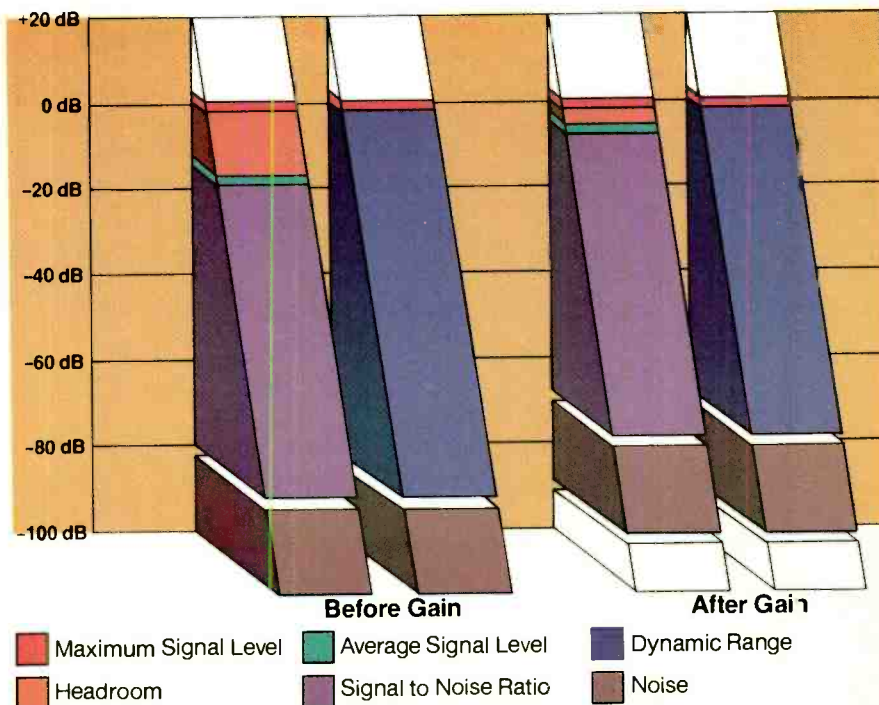

compressor brings up the lower level signal to a predetermined level. If that signal is the noise floor, then that is what will be amplified. What will result is a high concentration of circuit noise. Even though most of the higher quality units have been designed for low noise, it is still in your best interest to keep this in mind. By using a compressor or limiter before a volume pedal an interesting technique can be developed. This technique is particularly appropriate for steel guitar and electric piano. The compressor boosts the softer notes, giving the instrument greater sustain, and the volume pedal permits the artist to fade the music in and out smoothly for a fluid and gliding sound. The artist is also afforded the benefit of always knowing what level the signal is at before going into the volume pedal.

If you are using a dynamics dependent device you would not want to precede it with a limiter. These devices are dependent upon the unaltered level dynamics of the incoming signal to control their effect and therefore will seem more subdued if preceded by any device which alters the dynamics of the signal.

One interesting thing to try with multiple effects would be splitting the signal and processing it through different effects chains and monitoring amplifiers. Another thing

to try, which is especially effective with keyboards, is to have a phase shifter sweeping with a narrow width and fast speed, running into a flanger, sweeping with a wide width and slow speed.

Once again the general rule is to run gain devices ahead of effects devices. However, always consider what the desired effect is to be. Combining knowledge and imagination can certainly help musicians (and engineers) to get more out of their art and the most from their electronics.

MXR is helping musicians to achieve their goals and enrich their music by designing professional products which are functional, durable, and superior in performance. See your MXR dealer.

MXR Innovations, Inc.
247 N. Goodman Street
Rochester, New York 14607
(716) 442-5320



**Professional
Products Group**

THE IMPACT OF NEGATIVE FEEDBACK

ON THE TONE QUALITY OF AMPLIFIERS

by Robert Furst

The use of the THD (Total Harmonic Distortion) specification as a figure of merit for rating the tone quality of audio equipment has become a widespread practice. The concept is, the lower the "THD" specification, the better the equipment. Accordingly, modern audio amplifiers are showing ever lower numbers for THD. It is not unusual today to encounter claims for THD of .01% or less. These extremely low figures are invariably accomplished by the heavy application of overall negative feedback around the amplifier circuitry; 60 to 80 dBs of feedback have become quite common.

A Moment of Silence for the Tube

What contrast with the audio design technology of twenty years ago! In those vintage years of the vacuum tube, circuit design already had reached a high level of sophistication. Sonic quality was limited only by the quality of available electronic parts. The maximum overall negative feedback for stable operation was limited to 20-30 dB then, due to stability constraints imposed by output transformer impedances and other factors. The designer was forced to linearize every stage with tender, loving care before overall feedback was applied. The result was impressive sonic performance, even though the specifications then were not as good as they are today. Some amplifiers designed

Mr. Furst, an individual of no mean reputation in this business of audio, is vice president of Harman International Inds., Inc.

during that period are classics and compare favorably with the tone quality of many of today's amplifiers.

With the change from vacuum tube to semi-conductor circuits, designers suddenly found a new "freedom." With lower transistor impedances and elimination of the output transformer resulting in greater stability, there were not too many restraints on the overall negative feedback that could be applied to circuits, provided amplifier stability could be maintained. As a matter of fact, the inherent non-linearity of the early transistor circuitry made large amounts of negative feedback necessary. However, despite the fact that the semiconductor design technology has been vastly advanced since, and it is possible now to design audio circuits with low inherent distortion (open loop distortion), the general thrust toward applying ever larger amounts of feedback is continuing. Increasing doses of negative feedback had become the miracle cure. Thus, designers started to move in a direction that would eventually lead them to amplifiers with infinite negative feedback and zero distortion!

There are in theory three principal benefits to the application of negative feedback. They are:

- Reduction in static distortion (THD, SMPT-IM).
- Extension of frequency response.
- Increase of the speaker damping factor (by lowering amplifier output impedance.)

Let's take a closer look at these.

Reduction in Static Distortion: In

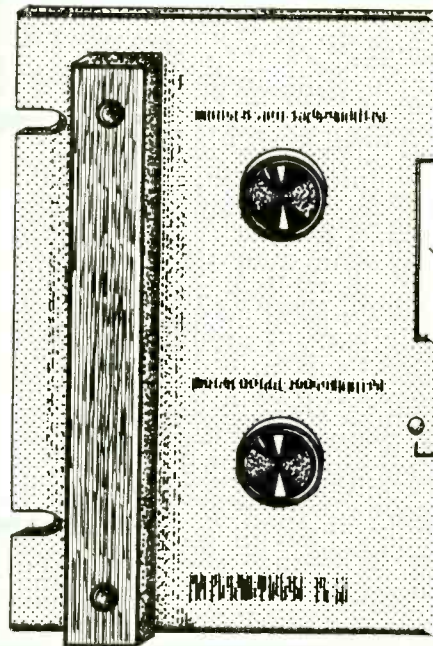

accordance with the basic feedback equation, THD and other static distortions are reduced in proportion to the amount of feedback applied. Within this mathematical framework let us imagine an amplifier with a typical 80 dB of overall negative feedback and a typical THD specification of 0.02%. 80 dB is the equivalent to a voltage ratio of 10,000 to 1. Multiplying 0.02% by 10,000 gives us then the THD of the amplifier before the application of feedback, or the theoretical "open loop" distortion, which in this case will be 200%. This, of course, is absurd. In practice it is impossible to specify actual open loop THD for this amplifier. The open loop gain is in the range of 110 dB and is typically in excess of its inherent dynamic range. High noise levels, severe instabilities and DC drifting make it very difficult to measure the open loop distortion.

There is at least one explanation for this puzzle. One way of increasing the amplifier stability to satisfy high negative feedback requirement is to sharply curtail the high end of the open loop frequency response. Our amplifier, with 80 dB of feedback, then

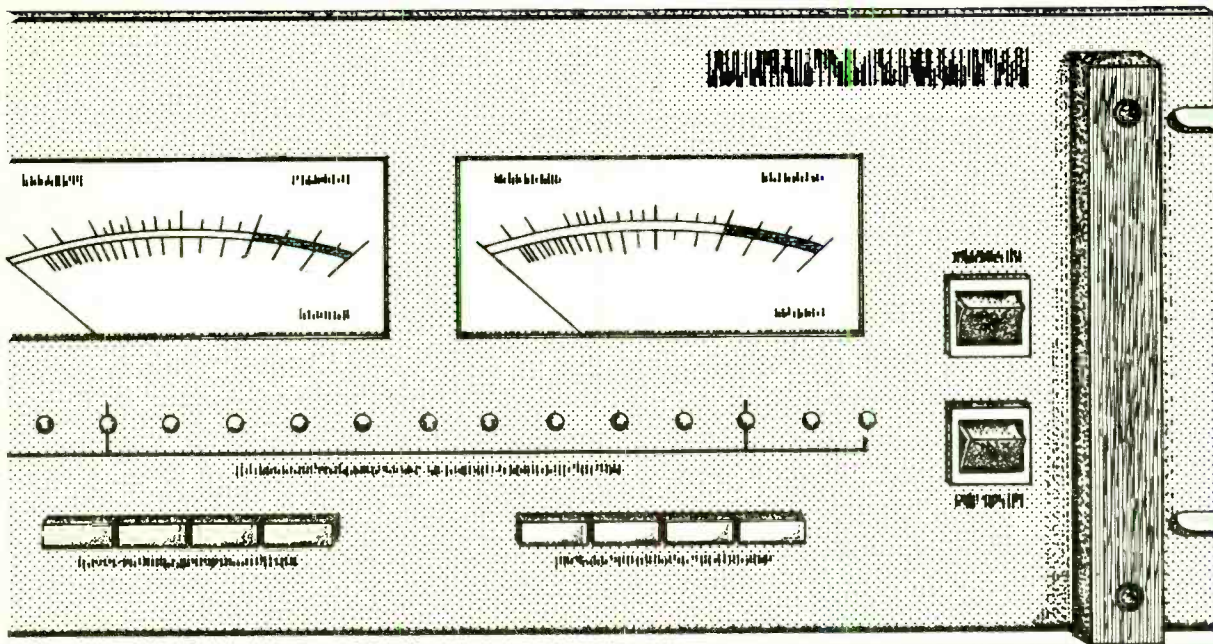

becomes a typically narrow band configuration, with the gain already dropping as much as 20-40 dB at 20 kHz. If the amount of feedback at 50 Hz is 80 dB, the feedback at 20 kHz then would be reduced to 40-60 dB. 10% open loop THD at 20 kHz would yield the required closed loop THD specification of 0.02%. This is still a high open loop distortion number, but plausible and probably typical.

Let us assume that the open loop THD of our amplifier is 5%, and, in order to keep matters simple, let us further stipulate that the THD contains only a second harmonic component. Let us now introduce a pure 1000 Hz sine wave into the input of the amplifier. The "feedback" error signal derived at the output of the amplifier now contains the original 1000 Hz and a new second harmonic component of 2000 Hz generated by the distortion mechanism within the amplifier. This error signal is then reinserted into the input of the amplifier along with the original pure 1000 Hz tone. It is then amplified by the very high open loop gain of the amplifier and submitted to the same distortion mechanism as the

original signal. Thus a new second harmonic distortion component is generated, and the second harmonic of 2000 Hz is 4000 Hz, which is also the fourth harmonic of the original 1000 Hz tone. To make matters worse, any distortion mechanism generating second harmonic distortion will also generate intermodulation components, specifically at the sum and difference frequencies of any two or more input signals. The "feedback error signal" will now show the original 1000 Hz plus 2000 Hz and 4000 Hz, plus the intermodulation products of 3000 Hz, 5000 Hz and 7000 Hz. As this new "enriched" error signal re-enters the amplifier input, the process continues to repeat itself, eventually creating a broad spectrum of "high order" distortion components.

This proliferation of harmonic intermodulation distortion products relates directly to the applied amount of negative feedback. These high order distortion components are usually sufficiently small to escape detection by conventional distortion analyzing equipment. But, because they have a strident and dissonant effect, they are

highly discernible to the ear. Therefore, it becomes evident that the employment of high negative feedback offers us some trade-offs. First order distortion components are reduced to a very low level, resulting in a low THD specification. This is happening, however, at the expense of the introduction of low level high order distortion components that deteriorate the musical quality of the equipment.

Extension of Frequency Response: Similar to the reduction in static distortion, the basic feedback equation indicates that frequency response is expanded directly in proportion to the amount of feedback applied. If we make the assumption that our earlier amplifier model is DC coupled, then it is reasonable to assume that no extension of the low frequency end is taking place, since the amplifier, both in the open loop and after the application of feedback, will go down to DC.

Now let us look at the high frequency end. Let us assume that our amplifier model has an open loop upper frequency cut-off at 2 kHz. 80 dB of feedback implies again a frequency ratio of 10,000 to 1 for an increase of

the amplifier bandwidth. That means that the theoretical closed loop cut-off frequency at the high end will become 20 megahertz. In practice, transistor amplifiers simply do not function in this way. The feedback equation does not take into account the phenomenon called "slewing." Slewing in a transistor amplifier occurs when a large input signal is of such rapid rise that it exceeds the capability of some of the slower transistors, or a poorly designed circuit to follow it. When this happens the rate of the change (i.e., the slope) of the signal will be "clipped." This is somewhat analogous to the lower frequency case, in which the amplitude of a signal may be "clipped" when it exceeds the power rating of the amplifier. The "slew rate" of an amplifier is usually expressed by a single number stating the maximum voltage or current swing at one microsecond just before slewing occurs.

The basic problem is that negative feedback can not physically speed up transistors, or increase the slew rate. On the contrary, increased feedback will require further reduction of the amplifier open loop frequency response to ensure stability, further reducing the slew rate. Thus, if a sharp high-frequency transient enters an amplifier designed with heavy negative feedback, the offending transistor or circuitry will go into slewing and block for an instance before it has had a chance to respond to the transient and permit the "error signal" to be fed back. During this instant the entire amplifier blocks and requires some time to recover. This causes a form of dynamic intermodulation distortion. The larger the amount of feedback, the greater is the current of the transient inside the feedback loop, and the higher is the distortion. This distortion mechanism was identified by Dr. Matti Ojala in 1969 and termed "Transient Intermodulation Distortion" (TIM). TIM is just one of a number of dynamic intermodulation distortions (DIM) suspected to exist. The others have so far not been as clearly identified, but the belief is that many are equally aggravated by the use of large amounts of negative feedback.

TIM manifests itself in a sharp, gritty tone at its worst, and in subtle coloration of musical instruments at its best. Dr. Ojala presented a paper at the AES convention in New York in November 1978 and described scientifically controlled listening tests during which trained listeners were able to

discern TIM levels as low as 0.003% RMS, an amount well below the noise level of the program. This is important, because it shows how sensitively the human ear responds to minute non-harmonically related, high-pitched disturbances.

Lowering the Damping Factor: The damping factor is the ratio of the nominal impedance of the speaker, usually listed as 8 ohms, and the output impedance of the amplifier. It is considered an important specification, because it decreases sound coloration near the resonances of the loudspeaker cones and enclosures. The larger the number, the better. Since the output impedance of the amplifier is again inversely proportional to the amount of feedback applied, the damping factor numbers can be very impressive indeed. Dr. Ojala in his paper on "Interface Intermodulation Distortion" (IIM) takes an altogether different and illuminating view of the relationship of amplifier output impedance and negative feedback.

The description of this distortion mechanism is as follows: A large portion of the energy—fed from the amplifier to the speaker—is not dissipated by the loudspeaker or radiated as sound, but temporarily stored in the reactive components of the speaker system such as crossover networks and mechanical resonances. After a short period of time this energy is returned to the amplifier terminals as a distorted and delayed signal and then propagated into the feedback loop. There, the distorted signal causes intermodulation with the incoming signal. Since this signal is originally derived from the amplifier output signal, it is of the same order of magnitude. Consequently, its potential to cause serious distortion is high. The magnitude can actually be as high as the static intermodulation in the amplifier particularly in the frequency spectrum near the speaker resonances. This may cause substantial coloration in the lower midranges of the music.

In his paper, Dr. Ojala showed that the relevant amplifier output impedance, as "seen" by the speaker, is the open loop output impedance, and not, as has been customarily assumed, the closed loop impedance. His suggested design rules to minimize IIM are:

- Lowest possible open loop amplifier output impedance.
- Caution in the application of overall feedback.

Thus, we can see that negative feed-

back has little influence on the amplifier output impedance in the most important application, but actually adds to distortion in the speaker amplifier interface.

Conclusions

We have only scratched the surface in identifying those distortion phenomena in electronic amplifying equipment that the ear can perceive. However, a number of important distortion producing mechanisms, directly related to the application of excessive negative feedback, are now understood and have been reviewed here. They explain why today's transistor amplifiers, with very low THD, typically sound poorly. It is curious to note that only a handful of designers and manufacturers have paid attention to this, and have designed audio equipment minimizing the dynamic feedback distortions. Most of the audio industry continues to design for low THD specifications with the application of high feedback particularly in the medium price range. Yet transistor technology has now sufficiently advanced such that highly linear audio circuitry can be designed without resorting to excessive negative feedback.

Several companies are showing that better sonic performance can be achieved, and even in moderately priced equipment. Some are using the following engineering criteria to design their amplifiers:

- Low open loop THD.
- Elimination of all "high order" harmonics above the fifth harmonic.
- Open loop frequency response DC-50 kHz at full power.
- Slew rate of better than 50 volts/microsecond.
- Elimination of TIM.
- Lowest open loop output impedance possible.
- Stable open loop operation.
- Excellent open loop sound quality.
- Determination of correct amount of negative feedback for optimum musicality (usually near 25 dB.)
- Listening at every step of the design to insure full preservation of the sonic performance.

The results refute the general dictum that all modern amplifiers are so good they all sound alike, and show that substantial progress is still possible in improving the tone quality of electronic audio components.

Many amps can deliver pure sound. The Sansui AU-919 delivers pure music.



Today's audio engineering has reached the point where you can select among a number of affordable high-power amplifiers that have virtually no "total harmonic distortion." That's good. But THD measurements only indicate an amplifier's response to a pure, continuously repeating, steady-state test signal (below, left). They don't tell you how the amp responds to the never-repeating, rapidly-changing transient waveforms of real music (below, right). And only an amplifier designed to reproduce the demanding dynamics of music signals can satisfy the critical audiophile. An amp like the Sansui AU-919

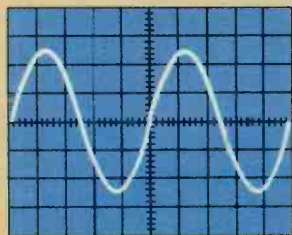

SINE WAVE

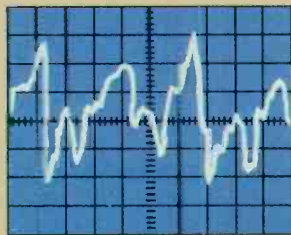

DYNAMIC MUSIC SIGNALS

Because low THD without low TIM is like sound without music, the Sansui AU-919 is designed to respond well to both simple sine-wave test signals and also to handle the jagged, pulsive edges required for realistic reproduction of music—without imparting that harsh, metallic quality known as "transient intermodulation distortion" (TIM).

The Sansui AU-919 sounds better than conventional amps because Sansui developed a unique (patent pending) circuit that is capable of achieving both low THD and low TIM simultaneously.

Our DD/DC (Diamond Differential/DC)* circuitry provides the extremely high drive current necessary to use proper amounts of negative feedback to reduce conventionally-measured THD (no more than 0.008%, 5Hz-20,000Hz into 8 ohms at 110 watts, min. RMS) without compromising our extraordinary 20CV/ μ Sec slew rate, ensuring vanishingly low TIM, as well. The power amplifier frequency response extends from zero Hz to 500,000Hz.

Since ultimate tonal quality depends on more than the power amplifier alone, Sansui also uses its DD/DC* circuitry in the phono equalizer section—where current demands are also particularly high—to prevent TIM. ICL (input capacitorless) FET circuits are used throughout the AU-919, and a "jump switch" is provided that will let you run pure DC from the Aux. input to the output.

Visit your authorized Sansui dealer today, and he'll show you a lot more that the AU-919 has to offer. Like twin-detector protection circuitry and our Penta-Power Supply system. Two-deck monitoring/recording/dubbing facilities. And a high-performance ICL/FET pre-preamp for moving-coil cartridges.

Then listen to the AU-919 with the most demanding music you can find. You'll hear the way the music should sound. Like music. Not just like sound.

*The Diamond Differential/DC, Sansui's (patent pending) totally symmetrical double ended circuitry with eight transistors, is named for its Diamond-shaped schematic representation.

SANSUI ELECTRONICS CORP.

Lynhurst, New Jersey 07071 • Gardena, Ca. 90247
Sansui Electric Co., Ltd., Tokyo, Japan
Sansui Audio Europe S.A., Antwerp, Belgium
In Canada: Electronic Distributors

PATCHWORK PAYS OFF.



When you start working with an 8-track recorder, there's a great temptation to rush out and buy a so-called "8-track" board. Forget it. You don't need the fat price tag. Because what you're really looking for is 8-buss operation.

That's why we've put together a systematic approach to 8-buss

operation built around our new Model 5B. You get control over all your tracks.

Total access to the signal flow. The ability to adapt quickly to each new session. And a rather large savings in cash outlay.

It starts with our new Model 5B. Eight-in/four-out. Expandable to 20x4. Color-coded controls get you where you're going faster, with fewer miscues. And new ICs have been incorporated throughout its circuitry. The slew rate has been improved by a factor of four. The result: better transient response. Tighter, sharper, cleaner sound.



Now add the Model 1. It gives you an independent 8x2 mix anywhere, anytime you need it. During basic tracks and overdubs, it's your monitor mixer. During final mixdown, it's ready for stereo echo. Any time you need another 8x2 mix, it's right there.

Our MB-20 lets you meter any line level signal you want. That's handy when you're using one mic or one instrument per track and driving your 8-track with the Model 5B's direct outputs.

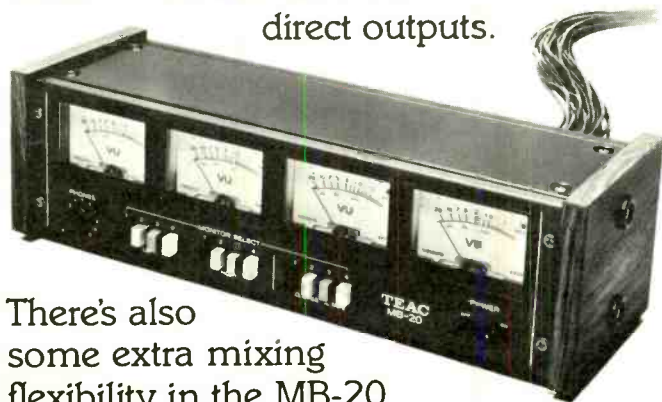

There's also some extra mixing flexibility in the MB-20. You get Buss/Tape selectors and an independent 4x2 monitor mixer.

Holding the system together is our PB-64 patch bay.

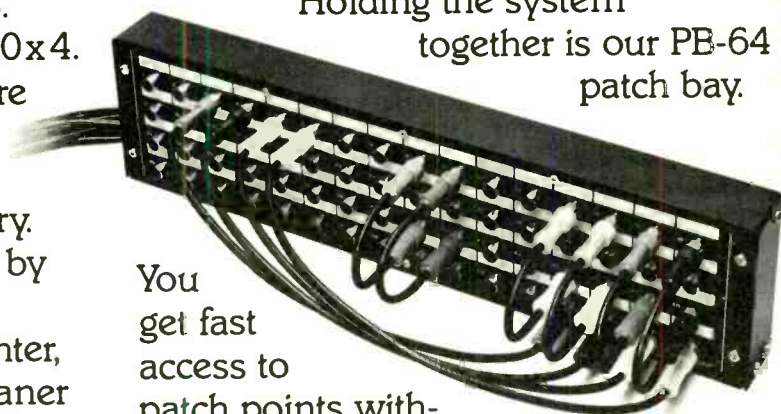

You get fast access to patch points without crawling behind and under your rig. You use jumper cables like push-buttons to route signals. And you don't get trapped into one hard-wired configuration. You can grow, change or completely re-arrange your set-up without throwing out the gear you've already invested in.

That's the Tascam concept of modularity. One that's paid off for recording artists for more than seven years.

See your Tascam Series dealer or write us for a free copy of our operations/hook-up bulletin,

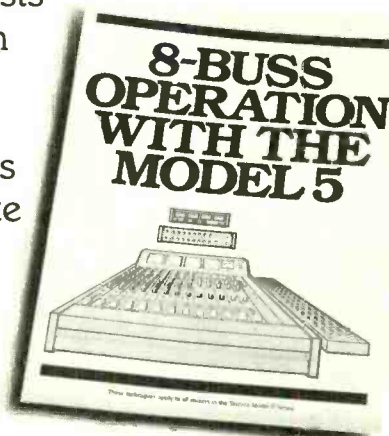

"8-Buss Operation With The Model 5." You'll see the functions you need. At a price you can afford.

Because patchwork does pay off.

TASCAM SERIES
TEAC Professional Products Group

Interview
with:

TOM SCHOLZ

by Gil Podolinsky

Since the release of the single "More Than A Feeling" and the first Boston album over three years ago, [group leader] Tom Scholz has been the subject of much interest. A former engineer in the Research Department at Polaroid, his electronic inventions and modifications have earned him a reputation as being the electronics genius of rock. The fact that he merely dropped an unsolicited demo in the mail, resulting in one of the greatest overnight success stories in show business is a story in itself. In this interview, Tom is quite open in discussing the behind-the-scenes story of Boston, his recording procedures and his feelings regarding being generally considered a modern day legend.

MR: How did you originally get interested in recording?

TS: I got interested in recording because I'd buy studio time and the end product never sounded like what I thought the band sounded like. It was so expensive, and I didn't have enough studio knowledge, that at \$75 an hour, I wasn't going to learn much. So, I *had* to put a four track together, a ¼ inch tape deck. I scoffed it up from my dad. He had a Roberts cross head something or other. He didn't know how to get it to record and play back. It was so complicated that I didn't either. So, I took it and tore out the insides and put in a few Sony playback heads—made a four track out of it. All this started around 1972. I learned a lot about the secrets of tape recording—technically—at Polaroid. They had a lot of audio experts there so I could pick their brains. I was there six and half years.

MR: So you worked in the audio department at Polaroid?

TS: Polaroid didn't have an audio department, just research and development, but they were very well educated in audio. Strangely enough, I'd just finished working on this one aspect of a project, while they were trying to put together some sort of sophisticated sound system for the instant movie. It had a viewer

designed by Bell & Howell. It wasn't very well suited—a cassette-held Super 8 film—and had a lot of flutter problems, which one guy solved by a digital storage method. It didn't look tough to me so I built this fixture and a few things which I thought would show the guy that I knew something about electronics. At the time I thought I did, but then realized I didn't. So I got myself into this project, designed a new unit and a sound unit for it and in the process picked up a great deal of knowledge about the electronics of tape recording. It was a pretty lucky chain of events, otherwise I would have been behind, especially with more complex equipment where you're always on the border line of pushing everything. I would have been much the worse for it.

MR: Did you do any assistant engineering, or any studio work per se?

TS: No assistant engineering. It would not have been a good use of my time. Even if it meant working with very inferior equipment, I decided it was better to have my own.

MR: So you worked Polaroid by day and your studio by night.

TS: Yes, right, only it wasn't much of a studio. I got another ¼ inch to mix down on, a couple of old Dynaco tube preamps. I made quite a few recordings on that crude system

before I decided to go all out.

Eventually I bought an old Scully 12 track. There was this studio out of town that had an old 16-track board but no multi-track machine. So, I threw it in there and I used it at night and they by day. I did it all in my spare time because the job was what was staking it all. By this time . . . let's see, we cut the deal (signed with Epic) in '75, so I must have got the Scully in '74, spent about a year . . . What I'd decided was to make a tape of three new songs and re-do a couple of old ones and do a real good job on 'em, so that's why I got the Scully. I wasn't looking for a real high class piece of machinery, just a multi-track because I realized that I couldn't possibly do what I wanted in a four track format, which was to display some songs in their best light and to show somebody, probably naively, *definitely* naively, looking back, that I knew something about producing a record. So, I needed more tracks. I could have done it on eight, but I found this twelve. I still use it, I absolutely love it.

I did a bunch of tests on a bunch of gear, before we recorded the second album. Since I only do electric guitars, bass, drums and organ, I got a Fast 40 transformer box, a storage 'scope and some other stuff. After doing that and buying some tape decks that I didn't

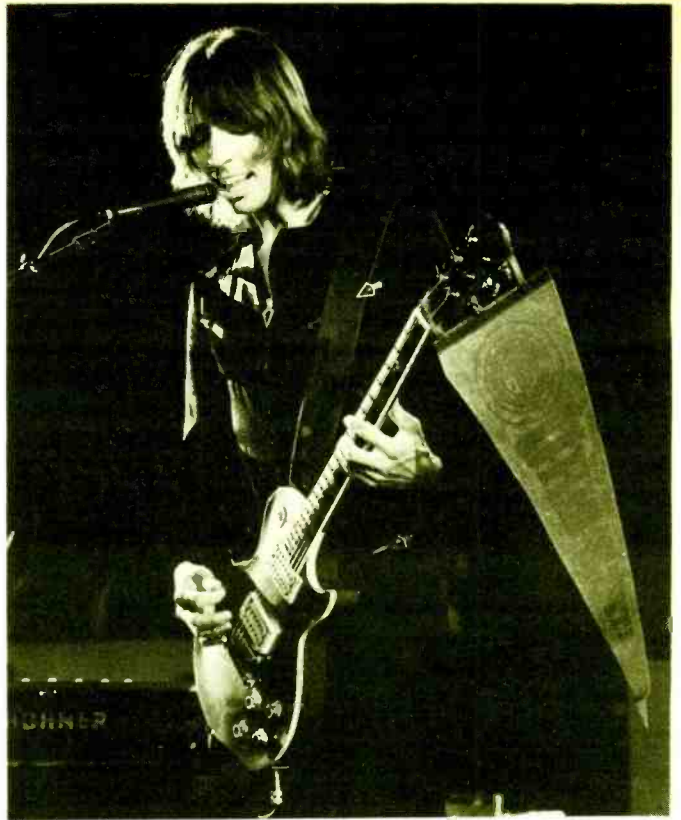

want afterwards and making measurements on other people's gear, I came to the conclusion that I really couldn't do better than the twelve track for overall recording quality. It's not a very flat response and the operating features are archaic, but it has an incredible S/N ratio, is very punchy, and the low end transient response is better than anything else I've measured.

When we did the first album, which was recorded in the basement of the apartment I lived in, it went from there to a 24-track MCI in California and played back for mixdown on a 3M, mixed down to a Studer. I didn't think it [the master] sounded as "umphy." I could hear the difference, so I wanted to find out why. I'm a little hesitant to say anything for certain, but apparently the biggest difference was in machines that had lousy low end transient response. They couldn't pick up the first excursion of a snare hit or something like that. It sounded dull.

MR: Do you still utilize the Scully and then transfer tracks?

TS: I did the basics of the new LP [*Don't Look Back*] on the Scully 12. The best idea would have been to link up the Scully and a 24-track 3M M79 for mixdown and just put overdubs down on the 24 track, but I was unable to come up with a link-up system that was reliable. So, just the basics went through the twelve. I may in certain instances put the vocals on the 12 without harmonies and then dub them in pre-mixed onto the 24 track. I never put the drums through the 24, however. So, I ended up transferring the basics from the Scully to the 3M. That didn't cost me much in terms of quality; I doubt that it's measurable. The old Scully has those linearity circuits which on 206 tape just work great. I talked to the guy who designed the system and the particular transistors they used for the linearity circuit to predistort the signal. You can't buy 'em any more, Germanium transistors. They were designed to be used with 202 tape, but on 206 tape, the predistort curve matches up with what comes off of 206 so well. I can go +8 dB over and above if you set 200 nanowebers at -3. I can go +8 before I get 1% harmonic distortion. Most other machines will give +4 at most. I know that you get a little bit of tape compression when you get that high, but that doesn't bother me because I don't like big high peaks that don't last very long anyway. I don't like that kind of sound that much for the kind of music

I'm doing. I had a sort of free ticket not to worry about tape wear 'cos I had all the basics on the one inch.

MR: Did you use this machine to record the demo?

TS: Yes and no. When I first got it it was a mess. It's probably the world's most expensive Scully. It has a home-built power supply that works. It makes *great* recordings. I hope that the next project I do I'll be able to have a satisfactory link-up. I ended up with a 3M 24 primarily because of the close head space. I like to be able to punch in and out. On most tracks you can get out without having to worry about it, and it's really noiseless and very small, which I like 'cos I like to keep things very close to me since I'm usually working alone. I still use the 3M for overdubs.

The only thing I don't like about the machines I measured with low transient response is that I just don't like the way drums come back . . . drums and a few percussive instruments, but it's basically because of the drums. So, I still do all of the overdubs on the 24 but linked to the 12 to get that original punch. If you take a snare and filter out the high end and look at the fundamental, which is basically a 180 degree cycle fundamental, and then look at the first peak as well as the shape of it, on a Scully it comes back so close to the original amplitude that it's unnoticeable. On the 3M it's maybe down 25% of the original amplitude on the first excursion, and the shape is quite a bit different. Also, there's quite a bit of difference from channel to channel. The shape I think is due to phase distortion. The MCI is a little worse and the Studers were like half of the original amplitude. I only checked two tracks, however, not the bigger machines. The Otari is somewhere between a 3M and an MCI. Nothing came close to the Scully. A Teac 8 track has real good transient response, almost as good as the Scully. It chews the hell out of the tape, though. Every time the capstan goes together I see a few flakes fall off. I'll probably always use the Scully for basics, I think.

MR: Did you transfer tracks on this album as well?

TS: Yes, I did transfer this time. What I ended up with was a recording that was no better than what the 3M could get. I had to record it at lower signal levels on the 3M and may have picked up ½ dB of noise, but I don't think it was measurable in terms of transient response. I briefly thought

about assembling a 24-track Scully, but they're so crude, so big and fall apart like crazy, so to hell with it.

MR: What did you use for a board on the first album?

TS: I first had an Aengus prototype, sixteen in/four out, which I thought was pretty good. Then I finished up on a Stevenson 16x4 P.A. board and did the first album on that. The only thing I hated was that the EQ knob was one inch off the board. I couldn't see it, and if you moved it just a fraction it jumped 6 dB—then you'd turn it half a rotation and nothing would happen.

MR: How many songs did you submit on the demo?

TS: Four, and then two more to those people who were interested.

MR: Were they all used on the album itself?

TS: Everything except "Don't Be Afraid" was on the first album; it is on the new one, though.

MR: I understand you just dropped the demo in the mail, totally unsolicited. Is that true?

TS: Right. Epic at first rejected it out of hand.

MR: You're kidding! So how did you come to end up on Epic?

TS: I mailed the demo to about two dozen labels, but most rejected it. There were a couple that were interested, and that interest caused a chain of events to happen that ended in my signing a management agreement with someone. They went back to Epic and made them listen to it harder.

MR: Why did they first reject it?

TS: There was no reason not to; I'd been sending them tapes for six or seven years. It was, to me, like buying a lottery ticket—you expect to lose, but you may as well open the envelope.

MR: I understand that the band didn't actually exist until after the record deal had been struck.

TS: There was a band before the demo. Barry, Brad and I had played together before in many groups over a six year period. I had been looking for a good singer and eventually found Brad. I stopped doing local gigs around '74 or '75. We weren't getting anywhere, couldn't get work.

MR: Is that because you were playing originals?

TS: No, we were willing to do *anything*, but we didn't know any agents, managers, club owners, anybody. Nobody was interested in any way locally. Oddly enough, the only people who would listen were national record companies. They don't listen very *well*,

but at least they listen . . . most of 'em. So, I thought of putting all my efforts into making the best tape I could make of four tunes, plus two additional tunes. So, the group had been there prior. Sib had played in a couple of groups with us. Once we got the deal I called up Sib and Barry, got Fran, with whom I'd never played but the rest had, and that was it.

MR: You co-produced the first album—how did that come about?

TS: I was naive about how record companies work. When I made the management deal, I stipulated that I had to be the producer and that was it, but was willing to do it for free. I was saying, what the hell, they had budgets for making records. I didn't know how big they were, but felt I should be able to rent a 24 track and a board I could either rent or buy and re-sell. I wanted to bring everything into my basement studio. That ended up not being feasible because as it turned out, Epic didn't even know I was working on a recording. Epic's choice of a producer was John Boylan, who brought an engineer, looked my place over for an hour and then said, "No way!" They were right. I don't think that they could have done it there. So he split, but wasn't sure he wanted to. So what happened was that he suggested I do the basics and then take it to be mixed out in L.A. where they had the facilities, and he'd split the production fee with me, fifty-fifty.

So, they left and I did the basics. We did the vocal overdubs in L.A., which was a big mistake because Brad had a lot of trouble. He'd never had trouble singing on tape before but I think it had to do with the atmosphere. He just couldn't hit notes he normally easily does. The sound wasn't as good. They did an entire song out there, one of Brad's, in order to masquerade the fact from Epic that I actually was in Boston finishing it up. Epic was getting nervous.

MR: Did you record "live" or track by track?

TS: Track by track. We record "live" when we're first working on a new song. We record hours of stuff so that by the time we do it [for release] everybody knows his part.

MR: Are the solos generally rehearsed or are they spontaneous?

TS: Most of the things you hear from us are spontaneous. A couple of things are worked out. Often when somebody makes a mistake, or does something out of feel but that sounds

good, you go back and try to figure out how it was done. Sometimes it's very hard. When we're actually in the recording process, we know what we're going to play. The only objective is to get the sound the way I want it and to get a good performance. I don't do the "live" studio thing at all.

MR: So then the guitar solos are overdubbed?

TS: Everything, even the rhythm guitars are overdubbed. Nothing is on tape when we start except the drums. In fact, I'm usually playing along with Sib when we're starting a drum track.

**“ It was ... like buying
a lottery ticket –
you expect to lose ... ”**

A lot of times he'll ask me to stop, so when I make a mistake it won't screw him up [*Laughs*]. He knows the song and would rather hear himself.

MR: What are your track assignments?

TS: I first do drums, then rhythm guitar, bass, leads, percussion and finally vocals.

MR: What types of mics do you use?

TS: I'm pretty . . . uh . . . I use [Shure] SM57s on all the drums, except the overheads, which are AKG 414s placed above the kit. I mic everything from on top. I haven't fooled around with miking from underneath so I don't know how that sounds.

MR: You use a 57 on the kick?

TS: Yeah [*Laughs*]. I never really thought it was a good idea, but I usually end up having to dial in more punch and snap to balance it off with the snare. Sometimes I dial in some low end, too, depending upon where I put the mic. The SM 57 has a dip in the midrange, and I usually dip in the midrange, so I thought it would be a good start. I know that you start to lose on the low end when you start to dial in a lot of EQ, like phase shift, so maybe it's not a great idea on the snare and kick. But, after measuring tape decks and speakers, the limiting factor for the low-end transient response wasn't going to be the EQ I put on the mic, even if it were extreme. So, I don't care too much. I don't think it would have made much difference which mics I used on the drum kit. I did purposely use cardioid dynamics or condensers that had a proximity effect to isolate the toms, snare and kick, and to isolate the low end and add the boost that I

would have had to dial in anyway. Therefore, I wouldn't have used an RE 20 or 16 or any of those. You can tell the difference in mics, even if you EQ them and try to match them up. You can tell that they aren't exact. It wouldn't have been any better using a \$300 mic vs. a \$70 one.

MR: What do you use on cymbals and hi-hat?

TS: I use two overhead mics and no hi-hat mic. I would like to get an anti hi-hat unit. I try to get Sib to hit his hi-hat and ride cymbal as easily as possible, but it never seems to be enough. I hate to use a Kepex as it's real bad on transients. I tried the Roger Mayer RM Noise Reduction Unit which is an alternative to the Kepex. It's supposed to have better transient response. It did in one sense, in another it was worse. A 200 cycle note on a Kepex takes forever to get up, but on that Mayer unit, the first one was real down, the second one way up. Next time I'm going to try to make an acoustical baffle around the hi-hat.

MR: Do you use a drum booth?

TS: The studio is designed with a decent-size control room so that I can play in it, including keyboards. The main room is about 20' x 14' and is so arranged that if you look through the window you can see the meters in the control room. I use a remote when I have to play in the main room. No, I don't have a drum isolation booth.

MR: Do you record the bass direct?

TS: The bass goes direct, as does the electric piano. Otherwise, everything else is miked.

MR: What mics do you use on the guitar amps?

TS: It's pretty much a question of whatever's lying around. I use a bizarre EQ. Most of what I do is guitar, which always goes through a third octave [EQ]. I don't feel that it really matters about which mic you use. I try to get a tube-amp-that's driven-to-distortion sound—smooth, yet at the same time not lose the harmonics.

I found a couple of things about tube amps—Marshall, Ampeg and Fender. I usually had to drop a lot of high end off the guitar before it went to the amp to get the "rattiness" out of it, and then put the high end back in later. I had to be careful not to turn the guitar down—otherwise it changes character completely. When you go into that high distortion to pick up high harmonics, and it gets really sizzling, you're putting something into it that in itself doesn't normally have a high

Rackability. Portability. Availability.



A glance tells you what a boon this new Stack Rack is to any music man who has to move and set up for a gig or a recording session. It is available to distributors through Neptune Electronics. It's like a mini studio on wheels. All your gear is rack mounted and ready to roll on a moment's notice. And, of course, Neptune designs all their fine equipment in 19" standard rack sizes — or in half-rack sizes with mounting ears. Many combinations of Neptune units are possible to make a compact, highly portable Sound Reinforcement System. Write for free catalog.

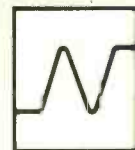

Neptune

934 N.E. 25th Avenue
Portland, Oregon 97232
Telephone (503) 232-4445

CIRCLE 58 ON READER SERVICE CARD

end. Consequently, when you turn it down, it gets really muddy. That is why you can't use any of the things you use [in the studio] on stage unless you want to adjust as you go along.

If you put new strings on a bright guitar and play through a Marshall with the treble turned up and the bass off, it will sound terrible. I checked the content frequency-wise. I tend not to like stuff in the range between one and two K, like 4-800 midrange emphasis. I like the honk at 2 or 4 K. I like guitar better when it's "missing" things.

MR: How do you mic the amp?

TS: Well, you can put a cabinet in one spot in the room, get away from it and it sounds great. Get in front of it and it sounds terrible. I think it has to do with the fact that I have two ears [Laughs]. Anyway, you get phase cancellation, mud from the room, etc., so I never utilize a room mic. I did look at miking from remote spots as well as from different angles up close to see what it looks like on the 'scope. It does look like it's missing parts. I did find that you could find sounds you liked near the cabinet, put a mic there, check the analyzer, put the dip in, get a read-out after moving the mic in tight on the speaker, put the dip in by hand, get rid of the room mud, and to some extent get the sound you heard, but it's never the same. I always mic *way* off axis on the cabinet so as not to get a reflective sound. I use a Marshall speaker cabinet with four twelves.

MR: Do you trust the analyzer more than your ears?

TS: No. I use my ears to see if I like it. I use the analyzer to see what's in the sound I like. Once the tape decks are calibrated, I don't go back and

measure. My ears aren't good enough to tell me that I've got a 9 dB boost at 600 cycles, so I use the analyzer for that. If I want to change a chord in a song that's been recorded, or if there's something wrong in a song and I have to duplicate a guitar, I have used the analyzer to tune in the guitar very quickly. On a twelve string with a lot of spikes of decay, the analyzer will help when you don't know what mic or where it was placed. It's a real time saver, but the biggest thing I get out of it is its telling me exactly what's in the sounds I like.

MR: With the transfer situation you have with two machines, you must do a lot of mixdowns.

TS: Ordinarily yes, but unfortunately we had a prematurely-planned tour to do. A couple of songs were just pulled off of the rough mixes I had done earlier. From a technical standpoint I was upset that I didn't get to mix it down the way I wanted. I had a whole lot of trouble. I had some grand plans for it, but ended up mixing down on an Otari two track MX 5050 or something. Some of it was mixed down on a late model Scully two track. I had a lot of trouble trying to get one that worked. I finally ended up buying a small Studer B77 for copies, but didn't want to mix down on it because I could really tell the difference in the lack of punch. Unfortunately, the response of the high guitar peaks which I found very pleasing stuck out too much. Such that when we cut the master they were nailing [overloading] the amp before they should, so we couldn't cut the master as hot as I had wanted. I was going to research it a bit through trial and error, but I didn't

have the time, which annoyed me. Also, I didn't quite get the sound the way I wanted. I originally had planned to do some mixes and listen to them on different systems and look at them closely. I didn't do that and I think my subjectivity was in pretty bad shape most of the time I was working on it. It wasn't off by much. I'm not really upset—it came close. There were some buried vocal lines that shouldn't have been and a few high end lead problems I'm going to fix. I'm going to remaster for fine refinements, fix all the stuff that happens when you're rushed. It's in my contract that I can go back and fix it. It was upsetting 'cos I had spent so much time getting ready for it

MR: So soon there'll be a "B" version of Boston II [*Don't Look Back*]?

TS: [Laughs] Well, after what I've seen of what comes out of a mastering room, I don't think you'll be able to hear much difference; we cut new parts all the time. I'll know it, though.

I picked up a couple of Scully 280 Bs and was gonna steal a few transistors from one for the other, figuring it had the same low end transients. Then I was going to modify the linearity controls, cut it hot on 206 tape to get the dynamics and have the noise real low. Couldn't do it, so I ended up using a straight level 280. Even the first test pressings were pretty hard to listen to.

MR: Roughly how many tracks do you actually use?

TS: On the average about 21 tracks per tune. If the tune has three-part harmonies, I usually at least double the [lead] vocal, but I *never* put the harmonies on the same track as the lead vocal. It's too messy in mixing. I *could* do all our stuff on twelve tracks, but it would be a pain.

MR: "Live," you, Barry and Sib sing back-up, but not on the actual recordings. Why is that?

TS: Brad does all the vocals on tape; he likes doing it. But yes, we all sing "live." It's probably faster to have Brad sing all the parts on tape than to have all of us learn different parts.

MR: Do you use vocal doubling and Scholz special effects "live?"

TS: Yeah, we have some doublers and some Scholz Specials. They're nothing more than what anyone else could do, but I'm not sure if anybody else puts much thought into what they're putting across in a speaker. We had to keep effects to a minimum because they're all problem oriented. You get that nice, full echo in these big halls anyway. I just try to make sure



Tom Scholz and Boston, enjoying an unusually quiet moment in the studio.

fact: this condenser microphone sets a new standard of technical excellence. & it sounds superb!

The Shure SM81 cardioid condenser is a new breed of microphone. It is a truly high-performance studio instrument exceptionally well-suited to the critical requirements of professional recording, broadcast, motion picture recording, and highest quality sound reinforcement — and, in addition, is highly reliable for field use.

Shure engineers sought — and found — ingenious new solutions to common

problems which, up to now, have restricted the use of condenser microphones. Years of operational tests were conducted in an exceptionally broad range of studio applications and under a wide variety of field conditions.

As the following specifications indicate, the new SM81 offers unprecedented performance capability — making it a new standard in high quality professional condenser microphones.



SM81 puts it all together!

- WIDE RANGE. 20 Hz to 20 kHz FLAT FREQUENCY RESPONSE.
- PRECISE CARDIOID polar pattern, uniform with frequency and symmetrical about axis, to provide maximum rejection and minimum coloration of off-axis sounds.
- EXCEPTIONALLY LOW (16 dBA) NOISE LEVEL.
- 120 dB DYNAMIC RANGE.
- ULTRA-LOW DISTORTION (right up to the clipping point!) over the entire audio spectrum for a wide range of load impedances. MAXIMUM SPL BEFORE CLIPPING: 135 dB; 145 dB with attenuator.
- WIDE RANGE SIMPLEX POWERING includes DIN 45 596 voltages of 12 and 48 Vdc.
- EXTREMELY LOW RF SUSCEPTIBILITY.
- SELECTABLE LOW FREQUENCY RESPONSE: Flat, 6 or 18 dB/octave rolloff.
- 10 dB CAPACITIVE ATTENUATOR accessible without disassembly and lockable.

Outstanding Ruggedness

Conventional condenser microphones have gained the reputation of being high quality, but often at the expense of mechanical and environmental ruggedness. This no longer need be the case. The SM81 transducer and electronics housing is of heavy-wall steel construction, and all internal components are rigidly supported. (Production line SM81's must be capable of withstanding at least six random drops from six feet onto a hardwood floor without significant performance degradation or structural damage.) It is reliable over a temperature range of -20° F to 165° F at relative humidities of 0 to 95%!

Send for a complete brochure on this remarkable new condenser microphone! (AL577)

SM81 Cardioid Condenser Microphone



Shure Brothers Inc., International Sales, 222 Hartrey Ave., Evanston, IL 60204, In Canada: A. C. Simmonds & Sons Limited
Manufacturers of high fidelity components, microphones, sound systems and related circuitry.

CIRCLE 118 ON READER SERVICE CARD

www.americanradiohistory.com

all the parts are sung correctly.

MR: What do you use for monitors in your studio?

TS: Cizek [Cizek Audio Systems, Inc., 15 Stevens St., Andover, Mass. 01810]. Yeah, I'm sure you haven't heard of them. I used to use Avid 102s, which I got from Polaroid. They were very accurate without having to add EQ. The same guy then turned me on to Cizek. I was amazed. First they showed me the frequency response sheet and it didn't look real! They're built not very far from me in Andover, Ma. They're smaller than the Avid 102s and have very good transient response as well as being very punchy. *Maybe* they're not as good as JBLs, but they are very good for being acoustic suspension speakers. I put them up against the Avids and they were almost the same. They're very accurate and quite loud for their size. I can't say enough about the Cizeks. I was amazed; they only cost about seventy-five dollars each.

MR: Since you've got such one-of-a-kind equipment, what do you do when you have to utilize another studio?

TS: Don't! [*Laughs*]. I don't foresee another situation where half of the album is done in my studio and the rest elsewhere. We put the control room together in a hurry so it isn't very acoustically sound. I had to EQ it for a localized area around the board and turn the speakers up for the room, but I'm going to correct that.

MR: There was quite a time span between the release of the first album and the second. As the explanation went, the new album was completed but a flood destroyed the tape, forcing you to re-record the album.

TS: The great biblical flood story was greatly exaggerated. For some reason, Epic put that out. There was a factory defect in a machine that did erase a few tracks, and that was bizarre. We had had some heavy rains and snow melting, which got the carpet wet in half the floor area of the two rooms. The guy who lives next door to me had about two feet in his basement. The "flood" didn't amount to much in the overall scheme of things when you're talking about the year between gettin' off the road and actually putting something out.

MR: How long does it take for you to make an album?

TS: For who, me? I've only got two, so there isn't much to take an average from. The first one, I'd been writing songs for since I began writing. My

very first composition is on there, "Foreplay." When it came time to do the second album, I had two songs and I figured I needed five more. Brad had a couple, so I figured we'd use one. I wrote or worked on nine new songs. It only took about four months for the actual recording; the first album about five or six.

MR: Without trying to nail you to the wall, if the first album took longer to actually record, why were there two years between the two?

TS: It was due to the amount of work. We had lots of tracks this time

“ .. we were willing to do anything ... ”

and I do like to overdub guitars. If you've got a complicated lead and want to double it, same with a vocal ... there are lots of nuances. You really don't want it to sound like two guitars, but want it to sound like it's all around you. First of all, you have to be able to play something repeatedly and you have to have the same kind of touch. It's very time consuming.

MR: I always thought of your guitar sound in terms of dual leads.

TS: No, it's not a question of two guitar players. I just always overdub the parts. Most of the stuff that Barry does is the single line work. It's very time consuming, but we're doing better as time goes on.

I was very unhappy with the way the guitars sounded on the first LP. I liked the demo better. The problem was, even though I cut at my place, that I didn't know what I was doing! Frankly, I don't think other people who make records do either, 'cos I've checked and asked. They seem to have gone through the same trial and error I did, and not understood why, so I made it a real objective *not* to start recording the second album until I'd educated myself a little bit. I primarily learned about guitars and drums. I learned a great deal between the first and second albums. I didn't have some of the gear that I needed for the first one. I knew I didn't have it, but wasn't sure that I needed it.

MR: What type of board did you put into your studio?

TS: It's a 501 Audiotronics that I had customized. It's a 26-channel board on which I had the EQ modified to gain more head room; instead of being limited to -12, it now goes up to -18. I also had some decent quad pan-

ners put in. It has a great deal of outboard gear in terms of its EQs and compressors. I had looked at a few but never seen one that had all that I wanted. This one came close. Without knowing a lot about it, I bought it. The 501 has very few transformers in it. I've had no problem with the unbalanced patch bay. I also like having four EQ points—I like it a lot. I'd always wished I'd had one more.

I don't use Dolby or dbx. The multi-track is always quieter without it (Dolby, dbx) 'cos if you've got your technique down, you don't put in noisy shit to begin with. I feel that the limiting thing in the studio is the two track. The pressings are always noisier than the two tracks. If they get into making quieter pressings, I'd get something like Dolby for the two track. But they [pressings] seem to be getting worse rather than better.

MR: Where was the first album mastered?

TS: The single was done at Sterling in New York. The album was mastered at Capitol in L.A. Capitol has a really nice EQ, and a Neve console. The fellow who works there does very attentive, reliable parts-cutting and mastering work—Wally Traugott. A very accurate guy. On this latest LP we didn't use any EQ'd tape copies for parts. They did, I found out, start to do that when they started to run out of the initial parts order, but I got them back off of that.

MR: Let's get back to your mic choices; what do you use on vocals?

TS: I use an RE 20 [E-V dynamic mic] on Brad. I did try a few condenser mics, but frankly, it was hard to tell any difference after minor EQ adjustments. The RE 20 worked best because Brad has a tendency to come on real strong in parts and has a real nasty "T" pop problem. I tried some Neumanns, an AKG, a 414. I found that there wasn't a great deal of difference overall. I don't think I could tell. I like the RE 20 because it doesn't have the proximity effect. Brad doesn't always sing the same distance from the mic.

MR: Do you like to isolate him at all when he sings?

TS: No. I'd just as soon get him on the tape flat and then use a coil reverb—although usually I use tape delay and not much reverb. For rock and roll, brute force has a greater place [is more important] than whether you use an Aphex or other effect.

MR: Although you are primarily a guitar band, you do use keyboards as

Take Your Pick

Whichever DOD product you choose you'll find consistent high quality design and materials.

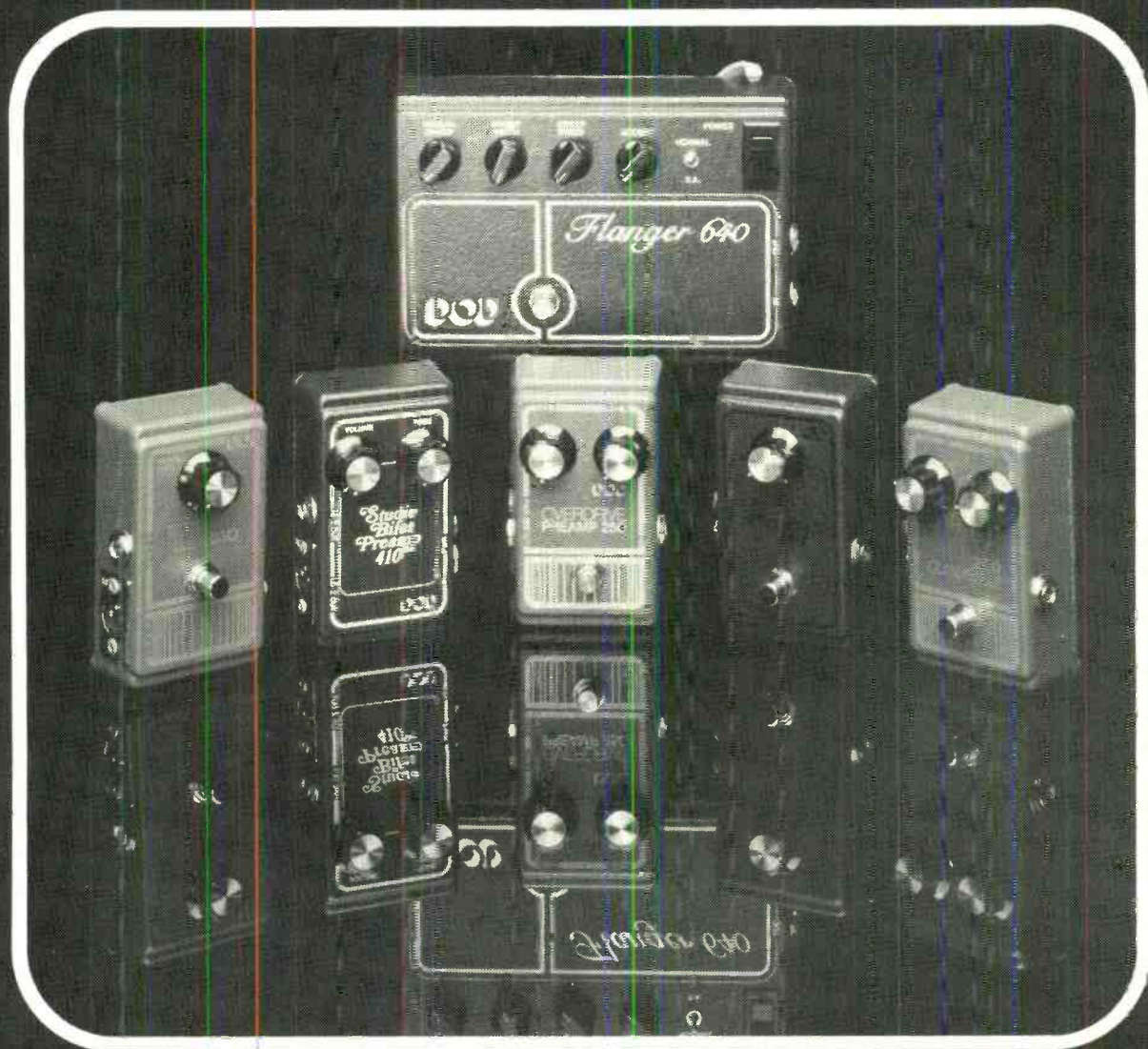

When we design a product we keep the musician in mind all the way. We demand a product that is functionally superior and to ensure that it will stay that way we use rugged name-brand components such as CTS, Carling Switch, National Semiconductor, Texas Instrument, Switchcraft, etc. We also

feature solid Die-cast Zinc and Aluminum cases and FR-4, G-10 Glass epoxy circuit board. All our products are hand assembled and individually tested by qualified technicians and have a full one-year warranty on parts and labor.

For further information write or call:



Electronics Company, 2895 South West Temple
Salt Lake City, Utah 84115, (801) 485-8534

CIRCLE 106 ON READER SERVICE CARD

well. When recording organ, how do you mic the leslie?

TS: Stereo, hi-low. It's a bitch getting two sides isolated. I put reflective things up, then move the mics around. I use a 414 on the bottom and an RE 16 on the top. Again, the mic doesn't really matter too much.

MR: You also used a grand piano on the second album. How did you mic?

TS: It was a Yamaha. I don't know much about recording/miking pianos. We recorded it at another studio [Northern Studios, Maynard, Ma.]. It was the only track on the album not recorded at mine, the reason being that I don't have a piano in my studio—couldn't find one that I liked. I used the miking arrangements suggested by the engineer there. It worked ok. After we had recorded it, Barry bought an old Steinway that sounds *great*. I was going to re-record the track at Barry's house, but once again, there was no time for that.

MR: And acoustic guitar miking?

TS: I used a 414 this time. I like the high-end boost. The only thing I do is notch out the guitar resonances that are troublesome on the low end. How I use one (acoustic guitar) depends on the part of the song or the sound I want. I put the mic in front of the hole and down, pointing in at the strings but a little below. What I go for is a little more high end and a little less pick noise. Pick noise always bothers me. For rounder tones I put the mic closer to the opening to get more of the bottom end and get warmer sounds as a result. Generally, there's more than one guitar on any given part anyway, so I never got into close vs. far miking.

I'll tell ya the truth, the kind of sound I like is where you're not able to know where the sound is coming from or who's making it. Therefore, I will purposely put two or three instruments on any given part and pan all the way out. When I *do* want a single instrument, I get into artificially doubling the guitar, panning it out a little bit. Just the high end of the guitar, but none of the lower mids.

We did some acoustical numbers, none of which ended up on this LP, but it seems to me that what people are after when they stick that mic out there are a couple of things: 1) The delay. They get a change in EQ on the mic; 2) Muddiness from the room. I like the delay but *not the muddiness!*

So, I figured you could do the same thing a little more consistently if you used an artificial delay on the high end

of the guitar and not have to worry about cancellation in the midrange.

MR: Is your studio strictly for Boston projects, or have you done other things as well?

TS: I've done a few minor things, and would really like to do some demo work, but there just isn't time. I mean, we got the deal, did the first album, went on the road for nine months, came home, built the new studio for three months, then wrote the songs for the new album, recorded it, went back out on the road, etc.

MR: So then each album has been recorded in a new studio?

TS: Yes. I moved to a small house and ended up putting in a fancier studio than I had anticipated. You're right, the second album was not recorded in the same room as the first.

MR: Could you tell a lot of difference between rooms?

TS: Yes. The studio I was working in before I finished the demo was built over a bar in a barn. The owner of the bar threw out the guys with the studio. So, I borrowed a few thousand bucks from my mother and bought the Stevenson console and built some walls in the basement of the apartment, tacked up some carpet, etc. It was very rudimentary. Then we did the proper job on this, the third studio.

MR: Who is responsible for your sound on the road?

TS: C.V. Lloyd is the company, but I supply them with our own soundman. I like the system, it's a four-way plus a couple of "blasters." I don't know if that's an audio term or not, but C.V. calls 'em blasters. What they are are midrange speaker columns that are part of the midrange horn system.

MR: Did you have any part in the design of the system?

TS: No. I had four days from when I got back from pressing the record to rehearse the band, learn the new material, go over the lighting design, choose monitors and overall sound. I didn't do anything but first figure out what we were going to play and then do something about our stage gear, which was in disastrous condition. I wanted a P.A. with low-end capability, floor mounted and modular. Most of the systems I looked at didn't have the low end capabilities.

MR: Do you take some of the equipment from the studio out on the road with you—things you've designed?

TS: Well, uh...uh....

MR: Or is this legend of you just a myth....?

TS: I hope so! "Better Music Through Science." I hope it [the legend] dies! GEEZZZZ! I haven't had the time to do some real design work. I'm not an electrical engineer, but a mechanical one by trade. What I know about electronics comes from the few courses I had in it, talking to people and trial and error.

I've never really been interested in commercial design. I have applied for patents on a number of things, primarily for guitar players, but not too much for studio applications. I just find that there are so many things missing for the professional. Even if you pay top dollar for a new guitar... I don't know of one you can immediately play on stage. It's like that for every aspect of the field.

I have designed an instant tuner I'm really excited about. The other things I've designed for our use are more along the lines of special effects gear, a flanger. A lot of it is common sense. There's an "L" pad on our amp speakers so we can balance the sound on stage. Barry and I have controls to adjust the volume on stage for leads so as to eliminate cues for the soundman. I try to plan ahead.

In terms of the studio, it's really a case of a plain instrument going through standard studio stuff. Vocals go through a VS thing (VariSpeed) and a compressor "live." The guitars are pre-EQ'd ahead of the amp, limited in some special way, then EQ'd after the speakers. We do *that* "live." A lot of the gear is not "special," just touched up, like modifying the Echoplex. The preamps for the Marshalls are not what you'd find in a store, but not *that* far off, just down to my nitpicking. Mostly it's just applying common sense used in the studio to "live" applications. We do have *tons* of limiters and compressors both on stage and in the house.

MR: You seem to use equalization rather freely. How do you feel about the purist philosophy that states the use of EQ gives an unnatural characteristic to the given instrument—that it's the "weak engineer's" crutch?

TS: I'm a firm believer in the use of EQ. When I'd check out guitars, I'd always wonder what made a Fender a Fender, and its sound different from that of a Gibson. That's when I realized what tone meant in an instrument. It's really the resonances of the instrument. I don't see anything wrong in using EQ to get the sound you want. I'm all for it.

WE HAD TO LET OUR CHIEF AUDIO ENGINEER GO.

We felt he was on the verge of something. He wasn't sleeping nights and was often found in corners talking to himself. Our chief engineer expressed a strong desire to go away for a few weeks to clear his thoughts. We let him go.

When he returned, he was grinning from ear to ear and began to explain...

He said he felt the audio industry—specifically pro audio amplifier design—had reached such a level of technology that everybody had quality specs. Manufacturers were developing "super-specs" for the sole sake of the specs themselves. A new direction was desperately needed. But where? How?

Our engineer had the answer. Why not develop an amplifier design that not only had incredible specifications, but considered total efficiency as a prime design philosophy?



QSC

AUDIO PRODUCTS
1926 Placentia Avenue
Costa Mesa, CA 92627
714/645-2540

His brain began to work overtime... creative electronics began to take place. He developed a high-turbulence flow-through ventilation system, direct-mounted power transistors for cooler operation, a unique PowerLimit circuit, error-free DC and sub-audio protection and functional LED power level indication. He also included a horizontal connector panel with balanced 3-pin XLR-type inputs and outputs. The importance being they all pull together into the first real complete "common sense" amplifier design.

As a result, we at QSC boastfully announce six new models that will set a precedent in amplifier design. We are constantly astounded by the performance, reliability and amazingly faithful reproduction obtainable from these new amplifiers.

Now our chief audio engineer smiles all day long.

CIRCLE 80 ON READER SERVICE CARD



Ambient Sound

BY LEN FELDMAN

Second Thoughts On Time Delay, Reverb And Other Reflections

In recent issues of *Modern Recording*, Norman Eisenberg and I have reported, quantitatively and subjectively, about several old and new audio time delay and reverberation products in the "Lab Report" section of this publication. We have marvelled at the electronics which makes possible precisely controlled audio time delay at a fraction of what it used to cost. We have thrown about such terms as audio time delay, reverberation, ambience, decay and more until all of these terms became rather blurred—in our own minds and, more than likely, in the minds of our readers. It's time, perhaps, to step back a bit and re-examine some of these sonic manipulations that are now affordable by non-affluent audiophiles, sound reinforcement engineers, recording engineers and just about everyone connected with sound reproduction.

Pure Time Delay

Pure time delay, whether achieved by means of "old fashioned" tape loops, or ultra-modern digital technology, had its origins not in the recording studio or the home audio system but rather in the field of sound reinforcement. Consider the case of a large auditorium or stadium—one in which the sound contractor has determined that, because of the size of the hall, there is no way to provide proper sound reinforcement by using a simple bank of loudspeakers up on stage, near the performers. The alternative is to have distributed loudspeakers—several of them—around the hall. But

the moment you do that you run into problems. For a listener sitting far from the performance, the "real" sound (whether reinforced by means of speakers on-stage or not) will take many milliseconds to reach that distant location. If you try to use local sound reinforcement speakers near the listener, the sounds coming from those local speakers will be heard long before the sound coming from on-stage. If the difference in time arrival between these two sounds is more than around 45 milliseconds or so, a blurring or "echo" effect begins to take place, reducing intelligibility of the overall sound field.

The solution, of course, is to "delay" the sounds fed to the local loudspeaker so that their time-arrival at the listener's ears is equal (or nearly equal) to the sound reaching that listener from the far-off stage. The requirements for this type of time delay are vastly different from those of the "time delay" devices intended to make a home listening room seem like a large auditorium or cathedral. Specifically, time delay devices used in sound reinforcement work must have good, wide-band response for good intelligibility. Conversely, the "hall ambience" type of delay now being sold for home hi-fi systems should have a limited bandwidth for the delayed channels, since these devices are trying to duplicate the "first reflections" from the walls or other surfaces of a concert hall, and such reflections contain much less high-frequency energy than do the original sounds reaching the listener directly from the performing stage. The professional sound-reinforcement time delay system, furthermore, must have wide dynamic range and low distortion—characteristics that are not all that important when delayed signals are simply being used to simulate concert-hall reflections, as in the case of home hi-fi time delay units.

During a recent visit to AKG Acoustics in Vienna, Austria, we were shown, and had demonstrated, a sophisticated modular type of professional time delay unit, Model TDU-7000. This unit operates with 16 K Random Access Memories (RAMs) and offers a frequency response range of from 30 Hz to 15,000 Hz and a dynamic range of 90 dB. Output modules in the flexible system can be adjusted, in increments of 1 milli-



AKG's TDU 7000: A new modular-configured precision electronic time delay system.

second, to provide delays of up to 399 milliseconds and delay extension modules can be added for further increases in the basic time delay, still maintaining complete fidelity, with no roll-off of highs.

Reverberation and Decay

Until my visit to AKG, I firmly believed that the days of mechanical spring reverb units were numbered. Many of the new "ambience recovery" systems I had encountered in the past couple of years featured electronic reverberation controls which, according to their makers, took some of the first-delayed audio signal and, by a complex process of successive recirculation (the delayed signal is fed back to the input, at diminished amplitude, and delayed again and again to form a typical reverberation-decay pattern which could be easily controlled from the front panel) created or recreated the "character" of the concert hall. The reverberation controls are supposed to be able to duplicate any hall character, from a small nightclub to a cavernous cathedral.

By contrast, the few "home" reverb units that I had tested years ago that used mechanical springs were, to my mind, nothing more than audio gadgetry, full of artificial sounding "spring twang" and, at best, erratic in their behavior.

Well, I learned a thing or two about natural reverberation during my visit to AKG, too. What had bothered me about those inexpensive spring reverb units was something called "coherent sound." In the real world of a concert hall or large auditorium, the multiple reflections and their decay pattern as sounds bounce from one surface to another are infinitely varied and random. The decaying sounds reach us from an infinite number of angles and with highly random degrees of attenuation. While total decay time in a hall is easily measured as the time it takes for the sound field to be attenuated by 60 dB and an overall decay curve can be plotted relatively simply, the exact composition of the sound field (how many reflections are there at any given moment and where is each one coming from) virtually defies precise definition. Reverberant sound in real life is incoherent, while those simple spring units I was familiar with and had used years ago were all too coherent.

The problem remains regardless of whether you are adding reverb to the two stereo channels, or attempting to create hall ambience using an extra pair of speakers elsewhere in the listening room, driven by an extra stereo amplifier. The difficulty is intensified when "coherent reverb" signals are added to the final mix of dry studio tracks because in addition to the undesired "coherency" of the delayed, reverb signals, those signals are now going to come at the listener from the primary "stage front" location instead of from all over the listening room.

The most recent versions of home audio time delay systems that I have heard attempt to solve this problem to some degree. In many cases, cross-feeding of delayed stereo signals is employed before reverberant electronic recirculation of signals takes place through

the delay circuitry. Often, attempts are made to develop a series of mathematically unrelated time delays to further randomize the nature of the electronically produced reverberant signals. But even the best of these schemes results in what can best be described as quasi-incoherent sound.

According to AKG's researchers, a vast amount of computer circuitry and programming would be required to take a first-delayed audio signal and "randomize" it sufficiently so that it approached true incoherency and hence, natural reverberation characteristics. It is for this reason that AKG continues to manufacture spring reverb units for professional reverberation applications and digital, all-electronic time delay units where professional time delay applications are called for. But, from what we saw at AKG, these are no ordinary run-of-the-mill spring reverb devices. Through a complex process of chemical etching, the spring elements used are altered so that their indi-



The professional BX-20 reverberation system favors mechanical spring reverb over electronic approaches to reverberation.

dual coils have varying densities and diameters along their entire length. In this way, a complex pattern of reverberation signals evolves when the spring is activated by a transducer at one end and the signals passed along the spring "transmission line" are picked up at the other end. These so-called reverb torsional transmission lines are extremely well isolated in foam-lined housings and additionally spring-suspended to eliminate effects of mechanical vibration as well as acoustic feedback. The most costly of these reverb units, Model BX-20, pictured here, will set a studio back by around \$20,000 per channel!

Based upon the sonic results I heard during my visit to AKG, I could only conclude that, for the moment at least, until further miniaturization and cost savings occur in the digital and computer fields, discrete time delay is best accomplished by purely electronic means, but recreation of a reverberant sound field is still accomplished most successfully not electronically, but by means of mechanical springs.

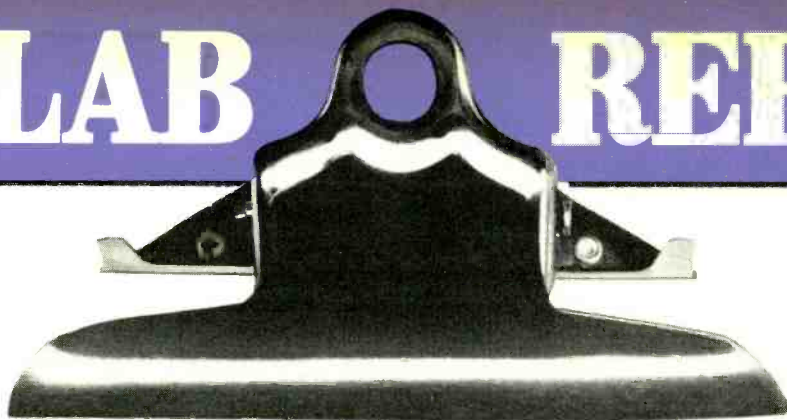

NORMAN EISENBERG AND LEN FELDMAN

Scott 830Z Audio Analyzer

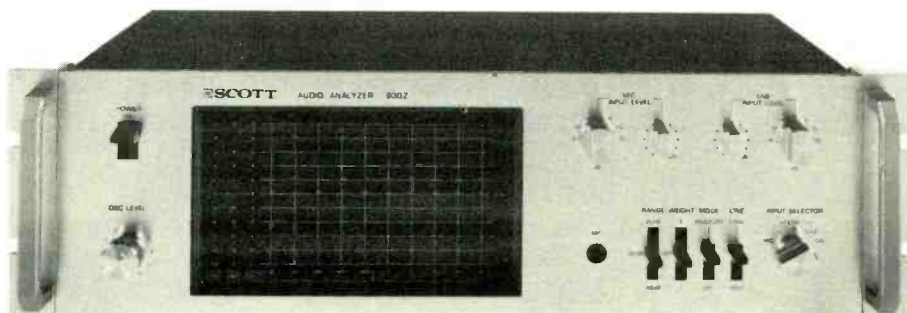

General Description: The Scott 830Z is a ten-octave real-time analyzer intended for making measurements of sound-pressure level, frequency-response (of individual components and of a system) and sound distribution in a room. The last-named application is of course preparation for adjusting room response, presumably with an octave-band equalizer. It may be interfaced with a sound system at various levels, and it is supplied with a calibrated microphone that may be plugged into its front panel.

The unit consists of two main sections. One is the oscillator which generates a 10-octave mixed (multi-frequency) signal on center frequencies from 32 Hz to 16 kHz which may be used for certain tests (amplifier response, tape recorder response, room response). For phono pickup tests, Scott supplies a special test record as the source. For measurements of sound-pressure levels, the manual instructs you to play music through the system.

The other main section is the analyzer itself which consists basically of a preamp, ten bandpass filters, ten logarithmic amplifiers (each with a separate detector), and a multiplexed LED display. The display occupies a prominent area on the unit's front panel. It is arranged as a grid with horizontal lines for + and - dB values, and vertical lines for the ten center frequencies (32, 63, 125, 250, 500 Hz, and 1, 2, 4, 8 and 16 kHz). The dB scale is adjustable to span ranges of 40 (± 20),

30 (± 15) or 20 (± 10) dB. The display is created by a matrix of 110 LEDs which come in various combinations at various levels to present a graphic response pattern as applicable.

To the left of the display is the unit's power off/on switch. Below this is the oscillator level control which, in its extreme counterclockwise position, clicks off.

To the right of the display and near the top of the front panel are two pairs of knob controls, one pair for microphone input level and the other pair for line input level. Each pair consists of a stepped attenuator and a continuously variable fine adjustment. These controls adjust the display on the screen.

Below these controls are the microphone input jack, followed by four toggle switches. These include the display range selector, a weighting selector ("A", off, and "C"); a mode selector (analyzer or SPL); and the line selector (low or high). Finally there's another knob for input selector (microphone, line left, line right, line left plus right and calibrate).

At the rear are the line inputs and the oscillator outputs. The former include both high and low connections. The high line terminals are press-to-connect types, one pair for each channel. These are used for connecting to the speaker outputs of an amplifier (or receiver). The low-line inputs are pin-jacks for each channel. A similar pair of jacks feeds the oscillator signal out. Also at the rear are a detachable power cord, a

ground connection, a fuse-holder, and a power-line voltage selector (110, 117, 220 and 240).

Test Results: The Scott 830Z uses a very special sort of test signal source. It consists of ten discrete frequencies, each centered at frequencies corresponding to the octave points used for the ten filters of the instrument's analyzer section. The frequencies of this multi-tone signal generator are not, however, fixed but are frequency-modulated by about ± 10 percent, ostensibly to eliminate or reduce the effects of standing waves when room response measurements are made.

Whether this technique "warble tones" produces more accurate room-response data than does more commonly encountered pink-noise signal sources could, we suppose, be debated. The argument in favor of the warble-tone technique is that pink-noise signals tend to make response measurements look somewhat better than they really are, while the modulated discrete frequencies, or warble tones, generally will provide a more rigorous test.

Be that as it may, the Scott 830Z lived up to every claim made for it. In addition to its usefulness as a sound-pressure level meter and a real-time analyzer when used with its supplied calibrated microphone, the unit's low- and high-level line inputs make frequency-response measurements of the electronics-only portion of a sound system extremely quick and easy. Not shown in our table of Vital Statistics is the residual noise level of the instrument, which is a full 16 dB below the 0-dB level of the display when controls are set for maximum sensitivity. This means that, using an AC voltmeter, the 830Z can read voltages as low as a couple of millivolts with good accuracy.

The inclusion of a test record that contains the same ten frequency-modulated center frequencies makes it possible to check out a complete system—from phono cartridge to speaker outputs.

Construction of the 830Z is on a par with that of professional test equipment, and from the brief (though fairly intensive) experience we had with it, we would judge it to be trouble-free and reliable even if subjected to daily, fairly continuous use.

The microphone supplied with the device comes with its own calibration curve (the response of the mic supplied with one sample is shown in Fig. 1). When the unit is in the SPL mode, and the microphone fine control is set to its CAL position, the input level is directly calibrated for dB/SPL, with the SPL selected on the switch corresponding to the 0-dB point on the display. Thus, the unit can be used for making noise measurements in industrial applications, much as would be done with a professional sound level meter

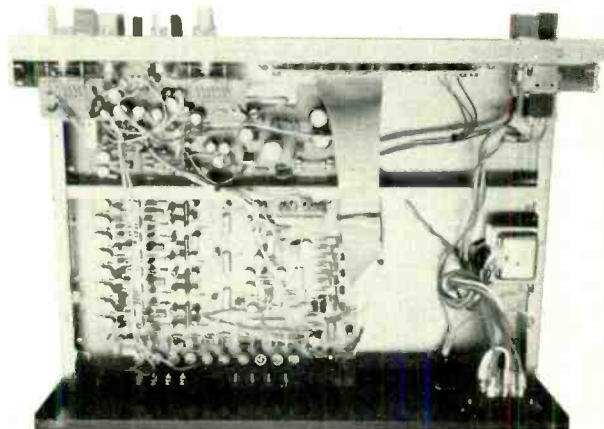

Scott 830Z: Internal view.

(many of which cost as much as the entire Scott analyzer). "A" and "C" weighting networks, conforming to I.E.C. standards, are built into the unit and may be introduced into such applications.

General Info: Dimensions are: 17 inches wide; 5¼ inches high; 14¼ inches deep. Weight is 9.7 pounds. Price is \$595.

Joint Comment by L.F. and N.E.: With the proliferation of octave-band equalizers (aimed at home stereo system owners as well as at professional and semi-pro users), it was probably inevitable that we should also see an increasing number of test instruments (aimed at the same broad market) that are designed to enable the users of equalizers to correctly install and adjust them. Not unlike the Crown RTA-2 which we reported on some months ago [February 1979], the Scott 830Z is an extremely versatile instru-

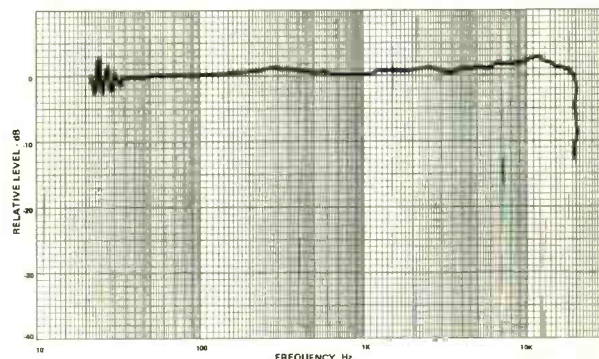

Fig. 1: Scott 830Z: Response of calibrated microphone supplied with the analyzer.

ment that can be used for measuring sound-pressure level, frequency response and distribution of any home or professional sound system. While it seems obvious that the 830Z had been designed primarily to appeal to the advanced audiophile (its front panel has a hi-fi component look about it), we would think that small recording studios and sound contractors would find it a very useful tool in calibrating the response of indivi-

dual components as well as in analyzing total sound and recording system loops.

In any event, it is good to see this caliber of product from a company that was, a short time ago, almost "counted out." With the kind of engineering and design that went into the 830Z it seems that one of the oldest names in audio manufacturing is still very much a welcome and significant part of the audio scene.

SCOTT 830Z AUDIO ANALYZER: Vital Statistics

PERFORMANCE CHARACTERISTIC	MANUFACTURER'S SPEC	LAB MEASUREMENT
Oscillator Section		
Center frequencies	32, 63, 125, 250, 500 Hz, 1, 2, 4, 8, 16 kHz	Confirmed
Sweep bandwidth	Center frequency, $\pm 10\%$	Confirmed
Sweep frequency	16 Hz	Confirmed
Frequency response deviation	± 1.2 dB	± 1 dB
Output level	0 to 900 mV	0 to 800 mV
Output impedance	1 K ohm	Confirmed
Preamp and Display Section		
Center frequencies	Same as above	Confirmed
Filter pass band	$\pm 20\%$ for -3 dB	$\pm 30\%$ (approx.)
Attenuation slope	20 dB/octave	Confirmed
Display level range	20, 30 or 40 dB	Confirmed
Level per LED step	2, 3 or 4 dB	Confirmed
Input sensitivity for 0 db		
line	10 mV to 31 V	7 mV to 33 V
mic (as supplied)	50 to 120 dB/SPL	50 to 125 dB/SPL
Input impedance, line	47 K ohm	Confirmed
Frequency response		
line	± 1 dB, 20 Hz to 20 kHz	± 0.75 dB, 20 Hz to 20 kHz
mic	± 3 dB, 30 Hz to 16 kHz	± 3 dB, 22 Hz to 15.5 kHz
Weighting curves	Flat, "A" or "C"	Confirmed

CIRCLE 26 ON READER SERVICE CARD

Yamaha M-4 Power Amplifier

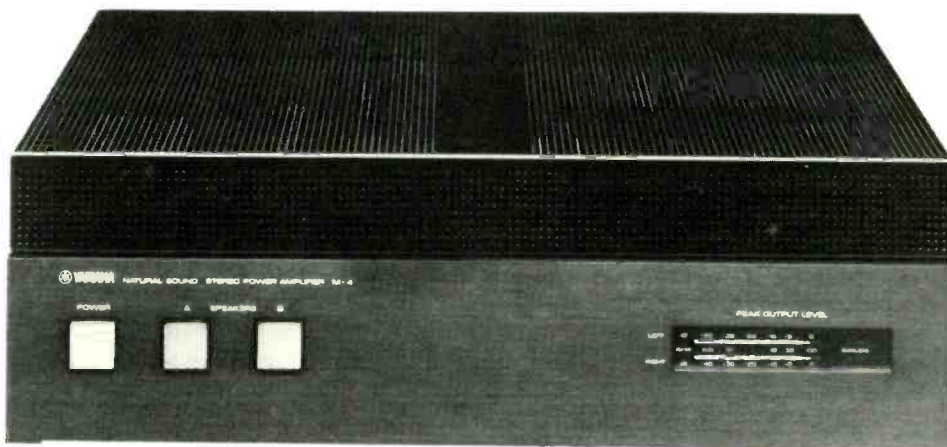

General Description: The Yamaha M-4 is a stereo "DC" power amplifier conservatively rated for 120 watts continuous power output per channel across the 20-Hz to 20-kHz band, with a rated THD of 0.005 percent, both channels driving 8-ohm loads simultaneously. With 4-ohm loads, the rated power output rises to 170 watts per channel. Input sensitivity for

rated output is 1 volt.

The amplifier has provision for connecting two pairs of stereo speakers, with front-panel selectors for choosing either or both. Also on the front panel are the unit's AC power off/on switch, and left- and right-channel output level displays—two rows of LEDs calibrated upward from 0.01 watt. Markings are given in

wattage figures, and in dB values. Associated with each channel indicator is an individual overload indicator which is designed to come on at clipping level or about 1 percent THD.

The rear of the amplifier contains the twin sets of speaker connections. These are press-to-connect types that accept stripped lead ends. Also at the rear are the input jacks ("hi-fi pin" types); a level control for each channel; a "DC/AC mode" switch; an unswitched AC convenience outlet; and the unit's AC power cord.

The term "DC" refers, of course, primarily to the fact that the amplifier circuitry is "direct-coupled." As is true generally of such amplifiers, response extends "flat" down to "DC" frequency. The "AC" switching option inserts a coupling capacitor into the input signal line whereby frequencies below about 10 Hz are cut off to avoid—as applicable—unnecessary amplification of very low-frequency noise (such as turntable rumble, excessive tone-arm/cartridge resonance, the peaks caused by warped discs, etc.).

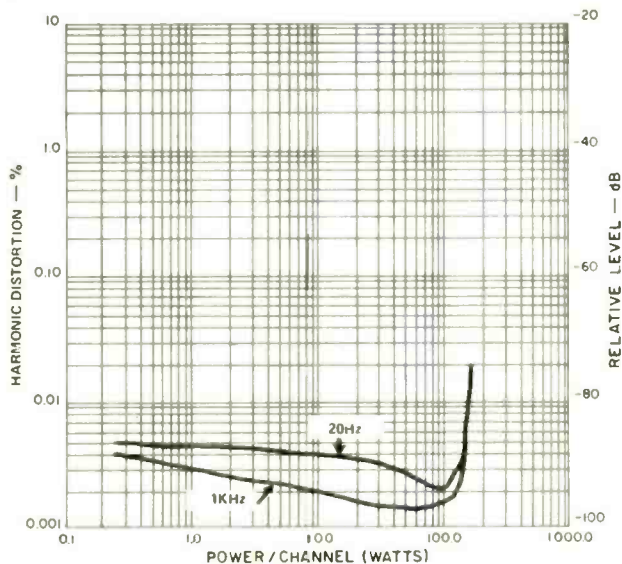

Fig. 1: Yamaha M-4: Power output vs. harmonic distortion, 8-ohm loads.

When the amplifier is used for driving two sets of speakers simultaneously, the manual states that only speakers having an impedance of 8 to 16 ohms should be used. For driving one pair of stereo speakers, impedances down to 4 ohms may be used. Incorporated in the M-4 is a load impedance detecting circuit that is activated when the load falls below 2 ohms. In addition, the set has a DC detection device that will disconnect the speaker from the amplifier if a DC voltage appears at the amplifier's output terminals. This protection circuit also serves as a muting system to protect the speakers from pulse or shock noises generated when power is turned on or off.

Test Results: In our tests, the Yamaha M-4 easily made or exceeded its published specs. Driving 8-ohm loads it could be legitimately called a 135-watt per

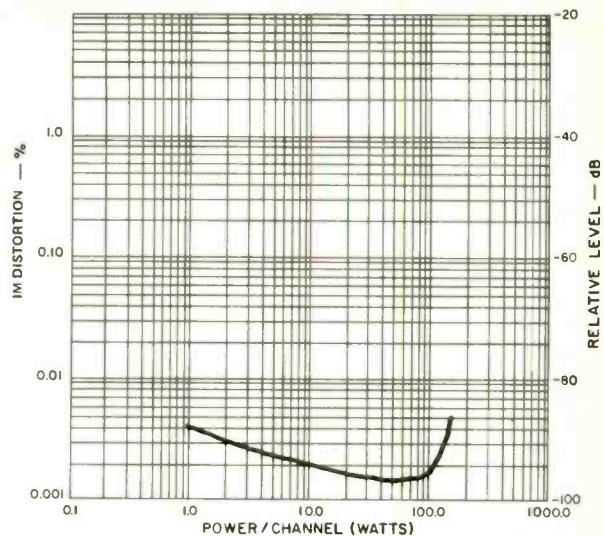

Fig. 2: Yamaha M-4: IM distortion vs. power output, 8-ohm loads, both channels driven.

channel amplifier; handling 4-ohm loads, it could be rated as a 180-watt per channel amplifier. These higher-than-claimed power figures were obtained at lower-than-claimed distortion levels. They also were obtained without any particular attention paid to ventilation other than to follow the advice in the owner's manual about not covering the holes on top of the unit.

The "Vital Statistics" in our report on this amplifier speak for themselves, but some words of explanation may be in order. We measured frequency response in the "AC" mode to avoid the possibility of having any DC voltage components enter the amplification circuitry. In this mode, selected by the rear-panel switch, a capacitor is inserted in the signal path which has a filtering action at the rate of 6 dB per octave, with a -3 dB cutoff at 6.4 Hz. In this mode, response was

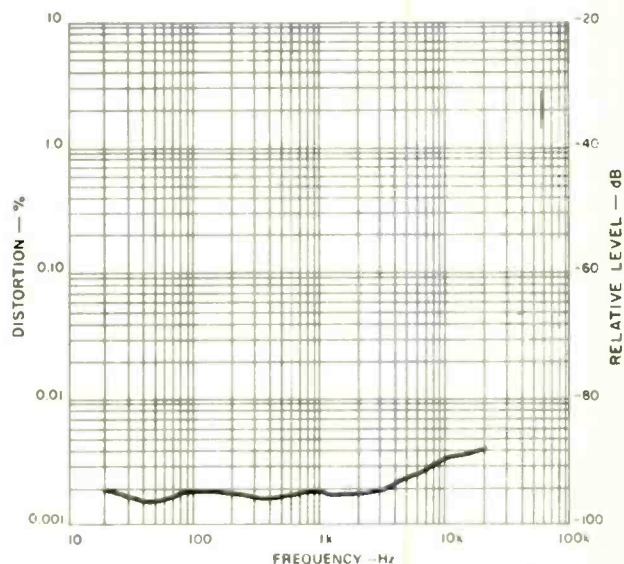

Fig. 3: Yamaha M-4: Distortion vs. frequency, 8-ohm loads, 120 watts/channel, both channels driven.

still flat within 1 dB all the way down to 10 Hz. Obviously, it would go even lower in the "DC mode," but our meters are accurate only down to about 5 Hz, so there seemed little point in trying to verify this.

The signal-to-noise figure published by Yamaha is referenced to full rated output (120 watts per channel) with the unit's input level controls set to maximum sensitivity. We confirmed that figure (118 dB "A" weighted), but we also measured S/N according to the new IHF Amplifier Measurement Standards, which are referenced to 1-watt output with a referenced input of 0.5 volts. At those settings of the input level controls and with that output used as a reference, hum-and-noise was down 98 dB—an excellent figure, especially as compared with that measured in this new way for other power amplifiers.

The front-panel LEDs for power output readout were found, in our tests, to be highly accurate as were the overload indicators.

General Info: Dimensions are 17 $\frac{1}{8}$ inches wide; 5 $\frac{3}{4}$ inches high; 14 $\frac{3}{4}$ inches deep. Weight is 41 pounds. Price is \$650.

Individual Comment by N.E.: On all counts—performance, cost, size, features—the Yamaha M-4 seems like a top contender in its power class. I personally would have preferred more professional-type speaker connectors, but who can deny the convenience of being able to hook up two pairs of stereo speakers with the facility for switching them right on the front panel of a power amp? The front-panel power readout is another convenient feature of the Yamaha M-4, the more welcome for its accuracy.

Astute listeners may argue over the merits of a DC amplifier versus the capacitor-coupled kind. Suffice it to say that the Yamaha "listens" as cleanly as its superb lab measurements suggest. Whether this is due to the direct-coupled stages or to just generally good circuit design (or both), I will not attempt to answer. It is, at any rate, an amplifier that merits serious consideration for a number of possible uses—from "semi pro" to "advanced home stereo."

Individual Comment by L.F.: It's getting so that I don't know quite what to say about some of the new power amplifiers these days. The "conventionally measured" specifications such as harmonic distortion, IM distortion and noise are so ridiculously low that the test equipment I spent so much money on just a couple of years ago is hard-pressed to provide meaningful readings. The more subtle forms of distortion—those that contribute to or detract from the "musicality" of an amplifier—don't lend themselves to easy bench measurement, nor is there yet universal agreement on how to measure them at all.

So, faced with the prospect of reporting on this good looking amplifier from Yamaha, I decided to dig into the circuit approaches, however lightly, and tell you something about the actual design of this amp.

The voltage amplifying stage employs a cascode-

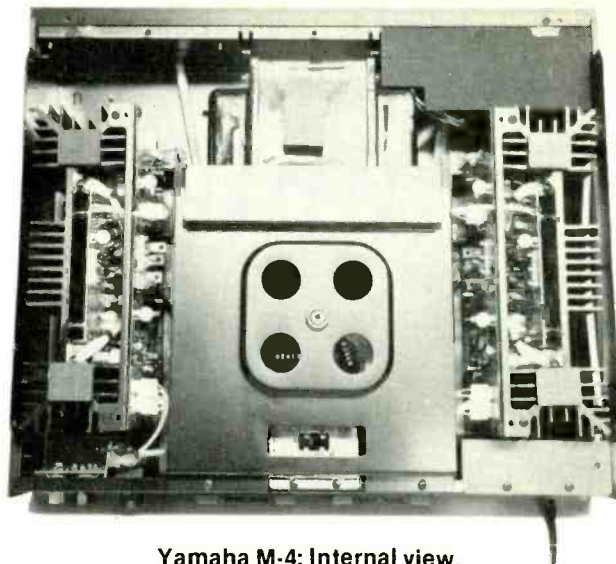

Yamaha M-4: Internal view.

connected differential two-stage circuit. According to Yamaha, the use of this dual-FET input and a cascode bootstrap circuit in the first stage and a cascode-connected, current-mirror and push-pull output in the pre-driver stage insures overall stability in this all-DC design. In the driver and power amplifier stages a three-stage emitter follower is paralleled with pure complementary, output capacitorless single-ended push-pull circuitry using newly developed Yamaha power transistors. While the output stages of both channels are powered by a single common supply (15,000 mfd filter capacitors are used for the dual polarity output transistors supplies), two separate constant-voltage supplies are used for the earlier voltage-amplifying stages.

Power ratings on the amp are extremely conservative, both for 8-ohm and 4-ohm operation. The mere fact that Yamaha supplies an "FTC Power Rating" at 4-ohms tells you something about the amp's thermal stability and long term reliability. If an amp can make the one-hour preconditioning test required by the FTC at 4-ohm loads, without the protection circuits popping repeatedly, you can be pretty certain that heat is not going to be a problem with it. This amp came through that test easily.

No doubt the super-audiophiles of the world will be able to "hear" ultra-subtle differences between this wideband amplifier and others of the same genre. If I had had a dozen or so all-DC amps of similar power rating in the labs and listening rooms when I put this one through its paces, I, too, could have probably differentiated between some of them and the Yamaha. Since all I could do was to audition this amp alone, using some of my favorite half-track master tapes fed directly from my deck to the amp (thanks to the presence of level controls on the M-4), I can only report that to my ears, sound was accurate, and there was no problem whatever with some of the tougher transients on my selected program material. There is literally nothing worth griping about in this reasonably priced high-powered amp.

YAMAHA M-4 POWER AMPLIFIER: Vital Statistics

PERFORMANCE CHARACTERISTIC	MANUFACTURER'S SPEC	LAB MEASUREMENT
Power output, continuous per channel, 1 kHz, 8 ohms/4 ohms	120/170 watts	150/210 watts
Power output, continuous per channel, 20 Hz to 20 kHz, 8 ohms/4 ohms	120/170 watts	136/180 watts
Power bandwidth	20 Hz to 20 kHz	10 Hz to 90 kHz
Frequency response	± 1.5 dB, 10 Hz to 100 kHz	± 1 dB, 10 Hz to 80 kHz ("AC mode")
Damping factor (8 ohms)	200	190 (at 50 Hz)
Rated THD, 8 ohms/4 ohms	0.005%/0.01%	0.002%/0.0035%
Rated IM	0.002% (8 ohms, 60 W)	0.0018% (8 ohms, 120 W)
Residual hum and noise	- 118 dB ("A" wtd)	- 118 dB (- 98 dB per new IHF Std)
Input sensitivity	1 V	1.1 V
Power consumption	580 watts max.	Confirmed

CIRCLE 27 ON READER SERVICE CARD

Pioneer CT-F800 Cassette Recorder



General Description: The CT-F800 is a recent Pioneer entry in what has become the "middle" price range of high-quality cassette recorders. It is a three-head machine with electrically separate record and play heads that are combined in a unitized housing so that there is no need for realignment of azimuth. Its two-motor transport shuttles the tape via a closed-loop dual-capstan system. Transport controls are "feather-touch" and logic-controlled so that fast-but-toning is possible. You can go directly into record mode from playback (without using the stop button) by holding down the play button and pressing in the record button. Switching between rewind and fast-forward is instantaneous. Going into record (or play) mode from the fast wind modes, similarly does not require the use of the stop button, although in these changes there is a very brief pause before the transport enters the newly selected mode.

The Pioneer CT-F800 uses, instead of conventional meters and needle pointers, a dual "bar graph" signal display in which successive segments of fluorescent blue segments light up to show signal levels on each channel. Calibration runs from -20 to +8 dB, and the meters may be switched to show either peak or average signal levels.

Also included is automatic switching for CrO₂ cassettes (those with the special notch in the top edge). Other tape adjustments include a switch for "stan-

dard" (LH) and FeCr tapes, with EQ and bias handled by the one switch. There also is a bias trim knob for additional optimizing of the recording characteristics with different tapes. Recommended settings of both controls for forty-eight different cassette tapes are given in the owner's manual.

The cassette is held in place by two metal sections across the upper and lower portions of the cassette well. There is no cover and no eject button. To load a cassette, you slide it up and into the recess. The top holding section "snaps" into position, and the bottom section may be hinged upward for added stability.

The remainder of this front-loading deck is divided into three main areas. The largest is a plastic-covered panel that contains the meters, a Dolby NR indicator, a CrO₂ indicator, the tape counter and its reset button, the tape/source monitor switch, the meter peak/average selector, the Dolby NR switch and the two tape adjustments.

A smaller panel contains the six transport buttons (rewind, fast-forward, stop, play, record, pause.) Finally there are the input level controls (large dual-concentric knobs for adjusting channels separately or simultaneously); the stereo headphone output jack; and the left- and right-channel microphone input jacks.

Line inputs and outputs, plus the unit's AC power cord are at the rear.

The CT-F800 has no output level controls. Head-

phone output is ample but not adjustable. Line output must be controlled by the volume controls on whatever amplifier the unit is patched into. There is no input mixing on the deck, and the mic input jacks override the line inputs, so that "switching" between mic and line involves plugging or unplugging the mic cables.

The recorder may be used (for playback or recording) with an optional external timer. Access to the heads, capstans, etc., for cleaning and/or degaussing is very easy because of the unusual loading arrangement.

Test Results: The Pioneer CT-F800 made its best response mark in our tests with CrO₂ tape which came in right on spec at ± 3 dB from 30 Hz to 17 kHz. As we have been finding with many cassette tests, this tape also produced somewhat higher distortion and a jot less of signal-to-noise ratio. However, the figures we got for these characteristics were still better than spec'ed and more than satisfactory, especially when one considers the relatively low price for a cassette recorder that offers three-head operation plus a fast-button type of transport.

The recording levels measured for the 3-percent distortion level were relatively high, but it must be

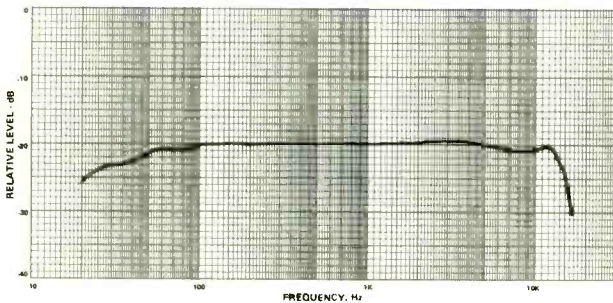

Fig. 1: Pioneer CT-F800: Record/play response using TDK AD tape.

pointed out that Pioneer has chosen in this model to set "0 dB" record level at about 160 nanowebers, which is about 2 dB below Dolby calibration level. There is, of course, no industry standard for "0 dB" on cassette recorders, and in a sense "it's every man for himself" in this tricky area. Nonetheless, even if you subtract 2 dB from the +8 we show for standard tape, and the +5.5 dB we got for TDK SA (chrome bias) tape, the figures are still impressive.

The vernier bias adjustment was a welcome feature. It should be added that in our response plots (Figs. 1 and 2) we used the precise settings recommended in Pioneer's unusually extensive listing of tapes and control settings. Had we wanted to push response a bit farther at the very high end, we could have backed off somewhat on the bias and got a little more "way up there." To do this, however, would have resulted in a somewhat less favorable S/N and a bit higher distortion at mid-frequencies. We feel the "tradeoff" is a good one in the interest of cleaner sound.

The dual-capstan closed-loop drive system is, of course, hardly unique in the better cassette decks, but

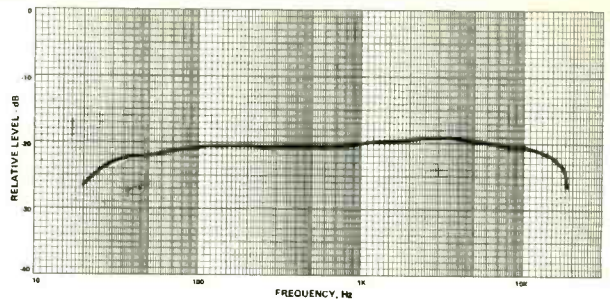

Fig. 2: Pioneer CT-F800: Record/play response using TDK SA tape.

it is rarely found in a unit at this price level. Transport action was extremely smooth and trouble-free. In several tests we could not cause any jamming, or create any unwanted slack in any cassettes we used.

Speed accuracy was almost perfect. Using one of our recently acquired TDK test tapes, we were also able to plot playback-only response for the 120-microsecond EQ, results of which are given in Fig. 3. Inasmuch as transport mode switching is entirely electronic, one can, if desired, add an external timer to the CT-F800 and thus use it either to record broadcasts while absent (or asleep), or to start tape playback (for wake-up, for instance) at a pre-determined time. Complete auto-stop action makes operating the deck this way when attended, perfectly safe.

General Info: Dimensions are 16¹/₁₆ inches wide; 5⁵/₁₆ inches high; 14 inches deep. Weight is 19 pounds, 13 ounces. Supplied in metal case, and with two stereo signal cables and three head-cleaning swabs. Price of the cassette deck: \$450.

Individual Comment by L.F.: How can one *not* like a stereo cassette deck that offers so much for so little? Pioneer's three-headed format is the kind that incorporates both the record and play head gaps in a single package, but since the record and play coils and gaps are separate, and separately driven electronically, Pioneer has every right to call this a three-headed machine. The criterion here is whether or not you can monitor taped results as they are being recorded and, in the case of the CT-F800 you can.

To my way of thinking, the "two-heads-in-one-package" approach to tape monitoring with cassette decks

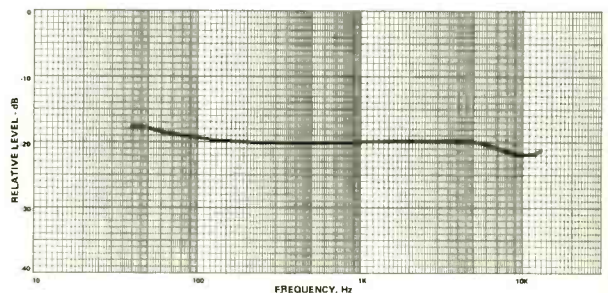

Fig. 3: Pioneer CT-F800: Playback-only response (120 μ sec EQ) using TDK #337 test tape.

actually has advantages over the three totally separate head configuration in that there are no azimuth alignment requirements between the record and play heads and that means one less adjustment for the user to misadjust.

I am a complete convert to the new fluorescent types of "meter" displays which several companies have now adopted to replace conventional mechanical motion meters. In deference to those of us who are accustomed to "average" reading meters, Pioneer does provide two sensitivities or "ballistic rates" for their all-electronic display format, but as far as I am concerned, the serious recordist will learn to use the peak indications quickly and forget about the "average" settings.

The fully exposed cassette (there is no plastic see-through cassette door) takes a bit of getting used to but I must admit that it makes some sense, particularly since there is a hinged cover that flips into place to protect the heads themselves from dust and dirt when a cassette is not in the machine.

Clearly, there are a few things missing which might have made the deck even more worthwhile. There is, for example, no output level adjustment, either for the line out circuits or the phone jack and there are no mic/line mixing facilities. In fact, plugging mics into the mic jacks gives those jacks priority over the line inputs, so it's important to disconnect all microphones when you want to record via the line inputs.

Still, in its price category, I think the Pioneer CT-F800 offers what most serious home recordists are looking for in a better-than-average stereo cassette deck—specifically, excellent signal-to-noise ratio, ultra-low wow-and-flutter, safe handling of tape cassettes and reasonably good frequency response when using better grade tapes.

Individual Comment by N.E.: As has been suggested here before, the cassette recorder field seems to have charted two main paths for the serious, quality-

mindful recordist. One is the road of "state of the art in which a manufacturer pulls all the stops and offers what it regards as the best and the most with little regard for the equipment's cost.

The other road is to design for a competitive price range, and within that framework, to offer what it feels is the optimum combination of performance competence and "features"—deliberately emphasizing some aspects, and "holding back" on others. The Pioneer CT-F800 clearly reflects this latter product philosophy. Thus, it has two motors and a sophisticated dual-capstan, closed-loop drive system with the fast-buttoning options. It has three-head operation, and without the need to recheck for azimuth periodically. It has a fine-bias adjustment and automatic CrO₂ switching and a simplified EQ and bias selector. While making certain that the recommended adjustments will thus prevail for three different kinds of tape, this system at the same time precludes deliberately "fooling around" too much with EQ and bias just to see what will happen. The unit also has a very nice metering arrangement, with the option to watch either peak or average levels. (We still feel that for most users, the peak levels are the really important ones).

The Pioneer CT-F800 does not have output level controls (which might be an inconvenience with some headphones that are jacked directly into the deck). It does not have input mixing of line and mic signals, and it has no switch to change from line to mic—this must be done by disconnecting the mic cables from the front of the deck. It has no provision for user-calibration of the Dolby NR system, and it has no memory rewind.

So, you pay your money and take your choice. At its price, the CT-F800 merits serious consideration; it does offer a worthy level of audio performance (especially good S/N and low distortion), plus those features its designers obviously felt should be included without running the price of the Pioneer CT-F800 over their avowed marketing goal.

PIONEER CT-F800 CASSETTE RECORDER: Vital Statistics

PERFORMANCE CHARACTERISTIC	MANUFACTURER'S SPEC	LAB MEASUREMENT
Frequency response		
Ferric oxide tape	± 3 dB, 30 Hz to 15 kHz	± 3 dB, 30 Hz to 14.5 kHz
CrO ₂ tape	± 3 dB, 30 Hz to 17 kHz	± 3 dB, 30 Hz to 17 kHz
Signal-to-noise, "A" weighted,	54 dB/improves by 4.5	62 dB/60 dB
Dolby off, ferric/CrO ₂	dB above 5 kHz	
Signal-to-noise, "A" weighted,	64 dB/improves by 4.5	71 dB/69 dB
Dolby on, ferric/CrO ₂	dB above 5 kHz	
THD at 0 record level,		
ferric/CrO ₂	1.3%/NA	0.75%/1.0%
Record level for 3% THD		
ferric/CrO ₂	NA	+ 8/ + 5.5
Wow and flutter (WRMS)	0.045%	0.05%
Speed accuracy	NA	- 0.05%
Mic input sensitivity	0.3 mV	0.27 mV
Line input sensitivity	64 mV	57 mV
Line output level	450 mV	440 mV
Headphone output level (8 ohms)	60 mV	70 mV
Fast-wind time, C-60	85 seconds	80 seconds
Power consumption	46 watts	42 watts

CIRCLE 28 ON READER SERVICE CARD



Studiomaster 16/4 Mixing Console

By Jim Ford and John Murphy

The Studiomaster 16 into 4 mixing console is primarily intended for use in multi-track recording in conjunction with a four-channel tape recorder. As the name suggests, the Studiomaster board will mix 16 inputs down to 4 outputs.

This mixer is also well suited for sound reinforcement applications. Up to 16 mic inputs can be mixed down to mono or stereo while providing outputs for 4 channel recording of the "live" performance. Making the console even more attractive for sound reinforcement work is the fact that it comes complete with a heavy-duty flight-case at no extra charge.

The 16 into 4 is priced at \$2295.

General Description: The input channels of the mixer are laid out in a modular fashion even though the unit is not actually of modular construction. Each of the 16 input channels occupies a narrow strip spanning the entire depth of the board. Collectively, the 16 input channels occupy approximately two-thirds (left to right) of the console face. Since the 16 input channels all have identical controls let's look at one input channel in detail.

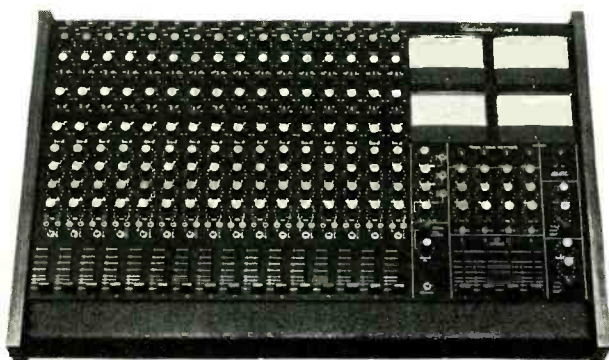

Starting at the top of the console (furthest from the operator) there is a slide switch for selecting or bypassing a 30 dB input pad. By switching in the pad for "hot" input signals the input sensitivity of the console is reduced and microphone preamp distortion can be avoided. Beside the input pad switch is an LED overload indicator which lights whenever the input channel is within a few dB of being overdriven. Below these is a rotary pot for adjusting the gain of the preamp from 15 to 60 dB. Since this is a true gain control, good noise performance can be maintained through the preamp for a wide range of input signal levels. The



gain control should be turned up until the overload indicator just starts flashing, and then backed off so that overload just ceases. This will assure that the signal is well above the noise floor and will still leave enough headroom to avoid distortion due to overload.

The next five rotary controls below the gain pot constitute the input channel's equalizer. There are three bands of EQ. The treble control provides 16 dB of boost or cut at 10 kHz and provides a shelving type response (See figures 1 and 2 for the EQ response curves). The midrange EQ provides 16 dB of boost or cut over a span of about 5 octaves of the frequency spectrum. A separate control allows the center frequency of the peak/dip to be varied from about 400 Hz to 8 kHz. Similarly for the bass there is one control for the amount of boost/cut (up to 16 dB) and another control for the nominal frequency of EQ action (30 Hz to 300 Hz). The equalizer section cannot be bypassed, so flat frequency response is obtained by setting each of the boost/cut controls to 0 dB.

Below the EQ section is a pair of rotary controls for echo 1 send and echo 2 send. These control the level of the signal sent to the two effects bus. For example, if a reverb unit is connected to the echo 1 output, then the echo 1 send controls the level of signal sent to the reverb, and therefore the amount of reverb on the signal from that channel. The echo sends are post fader so the fader also controls the echo send signal level.

Below the two echo pots is another rotary control labeled "foldback." This is a term the British use the way "cue" is used in the States. So if you are not familiar with "foldback" then think of this control as a cue send. In the studio the cue bus would be routed out into the studio area to feed the musician's headsets. In sound reinforcement applications the cue bus could be used to provide the on-stage monitor mix for the musicians. The foldback (cue) send is pre fader so the fader level does not affect the foldback signal level.

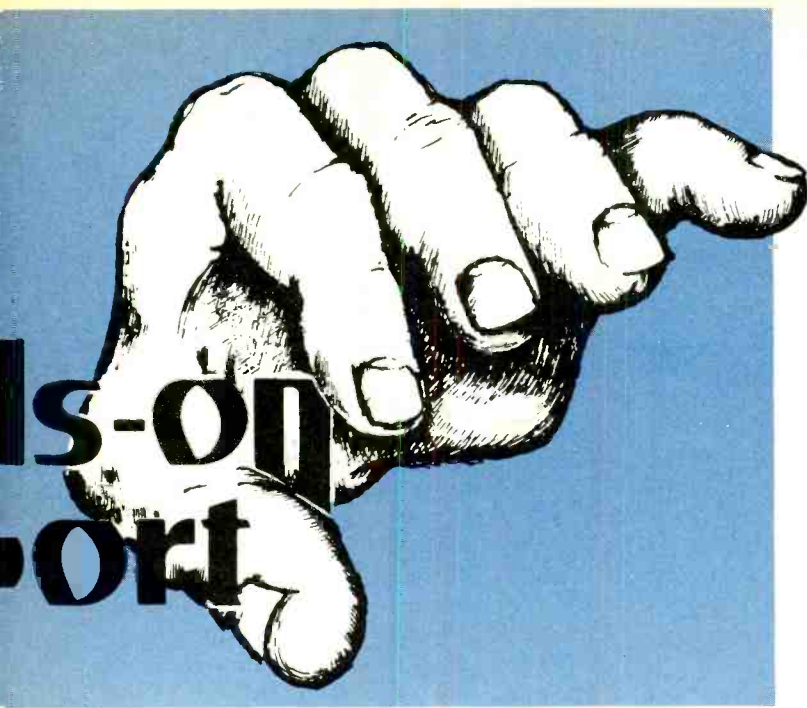

Next in line below the foldback send are the panpot and track assignment switches. There are two assignment switches, each with three positions. The center position is off in each case. The switch to the left assigns the input to either output channel 1 or 3. The switch on the right assigns the input to either output channel 2 or 4. The result is that the input can be assigned to either one or two channels or not be assigned at all. When the input is assigned to two output channels then the panpot allows panning between the two channels that have been selected.

At the bottom of the assign switches is a momentary contact push button labeled "PFM" (prefader monitor). When this button is pressed the input (prefader) is assigned to the PFM bus. This bus can be monitored as desired by selecting PFM in the monitor section. This is essentially a solo system where the monitor input has to be manually switched from normal to the solo bus. Below the PFM button is a linear fader for level control of that channel.

That's one input channel from top to bottom. Now, visualize sixteen input channels lined up across the console's input section. What an amazing array of knobs and buttons!

The remaining one third of the console face is dominated by four large VU meters, one for each of the four output channels. Below the VU meters and to the left is a vertical column of rotary controls. The top three are echo 1 send, echo 2 send and foldback send. These are the master send level controls. Beside each of these is a push button labeled "Mon." This button assigns the associated master send to the PFM (solo) bus. This allows the operator to solo the effects and cue buses as desired. Below these is a "Talkback Volume" control for adjusting the talkback level in the foldback (cue).

The monitor control section is below the talkback volume control. There is a two position rotary switch labeled "Normal" and "PFM (Meter 4)." In the normal

position the monitor outputs contain the signals assigned from the four output channels and the effects return buses. When switched to the PFM position the monitors then display whatever is on the PFM (solo) bus. Also, with this switch in the PFM position meter 4 is switched to display the signal level on the PFM (solo) bus. Therefore, in order to "solo" an input channel the operator has to do two things. First, switch the monitor from "Normal" to "PFM." Then, press the PFM button for whichever input channel or master send is desired to be heard solo. Below this switch is the control room monitor volume control. At the bottom of the monitor control switch and closest to the operator is a push button labeled "Talkback." This button injects the signal from the talkback mic into the foldback (cue) send signal and allows the console operator to speak to the musicians through the cue system (usually headphones).

To the right of the monitor section and centered below the VU meters is a group of four output channel controls. As with the input channels, the controls for each output are in a vertical column above the fader. At the top of each output channel section is a two-position rotary switch labeled "Track Status Selectors." This switch selects either record or remix (mixdown) operation of the output channel. More about this later. Moving down the console the next output channel control is the monitor send level control. This pot controls the level in the monitors of the signal through that output channel. Beneath the monitor level pot is a foldback send control. This controls the level of the output signal sent to the foldback (cue) bus. Below the foldback send control is a pan pot for panning the monitor send between the left and right monitor channels. Next, and just above the fader is a three-position monitor select switch. This switch selects the signal sent to the monitor and foldback buses but does not affect the output to the tape machine. In the center position there is no signal sent from that channel to either the monitor or foldback buses. In the position labeled LO (line out) the channel output signal is sent to both the monitor and foldback buses. In the LI (line input) position the signal from the tape machine's output is available to the monitor and foldback buses. The LI setting is used to monitor the synchronous playback of previously recorded tracks while new tracks are being recorded. The monitor select switch should be in the LO position for each track being recorded. There is a linear fader at the bottom of each output section for output level controls. In the LO mode the monitor and foldback sends are post fader so the fader controls both of these sends. In the LI mode the sends function independently of the fader, and in general may be carrying an altogether different signal.

Just to the right of the output section and to the far right of the console are controls for a 1 kHz lineup oscillator and the echo returns. The lineup oscillator is at the top of this section and the only control is an on/off switch. When the oscillator is switched on, a 1 kHz tone is placed on the bus to each of the output channels. The level of the tone can then be set to 0 VU

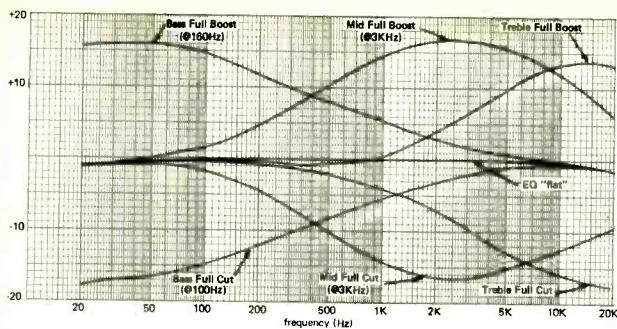

Fig. 1: Studiomaster 16 x 4: EQ control frequency response.

via the output faders and the record levels at the tape machine can be set as desired (normally to 0 VU). The oscillator is also convenient for calibrating signal levels through accessory equipment (compressors, equalizers, and the like).

Controls for the echo 1 and 2 returns are located below the oscillator switch. There are three identical controls for each of the two echo returns. First there is the return level control which is used to adjust the overall level of effects in the output channel. The other two controls are for assigning the effects to output channels 1 and 2 or 3 and 4, or the monitor, and for panning the effects between channels of the pair selected (or between monitor left and right channels).

Interfacing with the console is accomplished via the rear area of the unit. For each input module there is a 3-pin XLR-type connector for microphone input. In addition, there is a multicore cable connector for inputs 1-12 and a separate multicore connector for channels 13-16. These are intended for use with an optional 150 meter extension cable ("snake") available from Studiomaster. The second connector can be rewired to handle channels 17-24 when an optional add-on module (containing input channels 17-24) is used. The rear of the console adjacent the output section contains the remaining console connections. There are four 1/4-inch phone jacks for line outputs to a four-channel tape machine and below these are four more phone jacks labeled "Line Input" for returning the four-track machine's outputs to the console. Just below the four-track connectors are input and output connectors (1/4-inch phone jacks) for a two-track machine. When the board is used for mixdown the outputs of the four track are mixed to stereo and applied to the input of the two-track machine. No external patching or reconnection is necessary since the board handles all the switching for mixdown.

The sends and returns for the echo buses are through 1/4-inch phone jacks and are clearly labeled (as are all the other connections). The monitor outputs (left and right) are by way of XLR-type connectors and there is a separate stereo phone jack which can be used to feed the monitor output to a set of high impedance (600 ohms or greater) headphones. Similarly, the fold-back (cue) output is through an XLR connector with a separate stereo phone jack (wired for mono) capable of

driving 8-ohm headphones. The monitor output would normally be connected to a stereo power amp driving a pair of speakers placed in the control room. The cue output is normally sent to a mono power amp which is used to drive multiple headsets (and/or speakers) out in the studio area. This provides the musicians with the required cue material (either previously recorded tracks, new material as it is being recorded, or both). The only other audio connection is an XLR input for the talkback microphone, used by the console operator to speak to the musicians through the cue system.

At the far left of the console rear is a power on/off switch, AC line fuse and AC cord connector. (The line cord is detachable, so if you're using this gear when doing an out of town gig don't forget it!)

Field Test: We checked out the mixer's functions and controls by connecting it to a four-track tape machine (for multi-track recording) and a two-track tape machine (for mixing the multi-track tape down to stereo). The monitor outputs were connected to our reference playback system. The interfacing connections were made with no problems and the console operated as expected. With the output "Track Status Selectors" set to record, we recorded a rough guitar track and then overdubbed some equally rough guitar and vocal tracks. We found the console's functions straightforward and easy to use. With all four tracks of our multi-track tape filled with our inspired performances we put the console into the mixdown mode by switching the four track status selectors to "remix." In this mode the four-track tape outputs show up on input channels 1 through 4 and the two-track tape machine is fed through output channels one and two. Output channel one was panned left and two was panned right so that our monitors would display the two tracks as they would be played back in stereo. We assigned each of the four input channels to outputs 1 and 2 so that we could pan the tracks across the stereo mix as desired. After running the multi-track tape several times and exploring all sorts of bizarre EQ settings we decided that "flat" sounded best and recorded our two track "master" that way (flat EQ). We then monitored the playback of the two track master by simply setting the monitor to LI (line in).

It seems as though a fair degree of "human engineering" went into this mixer as the controls all

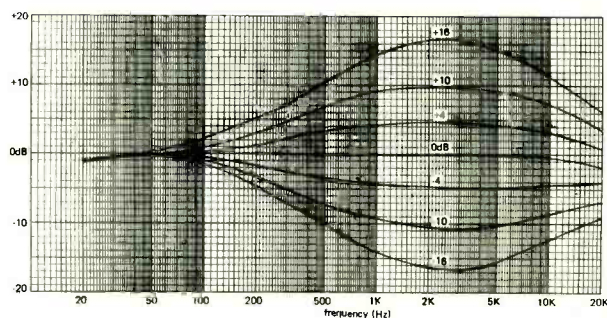
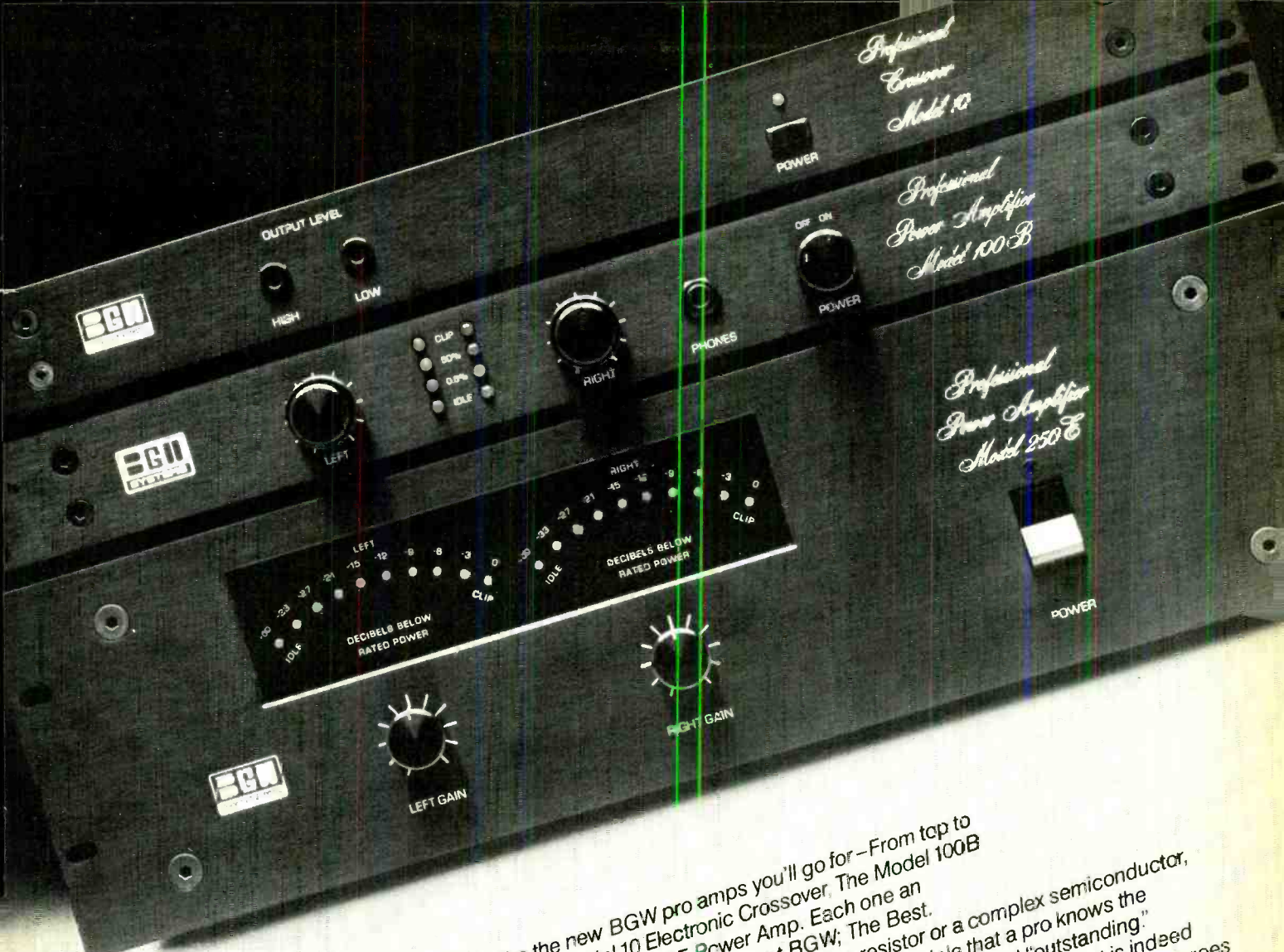

Fig. 2: Studiomaster 16 x 4: Mid EQ family of curves (@ 3 kHz).



Professionals Swear by Them, Competitors, at Them.

They're the new BGW pro amps you'll go for - From top to bottom, The Model 10 Electronic Crossover, The Model 100B Power Amp, and the 250E Power Amp. Each one an extension of our basic philosophy at BGW; The Best.

Whether its a simple resistor or a complex semiconductor, BGW is dedicated to the principle that a pro knows the difference between "good enough" and "outstanding." Because we know that quality in a pro product is indeed something you can see, touch and hear, everything we do in its manufacture, designed to back up the man who depends on our gear to make his living. And, like all BGW products, the new 250E with our exclusive arc-scale power indicators joins with the new 100B and Model 10 in answer to your demands. They're worthy additions to the solid-gold reputation that's been earned in recording studios, discos and concert stages throughout the world. If you're not already a BGW Pro we invite you to compare any of our products with anybody else's. Anybody's. You'll then see why so many of your pro friends swear by us. And our competitors, at us.

Go For The Best



BGW Systems, Inc.
 13130 South Yukon Avenue,
 Hawthorne, California 90250
 In Canada: Omnimedia Corp.,
 9653 Cote de Liesse
 Dorval, Quebec H9P 1A3

CIRCLE 72 ON READER SERVICE CARD

operated very logically and only a minimum amount of switching (and no reconnecting) was required to go between the record, mixdown and playback modes. We concluded that this would be a very easy console to use for four-track recording.

In order to perform our listening test on the console, we patched it into the tape monitor loop of our stereo preamp. We ran the signal into the mic input (using the 30 dB pad), assigned it to output 1 and returned to our preamp from channel 1 of four-track output. The gain controls were set so that there was no level change when we alternately switched the unit in and out, and we were careful to avoid overdriving it. Armed with our favorite direct discs we gave the mixer the acid test for audio quality. That is, we listened carefully as we inserted and bypassed it in our reference system. We are pleased to report that the console introduced very little audible change in the program. However, we did notice a very slight "change" in transients (such as percussive sounds, clicks, etc.). Don't let this discourage you though. We recommend this board to anyone looking for a mixer to do four-track recording or sound reinforcement (P.A.) work. It sounds good, it's flexible and it's easy to use.

Lab Test: Table 1 contains a summary of the lab test results. We found the noise levels to be quite low. The mic gain control does not begin to increase the output noise level until used above about 50 dB of gain. With typical fader and input gain settings, and assigning eight input channels to one output the noise was typically 74 dB below 0 VU.

The distortion figures are good but the increasing distortion at high frequencies indicates that slew rate limiting may be occurring. The slew rate measurement of 0.2 volts per microsecond (measured using a 0 VU level square wave) tends to support this. We noted that the peak indicator lights at 3.5 dB below clipping.

The response of the equalizer section is shown in figures one and two. In listening to the effects of the equalizer we found it to be quite natural. This is probably because the curves are rather broad and have gentle slopes.

The documentation supplied with the console was rather skimpy. We feel that such a complex device should be accompanied by very thorough documentation. We also noted some misalignment of the marker lines on the colored inserts of the various control knobs with respect to the marker lines on the knob itself. This resulted in some confusion as to where the EQ controls were actually set flat. This misalignment was not a serious concern however.

Although the console does not use separate input modules, there is pretty good access to the circuitry. By removing a single large cover on the back (fourteen screws) there is access to all of the electronics. We noticed that the mic preamp is a transformerless design, and a very good one considering the noise performance and headroom.

Conclusion: We found the Studiomaster 16 into 4 to be a very easy console to interface and use. The audio quality through the unit is good and the three-band EQ is quite musical sounding with gentle response curves. If you're looking for a console to do four-channel recording or P.A. work we suggest you check it out.

LAB TEST SUMMARY

Input Levels

(Note: 0 dBV = .775 volts rms)

Mic Input

Required input level for 0 VU indication with all level controls at maximum: -70.4 dBV
 With mic gain at minimum the input clips at: +4 dBV (pad out)
 +24.8 dBV (pad in)

Line Input

(in mixdown mode)

Required input level for 0 VU indication with all level controls at maximum: -49.2 dBV
 Input clips at: +25.0 dBV (pad out)
 +33.6 dBV (pad in)

Output Levels

(at four-track line out)

For 0 VU indication: +4.2 dBV
 Maximum output before clipping the input (all level controls maximum): +15.8 dBV

Noise

(Note: 20 kHz bandwidth, 200-ohm mic input load)

Equivalent Input Noise: -126.7 dBV
 With all level controls for one input and one output at maximum, noise is: -56.3 dB (ref: 0 VU)
 With all level controls at minimum noise is: -80.3 dB (ref: 0 VU)
 With input and output channel faders of one channel at nominal settings and the mic preamp set for 40 dB gain noise is: -77.3 dB (ref: 0 VU)
 With 8 channels set as above noise is: -74.0 dB (ref: 0 VU)

Distortion

(THD) at 0 VU

Frequency (Hz)	% THD
100	.017
1 K	.012
5 K	.041
10 K	.39
20 K	4.6

Slew Rate: .20 volts per microsecond (at 0 VU)

Frequency Response: ± 1 dB 20 Hz-20 kHz (EQ set flat)

Bandwidth (-3 dB points): 3.8 Hz-25.0 kHz

CIRCLE 29 ON READER SERVICE CARD



TROUPER SERIES



The 180S and 180SA are the first of UNI-SYNC's new line of packaged mixing systems. This package includes all the features and flexibility found on the Trouper I Stereo plus individual LED displays on each input and a built-in Model **UNI-SYNC** 100 Power Amp. See and hear the 180 Series **UNI-SYNC** at your nearest dealer.



742 Hampshire Road/Westlake, California 91361 • (805) 497-0766
Uni-Sync Div. of BSR (Canada) Ltd., 26 Clairville Rd., Rexdale, Ontario M9W5T9 • (416) 675-2402

Power And Lights With No Compromise!

CIRCLE 103 ON READER SERVICE CARD

GROOVE VIEWS

Reviewed by:
MIKE DEREVLANY
ROBERT HENSCHEN
NAT HENTOFF
JOE KLEE
ALLAN KOZINN
STEVE ROW
JEFF TAMARKIN

POPULAR

THE GRATEFUL DEAD: *Shakedown Street*. [Lowell George, producer; Dan Healy, associate producer; Bob Matthews, engineer; recorded and mixed at Club Le Front.] Arista AB 4198.

Performance: **Something different, but good**

Recording: **Careful, relaxed and very good**

This album will grow on you like few others that were released in 1978. Jerry Garcia, Bob Weir, Donna Godchaux and the rest have fashioned as

varied a selection of musical material, under the guidance of Little Feat's Lowell George, as one could expect from one of America's most enduring rock groups.

Without exception, the tracks are interesting examples of where music is heading these days—from the punkish-sounding cover of the Rascals' "Good Lovin'" to the purely African-sounding drum and percussion cut entitled "Serengetti" to the surprisingly crisp reggae number, "Fire on the Mountain." Urban blues are represented by the title track, for example, with a guitar hook that is quite a grabber, sounding in its eight-note descent as if it should accompany an animated cartoon of skeleton figures dancing (or something like that...).



THE GRATEFUL DEAD: An interesting example of where music is headed today

Nearly everything works on this album, so long as you are not looking for replays of "Casey Jones," "Truckin'" or "Uncle John's Band." The surprising softness of earlier Dead material, with its acoustic guitar accompaniment and airy vocal harmonies have given way to music with a harder edge, featuring more lead singing than group singing. And one of the biggest pluses of the album is the splendid instrumental accompaniment that is given each track.

The highlights of the album for real Dead fans probably will be "Shakedown Street," a shuffling street blues; "Fire on the Mountain," a reggae number with a fine rock guitar solo, and "Stagger Lee," a reworking of the familiar musical story in an arrangement that sounds almost as if it could have been chartered by the Band. But one cannot dismiss the diverting "France," with Donna Godchaux singing lead over an arrangement that features a Latin rhythm propelled by the most beautiful steel drums. The song has a Dan Hicks-feel to it, and the drums and guitar work at the end is especially nice.

"Serengetti" is much too short and could have developed into a drum and percussion showcase. As it is, the piece (just under two minutes) builds and expands in intensity and complexity before fading to a close, but not before causing the listener to get sucked into its earthy rhythm.

Along with "Good Lovin'," a song which opens the album with too jarring a note in my view, listeners will recognize the "All New Minglewood Blues," a reworked version of an earlier Dead song and one that features good guitar work in both lead and backup roles. Bob Weir's lead vocal here, as on "Good Lovin'," sounds a little too forc-

KELSEY[®]

PRO-CLUB SERIES

HERE AT LAST!

From the people who specialize in high quality mixers, "Kelsey" introduces its new line of "on-stage Mixers". The New Pro Club Series! And in the true Kelsey tradition, each Pro Club Mixer comes built in its own Road Case. If you're looking for the finest quality in any price range check out the new Pro Club Series.



Pro Club Series Mixers are available in mono and stereo with these standard features:

- L.E.D. on each input
- Transformer Balanced Inputs
- Variable Input Gain Control
- 3 Bands of EQ
- Monitor Send
- Fader Style Level Controls
- Built-in Reverb with Additional Effects Send

Dallas Music Industries

150 FLORENCE AVE. HAWTHORNE, N.J. 07536 201-423-1300

CIRCLE 88 ON READER SERVICE CARD



ed, though, and curiously unmusical.

"If I Had the World to Give" is a light and airy ballad, and "I Need a Miracle" is a blues rocker. "From the Heart of Me" features Donna Godchaux in lead and is the softest song of the ten on the album, with a relaxed guitar and percussion arrangement that is among the best on the release.

For those with the best equipment, a new and improved version of this record was released by Arista in early December, accompanied by the notation that both the group and the company "felt that the quality of the original pressing was less than top-notch, so some parts were recut, the record was remastered and the album is being reserviced." The casual listener may not be able to tell the difference between the two, when played back to back, but for those who want the best, the rereleased album can be identified by the notation on the back that it has been mastered by George Horn at the Automatt in San Francisco. It also lists the recording site for "Serengetti" as Meta Tantay, Carlin, Nevada, with Brett Cohen as engineer.

Shakedown Street contains a musical diversity that is most refreshing, with generally impeccable instrumental charts for each song. Dead fans won't be disappointed, and the album may win a few new fans as well. S.R.

THE BLISS BAND: *Dinner With Raoul.* [Jeff Baxter, producer; Bruce Robb, engineer; recorded at Cherokee Studios, Los Angeles, Ca.] Columbia JC 35511.

Performance: Promising but imitative
Recording: Steely, West Coast polish

Catchy "Rio" opens this album in a sunny groove, and you'll recognize the hip, vacation sound immediately—Steely Dan. With ex-Dan guitarist Skunk Baxter at the production helm here, comparisons between the groups are mandatory. If it weren't for some very favorable Steelyisms, a frowning Bliss Band might still be lost in the L.A. crowd.

Led by singer-keyboardist Paul Bliss, this new band sizzles along nicely on side one. "Over The Hill" and "On The Highway" are fair-to-good rockers, the previously mentioned "Rio" gets tasty Zappaesque marimba colorations from Vic Feldman, and a chorus hook to "Slip-away" could make for single material. Still, Blissdom reaches its peak on that tune, "Don't Do Me Any Favours," which most closely emulates Mssrs. Becker and Fagen. The senior group's harmonies are simulated, and even the socially critical Steely irony invades the lyrics: "Nobody loves a loser but the man who wins the game."

Wit slips to prophecy on side two's

opener "Right Place, Right Time," which may describe the mini-drama of this neo-Stelly sound. Bliss's lyrics call the singer a "desperate man" and implies that Paul is openly after a slice of the Dan's royalty pie. However, "Stay A Little Longer" immediately refutes that theory with a return to anonymous, upbeat pop.

And the duration of side two loses steam as the Steely Dan comparisons begin to fade. Baxter has done a fairly clean job of conjuring Dan's famous sound, and the Bliss Band sounds promising when at their best. But that best is not yet up to Steely standards, compositionally or otherwise, and the unknown band's present identity is almost wholly dependent on emulation. R.H.

RORY GALLAGHER: *Photo-Finish.* [Rory Gallagher, Alan O'Duffy, producers; Alan O'Duffy, engineer; recorded at Derks Studio, Cologne, West Germany.] Chrysalis CHR 1170.

Performance: No-frills hot-shot guitar rock

Recording: Kept clean and simple

The concept of the power trio in rock stretches back to the origins of the form, but really came to a head in the late sixties with Cream and the Jimi Hendrix Experience. At the same time those seminal outfits were all the rage, Ireland had its own power trio in Taste, a band which basically served as a backup unit for one hot-shot guitarist, Rory Gallagher. Taste disbanded in the early seventies, and Rory Gallagher re-emerged shortly after its demise with his own small band. After several personnel changes, concept changes, and personal difficulties, Gallagher took a two-year break from the music world, beginning in 1976 and ending with this new offering.

While there is no doubt that Gallagher is up there with the big boys, he's never received the accolades in which others of much lesser abilities often are smothered. And *Photo-Finish* might explain why: it's not that Gallagher isn't as good as the rest, he's just never gone out of his way to prove it.

There isn't a sleeper cut on this record, but then again, there's not a single track which leaves any lasting impression either. Each number is an exercise in Gallagher's "guitaristry," set in a blues mold, and rocked without



THE BLISS BAND: Openly after a slice of the Dan's royalty pie?

frills. By those standards, Gallagher should be a huge star, but unfortunately, because of the lust for flash today, his talents are overlooked in favor of fire-breathers and meat-eaters. Yet, Gallagher is to be admired for his pride, and taken on its own, *Photo-Finish* is a fine example of a dying art: good, stinging, hard-rock guitar playing.

"Shin Kicker," which opens the LP, is a classic rocker which sets the tone for the rest of the record. Gallagher's voice sounds like an odd cross between Roger Daltrey and Johnny Winter, but the voice is not the major concern here. It is that guitar, and throughout the record, which is mixed as simply as is possible, it is guitar front and center, with



RORY GALLAGHER: No frills

everything else always neatly placed behind it.

"Brute Force And Ignorance" utilizes a subdued mandolin, adding depth to Gallagher's lead riffing, and at one point Gallagher tries out a nifty duet with himself, playing both mandolin and a fuzzed-out guitar. The duet is forceful, and slices through the acoustic guitar (also Gallagher's) and the drums, both of which are keeping pace with this virtual one-man band.

"Cruise On Out" is the album's speed-show, but it's not showy. Gallagher puts some rockabilly percussion into the picture here, and adds a dimension to this otherwise typical rocker that would probably never occur to most musicians.

That takes care of the first three cuts, and the rest of the album follows suit. There are a number of straight blues tunes ("The Mississippi Sheiks," "Cloak and Dagger"), and high-energy

kickers ("The Last Of The Independents," "Shadow Play"). There are no production tricks to turn Gallagher's music into a spectacle, and one gets the feeling that the decision was one which was arrived at after much consideration. After all, one does not wait two years to record an album, and then put it out as a basic, three-piece rock-band vehicle if he were trying to outdo the Moody Blues. J.T.

JIVA: Still Life. [Stephen Barnard and Stuart Alan Love, producers; David Chackler, executive producer; Rick

Bralver and Rick Wilson, engineers; Mark Hanan, assistant engineer; recorded at Silvery Moon Studios, Los Angeles, Ca.] Polydor PD-1 6165.

Performance: **Sleep inducing**
Recording: **Overdone**

California seems to have spawned another over-produced under-talented would-be supergroup in the form of Jiva. Such a move presumably comes as a result of the success of such mammoth pillars of commercial mediocrity as the Doobie Brothers. Slickly smooth and market-ready, Jiva is a careful prepara-

DIGITAL DELAY SYSTEM MODEL D-250

TIME CONTROL



The Digital Delay System Model D-250 employs the latest technology available in analog to digital circuitry. Unique design features in the Model D-250 will meet your performance needs in all applications. The input display and gain control allows you to properly adjust front end sensitivity. The D-250 may be bypassed without affecting the internal memory. Regeneration controls quickly adjust the amount of feedback signal and the hold function gives you infinite repeat with no degradation of signal quality. Control oscillator functions include rate, width and wave shape (for additional special effects). The voicing function introduces random variations in the delay signal which is especially useful in creating a more natural vocal doubling effect. Delay time is selectable in one millisecond intervals and displayed in large bright numerals. Three way mode switching includes Straight Delay, VCO Effects and Flange. The output stage offers mixing, phase reversal and gain control. All dynamic functions may be footswitch or footpedal controlled and are LED indicated allowing you to use this unit as part of a real time instrument system. Back panel provisions are also included for external voltage control.

The D-250 is covered by a full one year parts and labor warranty.



ADVANCED Audio Designs

PROFESSIONAL PERFORMANCE SYSTEMS

1164 WEST 2ND AVENUE • EUGENE, OREGON 97402 • 503-485-4251

Also available: Instrument Preamp Systems, Guitarist Model 101 and Bass Guitarist Model 101B

Dealer Inquiries Invited

See Us At NAMM Booth 7177

CIRCLE 49 ON READER SERVICE CARD

tion of misguided producers' greasy schemes and session men's daydreams, although the result is more like a poor man's nightmare.

A five-man group with the unusual instrumental lineup of guitars, bass, keyboards, and percussion, Jiva's most important asset is vocals. When they're good, which they usually are, they're very good, and the mix wisely emphasizes this aspect of Jiva. If the vocals are in any way disturbing, it's because they are sometimes precise. They just sound too processed to be comfortable. A little too much production magic? Maybe. But it appears to be just a case of utilizing the best of what they have.

Some of the cuts are perfect "easy listening" fare—mellow to the point of being too laid-back, melodic but not moving, moderately interesting and nearly always antiseptically pleasant

cent guitar, and almost three-quarters of a hook.

The rest of the album is subject to dull arrangements, plain melodies, and lousy lyrics. If nothing else, Jiva makes the perfect cure for insomnia—easy to take, and no unpleasant side effects besides the unnecessary stylus wear.

I'm sure they tried reasonably hard. But, after all, not every Jiva who tries can be a Boston or a Grateful Dead or even a new Doobie Brothers. C'est la guerre. M.D.

AEROSMITH: *Live Bootleg.* [Jack Douglas, Aerosmith producers; Jay Messina, Lee DeCarlo and Jack Douglas, engineers; recorded at various concert locations during 1973, 1977 and 1978.] Columbia FC2 35564.



JIVA: When they're good, they're very, very good and when they're bad....

the way a good tasty mouthwash is.

The sound isn't the only tip-off that Jiva is aiming for elevator sound systems. It's their lyrics, which are so lame they have to crawl just to stay mediocre. What can you expect when the most exciting lyrics contain lines like "Give the tapdancer another room/He was three doors down/In the hallway gloom?" Ugh.

Given the right turn of events, though, Jiva could reach a level of listenability somewhere above somnolence. The cut "Face The Light," with its subtle energy and its sharp but undermixed instrumentation, indicates that there is some hope, however limited. "Face The Light" has some pleasing but uninspired piano work, de-

Performance: Y'mean bands still play like this?

Recording: Done on a cheap cassette recorder in the balcony

Just because they titled this album *Live Bootleg*, doesn't mean they had to make it sound as horrendous as one, does it? Well, somebody in the engineer's booth thinks so, because this is quite possibly one of the two worst "live" recordings of 1978 (the other one being Iggy Pop's *TV Eye*). *Live Bootleg* sums up on four sides of vinyl everything that is wrong with the concept of concert recordings.

For starters, Steven Tyler teaches us right from the first track that in order to be a successful rock star, one does

not necessarily have to know how to sing. "Back In The Saddle," recorded at an Indianapolis gig on July 4, 1977, is described here as a "lustly cowboy song." The liner notes go on to say that Aerosmith "looked hard for a version that would satisfy." Well, apparently they didn't pull all that much effort into their search if this is the version they came up with. The mix here is so off-centered, and the performance so common, that this cut only serves as a fair warning that the listener would be better off putting the record back in its jacket and placing it on the shelf, or preparing himself to nurse a severe headache for a long time.

"Sweet Emotion," which follows, begins as an all-out grand theft of the Stones' obscure psychedelic flip-side, "We Love You," from 1967. It eventually molds itself into a fairly hot, standard blues jam, but this track, and the rest of this side in fact, is recorded so sloppily that the only instrument that is discernible is the drums. "Toys In The Attic," the title cut from one of their best-selling LPs, is almost "punkoid" in nature here, but again, is mixed so haphazardly that it's a strain to listen to.

The second side starts off commendably enough, with "Last Child," a bluesy track recorded at a club in Boston. Obviously, the club setup is more conducive to a good "live" mix than the stadiums which Aerosmith inhabits regularly. But it also gives a false impression of what the average Aerosmith concert sounds like, since their club appearances are about as common as a reasonably-priced album these days. False impressions or not, this track is a more listenable recording, and since most of the side (which also includes the hit "Walk this Way" and the atrocious Beatles' cover, "Come Together") is also recorded at stadiums or coliseums, it makes one wonder why the same care wasn't taken on the first side to get at least a near-bearable mix.

One interesting trick is how the assorted concerts were blended so nicely together, so as to sound like the whole album is taken from one show. After the club recordings, the light, hollow ovation from the small crowd segues neatly into the stadium crowds' applause, with the transition going smoothly. In fact, that trick is the neatest of the record, since the music itself isn't worth beans.

And so on. The third side offers two Berry-esque rockers, "Mama Kin," and "S.O.S.," which, with a competent vocalist in front of them, might not be

Super Summer Giveaway!

Sept DRAWING for all enrolled in Summer classes.

- Bi Amp 8802 Stereo Mixer
- Sound Workshop 242C Stereo Reverb
- DBX RM 163 - 2 Mono Compressor/Limiters in a rack mount assembly
- Burwen 1201 Dynamic Noise Filter
- Audic Technica Microphones - 2 - 813's un directional microphones
- TCC Tape - 40 boxes of Audua -B3600 tape on 10" reels

RIA, the largest and most respected network of studios offering courses in the art of multi-track recording.

When today's music conscious society made recording the new art of self-expression, the RIA created the nationally acclaimed ten week course in the art of multi-track recording, entitled **Modern Recording Techniques**. All classes are conducted on location at 16 and 24 track recording facilities. Under the guidance of professional recording engineers as instructors, the students see, hear, and apply the techniques of recording utilizing modern state of the art equipment. The course includes live recording sessions so that the student may apply the techniques learned.

For information on RIA's Modern Recording Techniques course, call our local representative in the following cities:

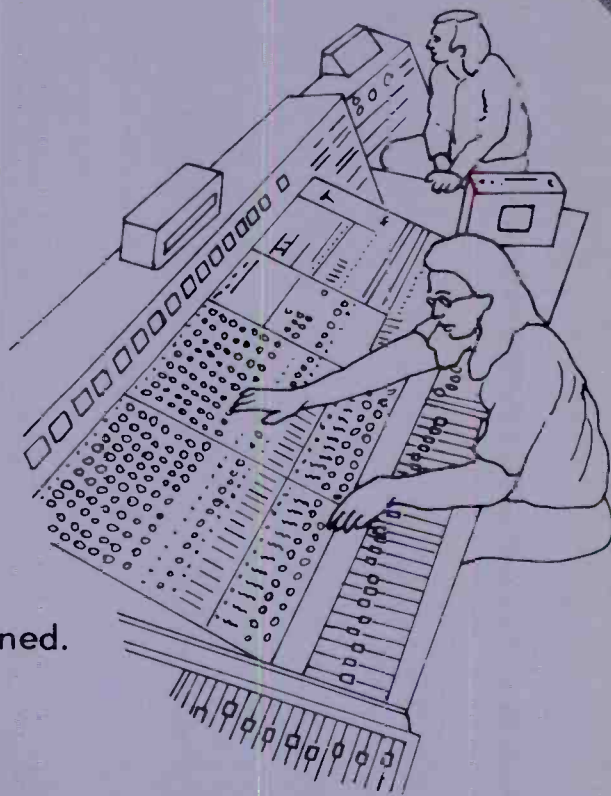

AMES, IOWA
A & R Recording Studio
(515) 232-2991

ALANTA, GA
Apogee Recording Studios
(404) 522-8450

BALTIMORE, MD
Sheffield Recs Ltd., Inc.
(301) 628-7280

BIRMINGHAM, AL
Solid Rock Sound
(205) 854-4150

BURLINGTON, VT
Starbuck/Ashley Record
(802) 658-4616

CHARLOTTE, NC
Reflection Studio
(704) 377-4596

CHICAGO, ILL
Universal Recording Studios
(312) 642-6465

CLEVELAND OHIO
Agency Recording
(216) 621-0810

COLUMBUS, OHIO
Mus. I - Col Rec'g
(614) 267-3133

COLUMBUS, GA
HNR Studios
(404) 327-9431

DALLAS, TEXAS
Sound One
(214) 742-2341

DENVER, COLO.
Applwood Studios
(303) 279-2500

DETROIT, MICH.
Recording Institute
(313) 779-1380

HONOLULU, HAWAII
Audissey Sound
(808) 521-6791

HOUSTON, TEXAS
Wells Sound Studios
(713) 688-8067

JACKSONVILLE, FL.
Cypress Recording Studios
(904) 246-8222

KNOXVILLE, TN
Thunderhead Sound
(615) 546-8006

L.A./ORANGE COUNTY, CA
United Audio
(714) 547-5466

NEW HAVEN, CT
Trod Nessel Productions
(203) 269-4465

NEW ORLEANS, LA
Knight Recording
(504) 834-5711

NEW YORK, N.Y.
RIA
(212) 582-3400

NORTHERN N.Y. STATE
Michels Audio
(315) 769-2448

PADUCAH, KY
Audio Creations
(502) 898-6746

PHILADELPHIA, PA
Starr Recording
(215) 925-5255

PHOENIX & TUCSON, ARIZ
Lee Furr Studios
(602) 792-3470

PITTSBURGH, PA
Audio Innovators
(412) 471-6220

RICHMOND, VA
Alpha Audio
(804) 358-3852

SANTEE/SAN DIEGO, CA
Natural Sound
(714) 448-6000

SEATTLE, WASH
Holden, Hamilton
& Roberts Recording
(206) 632-8300

TULSA & OKLA CITY, OKLA
Ford Audio and Acoustics
(405) 525-3343

CANADIAN
REPRESENTATIVES

MONTREAL, QUE.
RIA
(212) 582-0400

OTTAWA, ONT
MARC Production
(613) 741-9851

TORONTO, ONT.
Phase One Recording Studio
(416) 291-9553

CALGARY, ALBERTA
Sound West Recording
(403) 277-0189



CIRCLE 65 ON READER SERVICE CARD

bad songs. Joe Perry's redundant guitar playing even stands up for a lick or two here, but certainly not long enough to leave any viable impression.

The final side of *Live Bootleg* is the clincher though, the one that best documents the decay of a band which at one time had something to offer. "I Aint' Got You," and James Brown's "Mother Popcorn," recorded at a Boston club in '73, when the band was first making waves and had yet to be institutionalized, is some real classy blues. It's clean, simple, uncluttered, and shows some taste being applied, as well as a genuine relationship between musicians and audience. When this set segues into the blues standard, "Train Kept A Rollin'," recorded in a Detroit Coliseum, and done as a heavy-metal cliché, one can sense the distance between the band and its audience. The track is muddied, the musicianship sloppy and boring, and the audience reaction robotic. Music swallowed up by big bucks. So this is what success does to a band.

J.T.

THE POINTER SISTERS: *Energy*.

[Richard Perry, producer; Dennis Kirk, engineer; Gabe Veltri, assistant engineer; recorded and remixed at Studio 55, Los Angeles, Ca.] Planet P-1.

Performance: **The album title says it all**

Recording: **Bright and crisp**

ANGELA BOFILL: *Angie*. [Dave Grusin and Larry Rosen, producers; Dave Grusin, arranger and conductor; recorded by Larry Rosen at Electric Lady Studios, New York, N.Y., Jim Galante, assistant engineer and at



ANGELA BOFILL: Remarkable debut



THE POINTER SISTERS: Pulling out all stops and fulfilling the promise

A&R Studios, New York, N.Y. by Jim Boyer, Chaz Clifton, assistant engineer.] GRP/Arista GRP-5000.

Performance: **Surprisingly self-assured**

Recording: **Very good**

How refreshing it is to hear some black women use their pipes without getting trapped by the plastic monotony of the current disco rage! These two recordings show that by being given the right direction, in addition to having the talent, young women such as Ruth, Anita and June Pointer and Angela Bofill can provide solid contemporary music.

The new release by the Pointer Sisters is the first recording for producing wunderkind Richard Perry's new Planet label, and a better beginning could hardly be imagined. The Pointers have been knocking around for at least five years on record (several have been dumped into cutout bins already), gaining a somewhat sizeable audience for a heady blend of jazz and R&B tunes from such sources as Lambert, Hendricks and Ross and Allen Toussaint.

If their earlier records showed promise of being able to let out all the stops, *Energy* fulfills the promise. The only better title for this album might be "Fire," which is, coincidentally, one of the nine tracks on the album.

Listeners will note a variety of familiar tunes here, ranging from Bob

Welch's "Hypnotized" to Bruce Springsteen's "Fire" to Loggins and Messina's "Angry Eyes." Just about any of the cuts could become singles, I suppose, but that should not detract you from enjoying the album.

"Hypnotized," with its dusky vocals, features a good arrangement containing a harder edge than the Fleetwood Mac original. The sound is a little less ethereal here. A cool fire permeates the whole feeling of the Springsteen song, on which Anita takes the lead vocal, while "Angry Eyes" has been distilled to a much shorter version (less than three minutes) without losing any of the drive of the song.

The Pointers also perform the Doobie Brothers' "Echoes of Love" in a brassier setting than the original, Sly Stone's "Everybody Is a Star" in a version that leans toward country-rock, and a little-known (I haven't been able to find it on any of my records) Stephen Stills song, "As I Come of Age."

Another familiar tune is Steely Dan's "Dirty Work," and this may be where the only real mistake of the album crops up. While Anita's lead vocal is properly on the childish side, the group does a long ending, repeating the chorus several times. The harmonies are so good that one wishes Perry would have had the trio sing the final chorus acappella to break up what is almost a boring close. The full vocal strength is not realized. The closest the group gets to black rhythm and blues,

or soul, are "Come and Get Your Love," with Ruth singing lead, and Toussaint's "Happiness," with June singing lead.

The sisters, who are without Bonnie for this release, have some outstanding studio help, such as Waddy Wachtel and Danny Kortchmar on guitars, Jeff Porcaro on drums and David Hungate on bass. Under Perry's skilled direction, this album really takes off.

Angela Bofills, a 24-year old New Yorker who has been soloist for the Dance Theater of Harlem Chorus, has created quite a successful package for her debut solo recording. The material is not as familiar as that on the Pointers' album (she wrote four of the eight songs), but it is all performed with considerable skill and in a voice that is quite exciting.

Dave Grusin has arranged a nearly perfect setting for the voice, too, using just the right percussive and instrumental shadings to show off Bofill's splendid instrument. Some of the cuts feature nicely done string accompaniment, too, and a good example is the first song on the album, "Under the Moon and Over the Sky."

Bofill wrote a multi-media jazz suite by this title about three years ago, and if the entire suite is as pretty as this nearly six-minute song is, it must be a thing of great beauty. Grusin's shimmering arrangement works perfectly to complement Bofill's voice, and one is amazed at the lengthy sustained notes she holds at the end of the phrase "Over the sky." She also uses her voice as a percussive embellishment during some of the breaks.

Her usually clear voice becomes a bit huskier for "This Time I'll Be Sweeter," which has a very pretty melody and a lush arrangement. "Baby, I Need Your Love" opens with a jazzy bass, piano, drums and percussion introduction, and soon an insistent triangle-and-block rhythm is added. Bofill seat sings part of this song, but it is during the body of the song that one hears faint similarities to the voices of (oddly enough) both Anne Murray and Phoebe Snow—perhaps a voice that falls somewhere in between those two.

The recording of Ashford and Simpson's "Rough Time" creates the impression of Bofill's not inconsequential voice being projected out of the corner of a large, empty room, and the lyrics of this song begin with a theme that has been previously explored in the Beatles' "A Day in the Life."

*Do
Something
Creative
With Your
Musical and
Audio Talents
Subscribe To*

**MODERN
RECORDING**

The Only Magazine For
Active And Creative Music & Audio
Enthusiasts



**SMALL STUDIO
DESIGN**

WHEN YOU'RE JUST STARTING IN THE RECORDING BUSINESS EVERY DOLLAR COUNTS, AND YOUR SPACE IS JUST AS LIMITED AS YOUR BUDGET. WE THINK WE'VE GOT THE SOLUTION... STUDIO DESIGN INTENDED SPECIFICALLY FOR THE SMALLER STUDIO, WITH PERFORMANCE SPECIFICATIONS TO RIVAL THE BEST. FOR MORE INFORMATION CALL OR WRITE...



ABADDON SUN, INC.
P.O. Box 6520, San Antonio, Texas 78209
512-824-8781

CIRCLE 108 ON READER SERVICE CARD

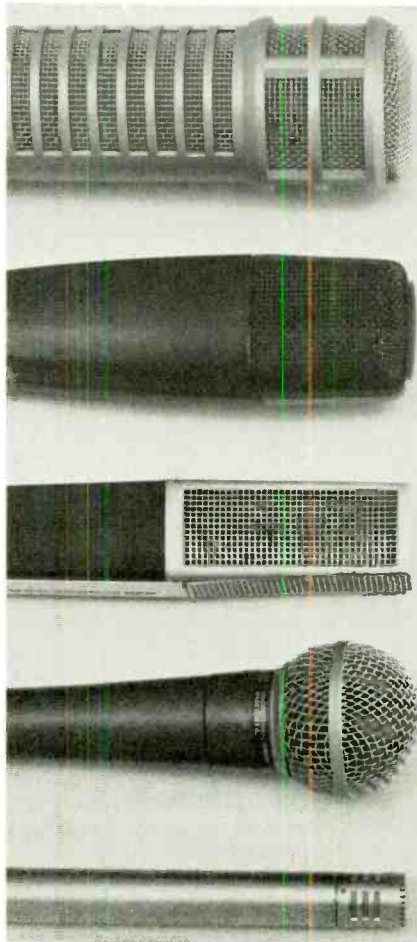

mikes by mail? for less? why not!

Buying microphones from The Mike Shop can mean a lot to you.

We don't have a high overhead... no storefront, no salesmen, so our prices are lower.

The Mike Shop, has a mail order only policy...

If you need microphones and accessories, we've got them, at the right prices.

Write us with your requirements, for a prompt price quote or for our current price sheet. Help us keep our prices down, enclose a 15¢ stamp with your request.

The Mike Shop, mikes by mail, for less... Why not!

The Mike Shop™
PO Box 366F, Elmont, NY 11003
A Division of Omnisound Ltd.

CIRCLE 33 ON READER SERVICE CARD

Latin rhythms are dominant on the recording, such as in "The Only Thing I Would Wish For" and "Share Your Love" and "Baby, I Need Your Love." Grusin gives flutes room to breathe on several cuts, and the charts for the drums and percussive devices are great.

Among the weak spots, though: "Share Your Love," with its rather weak and forgettable lyrics and an arrangement that is too lush, and "Children of the World Unite," with its predictable lyrics. Fortunately, the rhythmic accompaniment for the album only occasionally slips into the commercially marketable disco variety.

One tends to overlook the weaknesses in the album (particularly the choice of material) because of the splendor of Bofill's voice. She has created a remarkable debut album, just as the Pointer Sisters have fashioned a strong new direction in their already successful career. S.R.

SOUTHSIDE JOHNNY AND THE ASBURY JUKES: *Hearts of Stone*. [Steve Van Zandt, producer; Jack Malken and Michael Berry, engineers; recorded at Secret Sound Studios, New York, N.Y.] Epic 35488.

Performance: **Upbeat and tight**
Recording: **Excellent**

Southside Johnny is in a strange position artistically—that is, if he can be said to have any artistic pretensions at all. On the one hand, both he and his

more illustrious New Jersey compatriot, Bruce Springsteen, have been anxious to establish Southside's identity as something more than just a Springsteen clone. Yet, their musical, temperamental and geographical roots lie in the same direction, and what's more, Southside's emergence from New Jersey Barland is undeniably tied to Springsteen's success. After three LPs (Southside now trailing Springsteen by one), those ties seem more like an umbilical cord that hasn't been severed than merely a helping hand. In fact, *Hearts of Stone* seems to place the possibility of Southside's establishing his own identity farther out of reach than ever.

Why? Because aside from superficialities of instrumentation (the Jukes' horn sound), the major difference between Springsteen and Southside is that Springsteen is able to come up with consistently strong original material, while Southside can do little but draw from Springsteen's well, both directly and indirectly. Springsteen wrote or authored three of this LP's nine songs, including the title track. The LP was produced by E Street Band guitarist Steve Van Zandt, who wrote the songs that Springsteen didn't, but whose writing style is, not surprisingly, very similar to Springsteen's. Also, Asbury Jukes drummer Kenny Pentifallo is replaced here by Max Weinberg, another member of guess which band. Weinberg isn't just a sideman here, either. The strong impression he made on Springsteen's *Darkness at the Edge of Town* is reinforced on this album, and on several tracks—the open-

ing "Got To Be A Better Way Home" and Springsteen's typically derivative "Talk To Me," for instance—Weinberg's drumming stands out front and center, propelling the band toward their tightest playing on record to date. Even on some of the slower, quieter tracks, such as the Springsteenish "This Time Baby's Gone For Good" and the title tune, the rhythm section is central.

The band's playing and Steve Van Zandt's production and arranging are all superlative. Lead guitarist Billy Rush's solos, while they may not be the most ingenious or original in rock today, are energetic, at times even blistering, short and to the point. The brass section gives the Jukes' sound a certain repletteness and the ability to play with texture, something that Van Zandt handles quite well. At times, the horn recording sounds a bit cluttered, particularly where they are used to build up to a raucous, rocking ending such as that of "Take It Inside." On the whole, though, the sound on this LP is clearer and more crisp than that of their past two outings.

Oddly enough—and perhaps it's a bit unfortunate—the frontman, Southside Johnny, is all but lost in the shuffle, making the slightest impression of anyone connected with the LP. Sure, his singing is adequate, and his voice even sounds, dare I say it, like Springsteen's. The difference in their vocal approach seems to be that where Southside stands on adrenalin and immediacy, Springsteen relies on sensuality and emotion, equally valid approaches that complement each other. The real star of this LP, though, is Steve Van Zandt, who seems more than ready as a songwriter, producer and, of course, performer, to put out an LP of his own. A.K.

STEELEYE SPAN: *Live at Last*. [No producer listed; Mike Thompson, engineer; recorded "live" at the Winter Gardens, Bournemouth, England, March 7, 1978, and at Warner Bros. Recording Studios, Hollywood, Ca.] Chrysalis CHR 1199.

Performance: **A fitting farewell**
Recording: **Fine "live" sound**

It will be hard to accept the fact that one more island of serenity amid the turbulence of pop and rock music has atomized, but such apparently is the case with the release of *Live at Last* by the English folk-rock group Steeleye Span. There, on the back of the album,



SOUTHSIDE JOHNNY AND THE ASBURY JUKES: What artistic pretensions?

John Woram's The Recording Studio Handbook

FOR RECORDING ENGINEERS,
TECHNICIANS AND AUDIOPHILES

The technique of creative sound recording has never been more complex than it is today. The proliferation of new devices and techniques require the recording engineer to operate on a level of creativity somewhere between a technical superman and a virtuoso knob-twirler. This is a difficult and challenging road. But John Woram's new book will chart the way.

The Recording Studio Handbook is an indispensable guide. It is the audio industry's first complete handbook that deals with every important aspect of recording technology.

Here are the eighteen chapters:

- The Decibel
- Sound
- Microphone Design
- Microphone Technique
- Loudspeakers
- Echo and Reverberation
- Equalizers
- Compressors, Limiters and Expanders
- Flanging and Phasing
- Tape and Tape Recorder Fundamentals
- Magnetic Recording Tape
- The Tape Recorder
- Tape Recorder Alignment
- Noise and Noise Reduction Principles
- Studio Noise Reduction Systems
- The Modern Recording Studio Console
- The Recording Session
- The Mixdown Session

In addition, there is a 36-page glossary, a bibliography and five other valuable appendices.

John Woram is the former Eastern vice president of the Audio Engineering Society, and was a recording engineer at RCA and Chief Engineer at Vanguard Recording Society. He is now president of Woram Audio Associates.

This hard cover text has been selected by several universities for their audio training programs. With 496 pages and hundreds of illustrations, photographs and drawings, it is an absolutely indispensable tool for anyone interested in the current state of the recording art.

Use the coupon at the right to order your copy of *The Recording Studio Handbook*. The price is only \$35.00, sent to you with a 15-day money-back guarantee.

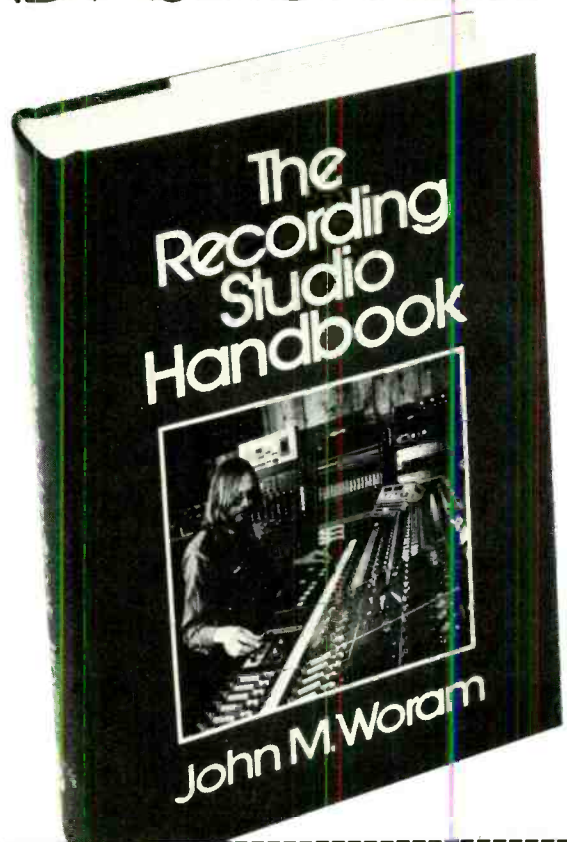

MODERN RECORDING MAGAZINE
14 Vanderventer Ave., Port Washington, N.Y. 11050

Yes! Please send copies of *The Recording Studio Handbook* at \$35.00 each. On 15-day approval.

Name

Address

City/State/Zip

Total Amount

N.Y.S. Residents add appropriate sales tax

Enclosed in payment for \$
907C Outside U.S.A. add \$2.00 for postage

Tim Hart writes: "This then is our eleventh and final album. Steeleye Span amicably disbanded five days after making this recording for reasons that are irrelevant here."

It's enough to make you want to pour another Guinness. For the past eight years, this exuberant and dedicated group of singers and musicians has tried to point out to the public the joys of traditional English folk music. To make the product more "relevant," they amplified when amplification would work; they rocked in the framework of already highly rhythmic music.

The sense of music and rhythm is captured well in the "live" performance used as the basis for the group's last album. The album is not a "greatest hits" package done in concert format; instead, it seems to represent the strengths of the group from its past recording history. There is one very long ballad, "Montrose," that will be a favorite of many listeners, and there is an interesting pairing of one of Span's best songs, "Saucy Sailor," with the Kurt Weill classic, "Black Freighter."

There are examples of the small ensemble folk music that marked the brief life of the Albion Country Band, and there is some very good duet work, such as in "The Maid and the Palmer." The lineup for the finale is a classic—Maddy Prior remains the lead singer and shows that she still has one of the purest voices in all of pop music; Rick Kemp is bassist; Martin Carthy is on guitars, along with Tim Hart; Nigel Pegrum is the drummer, and John Kirkpatrick sings. An accordion is promi-

nent in several of the songs.

Much like the music of the Chieftains, the music performed by Steeleye Span is exciting and exhilarating. It keeps the mind moving and the feet tapping. The dance cuts on the album are classic examples, and the opener, "Atholl Highlander's" and "Walter Bulwer's Polka," is just splendid. Lively, too, is "The Maid and the Palmer," which shows how well the group combined traditional folk music with the amplified sound of contemporary music. The shifts in tempo in some of Steeleye Span's music is shown by "The False Knight on the Road," one of the group's better known melodies.

"Montrose" is the showcase of the album, of course, with Prior singing lead vocal, the rhythms and keys shifting, multipart harmonies mixing with solo singing and the players providing a rich texture of instrumental accompaniment. The song lasts more than fifteen minutes and incorporates a folk dance, several new themes and returns to the original theme and chorus before drawing to a close. This song, more than any of the others, shows the true strength of Steeleye Span as a group of rather skilled musicians.

Something is missing from the album, however. What was needed was really a good acappella reading of something like "Sweep Chimney Sweep," from *Stormforce 10*, or a familiar song that could have inspired some audience participation, such as "Misty Moisty Morning." And in spite of what sounds to be a very well recorded set from the stage of a concert per-

formance, *Live at Last* does contain considerable distance between the performers and the audience.

The album also ends enigmatically, with a studio recording of "Rag Doll," the Crewe-Gaudio hit by the Four Seasons in 1964. One does not question whether the song should have been included in a concert, but one wonders why this song was chosen to close a recording career so firmly entrenched in more interesting music.

Be that as it may, one laments the passing of the group and hopes that something will bring about a reunion sometime down the road. Now one can treasure the records and agree with Tim Hart that "it is the music that counts, and it has proved to be timeless, indestructible and, curiously enough, popular." S.R.

THE BLUES BROTHERS: A Briefcase Full of Blues. [Bob Tischler, producer; Paul Schaffer, musical director; Warren Dewey, engineer; Jay Krugman, assistant engineer; recorded "live" at the Universal Amphitheater, Los Angeles, Ca., by the Record Plant, Los Angeles, Ca.] Atlantic SD 19217.

Performance: **Inspired and raucous**
Recording: **Very good concert disc, but is it really blues?**

This album has passed from novelty status to the genuine article. More than a million copies have been sold, concert dates are being booked and performed, and the Blues Brothers—Joliet Jake and Elwood—are popular musical performers with one of the hottest acts in the country. Which might come as a little surprise for John Belushi and Dan Aykroyd, two of the resident zanies in the Not-Ready-for-Prime-Time Players from *Saturday Night Live*. But they should have known, based on the reception their recreation of Chicago-style blues singing got on some of the shows, that they were on to something big.

Now comes the album, and the same wit and exuberance shown on television is captured on record. But is it blues? This one will be debated for a long time. Belushi and Aykroyd and the talented ensemble of musicians in the Blues Brothers Band can make good music, make no mistake about it. Backing up Belushi, who sings, and Aykroyd, who plays harmonica, are such luminaries as Steve Cropper on guitar, Donald Dunn on bass and Tom Scott on tenor sax.



STEELEYE SPAN: They'll keep your mind moving and your feet tapping

The band has nine players in all, and it produces some very bright and bold accompaniment for the songs.

The material is drawn from some familiar sources, too. *Briefcase* contains a dozen cuts, including Otis Redding's "I Can't Turn You Loose," Floyd Dickson's "Hey Bartender," King Floyd's "Groove Me" and the David Porter-Isaac Hayes classic that is the hit single from the album, *Soul Man*.

What some blues purists likely will take offense at, however, is that the cuts may be too raucous, too fast, to be true covers of original blues classics. "Messin' With the Kid," by Junior Wells, is a good example of a song that might be too lively and too brassy to be real blues. The same can be said of "Almost," with its bass sounding like a refugee from a rendition of "Night Train."

These songs sound too rushed, although perhaps this is what marked Chicago-styled blues. Giles Oakley, in his history of the blues entitled *The Devil's Music*, has observed, for example, that the blues from Chicago "have been characterized by the raw ghetto toughness of a Howling Wolf or an Elmore James. . . ." The usually slow rhythm could be seen as an outgrowth of the spiritual roots of the music, from the South, and this is not in any of the Blues Brothers cuts.

As sheer fun, one cannot fault the idea behind the record. Belushi can shout the blues very well, and Akroyd's harmonica work is splendid throughout. Some nice little effects are noticeable—the occasional singing by Belushi and Akroyd an octave apart, which often was used to simulate vocal harmonies; or Belushi's occasional use of black dialect ("Now my mind don't wuryk"); or the good solo breaks and instrumental bridges, particularly by Cropper and the horns.

Some of the songs work just right, too—such as "I Don't Know," with its low-down feeling and off-color lyrics. Nothing too subtle about these earthy verses! "Flip, Flop and Fly," although played perhaps too fast, is a standard blues piece, interchangeable with hundreds of others, with good harmonica work by Akroyd and tight work by the horns, bass and drums. The chorus at the end sounds sloppy drunk.

If the Blues Brothers come back with a second recording, they would be advised to heed the admonition given by Scott Joplin, who instructed those playing his rags to play slow, and not to play too fast. With a gutsier, more low-

MODERN RECORDING

BUY • SELL • TRADE

- PRODUCTS
- EQUIPMENT
- SERVICES

Classified Rates

75c per word

Minimum 10 words. Copy must be received at Modern Recording, 14 Vanderventer Avenue, Port Washington, N.Y. 11050 by the 1st day of the 2nd month prior to cover date (for example, the April issue closes February 1st). Payment must accompany order. Phone numbers count as 1 word. Zip codes are free.

DISPLAY ADVERTISING
\$100.00 per column inch

CLASSIFIED

YOU OWE IT TO YOURSELF



ASK YOUR DEALER FOR A DEMO

COUNTRYMAN ASSOCIATES
424 Stanford Avenue
Redwood City, CA 94063
Phone (415) 364-9988

CIRCLE 117 ON READER SERVICE CARD

Meet the Sam Ash Hot Liners!



Eric Harrison
Bria Orange
Mary Ann Robinson
John Saunders, Mgr.
Tom Farmer
Gene Warshaw
Mary Champion
Jay Kalas

The Sam Ash Hot Line is your direct line to the professional advice (and prices) you'll get only from Sam Ash, New York's Music Department Store. Call our Hot Liners on our toll free number and you'll understand why musicians all over the world depend on them for information, price quotes or just plain advice. There's no mystery: we're the biggest in the business, with six Sam Ash stores in the New York area plus a huge warehouse. And we've got a 55 year-old reputation that proves we know what our customers need. So don't guess and don't wonder about it, don't sweat it! Use the toll free Sam Ash Hot Line, and find out now.

GUITARS • AMPS • SOUND REINFORCEMENT EQUIP •
KEYBOARDS • DRUMS • ALL INSTRUMENTS & ACCESSORIES

HOTLINE CALL TOLL FREE:
800-645-3518
IN NEW YORK STATE CALL 212-347-7757

Since 1924
Sam Ash
MUSIC STORES



301 PENINSULA BOULEVARD, HEMPSTEAD NEW YORK 11552



CIRCLE 124 ON READER SERVICE CARD

down, meaner approach to the blues, Belushi and Akroyd could do for urban blues what Leon Redbone has done for the exposure and preservation of early twentieth-century music. S.R.

ROD STEWART: *Blondes Have More Fun.* [Tom Dowd, producer; Andy Johns, engineer; no recording location given.] Warner Brothers BSK 3261.

Performance: **His best in years**
Recording: **Quite good**

Rod Stewart, in this reviewer's opinion, has not recorded a totally satisfying album since *Every Picture Tells A Story* in 1971—until now, that is. This



ROD STEWART: A sexy new start

record is brilliant from track to track. The singing, writing, arrangements, production, and musicianship are the best to grace a Rod Stewart album since that groundbreaking monument of the early '70s, which ultimately brought Stewart to superstardom.

That isn't to say that Stewart's attitudes—toward himself, toward women—have gotten any better, but on a strictly musical level, the Mod One has really come through with a shiner. Stewart still sees the need to strut his stuff via such songs as "Do Ya Think I'm Sexy?" his discoesque LP opener, which John Rockwell of the *New York Times* successfully summed up as Stewart's answer to the Stones' "Miss You." But whether anyone besides Stewart himself thinks he's sexy, the

track is one of the most energetic offerings he's recorded of late, and the disco production, though more elaborate than "Miss You," is not overbearing, as one might expect.

There is an even number of rockers and ballads on the record, and while most deal with the familiar themes of Stewart's songs—his lust for women and his disappointment when they don't grovel for him—there's no sense of *déjà vu* on any of the tracks. Producer Tom Dowd must have been snapping a whip in Stewart's direction, because he's working him out of his redundancy, and that's quite a feat.

The album's real success, however, lies not in the emotional tangles which comprise Stewart's lyrics, but in the overall quality of the songs and the recording. Although his band is far from being as accomplished as the Faces, and all three guitarists in this band still can not equal the output of one Ron Wood, they are a tempered lot, and the crispness and simplicity of the mix brings forward their best. Additionally, Nicky Hopkins' piano and Tom Scott's horn playing fills in those gaps that the basic band leaves open. And Stewart, whatever his private ego may be like, has found his niche vocally here: he can be powerful when required to be, and when he's not trying so hard, he can even sound sexy.

The last three cuts on the record are, if not highlights, indicative of the consistency of the package. "Last Summer," were it released during the summer, would be a smash seasonal hit. Light and breezy, set to a tropical pace, and amended with bells and percussion, this is low-keyed Stewart at his best. Next, the Four Tops' hit, "Standin' In The Shadows Of Love" is redone as a powerful hard-rocker—backed up by Philip Chen's driving bass, and brought to a crashing finish with all three guitarists wailing away. Finally, "Scared And Scared" is another "Killing Of Georgie," only this time a lightly strummed acoustic guitar and a bluesy harp usher in the story of the condemned killer of a 17 year-old boy. The killer asks for a new start. The singer, Rod Stewart, has already earned his. J.T.

PETER TOSH: *Bush Doctor.* [Peter Tosh, Robert Shakespeare, and The Glimmer Twins, producers; Geoffrey Chung and Joe Gibbs Studio of Kingston, engineers; recorded at Dynamic Sounds, Kingston, Jamaica.] Rolling Stones Records COC 39109.

Performance: **Good to inconsistent**
Recording: **Pretty hot, mon**

Although Peter Tosh really smoked (literally) on his recent U.S. tour, his latest album is slightly inconsistent and virtually incapable of capturing the excitement Tosh creates "live." That is not to say that *Bush Doctor* is a bad album; its irresistible reggae rhythms keep *Bush Doctor* high key throughout, especially on "Soon Come" and "I'm The Toughest." But man does not live by beat alone.

Mick Jagger's guest vocals on "Don't Look Back" start *Bush Doctor* off on a phony, showbiz note. In the first place, any attempt to "rejuvenate" an old Temptations classic like this one ranks just short of heresy. The tune wouldn't sound half bad were it not for the gratuitous appearance of Jagger, whose lead and harmony vocals are decidedly *unsouful*. Borrowing from early American R&B has been an accepted reggae practice since the idiom began, but this one depends more on star status than musical merits. The other Glimmer Twin, Keith Richards, plays a less distracting guitar role on the title cut and on "Stand Firm."

A good instrumental brew distinguishes "Bush Doctor," the Jamaican's latest in a series of "legalize marijuana" appeals. Other reggae tunes like "Dem Ha Fe Get A Beaten" are funky continuations of the deep-voiced revolution themes that Tosh delivers better than almost anybody, including his former affiliates in The Wailers (Tosh was a founding member on rhythm guitar). But Peter's forte is his earthiness, and needless horn arranging on certain tunes may intrude on the raw power of his reggae. Cuts like "Stand Firm" or "Pick Myself Up" gain a lightweight pop attitude that doesn't hold up next to the singer's stronger stuff. Even the least impressive of these songs can boast funky appeal—but they often lack the gut-level urgency displayed on previous Tosh albums like *Equal Rights* (Columbia), for example.

"Moses - The Prophets" ends side one with a slow, perking religio-reggae message, but the album's finale, "Creation," really spells out the gospel according to rastaman. After a female choir introduces the piece with Handel's grandiose Hallelujah chorus from *The Messiah*, Tosh comes in reciting a Jah version of Genesis that reads: "...in the beginning Jah created the Heaven and the Earth." The balance of "Creation" is a very mellow hymn sung over



PETER TOSH BAND: Not the same excitement as "live," but very good

acoustic autoharp, guitar, and meteorological sound effects. It's a format similar to the prayers Richie Havens sang on *Stonehenge* (Stormy Forest) almost a decade ago. But it's a beautiful and effective departure for the Bush Doctor (as his friends now call him), known previously as a man who generally rocks right out of control.

R.H.



HERBIE HANCOCK & CHICK COREA: *An Evening With Herbie Hancock & Chick Corea.* [Herbie Hancock and David Rubinson, producers; Bernie Kirsh, engineer; Rory Kaplan, "live" sound engineer; recorded "live" at Masonic Auditorium in San Francisco, Dorothy Chandler Pavilion in Los Angeles, Golden Hall in San Diego, Ca. and Hill Auditorium in Ann Arbor, Mich. during February, 1978.] Columbia PC2 35663.

Performance: **Accomplished**
Recording: **Crystalline**

Jazz purists felt somewhat vindicated when this famous duo hit the road in 1978 with just two grand pianos to their name—no Headhunters, no Return to Forever, no synthesizers, and no lack of chops and/or imagination. Their parallel roots going back to Miles Davis in the sixties, these two keyboard giants had first played four-handed piano a couple of years earlier when "Soundstage" aired a version of "Someday My Prince Will Come" on PBS. It was evident then that Hancock

and Corea had much in common, and this subsequent tour certainly bears that out.

This seriously produced two-record set covers a lot of ground, including a thirty-five minute medley of "Maiden Voyage/La Fiesta" that closed most of the concerts. Producer David Rubinson, in his liner notes, explains that "...these performances have not been technically or electronically enhanced, nor is the sound limited or compressed. In order to achieve as nearly as possible a 'direct-to-disc' sense, the selections are presented in the order in which they were performed. Side Four is over 35 minutes long, which resulted in a slightly higher surface noise and overall lower level than could have been achieved had the tape been edited and the side made shorter."

If there is any difference in fidelity, it's barely noticeable—the sound on this album is excellent. The program followed on this record is almost identical to the one heard in almost every city on the tour. "Someday My Prince Will Come" is the light fantasy opener designed to create nostalgia for the Milesian era, a straight duet that's really just a warm-up for things to come. The next cut, George Gershwin's "Liza," strides into a more involved, four-handed exhibition, based on a rollicking blues tempo but spinning off into modal experimentation. Then back to boogie woogie, lightning-quick allusions to other Gershwin numbers, and a Tatumesque finish.

Also common to most of the Chick & Herbie Shows was "Button Up," a co-authored original taking up all of side two. This is a free experiment that builds to bumblebee speeds and eventually arrives at what the twosome called their "hook"—a muted note Chick

J&R
THE ONE-STOP MUSIC SHOP AT WHOLESALE PRICES

BLANK TAPES		REEL-TO-REEL		
CASSETTE TAPES		Maxell UD 35-90 1800 ft. \$5.49	Maxell UDXL 35-900 1800 ft. \$6.75	
Amplex Grand Master I C-60 \$2.14	Amplex Grand Master I C-90 \$2.79	Maxell UD 35 180 3600 ft. \$15.30	Scotch 212 1800 ft. \$4.35	
BASF Studio C-90 \$1.99	BASF Professional II or III C-60 \$2.99	Scotch 207 1800 ft. \$6.19	TDK L-1500 1800 ft. \$6.22	
Maxell UD C-60 \$1.92	Maxell UD L-90 \$2.85	VIDEO-TAPES		
Maxell UDXL I or II C-60 \$2.50	Maxell UDXL I or II C-90 \$3.47	BETA FORMAT		
Scotch low noise/Dynatrane C-90 / 3 pm. \$4.99 for 3	Scotch Master I C-90 \$2.84	Sony L-750 (3 Hour) \$18.95	Sony L-500 (2 Hour) \$13.95	
Scotch Master II or III C-90 \$3.29	Sony Ferrichrome C-90 \$3.58	Scotch L-500 (2 Hour) \$13.50	Zenith L-500 (2 Hour) \$13.95	
TDK D C-60 \$1.20	TDK D C-90 \$1.68	Amplex L-500 (2 Hour) \$12.95	VHS FORMAT	
TDK D C-120 \$2.10	TDK D C-180 \$2.99	JVC T-120 (4 Hour) \$18.75	TDK T-120 (4 Hour) \$19.50	
TDK AD C-90 \$1.79	TDK AD C-90 \$2.52	Fuji T-120 (4 Hour) \$17.95	RCA VK-250 (4 Hour) \$18.95	
TDK SA C-60 \$2.22	TDK SA C-90 \$3.18	RCA VK-125 (2 Hour) \$14.95	Panasonic NVT-120 (4 Hour) \$18.95	
			Panasonic NVT-40 (2 Hour) \$14.95	

CARTRIDGES		SHURE	
audio-technica		SHURE	
AT 20 SLA \$119.00	AT-15 SA \$85.90	V15 TYPE IV \$89.90	V15 TYPE III \$64.95
AT-14 SA \$48.95	AT-12 SA \$4.90	M5ED \$29.75	M7ED \$32.50
AT-10 \$12.00	881S \$72.50	M4E \$13.80	M7DE \$19.90
881EE-S \$55.00	881EE \$42.50	PICKERING	
680EE \$24.90	900E \$12.60	XSV/3000 \$49.95	XV15/200E \$39.95
EMPIRE		XV15/50E \$32.50	XV15/625E \$25.77
2000Z \$59.90	2000T \$31.50	XV15/400E \$22.45	
2000EIII \$19.50	4000DI \$29.90		

HEADPHONES		KOSS	
SIEMENSHEIMER		KOSS	
HD-44 \$23.88	HD-400 \$26.28	PRO 4AA \$39.90	PRO 4 AAA \$48.00
HD-414 \$44.88	HD-424 \$65.28	HV11 \$29.97	HV7LC \$35.37
		K16A \$19.97	

HOW TO ORDER: For shipment within 48 hours, send money order or certified check. Two weeks delay on personal checks. Please add \$3.50 per order for shipping & handling. (B5.50 for orders outside U.S.). N.Y.S. residents add tax. No C.O.D.'s. All merchandise 100% guaranteed, brand new & factory fresh.

J&R MUSIC WORLD
33 PARK ROW, NEW YORK, N.Y. 10038
ORDER TOLL FREE (800) 221-8180
CALL OR WRITE FOR FREE 96 PAGE CATALOG
CIRCLE 37 ON READER SERVICE CARD

By Popular Demand!

THE HISTORY OF **RECORDING**
By Robert Angus

The entire six-part series from Modern Recording Magazine. Reprinted as a specially bound book for only \$3.50. Send for this edition today! Send check or money order to:

Modern Recording Magazine
14 Vanderventer Ave.
Port Washington, N.Y. 11050

A SINGER'S DREAM!



REMOVES VOCAL FROM MOST STEREO DISCS

The Thompson Vocal Eliminator can actually remove most or all of a solo vocalist from a standard stereo record and yet leave the background music virtually untouched! Not an equalizer! We can prove it works on the phone. Write for a brochure and demo record. COST: \$195.00

ECHO REVERB

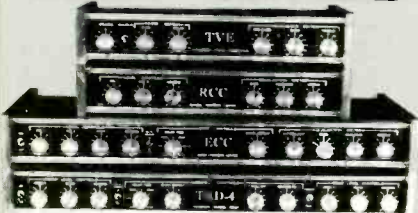

We do it BETTER FOR LESS

Whether your interest is in using ambiance for a concert hall effect or as an echo chamber for studio recording use, we manufacture a broad line of sophisticated analog delay Echo and Reverberation devices at prices which only direct sales make possible. Prices from \$159 to \$495.

Write for a brochure and demo record. Include \$1 to cover costs (refunded with order.)

Write to: **L T Sound, Dept MR**
P. O. Box 1061,
Decatur, GA 30031
Phone: (404) 284-5155



John Simonton's time-proven design provides two envelope generators VCA, VCO & VCF in a low cost, easy to use package.

Use alone with its built-in ribbon controller or modify to use with guitar, electronic piano, polytonic keyboards, etc.

The perfect introduction to electronic music and best of all, the Gnome is only \$59.95 in easy to assemble kit form. Is it any wonder why we've sold thousands?

Send GNOME MICRO-SYNTHESIZER Kit (\$59.95 plus \$2.00 postage)

GNOME MICRO-SYNTHESIZER (Fully Assembled) \$100.00 plus \$2 postage

Send FREE CATALOG

name: _____

address: _____

city: _____ state: _____ zip: _____

BAC/VISA MC card no. _____

B&A DEPT. 7MR
 1020 W. WILSHIRE, OKLAHOMA CITY, OK 73118

CIRCLE 60 ON READER SERVICE CARD

ROOTS:

COUNT BASIE, DIZZY GILLESPIE— and Black Arthur Blythe

By Nat Hentoff

For much of jazz recorded history, it was uncommon to hire musicians of different styles for the same session. The younger players, more adventurous harmonically and rhythmically, would unsettle the elders, it was said. Well, it all depends on who's asked to the date. One of the most thoroughly satisfying jazz albums of this decade is the newly released, *The Gifted Ones* (Pablo) on which the two main figures are Dizzy Gillespie and Count Basie.

There isn't the slightest sense of strain, and indeed, Dizzy and the Count sound as if they had been woodshedding together for years. The reason, as Joe Pass says in the notes, is that their "roots are the same." Dizzy, after all, came up in hot, swing-era bands while Basie was leading the most rhythmically flowing of all those orchestras. Both, moreover, are utterly confident in jazz's common language, the blues. Also, as Pass notes, "Basie never does the wrong thing." His spare, intensely attentive conception could spur and support just about any musician, of whatever age.

Dizzy here is manifestly enjoying himself, drawing even more nuances of color from his horn than usual, swinging long and deep as he plumbs the rhythm waves. There is more solo Basie than is customary, which all by itself greatly enhances the value of the set. And bassist Ray Brown and drummer Mickey Roker fit together with high, propulsive energy. The sound-quality is splendid—spacious, immediate, and exactly balanced.

The depth of Black Arthur Blythe's roots is such that, as one musician puts it, "he can play the entire history of the music in one phrase." An alumnus of Chico Hamilton's combo, among others,

Blythe is generally regarded these days as a key figure in the new jazz (or new black music) scene. And so he is, but his playing does indeed encompass all of jazz, as in *Lenox Avenue Breakdown* (Columbia). His colleagues, also deeply grounded in the jazz lineage, include flutist James Newton; guitarist James "Blood" Ulmer; bassist Cecil McBee; drummer Jak DeJohnette; the extraordinarily resourceful tuba player, Bob Stewart; and percussionist Guillem Franco.

Collectively, their sound seems huger than the number of the individual parts; and the soloists, soaring out of and then plunging back into the brilliantly textured ensemble, are continually compelling. Moreover, collectively and individually, there is an exceptional mastery of dynamics so that there are no doldrums. This music *moves* all the time, and part of the credit for such momentum is due the daring but firmly disciplined percussion section, one of the most exciting on record in a long time.

The engineering meets the challenge of placing all this rich, lively interplay into clear, precise, sonic perspective. It is encouraging, by the way, to see a major label support undiluted jazz of this range and quality.

DIZZY GILLESPIE, COUNT BASIE, RAY BROWN, MICKEY ROKER: *The Gifted Ones*. [Norman Granz, producer; Val Valentin, engineer.] Pablo 2310 833.

ARTHUR BLYTHE: *Lenox Avenue Breakdown*. [Bob Thiele; producer; Doug Epstein, engineer.] Columbia 35638.

Here's a Guide to the Record Business by the Pros!

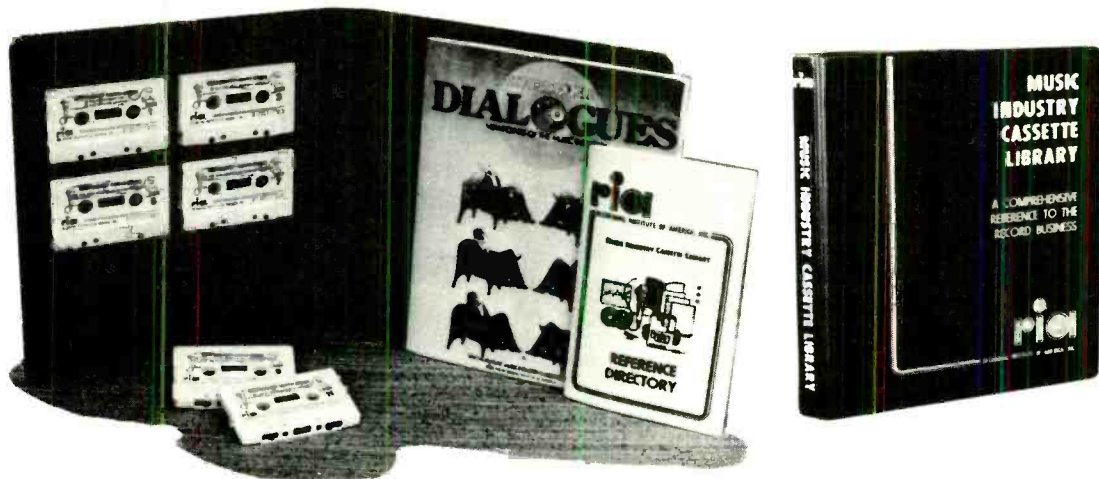

Compiled from Recording Institute of America's interviews with key executives and "hit-makers", plus Reference Directory and Dialogue's Viewpoints of industry "stars"

Listen to the industry "pros" describe the workings of the Music Business. Hear the most respected attorneys of the entertainment field define and discuss the legal terminology of Recording Contracts, Songwriter Contracts, Professional Management Contracts. Over 3½ hours of professional reference... could be the most important 200 minutes of your life!

Plus... RIA Reference Directory, including sample songwriter affiliation forms, sample artist contracts, writer contracts, etc., in addition to a Directory of Record Manufacturers, Music Publishers, Personal Managers, Producers and Booking Agents. Also Record World's "Dialogues" with over 50 candid interviews from Record World magazine, and a cross-section of "star" personality interviews.

You get all the above (regularly \$49.95) for only \$39.95 for MR readers.

Home Recording Course

—a must for every creative tape recorder owner!



HOME RECORDING TECHNIQUES is three hours on two 7-inch, 7½ ips, 4-track tapes, including a booklet of diagrams on:

- sample microphone placement
- instrument set-up
- console and machine patching for special effects
- and MUCH MORE!

ONLY \$19.95

ORDER FORM — MAIL TODAY

907C

MODERN RECORDING

Magazine
14 Vandeventer Ave., Port Washington, N.Y. 11050

Please send [] copies of Music Industry Cassette Library at \$39.95 each

Please send [] copies of Home Recording Techniques at \$19.95

Please Print

Name _____

Signature _____

Address _____

City _____ State _____ Zip _____

Total Amount _____ Check/ Money Order for \$ _____

10 Day Money Back Guarantee DATE ____/____/____



HERBIE HANCOCK AND CHICK COREA: Surprisingly compatible

makes by fingering a string inside the piano and hitting the corresponding key rhythmically—a percussive, steel drum sound that both men jam on exuberantly. Knocks, pings, slams, and echoes subsequently bring fascinating new sounds from the twin 9-footers.

Side three is all Hancock, a solo improve called “February Moment” that evolves from an ethereal, misty introspection into slow-walking left hand and gospel blues runs from the right. It’s great stuff and an excellent contrast to Corea’s previous 30-minute solo, a Herculean exploration of the piano that is not, for some reason, recorded here. Another concert highlight omitted on this collection is the twosome’s complex duet on “Mikrokosmos” by Bela Bartok. This should have been a three-record set instead of only these two.

The finale is a surprisingly compatible marriage of Hancock’s timeless “Maiden Voyage” and Corea’s “La Fiesta.” Hancock is enticed into the uncommon role of playing a Corea-like Spanish lead while Chick comps and stomps in real Spanish dance shoes, clapping hands and dancing as he did on *My Spanish Heart* (Polydor). It’s a rousing conclusion to an impressive, almost classical album. Now that Hancock’s going disco and Corea’s into pop vocals, jazz fans better cherish these serious efforts when and wherever the opportunities present themselves. R.H.

JEAN-MICHEL JARRE: *Equinoxe*. [Jean-Michel Jarre, producer; Jean-Pierre Janiaud, mixing engineer; assisted by Patrick Foulon; recorded at Jean-Michel Jarre’s private studio, January-August 1978.] Polydor PD 1-6175.

Performance: **Approaching state of the art?**

Recording: **Very good**

Listeners will either love or hate Jean-Michel Jarre’s second recording; there’s not likely going to be much middle ground on this, just as there isn’t much middle ground on similar recordings by Larry Fast, Klaus Schulze or Michael Hoenig. These men are musicians who have carried Terry Riley’s vision of music of the future into the present tense, for better or worse.

Jarre, the son of movie composer Maurice Jarre, is one of the better practitioners of the art of synthesized music because he knows what he is doing with a wide variety of electronic instruments, and knows what a melody is. *Equinoxe* is a satisfying blend of electronic wizardry and legitimate music.

Jarre also takes care of his product, and the end result is a clean, crisp sound that very easily could have become mushy and dense. The dense nature of some of the tracks is due more to the composition than to the recording.

For those of you that stickle for

details, Jarre has used the following instruments on *Equinoxe*: the 2600 ARP synthesizer, the AKS synthesizer, the VCS 3 synthesizer, the Yamaha Polyphonic Synthesizer, the Oberheim polyphonic synthesizer, the RMI harmonic synthesizer, the RMI keyboard computer, the ELKA 707, the Korg polyphonic ensemble, an Eminent, a Mellotron, the ARP sequencer, the Oberheim digital sequencer, the Matrisesequencer 250, the Rhythmi-computer and the Vocoder E.M.S. The resulting mix is a smooth blend of an incredible variety of sounds, virtually all of them pleasing to the ear, and most of them pleasing to the sensibilities.

One of the reasons *Equinoxe* succeeds as a recording is Jarre’s wise use of the separate channels on each of the tracks. Side one opens, for example, with a ping-pong ball of light sound, which develops into an arpeggio played over a single tone. Jarre creates flat tones, rounded tones, elastic tones, brittle tones. He both layers sounds atop each other, and bounces sounds against each other in this recording.

The material is hard to categorize when boiled down to its musical content. At its worst it probably would become Muzak for the folks in the data processing center if it blended real with synthesized instruments. Each side contains four tracks, although they occasionally advance without breaks. The dominant tempo is Spanish or Latin, and a few of the tracks even have a Spanish-sounding melody.

Jarre seems very businesslike in moving the tracks along, only occasionally pausing to throw some tension in through the use of major- and minor-key conflicts. He knows how to create some nice crescendoes, but his use of percussive effects does not add a substantial rhythmic underpinning—much less a plain old back beat—to the songs. The entire album sounds at first hearing almost as if it is written in the same time signature (of course, it is not), and the bass and percussion used here contribute more to the total sound of the compositions than to any sense of driving rhythm.

The album, however, is not without its sound effects—most noticeable, some crashing thunderclaps, rolling thunder and simulated rainstorms. And right near the end of the album comes one of the most delightful sounds of a carnival or gypsy caravan, starting in the distance in one channel, swelling to the center, stopping, and moving into

the distance of the other channel. It is a theme that is developed much too briefly, but one savors the tambourine and tuba for the short time they are heard.

There's a lot going on at all times in *Equinoxe*—rarely are there any fewer than four instrumental voices being played simultaneously—and almost all of it is interesting, even intriguing. The complaints about the cold, impersonal, mechanical, perfunctory and literally

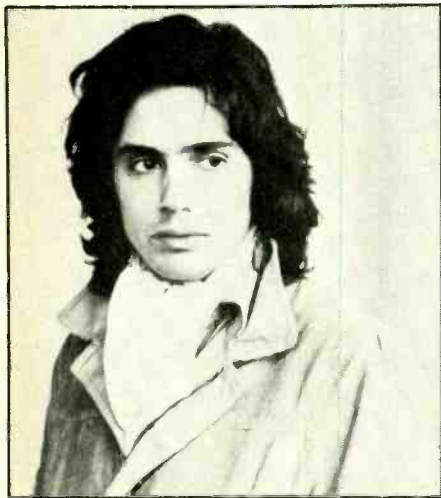

JEAN MICHEL JARRE: Fine synthesis

synthetic nature of this kind of music undoubtedly could be applied to *Equinoxe* (after all, how can one tell from a record whether Jarre is playing his ARP with any feeling or passion?), but the final product stands on its own merits, in its own category of recorded music, as an outstanding example of what man and machine can fashion. Jarre truly has synthesized some fine music here, a worthy successor to the widely-acclaimed *Oxygene*. S.R.

PAUL HORN: *Dream Machine*. [Al Schmitt, producer; recorded and mixed by Rick Ruggieri; Don Henderson, assistant engineer; recorded at Capitol Recording Studios, Hollywood, Ca., Jan. 23-27, 1978.] Mushroom MRS 5010.

Performance: **Sophisticated, sometimes earthy, mostly hollow**
Recording: **Smooth and bright**

At first hearing, one wonders if this is the same Paul Horn whose classically-inspired jazz flute records of the 1960s were so striking. But after repeated listening, one realizes that this is the same man, even though his

musical setting is much different.

Working with material that is composed, arranged and conducted by Lalo Schifrin, Horn and his ensemble of more than a dozen have produced some splashily bright jazz that leans toward both funk and fusion. At its worst, the material here sounds somewhat contrived and without real substance; at its best, it is generally upbeat in both tempo and mood and a good blend of skilled musicians.

What some jazz fans may notice, however, is that the overall sound of the material, both in melody lines and in arrangements, resembles something that is being cranked out with considerable regularity by Bob James and his compatriots over at Columbia's Tappan Zee jazz factory. Metallic bass pluckings, bright cymbals and drums, shimmering percussion and prominent synthesizer charts—all this can be found on the Horn record, just as it can be found on the Bob James records.

"Undercurrents" is a funky little song with a brisk, quick back beat in the bass and drums, featuring Horn's jazz flute over a backup of brass. "Dream Machine" starts out slowly, with a beautiful piano and flute duet, before subtly shifting speed to become another uptempo number. The synthesizer and female chorus before the final fadeout signal the return to the opening theme.

A Latin tempo marks "Vera Cruz," and this piece typifies my impression that this is just a Bob James-sounding jazz album in disguise. The song contains a percussion and brass passage that is very good, but it just fades out to nothing too quickly. Horn's throaty flute in the melody of "Witch Doctor" is very good, but the rhythm here, approaching disco, cannot be distinguished from the other uptempo pieces included on the album.

The last two cuts on the album are probably the best. "Quite Early One Morning" opens with a tiny, mousy synthesizer and cascading flute arpeggios. Crisp brass phrases, very nervous sounding, are played, and Horn provides an echo effect with his flute toward the end. The synthesizer is busy throughout and creates a nice call-and-response effect between channels. The bass by Abraham Laboriel assumes a strange cooing sound, which creates quite an effect with the drums, and Mike Melvoin has a good piano solo.

"The Juggler" has a slower tempo and Horn's flute has a brief, but very

SUBSCRIBER SERVICE

CHANGE OF ADDRESS

Planning to move? Please let us know six weeks in advance so you won't miss a single issue of MODERN RECORDING. Attach old label and print new address in space provided. Also include your mailing label whenever you write concerning your subscription to insure prompt service on your inquiry.

Name _____
Address _____
City _____
State _____
Zip _____
Date _____

New Address Here

Attach Label Here

Please print

MODERN RECORDING Magazine
14 Vanderventer Ave. • Port Washington, N.Y. 11050

DON'T MISS OUT on back issues of MR!



Just send \$2.00 plus \$.50 for postage and handling per issue to:

Modern Recording
Back Issues Dept.
14 Vanderventer Avenue
Port Washington, N.Y. 11050

Check Box:

- Dec. 1978 May 1979
 March 1979 June 1979
 April 1978 July 1979

Sorry! All other back issues are out of print.

Name _____

Address _____

City _____

State _____ Zip _____

breathy role here. The brass is muted, and the song features a relaxed improvisational line. A good guitar solo appears here, too.

This is not primarily a flute album, and some of Horn's old fans might be disappointed because of that. The

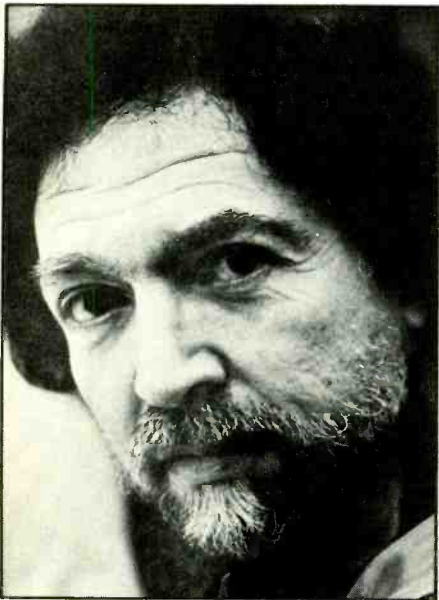

PAUL HORN: Splashy and bright

album also is not entirely new, because the current pressing actually is a restyled package of material that was released in the summer of 1978. The album does have more than forty minutes of bright, if somewhat inconsequential, collaboration between Horn and Schifrin. S.R.

CHARLIE PARKER: *The Complete Savoy Studio Sessions.* [Bob Porter, Steve Baker, producers; Rudy Van Gelder, remastering engineer. Original 78s produced by Buck Ram and Teddy Reig; recorded in New York, N.Y. and Detroit, Michigan, between Sept. 15, 1944 and Sept. 24, 1948; recording engineers included Doug Hawkins, Harry Smith and Jim Syracuse.] Savoy 5500.

Performance: **From early-Bird to midflight—all things wondrous and wise**

Recording: **Remarkable, especially considering how poor the originals were**

CHARLIE PARKER: *Apartment Jam Sessions.* [Art Zimmerman, producer; Jerry Valburn, reissue engineer; from home recordings in the collections of Gers Yowell and Don Lamphers;

recorded in the William Henry apartment building, New York, N.Y., in 1950.] Zim 1006.

Performance: **Late Bird—still wondrous and wise**

Recording: **Primitive, but at least it gives us the hint of genius**

To begin with a well-known and obvious fact, Charlie Parker was a creative and innovative jazz genius, perhaps the last we'll ever hear of that breed. That's quite a statement coming from a writer who followed Parker around Chicago in the late '40s trying to figure out the new jazz but totally unable to comprehend it. I think it's because of my bad habit of attempting to intellectualize music rather than relying on feelings and emotions. I'd have been better off had I read Parker's 1949 interview in *Down Beat* where he described his music as "It's just music. It's playing clean and looking for the pretty notes." And isn't that what all the jazz giants tried to do—Armstrong, Beiderbecke, Waller, all of them?

So here it is, and when they say *complete*, they mean *complete*. It's all here: the issued takes, the out takes, the false starts, the conversations, essentially every note Charlie Parker recorded for Savoy Records. Herman Lubinsky, tainted saint that he was, did at least one thing right. Everything that was recorded, issued or not, was preserved on sixteen-inch acetate safety copies. These were stored away in vaults and were not available to collectors. Consequently, when Bob Porter found them they were in shape to reissue. Bob would have made that project number one at Savoy except that the Detroit session of December 21, 1947 was missing. Bob wasn't about to bring out an incomplete complete collection. His patience was eventually rewarded, for while checking a stack of unlabeled ten inch dubbings, he turned up the missing Detroit safeties which had been recorded on ten-inchers due to a lack of sixteen-inch discs in the Detroit studio.

There is a lot of Charlie Parker on these LPs that you'll be hearing for the first time. The September 1944 Tiny Grimes session that opens this five-album set may well be the first session to show Parker as a fully-developed, mature artist. Before his next Savoy date, his first as leader, he had come to national attention via recordings with Red Norvo's group on Comet and two sessions with Dizzy Gillespie and

friends on Guild (later reissued on Musicraft and now part of the Prestige-Fantasy-Milestone catalog). From there on it grows. All the familiar favorites are there ("Ko Ko," "Donna Lee," "Now's The Time," "Parker's Mood"), along with their alternate takes and unfinished masters. Interestingly enough, only "Klaunstance" is a one-take job. The other selection with only one master, "Warming Up A Riff," is really an out-take on the chords of "Cherokee" which finally ended up as "Ko Ko," a Parker classic. The illustrated booklet is full of data, details and anecdotes as well as a revealing interview with Teddy Reig to whom we all owe more than we can pay for recording Bird in the first place. He had to deal with such insurmountable odds as Herman Lubinsky's penny-pinching, sub-standard engineering in some cases and, I'm sure, enough unpredictability on Parker's part that we can understand a lot of the frustration which he conveys in the interview that paints a less than flattering portrait of an artist who was known to be exasperating at times.

The Apartment Jams on the Zim LP came later, but they are no less essential. They had the disadvantage of being recorded on a home tape machine and the tapes had undergone some decay by the time that Art Zimmerman managed to get them onto LP (read his technical note on the sleeve for the full details). The other disadvantage is that so many players showed up at the jams, and there was so little available tape, that only Bird's solos were preserved. While I'd like to hear more of Jon Eardly on trumpet, Jimmy Knepper on trombone and Gers Yowell on piano, the most important player on the date was Bird and the priorities of the recordists were right on target. So we have other alternates from the repertoires of Savoy (e.g. "Half Nelson"), Dial (e.g. "Scrapple From The Apple") and the later Norman Granz/Mercury/Verve repertoire (e.g. "Star Eyes").

They are all separate parts of the whole Charlie Parker, done just as though five years before his untimely death he had a premonition that he'd better get his latest thoughts on these classics down. Frankly, I don't remember if he was playing things like "Donna Lee" and "Little Willie Leaps" as a part of his normal repertoire that late in his career or not. But he sure played them in 1950 at Gers Yowell's apartment jams.

So those who got hold of the com-

The new DN34 analogue time processor.

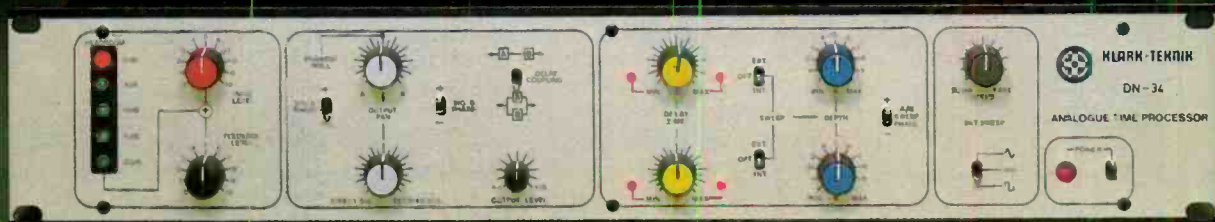

Think of the effect you'll have.

The new DN34 analogue time processor is an exceptionally versatile signal processing and special effects unit designed around two discrete, independently controllable delay sections.

Like other Klark-Teknik products, the DN34 is the result of intensive research and development - the best there is in state-of-the-art analogue delay technology.

With a product of this stature you can achieve all these effects cleanly and noiselessly.

- Positive flanging.
- Negative flanging
- Double tracking.
- Resonant flanging.
- Triple tracking.
- Loudness enhancement.
- Pitch detune.
- Pitch shifting.
- True vibrato.
- Chorus.
- 'Cardboard tube' echo.
- Doppler/Leslie effects.

And, if this isn't enough, the DN34 can give you such new effects as:-

- Crossover flanging.
- Time-related frequency synthesis.
- Complex Doppler effects.

The DN34 analogue time processor also offers you:-

- A dynamic range better than 90dB.
- A time sweep range of 70:1.
- T.H.D. at less than 0.3%.
- Numerous exclusive features including full 'on board' mixing and phase reversal facilities.
- Amazing performance and value for money.

The DN34 is unequalled in the signal processing field today.

And we're not just saying that for effect.



KLARK-TEKNIK

You know it's the best.

For further information about the DN34, our new DN70 digital time processor and also our DN27 and DN22 graphic equalisers:

Hammond Industries Inc. 155 Michael Drive,
Syosset, New York 11791 (516) 364-1900; West Coast
Office (213) 846-0500; Canada (416) 677-0545



CHARLIE PARKER: Wondrous & wise

plete Dial Sessions in the limited edition on Warner Brothers (maybe now Warners will put them out again since the Savoy's are available) and lack only the few odd sides on Comet, Guild/Musicaft, Continental and whatever that label was that Parker recorded for with Slim Gaillard, have almost every studio recording Charlie Parker made between his emergence as a major figure on the New York scene with what the press called "rebop" and September 1948, just prior to his signing with the Granz/Mercury conglomerate. There's a lot of clean playing to be heard here, a lot of pretty notes, but then there was that whenever Bird played—whenever, wherever.

God bless Teddy Reig and Gers Yowell and Bob Porter and Steve Backer and Clive Davis and Art Zimmerman and even Herman Lubinsky who, despite his miserly attitudes, sometimes let guys like Teddy Reig push him in the right direction. And God Bless Rudy Van Gelder—who ever thought anybody could clean up those scratchy, hissy 78s? But most of all, *God Bless Charlie Parker*—he's the one who made the music! J.K.

GARY BURTON: *Times Square*. [Manfred Eicher, producer; Tony May, engineer; recorded January 1978 at Generation Sound Studio, New York, N.Y.] ECM 1-1111.

Performance: **Neo-bebop**
Recording: **In line with
the best ECM sound**

ECM records, currently being distributed in the U.S. by Warner Brothers Records Inc., has always been the class new jazz label. Their product has always been well-produced, well-planned and well-engineered and their surfaces have been silence embodied. Their repertoire, from which I would also judge Manfred Eicher's tastes, runs mostly to the avant-garde but, at least in the case of Gary Burton, nothing is new and nothing is old. I hope I'm not damaging the sales of this superb LP when I point out that it's really bebop with a few new twists and turns. Gary Burton appeared on the jazz scene shortly after the bop generation had flourished but you can tell that he lived on an early diet of Charlie Parker and the rest of the best of the boppers. Many of his solos, like theirs, are constructed in a linear vein...yet Gary Burton can play with the full-voiced, chordal sense of a Red Norvo who predated bop but lasted well into the new music.

The classic Gary Burton Quartet included Burton on vibes, Steve Swallow on bass guitar, Larry Coryell on guitar and Bill Goodwin or Roy Haynes on drums. Haynes and Swallow are back again for this outing but Coryell has other music to fry. I'm glad that it was decided not to bring in another guitarist who would have either had to live up to the Coryell syndrome by imitating him or be compared in the balance and found wanting by those who want to go back to the good old days at the "Scene" and the "Cafe Au Go Go." But, alas, Steve Paul isn't on the scene anymore, Jim Kweskin dropped his jug band, and Tiny Tim is no longer a local character (he now belongs to the world). So the Burton Quartet



GARY BURTON: New twist on bebop

still lives on and flourishes but with a trumpet instead of a guitar. It's a softer sound, a prettier sound and certainly a more acoustic sound.

Most of the tunes on the album are Steve Swallow's compositions. There are two by Keith Jarrett, one by J. (Jim?) Hall and one which is a collaboration between Roy Haynes and Swallow. If I'm entitled to favorites (and I always have favorites whether I'm entitled or not) it's Gary's playing of Steve Swallow's "Midnight." Unfortunately, as in the case of most modern jazz musicians, there are no old standards to hang onto, but that's all part of the hang up of being contemporary.

The engineering of Tony May and the production of Manfred Eicher do nothing to call attention to themselves. They achieve a faithful reproduction of the music, not distorted or overblown. It's an example of what I consider the true ultimate goal in recording technology. It's so well done that you simply forget that it's there. J.K.

AURACLE: *City Slickers*. [Teo Macero, producer; Hank Cicalo and Terry Becker, engineers; recorded at Crimson Sound Studios, Santa Monica, Ca.] Chrysalis CHR 1210.

Performance: **Slicker, funkier**
Recording: **Equally hip**

Teo Macero has latched onto these prodigies like they were fledgling Miles Davises. Critic Dan Morgenstern dropped his jaw when he first heard them. And rave reviews have rolled in almost nonstop since Auracle emerged from the college ranks to play festivals and record *Glider*, their first album, for Chrysalis Records.

The fact that these six guys, aged 23-25, are just a year or so out of the Eastman School of Music speaks well for today's jazz education processes. Incredible technicians on their individual instruments, the members of Auracle are successfully fighting off the institutional tag that haunts other university jazz grads, i.e., that they supposedly lack soul and creativity. It is true that this band is not yet to the pioneering stage where they can burn their mark on the edges of established jazz. But Auracle is already exploring new seams between jazz, classical, and popular music—and finding an intelligent instrumental style uniquely their own.

If there are problems on *City Slicker*,

The new M12.

It eliminates the three deadly sins of live performance mixing.

If a mixer can't deliver a complete range of functions, high-quality electronics and rugged reliability, it can't bring a live concert to life.

But now, Fender® introduces the M12 Live Performance Mixer—a fully expandable 12 in/4 out mixer with staggering possibilities for both live concerts and live recording.

Functions you want for the options you need.

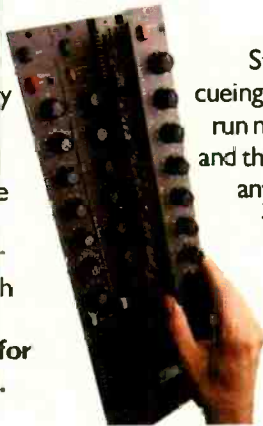

Start with submasters, limiters, cueing-talkback, hi-level in/outs that run multiple effects simultaneously and the capability of assigning signals anywhere on the board. They're functions you'd expect to find on mixers costing a whole lot more.

Mixing drums, keyboards or vocals is a job in itself. You can take advantage of the M12's full-function design by mixing as many mike or direct inputs as you need on one submaster, then mixing the rest of your band and patched-in effects on the other.

Full cueing-talkback. Listen to Program or any of the three monitor mixes or any independent channels via earphones. And communicate to Program, monitors or the cue/stage monitor mix with talkback.



High-performance electronics. All Lo-z input and output channels are transformer coupled and floating. High slew rate, low-noise op amps are used throughout. Continuous gain controls allow input impedances to remain unaltered. Equivalent input noise is -128 Dbm.

Rely on it. The M12 was definitely designed to perform every time.

The rigid extruded front panels and built-in case keep the M12 mixing down when other mixers give up. And modular construction makes a rare servicing a snap.

Check out the M12's complete value story at your authorized Fender dealer. With functions, electronics and reliability like this, the M12 just might be a whole new standard in live performance mixers. Check it out today.

NEW from
Fender
MADE IN U.S.A.

Professional Sound Products
1300 E. Valencia Drive
Fullerton, CA 92631

CIRCLE 101 ON READER SERVICE CARD



AURACLE: Using their skills in increasingly sophisticated ways

they pertain only to matters of individual taste and originality. Since writers like Steve Rehbein (percussion) and Rick Braun (trumpet) are still establishing themselves, it's easy to classify their opening "Little City Slickers" as a Weather Report offshoot. Because keyboardist Biff Hannon has just returned to the group from a three-year stretch with Maynard Ferguson, it's no surprise to hear glossy horn charts and commercial dance underpinnings on "Tied Shoes." Drummer Ron Wagner's indebtedness to Eric Gale seems cleverly disguised on "Rotary Andy's Raggedy." And yet, all of these tunes, and particularly the latter, contain colorful snatches of new sounds and ideas mixed with heady soloing.

Other compositions, not so easily categorized, come even closer to the Auracle ideal of eclectic influences, instrumental diversity, and oft-difficult head arrangements. "Bombs Away Ballet," for instance, is an incredible display of high-speed horn ensemble precision—a hustling theme with the flawless savvy of Supersax. "City Of Penetrating Light" has intriguing levels of intensity, and even the basic ballad format of "Honey" takes on added dimension because of a warming percussive groove.

Auracle plays interesting, multi-tiered music that puts to shame many so-called jazz veterans. Although immaculately produced and fastidious right down to each recorded detail, these people are not at all interested in

getting comfortable, they want to use their skills in increasingly sophisticated ways. Even Chuck Mangione (probably an idol to these Rochester-raised collegians) could learn something from the way Auracle reaches out on each of their two albums. R.H.

CLASSICAL

BERLIOZ: *Symphonie Fantastique, Op. 14 (Solo piano version by Franz Liszt)*. Idil Biret, pianist. [Ilhan Mimaroglu, producer; David Smith, George Piros, engineers; recorded at Town Hall, New York.] Finnadar SR 9023.

Performance: **Tour de force**
Recording: **Very good**

Although Franz Liszt's piano transcriptions of other composers' orchestral works do turn up occasionally, they are an unjustly neglected chunk of the virtuoso literature, and the present work, Liszt's 1833 transcription of the Berlioz *Symphonie Fantastique* is a real rarity. These sort of things always open themselves up to great pedantic debates. How, it is asked, can a piano transcription hope to convey the brilliance of coloration that distinguishes the Berlioz original?

Obviously, a great deal of the color is

lost in translation. But comparing the two versions is somewhat like comparing apples and oranges or, like comparing a color photo with a black and white print. The question to be asked here is whether the piano version can convey the sense of drama and emotion implicit in Berlioz's music, and the answer is that while there are very few letdowns (the "drum roll" at the end of the scaffold scene, for instance, doesn't quite come off on the piano), Liszt has captured the lion's share of the work's excitement. Of equal importance, he has created a startling virtuoso vehicle. Idil Biret, a Turkish pianist who is not yet widely known in the U.S. but whose previous recordings indicate an adventurous spirit, is equal to the task. In fact, she has even managed to play a section of the work written on a third staff by Liszt with the note: "This third line is not performable on the piano at the same time as the other ones, but simply acts as an indication of the context of the original score." According to the jacket notes, no overdubbing was used to achieve this feat. Biret's playing, particularly in the densely notated "Witches Sabbath" movement, is nothing less than astounding.

The recording is fine, although the side break occurs at an unfortunate spot (during the third movement). The surfaces were clean and quiet. A.K.

PINCHAS ZUCKERMANN & CLAUDE BOLLING: *Suite For Violin & Jazz Piano*. [Claude Bolling and Yves Chamberland, producers; Claude Ermelin, engineer; recorded in 1978 at Studio Davout, Paris, France.] Columbia M 35128.

Performance: **Classic jazz fusion**
Recording: **Comfortable and clear**

The idea of classical jazz fusion is nothing new. It has been attempted with varying degrees of success by such un-similar souls as George Gershwin, Darius Milhaud, Igor Stravinsky, Rolf Liberman, Scott Joplin, James P. Johnson, Duke Ellington, Ornette Coleman and Bix Beiderbecke. Few were any more successful than Claude Bolling in truly fusing the elements of improvised jazz and written down classical orchestration. Maybe Leonard Bernstein came closer than anyone but that was because he was truly a part of both idioms, being as at home on the Broadway stage as he ever was in Carnegie Hall. Bolling is out of the jazz

Carvin

The Professional's Choice

At Carvin you're not only buying the best, but the price is right too!

We handcraft guitars & other professional products in limited production quantities and sell only DIRECT to you thus passing on exceptional quality with big savings.

Our products include JBL, Emilar, & Gauss components housed in Horn-Loaded Bass Systems and Radial Horns. Mixing Boards ranging from 6 Ch Stereo w Power to 32 Channel Consoles. Our new Bi-Channel Guitar Amps feature 2 totally independent channels with separate EQ, Reverb, Sustain Drives, and Master Volumes with LED Foot Switch for Ch to Ch switching.

Our custom Guitars feature optional Birds-Eye Maple Hardwood with Gold Hardware, Ebony fingerboard, Schaller Keys, and the Super Hot M22 Pickups.

Try us for 10 Days and prove that we're better or your money back.

Write for our FREE 64 page Technical Catalog, or Call TOLL-FREE 800-854-2235 (Calif. 714-747-1710) Mon. Thru Fri. for more information.

JBL

gauss

Celestion

CARVIN

As Pictured

- VT112 TUBE AMP w Ch to Ch Switching — Direct \$325
- VTX412 BI-CHANNEL Amp w 4 12" Speakers — DIRECT \$695
- ASG600 Stereo 600W w Bi Amp Crossovers — DIRECT \$495
- JBL520 RADIAL HORN with JBL 2461 Driver — DIRECT \$350
- HORN-LOADED 1330 with JBL K130 — DIRECT \$295
- DC160 Birds-Eye Guitar w Gold Hardware — DIRECT \$720
- Q1608 Quad Board w Ch Parametric EQ, Joystick Panning, Etc. — DIRECT \$2950

Carvin

Dept. MR-25, 1155 Industrial Ave., Escondido, Calif. 92025

© RCLE 105 ON READER SERVICE CARD

www.americanradiohistory.com

FREE CATALOG
Carvin Dept. MR-25, 1155 Industrial Ave., Escondido, Calif. 92025
Name _____
Street _____
City _____ State _____ Zip _____
Guitars Speakers
Amps

sector and whatever his classical training may have been his first recordings show an early allegiance to the dixieland tradition with tunes like "Ory's Creole Trombone," "Riverside Blues" and "Georgia Bo Bo." Along with the 1950s, he got the Ellington bug and got into a more modern idiom. Most recently he has been doing suites for jazz piano and whatever classical virtuoso crosses his path. The first was Jean-Pierre Rampal, the excellent concert flutist. While I didn't enjoy the results, it sold very well; well enough for Columbia to try again with violinist Pinchas Zukerman, who seems to be more attuned to what jazz is all about, but still sounds as if he's reading every note off the printed page. That, to me at least, is not jazz but neither is Gershwin's "Rhapsody In Blue" or Liberman's "Concerto For Jazz Band And Symphony Orchestra" or Joplin's "Treemonisha" or even Bernstein's "Prelude, Fugue and Riffs." That doesn't make it bad. Why shouldn't composers like Gershwin, Liberman, Bernstein and Bolling set down their impressions of jazz, just as Beethoven set down his impressions of various folk songs? It's a valid concept. It's good music and Bolling and Zukerman certainly play their instruments well. If it gives me a twinge to feel that should these gents ever play this tune again it would be exactly the same, they can take heart in that the same was true of such bands as those led by Stan Kenton and Boyd Raeburn and it was frequently true of even Woody Herman's Orchestra (in pieces like "Summer Sequence" and "Lady McGowan's Dream").

Maybe it needs a new word. For a while Gunther Schuller and a few others were writing music that combined both jazz and classical elements and they called it Third Stream. Maybe that's what this is—but don't hold that against it. The music is enjoyable. The performances are workmanlike. The recording is good if unspectacular. George Gershwin's brother, Ira, once wrote, "Who could ask for anything more?" Who indeed? J.K.

ALBENIZ: *Asturias, Mallorca*; **BROUWER:** *Danza caracteristica (1957), Canticum (1968)*; **LAURO:** *Venezuelan Dances 2 and 3, Angstura*; **PONCE:** *Theme, Variations and Finale*; **SOR:** *Variations on a Theme By Mozart, Op. 9*. Sharon Isbin, guitar. [Russ Borud, producer and engineer; recording location not given.] Sound Environment TR 1010.

Performance: Mostly tasteful, sometimes mannered

Recording: Excellent if you don't play it too loud.

Here's an interesting debut disc by a young (22 years old) guitarist who has been making her name both on the recital stage and—unusual for a guitarist—on the international competition circuit. She was the top prize winner at both the International Guitar Competition, in Toronto, 1975, and at the Munich International/Bavarian Radio Competition, in 1976. Competition winners often sound as if they've been stamped out of a mold, playing "safely" in hopes of not alienating the juries. Isbin's style, however, is thoroughly personal. In the traditional works here—the Sor and Albeniz, particularly—her playing reveals a Romantic temperament that was more common in the height of the Segovia era than it is now, and perhaps this introspective approach is about to return after years of reaction against it. In the Albeniz and in the Ponce, these distinctive readings work well, transforming the all-too-familiar staples of the guitar literature into individualistic statements, thereby setting these readings apart from the dozens of others in the catalog. In the case of the Sor *Mozart Variations*, on the other hand, Isbin's manipulation of the phrasing seems to me to have been taken a bit *too* far, making for a mannered reading that takes some time to get used to.

I can't say I care much for the programming order either, especially on side one where the two Leo Brouwer works are separated by the Albeniz "Asturias" and followed by the Sor, making for a stylistic hodgepodge. This was done, no doubt, to help the listener distinguish between two unfamiliar contemporary works. The Brouwer pieces, actually, are the most interesting on the disc, and the stylistic differences between them—they were written eleven years apart—are great. The short *Danza caracteristica* is pleasant, rhythmic and really rather conservative. *Canticum* is more adventurous, calling for a strong technique and an understanding of the demands and vocabulary of avant-garde guitar writing. On this album, Isbin meets these challenges admirably.

The sound here is excellent if the volume control is set to approximate the level at which this soft-spoken instrument is heard in concert. Guitar

records, however, are frequently played "louder than life," and in this case that can be a problem. Even at a level slightly higher than that of a "live" guitar, the basses and strummed chords tend to be overemphasized and boomy. At the level suggested, the recording is perfectly crisp and vibrant, and Isbin's instrumental tone is well regulated and ingratiating. A.K.

BEETHOVEN: Symphony No. 9 in d minor, Op. 125. Kersten Lindberg-Torland, soprano; Else Jena, alto; Erik Sjöberg, tenor; Holger Byrding, baritone; Chorus and Orchestra of Radio Denmark, Fritz Busch conducting. [Producer, engineer not given; recorded "live," September 9, 1950 by Radio Denmark, Copenhagen.] Deutsche Grammonphon Privilege 2535 814—10.

Performance: Exciting

Recording: Solid and crystal clear mono

Among the latest entries in DGG's slightly lower-priced, semi-historical Privilege series is this concert recording of the Beethoven Ninth featuring Fritz Busch and a virtually unknown Danish cast in a performance that rivals many another in the catalog—historical or modern. The performance was taped in 1950, just a year and a week before Busch died, and it represents the height to which he brought the Radio Denmark orchestra since he began shaping it in 1933. The tempos here are brisk throughout, and Busch's pacing combined with the orchestra's tight ensemble playing endows this recording with a sense of excitement I find lacking in, just to name one, the widely revered Furtwangler version from 1942. There are a few flubs in the orchestra—such are the perils of "live" recording—but on the whole, the performers are responsive to Busch's refined and economical reading.

The sound is surprisingly good, certainly much better than one has the right to expect from a 1950 concert recording. This is a single disc, and the *Adagio molto e cantabile* is therefore split. The text of the choral movement is not given, but the assumption most likely is that this is a Ninth for collectors who have other recordings of the work and who can find the text elsewhere. And as such, it should be a welcome addition to any collection. A.K.



MODERN RECORDING

SERVING TODAY'S MUSIC / RECORDING-CONSCIOUS SOCIETY

Because you are...
 creatively involved in how
 sound is produced and
 reproduced, and are
 serious about creating
 & recreating music both
 live & recorded.
Modern Recording
 can help you
 develop your talent.
Subscribe Now.



907C

MODERN RECORDING
 A Worldwide Magazine for the Music Industry
 15 Vandewater Ave. Dept. 1111
 Mahwah, NJ 07430

I wish to subscribe
 renew today and
 save up to \$14.00

\$12.00 for 12 issues
 Save \$6.00

\$22.00 for 24 issues
 Save \$14.00

check money order
 enclosed for the amount of \$

(Foreign subscribers add \$3.00 for each
 year. Foreign subscriptions payable ONLY in
 U.S. funds by international draft or money order)

My account number is

NAME

ADDRESS

CITY

STATE

ZIP

Pay with
BANKCARD
 Visa or MasterCard

Master Charge

Master charge

Bank Americard

CLASSIFIED ADS

Advertiser's Index

R.S. #		Page #
108	Abadon Sun	107
54	Acoustic	41
49	Advanced Audio Designs	101
116	Altair	40
84	Ashly Audio	57
102	Audio-Technica	35
34	Audio-Video Supply	34
47	Audioarts Engineering	22
122	Beyer	25
72	BGW	95
No #	Bose	33
41	BSC	16
105	Carvin	121
112	Cetec Gauss	8
117	Countryman Music	111
88	Dallas Music	103
92	dbx	37
114	Delta Lab.	20
107	DiMarzio	Cover 3
106	DOD	79
42	EAW	11
82	Electro-Voice	26, 27
56	Fender	10
101	Fender	121
121	Gizmo	21
46	GLI	34
71	Harman Kardon	9
123	HH/Heinl Audio Developments	55
37	J&R Music World	113
96	Klark-Teknik (member Hammond Inds.)	119
115	Land Voice Productions	36
76	Loft	32
No #	LT Sound	114
79	Maxell	31
51	Music Emporium	40
94	MXR	Cover 2
120	MXR	64, 65
58	Neptune	75
33	Omni Sound	107
100	Orban	17
No #	Otari	39
60	PAIA	114
89	Peavey	50, 51
80	Quilter Sound Company	71
124	Sam Ash	111
111	Sansui	69
39	Sennheiser	18
118	Shure	77
113	Star Instruments	29
83	Studio Master	3
75	Tangent	7
77	Tapco	19
67	TDK	12, 13
125	TEAC	70, 71
98	Technics	Cover 4
103	Uni-Sync	97
119	U.S. Pioneer	15
110	Whirlwind	38
99	Yamaha	49

8 Track Package—80-8/DX8, model 5/Anvil case, accessories. EAPCO, Box 83, Gloversville, N.Y. 12078.

FREE information on home recording studios. Send stamped envelope to Trackmaster, Box 585, Bremerton, Washington 98310.

RECORDING STUDIO: immediate sale & occupancy. Partially equipped midtown NYC recording studio. Excellent acoustics and location. Wired for video. (212) 679-5670, (203) 226-4200.

SEMI-PRO AND CONSUMER AUDIO EQUIPMENT: TEAC/Tascam, dbx, AKG, Maxell, Delta Lab, Technics, others. Best prices! Prompt delivery! WDI, P.O. Box 340, Cary, NC 27511. (919) 467-8122.

FOR SALE Scully 280 2 track tape recorder space for dolby, \$1800.00. Villa Recorders, 3013 Shoemaker Ave., Modesto, Ca. 95351. (209) 521-1494.

REEL MEALS—complete entrees of Teac, Tascam, Otari, Studiomaster and other delectable studio packages. Side orders of Ampex and 3M tape. Call or write for our free menu. Man-O-Mann Productions, 1300 N. Triphammer Rd., Lansing, N.Y., 14822. (607) 533-7122, (607) 277-3971.

TASCAM 80-8 with DX-8 dbx. Four months old. Asking \$4,000. Mike Fuller (215) 687-3731.

Effortless moving of heavy speakers. Raises on legs for max. sound efficiency. Rolls on four wheels. Send self-addressed stamped envelope for brochure. Hlo Dolly, P.O. Box 2173, Santa Rosa, Ca. 95405.

NEUMANN CUTTING SYSTEM. ES-59 mono head, complete amplifier rack with cables. First \$750.00 takes. Send for used equipment list. Sound Recorders, Inc., 206 So. 44th St., Omaha, NE. 68131. (401) 553-1164.

FREE INFO! "Unique" piano, guitar and music reading methods. SELF-TAUGHT... hours. Guaranteed! Music Magic Co., Box 656, Dept. MR, Ellicott Sta., Buffalo, N.Y. 14205.

FOR SALE 8 channel 1/2 inch Otari MX5050 H5D tape machine, w/console & remote control. Tascam model 5 w/talkback-Anvil flight case, also Crowns, MXR lots of goodies. Call Tim Smith (216) 332-9916, 340 E. State St., Salem, Ohio 44460.

Maine Cape Cod with complete modern recording studio on 9 acres. Beautiful 5 bedroom restored home. Going business or ideal private recording set up. Floyd Ray Really, Auburn, Maine. (207) 784-2976.

BASYN custom digital programmable waveform synthesizers. Keyboards, guitars, vocals, etc. Polyphonic. For information and literature contact Gray Laboratories, 1024 Lancer, San Jose, Ca. 95129. (408) 257-4294.

A.B. Systems, Audioarts Engineering, Ashly Audio, Altec, AKG Pro., dbx, HM Electronics, Ivie, JBL Pro., Loft, Lexicon, Northwest Sound, PSL Products, Shure SR, SAE Pro., Tapco C-12 Dealers, Teac Multitrack, Tascam Model 15, Klark Teknik, Technics Pro., Showco and many more. Call or write for a quote. Professional Sound Labs, Inc., 42 North Franklin Street, Hempstead, New York 11550. (516) 486-5813.

Reinforcement, recording equipment—Tapco, EV, Atlas, etc. Write or call for low mail order prices. Sonix Company, P.O. Box 58, Indian Head, MD. 20640. (301) 753-6432.

If you have a professional multi-track studio, and are interested in becoming a licensed representative for R.I.A.'s Modern Recording Techniques courses, call or write Mr. Chas Kimbrell, R.I.A., 15 Columbus Circle, N.Y., N.Y. 10023. (212) 582-0400. A large profit potential with low operating costs.

**Use
MODERN
RECORDING's
Classified
Ads-
They Get
Results!**

Condensed Professional Recording Session on a 60 min. cassette, puts you right in the studio with the musicians and engineers. Hear the mixing procedures, headphone mixes, special effects, etc. ... contains tricks, techniques, and insight. \$8.95 each. A.M.K. Productions Ltd., P.O. Box 230288, Tigard, Ore. 97223.

MULTI-TRACK AND SEMI-PROFESSIONAL AUDIO EQUIPMENT: BEST PRICES! Prompt delivery! dbx, Teac/Tascam, Sound Workshop, AKG, Delta Lab, Phase Linear, Uni-Sync, Others. Dept. MR, WDI, P.O. Box 340, Cary, N.C. 27511. (919) 467-8122.

JBL AND GAUSS SPEAKER WARRANTY CENTER. Full lines stocked. Instant recone service, compression driver diaphragms for immediate shipment. NEWCOME SOUND, 4684 Indianola Ave., Columbus, Ohio 43214. (614) 268-5605.

UNISTAGE invites you to visit the Northeast's newest professional audio display complex. 4000 sq. ft. stocked with working P.A. systems featuring selections from over 40 brands of electronics; multi-track decks, mixers and monitors; custom keyboard and guitar systems; and complete disco sound arrays. Sales, rentals and service to the professional entertainment industry. Unistage, Inc., 330 Genesee St., Buffalo, N.Y. 14204. (716) 853-6500.

Pickups, Parts, Performance

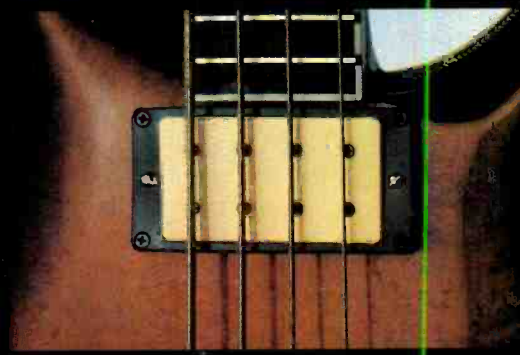
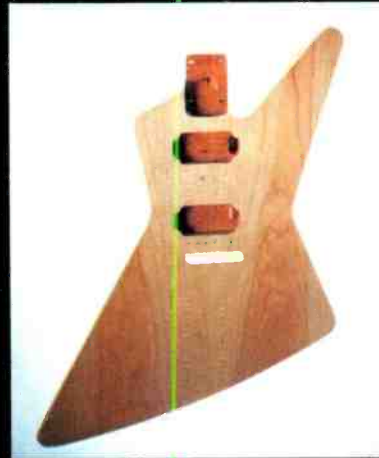
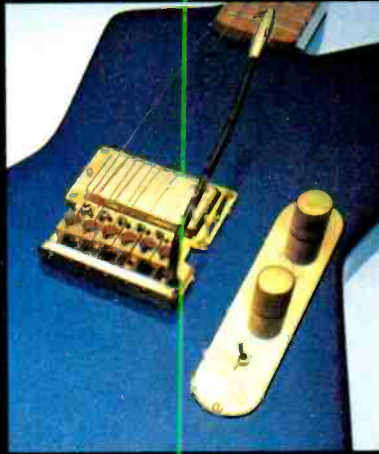

For a complete listing of all
hardware and a catalog, send \$1.00 to:



DiMarzio[®]
Musical Instrument Pickups, Inc.

Dept. MR
1388 Richmond Terrace, Staten Island,
NY 10310 USA (212) 981-9286

CIRCLE 107 ON READER SERVICE CARD

The Technics isolated-loop system.
It's the one big difference
between their decks and ours.



Every one of Technics four open reel decks has one thing in common: The performance of Technics isolated-loop tape transport system. And that means performance that's comparable to professional open reel decks costing thousands of dollars more.

By isolating the tape from external influences, our isolated-loop tape transport system minimizes tape tension to a constant 80 grams. This not only provides extremely stable tape transport and low head wear, it also reduces modulation noise and wow and flutter to the point where they're detectable on only sophisticated testing equipment.

Electronically, our line of isolated-loop tape decks are equally impressive. The reasons are as simple as the r IC, full-logic transport controls, highly accurate microphone amplifiers, FET mixing amplifiers and separate 3-position bias/EQ selectors.

And you'll get all this technology whether you choose the two-track RS-1500, the extended playing time of the 4-track RS-1506 (shown above), the convenience of the

4-track RS-1700 with auto-reverse or the studio features of the RS-1520.

There's also an optional full-feature infrared wireless remote control (RP-070). With it you can get your hands on all this sophistication from up to 20 feet.

All four decks hit the competition right between the reels. Because all four have: FREQ. RESP.: 30-30,000 Hz, ± 3 dB (-10 dB rec. level) at 15 ips. WOW & FLUTTER: 0.018% WRMS at 15 ips. S/N RATIO: 57 dB (1506 & 1700) and 60 dB (1500 & 1520) HAB weighted at 15 ips. SEPARATION: Better than 50 dB. START-UP TIME: 0.7 sec. SPEED DEVIATION: $\pm 0.1\%$ with 1.0 or 1.5 mil tape at 15 ips. SPEED FLUCTUATION: 0.05% with 1.0 or 1.5 mil tape at 15 ips. PITCH CONTROL: $\pm 6\%$.

Technics open reel decks. A rare combination of audio technology. A rare standard of audio excellence.

Cabinetry is simulated woodgrain.

Technics
Professional Series

CIRCLE 98 ON READER SERVICE CARD