

ROY ORBISON:  
1936-1988

HIGH-TECH DIGITAL-INPUT AMP FROM JVC

# HIGH FIDELITY

AUDIO • VIDEO • TEST REPORTS • MUSIC

\$2.50 USA \$2.95 CANADA

MARCH 1989

## FINDING A GOOD DEALER: Buyer's Guide to the Retail Jungle

**TESTED:**  
Realistic CD Changer,  
Harman Kardon Receiver,  
Marantz Amplifier,  
Advent Loudspeaker,  
and More!

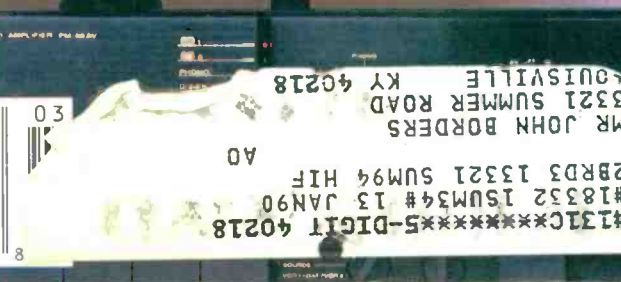

#131C\*\*\*\*\*5-DIGIT 40218  
#18332 1SUM34# 13 JAN90  
2BRD3 13321 SUM94 HIF  
AD  
MR JOHN BORDERS  
3321 SUMNER ROAD  
LOUISVILLE KY 40218



# END OF CONVERSATION.

Close your eyes, put on your favorite CD and listen. That's the best way to appreciate the natural, accurate musical reproduction of the new Elite TZ Series reference loudspeakers from Pioneer.

Designed by the same engineering team that developed Pioneer's renowned TAD studio monitors, the TZ Series speakers are designed to accommodate the extended dynamic range, superb clarity and depth of digital source materials.

Pioneer began by developing two entirely new diaphragm materials—ceramic graphite and ceramic carbon. These unique low-mass materials are used to construct midrange and high-frequency dome-type diaphragms that virtually eliminate spurious resonance while providing lightness, stiffness and excellent signal propagation speed. Now critical midrange frequencies and delicate highs will sound clearer and more natural than ever before.

To reproduce the extended low frequencies found on digital recordings, Pioneer developed a twin woofer system that packs a punch you'll feel as well as hear. Opposite-mounted bar-jointed

woofers placed in the center of the TZ's cabinet minimize standing waves while providing accurate low-frequency response to 20 Hz.

The cabinet of the 143-lb. TZ-9



Unique bar-jointed twin-woofers system.

is specially constructed, using 1" thick high-density board and a separate inner baffle that isolates the negative influence of low-frequency

vibration. Corners are specially rounded to eliminate diffraction and drivers are arranged for optimum sound-field intensity. The result is imaging and clarity that bring performances alive with smooth, true-to-life sound.

But enough conversation. If you're interested in hearing more about Pioneer's new TZ Series speakers, call 1-800-421-1404 for a technical white paper and the Elite dealer nearest you.

And let the speakers do the talking.



© 1989 Pioneer Electronics (USA) Inc., Long Beach, CA  
Model shown: TZ-9. Also available: TZ-7

►THE FACT IS, YOU SHOULD LISTEN TO NEC.

Fact: Over 1400 movies on videotape and laser disc have been encoded with Dolby® Surround Sound.

Fact: Compact discs have established a new level of audio realism.

Fact: TV broadcasts in rich, full-bodied stereo have become the rule, rather than the exception.

With all the amazing new audio source material that's available these days, it's understandable that you'd want to rush right out and get the equipment you need to enjoy it.

But the fact is, much of the equipment that promises to turn the act of listening into a big thrill, can actually turn out to be a big disappointment.

Which is why, when it comes to the subject of Sur-

round Sound, you really should listen to NEC.

►NEC HAS MORE EXPERIENCE WITH SURROUND SOUND THAN ANYONE ELSE.

And that's not the only thing that gives us an edge. You see, NEC Corporation is the leading maker of semiconductors. Since the technology of Surround Sound is largely dependent on micro-

processors, we're in a unique position to create the exact circuitry necessary to give you the most lifelike sound.

For example, only NEC offers digital delay circuitry throughout its entire Surround Sound line.

Many of our components have adjustable

digital delay, which lets you fine-tune delay time, in millisecond increments, to suit the acoustics of your room.

And all our Surround Sound components feature genuine Dolby circuitry, so you can take full advantage of the Dolby Surround Sound information encoded on so many tapes and discs.

What's more, our high-end components offer a level of

Surround Sound that is unsurpassed by anyone in the industry.

It's called Dolby Pro-Logic Surround.

►PRO-LOGIC. THE BEST OF THE BEST.

For sheer audio realism, it rivals anything you've ever heard in any movie theater.

Pro-Logic circuitry is remarkable for its ability to deliver far better channel

separation than conventional systems can: from 26 to 40dB, as compared to only about 3dB.

What's more, Pro-Logic has an active center channel—a separate, additional sound track—which conventional systems lack.

This center channel dramatically heightens realism.

Sound seems to emerge, not from any given speaker, but rather from the precise point in space that it should.

It also *moves* to follow the action of whatever's making the sound, whether it's a bee buzzing slowly across the screen, or an F-16 blasting over your head.

►YOU'VE GOT TO HEAR IT TO BELIEVE IT.

The feeling you get from NEC Surround Sound is impossible to describe in words. Which is why you should ask an NEC dealer for a demonstration.

It'll help reinforce one very important fact:

Certain things in life simply cannot be compromised.

## BEFORE YOU SURROUND YOURSELF WITH SOUND, SURROUND YOURSELF WITH FACTS.



# NEC

C&C

Computers and Communications For more information call: (312) 860-9500 x 3210. NEC Home Electronics (USA), Inc. © Dolby is a registered trademark of Dolby Laboratories.

# HIGH FIDELITY

MARCH 1989

VOL. 39 NO. 3



Tested: Harman Kardon receiver, four more 23



A customer/salesperson guidebook 40



Make way for Roger Norrington 46

## TEST REPORTS

Harman Kardon HK-990Vxi AM/FM audio-video receiver	23
Marantz PM-65AV audio-video integrated amplifier	28
Realistic CD-6000 Compact Disc changer	31
Advent Baby II loudspeaker	33
JVC AX-Z911BK integrated amplifier	35

## AUDIO & VIDEO

Cat 'n Mouse. Tips for selecting a knowledgeable and compatible audio-video salesperson./GORDON BROCKHOUSE	40
--	----

## MUSIC

CLASSICAL A Man for All Seasons. A conductor specializing in period-instrument performance, Roger Norrington is today one of music's most adventurous explorers./SCOTT CANTRELL	46
POPULAR/BACKBEAT Mercy. Lefty Wilbury to some, Roy Orbison to most, the man is dead—but the music thrives on two collections and a brand-new album./JEFF NESIN	49

## COLUMNS

Front Lines A sneak peek at Nakamichi's new DAT deck. MICHAEL RIGGS	5
Crosstalk Mono cancellation; ground terminals./LARRY KLEIN	16
Tape Tracks EQ problems; DBX levels; and more squealing tape. ROBERT LONG	19
The Autophile Riding the RF surf: Antennas catch the waves. BETH C. FISHKIND	21
Bits & Pieces Digital signal-processing reaches the home. DAVID RANADA	22
Medley For Elyse./TED LIBBEY. Fifteen candles for Olivia Records. LESLIE BERMAN	51

## DEPARTMENTS

Letters	6
Currents Infinity RS Series speakers; Hitachi 12-disc CD changer; RCA Pro-Wonder VHS camcorder.	14
Classical Reviews Bach by Rifkin; Harrison by Jarrett; Stravinsky by Stoltzman and Sting.	52
The CD Spread Schwarzkopf's Four Last Songs; Welitsch's Salome finale; Sviatoslav Richter recital.	63
Pop Reviews Fairground Attraction; Cowboy Junkies; CSNY; Anita Baker; Sonic Youth; Bangles; Phil Ochs.	65
In Short Order Carla Bley; R. E. M.; Johnny Winter; Lucinda Williams; Soviet jazz; Hendrix; Roughhouse.	78
Advertising Index	79

On the cover: the Realistic CD-6000 Compact Disc changer (top); the Marantz PM-65AV audio-video integrated amplifier (left); and the Harman Kardon HK-990Vxi AM/FM audio-video receiver (right).



Cover design: Joanne Goodfellow  
Cover photography and electronic image manipulation by David A. Wagner

HIGH FIDELITY (ISSN 0018-1455) is published monthly at 825 Seventh Ave., New York, N.Y. 10019, by ABC Consumer Magazines, Inc., Chilton Company, one of the ABC Publishing Companies, a part of Capital Cities, ABC, Inc. © 1989 by ABC Consumer Magazines, Inc. The design and contents are fully protected by copyright and must not be reproduced in any manner. Second-class postage paid at New York, New York, and at additional mailing offices. Authorized as second-class mail by the Post Office Department, Ottawa, and for payment of postage in cash. Yearly subscription in the U.S.A. and Possessions \$13.95; elsewhere \$20.95. Single copies \$2.50 (Canada \$2.95). Subscribers: Send subscriptions, inquiries, and address changes to HIGH FIDELITY, P.O. Box 10759, Des Moines, Iowa 50340. Change of address: Give old and new addresses, including ZIP codes. Enclose address label from last issue and allow five weeks for change to become effective. POSTMASTER: Send change of address to HIGH FIDELITY, P.O. Box 10759, Des Moines, IA 50340.



# Introducing the Delco/Bose Gold Series Music System.

By now you know that the Delco/Bose music system is the most widely reviewed, and highly acclaimed, automotive music system available. For those who can truly appreciate the quality of Cadillac and the experience of superb music, we invite you to audition the new *Delco/Bose Gold Series Music System*.

The first Delco/Bose music systems earned their acclaim because they represented a bold new approach to automotive musical reproduction, made possible by the most intensive research effort ever made in this field. The new Gold Series Music System builds upon this technological foundation by incorporating the results of six years of additional research and development.

Every critical system component is completely new: amplifiers, equalization circuitry, speakers, digital sound source—even the wire that harnesses them together. In developing them, we made full use of the latest advances in electronic and acoustical technology, materials and design. The result: an automotive music system with even more clarity, power and accuracy—one capable of bringing you even closer to the realism of live music while sitting inside your car.

*We submit that you simply must experience this new music system to believe it.* The Delco/Bose Gold Series is an available option in Sevilles, Eldorados, Fleetwoods and DeVilles at your Cadillac dealer.

**BOSE**  
Better sound through research.



**Delco Electronics**  
Subsidiary of GM Hughes Electronics  
*It's who we are.*



**Delco** **BOSE**  
**GOLD SERIES**



**Editor in Chief** Michael Riggs  
**Associate Publisher** Kathleen Green  
**Art Director** Joanne Goodfellow

**Managing Editor** Jonathan Tesser  
**Copy Editor** G. Donn Teal  
**Assistant Editor** Arinda J. Segarra

#### TECHNICAL DEPARTMENT

**Technical Editor** David Ranada  
**Associate Technical Editor** Beth C. Fishkind  
**Consulting Technical Editors** Edward J. Foster,  
Robert Long  
**Contributing Editor** Larry Klein

#### MUSIC DEPARTMENT

**Classical Music Editor** Theodora W. Libbey, Jr.  
**Popular Music Editor** Ken Richardson  
**Associate Classical Music Editor** Patricia Reilly  
**Contributing Editors** Robert E. Benson, Leslie Berman,  
Jim Bessman, Pamela Bloom, Joe Blum, David Browne,  
Francis Davis, Rev. Thomas L. Dixon, Thor Eckert, Jr.,  
Edward Greenfield, Thomas Hathaway, Paul Hume,  
David Hurwitz, Paul Moor, John Morland, Mark Moses,  
Andrew Nash, Jeff Nesin, Robert R. Reilly,  
K. Robert Schwarz, Terry Teachout, Noah André Trudeau,  
Michael Ullman, Richard C. Walls, James Wierzbicki

#### ART DEPARTMENT

**Assistant Art Director** Laura Sutcliffe  
**Technical Art** Roy Lindstrom

#### PRODUCTION DEPARTMENT

**Production Manager** Marina Paruolo  
**Advertising Production Manager** Gina Fladger  
**Atex System Manager** Mildred Richardson

#### CIRCULATION DEPARTMENT

**Subscriptions** Ora Blackmon-DeBrown, Harold Buckley,  
Maureen Buckley, Beth Healy, Thomas D. Slater,  
Raymond Ward  
**Newsstand** Mitch Frank, Jana Friedman  
**Customer Service** S. Adekemi-Adaralegbe

#### Vice-President

**Group Publisher/Editorial Director** William Tynan

#### ABC CONSUMER MAGAZINES, INC.

**Senior Vice-President** Richard D. Bay  
**Vice-President, Advertising** Peter T. Johnsmeyer  
**Vice-President, Circulation** Robert I. Gursha  
**Vice-President, Production** Ilene Berson Weiner  
**Director, Financial Analysis** Andrew D. Landis  
**Senior Art Director** John Clafalo

**President, ABC Publishing** Robert G. Burton

ABC Consumer Magazines, Inc. 

CHILTON Company, One of the ABC Publishing Companies,  
a part of Capital Cities/ABC, Inc.

HIGH FIDELITY is published monthly by ABC Consumer Magazines, Inc., Chilton Company, one of the ABC Publishing Companies, a part of Capital Cities/ABC, Inc. © 1989 Chilton/ABC Consumer Magazines, Inc. Member, Audit Bureau of Circulations. Indexed in Reader's Guide to Periodical Literature. Current and back copies of HIGH FIDELITY are available on microfilm from University Microfilms, Ann Arbor, Mich. 48106. Microfiche copies (1973 forward) are available from Bell & Howell Micro Photo Div., Old Mansfield Rd., Wooster, Ohio 44691.

#### ADVERTISING OFFICES

**New York:** ABC Consumer Magazines, Inc., 825 Seventh Ave., 8th Fl., New York, N.Y. 10019. Tel. (212) 255-8360. Peter T. Johnsmeyer, Vice President, Advertising; Walter Stolz, Associate Advertising Director; James R. McCallum, Advertising Director (Music/Books); Maria Manasri, Classified Advertising Director.

**Midwest:** HIGH FIDELITY, 191 South Gary Avenue, Carol Stream, Ill. 60188. Tel. (312) 462-2872. Starr Lane, Midwest Advertising Director.

**Los Angeles:** ABC Consumer Magazines, Inc., 2029 Century Park East, Suite 800, Los Angeles, Calif. 90067. Tel. (213) 284-8118. Howard Berman, National Sales Manager.

**Editorial correspondence** should be addressed to The Editor, HIGH FIDELITY, 825 Seventh Ave., New York, N.Y. 10019. Editorial contributions will be welcomed, and payment for articles accepted will be arranged prior to publication. Submissions must be accompanied by return postage and will be handled with reasonable care; however, the publisher assumes no responsibility for return of unsolicited photographs or manuscripts.



### From Nakamichi: DAT at Last?

By Michael Riggs

Last month, while discussing the future of home tape recording, I mentioned Nakamichi's splendid new DAT (digital audio tape) deck, the Model 1000. Shortly after I wrote that column, I had a chance to see, and hear, the machine put through its paces. It was a very impressive demonstration.

The 1000 comes in two relatively large boxes: one for the transport and associated electronics, the other for the A/D (analog-to-digital) and D/A (digital-to-analog) converters, switching, and so forth. Nakamichi has designed the transport so that cassettes load much the same as they would in an analog deck and remain visible while in use. It also winds and cues very fast—several times as fast as a conventional DAT transport, according to Nakamichi.

More interesting, however, is the converter unit (which can handle two Model 1000 transports). Like most such devices, it supports all three standard sampling rates: 32, 44.1, and 48 kHz. What's unusual, at least for a consumer product, is that it will record as well as play back at 44.1 kHz. It will even do direct digital dubs from CDs, regardless of whether the copy-prohibit flag is set on the disc. (A small indicator will light to tell you that the prohibit flag is on, but recording will proceed unfettered.)

This last is a startling departure for a consumer deck, even though it is practically and technically the right way to do things. Previous consumer DAT recorders have honored the copy-prohibit flag, mainly to appease the record companies. For the same reason, they also have been prevented from recording at the 44.1-kHz sampling rate. Unfortunately, these hobbles complicate the task of making dubs from CD to DAT for use in the car or a portable player, which is a key reason for wanting a DAT recorder in the first place.

The consequences of Nakamichi's action are hard to know in advance. For one thing, the 1000 is an extravagantly costly piece of equipment. At \$10,000, it will not compete directly with any other consumer tape recorder of any kind or sell in great volume. The record industry may therefore be inclined to treat the Nakamichi almost as though it were a professional machine (even though there is a separate pro version of the 1000)—and ignore it. Or the industry may decide to sue Nakamichi—as the RIAA has threatened to sue the first company to release a DAT deck in the U.S. consumer market—and to bring the 1000's digital dubbing capabilities before Congress with the claim that they represent a dangerous breach of faith by the audio industry.

The second big question is how other audio manufacturers will respond. Is the 1000 the stalking-horse for a wave of lower-price models from other companies? And if so, will its ability to make direct digital dubs of any CD or digital tape become the standard, or will it remain an aberration? We have heard no plans for DAT launches by other manufacturers, so we can only wait and hope that the 1000 is just a taste of what's soon to come.

That's enough about the deck's political significance. There are two other particularly interesting aspects of its design that I want to mention before closing. One is that the system's modularity lends itself to expansion. Nakamichi has confirmed that it is working on a companion CD player, presumably of similar quality and without internal D/A converters. The second is that the deck does not add dither noise to its analog inputs. I was only about half surprised to learn this, since most PCM adapters have lacked dithering (perhaps because it reduces the measured signal-to-noise ratio slightly). The function of dither in a digital recorder is somewhat analogous to that of bias in an analog deck: Both reduce distortion and increase dynamic range. Running an analog deck without bias is much worse than running a digital one without dither, but I hope dithered inputs will be the rule rather than the exception on future DAT machines.

Naturally, we are eager to get our hands on a Nakamichi Model 1000 and hope to test one as soon as possible. Watch for it. □



STEVE SMALLWOOD

**UNREALISTIC EXPECTATIONS**

In "Brief Life of a Salesman" ["Buying an Audio System," December 1988], Christopher J. Esse states: "The likelihood of getting courteous sales help is greater in a non-discount store, and you pay some for that privilege." I get the impression that Mr. Esse is taken aback by this situation. Naturally, you'll get better and more courteous help from a non-discount store. That you pay for this benefit should be no surprise. Low profit margins are the natural enemy of courteous, knowledgeable salespeople. Gee, Mr. Esse, what's this world coming to? You probably take all the packets of jelly at the diner and then complain when you're charged for a refill of milk. You probably take your taxes to H&R Block and then complain that your neighbor got better service from a CPA. *Nothing* is free. Say it with me: "Nothing is free."

It's about time consumers were exposed to the light of economic reason. Courteous, knowledgeable salespeople get paid for those qualities. If you want a bargain-basement price, expect limited help. On occasion, you might luck into a situation where a really good salesperson works for a discounter, but don't expect him to be there for long: He'll surely find a more profitable work environment.

You're misleading your readers by implying that discounters provide less of a service to their customers than non-discount dealers. A discounter's service is his price. If you want something beyond the lowest price, expect to pay for it. So stop your whining and grow up!

*J. Miller*  
Huntington Beach, Calif.

*Rereading the article in question, we find no indication of surprise at the retail situa-*

*tion described (and no whining). The point conveyed is essentially the one you make in your letter, though perhaps with a little more sympathy for the uninformed shopper.—Ed.*

**ENSEMBLE ENDORSEMENT**

Anyone planning on buying new speakers would be remiss if he did not consider and try out the new Cambridge SoundWorks Ensemble [test report, November 1988]. Intrigued by the advertisements and reviews, I ordered an Ensemble system as instructed, direct from the factory. My first impression upon receiving and opening the shipment was one of amazement at the level of engineering that had gone into merely designing the carton. The box and its contents could have survived World War III.

My second impression, after hooking up and placing the Ensemble components according to the instructions in the excellent owner's manual, was even more amazement at the magnificent sound emanating from those four tiny boxes. Ensemble, as advertised, truly makes the listening room an integral part of the total system. The smooth, seamless soundstage and the astonishingly deep and solid bass must be heard to be believed. I don't think any speaker system costing three or four times more could outperform Henry Kloss's new baby. In addition, the psychological effect of having such luscious sound emanate from nearly invisible speakers (the woofers are completely hidden in my system) adds another fascinating dimension to the Ensemble experience.

A bonus not specifically mentioned in ads or reviews accrues to Ensemble owners whose spouses can't abide room layouts that must be designed around the speakers. With Ensemble, the system can

be designed to fit the room, instead of the other way around.

I hope that having to order an Ensemble system unheard won't put off potential buyers. I don't believe anyone could go wrong with the unconditional money-back guarantee offered by Cambridge SoundWorks. Nor do I believe that anyone who does order and audition this superb speaker system would even consider shipping it back. I, for one, am grateful both to Kloss for designing Ensemble and to HIGH FIDELITY for its usual objective testing and reviewing of the system. Without the latter, I might not have seriously considered ordering—and that would have been my loss.

*John E. Foote*  
U.S. Embassy  
Belgrade, Yugoslavia

**CANADIAN SPEAKERS**

Thank you for Gordon Brockhouse's article on Canadian loudspeakers [November 1988]. HIGH FIDELITY is to be congratulated for not showing the reluctance of other major U.S. audio publications in covering Canadian speakers. Most of them offer unbeatable value, and if they make inroads in the U.S. market, I think American listeners will benefit.



NICHOLAS GAETANO

I was disappointed that you did not include test reports on any Canadian speakers to accompany the article. However, I know that Snell Acoustics has made use of the National Research Council facilities and Dr. Floyd Toole's expertise. Your review of the Snell Type C/II in the same issue indicates their remarkable success in applying what was learned. Clearly it is no



accident that the speaker's off-axis response is outstanding, since Dr. Toole's work has identified this as a key characteristic of high-quality loudspeakers—a fact not stressed in the Brockhouse article. However, I would be surprised if a speaker such as the Energy 22 Reference Monitor, which retails for about \$1,000 U.S., didn't produce similarly excellent measurements and sound. The same could be said for products from Canada's PSB, Paradigm, or Axiom in that price range or lower.

Incidentally, I had the pleasure of meeting Dr. Toole a few years ago. He was very modest about his substantial accomplishments and was happy to give me a complete tour of his testing facilities. I was fascinated by his comments about the latest "breakthroughs" of the day ("good advertising copy," as he put it) and the results of some double-blind listening tests in which highly regarded \$2,000 British speakers were blown away by \$450 Canadian econoboxes. I'm looking forward to the results of his Athena Project.

Paul R. Murray  
Calgary, Alberta

*We had wanted to review the Mirage M-1 loudspeaker in the November HIGH FIDELITY, but samples did not arrive in time; the report did make it into the December issue, however. Interestingly, Peter Snell's design philosophy anticipated Dr. Toole's work, so it is no surprise that the company finds the NRC lab a good place to iron the kinks out of a new speaker. Also, Kevin Voecks, who has designed the Snell loudspeakers since Peter's untimely death several years ago, formerly was the chief engineer at Mirage.—Ed.*

I read with great interest Gordon Brockhouse's article on Canadian loudspeakers and with equally great fascination David Ranada's review of the Snell Type C/II. They certainly whetted my appetite, but then I looked at how they are dressed. All the Canadian speakers are black with black knit grille cloths, and the Snell, too, is completely black. Who wants to have two black towers in his living room? I sure don't. What is needed to persuade speaker manufacturers to get away from this fixation on black?

Also, I would like to see comparisons of speakers so that one could get some idea of what family of sound and imaging a speaker being reviewed belongs to. For instance, how does the Snell Type C/II compare to the Dahlquist DQ-20?

Michael M. Piechowski  
Washburn, Wis.

*The Snell Type C/II and most of the other speakers shown with black cabinets are available in other finishes as well. When we review a speaker, we try to describe how it sounds as best we can. Comparisons with other loudspeakers would necessarily be restricted to other models we had tested and probably would be of little value to anyone*

*who had not actually heard one of these other speakers. They might even be misleading.—Ed.*

**CLEAR COMMUNICATION**

I never cease to be amazed at the clarity with which your technical editor David (Continued on page 10)

## Where to buy Polk Speakers

### AUTHORIZED HOME DEALERS

**CANADA** Call Evolution Technology, Toronto for nearest dealer 1-416-335-4422  
**AK Anchorage:** Magnum Electronics • Fairbanks: Holt's  
**AL Birmingham:** Audition • Oothan: International Audio • Huntsville: Sound Distributors • Mobile: Hi Fi Zone • Montgomery: The Record Shop • Tuscaloosa: Kincaid Stereo & TV  
**AR Ft. Smith:** Stereo One • Little Rock: Leisure Electronics • Searcy: Scottpop  
**AZ Flagstaff:** Sound Pro • Phoenix/Mesa: Hi Fi Sales • Tucson: Audio Emporium • Yuma: Warehouse Stereo  
**CA Bakersfield:** Casa Moore • Campbell: Sound Goods • Canoga Park: Shelley's • Chico: Sounds By Dave • Corona Del Mar: Pacific Coast Audio Video • Davis: World Electronics • Eureka: Eureka Audio Video • Lancaster: California Soundworks • Mountain View: Sound Goods • Napa: Futurvision • Orange: Absolute Audio • Penngrove: California Stereo • Redondo: Systems Design • Sacramento: Good Guys • San Diego: Sound Company • San Francisco & Suburbs: Good Guys, Stereo Store • San Gabriel: Audio Concepts • San Jose: Good Guys • San Luis Obispo: Audio Ecstasy • Santa Barbara: Creative Stereo • Santa Cruz: Sound Wave • Santa Maria: Creative Stereo • Santa Monica: Shelley's Stereo • Sherman Oaks: Systems Design • Stockton: Gluskins • Thousand Oaks: Creative Stereo • Ukiah: Music Hut • Ukiah: Audio Haven • Ventura: Creative Stereo • Victorville: Incredible Sounds • Westminster: Videotek Stereo  
**CO Boulder:** Soundtrack • Colorado Springs: Sunshine Audio • Denver & Suburbs: Soundtrack • Pueblo: Sunshine Audio  
**CT Avon:** Hi Fi Stereo House • Danbury: Carlson's • Fairfield: Audio Design • Greenwich: Al Franklin's • Hartford: Al Franklin's • New Haven: Audio Etc. • Newington: Hi Fi Stereo House • New London: Robert's • Norwalk: Audiotronics • Waterbury: Zino Music  
**DE Wilmington:** Bryn Mawr Stereo  
**FL Daytona Beach:** StereoTops • Ft. Myers: Stereo Garage • Ft. Lauderdale: Sound Advice • Ft. Pierce: Sound Shack • Ft. Walton Beach: Audio International • Gainesville: Electronics World • Jacksonville: Audio Tech • Kay West: Audio International • Lakeland: Sound Factory • Merritt Island: Southern Audio • Miami: Electronic Equipment Co. • Sound Advice • Naples: Stereo Garage • Orlando: Audio Spectrum • Panama City: Watsound Stereo • Pensacola: Fidler Hi Fi • Sunrise: Sound Advice • St. Petersburg: Cooper for Stereo, Sound Advice • Tallahassee: Stereo Store • Tampa: Sound Advice • W. Palm Beach: Electronic Connection, Sound Advice  
**GA Athens:** Hi Fi Buys • Atlanta & Suburbs: Hi Fi Buys • Augusta: Stereo City • Brunswick: Hi-Fi Service Store • Columbus • Merit TV • Macon: Georgia Music • Savannah: Audio Warehouse • Valdosta: Stereo Connection  
**HI Honolulu:** Honolulu Audio Video  
**IA Davenport:** Gregg's Music • Des Moines: Audio Labs • Dodge City: Sound World • Dubuque: Renner Iowa City: Hawkeye Audio • Mason City: Sound World • Waterloo: Team ID Boise: Stereo Shoppe • Sandpoint: Electracraft • Twin Falls: Audio Warehouse  
**IL Alton:** Reliable Stereo • Aurora: Stereo Systems • Carbondale: Southern Stereo • Champaign: Good Vibes • Chicago & Suburbs: United Audio • Decatur: J.R. Lloyd's • DeKalb: Audio Plus • Highland Park: Columbia • Joliet: Stereo Systems  
**IN Kankakee:** Barrett's Entertainment • Lansing: Audio Clinic • Naperville: Stereo Systems • Normal: Sundown One • Peoria: Team Electronics • Rockford: Columbia • Springfield: Sundown One • Spring Valley: Audio Labs • Vernon Hills: Alan's • Waukegan: Alan's  
**IN Bloomington:** Camous Audio • Bluffton: Eley TV & Appliance • Evansville: Riskey's • Ft. Wayne: Classic Stereo • Indianapolis: Ovalton • Lafayette: Good Vibes • Marion: Classic Stereo • Michigan City: Audio Connection • Muncie: Classic Stereo • South Bend: Classic Stereo • Terre Haute: Stereo Crafters

**KS Junction City:** Audio Junction • Overland Park: Audio Electronics • Wichita: Audio Visions • Topeka: Nelson's  
**KY Bowling Green:** Audio Center • Lexington: Ovalton Audio • Louisville: Audio Video Bin Design • Owensboro, Paducah: Riskey's • Pikeville: Mayo Inc.  
**LA Lafayette:** Sound Electronics • Metairie & New Orleans: Alternan Audio • Opelousas: Sound Electronics  
**MA Boston:** Waltham Camera & Stereo • Fitchburg: Fitchburg Music • N. Dartmouth: Sound II • Pittsfield: H.B.S. Stereo • Worcester: O'Coins  
**ME Bangor:** Sound Source • Camden: Harbor Audio • Portland: New England Music  
**MO Annapolis:** Spaceways • Baltimore: Soundscape • College Park: Spaceways • Galthersburg: Audio Buys  
**MI Ann Arbor:** Absolute Sound, Hi Fi Buys • Birmingham: Almas Hi-Fi • Dearborn: Almas Hi-Fi • Farmington Hills: Almas Hi-Fi • Flint: Stereo Center • Grand Rapids: Classic Stereo • Kalamazoo: Classic Stereo • Lansing/Midland: Hi Fi Buys • Potosky: Kurtz Music • Royal Oak: Absolute Sound, Court St. Listening Room • Troy: Kurtz Music  
**MN Duluth:** Mell's TV & Audio • Mankato: Audio King • Minneapolis & Suburbs: Audio King • Rochester: Audio King • St. Paul: Audio King  
**MO Cape Girardeau:** Stereo One • Columbia: Johnston Audio • Rolla: End of the Rainbow • St. Louis: Sound Central  
**MS • Hattisburg:** McLeland TV • Jackson: Hoopers • Pascagoula: Empress  
**MT Billings:** Video Sal • Sound Bozeman: Thrifty Sal • Great Falls: Rocky Mountain Hi-Fi • Missoula: Aspen Sound  
**NE Boone:** Holtons • Chapel Hill: Stereo Sound • Charlotte: Audio Video Systems Conover • Tri City • Greensboro: Stereo Sound • Hendersonville: Pro Sound • Kineston: Stereo Concepts • Moorehead City: Anderson Audio • New Bern: Anderson Audio • Raleigh: Audio Buys, Stereo Sound • Rocky Mount: Microwave Audio • Wilmington: Atlantic Audio • Wilson: Modern Stereo • Winston-Salem: Stereo Sound  
**ND Bismarck:** Pacific Sound • Fargo: Today Electronics  
**NE Kearney:** Midwest Audio • Lincoln: Stereo West • Omaha: Stereo West • York: Midwest Audio  
**NH Concord:** Audio of New England • Laconia: Lakeside Stereo • New London: North Star • Salem: Guamo's  
**NJ East Brunswick:** Atlantic Stereo • Maple Shade: Bryn Mawr Stereo • Montclair: Peptide Audio • Raritan: AC Audio • Ridgewood: Sounding Board • Shrewsbury: Monmouth Stereo • Toms River: Rands, Camera • Wall Twp.: Monmouth Stereo • West Caldwell: Perdue Radio  
**NM Alamogordo:** D&K Electronics • Albuquerque: West Coast Sound • Carlsbad: Beason's • Clovis: Towne Crier • Santa Fe: West Coast Sound • NV Las Vegas: Upper Ear  
**NY Albany:** Clark Music • Batavia: Unicorn Audio • Buffalo: Speaker Shop • Corning: Chemung • Elmira: Chemung • Fredonia: Studio One • Glens Falls: Audio Genesis • Goshen: Longplayer's Stereo • Ithaca: Chemung • Jamestown: Studio One • Manhasset: Audio Breakthroughs • Massena: Hi Fi Shop • Newburgh: Audio Expressions • New Hartford: Adirondack Music • New York City: Audio Breakthroughs, Electronic Workshop • Rochester: JB Sound • Scarsdale: Listening Room • Syracuse: Clark Music • Vestal: Hi-Fi Electronics • Woodbury: Audio Breakthroughs

**OH Akron:** Audio Craft • Canton: Belden Audio • Cleveland & Suburbs: Audio Craft • Cincinnati: Stereo Lab • Columbus: Stereo Lab • Dayton: Stereo Showcase • Findlay: Audio Craft • Lima: Classic Stereo • Toledo: Audio Craft  
**OK Lawton:** Hi-Fi Shop • Oklahoma City: Audio Dimensions • Shawnee: Rave Sounds • Stillwater: Carlines • Tulsa: Audio Advice  
**OR Beaverton:** Stereo Superstors • Eugene: University Hi-Fi • Grants Pass: Shekells • Medford: Shekells • Portland: Stereo Superstors  
**PA Allentown:** Bryn Mawr Stereo • Blakely: Hart Electronics • Bryn Mawr: Bryn Mawr Stereo • Camp Hill: Bryn Mawr Stereo • Chambersburg: Sunrise Electronics • Erie: Studio One • Johnstown: Gary's Entertainment • Kingston: Hart Electronics • Lancaster: G'n T Stereo • Longhome: Bryn Mawr • Montgomeryville: Bryn Mawr Stereo • Natrona Heights: Stereo Land • Philadelphia & Suburbs: Bryn Mawr Stereo • Pittsburgh: Audio Junction • Quakertown: Bryn Mawr Stereo • Reading: G'n T Stereo • Selinsgrove: Stereo Shoppe • State College: Paul & Lynn's Stereo • Stroudsburg: Main St. Audio Video • Westport: Audio Insight • Williamsport: Robert M. Sides  
**PUERTO RICO Rio Piedras:** Precision Audio  
**RI N. Providence:** Easdam Audio  
**SC Anderson:** Music Machine • Charleston: Audio Warehouse • Columbia: Music Machine • Greenville: Mitchell's Stereo • Music Machine • Greenwood: Stereo Shop • Spartansburg: Stereo Shop  
**SD Aberdeen:** Engel Music • Rapid City: Team Electronics • Sioux Falls: Audio King  
**TN Chattanooga:** R&R TV • Cookeville: Lindsey Ward • Chattanooga: New Wave Electronics • Kingsport: Audition • Knoxville: Lindsey Ward • McMinnville: Lindsey Ward • Memphis: New Wave Electronics • Nashville: Hi-Fi Buys  
**TX Amarillo:** Sound Systems Ltd. • Arlington: Sound Idea • Austin: Marcum Electronics • College Station: Audio Video • Corpus Christi: Tape Town • Dallas: Hillcrest Hi-Fidelity • El Paso: Soundquest • Ft. Worth: Sound Idea • Houston: Sheffield Audio • Hurst: Sound Idea • Laredo: Metek International • Longview: Audio Techniques • Lubbock: Electronics Supercenter • San Antonio: Bill Case Sound • San Marcos: Discovery Audio Video • Sherman: Worldwide Stereo • Temple: Audio Tech • Texarkana: Sound Town • Waco: Audio Tech  
**UT Logan:** Stokes Brothers • Ogden: Stokes Brothers • Salt Lake City: Broadway Music • St. George: Boulevard Home Furnishings  
**VA Bristol:** Audition • Charlottesville: Holdens, Stereo Machine • Falls Church/Mannassas: Audio Buys • Richmond: Gary's Stereo • Roanoke: Holdens • Virginia Beach: Digital Sound  
**VT Brattleboro:** Scientific Stereo • Essex Junction: Creative Sound • Rutland: Mountain Music  
**WA Bellingham:** OG Stereo • Chelan: Music Store • Oak Harbor: OG Stereo Center • Richland: Tin Ear Stereo • Spokane: Electracraft (Hall's)  
**WI Appleton:** Sound World • Eau Claire: EME Audio Systems • Green Bay: Sound World • Lacrosse: Sound World • Madison: Happy Medium • Milwaukee: Audio Emporium • Wausau: Sound World  
**WV Barboursville:** Beckley, Charleston: Pied Piper • Clarksburg: Audio Visual Concepts • Huntington: Fred Piper • Piedmont: Sound Gallery • Wheeling: Stereo Lab  
**WY Cheyenne:** Electronics Unlimited





# The ultimate in sound. The

**U2: Rattle & Hum** • New live set includes the hit Desire, Still Haven't Found What I'm Looking For, more. Island 200596

**Anita Baker: Rapture** • Sweet Love, Caught Up In The Rapture, You Bring Me Joy, Been So Long, Mystery, more. Elektra 173404

**Itzhak Perlman: French Violin Showpieces** • Carmen Fantasy, Tzigane, Poème, Havanaise, more. DG DIGITAL 115457

**Tracy Chapman** • Extraordinary singer/songwriter with hit Fast Car, Talkin' Bout A Revolution, Baby Can I Hold You, Mountains O' Things, Why?, etc. Elektra 153582

**Guns N' Roses: Appetite For Destruction** Welcome To The Jungle, Sweet Child O' Mine, It's So Easy, more. Geffen 170348

**Jerry Lee Lewis: Original Sun Greatest Hits** • Whole Lotta Shakin' Goin On, Great Balls Of Fire, more. Rhino 154118

**Kitaro: The Light Of The Spirit** • Sundance, Mysterious Encounter, The Field, In The Beginning, etc. Geffen DIGITAL 164228

**Richard Marx** • Endless Summer Nights, Should've Known Better, Don't Mean Nothing, etc. EMI-Manhattan 134073

**Jimmy Page: Outrider** • Wasting My Time, The Only One, Prison Blues, more. Geffen 123721

**Robert Plant: Now And Zen** • Dance On My Own, Heaven Knows, Tall Cool One, Ship Of Fools, etc. Es Paranza 134392

**Led Zeppelin: Houses Of The Holy** Dyer Maker, Over The Hills And Far Away, etc. Atlantic 134321

**George Harrison: Cloud Nine** • Title song, I Got My Mind Set On You, When We Was Fab, more. Warner/Dark Horse 174328



**Steve Winwood: Roll With It** 154633

**Liz Story: Speechless** • Forgiveness, Speechless, Welcome Home, Back Porch, Vigil, Frog Park, more. RCA/Novus 100494

**Decade/Best Of Steely Dan** MCA 154135

**Beethoven, Symphony No. 7: Coriolan & Prometheus Overtures** • Royal Philharmonic/Previn. RCA DIGITAL 153621

**Jethro Tull: Aqualung** Chrysalis 124705

**Whitney Houston: Whitney** • I Wanna Dance With Somebody (Who Loves Me), Didn't We Almost Have It All, more. Arista 152854

**Metallica: ...And Justice For All** • One, Blackened, title song, To Live Is To Die, Shortest Straw, more. Elektra 200478

**Talking Heads: Naked** • (Nothing But) Flowers, Mr. Jones, Totally Nude, Blind, The Democratic Circus, The Facts Of Life, etc. Fly/Sire DIGITAL 153810

**David Sanborn: Close-Up** • Lush jazz sax effort! Slam, You Are Everything, J.T., Goodbye, Same Girl, etc. Warner Bros. 134408

**Dwight Yoakam: Buenas Noches From A Lonely Room** • Title Song, Streets Of Bakersfield (with Buck Owens), more. Reprise 100099

**The Best Of The Band** Capitol 134485

**Classic Old & Gold, Vol. 1** • 20 hits! A Little Bit Of Soul, He's So Fine, A Teenager In Love, Sweet Talkin' Guy, etc. Laurie 134627

**INXS: Kick** • Need You Tonight, Devil Inside, New Sensation, title song, Never Tear Us Apart, The Loved One, Wild Life, etc. Atlantic DIGITAL 153606

**The Glenn Miller Orchestra: In The Digital Mood** • In The Mood, Chattanooga Choo Choo, more. GRP DIGITAL 143293

**Tangerine Dream: Phaedra** 100510

**Steve Winwood: Chronicles** • Higher Love, Valerie, While You See A Chance, My Love's Leavin', Talking Back To The Night, more. Island 134501

**Pictures At An Exhibition, Night On The Bare Mountain, more** • Montreal Symphony/Dutoit. London DIGITAL 125314

**Whitesnake** • Here I Go Again, Still Of The Night, Give Me All Your Love, Crying In The Rain, Bad Boys, more. Geffen 163629

**ZZ Top: Afterburner** Warner Bros. 164042

**Carly Simon: Greatest Hits Live** Anticipation, You're So Vain, Coming Around Again, Nobody Does It Better, etc. Arista 154537

**Huey Lewis: Small World** • Perfect World, Walking With The Kid, World To Me, Better Be True, Old Antone's, etc. Chrysalis 134347



**Horowitz Plays Mozart** 115436

**Najee: Day By Day** • Personality, title song, That's The Way Of The World, Tonight I'm Yours, Gina, Najee's Nasty Groove, etc. EMI-Manhattan 100001

**Genesis: Invisible Touch** • Land Of Confusion, title song, etc. Atlantic 153740

**More Dirty Dancing** • Do You Love Me, Love Man, Big Girls Don't Cry, Wipeout, Some Kind Of Wonderful, Cry To Me, more. RCA 130766

**The Who's Greatest Hits** MCA 164160

**Tchaikovsky, 1812 Overture; Romeo & Juliet; Nutcracker Suite** • Chicago Symphony/Solti. London DIGITAL 125179

**James Galway: Greatest Hits** RCA 173233

**The Moody Blues: Sur La Mer** • I Know You're Out There Somewhere, No More Lies, Here Comes The Weekend, Vintage Wine, etc. Polydor 124546

**The Beach Boys: Endless Summer** California Girls, Help Me Rhonda, Surfer Girl, more. Capitol 223559

**Cinderella: Long Cold Winter** • Gypsy Road, Don't Know What You Got (Till It's Gone), The Last Mile, etc. Mercury 114780



**Bon Jovi: New Jersey** 100516

**Strauss, Also sprach Zarathustra** Chicago Symphony Orchestra/Reiner. RCA 163627

**Charlie Parker & Dizzy Gillespie: Bird & Diz** • Leap Frog, My Melancholy Baby, Mohawk, etc. Verve 173413

**Robert Palmer: Heavy Nova** • Simply Irresistible, Disturbing Behavior, She Makes My Day, More Than Ever, Change His Ways, etc. EMI-Manhattan 100035

**The Very Best Of The Everly Brothers** Bye Bye Love, Crying In The Rain, Bird Dog, others. Warner Bros. 103826

**Kenny G: Silhouette** • We've Saved The Best For Last, title song, Tradewinds, Pastel, Against Doctor's Orders, Let Go, more. Arista 100603

**D.J. Jazzy Jeff & The Fresh Prince: He's The D.J., I'm The Rapper** • Parents Just Don't Understand, Nightmare On My Street, etc. Jive 264134

**Raffi: Singable Songs For The Very Young** Shoreline 144494

**Elton John: Reg Strikes Back** • A Word In Spanish, I Don't Wanna Go On With You Like That, Goodbye Marlon Brando, Town Of Plenty, etc. MCA DIGITAL 100602

**Elton John: Greatest Hits, Vol. 1** MCA 163322

**Vivaldi, The Four Seasons** • English Concert/Pinnock. Archiv DIGITAL 115356

**Joe Cocker: Classics** Contains 13 Hits! A&M 104887

**Bruce Hornsby And The Range: Scenes From The Southside** • The Valley Road and Jacob's Ladder, plus others. RCA 180187

**Crosby, Stills, Nash & Young: Greatest Hits (So Far)** • Suite: Judy Blue Eyes, etc. Atlantic 130230

**New Age Bach: The Goldberg Variations** Joel Spigelman plays the Kurzweil 250 Digital Keyboard. East-West 100488

**John Cougar Mellencamp: The Lonesome Jubilee** • Paper In Fire, Check It Out, Cherry Bomb, Rooty Toot Toot, etc. Mercury 134420

**Elvis: 18 Number One Hits** RCA 172190

**Robert Cray: Don't Be Afraid Of The Dark** Title song, Don't You Even Care, more. Mercury/Hightone 100471

**Jimi Hendrix: Kiss The Sky** • Purple Haze, All Along The Watchtower, Voodoo Child, Are You Experienced, etc. Reprise 161349

**Parton/Ronstadt/Harris: Trio** • To Know Him Is To Love Him, etc. Warner Bros. 114804

**Chicago 19** • I Don't Wanna Live Without Your Love, Heart In Pieces, etc. Reprise 154404

**Peter Cetera: One More Story** • One Good Woman, more. Warner Bros. 100463

**Buckwheat Zydeco: Taking It Home** Why Does Love Got To Be So Sad? (with Eric Clapton), Creole Country, more. Island 100597

**The Sound Of Music/Orig. Soundtrack** RCA 100046



**Phil Collins: Buster** 100517

**James Taylor's Greatest Hits** Warner Bros. 123790

**Dire Straits: Brothers In Arms** • Money For Nothing, Walk Of Life, So Far Away, more. Warner Bros. DIGITAL 114734

**Pops In Space** • John Williams & The Boston Pops. Music from Close Encounters, Star Wars, others. Philips DIGITAL 105392

**Rod Stewart: Greatest Hits** • Do Ya Think I'm Sexy?, Tonight's The Night, Maggie May, Hot Legs, etc. Warner Bros. 133779

**Andres Segovia Plays Bach** • Includes the famous Chaconne. MCA 163600

**Poison: Open Up And Say...Ahh** • Nothin' But A Good Time, Good Love, Fallen Angel, Love On The Rocks, etc. Capitol/Enigma 173989

**Bobby McFerrin: Simple Pleasures** Don't Worry Be Happy, All I Want, Drive My Car, title song, Good Lovin', more. EMI-Manhattan 164165

**Cream: Disraeli Gears** • Sunshine Of Your Love, more. Polydor 104898

**Simon & Garfunkel: The Concert In Central Park** • Mrs. Robinson, Bridge Over Troubled Water, etc. Warner Bros. 244006

**Alabama: Live** RCA 160027

**Previn: Gershwin** • Rhapsody In Blue, Concerto in F, more. Philips DIGITAL 115437

**Eagles Greatest Hits, Vol. 1** Asylum 123481

**Keith Richards: Talk Is Cheap** • Big Enough, How I Wish, Take It So Hard, Struggle, I Could Have Stood You Up, more. Virgin 100518



**Randy Travis: Old 8x10** 100008

**The Police: Every Breath You Take—The Singles** • Don't Stand So Close To Me ('86), Roxanne, etc. A&M 173924

**Sting: Nothing Like The Sun** • We'll Be Together, They Dance Alone, Be Still My Beating Heart, more. A&M 273965

**Mozart, Overtures** • Academy of St. Martin/Marriner, Marriage Of Figaro, 8 more. Angel DIGITAL 134267

### START NOW WITH 4 COMPACT DISCS!

Yes, pick any 4 compact discs shown here! You need buy just one selection at regular Club prices (usually \$14.98-\$19.98) . . . and take up to one full year to do it. Then you can choose another CD free as a bonus. That's 6 compact discs for the price of 1 and there's nothing more to buy . . . ever! (Shipping & handling added to each shipment.)

### HOW THE CLUB OPERATES

You select from hundreds of exciting compact discs described in the Club's magazine and mailed to you approximately every 3 weeks (19 times a year). Each issue highlights a Featured Selection in your preferred music category, plus alternate selections. If you'd like the Featured Selection, do nothing. It will be sent to you automatically. If you'd prefer an alternate selection, or none at all, just return the

ultimate in savings...

GET **6**  
COMPACT  
DISCS  
FOR THE  
PRICE OF  
**1**

WITH NOTHING MORE  
TO BUY...EVER!

Start with **4** COMPACT DISCS now!  
pay just shipping & handling  
with Club membership.  
Buy just **1** smash hit in one year's time.  
Then get **1** bonus CD of your choice.  
Enjoy **6** CDs for the price of one.

Nothing more to buy...EVER!

Steve Miller: **Born 2 B Blue** • Ya Ya, Born To Be Blue, Jus' A Little Bit, Gold Bless The Child, Filthy McNasty, etc. Capitol 100591

Anthrax: **State Of Euphoria** • Be All, End All; Make Me Laugh; Out Of Sight, Out Of Mind; Schism; more. Island/Megforce 100589

Johnny Cash: **Classic Cash** • Folsom Prison Blues, Ring Of Fire, I Walk The Line, Get Rhythm. Cry, Cry, Cry, more. Mercury 100595

Procol Harum: **Classics** • 12 great hits! A&M 134445

Special EP: **Double Feature** • The Lady And The Sea, Passages, Golden Days, Mirrors, more. GRP DIGITAL 100016

Jazz CD Sampler • Over 67 minutes of jazz, with 5 classic performances by Ella, Armstrong, Basie, Zetzi, etc. PolyGram 173406

The Judds: **Greatest Hits RCA** 144578

Allman Brothers Band: **Eat A Peach** Melissa, Bue Sky Ain't Wastin' Time No More, etc. PolyGram 163353



Dirty Dancing/Soundtrack 182522

Scott Joplin: **Plano Rags** • Joshua Rifkin plays The Entertainer, Maple Leaf Rag, Galopulus Rag, 14 more. Nonesuch 164C55

Eric Clapton: **Time Pieces (The Best Of)** Layla, I Shot The Sheriff, After Midnight, Cocaine, etc. Polydor 123385

card enclosed with each issue of your magazine by the date specified on the card. You will have at least 10 days to decide, or you may return your Featured Selection at our expense. Cancel your membership at any time after completing your membership agreement, simply by writing to us.

**FREE 10-DAY TRIAL**

Listen to your 4 introductory selections for a full 10 days. If not satisfied, return them with no further obligation. You send no money now, so complete the coupon and mail it today.

**SAVE 50%** INSTANT HALF-PRICE BONUS PLAN  
Unlike other clubs, you get 50%-off Bonus Savings with every CD you buy at regular Club prices, effective with your first full-price purchase!



**YOUR SAVINGS START HERE**

Mail to: BMG Compact Disc Club  
P.O. Box 91412 • Indianapolis, IN 46219

YES, please accept my membership in the BMG Compact Disc Club and send me the four Compact Discs I've indicated here, billing me for just shipping and handling under the terms of this ad. I need buy just 1 CD at regular Club prices during the next year—after which I can choose a FREE bonus CD! That's 6 for the price of 1...with nothing more to buy ever! (Shipping & handling is added to each shipment.)

**RUSH ME THESE 4 CDs** (Indicate by number)

D	D	D	D
---	---	---	---

I am most interested in the musical category checked here—but I am always free to choose from any (check one only):

**EASY LISTENING** (Instrumental, Vocal Moods)  **COUNTRY**  
 **HARD ROCK**  **POP/SOFT ROCK**  **CLASSICAL**

MR.  
 MRS.  
 MISS First Name Initial Last Name (PLEASE PRINT)

Address \_\_\_\_\_

City \_\_\_\_\_ State \_\_\_\_\_ Zip \_\_\_\_\_

Telephone (\_\_\_\_\_) \_\_\_\_\_  
Area Code

Signature \_\_\_\_\_

Limited to new members, continental USA only. Current CD Club members not eligible for this offer. One membership per family. We reserve the right to request additional information or reject any applications. Local taxes, if any, will be added.

YCT26 BU

(Continued from page 7)

Ranada communicates information on even the most complicated subjects. I frequently start his "Bits & Pieces" column thinking I'll never understand the subject, then wind up fully enlightened and wanting to read more! As complex as audio and video electronics have become over the last ten years, the technical concepts behind the products boggle the mind. Mr. Ranada unboggles them beautifully.

Loren Rosebraugh  
Agoura Hills, Calif.

#### A VILE COMPARISON?

In his review of Deutsche Grammophon's recent 20th Century Classics line of CDs ["Classical Reviews," December 1988], David Hurwitz makes the remarkable assertion that Kurt Weill is "a terribly underrated composer with a range at least as wide as Stravinsky's." Underrated, possibly, but Weill's few contributions to the literature of concert music have scarcely elevated him to a status approaching Stravinsky's—and for good reason. Stravinsky brought about a near revolution in the

areas of harmonic construct, rhythm and metrical organization, and structural processes. Weill, in such works as his Violin Concerto and his two rather labored symphonies, was content to competently utilize the vocabularies of popular music and of certain types of "serious" music already established by the likes of Stravinsky.

It is difficult to understand why any advocacy of Weill's talents would take the form of subjecting him to a rather cruel comparison with Stravinsky with respect to range. On the one hand we have a genre composer whose unequivocal successes are exclusively allied with Brechtian and American theater. On the other hand we have a 20th-century musical giant whose acknowledged masterpieces encompass chamber music, symphonic music, ballet, cantata and allied choral/orchestral forms, and, arguably, opera. One may as well assert that Norman Rockwell had a "range" at least as wide as Picasso's—which is perfectly ridiculous, of course, but no more so than this absurd assertion.

Leroy W. Southers, Jr.  
Tujunga, Calif.

David Hurwitz replies: I think it would be fair to say that both Stravinsky and Weill composed music in an astonishingly wide range of styles and forms. Their success in these areas, relative to one another, is a matter of taste. Interestingly, both of Weill's symphonies and the Violin Concerto predate Stravinsky's mature work in these genres; looked at in this light, Mr. Southers's contention that Weill appropriated Stravinsky's forms or vocabulary seems rather weak to me.

Stravinsky's stature cannot possibly be demeaned by comparison with Weill, any more than Weill's can be increased by comparison with Stravinsky. That was not my intention in making the comparison. And Stravinsky's reputation is secure without the kind of advocacy Mr. Southers exhibits here—which seems an effort to bolster one composer by deriding another.

#### THE CONTINUING STORY OF "SHE LOVES YOU"

On the question of the "soundstage flip" in the Beatles' "She Loves You"—first men-

(Continued on page 12)

## Slip Inside for a Remarkable Experience

Signet EP700 Extended Performance Dynamic Studiophones

When you first slip on our new Signet EP700 studiophones, prepare for the excitement of truly remarkable sound. You'll hear extended, flat frequency response, pin-point imaging, and superb definition. Our ultra-sensitive EP700 dynamic drive units feature low-mass diaphragms, high-conductivity voice coils, and samarium-cobalt magnets. The result is accurate, musical response to even the most demanding transients from today's digital recordings.

But superb sound is merely the starting point at Signet. A wide low-pressure headband and well-ventilated ear pads offer superior comfort. And the EP700 open-back design keeps you in aural contact with your surroundings. This thorough, uncompromising design approach is available in our complete line of Signet studiophones. Experience the remarkable Signet sound at your nearby dealer. Write for catalog and dealer list today.

signet 

4701 Hudson Drive, Stow, OH 44224



# You've invested too much in your audio system, CD's, LP's, and tapes not to hear all that's there.



There's an incredible amount of enjoyment, excitement, and beauty trapped inside all audio systems. And in CD's, LP's, and tapes!

You can't hear it. Or get it out. Until now.

Now you can unlock sound that's so spectacular you'll hardly believe your ears.

The key is BBE.

#### What's BBE?

Experts say it's:

"The most hearable advance in audio technology since high-fidelity itself." — *Music Connection Magazine*

"Clearly one of the most important advances in electronic reproduction of music to come along in my lifetime." — *Leonard Feather, Los Angeles Times, Washington Post Jazz Critic*

#### What's The BBE Effect?

"The effect is shattering!" — *Music Technology Magazine*

"Whether you are playing LP's, CD's or tapes, the system comes alive." — *Music & Sound Output Magazine*

"I can't imagine working on another album without BBE." — *Steve Levine, producer of The Beach Boys and BPI Producer of the Year.*

#### What's the BBE Difference?

It's "like the difference between high-fidelity speakers with and without pillows in front of them." — *Radio World Magazine*

#### Better Sound Than The Masters

*Music Technology Magazine* made cassette copies using BBE. It told it's readers: "The cassette sound-

ed better than unprocessed masters!"

#### Actions Speak Louder Than Words

When Michael Jackson tours, members of the Michael Jackson Band make sure BBE gets into the act.

#### No Artificial Flavoring

Rather than adding artificial elements, BBE restores natural harmonic balances that are present in live performances.

#### Let's Get Technical

Technically, BBE restores the proper harmonic structure of sound by compensating for amplitude and phase distortion.

#### The BBE SYSTEM:

- Divides the audio spectrum into three bandwidths
- Applies specific phase corrections to each band
- Continuously monitors program material
- Makes dynamic high-frequency amplitude compensations as required

#### BBE Really Fits In

Measuring 16 1/2" x 9" x 1 3/4", BBE fits perfectly into your audio rack. Then just plug it into your wall socket and standard tape loop.

#### Full Money-Back Guarantee

If you don't hear all the sound you've never heard with the new BBE 1002, return it within 30 days. We'll refund your money.

#### Full Warranty

All BBE products are backed by a full year's warranty on all parts and labor. And by our reputation for innovation and leadership in the audio and electronics industries.

#### Easy to Own

Cost of the remarkable BBE 1002 is

only \$189. Pay by check. Or, if more convenient, a major credit card. If you have a Macy's charge and are in New York or New Jersey, pick up your BBE 1002 in any of their audio departments.

#### Easy to Order

It's as easy as one, two, or three.

1. Call us. Toll free.

**1-800-233-8346.**

In California, 1-800-558-3963.

2. Complete and send us the coupon below.

3. Stop by the audio department of any Macy's in New York and New Jersey and take a BBE 1002 home.

Don't miss all the sound you've never heard. Order now.

## **BBE** Sound Inc.

5500 Bolsa Ave. Suite 245  
Huntington Beach, CA 92649  
(714) 897-6766

**1-800-233-8346**

In California, 1-800-558-3963

Send me  BBE 1002 unit(s) at \$189 each. (U.S. currency only. California residents add applicable tax. If rush shipping requested, additional charge is determined by destination. Canadian residents please write for additional information.)

Enclosed is a check for \$ \_\_\_\_\_.

Or please charge to my:

Visa  MasterCard

American Express

Card#

Exp. Date

Signature

Name (print)

Address

City/State/Zip

Area Code / Phone No. (To facilitate shipping)

(Continued from page 10)

tioned by Ken Richardson in his July 1988 review of *Past Masters, Vol. 1* and then clarified in his response to John W. Thiele's November 1988 letter—I'd like to offer the following explanation: This particular track has seven edits! Their times are 0:11, 0:37, 1:01, 1:15, 1:22, 1:29, and 1:31. A very careful listen to the original LP version of "She Loves You" will reveal

*The seven changes are not audible, however, on A Collection of Beatles Oldies. Is this merely because of the terrible fake-stereo sound of "She Loves You" on my vintage copy of that LP, compared with the original mono sound heard on both the Second Album LP and the Past Masters CD? Or is the Beatles Oldies version of the song a different take—or a different editing of various takes? And if the seven changes in*

*stores and bookshops) to determine which specific recordings you want from among the wealth of material listed: nearly 100 titles each by Basie, Ellington, and Goodman, as well as 30 by Miller and ten by Brown. Many of the record companies are major labels, and at least some of their releases should be available in your local record store. Chances are good that your store also will order for you any hard-to-find releases from smaller companies—or you may write directly to the companies using the addresses found in the back of the SCHWANN catalog. As for Severinsen, the catalog has no listing for Command Records, but there are two titles—Best Of and Ja-Da—available from the major label MCA and three more titles—Facets and two volumes of The Tonight Show Band with Doc Severinsen—available from the independent label Amherst (1800 Main St., Suite A, Buffalo, N. Y. 14208).—Ed.*



these edits. True, they are not really noticeable during an average LP hearing. But you know what they say about CDs: "Flaws and all."

*Gerard Masters*  
San Diego, Calif.

*Popular Music Editor Ken Richardson replies: Listening to Past Masters before writing my review, I did hear most of the changes in sound that Mr. Masters suggests are edits. They are especially (and sometimes only) noticeable in the ride cymbal. "Dropouts dog the cymbal," I wrote in my review, "probably because of a deteriorating master." I also wrote, in my response to Mr. Thiele's letter, that the infamous "flip" (the shift at 1:22) is "a disturbing change that is not present on LP versions." Well, consider all those words eaten: Going back to The Beatles' Second Album with fresh ears, I do detect all seven changes. My thanks to Mr. Masters, a very careful listener indeed.*

*the Past Masters version are in fact edits of various takes, which takes are they and why was the editing necessary? It seems we'll never know the answers: Mark Lewisohn's liner notes for the song's Past Masters appearance say "take details unknown," and his recently published book, The Beatles' Recording Sessions (Harmony), adds that "precise details of the recording takes no longer exist, but three reels of tape were filled in putting down 'She Loves You' and its B-side, 'I'll Get You.'"*

#### **BIG-BAND INFORMATION, PLEASE**

Can you tell me where I can obtain recordings of big bands led by Count Basie, Les Brown, Duke Ellington, Benny Goodman, Glenn Miller, etc.? Also, Doc Severinsen on Command Records? Thank you.

*Sally Winter*  
Quincy, Ill.

*Perhaps you should begin by consulting the SCHWANN catalog (available at record*

#### **OF CDs AND ROCK**

I do believe that CDs are great. I do not, however, choose to own any. The limited software available is much too costly. Besides, I enjoy LPs, and if I start listening to CDs, I may find LP surface noise more annoying than I already do. So I take my \$15 and buy a brand-new two-LP set or five bargain-price single LPs selected from musical works recorded throughout the past several decades.

My selections are primarily rock 'n' roll. Not only does the usually high signal level help to mask surface noise, but many of the instruments are electronic (or dependent on electronic devices) and therefore not always subject to the possible degradation in sound of the microphone/electronics chain. These features of rock music make it especially suited to audio reproduction in the home. I sense people discounting rock music too often, when it really makes an audio system do its thing best—aside from providing the juice that circulates in your soul.

*Dan Overman*  
Corvallis, Oreg.

#### **CORRECTION**

Our September 1988 "Autophile" column contained two errors. The DAT players available for the Cadillac Fleetwood Delco/Bose music system are dealer-installed, not factory-installed. Also, North American rights to the ETAK car navigation system are owned by General Motors.—Ed.

*All letters should be addressed to The Editor, HIGH FIDELITY, 825 Seventh Ave., New York, N. Y. 10019. Letters are subject to editing for brevity and clarity.*

# "They Were Designed To Play Music... And Make It Sound Like Music."

This They Do Very Well, In A Most Unobtrusive Way, At A Bargain Price... It's Hard To Imagine Going Wrong With Ensemble."

*Julian Hirsch  
Stereo Review, Sept. '88*

Cambridge SoundWorks has created Ensemble," a speaker system that can provide the sound once reserved for the best speakers under laboratory conditions. It virtually disappears in your room. And because we market it directly, Ensemble costs hundreds less than it would in stores.



*Henry Kloss, creator of the dominant speaker models of the '50s (Acoustic Research), '60s (KLH), and '70s (Advent), brings you Ensemble, a genuinely new kind of speaker system for the '90s, available only factory direct from Cambridge SoundWorks.*

## The best sound comes in four small packages.

Ensemble consists of four speaker units. Two compact low-frequency speakers reproduce the deep bass, while two small satellite units reproduce the rest of the music, making it possible to reproduce just the right amount of energy in each part of the musical range without turning your listening room into a stereo showroom.

## Your listening room works with Ensemble, not against it.

No matter how well a speaker performs, at home the listening room takes over. If you put a conventional speaker where the room can help the low bass, it may hinder the upper ranges, or vice-versa.

## What Henry Kloss tells his friends

Every time I came out with a new speaker at AR, KLH, or Advent, my friends would ask me, "Henry, is it worth the extra money for me to trade up?" And every time I would answer, "No, what you've already got is still good enough."

But today, with the introduction of Ensemble, I tell them, "Perhaps now is the time to give your old speakers to the children."

Ensemble is a Trademark of Cambridge SoundWorks, Inc.

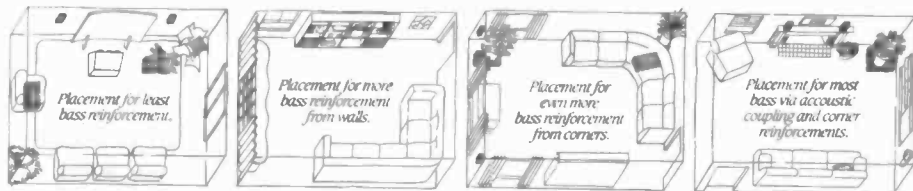

*You can put Ensemble's low-frequency units exactly where they should go for superb bass. You can't do this with conventional speakers because you have to be concerned about the upper frequencies coming from the same enclosures as the low ones.*

Ensemble, on the other hand, *takes advantage* of your room's acoustics. The ear can't tell where bass comes from, which is why Ensemble's bass units can be tucked out of the way—on the floor, atop bookshelves, or under furniture. The satellites can be hung directly on the wall, or placed on windowsills or shelves. No bulky speakers dominate your living space, yet Ensemble reproduces the deep bass that no mini speakers can.

## Not all the differences are as obvious as our two subwoofers.

Unlike seemingly similar three-piece systems, Ensemble uses premium quality components for maximum power handling, individual crossovers that allow several wiring options and cabinets



*Unlike seemingly similar satellite systems which use a single large subwoofer, Ensemble uses two separate, compact bass units. They fit more gracefully into your living environment, and help minimize the effects of the listening room's standing waves.*

ruggedly constructed for proper acoustical performance. We even gold-plate all connectors to prevent corrosion. An even bigger difference is how we sell it...

## Thousands agree: the best showroom is your living room.

We make it possible to audition Ensemble the *right way*—in your own home. In fact, Ensemble is sold *only* by Cambridge SoundWorks directly from the factory. Listen for hours without a salesman hovering nearby. If after 30 days you're not happy, return Ensemble for a full refund.

At only \$499—complete with all hardware and 100' of speaker cable—Ensemble is *the* value on today's speaker market.

Call 1-800-AKA-HIFI\*  
(1-800-252-4434)

Our toll-free number will connect you to a Cambridge SoundWorks audio expert. He or she will answer all your questions, take your order and arrange surface shipment via UPS. Your Cambridge SoundWorks audio expert will continue as your personal contact with us. We think you'll like this new way of doing business.

\*In Canada, call 1-800-525-4434. Audio experts are on duty Mon.-Fri., 9AM-10PM, Sat., Sun., 9AM-6PM Eastern Time. Fax #: 617-332-9229.

## CAMBRIDGE SOUNDWORKS

154 California St., Newton, Massachusetts 02158

Send more information and test reports.

Send Ensemble risk-free for 30 days, for \$499.\*

Send an Ensemble Gift Certificate for \$499.\*

I'm paying by  Check  MC  Visa  AmEx

Acct. Number \_\_\_\_\_ Exp. \_\_\_\_\_

Signature \_\_\_\_\_

Name \_\_\_\_\_

Address \_\_\_\_\_

City \_\_\_\_\_ State \_\_\_\_\_ Zip \_\_\_\_\_

Phone (Area Code) \_\_\_\_\_ Number \_\_\_\_\_

FOR IMMEDIATE SERVICE: 1-800-AKA-HIFI

MA residents add 5% sales tax

\*Plus freight (\$7-\$24).

Delivery time usually 2-7 days.

Suite 103M



Infinity's RS Series: six new speaker systems

## A New Generation

Borrowing advanced technology from both its Kappa Series and its \$50,000 Infinity Reference Standard (IRS) system, Infinity has rolled out six new RS Series speaker systems, including an active sub-woofer designed for use with any of the other new speakers. Prices range from \$85 to \$529 per speaker.

Woofers in the series are made with injection-molded graphite (IMG) cones, like those of the IRS. Infinity says that because this "Curvelinear" cone is injection-molded rather than vacuum-formed, the cone's shape can be critically controlled for lower mass, faster acceleration, and very high self-damping. RS Series dome drivers are made of Polyspherite, a new, proprietary composite material consisting of tiny, hollow graphite spheres bonded to an ultrathin diaphragm of polypropylene. The result is said to be a lightweight driver with the stiffness of graphite and musical neutrality of polypropylene.

The cabinets have been designed to be unobtrusive in the home. The RS-5001 tower, for instance, is 31 by 11½ inches wide by 9½ inches deep, requiring floor space of less than three-quarters of one square foot. Additionally, it positions the high-frequency drivers close to ear level for better imaging and dispersion. Available in either Chatsworth oak or black oak vinyl veneer. *Infinity Systems, 9409 Owensmouth Ave., Chatsworth, Calif. 91311.*

## An Even Dozen Discs

Six in one, half-dozen in the other is how to describe Hitachi's newest CD changer that houses 12 CDs in two identical, six-disc magazines. The DA-C70SW (\$450) lets users add or remove discs in one magazine while the other is playing. Three play modes (long, simple, and program) and three random-play modes can provide as much as 12 hours of uninterrupted music. In long-play, all 12 discs play without stopping; single-play functions much like a single-disc player. In program mode, you can choose as many as 32 selections from 12 loaded discs and play them back in the order you choose.

Under random-play mode, long play randomly plays back selections from all 12 discs. Random play used with single play causes selection order on a single disc to be random. Combining random and program enables you to set up a totally random playback sequence for as many as 32 selections. The DA-C70SW uses two-times oversampling and a Vibration Cut mechanism meant to prevent the laser pickup from skipping. Other features include a 41-key remote, a built-in clock on/off programmable timer, direct search, scan and play, repeat play, skip search, manual search, and resume play standby. *Hitachi, 401 W. Artesia Blvd., Compton, Calif. 90220.*

## Video Big Leagues

Bringing the capabilities of TV production studios to home video are two new full-sized VHS camcorders from RCA. The Pro-Wonder CC-310 (\$1,399) and CC-320 (\$1,499) both use the new ProEdit home video editing system.

ProEdit features include: a flying erase head to prevent video noise between recorded segments; audio-video dub for inserting new video segments or recording a new soundtrack onto the tape; mike mixing to add narration or new sound during dubbing to an already-recorded audio track; Edit Search to position the tape at the start of a new recording; and Synchro-Edit, which, with an optional editing cable, enables the camcorder to control a compatible VCR in order to compile an edited tape of selected scenes. Animation and time-lapse capabilities are provided.

Both models also have an 8:1 power zoom lens, wind-noise filter, auto focus, macro focus, automatic white balance, in-



Enjoy long-lasting tunes with Hitachi's 12-CD changer.



dex recording, high-speed shutter with auto exposure, and on-screen viewfinder display graphics. Additionally, each has an MOS image sensor, and the deluxe CC-320 has a titler/character generator as well as two-speed operation for recording as much as eight hours on a single tape. The CC-320 also has positive/negative recording capability and two-speed recording/playback (SP and EP). *RCA/Thomson Consumer Electronics, 600 N. Sherman Dr., Indianapolis, Ind. 46201.*

### Sony's 8mm Camcorder

Although it offers most of the same features and performance of the highly regarded CCD-V9 8mm camcorder, Sony's new CCD-V11 has a tape transport that is 60 percent smaller and half as heavy. To accomplish this surprising reduction in "form factor," Sony's video engineers took a cue from VHS-C and their own Betamovie system by reducing the diameter of the rotating video head drum (from 1.6 down to 1.05 inches). In the CCD-V11, the tape is wrapped around the drum for 292 degrees (instead of the conventional 180 degrees) and the drum itself contains four video heads, rather than two, as well as a flying erase head. Other innovations contributing to the camera's diminutive size are a tape-loading mechanism that has all the gearing on one horizontal plane and a thinner capstan motor. The new tape mechanism weighs only 6½ ounces, and the camera itself weighs only 2 pounds, 7 ounces, with battery. This is "less than many popular high-end single-lens-reflex (SLR) cameras with zoom lenses," notes Sony. Dimensions of the new camcorder are 3¾ by 4 by 12 inches.

The \$1,850 CCD-V11 uses a ⅓-inch, 420,000-pixel (380,000 effective) CCD as its image sensor. The 6:1 power zoom lens (with macro capability) has a through-the-lens autofocus system with switchable automatic iris control. The variable shutter speed has four settings (1/100, 1/250, 1/1000, and 1/4000 second) in addition to the normal 1/60 second. A built-in, two-page, eight-color, digital-memory graphics superimposer with scroll capability can be used for professional-looking opening and closing credits or other visual effects. A title can even be recorded at home for later superimposition. A date/time generator is provided. To connect the camera to other video equipment, the CCD-V11 has audio and video input and output terminals. In a distinct improvement over the CCD-V9, the V11's viewfinder will tilt upward for low-angle shots. *Sony Corporation*

*of America, Sony Dr., Park Ridge, N.J. 07656.*

### Compact Monitors

From D'Ascanio Audio come the Heybrook HB-150 monitor loudspeakers (\$800 per pair). They are based on the company's HB-2 model with a rear-facing port. The new HB-150s feature twin rear ports that are radiused and foam-lined at their exits for smooth airflow and low distortion, says D'Ascanio.

Drivers include a cast frame 6½-inch bass unit and 1-inch aluminum-dome tweeter. The dust cap on the bass unit has been replaced by a specially designed Cobex "phase plug," which complements the characteristics of the cone and allows it to be used without a crossover. Both drivers are bolted to the cabinet with high-tensile steel bolts for maximum rigidity and performance. The tweeter's crossover network uses polypropylene capacitors and metal film resistors hard-wired to a removable crossover block.

Real wood veneer finishes include black ash or crown walnut. The cabinet is filled with a sandwich of acoustic fiber and longhair wool calculated to absorb the rear radiation of the bass unit. D'Ascanio says this also keeps midrange clarity undisturbed by frequencies that would other-

wise be reflected from inside the cabinet. Impedance is 6 ohms. *D'Ascanio Audio, 11450 Overseas Hwy., Marathon, Fla. 33050. In Canada: D'Ascanio Audio, P.O. Box 1160, Station B, Weston, Ont. M9L 2R9.*

### The Pioneer Picture

Joining Pioneer's Elite series of audio-video components are two new projection monitors. The 45-inch Pro-71 (\$4,150) and the 50-inch Pro-91 (\$4,500) offer improved resolution and picture reproduction plus an expanded vertical viewing angle without perceptible changes in picture brightness. Pioneer accomplished this through a newly developed high-precision screen of 0.99mm dot pitch, 10 percent finer than on previous models. Both models also have a new high-resolution CRT using new electron guns and a green phosphor with improved luminance saturation—which Pioneer says gives a crisp, clear picture, even in corners. The Pro-91 is said to provide 300-footlambert luminance and 700-line horizontal resolution. Cabinet size is 46 inches wide by 52½ inches high and 26 inches deep. Slightly smaller is the Pro-71, measuring 42 inches wide by 49½ inches high by 25 inches deep. It is said to provide 350-footlambert lumi-

*(Continued on page 80)*



*The Pro-91 projection monitor joins Pioneer's Elite series.*



## Answers to Readers' Questions

By Larry Klein

### Mono Cancellation

*My turntable has acted strangely since I bought it. Things sound fine with my amplifier set to stereo, but when I switch to mono for playing some of my old discs, I lose volume and the records sound strange. I thought my amplifier might be at fault, but it works okay with a friend's turntable. Do you have any idea what is wrong?*

*Adam Chelmsky  
Fort Lee, N.J.*

The symptoms you describe would occur if one channel of the turntable had its ground and signal leads interchanged. When your amplifier is set to the stereo mode, the fact that one channel is reversed in phase is apparently not audible. But when your amplifier is switched to mono, the two channels are combined and the out-of-phase condition causes signal cancellation. Check the cartridge connections in the tonearm head shell. If the wiring seems correct but the problem persists, try interchanging the cartridge's right-channel hot- and ground-terminal connections. If the problem disappears, you need go no further. However, if you now hear hum, restore the original right-channel connections and switch the hot and ground leads of the cartridge's left channel. If *that* doesn't cure the problem without hum, the internal wiring of the cartridge or the turntable could be at fault.

### Ground Terminals

*What, if anything, should be done with the terminals marked "ground" found on the rear of most components? Should each component be connected to a separate ground, or should all the grounds simply be wired together? I've used a length of line to connect my integrated amp to the ground screw on a wall-socket plate and have heard no difference.*

*Porter Rostow  
Montebello, Calif.*

The general idea behind having all the metal chassis in a component system connected to a common ground is to ensure that there are no differences among what each component uses for its zero-volt reference level (which is the function of a ground). However, when you are dealing with the microvoltages that can be electromagnetically picked up by the very wires used to ground the equipment, the situation gets a little hairy—and hummy and buzzy.

I won't go into "ground loop" theory except to make the point that separate grounds should always be made to a single central point, rather than "daisy-chained" around a system. Since the shielded cables between your components already interconnect all the chassis' grounds, additional external ground wires can actually introduce problems rather than cure them.

Connections to a separate, external ground *can* be helpful if you live in an older house in which the grounding connections in the AC wiring have become loose or corroded. Under such conditions, an external ground connection—which should be firmly made to a cold-water pipe—can sometimes help minimize hum, RF pickup, or even shock hazards. But first try reorienting your equipment plugs in the AC wall sockets and listening for changes in hum level, since, depending on various factors, hum may actually be increased by a separate ground connection. . . . So, if everything is working fine, it's best to ignore the ground terminals on your equipment—except, of course, the one adjacent to the phono-input jacks meant for the ground lead from your turntable.

### Synthesizer Reproduction

*In several articles you have taken a firm stand favoring accurate reproduction. I agree with your arguments, but how does the question of "accuracy" relate to the reproduction of sound that had no original live reality—such as the product of a synthesizer? Or, for that matter, the sound from a loudspeaker driven by an amp being fed by an electric guitar?*

*L. B. Wend  
Schoharie, N.Y.*

This question sounds like the electronic version of the old philosophical conundrum about whether a tree makes a sound if it falls in a forest where no one hears it. The "sound" of a music synthesizer is, of course, that which comes out of the speaker attached to it. Therefore, it seems to me that if a recording is made from the *electrical* output of the synthesizer, rather than from the speaker (or headset) used by the composer, it is up to the composer to specify—if desired—the speaker or headset to be used by the listener in order to hear exactly what the composer had in mind (rather, in ear). While this has occurred, the more common alternative is for a synthesizer artist to audition his pieces on a variety of systems in order to make sure that the intended effect is produced, if not reproduced.

Electronic musical instruments whose acoustic output is always provided by amplifiers and speakers are another matter altogether. Again, it is helpful to keep in mind that a musical-instrument speaker is a sound *producer* and a hi-fi speaker is a sound *reproducer*. The special sonic characteristics of a musical instrument's amplifier and speaker must be considered as much a part of that instrument as, say, the wooden body of a Stradivarius. The difference is, of course, that any electric guitar can be hooked up to a wide variety of different amplifier/speaker combinations, and most rock musicians have their particular sonic favorites.

At the recording session, a musician usually wants to capture on tape the same sonic quality he hears live from his guitar-amp/speaker pairing, not the "sound" of merely

# DISCS, DISCS, DISCS, DISCS!



**The Traveling Wilburys—**  
Volume One. (Wib)  
375089



**Steve Winwood**  
—Roll With It.  
(Virgin) 371211



**Luciano Pavarotti—In**  
Concert. (CBS  
Master works) 373548  
**Barbra Streisand—Till I**  
Loved You. (Columbia)  
374884



**Anita Baker—Giving You**  
The Best That I Got.  
(Elektra) 374058  
**U2—Rattle And Hum.**  
(Island) 374017

## PICK ANY 8 CDs FOR A PENNY

plus shipping and handling, with membership

- Pet Shop Boys—**Introspective (EMI) 375592
- Nell Diamond—12 Greatest** Hits, Vol. II (Columbia) 314443
- Canadian Brass—The** Mozart Album (CBS Master) 374561
- Robbie Nevil—A Place** Like This (EMI) 374348
- Diane Schuur—Talkin'** Bout You (GRP) 374298
- Kronos Quartet** (Nonesuch) 373993
- Mieczyslaw Horszowski—**Mozart/Chopin/Schumann (Nonesuch) 373902
- Stanley Jordan—Flying** Home (EMI) 373860
- Emanuel Ax—Chopin 4** Scherzos, Mazurkas (CBS Master) 372466
- Grover Washington, Jr.—**Then and Now (Columbia) 371476
- Journey's Greatest** Hits (Columbia) 375279
- Johnny Mathis—Love** Songs (Columbia) 375220
- Michael Crawford—Songs** From Stage & Screen (Columbia) 370411
- Robert Palmer—Heavy** Nova (EMI) 370395
- David Sanborn—Close Up** (Warner Bros.) 370304
- Wynton Marsalis Quartet** —Live At Blues Alley (Columbia) 370080-390088
- Creedence Clearwater** Revival—20 Greatest Hits (Fantasy) 308049
- Tracy Chapman** (Elektra) 369892
- Schumann-Cello** Concerto—Yo-Yo Ma; Davis, Bavarian Radio Sym. Orch. (CBS Master) 369843
- John Williams—The** Baroque Album (CBS Master) 369769
- R.E.M.—Green** (Warner Bros.) 375162
- Ratt—Reach For The Sky** (Atlantic) 375071
- Claude Bolling, Piano—**Bolling's Greatest Hits (CBS) 369751
- Richard Marx** (EMI) 369611
- Van Halen—OU812** (Warner Bros.) 369371
- Michael Feinstein—**Remember: Michael Feinstein Sings Irving Berlin (Elektra) 369322
- Cheap Trick—Lap Of** Luxury (Epic) 368050
- Basia—Time And Tides** (Epic) 368043
- Sade—Stronger Than** Pride (Epic) 368027
- REO Speedwagon—**Greatest Hits (Epic) 367672
- Brahms—Double Concerto** Isaac Stern, Yo-Yo Ma, Abbado, Chicago Sym. (CBS Master) 367250
- Bangles—Everything** (Columbia) 373829
- Escape Club—Wild Wild** West (Atlantic) 373787
- Mendelssohn—Violin** Concerto, Saint-Saens: Infr. & Rondo Capriccioso; Massenet: Meditation. Nadja Salerno-Sonnenberg (Angel) 366872
- Mozart—Symphony No. 40** In G Minor, Kubeiik, Bavarian Radio Sym. (CBS Master) 339044
- Beethoven—Symphony** No. 9, Norrington, The London Classical Players (Angel) 365619
- Vladimir Feltsman—**American "Live" Debut (CBS Master) 365254-395251
- Wynton Marsalis—**Baroque Music For Trumpets (CBS Master) 364695
- Madonna—You Can** Dance (Sire) 362657
- Little Feat—Let It** Roll (Warner Bros.) 373720
- Luther Vandross—Any** Love (Epic) 373399
- Andres Segovia** Collection, Vol. 1—Music By Bach (MCA Classics) 362293
- George Michael—Faith** (Columbia) 362228
- Michael Jackson—Bad** (Epic) 362079
- Sting—...Nothing Like** The Sun (A&M) 361675
- Introducing The Hardline** According To Terence Trent D'Arby (Columbia) 361618
- INXS—Kick** (Atlantic) 361519
- Bruce Springsteen—**Tunnel Of Love (Columbia) 360115
- Kiri Te Kanawa—Sings** Gershwin (Angel) 359745
- Billy Joel—Greatest** Hits Vols. 1 & 2 (Columbia) 336396-396390
- Ozzy Osbourne—No Res:** For The Wicked (Epic) 373308
- Huey Lewis And The** News—Small World (Chrysalis) 371419
- Stevie Wonder—Orig.** Musiquarium I, Greatest Hits (Tamla) 314997-394999
- Beethoven—Piano Conc.** No. 5, Perahia; Hahnik, Concertgebouw Orch. (CBS Master) 357657
- Gloria Estefan & Miami** Sound Machine—Let It Loose (Epic) 356279
- Whitney Houston—**Whitney (Arista) 356154
- Vladimir Horowitz, Piano** —Favorite Encores (CBS Master) 355164
- Linda Ronstadt—Round** Midnight with Nelson Riddle And His Orch. (Asylum) 348987-398982
- Simon & Garfunkel—**Greatest Hits (Columbia) 219477
- Spyro Gyra—Rites Of** Summer (MCA) 370767
- Elton John—Reg Strikes** Back (MCA) 370536
- Pachelbel Canon—Other** Digital Delights, Davis, Toronto Chamber Orch. (Fantasy) 348649
- The Police—Every Breath** You Take... The Singles (A&M) 348318
- Buddy Holly—From The** Orig. Master Tapes (MCA) 348110
- The Beach Boys—Made In** U.S.A. (Capitol) 346445
- Motown's 25 #1 Hits** (Motown) 319996-399998
- Chuck Berry—The Great** Twenty-Eight (Chess) 343657
- Tchaikovsky—Eugene** Onegin, Seiji Ozawa, Berlin Phil. (Angel) 343244
- Enoch Light & The Light** Brigade—The Big Bands Of The Thirties (Project 3) 341263
- A Decade Of** Steely Dan (MCA) 341073
- Gershwin—Rhapsody In** Blue; etc. Tilson Thomas, L.A. Philharmonic (CBS Master) 339226
- Best Of The Doors** (Elektra) 357616-397612
- Bobby McFerrin—Simple** Pleasures (EMI) 369306



**Guns N' Roses—Appetite**  
For Destruction. (Geffen)  
359984



**Kenny G—Silhouette**  
(Arista) 371559



**The Movies Go To The**  
Opera.—Various Artists.  
(Angel/Studio) 372342



**Cocktail—Original**  
Soundtrack.  
(Elektra) 373779



**Portrait Of Wynton**  
Marsalis. (CBS  
Master works) 373555



**Dire Straits—Money For**  
Nothing. (Warner Bros.)  
373055

The age of CD sound is here—and you have a practical new way to find the CDs you want. As your introduction to the CBS Compact Disc Club, you can choose any 8 CDs listed in this ad for 1¢. Fill in and mail the application—we'll send your CDs and bill you for 1¢ plus shipping and handling. You simply agree to buy 6 more CDs (at regular Club prices) in the next three years—and you may then cancel your membership anytime after doing so.

**How the Club works:** About every four weeks (13 times a year) you'll receive the Club's music magazine, which describes the Selection of the Month... plus new hits and old favorites from every field of music. In addition, up to six times a year, you may receive offers of Special Selections, usually at a discount off regular Club prices, for a total of up to 19 buying opportunities.

If you wish to receive the Selection of the Month, you need do nothing—it will be shipped automatically. If you prefer an alternate selection, or none at all, fill in the response card always provided and mail it by the date specified. You will always have at least 10 days in which to make your decision. If you ever receive any Selection without having 10 days to decide, you may return it at our expense.

The CDs you order during your membership will be billed at regular Club prices, which currently are \$12.98 to \$15.98—plus shipping and handling. (Multiple-unit sets may be somewhat higher.) After completing your enrollment agreement you may cancel membership at any time; if you decide to continue as a member, you'll be eligible for our money-saving bonus plan. It lets you buy one CD at half price for each CD you buy at regular Club prices.

**10-Day Free Trial:** We'll send details of the Club's operation with your introductory shipment. If you are not satisfied for any reason whatsoever, just return everything within 10 days and you will have no further obligation. So why not choose 8 CDs for 1¢ right now?

**ADVANCE BONUS OFFER:** As a special offer to new members, take one additional Compact Disc right now and pay only \$6.95. It's a chance to get a ninth selection at a super low price!

### CBS COMPACT DISC CLUB: Terre Haute, IN 47811

**CBS COMPACT DISC CLUB, 1400 N. Fruitridge P.O. Box 1129, Terre Haute, Indiana 47811-1129** 63/589

Please accept my membership application under the terms outlined in this advertisement. Send me the 8 Compact Discs listed here and bill me 1¢ plus shipping and handling for all eight. I agree to buy six more selections at regular Club prices in the coming three years—and may cancel my membership at any time after doing so.

SEND ME THESE 8 CDs FOR 1¢

My main musical interest is (check one): (But I may always choose from any category)

**Hard Rock**  **Soft Rock**  **Jazz**  
 Van Halen, U2  Steve Winwood, Fleetwood Mac  Kenny G, Spyro Gyra  
 **Easy Listening/Pop**  **Classical\***  
 Barry Manilow, Barbra Streisand, Johnny Mathis, Roy Conniff  Vladimir Horowitz, Yo-Yo Ma

Mr. \_\_\_\_\_ Initial \_\_\_\_\_ Last Name \_\_\_\_\_  
 Mrs. \_\_\_\_\_  
 Miss \_\_\_\_\_  
 Address \_\_\_\_\_ Apt. \_\_\_\_\_  
 City \_\_\_\_\_  
 State \_\_\_\_\_ Zip \_\_\_\_\_

Do you have a VCR? (04)  Yes  No  
 Do you have a credit card? (03)  Yes  No

ADVANCE BONUS OFFER: Also send me one more CD right now at the super low price of just \$6.95, which will be billed to me.

DXP/F6    DXQ/F7

\*Note: we reserve the right to reject any application or cancel any membership. These offers not available in APO, IPO, Alaska, Hawaii, Puerto Rico; write for details of alternative offer. Canadian residents serviced from Toronto. Applicable sales tax added to all orders. \*Classical members serviced by the CBS Classical Club.

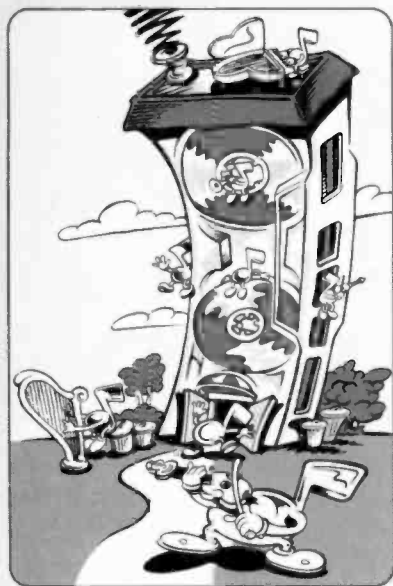

## IS YOUR CLASSICAL MUSIC SUFFERING FROM POOR HOUSING CONDITIONS?

TDK **SO REAL**

*High resonance housing will put any tape in a nasty mood. Especially when pests, such as modulation noise, gnaw on the purity of digitally sourced music.*

*At TDK, we believe the formula for perfect reproduction includes not only technologically superior tape, but housing that enhances its performance.*

*Our incredible new SA-X, for example, features an ultra low resonance SP-ARII mechanism. By utilizing our unique co-molding technique, the unified two-layer shell realizes maximum total rigidity to improve reliability. Which drastically reduces modulation noise—an enemy of clear, pure sound that even noise reduction systems are powerless against.*

*This undesired "noise" is also attacked by SA-X's revolutionary magnetic characteristics and smooth, flat tape surface. First, there are the densely packed and uniformly distributed ultra fine Super Avilyn magnetic particles. Then, there is the advanced dual coating technology.*

*Together, the result is an unbelievably quiet tape with an exceptionally low bias noise of -61.0 dB. Plus, low and high frequency MOLS of +5.0 dB and -6.5 dB respectively.*

*And SA-X, which provides transparent reproduction of the most powerful digital sources, is available in convenient lengths of 46, 60 and 90 minutes.*



## CROSSTALK

the electrical output of his guitar. That is why, in a recording studio, microphones are usually used to pick up the acoustical output of the musical instrument's speaker. Sonic accuracy, in this case, requires the playback system to faithfully reproduce the guitar-speaker sound, including any of its distortion and frequency-response anomalies.

### Audio Illusions

*Some of my audiophile friends have told me that it helps the sound of audio components to weight them down with bricks or other heavy objects. Others suggest that I mount my amplifier on sharp, pointed feet. Does either suggestion make sense?*

*Carlton Shibe  
Akron, Ohio*

Unfortunately, one of the side effects of excessive audiophilia is a tendency to develop auditory hallucinations. Various subjective acoustic effects are sometimes imagined and reported as having an objective existence despite obvious conflicts with the laws of electronics, physics in general, psychoacoustics, and even logic and common sense. But although intense audio involvement may lead to irrational behavior often suggestive of a mental aberration, such behavior resembles more a primitive, magic-based religion. Through the ritual application of totem objects—weights, specially insulated or wound oxygen-free speaker cables, mysterious liquids, special feet and stands, and so forth—to their sound systems, true believers are able to experience wonderful audible improvements not always perceptible (since they are nonexistent) to those without equivalent dedication or faith.

Viewing all this with incredulity and amusement are those who, if not atheists in this hobby, are at least agnostics on the question of the audible improvements wrought by wondrous whatever. Unfortunately, it's in the nature of the game that reviewers claiming to hear positive effects resulting from the application of the totem objects have far more credibility in the eyes of true believers than do the skeptics. The reverse is also true: Skeptical reviewers are valued more highly by the non-believers.

In short, the question of the audible improvements achieved by expensive accessories is very much subject to what I call the ambiguous ENC effect: Depending on which way you prefer to look at it, the abbreviation can stand for Enhanced New Component or Emperor's New Clothes.

*We regret that the volume of mail is too great for us to answer all questions.*



## In Re Yr Ltr of Recent Date . . .

By Robert Long

**A** sheaf of reader letters reached my desk from the Home Office recently. Since I can't reply to them all, I'll try to answer a few of the most popular questions here and in another column to follow.

**Tape Squeal.** I had hoped to put this pesky subject behind me with my October 1988 column, but the complaints continue to come in far faster than the solutions. To repeat: The only real solution I know of—and it applies only to open-reel tapes and only if you're willing to invest in a remedy that should last long enough for you to make a squeal-free dub—is the controlled-baking process of Scott Kent (c/o BKM Associates, Box 22, Wilmington, Mass. 01887). Do not try this at home, because without tight temperature control you can do far more harm than good.

On the same subject, I have had a couple of letters challenging my impression that the problem (at least in cassettes) is concentrated among those who use budget tapes on premium equipment or vice versa. The challengers have used only the best all round, and they still have squeal problems. These cases remain exceptions, however. On the other hand, I've always wondered about recordists who try to save a buck on both ends. Perhaps they have similar problems but don't bother to write to equipment magazines.

**Keyway Kapers.** A number of readers complain about tape-matching problems: Either their decks have too few adjustments for some tapes to play correctly, or they have so many that there's doubt about the correct switch to throw. Many decks these days adjust bias and equalization (EQ) automatically, on the basis of the keyways (slots) on the back edge of the cassette shell. The Type 1 (ferric) cassettes all have only the punch-open keyways for preventing erasure. This design was used for some time after chrome Type 2 cassettes came on the market, but Type 2 cassettes now have an additional set of keyways next to the punch-out tabs. This Type 2 design was also used for the earliest Type 4 (metal) tapes, because both required the same 70-microsecond playback EQ, but later Type 4 shells added still another pair of keyways, near the center of the shell's back edge.

In *playback*, all that matters is obtaining the correct EQ. Any metal tape will play identically with Type 4 and Type 2 settings, because both provide the same de-emphasis curve. But an old Type 4 cassette with just the Type 2 keyways will be underbiased if you try *recording* on it with a deck that chooses bias automatically. And an old Type 2 with just the Type 1 keyways will be both underbiased and incorrectly pre-emphasized during recording on such a deck.

Some prerecorded cassettes are recorded on Type 2 tape using Type 1 EQ (but Type 2 bias) to keep highs crisp and clean: Noise is increased slightly in order to obtain better high-frequency overload characteristics

through high-speed duplication. To ensure that equipment with automatic tape matching will play them correctly (with Type 1 EQ), these tapes are housed in shells without the extra Type 2 keyways. Users of manually adjusted decks must therefore set them to the "ferric" (or "Fe<sub>2</sub>O<sub>3</sub>," "normal," "120-μs," or "Type I") switch position, even though these prerecorded tapes are identified as chromium dioxide ("CrO<sub>2</sub>," etc.).

Again, the bias setting has nothing to do with playback. But a tape control that also changes the playback EQ should be set to the EQ stipulated on the prerecorded tape, rather than to the EQ that is standard for the magnetic particle in the tape, if that is different. Automatic decks will take care of themselves in this situation, but not when confronted with the old, unintentionally non-standard shells. The only solutions for that problem are to use a manually adjustable deck to dub the "unplayable" tapes to cassettes with standard tape in standard shells or, if you are reasonably dexterous, open the shells and transfer the tape and hubs to screw-closure shells with the appropriate keyways.

**DBX Levels.** Anyone who knows how to set recording levels when not using noise reduction can use precisely the same techniques with Dolby B or C. But not DBX. Instead of an allowable maximum of +3 dB or so, the manual may say you can let the indicator go whooshing up to some astronomical value, like +10. How come?

A peak-reading indicator reads the highest values the signal attains—which is what you need to know if you're not to ever overload the tape. But the signal is usually metered *before* it is subjected to the compression imposed by a noise-reduction circuit (if one is used). With Dolby B, it makes no difference where the signal is metered, because Dolby B leaves high levels untouched and imposes (upward) compression only on low-level, high-frequency signals. And, but for additional compression and a broader working range—plus a little downward compression, called "spectral skewing," at extremely high frequencies—Dolby C behaves the same way.

But DBX noise reduction doesn't reduce its action as the level rises, the way Dolby does. DBX applies the same 2:1 compression over virtually the entire frequency and dynamic ranges of the signal. At some level, usually below the meter's 0-dB calibration, the input and output voltages at the DBX circuit will be equal. Below this point, the compression is therefore upward; above it, the compression is downward. For instance, if the input level (as shown on the meters) is 8 dB above this neutral point, the DBX-compressed signal actually fed to the tape will be only 4 dB above it. That's why, when using DBX, levels can be so much higher before compression without overloading the tape. So don't go by past metering experience; with DBX, you should believe what your manual tells you. □

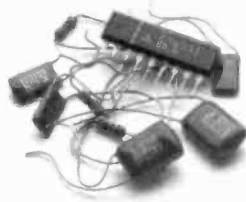

# Yamaha just solved the industry's biggest problem.

All those little capacitors, resistors and semiconductors?

They make up what's known as a CD player's analog filter.

A necessary evil designed to remove unwanted digital noise. While unfortunately distorting otherwise crystal-clear sound with phase shift.



Yamaha's exclusive Hi-Bit direct out technology bypasses the analog filter, resulting in pure, crystal-clear sound.

Ahem. Presenting Yamaha's exclusive Hi-Bit direct output technology.

A revolutionary technology we've incorporated into our CDX-910U, giving you the option of completely eliminating the analog filter with the touch of a button.

Allowing you, in turn, to enjoy improvement in music you thought couldn't be improved.

You'll also find 8 times oversampling. Giving you incredibly accurate waveform resolution and unbelievably natural sound.

Hi-Bit twin D/A converters to improve dynamic resolution and eliminate interchannel phase distortion.

And a host of features that add up to the most pleasurable listening experience yet.

Stop by your nearest Yamaha dealer today and hear the remarkable new CDX-910U CD player for yourself.

We think you'll come away sharing our philosophy that anything that comes between you and your music is definitely a big problem.

No matter how small it may be.



Use the 16-key wireless remote, or use a Yamaha RS integrated amp, preamp or receiver remote.

# YAMAHA®





## Antennas Do Make A Difference

By Beth C. Fishkind

**W**hen was the last time you thought about your car's antenna? I don't mean when it broke off in the car wash, got ripped off, keeled over from corrosion, or that time you rode through the RF surf, catching radio waves with the classic wire coat hanger. I mean: Have you thought about your antenna as an important part of your autosound system?

For music, the primary job of an auto antenna is good FM reception—antennas are *the* link for music delivered through the air. At the source, radio stations transform musical frequencies into an RF (radio-frequency) signal. A transmitting antenna spits this RF out into the air as radiated electromagnetic waves. Your car's antenna intercepts a small fraction of these waves and turns them into an electrical signal for your tuner. The tuner then takes over and pulls out the music.

To perform well, your tuner needs a strong RF signal delivered to its antenna terminals. If your antenna is mired with road gunk, or broken out in rust acne, or the lead wire from antenna to tuner shows signs of wear, your FM performance may suffer. That's because antennas work best when they are "tuned" to the frequencies they receive. For FM reception, this is usually between 31 and 33 inches long, resonant with the FM frequencies. Dirt and corrosion can upset these tolerances.

FM boosters (about \$20 to \$30) that will increase signals as much as 15 dB can be helpful, but this depends on where you drive: In wide-open spaces, boosters can help pull in weak signals; in a metropolitan area, they may overload some tuners. Amplified antennas, which some people prefer because of their shorter stature, are a similar story.

Happily for your bank account, replacing a standard original mast antenna costs only about \$10 to \$15. Experts recommend a stainless-steel whip antenna, because its one-piece construction makes it less vulnerable to the dirt and corrosion likely to collect in the segments of collapsible antennas. Even cheaper is cleaning your antenna regularly. West German antenna maker Hirschmann offers treated Antenna Cleaning Tissues at three for a buck, and recommends cleaning every two months. Hirschmann is an elite name among antenna makers and, along with Harada, a Japanese company, stands as one of the largest suppliers to auto makers and auto-products retailers. If the car is European and expensive, it probably has a Hirschmann antenna—for which a motorized model will run you up to \$250.

Should you spend a lot for an antenna? Antenna manufacturers claim that costlier designs and materials do enhance performance and durability, but without published test data to go on, I can't draw any conclusions. However, one manufacturer told me that the initial performance difference between a new inexpensive antenna and a new expensive antenna would be negligible. Yet over time, the

inexpensive antenna would wear out faster and cause a continual erosion in performance; the better-made model would continue to perform well.

Hirschmann says its antennas are built to withstand speeds in excess of 150 mph, for a casual drive on the German Autobahn. Not that you'll be rocketing down Main Street, U.S.A., but if you bump into a tree branch, the Hirschmann stands a better chance of surviving than a less solidly built antenna. As for the motorized part, the design is fully electronic with no mechanical relay. The actual mast is made of a highly conductive multiplated assembly, which Hirschmann claims gives its antenna extra sensitivity and reduces susceptibility to multipath interference, delivering more signal to the tuner.

Multipath interference, a partial culprit in the car-audio distortion known as "picket-fencing," is caused when several "copies" of the RF waves transmitted from the radio station reach your antenna at slightly different times. For instance, while driving in a city, radio waves bouncing off a building take longer to reach the antenna than do waves taking a line-of-sight route. The result is audio distortion.

In an attempt to solve the multipath problem, diversity tuning was introduced to car audio in the mid-1980s. The technique requires two antennas: a primary AM/FM antenna, and another—serving only the FM band—mounted approximately 30 to 40 inches from the main one. Whichever antenna is providing the stronger signal at the moment is the feed the tuner uses. Odds are that both won't be receiving a truly bad signal simultaneously, so multipath effects are reduced.

Despite the marked improvement it provides in FM reception, diversity tuning hasn't become popular in the autosound aftermarket. The reason is mainly cosmetic: Many car owners object to having two antennas. Consequently, a lot of diversity tuners died on the vine years ago. But a small number of manufacturers still offer it, in products such as Clarion's Audia 2000 (\$769) and Blaupunkt's Berlin TQR 07 (\$1,595).

The Berlin has quartz locking, with an auto-reverse cassette deck. Using two matched FM sections, each fed by a separate antenna, the unit evaluates the signals at the IF (intermediate frequency) stage in the tuner in order to look at criteria other than signal strength. For instance, noise levels at both antenna feeds are checked, so a signal can be chosen based on its sound quality.

Despite aftermarket doldrums, diversity tuning is doing well as an option in new cars. Autosound suppliers such as Clarion and Fujitsu Ten have been working with car manufacturers to hide the second antenna in the windshield, making the appearance more palatable for buyers. Nissan and Mazda are among those offering diversity tuning systems. If you are shopping for a new car, you might ask the dealer about this option. □



## Digital Signal-Processing News

By David Ranada

In last month's column, I discussed Analog Devices' 18-bit digital-to-analog converter chips. That Massachusetts company is also one of the world's leading producers of general-purpose digital-signal-processing (DSP) integrated circuits—specifically, the complex and expensive devices performing the high-speed arithmetic that forms the core of DSP techniques. In consumer audio products, however, general-purpose DSP chips are very rarely used—I know of no widely available component utilizing one. These chips' jack-of-all-trades design can make them both too powerful and not powerful enough for audio use. For a DSP chip to process signals as varied as those from deep-space probes, enemy radars, telephones, video cameras, and seismographs, it must contain features of little use to high fidelity audio, and such capabilities make the chip too expensive for mass-market audio products. Various other factors preclude many general-purpose DSP chips from processing signals with a full 20-kHz audio bandwidth.

General-purpose DSP chips *are* used in audio, but in products that consumers would rarely get to see, much less buy and use. An outstanding example of this is the new Sonic System from Sonic Solutions (the San Francisco company noted for its No Noise processing for CD remastering). Characterized as a "desktop audio workstation," the Sonic System is based on a MacIntosh II personal computer and contains several layers of high-power computing capability: the MacIntosh's own microprocessor, a 68881 floating-point coprocessor chip installed in the Mac, and a special-purpose Sonic Solutions circuit board that contains four Motorola 56001 general-purpose DSP chips.

Input and output to the system are via standard AES/EBU digital-audio bit streams, and the signals are stored on a 736-megabyte hard-disk drive that can hold 52 minutes of 16-bit stereo audio. All processing and audio-data paths are actually 24 bits "wide," to preserve dynamic range during calculation, and 44.1- and 48-kHz sampling rates are supported. Longer record/play times are available with added disk drives.

With the Sonic System and its supplied CD "pre-mastering" software, the user can record and play back four channels of digital audio. More important, it provides full, instant-access editing of the audio as stored on the hard disk. Its edits are of a quality and complexity impossible with analog recording systems and not even available with typical VCR-based digital studio editing equipment. Six types of crossfade "envelope" are provided, for example. Other signal-processing software implements such standard studio functions as mixing, filtering, equalization, and dynamic-range control.

In all, the Sonic System makes editing, and possibly even recording, easier and less expensive than the typical setup now used for digital taping and editing (meaning, at

least three 1/4-inch professional VCRs, a special digital editing console, and a digital-audio/video converter). And the Sonic System actually fits on a desktop! Of course, this versatility does exact a cost: \$44,100. Sonic Solutions tells me that ways are being investigated to make at least some of these capabilities available at price levels more appropriate for the home market.

Leave it to Sony, one of the acknowledged leaders in both professional and consumer digital-audio products, to come up with DSP chips *specialized* for audio applications, as well as to establish both professional and consumer-priced product lines using them. Sony's SDP-1000 professional digital-audio processor incorporates the Sony CXD-1160 and CXD-1355P DSP chips and has equalization and dynamic-range processing capabilities similar to those of the Sonic System. At this point, the SDP-1000 lacks any self-contained recording, playback, or editing capability—possibly because Sony doesn't want to immediately threaten its own domination of the traditional digital-audio editing market.

Of much greater significance to HIGH FIDELITY readers is Sony's use of its DSP chips in a *consumer* product: the TA-V925 preamplifier (available only in Japan). The DSP integrated circuits serve as the equivalent of both a dynamic-range and a surround-sound processor, as well as of a parametric equalizer. The dynamic-range software provides three levels of compression—1:1.25 above -16 dB, 1:1.6 above -14 dB, and 1:2 above -12 dB—presumably to make wide-dynamic-range CDs sound better in background-music and similar applications. The surround-sound processing incorporates three modes of variable signal delay: movie, music, and "simulated" surround. Dolby Pro Logic surround-sound decoding does not seem to be provided, however. So far, this is a function that is executed digitally only by the Lexicon's CP-1 ambience/reverb generator, a device employing Lexicon's own special-purpose DSP chip.

A typical, analog-based audio product containing this amount of signal-processing capability would probably have a front-panel jammed with knobs and dials. But DSP simplifies matters, since, under computer control, one switch can take on different control identities depending on the activated program. Accordingly, the TA-V925 has an array of four switches that are used variously to change parameters in the equalizer and surround-sound modes. Naturally, digital memory is used to retain myriad control settings (200 factory-preset and 10 user-programmed)

The TA-V925 was introduced last fall in Japan and, so far, is available only in that country. Sony tells me that it will soon introduce a line of consumer DSP products (but probably not including the 925) in this country. We hope to test one of them as soon as Sony makes samples available. □



Report preparation supervised by Michael Riggs, David Ranada, Beth C. Fishkind, Robert Long, and Edward J. Foster. Laboratory data (unless otherwise indicated) is supplied by Diversified Science Laboratories.

## Test Reports

**T**he HK-990Vxi is the top model of Harman Kardon's current receiver line. It is an audio-video model in the sense that it includes full switching to handle video components as well as audio ones. For most users, its facilities are above average in this respect. However (perhaps an index of the growing list

to Tape 1 or Tape 2.

The final knob of the group chooses the source you monitor. It can be set to any of the four tape options, SOURCE, or REMOTE. This last—an option repeated on the main selector—turns control over to the supplied wireless remote, powered by two AA cells. The remote can thus se-

### Harman Kardon HK-990Vxi AM/FM Audio- Video Receiver



DAVID A. WAGNER

of TV stations broadcasting MTS stereo), there is no explicit provision for TV-FM simulcasts.

Switching is handled in a direct, positive way. One knob selects the main "source," available for listening or recording or both—depending on how the remaining knobs are set. One of these is for recording and includes, in addition to the selected source, options for dubbing in either direction between two VCRs or between two audio-only tape decks. The source selector makes other dubbing options possible. You can, for example, set SOURCE at VCR 2 and the recording selector at SOURCE to copy from that VCR

lect the source for listening and that for recording or it can be locked out from either function. This avoids ruined tapes if someone picks up the remote while a recording is in progress. The remote option can be a little confusing until you get used to it; nevertheless, once you do, you may find it considerably less vexing than the often illogical logic that governs switching in other A-V receivers.

Though the 990Vxi avoids convoluted electronic logic, its switching scheme does have its twists, putting a premium on the manual's clarity. This one is in simple, idiomatic English and is well laid out; however, it falls a bit short in that

**Dimensions:** 17½ by 5¼ inches (front), 12½ inches deep plus clearance for controls and connections.

**AC Convenience Outlets:** One switched, one unswitched (180 watts max. each).

**Price:** \$1,199.

**Warranty:** "Limited," two years parts and labor.

**Manufacturer:** Made in Japan for Harman Kardon, 240 Crossways Park West, Woodbury, N.Y. 11797.

# Some Other Virgin Classics

VERITAS

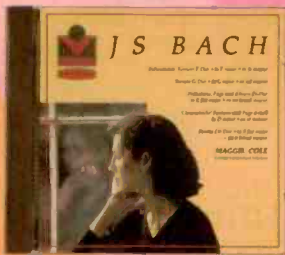

**BACH RECITAL**  
MAGGIE COLE  
4/2-90712

VERITAS



**HAYDN: SYM. 26, 52, 53**  
KUIJKEN, LPB  
4/2-90743

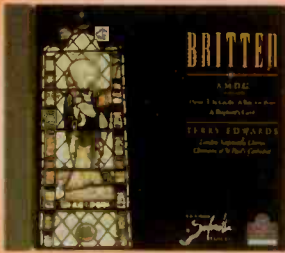

**BRITTEN: CHORAL WORKS**  
EDWARDS, LSV  
4/2-90728



**PROKOFIEV: VIOLIN CNTOS 1 & 2**  
SITKOVETSKY, LSO, DAVIS  
4/2-90734



**DVORAK: NEW WORLD SYMPHONY**  
LIBOR PESEK, RLPO  
4/2-90723

VERITAS

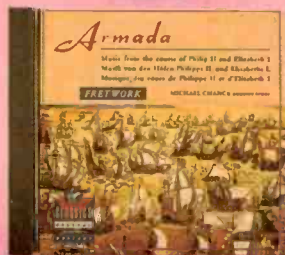

**ARMADA**  
FRETWORK  
4/2-90722

VERITAS



**WEBER: CLARINET CNTOS 1 & 2**  
ANTONY PAY, OAE  
4/2-90720



**HAYDN QUARTETS 1, 2, 3, OP. 54**  
ENDELLION STRING QUARTET  
4/2-90719



**V. WILLIAMS: 5TH SYM., 2 PNO CNTO**  
MENUHIN, RPO  
4/2-90733



**RACHMANINOV: RHAPSODY, CNTO NO. 1**  
PLETNEV, PO, PESEK  
4/2-90724

VERITAS



**MENDELSSOHN: ITALIAN DREAM**  
MACKERRAS, OAE  
4/2-90725

VERITAS



**DOWLAND: SONGS**  
ROGERS, O'DETTE  
4/2-90726

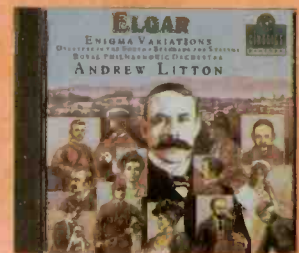

**ELGAR: ENIGMA, SERENADE, SOUTH**  
LITTON, RPO  
4/2-90720

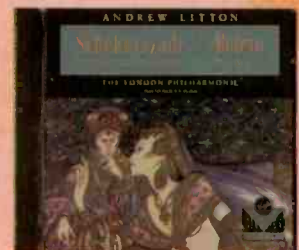

**R-K: SCHEHERAZADE, RAVEL: BOLERO**  
LITTON, LPO  
4/2-90729



**PHILHARMONIC FANFARE**  
CARL DAVIS, LPO  
4/2-90716

## ASSORTED IMAGES

2-90814

A LOW-PRICED  
CD ONLY SAMPLER



ON VIRGIN CLASSICS  
COMPACT DISCS AND  
CASSETTES.



© 1988 VIRGIN RECORDS AMERICA, INC.  
VIRGIN CLASSICS DISTRIBUTED BY ATLANTIC RECORDS THROUGH WEA

there are no how-to sections to walk you through specific setup procedures (which can be boringly redundant, I admit) and the control descriptions aren't comprehensive enough to do the job. To some extent, you're left with a trial-and-error approach.

Tuner operation is simplicity itself. There are up- and down-tuning buttons, plus a pair that toggle, respectively, the seek/manual tuning functions and Harman Kardon's proprietary Active Tracking circuit (I'll come back to this). Manual tuning progresses by half-channels (0.1 MHz) on FM, full channels (10 kHz) on AM. There are six preset buttons and one that steps through three "bands"—FM 1, FM 2, and AM—to give you 12 presets on FM, six on AM. Neither I nor Diversified Science Laboratories was able to achieve stereo reception without switching to the seek mode, although we were working with different samples. If this is intentional, it's a legitimate design choice, but it appears that owners are left on their own to discover it, since the manual does not go out of its way to spell out these details.

There is a separate mono/stereo button that affects all inputs. In the same rank on the front panel are switches for an infrasonic filter and an outboard-processor loop. Separate on/off switches control the two pairs of speaker outputs so they can be activated independently or both turned off for listening via the front-panel headphone jack.

The back panel has the usual color-coded pin jacks: stereo pairs for fixed-coil phono, moving-coil phono, CD, the external processor (in and out), and the tape connections; stereo pairs plus composite video for an A/V input and the two VCRs; composite video only for the monitor output. As with similar units, the rather skimpy binding posts accommodate an AM antenna (including the supplied loopstick, which mounts to the back panel) and 300-ohm FM twinlead. For 75-ohm coax, I was pleased to find a U.S.-standard threaded F connector. The massive speaker output binding posts comfortably accept 14-gauge (one step above heavy zip cord) bared leads. A nearby switch optimizes output for loads of either 8 or 4 ohms.

The intent of this switch is to deliver either more voltage with less current (the 8-ohm mode) or vice versa, so that maximum power can be achieved without overheating the receiver's output stages. A single pair of 8-ohm (nominal) speakers would get the 8-ohm mode; add a second pair to the B connections or switch to a 4-ohm model, and the 4-ohm position is recommended; the manual says

that use of two 4-ohm pairs requires caution and recommends against it.

DSL measured only a marginal increase in power at 4 ohms with a 4-ohm load (versus the 8-ohm setting with an 8-

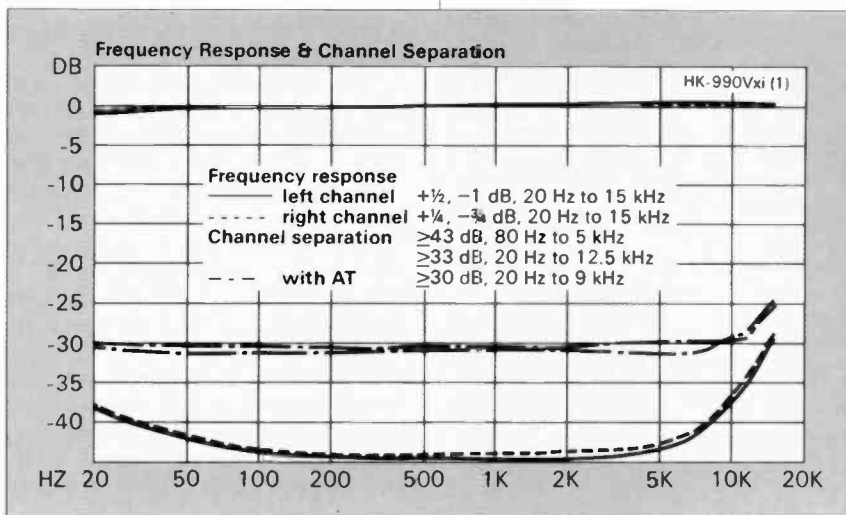

ohm load), though the dynamic power did increase by a full decibel when a 2-ohm load was substituted (still at the 4-ohm setting). Were a 2-ohm optimization available as well, it presumably would reduce that 2-ohm rating but also keep the amp running cooler while it was measured. Since even the rated 90 watts—and note that Harman Kardon publishes that figure for both loads—is ample for most home installations for which a receiver would be a logical choice, the output normally can be expected to loaf along well below maximum, making the setting of the impedance-matching switch somewhat less critical than the manual suggests.

It is a good amp by receiver standards, if not quite up to the level of HK's deluxe Citation line (with which it shares many design elements). Distortion, for example, is a little (though not necessarily audibly) higher than you would expect in separates and output impedance a little higher—lowering the damping factor, though again by only an insignificant amount. The design is basically broadband (a given in Harman Kardon products for two generations), with a switchable infrasonic filter to control such undesirables as warp output in playing LPs. Even this filter is more broadband than most, with a lower turnover and gentler slope than would be required by a record player with real problems in this department. Historically, Harman Kardon has favored such shallow filters to minimize phase shift.

There is a slight phono response error in both the moving-magnet and mov-

## FM Tuner Section

Except as noted, all data were measured with Active Tracking (AT) feature turned off.

## Sensitivity & Quieting

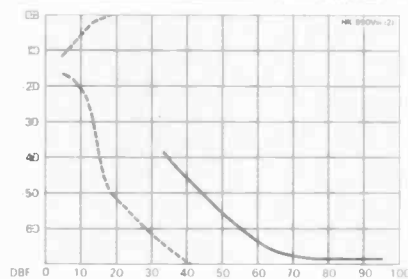

Stereo quieting (noise)		Mono quieting (noise)	
10 dB	32 1/4 dB	10 dB	31 1/2 dB
20 dB	28 dB	20 dB	27 dB
30 dB	24 dB	30 dB	23 dB
40 dB	20 dB	40 dB	19 dB
50 dB	17 dB	50 dB	16 dB
60 dB	15 dB	60 dB	14 dB
70 dB	13 dB	70 dB	12 dB
80 dB	11 dB	80 dB	10 dB
90 dB	9 dB	90 dB	8 dB

Stereo sensitivity (for 50-dB noise suppression)	
43 3/4 dB	at 98 MHz, with 0.62% THD+N
42 1/4 dB	at 90 MHz, 44 dB at 106 MHz

Mono sensitivity (for 50-dB noise suppression)	
19 dB	at 98 MHz

Muting threshold	32 1/4 dB
Stereo threshold	31 1/2 dB
Stereo S/N ratio (at 65 dBf)	66 1/4 dB
Mono S/N ratio (at 65 dBf)	74 dB
Capture Ratio	AT on: 3.5 dB, AT off: 1.7 dB
Selectivity	AT on: 67 1/2 dB, AT off: 61 1/2 dB
alternate-channel	23 3/4 dB
adjacent-channel	7 3/4 dB
Harmonic Distortion (THD+N)	
AT on (see text)	stereo, mono
at 100 Hz	1.1%, 0.13%
at 1 kHz	0.89%, 0.26%
at 6 kHz	1.5%, 0.44%
AT off	
at 100 Hz	0.33%, 0.11%
at 1 kHz	0.29%, 0.06%
at 6 kHz	1.1%, 0.12%
Stereo Pilot Intermodulation	0.14%
Intermodulation Distortion (mono)	0.03%
AM Suppression	72 1/2 dB
Pilot (19-kHz) Suppression	36 dB
Subcarrier (38-kHz) Suppression	52 1/2 dB

# Test Reports

## Amplifier Section

Power into 4- and 2-ohm loads was measured with output switched to 4-ohm setting; all other measurements were made with 8-ohm setting.

### Rated Power

at 8 ohms	19.5 dBW (90 watts)/channel
at 4 ohms	19.5 dBW (90 watts)/channel

### Output at Clipping (at 1 kHz; both channels driven)

8-ohm load	20.5 dBW (112 watts)/channel
4-ohm load	20.7 dBW (117 watts)/channel

### Dynamic Power (at 1 kHz)

8-ohm load	21.4 dBW
4-ohm load	21.5 dBW
2-ohm load	22.5 dBW

### Dynamic Headroom (re rated power)

8-ohm load	+1.9 dB
4-ohm load	+2.0 dB

### Harmonic Distortion (THD; 20 Hz to 20 kHz)

at 19.5 dBW (90 watts)	≤ 0.041%
at 0 dBW (1 watt)	≤ 0.026%

### Frequency Response

+0, -1/2 dB, 10 Hz to 34.5 kHz
+0, -3 dB, < 10 Hz to 101 kHz

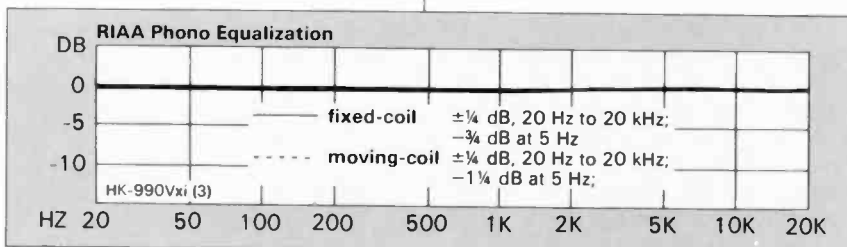

### Sensitivity & Noise (re 0 dBW; A-weighting)

	sensitivity	S/N ratio
aux input	14.5 mV	76 dB
fixed-coil phono	0.23 mV	73 1/2 dB
moving-coil phono	13 μV	74 dB

### Phono Overload (1-kHz clipping)

fixed-coil phono	210 mV
moving-coil phono	12 mV

### Input Impedance

aux input	28k ohms
fixed-coil phono	49k ohms; 140 pF
moving-coil phono	56 ohms

### Output Impedance (to tape)

from aux input	2,600 ohms
from tuner section	4,900 ohms
from phono inputs	3,500 ohms

### Damping Factor (at 50 Hz; re 8 ohms)

	83
--	----

### Channel Separation (at 1 kHz)

	68 1/2 dB
--	-----------

### Infrasonic Filter

	-3 dB at 15 Hz; ≈ 6 dB/octave
--	-------------------------------

ing-coil modes (chosen by an MM/MC switch on the front panel). Much of the treble lies some 1/4 dB higher than the midbass in DSL's frequency-response traces. Again, flatter response might be obtained in a separate, but the 990Vxi is better than most other receivers (and cartridges) in this regard.

Harman Kardon says the tone controls are designed to leave the midrange unaffected, for greater flexibility and precision of adjustment. DSL's measurements show them to be better than the tone controls in many other receivers but not exceptional in either their boost/cut symmetry or their avoidance of the 1-kHz range. Below 100 Hz, the bass control has a range of about +11, -12 dB; the treble manages about ±12 dB above 10 kHz. The loudness compensation responds relatively little to volume setting within the lab's test range, supplying about 10 dB of bass boost below 100 Hz and 5 dB at 20 kHz, relative to a mini-

so effective in this situation. The loss it exacts in stereo separation shouldn't matter if you have deployed your speakers well, and the increase in distortion is similarly insignificant. The loss in capture ratio is surprising, but its significance will depend on the specific reception problem at hand.

The signal-strength indicator has five segments, with thresholds between 22 and 49 dBf; thus they will help you orient your antenna only on fairly weak stations—where orientation is most important. Sensitivity is well within the receiver ballpark (though not as good as you'd hope for in separates), and other values are fairly typical of the genre.

From the viewpoint of American buyers, Harman Kardon has a lot going for it. It calls the shots from its Long Island headquarters, where the priorities of American buyers get top billing and those of international trade follow in their wake. Indeed, the very Americanness of the line (like that of its sister company, JBL) seems to have contributed to the brand's cachet among both European and Japanese buyers.

In any event, the result in this case is, overall, impressive. The HK-990Vxi is a receiver with good capabilities and—perhaps even more important to some users—without useless glitz. The extra power in the amp and the Active Tracking in the tuner are, above all, what justify the 990Vxi's not inconsiderable price. You won't find anything quite like it anywhere else.

Robert Long ▶

mum near 2 kHz.

All of this would constitute a good—but certainly not spectacular—receiver, were it not for the tuner section, which is the design's centerpiece. The Active Tracking feature (previously available only in HK's separate tuners, such as the TU-920, which we reviewed in March 1988) is Harman Kardon's way of solving awkward reception problems without demanding any special training of the operator. The company says its AT feature "simultaneously delivers two aspects of performance that were previously mutually exclusive: high selectivity and high fidelity." This is substantially true, though as our data show, some relatively minor trade-offs are involved. Otherwise, there would be no reason to shut it off.

But Active Tracking does solve problems. Rather than simply put filter "blinders" on the signal (usually as it passes through the IF, or intermediate-frequency, stage), AT phase-locks onto the carrier to distinguish it from interfering signals. The system was able to exclude most of a staticlike noise source that invades my neighborhood now and then for a few minutes at a time, for instance. No past device I've tried has been

### ABOUT THE dBW

We currently are expressing power in terms of dBW—meaning power in dB with a reference (0 dBW) of 1 watt. The conversion table will enable you to use the advantages of dBW in comparing these products to others for which you have no dBW figures.

WATTS	dBW	WATTS	dBW
1.0	0	32	15
1.25	1	40	16
1.6	2	50	17
2.0	3	63	18
2.5	4	80	19
3.2	5	100	20
4.0	6	125	21
5.0	7	160	22
6.3	8	200	23
8.0	9	250	24
10.0	10	320	25
12.5	11	400	26
16.0	12	500	27
20.0	13	630	28
25.0	14	800	29

# Are you hearing only 4/5ths of Beethoven's Fifth?

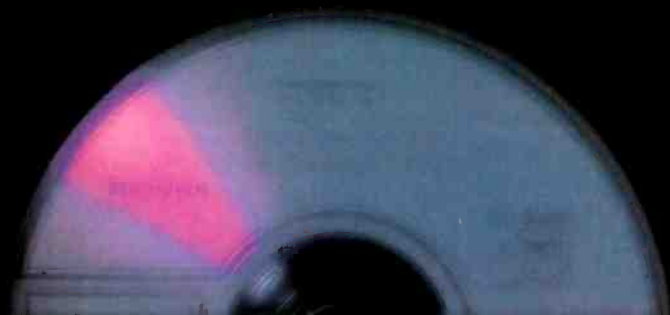

Photo represents sound without Monster Cable's CD SoundRing™



Photo represents sound with Monster Cable's CD SoundRing™

On data pits one millionth of an inch wide, a compact disc stores all the music information that's vital for accurate reproduction of a recording. Due to disc speed fluctuations, and internal and external vibrations, however, a CD player's laser is not able to read every pit.

Which means you're prevented from experiencing all the power, impact, and dynamics of the original performance.

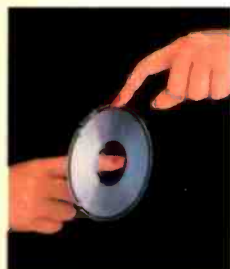

### Take the "Tap Test".

To demonstrate how susceptible your CDs are to vibration, take the Tap Test. Balance the CD with your finger through the center hole.

Hold the disc close to your ear and tap it. You'll *hear* a sustained "ringing" sound and *feel* vibrations with your finger.

### CD SoundRings™ solve CD problems.

Mounted on the outer edge of a compact disc, CD SoundRings by Monster Cable® provide rotational stability and reduced disc vibration while it is playing.

Based on a simple "gyro-stabilizer" principle (much like twirling a rock at the end of a string), CD SoundRings' carefully measured weight reduces laser to disc mistracking caused by disc rotation speed irregularities and vibrations from the player's motor, a poorly aligned spindle—even your speakers.

With the laser now able to read audio bits more accurately, digital data acquisition reaches full potential.

### The CD improvement *anyone* can hear.

With a damped and precisely spinning disc, you'll discover new depth and presence in a recording. With greater overall clarity. Extended frequency response. Smoother highs and deeper lows.

Best of all, you'll experience more natural and realistic music production. The gentle plucking of violin strings. A rock solid bass. A feeling of airiness in the vocals. And because there's greater soundstage and imaging, you'll be able to pick out individual instruments—bringing you closer than ever to the original performance.

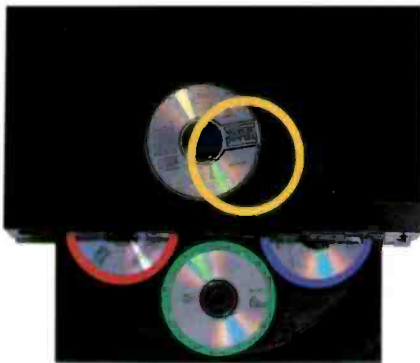

### Attaches in seconds. Fits all players.

Manufactured from a specially impregnated, high density material, CD SoundRings are designed to fit all home, car, and portable CD players, including multi-play changers.

Simply use the built in centering device to quickly and easily attach each ring onto the outer edge of a disc's label side. CD SoundRings' blue, green, red and yellow colors add an attractive touch, and let you color code your compact disc collection for easy identification.

### Discover how good your discs can sound.

It's a fact. Compact disc performance at its height is unprecedented in its power, range and impact.

Now with CD SoundRings, you can fully achieve that potential. Order the extraordinary CD SoundRings today.

Order Toll-Free

**1-800-888-2118**

24 Hours a Day, 7 Days a Week

### Our Policy:

- We accept VISA, MASTERCARD, and AMERICAN EXPRESS.
- Your credit card is not billed until we ship your order.
- Your order will be shipped within 48 hours.
- Your purchase is risk-free. If for any reason you are not delighted with the order you receive, just return it within 30 days for a prompt and courteous refund.

Send CD SoundRings risk-free for 30 days

Package of 24 for \$29.95 (\$3.00 for Shipping)\*

Package of 50 for \$49.95 (\$3.00 for Shipping)

I'm paying by: Check MC VISA AmEx

Acct. No. \_\_\_\_\_ Exp. \_\_\_\_\_

Signature \_\_\_\_\_

Name \_\_\_\_\_

Address \_\_\_\_\_

City \_\_\_\_\_ State \_\_\_\_\_ Zip \_\_\_\_\_

Phone (Area Code) \_\_\_\_\_ Phone \_\_\_\_\_

\*CA & WA add appropriate sales tax.

**Berkeley SoundLab**

2515 Benvenue Suite 402, Berkeley, CA 94704

## Marantz PM-65AV Audio-Video Integrated Amplifier

**I**t is perhaps unfair to Marantz to begin this report with a peccadillo of sorts, but it's bemusing enough to warrant special attention. The PM-65 is the first integrated amp—or preamp or receiver, audio-video or audio-only—I've encountered that makes no explicit provision for analog audio tape! Of course, it can accommodate your cassette deck, as the fairly detailed owner's manual makes plain. But up front there are only three labeled tape options: DAT (for digital audio tape, in case you've

subtitle of TAPE 1, while the two VCR options are marked TAPE 2 and TAPE 3, respectively. There are also input and output connections (delivered jumpered) for an outboard signal processor. Additional input connections include: provision for two CD players (one with a "direct" option, switchable at the front panel, that passes through the tone controls despite the designation); a tuner; a phono (moving-magnet or comparable cartridges); and two audio-video sets: CDV/VIDEO and TV/AUX. There is a



DAVID A. WAGNER

**Dimensions:** 16½ by 5¼ inches (front), 13¼ inches deep plus clearance for controls and connections.

**AC Convenience Outlets:** Two switched (200 watts max. total), one unswitched (100 watts max.).

**Price:** \$550.

**Warranty:** "Limited," three years parts and labor.

**Manufacturer:** Made in Japan for Marantz Company, Inc., 20525 Nordhoff St., Chatsworth, Calif. 91311.

been out of touch for a couple years), VCR 1, and VCR 2.

This is partly a sign of the times and partly a question of Marantz's self-image, it would seem. Certainly there is a very real demand for equipment that can handle two VCRs. But DAT? Well, Marantz made headlines by being the first company to announce plans to market a DAT deck in this country. I have yet to see one in a store, but perhaps that's beside the point. For Marantz, DAT is where recording will (or at least should) be at in a future so near as to make the old-fashioned designation passé.

On second look, you see that the DAT switch positions carry the telltale

composite-video output for your monitor. The speaker connections, for two sets of speakers, are heavy-duty binding posts that accept bared leads.

There are three sets of input selectors, so to speak. The large rectangular buttons near the bottom center of the front panel select the signal you hear and view: SOURCE and the three tape options. They serve the function of a monitor selector. The source selector itself is next to the volume knob and includes all inputs except the three tape options. The source for recording is handled by the third selector, at the bottom, next to the balance knob. It gives you the option of recording the source selected at the upper knob

or of dubbing from any of the three tape options to the other two.

Between this recording selector and the monitor buttons are one for "muting" (the usual attenuation by a nominal 20 dB) and two for "AV Sound." One of these simply switches the feature on and off; the other selects either of two modes: "music" or "movie." The action of each resembles that of a conventional loudness-compensation control except that the high treble is boosted as much as the deep bass—by up to about 7 dB, depend-



One of the amplifier's well-intentioned DAT switches (lower left).

ing on the volume setting. The music mode has most effect below 100 Hz and above 10 kHz; the movie mode is identical in the treble but moves the bass inflection points more than an octave higher, so most of its boost lies below 250 Hz.

Though the manual talks of using these options "to obtain more powerful sound when listening to music sources or surround software," the AV designation suggests (correctly, I think) that they will be most useful with video source material that has had less care taken with its audio than it should have and thus can profit from some emphasis toward the frequency extremes. On well-recorded fare, I find the AV Sound controls superfluous, but then I have never been very fond of loudness controls either.

Of course, you can tailor the frequency balance, with or without AV Sound, by using the tone controls. Their inter-step spacing is much more regular than is usual among the units we test. The boost/cut symmetry of the bass control is excellent; the treble control reaches a little lower in frequency when it is attenuating than when it is boosting. Both have a range of about  $\pm 12$  dB; the treble has most effect near 20 kHz, the bass at around 50 Hz.

The phono preamp is quite good, though the frequency-response trace

shows the midbass about 1 dB stronger than the treble above 5 kHz. A slight rolloff can be discerned in the extreme bass, but it isn't steep enough to constitute an infrasonic filter. Attenuation in the warp-output range is only about 6 dB, making it important that your phono cartridge and tonearm work well with each other.

The amplifier section seems very comfortable with 4-ohm loads, judging by the extra current (and hence power) it delivers into that load vis-à-vis the standard 8 ohms. The dynamic-power figure at 2 ohms is no higher than that with 4 ohms, but this doesn't necessarily mean that the amplifier itself is faltering. During bench testing at this level, the protection relay kicked in before any sign of clipping had yet appeared, thus preventing investigation of higher levels. Suffice it to say that the amplifier does well in the listening room as well as on the bench with standard test resistors, and the manual warns you off any speakers whose impedance and hookup would result in unusually low-impedance loads.

As in other products of the current generation, Marantz has not gone out of its way to accommodate FM/TV simulcasts (which I hope are being replaced by MTS-stereo TV broadcasts in most areas anyway). This simplifies switching con-

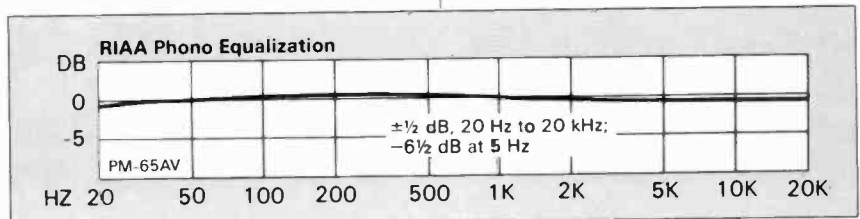

siderably and allows the PM-65AV to avoid the elaborately involuted control schemes of some models we've tested. Even so, it provides three-way dubbing among its tape options, which is a rare and luxurious capability. It is, all told, a well-designed and thoroughly up-to-date integrated amp. *Robert Long* ▶

#### REPORT POLICY

Equipment reports are based on laboratory measurements and controlled listening tests. Unless otherwise noted, test data are provided by Diversified Science Laboratories. The choice of equipment to be tested rests with the editors of High Fidelity. Samples normally are supplied on loan from the manufacturer. Manufacturers are not permitted to read reports in advance of publication, and no report or portion thereof may be reproduced for any purpose or in any form without written permission of the publisher. All reports should be construed as applying to the specific samples tested. High Fidelity and Diversified Science Laboratories assume no responsibility for product performance or quality.

#### Rated Power

8-ohm load	18.1 dBW (65 watts)/channel
4-ohm load	19.0 dBW (80 watts)/channel
<b>Output at Clipping (at 1 kHz; both channels driven)</b>	
8-ohm load	19.0 dBW (80 watts)/channel
4-ohm load	20.9 dBW (123 watts)/channel

#### Dynamic Power (at 1 kHz)

8-ohm load	19.5 dBW
4-ohm load	21.4 dBW
2-ohm load (see text)	21.4 dBW

#### Dynamic Headroom (re rated power)

8-ohm load	+1.4 dB
4-ohm load	+2.4 dB

#### Harmonic Distortion (THD; 20 Hz to 20 kHz)

at 18.1 dBW (65 watts)	$\leq 0.014\%$
at 0 dBW (1 watt)	$\leq 0.011\%$

#### Frequency Response

+1/4, -1/2 dB, 11 Hz to 40.6 kHz
+1/4, -3 dB, <10 Hz to 172 kHz

#### Sensitivity & Noise (re 0 dBW; A-weighting)

	sensitivity	S/N ratio
aux input	19 mV	86 dB
phono input	0.30 mV	79 dB
<b>Phono Overload (1-kHz clipping)</b> 160 mV		

#### Input Impedance

aux input	24k ohms
phono input	48k ohms, 165 pF

#### Output Impedance (to tape)

from aux input	375 ohms
from phono input	430 ohms

#### Damping Factor (at 50 Hz; re 8 ohms)

250
-----

#### Channel Separation (at 1 kHz)

77 1/4 dB
-----------



**"You might use  
your car for pleasure,  
but insuring it is  
a business decision."**

RAYMOND BARR

**Here's why...** With the cost of auto insurance, particularly with two or more cars, you must make informed decisions. The right insurance company with the right coverages, with the proper limits at appropriate rates. Those are *business* decisions that require the advice and counsel of an Independent Insurance Agent. We represent several fine companies...not just one...so you choose the right policy at the right price, with the right service. An Independent Agent — always a good *business* decision.



**INDEPENDENT INSURANCE AGENTS OF AMERICA**  
...and the insurance companies they represent INCORPORATED



**Realistic CD-6000  
Compact Disc  
Changer**

**I**'ve always believed that, all other elements being equal, simplest is best. Given that Compact Discs are better at preserving musical continuity than are LPs—and I have never liked using changers for LPs—why bother with a CD changer? The reasons I hear cited most often by serious music lovers are that you don't have to struggle with the so-called jewel boxes or even handle the CDs once they are stored in the six-disc

tons that basically follow the order in which you tend to use them, left to right. The first is the exception: the eject. It is followed by the series you press in programming: PROGRAM, DISC (to choose one of the six), up and down SKIP to choose the track number, and STORE to enter the selection thus chosen. Next comes REPEAT, which steps through three options: one (a single track), all (the programmed sequence or entire col-



DAVID A. WAGNER

magazines. And now that I've tried it, I see what the changerphiles mean.

Moreover, Radio Shack's Realistic CD-6000 actually is simpler to use than are many high-end single-disc players—and it costs less, to boot. It dispenses with all those fussy little features that add more to player cost than to practical musical enjoyment. And if you find the jewel boxes as annoying as many users evidently do, you may consider even the elaboration of the magazines to be simpler than coping with individual discs.

The controls are exceptionally logical in their layout. Across the bottom left of the front panel is a row of large but-

tion of discs), and clear (off). Rounding out the row are forward and reverse audible cue buttons.

The programming memory will retain as many as 32 tracks, chosen in any order from any of the six discs. By comparison to single-disc players, cycling times are naturally a bit longer, even between tracks on the same disc. Contiguous tracks acquire a gap in excess of one second when programmed for continuous playback. However, this is not a big trade-off for listeners who find the benefits of changers attractive.

The numerical display at the upper left of the front panel normally shows

**Dimensions:** 16½ by 4 inches (front), 13 inches deep plus clearance for connections.

**Price:** \$360; extra six-disc magazines, \$18.

**Warranty:** "Limited," one year parts and labor.

**Manufacturer:** Made in Japan for Radio Shack Division of Tandy Corp., 1700 One Tandy Center, Fort Worth, Tex. 76102.

# HIGH FIDELITY

AUDIO • VIDEO • TEST REPORTS • MUSIC

## SUBSCRIBE TODAY AND SAVE 60% OFF!

Subscribe to High Fidelity for only \$11.97 for 1 year (12 issues). That's more than \$18.00 off the \$30.00 cover price.

High Fidelity brings you in-depth evaluations, detailed test reports and sound buying advice on all the latest audio and video equipment. Also you'll get the most up-to-date information on new innovations and industry trends, articles about music and musicians and reviews of classical and popular recordings in all formats.

**Call Toll-Free Now —  
1-800-666-3977;**  
or fill in this coupon and mail it to

High Fidelity • P.O. Box 3234 • Harlan, IA 51593-0414

**Yes! Send me one year (12 issues) of High Fidelity for just \$11.97. I save 60% OFF the \$30.00 cover price.**

Double my savings! Send me 24 issues for just \$22.00.

Mr./Mrs./Ms. (circle one)

(please print)

Street

Apt. No.

City

State

Zip

My payment is enclosed

Please bill me later

HIGH FIDELITY's annual basic rate is \$13.95.

J3X55



disc number, track number, and program-entry number. The only time option, toggled by pressing a nearby button, replaces track and program information, respectively, with elapsed minutes and seconds in the current track. The current disc number can also be ascertained by looking at a window in the front of the magazine: While a disc is playing its slot appears black.

The supplied wireless remote control, which operates on a pair of AAA cells, repeats all of the controls except for AC power and eject, so you can even program the changer from your listening position. The readout's somewhat oversized amber numerals help materially in this if your chair isn't close to the player.

Overall, bench tests demonstrate performance comparable to that of other home players. Linearity at low levels is not up to that mark, however, and response is perhaps marginally less flat than that of most component-grade models, but this last is no more than a quibble. All of the tracking obstacles on the Philips test disk were traversed without difficulty, and even the much more demanding Pierre V erany disc didn't daunt the player unduly. It handled dropouts to 1.25mm with aplomb; by 1.5mm, the dropouts began to cause ticks or other symptoms that, of course, grew worse as the dropouts widened.

Keep in mind that Radio Shack has not indulged in any of the glittering technology that, others insist, adds so much to CD-player performance. The CD-6000 specs list only straight 16-bit decoding and don't even mention oversampling; the output filtration seems to be a relatively modest digital filter plus a

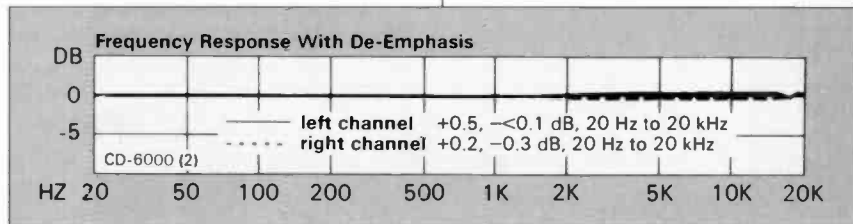
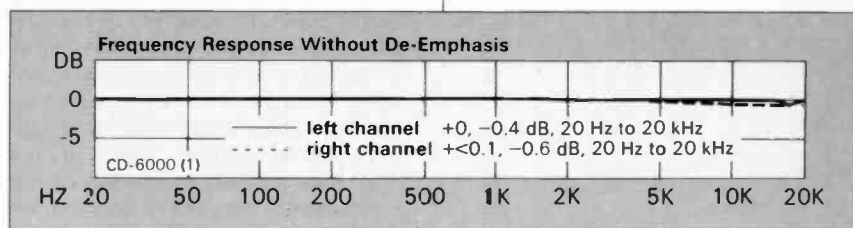

steep analog one. Yet the sound is very much what you might expect of a good CD player. I can't say that it's equal to the very best I have heard, but—our ability to fool ourselves on such issues being what it is—I can't swear it is significantly worse either. I believe I hear a difference, but I can't be sure that you will.

For those who want a changer simply to provide the convenience of continuous, announcer-free music, the foregoing is surely beside the point. For readers who take their sensibilities more seriously, I can recommend the CD-6000 for, above all, its ergonomic straightforwardness—a property that is both worthy and scarce. Its only fall from grace in that respect is that once a programmed sequence has been entered, I can find no way to cancel it, except by removing the magazine and reinserting it. But, at worst, this arrangement is only slightly inelegant. *Robert Long*

Channel Separation (at 1 kHz)	91 1/2 dB
Channel Balance (at 1 kHz)	±0 dB
<b>S/N Ratio (re 0 dB; A-weighted)</b>	
without de-emphasis	93 1/4 dB
with de-emphasis	94 1/2 dB
<b>Harmonic Distortion (THD+N; 40 Hz to 20 kHz)</b>	
at 0 dB	≤ 0.018%
at -24 dB	≤ 0.054%
<b>IM Distortion (70-Hz difference; 300 Hz to 20 kHz)</b>	
0 to -20 dB	< 0.01%
at -30 dB	0.021%
<b>Linearity (at 1 kHz; dithered below -60 dB)</b>	
0 to -40 dB	no measurable error
at -50 dB	+ 0.1 dB
at -60 dB	+ 0.7 dB
at -70 dB	+ 2.1 dB
at -80 dB	+ 4.8 dB
at -90 dB	+ 9.1 dB
at -100 dB	+ 8.6 dB
<b>Tracking &amp; Error Correction</b>	
maximum signal-layer gap	> 900 μm
maximum surface obstruction	> 800 μm
simulated-fingerprint test	pass
Maximum Output Level	2.03 volts
Output Impedance	1,850 ohms

**A**dvent's very first product was a "bookshelf" speaker called, simply, the Advent Loudspeaker. Its overriding virtue was excellent value for money, as the British say. A generation later, Advent's latest speaker, the Baby II, carries on that tradition. Its price is only a little higher in dollars; adjusted for inflation, that means it's less expensive than its progenitor. And it's smaller: It really will fit on many bookshelves, whereas the original wouldn't. And you know what? If memory serves, it even sounds better.

As the name almost mystically implies, this is the second incarnation of the Baby, with a new tweeter and an increased sensitivity rating. The 1/2-inch polycarbonate-dome tweeter employs ferrofluid in the voice coil for cooling. It is crossed over at 4.5 kHz to a 6 1/2-inch

long-throw woofer in a sealed enclosure. Both drivers are centered on the long axis of the front baffle, behind a removable black stretch-fabric grille.

Keeping this axis vertical should promote the best possible imaging, though Advent indicates that horizontal placement is acceptable (and, of course, some bookshelves will demand it). The end caps are of solid wood, with pleasantly rounded edges. The remaining surfaces are finished in black—even the back, in case you want freestanding placement. Color-coded spring-clip connectors for speaker cables are recessed into the back.

Advent rates impedance at 6 ohms nominal and 4 ohms minimum. As you can see from our data column, the average is above 8 ohms, but the curve does dip to 4.5 ohms in the extreme bass and 4.4 ohms at the woofer-range minimum,

## Advent Baby II Loudspeaker

## Test Reports

near 200 Hz. The woofer resonance, at 80 Hz, measures 16 ohms, and a broader maximum near the top of the woofer range measures 19.6 ohms, which accounts for the average. Still, the breadth of the woofer minimum argues in favor of treating the Baby as a 6-ohm or even 4-ohm model, should you decide to run speaker pairs in parallel.

Frequency response was measured by Diversified Science Laboratories with

begin at around 50 Hz. Off-axis response is very similar.

The Baby sounds smoother than the curves imply. The forwardness suggested by the midrange maximum is certainly there, and there is a slightly "etched" quality in the tweeter range (which may relate to the twin response peaks toward the top end). Ultra-low bass is simply absent—of necessity, in a speaker of this size—but so is the thumpiness by which



DAVID A. WAGNER

**Dimensions:** 13 by 16½ inches (front), 6¼ inches deep.

**Price:** \$250 per pair.

**Warranty:** "Limtled," five years parts and labor.

**Manufacturer:** Advent Division of International Jensen, Inc., 4138 N. Untled Parkway, Schiller Park, Ill. 60176.

the speaker on a 27-inch stand and 3 inches in front of the wall. The pronounced dip at around 300 Hz in both traces presumably is due, at least in part, to floor reflections (as it has been with many other speakers we have tested). However, the less pronounced dip in the neighborhood of 2.5 kHz is confirmed to some extent by near-field measurements, which indicate that the woofer rolls off somewhat short of the nominal cross-over point. Even including the floor-reflection dip, response stays between about +3¼ and -4¼ dB over the speaker's working range, which may be said to

some other small speakers have sought to compensate for the want of clean fundamentals at the bottom end.

Placement makes a good deal of difference with the Baby II. The finished back—and also my own general preferences—led me to begin with the Baby freestanding, but it isn't at its best that way. The lack of bass reinforcement emphasizes what roughness there is in the treble and makes the sound overbright and somewhat shallow—even rather harsh with some music. Almost any placement that puts a bass-reinforcing surface nearby is preferable. Even on the

floor, ridiculous as that looks with so small a speaker, and despite the shin-height tweeter, the sound is much more agreeable. I finally settled on (guess what?) a broad shelf with a backup wall. This truly is a bookshelf speaker!

The sound still is on the bright, crisp side, lending liveliness and detail without harshness as long as both the placement and the listening level are reasonable. The Baby II is not a big speaker and therefore can't be expected to fill large spaces with loud, clean sound—though it does better than most true mini-speakers in this respect. For example, distortion averages under 1 percent at the lab's lowest test sound-pressure level (85 dB SPL), but the figures increase rapidly as drive level is increased to 100 dB, where the average is on the order of 5 or 6 percent, depending on frequency.

Advent rates the Baby's power handling at 150 watts peak, 50 watts continuous. Given the 89-dB sensitivity (a spec confirmed by the lab), this implies the ability to reproduce something around 110 dB SPL, which probably is an over-optimistic figure for most speakers of

this size. Both the lab data and the listening tests suggest that you'd be better advised to seek sheer loudness from other designs. The Baby will play plenty loud for most purposes. Just don't push it.

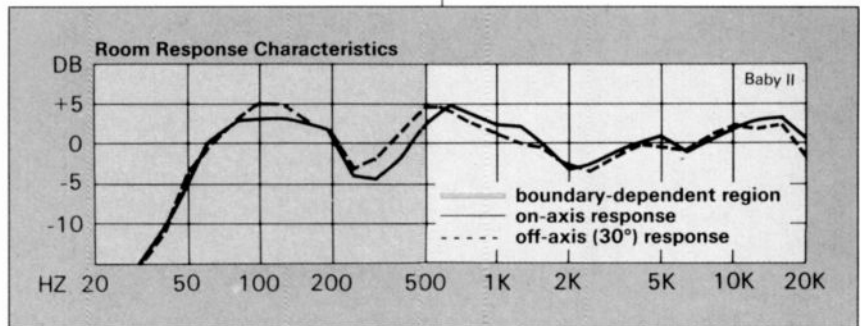

Advent's Baby II really is a very winning little speaker when used intelligently. Imaging is very good, as you'd expect, and there is a nice sense of bite, detail, and "air" in the music. Its clarity depends to some extent on its somewhat bright coloration, perhaps, and this won't satisfy all tastes—but what loud-speaker will, at any price! *Robert Long*

Sensitivity (at 1 meter; 2.8-volt pink noise) 89 dB SPL  
 Average Impedance (250 Hz to 6 kHz) 12.1 ohms

**T**he key feature of this hefty new amp is what JVC calls Digital Pure-A: a novel approach to maintaining Class A operation at all power levels without sacrificing efficiency. "Class A" simply means that the output transistors always receive enough bias current to prevent them from completely turning off, thus preventing what is known as crossover notch distortion. That's the advantage. The disadvantage is that this mode of operation normally consumes a lot of electricity and generates a lot of heat, even when signal levels are low.

There are two standard ways around this dilemma. One is a hybrid mode called Class AB, in which the output devices are biased for Class A operation only at low signal levels, where masking of crossover distortion by the desired signal would be relatively ineffective. The other is sliding-bias Class A, in which the bias varies according to signal level, so that it's always just great enough to prevent the transistors from ever having to switch completely off. JVC's own version of this method is called Super-A.

Digital Pure-A is more like having two conventional Class A amplifiers on the same chassis. At normal signal levels, the AX-Z911BK is a straight, low-power Class A amp; at high signal levels, the power-supply voltage and bias current jump up to make it a high-power

amp (still Class A) just long enough to handle the increased output requirement. Although two-step power supplies are not new, I have never seen one combined with this kind of bias switching before; in that respect, Digital Pure-A is unique.

It also is unique in the way it determines when to switch. The system works only on digital inputs. The incoming bit stream is split into two paths. One goes into a memory buffer that delays it by 150 milliseconds before passing it on to the AX-Z911BK's built-in digital-to-analog (D/A) converter. This is the path that feeds the power-amp section and the analog tape outputs. The other path goes to a control circuit that determines from the signal when a switch from low to high power (or back) is required. The delay in the main signal path gives this predictor time to work.

The beauty of Digital Pure-A is that it can make all the right choices at exactly the right times: The supply voltage and output-stage bias go up just when they need to and come down as soon as the additional power is no longer required. However, the technique does require a digital source to work. For analog inputs, the AX-Z911BK reverts to sliding-bias Class A operation.

Digital and analog inputs and outputs are arranged in separate columns on opposite ends of the back panel. The dig-

## JVC AX-Z911BK Integrated Amplifier

*The RTA Series*



RTA 111

*"They provide smooth, fast and incredibly well detailed sound."*

# "Polk's RTA Tower Loudspeakers Combine Legendary Polk Performance with Contemporary Style."

*Big speaker performance with an efficient use of space.*

## RTA 11t

The RTA 11t is the finest conventional (non-SDA) speaker that Polk Audio manufactures. Its extremely high power handling (250 watts) and high efficiency (90dB) provide remarkable dynamic range from both large and small amplifiers. The RTA 11t utilizes the same technologically advanced fluid-coupled subwoofer design found in Polk's flagship model. Dual 8" sub-bass radiators are coupled to two 6½" mid/bass drivers, resulting in a fast, powerful, deep, and ultra-accurate bass response, without the boomy, undetailed sound of large woofer systems.

## RTA 8t

In a slightly smaller package, the RTA 8t offers the same driver complement as the larger, more expensive RTA 11t, and thus shares its benefits of superior imaging, musicality, and detail.

Both Polk RTA series loudspeakers achieve the extremely rare combination of good looks and state-of-the-art performance. The tall, elegantly slender, and deep "tower" design cabinets allow for substantial internal volume for high efficiency and powerful bass, while requiring less than one square foot of floor space. The small baffle surface area around each driver minimizes diffraction (sonic reflections), thereby insuring outstanding imaging and low coloration.

Positioning the 1" silver-coil dome tweeter between the two 6½" trilaminate polymer bass/midrange drivers achieves what is called "coincident radiation." This means that both the mid- and high-frequencies appear to radiate from the same place on the baffle resulting in perfect blending at the critical crossover point. (See illustration, below).

Polk RTA speakers have an uncanny ability to perfectly reproduce the human voice, pianos, guitars, and every other instrument whose faithful reproduction demands superlative midrange and high-frequency performance. Bass and percussion instruments are accurately reproduced with full visceral power and realism, without the heaviness, boominess, or lack of detail that plague lesser designs.

The discriminating listener who seeks state-of-the-art performance and design will find the quintessential combination of both in Polk's RTA series loudspeakers.

## THE PRINCIPLES OF COINCIDENT RADIATION

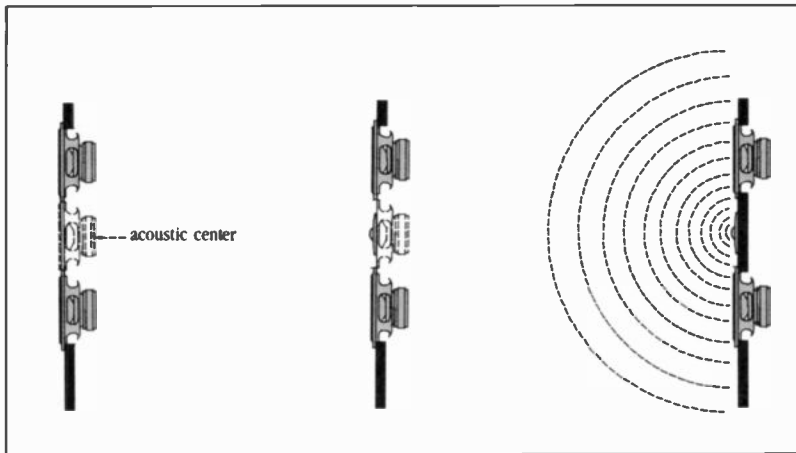

The perceived source of sound of two identical drivers is centered in the area between them.

The benefit of coincident waveform propagation resulting in precise imaging, uniform vertical dispersion and startling midrange accuracy.

In the Polk RTA loudspeaker, the tweeter is positioned at the acoustic center of the drivers.



Polk Audio's RTA 8t and RTA 11t High Performance Tower Speakers

**polkaudio**  
The Speaker Specialists®

5601 Metro Drive, Baltimore, Md. 21215

Except where indicated, all data were taken from the analog aux input to speaker output. Measurements through the digital input were to the tape outputs (except for noise and channel separation, which were taken to the speaker outputs) and were obtained by connecting a JVC XL-Z555BK Compact Disc player with the optical link. Test discs used were the Sony YEDS-7, CBS CD-1, and Philips 410 055-2.

#### Rated Power (8-ohm load)

20.0 dBW (100 watts)/channel

#### Output at Clipping (at 1 kHz; both channels driven)

8-ohm load 20.8 dBW (120 watts)/channel

4-ohm load 22.8 dBW (190 watts)/channel

#### Dynamic Power (at 1 kHz)

8-ohm load 21.6 dBW

4-ohm load 23.8 dBW

2-ohm load 24.6 dBW

#### Dynamic Headroom (re rated power; 8-ohm load)

1.6 dB

#### Distortion (THD; 20 Hz to 20 kHz; aux input)

at 20.0 dBW (100 watts)  $\leq 0.16\%$

at 0 dBW (1 watt)  $< 0.01\%$

#### Distortion (THD+N; 40 Hz to 20 kHz; digital input)

at 0 dB (maximum input)  $< 0.01\%$

at -24 dB  $\leq 0.055\%$

#### IM Distortion (300 Hz to 20 kHz; digital input)

0 to -20 dB  $< 0.01\%$

at -30 dB 0.012%

#### Linearity (at 1 kHz; digital input)

-0 to -50 dB no measurable error

at -60 dB +0.2 dB

at -70 dB +0.9 dB

at -80 dB +2.3 dB

at -90 dB +6.2 dB

at -100 dB +8 dB

#### Frequency Response (aux input)

+0, -1/2 dB, < 10 Hz to 25.2 kHz

+0, -3 dB, < 10 Hz to 69.6 kHz

ital column is much simpler, as it provides for fewer components and combines both channels on a single jack. There is an optical input, a coaxial input, and an input/output pair for a DAT deck—three sources total.

The DAT set is duplicated on the analog side, which provides another set as well, for a second tape deck or a signal processor. Also in the analog column are stereo pairs for two aux inputs, a CD player, and a phono cartridge. Right below the phono inputs is a pair of buttons. One adjusts the phono preamp for moving-magnet or moving-coil input; the other switches in an extra 6 dB of gain, thereby doubling the phono sensitivity. It also halves the overload margin, to a point I would consider barely adequate. Curiously, the sensitivity obtained with the extra gain is closer to what one normally would expect from an integrated amp.

The speaker connectors are sturdy, color-coded screw-down binding posts designed primarily to accommodate bared wires. However, the holes in the center posts can be opened wide enough to accept banana plugs. The only other significant feature of the back panel is a connector for JVC's Compu Link remote-control system, which can be used to tie together various JVC components

has taken a very direct and intelligent approach to the latter: You just dial in the amount of bass boost necessary to obtain the tonal balance that sounds right at the volume you've chosen, up to a maximum of about +5 dB below 100 Hz. In keeping with modern research, the loudness contour does not affect high frequencies at all. There are no conventional tone controls.

The display is devoted to the amp's two main source selectors. These are large buttons directly below the display: The one on the left is for the analog inputs, the one on the right for the digital inputs. Directly above each selector are indicators that show which source in that bank is selected, plus a pair of light bars that indicate which of the two banks is operating at the moment. For example, if the analog bank is the currently active one and you want to switch to a digital source, you press the digital selector button to switch sides. The bar under the analog indicator bank will go out and the one under the digital bank will come on. If you then want to choose a digital source other than the one active when you made the switch from analog, you press the digital selector to step through the various options.

This system is straightforward, and though I think JVC might have provided a more convenient method for switching from one source to another, it is okay for most purposes. The digital selector toggles through four alternatives: DIGITAL 1 (the optical digital input), DIGITAL 2, DAT MONITOR with DIGITAL 1, and DAT MONITOR with DIGITAL 2. This design prevents the switch from being used for source/tape comparisons. The best way to compare the source signal with that being recorded on the tape is by using the tape deck's switch. (The multilingual owner's manual does not make this clear, by the way, and is seldom of much help in understanding anything beyond the most basic aspects of the amplifier's operation.)

However, the wireless remote control does permit casual comparison between source and tape, as it has a separate selector button for each source and monitor option. All of the other front-panel controls except BALANCE and LOUDNESS are included on the remote as well, and it provides a "mute" switch that is not on the front panel. The MUTE is unusual in that it simply turns the volume control down a set amount, and repeated presses will cause further attenuation.

The analog selector is easier to figure out. You can dub from any source to either Tape 1, which is on the main selector, or Tape 2, which is on a separate

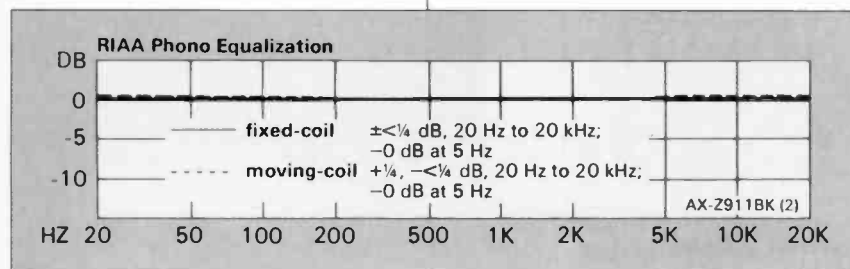
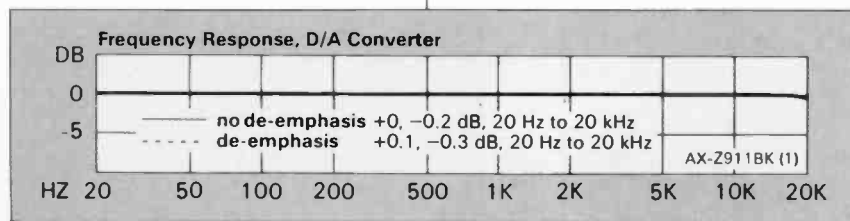

#### Sensitivity & Noise (re 0 dBW; A-weighting)

	sensitivity	S/N ratio
aux	43 mV	85 1/2 dB
fixed-coil (MM) phono	0.54 mV	78 3/4 dB*
moving-coil (MC) phono	44 $\mu$ V	73 1/2 dB*
digital input	see text	

#### Input Overload (1-kHz clipping)

aux	> 10 volts
fixed-coil (MM) phono	130 mV*
moving-coil (MC) phono	10 mV*

#### Input Impedance

aux	26k ohms
fixed-coil (MM) phono	48k ohms; 125 pF
moving-coil (MC) phono	470 ohms

for automatic source selection or synchronized recording from a CD player or turntable.

The amp's front panel is strikingly bare, dominated by a large display panel and an oversize volume knob (a nice touch for those of us who don't like pushbutton volume controls). The only other knobs are small to the point of being a little hard to manipulate. One is for balance, the other (labeled BASS CONTROL) for loudness compensation. JVC



monitor switch. The only restriction is that you cannot dub from Tape 2 to Tape 1. And since Tape 1 is on the main selector, you cannot monitor off the tape when you are using it for recording. A convenient consequence of having separate digital and analog selectors is that you can, for example, make a direct digital dub to a DAT deck on the digital side while listening to another source, such as FM, on the analog side.

When a digital input is selected, the display will indicate which of the three standard sampling rates is being used (32, 44.1, or 48 kHz) and that the Digital

in order to measure its frequency response, noise, distortion, and linearity. Most of these data were taken at the tape outputs, although noise was measured at the speaker terminals with the gain adjusted for full rated output. What we found was very good, though not outstanding, performance. I would prefer to see slightly better linearity figures, but the sound quality through the converter is above reproach.

As one might expect from the sheer weight of the AX-Z911BK, its most impressive characteristic is its power capability. The amp comfortably exceeded its

<b>Output Impedance (to tape)</b>	
from aux input	510 ohms
from phono input	≤ 380 ohms
from digital input	570 ohms
<b>Damping Factor (at 50 Hz; re 8 ohms)</b>	
	330
<b>Channel Separation (at 1 kHz)</b>	
aux input	67 3/4 dB
digital input	58 dB

\*Data shown here are for the normal gain setting. The +6-dB setting increased gain by 5.9 dB for the fixed-coil position and 6.0 dB for the moving-coil position. This increases the sensitivity to 0.27 millivolts for the fixed-coil input and 22 microvolts for the moving-coil input and reduces the overload points by an equivalent amount, to 65 and 5 millivolts, respectively.



DAVID A. WAGNER

Pure-A circuit is in operation. And if you want the bare minimum of circuitry in the signal path, you can press the D/A Converter Direct switch above the display panel, which sends the analog output from the amp's internal D/A decoder directly through the volume control to the power amp. There is very little excess control circuitry in the AX-Z911BK, however; engaging the direct path bypasses only the balance control and the analog selector.

Since this amplifier includes a D/A converter, some of the data are a little different from usual. We used a JVC CD player to feed the digital output from test discs into the AX-Z911BK's converter

rated power into 8 ohms and delivered nearly 200 watts continuously into 4 ohms (somewhat more than that, dynamically). And though JVC recommends against the use of speakers with rated impedances less than 4 ohms, dynamic power into 2 ohms reached almost 300 watts. Not surprisingly, given the Class A design, distortion is very low.

The AX-Z911BK lacks some of the control features normally found on integrated amplifiers of this class—tone controls, for example—but its performance is impressive. And it is among the components on the leading edge of design for this age of increasingly digital audio.

*Michael Riggs*

**Dimensions:** 18 3/4 by 6 3/4 inches (front), 16 inches deep plus clearance for controls and connections.

**AC Convenience Outlets:** One unswitched (200 watts max.).

**Price:** \$1,200.

**Warranty:** "Limited," two years parts and labor.

**Manufacturer:** Victor Company of Japan, Ltd., Japan.

**U.S. Distributor:** JVC Company of America, 41 Slater Dr., Elmwood Park, N.J. 07407.

# CAT 'N' MOUSE

## Tips for Dealing with Audio/Video Salespeople

BY GORDON BROCKHOUSE

**A**n old Italian proverb goes, "A mouse is safer in the mouth of a cat than a client in the hands of a lawyer." Many audiophiles feel the same about the customer/salesperson relationship. These listeners look upon stereo salespeople as a malicious breed, waiting to pounce on them and drain their wallets, while delivering precious little in return. Sometimes this opinion is justified, but a capable salesperson can be your greatest ally in putting together a good sound system, as long as you approach the relationship properly. Here are some tips on how to do just that.

### Keep Your Expectations Reasonable

A buyer usually has problems with salespeople because he expects too much. The first thing you have to realize is that salespeople are paid by store owners to sell equipment. They're not paid to act as unbiased consultants, objectively comparing other stores' products with their own. This is not to say that salespeople are dishonest, but if you ask how their products compare with their competitors', don't expect an unbiased answer. You should, however, receive an informed answer. Since he or she is paid through commissions or by a salary from the store, the salesperson is getting a cut of your audio-equipment budget and you should get something in return. Specifically, you should get a salesperson who: understands the basics of audio (or video, if that's what you're buying); is familiar with the store's products, their features, and where they fit into the market; is willing to listen to your needs; has the ability to find products that match those needs; and last, but certainly not least, is courteous.

Your chances of finding that combination are about fifty-fifty, according to Toronto journalist Wally Hucker. Since 1982, Hucker has written "secret shopper" stories for *Marketnews*, a Canadian magazine for audio-video dealers. For each article, Hucker visits several stores in a city, presenting the same product request in each. His encounters are summarized in reports designed to show the salesperson/customer relationship from the buyer's side. During the past six years, he has visited more than 150 stores. While Hucker's surveys have included only Canadian dealers, the situation in U.S. stores is not very different.

Half the time, he found various kinds of incompetence, mostly stemming from a lack of basic knowledge of the products. To cite just one example, Hucker says he has received some hair-raising explanations of Dolby noise re-

duction: Some salespeople claim it reduces surface noise when LPs are recorded; others repeat the absolutely untrue old saw that Dolby NR reduces high frequencies, so it's better left unused. Incompetence also shows in salesmanship, such as not listening to the customer's needs or, without asking about his budget, assuming he's looking for the cheapest possible product. Additionally, there are frequent lapses in basic courtesy.

That's the bad news. The good news, Hucker says, is that 25 percent of audio salespeople are competent and another 25 percent are actually very good. That ratio shouldn't surprise anyone familiar with retailing in general and audio retailing in particular. Customers reasonably expect salespeople to know audio and audio products—which is no small feat. Audio products are complex, and the technology is changing all the time. To understand audio, a salesperson needs to know basic audio theory—a significant sticking point.

Exacerbating this problem is the highly competitive nature of retailing. In a city of any size, there will be several audio-video dealers selling comparable products. Cutting equipment prices to compete for business means retailers also have to cut costs, and one of the easiest places to cut costs is in the number and quality of the staff: Retailing is a notoriously low-paying profession. So, despite the extra skills needed to sell audio compared with other types of products, the competitive nature of audio retailing prevents store owners from paying enough to attract people with those skills. Add to that the long hours associated with retail work, and Hucker's 50/50 estimates look downright optimistic.

### Shop for a Salesperson, and for a Store

The reason Hucker actually found so many good audio salespeople is that many of them love audio and really enjoy being in the business. It is these whom you should seek out, because, like it or not, you need them. Unless you're willing to devote all your waking hours to the subject, there is no way you can expect to be familiar with the entire range of products available. A good audio salesperson can

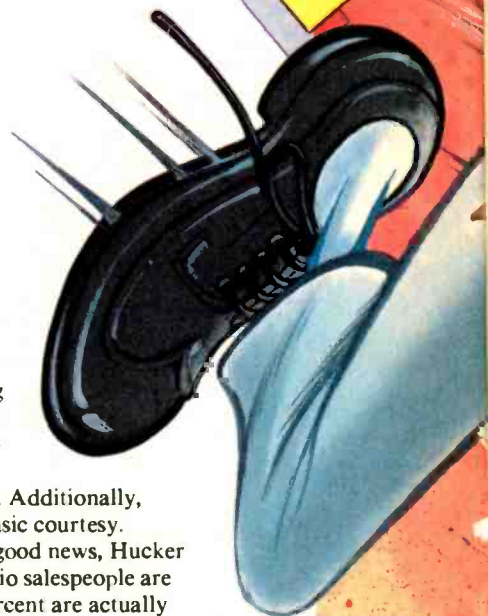

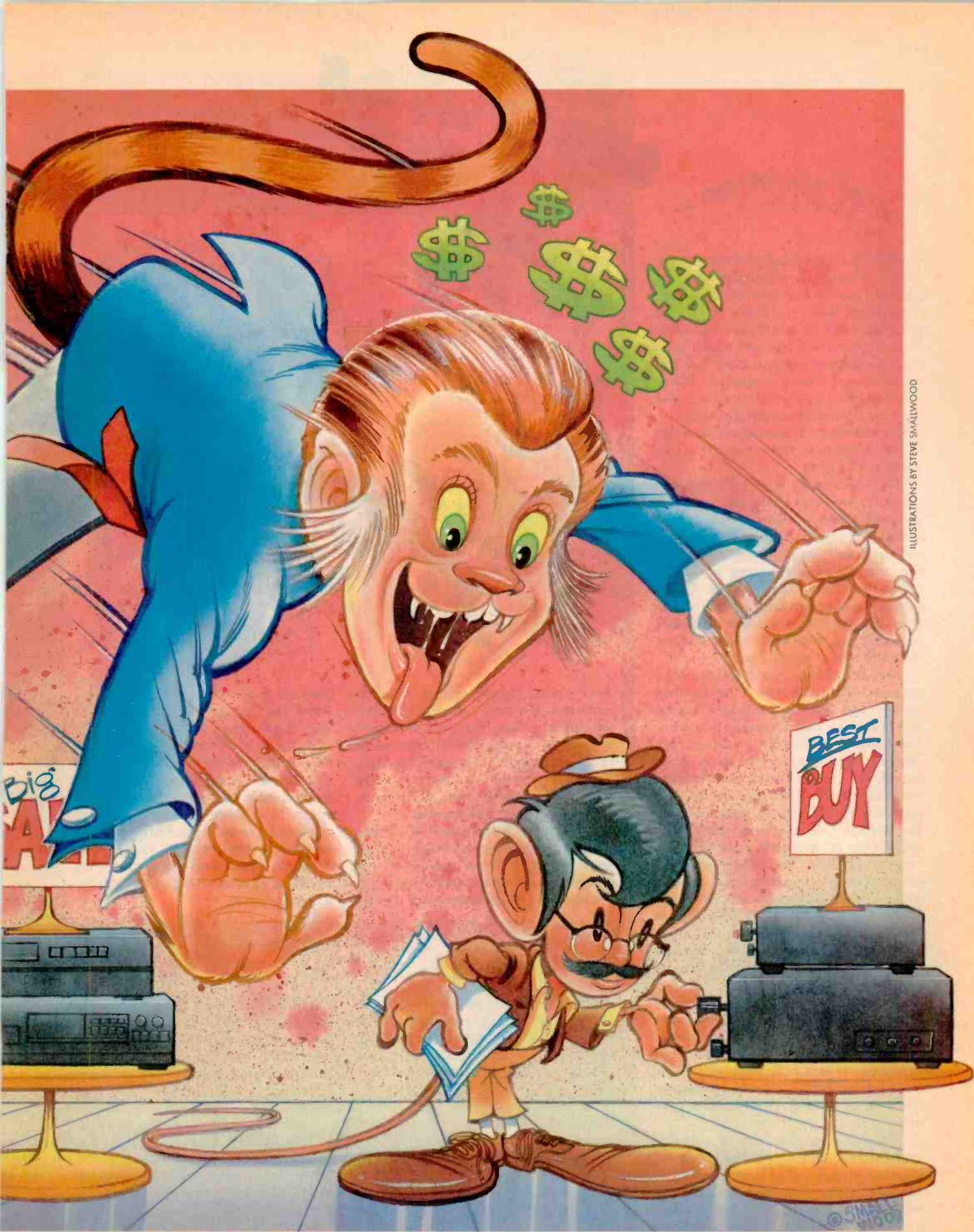

ILLUSTRATIONS BY STEVE SMALLWOOD

# AUDIO SUBSPECIES

There are many different kinds of audio salespeople—some helpful, some not. I present here some of the worrisome traits to watch for. Beware: Many salespeople exhibit more than one of these characteristics.



find the most appropriate product for your needs and budget. And he'll stop you from making a purchase decision based on misconceptions. When you finally make your purchase, you'll be making two decisions: what equipment to buy and which store (and salesperson) to buy it from. The two decisions are virtually inseparable. *Where* you buy, after all, influences *what* you buy—no store stocks everything. Even so, most consumers concentrate on the what-to-buy decision to the exclusion of the where-to-buy issue.

There are reasons why a good store and a good salesperson are so important. A good salesperson will steer you in the right direction if you're going wrong. A fast-buck artist will take the easiest route to the sale, even if it means saddling you with a system that won't keep you happy. A good store and salesperson want long-term relationships with their customers. A schlock operation just cares about today's sale—there will be new suckers tomorrow.

How do you separate the sheep from the goats? You can tell from the way they operate. The right store will carry a good selection of the kind of product you want. The salesperson will query you about your listening room, your taste in music, your budget, the system's users, your favorite music sources. He'll help you sort out your priorities: Should you get a basic system and add extra music sources later, when more funds are available, or instead buy everything right away? Only when he knows your needs will he begin demonstrating product. But he won't insist that you take his word as gospel. He'll demonstrate alternatives and explain the differences. (For more about the types of salespeople you might encounter, see "Audio Subspecies," at right.)

Your first priority should therefore be finding the right store and salesperson. If a salesperson starts pushing the deal-of-the-week as soon as you enter the store, go elsewhere. If he's rude or ill-informed, don't deal with him. If he won't demonstrate product, deal with someone who will.

Where do you discover competent, conscientious salespeople? Hucker found a higher proportion of incompetents at discount chains. Conversely, the better salespeople usually work for independent audio specialists. There's no mystery here.

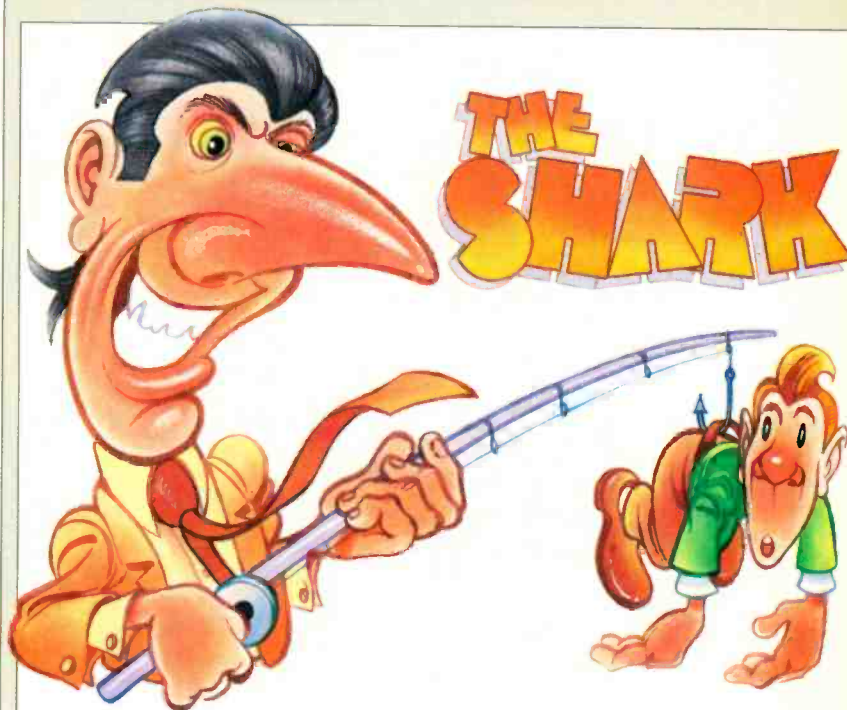

This is your legendary high-pressure salesclerk. His most common habitat is the discount chain, but he is also found in specialty stores. Equally common in three-piece suits and bluejeans, the shark wants the sale—and he wants it fast. The moment you're in the store, he'll pounce, showing you this week's special.

If he doesn't have your Visa card within five minutes of beginning his spiel, the hammerhead may accuse you of wasting his time and throw you out of the store. More subtle types will try very

hard not to give you a chance to say no. After they've delivered their pitch, they'll ask what you think. If your response is the least bit encouraging, they'll ask, "Do you want to take it with you, or have it delivered?" Or, "How much speaker wire do you need with the system?" The more forward types will produce an invoice, ask your name and address, and begin writing. The purpose, of course, is to maneuver you into buying by asking a question that invites an affirmative response.

## THE ZEALOT

The zealot has firm beliefs in what constitutes good sound—and a very short list of products that deliver it. Anything else draws a sneer. He thinks everyone should own those products, regardless of their priorities or budget. One example I recall involved a customer who wanted a new amplifier. The salesperson asked him what speakers he owned. When the shopper indicated a well-known, broadly distributed brand, the clerk snidely commented, "You have my sympathy."

This kind of salesperson cannot ac-

cept that others may not share his ideas. A high-end zealot may recommend obscure, unreliable brands to customers who simply want a reliable, okay-sounding system. The zealot may deride user conveniences, like remote control, to buyers for whom they are important. A heavy-metal zealot will push his favorite brand of boom box, even to listeners who want sonic accuracy. The zealot may know how to listen to audio equipment, but he doesn't know how to listen to his customers.

This salesperson is hopelessly out of his depth in audio. Either he's new to the business or hasn't taken the trouble to learn it. The ignoramus will come up with the most outlandish product explanations imaginable. For example, I remember hearing that a particular brand of cassette came in a red box "because you can record in the red [on the meters] with it."

Because he doesn't understand audio, the ignoramus carries around some fundamental misconceptions. He firmly believes that bigger speaker boxes with more drivers deliver better sound. He thinks you can determine the quality of a receiver from the number of LEDs on the front panel. The idea of balancing the capabilities of the components in a system to suit specific buyer needs is foreign to this subspecies.

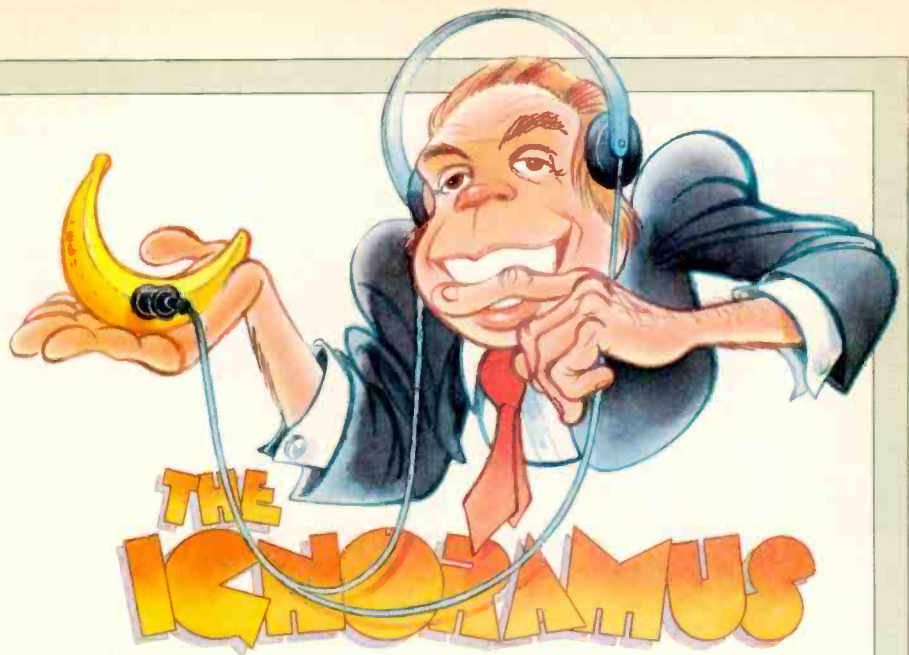

There are different kinds of slobs. Your salesclerk might be the paragon of courtesy, but he could be hindered by ill-mannered colleagues. A friend of mine recalls being serenaded by a group of salespeople singing into a boom box while he was trying to audition a system. Worse are those salespersons who forget

what their job is: helping customers to buy audio products. They may ignore you because they're too busy eating pizza, chatting with each other, watching TV, or playing papier-mâché golf. Another friend of mine was nearly decapitated by a salesperson swinging a nine-iron at a ball of paper.

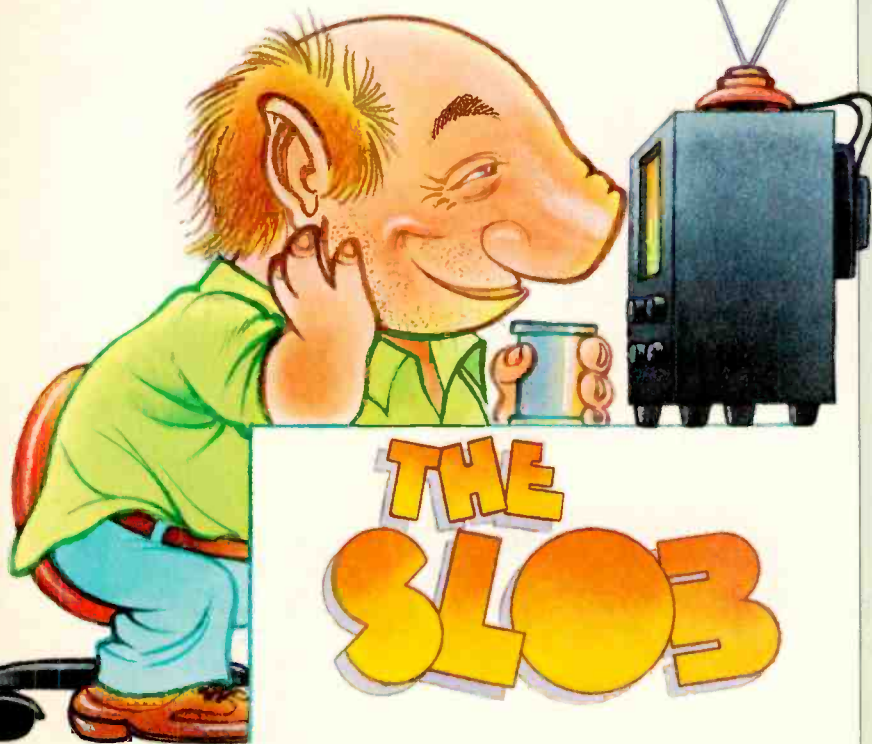

## THE MYSTIC

Like the ignoramus, the mystic cherishes certain audio myths. But unlike the former, he has some fundamental understanding of audio, so his beliefs are different. Alexander Pope's observation that "a little knowledge is a dangerous thing" applies perfectly to this type.

An ardent disciple of high-end audio mythology, the mystic harbors all kinds of weird notions. Among these bizarre and unfounded beliefs, for example, is one that some types of carpet affect the signal as it moves through the speaker cable lying on top of it. (See Ken Kantor's "Audio Fetishes," October 1988.) These beliefs extend to products as well. The ignoramus believes that a speaker with more drivers has to sound better; the mystic may think an amplifier with a heavier transformer and bigger filter caps has to sound better, or that floor-standing speakers must have spiked feet. Some mystics have their favorite types of capacitor and resistor. They often eschew scientific explanation and rational examination, requiring buyers to accept their word as a matter of faith.

*Like any business, audio retailing has its share of bad apples. But there are lots of capable, conscientious people out there. Finding the right salesperson is the first step toward finding the right components. And, if you are a salesperson yourself, the fact that you are reading this at all automatically eliminates you from all the above categorizations. Well... almost.*

G.B.

**SUPER VHS CAMCORDERS 8mm CAMCORDERS HI-FI STEREO CAMCORDERS**



CANON F1000 10:1Z



SONY Call

OLYMPUS VSX405 VX406

OLYMPUS VX802 Call



PANASONIC 445 420

MINOLTA 8200 PENTAX 850KV KD1700V



HITACHI RCA MINOLTA

**MOST POPULAR FEATURES**

- SUPER VHS 8:1 ZOOM w/FLYING ERASE HEAD INCLUDES ALL ACCESSORIES ..... **\$1199**
- SAME AS ABOVE w/CHARACTER GEN ..... **Call**
- SAME AS ABOVE w/DIGITAL ..... **\$1399**
- 8mm 6:1 ZOOM 5 LUX INCLUDES ALL ACCESSORIES ..... **\$799**
- VHS-C 6:1 ZOOM 7 LUX INCLUDES ALL ACCESSORIES ..... **\$699**
- VHS FULL-SIZE TAPE 7 LUX 6:1 ZOOM TIME/DATE (w/HARD CASE) ..... **\$799**
- SAME AS ABOVE w/FLYING ERASE HEAD ..... **\$899**

• TOSHIBA SKS80 — **Call for the BEST PRICE!**

**BEST VALUE:**

- OLYMPUS VX406
- OLYMPUS VXS405
- KYOCERA KD5010
- RICOH R620
- PANASONIC PV420
- CANON E708
- CANON E77KIT
- CANON F1000S
- CANON CG9825
- and MANY MORE!

**SUPER PRICE REDUCTIONS:**

- HITACHI 3100
- TOSHIBA SKS80
- GR25U
- SONY CCDF30
- PANASONIC PV460
- PANASONIC PV330
- GE CG9810
- GE CG9808
- GE CG9806
- MINOLTA 1400
- MINOLTA C50
- MINOLTA 8200

CANON E708 E70 & E77



Call For Lowest Price!

**VCR's - VHS & BETA**



- 4 HD VHS ..... **\$259**
- 4+2 HD Hi-Fi ST MTS ..... **\$359**
- 4+2 SUPER VHS Hi-Fi MTS SUPER & FLY ERASE ..... **\$699**
- 4+2 SUPER VHS Hi-Fi MTS SUPER & FLY ERASE w/DIGITAL ..... **\$985**
- VHS RECORDER ..... **\$200**
- BETA DECK ..... **\$300**
- PLAYER ONLY ..... **\$159**
- AC/DC ..... **\$198**
- 8mm & STEREO PCM Hi-Fi PORT. .... **\$700**
- 13" TV VCR PANASONIC ..... **\$550**
- 5" TV PLAYER ONLY ..... **\$399**

**SPECIAL EFFECT & CHARACTER GENERATORS**

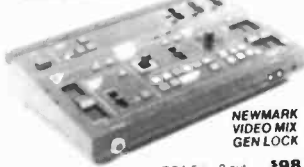

- NEWMARK VIDEO MIX GEN LOCK
- ZENITH Source Selector/ RCA 5 in-3 out. .... **\$98**
- ZENITH Character Generator VCG99 ..... **\$219**
- SANSUI Character Generator VCG99 ..... **Call**
- NEWMARK VAM2000 Digital Dispal ..... **Call**
- JVC JXWS Special Effects ..... **\$319**
- JVC Color Corrector ..... **\$199**
- SANSUI VX99 ..... **\$350**
- VAC301. **\$699** VAC312. **\$199**
- AZDEN or NADY Wireless Mics ..... **Call**

**SUN PAK VIDEO LIGHT**



- #150 ..... **\$88** • #300 ..... **\$119.00**
- NP77 ..... **\$68** • P6120 8mm SONY ..... **\$650**
- SUPER VHS TAPE (T120) ..... **\$10.00**

**TV's**

- 20" REMOTE COLOR TV MTS STEREO ..... **\$299**
- 9" AC-DC COLOR ZENITH ..... **\$219**
- SUPER 30" TV ..... **\$1199**

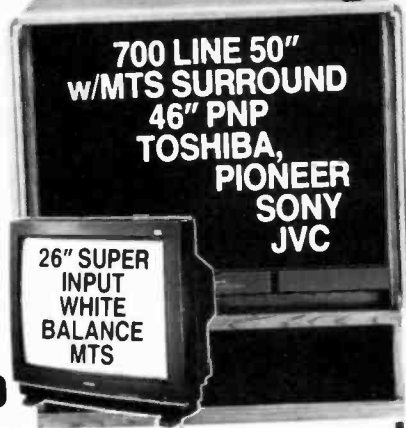

**AUDIO HI-FI RECEIVERS**



LASER DISC COMPACT DISC  
Pioneer • Magnavox Pioneer • Magnavox • JVC • Teac  
RECEIVERS

**CAR STEREOS**



JVC • SONY — Call

**FAX MACHINES**

SHARP UX80 ..... Call  
UX140 ..... Call  
MURATA M1200 ..... **\$675**



FOR MORE INFO, Call: (201) 696-6531 **WE WILL MATCH OR BEAT ANY LEGITIMATE PRICE**  
FEDERAL EXPRESS AVAILABLE

Call Toll-Free: **1 (800) 444-6300**  
Orders: **1 (800) 247-4654**

We ship within 24 hours. All prices quoted included manufacturer's standard accessories & U.S. Warranty. All units are factory sealed. Shipping & handling extra. Not responsible for typographical errors. S&H non-refundable.

# CAT IN MOUSE

The first goal of discounters is volume, the second is price. To achieve these goals, they advertise heavily, buy in bulk to reduce in-store prices, and cut other costs to the bone. (This is a generalization, remember. Not everyone who works at a discount outlet is a jerk, and you can find lemons at audio specialists.)

## Do Your Homework

The one essential skill for both buyer and seller is listening. The salesperson can't work in a vacuum. He needs to know your requirements before recommending products, so it pays to think about them before you go shopping. Be prepared to give him a description of your listening room: not only its size, but the proportion of reflective to absorptive materials, the layout of room, and the position of furniture. Think also about program sources and total budget. But don't cast your priorities in stone. Be prepared to change your mind. The buyer has to *listen*, too, not just because he may be saddled with misconceptions, but because the salesclerk may know of new developments and products unfamiliar to him.

Bear in mind, however, that even capable salespeople don't always put your needs first. Some store owners or manufacturers pay cash bonuses called "spiffs" for selling specific equipment. Sometimes spiffs are paid for end-of-line (recently discontinued) products, sometimes for products with higher-than-normal profit margins. And that's not necessarily bad: The end-of-line product may be available at a special price, and sometimes the performance differences between a new product and its predecessor are minimal. The older model may even be superior to its replacement. Similarly, stores may look to carry brands with decent profit margins so they can maintain a higher standard of customer service. Still, what you're looking for is a salesperson who recommends the best product for your specific needs that his store carries, not the product with the best spiff.

Even with the best of intentions, salesclerks may mislead customers. Audio myths are not confined to buyers—some salespeople entertain some pretty bizarre ideas about audio. Moreover, many stores train their people to push accessories,

where markups can exceed 100 percent, in order to make up for low profits on audio equipment. While some accessories make effective contributions to sound quality, others, such as exotic signal cables, are of dubious value.

How do you sort out an unbiased, well-considered product recommendation from one based on a spiff or audio mythology? This is a hard task for the newcomer to audio. What's required is a little research, so that you may embark on your shopping expedition with some basic knowledge of audio theory and some familiarity with available brands. Read equipment magazines, especially their product reviews, to gain some confidence with audio-video terminology so that you can ask intelligent questions. Coupled with a little forethought about your needs, the technical preparation should help you evaluate a salesperson's recommendations.

## Buy Equipment, Not Price

The biggest tip-off for a suspect recommendation is excessive emphasis on price. If you're being offered "the best deal in town" or if "the price is going up tomorrow," be on your guard. In my opinion, buying on price alone is the single greatest reason for poor purchase decisions. You'll be living with the equipment long after you've forgotten how much money you saved. Your chances of making a good choice are far greater if your goal is to acquire the best equipment for your needs, rather than simply a "deal."

Still, there are situations where it's in your interest to act quickly to get a special deal. Hot prices on recently discontinued components may enable you to buy a better product than you could otherwise afford. By definition, such end-of-lines are limited in quantity, so you might have to decide quickly. But try to avoid making impulsive decisions. Before you go shopping, I would suggest you resolve not to

make a purchase decision *in the store*. Get product recommendations and demonstrations, then, at home or in a restaurant over coffee, decide what to buy. That way, you can't be pressured into a decision you'll regret later.

One final word: There are shady salespeople in the audio trade, as in any business. But there are also crooked customers. In my view, it's unethical to pick the brains of a salesperson at a full-service audio store, then purchase the products he has recommended at a discounter for a few dollars less. It's unfair to the salesperson and unfair to his future customers. If too many buyers did that, they'd drive capable salespeople and full-service stores out of business. I'm not saying you have to pay through the nose for good in-store assistance: A salesperson can't reasonably expect you to buy from him if a competitor has a dramatically lower price. But at least give him a shot at the deal—don't nickel-and-dime him to death. If the price difference isn't huge, deal with the salesperson who's helped you the most. If he has given good service, he's already earned the price difference. Think of it as an investment in your audio future. □

*Gordon Brockhouse worked his way through university (as they say in Canada) selling stereo equipment. After graduating, he was Editor of Marketnews, a monthly trade publication for Canadian audio-video dealers.*

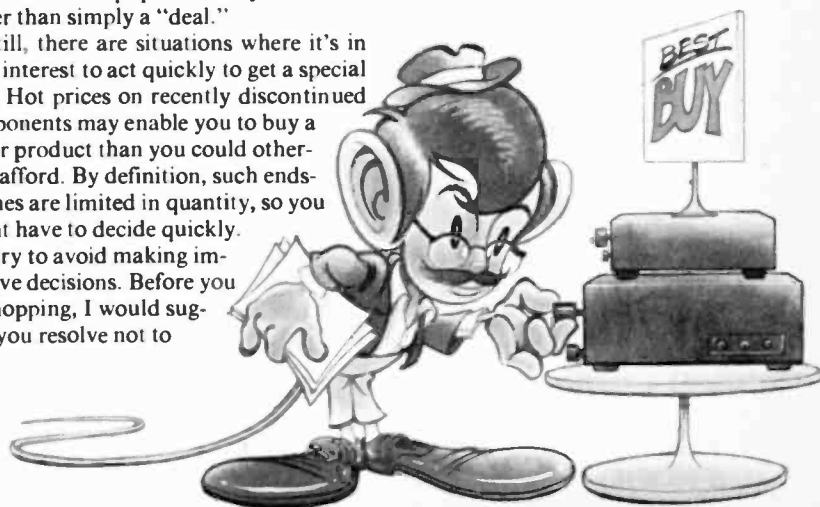

# A MAN FOR



ALEX VON KOETLITZ

**T**o anyone who has heard Roger Norrington conduct the finale of Beethoven's Third Symphony it will come as no surprise that the British conductor has a ready sense of humor. And he figures it's a quality he shares with Beethoven himself. "It's hilarious, extremely funny," says Norrington of the *Eroica's* last movement. "And that makes the moment when the sound of seriousness returns so much the more moving—as if in the midst of rejoicing they remember the fallen dead. But then they go back to the pub and have a few more pints of beer."

In this intermingled tragedy and hilarity, Norrington—a onetime Cambridge English major—finds a parallel with Shakespeare. It was a comparison drawn even during Beethoven's lifetime. "One of the things we've escaped from, I hope, is that Victorian idea that you can be either serious or humorous. Shakespeare and Beethoven show that you can be both at the same time."

This kind of revisionist thinking has helped make Norrington the most talked-about Beethoven conductor since Toscanini. Over the last couple of years, his ongoing survey of the Bonn master's symphonies with the period-instrument ensemble the London Classical

Players has created a sensation with critics as well as concert audiences and record collectors. Now the eternally restless Norrington is on to Schubert and Berlioz, and Schumann and Brahms lurk in the future.

Norrington is hardly the only period bandleader at work on the Beethoven canon. The recorded competition already includes full or partial surveys from Christopher Hogwood's Academy of Ancient Music, Frans Brüggen's Orchestra of the 18th Century, Jaap Schröder's Smithsonian Chamber Orchestra, and Roy Goodman's Hanover Band; and John Eliot Gardiner has a cycle in the works. But Norrington, more than anyone, has made a compelling case for such paradoxically revolutionary ideas as taking Beethoven's metronome markings at their word. The Beethoven that emerges from his performances, live and recorded, is far removed from the monumental, musty, mythic icon of post-Wagnerian tradition. "He's dramatic," argues the conductor, "intensely musical—and humorous."

In Norrington's performances part of the vividly mingled drama and humor has to do with the period instruments: the lean, lithe, gut-strung fiddles; the tangy, "woody" winds; the rasping brass; the snapping tim-

BY SCOTT CANTRELL



# ALL SEASONS

pani. But Beethoven's livelier metronome markings—which Norrington, unlike many of his ostensibly "authentic" competitors, follows pretty religiously—require a lighter touch, too, and cleaner articulation. Norrington's fastidious observance of the composer's accents, slurs, and dynamic markings gives the music an unpredictable freshness rarely to be heard in mainstream modern performances. Put all this together with a gut feeling for the shock value this music had when it was new—and a highly kinetic podium deportment—and you've got edge-of-the-seat excitement balanced by delicacy and real eloquence.

The irony—and yet the perfectly sensible fact—is that these revelations come from a man with no academic credentials in music. Asked when his musical education began, Norrington laughs and replies, "It never did. In fact, my musical training was like an apprentice's. I learned music, from the age of ten, in practical ways, without having a formal study of it. The weakness is that you may not know every possible name for a tetrachord, but the strength is that you regard music as an ordinary human activity which can be very exciting. You use technique to create an emotional experience which audiences of amateurs will enjoy."

**N**orrington's identification with musical amateurs comes naturally. Born fifty-five years ago this month (March 16) in the British university town of Oxford, he grew up in a household full of enthusiastic, if nonprofessional, music-making. Both his parents sang in the local Bach choir, and his mother played the piano. His three siblings were musical, too, and among family entertainments were singing madrigals around the piano and playing chamber music.

For his university study, Norrington headed not to Oxford but to rival Cambridge. Entering as a history major—soon changing to English literature—he was sufficiently skilled as a violinist and tenor to be a welcome and busy addition to the university's many musical groups. In fact, he was awarded a choral scholarship to sing in the Clare College Choir. Along with chamber music and orchestral concerts, Norrington the fiddler played for numerous operas, among them the British premiere of Stravinsky's *The Rake's Progress*. He also started to conduct, in his second year organizing a concert of Bach cantatas with a chorus of 12 and a similar-sized orchestra—"very much the sort of thing I would do today." He took no music lessons or music courses as such, but he had the experience of working with the likes of Boris Ord, then director of the famous Choir of King's College, and with Raymond Leppard. He also met and talked with the musicologist Thurston Dart, who sparked his interest in historic instruments and performance-practice issues.

After graduation, Norrington took a job with Oxford University Press, working first as a church-music editor and then in the publicity department. On the side, he continued singing and playing on an amateur basis, and conducting small choral groups. Early in 1962, one such group, dubbed the Schütz Choir, put on a concert devoted entirely to its 17th-century namesake. "People had been doing Handel and Bach concerts," Norrington recalls, "but Schütz was kind of a crazy idea. The surprise was that the concert was completely sold out, and all the critics came and wrote extensive notices about this group that was completely unknown. People really loved this music."

Suddenly, Norrington and his amateur chorus were in demand for broadcasts and recordings. But a monkey wrench was thrown in the works when the Oxford Press decided to post its young publicist to its East African office in Nairobi. In retrospect, the African summer of 1962 was just what Norrington needed: "I had a lot of spare time and didn't know a lot of people, so I stopped to think where I was going. And there was this growing realization that I had to make music the center of my existence, not a sideline."

So Norrington headed back to London and handed in his resignation. The very next day, a professional musician virtually by default, he was calling up everyone he knew in search of freelance playing and singing jobs. "I was like all those people in New York who sing in all those choirs. If you're a tenor and you're good, you get the work. That's how I made my living for five years, as a singer mostly."

Meanwhile, with Norrington still at the helm, the Schütz Choir was making its way through its namesake's music, plus Monteverdi and Purcell. Each composer became a kind of "cause," the subject of concentrated research leading to concerts, broadcasts, and records for the L'Oiseau-Lyre label. After a decade in the 17th century, Norrington and company ventured onward into the 18th. Gradually, period instruments were included, as they became more widely available; among highlights of the Schütz Choir's first two decades were what Norrington believes were the first modern performances with period instruments of the Monteverdi *Vespers*, Handel's *Messiah*, and Bach's *St. John Passion*. Still moving forward, Norrington tackled Haydn's *The Creation* and *The Seasons*, Mozart's Requiem, and Beethoven's *Choral Fantasia*.

Once he hit Beethoven, Norrington realized that musical emphases were shifting in a fundamental way. "It started to be evident that the next research period, from 1982 onward, was going to be orchestral, because the 19th century is the age of the orchestra." And since in that context "the Schütz Orchestra" no longer made sense, it was reconstituted, updated, and renamed the London Classical Players. ▶



**Roger Norrington came out of Oxford, Cambridge—and, yes, Africa. Today he is known as one of music's most adventurous explorers.**

# A MAN FOR ALL SEASONS

**A**longside his work with the Schütz Choir, Norrington was getting his operatic spurs. In 1969 he became music director of the newly formed Kent Opera, and over the next decade and a half he conducted more than 400 performances of 30 different operas. Period-instrument performances of Monteverdi were particular highlights, but Norrington also conducted more conventional fare, from *Don Giovanni* to *Eugene Onegin* and *La traviata*. Conductor and company came to a parting of the ways when the board nixed Norrington's plan to do all the Mozart operas with period instruments.

Norrington then teamed up with choreographer Kay Lawrence to create the Early Opera Project. Claiming historical staging, scenery, acting, and singing styles as well as period instruments, their 1984 production of Monteverdi's *Orfeo* was mounted in both Florence and Rome. Norrington and Lawrence—who is now his wife—hoped to do a *Magic Flute* this year, but funding didn't materialize. "We've shown what can be done in the authentic staging field," says Norrington, "but we just don't have the money right now. We have all sorts of pieces we want to do—Gluck, Monteverdi, Mozart—but the company is dormant. It's waiting. To be frank, though, the orchestra is so busy it would be difficult for me to find time for the opera."

Indeed, the London Classical Players' nine-week season this year will have expanded to 19 weeks by 1990. Along with concerts, television, and radio broadcasts, Norrington's orchestra has a daunting list of recordings in the works. A survey of all the Beethoven piano concertos, with fortepianist Melvin Tan, has just been completed; the first two concertos and the *Eroica* Symphony are on EMI's March release schedule.

Also due out soon is a Berlioz *Symphonie fantastique*, in which, says Norrington, early-19th-century instruments are a revelation. "The most striking thing is the brass. Instead of this huge homogeneous blare of sound which you get from the modern orchestra, you get a kaleidoscope of colors. There are the old hand horns, of course. Also, next to the natural trumpets, which were almost unchanged from the days of Monteverdi, you have the new cornet, which makes a completely different sound. Right next to the old trombones, almost unchanged from *Orfeo*, you have the ophicleides, which had been brought in by the Napoleonic army. That's five different kinds of brass instruments. The other big surprise is the absolutely delicious sound of the Érard harp of 1830; we used four of them, right at the front of the orchestra."

Norrington's September record release will include Beethoven's Symphonies Nos. 4, 5, and 7, and the Piano Concertos Nos. 3 and 4. In March 1990, the *Emperor* Concerto will appear, along with Schubert's Ninth Symphony and a record of Early Romantic overtures: Schubert's *Zauberharfe*, Weber's *Oberon*, Mendelssohn's *Hebrides*, Schumann's *Genoveva*, Berlioz's *Les Francs-Juges*, and—get this—Wagner's *The Flying Dutchman*, with the original 1841 ending.

This season's London Classical Players concerts are concentrating on Schubert. From here, it's on to Schumann, whose piano concerto and Symphonies Nos. 3

and 4 are scheduled for recording. Then there is Brahms to be tackled, with valveless horns (which Brahms preferred) and modern-disposition fiddles with historically authentic gut stringing.

One of Norrington's most talked-about innovations is the series of "Experiences" he has presented in London: full weekends of concerts, recitals, open rehearsals, exhibits, and lectures devoted to individual composers. Haydn was the first composer so treated, in 1984, followed by Beethoven in 1987, Berlioz last March, and Mozart at the beginning of this year. In a sense, each "Experience" is a microcosm of the research that has gone into each of Norrington's concentrations on individual composers. This coming August, Norrington will bring his "Beethoven Experience"—and the London Classical Players—to the PepsiCo Summerfare at Purchase, New York. The weekend will include performances of the Eighth and Ninth symphonies. The orchestra will also play concerts at Tanglewood, Great Woods, and Ravinia.

**T**he huge splash made by Norrington's Beethoven recordings—and his earlier reputation as a Monteverdi and Schütz specialist—has tended to obscure other aspects of his musical life. But he's now finishing a four-season stint as principal conductor of the Bournemouth Sinfonietta, a chamber orchestra based in the southeast of England, and he has appeared on a regular basis with the Jerusalem Symphony. His contemporary-music credits include no fewer than 50 world premieres of works by such composers as Nicholas Maw, David Matthews, Francis Piggott, and Christopher Headington.

Looking back over his slightly improbable career thus far, Norrington figures he has paid his dues. "Since 1962, really, I've been ready to conduct what you might call ordinary performances of ordinary music. Rachmaninoff or Dvořák or Stravinsky—I'll do it. I'm a working conductor, and I will tackle any good music. I'm a professional in that sense. I've been the principal conductor of a modern chamber orchestra, and I've conducted 400 performances of operas. That's why I can get on with the Boston Symphony: because I know how to conduct. I'm not a harpsichord player or a recorder player who's recently gotten into conducting. I speak these big bands' language."

Somehow, Norrington says these things with scarcely a hint of defensiveness in his voice. In conversation, at least, he is a friendly, relaxed fellow who sounds as if he hasn't a care in the world. But where might his career be heading now?

"In a sense, the London Classical Players is my permanent post for the next couple of years, and we're very busy. And right now it's important to me to have some time off in the country, for thinking and researching and just being quiet. I've just moved about 70 miles from London, to the middle of nowhere: a little thatched house on a few acres of land, in Berkshire. There's lots of wonderful country, but no sound and no streetlighting.

"But, in time, some orchestra somewhere—some modern orchestra—may want to set up an association with me, and that might be fun. We shall see." □

*Scott Cantrell is Music Critic of the Rochester (New York) Times-Union.*



ALEX VON KOETTITZ



# MERCY

"I'm so tired of being lonely/I still have some love to give," a quintessential Roy Orbison sentiment brought to life by his instantly recognizable mournful tenor, echoed across the airwaves at his untimely death in December. An undemonstrative performer whose riveting vocal range, dramatic repertoire, and trademark black clothes and shades seem to have quietly penetrated every market segment, Orbison had been experiencing a remarkable career resurgence: induction into the Rock and Roll Hall of Fame, with moving testimony from Bruce Springsteen; a television special called *Roy Orbison and Friends: A Black & White Night* (released on videocassette by HBO Video), where he was accompanied enthusiastically by thirty-something acolytes Springsteen, Elvis Costello, T Bone Burnett, and Tom Waits; the improbable Mount Rushmore alliance and success of the Traveling Wilburys; and now his first album of new songs in ten years, *Mystery Girl* (Virgin), finished just before his heart stopped. It's once again

---

*Roy Orbison  
crowns his come-  
back with a  
great new album  
but does not  
live to see  
it released.  
by Jeff Nesin*

---

plain that death don't have no mercy. Orbison was substantially different from the majority of artists who shared the radio with him over the past 30 years. For one thing, through initiative, savvy, and good timing, his professional career reflected all the developmental stages of

rock and roll. Starting in his hometown of Wink, Texas, with the Wink Westerners in the heyday of Hank Williams, Lefty Frizzell, and Webb Pierce, he saw the future and its name was Elvis Presley. Several years ago, he recalled for Colin Escott and Martin Hawkins how he caught the big train from Memphis and rode it back:

"I had a TV show in Odessa, Texas, and we played mainly country music. But after Presley came through town for a show in late 1954, I began to notice the rhythm music. I had heard groups like the Clovers and their hits like 'One Mint Julep,' and I really didn't like them, but at a New Year's Eve dance, we had to play through the actual time of midnight, and when someone requested 'Shake, Rattle, and Roll,' we struck up on it—but we had nearly ten minutes to go to the hour, so we kept playing the same song. By the time we were finished, I was fully converted."

Exit the Wink Westerners, enter the Teen Kings. Orbison was eighteen. Even while attending North Texas State Uni-

# MERCY

versity, ostensibly to study geology, he pursued the new sound vigorously, cutting a demo of his first hit, "Ooby Dooby," at Norman Petty's Clovis, New Mexico, studio in 1955, nearly two years before Buddy Holly made his own history there. On the basis of that demo, he was called, in March 1956, to the sacred fount of rockabilly, Sam Phillips's Sun Studios in Memphis, where he had his first modest run up the charts. But there was more in Orbison's vision and ambition than rockabilly novelties, even terrific ones like "Ooby Dooby," and two years later, emboldened by his success as a songwriter, he bought back his contract from Phillips, eventually landing with Fred Foster at his new label, Monument. While Phil Spector was only dreaming of "little symphonies for kids," Orbison and Foster constructed 2½-minute operas: tales told by the underdog, brimming with anxious melodrama, melancholy, fantasy, loss, and *that voice*, with a range that rivaled Elvis's and a high end still unmatched.

The rest—22 Top 40 entries, nine of them in the Top Ten—is indeed history, and it is readily available in two greatest-hits packages. Last year, Rhino remastered the original tapes and released *For the Lonely*—as a 46-minute Compact Disc subtitled *18 Greatest Hits* and a longer double LP subtitled *A Roy Orbison Anthology, 1956–1965* (does this make sense to anyone but a marketing mogul?)—happily superceding Monument's essential double album, *All-Time Greatest Hits*, which had been out of print for ten years. The CD version is certainly up to Rhino's usual high standards for reissues. The clarity and presence make the building tension in

"Only the Lonely" positively crackle: Floyd Cramer's nervous comping, the escalating orchestra and chorus shored up with chimes, and the silence surrounding Orbison's climactic ascension and slide (you can actually hear the ultimate glottal-stop!) are eerily unsettling. *For the Lonely* is the new reference standard.

modern mix with less artificial separation—and if Orbison's vocals are a little less urgent, they also are warmer and more intimate, which goes well with memory. Not my first choice, but this is a worthy endeavor and not a cheap knockoff.

It also points toward a sad fact that *A Black & White Night, Traveling Wilburys (Vol. 1)* (especially the stirring "Not Alone Any More"), and *Mystery Girl* absolutely confirm: Orbison was doing some of his best work at the time of his death, and that work is now abruptly ended. No matter how many illustrious rockers were moved or inspired by him, none of them can do what he did. His gifts were quite singular, and the book is now closed, so it's particularly gratifying to be able to report that the last chapter is so very good.

With tracks written and produced variously by Orbison and Mike Campbell, Jeff Lynne, T Bone Burnett, Elvis Costello, and U2's Bono, *Mystery Girl* coheres and succeeds because all hands are working for the man, properly focused on

the persona and the compelling voice. The LP ranges from the dramatic Monument-period classicism of Costello's "The Comedians" through "California Blue," one of several yearning midtempo ballads driven (like the Pomus-and-Shuman hits for the Drifters in the early 1960s) by acoustic rhythm guitars under rising strings and voices, all the way to "She's a Mystery to Me," a rhythmically sinuous, lyrically sensuous late-1980s love song contributed by Bono and The Edge. *Mystery Girl* is pure pop for now (and then) people: Roy Orbison at full strength, not a freeze-dried reprise. It's fitting to remember him this way. □



Roy (far left) and Traveling band (from left): Jeff Lynne, Bob Dylan, Tom Petty, George Harrison

The other collection, *In Dreams: The Greatest Hits*, was recorded for his new label, Virgin, and released in 1987 as the Orbison renaissance was gathering speed. It is this version of "In Dreams" that Dean Stockwell lip-synchs in the film *Blue Velvet*, and it has caused me to overcome, at least in this instance, my knee-jerk scholarly contempt for the age-old industry practice of rerecording past hits. It's easy for a listener to be caught in the catechism of memory and not allow vocal and interpretive development—I'm usually guilty and usually right. But *In Dreams* offers respect for the past, Rita Coolidge's smoky voice on "Oh, Pretty Woman," and a



**Edited by Ted Libbey  
and Ken Richardson**

## For Elyse

I had promised to say something about what's afoot at RCA and Erato, now that they are parting company . . . but that will have to wait until another month. Last week the world learned that Pan Am 103 was blown out of the air by a bomb, and while that would not seem to be something that calls for treatment in a music column, it turns out there was a connection. One of the victims of that bombing was a young American woman who loved the music of Brahms and was hoping to go to Juilliard. Her name was Elyse Saraceni, and one of our contributors, Chris Manion, spent an hour with her in Salzburg the week before she died.

Chris was in Austria on a business trip. He had some time between appointments that afternoon, so he took a stroll through the marketplace. It was two weeks before Christmas, and the stalls were stocked with foods and decorations for the holiday. At one corner of the square a man was playing the guitar and singing, the sort of thing you see all the time in Salzburg and in all the towns in Europe where tourists go. As Chris approached, the fellow was finishing up "Puff (The Magic Dragon)," when from a few feet away Chris heard the song's refrain doubled in a clear soprano voice. Having made his living for a couple of years as a roadhouse musician—one who plays a pretty respectable guitar himself—Chris appreciates a beautiful voice as much as the next guy. So he turned and threw a compliment in the young woman's direction, and without dropping a beat she replied—and that's how Chris met Elyse.

She had come to Salzburg to see Mozart's birthplace, and to breathe in all the music that is there. She was a junior at Seton Hill College in Greensburg, Pa., where both her parents are on the fine arts faculty, and she had spent the fall term in London on a program organized by Syracuse University. She was twenty, Brahms was her favorite composer, but she also liked other kinds of music. She was hoping to go to Juilliard after graduation, possibly as a composer, or, because of Brahms, as a pianist. She walked along with Chris, and when the time came for him to go, they swapped addresses. She was looking forward to going home for Christmas.

On January 2, Elyse's family and friends buried her. Chris went out to Greensburg to be with them, and to tell them what he could about her last week and her last thoughts. Around graduation time, Chris plans to go back. When he does, he wants to give something to Seton Hill in memory of Elyse: a collection of recordings of the music of Brahms—everything the composer wrote—in the hope that another young woman, or maybe more than one, will find in that music what Elyse found and loved.

*Ted Libbey*

## Olivia Turns Fifteen

Most anniversary hokum thrown by retailers as an excuse to drum up more business reeks of snake oil and should be treated as a sale-a-bration. Not so with Olivia Records' fifteenth-birthday shows, which spanned 1988 and culminated in a Carnegie Hall concert (and Waldorf Astoria ball) in late November. Olivia, which president Judy Dlugacz likes to call "the little label that could," was founded in 1973 to create a window through which women musicians—notably, lesbian feminist performers—could slip into the music industry.

In at the label's startup: a collective of administrators (none with previous music-business experience) and two singer/writers, Meg Christian and Cris Williamson, with sizable female followings and recognizably feminist material. Theirs was a small revolution, but it was real nonetheless: On Olivia's sparsely produced initial albums, women played all the instruments, engineered the sessions, mixed the masters, and marketed the finished product. Now, in these pragmatic and technologically advanced days, their brand of idealism seems a bit quaint. And home-recording equipment that's within the financial and technical reach of anyone who can operate a toaster has taken the pioneering spirit out of independent record-making. But in earlier days, those women who were uppity enough to build a record company, and through it a coherent touring circuit and even a culture, made a very dramatic statement.

The times have changed and the collective is no more; Meg Christian has retired from music-making and from public life; men are as likely to be found on Olivia tracks and at the studio controls as women (according to Olivia artist Deidre McCalla, "Now that the recording-skills level is up among women, we can turn our focus away from mandating women's participation and ignore gender when looking for the best person to do the job"). But there's still work to be done, so Olivia remains active, its mission and audience keeping the little company afloat.

In 15 years, there have been a few flops but many reasons to celebrate: Olivia has sold 1½ million LPs among its 30-plus titles. A good job and one worth applauding—so that's what the staff and performers did with their year-long party. Six acts represented Olivia's lineup at Carnegie; especially notable were Dianne Davidson's booming/crooning voice, Nancy Vogl's deceptively simple guitar-picking, bilingual singer Lucie Blue Tremblay's exotic whistling. But in the hushed hall, the real authors of Olivia's success applauded the label and themselves.

"Every time you spend a dollar, you're casting a vote for someone else's success," a new friend summed up neatly. Olivia Records has earned its standing ovation.

*Leslie Berman*

# A Century, and More, of American Song

## JAN DeGAETANI and GILBERT KALISH: Songs of America.

DeGaetani, Kalish, Robbins\*. Teresa Sterne, prod. Nonesuch 79178 (D). ◉ ◻

ADLER: *Time, You Old Gypsy Man*. BABBITT: *The Widow's Lament in Springtime*. BENSON: *American Primitive*. BOLCOM: *Waitin' (from "Cabaret Songs")*. CADMAN: *The Moon Drops Low*. CAGE: *Little Four Paws*. CARTER: *Dust of Snow; The Rose Family*. CLARKE: *Lethe*. COPLAND: *There Came a Wind Like a Bugle (from "Twelve Poems of Emily Dickinson")*. R. CRAWFORD SEEGER: *Home Thoughts; White Moon; Joy*. CRUMB: *The Sleeper*. DAVIDOVSKY: *Lost*. FINE: *My Father*.

FOSTER: *Beautiful Child of Song*. IVES: *Song (She Is Not Fair); The All-Enduring; Sunrise\**. JACOBS-BOND: *Nothin' but Love; I Love You Truly; Her Greatest Charm*. KAGEN: *The Junk Man*. KERNIS: *Stein X Seven: No. 6*. ROREM: *Interlude (from "Poems of Love and the Rain")*. SCHUMAN: *Dozing on the Lawn (from "Time to the Old")*. WALDEN: *Grandma (Millie)*.

Sometimes it just isn't worth mincing words. So I'll state at the outset: Jan DeGaetani and Gilbert Kalish's *Songs of America* is one of the most perfectly conceived and lovingly realized recordings I have ever had the pleasure to review. Filled with unknown gems unearthed from the deepest recesses of American vocal music, *Songs of America* is a constant delight on every level: historical, textual, topical, and musical.

Surely only DeGaetani and Kalish, whose partnership has extended over nearly three decades, could have succeeded in collecting a range of music this broad. Represented here are 21 composers whose 28 songs date from the 1860s to the 1980s. Stephen Foster rubs elbows with Elliott Carter, Ruth Crawford Seeger with Milton Babbitt, Carrie Jacobs-Bond with George Crumb and Mario Davidovsky. Nearly forgotten (or totally unknown)

works by Ives, Charles Wakefield Cadman, Sergius Kagen, Rebecca Clarke, and Stanley Walden share the spotlight with one of Copland's Dickinson settings, one of William Bolcom's cabaret songs, and a rare solo vocal setting by Ned Rorem. Throughout, the emphasis is on the great American song tradition; there are only two forays (for Crumb and Davidovsky) into the extended vocal techniques of the avant-garde.

That this astonishing stylistic and chronological sampling coheres into such a unified vision is a tribute to the versatility of DeGaetani and Kalish, who leap from folksy to genteel, from lowbrow to highbrow, from sentimental parlor song to dissonant modernism as if distinctions between them did not exist. Their elegance and poise ennoble everything that they touch—in their hands, even the unbearably syrupy "I Love You Truly" seems an art song. DeGaetani's rich, creamy voice is never overlaid with vibrato, and her varied vocal timbres mirror every nuance of the texts. Kalish's lucid, clear-textured pianism reaches beyond accompaniment to play an equal role in interpretation.

What puts the icing on this already flawless cake is the recorded sound, which has been engineered with a naturalness and clarity unprecedented, in my experience, on a voice and piano disc. Perhaps credit for that is due to Teresa Sterne, who produced the legendary DeGaetani/Kalish collaborations of the 1970s, and who marks her reappearance at Nonesuch with this recording. But giving credit is less important than ensuring this effort's success. Therefore, go forth, all you music lovers, and purchase this disc! For we must guarantee a sequel. Playing time: 73:55.

K. Robert Schwarz

BACH: *Aus der Tiefen rufe ich, Herr, zu dir, B.W.V. 131; Gottes Zeit ist die allerbeste Zeit, B.W.V. 106.*

Monoyios, Rickards, Brownless, Opal-  
lach; Bach Ensemble, Rifkin. Peter

Wadland, prod. L'Oiseau-Lyre 417 323-2 (D). ◉ ◻

BACH: *Ein feste Burg ist unser Gott, B.W.V. 80; Herz und Mund und Tat und Leben, B.W.V. 147.*

Bryden, Minter, Thomas, Opal-  
lach; Bach Ensemble, Rifkin. Peter Wad-  
land, prod. L'Oiseau-Lyre 417 250-2 (D).

◉ ◻

BACH: *Jauchzet Gott in allen Landen!, B.W.V. 51\*; Wachet auf, ruft uns die Stimme, B.W.V. 140\*.*

Baird\*, Minter\*, Thomas\*, Opal-  
lach; Bach Ensemble, Rifkin. Peter Wad-  
land, prod. L'Oiseau-Lyre 417 616-2 (D). ◉

It seems highly unlikely that anybody prior to Joshua Rifkin could have thought Bach's cantata *Ein feste Burg ist unser Gott* suitable for public performance by a grand total of 15 musicians. But Rifkin, a musicologist and part-time Scott Joplin specialist who believes that Bach intended his choral music to be played and sung by only one person to a part, is recording a series of cantatas performed along precisely those lines. In *Jauchzet Gott in allen Landen!*, of course, the point is moot, since the work is for solo soprano without chorus. In the other cantatas, however, Rifkin's thesis gets a pretty rigorous workout.

Thesis or no thesis, Rifkin's Bach Ensemble is a first-rate instrumental group by any standards. Countertenor Drew Minter, tenor Jeffrey Thomas, and bass Jan Opalach, who are heard together on three of the six cantatas, provide the basis for a highly satisfactory solo quartet, and it will be interesting to see how their work together develops in future recordings. For the most part, Rifkin proves to be an excellent, unobtrusive conductor. When these performances do go wrong, however, it is invariably because of a lack of rhythmic point and lightness. Julianne Baird, for instance, is insufficiently brilliant in *Jauchzet Gott*, but Rifkin's overly relaxed tempos and slightly spongy bass lines are very much a part of her problem.



Jan DeGaetani  
and Gilbert  
Kalish—partners  
in song for almost  
three decades

sis as chronologically wide-ranging as Josquin Desprez's early-16th-century *Stabat Mater* and Johannes Brahms's late-19th-century motets. In everything the group has done, whether accompanied by orchestra or not, the result has been a stimulating blend of interpretive profundity and sonic lightness. The latter characteristic—a product as much of tempo and articulation as it is of timbre and balance—seems especially useful as a leavening agent in the Bach cantatas recorded here. These are somber works whose funereal texts are potently expressed by Bach's dark harmonies and poignant melodic lines, and La Chapelle Royale's concerted approach keeps them sounding serious but never dreary.

The finest individual performances come from soprano Ingrid Schmithüsen and countertenor Charles Brett, both of whom are assigned intensely personal arias in the *Trauer Ode*. Their polished voices are also beautifully paired in the "Wirielen" duet of *Jesu, der du meine Seele*. The nonsinging (but not exactly unsung) heroes are Paul Dombrecht and Taka Kitazato, who deliver some of the finest Baroque oboe and oboe d'amore playing ever committed to disc. But it is Herreweghe's ensemble—16 choristers and 23 instrumentalists, recorded in an intimate-sounding room unidentified in the notes on the recording—that makes the biggest impression. On all counts, this latest effort by La Chapelle Royale is a subtle triumph. Playing time: 57:47.

James Wierzbicki

**BEETHOVEN: Concertos for Piano and Orchestra.**

*Barenboim; Berlin Philharmonic, Barenboim. Daniel Barenboim and Wolfgang Güllich, prods. Angel EMI CDCC 47974 (D, 3).*

*No. 1, in C, Op. 15; No. 2, in B flat, Op. 19; No. 3, in C minor, Op. 37; No. 4, in G, Op. 58; No. 5, in E flat, Op. 73 ("Emperor"). ▶*

Do Rifkin's scholarly conclusions make sense in practice? In the end, the slender volume of choral sound produced by the Bach Ensemble seems to me not quite right. (The fact that producer Peter Wadland tends to place the voices too far back in the mix should be noted as well.) The sonic expectations are far less frustrated here than in Rifkin's notorious Nonesuch recording of the B minor Mass, though, and the intimate scale of these performances makes more sense in a living room than in a good-size church or a concert hall. Right or wrong, they seem likely to wear well as recordings in a way that, for instance, Nikolaus Harnoncourt's Bach cantatas have not.

In any case, listen to these discs, even if you object to the interpretations on princi-

ple. Rifkin's notes, which make the strongest possible case for his approach, are intelligent and illuminating. Playing times: 38:35 (417 323-2); 53:05 (417 250-2); 42:44 (417 616-2). *Terry Teachout*

**BACH: Jesu, der du meine Seele, B.W.V. 78; Lass, Fürstin, lass noch einen Strahl (Trauer Ode), B.W.V. 198.**

*Schmithüsen, Brett, Cook, Kooy; Chorus and Orchestra of La Chapelle Royale, Herreweghe. Michel Bernard, prod. Harmonia Mundi France HMC 901270 (D). © HMA 331270. HMC 401270. (Dist. by Harmonia Mundi, U.S.A.)*

Under the direction of Philippe Herreweghe, the small chorus that forms La Chapelle Royale has recorded sacred mu-

Improbable as it may sound, Daniel Barenboim may very possibly succeed Herbert von Karajan as conductor of the Berlin Philharmonic. Internal sources say the orchestra members hold him in the highest regard—and in Berlin the players elect their own conductor, for life. I can't help wondering whether those players, without that exceptional regard and affection for Barenboim, would have permitted him the self-indulgence of doing double duty in these monumental works as both soloist and conductor. About 20 years ago, he did pull off something similar in a complete recording of Mozart's piano concertos, with the English Chamber Orchestra. At least the last three of the Beethoven concertos make substantially greater demands, though, and no pianist in his right mind would attempt such a stunt in actual performance, stripped of recourse to the possibilities of retakes and editing. Barenboim's doing both jobs here does give us his interpretation of these works exactly as he wants them, but I can't deny a nagging feeling that the project would have come off better, musically, if he had contented himself to appear only as soloist.

From the purely sonic standpoint, the cycle gets off to a disappointing start. In the first two works, this glorious orchestra—quite possibly the world's greatest—sounds downright woolly, not to say muddy. In fact, I wondered if something might possibly have happened to my rig, and made some comparative tests with Sviatoslav Richter's 1960 analog recording of the First Concerto (with Charles Munch and the Boston Symphony, on RCA 6804-2) and Martha Argerich's 1983 version of the Second (as soloist and conductor with the London Sinfonietta, on Denon C37 7322), both of which sounded splendid. The sound in Barenboim's set gets better as the opus numbers progress, but it never does attain the high level to which other CDs of this same orchestra have accustomed us. The piano, for some reason, sounds considerably better than the orchestra.

Generally speaking, as one would expect, Barenboim contributes solid, musicianly performances across the board. He particularly stands out in the more contemplative sections. He has a radiant, singing tone, and he shapes phrases with poetic, sometimes even moving sensitivity. Wherever Beethoven has provided the soloist with an *ossia* if he cares to show off a bit, Barenboim consistently makes the more self-effacing choice, as if he deliber-

ately wants to avoid the aura of the flashy virtuoso. Most of the time, he adheres faithfully to Beethoven's quite explicit instructions in the score, although from time to time he will deliberately contradict the composer's wishes concerning such things as phrasing, staccato, and the sustaining pedal.

I could live with that, but I have greater difficulty with Barenboim's inclination, at the slightest indication to slow down, to lapse into a mood and pace more suitable to a nocturne. Beethoven provided none of these works with metronome markings. He did, though, mark the Fourth's middle movement *Andante con moto* (with motion) and the Fifth's *Adagio un poco mosso* (a bit moved, stirred, agitated)—but you'd never know it from these interpretations. Barenboim tends to caress the slow passages almost to death.

Just as even the best writer can benefit from intelligent editing, so can the finest musician benefit from an intelligent recording producer, one who can diplomatically call his attention to inadvertent little deviations from the composer's printed intentions and wishes. Here, though, Barenboim, not content with starring as soloist and conductor, has also served as his own coproducer. That quite possibly explains such things as his giving in to a tendency not to hold long notes or rests for their full value—which is especially annoying if you have that innate sort of automatic metronome ticking away the steady tempo inside your head.

No one could seriously contest Daniel Barenboim's extraordinary gifts both as

pianist and conductor. Here, though, one comes away with the regretful feeling that he bit off a good deal more than he could chew. Playing time: 3:01:13. *Paul Moor*

**BEETHOVEN: Symphony No. 1, in C, Op. 21; Symphony No. 6, in F, Op. 68.**

London Classical Players, Norrington.  
 David R. Murray, prod. Angel EMI CDC 49746 (D).

Singing the praises of Roger Norrington is like preaching to the converted. Anyone with the slightest sympathy for the historical-performance movement has already discovered his dramatically personal interpretations of the Beethoven symphonies. Even those (such as this writer) who once touted Christopher Hogwood have taken note of the Norrington difference.

And what of the unconverted? They fall into at least two camps. The first group is sympathetic to historical performances but questions Norrington's choice of tempos. At a recent meeting of the American Musicological Society, Baltimore Symphony Orchestra conductor David Zinman and a panel of scholars devoted much time to criticizing those tempos, particularly the lumbering, folksy *alla marcia* in the finale of the Ninth Symphony. But, although the session left a bitter aftertaste—after all, the man being lambasted was not present to defend himself—even Norrington's critics did not dispute his innate musicianship.

The other camp will never make peace with historical performance of any kind. Reared on Furtwängler, Toscanini, Karajan, or their disciples, the members of this



Daniel Barenboim: Beethoven with less than enough bite, more than enough to chew



group find the period-instrument timbres and playing techniques to be nothing less than a perversion of the Beethoven they know and love. Until recently, they had one indisputable point in their favor: Historically aware performances were just too faceless, too impersonal, too drained of expression. How could a Hogwood hope to be spoken of in the same breath as the legendary conductorial interpreters of both the past and present?

While I would not presume to place Norrington in either Furtwängler's or Toscanini's league, his appearance has served to shatter the myth that historical performances must be reticent. In Norrington's hands, even the backward-looking, Haydnesque language of Beethoven's First Symphony is personalized. The simple introduction is impregnated with mystery; the crescendos and sforzandos are emphasized; additional dynamic shading and accentuations are interpolated. The conclusion of the first movement, capped in Norrington's account by a thrilling new crescendo that is blared out by the brass and whacked home by the timpani, is emblematic of the interpretation as a whole.

Norrington performs a tremendous service by placing the *Pastoral* Symphony within the context of its era, as part of a pictorial tradition that includes Haydn's *The Creation* and *The Seasons*. Never have I heard the evocations of nature sound so fresh, so sparkling, so genuine. Norrington's light, deft touch emphasizes the Haydnesque wit of the scherzo as well, and the flowing tempo of the "Scene by the Brook" makes the water sound like a rippling cascade rather than the usual stagnant pool. The winds—so crucial in any rustic depiction—are, for a change, properly balanced in relation to the strings; they dominate the textures with a pleasantly acrid pungency. And I defy anyone who hears the astonishing fortissimo outbursts of the "Sturm" to name a *Pastoral* tempest that is more dramatic.

A brief comparison of Hogwood's and Norrington's performances of Beethoven's First confirms that the former's phrasing is comparatively prosaic and lusterless, clicking along with metronomic regularity. Norrington's is shaped into large arches that are defined by strategically placed hesitations. But those who search for palpable differences in instrumental technique will be disappointed. Hogwood's Academy of Ancient Music, Norrington's London Classical Players, and Roy Goodman's Hanover Band all share essentially the same group of musicians, and they play superlatively no matter who is the conductor. For Norrington they do more than play: They interpret, with historically informed minds and intuitively expressive hearts. Playing time: 66:06. *K. Robert Schwarz* ▶

# NEW YORK WHOLESALE

- Prices subject to change
- Prices exclude shipping charges
- Not responsible for typographical errors

**FOR FASTEST SERVICE CALL (212) 684-6363 OR FAX (212) 684-8046**

HOURS: MONDAY-FRIDAY, 9AM-7PM EST • SATURDAY 10AM-5PM

OR Write Direct: 2 PARK AVENUE, DEPT. 15, NEW YORK, N.Y. 10016

We sell authorized U.S. branded merchandise and parallel imports. All products covered by manufacturer's warranty or New York Wholesaler's exclusive limited warranty. Manufacturer's rebates may not apply. Ask for full details at the time of purchase.

CD PLAYERS	LOUDSPEAKERS	AMPS & TUNERS	CAR STEREO'S	FAX					
<b>YAMAHA</b> CDX1110 749 CDX910 559 CDX710 389 CDX410 249 CDX510 279 CDX610 499	<b>MISSION</b> Argonaut 1249 Freedom 749 Renaissance 559 707 409 700LE Special 229 70 199	Mx600 New 429 Mx800 New 679 Mx1000 New 949 Ax900 549 Ax700 399 CX600 New 359 CX800 New 559 CX1000 New 949 TX900 249 TX500 199 ED1100 469 ED500 249 DSR100PRD 479 DSP1 683 AVC50 439 AVX100 559	<b>YAMAHA</b> 6262TR 279 KEH8050 339 KEH6050R 279 GMA2000 249 DEKX300CDMM100 779 <b>KENWOOD</b> KRC2000A 189 KRC555 319 KDC80 489 KRC757 399 KRC858 479 KRC959 649 KDC90R 699 KAC820 259	<b>SHARP</b> UX140 359 UX160 319 FD 300 249 FD 420 279 <b>CANON</b> FAXB 479 FAX20 319 FAX25 489 <b>TOSHIBA</b> 30100 399 3300 3700 <b>MURATA</b> 1600 1200 <b>TELEPHONE SYSTEMS</b> DENVER 219 PORTLAND 259 LEAMINGTON New 419 LOS ANGELES New 369 SAN FRANCISCO New 319 WASHINGTON 299 <b>DENON</b> DCR5520 449 DCR5425 399 DCR5220 279 DCA3280 249 DCC8920 699 <b>HIFONICS</b> THDR Please call for details GEMINI 1179 ODIN 194 VULCAN 159 EUROPA low 11500 TU800 low 59110 CALLISTO prices TC308 519 SF90 269 D60 159 D200 8050 TC301 9700 TC303 7650 <b>JVC</b> KSRX618 359 KSRX518 329 KSRX418 279 KSR48 199 <b>ADS</b> 320i 389 300i 279 P010 389 PH15 189 P55 1700 P020 519 S87 219 <b>INFINITY</b> RS452K 149 RS462K 109 RS4693K 189 CS1K 299 <b>BOSTON</b> 741 149 751 179 761 189 767 99 C700 159 C793 259 PW6 309 <b>POLK SPEAKERS</b> 6902 199 MM1A 209 MM4A 189 MM10A 149 <b>CONCORD CX</b> CX70 549 CX60 449 CX50 349 CX40 289 CX30 269 CX20 239 CX10 199 <b>RADAR DETECTORS</b> SMOOPER 04 Call SMOOPER 06 Call CDBRA3110 99 CDBRA3120 99 CDBRA3170 179 SPECTRUM II 175 WHISTLER 2 50 <b>SONY</b> BEL 876 129 BEL VECTOR 189 BEL 844S 189 UNIDEN RD9XL 159 UNIDEN RD9 139 <b>SONY</b> WPMDC 299 WFM100 III 129 WFM73 99 WMAF64 85 ALL MODELS Call <b>CANON COPIERS</b> HSJ3800 189 HST800 169 HSL360 99 HST380 109					
<b>PIONEER</b> DCM555 469 DCD1520 649 DCD910 New 429 DCD810 329 DCD610 269 <b>SONY</b> CDP950 389 CDPC70 359 CDPC100 449 CDP750 279 CDP570 New 199 CDP370 New 179 CDPC20 New 249 CDPC30 New 269 CDPC15ESD 649	<b>CELESTION</b> SL600 1549 SL65 I 769 DL10 II 649 DL8 II 609 DL6 II 329 DL4 II 259 <b>B&amp;W</b> MATRIK3 1799 MATRIK2 1179 MATRIK1 979 MATRIK1800 799 MATRIK1800 949 DM550 329 DM560 439 DM*70 519 DM580 729	<b>NAD</b> 3225 3240 3400 3400 2200 429 1300 1700 <b>DENON</b> PMA920 499 PMA720 389 PMA520 299 PMA1520 749 PGA2200 549 POA6600 549 PRA1100 399 TU450 169 TU600 279 TU800 369 PMA300 Special 169	<b>PIONEER</b> PDM700 499 PDM600 409 PDM500 329 PDM400 279 PD1700 399 PD5100 229 PD4100 169 CLD1030 639 <b>NAD</b> 5220 289 5240 379 5300 729 5100 479 5170 649 <b>JVC</b> XLM400 329 XLV444 249 XLV222 189 <b>MAGNAVOX</b> CDB486 New 269 CDB482 New 169 CDB480 New 139	<b>CANTON</b> KARAT20 579 KARAT30 699 KARAT40 1029 KARAT60 1289 CT80 1349 CT90 1949 PLUS S 279 PLUS C 479 GL260 349 <b>ADVENT</b> MAESTRO 469 LEGACY 349 PRODIGY 249 PRODIGY II 249 BABY 159 MINI/SUB 139 ea <b>AR</b> PARTNERS 259 ROCK PARTNERS 179 <b>PINNACLE</b> PN5+ 139 PN6+ 199	<b>RECEIVERS</b> <b>YAMAHA</b> RX1100 749 RX900 599 RX700 449 RX500 339 RX300 229 ORA25 209 <b>NAKAMICHI</b> TA1A New 269 TA2A New 449 TA3A New 629 <b>DENON</b> DRA1025 749 DRA825 649 DRA625 439 DRA425 359 DRA35V 269 DRA25 209 <b>SONY</b> STRAV1000 519 STRAV900 369 STRAV700 319 STRAV500 279 STRAV300 229 STRAV200 159 <b>JVC</b> RX222 199 RX555 299 RX777 429 RX999 579 RX1001 829 <b>PIONEER</b> VSX9300S 649 VSX7300 529 VSX5300 449 VSX3300 279 VSX1300S 329 SK2300 199 SK1300 169 <b>NAD</b> 7225 279 7240 429 7100 589 7600 1199	<b>VIDEO RECORDERS</b> <b>JVC</b> SFR95 599 HR8000 179 HRD440 349 HRD750 499 Other Models Call <b>PANASONIC</b> PV4870 139 PV4860 199 PV2812 279 PV4800 389 <b>NEC</b> 830T 519 L20T 549 L60T 359 <b>DENON</b> VPT390 349 VPT294 259 VPT200 219 VPT695 969 <b>RCA</b> VPT930 329 VPT940 269 VPT695 249 <b>NAKAMICHI</b> RD350 349 RD460 489 TD700 789 TD500 629 TD400 429 P4400 389 PA350 359 PA200 209 PA150 199 PA150 199 RD260 209 SP200 209 <b>ALPINE</b> 7907 679 9905 629 7385 469 7284 429 7280 359 7256 299 7156 219 7179 299 7180 329 3321 69 3501 69 3517 69 3523 69 3525 249 3528 249 6265 129 6394 179 <b>SONY</b> CDXA20 529 CDXR88 489 XR6100 159 XR7050 259 XR7300 499 XR6300 429 XR6150 199 XR7150 349 XR7200 429 XE8 249	<b>CASSETTE DECKS</b> <b>YAMAHA</b> KX1200 New 579 KX500 New 319 KX400 259 KX200 209 KX800 259 KX700 489 KXW202 New 279 KXW302 349 <b>DENON</b> DRM24HX 379 DRM34HR 489 DRM12HR 289 DRM10HR 239 DRM07 179 <b>NAD</b> 6155 379 6240 259 6300 729 6100R 399 <b>AIWA</b> ADW909 499 ADW805 139 ADW808 299 ADS27 99 ADS460 129 ADW8707 199 <b>PIONEER</b> CTS600 259 CTS800 529 CTW300 159 CTW500 219 CTW700R 309 CTW900R 459 <b>TURNTABLES</b> <b>DENON</b> DP59L 479 DP47F 349 DP35F 239 DP7F 159 <b>DUAL</b> CS503 169 CS505 219 CS2215 249 CS5000 349 <b>TECHNICS</b> SL1200 II 109 SLD033 349 SLD022 349 SLD010 69 SLD022 119 <b>THORENS</b> Call For Prices	<b>COMPONENT SYSTEMS</b> SONY FH808 589 SONY FH404 429 SONY FH606 469 SONY FH809 629 <b>PORTABLE CD PLAYERS</b> <b>PANASONIC</b> SDNY D4 209 SDNY D14 239 SDNY D20 289 SDNY D10 189 SDNY D15 309 TOSHIBA XR9 199 TOSHIBA XR9 259	<b>PERSONAL STEREO'S</b> <b>SONY</b> WPM6C 299 WFM100 III 129 WFM73 99 WMAF64 85 ALL MODELS Call

**BRITTEN: String Quartet No. 3, Op. 94.**

**TIPPETT: String Quartet No. 4.**

*Lindsay String Quartet. Roy Emerson, prod. ASV CD DCA 608 (D). (Dist. by Harmonia Mundi, U.S.A.)*

The Tippett gets first billing on the box presumably because this is its debut recording; the Britten work has already been recorded at least twice. [The Lindsay Quartet also gave Tippett's quartet its premiere in 1979.—Ed.]

Meirion Bowen, Sir Michael Tippett's friend who often speaks for him in print, provides the album notes for the Tippett; he links this quartet with the composer's Fourth Symphony and Triple Concerto, all of them composed in a single vast, subdivided movement, à la Beethoven in his late quartets (Opp. 130, 131, and 132). "Tippett's intention," he says, "seems to be to depict a complete cycle of human experience. . . . He has described his Fourth Symphony as a 'birth-to-death' piece, and the same caption could equally well be applied to the Fourth Quartet. Both works begin with a kind of 'birth image'—music burgeoning from stillness into effortful existence. Both works embrace conflict, dreams, and passions. Both end in the stillness of death, all passion spent." Well, I have listened hard and conscientiously, and I find little connection between all that and this music, but you may well react differently. The music itself will certainly force you to concentrate and think, in the same way that Elliott Carter's quartets do.

Benjamin Britten's tender, introspective five-movement piece contrasts sharply with the freely atonal aggressivity that dominates the Tippett. Lord Britten, already debilitated, completed this final major work a year before his death in 1976. He went to Venice to finish it, and he gave the final passacaglia Venice's own name: "*La Serenissima*." The Italian word means not only serene but also bright, cloudless, clear. Britten seems, consciously or unconsciously, to have applied that adjective to the manner in which he faced death, which he knew then would soon confront him. He reflected that mood in the elegiac but lyrical music that makes up most of this beautiful and moving work.

Both scores make cruel demands on the interpreters—the artificial harmonics alone would put off most string players—but this young group (in residence at the University of Manchester) takes all the intricacies and difficulties entirely in stride. ASV's engineers have captured both performances with admirable resonance and fidelity. Playing time: 52:47. *Paul Moor*

**HANDEL: Messiah.**

*Augér, Von Otter, Chance, Crook, Tomlinson; English Concert Choir, English Concert, Pinnock. Andreas*

*Holschneider and Charlotte Kriesch, prods. Deutsche Grammophon 423 630-2 (D, 2). © (3). □ (2).*

I had expected a lot from this *Messiah*. On some points I was satisfied, but overall there is less here than I'd hoped for. The major disappointment centers on the podium—perhaps I should say the harpsichord stool. Anyone who has heard Trevor Pinnock's recordings of various orchestral works by Handel knows that he brings an unequaled drive and excitement to the music, maintaining its nobility without sacrificing the precision of his ensemble. Precision and nobility are here in spades, but gone is the verve and dynamism that have become hallmarks of the English Concert. Like so many others before it, this *Messiah* is simply too polite. Handel's great oratorio is not a subtle piece: It is grand, majestic, powerful, joyous, full of pathos—and it is certainly not a work that deals in compromises. Pinnock, by so often seeking out the middle ground, has made the composer too genteel, and has robbed *Messiah* of its sweep.

Before listening to the record I felt certain misgivings over the choice of Arleen Augér and Anne Sofie von Otter as two of the soloists. Soprano Augér is a fine Handelian but hardly a singer one would associate with period performance. Von Otter, on the other hand, has turned in some fine singing for John Eliot Gardiner, but she seemed a rather dark and heavy choice for the alto solos here. As I listened, though, my fears regarding both singers were swept by the board. Augér positively sparkles; her voice is always well controlled and her delivery never seems overornamented or self-indulgent. And, although she shares the alto duties with countertenor Michael Chance, Von Otter makes a strong impression, particularly in her shaping of "O thou that tellest."

The men prove a less happy selection. Chance sings cleanly but with little involvement, while tenor Howard Crook shows great dignity but little warmth. Anyone who has heard Paul Elliott's "Comfort ye my people" in Christopher Hogwood's or Ton Koopman's performances of *Messiah* will fail to be comforted by Crook's rendition. Bass John Tomlinson is the weakest link in the chain; his voice, while powerful, is overladen with vibrato and tends to sound pinched over much of its range.

Pinnock's greatest misjudgment, however, is not in his selection of singers but in his choice of tempos. They are quite slow, and when delivered by an English Concert sounding more apathetic than I can ever remember, they strip the music of its power to inspire. The strength of the choir helps to compensate for this, but Pinnock fails to put a spring in their step, so that they often sound as tired as the orchestra.

Ultimately, this performance lacks the snap of the Hogwood, the drama of the Gardiner, and the atmosphere of the Koopman, and I would choose any of those three before it. The recording is very fine but a little lacking in depth. Playing time: 150:07. *Christopher Rothko*

**HARRISON: Piano Concerto\*; Suite for Violin, Piano, and Small Orchestra†.**

*Jarrett, Stoltzman†; New Japan Philharmonic, Otomo\*; unnamed orchestra, Hughest. Elizabeth Ostrow, prod. New World NW 366-2 (D). □ □*

Lou Harrison is one of the prime members of what might be called the California school of composition. California, as Harrison has observed, is geographically closer to the Orient than to Europe, and it tends to breed composers more attuned to the East than to the West. Like Califor-

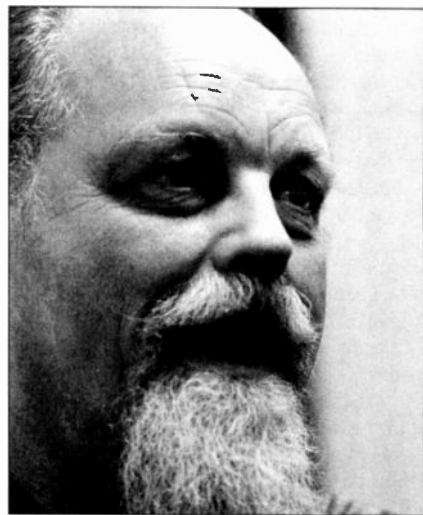

*Lou Harrison*

nians John Cage and Henry Cowell, Harrison (who was born in Portland) grew up hearing as much non-Western music as Western. Like, Cowell, his teacher, and Cage, his fellow student, he translated those non-Western sounds into percussion works that blended "found" objects with conventional instruments.

Yet while Cowell and Cage went on to other things, Harrison never abandoned his original aesthetic, which relied on nothing less than a fusion of Western and non-Western structures, techniques, and instruments. His early Suite for Violin, Piano, and Small Orchestra (1951) evokes the Orient in its parallel, open harmonies, pentatonic melodies, and metallic sonorities (produced by Harrison's own "tack piano," an upright with thumb tacks inserted in its hammers).

Beginning in the 1960s, Harrison made several trips to Asia, experiencing firsthand the music he had already grown to love in California. By the 1970s, he became impatient with merely imitating the

sound of non-Western instruments, and began building the first of several American gamelans.

These experiences inform his Piano Concerto (1985), written specifically for Keith Jarrett. Although it begins with a powerful neo-Romantic flourish, the Concerto eschews the dialectics and directionalized motion of Western music. Wandering pentatonic melodies, parallel modal harmonies, and nontempered tuning all flaunt Western convention. In the *perpetuo moto* second movement, entitled "Stampede," the drums set up an unremitting rhythmic tattoo, while the piano, acting as a percussion instrument, hammers out jazz-inflected chord clusters. Otherwise, the piano part is introspective and meditative, shunning virtuosity and contention in favor of harmonious cooperation with the orchestra—a metaphor for Harrison's worldview.

Jarrett seems most comfortable in the motoric, rhythmic sections; I could easily imagine another pianist imbuing the lyrical ones with greater poetry. But he is obviously deeply committed to Harrison's music, and if his involvement succeeds in bringing it before a wider public, so much the better. I am inclined to be forgiving toward the New Japan Philharmonic, for a live recording such as this is never likely to show a second-rate orchestra in the best light.

The focus of this recording, however, remains on Harrison himself. 1988 was a year unusually filled with public recognition of the composer, what with New Albion's release last spring of his gorgeous *La Koro Sutro* (NA 015). Let's hope that 1989 sees more attention paid to this authentic American original. Playing time: 51:51.

K. Robert Schwarz

**MENDELSSOHN: Symphony No. 3, in A minor, Op. 56 ("Scottish"); Symphony No. 4, in A, Op. 90 ("Italian").**

*London Philharmonic Orchestra, Bychkov. Erik Smith, prod. Philips 420 211-2 (D).*

**MENDELSSOHN: Symphonies (3); Incidental Music to "A Midsummer Night's Dream," Opp. 21, 61\*.**

*Phillips\*, Warner\*; unnamed orchestra, Toscanini. ATRA 268 (A, 2). (Dist. by Allegro Imports.)*

*Symphonies: Symphony No. 3, in A minor, Op. 56 ("Scottish"); Symphony No. 4, in A, Op. 90 ("Italian"); Symphony No. 5, in D minor, Op. 107 ("Reformation").*

I will begin by saying (for those who want the assurance) that I listened to every note of Semyon Bychkov's recording of these Mendelssohn symphonies. However, I can't recommend that anyone else do the same. These are the performances of a person incapable in this instance of getting the

orchestra to play accurately or beautifully; with inadequate rhythmic sense to impose an overall pulse on a section of a score, let alone a movement; and with insufficient musical taste to keep his accents, pauses, accelerations, crescendos, and decrescendos—the sum of his "ideas"—in proportion to anything perceptible as a coherent progression.

The opening of the *Scottish* Symphony is slow, lingering, overemphatic, and lugubrious; the tempo of the rest of the first movement is unexceptionable, but what little tension mere speed gives it slackens at every transition. In the second movement (as in the fourth) the pointed accents at the beginnings of passages that are passed from one section to another disrupt the musical flow, resulting in a choppy quality that is magnified by the orchestra's poor ensemble. The Adagio is logy in spite of all manner of accentuation and the engineer's highlighting of individual instruments. (Ironically, the excessive number of microphones Philips's engineers have chosen to use throws the orchestra out of focus, making it sound scrawny throughout.)

The grandiose conclusion of the symphony is loud enough, but with Bychkov coming to a full stop at the end of each phrase, it is hardly stirring. Without going into detail, the recording of the *Italian*

Symphony may be said to be similarly unsatisfactory. The present-day recording to own of the *Scottish* Symphony is Claudio Abbado's on Deutsche Grammophon (415 973-2). I have not heard Abbado's recording of the *Italian*.

For those interested in historic recordings, I call attention to some good-sounding Compact Discs of Toscanini's superb Mendelssohn performances from the 1940s. (The exception here is the *Reformation* Symphony, whose outer movements Toscanini makes overimpassioned.) The playing of the radio orchestra—I don't mention the name because the jacket purposely does not—is picked up from a more natural listening distance than it was in later years. Consequently, the sound here has unusual spaciousness, resonance, and body. (Toscanini, who listened to records as though from the podium, was said by his son to have preferred the later, closer pickup.)

The 1942 performance of the *Italian* Symphony is notable for being more relaxed than the broadcast from Toscanini's last season, which was issued by RCA. Some might prefer Koussevitzky's marvelous performance to either of Toscanini's for the even more exquisite sonorities he got from the Boston Symphony ("You like the str-rings?") Koussevitzky used to

# Low-Price Accessories

## For CD Players

Sims Original CD Stabilizer Ring  
Starter kit: 15 w/locator 19.95  
Complete Kit: 25 w/locator 29.95  
Bonus Kit: 50 + free locator 49.95  
AQ CD Isolation Feet (4) 19.95  
CD Interconnects: See Cables

## Accessories

DB Passive CD preamp 99.95  
Magnavox CD Players:  
CDB480 \*\*139.95  
CDB482 w/remote \*\*149.95  
CDB582 w/remote \*\*199.95  
CDB473 w/remote \*\*249.95  
CDB486 16 bit CD Changer \*\*249.95  
CDV474 CD/Video Laser Call  
Mod Squad CD damper kit 29.95

## Hard-to-Find Audiophile LP/CD's:

Chesky Records: RC10 LL Kijie (lp) 14.98  
RC11 Reiner Sound (lp) 14.98  
RC-8 Gershwin, RC-9 Spain (lp's) 14.98  
CR-6 Brahms & Tchaik (cd/lp) 14.98  
CR-7 Bizet & Tchaik (cd/lp) 14.98  
Proprius: Contate Comino (cd/lp) 17.95  
Jazz at Pawn Shop: cd 16.95 lp 34.95  
Reference Recordings: LP or CD  
RR12 Dalos, RR20 Serendipity 15.99  
RR25 Nojima plays Liszt 15.99  
RR26 Redheads (Jazz) 15.99  
RR27 Fuller plays Rameau 15.99  
Sheffield/Moscow Ses. cd/lp(set) 39.95  
KodoDrums or Test Record(cd/np) 14.99

## For Turntables

Alphason Auto arm lift 29.95  
AR ES-1 turntable, armless \*\*419.95  
ES-1 w/AQ PT-5 tonearm \*\*649.95  
ES-1 Precut metal armboards: for AR, MMT, RB300 34.95  
Cartridge Alignment Protractors: DB Systems Protrac 24.50  
Denness SounDractor 149.95  
Grado Cartridges: Grado ZTE+1 19.95  
Grado Sig 8M2, MCZ, TLZ Call

## Record Doctor: vacuum-powered record cleaning machine \*\*169.95

LAST Record Care Products:  
#1 Power Cleaner 11.95  
#2 Preservative 14.95  
#4 Stylus Cleaner 7.95  
#5 Stylus Treatment 16.95  
Headshells: AQ-16 for MC's 39.95  
Sumiko HS12 for MMT 29.95  
Headshell wires: Livewire, Sumiko 9.95  
SME Itz BEST AVAILABLE 22.95  
Record Brushes: AQ or NG 9.95  
Record Cleaning Solutions:  
NG First: Boz 14.95 / 16oz. 24.95  
Torumat TM-7XH: 16oz. 14.95  
SuperCleaner: 16 oz. 12.95 / 52oz. 16.95  
1 gal. 24.95/ SuperSize: 2.5gal. \*\*49.95  
Record Mats: AQ mat 29.95  
Sofa acrylic mat. 129.95  
Sumiko acrylic mat. 84.95  
Sofa Reflex Clamp 89.95  
Stylus Gauges: Shure Gauge 14.95  
Electronic Stylus Gauge 99.95  
Electronic Stylus Cleaner 19.95  
Sumiko: FB-1 MC Demagnetizer 149.95  
VTA-16 VTA for MMT arm 74.95  
Tip Toes for turntables: C3-AR 4.95  
C-17-VPI, C-37-Sofa, C-10-Grace 8.95

Turntable Stands: Lead Balloon \*\*249.95  
Target TT-2 w/2 shelves \*\*139.95  
Turntable Wall Shelves: TT-1 \*\*99.95  
Target PS-1, for large tables \*\*149.95  
VPI Record Cleaning Machine Call  
VPI PLC Power Line Conditioner Call

## Audio/Video Powerstrips:

Deluxe Dataqad 6 outlet strip 49.95  
Tripplite ISOBAR line Filters:  
IB-4 4 outlets, 2-stage filtering 69.95†  
IB-8 8 outlets, 3-stage filtering 99.95  
Tripplite regulator/line conditioner:  
LC-1200 4 outlet voltage reg. \*\*199.95  
LC-1800 6 outlet voltage reg. \*\*299.00  
† available in 220volt. 50/60 Hz add 10.00

## Speaker Stands/Equipment Racks

Chicago "Hercules" speaker stands:  
12" \*134.95 15" \*139.95  
20" \*139.95 25" \*149.95  
ARCICI Riser 1 Riser adjust. stand \*119.95  
ARCICI Quad stand \*169.95  
Sound Anchor stands for VS IIC \*219.95  
Target Speaker Stands (blk or white) Call  
Target BT-1 adj. wall bracket 24.95  
Target Equipment Racks (black or white):  
AIB-1 amp floor stand, 4' 69.95  
TT-3 33" tall, 3 shelves \*199.95  
PS-3 33" w/large shelves \*249.95  
TT-5T 40" tall, 5 shelves \*274.95

## Cables and Cable Accessories

Interconnect Cables:  
As-One, Cardas, FMS, Distech, Livewire, MIT, Monster, VandenHul Call  
Custom longer length cables Call  
Speaker Cables: Aural, Cardas, FMS, Livewire, MIT, Monster, VandenHul Call  
Banana Connectors: King Size 8 ga. 7.95  
Monster X-terminators (pr) 24.95  
Tiffany RCA's: 4, 5.5, 7.9mm (pr) 13.50  
Silver Solder/Wonder Solder: 1.5oz. 9.95  
WBT 250g roll 8mm 29.95  
500g roll 1.5mm 59.95

## Misc. Accessories

ASC Tube Trap room dampers Call  
AQ Sorbothane Isolation Ft. Lg. (4) 34.95  
Small (CD) Feet (4) 19.95  
dbx 200XG tape routing selector \*\*99.95  
Sonex Juniors: 2"x2"x2" sheets (4) 49.95  
Regular Sonex products Call  
Speaker Switching: Niles SPS-1 74.95  
QED UHS4: for heavy cable 114.95  
Terk "PI" FM Antenna 74.95  
Tip Toes for speakers: 1 1/2" 8.95  
Tubes: RAM/Gold Aero Premium Call  
Sorbothane Tube Dampers 2.50  
Tweak contact treatment 14.95  
VPI HW-5db "Magic Brick" 34.95

Prices subject to change

## Shipping Charges

UPS, Insured, 48 States  
Accessories: One Item 3.95  
Each Extra Item 1.25  
\*Turntables, Stands 12.95  
\*\*Electronics 8.95

## UPS Air to Western Europe, Far East, Auss., NZ—most shipments under \$50 and less than 5 days.

1-800-669-4434  
MasterCard / Visa / Amex / Discover



audio advisor, inc.  
225 Oakes SW • Grand Rapids, MI • 49503  
FAX: 616-451-0709 Service: 616-451-3868

ask visitors to the Green Room, some of whom baited him to hear him ask the same thing year after year. "You like *son-nor-ee-té*?" However, it is Toscanini who gives greater clarity and musical sense to the contrapuntal inner lines that Mendelssohn took pains to write.

The music from *A Midsummer Night's Dream* is notable for being more gracefully inflected and better reproduced here than in the recording Toscanini made for RCA a few days later. (The vocal numbers, which were omitted from the RCA record, are poorly sung here, however.)

Readers may want to be warned of flaws in the sound of these transcriptions, for instance the two audible splices in the *Scottish Symphony*, the harsh-sounding moments at the start of the *Midsummer Night's Dream* music, and the faint interference from another radio station in the quietest passages of the same piece. Toscanini's admirers will buy the set anyway, of course, and they will buy it even in defiance of the liner notes—by someone named Breckbill—which warn through the wrapping that "the present collection will be helpful in demonstrating a significant limitation of the great Italian conductor's artistic sensibility." But will curious new listeners buy it after such a warning? Shooing away customers is not the only unconventional side of ATRA's operations, but it is certainly one of the most unexpected. Playing times: 69:04 (Philips); 123:30 (ATRA). *Thomas Hathaway*

**MOZART: Concerto for Flute, Harp, and Orchestra, in C, K. 299\***; **Andante for Flute and Orchestra, in C, K. 315†**; **Concerto for Bassoon and Orchestra, in B flat, K. 191\*\***;



*Mariss Jansons: a secure sense of sonic architecture and a feeling for Rachmaninoff's changing moods*

**Concerto for Flute and Orchestra, in G, K. 313†.**

● *Bezanosuk\*\*††, Kelly\*, Bond\*\**; *Academy of Ancient Music, Hogwood. Peter Wadland, prod. L'Oiseau-Lyre 417 622-2 (D).* ☉ ☐

The praises of Christopher Hogwood's period-instrument Mozart readings hardly need singing at this point, and these days it's almost assumed that the soloists he features represent the choicest that London's

vigorously active early-music scene has to offer. To put it another way, this is quite a perfect little recording. Along with the refreshingly "soft" yet extremely articulate sound that Danny Bond draws from his reproduction of a ten-keyed 18th-century bassoon, what makes it especially endearing is the soloists' commentary on why they chose to play Mozart on *these* particular instruments. Bond writes eloquently about his fondness for the "covered qualities" of his copy by Peter de Koningh of a Heinrich Grenser original; Lisa Bezanosuk says she prefers her six-keyed flute, built by Roderick Cameron after a model also by Grenser, because it allows her to make the most of Mozart's "legato chromatic passages" and "wide intervals"; Frances Kelly, who plays a restored single-action harp dating from around 1800, observes that this is an instrument not only of great clarity but also the perfect vehicle by which young girls of that era could display both their charms and their ankles. Obviously, these are players who care as deeply about their sound as about their handling of Mozart's material, and the results—musically, sonically, and in every other way—are simply glorious. Playing time: 74:47.

*James Wierzbicki*

**RACHMANINOFF: Symphony No. 2, in E minor, Op. 27 (complete).**

● *Philharmonia Orchestra, Jansons. Brian Couzens, prod. Chandos CHAN 8520 (D).* ☉ *ABRD 1230.* ☐ *ABTD 1230.* (Dist. by Koch Import Service.)

**TASKAMICHI AUDIO**, FOR ORDER ONLY **1-800-622-HIFI\***; FAX **1-206-562-8720** <sup>24</sup>Hrs.  
 \*This Toll Free number is for orders only. No other brand names are offered. This ad is our total product line and no price list is mailed out. For customer service or product availability information CALL **1-206-747-9999**  
 P.O. Box 25583 Seattle, WA 98125 All equipment are U.S.A. Models, Brand New with USA warranty.  
 We ship most orders within 24 hours; receive orders within 1-7 days. 2 weeks damage and defect replacement period.  
 We accept VISA/MC, AMEX, Discover, Diners Club, COD Price are subject to be changed without notice

Receivers		Rotel		Rotel		M4.0T		Nakamichi	
RX1100U	\$799	RX875	\$519	RD870	\$399	M200T	679	EC200H	\$169
RX900U	639	RX855	449	RD855	299	M500T	369	PA100	109
RX700U	479	<b>CD players</b>		<b>NAD</b>		TX2	349	PA150	189
RX500U	329	<b>Yamaha</b>		<b>Separates</b>		TX11A	589	PA400M	439
RX300U	239	CDX5000U	\$1799	5300	\$729	<b>Luxman</b>		SP10	149
<b>Carver</b>		CDX1110U	979	5240	389	LV-112	\$449	SP40	109
AVR-100	\$949	CDX910U	559	5170	649	LV-117	899	SP50	119
Rec-150	639	CDX900U	529	<b>Cassette</b>		LV-109	1,249	SP65	249
6200	589	CDX710U	419	<b>Yamaha</b>		T-100	819	SP20	209
6250	739	CDX700U	369	KK1200U	\$599	T-111	209	SP300	319
<b>Luxman</b>		CDX510U	289	KK640U	359	T-117	249	SP-7	75
R-117	\$959	CDX410U	259	KK500U	319	T-407	309	RM-15	CALL
R-115	649	CDX610U	499	KK400U	269	<b>Denon</b>		<b>Turntables</b>	
R-113	369	<b>Carver</b>		KOR700U	469	DAP5500	\$1,249	Yamaha	
<b>Denon</b>		DTL50	\$459	KOR900U	559	PMA1520	799	PF800	\$479
DRA1025R	\$789	DTL200 II	559	KXW300U	359	PMA720	359	TT500	199
DRA825R	679	<b>Luxman</b>		KXW200U	279	TU800	419	<b>Loudspeakers</b>	
DRA95A	529	D-30	\$369	<b>Luxman</b>		TU600	329	<b>KEF</b>	
DRA625	449	D-111	289	K-105	\$489	DSR-100	239	104.2	Kube
DRA425	369	D-112	419	K-106	489	DSR-100	239	104.2	1,499
<b>Kyocera</b>		D-113	549	K-111	239	DSR-100	239	105.3	1,039
R-861	\$969	D-107	729	K-112	449	MVS-1	1700	102	649
R-861	729	D-109	1,249	<b>Denon</b>		SR50	279	C26	978
R-461	529	<b>Denon</b>		DRM30HX	\$409	TX 500	269	C75	578
<b>NAD</b>		DCD3520	\$1,349	DRM24HX	369	TX 900	429	C55	418
7600	\$1,299	DCD1520	1,199	DRM12HX	279	TX 1000	329	C35	338
7400	889	DCD1500 II	669	DRM10HX	229	400T	449	C25	278
7250PE	529	DCD1400	499	DRM10HX	239	R8800	3300	C15	198
7240PE	429	DCD810	339	<b>Kyocera</b>		C1	\$999	<b>B &amp; W</b>	
7220PE	259	DCD610	249	D 811	\$599	C2	499	DM570	\$1,069
7175PE	689	DCD610	249	D 611	439	R4870BX	\$519	Matri2	1,199
7100	629	DCM555	469	<b>NAD</b>		R8870BX	439	CM1	559
<b>Nakamichi</b>		6300	\$729	CT-7	659	R8850	239	<b>Tannoy</b>	
SR3A	\$589	6240	249	M1.0T	459	RC870BX	359	C6	\$219
SR2A	369	6155	369	M1.5T	699	Rc850	439	Eclipse	299
						R850	239	Jupiter	669

As a symphonist, Sergei Rachmaninoff had less than the best of luck. At the world premiere of his First, he had to stand helplessly by while the drunk on the podium (Alexander Glazunov!) turned the occasion into a catastrophe of major proportions. The trauma of that fiasco plunged the twenty-four-year-old composer into a three-year depression and creative block that began to improve only after protracted neurological treatment in Dresden. Rachmaninoff's Second Symphony won the important 1908 Glinka Prize (pushing Scriabin's *Poem of Ecstasy* into second place), but almost ever since then conductors have cavalierly whittled away at it to bring it down to something closer to conventional size. One wonders why, really: James DePreist's recent—and cut—version with the Oregon Symphony (Delos DCD 3071) takes only 2:39 less than this account.

Here, for once, Mariss Jansons gives us the un mutilated score, and I personally find it not a minute too long. Jansons's Latvian Soviet father, Arvid Jansons, long shared the conductorship of the Soviet Union's finest orchestra, the Leningrad Philharmonic, with the legendary Evgeny Mravinsky. The son, born in Riga in 1943, studied in Leningrad, then in Vienna with Hans Swarowski and in Salzburg with Herbert von Karajan, and won first prize in the 1971 International Karajan Competition in Berlin. Since 1985 he has held the same Leningrad post his father once did, in addition to serving the Oslo Philharmonic as its principal conductor.

On this recording, Jansons has one of the world's greatest orchestras at his disposal, and he makes the most of the opportunity. He conducts with enormous Romantic flexibility of tempo, but the orchestra sticks right with him. Where Rachmaninoff piles on one climax after another, Jansons shows an unusually secure sense of sonic architecture. In turn brooding, melancholy, reflective, joyous, he makes seamless transitions from mood to mood. In addition to everything else, the acoustics of All Saints' Church in Tooting make it all sound unusually moving and thrilling. Playing time: 54:32.

Paul Moor

**SCHMIDT: Symphony No. 1, in E; Notre Dame (orchestral excerpts from Act I).**

① *Budapest Symphony Orchestra, Halász. Marco Polo 8.223119 (D).* (Dist. by Harmonia Mundi, U.S.A.)

**SCHMIDT: Symphony No. 3, in A.**

① *Slovak Philharmonic Orchestra, Pešek. Supraphon CO 1668 (D).* (Dist. by Denon.)

The way the Austrians talk about Franz Schmidt (1847–1939), you would think he was a major composer, only waiting to be rediscovered à la Mahler. Until now, there

have been intermittently available recordings of the Fourth Symphony, *The Book with Seven Seals*, the Piano Quintet (Op. 51), and orchestral excerpts from the opera *Notre Dame*. All of these works are of sufficient quality to lead one to suspect that Schmidt's other works would offer something special in the same, late Romantic vein. With these releases of his Symphony No. 1 on Marco Polo and Symphony No. 3 on Supraphon, we are in a better position to know.

The Third Symphony is a real find, and it bears the genuine stamp of individuality. It is a subtle, finely graded, highly lyrical work of gentle beauty and mystery. The first movement is a mesmerizing treatment of a fairly lengthy tune that is stated, in various forms—some 13 times—without fatigue. The cumulative effect is utterly beguiling and magical, and the movement is passionately powerful in its culmination. Much of the rest of the symphony is equally distinctive, especially the introspective Adagio and the final movement. The capable Libor Pešek leads the Slovak Philharmonic Orchestra (from Schmidt's home town, Bratislava) in a fine rendition with good sound.

I began to enjoy the First Symphony only when I learned to detect in it early signs of Schmidt's emerging personality, such as his particular use of side-slipping enharmonic modulations and other characteristics apparent from frequent listenings to Symphony No. 3. Otherwise, the First Symphony is as extroverted and broad as the Third is introverted and intimate. Schmidt must have changed a great deal in the nearly three decades that sepa-

rate these works. The First has a brassy exuberance and plenty of lyricism, and was a prizewinner in its day (as was Symphony No. 3). But it does not wear well. Too much of it is on the outside, or perhaps seems so in this overly bright recording by the Budapest Symphony Orchestra under the direction of Michael Halász. The coupling is a set of orchestral excerpts from Act I of *Notre Dame*. In an inexplicable goof, the four movements of the symphony are not banded.

I recommend the First to Schmidt fans and the Third as something genuinely lovely. Playing times: 58:46 (Marco Polo); 48:15 (Supraphon). *Robert R. Reilly*

**SCHUBERT: Winterreise, D. 911.**

① *Ludwig, Levine. Cord Garben and Claudia Hamann, prods. Deutsche Grammophon 423 366-2 (D).*

This superlative performance has just about everything—with one whopping shortcoming. Christa Ludwig's rare combination of intelligence, musicality, and an exceptionally beautiful voice have made her the darling not only of lay music-lovers worldwide but also of some of the most demanding conductors alive. Here, James Levine, one of those conductors, accompanies her at the piano, on equal footing, and although he at times pushes the music in the Romantic direction, he still provides a handsome musical complement.

One minor irritation does recur fairly frequently. In slow pieces, Schubert has a way of ending a fairly long phrase with the final, cadential note held for an entire measure. This sets a trap for the narcissistic performer, who equates repose with

**GET WIRED**

**And bring back the sound & feel of live music.**

Amazing! That's how most people react when they hear the new *LiveWire* cables from AudioQuest. The music is cleaner and clearer — like a picture in better focus.

With eleven speaker cables and six interconnects to choose from, *LiveWire* has a cable that's right for you. Hear *LiveWire* cables at your local dealer or contact AudioQuest for more information.

**audioquest** P.O. Box 3060  
San Clemente, CA 92672 USA  
Tel: 714/498-2770  
Fax: 714/498-5112 Tlx: 205864

dereliction of duty—and jumps the gun, rhythmically speaking, in order to get on with things.

But the main mischief here arises from one source: sex—or, if you will, gender. In any song, by any composer, the singer transmits the words of the poet; in other words, the poet serves as ghostwriter for the singer. All 24 songs in this glorious cycle sing primarily of the poet Wilhelm Müller's profound depression and Welt-schmerz, but six of them make unequivocally clear the poet's (ergo, the singer's) ill-starred relationship with, to use clinical terminology, a female object.

The leaflet, self-defensively, says that "in our century" both Elena Gerhardt and Lotte Lehmann sang this cycle. True; but they did it during an era before the work of Freud, Kinsey, and their followers had made people aware of the homosexuality of about one-tenth of your neighbors and mine. And did they do it before German-speaking audiences? I strongly doubt that.

If—like many Americans who know their mother tongue only—you disregard the literary content of songs in foreign languages, this superb, almost exemplary performance may delight you without any reservations at all. If you double your aesthetic enjoyment of it, though, by according both poetry and music equal attentiveness, you will probably have the same problem with it I did. One certain fact: Christa Ludwig's musical realization can teach volumes to most male singers who attempt this melancholy masterpiece. Playing time: 74:18. *Paul Moor*

#### STRAVINSKY: *L'Histoire du soldat*.

Sting, *Redgrave, McKellen*; London Sinfonietta, Nagano. James Mallinson, prod. Pangaea PAND 6233 (D).  (Dist. by MCA.)

Sting used to be a member of the celebrated rock group The Police, in which capacity he composed such familiar Top 40 hits as "Every Breath You Take," "King of Pain," and "Every Little Thing She Does Is Magic." With the dissolution of The Police, he struck out on his own as a solo artist, a movie star, and, most recently, a recording mogul, starting a label of his own called Pangaea that specializes in offbeat music of all kinds.

Pangaea's latest release is an English-language recording of Igor Stravinsky's *L'Histoire du soldat*, and there is nothing at all gimmicky about it. Kent Nagano leads the London Sinfonietta in a crisp, dapper performance of Stravinsky's wittyest score. Nona Liddell, familiar from previous Sinfonietta recordings, tosses off the crucial violin part with abundant panache. Ian McKellen is the superb narrator, and Sting does a fine job as the soldier. Vanessa Redgrave is far too fruity as the devil—one expected rather more of her than this



CHRISTIAN STEINER

Kent Nagano

mustache-twirling cardboard villain.

All of the little touches on this recording are impeccably right. James Mallinson's digital sound is a trifle heavy-handed in the echo department but otherwise quite good. The performance is fully band-ed and indexed. John Carewe's 1987 critical edition of Stravinsky's score is used. The liner notes are by Andrew Porter. The booklet is beautifully designed. Point for point, the results add up to the most convincing English-language version of *L'Histoire du soldat* on record. Playing time: 57:43. *Terry Teachout*

**SZYMANOWSKI: Concertos for Violin and Orchestra: No. 1, Op. 35\*; No. 2, Op. 61\*; Symphony No. 4, Op. 60 (Symphonie concertante)†.**

 *Kulka\**, *Palczyński*; Polish Radio National Symphony Orchestra, Maksymilik\*, *Semkowł*. Gerd Berg, prod. Pantheon D 18401 (A). (Dist. by Outlet Book Co.)



This splendid CD offers outstanding performances of three concerted works by Karol Szymanowski (1882–1937), a major figure in Polish music during the first half

of this century. Szymanowski's output was not large. Most of what he composed was written for voices or solo piano; he also wrote four symphonies and a few stage works, as well as an opera, *King Roger*. Much of the music is hauntingly beautiful, mystical, and exquisitely textured, and it is often reminiscent of Scriabin. Szymanowski's Violin Concerto No. 1, the more exotic of the two he composed, was completed in 1916; the second came along 16 years later. Each concerto consists of one movement with contrasting sections. Both are dedicated to the distinguished Polish violinist Paul Kochanski, who assisted in editing them and wrote the cadenzas. There have been several fine recordings of the First Concerto, notably one by David Oistrakh, and Henryk Szeryng made a superlative recording of Concerto No. 2. It is remarkable that these two works, with their rhapsodic beauty, are not played by today's leading violinists. Symphony No. 4, sometimes identified as the *Symphonie concertante*, is more of a concerto grosso with an important part for solo piano. It is not a flashy work, but Artur Schnabel championed it and even made an early RCA recording of it (the score is dedicated to Schnabel).

The performers on this Pantheon release are not well known in the West, but their artistry is sterling and they obviously have great affection for their countryman's music. These are analog recordings made in 1979 (the violin concertos) and 1982 (the *Symphonie concertante*), but the sound is beautifully balanced and transparent, and does justice to the unique sonority of Szymanowski's orchestral scoring. Playing time: 71:55.

*Robert E. Benson*

**WAGNER: Overture from "Tannhäuser und der Sängerkrieg auf Wartburg"; Siegfried Idyll; Prelude and "Liebestod" from "Tristan und Isolde."**

 *Norman*; Vienna Philharmonic Orchestra, Karajan. Günther Breest, prod. Deutsche Grammophon 423 613-2 (D). 

**WAGNER: Opera Excerpts.**





 *Norman*; Ambrosian Opera Chorus, London Philharmonic Orchestra, Tennstedt. James Mallinson, prod. Angel EMI CDC 49759 (D).

*Prelude and "Liebestod" (Tristan und Isolde); "Dich, teure Halle, grüss' ich wieder" and Elisabeth's Prayer (Tannhäuser und der Sängerkrieg auf Wartburg); "Johohoe! Traft ihr das Schiff" (Der fliegende Holländer); Brunnhilde's Immolation (Götterdämmerung).*

**LOTTE LEHMANN: Opera and Operetta Arias.**

 *Lehmann*; Berlin State Opera Orchestra <sup>1236789</sup>, Berlin Municipal Opera Orchestra†, Vienna Philharmonic Orchestra<sup>4</sup>,

## FORMAT KEY

- |  |   |
|--|---|
|  LP           |  Videocassette |
|  Cassette     |  Videodisc     |
|  Compact Disc |   |

## RECORDING INFORMATION

(A) Analog original (D) Digital original

Large symbol at left margin indicates reviewed format. Small symbols following catalog number of reviewed format indicate other available formats (if any). Catalog numbers of formats other than the reviewed format are printed only if their basic numbers differ substantially from that of the reviewed format.

Arabic numeral in parentheses indicates number of items in multi-item set.

unnamed studio orchestra<sup>3\*\*</sup>, Gurlitt<sup>\*of</sup>, Weissmann<sup>12359\*\*</sup>, Jäger<sup>6</sup>, Szell<sup>7</sup>, Zweig<sup>8</sup>, Heger<sup>4</sup>. Angel EMI CDH 61042 (A).

**BEETHOVEN:** *Komm, O Hoffnung (Fidelio)\**. **WEBER:** *Wie nahte mir der Schlummer (Der Freischütz)†*; *Ozean, du Ungeheuer! (Oberon)‡*. **NICOLAI:** *Nun eilt herbei! (Die lustigen Weiber von Windsor)\**; *Euch lüften (Lohengrin)†*; *Allmächt'ge Jungfrau (Tannhäuser)‡*; *Liebested (Tristan und Isolde)†*.

**R. STRAUSS:** *Da geht er hin (Der Rosenkavalier)\**; *Sie atmet leicht . . . es gibt ein Reich (Ariadne auf Naxos)\**; *Mein Elemer (Arabella)†*; **KORNGOLD:** *Der Erste, der Lieb' mich gelehrt (Die tote Stadt)‡*; *Ich ging zu ihm (Das Wunder der Heliane)\**; **J. STRAUSS:** *Klänge der Heimat (Die Fledermaus)†*; **LEHAR:** *So war meine Mutter . . . Wär es auch nichts als ein Augenblick (Eva)\*\**.

With joy I pounced on all three of these records—the first two brand-new, the third recorded between 1924 and 1933—anticipatory joy. All offer Isolde's "Liebestod" by superlatively gifted sopranos, and for a really great "Liebestod" I will do almost anything short of kill. With regret I have to report enthusiasm in only one instance out of three.

Jessye Norman, as recorded by Deutsche Grammophon in live performance (for a film) with Herbert von Karajan, seems to have had a slightly off day; in her higher register, this super-soprano displays a sort of ambiguity of pitch I have never heard from her before. Klaus Tennstedt and EMI have caught her in noticeably better voice. Lotte Lehmann (1888–1976) surely never risked even attempting Isolde on the stage; in this 1930 recording, the microphone compensates, and she projects this unique aria's literary and psychological content far more than the vast majority of her colleagues. However, an indulgent conductor (Frieder Weissmann) permits her all sorts of liberties with the tempo, and that makes the whole considerably less than ideal.

Those quibbles aside, each disc contains a lot to praise. Karajan's insistence on transparency in Wagner stands the irresistible little *Siegfried Idyll* in especially good stead, and in all these works the Vienna Philharmonic plays above reproach. Tennstedt conducts a powerful *Tristan* Prelude and contributes importantly to Norman's five big arias. Her "Liebestod" with him offers us probably the best available in the world today; the same goes for her incandescent singing of that great scene that closes the *Ring*—although here, too, like virtually all sopranos, she has trouble landing precisely on that first stratospheric high note toward the end.

The 13 arias that fill out the Lehmann disc include reunions with some unfairly neglected music from yesteryear. The

three Strauss excerpts stand out particularly, and the first—"Da geht er hin," from *Der Rosenkavalier*—makes clear why the composer gave Lehmann a photograph of himself inscribed "To the greatest of all Marschallins." Playing times: 54:10 (DG); 60:13 (Angel EMI CDC 49759); 73:08 (Angel EMI CDH 61042).

Paul Moor

## Recitals and Miscellany

### BENJAMIN LUXON and BILL CROFUT: "Two Gentlemen Folk."

Luxon, Crofut, various artists. Robert Woods, prod. Telarc CD 84401 (D).

*The Ash Grove; Bold Nelson/Eddy-stone Light; The Cuckoo/Leatherwing Bat; Flowers to Your Daddy; Danny Boy; The Dancer of the Forest; The Leaving of Liverpool; San Francisco Bay; She's Like the Swallow; Sweet Nightingale; The Tinker; Turkey in the Straw; The Wabash Cannonball; Waltzing Matilda; Waly Waly; White-Haired Cassidy.*

### VAUGHAN WILLIAMS: Songs (22).

Luxon, Willison. Brian Couzens, prod. Chandos CHAN 8475 (D). © ABRD 1186. □ ABTD 1186. (Dist. by Koch Import Service.)

*Four Poems by Fredegond Shove; The House of Life: Love-sight, Silent Noon, Love's Minstrels, Heart's Haven, Death in Love, Love's Last Gift; Linden Lea; Songs of Travel: The Vagabond, Let Beauty Awake, The Roadside Fire, Youth and Love, In Dreams, The Infinite Shining Heavens, Whither Must I Wander?, Bright Is the Ring of Words, I Have Trod the Upward and the Downward Slope; Tired; The Winter's Willow.*

The vast majority of singers, by the time they acquire the polish necessary for concert and operatic singing, have lost the spontaneity and naturalness required to make authentic folk song sound effective.



Benjamin Luxon

GUARANTEED LOWEST USA PRICE!

# HIGHVOLTAGE

<b>RECEIVERS + AMPS</b> Pioneer VSX-9300S New Pioneer VSX-5300 Call Pioneer VSX-3300 249 Pioneer VSA-910 Call Sony STR AV1000 489 Sony STR AV900 369 Sony STR AV290 199 Nikko Alpha 650 949 Nikko Alpha 450 579 JVC RX 1001V Call JVC RX 777 399 JVC RX 333 199 JVC SVA30 175 SSI 4020 Pro Logic New SSI 360 II 299	<b>SURROUND SOUND</b> SSI System 4000.....Call • #1 Pro Logic • Wireless Remote Control • Volume Control For Entire A/V System • Center Ant Sub Woolf Ch. • Four A/V Inputs  <b>CAMCORDER SPECIALS</b> Panasonic PV S350 1599 Panasonic VU 420 989 RCA CC 310 New RCA CC 320 Call Sony CCD V11 Call Sony CCD F40 1075 Minolta V2000 Call Olympus VX 802 899 JVC GRC 55U 1199 JVC GRC 25U 899
<b>CASSETTE DECKS</b> Pioneer CT W900R New Pioneer CT W700R Call Pioneer CT W300 145 JVC TDW 999 BK 325 JVC TDW 444 BK 205 Technics RST 33R 249	<b>VCR SPECIALS</b> Panasonic PV S4864 699 Panasonic PV 4860 469 RCA VPT 699 899 RCA VR 595 New RCA VR 475 Call JVC HRS 8000U Call JVC HRS 7000U 799 JVC HRD 750 489 Mitsubishi U-70 New Mitsubishi U-50 Call Quasar VH 5677 Call Quasar VH 5485 439
<b>AZDEN HEADPHONES</b> DSR 90 Pro Digital 75 DSR 50 Digital 49	<b>CD PLAYERS</b> Pioneer PD M700 Call Pioneer PD M600 Lowest Pioneer PD 7100 Prices Pioneer PD 4050 135 JVC XLM 600 369 JVC XLM 400 295 JVC XLZ 444 220 JVC XLV 222 159 Sony CDP C70 335 Sony CDP 350 189 Magnavox CDB 650 289 Magnavox CDB 473 249 Technics SLP 770 New Technics SLP 550 325 Technics SLP 350 269
	<b>RADAR DETECTORS</b> Under RD9 XL 149 Under RD9 135 Cobra 3170 175 Cobra 3120 99 Spectrum II 169

**800-654-7787**  
 FAX 212-268-6828  
 HIGHVOLTAGE, 39 W. 32nd St., New York, NY 10001  
 VISA, MC and COD Accepted. All Products New, Factory Fresh and Subject to Availability. Customer Service Call 212-554-4410

## SAVE YOUR COPIES OF HIGH FIDELITY

These custom-made titled cases are ideal to protect your valuable copies from damage. They're designed to hold a year's issues, constructed with reinforced board and covered with durable leather-like material in flag blue.

- The title is hot-stamped in gold.
- Free personalization foil included for indexing year.
- Cases are V-notched for easy access.



Cases: 1—\$7.95 3—\$21.95 6—\$39.95

### HIGH FIDELITY

Jesse Jones Industries, Dept. HF  
 499 East Erie Ave., Philadelphia, PA 19134

Enclosed is \$ \_\_\_\_\_ for \_\_\_\_\_ Cases;  
 Add \$1 per case for postage & handling. Outside  
 USA add \$2.50 per case (US funds only). PA resi-  
 dents add 6% sales tax.

Print Name \_\_\_\_\_

Address \_\_\_\_\_

No P.O. Box numbers, please

City/State/Zip \_\_\_\_\_

CHARGE ORDERS (Minimum \$15): Am Ex, Visa, DC,  
 MC accepted. Send card name, #, Exp. date.  
 CALL TOLL FREE 7 days, 24 hours #1-800-972-5858

..... SATISFACTION GUARANTEED .....

High on the short list of exceptions stands the name of the Cornish baritone Benjamin Luxon. Both in concert and in opera, he has credentials of the first order, including Glyndebourne and the Met, but he still enjoys nothing better than to unbend and join in what Alan Lomax, Pete Seeger, and Co. used to call a hootenanny. These two recordings, one as delightful as the other, show us not so much the two sides of Luxon's personality as the contrasting components making up the fetching and harmonious whole.

Ralph Vaughan Williams wrote some of the most impressive songs in the English language; popularity once wore out the welcome of his 1903 setting of Rosetti's "Silent Noon," but it still can hold its own against almost anything in the Romantic repertory. These 22 selections include not only that one but also two other favorites, "The Roadside Fire" and "Linden Lea." Luxon sings them as if he had grown up singing them all. The clarity of his enunciation matches the beauty of his voice, and his intelligent projection of their contents adds to the overall pleasure of hearing him.

The recording entitled *Two Gentlemen Folk* brings Luxon together with eight people who have impressive academic cre-

entials but still, as you quickly hear, get one hell of a bang out of singing and playing authentic folk material. The accompanying leaflet says: "It all started in a pub in Munich. American singer Bill Crofut was performing in Bach's *St. Matthew* Passion with the Munich Bach Choir under Karl Richter, and after-hours one night he joined the production's Jesus, British baritone Benjamin Luxon, for a taste of Munich's finest. When conversation turned to Crofut's career as a folk singer, Luxon confessed to his own great love of folk singing. Out came Bill's banjo, and the duo was born."

The instruments Crofut's friends play here include pennywhistles, mandolin, washboard, train whistle, and, naturally, banjo and 12-string guitar. It all adds up to sheer delight, and of an unusually high musical standard. Playing times: 56:38 (Telarc); 67:08 (Chandos). *Paul Moor*

#### RICHARD STOLTZMAN: *Ebony*.

Stoltzman; *Woody Herman's Thundering Herd*. Leroy Parkins, prod. RCA 6486-2 (D). □ □

STRAVINSKY: *Ebony Concerto*. BERNSTEIN (arr. Bennett): *Stories from the West Side*. COPPOLA-GUARALDI: *Cousins*. DOUGLAS: *Waltz for Woody*. ELLINGTON (arr. Fedchock): *Come Sunday* (from "Black, Brown and Beige"). ODDO: *American Medley*. ROGERS-NORVO: *Igor*.

Igor Stravinsky wrote *Ebony Concerto* in 1945 for Woody Herman's big band. The First Herd, as this group later came to be known, was one of the most extraordinary collections of jazz virtuosos in the business. "Their instrumental mastery was astonishing," Stravinsky recalled in *Dialogues and a Diary*. Stravinsky carefully studied various recordings by the band before composing this, the freshest and most engaging of his various forays into jazz-flavored neoclassicism.

Stravinsky conducted the Herman Herd in the first recording of *Ebony Concerto*, and that performance, originally issued in 1946 as Columbia 7479M, is an invaluable document. To hear Stravinsky's music played by such renowned jazzmen as Herman, Flip Phillips, and Bill Harris is an experience that simply cannot be duplicated by classical players, least of all the underrehearsed pickup group fronted by an anemic-sounding Benny Goodman that Stravinsky conducted in the stereo remake of *Ebony Concerto*, currently available on CBS MK 42227. There have been good recordings of *Ebony Concerto* since 1946, particularly Simon Rattle's recent version with the London Sinfonietta (Angel EMI CDC 47991) and Edo de Waart's 1975 recording with the Netherlands Wind Ensemble, part of a superb collection of Stravinsky's wind music on Philips

that is currently out of print. But Herman's *Ebony Concerto* remains unmatched 40 years later.

Woody Herman himself was, oddly enough, never quite satisfied with his first recording of it, and he was planning to remake the piece at the end of his life, with clarinetist Richard Stoltzman playing the solo part that the aging bandleader could no longer handle. Herman's final illness prevented him from going into the studio with his band for that recording, taped in May 1987 but recently released by RCA as part of an album called, not surprisingly, *Ebony*.

The new performance inevitably sounds a bit bland when compared to the 1946 recording, but it is more than satisfactory in its own right. Herman's last *Thundering Herd* was one of his very best, and Stoltzman, over the last few years, has turned himself into a perfectly respectable imitation of a jazz clarinetist. To hear *Ebony Concerto* played by a working jazz band is a rare treat, and this crisp and convincing recording is full of idiomatic touches that no classical ensemble, however carefully rehearsed, can duplicate.

The rest of *Ebony* is given over to an assortment of charts ranging from a lovely version of Duke Ellington's "Come Sunday," scored by trombonist John Fedchock, to pleasant but undistinguished medleys of patriotic songs ("American Medley") and selections from *West Side Story* (called "Stories from the West Side"). Two interesting remakes of old First Herd recordings are thrown in. The 1945 "Apple Honey" is heard in a slicked-up arrangement by Nat Pierce; "Igor," composed by Shorty Rogers and Red Norvo as a tribute to Stravinsky, is heard in a transcription of the 1946 recording by Herman's Woodchoppers, a nine-piece combo drawn from the ranks of the First Herd. Dick Sudhalter's liner notes are excellent, but RCA didn't bother to list the members of Herman's band—not to mention the harpist and guitarist brought in for *Ebony Concerto*.

Those who want to hear more of Woody Herman's last band should listen to *50th Anniversary Tour* (Concord Jazz CCD 4302) and *Woody's Gold Star* (Concord Jazz CCD 4330). The original "Igor," together with nine other Woodchoppers recordings from 1946, is available on *The Small Groups: New Directions* (CBS CK 44222). The original "Apple Honey," together with 15 other recordings by Herman's First and Second Herds, is available on *The Thundering Herds 1945-1947* (CBS CK 44108). CBS could easily fill another CD with more great recordings by Herman's First Herd—including *Ebony Concerto*. Unfortunately, no such plans have been announced. Playing times: 53:01. *Terry Teachout*

MAIL TO:

#### HIGH FIDELITY SUBSCRIBER SERVICE

P.O. Box 10051 Des Moines, IA 50340-0051

**Change of Address:** Please advise as early as possible. Attach label with your old address and write in new address below.

**New Subscriber:** Fill in your name and address below. Use separate sheet for gift orders.

PLACE LABEL HERE

**Renewal:** Attach label.

..... One year \$13.95 ..... Two years \$26.00  
(Foreign subscribers please add \$7.00 per year for postage)

NAME

STREET

CITY STATE ZIP

..... Please bill me ..... Payment enclosed

For other subscription questions or problems, please write a note and send entire form to the above address.





## MINI-REVIEWS OF THE LATEST COMPACT DISCS

By Robert E. Benson, David Hurwitz, Paul Moor, Robert R. Reilly, Christopher Rothko, Terry Teachout, and James Wierzbicki

### HAYDN SYMPHONIES NOS. 45, 81: ORPHEUS

The Orpheus Chamber Orchestra continues its Haydn symphony series, bringing infectiously high-spirited playing to two more gems: Symphonies Nos. 45, in F sharp minor (*Farewell*), and 81, in G. By not using a conductor, Orpheus avoids the danger of the kind of stop-and-start conducting that can ruin Haydn. The group compensates with its sure conception of the whole of each movement and the marvelous energy and flow of its playing. This is what music sounds like when musicians listen to each other. If you like Haydn with rhythmic bounce, precise ensemble, and sheer joie de vivre, this is it. The recording is nicely balanced, with beautiful sound and detail. Playing time: 50:13. (Deutsche Grammophon 423 376-2.) R.R.R.

### STRAUSS "FOUR LAST SONGS," OPERA EXCERPTS: SCHWARZKOPF

Richard Strauss's *Four Last Songs* have achieved remarkable popularity in the past decade, and there are currently at least ten CD versions available. For many listeners, however, the definitive recorded account remains this one, from 1953, by Elisabeth Schwarzkopf with Otto Ackermann and the Philharmonia Orchestra. Schwarzkopf was at her best in this recording, both vocally and interpretively. Her singing here has a relaxed but youthful intensity and remarkable control, and she steers clear of the archness that crept into many of her later performances. Also included is Schwarzkopf's glowing account of the final scene from *Capriccio*, in which the Countess questions which is more important, words or music. This probably was the catalyst for her complete recording of the opera several years later (recently reissued on Angel EMI CDCB 49014, two CDs).

To fill out the disc, EMI has included almost all of the *Arabella* highlights Schwarzkopf recorded in 1954 with Josef Metternich as Mandryka, Anny Felbermayer as Zdenka, and Lovro von Matačić conducting the Philharmonia. It is unfortunate that no texts are provided. Playing time: 68:05. (Angel EMI CDH 61001.)

Schwarzkopf admirers will also wish to have her 1966 stereo recording of the *Four Last Songs* with George Szell, generously coupled with a dozen other Strauss songs (Angel EMI CDC 47276.) R.E.B.

### BRAHMS, SCHUMANN WORKS: SHIFRIN, ROSENBERGER

The emotive and—to a large extent—stylistic compatibility of the pair of sonatas that Johannes Brahms wrote in 1894 for clarinet and piano and the three *Fantasy Pieces*, Op. 73, that Robert Schumann produced for the same combination almost 50 years earlier is reason enough to link these compositions on this disc. But the works also have in common their presence on the program of a private concert given when Brahms's Opus 120 sonatas existed only in manuscript.

Accordingly, Delos's "Brahms/Schumann Soirée" is billed as a re-creation of the musicale hosted by Schumann's widow, Clara, at her Frankfurt home on November 13, 1894. David Shifrin takes the role of Richard Mühlfeld, the Meiningen clarinetist for whom Brahms wrote not only the masterly sonatas but also the Opus 114 Trio and the Opus 115 Quintet; pianist Carol Rosenberger doubles as Brahms, who partnered Mühlfeld in the sonatas, and as Clara, who served as accompanist in the alternately stormy and pastoral music of her late husband. The album's premise is charming, and Shifrin's and Rosenberger's performances (recorded in the warm space of a California high-school auditorium) are absolutely superb. Playing time: 56:01. (Delos DCD 3025.)

J.W.

### DEBUSSY, PROKOFIEV, SCRIBIN PIANO MUSIC: RICHTER

Sviatoslav Richter has always hated studio recording, and Deutsche Grammophon accommodated him by recording most of the works in this midprice compilation in actual recital. His excellent accounts of Debussy's *Estampes*, three selections from Prokofiev's *Visions fugitives*, and Scriabin's Sonata No. 5, Op. 53, capture the tension and electricity of live performances, but some curious noise mars the start of the *Visions* excerpts, and at other points the audience's thoughtless coughing makes you think he must have recorded these pieces in the good old U.S.A. The slow movement of Prokofiev's Eighth Sonata, Op. 84—one of the studio efforts on this disc—has always struck me as the closest this composer ever came to "salon music" kitsch, even when trying to appease Stalin's cultural hatchet man, Andrei Zhdanov, but Richter's majestic real-

ization of it here forces me to revise my opinion. His performances of *Estampes*, three pieces from Debussy's first book of *Préludes*, and especially the Scriabin sonata set standards lesser pianists can only yearn for.

DG's generous leaflet provides one article in German and English, plus another in French and yet another in Italian. Playing time: 67:19. (Deutsche Grammophon 423 573-2.) P.M.

### WARD SYMPHONIC WORKS: NORTH CAROLINA, ZIMMERMANN

This collection, on the innovative Albany label, spans 35 years in the career of Robert Ward (b. 1917) and was produced under the supervision of the composer, a former student of Howard Hanson, Frederick Jacobi, and Aaron Copland. The *Jubilation Overture* (1945) helped to put Ward on the map and was noted at the time of its composition for its successful integration of jazz elements and popular dance rhythms—though these sound quite tame to today's ears. It is a well-crafted, energetic piece. The Symphony No. 4 (1958) is another attractive example of mainstream American symphonic writing of the tonal variety. It exudes the bold confidence, big themes, lively rhythms, and optimism heard in so many post-World War II compositions of the Prairie Romantic school, before so many American composers were persuaded to incorporate German angst in their works.

One can hear that Ward has kept to the same idiom, without a great deal of development, in the more recent pieces on the disc: the Concerto for Saxophone (1983) and *Sonic Structure* (1980). I find the concerto's evocation of the swing-band era a bit too heavy on nostalgia, though the solo part is beautifully played by James Houlik. The program is well performed by the North Carolina Symphony Orchestra, conducted by Gerhardt Zimmermann. The sound is excellent. Playing time: 53:24. (Albany AR 001. Dist. by Classical Music, Inc.) R.R.R.

### BACH "GOLDBERG VARIATIONS": KOOPMAN

Ton Koopman's new account of the *Goldberg Variations* gets off to a rather shaky start. The opening aria is taken slowly and somewhat hesitantly, which results in so many short phrases that the movement be-

comes a series of individual thoughts, with little sense of continuity. Koopman seems to forget that it is an *aria*—his reading possesses neither grace nor a singing quality. The first variation comes as a stark contrast, coupling blazing speed and rhythmic rigidity and leaving a rather unpleasant impression. As the variations proceed, the harpsichordist seems to settle down, more often finding the *tempo giusto*, while better weaving his insights into the fabric of the piece. Characteristically, Koopman ornaments heavily, and to good effect—which helps to heighten the differences between variations and lends his playing an improvisatory sense.

Taken as a whole, this is a very “public” performance, with plenty of poise and bravura but little warmth, affection, or reflectiveness. The interpretation does not lack intellectual rigor, yet one misses the more meditative approach of a Kenneth Gilbert or Gustav Leonhardt. Koopman’s harpsichord is an excellent modern copy, beautifully captured by Erato, although the image is a bit larger than life. Playing time: 62:22. (RCA Erato ECD 75472.) C.R.

#### **BARTÓK ORCHESTRAL SUITES: FERENCSIK, ERDÉLYI**

Bartók’s early Suite No. 1, Op. 3, for full orchestra, and Suite No. 2, Op. 4, for small orchestra, deserve more attention than they currently get. When was the last time a major orchestra programmed one of them? Though certainly not written in the composer’s mature style, they are full of great tunes, evocative orchestral colors, and a rhythmic vitality that clearly foreshadows the masterful achievements to come. How sad, then, that Hungaroton’s generous coupling—both suites on one CD—can’t be recommended.

In the First Suite, performed by the Hungarian State Orchestra, conductor János Ferencsik makes several huge cuts. Admittedly, the work may be long for its material, but even the young Bartók was too good a composer for this treatment; each listener should have a chance to get to know this music on its own terms. The Second Suite suffers from the Budapest Symphony’s dull playing and Miklós Erdélyi’s uninspired conducting. Both suites are quite difficult technically and require virtuoso playing in order to succeed. Hungaroton’s lackluster recording does nothing to promote the cause. Playing time: 69:36. (Hungaroton HCD 31045. Dist. by Qualiton Imports, Ltd.) D.H.

#### **LJUBA WELITSCH: OPERA ARIAS**

This is a valuable, if rather frustrating, issue. It offers *almost* all of the stunning Bulgarian-born soprano’s EMI recordings—arias from *Eugene Onegin*, *Aida*,

*Tosca*, and more, all dating from 1947 and 1948, a period when she was at her zenith—as well as a magnificent interpretation of the final scene from *Salome*, the opera for which she is best known, taken from a 1944 Austrian radio broadcast. All of these selections capture the essence of Welitsch: the security and thrusting ease of her vocal production, the accuracy and purity of her sound. If there is a better performance of Tatiana’s Letter Scene from *Onegin*, I’ve not heard it. Welitsch’s *Salome* finale is perhaps definitive, and even with its dated monophonic sound, the performance is sufficiently well conveyed to display operatic characterization at its finest. Welitsch first sang *Salome*—at Richard Strauss’s suggestion and under his direction—in the same year that the broadcast included here was made, so this account is doubtless representative of what the composer himself heard and enthusiastically endorsed. The innocent quality of the interpretation is far removed from the Wagnerian masses of sound of some other sopranos who have attempted this role, yet Welitsch still has plenty of power for the dramatic climaxes.

The disappointing aspect of this CD is what it does *not* include. In 1948, Welitsch recorded the *Salome* finale with Herbert von Karajan and the Vienna Philharmonic. The master of the second of the four 78-rpm sides was damaged, and the release of the recording was delayed until it appeared on a World Records LP (SH 286), now out of print. This historic and quite fabulous performance easily would have fit onto this CD. Anyone interested in either Welitsch or *Salome* surely would not mind having two versions of the final scene, even if one is incomplete. This mid-price CD offers a brief appreciation of the singer by Alan Blyth, which her admirers will enjoy, but it is unfortunate that no texts are provided. Playing time: 52:28. (Angel EMI CDH 61007.) R.E.B.

#### **SUSATO “DANSERYE 1551”: CAMERATA HUNGARICA, CZIDRA**

“Danserye,” in old Flemish, simply means dance music; the original, rather prolix title of the publication that yielded these pieces translates as “Third Little Music Book made in its entirety in our Netherlandish language, in which are included all kinds of dance music.” Tylman Susato, who lived in Antwerp, published that work (mostly a collection of his arrangements of *basses danses*, *rondes*, *allemandes*, *pavanes*, and *galliards*) in 1551. The only complete copy, the property of Berlin’s Deutsche Staatsbibliothek, disappeared in the course of World War II, but single-part scores survived in Munich and in The Hague.

The 31 selections recorded here, in arrangements by conductor László Czidra

and Gergely Sárközy, range in length from less than a minute to not quite three. Some of the more vivacious numbers, particularly those with an anapestic drumbeat ostinato, sound surprisingly like the Provençal music recorded by the late David Munrow’s Early Music Consort of London. The five singers and 13 instrumentalists who compose the Camerata Hungarica employ lutes and viols plus chalumeau, crumhorn, shawm, and curtals, and they play with unflagging vigor and conviction. Playing time: 52:00. (Hungaroton HCD 12194. Dist. by Qualiton Imports, Ltd.) P.M.

#### **PURCELL “AYRES FOR THE THEATRE”: PARLEY OF INSTRUMENTS**

The Parley of Instruments, a British original-instruments ensemble led by Peter Holman, has recorded a delightful selection of Purcell’s theater music for Hyperion, England’s most imaginative small record label. Suites from *The Virtuoso Wife*, *Bonduca*, *The Gordian Knot Unty’d*, and *Abdelazer* and two items from *Timon of Athens* are included, and the Chacony in G minor is thrown in for good measure. This music is likely to be unfamiliar to the average listener, with the exception of the “Rondeau” from *Abdelazer*, which Benjamin Britten used as the theme of his *Young Person’s Guide to the Orchestra*. The Parley of Instruments plays all of it with gusto. Very highly recommended, not least for Peter Holman’s fine liner notes. Playing time: 58:46. (Hyperion CDA 66212. Dist. by Harmonia Mundi, U.S.A.) T.T.

#### **“ITALIAN BEGGARS’ SONGS”: SALVATORE**

Not only ethnomusicologists will find this collection irresistible. All 14 songs come from the southern Italian province of Apulia. There, father has handed them down to son for at least seven centuries; Matteo Salvatore, born into poverty in 1925, started learning them at the age of seven from a blind fiddler, who wound up tutoring him for the next 14 years. Salvatore’s own story, told all too briefly in the leaflet, alone almost justifies buying this delicious, earthy disc. As you would expect, he sings the songs colloquially, and at least partially in dialect, accompanying himself on the guitar. Unfortunately, the leaflet fails to provide texts, or even summaries, but Salvatore has pellucid diction, and with even the smallest smattering of Italian you will discern the fishmonger extolling his wares, the socialist sympathizer twitting the fascists, and so on. Even if you understand not a word of Italian, but love the country and its authentic folk music, don’t fail to look into this one. Playing time: 38:10. (Harmonia Mundi France HMA 190434. Dist. by Harmonia Mundi, U.S.A.) P.M.

# INTRODUCING

## FAIRGROUND ATTRACTION: The First of a Million Kisses.

● *Fairground Attraction and Kevin Moloney, prods. RCA 8596-2.* ◻ ◻

## COWBOY JUNKIES: The Trinity Session.

● *Peter Moore, prod. RCA 8568-2.* ◻ ◻

Though Fairground Attraction's upbeat, moonstruck ditties and Cowboy Junkies' post-catharsis, sensual whisperings are emotionally poles apart, the two groups do share common points: distinctive femme lead singers and a few-frills instrumentation and sound that serves as a calculated alternative to the high-gloss, machine-driven formula of contempo pop/rock.

Fairground Attraction, a British band making its American debut, takes a neo-skiffle approach (brushes on the drum, acoustic bass), with rockabilly, blues, and pure pop making up the melodic mix. Lead singer Eddi Reader and guitarist/songwriter Mark E. Nevin combine their feelgood talents to hit and maintain a lightly pleasurable groove throughout. The first U.K. hit, "Perfect," sums up their knack: shameless enough to put fingersnappin' on the last verse, clever enough to get away with it. Reader's Maria Muldaurisms and Nevin's lyrics can get a little cutesy, but hey, lighten up. Put this on the don't-worry/be-happy pile.

Meanwhile, the Canadian group Cowboy Junkies, whose second indie album

has just become their first major-label release, are working the other side of the street, where disillusionment has turned to lassitude and the best one can do is to sigh or die. Their sound manages to be both big and soft; pulsing, dark, it spreads into the surrounding silence. It's a subtle texture best heard on Compact Disc, through headphones, lights dimmed. (Both of these CDs offer two non-LP cuts, another reason to pick the digital format.) Lead singer Margo Timmins's vocals contrive to become part of this airy web, and the group's mod world-weariness combined with its solid c&w and blues roots make this an engrossing and singular project. If you don't fall asleep halfway through the disc (not from boredom but empathy), you'll be rewarded with a gentle but effective version of Lou Reed's "Sweet Jane," as well as a handful of inconsolable originals by Margo and her brother, group guitarist Michael Timmins. Put this on the sweet misery pile.

*Richard C. Walls*

## CROSBY, STILLS, NASH & YOUNG: American Dream.

● *Niko Bolas and Crosby, Stills, Nash & Young, prods. Atlantic 81888-2.* ◻ ◻

*American Dream* is the sound of four middle-aged men groveling for common ground after years of wasted talent, slack records, chemical indulgence, and general

laziness. Hardly the scenario for an uplifting rock 'n' roll album, but that's the last adjective you could associate with Crosby, Stills, Nash & Young's belated follow-up to 1970's *Déjà Vu*. The voices alone tell the story: Although Neil Young's tenor remains ragged but right, David Crosby's is shockingly deep, Stephen Stills's has been reduced to a croak, and Graham Nash's has gone thin and reedy. Considering the group's sad history, a line in Young's non-descript title track—"How could something so good go bad so fast?"—applies as much to his bandmates as to the likes of targets Gary Hart, Oliver North, and Jimmy Swaggart.

Some things never change, though. *American Dream* still sounds like the work of four disparate men with very divergent styles of singing and writing. Crosby contributes a meandering ballad about his lost weekends ("Compass") and a strident Down-with-the-CIA rocker ("Nighttime for the Generals"). As always, Stills's songs—robustly produced tunes like "That Girl" and "Got It Made" (shades of Fleetwood Mac's "Dreams")—actually have pop hooks, but they also have embarrassingly little to say, especially the lame-brained car song "Drivin' Thunder." Nash's songs about ecology, "soldiers of peace," and that special someone ap-

*(Continued on page 68)*

*Fairground Attraction*

*Cowboy Junkies*





### Cassette Decks



**Teac V-285CHX Stereo Cassette Deck**  
 • Dolby B & C • Dolby HX Pro headroom extension system • Two tape head design • DC motor • Tape bias control • Black finish

Sale Price **\$99<sup>95</sup>** Retail \$160

**Teac R435X**  
Auto Reverse Dolby B/C and dbx **\$149<sup>95</sup>**

**Technics RSB29R**  
Auto Reverse Dolby B/C, Music select **\$189<sup>95</sup>**

**Teac V770 3-Head**  
Tape monitoring, Dolby B/C/HX Pro **\$269<sup>95</sup>**

**Teac V570**  
Dolby B/C/HX Pro 2-motor/head **\$219<sup>95</sup>**

**Teac R616X**  
Auto Reverse Dolby B/C/HX Pro, dbx **\$299<sup>95</sup>**

**Teac R919X**  
A/R, 3-head/motor, Dolby B/C/HX Pro **\$499<sup>95</sup>**

### Double Cassette Decks



**Teac W-660R Double Auto Reverse Cassette Deck**  
 • Dolby B and C • One touch high speed cassette dubbing • Continuous play • Memory play/search/dubbing • Full logic control • Black

Sale Price **\$299<sup>95</sup>** Retail \$519

**Teac W350C**  
High Speed Dolby B, 8-ls fine tuning **\$99<sup>95</sup>**

**Sherwood S289DR**  
Double auto reverse, Dolby B/C **\$199<sup>95</sup>**

**Technics RST80R**  
Auto reverse, Dolby B/C, dbx **\$459<sup>95</sup>**

**Technics RST230**  
Dolby B/C Feather touch logic transport **\$179<sup>95</sup>**

**Sharp RTW800**  
Hi-Speed Dual auto reverse, Dolby B **\$159<sup>95</sup>**

**Teac W990RX**  
Remote, Dolby B/C, dbx, 3-motor **\$499<sup>95</sup>**

### Compact Disc Players



**ADC CD16.2R Remote Control Compact Disc Player**  
 • Look at these features! • 3-beam laser • 16 track programming • Convenient wireless remote • Advance error correction • Black finish

Sale Price **\$149<sup>95</sup>** Retail \$329

**Sharp DX650**  
3-beam, 20-track prog, 2x oversampling **\$117<sup>95</sup>**

**Teac PD425**  
Remote, 3-beam, 15 track memory **\$159<sup>95</sup>**

**Technics SLP230**  
16-bit 4x oversampling, Dual D/A's **\$199<sup>95</sup>**

**Technics SLP350**  
18-bit 4x oversampling, CD edit & peak **\$259<sup>95</sup>**

**Teac PD450**  
Remote 16-bit 20-track memory **\$174<sup>95</sup>**

**Technics SLP400C**  
Changer 6-disc magazine, remote **\$269<sup>95</sup>**

## This Month's

### LP/Cassette/CD Specials

#### THE CHESS BOX

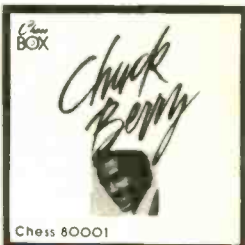

Chess 80001

**35<sup>99</sup>** 3 CD Set **29<sup>99</sup>** 6 LP or Cassette Set

### More CD Specials



**Teac AD-4 CD Player/Cassette Deck Combo**  
 • Wireless remote control of both CD & cassette sections • 16-track random program dubbing & play • Dolby B & C • Auto reverse record/play • Synchro start dubbing

Sale Price **\$279<sup>95</sup>** Retail \$599

**Teac PD500M**  
6 disc changer, remote, 32 track prog **\$239<sup>95</sup>**

**Magnavox CDB582 NEW**  
Dual 16-bit D/A's, 20 track prog **\$199<sup>95</sup>**

**Teac AD7**  
Powerful remote cassette/CD combo **\$399<sup>95</sup>**

**Nikko CD500**  
Direct access remote **\$199<sup>95</sup>**

**Shure D6000 "Ultra"**  
16-bit dual D/A's, 2x oversampling **\$249<sup>95</sup>**

**Technics SLP150**  
4x oversampling, dual D/A's, 20-track **\$174<sup>95</sup>**

### Receivers



**Sherwood S-2770CP-II Remote Control Audio/Video Receiver**  
 • 70 watts RMS per channel • 7-band equalizer • 2 video inputs • Surround sound circuit • Spectrum analyzer display • 16-preset digital AM/FM tuner • Black

Sale Price **\$249<sup>95</sup>** Retail \$500

**JVC RX950VBK**  
120 watts/channel, remote, A/V inputs **\$449<sup>95</sup>**

**Harman Kardon HK795I**  
70 watts/channel, ultrawideband amp **\$449<sup>95</sup>**

**Technics SA130**  
Analog, 35 watts/ch, speaker A/B **\$89<sup>95</sup>**

**Technics SA290**  
Digital 50 watts/channel, 16 presets **\$149<sup>95</sup>**

**Sherwood S2730CP**  
Surround A/V features, 35 watts/ch **\$119<sup>95</sup>**

**Sherwood S2750CP**  
Digital A/V surround system, 55 watts/ch **\$149<sup>95</sup>**

### Speakers



**The Bose Acoustimass AM-5 Speaker System**  
 • A new technology for the home • Clean sound & low distortion system contains 2 miniature satellites & 1 sub-w/ce/ter for big sound in a small package • Black satin finish

Sale Price **\$699<sup>95</sup>** Retail \$799

**Bose 101**  
High quality sound, black **\$179<sup>95</sup>**

**Pinnacle PN+**  
2-way 5.25" woofer, 50 watts **\$139<sup>95</sup>**

**Technics SBL36**  
10" woofer, 2" tweeter, 100 watts **\$99<sup>95</sup>**

**Technics SBL56**  
10" woofer, 4" midrange, 2" tweeter **\$149<sup>95</sup>**

**Bose RM2 RoomMate II**  
Built-in amps & active EQ **\$299<sup>95</sup>**

**BSR 82**  
8" system with 2" tweeter, w/ctrl **\$69<sup>95</sup>**



Chess 16500

**20<sup>99</sup>** 2 CD Set **14<sup>99</sup>** 3 LP or Cassette Set

### Portables



**Sharp QT-CD20 Portable AM/FM/Cassette/CD Player**  
 • Big sound from a compact system • 20 track programmable CD player • 3-band graphic equalizer • Easy CD to cassette dubbing • 10 watt output

Sale Price **\$199<sup>95</sup>** Retail \$339

**Sony WM-AF64 Megabass**  
AM/FM/auto reverse cassette walkman **\$99<sup>95</sup>**

**Panasonic RXSR39**  
AM/FM/cassette stereo-to-go recorder **\$89<sup>95</sup>**

**Toshiba KT4568**  
Digital AM/FM/auto rev. cassette **\$119<sup>95</sup>**

**Technics SLXP6**  
CD Player, ultra compact **\$279<sup>95</sup>**

**Sharp JC130**  
Portable AM/FM cassette, black **\$19<sup>95</sup>**

**Sony CFSW501**  
Double cassette, AM/FM, 5-band EQ **\$139<sup>95</sup>**

### Audio Add-Ons



**Terk FM-8500 Electronic Indoor FM Antenna**  
 • Omnidirectional design improves reception • Adjustable gain control • Amplifies incoming signal by up to 24 times • AC operated • 1-year warranty

Sale Price **\$34<sup>95</sup>** Retail \$89

**Terk 9500**  
FM Antenna Electronic 24db gain **\$49<sup>95</sup>**

**Nikko CO23**  
2-way stereo, 3-way mono, Crossover **\$249<sup>95</sup>**

**Terk 9600**  
FM Antenna 30db adjustable gain, white **\$79<sup>95</sup>**

**dbx 200XG**  
Controls 3-processors, 3 decks & NR **\$79<sup>95</sup>**

**Parsec L54**  
FM Antenna, 32db gain, great FM **\$49<sup>95</sup>**

**dbx 18XDS**  
Expander/compressor **\$179<sup>95</sup>**

### Turntables



**Dual CS-2110A Belt Drive Turntable**  
 • Convenient semi-automatic, auto return operation featuring easy-to-use top-mounted controls • Hinged dust cover • European styling

Sale Price **\$99<sup>95</sup>** Retail \$189

**Dual CS505-3**  
Semi-auto, belt drive, heavy platter **\$249<sup>95</sup>**

**Technics SLQD22**  
Quartz direct drive, accept I-mount **\$119<sup>95</sup>**

**Technics SLBD22**  
Belt drive, semi-auto, pitch & strobe **\$89<sup>95</sup>**

**Dual CS5000/X3MC**  
Turntable with Ortofon X3MC cart **\$449<sup>95</sup>**

**ADC LT34**  
Full auto, belt drive, linear tracking **\$69<sup>95</sup>**

**Technics SLJ33**  
Auto Convenient LP jacket set **\$179<sup>95</sup>**

### Cartridges



**Shure V-15 Type V-MR Deluxe Micro Ridge Phono Cartridge**  
 • Micro ridge stylus tip • Excellent trackability • Dynamic stabilizer • Side-guard stylus protection • Duo-point alignment gauge

Sale Price **\$129<sup>95</sup>** Retail \$299

**Shure V15-Type IV MR**  
Hyperelliptical stylus, standard mount **\$69<sup>95</sup>**

**Shure M111HE**  
Universal Hyperelliptical stylus **\$49<sup>95</sup>**

**Audio Technica AT231LP**  
Universal mount, linear contact stylus **\$39<sup>95</sup>**

**Audio Technica AT221EP**  
Universal mount, bi-radial stylus **\$29<sup>95</sup>**

**Audio Technica AT152MLP**  
P.Mount, square-shank microline stylus **\$99<sup>95</sup>**

**Shure V15HRP**  
P.Mount New hyper-ridge stylus **\$49<sup>95</sup>**



# MUSIC WORLD

## Super Specials

### VHS Video Movie Specials

Box Office Hits From Paramount



Your Choice  
**18<sup>95</sup>** Each



- Also Available...
- Beverly Hills Cop
  - Children Of A Lesser God
  - Crocodile Dundee
  - Indiana Jones
  - The Jazz Singer
  - Raiders Of The Lost Ark

### Amplifiers/Tuners



**Nikko Alpha-230**  
Professional Power Amplifier  
• 120 watts RMS per channel • High speed, non-switching design • A/B speaker selector • LED power display • 19" rack mountable

- |                      |                                      |                           |       |
|----------------------|--------------------------------------|---------------------------|-------|
| Sale Price           | <b>\$349<sup>95</sup></b>            | Retail                    | \$499 |
| <b>Nikko NA1050</b>  | Integrated 105 watts/channel, black  | <b>\$229<sup>95</sup></b> |       |
| <b>Nikko Gamma30</b> | AM/FM Tuner Quartz lock, 14 presets  | <b>\$179<sup>95</sup></b> |       |
| <b>SAE T101</b>      | AM/FM Tuner, Fully electronic,       | <b>\$249<sup>95</sup></b> |       |
| <b>Nikko A130</b>    | 100 watts/channel, rack mount        | <b>\$249<sup>95</sup></b> |       |
| <b>Nikko A450</b>    | 220 watts/channel, Non-switching amp | <b>\$499<sup>95</sup></b> |       |
| <b>Nikko NT950</b>   | AM/FM Tuner Quartz lock, 20 presets  | <b>\$159<sup>95</sup></b> |       |

### DJ Equipment

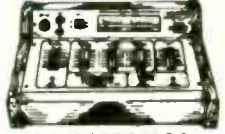

**Gemini MX-4200**  
Disco Mixer with Echo  
• Features • 3-phono inputs • 3-line Separate faders inputs • 1-microphone input • Peck reading VU meters • Echo mixing • Black finish

- |                        |   |                           |       |
|------------------------|---|---------------------------|-------|
| Sale Price             | <b>\$109<sup>95</sup></b>               | Retail                    | \$139 |
| <b>Atus AM100</b>      | Disco Mixer 2-phono & 2-aux inputs      | <b>\$79<sup>95</sup></b>  |       |
| <b>Gemini DJQ1500</b>  | Direct drive, manual turntable          | <b>\$259<sup>95</sup></b> |       |
| <b>Stanton 8BOEL</b>   | DJ Cartridge Standard mount, elliptical | <b>\$54<sup>95</sup></b>  |       |
| <b>Stanton 500AL</b>   | DJ Cartridge Standard mount, spherical  | <b>\$19<sup>95</sup></b>  |       |
| <b>Stanton 890AL</b>   | High performance elliptical cartridge   | <b>\$64<sup>95</sup></b>  |       |
| <b>Pickering 625DJ</b> | Standard mount, elliptical stylus       | <b>\$29<sup>95</sup></b>  |       |

### Equalizers



**ADC SS-525X**  
Computerized Graphic Equalizer  
• 12 bands per channel • Automatic room/speaker flat equalization • Wireless remote • Analyzer/EQ display • Pink noise generator • Microphone • Black finish

- |                        |                                  |                           |       |
|------------------------|----------------------------------|---------------------------|-------|
| Sale Price             | <b>\$349<sup>95</sup></b>        | Retail                    | \$599 |
| <b>Nikko EQ30 Pro</b>  | 1/3 Octave 3-band single channel | <b>\$229<sup>95</sup></b> |       |
| <b>Teac EQA5</b>       | 10 Band/Channel LED display      | <b>\$69<sup>95</sup></b>  |       |
| <b>Teac EQA30</b>      | EQ/Analyzer 10 bands/channel     | <b>\$199<sup>95</sup></b> |       |
| <b>ADC SS300SL</b>     | EQ/Analyzer 10 bands/channel     | <b>\$159<sup>95</sup></b> |       |
| <b>AudioSource EQ8</b> | 10-Band LED Illuminated sliders  | <b>\$99<sup>95</sup></b>  |       |
| <b>ADC SS325X</b>      | 12 band/channel, 5 memories      | <b>\$269<sup>95</sup></b> |       |

### Video Specials



**Akai VS-565U**  
Audio/Video HiFi Video Recorder  
• DX4 head system • HQ circuitry • MTS stereo cable ready tuner • Remote control • On-screen programming & displays • 10 watt stereo amp built-in • 14 day/6 event

- |                                |   |                           |       |
|--------------------------------|---|---------------------------|-------|
| Sale Price                     | <b>\$449<sup>95</sup></b>                   | Retail                    | \$649 |
| <b>Sony KV27SXRI0</b>          | 27" Stereo XBR monitor/receiver, MTS        | <b>CALL</b>               |       |
| <b>JVC HRS8000U S-VHS</b>      | Top-Of-The-Line, digital effects, HiFi, MTS | <b>CALL</b>               |       |
| <b>Toshiba SV970 S-VHS</b>     | 4-head, MTS, HiFi stereo, digital effects   | <b>CALL</b>               |       |
| <b>Samsung VR2000</b>          | VHS HQ Cable ready, 14 day/4 event          | <b>\$229<sup>95</sup></b> |       |
| <b>Parasonic PVS4864 S-VHS</b> | MTS stereo tuner, HiFi, bar code            | <b>CALL</b>               |       |
| <b>Parasonic PVS445 S-VHS</b>  | Super-VHS camcorder, 8:1 power zoom         | <b>CALL</b>               |       |

### Scanners/Radar

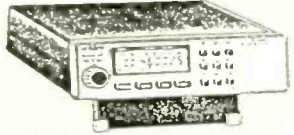

**Uniden Bearcat 550XLT**  
Mobile Scanner  
• Exciting 10-band radio scanning on the road • 16 programmable channels • Weather search • Direct channel access • Frequency review key • Mobile mounting bracket

- |                              |   |                           |       |
|------------------------------|---|---------------------------|-------|
| Sale Price                   | <b>\$114<sup>95</sup></b>               | Retail                    | \$199 |
| <b>Uniden Bearcat 760XLT</b> | Hand-held 10-band prog scanner          | <b>\$288<sup>95</sup></b> |       |
| <b>Uniden RD9 Radar</b>      | Ultra compact, superheterodyne          | <b>\$122<sup>95</sup></b> |       |
| <b>Whistler Spectrum 2</b>   | Triple conversion, variable filter, LED | <b>\$174<sup>95</sup></b> |       |
| <b>Cobra RD3170 Talking</b>  | Record your own message, X&K band       | <b>\$168<sup>95</sup></b> |       |
| <b>Cobra RD3120 Radar</b>    | X&K band dual A/V alarms, compact       | <b>\$109<sup>95</sup></b> |       |
| <b>Bel 976 "Vector 3"</b>    | X/K/Xa band, GaAs diodes, visor/dash    | <b>\$166<sup>95</sup></b> |       |

### Musical Instruments



**Casio DH-100**  
Digital Horn  
• An all-new wind instrument featuring 6 preset tones, portamento effect and a built-in speaker • MIDI output • Key transpose • Requires 5 AA batteries

- |                             |  |                           |       |
|-----------------------------|--|---------------------------|-------|
| Sale Price                  | <b>\$99<sup>95</sup></b>                 | Retail                    | \$149 |
| <b>Yamaha DD5 Drum Pads</b> | Electronic, 30 presets, MIDI in/out      | <b>\$99<sup>95</sup></b>  |       |
| <b>Yamaha PSS130</b>        | Mini Keyboard 32 keys                    | <b>\$34<sup>95</sup></b>  |       |
| <b>Yamaha PSS140 MIDI</b>   | 100 presets sounds, 5 drum pads, 37-keys | <b>\$72<sup>95</sup></b>  |       |
| <b>Casio DG20 Guitar</b>    | 20 sounds, 4 drum pads, MIDI             | <b>\$284<sup>95</sup></b> |       |
| <b>Casio CT6000</b>         | 61 key full size, 20 sounds              | <b>\$349<sup>95</sup></b> |       |
| <b>Yamaha PSS480 MIDI</b>   | 49 keys, 100 sounds/rhythms              | <b>\$149<sup>95</sup></b> |       |

### Headphones



**Beyerdynamic DT990**  
Pro Stereo Headphones  
• Open air style headphone with unbelievable wide dynamic driver • Excellent transient and frequency response • Unique moving coil assembly

- |                               |  |                           |       |
|-------------------------------|--|---------------------------|-------|
| Sale Price                    | <b>\$199<sup>95</sup></b>                | Retail                    | \$220 |
| <b>Koss Pro4AAA+</b>          | Digital ready, closed ear comfort        | <b>\$38<sup>95</sup></b>  |       |
| <b>Sennheiser HD250</b>       | Digital ready closed ear design          | <b>\$149<sup>95</sup></b> |       |
| <b>Sennheiser HD480</b>       | Digital Open air dynamic design          | <b>\$69<sup>95</sup></b>  |       |
| <b>Beyer DT880-STUDIO Pro</b> | For the true audiophile                  | <b>\$184<sup>95</sup></b> |       |
| <b>Sony MDRV6</b>             | Digital ready closed ear monitor drivers | <b>\$74<sup>95</sup></b>  |       |
| <b>Koss Pro450</b>            | Dual Driver Dynamic closed ear design    | <b>\$138<sup>95</sup></b> |       |

### Auto Accessories



**Monster Cable Zapit**  
Optical Remote Control Power Booster  
• Mounts on the front of any remote control • Powerful Infrared light amplifier • Special multiple lens system • Tilt operation slants control for easy view of buttons

- |                                   |  |                          |      |
|-----------------------------------|--|--------------------------|------|
| Sale Price                        | <b>\$19<sup>95</sup></b>                 | Retail                   | \$30 |
| <b>AudioSource LLC1 Cleaner</b>   | Actually cleans your CD player's laser   | <b>\$24<sup>95</sup></b> |      |
| <b>Discwasher Diskit</b>          | Record/stylus cleaners, Zerostat, case   | <b>\$31<sup>95</sup></b> |      |
| <b>Audioquest Sorbothane Feet</b> | Improves isolation, 4-pack               | <b>\$34<sup>95</sup></b> |      |
| <b>Naiaid RF2</b>                 | Stackable record cabinet, hold 65 LPs    | <b>\$17<sup>95</sup></b> |      |
| <b>Naiaid CD2</b>                 | All wood construction, stackable, 65 CDs | <b>\$17<sup>95</sup></b> |      |
| <b>Memorex CS40</b>               | Cordless operation of headphones         | <b>\$68<sup>95</sup></b> |      |

### Blank Tape



**Maxell XLII-100**  
Audiophile High Bias Cassette Tape  
• 100 minutes for extended length and compact disc recording • New resonance-proof cassette mechanism for improved performance

- |                       |                                    |                         |      |
|-----------------------|------------------------------------|-------------------------|------|
| Sale Price            | <b>\$24<sup>95</sup></b>           | Retail                  | \$30 |
| <b>Sony UMPRO60</b>   | High Bias Special purchase         | <b>18<sup>95</sup></b>  |      |
| <b>Sony Metal90</b>   | Perfect for live & digital sources | <b>34<sup>95</sup></b>  |      |
| <b>TDK SD90</b>       | New high bias dynamic cassette     | <b>13<sup>95</sup></b>  |      |
| <b>Fuji FRMETAL90</b> | Wide range, ultra low noise        | <b>21<sup>95</sup></b>  |      |
| <b>Maxell XLII590</b> | The premier high bias cassette     | <b>22<sup>95</sup></b>  |      |
| <b>TDK MAXG90</b>     | Metal bias, precision metal shell  | <b>\$5<sup>95</sup></b> |      |



### FREE CATALOGUE

For a FREE catalogue call toll-free 800-426-6027, or Write: J&R Music World, Department HFO289, 59-50 Queens-Midtown Expressway, Maspeth, NY 11378.

Name \_\_\_\_\_

Address \_\_\_\_\_

City \_\_\_\_\_ State \_\_\_\_\_ Zip \_\_\_\_\_

TO ORDER BY MAIL: SEND MONEY ORDER, CERTIFIED OR CASHIER'S CHECK, MASTERCARD, VISA, AMERICAN EXPRESS or DISCOVER CARD (Include Interbank No, expiration date and signature) TO: J&R MUSIC WORLD, DEPT. HFO289, 59-50 QUEENS-MIDTOWN EXPRESSWAY, MASPETH, QUEENS, NY 11378. Personal and business checks must clear our Authorization Center before processing. Shipping, Handling & Insurance Charge is 5% of Total Order with a \$4.95 minimum. (Canadian Orders Add 15% Shipping, with a \$9.95 minimum charge.) For shipments by air, please double these charges. \$25 MINIMUM ORDER. DO NOT SEND CASH. SORRY, NO C.O.D.'s. NEW YORK RESIDENTS PLEASE ADD SALES TAX. WE ARE NOT RESPONSIBLE FOR TYPOGRAPHICAL ERRORS. ALL PICTURES SHOWN FOR VISUAL REPRESENTATION ONLY. ALL MERCHANDISE SHIPPED BRAND NEW, FACTORY FRESH, AND 100% GUARANTEED.





CHRIS CUFFARO

Stay Awake mastermind Hal Willner: Don't beware the dark side of Disney.

a-rock-star thing of "Kissability," the we've-been-reading-our-reviews analysis of "Total Trash," the artsy/experimental "Providence." Other times, you wonder if they're being satirical or just themselves, as on "Eric's Trip," where the lyrics sound like one solipsistic hippie putting down another, the bad attitude punctuated by guitar-generated Godzilla whoops. But this is a long set (just over an hour, the double album fitting on a single CD), and the group has plenty of room to stretch and do what, at this point, it does best: make edgy, imaginative guitar music, spacey and spikey all at once.

Richard C. Walls

**VARIOUS ARTISTS: Stay Awake: Various Interpretations of Music from Vintage Disney Films.**

① Hal Willner, prod. A&M CD 3918. ⊕ ⊞ Producer Hal Willner may be the closest thing pop music has to a conceptual artist. Already to his credit are three albums of various singers and players taking their own approaches to the work of a certain composer. The results have been stunning: Debbie Harry and Chris Stein interpreting a Nino Rota score for Fellini (*Amarcord* Nino Rota, 1982), Chris Spedding duetting with Peter Frampton on Thelonious Monk's "Work" (*That's the Way I Feel Now*, 1984), Todd Rundgren doing a

dance version of Kurt Weill's "Call from the Grave/Ballad in Which MacHeath Begg All Men for Forgiveness" (*Lost in the Stars*, 1986).

Now comes *Stay Awake*, at once Willner's most audacious and most potentially rewarding project: a tribute to songs from the films of Walt Disney. These are tunes we all know, no matter what generation we're from, but Willner and the artists he has enlisted pump them through their varied visions, transforming the familiar into something else again. In the hands of NRBQ, "Whistle While You Work" rocks harder than anything Disney might want

to have imagined. Bonnie Raitt, paired with Was (Not Was), performs an incredibly soulful version of "Baby Mine," making it possibly the best lullaby for adults ever recorded. Meanwhile, Buster Poindexter (a.k.a. David Johansen) and the Banshees of Blue take "Castle in Spain" for a salsa-fied workout, with Buster both menacing and comic at the low end of his register.

Which is another facet of Willner's revisions: Sometimes, there's a dark side to this music, downplayed in the original, now brought forward. Willner himself has noted with some amusement that the Replacements turn "Cruella DeVille" into a stripper. Even darker are the readings by jazzpoet Ken Nordine over Wayne Horvitz and Bill Frisell's avant takes on "Hi Diddle Dee Dee (An Actor's Life for Me)" and "Desolation Theme," the latter reflecting the kind of bitterness only a father can feel about a wayward puppet. The gloomiest look, though, is Tom Waits's interpretation of "Heigh Ho (The Dwarfs' Marching Song)," done with mechanical resonance and recorded in deep murk.

Not that *Stay Awake* is a grim record by any stretch of the imagination. The musicians who seem to be having the most fun are the two jazz vets: Betty Carter is absolutely sublime on "I'm Wishing," and Sun Ra and His Arkestra turn in one of the album's most hilarious takes, "Pink Elephants on Parade." Dr. John and Aaron Neville sound like they, too, are enjoying themselves with the "Mickey Mouse March" ("Y? Because we love you!"). Los Lobos' version of "I Wanna Be Like You (The Monkey Song)" may be a little truer to *Jungle Book* than Willner might like, but it retains the band's earthy appeal. And Syd Straw is such a persuasive vocalist, and her cowboy/country backing so authentic, you can almost feel the sunset and see the "Blue Shadows on the Trail."

The album is broken up into medleys, which can be annoying on this (non-indexed) CD: If you want to hear the Replacements, you have to fast-forward through Garth Hudson, NRBQ, and Carter. Then again, this is an album made to be listened to—and listened to all the way through. To this end, the songs slip together easily. Still, there are tremendous variations in dynamics, from Suzanne Vega's a cappella rendering of the title cut and Sinéad O'Connor's breathy "Someday My Prince Will Come" (accompanied only by Andy Rourke's acoustic guitar) to the overblown orchestrations that somehow befit Yma Sumac's voice on "I Wonder" and the chaos that surrounds Harry Nilsson's "Zip-a-Dee-Doo-Dah."

But the familiarity of these songs is what makes the album, above all, comfortable. "Second Star to the Right" is both

## FORMAT KEY

- ⊕ LP/EP
- ⊞ Videocassette
- ⊞ Cassette
- ⊞ Videodisc
- Ⓛ Compact Disc

Large symbol at left margin indicates reviewed format. Small symbols following catalog number of reviewed format indicate other available formats (if any). Catalog numbers of formats other than the reviewed format are printed only if their basic numbers differ substantially from that of the reviewed format.

"In Short Order": Note that these mini-reviews provide only the reviewed format and its catalog number.

Arabic numeral in parentheses indicates number of items in multi-item set.

# WDS

1-800-356-9514

Wisconsin Discount Stereo  
 2417 W. Badger Road  
 Madison, WI 53713  
 608-271-6889



NEW HOURS  
 M-F 9-8  
 SAT 9-5  
 or COD



5-STAR RATING  
 STEREO REVIEW BUYER'S GUIDES: Send \$3.95 for STEREO — \$3.95 for VIDEO — or \$7.00 FOR BOTH

# 1-800-356-9514

### VCR SPECIALS

TOP RATED 4-HEAD \$269	VHS MTS HIFI \$349	4-HEAD MTS HIFI \$389	JVC HRD750 \$355
<p>On screen programming with 6/8/9 day and 97 function remote</p>	<p>Over 20 4-Head MTS Hifi models under \$400—CALL!</p>	<p>4-Head MTS Hifi with O.S.P. BEST BUY!</p>	<p>GUARANTEED LOW PRICE</p>

### VCR SPECIALS

PANASONIC PV4860 CALL!	JVC HR55000 \$349	GE VQ7795 \$389	JVC GR555 \$355
<p>4-Head MTS Hifi with O.S.P. VCR STOCK MOST MAJOR BRANDS!</p>	<p>Super VHS 4-Head MTS Hifi. TOP RATED!</p>	<p>Super VHS 4-Head MTS Hifi. BEST BUY!</p>	<p>GUARANTEED LOW PRICE</p>

### CAMCORDER SPECIALS

JVC GR C11 \$599	PANASONIC PV400 \$349	GE CG9810 \$389	JVC GR555 \$355
<p>AUTO FOCUS + ZOOM LENS. Call for JVC Specialist!</p>	<p>AUTO FOCUS. GUARANTEED LOW PRICE. Call for RCA specialist!</p>	<p>FLYING ERASE HEADS. Panasonic PV490. CALL!</p>	<p>GUARANTEED LOW PRICE. SUPER VHS FORMAT. GUARANTEED LOW PRICE. Call for Zenith specialist!</p>

### CAMCORDER SPECIALS

SONY CCD330 \$349	RCA CC300 \$349	PANASONIC PV3350 \$349	GE CG9885 \$355
<p>GUARANTEED LOW PRICE. Call for SONY specialist!</p>	<p>CALL! 8:1 ZOOM. Call for RCA specialist!</p>	<p>CALL! SUPER VHS. Call for Panasonic specialist!</p>	<p>GUARANTEED LOW PRICE. SUPER VHS. Call for Zenith specialist!</p>

### TV SPECIALS

PANASONIC PWA8098 \$749	SONY KV75XR10 \$749	SONY KV9795 \$749	ZENITH SYSTEM 3 \$329
<p>COMBINATION 20" TV + VCR. Best 27" Monitor/Receiver</p>	<p>GUARANTEED LOW PRICE</p>	<p>97" Monitor/Receiver—BEST BUY!</p>	<p>20" Stereo Remote. Variable Audio. Cuts</p>

### MISC. SPECIALS

COASTER VTR60 \$59	COASTER X1308 \$59
<p>Spring load tripod. Opens to 58 inches.</p>	<p>Aluminum case for most camcorders.</p>

### WHY YOU SHOULD BUY FROM US!

- Guaranteed LOW price.
- All products BRAND NEW with full factory warranty.
- Most orders shipped within 24 hours.
- Ten day return policy.\*
- 30-day Buyer Protection Plan—FREE
- The ONLY mail order with factory authorized service center.

## WE STOCK MOST MAJOR BRANDS

Some Items Limited Quantities

### DISC PLAYER SPECIALS

JVC XLV550 \$219	TEAC PD600 \$229	TEAC AD4 \$275	TEAC AD7 \$355
<p>Loaded with features and performance. BEST BUY!</p>	<p>5-disc stacker with 32 program memory.</p>	<p>Combination CD/Cassette. Dolby B+C. HOT BUY!</p>	<p>Combination CD/Cassette. Dolby B+C+HX. HOT BUY!</p>

### PORTABLE DISC PLAYER SPECIALS

SONY D2 \$149	SONY D160 \$188	SONY CDM44 \$225	SONY D15 \$169
<p>DISC MAN. Sharp QTCDD30</p>	<p>GUARANTEED LOW PRICE. CAR DISC MAN</p>	<p>Portable with CD Player</p>	<p>GUARANTEED LOW PRICE. Smallest Discman</p>

### MISCELLANEOUS STEREO SPECIALS

SHERWOOD S97701 \$239	TEAC V670 \$265	TEAC V885 CHX \$97	AUDIO SOURCE S5-ONE II \$169
<p>Audio/Video receiver with 74 watts/channel!</p>	<p>3-Head, 2 motor cassette deck with Dolby B+C+HX Pro.</p>	<p>Dolby B+C+HX Pro cassette deck with tape bias control.</p>	<p>Dolby surround sound Audio Source S5 Two—CALL!</p>

### MISCELLANEOUS STEREO SPECIALS

KOSS JCR3005 \$109	SONY WAF100 \$119	DUAL CS3000 \$788	SHARP UX30 \$788
<p>WIRELESS HEADPHONES. Sony MDRCD6</p>	<p>Super Walkman. Dolby + Auto Reverse</p>	<p>GUARANTEED LOW PRICE. Top rated turntable. Hand rubbed walnut base.</p>	<p>FAX MACHINES. Packd 3300. Mura M1900. CALL!</p>

### CAR STEREO SPECIALS

SHERWOOD CRD210 \$159	PLYE KR6940 \$59	SHERWOOD S5693 \$59	SHERWOOD XR1604 \$239
<p>Auto-reverse with CD inputs. Dolby B+C and high power.</p>	<p>6x9 SPEAKERS. WE STOCK JVC, SONY, CLARION, ALPHASONIC, AND MORE</p>	<p>6x9 3-WAY</p>	<p>Removable DIN chassis. LOADS—TOP PERFORMANCE.</p>

### SPEAKER SPECIALS

DESIGN ASSOUTICS PS103 \$248 ea.	RECOTON WIRELESS 100 \$176 SET
<p>SPECIAL PURCHASE. Top rated under \$1000</p>	<p>Wireless remote speakers</p>

WE STOCK MOST MAJOR BRANDS WHY PAY MORE? WE STOCK MOST MAJOR BRANDS WHY PAY MORE? WE STOCK MOST MAJOR BRANDS WHY PAY MORE? WE STOCK MOST MAJOR BRANDS



SHEILA ROCK

Bangles: stars in clumsy search of arrangements, harmonies, and writers

terrific James Taylor and a very clean take on the tune (can you say "hit single"?). And how could anyone resist poor old off-key Ringo Starr doing "When You Wish Upon a Star," especially when he introduces Herb Alpert's solo with "Take it, Herb"? That's the stuff of musical legends.

Hank Bordowitz

**BANGLES: Everything.**

Davitt Sigerson, prod. Columbia CK 44056. ◉ ◉

Why is it that recording artists who find themselves suddenly "big" often feel compelled to then try to become something they're not? That's one of those questions you could throw a philosophy book at—and suffice to say that sometime between the release of the Bangles' last album, the delightful *Different Light*, and their new one, the three-years-in-the-making but not-so-delightful *Everything*, perhaps somebody should have thrown a tome or two at their collective noggin to knock some sense into them before it was too late. Up until this album, one thought of the Bangles as a band with an infectious '60s-based instrumental sound, the neatest group harmonies this side of the Hollies, and the admirable ability to augment their own good-but-not-great original songs with excellent interpretations of outside

material. With the release of *Everything*, however, it's hard to know what to think, because all these seemingly essential Bangles elements appear to have been turned inside out.

Instead of musical infectiousness, there's mainly a rash—of clunky, heavy-handed arrangements featuring far too many gratuitous "psychedelic" flourishes (a sticky "Strawberry Fields" keyboard here, a day-glo-lit bouzouki there)—and instead of free-flowing group harmonies, there are self-conscious just-vocals-and-drums passages tossed in at exactly the same point in various tracks. And most disappointingly, instead of a nice mix of originals and covers, virtually all the songs here are appallingly weak "collaborations" between the group and outside writers. I suppose the Bangles thought that if they couldn't write "A" material on their own, but didn't want to be forever branded as a group that scored hits with only other people's songs (Prince's "Manic Monday," Liam Sternberg's "Walk Like an Egyptian," Paul Simon's "Hazy Shade of Winter"), they could now, as stars, bring in ringers to improve the quality of their own stuff. Unfortunately, the plan backfires, and badly.

It's hard to believe it took three whole people (Susanna Hoffs, assisted by "True

Colors" authors Billy Steinberg and Tom Kelly) to come up with lyrics as mundane as the ones on "Waiting for You" (sample rhymes: "here alone"/"on the phone," "in your arms"/"safe from harm"), or that no one thought it unprofessional that "Something to Believe In" and "Eternal Flame" follow each other on the album with virtually identical lines ("Watching you as you lay sleeping" becomes "I watch you when you are sleeping"). As for the first single, "In Your Room" (I don't want to belabor this, but the word "room" appears in no fewer than five separate songs), all I know is that as a young rock critic, I was always taught that mid-tune key changes are usually just a contrived way of simulating excitement. Which is exactly what it sounds like here. Oh, well, you know what they say: Money changes *Everything*.

Billy Altman

**PHIL OCHS: The War Is Over: The Best of Phil Ochs.**

Jeffrey Gold and Geoffrey Schulman, exec. prods. A&M CS 5215. ◉

**THE FLYING BURRITO BROTHERS:**

**Farther Along: The Best of the Flying Burrito Brothers.**

Jeffrey Gold and Sid Griffin, exec. prods. A&M CS 5216. ◉

Procol Harum and Sergio Mendes. Humble Pie and the Sandpipers. Joe Cocker and Burt Bacharach. During the late '60s and early '70s, A&M had one of the strangest rosters in pop history, thanks in large part to Herb Alpert being the *A* in the company's name. In that regard, these

(Continued on page 77)

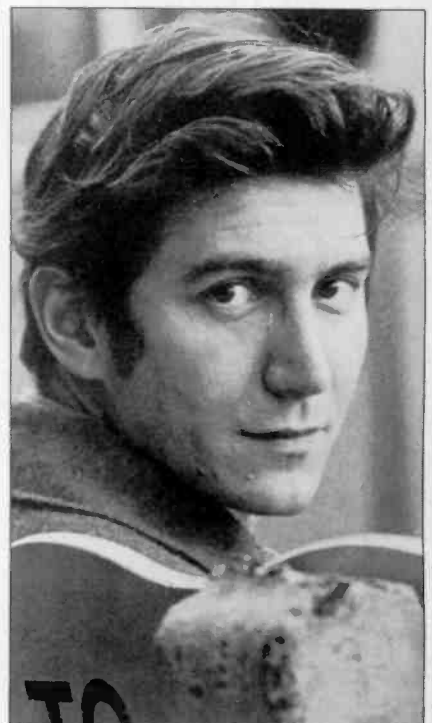

HIGH FIDELITY ARCHIVES

Ochs in the late '60s



★ LEGAL DAT TODAY ★

# Are You Ready To Enter The True Digital Domain?



A DAT Recorder Is Like Having Your Own Home/Portable Recording Studio.

Master Quality Sound Production With No Distortion! No Tape Hiss!

- English Operating Manuals
- All Connecting Cables
- AC Converters

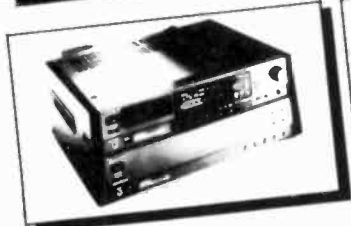

**SONY PCM-2500**  
Professional two piece studio standard

- Wireless remote control
- Fully programmable
- Switchable sampling freq. 32/44.1/48 khz



**SONY DTC-500ES**  
Sony's second generation bestseller

- Direct digital-to-digital
- Transmission capability
- Switchable sampling freq. 32/44.1/48 khz



**SONY TCD-D10**  
Sony's #1 consumer portable

- High-speed (near-instant) index search
- Built-in clock/calendar
- Stereo microphone and windscreen



**TECHNICS SV-D1100**  
18 Bit high resolution DAT

- Full function remote
- 6-speed CRV digital servo system
- Reduce conversion error by 75%



**PANASONIC SV-250**  
A masterpiece of miniaturization

- 9 x 1 3/4 x 5 1/2, under 4 lbs.
- MASH A/D converter w/ 64X O. Samp.
- Digital-to-digital editing



**CLARION DAC-2000** CAR STEREO

- Full-logic transport
- High-speed music search
- Intro tape scan

**KENWOOD KDT-99R** CAR STEREO (not pictured)

- Din-size. Dual-chassis
- Wireless remote control
- Direct track access

## Did You Know:

- DAT** recorders offer you better sound quality than CD players, plus all the benefits of a cassette recorder.
- DAT** cassettes are half the size of standard analog cassettes, and are a higher quality tape.
- DAT** recorders are fully programmable, with high speed (up to 300 times playback speed) indexing and music search.

CHOOSE FROM THE FOLLOWING:

- Sony • Panasonic • Technics • Tascam  
• Kenwood • Pioneer • Akai • Sharp • Alpine  
• Nakamichi • Denon • Yamaha

Knowledgeable, Friendly Customer Service.

# American International Audio Video

127 ROUTE 206 TRENTON, NJ 08610



**DAT HOTLINE**  
609-888-4414

609-888-2930  
FAX ORDERS

**FLEXIBLE LEASING PROGRAMS**  
START AT

**\$69** per month

- NO MONEY DOWN
- QUICK APPROVAL
- COMMERCIAL ACCTS WELCOME

- USA Written Warranty
- Nationwide Service Centers
- Pro User Extended Warranties



# HIGH FIDELITY CLASSIFIED

**MAIL TO:** 825 7th Ave., 9th floor, New York, N.Y. 10019. Phone: **1-800-ABC-MAGS**. In New York call: (212) 887-8458. **GENERAL:** all copy subject to publisher approval. Users of P.O. Box **MUST** supply permanent address and telephone number before ad can run. **CLOSING DATE:** 1st of second month preceding cover date. **15 Word minimum** No charge for Zip Code. **CLASSIFIED RATES:** regular type, per word: 1x—\$2.95; 3x—\$2.85; 6x—\$2.75; 12x—\$2.65. Words in caps—15¢ extra each. **IMPERIAL type, per word: 1x—\$3.95; 3x—\$3.85; 6x—\$3.75; 12x—\$3.65. Words in caps—15¢ extra each.** Minimum 15 words. Box numbers: \$3.00 additional per insertion to cover cost of handling and postage. Display, per inch: 1x—\$365; 3x—\$355; 6x—\$345; 12x—\$330. **PAYMENT WITH ORDER:** Send check, M.O., MASTERCARD or VISA No. and expiration date to: Maria Manaseri, Classified Dept., HIGH FIDELITY, 825 7th Ave., 9th Floor, New York, NY 10019.

## AUDIO/VIDEO SPECIALTY SHOP

WE HAVE THE FINEST SHOWROOM IN OUR AREA WITH the widest selection of Audio/Video components on display and in stock. Adcom, Infinity, Thorens, Dual, Jamo, Yamaha, Canton, Luxman, Sony ES, Klipsch, Allison, NEC, Bose, Proton. CONTINENTAL SOUND, 98-77 Queens Blvd., Rego Park, NY 11734. (718) 459-7507.

## BUSINESS OPPORTUNITIES

GET PAID for mailing letters! \$200.00 daily. Write: PASE - MM5, 161 Lincolnway, North Aurora, IL 60542.

YOUR OWN RADIO STATION, AM-FM, licensed/unlicensed, free tapes/records. Broadcasting, Box 130-H, Paradise, CA 95967.

## CLUBS/SINGLES

CLASSICAL MUSIC LOVERS' EXCHANGE. Nationwide Link Between Unattached Music Lovers. CMLE, Box 31, Pelham, NY 10803.

## COMPACT DISCS

**COMPACT DISC—at low warehouse prices. Now in our fourth year. Over 6,000 titles available. Free Catalog plus regular updates and monthly specials starting at \$10.99. OZ Warehouse, 1575P Hwy. 29 Lawrenceville, Ga 30244.**

low COMPACT DISC prices—LARGE inventory—mini-Catalogs \$1—DUWARS, PO BOX 6662-F, GREENVILLE, SC. 29606

**WE'VE SLIPPED OUR DISC PRICES TO FIT your budget, prices start at \$8.99! Write; Laser Locker Box 8611 Somerville, N.J. 08876.**

MAGNAVOX CD PLAYERS: CDB480 \$139.00, CDB482, \$165.00, CDB582 call. CDB486, changer call, CDB473, \$195.00, CDB650, reconditioned \$259.00. Philips/Mod. Heybrook, Audioquest, Mod Squad, Soundcraftsmen, Digital Sound, (312) 674-8024.

## CABLE TV

### CABLE TV DESCRAMBLERS & CONVERTERS

Your best buys and warranty's start with a free catalog from M.D. Electronics call toll free or write us today!

All products guaranteed we accept Visa, M.C., C.O.D.  M.D. Electronics  
115 New York Mall  
Ste. 133H  
Omaha, NE 68114  
**1-800-624-1150**

Cable TV descramblers: Jerrold combo w/remote \$165, TRIBI \$90, Zenith SSAVI \$145, TOCOM VIP call for \$55. Hamlin combo w/remote \$160 quantity discount. Please call for anything not listed. Dealers wanted. 702-887-3894.

**CABLE TV CONVERTERS.** Jerrold, Scientific Atlanta. All major Brands available. Visa/MasterCard. Call for information 1-800-638-6898. E&O Video, 9691 1 East 265th Street, Elko, MN 55020.

**CATV CONVERTERS & DESCRABLERS.** Quality Products. Professional Service. Call **1-800-541-5487. Visa/MC Accepted.** Mountaintech, Inc., Box 5074, Mt. Crested Butte, CO. 81225.

### CABLE CONVERTERS & DESCRABLERS

<ul style="list-style-type: none"> <li>• Jerrold</li> <li>• Dial</li> <li>• Zenith</li> </ul>		<ul style="list-style-type: none"> <li>• Hamlin</li> <li>• Scientific Atlantic</li> <li>• Many others</li> </ul>	
			
<p><b>NEW CHANNEL LINK</b></p> <ul style="list-style-type: none"> <li>• Transmits UHF signal throughout house</li> <li>• No hand wiring</li> <li>• The use of both products allows you to run several TVs with no wiring</li> </ul>		<p><b>NEW REMOTE EXTENDER</b></p> <ul style="list-style-type: none"> <li>• Extends use of any remote</li> <li>• Super long range</li> </ul>	
<p><b>30 DAY TRIAL</b></p>			
<p><b>VIDEO CASSETTE REWINDER WITH TAPE CLEANER</b></p> <p>Available in VHS or BETA</p> 		<p>Regular \$69 <b>NOW \$39</b></p>	
<p><b>WIRELESS REMOTE SWITCHER</b></p> <p>The V-430A Wireless Remote Switcher is a state of the art 4 in 3 infrared remote signal switching system</p> 		<p>Regular \$149 <b>NOW \$109</b></p>	
<p>One year warranty—immediate delivery—30-day trial</p>			
<p>Toll Free 1-800-826-7623 B &amp; B Incorporated P.O. BOX 21-327 ST. PAUL, MN 55121</p>			

## ELECTRONICS

**"STEREO WORLD" IS YOUR DISCOUNT mailorder source with super deals on Audio/Video & Car Stereo. Lines like: Magnovox, JVC, TEAC, AIWA, Technics, Pioneer, Uniden, Zenith, Sennheiser, Blaupunkt, Pinnacle, TDK, Maxell, Panasonic, Advent, Blaupunkt, AIWA G & S Amps, Technics, ADC. Car Stereo: Pyle, Clarion, Sherwood, Philips, Sony, Pioneer, Canon, Precision Power Amps, JVC, Jensen, Panasonic & more! Call or write for FREE catalog! Call for closeout specials! FREE shipping each order! P.O. Box 596, Monroe, NY 10950. 914-782-6044, M-F till 6:00 pm, Wed. till 9:00 C.O.D. accepted. FULL U.S.A. WARRANTIES**

## EQUIPMENT FOR SALE

**Buying and selling new and used audio equipment! Including high-end. AUDIO AMERICA (Virginia). Call 1-703-745-2223.**

DISCO LIGHTING, DJ SUPPLIES, FOG MACHINES, STAGE lighting effects at wholesale prices. Send \$1.00 for catalog. P.O.B. 20395, Bowling Green, KY 42101.

## CABLE TV

### Converters / Descramblers GUARANTEED LOWEST PRICES IN U.S.

Jerrold, Hamlin, Zenith—Many Others! Lowest Dealer Prices! Orders shipped within 24 hours! Complete FREE illustrated catalog. MasterCard-VISA-COD accepted  
PACIFIC CABLE CO., INC. (800) 345-8927  
7325 1/2 Reseda Blvd. • # 829 Reseda, CA 91335

## FOR SALE

### THE FINEST IN HOME AUDIO, CAR STEREO & VIDEO EQUIPMENT

- |                  |                    |
|------------------|--------------------|
| • ADS            | • MISSION          |
| • ADVENT         | • ORION            |
| • AKG            | • OLYMPUS          |
| • ALTEC-LANSING  | • POLK AUDIO (CAR) |
| • AUDIO CONTROL  | • PROTON           |
| • AUDIO DYNAMICS | • SAE              |
| • B & W          | • SANSUI           |
| • dbx            | • SONY             |
| • DENON          | • SURROUND SOUND   |
| • GUL            | • SNOOPER          |
| • HAFIER         | • SONANCE          |
| • INFINITY (CAR) | • SOUND            |
| • JVC            | • CRAFTSMEN        |
| • KENWOOD        | • TERK ANENNAS     |
| • KICKER         | • CLESTION         |
| • MINOLTA        | • CERWIN VEGA      |

**Sound CITY**   
Meadtown Shopping Center  
Route 23 South  
Kinnelon, N.J. (201) **838-3444**

WE SELL SECOND HAND HIGH QUALITY AUDIO-VIDEO with money back guarantee! Send your name and address for FREE monthly inventory. Ross' Stereo & Video Exchange, 2423 Morena Blvd., San Diego, CA 92110. (619) 275-3632.

LOW PRICES!!! YAMAHA • DENON • CARVER • ADCOM • BOSTON ACOUSTICS • LUXMAN • HAFNER • A/D/S • B&K • KEF • ONKYO • PROTON • BOSE • SNELL • DCM • SPICA • M&K • P.S. AUDIO • AR & MANY OTHERS • SOUND ADVICE (414) 727-0071

ORDER: 1-800-622-HIFI (4434), NAKAMICHI, YAMAHA, KYOCERA, DENON, HARMAN KARDON, JBL, NAD, CARVER, DBX, MISSION, LUXMAN, KEF, ADCOM, ONKYO, B&O. Manufacturers USA warranty, factory fresh, 15%-35% off list. Tax free (expect Wash. Res.). Most equipment received within 2-7 days. 7 day defective exchange. VISA/MC, Discover, Diners, Amex, COD. Warranty information, service or order, please call: 1-206-747-9999, TASKAMICHI AUDIO. See ad page 71.



## A SINGER'S DREAM!

### REMOVES VOCALS FROM RECORDS!

Now You can sing with the world's best bands! The **Thompson Vocal Eliminator** can remove most or virtually all of a lead vocal from a standard stereo record and leave most of the background untouched! Record with your voice or perform live with the backgrounds. Used in Professional Performance yet connects easily to a home component stereo system. Not an equalizer! We can prove it works over the phone. Write or call for a Free Brochure and Demo Record.

**LT Sound**, Dept. HF-3, 7980 LT Parkway  
Lithonia, GA 30058 (404) 482-4724

**24 HOUR PHONE DEMO LINE: (404) 482-2485**

EXPERIENCED FRIENDLY ADVICE!  
THORENS, FRIED, STAX, CWD, PS,  
MONSTER CABLE, GRADO, AUDIRE,  
SPICA, MIRAGE, SUPERPHON,  
STRAIGHTWIRE, QUAD, more. Immediate,  
FREE shipping. READ BROTHERS STEREO,  
593-C King Street, Charleston, South  
Carolina 29403. (803) 723-7276.

CARVER, NAKAMICHI, BANG & OLUFSEN,  
A.D.S., CROWN, REVOX, HAFLE, ADCOM,  
MISSION, MERIDIAN, N.A.D., HARMAN/  
KARDON, KYOCERA, YAMAHA, LUXMAN,  
DENON, KLIPSCH, B & W, POLK, KEF,  
D.C.M., E-V, J.B.L., INFINITY, D.B.X., AKG,  
BEST PRICES PROFESSIONAL  
CONSULTATION, AMERISOUND SALES,  
INC. EAST: (904) 262-4000; WEST (818) 243-  
1168.

## CHADWICK MODIFICATIONS

Our speaker cables and interconnects bring the music back to you!

- Upgrades for Thorens turntables & Grado cartridges
- Corktone Platter Mat, F-1 Dustcover Weight and more ...
- Complete catalog \$3.00, refundable with purchase.

1925 Mass. Ave., Cambridge, MA 02140 (617) 354-8933

## SERIOUS AUDIOPHILES DESERVE SERIOUS SERVICE.

And that's what you'll get at Reference Audio Systems. We offer the best in high-end audio and the best in friendly service by our knowledgeable staff. From the latest CD player to a classic mega-watt amplifier, you'll like our surprisingly affordable prices and fast shipping.

## Reference Audio Systems

Call Us... (213) 719-1500

Member Better Business Bureau  
18214 Dalton Ave, Dept. D, Gardena, CA 90248  
Hours: M-F 9 to 6, Sat. 9 to 1 Pacific Time

COUNTERPOINT · N  
PS AUDIO · BEYER  
REVOX · MEITNER  
JBL · HARMAN KAR  
ONKYO · JSE · SON  
HAFLE · PROTON  
DAHLQUIST · BOSE  
AUDIOQUEST · VPI  
ACOUSTAT · TEAC  
DCM · OHM · SME  
PHILIPS · DISTEC  
MOD SQUAD · SAE  
SUPERPHON · AKG  
CAMBRIDGE · KL  
FOSGATE · EMINE  
MAGNAVOX · DBX  
THORENS · NITTY  
CELESTION · RAUN  
STAX · AUDIOPRO  
SONANCE · ENER  
GRADO · MAGNUM  
DUAL · ORTOFON

BANG & OLUFSEN FULL LINE, ADS, B&W  
AND BOSE SPEAKERS AND OTHER  
QUALITY PRODUCTS AT REASONABLE  
PRICE, SOUNDCREST, INC., (201) 756-4858

## The Sound Seller

For the Musical Difference

Authorized Dealer For:

Acoustat	CWD
Audio Control	dbx
Nitty Gritty	Fried
M&K	Harman Kardon
Oracle	3D
PROAC	Onkyo
Proton	Grado
STAX	Audioquest
Thorens	Celestion
Dahlquist	DCM
Hafle	Niles
Monster Cable	Kinergetics
NAD	Duntech
Belles	Citation

1706 Main St.  
Marinette, WI 54143  
(715) 735-9002  
800-826-0520

### PAUL HEATH AUDIO

for 34 years only the finest products in the world.  
KNOWLEDGE is everything, and your best investment in  
sound is this number-716-262-4310.

**LOWEST PRICES ON OVER 120 HIGH  
quality famous brands esoteric/car/video.**  
Wide selection means you get what you  
want. Thousands of happy satisfied  
customers. For specials list only—call 800-  
233-8375. prices 503-963-5731. Audio  
Unlimited, 1203B Adams, La Grande,  
Oregon, 97850.

**CAUTION DAT BUYERS!  
SOME DEALERS ARE OFFERING DAT  
EQUIPMENT THAT IS NOT DESIGNED FOR  
USE IN THE U.S., AND IS NOT COVERED BY  
A LEGALLY BINDING WRITTEN  
WARRANTY. YOU NEED TO KNOW THE  
FACTS ON DAT—CALL THE DAT HOTLINE  
TODAY! 609-888-4414**

**CAUTION, YAMAHA BUYERS!!** Some  
dealers are offering Yamaha products for  
sale that are not designed for use or sale in  
the U.S.A. These units may not carry the UL  
approval for safety nor are they designed  
for usage on 110 volt U.S. current. YAMAHA  
ELECTRONICS CORPORATION, USA  
CANNOT BE HELD RESPONSIBLE FOR  
THESE UNITS MEETING U.S.  
PERFORMANCE SPECIFICATIONS NOR  
ARE WE RESPONSIBLE FOR WARRANTY  
SERVICING. For the name and location of  
your nearest authorized Yamaha dealer  
write, Yamaha Electronics Corporation,  
USA, P.O. Box 6660, Buena Park, CA 90622.

## ATTENTION DENON CUSTOMERS

Not everyone offering Denon  
products for sale is an authorized  
Denon dealer. This has great  
significance to you as a potential  
Denon customer.

Denon America's warranty applies  
to the original purchase only. Denon  
products sold by non-authorized  
dealers are not covered under this or  
any other warranty.

Additionally, some of this equipment  
may have been designed for foreign  
markets and therefore will not meet  
Denon America's specifications.

So look for the Authorized Denon  
Dealer Sticker before you buy.

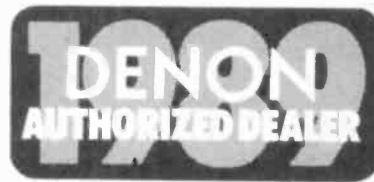

To find your nearest  
AUTHORIZED Denon Dealer call:  
1-201-575-7810 (9:00am - 5:00pm EST)

# HIGH FIDELITY CLASSIFIED

## HELP WANTED

EASY WORK! EXCELLENT PAY! ASSEMBLE PRODUCTS at home. Call for information 504-641-8003 Ext A-5037

## INVENTIONS

INVENTORS! AIM wants—Ideas, INVENTIONS, NEW products. Improvements on existing products We submit ideas to manufacturers Confidentiality Guaranteed Call in U.S. & Canada Toll Free 1-800-225-5800 for information kit.

## MISCELLANEOUS

IS IT TRUE JEEPS FOR \$44 THROUGH THE GOVERNMENT? Call for facts! 1-312-742-1142 Ext 4671

## MUSICAL INSTRUMENTS

WE BUY USED BRASS & WOODWINDS Top \$ Send INF Rayburn Music, 263 Huntington, Boston, MA 02115 (617) 266-4727 Emilio or David

## SCHOOL & INSTRUCTION

BE A RECORDING ENGINEER! New classes quarterly Institute of Audio/Video Engineering, 1831 Hyperion Ave., Hollywood, Ca 90027 213-666-2380 or outside Ca 800-551-8877 - approved by NATTS

**BE A RECORDING ENGINEER; Train at home for High Paying — Exciting Careers. FREE Information. AUDIO INSTITUTE, 214 Union St. Suite 22 G, San Francisco, CA 94123**

## SPEAKER COMPONENTS

SAVE 40% ON HIGH-END HOME SPEAKERS, subwoofers, amplifiers. FREE CATALOG! RTRD-1, 3021 Sangamon Ave., Springfield, IL 62702. (217) 529-8793.

**AUDIO PRO POWERED SUBWOOFERS — The most accurate Powered Subwoofer available today. Call for the dealer nearest you. Sonic Research, New Milford, Conn. 1-800-243-2673.**

**SONUS CARTRIDGE OWNERS! Looking for a replacement stylus? Call 1-800-243-2673. Also complete reconditioning of all Sonus cartridges with a new 2 year warranty.**

**SPEAKERS - SPEAKERS - SPEAKERS. Best Selection, Best Prices — All types. 88 page catalog - 1,000's of values. Send \$2.00 McGee Radio — 1901 McGee, Kansas City, MO 64108 Dept 2G**

FIND OUT WHY WE SELL MORE HIGH PERFORMANCE speaker kits than anyone in the U S For free catalog call 1-800-346-9183 AUDIO CONCEPTS INC 901 South 4th St La Crosse, WI 54601

## WANTED TO BUY

MARANTZ. & MCINTOSH TUBE EQUIP. all late model high-end items — vintage speaker systems Charlie Dripps (818) 444-7079 fax (818)-444-6863

## TAPES & RECORDS

3.95 SHIPPING ANY SIZE ORDER, UPS 1-800-245-6000

TDK	1/120/1750	MG	SONY	MAXELL
MAX CD90 6.25	TDK MARCELL 3.80	4.80	SONY URS 96 2.25	MAX 80 2.80
MAX 90 3.85	TDK HDX PRO 7.20		SONY URS 90 2.50	ELIS 80 2.40
MAX 80 2.75	MARCELL ELHF 5.90		SONY URS PRO 90 2.90	ELIS 90 1.90
LAUF 90 2.80	KONICA 3.90	5.90	SONY ES 90 3.90	UD90 80 1.70
ARE90 2.80	FUJI-SONY 3.80	4.70	MARCELL ELH 100 2.40	ULR 90 1.80
SA 80 1.70				ULR 80 1.80
MAX 110 3.90				ULR 100 1.90
SD 90 1.70				ULR 120 1.90
AS 90 1.80				
CS 90 1.80				
FI 90 1.80				
FI 150 1.70				
FUJI METAL 90 2.00				
SEMP METAL 120 4.90				

TAPE WORLD  
TRIAD DAT CALL

VISA MC NO EXTRA CHARGE

FREE 88 PAGE CATALOG WITH 50 OTHER SPECIAL OFFERS! We Beat Any Price of the Total Order including All Shipping & Handling Charges by 1% 3.95 Shipping Any Size Order CD Add 2.00 All Tapes Have U.S. Importation Permit Pass 5 in Call

MA-F 8:30-5:00  
412/253-8021  
800/245-6000

SOUNDTRACKS, SHOW, NOSTALGIA & JAZZ—SEND your want list—A-1 Record Finders, P.O. Box 75071-H, L A CAL 90075

CASSETTE CATALOG—ALL CATEGORIES OVER 7000 titles Cheapest prices anywhere Send \$1 00 for postage Music by Mail, P.O. Box 090066-Dept HF, Ft Hamilton Station, Brooklyn, NY 11209-0002

SHOW ALBUMS—Rare, out-of-print lps 64-page list \$1 00 Broadway-Hollywood Recordings Georgetown, CT 06829

RECORD COLLECTORS SUPPLIES, REPLACEMENT jackets, inner sleeves, 78 rpm sleeves, opera boxes, CLD supplies, etc Free brochure Cabco, Room 301-6, Box 8212, Columbus, Ohio 43201

FROM EDISON TO ELVIS (AND BEYOND) LP's, 78's, 45's etc Visit or mail in wants The Olde Tyme Music Scene, 915 Main Street, Boonton, NJ 07005 201/335-5040—Tuesday thru Sunday

RARE CLASSICAL AND JAZZ 250,000 LP's The Record Collector, 1158 N Highland, Los Angeles, CA 90038 (213) 467-2875

**AMPEX OPEN REEL TAPE—USED ONCE; 1800' or 2400' (boxed)—10 Reels: \$25.00. Sample: \$2.50. Also: New MAXELL Reels/Cassettes. AUDIO TAPES, Box 9584-T Alexandria, VA 22304. (703) 370-5555. VISA/MC.**

**FREE CD/RECORD OFFER! FREE CATALOG! "World's Best" Brass! Woodwinds! Orchestral Crystal Records, Sedro-Woolley, WA 98284.**

FREE RECORD, CASSETTE AND COMPACT DISC CATALOG Features a tremendous selection of remastered LP and cassette values in all musical categories Compact disc, cassette and LP new releases at discount prices Many imports and smaller labels offered Prompt delivery Rose Records, Dept H, 214 South Wabash Avenue, Chicago, IL 60604

SEARCHING FOR OUT OF-PRINTS? Try for Discontinued Records, 444 South Victory, Burbank, California 91502 (213) 849-4791

LIVE OPERA TAPES, CASSETTES Incredible selection Free Catalogue, Live Opera, Box 3141 Steinway Station, L I C, NY 11103

OLDTIME RADIO PROGRAMS Classic broadcasts on high quality tapes Mystery! Adventure! Comedy! Music! Free catalogue Carl Froelich, 2-H Heritage Farm, New Freedom, Pennsylvania 17349

BUY-SELL-TRADE USED CDs, Videodiscs, VHS video All classical and opera Tues-Fri 3-9 Sat 10-4 EST MC/Visa Pro Musica Ltd 716-693-5150

COLLECTORS' SOUNDTRACKS MINT TOP TITLES, speedy service List \$1 00 (refundable) Jemm's P.O. Box # 157, Glenview, IL 60025

IN PRINT & OUT OF PRINT RECORDS ALL CATEGORIES & nostalgia video tapes Spectacular Catalog! \$2 00 USA \$4 00 Foreign Serendipity Records, 4775 Durham Road, Guilford, CT 06437 USA

## PROTECT YOUR LPS

Poly sleeves for jackets 13¢ Poly sleeves for records 8¢  
Polylined paper ..... 17¢  
Cardboard Jackets ..... 50¢  
Postage \$3 00  
House of Records P.O. Box 323, Hillburn, New York 10931

CASSETTES 11 Real-time, RECORDS (DMM) AND COMPACT DISCS Classical only Free catalog Gasparo CO., P.O. Box 120069, Nashville, TN 37212 (615) 254-8460

**SERIOUS JAZZ COLLECTORS! A new service for discriminating collectors of jazz recordings. Also: Gospel, Folk, Ethnic and Americana, Classic Pop, Entertainment. Quarterly issues. Jazz Antiqua, P.O. Box 6567, Dept. HF, Bloomington, IN 47407.**

## RECORD STORAGE

THE BEST RECORD RACK IN AMERICA

Stackable, portable, oak units hold LP's, CD's and tapes

Free Mailorder Brochure (please mention High Fidelity)

Per Madsen Design (415) 928-4509  
P.O. Box 330101, San Francisco, CA 94133

## MONEY MAKING

**HIGH FIDELITY**  
Attn: M. Manasari, 7th Floor  
825 7th Avenue  
N.Y., N.Y. 10019  
212-887-8458  
1-800-ABC-MAGS

NAME \_\_\_\_\_  
ADD. \_\_\_\_\_  
CITY \_\_\_\_\_ ST. \_\_\_\_\_  
ZIP \_\_\_\_\_ TEL. \_\_\_\_\_  
PAYMENT: \_\_\_\_\_ CHECK  
M.O. \_\_\_\_\_ VISA \_\_\_\_\_  
Mastercharge \_\_\_\_\_  
CARD # \_\_\_\_\_  
\_\_\_\_\_ exp. \_\_\_\_\_  
run ad copy for the \_\_\_\_\_  
issue: \_\_\_\_\_

(Continued from page 72)

two tightly packed anthologies—60-plus minutes each, available on cassette and CD only—are designed not just to spotlight two overlooked A&M acts from that era but also to make you forget that pre-ski-bum Claudine Longet was a labelmate.

*The War Is Over* concentrates on the period of Phil Ochs's career (1967–70) when the manic-depressive troubadour moved to L.A. and began writing more ornate, less overtly political songs, like this set's best-known track, the sardonic "Outside of a Small Circle of Friends." Those familiar only with Ochs's earlier folk-protest material will hear elegiac cuts from his long-out-of-print masterpiece *Rehearsals for Retirement*, assorted hymns to despondency ("No More Songs"), and rarities like the Faron Young-on-acid "Kansas City Bomber" (written for, of all things, a Raquel Welch film). Although some of his best attempts at self-analysis ("My Life," "Bach, Beethoven, Mozart & Me") are omitted in favor of slighter ditties like "Gas Station Women," the digital remixes enhance the rich strings and bass lines on chamber pop like "Flower Lady" and "One-Way Ticket Home."

Another doomed soul, Gram Parsons, is the focal point of *Farther Along*, much of it culled from the Flying Burrito Brothers' first two albums, *The Gilded Palace of Sin* (1969) and *Burrito Deluxe* (1970). Parsons was a genuine eccentric whose dream—seeing hard-country tunes sung to rock audiences—came to pass only years after his 1973 death. His best songs—majestic heartbreakers like "Hot Burrito #1," jauntier social commentaries like "Christine's Tune (Devil in Disguise)" and "Sin City," all here—have held up remarkably well. And the assorted rarities, taken from deleted domestic and import albums, showcase the band's wild-eyed taste in covers: Parsons was equally at home with the Rolling Stones' "Wild Horses," the Bee Gees' "To Love Somebody," and Dave Dudley's "Six Days on the Road." Even better, *Farther Along's* crisp remix greatly improves on the tinny sound of the original LPs, emphasizing Chris Hillman's wholesome harmonies and Sneaky Pete Kleinow's slithery pedal steel.

The misleading titles of these compilations are another story. By neglecting the Burritos' post-Parsons albums (which, granted, are comparatively bland), *Farther Along* isn't the career overview that it's labeled. In the case of Ochs, the "best of" title is more egregious, since (aside from a previously unreleased live take of "I Ain't Marchin' Anymore") it omits any of the scathing, vibrant broadsides from his Elektra years. Although we should consider ourselves lucky that neither of these is a Tijuana Brass retrospective, each



Was (Not Was) and vocals (from left): Sweet Pea Atkinson, David Was, Don Was, Sir Harry Bowens

still makes you wonder whether CD reissues of *Gilded Palace* and *Burrito Deluxe* or Ochs's *Pleasures of the Harbor* or *Greatest Hits* wouldn't have been a better idea.

David Browne

#### WAS (NOT WAS): What Up, Dog?

Don Was, David Was. Paul Steveley  
● O'Duffy, and Steve Salas, prods.  
*Chrysalis VK 41664.* ◻ ◻

The characters in Was (Not Was) songs were never treated well by their creators, but five years of downtime and lawsuits seem to have taught Don and David Was some humanity. The standard losers still people *What Up, Dog?*, but they are drawn gently. There is sympathy wafting through the *norteño* licks of "Shadow and Jimmy," sorrow but hope for "a kinder, gentler nation" in "Somewhere in America There's a Street Named After My Dad," lounge-band compassion for the lovers taking their "Wedding Vows in Vegas" (offered by Frank Sinatra, Jr., no

less), and soul tenderness in "Anytime Lisa"—all of which would have been reduced to cynicism on previous albums.

But there's abundant sneering through the characters on this album as well, like the guy in the title track who goes around using his pit bull as a credit card, or the hero (?) of the demented "Dad, I'm in Jail." Hear also "11 mph," the perfect dance tune for the 25th Anniversary of the Kennedy Assassination cotillion. Was (Not Was) still have the good groove, with "Walk the Dinosaur" perhaps the funn(k)iest dance song in a dog's age. "Spy in the House of Love" has even landed them something they've deserved for nearly a decade: popular acceptance!

The CD version is worth the added bucks for three extra tracks: "Robot Girl," the aforementioned "Wedding Vows in Vegas," and a version of Otis Redding's "I Can't Turn You Loose" that establishes Sweet Pea Atkinson as the new king of soul.

Hank Bordowitz

**CARLA BLEY/STEVE SWALLOW: Duets.**

● *WATT/20 (837 345-2). (ECM.)*  
For those fans of pianist/composer/arranger Carla Bley who with dismay have followed her development from eccentric avant-garde satirist to purveyor of pretty music, *Duets* will come as an encouraging sign: Though far from her best, it's her best in years. True, her solo-bites tend to be short and melodic, and when bassist Steve Swallow goes into his bent-note guitar-like mode (as on "Utviklings-sang"), we're back to, well, pretty music. And notice that even a fairly recent composition like "Reactionary Tango, Parts 1/2/3" appears now with only trace elements of its original irony. But the stand-and-deliver acoustic-duo context does force Bley to dig a little deeper into the songs, a change from the unbearable lightness of her last few albums. One can hope this may presage a rekindling of the old inspiration. *Richard C. Walls*

**R.E.M.: Green.**

● *Warner Bros. 25795-1.*  
Here they are—on a new label, perhaps, but back with more meditations on utopianism and its flip side. And with more strong pop songs, like the rat-tat-tat "Orange Crush" and the aptly named "Pop Song 89" (which deftly skews Jim Morrison's vocal line from "Hello, I Love You" and Jimi Hendrix's guitar line from "Purple Haze"). The big news is that Michael Stipe's vocals are mixed way up front so you can understand him—but I dunno, I still don't pay as much attention to the lyrics as I do to the voice as one element in the overall sound. I'm more impressed, in fact, by what a powerhouse drummer Bill Berry has become, by how much more Peter Buck's guitar snarls, and by how the mandolins add such texture. Otherwise, this sounds *just like* an R.E.M. album, and that's the neatest trick of all: Everything's changed, but everything's stayed the same. *John Morthland*

**JOHNNY WINTER: The Winter of '88.**

● *MCA MCAD 42241.*  
After three gritty blues albums on the Chicago indie Alligator, Texas guitar-slingin' legend Johnny Winter jumps back to the big-label world of MCA with *The Winter of '88*. This all-digital Compact Disc gives his feisty licks a crisp edge, especially on the textural "Rain" and "Anything for Your Love." A bonus is the CD-only cut "Mother Earth," where his Erlewine Lazer wails over bassist Jon Paris's har-

monica. "I make my living feeling rotten," Winter howls on "World of Contradictions," "but I feel good when I play blue." Who's to argue? Settle in for the chill.

*Michael K. Mettler*

**LUCINDA WILLIAMS: Lucinda Williams.**

● *Rough Trade ROUGH US 47.*  
Lucinda Williams has been fighting for a toehold in the folk scene for a decade now—she's got two prior albums on Folkways—but if this LP doesn't finally signal her arrival, there really is no justice left in

**VARIOUS ARTISTS: Jazz '84: Highlights from the IXth Moscow Jazz Festival.**

● *Mobile Fidelity Sound Lab MFCD 894.*

It may come as a surprise to some, but jazz has, if not flourished, then persevered in the Soviet Union almost as long as it has in this country. And whereas in the States it has at times suffered from being associated with blacks, eggheads, and other suspect groups, in Russia it has suffered by dint of its being a flower of the decadent West. Punchline: The newly released disc of the



*Williams: country, country blues, and rock, evoking a traditional Southern setting*

this one-horse record business. Shamelessly romantic—in 1989!—she has fully assimilated country and country blues, juiced them up with some judiciously applied rock, and put them in the service of melodic, guileless songs that are full of hooks and sharp imagery, going right for the heart. Williams can tell you about love as lust ("I Just Wanted to See You So Bad") or as spiritual healing ("Like a Rose"), and "Changed the Locks" is as pissed-off as pissed-off gets. She's a great storyteller ("The Night's Too Long"), and her songs evoke that traditional Southern setting without sounding at all like museum pieces. Not bad, for a Dodger fan.

*John Morthland*

IXth Moscow Jazz Festival of 1984 displays a range as wide as most American jazz fests, and as narrow. Such festivals tend to be conservative, and the avant-garde is not well represented here. Russian folk songs and classical music, as well as pop and jazz standards, serve as source material for styles ranging from modish postbop to a tentative fusion and on to Dixieland; there's even a cut reminiscent of U.S. commercial schlock, and another that offers a schmaltzy dance-band rendition of "Stardust." But this is more than just a curio: On balance, the music holds its own, and the brief exposure afforded some of the players can only serve to whet the appetite. *Richard C. Walls*

**JIMI HENDRIX EXPERIENCE: Radio One.**

● *Rykodisc RCD 20078.*

Readers of this magazine know that we usually love CDs from Rykodisc, but I'll be damned if I'm going to embrace the Jimi Hendrix product that Alan Douglas has been exhuming for the company. You'll remember that *Live at Winterland*, a dispiriting performance with often foggy sound, was released in 1987 to the unknocking cries of "the definitive Hendrix concert disc" and (here's a laugh) "by far the best-sounding CD I have ever heard." Now we have *Radio One*, collecting 17 BBC radio recordings from 1967, and the problems multiply. First, the sound quality for most of the tracks, no matter what Rykodisc has been able to do, still borders on the bootleg, with Tin Man guitar all over. Second, that sound is sometimes much closer to fake stereo (bass on left, treble on right) than the true mono claimed for the original recordings. Third, the repetition factor is getting ridiculous. ("Killing Floor," "Fire," "Purple Haze," "Hey Joe," and "Foxy Lady," all on *Winterland*, are here, too—as if we needed those last three in the first place. "Spanish Castle Magic" is here as well, even though *Winterland* boasted its appearance there as "the only live version known to have been recorded." Hmm.) Fourth, *Radio*

*One* is marred by filler ("Radio One Theme") and bad covers ("Day Tripper," "Hound Dog"). And fifth, Leland Stein's even-worse-than-*Winterland* liner notes are quite possibly the worst of 1988. (Samples: "A treat!" "Simply wild!" "Nuff said!" "When your battery needs recharging, plug this in for a dazzling jolt of rhythmic energy. Guaranteed to get you a speeding ticket!" For "Hey Joe": "In concert he often improvised an extended intro and played the solo with his teeth." *You don't say.* For "Burning of the Midnight Lamp": "Change in chord progression at end a novel touch." Hey, Billy, when you're done with the Bangles elsewhere in this issue, I've got another one who thinks a mere *key* change is "novel.") Fortunately, Hendrix's first session for the *Top Gear* radio program (excepting "Hound Dog") is excellent, with well-balanced original sound that finally gives a warm, realistic tone to the guitar during three good tracks: "Drivin' South" (fiercest Hendrix soloing heard in years), "Catfish Blues," and the de-psychedelicized "Midnight Lamp." Those three tracks total 14 minutes and would have made a smashing CD-3. The rest of this hour-long CD proves that Rykodisc and Douglas should go back to superior original material—like, I'll say it again, *Hendrix in the*

*West*—or simply stop this game. Just as I should stop this entirely too long "mini" review. But really, folks, buy any other Rykodisc CD you want—just don't be fooled by such an out-of-character money-grabber as *Radio One*. Ken Richardson

**ROUGHHOUSE: Roughhouse.**

● *Columbia CK 44178.*

The bad news: This Philadelphia-area band was first called Teeze, has dubbed one of its songs "Teeze Me Pleeze Me," and used to write basic, boring lite metal (the old material at the end of this disc). The good news: The band is now called Roughhouse, has stopped spelling like Slade's Noddy Holder and instead encourages lead vocalist Luis Rivera to occasionally sing like him (and otherwise beef up his voice), and now writes appealing hard rock. Guitarist and main writer Gregg Malack may already be losing steam—his "Love or Lust" is just a plain rehash of his older "Tonight," one of two great tracks here—but bassist Dave Weakley is building, as his leadoff number, "Don't Go Away," is the other great track, and "Can't Find Love" is very good as well. Def Jovi in the making? Could be. The CD has no better sound, no more tracks, and fewer pix than the LP, so economize. Ken Richardson

# A D V E R T I S I N G I N D E X

Many advertisers will send you additional product literature free of charge. Write them in care of Dept. 3/89, unless otherwise noted, at the address below. If no address appears, literature is available only through dealers. Bold-face numbers by company names are page numbers for ads in this issue.

**American Int'l  
Audio Video (73)**  
127 Route 206  
Trenton, NJ 08610  
609-888-4414

**Electronic Wholesalers  
(44)**  
1160 Hamburg Tok  
Wayne, NJ 07470  
1-800-223-3411

**NEC Home Electronics  
(2)**  
1225 Michael Dr.  
Wood Dale, IL 60191  
312/860-9500 ext. 3210

**Radio Shack (Cov. 3)**  
300 One Tandy Center  
Ft. Worth, TX 76102  
817-390-3672

**TDK (18)**  
12 Harbor Pk, Drive  
Port Washington, NY 11050  
516/625-0100

**Audio Advisor (57)**  
225 Oakes S  
Grand Rapids, MI 49503  
1-800-669-4434

**High Voltage (61)**  
39 West 32nd Street  
New York, NY 10001  
800/654-7787

**New York  
Wholesalers (55)**  
Dept. 15  
2 Park Avenue  
New York, NY 10016  
212/684-6363

**Reliable Video (80)**  
933 Long Island Drive  
Brooklyn, NY 11230  
1-800-525-9922

**Wisconsin Discount  
Stereo (71)**  
2417 W. Badger Road  
Madison, WI 53713  
1-800-356-9514

**Audio Quest (59)**  
P.O. Box 3060  
San Clemente, CA 92672  
714-498-2770

**Illinois Audio (69)**  
12 E. Delaware Place  
Chicago, IL 60611  
1-800-621-8042

**Pioneer  
Electronics  
(Cov. 2, p. 1)**  
2265 E. 220th Street  
Long Beach, CA 90810  
213/835-6177

**Signet (10)**  
4701 Hudson Avenue  
Stow, OH 44224  
216/688-9400

**Cambridge Soundworks  
(13)**  
154 California Street  
Newton, MA 02158  
1-800-252-4434

**J&R Music  
World (66, 67)**  
23 Park Row  
New York, NY 10038  
212/732-8600

**Polk Audio (4, 36, 37)**  
5601 Metro Dr.  
Baltimore, MD 21215  
301/358-3600

**Taskamichi Audio (58)**  
Box 25583  
Seattle, WA 98125  
206/747-9999

**Yamaha (20)**  
6660 Orangethorpe Avenue  
Buena Park, CA 90620  
714/522-9105

(Continued from page 15)

nance and 650-line horizontal resolution.

Convenience features include a remote control able to "learn" commands from virtually any infrared audio or video remote. In addition, there's a three-mode Dolby Surround System processor with digital delay. Both models feature four A/V inputs, with one on the front panel for portable component connections, including camcorders, and a connection for "S"-video source input, such as an S-VHS VCR. The Pro-71 and Pro-91 also have two A/V memories for recall of a preset picture and sound, a 10-watt-per-channel amp, and two built-in 6-inch stereo speakers. Pioneer Electronics, P.O. Box 1720, Long Beach, Calif. 90801-1720.

Lotsa Car Stuff

Alphasonik has rolled out a lot of new car products, including an EQ/preamp, three subwoofers, and four Deltasonik power amps. The PS-7B EQ/preamp (\$220) is a seven-band stereo unit using a continuously variable subwoofer crossover with a 24-dB-per-octave slope. From the front panel, users can select high- and low-level tape inputs and a CD input whose sensitivity adjustment is continuously variable. The unit also features a built-in front/rear fader, a mono/stereo switch on the subwoofer output, and seven-segment signal LEDs to mark equalizer control positions. EQ control frequencies are 50 Hz, 150 Hz, 350 Hz, 1 kHz, 2.5 kHz, 6 kHz, and 16 kHz, with a control range of ±18 dB.

Subwoofers in the XL series include the 8-inch XL-8 (\$150), 10-inch XL-10 (\$225), and 12-inch XL-12 (\$300), and all have long-throw damped paper cones. The nominal impedance of each is 4 ohms.

Three of the four new Deltasonik power amps use Alphasonik's proprietary Variable Permactec (PMA) technology. The company says Variable Permactec is an "intelligent" protection system that maintains safe operating conditions for all internal components and doesn't hamper sound quality. Two models using PMA are the DP-360 at 180 watts (22.6 dBW) per channel (\$595) and DP-200 at 100 watts (20 dBW) per channel (\$345), both stereo amps with four- or three-channel capability using optional connectors. The DP-90 (\$170), also with PMA, is a stereo amp that can be bridged for mono without adaptors. At 18 watts (12.6 dBW) per channel, the DP-40 (\$79) is a basic stereo amp and the only model without PMA circuitry. Alphasonik, 701 Heinz Ave., Berkeley, Calif. 94710.

GUARANTEED BEST PRICES IN USA

AC ADAPTER FREE!

CAMCORDERS: UP TO 24 PIECE OUTFIT

A/C ADAPTER POWER SUPPLY - BATTERY - BATTERY CHARGER - RF-TV ADAPT. - 75 TO 300 OHM CONVERTER - BALUN - AUDIO/VIDEO WIRELESS - SHOULDER STRAP - CARRY HANDLE - PROTECTIVE LENS HOOD - PROTECTIVE LENS COVER - BLANK TAPE - ENGLISH INSTRUCTION BOOK - COAXIAL CABLE - VHS-C/VHS ADAPTER - MICROPHONE - A/B SWITCH KIT - CAMCORDER CLUB MEMBERSHIP - MPF'S USA ACCESSORY KIT - MPF'S USA WARRANTY - RELIABLE ACCESSORY BOOK - REMOTE CONTROL - LENS CLEANING KIT - CARRY CASE

RELIABLE

C.O.D. NO EXTRA CHARGE

INFORMATION: 1-718-462-9500 NEXT DAY & 2ND DAY DELIVERY VIDEO TAPES; 1-800-522-8991 AUDIO/VIDEO; 1-800-525-9922 AVAILABLE

NO INCOMPLETE VHS CAMCORDER "DEALS" (HD CS, 2 HR BATT.)

NO BAIT & SWITCH TO: MINOLTA, PENTAX, SHARP

NO EXTRA CHARGE FOR U.S. WARRANTY

Table listing SONY and PIONEER products with prices. Includes items like SLP 70 HF VHS, SLP50 HiFi, SLP30HiFi, SLHF 860 Zoom, etc.

Table listing CAR STEREO products with prices. Includes items like KEH9292, KEH4252, KEH282TR, etc.

Table listing AUDIO products with prices. Includes items like CDPCT0, MOP700, STRAV1000, etc.

Table listing PHONE products with prices. Includes items like SPP90, SPP110, SPP300.

Table listing WALK/DISCMAN products with prices. Includes items like WMF100 mini DT15, D10, D29, etc.

Table listing PAL/SONY products with prices. Includes items like CDF50 (V30), CDF50 (V5), CDF90 (V9), etc.

Table listing PAL NATIONAL products with prices. Includes items like NVM7, NVCS, JVC VIDEO.

Table listing JVC VIDEO products with prices. Includes items like HRD400 4 Hd, HRD440 4 Hd, HRD750 Newsl, etc.

Table listing JVC AUDIO products with prices. Includes items like RX1001, RX999 VBK, RX777 VSBK, etc.

Table listing ZENITH products with prices. Includes items like VM7500S w/c, VM7500 w/Hd Cs, VRE550, etc.

Table listing VIDEOCRAFT products with prices. Includes items like AVP100, AVS100, VCP100, etc.

Table listing MINOLTA products with prices. Includes items like VM7500S w/c, VM7500 w/Hd Cs, VRE550, etc.

Table listing SANSUI products with prices. Includes items like E80, E70, VM E77, E-708 PRO, etc.

Table listing MITSUBISHI products with prices. Includes items like HSU80 SVHS, HSU70 SVHS, HSU50, etc.

Table listing SHARP, RICOH, CHINON, and RCA products with prices. Includes items like VL 80 VA, VLL 250 12x10A, etc.

Table listing OLYMPUS products with prices. Includes items like VX802 HiFi, VX405 S-VHS, VX406 C Hardon, etc.

Table listing HARMON KARDON products with prices. Includes items like CD 200, CD 400, CD 800, etc.

Table listing PANASONIC products with prices. Includes items like PV2800, PV2820, PV4820, etc.

Table listing CROWN products with prices. Includes items like D150, D300, D300, etc.

Table listing ACCSSRY products with prices. Includes items like Pro Fluid Hd Tripod, 3 Video Filters, etc.

Table listing NIKON products with prices. Includes items like AVP100, AVS100, VCP100, etc.

Table listing MARANTZ products with prices. Includes items like AG1950 1038, AG1800, etc.

Table listing MINOLTA products with prices. Includes items like VM7500S w/c, VM7500 w/Hd Cs, VRE550, etc.

Table listing TOSHIBA products with prices. Includes items like SV970 S-VHS, SV950 S-VHS, DX900 PCM, etc.

Table listing BOSE products with prices. Includes items like VC-1 Colorizer, 4AB1 Editor, etc.

Table listing NIKON products with prices. Includes items like NV900 HiFi, etc.

Table listing CANON products with prices. Includes items like E80, E70, VM E77, etc.

Table listing SANSUI products with prices. Includes items like E80, E70, VM E77, etc.

Table listing MITSUBISHI products with prices. Includes items like HSU80 SVHS, HSU70 SVHS, HSU50, etc.

Table listing AUDIO products with prices. Includes items like E80, E70, VM E77, etc.

HAVE A GOOD DEAL & WE'LL BEAT YOUR BEST DEAL "BOSS"

Reliable Video, 933 Coney Island Ave., Brooklyn, NY 11230. Please add appropriate shipping, handling, and insurance. Service after sale, ask how others handle defectives. Shipping charges not refundable. NO EXTRA C.O.D. CHARGES - ALL ITEMS FACTORY COMPLETE! Fax phone: (718) 469-7050 (PG 1193-103/231) 12/88

5 YEAR WARRANTY AVAILABLE

5 YEAR WARRANTY AVAILABLE



# THE LOGICAL CHOICE



## REALISTIC®

### Logic Controlled, High-Speed Dubbing Cassette Deck

Realistic, America's best-selling brand of cassette equipment, brings you the logical choice in stereo tape decks. The SCT-84 is logic controlled for smooth and precise recording, playback and dubbing. Logic also gives you simplicity. Just touch a button to record great-sounding copies of personal tapes at normal or high speed. You can play one tape continuously, two in sequence, even make unattended recordings with a timer.

Dolby B noise reduction cuts hiss

and widens dynamic range. Dolby C trims noise to the vanishing point,  $\frac{1}{10}$  of its original level. SCT-84 automatically selects bias level for normal, chrome and metal tapes. And a fine-bias control lets you adjust for the best possible sound from any cassette.

Instant auto-reverse on tape-2 changes tape direction in  $\frac{1}{10}$  of a second and works on both playback and recording. You also get handy LED direction indicators, an 8-step LED

peak-level meter, digital tape counter and convenient record-mute function.

For adding cassette or replacing an older mechanically controlled deck, Realistic SCT-84 is the logical choice. Try it out today. Just 259.95

Exclusively at

**Radio Shack**  
**The Technology Store™**

A DIVISION OF TANDY CORPORATION

FREE 184-Page Radio Shack Catalog! Write: Dept. 1166, 300 One Tandy Center, Fort Worth, TX 76102

\*TM, Dolby Laboratories Licensing Corp. Price applies at participating Radio Shack stores and dealers. We service what we sell.

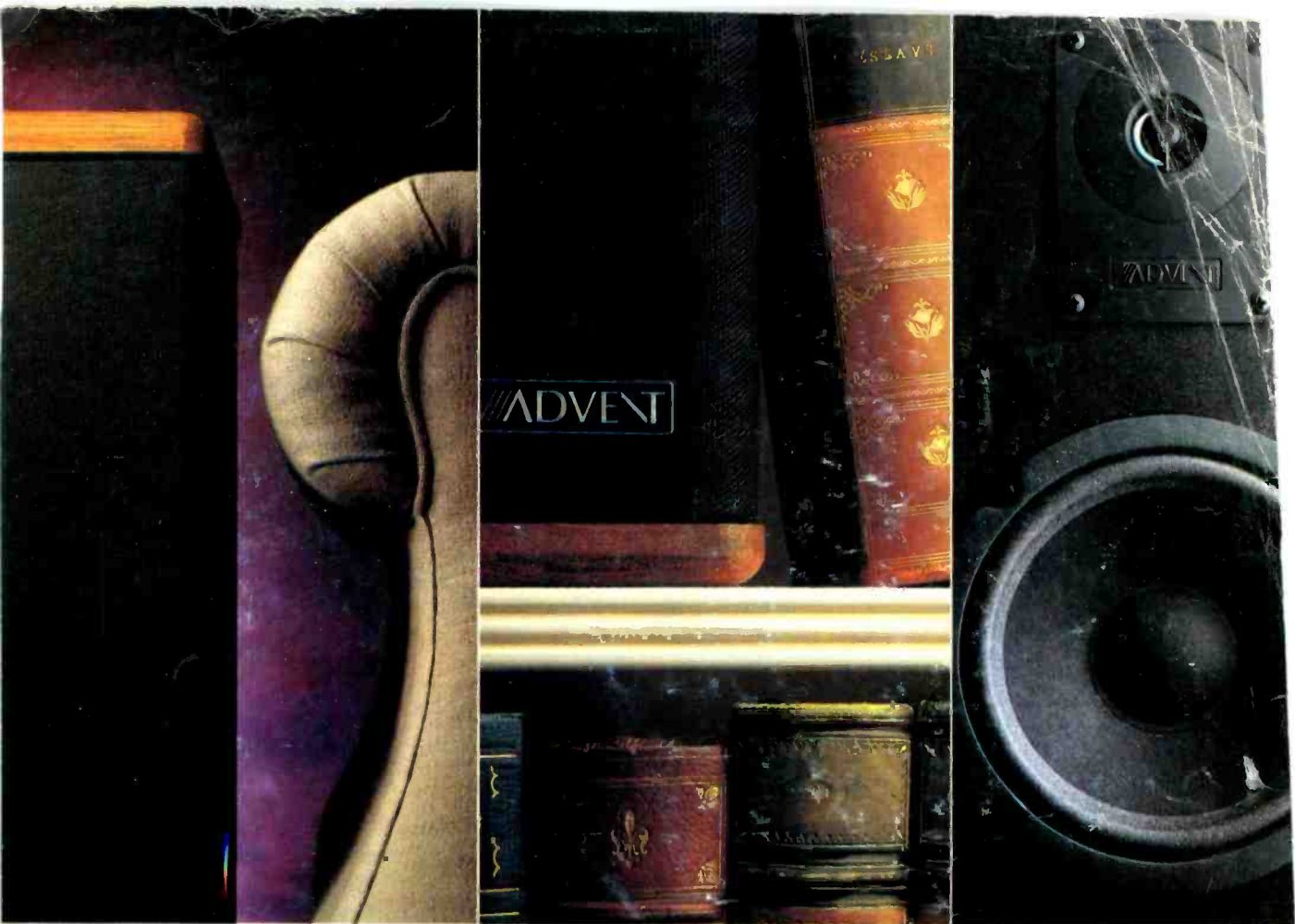

# FROM THE PEOPLE WHO GIVE YOU ACCURATE SOUND, NOW COMES MORE ROOM TO ENJOY IT.

**INTRODUCING THREE SPACE-SAVING LOUDSPEAKERS FROM ADVENT.** Now you can enjoy the accurate sound of Advent® in more places than ever. Our three new speakers give you the clean, clear sound you expect from Advent, yet take up less space to do it.

**THE MINI-ADVENT AND MINI-ADVENT SUBWOOFER SYSTEM.** Mini-Advents are the perfect size for bookshelves. Desks. Even walls and ceilings, using our optional mounting brackets. They're small, but get big sound with 5¼" high excursion woofers, polycarbonate tweeters, 120 watts peak power and a tuned bass port. Or, add our subwoofer. It gives Mini-Advents the bass of a much larger system and creates exceptional stereo imaging for audio/video or surround sound systems.

**THE PRODIGY TOWER.** Taller and thinner than our still-famous Advent Prodigy, the Prodigy Tower gets maximum sound using minimum floorspace. How? With 300 watts

peak power, a more efficient 8" woofer and a polycarbonate dome tweeter for improved dispersion.

**THE BABY II.** Last, but not littlest, is the improved Baby Advent. Just as compact as the original Baby, but with a couple of changes that show it's maturing quite nicely. Like a ferrofluid-filled polycarbonate dome tweeter and re-adjustable logo for horizontal and vertical speaker placement.

All three new Advents have natural wood tops and bases. Even if you never hooked them up, they'd make great looking furniture.

Come in to your nearest Advent dealer and listen to the new Mini-Advent, Prodigy Tower and Baby Advent. And don't worry about the crowds. With these speakers, there's always plenty of room.



**ADVENT**  
Sound as it was meant to be heard.