

JUNE 1985

HIGH FIDELITY

AUDIO VIDEO TEST REPORTS MUSIC

Amazing Speaker Designs Achieve Sonic Marvels!

**AR, Bose & DBX
Set New Limits
Of Performance**

**Speaker
Engineer Reveals
How To Buy The
Best Model**

**Buying Guide To
More Than 25
Video Speakers**



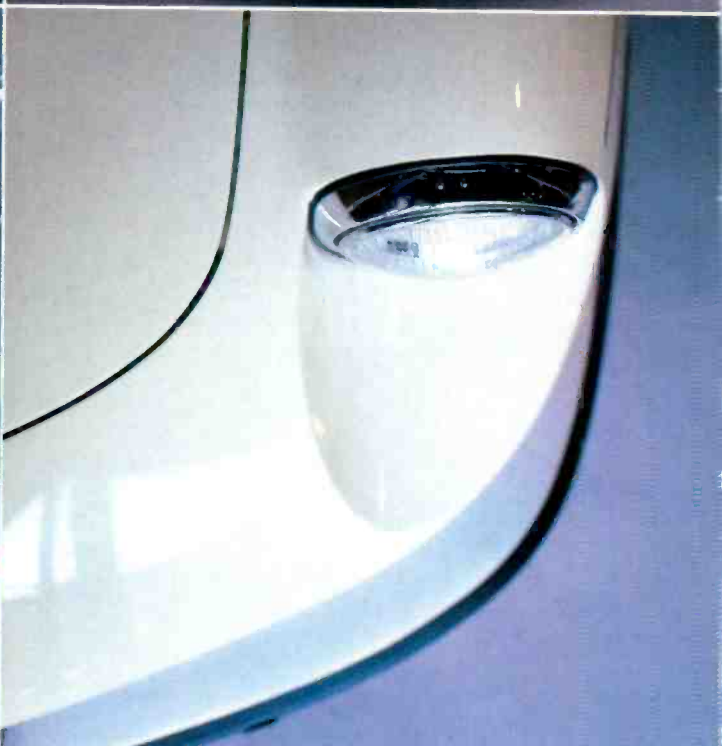
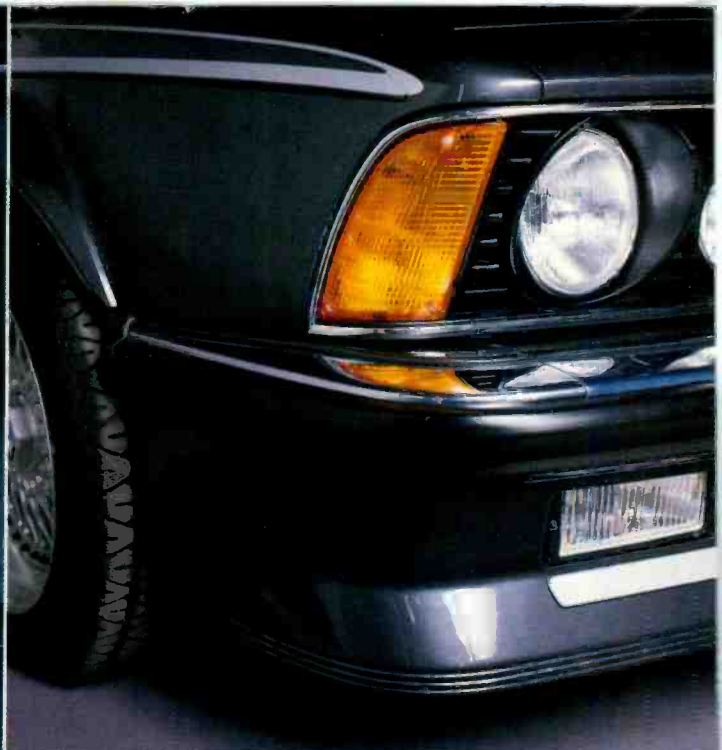

Very few companies selling car stereos are real *audio* companies. With 75 years of experience reproducing sound, Denon simply wishes to point out the level of their home audio technology present in the new DC-series of car audio equipment.

For example, the only audio components — home or auto — offering the level of circuit sophistication found on the new Denon Car Audio DCA-3250 Power Amplifier are Denon's own top-of-the-line receiver and separates.

Similarly, the Dynamic Range Expansion circuitry found on Denon's new Car Audio DCR-7600 AM/FM Stereo Tuner/Cassette Deck otherwise can be found only on Denon's DE-70 Dynamic Equalizer.

The *differences* between Denon car and Denon home audio equipment will become apparent the moment you sit behind the wheel. To build car audio for people who love good sound as much as fine cars, Denon created a very limited, ultra-high quality range of car audio components, specifically engineered to become *part* of the automobile. Controls fall to hand and information is displayed with the *driver* clearly in mind.

For the car lover, Denon Car Audio does more than offer true auto high fidelity — it becomes an integral part of the thrill of driving.



**Finally,
car audio as good
as your car.**

Circle 22 on Reader-Service Card

HIGH FIDELITY™

AUDIO & VIDEO

- 36 Sonic Marvels**
by Peter W. Mitchell
Three breakthrough loudspeaker designs set new performance limits.
- 38 Special Test: Bose AWMS**
by Peter Dobbin
Laboratory and listening evaluations of this revolutionary speaker
- 46 Shopping for Speakers**
by Timothy Holl
A loudspeaker designer reveals what really counts.
- 49 Video Speaker Buying Guide**
by Peter Dobbin and Frank Lovece
Complete comparison of more than 25 models

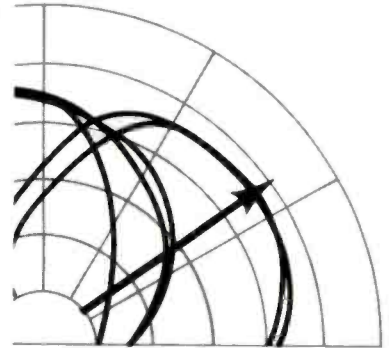

TEST REPORTS

- 54 Dali 3** loudspeaker
- 56 Baby Advent** loudspeaker
- 57 Mission 770F** loudspeaker
- 58 Heybrook HB-1** loudspeaker
- 59 Fried Beta** loudspeaker
- 65 B&W VM-1** video loudspeaker
- 67 Phoenix P-250DL** surround-sound decoder

MUSIC

Classical

- 70 Discovering Gershwin**
by David Patrick Stearns
Michael Tilson Thomas takes a fresh look at well-known and unknown works.
- 71 Notes from Underground**
by Bálint András Varga
From Budapest: Magyar offerings

- 83 Film Crop 1984**
by Noah André Trudeau
A roundup of some of the year's best and worst soundtracks

Popular/Backbeat

- 84 Arto Lindsay, Alone and Together**
by John Piccarella
Envy, his first solo album, reveals a complex emotional sensibility.

- 88 The 12-inch Report**
by Vince Aletti
USA for Africa, the New Jersey Mass Choir, and a return to the hedonistic dance floor

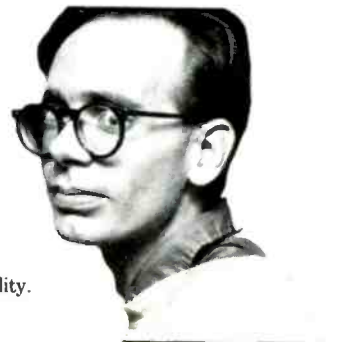

DEPARTMENTS

- 4 The Editor's Page**
- 9 Letters**
- 16 Currents**
- 27 Crosstalk**

- 28 Basically Speaking**
- 30 The Autophile**
- 69 Medley**
- 73 Classical Reviews**
- 78 Critics' Choice**

- 84 Popular Reviews**
- 89 Jazz Reviews**
- 98 Reader-Action Page**
- 98 Advertising Index**

Cover Design: Tony Palagonia Cover Photo: Ralph Sammarco
 Special Effects: Christopher Richards
 Computer Screen Drawing: Wilbert Stratton
 On the Cover: Left to right: DBX Soundfield One loudspeaker,
 AR MGC-1 loudspeaker, Bose Acoustic Wave Music System
 IBM PC system courtesy Personal Computer Rentals, Stamford, Conn.

HIGH FIDELITY (ISSN 0018-1455) is published monthly at 825 Seventh Ave., New York, N.Y. 10019, by ABC Leisure Magazines, Inc., a subsidiary of American Broadcasting Companies, Inc. Copyright © 1985 by ABC Leisure Magazines, Inc. The design and contents are fully protected by copyright and must not be reproduced in any manner. Second-class postage paid at New York, New York, and at additional mailing offices. Authorized as second-class mail by the Post Office Department, Ottawa, and for payment of postage in cash. Yearly subscription in the U.S.A. and Possessions \$13.95; elsewhere \$20.95. Single copies \$1.95. Subscribers: Send subscriptions, inquiries, and address changes to HIGH FIDELITY, P.O. Box 10759, Des Moines, Iowa 50340. Change of address: Give old and new addresses, including ZIP code. Enclose address label from last issue and allow five weeks for change to become effective. POSTMASTER: Send change of address to HIGH FIDELITY, P.O. Box 10759, Des Moines, IA 50340.

Sherwood car stereo: Quality, innovation, and money left over for the good times.

At Sherwood, we think you shouldn't sacrifice your lifestyle for your car stereo. So we make great car stereos that don't cost like great car stereos.

Built into every one is the quality and innovative design that has been Sherwood's benchmark for more than 30 years. The result is performance that sets standards for the more expensive brands.

New CRD-180.

Take, for example, our new CRD-180. It not only performs with the finest car stereos, it has features you usually find only on far more expensive units. It has auto reverse, Dolby,* metal tape capability, pre-amp output with fader, separate bass and treble controls, locking fast forward and rewind, and terrific night illumination.

Great FM, and AM stereo. And the CRD-180 not only has electronic synthesizer tuning with MOS-FET front end for super FM, it also has **AM stereo**, opening a whole new world of exciting

long-range on-the-road listening. (Sherwood was the first to introduce AM stereo in separately available car receivers.)

Computerized features. Advanced digital tuning lets you enjoy two scan-

because this display lets you know what's happening, including time of day, since it even has a **digital clock**.

Fits your budget. All of this innovation and performance comes in a mini chassis, so this great car stereo will fit just about any car. And just about any budget.

How much you pay for a great car stereo may not be the only thing on your mind, but it's not the only place you have to put your money, either. So have a little money left for the good times,

but get all the car stereo you want. Buy Sherwood.

 **Sherwood**

Quality and Innovation You Can Afford

13845 Artesia Boulevard, Cerritos, California 90701.

In Canada, The Pringle Group, Don Mills, Ontario.

*Dolby is a trademark of Dolby Laboratories.



ning modes: Scanning all stations, or just the ones in memory. This unique preset scan feature works with the ability of the CRD-180 to remember up to 12 of your favorite stations.

LCD display and digital clock. The latest in convenience, a multifunction liquid crystal display (LCD) indicates frequency, preset channel, local/distant, stereo, AM/FM, Dolby, tape direction and more. The CRD-180 is easy to use

© 1985, Inkel Corporation.



HIGH FIDELITY

Publisher Steven I. Rosenbaum
Editor-in-Chief/Associate Publisher William Tynan
Editor, Musical America Shirley Fleming
Senior Editor Michael Riggs
Managing Editor Peter Dobbin
Senior Copy Editor Ken Richardson
Copy Editor Patricia Reilly

TECHNICAL DEPARTMENT

Technical Editor Michael Riggs
Electronics Features Editor Peter Dobbin
Assistant Editor (Administration) Randy Brozen Day
Consulting Technical Editors Edward J. Foster, Robert Long
Contributing Editors Paul D. Lehrman, Frank Lovece

MUSIC DEPARTMENT

Classical Music Editor Theodore W. Libbey, Jr.
Popular Music Editor Georgia Christgau
Assistant Editor Mildred Camacho
Assistant Mark I. Garrison
Photo Editor Susan E. Fingerhut
Contributing Editors Vince Aletti, Robert E. Benson, Crispin Cioe, Mitchell Cohen, R. D. Darrell, The Reverend Thomas L. Dixon, Steve Futterman, Edward Greenfield, Thomas Hathaway, Paul Hume, Joyce Millman, Paul Moor, John Morthland, Thomas W. Russell III, David Patrick Stearns, Noah André Trudeau, James Wierzbicki, John S. Wilson

ART DEPARTMENT

Art Staff Robin Pelkki (layout and graphics), Tony Palagonia (cover and consultant)
Technical Art Roy Lindstrom, Nina Wallace

PRODUCTION

Director of Production Kathleen Davis
Advertising Production Manager Janet Cermak
Associate Production Editor Susan E. Fingerhut
Production Assistant Paula Ballan

CIRCULATION

Vice President, Circulation Stephen J. Bernard
Circulation Director/V.P., Newsstand Marketing Dominic Mustello
National Sales Manager/Newsstand Michael Gerardo
Circulation Director/Subscriptions Lillian Gmitruk
Circulation Subscription Staff Mary Beth Colucci, Barbara Donlon, Timothy Farrell, William Johnson, Janice Raiford
Customer Service Mary Losi

Assistant to the Publisher Randi Vaughan
Assistant to the Editor-in-Chief Darlene Edwards



HIGH FIDELITY and HIGH FIDELITY/MUSICAL AMERICA are published monthly by ABC Leisure Magazines, Inc., a division of ABC Publishing, Inc., and a subsidiary of American Broadcasting Companies, Inc. ABC Publishing, Inc., Robert G. Burton, President, ABC Leisure Magazines, Inc., Ronald Stuart, President; Steven I. Rosenbaum, Vice President, High Fidelity Group; Herbert Keppeler, Senior Vice President, Photographic Publishing Division; Roger Caspary, Controller; Ernest G. Scafone, Vice President, Graphics and Production; Stephen J. Bernard, Vice President, Circulation; Dominic Mustello, Vice President, Newsstand Marketing; Member, Audit Bureau of Circulation. Indexed in Reader's Guide to Periodical Literature. Current and back copies of HIGH FIDELITY and HIGH FIDELITY/MUSICAL AMERICA are available on microfilm from University Microfilms, Ann Arbor, Mich. 48106. Microfilm copies (1973 forward) are available through Bell & Howell Micro Photo Div., Old Mansfield Road, Wooster, Ohio 44691.

ADVERTISING OFFICES

New York: ABC Leisure Magazines, Inc., 825 7th Ave., 8th Floor, New York, N.Y. 10019. Tel: (212) 265-8360. James A. Casella, Advertising Director, Richard J. Merino, Associate Director of Advertising, Michael H. Goldberg, Eastern Advertising Manager, James R. McCallum, Record Advertising Manager, Candice Leyden, Classified Advertising Manager, Kathleen Davis, Director of Production, Janet Cermak, Advertising Production Manager.

Midwest: High Fidelity, Hitchcock Building, Wheaton, Ill. 60187. Tel: (312) 653-8020. Starr Lane, Midwest Advertising Manager.

Los Angeles: ABC Leisure Magazines, Inc., 2020 Avenue of the Stars, Suite 245, Century City, Calif. 90067. Tel: (213) 557-6482. Rita Weitzen, Western Advertising Manager.

Editorial correspondence should be addressed to The Editor, HIGH FIDELITY, 825 7th Ave., New York, N.Y. 10019. Editorial contributions will be welcomed, and payment for articles accepted will be arranged prior to publication. Submissions must be accompanied by return postage and will be handled with reasonable care; however, the publisher assumes no responsibility for return of unsolicited photographs or manuscripts.

EDITOR'S PAGE

by William Tynan

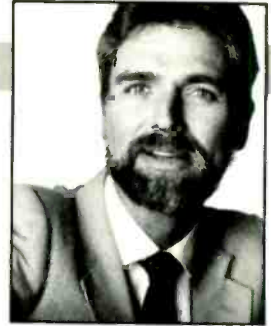

Rethinking the "Iron Law" and other sonic facts

Fact is the consensus of truth at a given moment in time. This concept may at first seem foreign, but close inspection reveals an indisputable validity. As facts are re-formed over time, so laws change and are perhaps shown not to be inviolate—not to be laws, but simply limits imposed by narrow horizons. And so some of our basic thinking about loudspeakers has been turned upside down by the recent development of three limit-breaking designs.

A fascinating exploration of these innovations—from AR, Bose, and DBX—forms the centerpiece of a special 20-page report this month on today's audio and video speakers. Included in Peter W. Mitchell's "Sonic Marvels" is a HIGH FIDELITY test report on the Bose Acoustic Wave Music System, an advance that shatters the "Iron Law" relating speaker size, efficiency, and bass response. Design engineer Timothy Holl follows with some fresh ideas on "Shopping for Speakers." Among the critical parameters he cites is power-handling capability, which is directly related to the acoustic properties of your listening room. Easy-to-use charts show how power requirements vary for live, dead, and normal rooms. Then, in another of his comprehensive buying guides, Frank Lovece details more than two dozen video speakers—models specifically designed to fit into an audio-video system. And completing our analysis are lab/listening reports on six new midsize speakers, including one video model.

Our music coverage includes David Patrick Stearns's interview of conductor Michael Tilson Thomas on his George Gershwin recording project. Thomas's family and the Gershwins were friends, and Thomas grew up greatly influenced by Gershwin's music. Much of the new release comprises material drawn from unpublished musical sketches left at the time of the composer's death and never before recorded. Building on these, the project provides revealing insights into Gershwin's creative processes.

Joining the classical section this issue as a regular column is "Notes from Underground," in which a variety of contributors from locales such as Tokyo, London, and Budapest will keep you current on behind-the-scenes recording activities.

This month's BACKBEAT offers a look at a broad range of recordings. Vince Aletti's "12-inch Report" discusses, among other things, "We Are the World" by USA for Africa, the best-selling 12-inch to date.



Introducing a slight improvement on perfection. The new Technics Compact Disc Players.

Technics compact disc players. And the compact disc. Together they've given you what no conventional audio system can: the perfection of musical reality. Instead of the conventional stylus, Technics compact disc players use lasers and computers. So there's none of the noise. None of the distortion. And none of the wear and tear that affects ordinary records.

With Technics, what you hear is not just a reproduction of a performance, but a re-creation of it: perfection.

But occasionally even the musical perfection of a compact disc can be marred by fingerprints, dust or scratches. So the new Technics SL-P2 compact disc player has improvements like an advanced error correction system. This system has been designed to compensate for those imperfections. To help ensure that the sound you hear is still completely flawless.

COMPACT
disc
DIGITAL AUDIO

You also get sophisticated, convenient controls for accurate, rapid response to your commands: 15-step Random Access Programming so you can play any selection. In any order. Auto Music Scan lets you sample the first few seconds of each song. Automatically. Full information fluorescent displays let you keep track of tracks, playing time and other player functions.

And all of this can be controlled from across the room with Technics wireless, infrared remote control.

So enjoy an improvement on perfection. With the full range of Technics compact disc players. Including the SL-P2, SL-P3 and very affordable SL-P1.

The digital revolution continues at Technics. Perfectly.

Technics
The science of sound

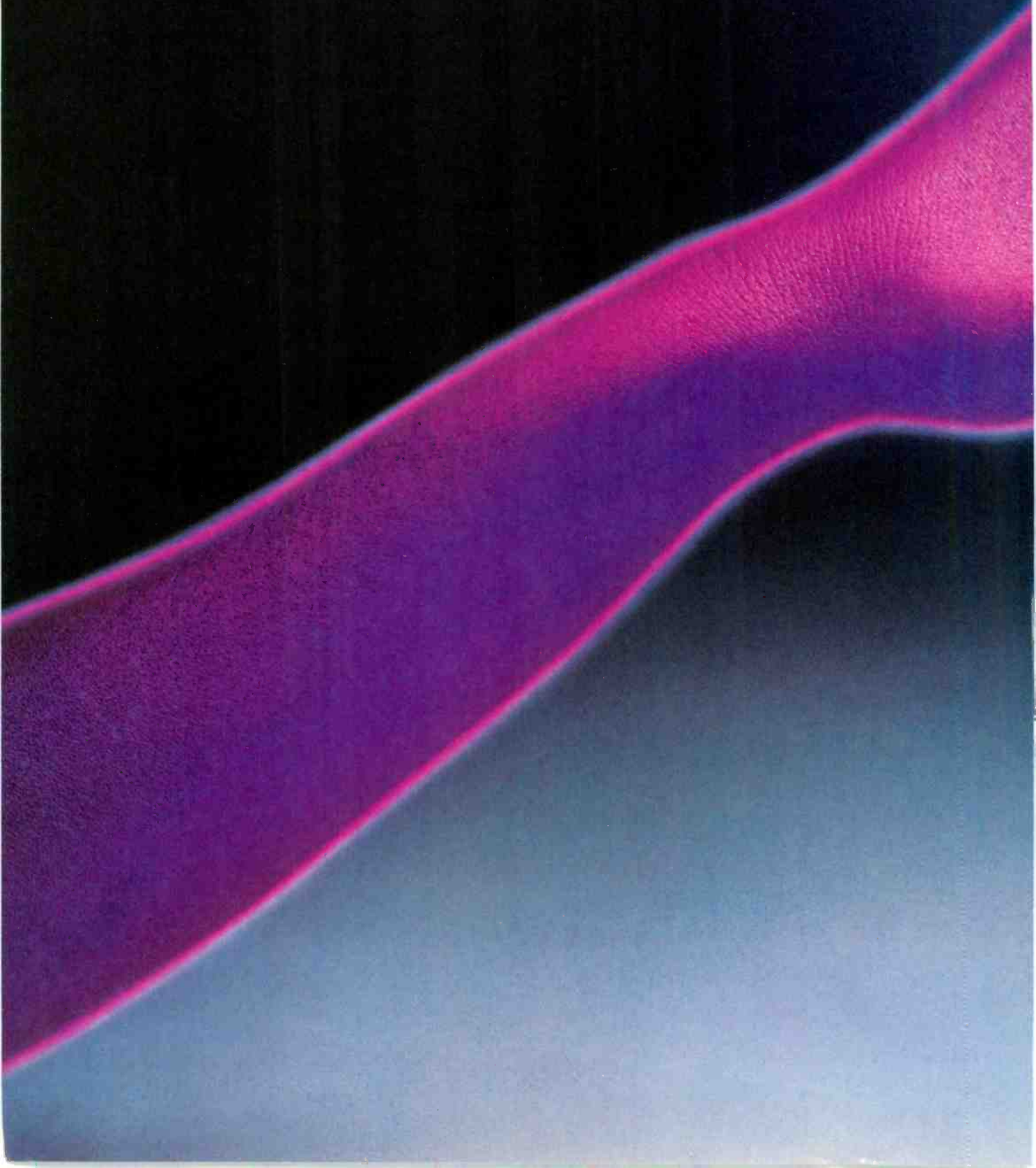



SONY INTRODUCES A CLEAR CASE FOR SOUND OF A DIFFERENT COLOR.

It's different alright. Clearly different.
In fact, it's unheard of.

Imagine sound so rich and dazzling,
so dynamically out-of-this-world, so clearly
clear, so oh so colorful.

Imagine rock's sonic sounds sounding
supersonic. And soul's fiery tones breathing

fire. And a very vivid Vivaldi. And jazz that
jumps.

Imagine all that explosive vibrancy in
a clear cassette that gives you a clear
view of exactly how much Sony tape is left.

Unheard of? Of course.
Every other tape pales by comparison.



Circle 24 on Reader-Service Card

You'll know why

we're first, the second

you hear us.

First it was DC. Then DD/DC and Super Feedforward. Now Sansui astounds the audiophile with the greatest improvement in an amp. X-Balanced circuitry. It cancels out external distortion by eliminating the transformer to chassis ground; and decisively removes IHM.

You'll find X-Balanced circuitry in a wide range of superior Sansui products, like our AU-G99X amp, shown with TU-D99X quartz-PLL synthesizer tuner which incorporates our new Super Linear Digital Decoder for improved rejection of spurious signals and interference. Another version of this tuner even has AM stereo capability.

There's more worth hearing about these great Sansui components. Write: Consumer Service Dept., Sansui Electronics Corp., Lyndhurst, NJ 07071; Carson, CA 90746; Sansui Electric Co., Ltd., Tokyo, Japan.



Putting More Pleasure in Sound.



LETTERS

GETTING CLEANED

The use-and-care guide that comes with practically every Compact Disc says that cleaning the disc involves no more than wiping it with a dry cloth. But shrewd manufacturers have realized that extravagant audiophiles would think this a bit too good to be true. Hence, we have CD cleaning kits. They're expensive, all right, but it must be a real trick to develop a solvent that actually helps the cleaning process without harming the disc.

What's next? I expect to see a laser-cleaner disc on the market soon. After all, you wouldn't want to play your clean CDs with a dirty laser.

John Paul Middleworth
Statesville, N.C.

CD OVERLOAD

Robert Long's response to Alan Klein's letter about overload distortion from his CD player ("Crosstalk," August 1984) misses the point entirely—and it seems to me that it's an important point. Not only have I experienced the same problem, but I have heard from several other people, with different components, that they have as well.

I use a Yamaha CD-X1 CD player and an RGR 4-1 preamp. In past years, with prior preamps, I have had input overload problems from my tape deck that disappeared when I reduced the input level. For this reason, I vowed never to buy a component with a line-level output that has no level control. Unfortunately, however, almost no CD players have such a basic control.

When the problem materialized with my CD player and current preamp, I inserted an inexpensive external stereo volume control between the two, and as I expected, it disappeared. However, I was less than happy routing such a high-quality signal through a cheap control, so I called both Yamaha and RGR. Yamaha responded, essentially, that it must be the preamp and that there was nothing wrong with the player—which is true as to its operation but not, I feel, as to its design, since such a simple and inexpensive control was left off.

When I called RGR, I was lucky enough to have Robert Grodinsky himself answer the telephone. He came to the same conclusion that Mr. Long did—that clearing out everything in the signal path (in my case, three tape decks and five signal processors of various kinds) should be the first step. If that

didn't help (it did), there might be a malfunction in the preamp's input stage, which he would be glad to check out. Mr. Grodinsky agreed, however, that the easiest solution to the problem was not to hunt for its cause amongst so many components but simply to lower the output from the CD player, and he kindly offered to wire an RGR volume control into the body of the cheap unit I was using at nominal cost. (This, I might add, was not only above and beyond the call of duty, but also what I think the high fidelity industry is supposed to be all about.)

My problem is gone, but I feel that despite RGR's generosity, it was not really theirs to solve. From everything I have heard, CD players appear to be more likely to need an output level control than any other source, both to prevent overload distortion and to match levels with the turntable and other sources. Instead of all the bells and whistles, which neither I nor anyone I know considers all that important, manufacturers should put in a volume control. It seems to me that HIGH FIDELITY should focus on points like this rather than on the ease with which a new model can play a Beethoven symphony backwards. And certainly Mr. Klein should not have been made to feel that his problem is an isolated one.

Manuel W. Gottlieb
New York, N.Y.

Agreed that output level controls are a convenience, but they should not be a necessity. (And frankly, we have not seen any evidence that the problem you and Mr. Klein have experienced is widespread.) Preamps should have buffer amps in their tape outputs to isolate the main signal path from the devices attached to them, thereby preventing the impedance-loading effects that are at the root of your woes. Most don't because it saves money and so few people have systems as elaborate as yours, but we don't think CD players should have to be designed to make up for shortcomings elsewhere in the reproduction chain.

If disconnecting everything from your preamp's tape loops had not solved the problem, it would have been a sign that the unit was defective. (Any preamp should be able to take the full output of a CD player without overload, and we have never tested one that couldn't.) The best course would then have been a trip to the repair shop,

Introducing the MODEL 20, the first Loudspeaker from NAD.

Our goal was straightforward: to develop a loudspeaker whose design and performance would be in keeping with the NAD tradition of quality. The result—the NAD 20—offers uncolored tonal balance, extended response and wide dynamic range—all at a reasonable price.

Perhaps the most novel aspect of the NAD 20 is its cabinet design. Most high performance loudspeakers tend to be large and overpowering. The slim, tower design of the NAD 20 occupies only 0.6 square feet of floor space, allowing the placement flexibility of "mini" speakers while delivering the high efficiency and extended bass of larger loudspeakers.

The NAD 20 loudspeakers are the ideal choice to complement any high quality electronics system. We invite you to visit your local NAD dealer and listen to the speakers for yourself. We are sure you'll agree.



For more information on the NAD Model 20 and a list of dealers, send us the coupon below.

NAME _____
ADDRESS _____
CITY _____
STATE _____ ZIP _____

NAD (USA), INC., 675 Canton Street, Norwood, MA 02062

Circle 19 on Reader-Service Card

since other, less obvious problems might be present as well. For example, one likely source of premature input overload is a faulty power supply, which would bring down the phono overload point, too.—Ed.

WHOSE VOICE IS IT?

I am surprised that Bert Wechsler thinks Ljuba Welitsch is the one redeeming aspect in Wilhelm Furtwängler's 1950 *Don Giovanni* [February]. The only thing I want rescued from that dismal performance (Mr. Wechsler's use of "frenetic" is curious) is a single aria: Donna Anna's "Or sai chi l'onore." But on my copy—and, I assume, on all others, too—this aria is sung not by Welitsch but by Elisabeth Grümmer, presumably spliced in from another (1953) pirated recording.

The combination of purity and passion that made Grümmer's Mozart—like that of Sena Jurinac—so wonderful seems particularly electrifying in this recording, when up to this point in the score Donna Anna's music has been projected (with all due respect) with

much wobble and little style. Has the Melodram 713 pressing "corrected" this intrusion, or is Mr. Wechsler not able to recognize the difference between Welitsch's voice and Grümmer's?

Anthony Pugh

Frederickton, New Brunswick,
Canada

Bert Wechsler replies: The practice to which Mr. Pugh refers was, alas, widespread in the pirate market during the 1960s. There is a Traviata (with Beniamino Gigli) where the poor baritone has his aria replaced by a commercial recording of Giuseppe De Luca's. A Tosca still circulates that purports to be of Welitsch where the soprano is actually Dragica Martinis (Welitsch herself repudiated this one 15 years ago).

Of course, I listened again to the "Or sai chi l'onore" on the Melodram 713 Don Giovanni, comparing it to another of Welitsch's conducted by Fritz Reiner on Melodram 096 (I no longer own the previous re-

leases of Furtwängler's Don). While I am not a student of the abiding art of Elisabeth Grümmer, I am convinced that this is Welitsch. There is the same abandon, the same open tone on the unprepared high notes, the same "little girl" sound on the passing ones—the same style. There is also no reason to suspect that Italian Melodram used a tape from New York to prepare its edition.

But to cover myself, let me say that Welitsch does sing the aria even better with Reiner. Perhaps Mr. Pugh will listen again to Melodram's Furtwängler and give us his opinion.

GONE FOREVER?

I read with interest Paul Moor's review of Robyn Archer's recent release [December 1984]. Whatever the other merits of this entertainer may be, she certainly is not an exponent of the Brecht style as we know it through Gisela May, Therese Giehse, etc., not to speak of Lotte Lenya. I'm glad that someone knew better than to join in the gen-

Discwasher.[®] The clear choice for record care.

Where do you turn to get the best sound from your records? The answer is clear. To the Discwasher D4+™ Record Care System. Its scientific design uses a unique fluid and directional micro-fiber pad to clean

records safely. Without leaving residues behind. And the SC-2™ Stylus Care System loosens and wipes away damaging stylus contaminants. All to keep your records playing clean and clear.

You can trust Discwasher. The clear choice for tape and video care, too.

Discwasher, leader in the technology of audio and video care products, also provides advanced systems for cleaning tape decks and VCR's.



The sound and sight come through clean and clear.

discwasher

©1985 Discwasher
A DIVISION OF INTERNATIONAL JENSEN INC.

1407 North Providence Road, P.O. Box 6021, Columbia, MO 65205

◀ Circle 1 on Reader-Service Card ▶

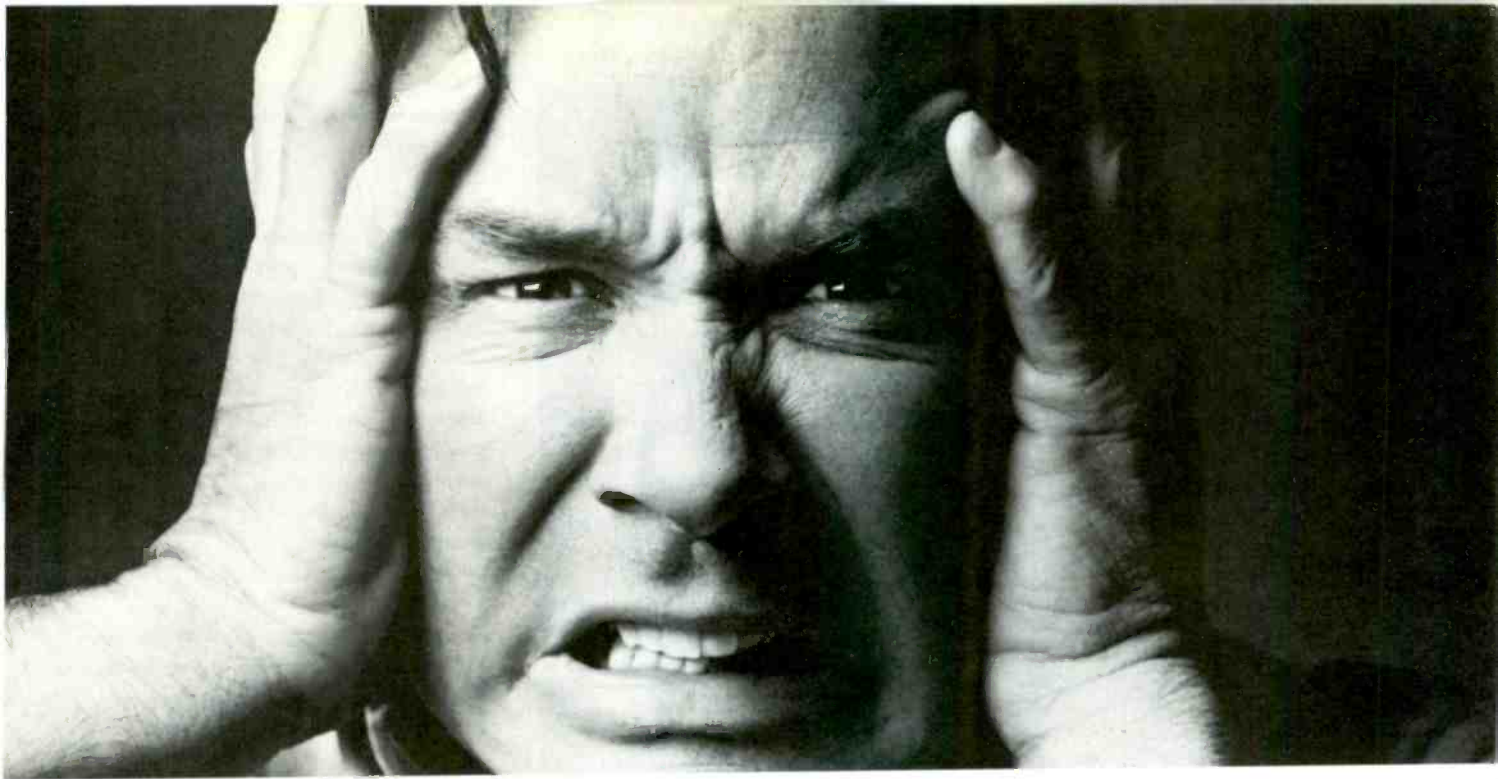

What most speakers have done to your favorite music is too shocking to hear.

Look what they've done to your song.

They've distorted it. Colored it. Added and subtracted from the music. That's because most speakers depend on conventional cone drivers. Now, cones may be great for ice cream, but they don't give you the true flavor of great music. You see, sound waves are distorted by the cone's shape and come to you unevenly. In fact, they're usually biased toward the low-end of the scale.

So what you really hear is the cone's interpretation of the original. Prince's cone, for instance, instead of Prince. Or Rubinstein's version of the "Moonlight Sonata" as interpreted by the cone.

The Dynawave

series from Sawafuji America Corporation gives you the real thing. These sophisticated speakers use Dynapleats, a patented driver system developed after years of research in flat-wave technology.

This revolutionary system allows sound to come off evenly and simultaneously from the entire surface of the driver.

Just listen to the difference.

The flat-wave sound is virtually free of the distortion caused by cone drivers. It's a natural, full, rich sound with superb imaging, wide dynamic range and accurate reproduction throughout the fre-



Revolutionary dimensions:
6 1/4" x 6 1/4" x 1"

quency range. And it's about as close to the real Bach or B.B. as you can get.

These speakers look as good as they sound. Because the flat-wave drivers are slimmer and relatively light, they permit a more elegant and stylish cabinet design. A proper setting for the music you love.

The Dynawave series makes this revolutionary sound technology available at popular prices for the first time. There are three unique models to choose from. And each one gives you music the way it was really meant to be heard.

You may be shocked when you hear the truth.

DYNAWAVE[®]
Sawafuji America Corp.

23440 Hawthorne Blvd., Torrance, CA 90505
(213) 373-0620

© 1985 Sawafuji America Corp.

Circle 41 on Reader-Service Card

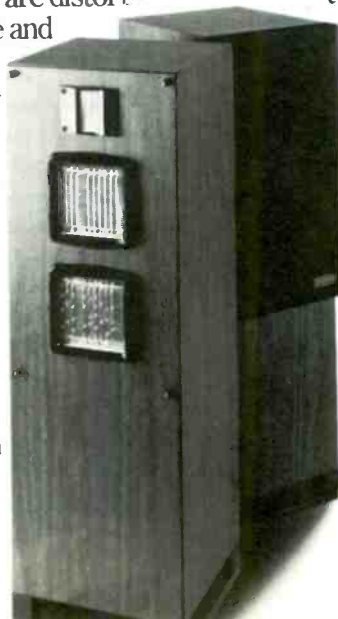

MUSICAL

The CARVER C-1 Sonic Holography Preamplifier: Appreciated for Musicality

Acclaimed for superlative performance, meticulous engineering, high reliability and finest sonic quality, the C-1 fulfills the requirements of the most demanding audiophile. And more...

The C-1 provides a very affordable way to experience the sheer musical pleasure of SONIC HOLOGRAPHY—a recreation of the three-dimensional sound field of the original, live performance.

Sonic Holography has been acclaimed as a scientific and artistic achievement of significant merit. Solving the problems of sonic imagery inherent in conventional stereophonic reproduction, Sonic Holography presents timing and phase information that exists in stereo program material but is normally inaudible.

With Sonic Holography, this information emerges in three-dimensional space around the listener who is thus able to establish the precise location of the instruments and voices.

The Carver C-1 is a quality instrument replete with precision gold-band laser-trimmed resistors, life-time lubricated sealed switches, G-10 glass epoxy boards, and machined solid metal parts; the C-1 provides moving coil input, soft touch controls, an infrasonic filter, a headphone amplifier, dual tape monitors, variable turnover tone controls, silent muting, and an external processor loop.

Its straight-wire engineering assures that a watt of input leaves with just 0.000000251 watts of distortion. Or less.

If you seek new levels of detail, openness and three-dimensionality in an audiophile preamplifier, we invite you to audition the CARVER C-1.



C-1

CARVER

POWERFUL

CORPORATION 19210 33rd Avenue N.W., Lynnwood, WA 98216

MUSICAL

ACCLAIMED

Distributed in Canada by EVOLUTION AUDIO, LTD.

Circle 8 on Reader-Service Card

eral chorus of admiration.

Something else piqued my interest: a reference to the complete recording of *Mother Courage* with Helene Weigel (Eterna 860 122-4). For a year now, I have been seeking a recording by Weigel and Ernst Busch of the songs from that play. How much better it would be to have the complete work! Where can one find this Eterna label? Record dealers have been unable to help me.

Jean-Louis Côté

Ottawa, Canada

Finding that recording anywhere in the Western Hemisphere may be impossible. Eterna is the label of V.E.B. Deutsche Schallplatten, the East German state recording agency. Eterna releases rarely circulate outside East Germany, and when they disappear from the catalog there, they are gone forever.—Ed.

SUPPORT FILM MUSIC

It is surprising that Noah André Trudeau, in his reply to Alan M. Foss and Richard Sebolt ["Letters," February], considers that the use of other composers' "solutions" is a detriment to enjoying film music. It's well known that composers have always borrowed ideas, themes, and styles of contemporaries and predecessors.

It seems a valid contention that film music, despite the rigid demands of the medium, is producing a richly varied supply of new "classically influenced" music. You need only compare scores of the '40s to ones of the '70s to see the progression from the more or less stilted and narrowly channeled ideas of the past to the "anything goes" concepts of today. Probably the largest breakthrough was John Williams's *Star Wars*, which seemed to free up the concept of motion picture music.

The now-much-discussed James Horner is obviously a variant of this school of writing. Personally, I find Horner's scores interesting and listenable and would suggest that *Krull* is his (and his orchestrators') most outstanding work. That it is or is not derivative doesn't matter. It is an effective piece of music, one that I prefer to the atonal hacking and sawing that passed for "serious" music about 20 years ago.

Your magazine doesn't review enough film music—and when Mr. Trudeau does review it, he doesn't seem to enjoy it. It is not too outrageous to say that since music for

Circle 35 on Reader-Service Card ▶

"Polk Reinvents the Loudspeaker."

High Fidelity

Polk's Revolutionary TRUE STEREO SDAs*
Always Sound Better than Conventional Speakers.



SDA-CRS
\$395.00 ea.

SDA-2
\$600.00 ea.

SDA-11
\$849.95 ea.

Digital Disc Ready

"Literally a New Dimension in Sound!"

Stereo Review

"They truly represent a breakthrough!"

Rolling Stone Magazine

Polk's exclusive, patented, Audio Video Grand Prix Award winning SDA technology has been called the most important fundamental advance in loudspeaker design since stereo. In fact Polk's remarkable SDAs are the world's first and only TRUE STEREO loudspeakers. The experts agree; Polk SDA'S always sound better than conventional speakers.

"Astounding"

High Fidelity

Polk's revolutionary TRUE STEREO SDA technology results in spectacularly lifelike, three dimensional imaging and sound. Stereo Review said, "Spectacular... the result is always better than would be achieved by conventional speakers." High Fidelity said, "An amazing experience... astounding... mind boggling... labbe-gasting... extracrinary... cavestatingly dramatic."

"Spectacular"

Stereo Review

Near SDAs' Remarkable Sonic Benefits Now!

"You owe it to yourself" *High Fidelity*

Polk Audio Inc.
1915 Annapolis Road
Baltimore, MD 21230

Canadian Distributor: Evolution Audio

polk audio
The Speaker Specialists®

*U.S. Patent No. 4,489,432. Other patents pending.

For Dealer Nearest You Call TOLL-FREE 1-800-843-3800

the stage theater made up a substantial body of classical music in the past, we need to support today's music for the movie theater to build a new supply of classics for the future.

Robert Tyler
New York, N.Y.

Noah André Trudeau replies: There's a big difference in my book between imitation and creative borrowing. Film composers, who must always make their musical point quickly and effectively, are all borrowers to one extent or another. The best of these composers borrow a known sound idea, build on it, and make it their own. Lesser composers just patch the imitated ideas together and the result is second-rate music.

Concerning the comment that I don't seem to enjoy the film music I review, I've checked the four soundtrack reviews that have appeared in HIGH FIDELITY/MUSICAL AMERICA since my (now controversial) Star Trek III piece in October 1984 and find the tally to be two very positive, one very negative, and one so-so.

And concerning Mr. Tyler's comment that we don't review enough film music, see Mr. Trudeau's featurette in this issue.—Ed.

THE REPAIRMAN WRITES BACK

I own a small stereo service shop and therefore read Robert Long's "What to Do 'til the Repairman Comes" ("Currents," March) with interest. I agree with all that he says,

especially the value of a little troubleshooting in saving time and money. But I would like to amend Step 1 slightly.

It is a good idea to check the fuses. Just knowing that a component blows fuses can help a serviceman figure out what might be wrong. However, fuses usually don't blow without a good reason; they don't just burn out with age the way light bulbs do. So it's vital that you never, ever substitute a larger fuse for the original. Violating this rule can cause expensive damage. (Service shops get a good bit of business from people who try to fix things they don't understand or who say, "3½ amps is close to 3, I think I'll try it.")

Some components are built with separate fuses inside or even a second fuse in line with the one accessible from the back panel. These are intended to protect the unit if the user does install an oversize fuse in the external holder. Most are soldered in place. If you want to try replacing one anyway, that's fine, but it probably will just blow again. And be careful not to touch anything inside the component. Capacitors can store a big charge, and a very unpleasant shock could result from touching the wrong two places at the same time.

Keith Burgess
Burgess Electronics
Riverside, Utah

I especially enjoyed reading "Punked Out" and the music reviews in your January issue. Joyce Millman's review of the dB's is right on target. Could you tell me how I can write

to Mitch Easter, a producer mentioned in the article? Thanks.

R. W. Ammons
Ridgeland, Miss.

International Records Syndicate (IRS), a division of A&M, will be happy to forward mail to Mitch Easter, whose own band, Let's Active, has released a new album entitled Cypress on their label. Their address is 595 Madison Ave., 32nd floor, New York, N.Y. 10022.—Ed.

TRANSLATION NEEDED

Compact Discs are magnificent, and I find myself playing the two dozen I own much more frequently than my hundreds of LPs. Recently I bought a CBS/Sony release of two Mozart violin concertos, played by Pinchas Zukerman with the St. Paul Chamber Orchestra—a very beautiful recording. However, the booklet was entirely in Japanese, even though the cover was in English (giving the impression the notes would be, too). I returned the CD and don't plan to buy another CBS/Sony disc until the booklets are printed in English.

Charles Prager
Orinda, Calif.

Apparently you got hold of a "gray market" CD, imported directly from Japan through other than the authorized channels of distribution. This problem should quickly disappear as CD production increases.—Ed.



the HEYBROOK SYSTEM

Presenting the TT2A Turntable and available soon, Heybrook's C2 Pre Amplifier and P2 Power Amplifier. When integrated with your favorite Heybrook Loudspeakers, you'll agree that this new system from Heybrook is MADE FOR MUSIC.

D'Ascanio Audio
Importers & Distributors of Heybrook In the U.S.
11450 Overseas Highway, Marathon, FL 33050

FOR INFORMATION ON HEYBROOK COMPONENTS, WRITE or PHONE: (305) 743-7130

A Breakthrough in Amplification

The current availability of high performance automotive loudspeakers coupled with high quality sound sources, such as real time cassettes and compact discs, creates a fundamental need for a new breed of mobile amplifier. The Infinity MRA-150 will allow greater recovery of ambience, musical timbre and dynamic range than any competing design; it will provide the power and stability to drive all speakers, including the most inefficient, to satisfying volume levels. There's no longer any reason for the music to get lost in the electronics.

SPECIFICATIONS

- 75 watts RMS per channel into 4 ohms at less than 1% THD \pm 1kHz.
- 60 watts RMS per channel into 4 ohms, 20 Hz - 20 kHz at less than 0.25% THD.
- 90 watts RMS per channel into 2 ohms at less than 1% THD at 1kHz.

FEATURES

- Automatic shut-off/recycle circuits protect against dead batteries, short circuits and thermal overload.
- Tightly regulated, pulse width modulated power supply.
- Made in U.S.A.



 **Infinity**

We get you back to what it's all about. Music.

Infinity Systems, Inc. • 9409 Owensmouth Avenue • Chatsworth, CA 91311 • (818) 709-9400
Circle 43 on Reader-Service Card

CURRENTS

Edited by
Peter
Dobbin



CD Availability: The Line Forms To the Right

Should you put off buying a particular Compact Disc and your local record store runs out of the title, you may find it well-nigh impossible to track it down again for a very long time. The reason is simple: The world's six major pressing plants cannot keep up with the demand created by the tens of thousands of players sold this past Christmas.

Particularly hard hit in this software crunch are specialized titles—jazz, chamber music, show tunes, folk music, and the like. Most of the players being sold nowadays are inexpensive models, priced to appeal to the young buyer whose tastes lean toward mainstream rock 'n' roll. Thus, record companies are allocating their production to suit the new market, leaving more eclectic listeners to wait for a lull that may not soon appear. But even with rock titles, record

companies are finding it difficult to introduce simultaneous LP and CD versions of new releases; the silver discs are, in fact, lagging three to four months behind their black vinyl counterparts.

"When CBS runs out of a title like *A Chorus Line*," a New York record dealer told me, "it has the choice of reordering it or pressing a new album by Cyndi Lauper or Bruce Springsteen. We've been pressuring for more pop titles, and so have the other dealers. The result is that once some of those earlier releases are sold out, they won't be available again for quite some time."

According to Leslie Rosen, spokesperson for an industry trade group, 3,000 CD titles have been pressed, "but that number may include some titles that are no longer available or are in short supply." Rosen was quick to add that no CDs have actually been deleted from record companies' catalogs, "although it's quite possible that some of the slow-moving titles may become collector's items as dealers' stocks are depleted."

The only real solution to the problem of CD shortages is to increase production capacity, but U.S. companies have been slow to take the initiative. Discovision Associates titillated the industry with talk of an independent pressing facility that was "scheduled" to go on-line last year in Virginia. Alas, Discovision's deadline came and went, and the ground in Virginia where the plant was supposed to stand remains unbroken. Major record companies like RCA and Warner/Elektra/Atlantic have been reluctant to commit

themselves to the enormous capital investment such a facility would require. Only CBS/Sony has a pressing plant in the U.S., but its Terre Haute facility has been slow in expanding to meet growing demand.

Limited supply and high demand means a continuation of high prices. Record companies are trying, however, to lower their manufacturing costs by finding a replacement for the expensive plastic jewel-box case that CDs are currently packaged in. WEA recently announced the results of a study by the United States Testing Company it commissioned to determine whether a cardboard sleeve-and-paper envelope would protect a disc as well as the rigid plastic case. The results suggested that the cardboard sleeve offers as much or greater protection against abrasion and temperature extremes. A similar study undertaken by JVC in Japan for WEA corroborated the findings.

Sony, too, would like to replace the present jewel-box case. Its solution is a slimmed-down plastic case with a hinged bottom that will allow users to insert a CD into a car player without first having to remove the disc from the case. Chances are that the three record giants (Polygram, which invented the jewel-box case; WEA; and CBS/Sony) will not come to the same conclusion about packaging, especially since Polygram's senior director, Hans Gout, has been quoted as saying that a cardboard package would have to be introduced over his dead body.

Robert Angus
(Continued on page 18)

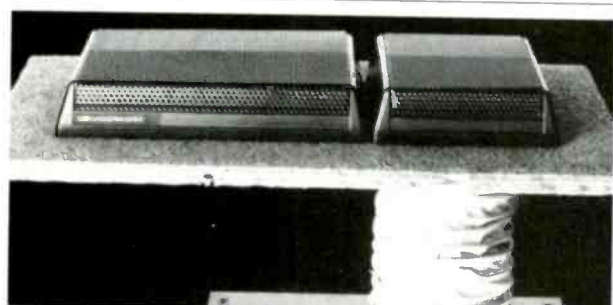

KEF On the Move

One of the most prestigious of the English speaker makers, KEF is bringing its transducer expertise to the automotive realm with two intriguing offerings. Shown here is the company's GFT-200 system, which consists of a panel-mount speaker and a separate subwoofer. The two-way plate speaker (available without an accompanying subwoofer as the GFT-100 system) comprises a 4 1/2-inch woofer and a 1-inch soft-dome tweeter, linked by a close-tolerance, six-element crossover network. The subwoofer modules consist of a pair of 8-liter enclosures, each containing an 8-inch woofer. These units, designed for mounting in the trunk, deliver their output to the interior of the car via a 4-inch diameter opening in the rear deck. KEF recommends that the two-way plate speakers be mounted close to the subwoofer vent on the rear deck, an arrangement that the company says will create a fully integrated soundfield. For more information, write to KEF, 695 Oak Grove Ave., Menlo Park, Calif. 94025.

ULTI-MATES.



If you haven't discovered the ultimate truth about audio cassettes, you're about to. No one makes finer normal or high-bias audio cassettes than TDK.

But don't just take our word for it. Take the sound of our AD-X and SA-X Pro Reference Series audio cassettes as proof. Each is designed to deliver unmatched performance for every type of music.

When you record in the normal-bias position with the Avilyn-based AD-X, you'll discover the higher MOL, broader frequency sensitivity, and greater headroom. All this enables AD-X to handle your most demanding program sources—without distortion.

SA-X, with its unique dual coating of Super Avilyn particles, actually goes beyond the former limits of high-bias. With increased sensitivity and higher MOL across the entire audible frequency range, SA-X delivers saturation-free brightness and clarity never before found in a conventional high-bias audio cassette.

To assure you of an ultimate performance play after play, our specially engineered Laboratory Standard mechanism provides smoother tape transport and better tape-to-head contact for total reliability and trouble-free performance.

You can also obtain the ultimate listening pleasure from two

more TDK Pro Reference Series cassettes: HX-S metal particle high-bias—the ideal cassette for digitally-sourced material—and the world renowned MA-R metal.

Each tape in the series is designed to deliver the purest listening pleasure, plus long-time performance reliability...thanks to the assurance of our Lifetime Warranty.

When you want the finest musical reproduction attainable in any audio cassette, keep this in mind: Ultimately, you'll select TDK.

 **TDK**
THE MACHINE FOR YOUR MACHINE.®



Baby Bose

A ported minispeaker using a single full-range driver, the Bose 101 is a first cousin to the company's Roommate speaker introduced last year. The new model lacks the Roommate's built-in stereo amplifier, but is otherwise identical. Just 9 inches high and 6 inches deep, the 101 should fit into even the most crowded spots. It is available in black with a matching black metal mesh grille or in a white enclosure with a choice of green, blue, red, or white cloth grilles. A pair of 101s costs \$179. For more information, write to Bose Corp., 100 The Mountain Rd., Framingham, Mass. 01701.

A Slimmed-Down Monster

If you've been thinking of replacing your current ten-cents-a-foot speaker wire with the exotic stuff but have been put off by the

price of audiophile cables, Monster Cable says its new Powerline 3 may be just what the accountant ordered. Two 30-foot lengths will cost you \$90—a bargain of sorts when compared to Monster Cable's own top-of-the-line Powerline 2, which sells for \$2.75 per foot. Anyway, if the new cable does what its manufacturer says it does—"eliminates phase inaccuracies, as well as aligning high and low frequencies to travel at the same speed for dramatically improved frequency response and three-dimensional imaging"—who could quibble with the price? For more information, write to Monster Cable, 101 Townsend St., San Francisco, Calif. 94107.



A Cleaner "Window"

The DCM Time Window loudspeaker has had a loyal cult following for years, and we eagerly await a chance to hear the redesigned version, now called the Time Window 1A. According to the manufacturer, the new speaker is more accurate than the original, with a more open soundstage and better sound-image resolution. The speaker also uses new ferrofluid-cooled 3/4-inch dome tweeters for greater power-handling capability. Rated sensitivity is 91 dB for a 1-watt (0-dBW) input. A pair of Time Window 1As costs \$877. For more information, write to DCM Corp., 670 Airport Blvd., Ann Arbor, Mich. 48104.

Circle 21 on Reader-Service Card

Tandberg's engineers designed the TCD-3014A to be the most musically accurate cassette deck in the world. It is an intelligent interface between electronics, machine and [32K] automation, devoid of visual distractions and gimmicks that impress the eyes and deceive the ears.

The only thing ostentatious about the TCD-3014A is its performance.

TANDBERG OF AMERICA

One Labriola Court, Armonk, NY 10504
(914) 273-9150



TANDBERG



CD Storage

If you own a personal computer that uses 5¼-inch floppy disks, you're probably familiar with the plastic storage case pictured here. The manufacturer, Ring King Visibles, discovered that CDs fit as nicely in the case as floppy disks and is offering the locking storage system to music collectors as a potential home for 12 CDs. Such cases are available from just about any computer supply dealer and range in price from \$20 to \$35. If you own a car CD player or Sony's portable Discman, Shore Brothers' new CD/Mate "wallet" may have some appeal. The tote's nylon pockets are lined in velour and can accommodate six discs (without their plastic jewel boxes). A Velcro tab keeps the case securely closed. The CD/Mate costs \$12.95 and is available in black, red, or blue. For more information, write to Shore Brothers, Ltd., 2323 Corinth Ave., Los Angeles, Calif. 90064.



EPI All Charged Up

One of the most interesting electrostatic/dynamic hybrid loudspeaker designs we've seen in quite a while was introduced at the recent Winter Consumer Electronics Show. The EPI Stat 450 combines three electrostatic elements (totaling 60 square inches of radiating surface) with a 10-inch dynamic woofer. It derives its polarizing voltage from an AC wall outlet. The cabinets are relatively compact (measuring 37½ inches high by 17 inches wide by 10½ inches deep), and because the back wave from the electrostatic drivers is absorbed by damping material within the enclosure, EPI claims you'll have exceptional freedom in positioning the speakers in the listening room. A pair of Stat 450s costs \$700. For more information, write to Epicure Products, Inc., 25 Hale St., Newburyport, Mass. 01950.

(Continued on page 20)

FUJITSU TEN
Car Audio

*For those with a
passion for perfection!*

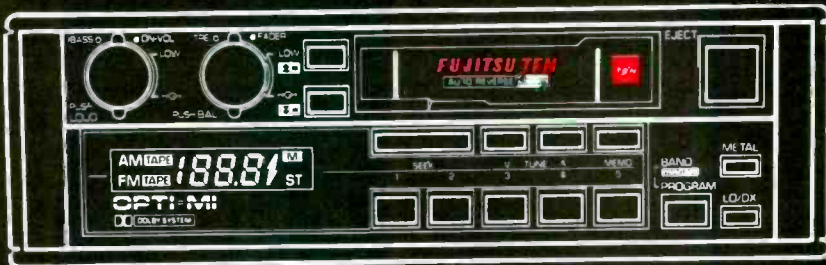

Car audio is our life. There's no way we would settle for less than the best. Why should you?

© 1985, Fujitsu Ten Corp. of America, 19281 Pacific Gateway Drive, Torrance, Calif. 90502. In Canada: Norelco Canada Inc., Toronto, Ontario. Manufactured by Fujitsu TEN Ltd.

Circle 17 on Reader-Service Card

The New Magic!



The 3D303
is now auditioning
in New York City at



The Model 3D303
Defining a new dimension
in bookshelf-speaker dynamics

3D ACOUSTICS

652 Glenbrook Road • Stamford, CT 06906 • 203/327-7199

Discover 3D's magic at fine audio dealers from coast-to-coast.

Circle 16 on Reader-Service Card



ADS's Pint-sized Power Amp

Thanks to a high-efficiency digital power supply, the new ADS P-40 car amplifier man-

ages to pack a lot of punch in a 3½-pound package. The amp's power supply uses a load-sensing feedback-control system that monitors power requirements as they shift with the music being played and adjusts the power converter's output to best meet the dynamic needs of the music. This arrange-

ment, says ADS, results in a 20 percent increase in efficiency and lower operating temperatures. The unit is said to be capable of pumping out more than three times its rated power (20 watts per channel into 4 ohms) in response to instantaneous program peaks. The P-40 costs \$175. For more information,

SYSTEMS & SOLUTIONS

When Your Equipment Needs Repair

Inevitably, the time will come when your system no longer operates as it did when you first set it up. What do you do? Some of the answers supplied by an industry executive who has risen through the equipment-repair ranks may surprise you. At my suggestion, he has chosen to remain anonymous lest readers jump to the unwarranted conclusion that his equipment needs more servicing than average—though, as a matter of fact, most of his hands-on experience has been with other brands.

A very important first step is to locate the source of your problem (see "What to Do 'til the Repairman Comes" in "Currents," March). All too often, my informant tells me, owners will find one speaker dead and ship it off to the shop without even pausing to be sure that the cable from the amplifier has not come loose.

Once you're sure you know the source and nature of your problem and are prepared to give a repairman an intelligible report of what happened when you did what, you must decide (possibly with a little help from the shop) whether repair really is the way to go. And here is the shocker—the point at which New Englanders like me tend to balk. As my mentor puts it, "We've been told so often to think of the starving children in Africa and clean our plates that the idea of just discarding a component is repugnant. But the fact is that more and more of the equipment we use is, in a sense, disposable."

It's a question of economics. A generation ago, when stereo was new, you could spend \$350 on what was considered a good receiver. It was largely hand-built, contained tubes (which not only burn out but generate enough heat to degrade other parts as well), and delivered about 20 watts per channel. If it broke, the repair station might have been able to earn back its overhead with a charge of \$10 or \$15 (plus parts, of course)—making

the repair job worth about four percent of the receiver's replacement cost.

Even if you make no allowance for inflation, economies of scale and automation have brought equipment costs much lower today. A comparable 20-watt receiver may cost \$150, have better specs, and be composed largely of printed circuit (PC) boards studded with integrated circuits (ICs). But other costs, particularly for labor, have risen sharply. To earn back his overhead for merely looking at your receiver, the service man may have to charge \$50—more than 30 percent of the replacement cost, or a relative increase of about 1,000 percent. And the cost of parts and of troubleshooting any problems that pose more than routine difficulty is extra.

Transistors and diodes (including those incorporated into ICs) are quite delicate, and a malfunction in one part of a circuit board may trigger failures elsewhere. And when one element goes, it takes time (and therefore money) to determine what may have gone with it. In many cases, it may cost considerably less to simply replace the whole board with a new one—or with one that has been sent back to the factory, diagnosed on automated equipment, and restored to as-new condition, which costs far less than the hand testing that most repair stations must rely on. In some cases, the cost of repair simply will exceed the entire replacement cost.

This will depend, to some extent, on where you take your problem child for repair. My source strongly recommends factory service stations—that is, warranty repair stations that are actually operated by the company in question. In general, they exist to create satisfied customers. Profits, if any, derive from the brand loyalty and word-of-mouth recommendations the repair engenders, not from the repair fees. And because the facility is devoted to a single brand, the technicians come to know its little foibles intimately. If your receiver rests on a bench that has held a dozen or a hundred other samples of the same model within the last week, little or no exploratory surgery may

be necessary for a complaint that would take the local TV repairman hours to pinpoint.

In part, these considerations also apply to independent warranty repair stations. The intimate knowledge of likely failure modes and the access to parts, circuit boards, specialized diagnostic equipment, and repair manuals and bulletins should be on a par. Cost may be higher at the independent station, however. The dollar allowances that manufacturers write into their warranty-repair contracts usually are very tight-fisted. But if a repair service signs the contracts, it automatically gains both credibility and non-warranty business, so it can afford to make little or no profit on the warranty repairs themselves—as long as it takes care to make a profit on equipment that is no longer under warranty.

More than ever, repair is an unavoidable gamble. If it will cost you \$50 to have your five-year-old receiver looked at, and then you find that the additional cost of the repairs themselves will add up to more than the price of a replacement model with extra features you covet, the initial \$50 is a lost investment. On the other hand, it may be the down payment on a modest repair that will keep the original in fine fettle for another five years. Neither you nor the repair station can tell for sure.

Unfortunately, the gamble may prove largest for Compact Disc players, according to my informant. There is no history of likely failure modes to guide repair services yet, and some of the technology (the laser pickup and its servo guide system, even more than the digital electronics) is foreign to personnel accustomed to receivers and cassette decks. Just how long the tracking and error-correction circuits in typical CD players will continue to perform correctly is anybody's guess. Only when they begin failing in large numbers will manufacturers know what elements need redesign to increase reliability—or even whether any redesign is necessary. Meanwhile, the search for the causes of failure may prove very expensive.

Robert Long

TEAC SPEAKS.



Teac, the voice of authority in the precision reproduction of sound from tape, introduces the 6110 and 6112 Speakers.

We've eliminated the middle man, so to speak, between our playback heads

and your waiting ears. So now you can hear what a Teac does so well, just the way the maker intended.

We could reel off a series of quite impressive specs for you right here. But

those abstractions aren't equal to the sound itself. So, instead, we suggest you visit a Teac dealer where you can hear them with your own ears. And we'll let our speakers do the talking.

TEAC MADE IN JAPAN BY FANATICS.

COPYRIGHT 1984, TEAC CORPORATION OF AMERICA, 7733 TELEGRAPH ROAD, MONTEBELLO, CA 91643

write to Analog & Digital Systems, Inc., 1 Progress Way, Wilmington, Mass. 01887.

SYSTEMS & SOLUTIONS

Audio Cassettes: Is Newer Better?

If there's any constant in the world of audio, it's that cassette formulations are constantly changing. Throughout the year, we receive news of wonderful new cassettes that upgrade past formulations and make taping better than ever. That doesn't mean that your recordings are going to *sound* better, however. In fact, they may sound worse—unless you take some steps to adjust your deck to the characteristics of the new formulation.

If you look at the technical literature, you're likely to see considerable crowing about the increased coercivity and remanence of the new formulations. These figures (which are of little use to the average recordist), are measures, respectively, of the way the magnetic particles respond to the

field of the recording head and the current they induce in the playback head as a result. In the best of all possible decks, increases in coercivity and remanence translate into lower distortion and greater dynamic range in the final recording. To that extent, manufacturers are perfectly correct in calling these tapes "improved."

But increased coercivity also implies that more bias current is necessary to achieve these qualities in the recording. And increased output (remanence) not only implies greater ability to override noise, but altered Dolby tracking as well. The result of both in a deck that's perfectly adjusted for the "old" tape tends to be increased brightness and brittleness in the highs, even though very loud high frequencies probably will be cleaner because of the improved high-frequency headroom. And if you can find a print-through spec (most manufacturers are reticent about releasing it), it will probably show an increase, implying that when you play a cassette after long storage, you're more likely to hear the pre- and post-echo of

loud passages lurking in soft ones nearby.

You can't do anything about print-through, short of taking extra pains to keep stored tapes cool (which slows molecular activity). But you can do something about the altered bias (coercivity) and sensitivity (remanence) problems. If you have a deck whose bias, recording EQ, and recording sensitivity are adjustable, you're well ahead of the game, although some tape upgrades may produce minor irregularities in high-frequency response at any available bias/EQ setting. If the deck doesn't have all three adjustments, it's less likely to do a good job of matching new formulations. And some new tapes may be beyond the adjustment range of an old deck.

Your first line of defense, therefore, is to decide on a tape and have your deck optimized for it by a competent service technician. Once that is done, make sure to use that tape exclusively so you get to know exactly what it can and can't do. And if all your recording is done with a single brand and type of tape, you'll be able to buy the stuff by the

Discwasher.[®] The clear choice for tape care.

To maintain sound quality and prevent damaged tapes, use Discwasher tape care products regularly. The Perfect Path™ Cassette Head Cleaner is a unique, non-abrasive dry cleaning system. Scientifically

designed to remove oxides and residues from the entire tape path and tape heads. Discwasher C.P.R.™ cleans capstans and pinch rollers to prevent tape jamming. To eliminate magnetism problems, use

Discwasher D'Mag.™ For total tape care maintenance, you can trust Discwasher.

Discwasher, the leader in audio care technology, is the clear choice for video care, too.



The sound and sight come through clean and clear.
discwasher

©1985 Discwasher
A DIVISION OF INTERNATIONAL JENSEN INC.

1407 North Providence Road, P.O. Box 6021, Columbia, MO 65205

Circle 2 on Reader-Service Card

What do Beethoven's Ninth, the destruction of the Death Star, Mozart's laugh and rock video's latest thriller have in common?

Uncommon sounds. Sounds that make exceptional demands on your audio system. Because from the crescendo of a massed chorale to the detonation of proton torpedos, the sounds of modern entertainment reward audio high-performance as never before. And nothing performs like Yamaha.

Yamaha's sophisticated new R-9 receiver is designed to make the most of today's home entertainment possibilities. With seven audio and three video hookups, the R-9 can serve as the control panel for your entire home audio/video system. And because it has a separates-quality 125-watt-per-channel* amplifier with Auto Class A Power amplification, it provides the high power and wide dynamic range that add a whole new dimension to your home entertainment experience.

Now you can hear digital recordings and compact discs reproduced with the full clarity and resonance demanded by serious audiophiles. Experience the high-decibel impact of the sound effects that make your

favorite films special. And do it through a receiver so advanced it uses discrete circuitry like that found in Yamaha's finest separate components.

The R-9's AM/FM stereo tuner features digital tuning with a unique 5-digit capability that allows you to fine-tune in increments of 0.01 MHz (FM).

This is particularly helpful in obtaining maximum signal quality when tuning relatively weak stations interfered with by stronger adjacent stations.

Combined with our new Computer Servo Lock Tuning System, it gives you the best of both digital and analog tuning capabilities.

The R-9 includes a multi-function infrared remote control. And it is just one in a complete line of advanced Yamaha receivers.

Now that's entertainment.

*125 watts RMS per channel, both channels driven into 8 ohms, from 20 to 20,000 Hz, at no more than 0.015% Total Harmonic Distortion.

Yamaha Electronics Corporation, USA, P.O. Box 6660, Buena Park, CA 90622.



case for maximum consistency as well as minimum cost. This, in fact, would be good advice even if tapes never changed. When the day inevitably comes that your chosen tape is significantly reformulated or discontinued altogether, try alternatives, make a new decision, and (unless you're satisfied with the combination as it is) have the deck retweaked for the new tape. *Robert Long*

Hooker-upper Helpers

As audio-video systems grow ever more complex, the need for integrated switching devices becomes apparent. Numark Electronics responds with the VS-3200 (\$349), an audio-video switcher with a healthy complement of audio signal-processing features. As a video integrator, it will accept three direct sources (two VCRs plus a play-only machine) and an antenna or CATV feed. Its front-panel dubbing switches give you one-button control over tape copying, and an audio dubbing switch enables you to substitute a new soundtrack during the copying process. A choice of video outputs—either RF modulat-

ed (switchable to Channel 3 or 4) or direct—enables you to use the VS-3200 with a standard TV set or with a video monitor. Its audio-processing features include a variable dynamic-range expander (maximum expansion, 1.4 to 1), a ten-band graphic equalizer, a DNR noise-reduction circuit, and a stereo synthesizer. For more information, write to Numark Electronics Corp., 503 Raritan Center, Box 493, Edison, N.J. 08818.

Dedicated to similar ends is the AV-One (\$580) from Audiosource, an audio-video switcher with additional signal-processing and switching capabilities. Its roster of features makes it similar to a studio mixdown board. There are connections for two VCRs, three direct-video/stereo-audio sources, and a microphone. For audio noise reduction, it offers both DNR and a switchable high-cut hiss filter. Also notable are its mike-line mixing controls, and separate audio and video faders. For video enhancement, the unit also offers separate detail and sharpness controls. For more information, write to Audiosource, 1185 Chess Dr., Foster City, Calif. 94404.



Going Mobile

VDO-Pak's catalog of portable video accessories now includes the CLM-11, a cigarette-lighter adapter and 6-foot cord that lets you use your car's electrical system to power your portable VCR. The \$22 adapter is compatible with 24 VCRs, including models from Panasonic, Magnavox, J. C. Penney, Canon, Sylvania, GE, Olympus, Philco, and Quasar. For a complete catalog of the company's video accessories, write to VDO-Pak Products, Box 67, Port Orange, Fla. 32029-0067.

Keep It Clean

Though Compact Discs seem destined to supplant LPs, many of us still treasure our collections of vinyl discs and work assiduously to assure best-possible sound from this all-too-fragile medium. Proper cleaning is the first line of the defense in the war against LP deterioration, and we're always happy to try a new cleaning system. The latest creation to pass across our desk is Reveal, a water-based solution containing an emulsifier and a vinyl preservative. The complete \$16 cleaning kit contains a 4-ounce bottle of fluid, a fine-mist spray pump, an applicator, and two lint-free drying cloths. (A kit containing 2 ounces of fluid costs \$11, and 4-ounce refills cost \$6.)

The people at Reveal make some large claims for the product, which they back up with laboratory data generated by an independent testing company. Included in these claims are a reduction in low-frequency noise, a significant reduction in total harmonic distortion (THD), and long-term protection against record wear. The lab opines that some of these effects can be traced to the product's lubricating properties and to its ability to loosen and remove the waxy mold-release compound left on the surface of an LP by its stamper. Our informal test of the product couldn't confirm these claims, but we did find it to be an effective cleaning system. If you'd like to try Reveal, the company is willing to forward you a free sample so you can conduct your own evaluations. Just write to Reveal Products Corp., 1931 Arnold Industrial Way, Concord, Calif. 94520.

AR

At AR, we design our loudspeakers for the way people hear. Our continuous research into loudspeaker design, auditory perception and room acoustics, is focused toward one goal: natural, believable sonic accuracy and refinement. Every detail of every AR loudspeaker reflects our precisely integrated system design, from Acoustic Suspension to Controlled Radiation. Stop by your local stereo components dealer, and listen to the new AR loudspeakers. Hear for yourself the sound of perfect harmony.

Optimum Performance.
The sound of perfect harmony.



TELEDYNE ACOUSTIC RESEARCH



BEYOND CONVENTIONAL AMPLIFICATION

ONKYO'S NEW REAL PHASE TECHNOLOGY

Today's speakers, with their multiple driver construction and complex crossovers, differ electrically from the simple resistive load used by amplifier designers to simulate the loudspeaker load. The actual load that is "seen" by the amplifier causes severe phase shift between the voltage and current sent to the speakers. This causes an audible loss of sonic clarity and dynamics.

Onkyo's Real Phase Technology uses not one, but two power transformers to correct this problem. A large high capacity primary transformer together with a special

In-Phase secondary transformer prevents this phase shift, providing increased power output into the loudspeaker load as the music demands it. The result is clean, dramatic dynamics; musical peaks are reproduced with stunning clarity.

Now, the dynamic range of the music can be fully realized. For complete information on the Onkyo Real Phase story, see your Onkyo dealer or write to Onkyo directly.

Shown is our new A-8057 Integra amplifier, with Real Phase Technology and our exclusive Dual Recording Selector.

Artistry in Sound

ONKYO®

200 Williams Drive, Ramsey, N.J. 07446

MAXELL TAKES COMPACT DISC QUALITY OUT OF THE LIVING ROOM.



Ah, the comforts of home. They're tough to leave behind. Especially when it comes to things like your compact disc player.

But even though you might not be able to take the player with you, you can take the brilliant sound quality. If you record your compact discs on Maxell XL-S cassettes.

By producing smaller, more uniform magnetic particles, we can pack more of those particles on the tape surface. Which makes it possible to record more information on a given area of tape.

As a result, AC bias noise is greatly reduced. And maximum output levels are significantly increased. In fact, the dynamic range of XL-S is expanded so much, it can capture everything from the subtle passages to the extreme bursts inherent to compact discs.

So record your compact discs on Maxell XL-S.

Then you can enjoy their sound quality wherever you feel at home.



IT'S WORTH IT.

© 1985 Maxell Corporation of America, 60 Oxford Drive, Manasquan, N.J. 07074.

CROSSTALK

by
Robert
Long



PULLER-INNER

Is there a good indoor antenna I can use with my Onkyo TX-15? My T-wire antenna delivers poor reception on medium-to-distant stations.

Bren A. Hartman
East Lansing, Mich.

No indoor antenna can do as effective a job on distant stations as a high-gain, high-directivity, rotatable outdoor model. "Rabbit ears" designed for VHF TV reception often do better than T-wires because they can be rotated and "tuned." The only current model specifically for FM about which I've encountered favorable comment is the Den-nesen Polaris.

POPS IN POP

The main purpose of my stereo system (Mitsubishi electronics, cassette deck, and turntable, Sonus Super Blue II cartridge, and ESS Model 5 speakers) is to make the cleanest possible cassette tapes from my records—mostly soft rock and country. I usually listen to an album to decide which songs I want to dub and then make the tape the next day. I use only Maxell XL-IIS cassettes, and I clean and demagnetize the deck prior to dubbing. I also clean the record with a D-4 Discwasher and play it on a D-Stat II mat. Yet I still have trouble with pops and ticks.

One magazine article suggested using a KLH TNS-7000 Transient Noise Suppressor. Do you think a DBX Model 224 would help? I'm also confused about what cartridge to use. Some articles say a moving-coil

model would be better, though my receiver has no built-in provision for one. I have heard only good things about the Shure V-15 Type V-MR, but it's a fixed-coil model like my Sonus. The more I read and talk to salesmen, the more confused I become.

J. Richard Damron
Richmond, Va.

Outside of using the Transient Noise Suppressor (or SAE's more readily available 5000A impulse noise reducer), the only measure I can suggest that you haven't already adopted is to avoid introducing a high-end response peak, which tends to emphasize the pops and ticks. Many moving-coil pickups do so; some fixed-coil models do, too, but most (including the Shure) are quite flat at the top end today. Choosing a tape that's too "hot" for your deck also can do so. Try using a less-premium variety—perhaps Maxell XL-II or UDS-II.

"Noise reduction" is an ambiguous term. The DBX 224 isn't designed to remove noise that's already there (your problem), but to limit the amount of hiss added by a process like taping. So I don't see how it would help in this particular context. Finally, some records are noisier straight out of the wrapper than they are after the "polishing" afforded by a few playings. Mobile Fidelity, for instance, specifically avoids "dehorning" its masters so that the grooves will retain maximum fidelity. Maybe you're being too protective of your discs.

PAL OF MINE?

If I get a Sony Betamax like my family in England has, would I be able to play copies of their tapes? Their TV makes mine look sick.

Bill Motttram
Biscayne Park, Fla.

Theirs uses the PAL system; U.S. television uses the incompatible NTSC system. If you got an all-PAL system, it would play the British tapes but not American ones, and it would probably require 50-Hz, 220-volt line current for correct operation. If your British contacts could send NTSC dubs, it would be much simpler—for you, if not for them.

KEEP YOUR GUARD UP

Does the manufacturer of Sound Guard record preservative still exist, and where can I contact it? The refill bottles are virtually impossible to find, and I don't want to buy the whole kit to get more fluid.

Phil Cohen
Bay Harbor, Fla.

Audio-Technica, which recently took over Sound Guard, has revamped its whole accessory line. The new products may have begun reaching dealers by the time you read this. If you can't find Sound Guard and can't wait, call Audio-Technica at (216) 686-2600; if you ask for the Sales Department, they'll give you the names of dealers in your area.

SENSITIVE SUBJECT

Your review of the Yamaha T-80 tuner [January] puzzles me because of the comment about

sensitivity ("disappointing") and the figure shown (21 dBf in mono). I have a Mitsubishi DAR-15 receiver, bought on the basis of your review of the DAR-25 [March 1982], which indicated 14-dBf mono sensitivity. The Yamaha's sensitivity definitely is better than that of the Mitsubishi. Perhaps your report should have included a DX sensitivity figure for it; that measurement, I feel, must be better than 14 dBf.

B. H. Etling
Solvang, Calif.

The 21-dBf figure you quote for the T-80 is for the DX (narrow IF bandwidth) mode. If you look at the quieting graph, you'll see that the DX and wideband curves converge at about -50 dB—the noise suppression at which sensitivity is rated—so the two mono sensitivity figures are virtually identical. And sterling as the T-80's virtues are, outstanding sensitivity (like the DAR-25's) is not one of them. I suspect that the problem lies in assuming that your DAR-15's tuner is identical to that in the DAR-25. If you're using the "detuning" feature of the Yamaha to get a cleaner signal than it can derive at the exact carrier frequency, that may help, and your sample may be different from the one that we tested. But neither of these factors could make up the significant difference between the quieting curves on the two products we reviewed.

We regret that the volume of reader mail is too great for us to answer all questions individually.

BASICALLY SPEAKING

by
*Michael
Riggs*



What You Can Hear: Loudspeakers

For the last couple of issues, I've been discussing what you can and can't hear from the standpoint of component features and specifications. This column continues that theme. For a description of the underlying philosophy, see "Basically Speaking," May and (especially) April.

This being a loudspeaker issue, it seems only fitting to touch upon a matter relating specifically to that topic. For almost as long as high fidelity sound has been available, audiophiles have debated the relative merits of electrostatic and dynamic loudspeakers. The latter are by far the more common, because they are reliable, relatively inexpensive to manufacture, and can be made to sound good and play quite loud. Their building blocks are drivers of various sizes, each consisting of a cone or dome diaphragm mounted rigidly at its apex or edge to a coil of wire (the voice coil) immersed in a magnetic field. (Normally, this field is supplied by a strong permanent magnet at the back of the driver's frame). When an alternating current, such as the audio signal from a power amplifier, is passed through the voice coil, it induces an alternating magnetic

field that interacts with the field of the driver magnet, causing the coil (and therefore the diaphragm) to vibrate back and forth in synchrony with the input.

An electrostatic arrives at the same end by slightly different means. The diaphragm consists of a very thin sheet of some insulator—usually polyester—impregnated with enough of a conductive substance to allow it to hold an electrical charge. It is suspended between two metal grids, to which the amplifier leads are attached. A DC "polarizing voltage" is applied to the diaphragm to keep it constantly charged. When signal current from a power amplifier passes through the grids, their resulting electrostatic charges (which are of opposite polarity) push and pull the diaphragm back and forth between them by means of electrostatic repulsion and attraction.

The classic advantages of electrostatic drivers are their low distortion (arising from their highly linear push-pull mode of operation) and their potential for full-range operation, without crossovers to split the signal into two or more frequency ranges for reproduction by specialized drivers. On the other side of the coin is the difficulty of getting adequate deep bass reproduction (because of cancellation from the diaphragm panel's backwave), high volume (because of excursion limitations), or wide treble dispersion (because of the large size of the diaphragm required to get adequate loudness). Electrostatics are also more failure-prone than dynamics.

This is not to say that these problems are insurmountable or that excellent electrostatic loudspeakers are not possible. Indeed, some of the world's most beloved designs have been electrostatics. The reason is what tends to be the characteristic electrostatic sound, which is clean, dry, and precise, possessing excellent detail and stereo imaging. And many people have considered these qualities desirable enough to put up with the limitations that often attend this type of design.

The question, however, is whether the "electrostatic sound" is really something unique to electrostatic drivers or merely an effect that could be mimicked by dynamic speakers. Proponents of electrostatic design attribute it to low distortion and superior transient response and usually claim that dynamic drivers are inherently inferior in these respects. The evidence is mixed, however. It is true that electrostatic elements produce unusually low distortion, but carefully designed dynamic drivers also can be very good in this respect. And they actually have better transient response than electrostatics, which usually exhibit a multitude of poorly controlled diaphragm resonances. As a result, they tend to continue vibrating after the driving signal has terminated. (Fortunately, the amplitude of this "ringing" is low enough that it probably is completely inaudible.)

If I were to pick one thing as the most likely source of the electrostatic sound, it would be radiation pattern. Because they

typically are panels with large radiating surfaces, electrostatic loudspeakers are usually rather directional. This minimizes reflections off the side walls, floor, and ceiling that can muddy the sound and degrade stereo imaging. Support for this theory can be found in the new Acoustic Research MGC-1 loudspeaker, which sounds much like an electrostatic with unusually good bass when its side drivers are turned off. Significantly, this speaker is designed so that the output from its forward driver array is restricted to a relatively narrow angle both horizontally and vertically. (See "Sonic Marvels," page 36.)

But there may be other contributing factors. In single-driver full-range electrostatics, such as the Quad, the absence of the usual interference effects between the outputs of several drivers helps smooth both the frequency response and the radiation pattern. And the absence of crossovers helps maintain accurate phase response. (I'm not convinced that this matters, but it can't hurt.) Another possible contributor is the bass leanness of most electrostatic speakers, since increasing low-frequency response tends to obscure midrange detail (a psychoacoustic effect known as upward masking). Perhaps that's part of why the old West Coast sound of years gone by entailed boosting the presence range as well as the bass: to keep the sound from losing too much of its clarity behind all that boom.

A FACE THAT ONLY AN AUDIO BUFF COULD LOVE.

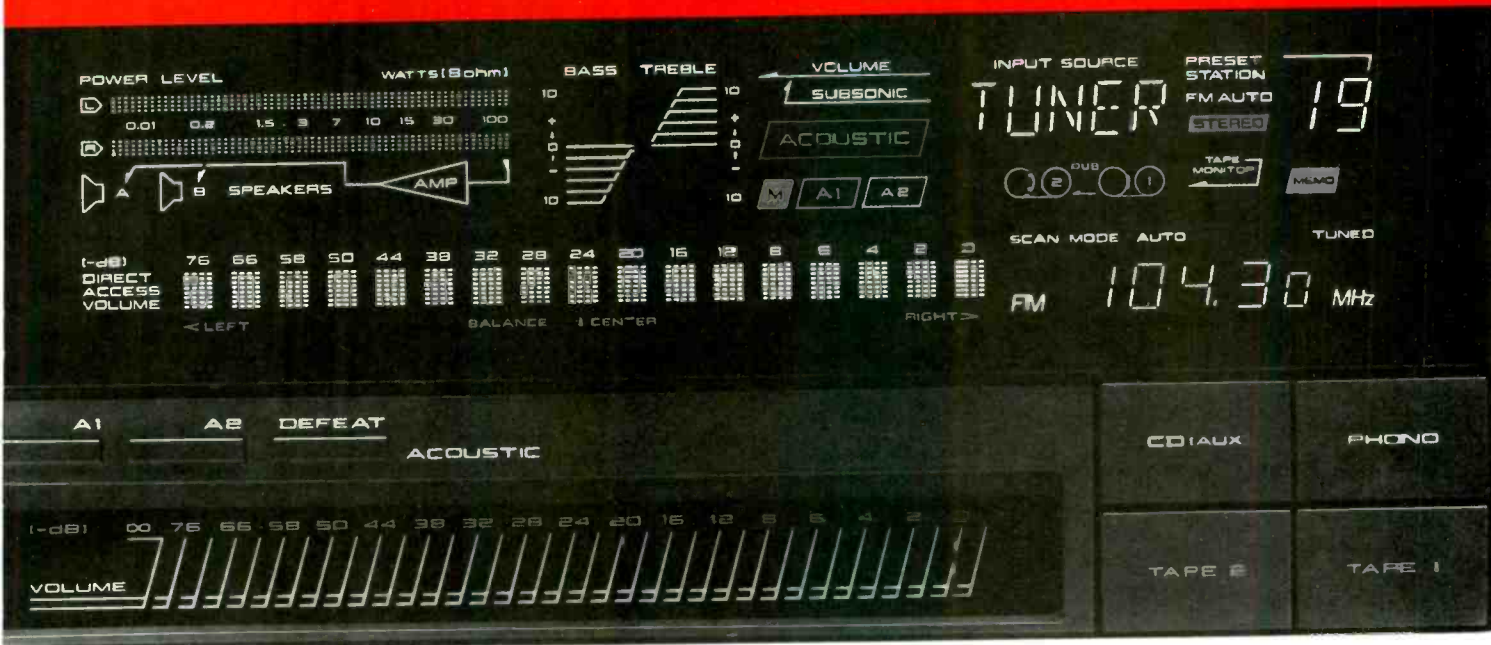

This isn't just another pretty face. It's a masterpiece of electronic sophistication and technical wizardry.

One look at its dazzling FL display gives you instant verification of station frequency, memory program number, output and input source, Acoustic Memory settings and virtually every other AA-A45 receiver operating function.

You'll find AKAI innovations like Direct Access Volume Control. Just one of many computer-controlled functions, it responds with instantaneous volume settings at the touch of a bar. A special safety circuit automatically prevents

abrupt volume increases and resulting performance problems.

Tuning is also at your fingertips, thanks to 20 Station Random Pre-Set Memory. An advanced tuner section that incorporates quartz frequency synthesis for continuous, drift-free reception.

There's even a Zero-Drive circuit that eliminates distortion and negative feedback. A Dual Pole DC Servo Circuit for greater signal resolution and musical fidelity. And an MC head amp with Moving Coil Cartridge compatibility.

But the thing you'll really love about the AA-A45 is its reasonable price.

Because while a lot of companies can design a receiver that an audio buff would love, AKAI's also designed one that you can afford.

For more information on AKAI's full line of receivers, write to AKAI America, Ltd., P.O. Box 6010, Compton, CA 90024.

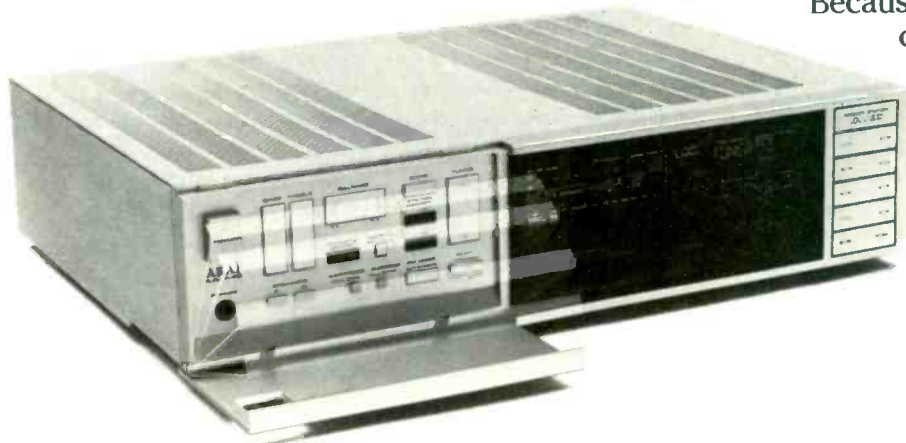

AKAI

THE AUTOPHILE

by
Jay
Taylor

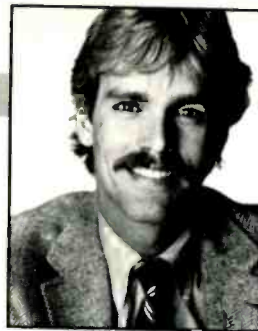

Keeping the Bad Guys At Bay

High-spec car stereo products are must-have items for many of us. Unfortunately, their allure extends down to the less reputable members of society, making theft a problem that most owners will experience sooner or later. So grave has the problem become that car stereo manufacturers have joined in the fight, applying their considerable engineering know-how to come up with antitheft devices.

If you're the type who thinks that all alarms are useless—that a dedicated thief will get what he wants no matter what steps you take to dissuade him—you're at least partially wrong. Sure, pros can probably work fast and clean enough to get your car stereo (and possibly your whole car) without tripping an alarm, but a large percentage of would-be thieves are ham-handed amateurs who can mess up your car interior in a hasty attempt to rip out the electronics and speakers. It's much more expensive to repair a ravaged dash and electrical system (and perhaps a power window mechanism) than it is to replace a car stereo, so why not foil the attempts of those whose are destined to cost you the most?

Don't fall into the trap of thinking that insurance is an adequate safeguard against theft. Insurance will cover the cost (a) if you have a separate rider and (b) if you pay a premium for that

rider. But insurance companies cover their losses by bumping up that premium if your system is stolen. However, if you install a security device, some companies will give you an up-front discount of about 15 percent. And because the likelihood of theft decreases with an alarm in place, you'll be helping to avoid any future premium increases.

Before you buy an alarm, you must do some homework. If you want the discount on your insurance premium, ask your agent what kind of alarm merits it. Companies differ in what they feel are adequate security measures. Then decide exactly how sophisticated and complex your setup will be.

The lowest level of security involves protecting just your stereo system. One of the easiest and least expensive ways to protect the front end is with an alarm module available for all of JVC's new in-dash receivers. The KS-U2K (\$40) is wired between the receiver and the car's horn. If current is interrupted in the line, such as when a thief cuts the wires leading to the radio, the horn blares a warning.

Taking things a step further, if the thief can't get into the car, both the car and the stereo system are safeguarded. The traditional first line of defense against intruders is pin sensors mounted in the door-jamb. More sophisticated alarm setups add sensors capable of reacting to the slightest motion of the car and sonic discriminators that react to the sound of breaking glass.

Do you have to spend a fortune to protect your car and its contents? Absolutely not. Pio-

neer, a major contestant in the car stereo business, attracted lots of attention at the recent Winter Consumer Electronics Show with its response to the car security problem. The company's initial offerings, four systems ranging in price from \$420 to just \$100, combine multi-mode sensors with a healthy complement of convenience and fail-safe features.

The top-of-the-line PAS-400, for instance, can be activated or deactivated from outside the car via hand-held RF (radio frequency) transmitters. The heart of the setup is an ultrasonic sensor that reacts to movement within the car. Glass-breakage detectors, hood and trunk sensors, an ignition cutoff relay, and a heavy-duty back-up battery are also included. For \$100 less, the PAS-300 gives you remote control, a shock sensor that reacts to car motion, door sensors, a headlight blinker and siren, an ignition cutoff relay, and hood and trunk protection. Plus, if your car is equipped with power door locks, a series of inexpensive interface modules enables you to operate them via the remote.

If you do your traveling on two wheels instead of four, your options are more limited. Most motorcycle alarms depend on shock sensors that react when the bike is jostled. If you like to cover your motorcycle when it's parked, a neat product from Covr-Larm in Marina Del Rey, California, may be of some interest. The company's Vandl-Larm device (\$90) uses sensors

taped to the underside of the cover—not to the bike itself. An alarm like this, plus body-mounted shock sensors, might be an effective double whammy for thieves.

I promised last month in my WCES roundup of new car-stereo products to fill you in on any notable models that I unintentionally omitted. Well, it looks like I missed a whole new line—but not because of any oversight. JVC, which did attend the yearly trade event, chose to wait until after the show to introduce its latest autosound goodies—15 new products in all. In front ends, look for four new standard models, ranging in price from \$340 to \$180, and four Audio Express entries: the KSRX-450 (\$400), the KSRX-250 (\$340), the KSRX-115 (\$260), and the KSRX-105 (\$230), each with high-power output stages and high-visibility amber readouts. The top models in both the standard and Audio Express lines continue the parade of flat-faced receivers that began at the WCES.

New to JVC's speaker lineup are two 4-inch and two 6½-inch models. Also notable is the first 5-by-7 three-way speaker designed to fit the rear deck of new Chrysler cars: the Model CS-5731 (\$120 per pair). JVC's more exotic entries include the CS-6940 (\$200 per pair), a 6-by-9 four-way design, and the CS-80K (\$170 per pair), a plate-type component system with a 5¼-inch woofer and a soft-dome tweeter.

"My high-tech training gives me something I didn't have back home. A high-tech future."

SP4 Wayne Haney, Telecommunications

"I knew I needed a high-tech skill to compete in today's world, but none of the jobs back home in Cedar Rapids, Iowa, offered me the kind of training I wanted.

"I found exactly what I was looking for, in the Army.

"It's funny how things happen sometimes. I visited an Army Recruiter one day and told him what I wanted. He tested me, and said I qualified for a lot of high-tech skills. They all sounded pretty good, but electronics sounded the best.

"So here I am, Wayne Haney, working with electronic switching systems."

Army service is helping Wayne Haney prepare for a brighter future. And it can do the same for you. For more information, see your Army Recruiter. Or call toll free 1-800-USA-ARMY.

**ARMY.
BE ALL YOU CAN BE.**

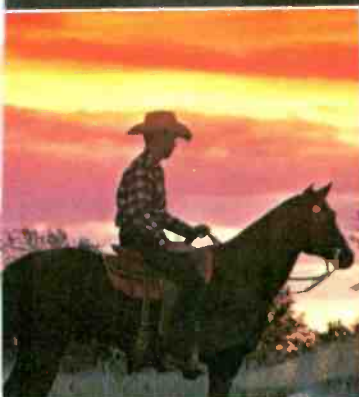

**LEAVE THE WORLD OF MASS-MARKET HI-FI.
ENTER THE NEW STONE AGE.**

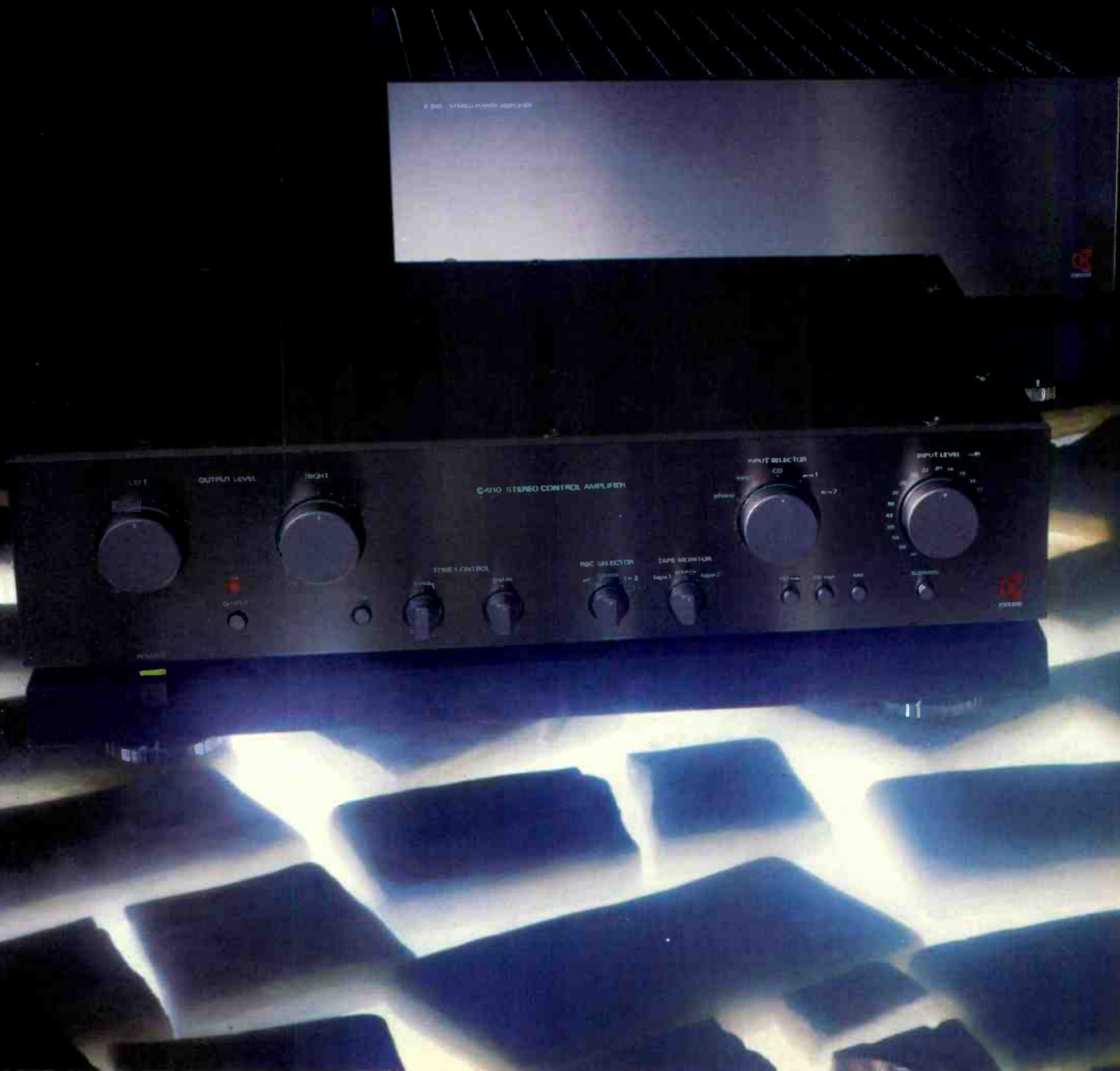

Kyocera believes there are two distinct categories of audio components: hi-fi and high fidelity. Hi-fi is mass produced for a mass market. The principal design objective is reduced cost. High fidelity is made by perfectionists for perfectionists. The principal design objective is sonic excellence. This is the inspiration behind the Kyocera 910 Series.

COMPONENTS FROM THE NEW STONE AGE.

In creating the 910 Series, Kyocera has harnessed the potential of an entirely new generation of materials: Fine Ceramics. Recognized for their rigidity, thermal stability, and anti-resonant properties, these "21st Century" materials are finding new uses in everything from high-efficiency car engines to computers. And now Kyocera puts Fine Ceramics to work in the fight against audio resonance.

Most mass-market hi-fi is defenseless in the face of vibration and resonance. Not only can resonance interfere with the signal content; it can even generate spurious signals of its own, which impair sonic resolution. Kyocera attacks this problem with a Ceramic Compound Resin (CCR) base formulated for incredible resistance to vibration. Kyocera bolts circuit boards, power transformers and heat sinks directly onto the CCR base. And Kyocera encases sensitive, low-level circuits in Fine Ceramic Linear (FCL) modules for minimum vibration in the pursuit of maximum sonic resolution.

A PREAMP THAT'S DISCRETE.

In the world of mass-market hi-fi, integrated circuits reduce cost at some sacrifice in sound quality. Kyocera believes that ICs do have their place—far away from the audio chain. That's why the Kyocera C-910 Control Amplifier uses 100% discrete components in the audio circuit.

ABSOLUTE POWER.

Even mass-market amps perform well in the laboratory. But they struggle under real-world conditions. Like low-impedance loads and dynamic digital material. The Kyocera B-910 Power Amplifier has a huge 600 VA seamless core power transformer and giant 27,000 μ F filter capacitors to confer absolute power, driving all loads, under all operating conditions.

A MOST INTELLIGENT TUNER.

Most mass-market tuners have only one antenna input and one IF section. In contrast, the Kyocera T-910 switches between two antenna inputs and two IF sections for first-class reception. What's more, the T-910 is smart enough to remember the right settings for each preset station.

How much does all this cost? In mass-market terms, the Kyocera 910 Series is admittedly expensive. But even in The New Stone Age, one thing remains true. You get what you pay for.



Built right from the ground up.



HERE'S WHERE TO ENTER THE NEW STONE AGE.

ALABAMA

Campbell's Audio Video
Huntsville
205-539-9806

ARKANSAS

Custom Audio
Little Rock
501-227-9077
North Little Rock
501-758-0053

ARIZONA

Jerry's Audio
Phoenix
602-263-9410
Tucson
602-747-7267

CALIFORNIA

Audio Excellence
San Francisco
415-433-1335

Beverly Stereo
Los Angeles
213-651-3523

Catania Sound
San Rafael
415-479-7043
Santa Rosa
707-526-7555

Century Music
San Jose
408-998-7474

D B Audio
Berkeley
415-548-8733

Dimensions in Stereo
Torrance
213-542-8521

Garland Audio
San Jose
408-244-6724

Gross National Product
Pasadena
818-577-7767

Hermery's
San Carlos
415-592-9480

House of Audio
Goleta
805-967-2341

Monterey Stereo
Monterey
408-649-6303

CALIFORNIA

Safe and Sound
Santa Monica
213-392-3031

North County Stereo
Encinitas
619-753-2081

Serra Stereo
Colma
415-992-5018

Sound Advice
Bakersfield
805-323-0636

Sound Center
Woodland Hills
818-883-2811

Stereo Design
San Diego
619-573-0060

Stereo Showcase
Vallejo
707-552-1515
Sacramento
916-483-5141

Stereo Solution
Santa Cruz
408-458-9111

Systems Design Group
Redondo Beach
213-370-8575
Sherman Oaks
818-783-9507

COLORADO

Boulder Sound
Boulder
303-444-2640

Innovative Home Audio
Colorado Springs
303-574-3055

CONNECTICUT

Audiotronics
Norwalk
203-521-7250

Aud-Vid Inc.
Greenwich
203-869-0666

Car Stereo Consultants
Danbury
203-748-0311

The Stereo Shop Inc.
Hartford
203-521-7250

Tweeter Etc.
New Haven
203-562-4617

DISTRICT OF COLUMBIA IOWA

Meyer Emco
Washington, DC
202-293-9100

FLORIDA

Sound Performance
Coral Gables
305-446-8055

Stereo by Design, Inc.
Miami
305-232-1812

GEORGIA

High Fidelity SSS
Atlanta
404-237-6336

The Stereo Shop
Lilburn
404-925-7123

ILLINOIS

Absolute Audio
Rockford
815-962-2806

Audio Consultants
Evanston
312-864-9565
Hinsdale
312-789-1990
Libertyville
312-362-5594

Audio Enterprises
Chicago Heights
312-754-6056

Audio Labs
Spring Valley
815-663-6941

Glen Poor's Audio
Champaign
217-356-5456
Normal
309-454-1493

Paul Health Audio
Chicago
312-549-8100

Quintessence Audio Ltd.
Naperville
312-357-4190

INDIANA

Audio Specialists, Inc.
South Bend
219-234-5001

Audio Labs, Inc.
Des Moines
515-288-2216

Audio Odyssey
Davenport
319-391-2244

KANSAS

Audio Mart
Leawood
913-648-1333

Audio Plus
Wichita
316-688-0614

Audio Specialists, Inc.
Hays
913-628-8313

Kief's Gramophone Shop
Lawrence
913-842-1544

KENTUCKY

The Stereo Shop
Lexington
606-278-7278

LOUISIANA

Wilson Audio
New Orleans
504-866-3457

MAINE

Harbor Audio Video
Camden
207-236-9596

New England Music
Scarborough
207-883-4173

MARYLAND

Meyer Emco
Rockville
301-468-2000

MASSACHUSETTS

Prism Electronics
Brockton
617-588-9020

Hanover
617-826-4546
Hyannis
617-771-7280

Stereo Shoppe of MA
Newton
617-964-1020

MICHIGAN

Alma's Hi Fi Stereo

Dearborn
313-584-1860
Birmingham
313-644-5230
Farmington Hill
313-553-4360

Stereo Center

Flint
313-239-9474
Ann Arbor
313-663-3600

MINNESOTA

Perfectionist Audio

Mankato
507-345-7186

Audio by Design

Wayzata
612-541-1300

MISSOURI

Flip's Stereo

Crestwood
314-842-1600
Ballwin
314-227-6121

NEBRASKA

Custom Electronics

Omaha
402-397-4434

NEW JERSEY

AC Audio

Raritan
201-526-1777

Audio Advocate

Union
201-467-8988

Audio Guild

Englewood
201-569-7766

Franklin Lakes Stereo

Franklin Lakes
201-891-4745

High End Associates

Upper Montclair
201-744-0600

Hi-Fi Connection

Deptford
609-228-0002

Sight & Sound

Morristown
201-267-6700

Sound Inc.

Northfield
609-646-2200

The Speakerman

Hawthorne
201-427-4967

Woodbridge Stereo

Woodbridge
201-636-7777

NEW JERSEY

Woodbridge Stereo

West Long Branch
201-542-5255

NEW MEXICO

MC2 Entertainment Inc.

Los Alamos
505-662-2016

Sound Ideas

Albuquerque
505-292-1188

NEW YORK

Audio Breakthroughs

Manhasset
516-627-7333
New York
212-595-7157

Audio Salon

New York
212-249-4104

Audio Visual Concepts

New York
212-532-8844

Aurico Sound

New York
212-319-6200

Continental Sound

Rego Park
718-459-7507

Gala Sound

Rochester
716-461-3000

Harmony House II

New York
212-751-9188

Lyric Hi Fi

New York
212-535-5710

Marrt Electronics

Cedarhurst
516-295-2100

Performance Audio Video

Freeport
516-378-4389

Stereo Emporium

Buffalo
716-874-3372

Thalia Hi-Fi

New York
212-861-0420

The Listening Room

Scarsdale
914-472-4558

NORTH CAROLINA

Stereo Showcase

Charlotte
704-334-0744

OHIO

Jamiesons

Toledo
419-536-8397

OHIO

Stereo Showcase

Centerville
513-435-0946

The Audio Arts Company

Youngstown
216-758-2158

OKLAHOMA

Contemporary Sounds of Oklahoma

Oklahoma City
405-755-0795

Imperial Sound

Tulsa
918-622-6111

OREGON

Audio Alternative

Beaverton
503-297-1127

Hawthorne Electronics

Portland
503-234-9375

PENNSYLVANIA

Chestnut Hill Audio Ltd.

Philadelphia
215-923-3035

House of Records

Erie
814-456-6713

TENNESSEE

Watkins Stereo

Kingsport
615-246-3701

TEXAS

Audio Concepts

Austin
512-459-3321
Austin
512-478-7421

Bjorn's Stereo

San Antonio
512-828-2559

TEXAS

Harolds

Odessa
915-332-4842

Hillcrest High Fidelity

Dallas
214-528-0575

UTAH

Audio Design

Salt Lake City
801-486-5511

VERMONT

Audio Den, Inc.

S. Burlington
802-863-4398

VIRGINIA

Audio Arts Ltd.

Richmond
804-644-8903

Myer Emco

Falls Church
703-536-2900

Videorama Inc.

Virginia Beach
803-497-3802

WASHINGTON

Audiophile Mike's

Wenatchee
509-662-0751

Definitive Audio

Seattle
206-524-6633

WISCONSIN

Flanner & Hafsoos

Milwaukee
414-476-9560

Fond du Lac Hi Fi

Fond du Lac
414-923-1785

The Happy Medium

Madison
608-255-2887



Built right from the ground up.

Kyocera International, Inc.,
7 Powder Horn Drive, Warren, NJ 07060-0227

Sonic Marvels

**New design
innovations push
back the limits
of loudspeaker
performance.**

Around the turn of the century, a then-famous scientist remarked that the government Patent Office might as well be closed down, because virtually everything of importance had already been invented and further major breakthroughs were unlikely. This, of course, was before the advent of such trivial developments as the first airplane flight, the vacuum tube, and the superheterodyne radio—not to mention FM, television, and stereo.

A few years ago, one might have been forgiven for harboring similar thoughts about audio, particularly loudspeakers. Most of today's speakers are essentially iden-

**By
Peter W.
Mitchell**



The heart of the Bose AWMS is a compound resonator—two tubes joined end-to-end with the woofer at the joint. The actual tube length is 2 meters (bottom), but complex folds (right) enable it to be squeezed into an enclosure that occupies just 1½ feet of bookshelf space.

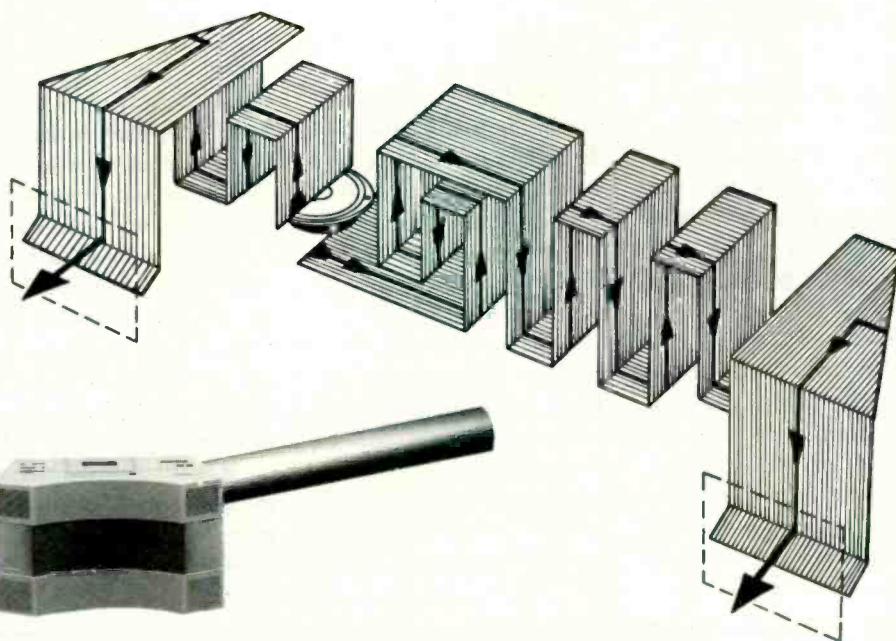

tical to the "bookshelf" models that launched the stereo era in the late '50s. The acoustic suspension woofer, the dome tweeter, and the first practical electrostatic speakers were all developed during the '50s. The quarter century since then has been devoted mainly to refinements (greater power handling, smoother driver response) rather than to fundamental discoveries. There have been a few innovations (notably the Bose Direct/Reflecting idea and the Heil Air Motion Transformer), but they have had relatively little direct influence on other speaker designs.

In the last year, however, three major manufacturers have introduced novel designs that reflect a fundamental rethinking of what loudspeakers can (and should) do. The boundaries of speaker performance have been expanded as a result. One of these new approaches, from Bose, surpasses previous limits of woofer performance. The other two, from DBX and AR, focus on the control and tailoring of off-axis response—to enhance stereo imaging (DBX) and to

diminish the effect of listening-room acoustics (AR).

Bose's Acoustic Wave

Loudspeakers are notoriously inefficient. A typical speaker has an efficiency of only 1 percent, meaning that if you feed 100 watts of electrical power into the speaker, only about 1 watt is converted to acoustic power. The other 99 percent ends up as heat. If this waste could be reduced from 99 to 95 percent, we could obtain with a 20-watt amplifier the same acoustic output that now requires a costly 100-watt amp to achieve.

That's not easy to do, because the inefficiency of the direct-radiator loudspeaker arises directly from basic laws of acoustical physics. Trying to move air by back-and-forth pushing is an inherently inefficient process, especially when the "pusher" (the speaker diaphragm) moves slowly, as it does at low frequencies. The behavior of all direct-radiator speakers is governed by a re-

lationship between efficiency, size, and low-frequency performance that Henry Kloss once called the "iron law" of woofer design.

In simple terms, the iron law says that small speakers can't produce great bass and also be efficient. It's theoretically possible to make a small

The Iron Law

The iron law for woofers is expressed by a simple formula: $\text{Efficiency} = K(L \times f)^3$. L is the linear size of the cabinet, i.e., the average of its length, width, and depth; f is the cutoff frequency, below which the woofer's response rolls off; and their product ($L \times f$) is cubed to determine the efficiency. K is a numerical factor that depends on whether the cabinet is vented (bass reflex) or sealed (acoustic suspension) and on how steeply the response rolls off below the cutoff frequency.

The iron law says that if you want to design an efficient speaker, you can make it large, or you can choose a high cutoff frequency, rolling off the deep bass. The smaller the box and the deeper the bass response, the lower the efficiency.

To illustrate how the iron law works, let's suppose that you have a typical "bookshelf" speaker, 1 cubic foot in size, with a cutoff frequency of 50 Hz. If you want to make a subwoofer that goes down to 25 Hz with the same efficiency, its size must be doubled to 2 feet in each dimension (occupying a volume of 8 cubic feet).

If you want to shrink your 1-foot speaker to a "mini" just 6 inches wide, deep, and high, you must raise its cutoff frequency to 100 Hz in order to maintain the same efficiency. If you try to keep the original 50-Hz cutoff frequency while halving each dimension, you'll find that you need eight times as much amplifier power to produce the same acoustic output.

Peter W. Mitchell

speaker with a very low cutoff frequency for extended bass response, but its efficiency would be so low that you would need a huge power amp to drive it (and water cooling to dissipate the voice coil's heat).

One speaker design manages to skirt the iron law: the horn, especially the Klipsch corner horn that uses the walls of the room as an extension of the horn mouth. The horn acts as an acoustic transformer, boosting the acoustic

output of the woofer hidden within the box. But to reinforce low frequencies, the horn itself must be large, so in practical terms the iron law still applies: A small speaker must sacrifice either efficiency or bass.

This is why the Bose Acoustic Wave woofer has been hailed as a breakthrough. It offers the possibility that a small speaker can produce deep bass and still be efficient enough to operate with modest amplifier power.

The Acoustic Wave system is like the Klipschorn in that the driver is buried within the interior of the box, its acoustic output coupled to the room through a long tube that is artfully folded to minimize the overall size of the system. But in the Acoustic Wave system, the tube is not a horn. It is a resonator, like an organ pipe or a flute.

How is it that a tiny flute can generate enough acoustic power to be heard throughout a concert hall? How does an

organ pipe only a few inches in diameter produce a shuddering bass wave that fills a cathedral? Each is a simple tube containing a column of air that, when stimulated, vibrates forcefully at a fundamental frequency whose wavelength is dictated by the length of the tube (and at harmonic overtones of that frequency). The efficiency of a resonator is directly related to its narrowness of response, which is why a pipe organ contains many pipes of different

HF Puts the Bose AWMS Through Its Paces

The Acoustic Wave Music System is billed as the Bose Corporation's most important product ever. Envisioned by Dr. Amar Bose as a hi-fi system for "everyman," the product's ground-breaking bass-loading technology will probably hold little interest for the audience to which the system will most appeal. Indeed, that's part of the genius of the approach. With the Acoustic Wave technique, Bose was able to create a small, lightweight high fidelity music system that sounds better than superficially similar "boom boxes" but is so simple to operate that even a technophobe should feel at ease with it.

Equipped with a cassette recorder with automatic level control and nondefeatable Dolby B and an AM/stereo-FM tuner with five station presets, the unit is housed in a gray plastic case with integral grilles for the two tweeters and the two ports of the Acoustic Wave bass driver. On the back, there's a set of line-level inputs and outputs and connections for an external 300-ohm FM antenna. Controls are few—just an on/off button, a volume slider, and two cut-only tone controls. The loudness compensation is nondefeatable, but is so tastefully done that we never had any desire to disable it. Of course, there are the usual tape transport and tuning controls, but logic circuits in the AWMS automatically switch to tape whenever the transport is operating and back to tuner when it isn't. To listen to an external source, you have to press an aux button, but that's

as complex as it gets.

Naturally, we were interested in how well the AWMS could perform, particularly with respect to Bose's claims for its novel loudspeaker system. We therefore sent our sample to Diversified Science Laboratories, which subjected it to an extensive battery of tests. The loudspeaker measurements were made with the Music System on an 18-inch stand against a wall, to simulate table placement in a home. As you can see from the graph (right), the on-axis response (solid line) is remarkably smooth and extended: We've seen many full-size loudspeakers that don't do as well.

Bose says that the bump in the bass was put there purposely to compensate for the loss that will occur when the unit is used away from any reinforcing room boundaries. It can be removed by turning down the bass control (which we did for most of our listening). The dip centered on 400 Hz probably is a cancellation notch caused by interference from reflections off the floor. The only other notable irregularity is a sharp peak at 10 kHz followed by a swift rolloff (-3 dB at approximately 15 kHz). Bass response is 3 dB down at approximately 50 Hz, with a fast rolloff below (partly because of the 18-dB-per-octave high-pass filter built into the amplifier). This is about what we'd expect to see from a conventional "bookshelf" loudspeaker twice the size of the Music System's woofer section.

Overall, the on-axis response is within

about ± 5 dB from 50 Hz to 16 kHz. Off-axis response is more irregular, mainly because of a rise in the high treble. (The tweeters are canted slightly outward, so that 30 degrees off axis of the cabinet is approximately on-axis of one or the other of the high-frequency drivers.) And we did find that we preferred a slight treble cut for most of our listening.

The other side of the equation is sensitivity. In a conventional system, the only way to get good bass response from a small box is to sacrifice efficiency. Unfortunately, because the Music System's amplifiers are built in and therefore inaccessible, it is impossible to get a definite reading of the speaker's sensitivity. However, if we accept

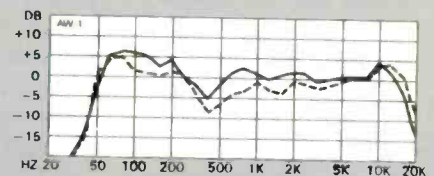

Bose's 25-watt (14-dBW) rating for the bass amp and assume 3 dB of dynamic headroom (about the most you might expect), it is possible to estimate the efficiency from the maximum undistorted output on our 300-Hz tone-burst test—115 $\frac{3}{4}$ dB SPL (sound pressure level).

The first clue that the system is really something special is the number itself, which is typical of what we get from conventional loudspeakers driven with several hundred watts of power. And backfiguring the sensi-

lengths, one for each note.

That "one-note" response makes the organ-pipe principle unsuitable for loudspeakers, which must respond with equal efficiency at every frequency. But Bose discovered a way to join two tubes end-to-end, with the woofer at the joint, to form a compound resonator whose response is fairly uniform over a wide range of frequencies. That involves using the harmonic overtone modes as well as the fundamental resonance modes of

the two tubes, adjusting the compliance of the woofer so that it serves to partially couple the vibrating air columns as well as excite them, and folding the tubes to locate their mouths a critical distance apart so that their outputs interact to yield the smoothest overall response. It's a complex design that required a computer for its optimization.

The Acoustic Wave woofer is making its first appearance in a one-piece stereo system that offers remarkably

good sound (including rich bass to below 60 Hz) in a semi-portable 12-pound package that is only 6 inches deep and occupies just 1½ feet of bookshelf space. The new speaker is likely to prove popular for stereo TV since it can be built right into a 19-inch TV chassis, obviating the need to add external speakers and electronics to get wide-range sound. For more floor-shaking impact, a bookshelf speaker could be designed using Acoustic Wave technology to

produce powerful bass all the way down to 20 Hz.

DBX: Wide-seat Stereo

Before joining DBX, engineer Mark Davis was engaged in psychoacoustics research at the Massachusetts Institute of Technology. In "What's Really Important in Loudspeaker Performance" (June 1978), he

tivity yields a value of almost 99 dB SPL for 1 watt (0 dBW) at 1 meter—a good 4 dB better than the highest figure we've obtained from any other speaker. Indeed, taking into account the bass extension, the size of the enclosure, and the sensitivity, we'd say that the Acoustic Wave Music System enjoys at least a 6-dB efficiency advantage over conventional direct-radiating loudspeakers. This is a remarkable achievement and a major advance in the state of the art.

The other sections of the Music System perform adequately, though not with the loudspeaker's distinction. Tuner sensitivity (for 50-dB quieting) checked in at 25 dBf in mono and 50 dBf in stereo through the 300-ohm external antenna terminals. These measurements may have been degraded by the presence of the unit's whip antenna, which cannot be disconnected. Nonetheless, this is the Music System's least impressive characteristic. Alternate-channel selectivity is 49 dB; capture ratio, 2½ dB; and AM suppression, 42 dB. Distortion is less than 1 percent from 100 Hz to 6 kHz. These are not great figures by home audio standards, but they would not be unreasonable for a car tuner—perhaps a more apt comparison given the Music System's size and portability. Frequency response is outstanding, however, remaining within ±¼ dB from 20 Hz to 15 kHz (better than that of many homebound units), and channel separation is almost as even at 28 dB across the band. Because the cassette section incorporates Dolby B noise reduction, Bose has taken care to thoroughly remove the 19-kHz stereo pilot and 38-

kHz subcarrier, both of which are more than 70 dB down in the audio output.

Because the Dolby is always on, the lab was unable to run playback response curves with its standard test tape. It did, however, take record/play measurements for Type 1 (ferric) and Type 2 (chrome) cassettes. (The manual specifically advises against using Type 4 metal.) Bose suggested BASF Pro-II as the Type 2 and TDK AD as the Type 1. Unfortunately, the bias is fixed for recording on the chrome tape, which means that the ferric is always overbiased, causing a sharp rolloff above 7 kHz. However, equalization is switched (automatically, according to the cassette shell keyways), so that any prerecorded Dolby B tape should play back correctly. Record/play response for the Type 2 tape is very smooth, remaining within +1½, -3 dB from 24 Hz to 11.5 kHz, which is quite respectable for this type of product.

It is hard to see why Bose elected not to switch the bias as well as the EQ, but given only one option, we would have optimized for the Type 1 formulation. People who are unfamiliar with tape are likely to wind up with ferrics rather than chromes, and since the tone controls are cut-only, it is possible to compensate somewhat for the effects of underbiasing, but not for overbiasing. Bose argues that the Type 2 is capable of better performance, and indeed, the signal-to-noise (S/N) ratio with the chrome is 3 dB better than that with the ferric: 67 dB as opposed to 64 dB (both very good, however). Speed accuracy is essentially perfect from 105 to

127 volts AC, and flutter is only ±0.15 percent—good by any standard and superb for a portable.

We've had the chance to listen to the AWMS for several weeks, subjecting it to every conceivable musical genre we could dredge up from the not inconsiderable reserves of our listening room. As to its sound, one staffer summed it up in a word—amazing. The little gray box really can belt out a song. Its bass punch is incredible—deep and detailed, comparing favorably with bookshelf speakers twice its size. Voice is a stringent test of any speaker system's ability to reproduce midrange frequencies, and here too the AWMS shines. From massed chorales to the most lyric solo sopranos, the reproduction was natural and smooth. Only in the highest treble registers did we note anything untoward. But even here, the slightly brittle sound that occasionally lent some extra sheen to brass and strings could easily be tempered by a bit of treble cut.

The Acoustic Wave Music System is no substitute for a full-size audio system. Large speakers and a big amp will give you more volume, deeper bass, and a stereo spaciousness that simply is not attainable with a single-box approach. And the unit's tuner and cassette deck can easily be bettered with separate components. But if you're looking for an all-in-one system that sounds great and demands a minimum of fuss to operate, the Bose AWMS simply has no peer. In fact, at \$649 it is one of the best values around.

Peter Dobbins

The Sight and Sound of
QUALITY

YOU CAN SEE AND HEAR

When you're this good, you put your warranties where your mouth is. That's why, overall, Hitachi probably has the finest limited warranty protection ever offered in home electronics products. Products that perform so well, you may never get a chance to see how good our warranties really are.



HITACHI

A World Leader in Technology



NEW SIGNAL TRACKER COMPONENT TV

Backed by Hitachi's incomparable 10/2/1 limited warranty, this state-of-the-art 20" diagonal flat square tube receiver/monitor integrates all your home entertainment functions. VCR, VideoDisc Player, stereo system, video games, home computer and total TV reception. Enjoy more on-screen picture and less distortion. And only Hitachi has Signal Tracker control, our most advanced color control system ever. With the handy wireless remote control and wood cabinetry you get ease of operation, great sound and quality good looks.

Simulated TV picture.



NEW COMPACT DIGITAL AUDIO DISC PLAYER

Hitachi leads the way in compact disc performance with Laser Life, a two-year limited parts warranty, twice as long as our major competition. Introducing the DA-600. Three spot laser pick-up servo system; wireless remote control that reads, selects, repeats, skips and scans; memory programming for up to 15 selections; slim-line, front load design.

NEW 5 + 2 HEAD HI-FI VCR

With Adjustomatic, a limited warranty superior to industry standards, the exceptional VT-89A VCR from Hitachi has brought hi-fi technology to video sound. Sound finer than any turntable or conventional tape deck... far superior to ordinary VCRs, it's sound you have to see to believe. Five video heads, two audio heads, cable ready, with a computer brain that guides you through every program function. Each step is displayed on your TV screen.



HITACHI

401 W. Artesia Blvd., Compton, CA 90220. (213) 537-8383

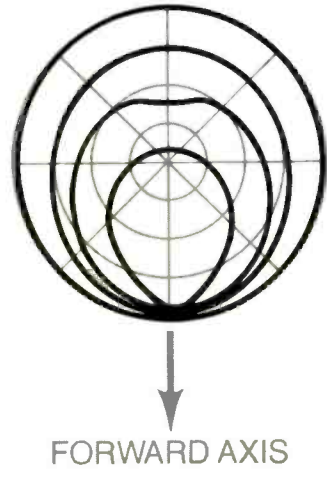

CONVENTIONAL DIRECTIVITY

Fig. 1: This polar pattern of a typical loudspeaker shows the changes in directivity that occur as frequency rises. Progressing from 20 Hz (the outermost trace) through 200 Hz, 2 kHz, and 10 kHz, the radiation pattern becomes increasingly directional.

described an experiment leading to a remarkable conclusion: When an ordinary loudspeaker was used in an anechoic chamber (where all of its off-axis output was absorbed) and any errors in on-axis output were equalized to yield flat response, the speaker became a virtually perfect link in the audio chain.

In a living room with normal acoustics, this result cannot be obtained. No amount of experimenting with an equalizer will eliminate the characteristic colorations of different types of loudspeakers. The reason is well known: In a living room, only a small part of the sound travels directly to your ear from the speaker. Most sound arriving at your ears has traveled an indirect path, being radiated upward, downward, or sideways from the speaker and bouncing off walls and other surfaces before reaching you. A speaker's perceived sound quality therefore depends on its radiation pattern—its response in every

direction, not just in the forward axis.

Accepting that the off-axis response is important, what is the ideal? What should the radiation pattern look like? In view of the anechoic-chamber experiment, you might suppose that the ideal off-axis response would be *no* response, so that you could hear only the on-axis response (and equalize it for perfection, if need be). But it can't be done. At low frequencies, where the wavelength of the sound is larger than the speaker cabinet, all speakers are inherently omnidirectional, radiating the bass with equal strength in all directions. This can't be helped.

If you decide to confine the tweeter's radiation to a narrow on-axis beam, you have an anomaly: The speaker will have strong off-axis output in the bass, little or no off-axis output in the treble, and an abrupt or gradual transition from strong to weak off-axis output somewhere in be-

tween, in the midrange. Because the off-axis sound bounces off the walls and reaches your ears, that transition from strong to weak response must affect the quality of the sound you hear.

In fact, many speakers behave precisely this way (deliberately or not), because tweeters tend to beam the highest frequencies in the forward direction. This behavior is illustrated by Fig. 1, which shows a polar plot (an imaginary overhead view) of the output of a well-known speaker at three frequencies. In the bass, the speaker radiates uniformly in all directions. In the treble, it radiates strongly forward, with little output to the sides and rear. In the midrange, its behavior is in-between, neither uniformly strong nor especially weak off-axis. This speaker's frequency response is flat on-axis, but its off-axis output (and therefore its total sonic output) are dull.

In developing the DBX

speaker, Mark Davis chose two goals: (1) to eliminate the disparity between on-axis and off-axis sound and produce a radiation pattern that is nearly the same at all frequencies, and (2) to improve stereo imaging by shaping that radiation pattern. The first involves making the speaker quasi-omnidirectional in the horizontal plane, with drivers mounted on all sides in order to produce off-axis response curves that are as flat as the on-axis response.

The second goal involves manipulating the two cues that the human hearing system relies on when judging the directionality of a sound source: the relative intensity of the sounds arriving at the two ears and the relative timing of those sounds. In a conventional stereo setup, these cues reinforce each other: If you move off the central stereo axis toward the left, the sound from the closer (left) speaker will arrive at your head first, and it will tend to be

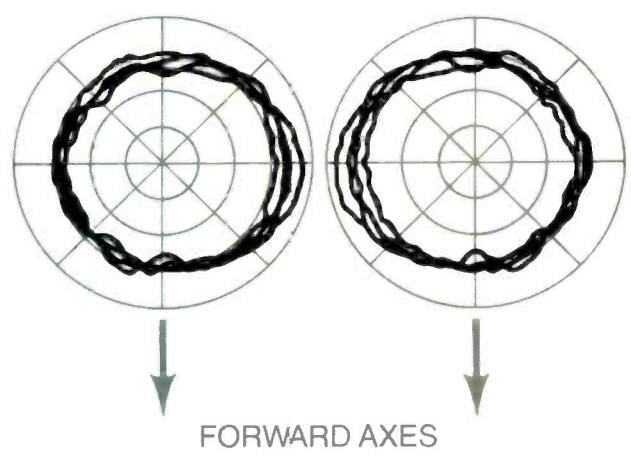

DIRECTIVITY DBX STYLE

Fig. 2: The complex driver/crossover system in a pair of DBX Soundfield One speakers creates a radiation pattern that is virtually the same at all frequencies except the lowest. It is shaped to stabilize the stereo image over a wide listening arc.

ILLUSTRATIONS: NINA WALLACE

THE 1985 MUSICAL AMERICA

INTERNATIONAL DIRECTORY OF THE PERFORMING ARTS

25TH ANNIVERSARY ISSUE

Musical America is pleased to invite you to obtain your copy of its 1985 *Directory* at a publication price of \$50.00.

The authoritative reference source for international listings in music and dance presents in one comprehensive 600-page volume the 1985 listings for:

Music.

Over 600 orchestras, chamber ensembles, opera companies and choral groups are listed with important information on their repertoires, artists and concert halls.

Dance.

From Alvin Ailey to Zorongo Flamenco, over 600 dance companies are listed: ballet theatre, comedy, children's dance, folk and mime. Includes regional and national companies throughout the U.S. and Canada.

Performing Arts Series and Festivals.

A survey of popular and classical music, theatre and dance series sponsored by communities, societies and universities.

Music Schools, Contests, Foundations and Awards.

From small music schools to music departments at major universities. In addition, over 100 international music competitions are accompanied by information on requirements for entry.

Plus complete international listings for:

Music publications. Professional services and organizations. Artist managers. Music publishers. And performance schedules for North American concert halls.

Each listing will also provide you with an address, phone number and the names of key people to contact.

To receive your copy of the 1985 International Directory of the Performing Arts at the publication price of \$50.00, please return the form with your check to: **Musical America**, Circulation Department, 825 Seventh Ave., New York, NY 10019.



R.S.U.P.

MUSICAL AMERICA

CIRCULATION DEPARTMENT, 825 SEVENTH AVENUE, NEW YORK, N. Y. 10019

DJUNE

Please send my copy of the 1985 International Directory of the Performing Arts at the publication price of \$50.

I enclose \$ _____ for

_____ Directory (Directories).
(Price includes postage and handling on U.S. orders. Outside the U.S. add \$10 for surface mail, \$20 for Air Mail.)

NAME _____

ADDRESS _____

CITY/STATE ZIP _____

(IF FOREIGN) PROVINCE/COUNTRY _____

CHECK ENCLOSED

CHARGE _____

MASTER CARD CARD NO. _____

VISA _____

EXP
DATE _____

PAYMENT IN U.S. CURRENCY ONLY (PAYMENT MUST ACCOMPANY ORDER)

more intense than the sound from the more distant (right) speaker. As a result, the entire stereo image tends to collapse into the nearer speaker. Because of this, stereo tends to be a solitary pleasure: A balanced stereo image is heard only by the listener in the "stereo seat" equidistant from the two speakers.

In England, image-conscious audiophiles have long used a technique called time/intensity trading to stabilize the stereo image. The stereo speakers are angled in toward each other at about 45 degrees, so that their axes cross in front of the listener. Now, if you move off center toward the left, you go farther off the left speaker's axis and approach the right speaker's axis, where its sound is strongest. Thus the early arrival of the sound from the closer (left) speaker is approximately compensated by the greater intensity of the sound from

the farther (right) speaker. The two conflicting cues tend to cancel out, and the stereo image remains stable instead of collapsing into the nearer speaker. A similar effect occurs with the Bose 901 system: If you stand in front of the left-channel speaker, the direct sound from its single front driver is offset by strong reflected sound from the four drivers on the angled rear panel of the right speaker, so full stereo is heard.

The DBX Soundfield One system (test report, November 1984) is the first speaker to be specifically designed for time/intensity trading, following a long series of experiments to discover how the radiation pattern should be shaped to provide the most stable stereo imaging over a wide range of listening positions. Davis used a computer to optimize the design of the complex crossover, apportioning signal strength and phas-

ing among 14 drivers to produce nearly flat frequency response in all directions and a radiation pattern that has the desired oval pattern at all frequencies except the very lowest (see Fig. 2). The result is a remarkably open, airy stereo image that can be enjoyed by listeners in a wide range of seating positions.

AR: Controlled Reflection

For many years, "wide dispersion" has been a catchphrase in speaker design as manufacturers have attempted to minimize the disparities between on-axis and off-axis sound by producing speakers (especially tweeters) whose response is flat over the broadest possible angle. Acoustic Research was a leader in that quest.

Narrowly directional speakers are now coming back into fashion among audiophiles who have become aware of the effects of strong reflections off the floor and wall surfaces near the speaker. Three of these effects are particularly important:

1. The "double room" effect. If the sound from the speakers reverberates strongly within the listening room, that room sound is superimposed on the recorded ambience and tends to obscure it.

2. Flat imaging. The ear's perception of details in the stereo image depends on timing differences of less than a millisecond between the channels. Since sound travels in air at a speed of about one foot per millisecond, strong reflections off floor or wall surfaces near a speaker typically arrive at the ear a millisecond or two af-

ter the direct sound, confusing the ear's perception of the delays within the recorded program. Even things like cabinet diffraction can affect imaging.

3. Comb filtering. The mixing of direct and delayed sound produces an alternating series of peaks and notches in the frequency spectrum, with a spacing related to the delay time. A 1-millisecond delay produces notches at 500 Hz, 1.5 kHz, 2.5 kHz, and other frequencies, altering the apparent timbre of the sound.

It is now widely recognized that the legendary clarity of large-pane electrostatic speakers is due at least in part to their narrow directivity, which drastically reduces the incidence of room reflections. There is a single strong bounce off the wall behind the speaker, but very little sound is radiated upward, downward, or toward the side walls from the large, flat panel.

Many recording studios use a pattern of acoustical treatment known as live-end/dead-end design: Surfaces around the speakers are absorptive to suppress early reflections, while the area around and behind the listener is made reflective to integrate the sound field into a seamless whole. Some audiophiles have been adopting similar treatment for their living rooms.

Other listeners have found that by placing the loudspeakers at least two or three feet away from all walls, the stereo image gains noticeably in depth and detail. The greater separation of the speaker from reflecting surfaces weakens any reflections and delays them by several milliseconds—long enough to let the ear/brain system capture all of the timing information in the recording before the first



A pair of DBX Soundfield One speakers has a total of eight 10-inch woofers, eight 4-inch midrange cones, and twelve ½-inch dome tweeters.

LEFT SPEAKER

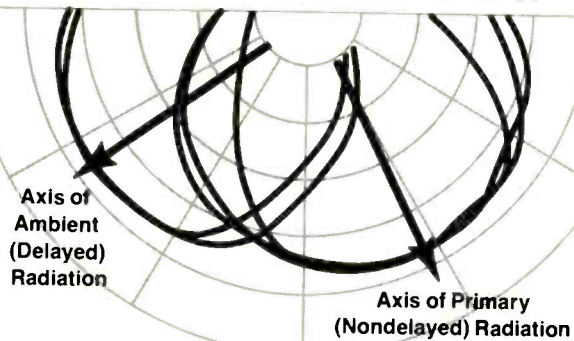

RIGHT SPEAKER

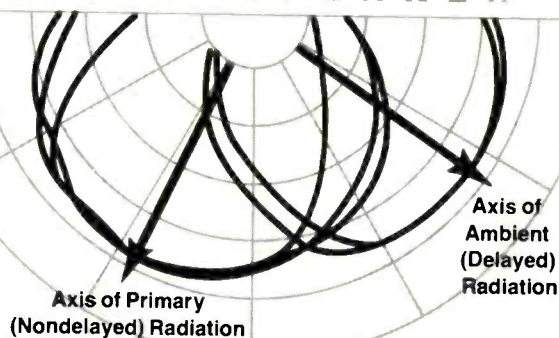

AR MAKES MAGIC

The on-axis, first-arrival sound from a pair of MGC-1s is highly directional and aimed in toward the listening area. The delayed, ambient sound reaches the listener indirectly, after reflecting off a wall. Polar response of the primary drivers is charted at 1.25 kHz, 5 kHz, and 12.5 kHz. Ambient response is plotted at 1 kHz and 5 kHz.

reflections arrive.

A remarkable new speaker system, the Research Series MGC-1 from Acoustic Research, addresses these concerns directly. It is, in effect, two complete speaker systems in one cabinet—one directed at the listener, the other toward the side walls. The front-firing midrange and tweeter are recessed within horn-shaped acoustical absorbers that restrict their radiation pattern to an angle of ± 30 degrees, both horizontal and vertical, effectively preventing any early sound from reflecting off the floor, ceiling, or side walls. These absorbers also prevent the delayed reradiation of sound

that can occur at sharp cabinet corners because of diffraction. As a result, the direct sound from the speaker has much of the clarity and imaging traditionally associated with electrostatic designs.

The most unusual aspect of the MGC-1 is that the side-firing drivers don't produce their sound simultaneously with the front drivers. They are fed from a delay circuit so that the sound reflected off the walls arrives at the listener about 20 milliseconds after the direct sound. (The delay circuitry and amplification for the side-firing speakers are included with the system.) Since a delay of this length would normally be obtained only in a

much larger room, it makes the listening room seem much larger than it is, minimizes the double-room effect, and provides a welcome feeling of bigness to the sound field that is often missing from narrowly directional systems. Moreover, with a delay of this length any comb-filter notches in the combined sound are so closely spaced in frequency that they become inaudible, eliminating a common source of coloration.

As a further bonus, the delay circuitry can be switched to route the L-R difference portion of the stereo signal, instead of the normal left and right signals, to the side-firing drivers. In concert-hall record-

ings, this difference signal often contains a large proportion of the hall ambience. By extracting this signal, delaying it, and bouncing it off the walls so that it arrives at the listener's ears from the sides, a striking increase in three-dimensional realism can be obtained.

Building a speaker system this way, with multiple sets of drivers plus a delay circuit, isn't cheap. But the idea of providing independent control over the direct and reflected portions of the sound is one that holds great promise. •

The author is the principal of Mystic Valley Audio, an audio design/consulting firm.

YOU'VE ALREADY HEARD THE GENESIS 44

If you are familiar with the sound of live music, then you have a good idea what the Genesis 44 sounds like. Julian Hirsch in the December '84 Stereo Review reported, "The Genesis 44's created an unmistakable feeling of depth...that was simply lacking in the sound of other speakers..."

"Whatever the reason(s), we could listen indefinitely without being reminded that we were listening to loudspeakers." Drive units, engineered by Genesis and found in no other speaker in the world give the 44 performance without compromise. Frequency response extends smoothly and

clearly from 23 kHz down to 25 Hz, even at 250 Watt power levels. Correct time and phase response are an integral part of the design. The 44 delivers the

definition, inner detail and imaging previously expected only from the world's most expensive systems.



Like all Genesis speakers, each 44 is individually tuned and tested, and covered by a Full Lifetime Warranty.

GENESIS
physics corporation

225 heritage avenue
portsmouth, n.h. 03801
telephone 603-431-5530

SHOPPING FOR SPEAKERS

An Essential Guide to Seeking Sonic Truth

By TIMOTHY HOLL

The loudspeaker market can be a bewildering maze. Hundreds of models await you, each purporting to represent the highest fidelity. For fear of missing the one special system that outperforms all the others, you study test reports, collect brochures, and beg the advice of friends whose ears you trust. And still you can't decide.

Happily, there is a way out of the confusion. Selecting speakers can be a simple and enjoyable task if you arm yourself with some information. From a technical point of view, all you really need to understand are the meaning and relative importance of a few specifications. What's more crucial is the way you approach listening; making the right decision about speakers demands careful, logically conducted auditions.

Loudspeaker specifications represent a rather dubious area in high fidelity. Because there is no universally accepted set of standards for speaker performance or even for how to measure it, each manufacturer goes about the task in its own way. This makes many of the numbers you'll find on a spec sheet

largely meaningless, especially when you try to compare the products from Company X with those from Company Y. Why, then, should you be concerned with specifications at all? Because there *are* a few measurements that most manufacturers make in a similar way and that do tell you some important fundamentals about a speaker. Plus, HIGH FIDELITY's test reports use the same data-generating techniques for each speaker, thus providing a benchmark across brands.

There are really only two specifications you should pay attention to when shopping: impedance and sensitivity (often referred to as efficiency). Impedance is a measure of the electrical load presented by the speaker to the amplifier. Impedance varies widely across the audible frequency band, but manufacturers usually quote just one number. Use this number as a rough guide to determine whether your amplifier will be happy working with a particular speaker.

Most modern amplifiers will be comfortable operating into typical 8-ohm loudspeakers. Connecting two pairs of 8-ohm speakers in parallel to an

amp results in a total impedance of just 4 ohms, however. And combining pairs of 8-ohm and 4-ohm speakers results in a total impedance of just 2½ ohms. Consult your receiver's or amplifier's operating manual to see if such loads are hazardous to its health. (With receivers especially, some manufacturers disguise the amplifier section's inability to deal with low-impedance loads by wiring the two sets of speaker connectors in series. This has the effect of summing the speakers' impedance, safeguarding the amp at some expense in sound quality.) Impedance is a complex topic, and I urge you to read Peter W. Mitchell's article "The Uneasy Symbiosis" (October 1980) for an in-depth understanding of the intricacies involved in the amplifier-speaker interface.

Now for sensitivity. This usually is quoted as the sound pressure level (SPL) in decibels (dB) generated when a speaker is fed a 1-watt (0-dBW) signal. Should you assume that the higher the sensitivity figure, the louder the speaker will play? And can you learn anything from a sensitivity measurement about the kind of amplifier you'll need? The answer to both questions is a qualified yes. The sound pressure levels achievable by any speaker vary not just with sensitivity and amplifier power, but with room size, room furnishings, and listening distance. (A "minimum power requirement" spec is of only limited value, as it takes no account of your particular listening environment.) To help you select an amplifier-speaker combination that will give you adequate volume in your listening room, use the charts you see here, which reflect the power

requirements necessary to achieve a loud volume (106 dB SPL) with different speakers of varying sensitivity. Each chart depicts power requirements as a function of room size and acoustics.

First, determine whether your room is sonically dead, live, or average. To do this, listen carefully to someone speaking or clapping. If the sound is dull, you have a dead room (lots of drapery, an over-stuffed sofa and chairs, plush carpeting). If the voice is reverberant or hollow, or if the handclap results in an echo, the room is live (fairly bare of sound-absorbing materials). An average room lies somewhere between these extremes. Once you have resolved which chart to use, calculate the room's volume in cubic feet by multiplying its width by length by height.

Keep in mind that these charts reflect a loud peak sound pressure level with average program material. If you do not play your music at such volume, a less powerful amplifier can be used. While thinking about power requirements, don't dismiss a loudspeaker from your audition list simply because your amplifier's maximum power rating does not agree with the speaker's rated maximum power-handling ability. Many people assume, for example, that a speaker with a maximum power-handling rating of 100 watts should never be used with a 150-watt amplifier. But in most cases, such a pairing will work well. If you do not play music at very loud levels, the amp won't strain the speakers in the slightest. It takes music played at disco levels over an extended period to cause drivers to fail.

Now you should consider tonal balance. Can you learn

Formerly chief of research and development for Acoustic Research, Timothy Holl has been designing loudspeakers for 20 years.

PRESENTING THE ALL-NEW 11th EDITION OF THE SCHWANN ARTIST ISSUE

Locate over 25,000 classical recordings
according to orchestra, trio, quartet, conductor,
soloist, vocalist, choral group or operatic company.

The all-new 11th Edition of the Schwann Artist Issue is finally here. And the sooner you return the order form below, the sooner your copy will be in your hands.

This is the first new Artist Issue in three years. Completely revised and updated, it includes 300 pages—over 25,000 listings—that help you quickly locate virtually any classical recording by:

Orchestra - categorized by conductor.

Conductor - their recordings with various orchestras and choral groups.

Quartets and Trios.

Soloists - listed according to instrument.

Operatic and Choral Groups - including soloists for each recording.

Vocalists - and their recordings by composer.

The Schwann Artist Issue is comprehensive and easy to use. And it is the *only* classical recording directory of its kind.

To order your copy of the all-new Schwann Artist Issue, return the coupon today.

Copies will be mailed within 4 to 6 weeks after we receive your order.



Reserve my copy of the
new Schwann Artist Issue.

SJUNE

I enclose \$6.95 (plus \$1 for postage and handling) per copy.

Number of copies _____

Amount enclosed \$ _____

(Payment must accompany order. Payment in U.S. Currency only.)

Name

Address

City
(if foreign)

State

Zip

Province _____ Country _____

SCHWANN ARTIST ISSUE Dept. 11, Single Copy Sales, 825 Seventh Ave., New York, NY 10019

SHOPPING FOR SPEAKERS

anything about how a speaker sounds from published frequency response curves? Unfortunately, no. There are so many different ways of measuring frequency response—and it is so easy to get a “flat as a board” curve—that you’d be well advised to ignore the pretty graphs displayed by speaker companies. Frequency response is affected by many factors, so the only valid way for a prospective purchaser to judge a speaker is to listen to it.

In a store, your first step is to make sure that the speakers are placed similarly to the way they’ll be positioned in your listening room. The effect of placement on tonal balance is so great that unless you can get the dealer to shift his speakers to match your intended placement, you may as well not bother to listen at all. Bad placement can make even the best of speakers sound mediocre.

Many stores have speakers displayed and connected in such a manner that a quick switch can be made between different pairs while auditioning. This is known as A/B comparison, and it can give a good idea of relative merits—if two potential problems are avoided. The first involves dissimilar playback levels. Speakers with differing sensitivities will play at different volumes for the same level-control setting on the amplifier. This makes comparison difficult, as the louder pair invariably will sound more impressive. To overcome this, some stores have level-compensation networks built into their A/B switching systems so that all speakers can play at the same volume. The other problem you should be aware of is that you’ll learn nothing about the relative capabilities of the

speaker pairs if they are placed too far apart. If the two pairs you’re interested in are at opposite ends of the store and the dealer won’t move them together, look for another dealer.

In making your auditions, resist a loudspeaker that is impressive in just one area, such as the bass. Listen instead for well-balanced output. The bass should extend smoothly down to a point that is acceptable to your ears. Overwhelming or thumpy bass is unacceptable. Low-frequency extension can be checked with organ music; bass-drum sounds will disclose any tendency to loose or uncontrolled behavior. Equally important is a smooth, extended treble, which can be judged with music containing snare drums or cymbals. The treble is also crucial because it determines the transient response of the entire system. Indeed, a realistic bass performance depends on both the woofer and the tweeter, with the high-frequency driver handling the attack portion of the notes. Lastly, to check the midrange, play some solo voice recordings and listen for any harshness.

Next, determine how well the speakers create a stereo image: A solo voice should not wander across the soundstage. Then check the speakers’ dispersion pattern. Move around in front of them; if the sound changes dramatically with position, only one person at a time will be able to hear the best sound that your system can achieve.

One final point: Don’t let your budget stop you from auditioning pricey speakers. If you discover a very expensive model with a sound you like, use it as a yardstick to help you find an affordable speaker with a similar sound. •

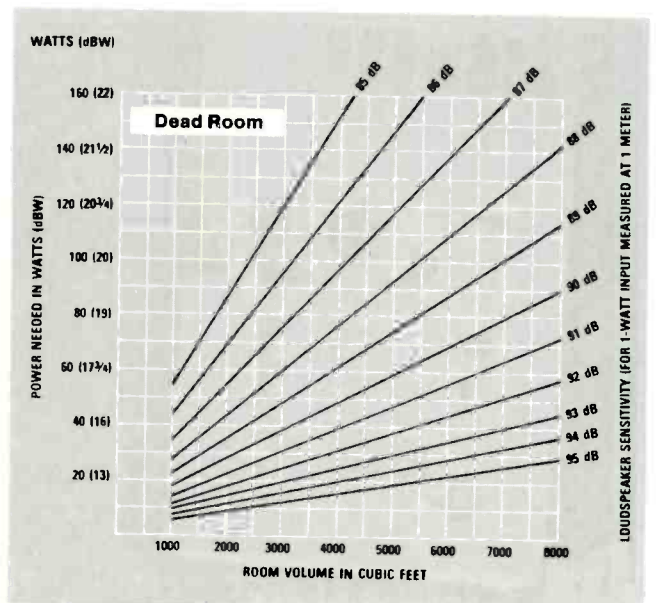
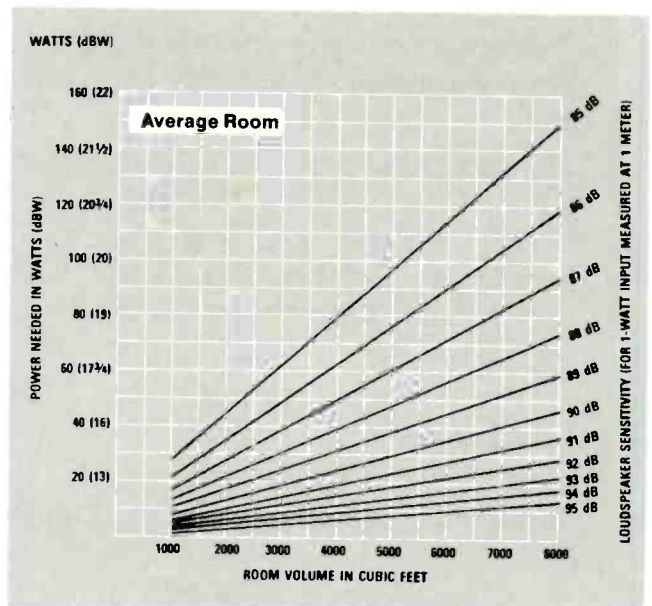
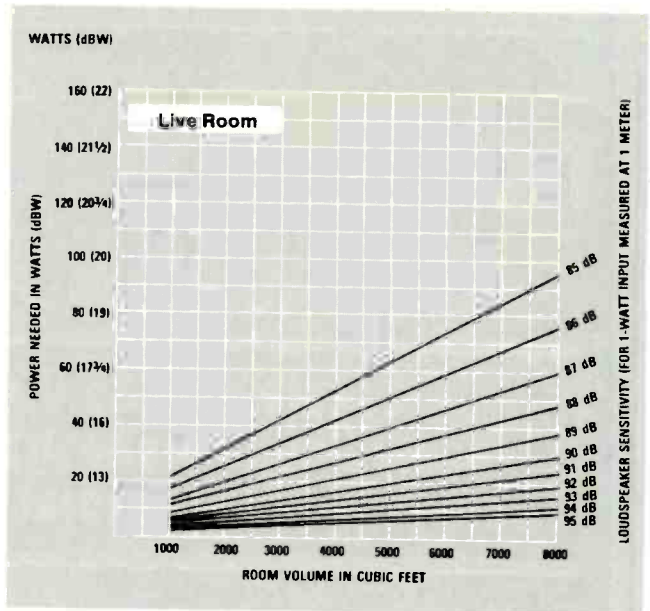



The notion of a high-quality speaker designed to reproduce TV sound may strike some audiophiles as amusing. After all, until a few years ago the quality of the source signal was hardly up to the standards many of us would consider high fidelity. Bypassing the 3-inch speaker built into a typical TV set and routing the audio to a stereo system resulted in little more than full-range reproduction of the buzzes, whistles, and hiss that used to be endemic to TV sound. And if you tried to move your speakers close to the TV set to achieve some congruency between the sonic and the visual images, you'd eventually run into the problem of color smearing and distortion caused by the interaction of the speakers' magnetic fields and the picture tube's electron beam.

The TV-sound situation changed abruptly in 1980 when Pioneer introduced its first Laserdisc player. Suddenly, it was possible to watch a film or concert accompanied by a first-rate stereo soundtrack. (The eventual addition of CX noise reduction to Laserdisc soundtracks further improved the quality of optical videodisc sound.) "Stereo" became the new buzz word in video, and VHS videocassette recorder makers quickly added edge-track stereo recording and playback to their decks. Beta manufacturers didn't rush to match their competitors with the same technology; instead, they waited until they could perfect a truly high fidelity

stereo recording system for VCRs—called, appropriately, Beta Hi-Fi. It took the VHS group more than a year to come up with a response, but VHS Hi-Fi offers similar performance, providing stereo recording and playback with virtually flat frequency response

system for maximum enjoyment?

The answer lies with full-range stereo speakers sized to complement the TV sets and monitors they will accompany and shielded to prevent their stray magnetic fields from interfering with the picture.

VIDEO SPEAKER BUYING GUIDE

and a dynamic range in excess of 80 dB.

Television broadcasters did not sit idly by while these developments occurred. They, too, took measures to improve the quality of their audio feeds, but the big breakthrough—stereo TV broadcasting—had to await approval by the Federal Communications Commission. That endorsement came in March '84, when the FCC gave its nod to a multiplex system with noise reduction, developed by Zenith and DBX. About ten stations have already started broadcasting stereo sound, and some industry pundits claim that as many as 100 stations will be transmitting a stereo signal by the end of the year. Stereo TV represents a turning point for broadcasters, TV receiver manufacturers, and speaker makers. Suddenly, speakers have become the weakest links by far in just about any video setup. With full-range stereo available from broadcasts, videotapes, and videodiscs, how should you configure your

The 28 models detailed in this guide are first-generation responses by speaker makers and TV manufacturers to the challenges such designs represent. The reason I say "challenges" is that no one is sure yet how most people will choose to organize their home video theaters. If you elect to combine your video and audio systems into one unified setup and can somehow arrange the position of your current speakers to create a soundstage that makes sense relative to the center video image, then you probably don't need an additional pair of video speakers. (Many people who integrate their systems rely on their TV set's own speaker to create a mono center channel for dialogue. This anchors the image, allowing the stereo speakers to handle sound effects and ambience.)

If your video components are located apart from your audio system, specially designed video speakers are the best choice. Positioning them

close to the set gives you both a center image and stereo ambience. But how will you power them? Though many video speakers are reasonably efficient, you'll still run into headroom and distortion problems if you rely on the 5-watt amps built into typical "stereo-ready" TV sets. Your best bet is to invest in a modest integrated amp or stereo receiver to handle amplification chores. Some speaker companies have reacted by offering self-powered video speakers—a good idea, but without an integrated amp or receiver nearby, you'll have to invest in an audio-video switcher to handle the routing of signals to the speakers. (Sophisticated TV sets and monitor/receivers are appearing with lots of switching capabilities built in, so you may be able to avoid the expense of an out-board switcher.)

As with any speaker, listening is the key to finding the right model for your tastes. Use this guide as a starting point in your shopping expedition. Factors such as cabinet finish, styling, and size are also likely to be important to you since the speakers will be placed next to the TV set. And finally, though we have dutifully reported information like driver size and acoustic loading, we urge you not to make assumptions about the sound of a speaker based solely on such details. Designing a loudspeaker involves a complex balancing of several factors, the result of which can never be predicted from just a few descriptive comments. *Peter Dobbin*





VIDEO SPEAKER BUYING GUIDE

MODEL	TYPE	WOOFER	MIDRANGE	TWEETER	SENSITIVITY	FINISH	SIZE ¹	PRICE ²
B&W VM-1	Bass reflex	8 in.	—	1-in. dome	90 dB	Silver metallic or black	19 1/4 by 10 1/4 by 10	\$338
B&W VM-2	Acoustic suspension	8 in.	—	1-in. dome	90 dB	Silver metallic or black	26 3/4 by 11 1/2 by 12 1/2	\$538
Boston Acoustics A-40V	Acoustic suspension	6 1/2 in.	—	3/4-in. dome	88 1/2 dB	Wood vinyl	13 1/2 by 8 1/4 by 7 1/2	\$170
Infinity³ VRS-4	Acoustic suspension	6 1/2 in.	—	3/4-in. dome	Not avail.	Black	13 1/2 by 8 1/2 by 7 3/4	\$199
Infinity VRS-3	Acoustic suspension	Not avail.	—	1-in. dome	Not avail.	Black	18 to 25 (height adjustable) by 10 1/2 by 11 1/2	\$299
Infinity VRS-2	Acoustic suspension	8 in.	—	1-in. dome	Amp. ⁴	Black	Same as VRS-3	\$419
Infinity VRS-1	Acoustic suspension	8 in.	2-in. dome	EMIT	Amp. ⁵	Black	Same as VRS-3	\$750
Jensen AVS-5250	Passive radiator	5 1/4 in.	—	1-in. dome	88 dB	Silver	22 1/2 by 8 by 8	\$230
NAD 8100	Acoustic suspension	5 in.	—	1-in. dome	Amp. ⁶	Black	30 1/2 by 9 by 10	\$248
Panasonic SB-405T	Bass reflex	6 1/2-in. full-range cone	—	—	91 dB	Silver metallic	11 1/4 by 7 1/4 by 7	\$140
Pioneer CS-V70	Bass reflex	13 in.	4 3/4-in. cone	3-in. cone	92 1/2 dB	Black	26 1/2 by 16 1/2 by 12 1/2	\$349
Polk VS-12	Bass reflex	6 1/2 in.	—	1-in. dome	93 dB	Silver, black, or wood vinyl	14 1/4 by 8 1/2 by 11	\$200
Polk VS-19	Bass reflex	6 1/2 in.	—	1-in. dome	93 dB	Silver, black, or wood vinyl	17 by 8 1/2 by 11	\$300
Polk VS-25	Passive radiator	6 1/2 in.	—	1-in. dome	93 dB	Silver, black, or wood vinyl	21 by 8 1/2 by 11	\$400
Proton 302	Acoustic suspension	4 1/2 in.	—	1 3/4-in. cone	86 dB	Black hardwood	18 by 6 1/2 by 7 1/4	\$130
Proton 303	Acoustic suspension	4 1/2 in.	—	1 3/4-in. cone	86 dB	Black hardwood	23 by 6 1/2 by 7 1/4	\$150
Proton 312	Passive radiator	4 1/2 in.	—	1 3/4-in. cone	Amp. ⁷	Black hardwood	18 by 6 1/2 by 11	\$300
Proton 313	Passive radiator	4 1/2 in.	—	1 3/4-in. cone	Amp. ⁷	Black hardwood	23 by 6 1/2 by 11	\$300
Quasar SW-494	Acoustic suspension	11 1/2 in.	4 3/4 in.	horn	92 dB	Wood vinyl	29 by 16 by 16	\$350
RCA SPK-215	Passive radiator	4 in. (2)	—	2-in. cone	86 dB	Black or wood vinyl	23 1/2 by 5 3/4 by 12 1/4	\$159
RCA SPK-375	Air suspension	11 in.	4-in. dome	1-in. dome	91 dB	Black or wood vinyl	24 by 14 by 12	\$400
Sansui S-V727	Passive radiator	8 in.	4-in. cone	2-in. cone	90 dB	Wood vinyl	34 by 13 by 10 1/4	\$320
Sansui S-V1127	Passive radiator	12 in.	4-in. cone	3/4-in. dome	92 dB	Wood vinyl	41 by 14 by 13	\$720
H. H. Scott 206-V	Acoustic suspension	6 1/2 in.	—	1 3/4 in.	90 dB	Gray vinyl	13 1/4 by 8 1/2 by 7 1/4	\$220
Sony SS-X2A	Bass reflex	4 in.	—	2-in. cone	Not avail.	Silver metallic	6 1/4 by 10 3/4 by 5	\$110
Sony APM-X250	Passive radiator	26.4 sq. in. APM ⁸	—	11.9 sq. in. APM ⁸	Not avail.	Silver metallic or wood vinyl	22 by 11 by 8 1/4	\$200
Teknika ATV-S2	Passive radiator	5 in.	—	2-in. dome	90 1/2 dB	Silver metallic	21 1/2 by 5 by 12	\$199
Zenith CV-150 Allegro	Bass reflex	6 1/2 in.	—	2 1/2-in. cone	91 dB	Pewter metallic	11 by 11 by 8 1/4	\$100

CHART BY FRANK LOVECE

¹Dimensions in inches, height by width by depth. ²Per pair. ³Infinity's video speakers are scheduled for delivery in late June or early July. ⁴Built-in 40 W/ch amp. ⁵Built-in 60 W/ch amp. ⁶Built-in bi-amplification: 28 watts for woofer, 12 watts for tweeter. Dynamic signal-processing circuitry to give maximum low-frequency output with minimum distortion. ⁷Built-in bi-amplification: 20 watts for woofer, 5 watts for tweeter. ⁸Accurate Pistonic Motion, Sony's term for a flat, square driver.

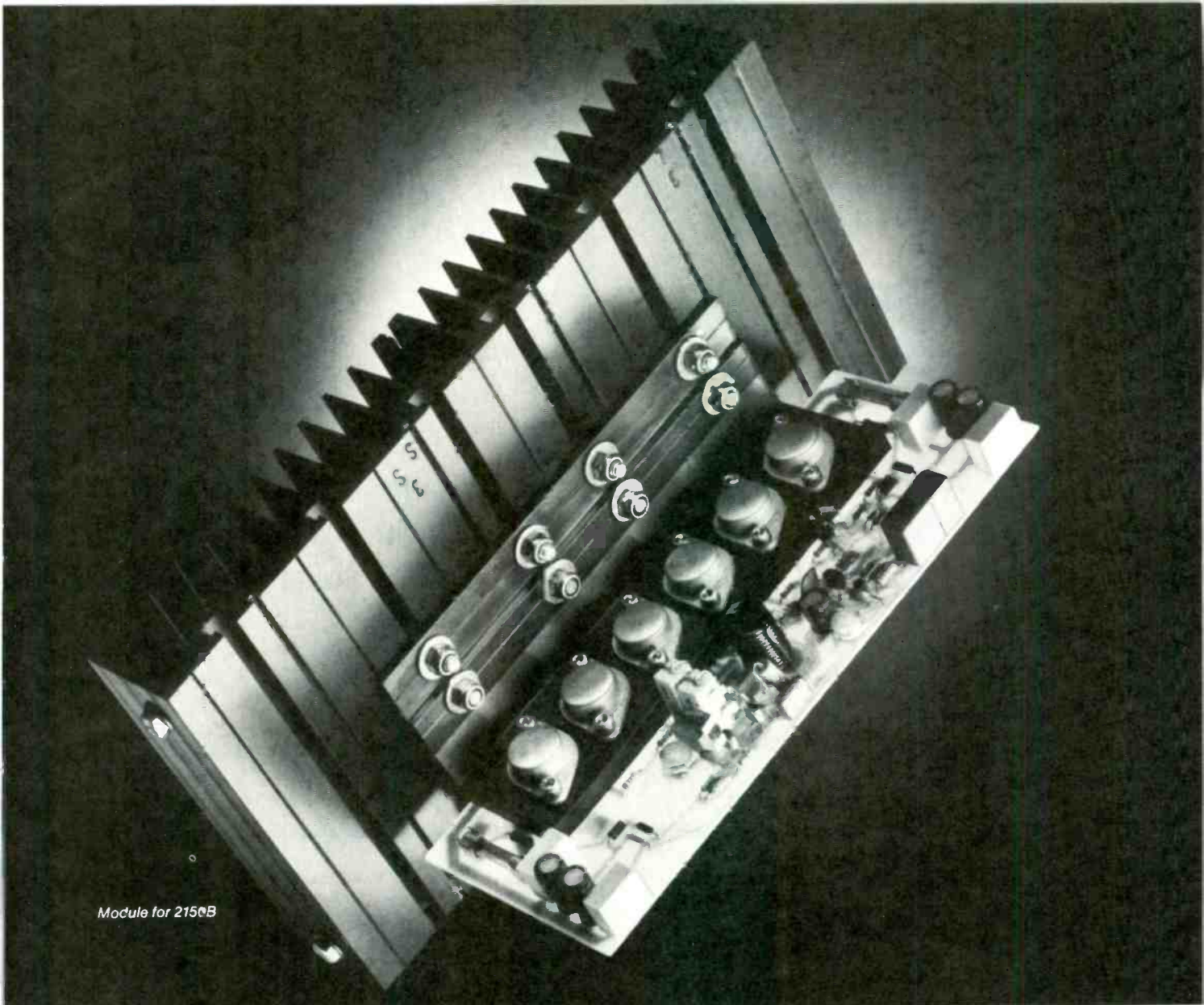

Module for 2150B

PERREAUX INTRODUCES THE OBSOLESCENCE OF PLANNED OBSOLESCENCE

THE COMPONENTS

When you acquire a Perreaux audio component, you enter into a company. Our future does not lie in throw-away components, since the components we manufacture do not become obsolete. Our future does not lie in trendy styling, but in the enduring elegance of fit and finish. Perreaux understands that performance can become obsolete by an advance in technology. In fact, Perreaux has been responsible for significant design and manufacturing breakthroughs:

- The first high power MOS-FET amplifier
- The first high power amplifier requiring no protection circuitry
- The first wide bandwidth amplifier (3,000,000 Hz)
- The first preamplifier capable of accepting any phono-cartridge with a single gain stage
- The first passive RIAA phono section with low noise
- The first pre and power amplifier combination with $\pm 1^\circ$ phase accuracy.

When Perreaux develops a new circuit, it makes certain that existing Perreaux amplifiers and preamplifiers can be upgraded to the new technology for substantially less than the cost difference of a new component. Perreaux's classic styling will never appear out of date. You do not purchase Perreaux...you invest in Perreaux.

THE AUDIO SPECIALIST

With your investment in Perreaux, comes the assurance of the highest level of service.

Perreaux is available only at the finest audio specialists. Personnel, trained by Perreaux, both sales and service, have a thorough understanding of each component. They will be happy to install a Perreaux system in your home and be sure it is operating properly. If by chance, your Perreaux should require service, it is backed by the longest warranty period in the industry. We assure you in writing that Perreaux's value is unsurpassed.

In a vote by audio critics and dealers, Perreaux was awarded the Audio/Video Magazine HI FI Grand Prix for "its Mercedes-like construction". It is, therefore, only fitting that one of the world's finest possessions should be presented by some of America's finest audio/video showrooms. Whether or not you intend to acquire a Perreaux, we urge you to visit a Perreaux representative. You can be assured that they have been screened by us for knowledge of audio, customer service and business practice. The showroom personnel have made quality audio and video a part of their lives and can be counted on for an honest appraisal of your needs.

Please turn the page for a partial directory of America's finest audio/video showrooms.

For the Perreaux showroom nearest to you call 516-683-3000

*In a vote of audio critics and retailers,
Perreaux was awarded the Hi Fi Grand Prix
for "its Mercedes-like construction."*

Audio/Video Magazine, USA



In Los Angeles, California
we invite you to see and hear
the world acclaimed Perreaux.

PARIS AUDIO
Los Angeles 213-820-2578

*"The Perreaux has the talent
for making music become
a physical entity within the room."*
Hi Fi For Pleasure Magazine, England



In Pasadena, California
we invite you to see and hear
the world acclaimed Perreaux.

GNP
Pasadena 818-577-7767

*"The Perreaux 2150B is a
no-compromise brute of an amplifier
almost certainly indestructible in normal use."*

Stereo Review Magazine, USA



In Hollywood, California
we invite you to see and hear
the world acclaimed Perreaux.

AMETRON
Hollywood 213-464-1144

*"... due to Perreaux's verifiable quality,
it is likely to be the best
value purchase in audio."*

Son Hi Fi Magazine, Canada



In Redondo Beach, California
we invite you to see and hear
the world acclaimed Perreaux.

SYSTEM DESIGN GROUP
Redondo Beach 213-370-8575
Sherman Oaks 818-783-9507

*"Perreaux electronics have all
the appearance and finish
of the finest Swiss machinery."*

Revue du Son Magazine, France



In Greenwich, Connecticut
we invite you to see and hear
the world acclaimed Perreaux.

AUD-VID

Greenwich 203-869-0666

*"Peter Perreaux's masterpiece
is as smooth and velvety in sound
as its graceful front panel is in finish."*

Hi Fi & Elektronik Magazine, Denmark



In Georgia
we invite you to see and hear
the world acclaimed Perreaux.

HI-FI BUYS

Atlanta 404-261-4434

Marietta 404-427-4434

North Lake 404-938-4434

Sandy Springs 404-843-3900

*"The practical realization of the Perreaux
amplifier is of the highest quality level
both for the technical solutions employed
and the caliber of components used."*

Audiostop Magazine, Italy



In Fairfield, Connecticut
we invite you to see and hear
the world acclaimed Perreaux.

AUDIO DESIGN

Fairfield 203-336-4401

*"The Perreaux SM-2 preamplifier
is the synthesis of all you could demand,
perfectly accomplished."*

Stereo Magazine, Germany



In Colorado
we invite you to see and hear
the world acclaimed Perreaux.

LISTEN UP

Denver 303-778-0780

Boulder 303-444-0479

TEST REPORTS

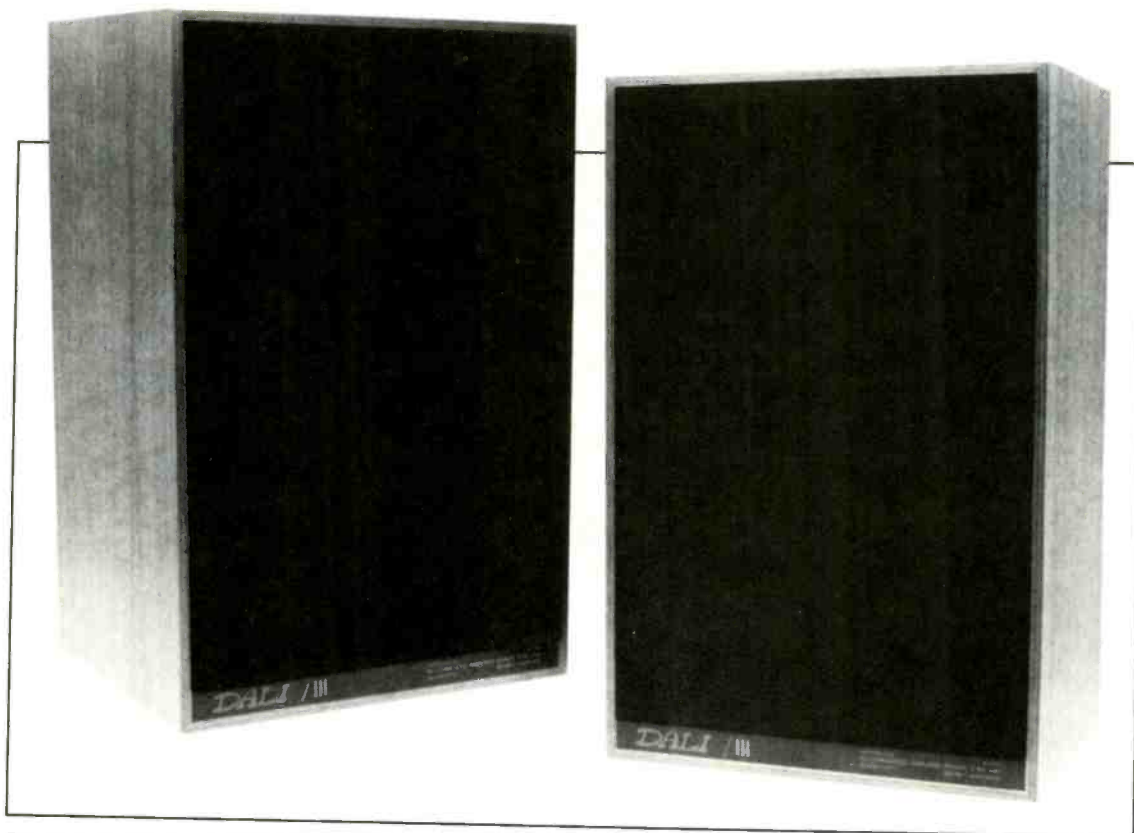

DALI 3 LOUDSPEAKER

Type: compact, two-way acoustic suspension system in particleboard enclosure with walnut veneer finish. Dimensions: 11 by 17¼ inches (front), 9¼ inches deep plus clearance for grille. Price: \$150 per pair plus \$12.50 shipping. Warranty: "limited," five years parts and labor. Manufacturer: Audionord, Denmark; U.S. distributor: Danish American Ltd., Inc., Box 55386, Valencia, Calif. 91355.

Dali (an acronym for Danish American Ltd., Inc., which distributes the speakers in this country) is a five-model series that is designed and built in Denmark. Among the manufacturer's standard practices are use of real walnut veneer finishes on all its speakers, fine-tuning of its designs through relatively elaborate evaluation by a listening panel, and attention to phase response in overall design. Employing a method atypical of the audio industry, Dali sells its products directly to its customers (with a 30-day money-back guarantee of satisfaction), thus by-

passing dealers, at least in the conventional sense. Dali buyers have the option of becoming Dali dealers and thereby making a little money for themselves. Dali reports that this system of distribution has worked well for its parent company in Denmark and is in no small measure responsible for its ability to sell its speakers at such low prices.

The Dali 3 is the larger of two very compact models, both of which are larger than true minis but decidedly smaller than classic "bookshelf" speakers. And both are two-way sealed (acoustic suspension) systems with a 1-inch dome tweet-

Report preparation supervised by Michael Riggs, Peter Dobbin, Robert Long, and Edward J. Foster. Laboratory data (unless otherwise indicated) is supplied by Diversified Science Laboratories.

er. Compared with the Dali 2, the Dali 3's woofer is larger (8 inches, as opposed to 6½), its enclosure a little bigger, and the particleboard of its front and back panels thicker (7/8 vs. 5/8 inch). The tweeter is offset about 1 inch to the left of the woofer's vertical axis, and both are covered by a knit grille stretched over a wooden frame that is shaped to minimize sonic diffraction. Color-coded spring clips for the amplifier leads are recessed into the back panel. There are no controls.

Although there are other very respectable loudspeakers in the Dali 3's price range, they are by no means abundant. It's not easy to design a really good speaker that can sell profitably for so little money. Nonetheless, Diversified Science Laboratories' measurements of the Dali 3 turned up only one point of concern, which proved to be one of those things that looks much worse on paper than it sounds in the listening room. Our test samples exhibited a strong cabinet buzz triggered by signals in the 250-Hz region, pushing distortion up to about 10 percent in that one band at all drive levels, though the figures at other nearby frequencies are much lower. This perturbation is squarely in the midst of typical music (the fundamental of a piano's middle C is about 260 Hz, depending on tuning practice). We could not detect it in listening, however.

If we ignore this frequency band (and the bass below 80 Hz, where the inherent rolloff creates unrealistically high figures), distortion averages less than ½ percent at 90 dB sound pressure level (SPL) and below, about ¾ percent at 95 dB, and less than 1½ percent at 100 dB. The abrupt rise in this last measurement suggests that the drive level is approaching the speaker's limit with steady-state signals.

In the 300-Hz pulse power-handling test (which more nearly approximates the stresses imposed by musical signals), the Dali 3 accepted the full output of the test amplifier without serious waveform dis-

tortion on the oscilloscope, dissipating peaks of 26½ dBW (450 watts)—well above the speaker's recommended maximum input of 80 watts, or 19 dBW. This calculates to a whopping output of 117½ dB SPL. But an audible change in reproduction quality at 112½ dB SPL (still a highly respectable figure) suggests that this might more reasonably be taken as the limit of good musical reproduction. If so, peak input power, too, should be kept 5 dB lower—to 21½ dBW (140 watts), which approximates the dynamic power capabilities of most amplifiers rated at Dali's recommended maximum.

Impedance is fairly uniform across the frequency range. It drops to minima of 6.3 ohms at both 20 Hz (the lower limit of testing) and about 160 Hz (the conventional rating point, above bass resonance). Another trough, near 10 kHz, measures 7.3 ohms. The peaks are just under 25 ohms at bass resonance (near 78 Hz) and 21 ohms in the crossover region, just below 1.5 kHz. The speaker therefore should not be a difficult load for any decent amplifier or receiver.

Response was measured with the speaker on a 21-inch stand, placed near the wall. The bass bumps up slightly around 100 Hz, and there is a dip in the midrange around the 315-Hz band. The former effect at least partially results from acoustic reinforcement from the wall behind the speaker, the latter from cancellation due to reflections off the floor. Otherwise, the curves are remarkably smooth, extended, and consistent between on- and off-axis measurements.

In listening, we made the most of these properties by keeping the speakers away from the walls. This doubtless decreased deep-bass response somewhat, though we judged the Dali 3 excellent in this respect for so small a system. Tonal balance and freedom from coloration also struck us as remarkable for the price. We noted some muddying of textures when the speaker

ROOM RESPONSE CHARACTERISTICS

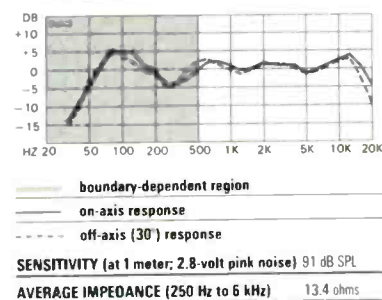

was driven hard, but only by comparison with the relative transparency at moderate sound levels. Stereo imaging is quite stable and spacious, and transient response is quite good.

The company has much to say about how conventional distribution practices drive up the prices of audio products. Perhaps the Dali 3 would have cost twice as much to sell in shops, and at \$300 per pair, it would be less noteworthy. But at \$150 per pair, it is outstanding. Whether Dali's unorthodox method of selling speakers will work in the long run remains to be seen; we suspect that it will, if the company can maintain this high level of value. ●

BABY ADVENT LOUDSPEAKER

Type: compact, two-way acoustic suspension system in particleboard enclosure with walnut-stained hardwood endcaps. Dimensions: 11 by 16¼ inches (front), 6¼ inches deep. Price: \$198 per pair. Warranty: "limited," five years parts and labor. Manufacturer: Advent Div., International Jensen, Inc., 4138 N. United Pkwy., Schiller Park, Ill. 60176.



Advent built its reputation on good inexpensive speakers, and the Baby (a.k.a. Model 1002) reflects that heritage. At the same time, it breaks with tradition in several ways. It is smaller than most Advents and has a slightly different enclosure design. The case is made of particleboard covered with black vinyl except on the top and bottom (or the ends, if you prefer), which are solid hardwood caps with a walnut stain. A wraparound grille is held in place by a low-diffraction molded plastic frame. The overall appearance suggests a good brand of audio furniture or certain electronics separates more than it does the classic Advent box/frame with inset grille panel. The two-way sealed (acoustic suspension) system consists of a 6½-inch woofer crossed over at 2.5 kHz to a 1¼-inch cone tweeter. The woofer is centered laterally, and the tweeter slightly offset to the left. Color-coded spring clips for amplifier connections are recessed into the back panel. No controls are provided.

Diversified Science Laboratories' measurements reveal fine performance for so compact a speaker. At moderately loud levels, total harmonic distortion (THD) averaged about ½ percent from the 80-Hz band upward, and with the reproduction level cranked up to 95 dB sound pressure level (SPL), it still averaged only about ¾ percent. At 100 dB SPL (our testing limit), average distortion increased sharply to about 2 percent over the same range, suggesting that the speaker was approaching steady-state overload. This is more than respectable for a small speaker; most minis, for example, produce higher distortion even at lower levels and

even if the 80-Hz band is excluded from the average as below their operating range.

On 300-Hz pulses, the Baby Advent accepted about 20 dBW (100 watts) peak, for a calculated output of 107¼ dB SPL, without severe strain. Some waveform distortion was visible on the oscilloscope, however, and a change in sound quality (usually a sign of impending overload) was apparent about 1 dB lower in level. Again, this is no complaint; only a significantly larger speaker could be expected to do better as a matter of course, and 107 dB SPL is more than loud enough for most home purposes.

Impedance varies somewhat more (but certainly not much more) with frequency than it does in most of the speakers we test. It precisely matches Advent's specified minimum of 5.5 ohms at both 20 Hz (where it has leveled off below bass resonance) and near 200 Hz. At bass resonance (approximately 80 Hz), it rises to a hair more than 20 ohms, and near the crossover frequency it reaches a peak of almost 35 ohms. There is a dip to 7 ohms at about 10 kHz, and the impedance is 8.2 ohms and rising at the 20-kHz limit of testing.

The average impedance is relatively high: 17.9 ohms with our usual band-limited pink noise, 13.4 ohms over the full audio range. In other words, there is no need to expect trouble in any reasonable setup, even if it involves paralleling the Baby Advents with other speakers, unless your amplifier is skittish about low load impedances or unless the additional speakers present an unusually low impedance—particularly in or around the 200-Hz range.

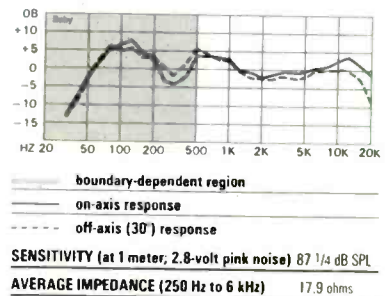

REPORT POLICY

Equipment reports are based on laboratory measurements and controlled listening tests. Unless otherwise noted, test data are provided by Diversified Science Laboratories. The choice of equipment to be tested rests with the editors of *HIGH FIDELITY*. Samples normally are supplied on loan from the manufacturer. Manufacturers are not permitted to read reports in advance of publication, and no report or portion thereof may be reproduced for any purpose or in any form without written permission of the publisher. All reports should be construed as applying to the specific samples tested. *HIGH FIDELITY* and Diversified Science Laboratories assume no responsibility for product performance or quality.

Advent says that the speaker can be placed almost anywhere. The lab tested it on a 19-inch stand just in front of a wall. In the graph, you can see the usual cancellation dip centered in the 315-Hz band (caused by reflections off the floor). On-axis response, including this dip, is within $+6\frac{3}{4}$, -4 dB above the 40-Hz band. If you ignore the dip as an artifact of the room, the spread is $+6\frac{3}{4}$, -2 dB. Off-axis response is quite similar except at very high frequencies, where the speaker's increasing directivity brings it down slightly. The surprise here is that

there is so little beaming, given the relatively large tweeter diaphragm.

To minimize bass reinforcement from room boundaries, we moved the Baby Advents out into our listening room, away from the walls. This tends to reduce output in the deep bass, but it also eliminates the thickness suggested by the midbass hump in the response curves. Heard that way, the speaker is an unqualified success, given its modest price and dimensions. Balance is excellent, coloration low, and transient handling and stereo per-

spective good. And add "very" all around if a comparison is made strictly with speakers in the same price class.

Whether you're seeking high-quality speakers for a budget system or extension speakers for a more elaborate one, the Baby Advent may well be just what you're looking for. It will give you wider dynamic range and frequency response with more accuracy and excitement than most comparable speakers, and it will significantly outperform most true minis in both respects. •

MISSION 770F LOUDSPEAKER

Type: two-way bass-reflex system in particleboard enclosure with black or walnut veneer finish. Dimensions: 10 $\frac{5}{8}$ by 24 $\frac{1}{4}$ inches (front), 12 inches deep plus clearance for connections. Price: \$799 per pair; optional stands, \$59 per pair. Warranty: "limited," five years parts and labor. Manufacturer: Mission Electronics, Ltd., England; U.S. distributor: Mission Electronics Corporation of America, 5985 Atlantic Dr., Unit 6, Mississauga, Ont. L4W 1S4, Canada.

Pursuing its own vision of perfection, Mission has continually refined and gradually expanded its series of loudspeakers. All are two-way designs, because the company feels that additional drivers create more problems than they solve, and all demonstrate an unusual degree of attention to detail and materials. The goal is low coloration and accurate imaging that does not sacrifice dynamic range, sensitivity, or the ability of the speaker to be driven by typical amplifiers and receivers. To that end, Mission uses carefully designed drivers in rigid, well-damped enclosures and avoids excessively elaborate crossover networks, which could cause undesirable phase shifts and power losses.

Perhaps the best exemplar of this philosophy is the 770F, the next-to-the-top model in the line. (The 780A is something of a departure in that it is said to present a very difficult load to the driving

amplifier.) The driver complement of the 770F comprises an 8 $\frac{1}{2}$ -inch homopolymer-cone woofer crossed over at 2 kHz to a 1-inch polymer-dome tweeter with ferrofluid for cooling and damping. They are aligned vertically on the front baffle above the enclosure's reflex port and normally are covered by a dark cloth grille.

The cabinet itself is quite handsome. On the bottom are four rubber feet to protect any surface on which you might place the speaker, as well as fasteners for rigidly coupling it to one of Mission's optional stands. Amplifier leads connect to color-coded five-way binding posts recessed into the back panel.

Mission provides very specific placement instructions for the 770F, which we followed for both measurement and listening. Diversified Science Laboratories put the speaker on a 9-inch stand within a few inches of the wall behind it. The resulting room response curves are



smooth, extended, and gratifyingly similar. On-axis response is within ± 5 dB from below the 50-Hz band to 20 kHz, while the off-axis curve stays within $+5, -3\frac{1}{2}$ dB out to 16 kHz, rolling off slightly faster in the extreme treble as the tweeter becomes increasingly directional. The only significant irregularities are a dip centered on the 315-Hz band, caused by interference from reflections off the floor, and a smaller one in the crossover region. Overall, these are fine results; we are particularly impressed by the absence of any strong peaking in the upper treble such as one finds in many lesser reproducers.

Sensitivity is higher than average, and in our 300-Hz pulse power-handling test, the 770F proved capable of taking everything the lab could dish out: 62 volts peak, equivalent to $26\frac{3}{4}$ dBW, or 481 watts, into 8 ohms for a calculated sound pressure level (SPL) of $118\frac{3}{4}$ dB. In other words, this is indeed a speaker with plenty of dynamic range. Another of Mission's design objectives was very low distortion, and

here again it has succeeded. From 100 Hz to 10 kHz, total harmonic distortion (THD) averages less than $\frac{1}{4}$ percent at 85 dB SPL and barely more at 90 dB. At 95 dB SPL it still is less than $\frac{1}{2}$ percent, and even at 100 dB it doesn't break 1 percent. Nor are there any distortion "hot spots"—localized peaks that might indicate the presence of uncontrolled driver resonances.

The 770F's impedance is highest at its twin resonance peaks, one at 66 Hz and the other just below 20 Hz, both of which rise to approximately 20 ohms. Impedance reaches another peak of 17.1 ohms at 1.4 kHz before dropping to a minimum of 4.7 ohms at 8 kHz. By 20 kHz, it is back up to 6.5 ohms—the same as at 180 Hz, which in this speaker would be the conventional rating point above bass resonance. Just about any good amplifier should take this load in stride.

We also were very pleased with the 770F's performance in the listening room. The sound is smooth, clean, and perhaps just a touch warm. The low end is well extended

ROOM RESPONSE CHARACTERISTICS

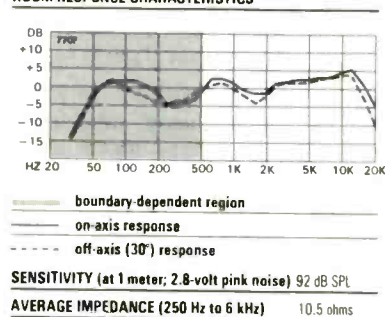

without being mushy or tubby, and the top is all there without exhibiting even a trace of stridency. Stereo imaging is superb. Localization is precise and stable, but not constricted, giving a comfortable sense of openness and life to the portrayal. And detail is vividly rendered without becoming over-etched. So all in all, we'd call the 770F a job well done. Mission's careful attention to every aspect of its performance has paid off in accurate, engaging musical reproduction at a reasonable, if not bargain, price. ●

HEYBROOK HB-1 LOUDSPEAKER

Type: compact, two-way acoustic suspension system in particleboard enclosure with black or walnut-grain vinyl finish. Dimensions: 11½ by 18½ inches (front), 9¼ inches deep plus clearance for connections. Price: \$298 per pair; optional HBS-1 stands, \$138 per pair. Warranty: "limited," five years parts and labor. Manufacturer: Mecom Acoustics, Ltd., England; U.S. distributor: D'Ascanio Audio, 11450 Overseas Hwy., Marathon, Fla. 33050.

Although well known in their native England, Heybrook loudspeakers have been imported to the U.S. only relatively recently. The HB-1 is the lowest-priced, though not the smallest, model in a three-speaker line. It uses an 8-inch woofer in an acoustic suspension enclosure, crossed over at 4 kHz (a relatively high frequency for a two-way system) to a 1-inch dome tweeter. The drivers are aligned on the baffle's vertical axis and are hidden by an acoustically transparent re-

movable grille of black foam. The cabinet is made of $\frac{3}{4}$ -inch particleboard finished in black or a handsome walnut-grain vinyl. Color-coded five-way binding posts for amplifier connections are partially recessed into the back of the enclosure.

Heybrook strongly recommends the use of its optional HBS-1 stands, which are very sturdy and flexible. They include adjustable spiked feet—all the rage among British audiophiles these days. The added

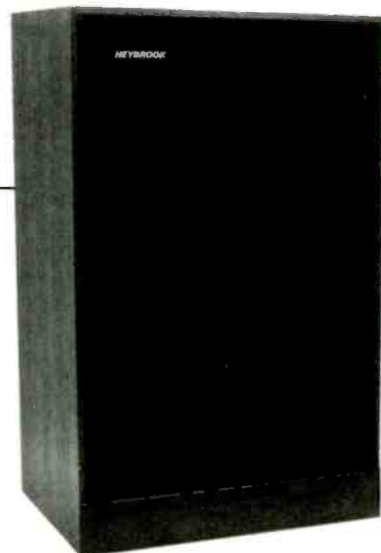

stability is supposed to improve the sound. Diversified Science Laboratories used the stands for its tests, raising the speaker 19 inches above the floor, a few inches from the wall behind it.

So placed, the HB-1 proved to have very smooth and extended response—within $\pm 5\frac{1}{2}$ dB from 50 Hz to 20 kHz on-axis and $+3\frac{3}{4}$, -5 dB to 16 kHz off-axis. The principal irregularities are a dip in the lower midrange, around 300 Hz (caused by interference from floor reflections); another, smaller dip at about 5 kHz (perhaps a crossover artifact); and a peak centered on the 12.5-kHz band. The curves are remarkably flat through the upper midrange and lower treble, and they are quite similar to one another, which is usually a good sign. The tweeter does begin to roll off slightly earlier off-axis because of its increasing directivity, but does so less dramatically than in most other speakers.

Sensitivity is high, particularly for such a compact design, and the impedance curve is relatively well behaved. There are peaks of 20.7 ohms at bass resonance (approximately 80 Hz) and 16.7 ohms at 3 kHz. The minimum is 5.4 ohms at approximately 15 kHz, rising to 5.7 ohms at 20 kHz. Two other low points appear in the curve, both 6.4 ohms, at 20 and 200 Hz. Any decent amplifier should find this a very

congenial load and have no difficulty driving the loudspeaker.

At moderate outputs, distortion is agreeably, though not spectacularly, low, averaging about $\frac{1}{2}$ percent from 100 Hz up at 85 dB sound pressure level (SPL) and just a smidgen more at 90 dB. It rises more swiftly at higher levels, reaching approximately $1\frac{1}{4}$ percent at 95 dB SPL and $1\frac{3}{4}$ percent at 100 dB. But these are very high levels for continuous tones. In our 300-Hz pulse power-handling test, which more closely approximates the demands of music, the HB-1 accepted without distress the full 60-volt peak output of the lab's amplifier (equivalent to $26\frac{1}{2}$ dBW, or 450 watts, into 8 ohms). This yielded a calculated sound pressure level of $118\frac{1}{2}$ dB—more than enough for music in the home, we should think. In short, the HB-1's dynamic range appears to be more than adequate.

We confirmed this in our listening room, where we were able to play the speakers at very high volumes without audible distortion. After some initial experimentation, we settled on a placement similar to that used in the lab. The resulting sound was smooth and well balanced, though we noted a slight tendency to brightness. Bass response is good for such a compact system. The extreme bottom is attenuated, but that is to be expected; on most

ROOM RESPONSE CHARACTERISTICS

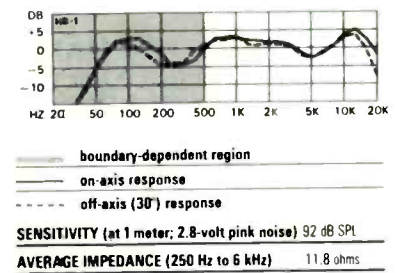

music, you won't miss it. Those who prefer a very rich low end may be put off by the HB-1's relatively tight, lean reproduction in the mid-bass. However, we think it is more accurate in this range than most competing models for exactly that reason.

Perhaps the speaker's greatest virtues are its stereo imaging, which is precise and convincing, and the clarity with which it renders musical detail. (We suspect that the vertical driver alignment, uncluttered baffle surface, and high crossover frequency all play roles here.) These aspects of the HB-1's performance are in considerable measure responsible for the clean, analytical quality of its sound. If accuracy of reproduction in a small speaker is your prime concern, this most modest of the Heybrook family warrants your attention. ●

FRIED BETA LOUDSPEAKER

Type: compact, two-way vented system in particleboard enclosure with walnut-grain vinyl finish. Dimensions: $8\frac{1}{4}$ by $13\frac{1}{4}$ inches (front), $8\frac{1}{2}$ inches deep. Price: \$290 per pair. Warranty: "limited," five years parts and labor. Manufacturer: Fried Products Co., 7616 City Line Ave., Philadelphia, Pa. 19151.

Bud (Irving M.) Fried was among the first American loudspeaker manufacturers to contend that "sounds good" isn't enough—that accuracy is the ultimate criterion. During the many

years it has taken his colleagues to come around to his way of thinking, he has continued honing his craft, recently applying it to compact designs of striking accuracy, if not economy. The Beta, one of the Fried

AUDIO EXCHANGE
Westbury, New York
334-3443

SOUNDFIELD

SOUND CHAMBER
Rochester, New York
Monroe Ave. 381-9348
West Ridge Rd. 225-8660

SOUNDFIELD

SOUND STAGE AUDIO & VIDEO
Manhattan & Queens, New York
Manhattan 227-6738
Fresh Meadows 961-9888

SOUNDFIELD

PERDUE RADIO
W. Caldwell & Montclair, New Jersey
W. Caldwell 575-8264
Montclair 744-4343

SOUNDFIELD

JSG AUDIO
Binghamton, New York
723-2212

SOUNDFIELD

HAL'S STEREO-VIDEO CENTER
Lawrenceville, New Jersey
883-6338

SOUNDFIELD

Soundfield Imaging...

**STEREO
EVERYWHERE!**

Or in others' words:

GREAT AND IMPORTANT
—Julian Hirsch
GLORIOUS ...
UNPRECEDENTED
—David Ranada
BREAKTHROUGH
—Peter Mitchell
INCREDIBLE
—Len Feldman
**TOUR DE FORCE
OF THE ENGINEERING
IMAGINATION**
—Hans Fantel
**SIGNIFICANT ADVANCE
IN THE STATE OF THE ART**
—Michael Riggs et al.

Soundfield Imaging Speakers
Models One and Ten

Hear for yourself, at these and
other Soundfield dealers.
Or call us, at (617) 964-3210.

Technology patented under US no. 4,503,553
71 Chapel St., Newton, Mass. USA 02195

dbx[®]

OMNI ELECTRONICS
Raleigh, North Carolina
872-0950

SOUNDFIELD

THE GRAMOPHONE
Birmingham, Michigan
642-9777

SOUNDFIELD

HI-FIDELITY INC.
Louisville, Kentucky
897-2552

SOUNDFIELD

MUSICRAFT INC.
Chicago, Illinois
Morton Grove 967-6690
Palatine 991-7220
Villa Park 530-7400
Oak Park 383-7006
Homewood 799-2400
Evergreen Park 425-9055
Chicago 337-4150

SOUNDFIELD

SOUND PRODUCTIONS
Carmel, Indiana
844-1103

SOUNDFIELD

BRANDSMART STEREO
Kansas City, Missouri
363-4499

SOUNDFIELD

HOME ENTERTAINMENT

Houston, Texas

Kirby Dr. 526-4317

Westheimer 781-1013

Southwest Freeway 777-0353

West Montgomery 955-0615

SOUNDFIELD

BEVERLY STEREO

Los Angeles, California

651-3523

SOUNDFIELD

BJORN'S STEREO DESIGNS

San Antonio, Texas

828-2559

SOUNDFIELD

REFERENCE AUDIO SYSTEMS

Gardena, California

398-4205

SOUNDFIELD

JERRY'S AUDIO EXCHANGE

Phoenix & Tucson, Arizona

Phoenix 263-9410

Tucson 747-7267

SOUNDFIELD

AUDIO TODAY

Westminster, California

891-7575

SOUNDFIELD

Signature Series, speaks eloquently of care in its design and manufacture, but it also is possibly the best buy ever from this company.

On the front baffle, behind a knit grille, are a 6½-inch polypropylene-cone woofer and a 2½-inch "cone-dome" tweeter. Both are on the baffle's vertical axis. Two small holes to the left of the tweeter act as "pressure relief" (part of the damping system), rather than as a conventional bass-reflex loading system. The cabinet finish is vinyl, which convincingly simulates walnut veneer. In a recess at the back are color-coded five-way binding posts for power leads and a reset button for a protective circuit breaker.

Unlike conventional ported systems, the Beta exhibits only one low-frequency impedance peak, which rises to a hair less than 15 ohms at the bass resonance, just below 80 Hz. The curve drops off below it and is still falling at the lower limit of testing (20 Hz), where it is at 6.7 ohms. At the minimum above bass resonance (around 180 Hz in this case), the impedance is 5.7 ohms. It reaches a maximum of just over 20 ohms at about 1.8 kHz, drops to 11.2 ohms around 12 kHz, and is rising slightly by the termination of testing at 20 kHz. The relatively modest spread between maximum and minimum impedance and the high average value should make the Beta an easy load for typical amplifiers, and most should be able to drive another pair of speakers in parallel without difficulty. If, however, the impedance of the second set drops to less than 6 ohms in the range between 150 and 250 Hz, the most finicky transistor amplifiers might show signs of distress when both pairs are played simultaneously.

In addition to taking the measurements from which we prepare our response graphs, Diversified Science Laboratories checks the near-field responses of the drivers and vents (if any). The results for the Beta indicate that its woofer

output reaches a maximum near 125 Hz and rolls off smoothly below 80 Hz, while the vents appear to contribute useful energy in a broad range centered on 80 Hz.

DSL tested the Beta on a 19-inch stand placed against the wall behind it. The room response curves are very flat throughout the mid-bass, midrange, and treble, except for a dip centered on the 315-Hz band, which is created by interference from floor reflections. If we ignore it, on-axis response is within +6¼, -2 dB above the 50-Hz band. (The dip, which is placement-dependent anyway, drops barely 2 dB below the next-lowest point, at 5 kHz.) Off-axis response (in which the dip is much less pronounced) is very similar up to the extreme top of the frequency range, where a slight increase in directivity betrays itself as a rolloff.

After the lab had finished its tests, Fried Products sent literature stating that placement of the Betas should not be critical, but that they "are basically monitoring devices, meaning that they are intended to be used, if possible, free and clear of walls and corners." Because a great many professional monitors—perhaps most—are used in environments too cramped to permit this sort of placement, the statement is somewhat confusing. Presumably what Fried meant was that the response has not been tailored to any placement near room boundaries—that is, an attempt has been made to ensure a flat response in what might be considered the most objective sense.

For our listening tests, we kept the speakers on stands and away from the walls to minimize the slight bass emphasis that is detectable in the curves, made with the speaker against the wall. What we heard was mighty impressive for so tiny a speaker. The bass has a depth and musicality that you'd expect only from much larger speakers, and the remainder of the range is remarkably smooth. Stereo imaging is excellent: crystalline and un-



ROOM RESPONSE CHARACTERISTICS

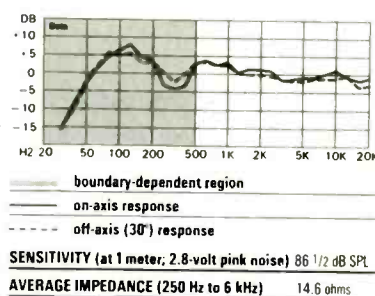

equivocal. (The vertical alignment of the drivers probably helps here.) Detailing and transparency are excellent, as is dynamic range.

Measured distortion is not exceptionally low, however. From the 63-Hz band upward, total harmonic distortion (THD) averages about 1/2 percent at 85 dB sound pressure level (SPL), 1 1/4 percent at 90 dB, 1 1/2 percent at 95 dB, and 2 percent at 100 dB. In our 300-Hz pulse power-handling test, the Beta accepted

the full output of the lab's amplifier (equivalent to 26 3/4 dBW, or 470 watts, peak into 8 ohms, for a calculated output of 113 1/4 dB SPL) without gross distortion, though an audible change in reproduction quality did occur at 23 dBW (200 watts) at a calculated peak acoustic level of 109 1/2 dB SPL. Thus, the dynamic range is good (particularly for a small speaker) and can be pushed to excellent if you're willing to accept slightly higher distortion.

Our net evaluation is that if you want a very compact speaker, you probably won't find the equal of the Fried Beta and you will find far worse almost everywhere you look. In its class, it's a superb system and even a very good value, though it is priced higher than most models of comparable size. In fact, there are many considerably larger and more expensive models on the market that are decidedly less accurate in reproducing music. •

B&W VM-1 VIDEO LOUDSPEAKER

Type: compact, two-way bass-reflex system designed for minimum stray magnetic field, in particleboard enclosure with simulated black-ash veneer or silver-gray vinyl finish. Dimensions: 10 1/4 by 19 1/4 inches (front), 10 1/2 inches deep including grille. Price: \$250 per pair (\$149 each). Warranty: "limited," five years parts and labor. Manufacturer: B&W Loudspeakers, Ltd., England; U.S. distributor: Anglo American Loudspeakers, P.O. Box 653, Buffalo, N.Y. 14240.

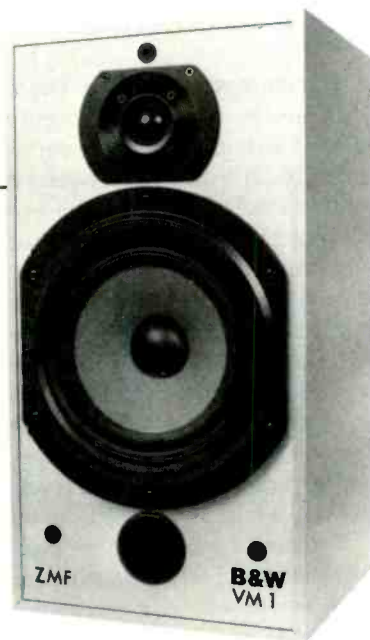

A new frontier of loudspeaker design is occasioned by the increasing integration of audio and video components in home entertainment systems. Unless driver magnet fields are adequately controlled, they can cause picture distortion or misconvergence when a speaker is used close to a TV monitor or receiver. B&W is by no means the first major audio manufacturer to address the problem, and its VM series of video speakers successfully reduces stray fields through redesign of magnet structure and magnetic circuitry.

So far, there are two Zero Magnetic Field (ZMF) models in the VM series. We chose to test the smaller, the VM-1. Its compact enclosure houses a 1/2-inch polyamide-dome tweeter crossed over at 3 kHz to an 8-inch woofer loaded by a ducted port about 2 inches in diameter and venting to the front baffle. All three elements—tweeter, woofer, and vent—are aligned on the vertical baffle axis. Binding posts for the amplifier leads are recessed into the back panel. As we'd expect, giv-

en B&W's traditional care in manufacturing, the edges of the recess are beveled and the bare-wire holes in the binding posts aligned to simplify hookup. (The VM-2 appears to be similar except that its larger, sealed enclosure and dual woofers extend bass response and power handling.)

Diversified Science Laboratories tested the VM-1 as we would expect you to use it: on a 19-inch stand and with its back 10 inches away from the wall behind it (to position the grille flush with an imaginary TV screen). The resulting frequency response is quite flat, smooth (particularly on-axis), and very extended. On-axis, it falls between +2 3/4 and -4 dB over its pass-band, from below the 63-Hz band to above the band centered on 20 kHz. The spread off-axis is a little wider (+3, -4 1/2 dB), but the general contour is gratifyingly similar. Of the visible prominences—at around 3 kHz in the treble, in the midrange around 800 Hz, and at bass resonance (about 80 Hz)—all but the last are quite mild. The dip at about

400 Hz presumably is the result of floor reflection; the gentle dip centered on 1.25 kHz is more likely to be inherent in the speaker.

Impedance is very well controlled across the frequency band. It never drops below $6\frac{1}{2}$ ohms nor climbs above $17\frac{3}{4}$ ohms within what usually is the most heavily modulated region, below 2 kHz, but falls to just above 4 ohms at about 3.7 kHz. Despite that 4-ohm minimum, no well-designed amplifier should have the slightest trouble driving the VM-1. In addition to its twin bass-impedance peaks, the speaker displays the characteristics of bass-reflex systems by delivering relatively high output for its size, though the 90-dB sensitivity figure certainly isn't extreme these days.

Dynamic range is good. On the DSL bench, the VM-1 accepted without serious distress the equivalent of 25-dBW (320-watt) peaks, for a calculated sound pressure level (SPL) of 115 dB at 1 meter—much more than adequate for the intended application. And overall distortion is reasonably low. At a moderate level (85 dB SPL), total harmonic distortion (THD) averages about $\frac{1}{2}$ percent from the 50-Hz band up, creeping up to above 1 percent as the reproduction level is raised to a loud 100 dB SPL.

For our listening tests, we began with the sort of wide-range material we would use with any component-grade speaker. Reproduction was basically clear, clean, and smooth, with very good stereo imaging. Here and in our later tests we found the sound a shade bright with some program material, but a modest treble cut at the tone controls redressed the problem when it arose. Bass is a bit thumpy if you make an unfair comparison with B&W's (or anybody else's) large monitor speakers, but fairly typical of a "bookshelf" bass-reflex design. As a regular high fidelity speaker, then, we consider it a good representative of its medium-small enclosure and price categories.

We then used it in conjunction with a television system. With the speakers on either side of the monitor, we could detect no picture aberration. TV sound being what it is, the subjective evaluation of the sound (particularly with the picture turned off) varied radically depending on the source. With some network shows, an inherent rolloff in the highs was nicely complemented by the VM-1's tendency to brightness; in others, with an arbitrary treble peak to "compensate" for poor bandwidth, music sometimes took on a hard edge and applause suggested shattering glass. Similarly, bass varied from boomy and exaggerated to nonexistent depending on the signal manipulation (or lack of it) that preceded reproduction.

What this boils down to is that most video media are not yet accompanied by high fidelity sound even if they're technically capable of it, and high fidelity reproducers can sometimes display without mercy the resulting shortcomings. An intentionally band-limited speaker may ignore some of the problems (high-frequency buzz, for instance, which is reproduced all too clearly by the VM-1), but it will never do a good job with those video sources that do offer high-quality sound. So, you're best advised to choose a wideband speaker like the B&W and shape its response as necessary with an equalizer—preferably one designed specifically for TV audio.

And the VM-1 is a high fidelity reproducer—unlike some other TV models, which seem to concentrate more on the problem of stray magnetism than on sound. The choice of finishes (silver-gray or simulated black ash) also seems both classy and well adapted for the purpose; the traditional oiled-walnut look simply doesn't make it in conjunction with today's high-tech video monitors. In short, the VM-1 is the most impressive TV speaker we've tested to date and well worth your consideration.

ROOM RESPONSE CHARACTERISTICS

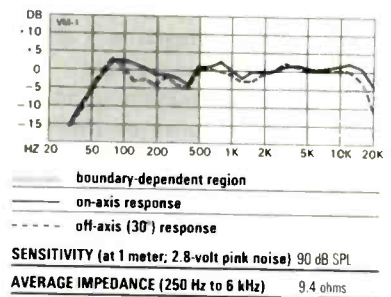



PHOENIX P-250DL SURROUND-SOUND DECODER

Dimensions: 12 by 2 inches (front), 5 3/4 inches deep plus clearance for controls and connections. Price: \$250 (\$179 in kit form). Warranty: "limited," one year parts and labor. Manufacturer: Phoenix Systems, Inc., Box 338-B, Stone Mountain, Ga. 30086.

The Phoenix P-250DL Ambience Extraction System is a signal processor designed to decode surround-sound effects from the Dolby-encoded soundtracks of many video sources, such as Laserdiscs and stereo videotapes. It also is claimed to extract ambience information from normal stereo program material, such as Compact Discs, LPs, stereo FM, and so forth. In addition, the P-250 has a built-in stereo synthesizer to create simulated stereo from mono sources.

The P-250 connects either between your stereo preamp and power amp or within a tape-monitor loop. (Phoenix recommends the former configuration wherever possible.) Its left and right inputs feed the front left and right outputs without modification, merely passing the signals through a volume control and buffer amplifier on their way. Only the output to the back channel is processed. In the stereo mode, the two channels are subtracted to create a difference (L-R) signal that contains the ambience information. According to the manufacturer's specifications, this signal is delayed 5 to 50 milliseconds (adjusted by a front-panel control) before being fed to the rear-channel output. A 30-millisecond delay—the 12 o'clock position of the control—is recommended as a good starting point. Although only one back-channel signal is generated,

Phoenix recommends that two speakers, flanking and to the rear of the listener, be used for best effect.

The P-250 draws so little power that it can be left on continuously. Doing so prevents a severe turn-on transient in the back output and is highly recommended. In addition to the front left and right outputs and the rear output, the P-250 provides a mono (L+R) front-center output to overcome the "hole in the middle" effect on some stereo programs and to help keep the dialogue "on screen" with video sources. (If desired, the front-center output could be low-pass-filtered and used to drive a powered subwoofer.) There is a control for setting the balance between the front-center channel and the main left and right channels. Once its relative level is set, the center output tracks the front left and right outputs as set via the master level control. In addition, there is a rear level control that establishes the balance between the surround output and the front outputs. Again, the back output level tracks changes in the front outputs according to the setting of the master level control.

A mode switch is used to inform the unit of the type of signal it is receiving. When it is in the stereo position, the P-250 extracts the ambience or surround-sound information and delivers it to the

FREQUENCY RESPONSE (front channels)

left and right	+0, -1/4 dB, < 10 Hz to 235 kHz
center	+0, -1/4 dB, < 10 Hz to 165 kHz

OUTPUT AT CLIPPING (at 1 kHz)

front left and right	9.4 volts
front center	9.6 volts
surround	9.8 volts

MAXIMUM INPUT LEVEL (at 1 kHz)

	> 10 volts
--	------------

MAXIMUM GAIN (at 1 kHz)

front left and right	5 1/2 dB
front center (both channels driven)	11 1/4 dB
front center (one channel driven)	5 1/2 dB

S/N RATIO (re 0.5 volt; A-weighted)

front outputs	≥ 97 dB
surround output	≥ 77 dB

TOTAL HARMONIC DISTORTION*

front outputs	< 0.01%
surround output	≤ 3.0%

INPUT IMPEDANCE

	14k ohms
--	----------

OUTPUT IMPEDANCE

	50 ohms
--	---------

CHANNEL SEPARATION (at 1 kHz; front outputs)

	83 1/2 dB
--	-----------

DELAY TIME (surround output)

	8-70 msec
--	-----------

*Measured from 20 Hz to 20 kHz at the front outputs, from 100 Hz to 4 kHz at the surround output.

back output. When it is in the mono position, simulated stereo is derived by means of reciprocal comb filters (the best method) and fed to the front left and right outputs while a delayed version of the mono input is fed to the back output.

If you elect to use the front-center output (which is not required for surround-sound or ambience extraction), Phoenix suggests that the power amp used to drive the front-center speaker carry a power rating equivalent to that of the main

front-channel power amps. You could use one channel of a stereo power amp and use the other channel to drive the back speakers. Although this is perfectly feasible (and probably the most cost-effective approach), it's a bit of overkill. According to Phoenix, the back channel requires only one-quarter to one-half the power of the front channels for perfectly adequate reproduction. (We think even less would do.) And because the back channel requires neither the bandwidth nor the accuracy of the front channels, the speakers you use for the rear needn't be as good as those for the front.

Those of you who have followed the progress of four-channel sound and ambience extraction over the years will recognize that the Phoenix P-250 combines the best features of the following two principles of operation: L-R ambience extraction (à la the Dynaquad circuit devised by David Hafler) and "time delay" ambience unmasking as proposed by E. Roerback Madsen many years ago. Dynaquad was capable of pulling out the ambience information hidden in many stereo recordings in the out-of-phase (L-R) signal. Delaying this information (as the Phoenix P-250 does) before presenting it to the rear-channel speakers is said to enhance localization of the front-channel information while maintaining the sense of space imparted by the extracted ambience information. This is according to the Haas precedence effect, by which our ears tend to localize a sound source at the point from which we hear it first.

Phoenix sells the P-250 in kit or finished form. Assembly of the kit is fairly straightforward, but you do need a VOM and some idea of what resistors, capacitors, and so forth look like. If you haven't assembled at least one kit already, you probably should stick with the assembled version. There's a 30-day money-back guarantee of satisfaction on the assembled unit, so you get a chance to try it out for free. Both kit

and assembled units are warranted to meet or exceed published specifications for three years.

Diversified Science Laboratories tested a factory-assembled unit. Performance through the three front channels—left, right, and center (L+R)—is as perfect as modern electronics will allow. Response is ruler-flat throughout the audio band and well beyond. Channel separation (between front left and front right) is more than adequate, and the input is virtually overload-proof. Distortion at the 2-volt level is below our reporting limits across the band, and the system will pump more than 9 volts into our standard load from any output. Output impedance is a low 50 ohms from all three output terminals, so the P-250 can be expected to drive any power amp with ease. Input impedance is adequately, if not generously, high.

Noise at the front-left output is a remarkably low -100 dB with regard to the standard reference level of 0.5 volt—performance that few preamps can match. The figure for the front-center channel is 3 dB higher because it contains noise from both left and right inputs, but the signal-to-noise (S/N) ratio is still far more than adequate.

We are particularly impressed with the low noise level and wide bandwidth of the back channel. A lot of signal processing is applied to the rear output—including passing the difference signal through a 2,048-stage "bucket brigade" delay line—so we'd expect substantially more noise. But not so! The worst-case S/N ratio (with maximum delay) is 77 dB, and with the delay set at midpoint (where you'd probably use it), the noise is almost 82 dB down. Delay time ranges from 8 to 70 milliseconds and is about 43 milliseconds with the control centered.

Maximum gain (with the master level control fully advanced) is almost 6 dB (a factor of two) to the front channels. When left and right inputs are driven in parallel (simulating a full-center front signal),

gain to the front-center output almost doubles.

As with any signal processor of this type, frequency response to the delayed output (the back channel) is difficult to quantify since it depends on delay time. Suffice it to say that the P-250 has wider-than-average bandwidth, with a low-frequency -3-dB point of 25 Hz and a high-frequency cutoff that is always higher than typical for the delay setting. The distortion in the back output also is difficult to tie down, because it varies greatly with frequency. Although it is much greater than that in the front channels, we weren't aware of it in our listening tests.

We auditioned the P-250 using straight music (from Compact Discs) and Dolby-encoded video soundtracks (from Laserdiscs). We greatly appreciated its wide bandwidth and low back-channel noise, especially with a CD source. However, there's a tendency for the image to shift to the rear occasionally with some music, which can be distracting. This effect can be mitigated by reducing rear-channel level or fiddling with the delay; it depends as much on the microphone/mixing setup used during recording as anything else. Although we have used ambience extraction systems that provide a more stable image than the P-250 with a wider variety of source material, the Phoenix system gives you the controls you need to adjust the sound field to your taste.

With Dolby-encoded video soundtracks, the surround-sound effect is dramatic, although, again, we often were more aware of the back speakers than we were with decoders adhering more closely to the bandwidth limitations of the Dolby standard. In the final analysis, any system like the Phoenix P-250 must be heard to be appreciated, and Phoenix gives you the opportunity to audition the system in your own home for 30 days provided you buy the assembled unit. So how can you lose? ●

MEDLEY

Edited by
Georgia Christgau
and Ted Libbey



A Flygirl Fights Back

U.T.F.O.'s big hit, "Roxanne, Roxanne," is like a werewolf. In the heat of the moment at a crowded, dark nightclub, it was frisky enough to make me twitch my butt something fierce. It was baad, def, whack. But outside the land of the funk/break track—my favorite hangout, New York's Roxy—the groove seemed like it was loitering. In the glare of daylight, as the critic in me re-emerged, it lost some of its power.

Like most rap songs, "Roxanne, Roxanne" relies on minimalism to achieve its goal—to get you dancing. Big, fat drums and a few handclap and scratch effects are all the instrumentation it has. In the studio, such a bare-bones track is a challenge to work with. Since there is very little for the listener to focus on, what is there must constantly engage him. A couple of fast synth wipes and tape edits can be seductive, breaking up the monotony of the beat; the Emulator can do more than U.T.F.O. ask it to.

If the track were as durable (or silly) as the words, "Roxanne, Roxanne" could have been a great rap about three homeboys trying their darnedest to make some awesome flygirl. The lyrics have apparently been enough, however, to sell more than 250,000 units. "Roxanne" has become part of inner-city slang, used by males to describe girls who will not talk to them, and to date an unprecedented four

answer records have hit the racks. "Roxanne's Revenge," the unofficial response by Roxanne Shanté (a.k.a. Lolita Gooden), is hot. Even before it was out on vinyl, New York's WRKS, for one, was plugging it. Ms. Shanté thinks that U.T.F.O.'s rap is pure bull, and she shoots her message to them straight as an arrow. Groups are responding not so much to U.T.F.O.'s single as to the anger and sass of this fifteen-year-old student with no recording experience, who says she originally wrote "Roxanne's Revenge" as a joke.

"The Real Roxanne," the official answer by the girl who



Gooden: Revenge is sweet.

inspired U.T.F.O. In the first place, is less explicit. "I just had to do something," she explained to the *New York Daily News*. "Sparkie's Turn," by Sparkie D, contends that instead of making answer raps, Roxanne should be home doing homework. Leaving, in other words, the emceeing to her. "Roxanne's Doctor," a "psychiatrist," just released a record, too. Even Kurtis Blow and Edwin Birdsong have Roxanne records in the works. But

U.T.F.O.'s "Calling Her a Crab," which should be released by the time you read this, may be the last word. Seems fitting that they should finish what they started.

Havelock Nelson

Made in the U.S.A.

The New York Philharmonic continues to make its presence felt on the recording scene, though on a project-by-project basis rather than by contract with a particular label, as in the past. The orchestra's most recent sessions took place January 31 through February 5, as CBS recorded concert performances in Avery Fisher Hall of Act I of Richard Wagner's *Die Walküre*, with soloists Eva Marton, Peter Hofmann, and Martti Talvela. Zubin Mehta, the Philharmonic's music director, conducted. I was present at the first night's performance and was disappointed by Hofmann's coarse and ill-mannered singing, Mehta's somewhat superficial conducting, and the miserably out-of-tune playing of the cellos and basses—but reliable observers report that things went significantly better at later performances, so there is still hope for a worthy addition to the Wagner discography. CBS plans to release the recording sometime this winter.

CBS engineers were also busy across town at the 92nd Street Y, recording Schubert's String Quartet No. 15, in G, Shostakovich's String Quartet No. 15, and Mozart's Adagio and Fugue, in C minor, performed by violinists Gidon Kremer and Daniel Phillips, vio-

list Kim Kashkashian, and cellist Yo-Yo Ma.

It was an important week for recording outside New York as well. In Philadelphia, EMI was on hand to tape Scriabin's Symphony No. 1 with Riccardo Muti and the Philadelphia Orchestra. The sessions took place in the orchestra's new recording venue in Fairmount Park, Memorial Hall.

Meanwhile, the Cleveland Quartet, long associated with RCA, has expanded its recording activities through new contracts with Pro Arte (eight digital releases over the next four years, to include the complete quartets of Bartók and Tchaikovsky, a two-disc set devoted to the chamber music of Ernst von Dohnányi, and single discs of Bruckner's Quintet and Dvořák's *American Quartet*) and Telarc (three albums over the next two years, beginning with the quartets of Debussy and Ravel, due for release this fall.) Under consideration at RCA is a series of recordings teaming the Clevelanders with pianist Emanuel Ax.

Finally, a tip for folk music enthusiasts: The American Folklife Center of the Library of Congress has recently published an illustrated guide entitled *American Folk Music and Folklore Recordings 1983: A Selected List*. The entries were chosen for their high quality by a panel of experts and members of the Center's staff. The booklet is available free of charge and can be obtained by writing to Selected List, American Folklife Center, Library of Congress, Washington, D.C. 20540.

Ted Libbey

Discovering Gershwin

A new recording project aims to restore the well-known and the unknown works.

Michael Tilson Thomas grew up all-but-genetically predisposed to George Gershwin's music. Like a distant but much-talked-about uncle, Gershwin was close enough to the Thomas family to have given piano lessons to Michael's father, Ted, and to have talked with grandfather Boris Thomashefsky about writing for the Yiddish theater in New York. Gershwin remained such a presence—even after his death in 1937 and the Thomas clan's migration to Los Angeles—that Michael was able to pick up the composer's piano style from his father. And he learned to play Gershwin's show songs, from the standard chestnuts to the pre-Broadway casualties, in that style.

In the 1970s, however, when Thomas resurrected Gershwin's seldom-heard, much-maligned *Second Rhapsody*, his "Gershwin gyroscope"—as he calls his innate sense of the music—went on the blink. The piece just wasn't the same as what he had first heard as a child, whether on radio air checks or in one of Oscar Levant's last performances at the Hollywood Bowl.

"It was so early, I don't remember where I first heard [the *Second Rhapsody*] . . . but I do remember certain kinds of sounds . . . and they just weren't there anymore," Thomas says. "Sure enough, the version in print . . . was not based on George's original manuscript, but on one of a series of arrangements that was done after George died."

Thomas's search for the real *Second Rhapsody*, whose orchestral parts had been lost, was the beginning of an all-Gershwin recording project soon to emerge on CBS Masterworks. The first disc, due for release this month, includes the premiere recording of the *Second Rhapsody* in Gershwin's own orchestration, a thorough reexamination of the original Ferde

Grofé jazz-band orchestration of *Rhapsody in Blue* (1924), and a handful of Gershwin miniatures previously unheard because the composer had either never published or never finished them. Not surprisingly, this substantial project was aided by such Gershwin contemporaries as Kay Swift, by members of Thomas's family, and more importantly, by the composer's brother Ira Gershwin. Prior to his death in 1983 at the age of

(Continued on page 72)



Pianist and conductor Michael Tilson Thomas at work

by David Patrick Stearns

Magyar Offerings

by *Bálint András Varga*

Budapest—The world premier recording under Lamberto Gardelli of Ottorino Respighi's last opera, *La Fiamma*, was one of the highlights of Hungaroton's Mini Record Week at the end of March. The actual Record Weeks, held in September, coincide with the start of the concert season; the mini-series runs during Budapest's recently established Spring Festival.

La Fiamma, premiered in Rome in 1934 and performed in Chicago the same year under the baton of the composer, also has close associations with the Budapest State Opera House: The Hungarian production, the first outside Italy on the European continent, proved highly successful and was judged by the composer and his wife to be superior in many respects to the other productions. The principal role in the Hungaroton recording is sung by one of Hungary's leading sopranos, Ilona Tokodi, who has also made a name for herself in the United States.

There were four other novelties released at the end of March: Ferenc Erkel's *Hunyadi László*, Schubert's great C major Symphony, two one-acters by Telemann and Cimarosa, and the first album in a series covering the full range of Hungarian folk music.

Ferenc Erkel, founder of Hungarian national opera in the 19th century, combined a Verdian flair for the stage with melodies rooted in the Hungarian idiom. His popularity continues to be immense—which is one reason why Hungaroton has decided to release the opera *Hunyadi László* (based like all other Erkel operas on a historical subject) in a new rendition. Another interesting feature of the album is the fact that 17 cuts, imposed by different conductors and directors over the past one hundred years or so, have been eliminated. With the work more or less restored to its original form (some changes have been preserved), fans of Hungarian opera will be able to rediscover this national musical monument, now with new arias and with subsidiary roles promoted to principal

Bálint András Varga works in Budapest at Editio Musica, the state music-publishing agency.

ones. *Hunyadi László* also marks the recording debut of one of the rising stars of the young generation of Hungarian conductors—János Kovács. Of the cast, the name of soprano Sylvia Sass should ring many a bell in America; tenor Dénes Gulyás, winner of a Pavarotti competition in Philadelphia, may also be familiar.

The Budapest Festival Orchestra, whose recording of Schubert's Ninth Symphony was made available in the shops during the Mini Record Week, is a new departure in Hungarian musical life. Set up by the young Hungarian pianist Zoltán Kocsis and his contemporary, the conductor Iván Fischer (brother of Adám Fischer whose debut in Chicago late last year was such a sensation), the orchestra is drawn from the pool of musicians who make up all the different orchestras in Budapest. Only the best musicians have been picked—something that has engendered considerable jealousy and caused quite a furor in Budapest—and rigorous standards have been imposed. The orchestra (which is better paid than the other orchestras) meets only twice a year, holds an unprecedented number of rehearsals, gives a few concerts, and goes right to the Hungaroton recording studios. The Schubert C major Symphony disc, however, is a live recording of the orchestra's Christmas concert—packed to the rafters, incidentally, and enthusiastically applauded.

The Hungarian bass József Gregor, whose bulky figure has adorned many a record cover, is the star of two one-act operas: Telemann's *Der Schulmeister* and Cimarosa's *Il maestro di capella*. Both are available in the international catalog, but not, apparently, in this particular pairing. Gregor is a delightful buffo singer who has a considerable following in Hungary. Neither recording has a clinical studio atmosphere, especially not that of *Der Schulmeister*, where Gregor is joined by a boys' chorus. He has even supplied Hungaroton with his own "libretto" of sound effects, which should enhance the humor inherent in the music.

Following the international success of Hungaroton's world premiere recording of

Karl Goldmark's opera *Die Königin von Saba*, the company plans to come out with four of the composer's overtures. Three of them are concert overtures—*Šakuntala*, *Im Frühling*, and *In Italien*—while *Der gefesselte Prometheus* is linked to the tragedy by Aeschylus. András Kóodi conducts the Budapest Philharmonic Society Orchestra in this recording.

The centenary of Otto Klemperer's birth on May 14 will be marked by the release of the ninth disc in the series "Klemperer in Hungary." The outstanding German conductor was attached to the Budapest State Opera House between 1947 and 1950. Many people remember this as an unforgettable period of opera and concert performances of the highest standard. The new release will be



Conductor Otto Klemperer in 1950

a live recording of *The Magic Flute*, starring some of the best Hungarian singers of the time.

Finally, a curiosity: Aristid von Würtzler, the Hungarian-born American harpist and founder of the New York Harp Ensemble, has recorded transcriptions. Harpists around the world are a close-knit community, and Hungaroton expects to sell a few thousand copies of this album. ●



In the control room with producer Steven Epstein during an edit session

eighty-six, Ira not only rehearsed extensively with Thomas on idiomatic Gershwin interpretation, but eventually entrusted unpublished manuscripts to his care, including sketches for piano-orchestral works that Thomas will be poring over for years to come.

Might these newly unearthed pieces be more than just curiosities? "Oh, yeah," Thomas says with quiet confidence. "These are real pieces. I expect that they will find their way into the repertory."

Given the layers of red tape that must be gone through in such situations, he can't be too specific about the future: "There will be more recordings of more unknown music." How many? "I don't want to say." Are the pieces all unfinished? Orchestral? Solo piano? "A variety."

The tantalizing first album, three years in the making, is aptly divided according to decade—it contains music from the 1920s on Side 1 and the 1930s on Side 2. In addition to the *Rhapsody in Blue*, the first side includes the well-known *Three Preludes* from 1925, followed by two little-known preludes from the same year, collectively titled *Short Story*. The original manuscript was lost, but Thomas reconstructed the pieces from a violin-piano transcription by Samuel Dushkin. Even more rare is a 32-bar fragment, *Violin Piece*, composition date unknown, that Thomas expanded and completed under Ira's guidance.

Following the *Second Rhapsody*, Side 2 features a 1933 unfinished piece titled *For Lily Pons*, sketched on three lines and completed by Thomas, who believes it was originally meant to be a piano-orchestral work and will flesh it out as such for a future album. *Sleepless Night* was often believed to be a missing prelude from the series of six that Gershwin wrote in the 1920s, but it was actually written for no particular reason in 1936 when Gershwin was working on the film *Shall We Dance*. *Promenade*, some-

times called *Walking the Dog*, from *Shall We Dance* was known for years in a piano version reconstructed from memory by pianist Hal Borne, who worked on the film. However, the original chamber orchestra version turned up in 1978 in an RKO warehouse and appears for the first time on the forthcoming album.

Why these previously unheard works may be more significant than chips off any other master's woodbench has to do with Gershwin's creative process. A born improviser, he seems not to have committed musical ideas to paper until they were fully hatched, as illustrated by his sketchbooks in the Library of Congress. Aside from a few curious scraps of counterpoint scribbled in the corners of the pages—perhaps to exercise his growing formal expertise—nearly everything that Gershwin took the time to write down was notated with considerable precision and eventually became the songs and concert works that have attained such wide familiarity.

"George knew his greatest strength was the ability to invent new material," says Thomas. "His challenge was to get the maximum out of the materials he wrote—doubling the speed, inverting the chords, working out what the possibilities were. Also, the course of his entire life is a progression toward specificity. As he went along, he became more exact [in writing the music down]."

Perhaps the major fascination of the newly uncovered miniatures is that they're not more of the same thing, but show a personal, introspective side of a composer who was not exactly known for being confessional. Gershwin generally revealed his musical personality through the stylish outer garments he so smartly wore. But here, he is often stripped bare—with none of the familiar Broadway and Hollywood fashions—in some of the purest, most unaffected music he wrote. Whether or not *For Lily Pons* was

sketched for the famous opera singer or was inspired by the milieu she represented, the piece is as harmonically abstract, mysterious, and haunting as a Debussy prelude.

The two rhapsodies, though, are the major drawing cards of the forthcoming album, with *Rhapsody in Blue* rescued from the side effects of its own popularity and the *Second Rhapsody* rescued from the neglect Gershwin himself was partly responsible for. Though written for the Paul Whiteman Orchestra, *Rhapsody in Blue* became accepted into the symphonic repertory—after all, few big bands beside Whiteman's could really play it—and thereafter became laden with larger orchestrations that dictated slower, more portentous tempos and less rhythmic spring. Gershwin had so little formal training at age twenty-five that Grofé was put in charge of the orchestration; it's not surprising that the piece seemed to career out of the composer's control, evolving from what it initially was into something barely recognizable.

Taken back to its original form, Thomas says, "[*Rhapsody in Blue*] is revealed as a piece of the 1920s, a flapper, jazzy piece. It's played at a very hot tempo, which does not relate to the way it has been played over the years. It is totally a product of this twenty-five-year-old jazz improviser. . . ."

Though the 1931 *Second Rhapsody* failed to catch on like its predecessor, it excludes all the technical assurance Gershwin lacked only seven years earlier. While *Rhapsody in Blue* often sounds like orchestrated songs, the *Second Rhapsody* is built out of symphonically conceived thematic and rhythmic material. The dense, elaborate orchestration, entirely Gershwin's own, uses the various instruments in all sorts of innovative ways, from the subtle exploration of exotic sounds (such as what is achieved by doubling the oboe and the trumpet) to the use of the French horn as a rhythmic instrument.

The genesis of the *Second Rhapsody* was an instrumental sequence for the 1931 film *Delicious* with Janet Gaynor; the music was meant to depict New York City street life. Gershwin never wanted it published; Thomas believes he planned to expand it into something larger and allowed only limited performances until he could get back to it. Library of Congress music specialist Wayne Shirley says Gershwin told Frank Campbell-

(Continued on page 97)

REVIEWS

A Landmark Schoenberg Set, Here at Last

SCHOENBERG:

Vocal and Instrumental Works.

⊙ Performances by Martin, Minton, Nimsgern, Mesplé, Wenkel, Hudson, Partridge, Shirley-Quirk, Rolfe Johnson, Bowen; BBC Symphony Orchestra, BBC Chorus, Ensemble Intercontemporain, Boulez. Roy Emerson and Georges Kadar, prods. CBS 13M 37863 (D, 3).

Die Jakobsleiter; *Erwartung*, Op. 17; *Die glückliche Hand*, Op. 18; *Four Orchestral Songs*, Op. 22; *Chamber Symphony No. 1*, Op. 9; *Chamber Symphony No. 2*, Op. 38; *Three Pieces* (1910).

Arnold Schoenberg, God knows, thought big. His original 1912 conception for his posthumous, never completed oratorio *Jacob's Ladder*—no doubt invigorated by Gustav Mahler's having marshaled more than a thousand performers for his Eighth Symphony's world premiere in Munich five years earlier—called for 20 flutes (10 interchangeable with piccolos), 20 oboes (10 interchangeable with English horns), 24 clarinets (12 in E flat, 6 in B flat, 6 bass), 20 bassoons (10 interchangeable with contrabassoons), 12 horns, 10 trumpets (2 bass), 8 trombones (including 2 alto, 2 bass), 6 tubas, 8 harps, celesta, percussion, 50 violins, 30 violas, 30 cellos, 30 basses, 13 solo voices, and last but far from least, a chorus of 720. Final score, surprisingly: 1,030 to 1,003—in Mahler's favor. (Henri-Louis de La Grange's notes say of *Schoenberg's* original demands: "In other words, probably the largest forces ever called for"—an oddly absent-minded observation to come from the author of an outstanding Mahler biography.) You will not hear such massive forces in this recording, though: Schoenberg revised his *Jacob's Ladder* scoring downward in 1944. You will hear, if you have the fortitude, a total of slightly over two-and-a-half hours of Schoenberg's most important music, ranging all the way from the days when he still employed key signatures to his final, revolutionary disintegration of the octave into 12 equally important tones—what he called "the liberation of dissonance."

One cannot get around Schoenberg's

pivotal importance in the history of musical development; his dodecaphonic technique of composition opened up a new musical world—even stiff-necked old Igor Stravinsky, with his greatest rival Schoenberg safely dead, finally had to capitulate, adapt, and embrace it. Neither, though, can one get around the fact that the passage of the decades has not made this music any easier to listen to. In his very fancy notes on *Erwartung*, Robert Craft writes: "Even now, more than a half century after it was written, *Erwartung* has been fully absorbed by only a very few musicians." If that applies to the professionals, where does that leave even the most sedulous musical amateur? Over the decades, I have heard a great deal of dodecaphonic music, most of it performed by acknowledged, expert specialists, but I have to admit that I approached this blockbuster three-record set, even with the scores in front of me, with considerable trepidation, and that when I finally closed it I felt, in the main, that same measure of intellectual accomplishment associated with attaining the ultimate page of one of the longer, more recondite tomes of some such author as Jürgen Habermas. I do feel the better for having done it, but I can think of a long, long list of works that would have given me a great deal more purely subjective pleasure. Face it, though: *Jacob's Ladder* and the other works recorded here make up an album of significant music by a composer of epochal importance, and in superlative performances. If you feel up to it, I wholeheartedly recommend it to you. Don't, though, expect it to let you off easy.

Logically, you should conduct this exploration chronologically, but watch out for the opus numbers, which in Schoenberg can mislead you: for example, he began his Chamber Symphony No. 2, Op. 38, in 1906, but didn't get around to completing it until 33 years later. I suggest you start with the two Chamber Symphonies. Schoenberg wrote them with key signatures, but even then the foundation of tonality beneath his feet, the same as under the feet of every composer in history up to him, had begun to shift, buckle, and crumble, and even as early as that his music had become so chromatic, so fluid, that for long passages on end the listener has no perceptible tonal handrail to hang on to. These two works, difficult but thoroughly enjoyable (and after a few hearings, relatively easy for even the amateur to assimilate), provide a valuable bridge to the more problematic and demanding works that follow. You may, just possibly, find it easier to tackle them in this order: *Erwartung*, *Die glückliche Hand*, the Songs of Opus 22, and *Jacob's Ladder*. Those three little orchestral pieces from 1910 hardly count; altogether they add up to only 2:15.

This album transports us back to Central European expressionism during the most intense of its *O Mensch!* phase. The monodrama *Erwartung* shows some Freudian influence (although not nearly so much as Craft would have us to believe); Schoenberg himself called it "an anxiety dream"—a nightmare. Janis Martin, our impressive San Francisco Opera Elektra this past winter, sings it probably as well, as hair-raisingly, as anyone could. *Die glückliche Hand* has a



Superlative performances from conductor Pierre Boulez and his forces

preposterous, transparently autobiographical text by Schoenberg himself, with endless stage directions far more extensive than the material actually sung, and sung expertly, by Siegmund Nimsgern and the BBC Chorus. Yvonne Minton (*Yvonne Minton! Brangäne!*: How in the world does Boulez sweet-talk these singers into learning and singing this kind of thing?) manages the four songs of Opus 22 with great expressivity, singing poems by Dowson (translated by Stefan George) and Rilke.

Jacob's Ladder, even unfinished, lasts a bit over 47 minutes, with no break except the one necessary to turn the record over. If you want to bicker about the true way to interpret *Sprechgesang*, the gamut of approaches here will provide you with ample grounds for agitation. One assumes that all, or at least most, of these unusually secure artists have absolute pitch, for they stick exceptionally close to Schoenberg's notation. Unfortunately, Boulez failed to shepherd them toward a consistent consensus; some (Ian Partridge, for example) almost speak, some (Anthony Rolfe Johnson, Ortrun Wenkel) almost sing—an unfortunate discrepancy.

As you would expect, Boulez performs all these works with dedication and the greatest possible transparency. One notes a few surprising, inexplicable lapses—for instance, in the final 32 measures of the Second Chamber Symphony he casts a largely blind eye upon Schoenberg's tempo changes, and at rehearsal no. 158 in *Jacob's Ladder* he turns the *ppp* almost into a *sforzato*—but he certainly adheres more closely to these difficult scores than most conductors adhere to anything.

CBS provides a trilingual 44-page booklet; it contains a vast amount of interesting

information, but one must call it, editorially, a mess. I doubt that anyone, and I mean *anyone*, ever proofread it; could Robert Craft, even at his fanciest, ever write: "‘Nightmare’ is a possible subtitle for readers in search of descriptive help, but Schoenberg's own ‘*Angsttraum*’ is a better word as well as less of present to ill-intentioned reviewers"? You have to turn to the French section to learn that Henri-Louis de La Grange wrote the notes about *Jacob's Ladder*; someone else, anonymous, wrote those that appear only in German. A good overall introduction to Schoenberg by George Perle appears in English and German, but if you read French I call your attention to the article reprinted from *Relevés d'apprenti*, the 1966 collection of writings by Boulez, which the booklet for some reason does not translate. It does provide trilingual texts for *Erwartung*, *Die glückliche Hand*, and the four songs, but it gives the *Jacob's Ladder* text in German only, and anyone who can't read that will need, and need desperately, a translation. *Jacob's Ladder* has eight soloists, but the booklet does not list them except for their names; to find out who sings which role, you have to decipher the fine print on the record label.

Well, *Jacob's Ladder* does in actual fact have *nine* soloists, although the label, the booklet, and even the front of the score itself lists only one soprano as The Soul (of The Dying Man, which the label calls a Dying Woman—but don't let's get into *that*), whereas the closing 16 measures of the score itself, and the recording, provide us with two sopranos singing two lines simultaneously, with only Mady Mesplé given credit. Quite a trick.

When Venice's musical *Biennale* gave

the world premiere of the opera *Intolerance* by Luigi Nono (Schoenberg's son-in-law, incidentally) at La Fenice years ago, the Venetians brought the BBC Symphony all the way from London on the grounds that the orchestra could play *anything*. Well, it still can. The Ensemble Intercontemporain, from Paris, consists of 19 soloists of extraordinary virtuosity—nineteen, that is, according to that wretched booklet, which names those but fails to name the astonishing first trumpet (or for that matter, the second). After hearing what he and the first hornist André Cazalet do in measures 417–421 of the Second Chamber Symphony, I strongly suspect both of them of having entered into some sort of pact with the Devil. *Paul Moor*

Editor's note: This Schoenberg collection was originally released by CBS in Europe in 1982 and is only now available domestically. The album was voted an International Record Critics' Award in 1983; see the December '83 issue of HIGH FIDELITY.

MAHLER:

Das klagende Lied.

Ⓢ Döse, Hodgson, Tear, Rae; City of Birmingham, England, Symphony Orchestra and Chorus, Rattle. John Willan, prod. EMI Angel DS 38159 (D). □ ◻ ◻ CDC 47089.

Mahler's early (1880) cantata based on Grimm's *The Singing Bone* is, with all its flaws, a prodigious achievement for a youngster who had barely turned twenty. In its melodic, dramatic, and pictorial strengths, it knows few counterparts in musical history. Yet performances of its complete three-part version have a built-in problem. In 1888,

I N T H I S I S S U E

ADAMS:
Grand Pianola Music.

BACH:
Harpichord Works.

DUPARC:
Songs.

GROFÉ:
Orchestral Suites.

JOACHIM:
Violin Concerto in G;
Elegische Ouverture.

LLOYD WEBBER:
Requiem.

MAHLER:
Das klagende Lied.

MOZART:
Symphonies.

PAGANINI:
Violin Works.

RAVEL:
Shéhérazade.

REICH:
Eight Lines.

SCHOENBERG:
Vocal, Instrumental Works.

Mahler made the decision to excise the first part (*Waldmärchen*), possibly because its plot—in which one brother kills another—renewed his feelings of guilt over his own brother's death in 1874. Then in the late 1890s, Mahler embarked on an elaborate revision of the remaining two sections—substantially creating music of his maturity. Apparently, the scores of the original versions still exist, but thus far, no performance of them seems forthcoming in the foreseeable future.

As a result, the differences that exist between the two editions cannot yet be ascertained, but it is certainly obvious that Mahler's 1899 edition of the later sections (*Der Spielmann, Hochzeitsstück*) is considerably tidier and more transparent in orchestration than *Waldmärchen*, which is string-heavy and full of unnecessary doublings. Therefore, a conductor has his work cut out for him in trying to make the complete version sound like a cohesive whole. Pierre Boulez, in his pioneering recording in 1971 (CBS M2 30061), couldn't quite make it all jell, but he

surely was more successful than Simon Rattle, who on this new disc gives a curiously dispiriting performance. This disappointment is surprising, since Rattle three years ago (with the Bournemouth Symphony Orchestra, on Angel) gave a most compelling rendition of Mahler's Tenth Symphony in Deryck Cooke's performing edition. (Coincidentally, with *Das klagende Lied*, Rattle becomes the first conductor to record Mahler's first and last orchestral works in complete versions.)

The fact that Angel has fit all three sections of *Das klagende Lied* on two sides rather than three (as in Boulez's recording) would, on the surface, be a plus economically. But alas, on the surface is just what we get. Rattle fares decently enough in *Waldmärchen*, even if he can't clarify the thick and sometimes turgid instrumentation quite as well as Boulez can. But severe problems beset his reading of the remaining sections. He seems oddly uninvolved for most of the way; rhythms are slack, accents are frequently gelatinous, while the wide range of

colors and dynamics is balefully muted. The chorus signs well enough, but the Birmingham orchestra has certainly been heard to better technical advantage (as in last year's Britten *War Requiem*, Angel DSB 3949). The four vocal soloists are a generally undistinguished lot (the best-known of them, Robert Tear, is painfully out of voice).

What's more, whatever virtues there are in this performance are betrayed by monochromatic recording. There's hardly any impact to the big choral-orchestral outbursts, while the offstage band at the beginning of Part III (one of Mahler's most arresting inventions) sounds as if it's coming over a telephone wire. Perhaps the generous amount of playing time (35 minutes) granted Side 2 is partly at fault for all this congestion, but to be truthful, Side 1 sounds only marginally better. Perhaps a CD issue might improve matters, but in the meantime, Bernard Haitink's version of the last two sections (on Philips) walks all over this new one sonically; Boulez's recording of the complete edition is, despite its age, also noticeably bet-

ORDER TOLL-FREE
800-221-8180
IN NEW YORK STATE
CALL (212) 732-8600

J&R MUSIC WORLD

23 PARK ROW
NEW YORK CITY
NEW YORK
10038

WHEN BUYING MAIL ORDER—WHO YOU BUY FROM...
IS AS IMPORTANT AS WHAT YOU BUY...
REMEMBER, WE ARE
RELIABLE!

TOP 10 RECEIVERS

Technics SA-150

+25 watts per channel
+Digital FM AM Tuning
+Auto Retune
\$119⁹⁵
AKAI AA475 5W in Silver or Black 139.95
AKAI AA475 5W in Silver or Black 179.95
AKAI AA475 5W in Silver or Black 129.95
SANSUI SR1070 5W in Silver 126.95
SANSUI SR1130 5W in Silver 149.95
SHERWOOD S2160 5W in Silver 199.95
SHERWOOD S2160 5W in Silver 139.95
SHERWOOD S2160 5W in Silver 139.95
TECHNICS SA180 5W in Silver 199.95

TOP 10 CASSETTE DECKS

AKAI HX4-2

+Soft Touch Controls
+Dolby B & C Noise
+Metal Tape
\$69⁹⁵
AKAI CA855 AutoRev. Dolby B & C 139.95
AKAI CA866 AutoRev. Dolby B & C 179.95
SANSUI DW100 AutoRev. Double Deck 139.95
TEAC W5600 Soft Touch Dolby B & C 199.95
TEAC W5600 Soft Touch Dolby B & C 179.95
TECHNICS PSB11W Double Deck 159.95
TECHNICS PSB12 Soft Touch Dolby 189.95
TECHNICS PSB78R A & B Rev. 125.95

TOP 10 COMPACT DISC PLAYERS

Technics SP-1

+Programmable up to 15 Tracks
\$299⁹⁵
AKAI CD477 8W in Silver 189.95
HITECH DA8000 Programmable Back 159.95
HITECH DA8000 Programmable Remote 159.95
MARANTE CD54 8W in Silver 179.95
NIREKO NC1000 Programmable Back 149.95
SANSUI PC1600 Programmable Back 159.95
SHERWOOD CD1000 Programmable 159.95
TECHNICS SP1 Remote Programmable 179.95
TECHNICS SP1 Remote Prog Back 139.95

TOP 10 EQUALIZERS & MIXERS

AUDIO CONTROL SYSTEM C-101

+10 Bands Per Channel Equalizer
+Spectrum Analyzer
+Auto Sonic & Rumble Filter
\$329⁹⁵
ADC SS115 10-band EQ 99.95
ADC SS115 10-band EQ w/ Amp 129.95
AUDIO CONTROL SYSTEM C-101 199.95
AURORA SOURCE 8014 7-band EQ w/ Amp 129.95
NUMARK D4150 Master Pre-Amp EQ 119.95
NUMARK DM100 Master Pre-Amp EQ 129.95
TECHNICS SM823 7-band Channel EQ 84.95
TECHNICS SM825 7-band Channel EQ 129.95

TOP 10 HEADPHONES & SPEAKERS

KOSS PORTAPRO

+Light Weight Headphones
+Comes with 1/4" & Mini Plugs
\$44⁹⁵
KOSS PRO400 Stereo Headphones 44.95
KOSS PRO400 Stereo Headphones 44.95
SONY MDR77 Digital Amp 69.95
SONY MDR77 Digital Amp 69.95
EPI TE 100 8" 2-way DMR 179.95
EPI TE 100 8" 2-way DMR 179.95
EPI TE 100 8" 2-way DMR 179.95
EPI TE 100 8" 2-way DMR 179.95
EPI TE 100 8" 2-way DMR 179.95

TOP 10 CARTRIDGES & TURNTABLES

SURFONE V-15

TYPE VMR
+Micro Probe Stylus
\$139⁹⁵
AUDIO TECHNICA 152LP Mount 179.95
PCE WING 83501 DMC 129.95
SHURE V15 VMR V8 109.95
STANTON SB08L DMC 149.95
TECHNICS SL0300 Auto-Drop 169.95
TECHNICS SL800 Manual Rev. 164.95
TECHNICS SL820 Auto-Changer 169.95
TECHNICS SL11 Multi-Rev. 169.95
TECHNICS SL0300 Semi-Auto 179.95

TOP 10 STEPEO-TO-GO

SONY WMF-10W

+Super Miniatur
+AM FM Cassettes
+Dolby B Metal Tape
\$89⁹⁵
KOS5 48 FM AM Auto-Tuning 59.95
PANASONIC RW535 FM Car. Dolby Met. 174.95
SAINTY MC805 AM FM Auto-Tune 154.95
SONY WM10W Super Miniatur Cassette 59.95
SONY WM10W Auto-Tuning 154.95
SONY WM10W Auto-Tuning 154.95
SONY WM10W Auto-Tuning 154.95
SONY WM10W Auto-Tuning 154.95
SONY WM10W Auto-Tuning 154.95

TOP 10 TELEPHONES & ANSWERING MACHINES

Panasonic KX-12425

+Telephone & Answering Machine
+Answerphone
+16 Memory's Tone
+Pulse Dialing
\$189⁹⁵
AT15 51200 NOMAD-4000 1320T Auto 99.95
COPRA CP460 1000T Tone Auto 149.95
CODE-A-PHONE 2330 Beepers Rem 139.95
PANASONIC KX1415 Remote VCR 99.95
PANASONIC KX1425 Beepers Rem 109.95
PANASONIC KX1435 Beepers Rem 109.95
PANASONIC KX1445 Beepers Rem 109.95
PANASONIC KX1455 Beepers Rem 109.95
RECORD-A-CALL 690 Dual Remote 101169.95

Scotch Rated #1 by Consumers

T-120 or L-750

YOUR CHOICE
\$25 EACH

Scotch T-120HCX Plus or L-750HCX Plus

YOUR CHOICE

YOUR CHOICE
\$948 EACH

ALL PRODUCTS CARRY U.S. WARRANTIES

ALL DEFECTIVE PRODUCTS EXCHANGED WITHIN 30 DAYS

ALL NEW FOR 1985

3 FREE CATALOGS

+368 PAGE AUDIO/VIDEO COMPONENT ELECTRONICS CATALOG
+80 PAGE RECORD CATALOG
+128 PAGE VIDEO MOVIE CATALOG
IF YOU ARE NOT SURE WHICH CATALOGS YOU WANT PLEASE ASK FOR THEM IN COLOR AND WE WILL SEND THEM OUT FREE!

23 PARK ROW DEPT. H6-6 NEW YORK, NY 10038

NAME: _____
ADDRESS: _____
CITY: _____ STATE: _____ ZIP: _____

PLEASE SEND \$1.00 FOR SHIPPING AND HANDLING. CASH OR CHECK ONLY. NO C.O.D.'S.

TOP 10 CAR STEREOS & SPEAKERS

KENWOOD KRC1022

+Digital Pre-Amp, Dolby B
+Auto-tuning, 12 Preset Stations
+DIN Size Chassis
\$429⁹⁵
BLAUPUNKT ASPH SOR A 8 DO 329.95
CLARION 8500/8530 DQ & APZ 154.95
DINOR 12700R Black Silver Chassis 139.95
SANYO CTC30 A 8 DO Chassis 159.95
ALCANTARA AM 1550 1500 119.95
JENSEN 18013 1550 119.95
JENSEN 18013 1550 119.95
JENSEN 18013 1550 119.95
JENSEN 18013 1550 119.95

TOP 10 AUDIO TAPES

TDK SAC-90

+Super Audio
\$179 each
BASF C6090 2PM Chrome 2-Pack 13.99
MAXELL K125-90 180 14.99
MAXELL K125-90 or K125-90 14.99
SONY HPS-90 2PM Normal Bias 1.99
SONY LK125-90 Super Hi-Bias 2.49
TDK SA90 180 14.99
TEAC CDC-90 Normal Bias 1.99
TEAC CDC-90 Super Hi-Bias 2.49

TOP 10 VIDEO ACCESSORIES

SURROUND SOUND M-360

+Micro Picture Sound Effects Decoder with Dolby Stereo, Audio Time Delay & Internal Audio Amplifier
\$269⁹⁵
ADC V200 Video Enhancer 99.95
NORTONSON VCR180 VHS Headcutter 129.95
NORTONSON VCR185 VHS Headcutter 119.95
RECTORON V612A 035 Switcher 119.95
RHODES SW534 Switcher 2781 158.95
VIDEOKRAFT V100 1/2 In. Ext. Com. 118.95
VIDEOTEK S8838 035 Switcher 39.95
VIDEOTEK SV5440 035 Switcher 129.95

TOP 10 AUDIO ACCESSORIES

discwasher RECORD CAR SYSTEM

Includes Da Brush, Da Fluid & DC 1 Tap Cleaning Brush
\$99

TOP 10 VIDEO RECORDERS

SANYO VC-7200

+Beta Hi-Fi Recorder
+14 Day E-Event, Cable Ready
+Wireless Remote
\$349⁹⁵
SANYO V6400 Beta Hi-Fi Remote 129.95
SONY SL7000 Beta Hi-Fi 149.95
SONY SL7000 Beta Hi-Fi 149.95
TOSHIBA VE 441 Beta Hi-Fi 149.95

TOP 10 VIDEO TAPES

SONY T-120HC or L-750HC

Ultra High Grade
Your Choice
\$95 each
MAXELL HGB-120 High Grade 6.99
MAXELL L120 6.99
RCA T-120 6.99
SCOTCH L-750 6.99
SONY L-830 6.99
TDL L-850 6.99
TDL HST-120 Hi-Fi Formulation 5.99
TDL HST-120 Extra High Grade 5.99

NOTE: WE CARRY A FULL LINE OF AUDIO, VIDEO AND COMPUTERS IN EVERY MAJOR BRAND. THIS LISTING IS JUST A SMALL SAMPLE IN OUR 100,000.00 INVENTORY. PLEASE CALL US TOLL FREE OR WRITE TO US FOR PRICES ON ITEMS NOT LISTED IN THIS AD.



Playing the spots off of Paganini's sheer trash: violinist Salvatore Accardo

ter-sounding. The Rattle release includes liner notes, but no texts or translations. To quote Mahler's oft-repeated line in this cantata, "O Leide, O Leide!" *Bill Zakariassen*

PAGANINI:

Works for Violin and Orchestra.

Ⓞ Accardo; Chamber Orchestra of Europe, Tamponi. John Mordler, prod. EMI Angel DS 38127 (D). ☐

Variations on "The Carnival of Venice," Op. 10; Variations from Rossini's "Mosé"; Larghetto con passione; Moto perpetuo, in C; Andante amoroso; Sonata per la gran viola.

PAGANINI:

Works for Violin and Orchestra.

Ⓞ Accardo; Chamber Orchestra of Europe, Tamponi. John Mordler, prod. EMI Angel DS 38128 (D). ☐

Sonata Varsavia; Sonata Maria Luisa; Polacca with Variations, in A; Balletto campestre.

Musically speaking, when it comes right down to sheer narcissism, one would have to look far—even among operatic sopranos and tenors—for anyone to rival Niccolò Paganini, let alone match him. Edward Neill, in his notes for these two discs, sums up Paganini's aesthetics in one deft sentence: "In order to show off his extraordinary violin technique he preferred, with some exceptions, to compose his own music rather than play the works of other composers." Paganini looked upon music rather as Shakespeare did upon a plot: as a mere peg to hang display on. As a result, these discs offer 1 hr. 44 min. 55 sec. of sheer trash—but quality trash, with a legitimate purpose, and of the sort that makes violin aficionados' eyes light up with a diabol-

ic gleam.

The prospective buyer will want the answer only to the question of how Salvatore Accardo, internationally famed as a Paganini maven, plays this stuff: He plays the spots off it. In the *Moto perpetuo*, for instance, he fires off almost 3,000 successive solo notes, with the pitiless implacability of machine-gun bullets, in only 4:14. Who, if one likes that sort of thing, could ask for anything more?

Five selections here get their first recordings ever, four others their first with orchestra, and the *Sonata per la gran viola* its first using a five-string *controviola*, in this case one especially made for Accardo. *Ecco!*

Paul Moor

RAVEL:

Shéhérazade.

DUPARC:

Songs.

Ⓞ *Te Kanawa*; Belgian National Opera Orchestra, Pritchard. John Fraser, prod. EMI Angel DS 38061 (D). ☐. Ⓞ CDC 47111.

Songs: *Phidylié; L'invitation au voyage; La vie antérieure; Le manoir de Rosemonde; Testament; Au pays où se fait la guerre; Chanson triste.*

Since I have a special love for this music and this singer, it really pains me to report that this record has disappointed me. Only at a very few points do we hear the fresh, natural, spontaneous vocal opulence we expect from Kiri Te Kanawa, and anyone fluent in French will deplore the evident lack of study, coaching, and general linguistic preparation

and comprehension that EMI ought to have insisted upon in advance. Dame Kiri sings impure vowels (*chéri* sounds almost like *sherry*, for instance), and she has far from mastered such peculiarly French sounds as *u*, *in*, *on*, etc. (In a purely linguistic comparison with the Ravel and three of the Duparc songs in EMI's four-disc album "L'Exquise" *Maggie Teyte* [RLS 716], Dame Kiri comes off poorly; she would have profited by learning from Dame Maggie's example, not to mention those of several Francophones who have recorded these works with exemplary diction.)

The Belgians play all right, but at several points in the Ravel, conductor and soloist come perilously close to going their separate ways. For good reason, Ravel wanted—in this case, in vain—certain long phrases sung in one uninterrupted breath: "*Je voudrais voir des calumets entre des bouches/Tout entourées de barbe blanche*," for instance, or "*Et des cadis, et des vizirs/Qui du seul mouvement de leur doigt qui se penche. . .*" He also wanted the cycle's third song, *L'Indifférent*, sung at a *very* indolent, sexy, sultry one beat per second; like so many inattentive performers, these get nervous and start out too fast.

In general, this record leaves me with the impression of inadequate long-range preparation and ultimate recording-session compromises, and no one regrets it more than I do.

Paul Moor

MOZART:

Symphonies (6).

Ⓞ *Bavarian Radio Symphony Orchestra, Kubelik*. David Mottley and Friedrich Welz, prods. CBS Masterworks D3 36930 (D, 3). ☐

No. 35, in D, K. 385, "Haffner"; No. 36, in C, K. 425, "Linz"; No. 38, in D, K. 504, "Prague"; No. 39, in E flat, K. 543; No. 40, in G minor, K. 550; No. 41, in C, K. 551, "Jupiter."

These are good performances, with the exception of No. 39, in E flat, and No. 40, in G minor, which are too slow—the G minor may be more impassioned than any other Mozart symphony, but *allegro* still means *allegro*. However, the positive impression of the rest must be qualified with small reservations.

If one compares these recordings only with the usual exaggerated performances of today, one can imagine any community feeling fortunate to have Kubelik as the director of its orchestra. For the same reason, if one wanted to give someone a set of these symphonies as an introduction, this version

would be a good choice. It has no wrong ideas to become irritating with repetition, and its recorded sound is naturally balanced and gives a good representation of what a live orchestra sounds like. (I heard only the analog discs.)

However, measured against recordings of these same works by Carlo Maria Giulini, Colin Davis, or Benjamin Britten, Kubelik's seem pale. What is missing is something perceptible in Britten's performances particularly: the sharply pointed inflection of not only the upper voices one hears as melody, but also the middle and lower parts, whether they are countermelodies or merely chord progressions. For in Mozart's instrumental music these inner parts perform the same function in relation to the others as the whole orchestra does in his operas: They keep up a running commentary on what is happening onstage, heightening its expressiveness one minute and entirely altering its context and meaning the next.

The extended introduction to the *Prague* Symphony has the silencing force of an overture, preparing one's attention for the rush of dramatic ideas in the Allegro. What makes the introduction powerful and the Allegro dramatic are tensions created by the harmonies, suspensions, and simultaneous comments of different instrumental groups. Once they have been brought to one's attention by the sharp outlines of Brit-

ten's recorded performance, the comparatively expressionless background murmuring in Kubelik's recordings may make his versions, even the graceful renditions of the *Jupiter*, *Haffner*, and *Linz* symphonies, seem slack.

Those not wanting a boxed set may prefer the single London records by Britten of the *Prague* (No. 38) and the G minor (No. 40) symphonies. Davis's recordings of No. 39 and the *Jupiter* (No. 41) are on Philips, and István Kertész recorded the *Linz* and *Haffner* on London. (We can always hope for an LP remastering of the incomparable Toscanini performance of the *Haffner* recorded on 78s in 1929.)

The liner notes for the Kubelik set are in three languages, but they aren't the same notes in each language: The ones in German and French are quite good; the English ones are appalling. No one should listen to the finale of Symphony No. 39 for the first time and expect to hear the strings doing "a good deal of fiddling that may be considered Mozart's closest approach to American barn dance style." What has gotten into CBS?

Thomas Hathaway

JOACHIM:

Concerto for Violin and Orchestra, in G⁺; Elegische Ouverture, Op. 13.

⊙ *Nishizaki*; Stuttgart Radio Symphony Orchestra, Minsky. Teije van Geest, prod. Marco Polo HK 6.220190 (D). (Distributed by Harmonia Mundi, U.S.A.)

This mysterious, supranational recording (music written by a German Jew performed by a Japanese with a German orchestra led by a Polish-born Israeli living in New York—produced by a Dutchman for a firm based in Hong Kong) deserves some attention, although not very much. It appeals mainly as a bit of musicological esoterica, for Joseph Joachim's reputation today rests entirely upon his activities as the virtuoso who championed Brahms's Violin Concerto. The overture completing Side 2 memorializes the great German dramatist Heinrich von Kleist, still almost totally unknown in our theatrically uncultured country, whose novel *Michael Kohlhaas* provided the prototype of Coalhouse Jackson in *Ragtime*. Paul Moor

BACH:

Works for Harpsichord.

⊙ *Gilbert*; Pinnock†. Andreas Holschneider, reissue prod. Archiv 413 103-1 (A and D, 10).

FORMAT KEY

- ⊙ LP
- ⊠ Cassette
- Compact Disc
- ⊠ Videocassette
- ⊙ Videodisc
- ⊙ Open reel

RECORDING INFORMATION

(A) analog original

(D) digital original

Large symbol beneath title indicates reviewed format. Small symbols following catalog number of reviewed format indicate other available formats (if any).

Catalog numbers of all formats of a particular recording usually are identical except for differing prefixes or suffixes. Catalog numbers of formats other than the reviewed format are printed only if their basic numbers differ substantially from that of the reviewed format.

Arabic numeral in parentheses indicates number of items in multi-item set. Unless otherwise indicated, all multi-LP sets are in manual sequence.

McIntosh[®]

Get all the newest and latest information on McIntosh stereo equipment from McIntosh Laboratory.



XL 1 Speakers

MR 500 Tuner
MC 502 Amplifier
C 504 Preamp

C 33 Stereo Preamp

MC 2255 Stereo Power Amplifier

Send For Your Stereo Information

McIntosh Laboratory Inc. HF 685
East Side Station P.O. Box 96
Binghamton, N.Y. 13904-0096

Name _____
Address _____
City _____ State _____
Zip _____
Phone _____ Area Code _____

The Well-Tempered Clavier, Bks. I and II, B.W.V. 846-93; 15 Inventions, B.W.V. 772-86*; 15 Sinfonias, B.W.V. 787-801*; Concerto from Vivaldi, Op. 3, No. 9, in D, B.W.V. 972†; Italian Concerto, B.W.V. 971†; French Overture, in B minor, B.W.V. 831†; Toccatas (7), B.W.V. 910-16†; Fantasia, in C minor, B.W.V. 906†; Prelude and Fugue, in A minor, B.W.V. 894†; Chromatic Fantasia and Fugue, in D minor, B.W.V. 903†; Goldberg Variations, B.W.V. 988†.*

One of the greatest challenges facing any competent keyboard artist who sits down to record (or just to play) *The Well-Tempered Clavier* is what to do with the work's first two pages—how, without being fancy or eccentric, to breathe new life into that all-too-familiar series of dry-looking arpeggios, the C major Prelude. Kenneth Gilbert meets this challenge and passes with flying colors; the particular way in which he does so sets the tone for this superb collection, the first of two that will cover the nonorgan keyboard works in Archiv's new Bach Edition.

Sober, slightly tentative yet unaffected, lyrical, and expansive, the C major Prelude emerges from Gilbert's hands as the minor masterpiece that it is and always has been—but that I, for one, had forgotten it was. Many other such unobtrusive revelations follow. Throughout the great compendium, and also in the less interesting Inventions and Sinfonias, Gilbert is unfailingly straight and direct, inclined to deliberate tempos, never flashy or especially innovative, but never lacking in high spirits when the music calls for them. The result is deeply satisfying, various yet perfectly balanced.



Kenneth Gilbert: deeply satisfying Bach

Trevor Pinnock's playing is similar in character, equally solid and unshowy yet never dull or lacking in profile. He takes the Aria of the *Goldberg Variations* more slowly than it is often taken, and he gives great weight to the variations that demand it (Nos. 9, 10, 12, et al.). But variations such as No. 14 are brilliant and dashing enough for any listener. Pinnock's tempos in the outer movements of the *Italian Concerto* are also a shade deliberate, but the finale is wittier and more playful than in many faster readings,

and the whole performance is a delight.

The rest of the music allotted to Pinnock is all first-rate: the grand *French Overture*, the twistingly chromatic C minor Fantasia, the more extroverted A minor Prelude and Fugue, the buoyant *Concerto from Vivaldi*, the dazzling *Chromatic Fantasia and Fugue*, the brilliant and varied Toccatas. And it is all played flawlessly.

The performances gathered here date back to 1978, and most of them—all but the Inventions and Sinfonias, I believe—have been previously issued. All are warmly and spaciouly recorded, and surfaces are excellent. I can't think of a recent collection that better demonstrates the extraordinary range and quality of Bach's keyboard achievement.

William Youngren

ADAMS:
Grand Pianola Music.

REICH:
Eight Lines.

⊙ *Ambush, Bryden, Wheeler, Feinberg, Opens; Solisti New York, Wilson. Patti Laurson, prod. EMI Angel DS 37345 (D).* □ ⊕

John Adams, familiar to us San Francisco Bay area residents as a gentle, likable, intelligent young man, composer-in-residence to the San Francisco Symphony and director of its outstanding New and Unusual Music concert series, writes gentle, likable, intelligent music—which, at its best, becomes remarkably beautiful. When *Esquire* recently honored Americans under forty "who are chang-

CLIVE BARDA/COURTESY ARCHIV RECORDS

C R I T I C S ' C H O I C E

The most noteworthy releases reviewed recently

BARTÓK:
String Quartets, Nos. 1-6.
Takács String Quartet. ⊕ Hungaroton SLPD 12502-04, May.

BUSONI:
Turandot Suite, Op. 41;
Sarabande, Cortège;
Two Studies for "Doktor Faust," Op. 51.
Cincinnati Symphony Orchestra, Gielen. ⊕ Vox Cum Laude D-VCL 9072, April.

FALLA:
El Corregidor y la Molinera.
Berganza Lausanne Chamber Orchestra, López-Cobos. ⊕ Claves D 8405, May.

HAYDN:
Symphonies: No. 100, in G ("Military"); No. 104, in D ("London").
Academy of Ancient Music, Hogwood. ⊕ Oiseau-Lyre 411 833-1, Mar.

MENDELSSOHN:
Concerto for Violin and Orchestra; Overtures: "Ruy Blas"; "A Midsummer Night's Dream"; "The Hebrides."
Silverstein; Utah Symphony Orchestra, Silverstein. ⊕ Pro Arta PAD 187, May.

MUSSORGSKY:
Boris Godunov.
Vedernikov, Shkolnikova, Koroleva, Arkhipova, Piavko, Eisen, Mishutin, Matorin, Sporgis, Mazurok; U.S.S.R. TV and Radio Large Symphony Orchestra and Chorus, Fedoseyev. ⊕ Philips 412 281-1, May.

VARESE:
Instrumental Works.
Yakar, Beauregard; Ensemble Intercontemporain, Chorus of Radio France, Boulez. ⊕ CBS Masterworks M 39053, April.

VAUGHAN WILLIAMS:
Overture to "The Wasps"; Serenade to Music.

DELIUS:
Orchestral Works.
London Philharmonic Orchestra, Handley. ⊕ Chandos CD 8330, April.

VIVALDI:
Chamber Works.
Ayo, Demenga, Holliger, Jaccottet, Pellegrino, Petri, Rubin, Thunemann. ⊕ Philips 411 356-1, Mar.

PARLEY OF INSTRUMENTS:
Purcell's London.
Parley of Instruments, Goodman and Holman. ⊕ Hyperion A 66108, April.

TREVOR PINNOCK:
Baroque Keyboard Works.
Pinnock. ⊕ Archiv 413 591-1, May.

ing America," it included John (*not* first-naming people out here usually insults them), passing over all his fellow "minimalists"—a decision I can understand and go along with. *Grand Pianola Music* is a highly enjoyable three-movement work that combines all sorts of autochthonous American elements, including gospel, all of them unshakably tonal and usually even diatonic. Only in one minor detail does he get just a bit cute and coy: Although the three sopranos, to quote the sleeve notes, "sing wordlessly through most of the score, there is a place in the last movement where the composer has provided them with a seven-word text (which he has asked not be revealed here)."

Steve Reich, a minimalist pioneer, has something improbably in common with his Hungarian-born colleague György Ligeti, even though their respective works sound vastly different in actual performance. Harmonically, both roll out bolts of coruscating surface iridescence; only retrospectively do you notice that minute changes in texture have in fact taken place. Ligeti dispenses

with rhythm almost entirely; Reich uses it almost as an ostinato. I find listening to his music and to the music of most minimalists, John Adams excepted, in some ways comparable to having my teeth ground by a finely skilled hand after a slightly-less-than-totally-effective injection of Novocain. Solisti New York perform both works to perfection, but someone really ought to persuade them that their affected, pretentious name translates quite easily into the vernacular as simply The New York Soloists. *Paul Moor*

LLOYD WEBBER:
Requiem.

⊙ *Brightman, Domingo, Miles-Kingston; Winchester Cathedral Choir, English Chamber Orchestra, Maazel. David R. Murray, prod. EMI Angel DFO 38218 (D).* ☐. ● CDC 47146.

Yes, it's the Andrew Lloyd Webber, composer of *Evita*, *Jesus Christ Superstar*, *Cats*, and other Broadway/West End megahits playing now and forever somewhere. Actually, the only real surprise about this record (other than the quality of the music) is that

Lloyd Webber didn't get around to writing a piece like this before. He had a notably well-rounded musical education—his father encouraged an appreciation for pop singing, but also for the classics, particularly the choral repertory (Lloyd Webber Sr. was organist at Westminster Hall). Andrew's first compositions (lost, unfortunately) were actually some Anglican church choruses and music for puppet theaters. He also attended the Royal College of Music, but dropped out after a year, since his father didn't want him to be "overtrained."

However, the string of blockbuster popular successes that began with *Joseph and the Amazing Technicolor Dreamcoat* in 1968 (when Lloyd Webber was twenty) largely precluded forays into further classical endeavors—the only diversion was the *Paganini Variations*, written in 1978 for his cellist brother Julian. In the same year, the BBC asked him to compose a requiem for Northern Ireland, much in the manner of the Benjamin Britten *War Requiem*, with English and Irish poetry juxtaposed with the lit-

illinois audio

SAVE MONEY • TIME • FREIGHT ON NAME BRAND STEREO

COMPONENTS

AKAI AAA-35 NEW! AM-FM DIGITAL RECEIVER (48x2)	\$198.00
AKAI GX-7 3 HEAD DOLBY B & C CASSETTE DECK	229.00
KENWOOD KR-930B 60x2 DIGITAL HIGH-SPEED RECEIVER	199.00
AIWA ADF-330 DOLBY B&C, SOFT TOUCH CASS.	149.95
ADC SS-315X 10 BD PER CH. EQUALIZER with ANALYZER	CALL
SANSUI DW-10 SANSUI'S BEST DOUBLE CASSETTE DECK	CALL
SANSUI SX-1130 New! TOP RECEIVER w/AM STEREO	CALL
TEAC EQ-A20 10BD. PER CH. EQ. w/SPECTRUM ANALYZER	99.00
TEAC R-666XBL DOLBY B, C, & dbx & AUTO-REV. CASS DK.	250.00
TEAC V-350C DOLBY B&C CASS DK.	95.00
TEAC V-530X DOLBY B, C, AND dbx CASS DK.	190.00
TEAC V-900X 3 HEAD, DOLBY B, C, AND dbx CASS DK.	400.00
KOSS CM-530 8" 2-WAY SPEAKER	80.00
TECHNICS SA-450 'NEW' (50x2) DIGITAL RECEIVER	199.00
TECHNICS SL-B 200 BELT DRIVE, FULLY-AUTO. TURNTABLE	80.00
TECHNICS RSB-78R AUTO-REV. DOLBY B, C, & dbx CASS DK.	CALL
MARANTZ SR-8100 DC (90x2) DIGITAL RECEIVER w/CLOCK	255.00

PORTABLES

SONY WM-11 CASSETTE PERSONAL PORTABLE	39.00
SONY WM-16 WITH DOLBY B & AUTO REVERSE	45.00
SONY WM-F10 SUPER WALKMAN CASS. WITH DOLBY & FM	70.00
SONY CFS-5000 3-PC., AUTO REV., DOLBY, 5 BD. EQ.	99.00
JVC PC-200 3-PIECE PORTABLE SYSTEM w/AUTO. REV.	190.00

AUTOMOTIVE

JENSEN RE-980 AM/FM DIGITAL CASS.	180.00
JENSEN EQA-5000 7 BAND GRAPHIC EQUAL /40 WATT AMP	89.95
JENSEN J-3033 6x9 TRIAX SPEAKERS (PAIR)	79.95
SANYO FTE-D6 FOR GM, FORD & CHRYSLER, DIN-COMPATIBLE	178.50
SANYO FTU-52 AM/FM CASS. w/DOLBY B&C, METAL CAPABLE	145.00

VIDEO RECORDER

SANYO VCR-7200 BETA HI-FI STEREO w/WIRELESS REMOTE	385.00
--	--------

HEADPHONES

KOSS PORTA PRO NEW HEADPHONE	\$44.95
SONY MDR-CD5 'NEW' DIGITAL READY	65.00
SENNHEISER MS-100 MINI-OPEN AIRE	39.95

TAPE—AUDIO & VIDEO

SONY UCXS-90 NEW HIGH BIAS CASSETTE TAPE	20.00/10
TDK SA-90 SUPER AVILYN CASSETTE TAPE	18.50/10
TDK SAX-90 DOUBLE COATED 'SA' TYPE CASSETTE	28.00/10
TDK HX-S 90 HIGH BIAS, METAL PARTICLE	47.00/10
TDK D-90 LOW NOISE CASSETTE TAPE	15.00/10
BAFJ PRO II-90 "WORLD'S QUIETEST HIGH BIAS TAPE"	15.90/10
FUJI M-90 METAL CASSETTE	30.00/10
MAXELL XL 'S' 90 TYPE I OR II (PLEASE SPECIFY)	27.50/10
MAXELL UD 'S' 90 II NEW HIGH BIAS, (NOT 'XL')	20.00/10
MAXELL XL-II-90 SAVE \$5.00 PER CARTON	22.00/10
LESS \$5.00 MAN. REBATE AS OF 5/1/85 = \$18.00/10 NET	

CARTRIDGES

SHURE V-15 TYPE 5 MR NEW TYPE "5"	CALL
SHURE V-15 VP TYPE 5 "P" MOUNT	CALL
AUDIO-TECHNICA AT-155LC REGULAR MOUNT	79.95
AUDIO-TECHNICA AT-122LP "P" MOUNT	27.95

COMPACT DISC PLAYERS

SHARP DX-100B PROGRAMMABLE, LOW PRICE	CALL
TECHNICS SL-P1 'NEW' COMPACT SIZE	CALL
TECHNICS SL-P2 'NEW' WIRELESS REMOTE, PROGRAMMABLE	CALL
SONY D-5 PORTABLE CD PLAYER	CALL
OTHER CD BRANDS AVAILABLE	CALL

SEE A BETTER PRICE? CALL US! WE WANT YOUR BUSINESS!!

UPS rates apply on these units. Prices and Availability Subject to Change



illinois audio

12 E. Delaware Pl., Chicago 60611

Phone Now
1-312-664-0020
Price Lists & Quotes

Hours:
10:00-5:00
Mon. thru Sat.

TOLL FREE
1-800-621-8042
Orders & Quotes



— send for free price list —

Name _____
Address _____
City _____
State _____ Zip _____

or use your address label



Requiem composer Lloyd Webber (r.) with conductor Maazel (l.) and tenor Domingo

urgency of the mass. Although the project tempted him (his first hearing of the *War Requiem*, at age 13, was a profoundly moving experience that he says has never left him), he was too tied up with producing *Evita* at the time.

The idea of a requiem began fermenting again in 1982, when three crucial events occurred in Lloyd Webber's life: First, his father died, then a close friend was killed during the IRA bomb attack on Harrod's department store, and later, he read a newspaper article about a Cambodian boy who had to choose between killing his mutilated sister or being killed himself. In addition, Lloyd Webber's friend Plácido Domingo had been begging him to write something for his voice. These experiences at last got the Requiem in motion.

Lloyd Webber worked exclusively on the Requiem from March to October of 1984; during that time, he received valuable advice on orchestration and other pertinent musical matters from another prominent friend, Lorin Maazel, who conducted a tryout performance of the unrevised score that summer. The Requiem received its world premiere at Winchester in December 1984, and it was recorded shortly afterward. Its American premiere (for a specially invited audience of notables) took place in New York's St. Thomas's Church on February 24, 1985.

Well, how does it sound? Very good, indeed. Lloyd Webber has written an eclectic yet highly effective work that communicates directly and forcefully with the listener. Lasting 45 minutes, it doesn't wear out its welcome. Lloyd Webber succinctly divides

the Mass into seven sections played without pause—Requiem and Kyrie, Dies irae, Offertorium, Hosanna, Pie Jesu, Lux aeterna, and Libera me. Not unexpectedly, one can hear a definite Britten influence from the opening pages—those haunting Brittenlike parallel thirds almost become the signature tune—while Poulenc (particularly his *Dialogues of the Carmelites*), Orff, and even Shostakovich and Prokofiev make their presences known. But like all capable composers, Lloyd Webber juggles his influences adroitly, managing to speak his own language in the process. Lloyd Webber's more familiar language, of course, comes amusingly to the fore in the Hosanna, which turns into a jaunty *paso doble* that easily could serve for one of the political rallies in *Evita*. This Requiem makes an often thunderous noise, but its basic message is contemplation—the very close of the score, with the boy soprano repeating the haunting “*perpetua, perpetua,*” into infinity, much in the manner of the “*Ewig, ewig*” from Mahler's *Das Lied von der Erde*, leaves no doubt as to the composer's feeling and compassion for his subject.

The performance, bearing as it does the imprimatur of the composer, would seem definitive. Maazel grasps the wide coloristic range of the dark-hued orchestration (no violins) and Lloyd Webber's canny structural sense superbly, and the playing of the English Chamber Orchestra (no doubt greatly augmented) leaves nothing to be desired. Domingo sings his soaring vocal lines with brazen tone and commitment, while Sarah Brightman (the original soprano lead in the London production of *Cats*, whose part here

extends to several high Ds) proves she's a singer well worth hearing again. Master Paul Miles-Kingston handles the extensive treble solos in an almost precocious fashion. The recording has optimum presence at any volume, and the bottom end, given the prominent organ part, has frequently astounding impact—it should be one of the great demo CD issues.

Lloyd Webber has called the Requiem “the most personal of my compositions.” It very well may be that it is the finest work of its kind written by a British composer since its Britten counterpart was premiered over 20 years ago. *Bill Zakariasen*

GROFÉ:

Aviation Suite; Hudson River Suite; Mississippi Suite.

⊙ Promenade Orchestra, Stulen. Piet Kiel, Jr., and Joop Reiziger, prods. CBS Masterworks M 39293 (A). □

Listeners who really want to spend time with Ferde Grofé's *Mississippi Suite* (1925) would do well to bypass this release and look instead to the more expansive, more neatly executed, and altogether more brilliantly recorded digital version by Enrique Bátiz and the Royal Philharmonic Orchestra issued last year on Angel (DS 38081).

The CBS disc does, however, offer the premiere recordings of both the *Aviation Suite* (1944) and the *Hudson River Suite* (1955). The first piece is an airy tone poem whose five movements (“The Take-Off,” “Glamour Girl,” “Plane Loco,” “Clouds,” and “Happy Landing”) collectively pay homage to the city of Detroit's contribution to the Air Force in World War II; the second is a panorama that attempts to portray in succession the river itself, its namesake explorer, the fictional Rip Van Winkle, and a gala nighttime boat ride around Manhattan. This is pops-concert stuff, composed in between various Hollywood film-score projects, and not nearly so sophisticated in orchestration or content as the *Mississippi Suite* or the perennially popular *Grand Canyon Suite* (1931). But even shallow music deserves better than the superficial readings and spotty performances these pieces get from Jan Stulen and his Dutch pickup ensemble. The liner notes consist only of capsule synopses of the “plots,” and the centerfold artwork looks suspiciously like an advertisement for KLM or Fokker. *James Wierzbicki*

FILM CROP 1984

A fearless look at some of the best and worst soundtracks of the year

PLACES IN THE HEART

Howard Shore, Doc and Merle Watson, and the Texas Playboys have provided a rich celebration of Americana in this song-filled score. The appealing qualities of Doc and Merle's "mountain-music" sound aren't lost amid Shore's tasteful adaptations. At turns celebrating life and touching simple pains, the music speaks with directness and honesty. An interesting technical note appears on the back jacket: "In order to capture a sound similar to that of original 1930s recordings, these performances have been taped using actual period microphones and production techniques." *Places in the Heart* wins a place in mine. (Varèse Sarabande ◉ STV 81229. ◻)

DUNE

The effusive, self-congratulatory credits that take up a good fifth of the back of this album read right out of a high-school yearbook. (Example: "Special thanks to David 'Pop the Cow' Lynch, who will eternally be our guide to the unknown.") The level of musical accomplishment isn't much higher. This soundtrack by Toto and Brian Eno (with the Vienna Symphony Orchestra) is sophomoric, pretentious, cliché-ridden, and as over-hyped as the movie itself. Forgive the obscenity, followers of *Dune*, but this album can go dehydrate itself. (Polydor ◉ 823 770-1. ◻)

HERCULES

Pino Donaggio has a knack for writing first-class scores to second- and third-rate films

(*Piranha*, *Tourist Trap*).

This time, however, he has turned in a third-class score to a fourth-rate film. *Hercules* is an excruciatingly uninspired exercise in spaghetti-epic music; listening to it ought to be considered Labor No. 13. Next time, I'll take the stables, if you don't mind. (Varèse Sarabande ◉ STV 81187.)

STAR MAN

Even though the instrumentation is largely electronic, this is an old-fashioned romantic score with a big, sloppy love theme, balanced off by some darkly colored suspense cues. Those cues are pretty much of one cloth: thick ostinato punctuations against the steady wash of an electronic backdrop. The romantic moments grow out of a slowly pulsing theme that strikes me as being more effective in its one solo-keyboard presentation than in its wide-screen guise. Curiously, this Jack Nitzsche effort sounds a lot like director John Carpenter's own film scores (*Halloween*, *The Fog*, *Escape from New York*). If you're in an old-fashioned mood, this is the score for you. (Varèse Sarabande ◉ STV 81233. ◻. ◉ VCD 47220.)

CONAN THE DESTROYER

Seldom have so many notes been set down for so little effect. Basil Poledouris has sequenced his *Conan the Barbarian* score with another exercise in soft-sell exoticism and watered-down *Ben-Hur*. It's obvious that he lavished a lot of attention on this score: The instrumentation is extensive, few motives are repeat-

ed, and the length is sizable. I just wish it all amounted to something. Poledouris's new *Conan* is colorful, well put together, and big—but then so is my two-tone refrigerator. (MCA ◉ 6135. ◻)

THE NEVER ENDING STORY

Klaus Doldinger, a member of the jazz-fusion group Passport, turned in one of the pleasant surprises of 1982 with his rock-oriented score for *Das Boot*, the World War II German submarine drama. He gets one side of this new album to himself—and proves he's no flash in the pan. The frenzied beat and hard-driven strings of *Das Boot* are here, but so are a number of distinctive new touches, all of which suggest that we can look forward to more interesting scores from his pen. Giorgio Moroder's side reinforces my impression that he is a one-idea composer who has overstayed his welcome. (EMI America ◉ ST 17139. ◻)

RUNAWAY

Veteran film-music master Jerry Goldsmith handles the keyboards and keypads with dexterity and aplomb for this all-electronic soundtrack. But even when his writing is all electronic, Goldsmith's thinking is instrumental, and the result is a disappointing score that tries hard to be something it isn't. Still, *Runaway* offers some varied and imaginative solutions to noninstrumental movie music and, from that perspective, is clearly a notch above the synthesized pack. (Varèse Sarabande ◉ STV 81234. ◻. ◉ VCD 47221.)

THE LAST STARFIGHTER

Just when I was beginning to fear that John Williams had beaten the intergalactic symphony to death, along comes Craig Safan to prove there's life in it yet. This score, genus *Star Wars*, is a delight. The orchestration throughout is done with a sure hand, and the textures are wonderfully transparent. A striking cue titled "Outer Space Chase" begins with a clever ostinato figure that winds up breathless and at a point of Copland-esque ecstasy. This is a thoroughly enjoyable album and a solid addition to the space epic genre. The Southern Cross folks provide a wide, bright, well-detailed sound admirably suited to the music. (Southern Cross ◉ SCRS 1007. Distributed by Fifth Continent Music Group.)

UNTIL SEPTEMBER

By all accounts one of the dud films of 1984, this score is, by my account, far better than the movie deserved. John Barry turns in one of his always pleasurable, richly textured, softly focused romantic specials. Flute and guitar carry the burden of the melodic argument against a slowly breathing, string-dominated tonal canvas. The mood seldom varies from a leisurely adagio, and Barry has wisely refrained from any overt evocations of the film's Paris setting. In lesser hands, this monothematic, single-mood piece would have paled quickly. But quality has a way of shining through and sustaining interest. (Varèse Sarabande ◉ STV 81226.)

by Noah André Trudeau

REVIEWS



Arto Lindsay, Alone and Together

ARTO LINDSAY:

Envy.

© Peter Scherer, Arto Lindsay, and M. E. Miller, prods. Editions E.G. EGED 39. (Distributed by Jem, 3619 Kennedy Rd., South Plainfield, N.J. 07080.)

Arto Lindsay's first group, DNA, was the most enduring and committed of the Soho art punk bands that comprised Brian Eno's 1978 *No New York* anthology. They were also the most underrecorded. The collected product of their five-year career, just 12 tracks, can be listened to in less than half an hour. In DNA, Lindsay's slashing bursts of 12-string atonality, derived from '60s avant-jazz guitarist Sonny Sharrock and sounding like piano strings played with a hacksaw, together with his strangled vocalese, were powerfully tense distortions of blues mannerisms. With drummer Ikue Mori and bassist Tim Wright conversing in ballistic pulses, Lindsay created percussive miniatures that were as primitive as they were formal. Subsequently, as an instrumentalist in John Lurie's "fake jazz" *Lounge Lizards* and on Kip Hanrahan's Pan-American jazz/poetry albums, he exerted an apparent conceptual in-

fluence, but his unassimilable guitar style was mixed way down, serving as mere accentual ornament. Then recently, in collaboration with Anton Fier on *The Golden Palominos*, Lindsay's fragmented lyrics and twisted articulations leaped into funky expressionism via the drummer's more solid rock beats and the session's impressive range of textured noise.

Envy, his first solo album, combines the polyrhythmic, multipercussive atmosphere of the Hanrahan records with the loft funk of the Palominos. It also has (North and South) American pop grooves all over it; relying on his Brazilian background, Arto blends the music of some of the Latin percussionists Hanrahan used with the arty beats of synthesist/drum programmers from the Palominos. Rather disjointed as an album, *Envy* really feels like two EPs, one framed by the other. The opening and closing tracks of both sides, each four or five minutes long, with music composed largely by Ambitious Lover Peter Scherer, are modern dance funk; the remaining nine cuts, each under three minutes, explore percussive modes

ranging from straight Latin to high-speed electric cross-chatter. Taking several listens to gel, *Envy* reveals a complex emotional sensibility in a sensual continuum from soft flesh to raw nerves.

Both "Cross My Legs" and "Locus Coruleus" key Lindsay's sexy docu-dramatic conversational phrases into funky syncopations of DMX and synthesizers, occasionally interrupted by guitar or percussion. Scherer's electric rhythm tracks, enhanced by fellow Lover M. E. Miller and on "Locus Coruleus" by guest programmer Fier, are the most lucid settings Lindsay the songwriter has ever used; but he doesn't ever settle for an easy context, always skronking up the background or breaking off the beat for some textural intrusion. And he offsets his soft-voiced singing style on "Let's Be Adult" and "Too Many Mansions" with jarring rhythmic dislocations from the band. The shorter pieces feature and specify the Latin or avant-garde moods that decorate these four longer tracks.

"Pagode Americano," "Badu," and "Beriberi," with their deep surdo drums and

KERI PICKETT

various higher-pitched percussion instruments arranged and played by band members Claudio Silva, Toni Nogueira, and Reinaldo Fernandes and guests, are traditional pieces in which Lindsay is marginal or absent. Yet he sings the sweet Brazilian ballad "Dora" in aching, authentic Portuguese. "Trouble Maker" takes the Palominos' groove and the Philip Glass-like eighth-note ostinato from "Locus Coruleus" to crazier levels of energy. And on "Nothings Monstereed," "Crowning Roar," and "My Competition," Miller, with help from David Moss, generates noisier polyrhythms for Lindsay's cryptic haiku imagery. "Venus Lost Her Shirt" brings the acoustic and electric percussion all together for two minutes of dense, precise rhythm fabric.

Arto Lindsay has always been a collaborative artist; his extreme style has found a voice in a variety of cooperative musics. *Envy* stakes out more common ground, with the Ambitious Lovers creating collective cohesion and freedom through impressive but disparate explorations. For what sounds like tension and aggression in Arto Lindsay's music is a strong, sexy drive to find new means to real connections.

John Piccavella

DeBARGE:

Rhythm of the Night

⊙ Various producers. Gordy 6123-GL. ☐

Because it's easy to mythologize the five DeBarges as grand innocents, the awkwardness of their new album is complicated: Is this the awkwardness of adolescence reaching for adulthood, or just another act hitting a rough patch of ground? On their second and third albums, *All this Love* and *In a Special Way*, these four brothers and a sister put forth a vision of pop romance so delicate it risked ridicule, so idyllic it could only exist on a piece of vinyl. Their close harmonies, whose timbre is epitomized by brother Eldra's high, keening sighs, flourish at slow-to-medium tempos, all the better for their clear voices to mull over the most courtly mash notes to hit the radio since the Stylistics. But though DeBarge may have seemed naive in their consuming passion, they always seemed secure in their naiveté.

On *Rhythm of the Night*, DeBarge start to grow up, following preordained patterns that don't really suit them. Eldra, who produced *In a Special Way* with feathery precision, cuts down his board work and steps out

so drastically as lead vocalist that this hardly seems like a quintet anymore. Bunny, the sister, whose rippling voice grounded the group's ideal of womanhood, is mostly absent except for her touching leads on two older tracks. The presence of five sets of producers only magnifies the confusion. Jay Graydon's prefab songs and shag-carpet arrangements, in particular, pretend that DeBarge are as innocent in the studio as they are vulnerable in their songs.

If nothing else, DeBarge relish their professionalism, and they find fillips and curls in the slower Graydon ready-mades, "The Heart Is Not So Smart" and "Who's Holding Donna Now," that other singers would miss. Especially on the first, Eldra plonks down his notes with appropriate weariness, only to have them snagged by the synthetic island rhythm Graydon has set up. The title hit, which is also part of the soundtrack to Motown's *The Last Dragon*, is a seamless Richard Perry-produced affair, as plastic as it is irresistible. But its distinction has nothing specific to do with the group: A thousand other singers could have daubed their voices onto its bubbling Calypso beat and sung Diane Warren's optimistic lyrics. You couldn't say the same about the track that precedes it, the rereleased "Share My World" (which, like "Queen of My Heart" on *In a Special Way*, was lifted from the group's self-titled 1981 debut), written and sung by Eldra and Bunny. This fragile offer of—what else—impossible, everlasting devotion is phrased slowly, hesitantly, making dreams survive the daylight. Unlike anything else on *Rhythm of the Night*, it suspends the listener's belief for a short moment and stands as the unwitting centerpiece of an album that prefers to relegate such innocence to the province of childhood.

Mark Moses

PHILIP BAILEY:

Chinese Wall

⊙ Phil Collins, prod. Columbia BFC 39542.

JERMAINE STEWART:

The Word Is Out

⊙ Peter Collins, prod. 10/Arista AL8 8261. ☐

These two late-'84 sleepers are fusion records in the most elegant sense, their suave gait and sweet melodiousness the result of a gentleman's agreement between American r&b and British pop: with their brittle rhythmic motion and high, agile voices, *Chinese Wall* and *The Word Is Out* give us dandy's

blues. In contrast to George Duke's billowy production of Philip Bailey's solo debut, *Continuation*, Phil Collins's work on *Chinese Wall* offers a consistent band instead of scattered session honchos, melodies instead of meandering riffs, well-turned lyrical banalities instead of lax ones. The problems that have dogged Bailey since his first days with Earth, Wind & Fire remain: the tendency of his voice to lose itself in its shrill highs for no reason other than the thrill of flight, and a deadly taste for mystical mumbo jumbo.)

Collins is enough of an EWF fan to think Bailey is a great singer, and he goes about building him a showcase based on his own newfound love of the beat. The crackling Linn-drum stutter of "Photogenic Memory" prods Bailey and vocoded voices forward against their will in a sharp song about being unable to leave the past behind. The obnoxious/catchy-as-all-get-out Collins-Bailey duet, "Easy Lover," wherein the listener is transported via giant hooks to the sleaziest miscogyny since "Maneater," has a grunting guitar and coiling beat to propel its macho bluster. But the biggest surprises, and the surest measure of this collaboration, are three patient ballads: the whispery "Show You the Way to Love," the old-fashioned valentine, "For Every Heart That's Been Broken," and, best of all, the compassionate "Children of the Ghetto." When Bailey bends his voice to tell those street kids to "Keep your head to the sky," quoting the title of EWF's 1973 hit, he mingles standing tall with religious deliverance in a message of inspiration that betters any EWF homily of recent years.

Such realism would be anathema to Jermaine Stewart. His debut, *The Word Is Out*, is such a stylishly sustained artificial world that to carp about its lack of content is as vulgar as it is irrelevant. The American-born Briton has teamed up with British producer Peter Collins to make what might be the most extreme English r&b dance record of all—purged of bluesiness, painted in the brightest party colors, unruffled by anything more tangible than gossip. Yet, there's nothing cold about Stewart's craft: His grab bag of song styles may be diffuse, his voice may verge on sexlessness, but he plies both with chipper verve.

No matter how crashing the electronic downbeat on the hit title track or "Get Over It," these arrangements never trudge. It's as

if the rhythms were played with bottles, and each hollow stroke sent slivers of colored glass flying. As in much British r&b today, there's a cosmopolitan array of beats; Stewart's wiry voice takes to the skewed reggae of "You" and the Caribbean mirth of "Month of Mondays" as gamely as it does to the updated sock-hop bounce of "Debbie." With his cascading melodies, his cheery What-me-worry, and his boundless stylistic voracity, Stewart comes on as much a semidetached assimilator as primo Elton John, immaculately conceived by two singles in a jukebox at the side of a dance floor. On this album, "Spies" are notable for their trench coats rather than the fears they inspire, lovers bring not overwhelming passion but "Brilliance," and adolescent confusion takes on a baroque grandeur ("Reasons Why"). Dandy's blues, indeed. But, as with much of the glossy music emanating from England, its total evasion of hard truths acknowledges their pervasiveness almost as boldly as would any grand statement about them.

Mark Moses

SADE:

Diamond Life.

Ⓢ Robin Millar, prod. *Portrait BFR 39581.* (Distributed by CBS.) Ⓢ Ⓣ

Sade is a voice, a face, Britain's newest Euro-pop/jazz quartet, and the beginnings of a sleek, pseudosophisticated genre about to supplant the outrageous excess of last year's angular funk. The fulcrum of the group is twenty-four-year-old Sade Adu, a stunningly beautiful woman of Nigerian and British descent, whose smoky contralto and uncompromising presence have sparked a string of U.K. hits, including "Smooth Operator," "Hang Onto Your Love," and "Your Love Is King." *Diamond Life*, their debut, pedals a low-key blues-tinted jazz that sug-

gests but never fully admits that it wants something more than to lie under a hot Brazilian sun and percolate. Suggestion, however, can go a long way.

There's not enough energy here to scat, and though Sade fashions herself a storyteller, her filmy diction and dime-store lyrics do little to illuminate a narrative line. What you do hear first and foremost, and can't forget, is the haunting color of her breath: milky, iridescent, yet cracked in a thousand places. Despite a limited range and disjunct timbres, her sweetly fragile voice is somehow completely arresting, beckoning you forward just as it threatens to disintegrate in your hands. With a pigtail hanging down her back, Sade at times can look and sound like the girl next door, but something unspoken unsettles: Inside a throat as wide as a four-lane, danger lurks behind a resonance smudged with nicotine and the soot of city life.

Untrained as a musician, Sade the songwriter exhibits the savvy of the clothes designer she once was, tailoring tunes to bend and curve with the peculiarities of her instrument. Essential to the aural balance, however, is saxophonist/guitarist Stuart Matthewman, co-writer and alter ego, whose suave, rich, and always gentlemanly tenor manages to batten down her ethereal proclivities, braving melodies her voice can't yet negotiate. Together they have computed bio-rhythms that perfectly suit her sphinxlike temperament: effortless sambas, twilight r&b, hot-and-cold tempos that suggest a passion not so much absent as mysteriously submerged. For a while, the geisha mystique keeps you leaning forward, but eventually, after nine songs, the lack of rhythmic variation can wear your patience thin.

Still, an extraordinary phrase or two does stand out. Practically musical soul

FORMAT KEY

- Ⓢ LP/EP
- Ⓢ Cassette
- Ⓢ Compact Disc
- Ⓢ Videocassette
- Ⓢ Videodisc
- Ⓢ 12-inch single
- Ⓢ Open reel

Large symbol beneath title indicates reviewed format. Small symbols following catalog number of reviewed format indicate other available formats (if any).

Catalog numbers of all formats of a particular recording usually are identical except for differing prefixes or suffixes. Catalog numbers of formats other than the reviewed format are printed only if their basic numbers differ substantially from that of the reviewed format.

Arabic numeral in parentheses indicates number of items in multi-item set.

mates, "Frankie's Affair" and "Sally" cut into the sharpest edge of Sade's voice; the latter song was inspired by a visit to a Salvation Army hostel on the Bowery. And on "Smooth Operator" the distillation of her attitude is so crystal-clear it hurts: the capella phrase "no need to ahhs" hangs in midair, exquisitely suspended like a proto-jewel of cool.

This is a great disc to lip sync, even better if you can manufacture the rasp and sing along. Hot blasé is so contagious, blissfully untaxing, neo-Rio-with-your-toes-in-the-sand. Feeling fat, nerdy, a tad self-conscious? Dab on a little Sade before a date and take a deep breath: She's more potent than you'd imagine.

Pamela Bloom

BILLY BRAGG:

Brewing Up with Billy Bragg.

Ⓢ Edward De Bono, prod. *CD Presents CD 027.* Ⓢ (1230 Grant Ave., Suite 531, San Francisco, Calif. 94133.)

Billy Bragg's press handout describes him as a "one-man Clash," and he sure fits the part. The British folkie-punk has a gruff guttersnipe voice and strums his electric guitar with a fingernail-bleeding vengeance, and his politically incisive lyrics bristle with anger and irony. His second album, *Brewing*

I N T H I S I S S U E

POP

BRYAN ADAMS:
Reckless.

PHILIP BAILEY:
Chinese Wall.

THE BLASTERS:
Hard Line.

BILLY BRAGG:
Brewing Up with Billy Bragg.

DeBARGE:

Rhythm of the Night.

HÜSKER DÜ:
New Day Rising.

ARTO LINDSAY:
Envy.

SADE:
Diamond Life.

JERMAINE STEWART:
The Word Is Out.

JAZZ

ART ENSEMBLE OF CHICAGO:
The Third Decade.

ALVIN BATISTE:
Musique D'Afrique Nouvelle Orleans.

CARLA BLEY:
I Hate to Sing.

DUKE ELLINGTON:
Paul Gonsalves.

BRUCE NOVACK:
Time Slabs.

ANITA O'DAY:
A Song for You.

JOHN SCOFIELD:
Electric Outlet.

VARIOUS ARTISTS:
Conjure.

Up with Billy Bragg, portrays the consequences of Tory politics in terms of working-class lives, and his sharp-focus lyrics are brutally eloquent. "It Says Here" savages sensationalist newspapers in which "politics mix with bingo" and the government line is sacred. On "Island of No Return," he's an ill-prepared and frightened British soldier in the Falklands, learning that there's no such thing as a small war—the enemy still carries real guns.

While Bragg may be a blunt realist, he's also sentimental. He doesn't kiss off love like many of his punk grandfathers did; he depicts relationships with earthy sexual inquisitiveness and warm humor, turning boy-girl clichés inside out. "This Saturday Boy" is his winsome remembrance of unrequited first love, and in "A Lover Sings," he captures an affair in minute, sexy detail, generously exalting the couple in a glowing last line: "Adam and Eve are finding out all about love/Teresa and Steve are finding out all about love."

The roughhewn urgency of Bragg's playing and his unabashed emotionalism tower above much of Britain's current fussy, frozen pop; when he interrupts a paean to responsible birth control ("This Guitar Says Sorry") to thrash Bo Diddley's "Mona" like a kid fooling around in the garage, he reminds us that rock 'n' roll is about wrestling with impulse. He also reminds us how much noise one guy and his guitar can make.

Joyce Millman

HÜSKER DÜ:

New Day Rising.

Spot and Hüsker Dü, prods. SST 031. ☐ (P.O. Box 1, Lawndale, Calif. 90260.)

"It's dawn in America," the Great Communicator keeps telling us, even as Jesse Helms warns, "It's time to wake up and smell the coffee" and arm ourselves to the teeth for the coming Red menace. Hüsker Dü's *New Day Rising* is a useful response to such wake-up calls. In "Folk Lore" they caterwaul, "Women sewed the Stars and Stripes/ And the men, they fought the wars/The children learned arithmetic/And everyone was poor." The song builds, but the story doesn't: It says not much has changed since Revolutionary days. The Hüskers have issued nothing but ferocious, throttling records for four years, but what makes *New Day Rising* their greatest is that they've learned how to bank the paranoia that formerly ruled them;

here they work out on it as if it were a Nautilus machine. It makes them stronger. The bitterness of "Folk Lore" is one example; formerly they would have taken their frustration out on themselves, not our leaders.

Hüsker Dü are the serrated edge of the hardest rock, now more than ever: rattling like Boom-Boom Mancini, creating with each song little natural disasters from Grant Hart's ample drum technique (Berklee School of Disgust) and Bob Mould's slabs of guitar noise. If dried out in the sun, this stuff could construct whole communities. The Hüskers' growth was obvious on last year's two-record dictionary of dread, *Zen Arcade*. But here, shorn of marginal experiments and boosted by some affecting pop harmonies and song structures, they make their progress stick. "Celebrate the Summer," the album's best moment, is instructive: It's a bitter brood about summer's end, but instead of just blasting away on waves of fast, scorching guitar, the band employs rhythm changes and folk guitars to do as much of the work. And "Books About UFOs" is goofy and actually danceable (well, you could always slam to their repertoire).

Which doesn't mean that Hüsker Dü's old, convincing ugliness isn't present. The definitive "Plans I Make" is babble set to the sound of every Japanese movie monster humping in a noisy arena. "Don't want to live with myself/Can't live with what goes on," Mould laments at one point. But he does, he does. He and the Hüskers have moved beyond rejecting the world that makes them hurt; now they reject their misery instead.

R.J. Smith

THE BLASTERS:

Hard Line.

☉ Jeff Ehyrich and Don Gehman, prods. *Slash* 25093-1. ☐ (Distributed by Warner Bros.)

The Blasters are at a crossroads. *Hard Line*, their fourth album (fifth if you count a five-song live-in-England EP from two years back) is, as usual, full of the openhearted earnestness and energy that have made them beloved by musicians, critics, and a devoted claue of fans who flock to the band's sweat-drenched, exhilarating live shows. The new LP also features one song written by and two produced by heartland wise guy/whiz John Cougar Mellencamp (credited as Little Bastard) and his control-room partner, Don Gehman. And the contrast created by

TRY & BEAT OUR PRICES & SERVICE!

80 MAJOR BRANDS

CALL OUR AUDIO/VIDEO HOTLINE TOLL-FREE!

800-221-0974

MON-FRI 9AM-10PM SAT 9AM-5PM E.S.T.

(ex. N.Y., AK, HI.)

In N.Y. State Call: (718) 253-8888

SHURE

V15-5MR \$138
V15-5P \$103
ML-140HE \$82
M-111HE \$45

Technics

SL-P2 • programmable music-scan
• wireless remote control • FL display
Call for price!

Sansui

M-77 AUDIO

VIDEO PROCESSOR
• Video effector
• bi-directional VCR tape dubbing
Call for price!

SONY

WM-F10 II \$84
D-5 Call
WM-10 II \$59

Technics

SA-550 RECEIVER
• 70 watts channel
• Black finish
\$240
Limited Quantities

BOSE

SPEAKERS!
Complete line of Bose speakers now available.
Call for price!

YOUR CHOICE

SONY UCX-C-90
FUJI BASF
FR11 C-90 PRO II C-90
\$1.55 ea.
Minimum purchase of 20 tapes

FUJI T120
Our Price... \$5.49 ea.
Less Mfr. Rebate... 1.00 ea.
Your Net Cost... \$4.49 ea.
Minimum purchase of 10

JVC

R-X500B RECEIVER
• 100 watts/ch.
• 7-band EQ
• digital tuner with 30 presets.
Call for price & availability!

TEAC

V-900X CASSETTE DECK
• DDX[®] N.R.
• Dolby[®] B&C
• Auto Tape Select
Call for price!

All merchandise is brand new & fully warranted. Quantities limited. Prices subject to change. Minimum shipping and handling charge \$5.

• LET US BEAT ANY PRICE YOU CAN FIND!

THIS IS JUST A SMALL SAMPLING OF OUR GREAT PRICES!

Call or write for FREE catalog.

MasterCard VISA
STEREO CORPORATION OF AMERICA

Dept. 602 1629 Flatbush Avenue, Brooklyn, N.Y. 11210

Circle 15 on Reader-Service Card

Sink In and Let Go

Writing on the eve of the release of what is likely to be the year's most commercial 12-inch—certainly its most hyped-up (how many other singles make the cover of *Life* magazine? the network news?)—one wonders if we'll be burned out on USA for Africa by the time this reaches print. The first song recorded to aid Ethiopian famine relief, Band Aid's "Do They Know It's Christmas?" (Columbia 5157), faded quickly after that holiday in spite of an all-star British cast including Boy George, Sting, Phil Collins, George Michael, Paul Young, and Duran Duran. But if Band Aid's effort was more well intentioned than inspired—the Christmas tie-in was not only unfortunate for the long-term life of the record, but irrelevant to the Ethiopian suffering—the song was immensely successful as both fund and consciousness-raiser and as an example to other concerned performers. USA for Africa's "We Are the World" (Columbia 5179) benefits from that example and its mistakes, pulling together a remarkable range of singers for a pop spiritual so smooth and shapely that it sounds like a standard after one listening.

Written by popmeisters Michael Jackson and Lionel Richie, "We Are the World" has the feel of a punched-up "We Shall Overcome," the sort of song that sets people swaying and singing along. And who could resist joining this chorus of voices: Stevie Wonder, Ray Charles, Bob Dylan, Cyndi Lauper, Michael Jackson, Dionne Warwick, Diana Ross, Bruce Springsteen, Tina Turner, and a dozen others, each stepping forward for a brief solo, a quick duet, filling the record with constant flashes of recognition. These flashes may not add up to a single pure brilliance, but they are unexpectedly thrilling—and touching in a way that chart hits rarely are these days. Band Aid, for all its compassion, sang of the Ethiopians as "the others" ("Thank God it's them instead of you"), but USA identifies, embraces: They move out into the world, and it's hard not to go where these voices lead us.

To continue in this spiritual vein, listen to the gospel voices on singles by the New Jersey Mass Choir and the Joubert Singers. The Choir's "I Want to Know What Love Is" (Savoy 0004) takes the Foreigner hit to church (this same group backed up the original, so it was already halfway there) with vocals and pacing that discover new depths in the song's soulful yearning. The lead singer turns Foreigner's fragile, anxious world-weariness into a glowing celebration of faith as he's joined by a big, joyous chorus and other shouting soloists. The Joubert Singers' "Stand on the Word" (Next Plateau 50028) is more rough-hewn gospel in spite of the several dance remixes on the

by Vince Aletti

disc, and the message is hardly a secular one: The word is God's. But the spirit is so exuberant that the song moves quickly into a funk rave-up—complete with piano, spilling electronic organ, crisp drums, and bass—rocking the house as viciously as any Sugarhill groove.

Back to a more hedonistic dance floor for two of New York's biggest club hits at the moment. "Boy" (Sire 20299), by Book of Love, has got the beat, beat, beat—a machine-made metallic kick that cuts through the decorative synth curtains like a series of gun shots. "Boy" 's music is as pared down as its title—cold, emphatic, sharp—

so even when producer Ivan Ivan (responsible for the sound of last year's *Domina* record) softens things a bit with electronic "bells" and seductive keyboard effects, the toughness remains. But when Book of Love's female lead pouts, slightly off-key, through minimal lyrics suggesting gender envy ("It's not my fault that I'm not a boy") and self-acceptance (or something), she tips this charming "Boy" into postmodern girl-group heaven.



Book of Love: pouting their way into postmodern girl-group heaven

Equally eccentric, but even more *out*, is Strafe's "Set It Off" (Jus Born 001), a cult hit that should be available nationally as you read this. More than any other record in recent years, it evokes the atmosphere and energy of a serious dance club at four in the morning: lights out, floor packed, ready for takeoff. "Set It Off" pushes the peak-time button without half trying. The song percolates, does a slow burn; it's so understated it's almost elegant. But Strafe is far from polished (the vocals are especially amateurish), and the record sounds almost homemade save for its terrific mix, so its success is a triumph for bad art, a stunning freak. Listened to out of context, particularly in its 12:24 instrumental version, "Set It Off" may sound merely weird. A record this dense and unfocused takes some getting into, but once it clicks, you're hooked. Treat Strafe like an immersion tank: Sink in and let go.

More immediately accessible is Harold Faltermeyer's synth-bop theme from *Beverly Hills Cop*, "Axel F" (MCA 23534), extended to just over seven minutes for the 12-inch. The snappiest instrumental so far this year, "Axel F" is lean, clean, and supremely stylish—the perfect soundtrack to urban life on the upside. (Watch for rap versions to give it a little more edge.) Paul Hardcastle's durable "Rain Forest" (Profile 7059) is the other essential instrumental for our times, taking synths in a dreamier direction but never losing touch with the brittle metal beat. The result is romantic but no-nonsense: mood music for your next love affair.

the complex and effective commercial studio craft on those very tracks points directly at a couple of crucial problems, both of them holdovers, neither clearly resolved, on *Hard Line*.

The first, though it has improved and been better recorded, is lead singer Phil Alvin's voice. The cold light of vinyl again reveals it to be limited in its expressiveness—no throat and little range—and, ultimately, one-dimensional. The Gehman/Mellencamp cuts meet this problem head on by using a single male harmony vocal to take some of the pressure off, to buttress and add warmth to the lead. On "Colored Lights," which Mellencamp also wrote, the second vocal comes from visiting fireman Stan Lynch of Tom Petty's band, but on "Just Another Sunday," it's brother Dave Alvin, the band's lead guitarist and songwriter. The success of this obvious pairing makes me wonder why it took so long. If your band isn't blessed with Elvis, Sam Cooke, or Bruce Springsteen out front, a Mick & Keith solution makes good sense. And it's a particularly vivid way to project the essential unity of the band—after all, they *are* brothers.

The other eight tracks, produced by Jeff Ehyrich, really sound no different from the band's earlier, autonomous efforts. When Ehyrich leaves Phil out there unassisted, he gets by on "Hey, Girl!" with the help of nifty Cajun accompaniment, but his studied country mannerisms on "Little Honey" simply sound forced. Adding a stylized chorus like Elvis's own Jordanaires to shore up "Trouble Bound" only accentuates the negative. This brings me to the second problem, a kind of stiff conceptual classicism that I hear on all but the Gehman/Mellencamp cuts. On "Just Another Sunday," Dave's guitar actually snarls—a first for L.A.'s nicest guys—and "Colored Lights" sports his simplest and best solo on the album. The Hoosier production team fills these tracks with more dimension, more memorable *texture*—layered acoustic guitars, organ, marimba, and extra percussion—than the Blasters have managed in all four previous records. As anyone who has been hooked even momentarily by *American Fool* or *Uh-Huh* knows, judicious application of this crafted coloration heightens the impact and the long-term listenability of good songs. Which means, if the Blasters want hits—and they say they do—they won't need a road map to figure their way through this crossroads. *Jeff Nesin*

BRYAN ADAMS:

Reckless.

☉ Bryan Adams and Bob Clearmountain, prods. A&M SP 5013. ☐ ●

In spirit, Bryan Adams is something of a Canadian version of John Cougar Mellencamp. He has a rough and rumpled air, a brooding quality softened by the Everyguy his video wardrobe of basic blue jeans and white T-shirt suggests. In sound, though, he's more like the ubiquitous Steve Perry, with an appealingly ragged contemporary-hit-radio voice that could remind you of a half-forgotten teenage love affair, or probably persuade you to buy a large American car.

As a title, *Reckless* is not quite apt: Adams sows his wild oats very carefully in the concisely crafted tunes he coauthored with Jim Vallance. But what the LP lacks in surprise, it makes up for in almost instantaneous familiarity—a familiarity that, in this case, does not breed contempt. Its aims are undisguisedly modest. Adams presents his time-tested subject matter—one-night stands, cheatin' hearts, the by-now self-evident truth that "kids wanna rock"—so straightforwardly that the guy seems absolutely ingenuous. He can be accused of overreaching only in his ill-advised decision to include lyrics on the LP sleeve.

Bob Clearmountain's coproduction is as fuss-free as the writing. At once matter-of-fact and exciting, *Reckless* could have been a particularly enthusiastic rehearsal someone was lucky enough to preserve on tape. Adams remains a formidable vocalist—he even holds his own with Tina Turner on their duet, "It's Only Love." So what if he never becomes a Boss; he's already convincing enough as one of the boys. *Michael Hill*

J A Z Z

ART ENSEMBLE OF CHICAGO:

The Third Decade.

☉ Manfred Eicher, prod. ECM 25014-1. ☐ ●

Even though it will be a few years before this adventuresome quintet enters its third decade, the title of their latest release suggests that they're already in a retrospective mood. Accordingly, all the bases of their eclecticism are touched with a succinctness not heard since 1979's instant classic *Nice Guys*—minus, however, that album's inspiration.

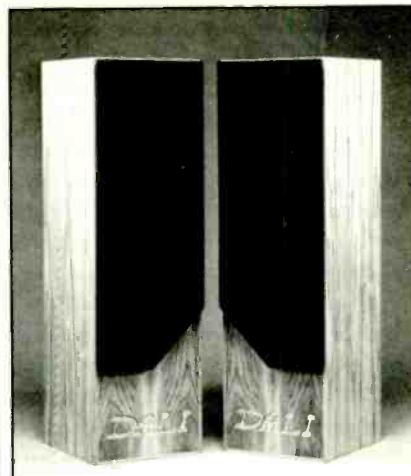

DALI

The DALI line of world class high-fidelity loudspeaker systems . . . Combining modern computerization of engineering and design with traditional European craftsmanship.

The following systems are now being offered at factory direct prices:

- DALI 2 — 6", 2-way
- DALI 3 — 8", 2-way
- DALI 4 — 2X8", 2-way
- DALI 10 — 6", 2-way
- DALI 6 — 10", 3-way

Model	Your Cost Per Pair	Shipping Charge	Retail Value
DALI 2	\$120.00	\$10.00	\$210.00
DALI 3	\$150.00	\$12.50	\$270.00
DALI 4	\$220.00	\$24.00	\$450.00
DALI 10	\$319.00	\$33.00	\$600.00
DALI 6	\$396.00	\$40.00	\$750.00

"Hi-Fi & Elektronik", the most recognized Danish Hi-Fi magazine tested our DALI 3 and rated it higher than the Tannoy Titan and B&O Beovox X-35, and concluded, "... this speaker sounds better than you'd expect at the price... the DALI 3 represents a truly outstanding value."

Our offer is really risk free; if you are not absolutely satisfied with our speakers simply return them within 10 days for a full refund, including shipping costs both ways!

There's more! With your purchase of any pair of DALI speakers, you may become an official DALI sales representative and start making handsome commissions immediately!

To place your order, or for more information, call toll-free at 1-800-251-DALI (in California call 805-252-7203) or complete the coupon and mail it in today.

Mail this coupon to:

DALI
Danish American Limited, Inc.
P.O. Box 55386
Valencia, CA 91355

Name _____

Address _____

City _____

State _____ Zip _____

Circle 10 on Reader-Service Card

"Prayer for Jimbo Kwesi," a Joseph Jarman composition that debuts his use of synthesizer, is dedicated to "the first Black officer to serve and die for Her Majesty, Queen of England," but knowing this hardly prepares one for the simple, generic Old English air Jarman has devised. Swelled to grandiose and gorgeous proportions by the synthesizer until it sounds like the soundtrack for an empire epic David Lean never got around to filming, "Prayer" then evolves into a jazzy

do Don Moye is followed by a suspended-time segment whose wailing siren suggests an ominous urbanscape. By the time the final, free-blowing section is tacked on, one feels that the group is taking a rambling stroll through its museum of famous genres ("Ah yes, energy music—that would be from the '65-'75 period"). Similarly, Mitchell's own "Bell Piece," from its churning-pits-of-hell opening through its discursive chimes and chilly horns, is an intriguing structure

also with having "directed" it. This isn't as incongruous or pretentious as it sounds, for Hanrahan, if anyone, embodies the notion of record producer as auteur.

Although *Conjure's* main focus should be the words of poet/novelist/essayist Ishmael Reed, it is Hanrahan's imaginative collision of top-notch players from diverse musical worlds that gets your attention. As on his own albums *Coup de Tête* and *Desire Develops an Edge*, he mixes and matches, hoping that contrast and exchange will draw out unexpected results. He turns composer/performers Taj Mahal, David Murray, Carla Bley, Allen Toussaint, Olu Dara, and Puntilla Orlando Rios (among others) into a unified, sympathetic band.

Conjure's common ground is r&b, which jibes perfectly with the earthy mythology of Reed's poetry. But Hanrahan never lets things sound too familiar. When the funk gets too specific—say, New York or New Orleans—he brings in congeros Milton Cordona and Puntilla Orlando Rios to turn the beat around. Hanrahan also juggles prescribed roles; it's nothing new hearing Taj Mahal sass up the blues, but trumpeter Lester Bowie may have a new career ahead as a singer. It's also a rush to hear Murray revealing in his r&b roots, coming on like the missing link between Albert Ayler and Junior Walker. With this constant convergence of styles and influences, even the most basic adaptations sound fresh and clever. *Conjure* is not only the voice of Hanrahan and Reed; its special language emanates from each musician who dared to be involved.

Steve Futterman



The Art Ensemble of Chicago: After almost 20 years, they're still nice guys.

anachronism reminiscent of Trane's "Green-sleeves," all soprano sax (and flute and flugelhorn) and hip accents. It's conservative and sentimental, audaciously so. Unfortunately, it's followed by two rather stock examples of the ensemble's tongue-in-cheek classicism (and this putting all the "easy" stuff on one side is a bad idea that gives the album a draggy pace). "Funky AECO," a group composition, subsists too long on the back of a less than compelling riff, and if it weren't for the occasional synthesizer squibble and bicycle horn, it could be mistaken for the hackneyed real thing. "Walking In The Moonlight," composed by the father of reedman and percussionist Roscoe Mitchell, is also given a lackluster treatment—the satire has no meaningful zing and it only undermines whatever homage value the song may have.

As for the second side's more recondite material, the title cut sounds like three fragments arbitrarily juxtaposed. A percussion interlude with a Hawaiian flavor by Famou-

that seems randomly cobbled. Only when trumpeter Lester Bowie takes a brief, coherent, and surprisingly moving solo do the piece's components sound like they're starting to coalesce—and then it ends.

Bowie is also the composer of the most satisfying cut, "Zero," an unpretentious bit of neobop that the group swings like mad. But anyone familiar with the Art Ensemble's last three ECM efforts, Bowie's ambitious and witty releases under his own name, and Mitchell's amazing Sound Ensemble sides will probably be disappointed by the formulaic eclecticism and knee-jerk satire of *The Third Decade*. Richard C. Walls

VARIOUS ARTISTS:
Conjure—Music for the
Texts of Ishmael Reed.

☉ Kip Hanrahan, prod. American Clavé AMCL 1006. (213 E. 11th St., New York, N.Y. 10003.)

Kip Hanrahan is credited not only with having produced and conceived *Conjure*, but

DUKE ELLINGTON:
Duke Ellington and His Orchestra,
Featuring Paul Gonsalves.

☉ Fantasy F 9636. ☐

This album is a tribute to a man who helped save Duke Ellington's career. By the time of the 1956 Newport Jazz Festival, Duke's band had been out of favor for five years, largely because of the defection of soloist Johnny Hodges. Although Hodges had by then returned to the fold, the public and critics had not, and a determined Ellington was out to prove himself all over again. He did, but the hero of that night was an unheralded tenor saxophonist. Duke called for a solo on "Diminuendo and Crescendo in Blue"—27 breathless choruses later, Paul Gonsalves had the crowd on its feet and the band was

DAVID GAHR

back in business.

This previously unreleased 1962 session is an oddity. Surrounded by some of the cream of the greatest of Ellingtonia—Hodges, Harry Carney, and Ray Nance among them—Gonsalves takes every solo. And he more than measures up to this challenge; his gracefully gritty playing shows you why young firebrands like David Murray list him as a key influence. His style was unclassifiable. Like a number of undervalued big band saxophonists (Frank Wess, Al Cohn), Gonsalves held on to the romantic leanings of the swing era even after he absorbed the iconoclastic teachings of Charlie Parker. Adapting the husky, straight-from-the-gut tone and waste-free lyricism of Duke's first great tenor, Ben Webster, Gonsalves then swapped the patriarch's swing time for bop's rhythmic momentum. This ability to glean the best of both worlds made him the perfect interpreter for the forward-thinking Ellington, but may have also distanced him from the pigeonholing public.

It was this time-transcending embrace that allowed Gonsalves to personalize both Ellington warhorses ("C Jam Blues," "Take the 'A' Train," "Caravan") and contemporary tunes ("Ready, Go," "Paris Blues"). Although he handles the uptempo numbers with dexterity, Gonsalves is more affecting on the slower tunes like "Just a-Sittin' and a-Rockin'" and "Happy-Go-Lucky Local," where he can flaunt his breathy, after-hours blues blowing; however, "Happy Anniversary," the bandleader's showcase for Gonsalves, is strangely missing. For 24 loyal years Gonsalves was the perfect team player, expressing himself eloquently through Ellington's greater vision. Together they were one of the great mutual-appreciation societies in jazz history.

Steve Futterman

ANITA O'DAY:

A Song for You.

☉ Larry Smith, Carol Smith, Alan Eichler, and John Poole, prods. Emily ER 83084. □ (P.O. Box 123, North Haven, Conn. 06473.)

Anita O'Day has outlasted almost all of her contemporaries—only Ella Fitzgerald, who joined Chick Webb's band in 1934, has been performing longer than Anita, who started at the Three Deuces in Chicago, 1939—and that resilience is reflected in the sound, after almost 50 years, of her voice. She has been through drugs and alcohol, spent her life in

**OPEN SUNDAYS
VIDEO • ELECTRONICS • APPLIANCES
GUARANTEED LOWEST PRICES
TOLL FREE 1-800-223-6779
OUT OF N.Y. FOR CUSTOMER SERVICE
CALL (718) 387-7770**

OPEN SUNDAY 10-5

FASTEST DELIVERY

VCR'S (VHS)	299.00	PANASONIC PK958	695.00	TYPEWRITERS		
PANASONIC PV1225A	359.00	PANASONIC PK450	469.00	OLYMPIA ORBIT P	199.00	
PANASONIC PV1231R	519.00	PANASONIC PK558	499.00	OLYMPIA COMPACT II	349.00	
PANASONIC PV1530	599.00	PANASONIC PK97E	799.00	OLYMPIA CE12	179.00	
PANASONIC PV1630	749.00	JVC GXN7U	629.00	BROTHER CE25	215.00	
PANASONIC PV1730	499.00	VCR'S BETA		BROTHER CE65	309.00	
PANASONIC PV5800P	719.00	SANYO VCR 4400	195.00	BROTHER CE70	439.00	
PANASONIC PV8500P	949.00	SANYO VCR 4650	239.00	BROTHER EM80	449.00	
PANASONIC PV9600P	949.00	SANYO VCR 4670	349.00	SCM Ultrasonic 450	269.00	
JVC HRD 150	469.00	SANYO VCR 4750	479.00	TELEPHONE ANSWERING MACHINES		
JVC HRD 131	375.00	SANYO VCR 7200	365.00	PANASONIC KXT 2130	66.00	
JVC HRD 140	1089.00	SANYO VCR 7500	519.00	PANASONIC KXT 3130	109.00	
JVC GRClU	649.00	SANYO VCR 200	899.00	PANASONIC KXT 1410	59.00	
JVC HRD 725	CALL!	CALL US FOR BEST PRICES ON ZENITH, G.E., HITACHI, SONY, NEC, TOSHIBA, QUASAR VIDEO & VIDEO ACCESSORIES			PANASONIC KXT 1425	95.00
JVC HRS 100	CALL!	PERSONAL STEREOS		PANASONIC KXT 2425	175.00	
RCA NEW VKT 375	CALL!	SONY WMDGC	225.00	CODE A PHONE 2530	109.00	
RCA VKT 385	CALL!	SONY WMF1011	97.00	CODE A PHONE 2555	119.00	
RCA NEW VLT 450	CALL!	SONY WM10RV	95.00	CODE A PHONE 2570	138.00	
RCA VKT 550	CALL!	SONY WMR15	114.00	MICROWAVE OVENS		
RCA VKT 650	CALL!	SONY WM11	29.00	LITTON		
RCA NEW VLP 600	CALL!	AIWAHSJ400	122.00	1131	159.00	
RCA VLP 800	CALL!	AIWA HSP02MK	84.00	1422	159.00	
RCA VKP 900	CALL!	AIWA HFS07	116.00		1145	
RCA VKP 950	CALL!	TOSHIBA KTRSI	85.00		1435	
RCA CL020 (AutoFoc.)	269.00	TOSHIBA KTV50C	75.00		179.00	
SHARP VC 58/U	489.00					
SHARP VC 489	725.00					
SHARP VC 5815	319.00					
SHARP VC 586	475.00					
SHARP VC 487	559.00					



Store Hours: Mon-Thurs 9 to 6, Fri 9 to 2, Sun 10 to 5, Sat closed

OUR EXPERTLY TRAINED STAFF ARE WAITING TO ASSIST YOU!
ELECTRONICS & APPLIANCES
NEW ADDRESS 633 Bedford Ave., Brooklyn, N.Y. 11211
Master Charge, Visa, MC accepted. Credit card orders subject to change at time of order. Add shipping, handling & insurance.

Circle 40 on Reader-Service Card

**WHY PAY MORE?
COMPARE PRICES..
TOLL FREE 800-356-9514**

PORTABLE STEREOS

Sanyo M9825 4-speaker with EQ	\$79.00
Toshiba RT-140s 4-speaker with auto-reverse	\$79.00
Sony CFS250 BIG POWER	\$59.00
JVC DC-33 with turntable and EQ	\$288.00
Sansui CP-5 Portable Home Stereo	\$249.00
Sony CFS3000 with EQ	\$44.00
CALL FOR OTHER PORTABLE SPECIALS	

Sanyo VCR-7200 **\$369**
Beta HiFi

Digital with Bass and treble **\$179**
Sansui RX-3000

3-Head with dbx **\$399**
Teac V-900x

RECEIVERS

Technics SA-450 50 watts/ch	\$189
Sansui/R-410 20 watts/ch	\$88
Marantz SR-940 Wireless Remote	\$169
Sanyo DCR-100 20 watts/ch	\$72
Sansui SX-1130 Top-of-the-Line	CALL!
Akai AAA-35 Digital	\$199
Sherwood S2660 Top-Rated	CALL
Scott 349s Best-Buy	\$169
Technics SA-350	\$169

SANSUI A-505

30 watts/ch	\$79
Sansui T-510 Tuner	\$49
Sansui T-1110 Top-of-the-Line	\$139
SAE A-201 100 watts/ch	CALL
Nikko Alpha 450 220 watts/ch	CALL
Adcom GFA2 100 watts/ch	CALL
Nikko ND-1000 Top-of-the-Line	CALL
Sharp RTW600s Hi-Sp Dub	\$109
Akai HX-3 Dolby B&C	\$106
Akai HXA1 Soft-Touch	\$78
Hitachi DW500 Hi-Sp Dub	CALL

SPEAKERS

Bose Bookshelf 2-way	\$49 ea.
Advent BABY	\$59 ea.
Sansui Floor-standing	\$36 ea.
EPI 2.0	\$149 ea.
Koss 210	\$139 ea.

ACCESSORIES

Teac EQ-10 EQ	\$79.00
Audio Source EQ-III EQ	\$249.00
ATT Noteworthy Phone	\$29.00
Sony WMF10 FM Cassette Walkman	CALL
Sony T-120	\$4.69 ea.
Fuji FRI or FRIL	\$1.59 ea.
Fuji L-750 or T-120	\$4.99 ea.

Some items close-outs, some items discontinued. Some items limited quantities, all factory sealed with full warranty.

Compact Disc Specials

Sanyo CP-200 or CP-300	\$199
GE 5030	\$219
Sansui PCV-500	CALL
Akai CD7T Remote DAD	\$369

WDS
WISCONSIN DISCOUNT STORE
2417 W. Badger Rd. Madison WI 53713

C.O.D. Mon-Thurs 8-8
Friday 9-8
Saturday 9-5
Or, Call 608-271-6889

Circle 7 on Reader-Service Card

The art of shaping sound.

Does your music sound better in the next room? Pro audio kills resonances with SONEX acoustic foam, and now you can too. Control acoustics and turn your room into a studio. At midrange, SONEX has twice the sound absorption of good carpeting for about the same cost. If your dealer doesn't have SONEX, send us \$40 for a sample box of four 24" x 24" sheets, or write for our color brochure.



illbruck/usa

techniques with foams

3800 Washington Ave. N. Minneapolis, MN 55412

Circle 34 on Reader-Service Card

Moving?

Be sure and send us your new address 8 weeks before you move so you won't miss any copies of HIGH FIDELITY.

And please include an old mailing label from our magazine when writing us about your subscription.

Write to: HIGH FIDELITY,

P.O. Box 10759, Des Moines, Iowa 50340

Change of address.

Enter new subscription. 1 yr. \$13.95

payment enclosed bill me

Add'l postage: \$6 per year outside U.S., its poss.

AFX LABEL

If you have no label handy, print DLD address here

name	please print
address	
city	
state	zip code

New Address

name	please print
address	
city	
state	zip code

**FOR EVEN FASTER SERVICE
CALL TOLL FREE
1-(800)-247-5470**

G3031

carcinogen-filled rooms, and often used a raw, shouting style that must rub a vocal cord the wrong way. Yet she still sounds great.

Now in her mid-sixties, O'Day continues growing, even though she no longer sings with the range she once had. On most of *A Song for You* (released on her own label), she is backed by a quartet that includes Ronnell Bright, a supportive pianist with a keen ear, and Don Ruffell, a saxophonist reminiscent of Lester Young. Because O'Day was originally a Billie Holiday derivative and Billie and Lester were incomparable when they wound around each other musically, this new conjunction has unexpected moments of familiarity. Anita's outgoing, charging, husky-voiced side comes swinging through the faster pieces ("Opus One," "Undecided," "I Get a Kick out of You"). However, she resorts to trickery (such as the glottal staggering of Mel Torme) as she tries to keep a slow ballad from dragging.

But there are also three songs with only piano accompaniment and one with piano, bass, and drums, all of which project a rarely seen or heard Anita O'Day. She stretches her vocal range, especially at the low end, working on darker colors and even adapting them to a beguiling kind of slow scat singing. Intimate and reflective, O'Day reveals someone much more sensitive and vulnerable than the aggressive, assured performer we know.

John S. Wilson

ALVIN BATISTE:

Musique D'Afrique Nouvelle Orleans.

Alvin Batiste, prod. *India Navigation IN 1065*. (Distributed by New Music Distribution Service, 500 Broadway, New York, N.Y. 10012.)

With so much attention directed toward the stream of New Orleans's up-and-coming, would-be jazz greats, everyone has overlooked veteran clarinetist Alvin Batiste. A classically trained musician and current director of Southern University's Jazz Institute in Baton Rouge, he has toured or recorded with Ray Charles, the Duke Ellington Orchestra, Cannonball Adderley, and Billy Cobham, as well as performed his own compositions with the New Orleans Philharmonic. Not that he has been very accessible on vinyl; although he co-led 1984's *Clarinet Summit*, with David Murray, Jimmy Hamilton, and John Carter, *Musique D'Afrique Nouvelle Orleans* is his first studio album as a leader.

Recorded in 1981, *Musique* is a quartet of complex constructions and aural experiments that challenge the ear. This contemplative album draws not only from obvious European classical and jazz influences, but also from more esoteric sources, specifically Cuban, Brazilian, and other "world music" subgenres. Earlier in his career, Batiste traveled to the Ivory Coast, where he organized (with a grant from the National Endowment for the Humanities) a multi-ethnic curriculum with a jazz emphasis. *Musique* is a cumulative synthesis of Batiste's career as both player and teacher.

We are greeted by "Suite No. 3" 's chantlike theme, a satisfying, mystical line. Weaving its trail through the nine-part composition, the tantalizing melody constantly resurfaces. In two instances, spoken rhyme makes direct reference to Batiste's affiliation with the Rosicrucians, a sect he considers "a cultural fraternity" rather than a religious order. A continuous flow dominates, despite the many abrupt, unexpected pauses and unconventional changes that are mostly triggered by the unorthodox note choice of guitarist Ray Mouton or the articulate electric-bass playing of Elton Heron. Mouton's tone, phrasing, and attack are surprisingly similar to those of the purveyors of the mid-1960s "San Francisco Sound." "Endocrine Song" conjures up the logical romanticism of Liszt, Debussy, and Telemann, yet the piece is dotted with the seemingly unrelated vibraphone notes of guest artist Charles Allen. In the gospel/blues tradition, "Words of Wisdom"—a composition written like a round—symbolizes a rejuvenation, a rekindling of the spirit, highlighted by the interplay between Cheryl Keyes's piano and Batiste's soaring clarinet runs. "The Kheri Hebs" again demonstrates Batiste's involvement with the mystical, the abstract. And *Musique*'s eclectic viewpoint successfully translates Batiste's desire to pique our curiosity with uncommon music.

Jonathan W. Poses

CARLA BLEY:

I Hate to Sing.

Carla Bley, prod. *Watt 12 1/2*. (Distributed by New Music Distribution Service, 500 Broadway, New York, N.Y. 10012.)

After the normalizing tendencies of Carla Bley's *Social Studies* and *Live!* albums culminated in the "tastefully" restrained jazz of

(Continued on page 96)

Circle 14 on Reader-Service Card

LABELLE

CAMERA & STEREO OF MAINE

IN MAINE
155 MAIN STREET
BIDDEFORD, MAINE
1-207-283-1401

IN NEW YORK
224 WEST JERICO TPK.
SYOSSET, L.I., NY
1-516-496-2235

BLANK TAPE BLOWOUT

AUDIO TAPES



SONY
UCX-90 \$1.99
ES-90 \$4.99
Minimum 10 Tapes

TDK



SAC-90 \$1.75
SAX-90 \$2.48
Minimum 10 Tapes

maxell.



XL-II C90 1.79
XL-II S90 2.49
Minimum 10 Tapes

SONY



T-20

VIDEO TAPES

TDK T-120 \$4.70
Maxell T-120 \$4.70
Maxell T-120 HGX \$6.90
TDK extra hi grade \$6.90
Minimum 10 Tapes

FOR MAIL ORDERS CALL TOLL FREE 1-800-341-0783 or 1-800-443-1927

In Maine and Alaska Call 1-207-283-1401 CALL FOR HANDLING AND SHIPPING CHARGES

Send all mail order checks to: 155 Main Street, Biddeford, ME 04005

PRICES AND PRODUCTS IN EFFECT MAY 25 THRU JUNE 24

We accept Visa, Mastercard, American Express & Diners Club. Ask about details on COD orders. Money orders accepted. Allow 4 weeks clearance on personal checks.

mitsubishi



AM-FM Car Stereo. The top of the line... digital quartz, separate base & treble. Dolby® fader control, etc.

\$259⁹⁵

CZ-757 includes 100 Watt AMP

RX-737 229.95 RX-740 219.95
RX-735-2 179.95 RX-724 89.95
RX-734 159.95 RX-909 179.95
RX-731 129.95 RX-733 159.95

All Mitsubishi Products at Lowest Prices

BLAUPUNKT TUCSON



• AM-FM digital stereo, push button tuner, auto reverse. Dolby® fader

\$359⁹⁵

AM-FM CAR STEREO

Frankfort 119.95 Washington Sq. 439.95
Seattle 179.95 New Yorker Sq. 519.95
Richmond 219.95 Chicago 219.95
Manhattan 219.95 BEG FR 139.95
Aspen SQR 24 239.95 BEA 40 89.95
Sacramento 279.95 BEA 80 139.95
Houston 449.95 BPA 415 89.95
BPA-260 209.95 BPA 430 209.95

JENSEN CAR AUDIO RE-900



Digital unit, quartz clock, 12 presets, scan tuning, fader control, 10 watts

\$129⁹⁵

AM-FM CAR STEREO

ATZ 500 349.95 RE 980 206.95
ATZ 400 309.95 RE 960 178.95
ATZ 300 279.95 RE 940 164.95
ATZ 200 249.95 RE 920 149.95
ATZ 100 219.95 RE 908 129.95
EQA 5000 89.95 R 220 149.95
EQA 2500 69.95 A-35 44.95

All Jensen Car Speakers at Lowest Prices.

Radar Detectors



WHISTLER SPECTRUM \$189⁹⁵
Quadradyne Radar Detector

Whistler Spectrum remote 199.95
Whistler Q-1200 119.95
Fox XK 79.95
Fox XK remote 99.95
Super Fox Vixen 159.95
Super Fox remote 199.95

BELL 834-S/ KR VIII Super Hydrodyne Radar Detector (rated #1) \$189⁹⁵

Bell 861 99.95
Bell 860 134.95
Bell 837 179.95
Bell 720 79.95
Bell 854 89.95
Bell 841 109.95

Panasonic



COS-934 supreme series AM-FM stereo cassette player auto reverse, DBX, NR, digital

\$219⁹⁵

COS-884 209.95 COS-747 129.95
COS-793 149.95 COS-834 184.95
COS-958 239.95 CYSG-100 139.95
COS-734 129.95 CYSG-50 89.95
COS-804 159.95

All Panasonic Car Speakers Discounted!

CONCORD



HPL-122 R • 10 watts per channel, Dolby® B, digital

229⁹⁵

HPL-502 189.95 HPL-550 479.95
HPL-516 239.95 HPO-890 59.95
HPL-520 319.95 HPO-90 59.95
HPL-532 349.95 HPA-51 129.95
HPL-518 329.95 HPA-71 179.95
HPL 117 239.95

All Concord Speakers Discounted!

Clarion 8500R



Digital AM-FM stereo tuner auto-reverse tape separate base and treble

139⁹⁵

8550R 139.95 300EQB4 109.95
8100R 109.95 4100R 59.95
6900R 129.95 200EQB-2 79.95
6300R 109.95 6700R 109.95
4700R 99.95 6100R 99.95
9500RT 239.95 8725R 169.95

SANYO FTE-25



All night illumination, Dolby® B & C, A.M.S. 9 1/2 watts per channel, fader clock

\$189⁹⁵

FTE-20 169.95 FTU-42 119.95
FTD-6 189.95 FTU-55 139.95
FTD-7 219.95 PA-6100 119.95
FTU-35 99.95 PA-6110 139.95
EQZ-6210 68.95 PA-6050 99.95
EQA-600 79.95

CAR SPEAKERS JENSEN J3033



6x9 Triax® II 100 watts/3 way **79⁹⁵**

Jensen

J1365 6x9 50 watts/3 way 64.95 pr.
6x9 Coax 50 watts 64.95 pr.
J3023 6x9 Triax 75 watts 79.95 pr.
3003 4x4 Coax 50 watts 49.95 pr.
US630 5x4 Triax 65 watts 64.95 pr.
US620 5x4 Coax 55 watts 49.95 pr.
US 420 4x4 Coax 35 watts 39.95 pr.
P/EQ-1 1 1/2" full range 100 watts 79.95 pr.

Sony

ES-5 92 6x9 Coax 80 watts 69.95 pr.
ES-52 5/4 Coax 40 watts 49.95 pr.

Blaupunkt

DL 3530 3 1/2" 30 watts 34.95 pr.
CL 4635 4 1/2" x 6 Coax 35 watts 69.95 pr.
CL 5050 5 1/2" Coax 50 watts 69.95 pr.
DL 4145 4 1/2" x 10 1/2" 50 watts 69.95 pr.
DL 4145 4 1/2" x 10 1/2" dual cone 45 wt 49.95 pr.
SE-520 5" Coax 30 watts 39.95 pr.

Clarion

SE-980 6x9 3 way 90 watts 79.95 pr.
SE-970 6x9 Coax 60 watts 59.95 pr.
SE-60 6 1/2" 3 way 60 watts 69.95 pr.
SE-530 5" 3 way 40 watts 49.95 pr.
SE-420 4" Coax 30 watts 39.95 pr.

Sanyo

SP-96 6x9 3 way 100 watts 79.95 pr.
SP-94 6x9 3 way 40 watts 59.95 pr.

AM-FM RECEIVERS AKAI AA-A35 179⁹⁵



• 48 watts per channel
• Quartz lock digital tuning

SPECIAL LOW PRICES ON:

Akai AA-A1 (22 watts) 99.95
Akai AA-A25 (32 watts) 139.95
Akai AA-A45 (65 watts) 229.95
JVC R-K 200 (40 watts) 219.95
JVC R-X300 (55 watts) 239.95
JVC R-X350 (55 watts) 329.95
JVC RX-400 119.95
Technics SA150 (25 watts) 179.95
Technics SA360 (40 watts) 179.95
Technics SA460 (50 watts) 209.95
Technics SA550 (70 watts) 259.95
Nikko NR550 (35 watts) CALL
Nikko NR1000 (65 watts) CALL
Scott 379RS (45 watts) 299.99
Scott 359RS (42 watts) 239.99
Marantz SR640 (45 watts) 189.95
Marantz SR840 (70 watts) 329.95
Marantz SR-940 (100 watts) 439.95
Marantz SR-440 (30 watts) 199.95

CASSETTE DECKS AKAI HXA-2 69⁹⁵



metal tape compatible/cassette deck/Dolby® B and C/NR

Akai HXR-44 auto rev 179.95
Akai GXR-55 239.95
Akai GXR-66 279.95
Akai HX A-3 149.95
Akai HX A-5 189.95
Akai GX R-88 369.95
Akai GX R-99 519.95
TECHNICS RS B12 89.95
TECHNICS RS B14 99.95
TECHNICS RS B11W 129.95
TECHNICS RS B11H 148.95
TECHNICS RS-B68R 215.95
TECHNICS RS-B78R 254.95
TECHNICS RSM-245X 206.95
JVC KD-V300 149.95
JVC KD-V6J 379.95
TEAC V-800X 439.95
TEAC V-900X 439.95
TEAC TR77X 359.95
Marantz SD-530 199.95
Marantz SD-530 239.95

VIDEO VIDEO VIDEO

CALL US FOR LOWEST PRICES ON ALL VIDEO RECORDERS!

Panasonic PV 1530 CABLE READY
4-HEAD STEREO RECORDER
• Electronic tuning
• 14 day/4 event
• High speed search
\$539⁹⁵

Panasonic PV 1225A
2-HEAD
• 14 day program
• remote control
• slow motion
• still frame
\$299⁹⁵

Panasonic PV 5800
8 HOUR VHS RECORDING
• remote control
• high speed search
• compact, lightweight portable
PACKAGE \$1079

JVC VHSR 4-HEAD WIRELESS RECORDER
• 8 hour VHS
• 14 day program
• high speed search
• front loading
\$399⁹⁵

RCA VUP170
8 HOUR VHS LIGHTWEIGHT PORTABLE RECORDER
• 14 day program
• full function
• fast & slow motion
\$619⁹⁵

CALL FOR LOWEST PRICES ON ALL VIDEO RECORDERS, CAMERAS & ACCESSORIES

MODEL PK455
• compact auto-focus color camera
• 6.1 power zoom
• light weight

EQUALIZER/MIXERS

ADC



ADC S8315X Equalizer and Spectrum Analyzer w/microphone **249⁹⁵**

ADC SS215X 174.95
AudioSource EQ-1 series 2 279.95
AudioSource EQ-4 1/2 band EQ 119.95
AudioSource EQ-8 w/spectrum display 139.95
AudioSource RT-3A 89.95
TEAC EQA-10 89.95
TEAC EQA-20 109.95
Technics SH-8025 89.95
Technics SH-8055 229.95
Numark DM-500 139.95
Numark DM-1150 89.95
Numark DM-1550 209.95
Numark DM-1650 299.95
Akai EA-A2 109.95
Akai EA-A7 179.95

TURNTABLE

Technics SLJ-2



Direct Drive Linear Tracking/Quartz Turntable **\$109⁹⁵**

Technics SLB-200 semi-auto belt drive 64.95
Technics SLQX-200 quartz semi auto 119.95
Technics SLQX-300 quartz fully auto 134.95
TECHNICS SLJ3 linear tracking 139.95
Technics SH-9025 289.95
Akai APD3 Direct drive fully auto 89.95
Akai APM33-2 linear tracking 109.95
JVC QLA-220 quartz, semi-auto 64.95
JVC QLF-320 quartz, fully auto 89.95
JVC QLL2 linear tracking quartz 129.95

Call For Best Prices On All Turntables

CARTRIDGES

AUDIO-TECHNICA HR 201 E/U



Frequency response 15 to 27,000/stereo separation 29 decibels/elliptical stylus fits all p-mounts and standard

\$54.95

SHURE

DT-15P 39.95
DT-25P 59.95
DT-35P 79.95
V-15V-MR 149.95

STANTON

PRO-3000 29.95
PRO-4000 59.95
PRO 5000 79.95
PRO 96 89.95

AUDIO TECHNICA ORTOFON

HR 101 EU 39.95
HR 201 EU 54.95
HR 301 EU 74.95
HR 401 EU 89.95

TM-7 44.95
TM-14 44.95

call for other models

TELEPHONES

PANASONIC KX-T245 189⁹⁵



Telephone & Answering Machine/Beeperless Remote Speaker Phone/16M Memory Pulse Dialing

Panasonic KXT 2415 phone & answer 149.95
Panasonic KXT 1415 remote voice 89.95
Panasonic KXT 1425 tone, rem, ans 119.95
Panasonic KXT 1410 voice activated 74.95
Panasonic VA 8030 phone and rem ans 179.95
Panasonic KXT 3130 2 line auto dialer 129.95
Panasonic KXT 2340 phone auto dial 89.95
Code-A-Phone 2530 #1 rated, remote 129.95
Code-A-Phone 2570 phone/ans unit 129.95
Code-A-Phone 7420 79.95
Sanyo TAS-1100 voice activated 79.95
Sanyo TAS-300 remote ans 99.95
Phone Mate IQ-940 beeperless remote 99.95
Phone Mate IQ-2845 beeperless 119.95

STEREO TO GO

SONY WALKMAN 10 RV



cassette player with Dolby® and auto reverse **\$79.95**

Sony WMF10 II am/fm Dolby B, metal tape 89.95
Sony WM10 II super Walkman cassette 59.95
Sony WM6C Pro Walkman Dolby B/C 239.95
Sony WMDC2 Quartz Dolby B/C 139.95
Sony WMF5 Sports fm cass. Walkman 89.95
Always HXSJ 400 am/fm cassette recorder 139.95
Always HSP97 fm cassette Dolby® 99.95
Toishia RTV53 am/fm cassette 49.95
Toishia RP200 am/fm ultracompact 49.95

HOME SPEAKERS

ADVENT 2002



2 way bookshelf speaker **\$129⁹⁵** pair

SCOTT

177 DL 3-way 120w total **\$139⁹⁵** pair

INTERAUDIO by BOSE Alpha 4 Tower Speakers **449⁹⁵** pr. (limited quantity)

DISC PLAYERS

AKAI CD-A7T



27 function programmable wireless, remote control, available in black and silver.

\$369⁹⁵

Technics SLP-1 289.95
Technics SLP-2 349.95
Marantz CD-54 449.95
JVC-XLV300 319.95

For Best Prices On All Compact Disc Players... CALL!

35MM CAMERAS

CALL FOR ALL MODELS

MINOLTA X-700



body with Canon 50mm 1.8 lens **\$189⁹⁵**

body with Minolta 50mm 1.7 lens **\$199⁹⁵**

CANON AE-1 PROGRAM



body with Canon 50mm 1.8 lens **\$189⁹⁵**

NIKON F-G



body with Nikon 50mm 1.8 lens **\$189⁹⁵**

PENTAX ME-Super



body with Pentax 50mm Pentax 1.8 lens **\$159⁹⁵**

OPEN MON. THRU FRI. AND SUNDAY, 10AM-8PM EST. CLOSED SATURDAY

NEW YORK AND MAINE RESIDENTS ADD LOCAL SALES TAX • ALL MERCHANDISE IS NEW AND GUARANTEED SEND \$1 FOR LABELLES CATALOGUE

20 day return policy. All returns must be phoned in for prior authorization and must be received within 20 days from receipt of original shipment. All products must be returned in original factory packaging, clean and unscratched, and blank warranty card. Do not tape, or deface manufacturers' original cartons. Shipping and handling charges not refundable. Pictures are for illustration only... and do not represent the product exactly as shown. Rainchecks available upon request. Please call and reserve your purchases if you plan to pick up at store. Quantities are limited and subject to availability.

High Fidelity Classified

MAIL TO: 825 7th Ave., 7th floor, New York, N.Y. 10019.
Phone: 1-800-ABC-MAGS. In New York call: (212) 887-8459. GENERAL: all copy subject to publisher approval. Users of P.O. Box MUST supply permanent address and telephone number before ad can run.

CLOSING DATE: 1st of second month preceding cover date. 15 Word minimum No charge for Zip Code.
CLASSIFIED RATES: regular type, per word: 1x—\$2.75; 3x—\$2.65; 6x—\$2.55; 12x—\$2.45. Words in caps—15¢ extra each. IMPERIAL type, per word: 1x—\$3.75; 3x—\$3.65; 6x—\$3.55; 12x—\$3.45. Words in caps—15¢ extra each. Minimum 15 words. Box numbers: \$3.00 additional per insertion to cover cost of handling and postage. Display, per inch: 1x—\$350; 3x—\$340; 6x—\$330; 12x—\$315. PAYMENT WITH ORDER: Send check, M.O., MASTERCARD or VISA No. and expiration date to: Candice Leyden Classified Dept., HIGH FIDELITY, 825 7th Ave., 7th Floor, New York, NY 10019.

For Sale

BANG & OLUFSEN FULL LINE, ADS, B&W AND BOSE SPEAKERS AND OTHER QUALITY PRODUCTS AT REASONABLE PRICE. SOUNDCREST, INC., (201) 756-4858

AUDIO PRO POWERED SUBWOOFERS. The Most Accurate Powered Subwoofer Available Today. Call For The Dealer Nearest You. Sonic Research, 27 Sugar Hollow Road, Danbury, CT 06810, (203) 792-8824.

THEY DON'T DISCOUNT IT? WE DO! GET LOW PRICES on ALL types of audio equipment—including high-end and even esoteric products not normally discounted! Now we can save you money on the equipment you REALLY WANT. Extensive selection—no need to settle for second choice. Thousands of satisfied customers nationwide. Call us for price quotes or friendly, expert advice. Catalog \$1. 616-451-3868. VISA/MC/AMEX. The AUDIO ADVISOR, INC., BOX 6202, Grand Rapids, MI 49506.

NAKAMICHI • KOETSU • ACCUPHASE • LUX • MICRO BEIKI
ALL JAPANESE HIGH-END DISCOUNTED
America's Largest Selection
OVER 100 CARTRIDGES, 50 TONEARMS,
30 TURNTABLES, 100 ACCESSORIES, & MORE
CATALOG \$3.00
JAPANESE STEREO
930 N. La Cienega Blvd
Los Angeles, CA 90069 (213) 859-8550
BAEC • HIGHPHONIC • SONY EB • ESPRIT • ENTRE • STAK •

SAVE 50% BUILD YOUR OWN SPEAKER SYSTEM. Write McGee Radio Electronics, 1901 McGee Street, Kansas City, Missouri 64108.

CALL TOLL FREE 1-800-826-0520 FOR ACOUSTAT, DAHLQUIST, NAD, HAFLER, DENON, dbx, 3D, PROTON, TANDBERG, BELLES, ORACLE, M&K, GRADO, NITTY GRITTY, AUDIOQUEST, NEC, DUNTEC, MONSTER, SUMIKO PERREAUX, CWD, SNELL, B&W, DEM, THORENS, VSP, STAX, SOTA, GRACE, ASTATIC, DYNAVECTOR. THE SOUND SELLER, 1706 MAIN STREET, MARINETTE, WI 54143, (715) 735-9002.

Quality Tapes

THIS MONTH'S SUPER SPECIALS

TDK		MAXELL	
SA 90	1.69	SA-X 90	2.39
SA 60	1.59	SA-X 60	2.29
AD 90	1.79	HX-5 90	4.15
AD 60	1.45	HX-5 60	3.85
D 90	1.09	MA 90	4.19
D 60	.99	MA-R 90	5.75
HD-01 D MAC	12.40	CX 95-908 7 RL	6.49
SONY			
UCX-5 90	1.89	HF 90	1.05
HF-5 90	1.79	HF 60	.95
TEAC reel to reel in cassette			
CDC 90	2.99	CRC 90 (M.B.)	3.29
DISCMASTER			
DISKIT	32.40	DISCSET	14.49
Rec Care Sys	9.49	Tape Care Set	9.00
16 oz. Reel#	9.99	D'MAC	12.40
VIDEO TAPES			
		FR METAL 90	3.39
		FR H 90	1.89

CALL NOW: 718-434-3417 OR ORDER BY MAIL
Shipping cost is only \$4.50 for any order in USA.
COD costs \$2.00 more. No extra charge for VISA/MC.

QUALITY TAPES
864 East 7th Street, Dept. MF 6, Brooklyn, NY 11230

CALL US!! HARMAN-KARDON, PERREAUX, SAE, STAX, ADCOM, KLIPSCH, HEYBROOK, PYRAMID, AUDIO PRO, VSP LABS, HAFLER, NAD, AMBER, DENON, TANDBERG, ADS, DCM, CONRAD-JOHNSON, GRACE, DBX, PS AUDIO, OHM ACOUSTICS, GRADO, DYNAVECTOR, INFINITY, NITTY GRITTY, MONSTER ALPHA, AKG, CELESTION, AUTOMOTIVE, SONY, THORENS, KENWOOD, ZAPCO, CRIMESTOPPERS SECURITY, MORE! FRIENDLY, EXPERT CONSULTATION. FAST, FREE SHIPPING!! MC/VISA. REFERENCE AUDIO SYSTEMS, 18214 DALTON AVENUE, GARDENA, CA 92048. (213) 398-4205, (213) 391-2679.

CAUTION! NAKAMICHI BUYERS!! Nakamichi goods not intended for sale in the United States are being sold by unauthorized dealers. NAKAMICHI U.S.A. CANNOT BEAR ANY RESPONSIBILITY FOR SALES OR WARRANTY SERVICING OF UNITS NOT COVERED BY OUR APPLICABLE WARRANTY. For the name of your nearest authorized Nakamichi dealer, call 1-800/421-2313. In California, call 1-800/223-1521.

HARMAN/KARDON, NAKAMICHI, CROWN, CARVER, HAFLER, THORENS, TANDBERG, REVOX, NAD, LUXMAN, DCM, DBX, ELECTRO-VOICE, VANDERSTEIN, AND OTHER QUALITY COMPONENTS, BEST PRICES - PROFESSIONAL SERVICE, EAST (904) 262-4000; WEST (818) 840-0878.

AUDIO, VIDEO, AND AUTO-SOUND AT UNHEARD OF PRICES!! Now you can own the finest in Audio, Video and Auto sound including the esoterics at incredible prices. DIRECT SIGHT AND SOUND (the expanded Direct Sound Marketing) provides sensible expert advice, complete service facilities and factory fresh components on an in-stock basis. Call (404) 233-9500 or send for our FREE catalog to DIRECT SIGHT AND SOUND, 3095 Bolling Way, Dept. #H, Atlanta, Georgia 30305. MC/VISA/AMEX accepted.

SONY ELCASET TAPEDECK, Model EL-7, with RM30 remote control and 72 tapes. Single package only. 5467 Nickless Drive, Oshkosh, WI 54901. (414) 582-7146.

EXCEPTIONAL AUDIO REPRODUCTION SYSTEMS... REASONABLY PRICED!! E.A.R.S., P.O. BOX 658-H, WEST COVINA, CA 91790. 818/961-6158, EVENINGS, WEEKENDS. STAMP BRINGS MONTHLY SPECIALS. MC/VISA.

CALL US LAST !!!!!!
Shop around, Get your best price, Then call THE SOUND APPROACH. Guaranteed LOWEST PRICES on all HOME and CAR STEREO. Featuring: ADS, AIWA, AUDIO CONTROL, BLAUPUNKT, BOSTON ACOUSTICS, BANG & OLUFSEN, DENON, HARMAN KARDON, HAFLER, INFINITY, NEC, ORTOFON, THORENS... Factory fresh, Fully warranted. For FAST FREE DELIVERY and GUARANTEED LOWEST PRICES, call THE SOUND APPROACH, 6067 Jericho Tpke., Commack, New York, 11725 (516) 499-7680. VISA/MC/Amex.

FREE catalog—LOWEST DISCOUNT PRICES on stereo/esoteric components for home and car. Sony, Bose, JVC, AR, SAE, Crown, other 'high quality' brands. AUDIO UNLIMITED, 1203 1/2 C Adams, LaGrande, OR 97850 (503) 963-5731. 10-6/M-Th Pacific Time.

BRITISH EQUIPMENT DIRECT FROM THE U.K. Most quality makes of equipment available at advantageous prices. For price list and price quotes write to AUDIO T., Dept. A, P.O. Box 152, Enfield, Middx. EN2 0PL, U.K. or call (01) 366-5015.

EXPERIENCED RECOMMENDATIONS! ACOUSTAT, MITSUBISHI, SAE, HAFLER, QUAD, KLIPSCH, THORENS, FRIED, ADCOM, MIRAGE, PS, GRADO, CD PLAYERS, more. Immediate, FREE Shipping! READ BROTHERS STEREO, 593-C King Street, Charleston, South Carolina 29403. (803) 723-7276.

NAKAMICHI BX-150 \$389, Bx-300 \$589, RX-202 \$519, RX-303 \$719, RX-505 \$879, ZX-9 \$1,089, DRAGON \$1,349, 1000ZXL \$2,799. YAMAHA R-100B \$629, R-100S \$589, T-1000B \$289, T-1000S \$259, T-700B \$259, T-700S \$199, A-1000B \$539, A-1000S \$499, A-700B \$399, A-700S \$349, A-500B \$259, A-500S \$239, K-2000B \$699, PF-800 \$449, NS-500M \$699, NS-1000M \$1,099. TASCAM 244 \$849, 34 \$1,049, 32 \$899, 38 \$2,099, M-30 \$929, M-2A \$299. SONY TC-D5M \$489, WM-D6C \$269. New with U.S.A. warranty. Also import Yamaha pianos U2 \$3,995, U3 \$4,195, G2 \$7,295, G3 \$7,895. Shipping anywhere U.S.A. and Canada. Set-up and tune. VISA/MC/Amex/Diners/COD. Taskamichi Audio & Piano Direct Importers, 11555 27th N.E., Seattle, WA 98125. (206) 221-2977 or (206) 361-2455.

A SINGER'S DREAM!



REMOVES VOCALS FROM RECORDS!
Now You can sing with the world's best bands! The Thompson Vocal Eliminator can remove most or virtually all of a lead vocal from a standard stereo record and leave the background!
Write or call for a free brochure and demo record.
LT Sound, Dept. HF, P.O. Box 338,
Stone Mountain, GA 30086 (404) 493-1258

1-800-431-3232
Specializing only in
cartridges + mics + headphones

B&O • audio-technica • AKG • Ortofon
Dynavector • Grace • PICKERING • Stanton

We quote pro advice + lowest price
24 Hr. Shipment on all our equipment
COD's are Okay, call us, don't delay
P.O. Box 37, Brooklyn, NY 11204 (718) 438-6400

audio

LOWEST POSSIBLE PRICES ANYWHERE!
FULL WARRANTY — Most Audio Brands!!
C.D.'s — Car Products — Computers
(Hardware-Software) — Most Video
Brands!! ELECTRIFIED DISCOUNTERS, 996
ORANGE AVENUE, WEST HAVEN, CT
06516, MC/VISA (203) 937-0106.

Tapes & Records

TAPE WORLD TOLL FREE 1-800-245-6000

TDK	MAXELL	TDK	TDK	TDK	TDK
MA 90	5.99	4.99	1.00	1.00	1.00
MA 90	4.99	4.99	1.00	1.00	1.00
SA 10	2.49	1.99	1.00	1.00	1.00
421 80	2.99	1.99	1.00	1.00	1.00
SA 80	1.79	1.49	1.00	1.00	1.00
SA 80	1.99	1.49	1.00	1.00	1.00
AD 90	1.99	1.49	1.00	1.00	1.00
AD 80	1.49	1.00	1.00	1.00	1.00
D 80	1.99	1.49	1.00	1.00	1.00
D 60	99	1.00	1.00	1.00	1.00

WE WILL BEAT ANY COMPETITOR'S PRICE OF THE TOTAL ORDER, INCLUDING ALL SHIPPING AND HANDLING CHARGES BY 1%.

VISA MC No. + 1% charge. COD add \$1.99 PA. Add. Sales Tax, Shipping and Post. in PO. Orders shipped in 48 hours. Close at 5 PM. 9A-8:59P

220 Spring St. Box 361 Butler, PA 16001 412-283-8621

OPEN REEL TAPE-AMPEX 641/671, used once, unspliced, unboxed. 7" 1800' or 2400' Reels; 30 for \$35.00. Sample: \$2.00. Ten 3600' 10 1/2" Reels: \$39.00. Sample: \$3.75. New, Premium High-Blas cassettes; Sample: \$1.00. AUDIO TAPES, BOX 9584-J, ALEXANDRIA, VA 22304. (703) 370-5555 VISA/MC

SOUNDTRACKS, SHOW, NOSTALGIA & JAZZ—FREE Catalog & Offering List—A-1 Record Finders, P.O. Box 75071-H, L.A. CAL 90075.

LIVE OPERA TAPES, CASSETTES, DISCS. Incredible selection. Free Catalogue, Live Opera, Box 3141. Steinway Station, L.I.C., NY 11103.

SEARCHING FOR OUT-OF-PRINTS? Try for discontinued Records, 444 South Victory, Burbank, California 91502 (213) 849-4791.

RARE CLASSICAL AND JAZZ 150,000 LP's. The Record Collector, 1158 N. Highland, Los Angeles, CA 90038. (213) 467-2875.

SHOW ALBUMS—Rare, out-of-print lps. 64-page list \$1.00. Broadway-Hollywood Recordings, Georgetown, CT. 06829.

OPEN REEL TAPES from Studio masters. Catalogue \$1.00. Barclay-Crocker, 313-H Mill Street, Poughkeepsie NY 12601.

RECORDS BY GASPARO. Chamber music, solo, baroque—We have something for you! Write for free catalog, P.O. Box 120069, Nashville, TN 37212.

OPERA-HISTORICAL PERFORMANCES ON VIDEO AND DISC. Most comprehensive selection. Send \$1.00 for catalog. LYRIC, P.O. BOX 622, MERRICK, NY 11566.

PIXOFF BY SONIC RESEARCH. Dry Clean Your Records. No Messy Liquids. Call For The Dealer Nearest You. Sonic Research, Inc., 27 Sugar Hollow Road, Danbury, CT 06810. (203) 792-8824.

IN PRINT & OUT OF PRINT RECORDS ALL CATEGORIES Spectacular Catalog!! \$2.00 USA \$3.00 Foreign. Serendipity Records, 4775 Durham Road, Guilford, CT 06437 USA.

FREE RECORD, CASSETTE AND COMPACT DISC CATALOG: Features a Tremendous Selection of Remaindered LP and Cassette Values in All Musical Categories Compact Disc, Cassette and LP New Releases at Discount Prices. Many Imports and Smaller Labels Offered Prompt Delivery Rose Records, Dept. H, 214 South Wabash Avenue, Chicago, IL 60604.

LIVE OPERA TAPES, REELS-CASSETTES-VIDEOS—Unbelievable treasures since 1926, over 10,000 selections. Deluxe alphabetical catalog. Mr. Tape, Box 138, Murray Hill Station, NYC 10016.

Protect your LP's. Poly Sleeves .13¢. Polylined Paper .16¢. Cardboard Jackets .40¢, postage \$2.50. We buy and sell like new LP's, pre-recorded reel tapes, and cassettes. Catalogue \$3.00. HOUSE OF RECORDS, Box 323, Hillburn, N.Y. 10931.

AMPEX PROFESSIONAL SERIES AUDIO TAPE SALE. High Quality Open Reel 1800' or 2400' on 7" Reels. Used Once. Case of 40, \$45.00. 10 1/2" x 3600' and Cassettes. MC/Visa. Valtech Electronics, Box 6-H, Richboro, PA 18954. (215) 322-4866.

FROM EDISON TO ELVIS (AND BEYOND) LP's, 78's, 45's, etc. Visit or mail in wants. The Olde Tyme Music Scene, 915 Main Street Boonton, NJ 07005. 201/335-5040—Tuesday thru Sunday.

RECORD RATERS WANTED: IN EXCHANGE FOR YOUR OPINION YOU CAN BUILD A SUBSTANTIAL ALBUM COLLECTION. SMALL MEMBERSHIP FEE INCLUDES GIFT CERTIFICATE — WRITE EARS, BOX 10245F, Milwaukee, WI 53208.

JAZZ RECORDS, BOOKS & VIDEOTAPES — ELLINGTON, BASIE, ETC. FREE LISTS! JAZZLAND, BOX 366, DAYTON, OHIO 45401.

Equipment for Sale

SONUS SUPER BLUE LAMBDA BY SONIC RESEARCH. The World's Most Phase Coherent Cartridge. Call For The Dealer Nearest You. Sonic Research Inc., 27 Sugar Hollow Road, Danbury CT 06810. (203) 792-8824.

DJ's, BANDS, NIGHTCLUBS—Disco, Stage Lighting, Professional Sound Equipment—super prices! Send \$1.00 for Catalog, P.O. Box 20395, Bowling Green, KY 42101. COD and Visa orders (502) 781-2448. Specials: Foggers \$225, Color Organs \$89, Rain Lights \$32, 800-Watt Amp \$599, Mixers \$79.00.

HIGH PERFORMANCE AUDIO PLUS CAR STEREO AT A LOW, LOW PRICE. Featuring: ADS, Advent, Aiwa, Alphasonik, Alpine, Amber, AR, Audio Source, Blaupunkt, Bose, Celestion, Clarion-Audio, Concord, DBX, Denon, Dual, Dynavector, Energy, Grace, Grado, Harman-Kardon, JBL, Kenwood, Kyocera, Mitsubishi, Monster-Alpha, Onkyo, Pioneer, Pyramid, Robertson, Audio, Scott, Sherwood, Signet, Soundcraftsmen, Sound Dynamics, Sony, Systemdek, Tandberg, Thorens, Vampire Wire, Wharfedale Diamond, Walker, others. Providing: professional advice, personal service, "no rush" showroom, prompt shipments, free delivery and set up trade-ins, extended warranty. RETAIL-MAIL ORDER-EXPORT. Call 12 Noon to 7PM E.S.T., or write today (regarding specific make and models), HAROLD MINTO, PERFORMANCE AUDIO/VIDEO LTD. 365 South Bayview Avenue, Dept. HF, Freeport, LI., NY 11520. (516) 378-4389. Financing, MC/VISA, AMEX. NO SALES TAX CHARGED TO OUT OF STATE RESIDENTS.

NOTICE: THE High Performance Audio Kit company has a new address; PHOENIX SYSTEMS, INC.-HF, P. O. Box 338-b, Stone Mountain, GA 30086. (404) 934-9626.

Inventions Wanted

Inventions, ideas, new products wanted for presentation to industry and exhibition at national technology exposition. Call 1-800-528-6050, Arizona 1-800-352-0458. x831

Compact Discs



COMPACT DISC CENTER
P.O. Box 616, Clifton Park, NY 12065
(518) 664-2550

Many Discs \$13.99
Quantity 10 and over only \$12.99
\$2.00 Cont. U.S. shipping
FREE CATALOGUE

COMPACT DISCS & ACCESSORIES. Call TOLL FREE 1-800-ALL-DISC (in Connecticut 1-452-0203) For Free CATALOG M-F, 10-8, Saturday 10-6, Sunday 11-4. All Disc Music Inc., 133 Wheeler Road, Monroe, CT 06468.

COMPACT DISCS—Most \$11.99-\$13.99. 2,800 Plus Titles in Stock. Free Catalogue Plus Monthly Updates. OZ Records, 5246H Memorial Drive, Stone Mountain, GA 30083, (404) 292-5452.

CD/MATE the latest in compact disc accessories allows portability plus safe, durable protection for your CD's. Available in six pack and ten pack, CD/MATE is made of durable nylon with velour lining and velcro closure. CD/MATE's lightweight, compact design eliminates the need for bulky plastic boxes. Send \$10.95 for six pack (holds six CD's) or send \$12.95 for ten pack (holds ten CD's) plus \$2.00 postage and handling in black, red and blue from Shore Brothers Ltd., Box H, 2323 Corinth Avenue, LA, CA 90064.

COMPACT DISCS AT COMPACT PRICES!!!! Over 2,000 Discs from \$9.49. Send \$2.00 for Complete Catalogue. DISC HAVEN, Box 60 Dept. H, New London, CT 06320.

GET ORGANIZED. Beautiful solid oak CD storage system. Holds 75 CD's. Three shelves. Handsome finish. 11" wide, 15" high. Unconditional guarantee. High Quality without the high price. Only \$24.95 complete or send for brochure. (Dealer Inquiries invited.) The Oak People, 5503 17th N.W., B205-H3 Seattle, WA 98107.

C.D.SUPERMARKET—MOST COMPACT DISCS \$13.49. LARGE SELECTION. Next day shipping in most cases. For information and phone orders, call TOLL-FREE 800-382-1985. CA residents 800-322-1985. C.D. Supermarket, 1525 Aviation Blvd., Suite B-210, Redondo Beach, CA 90278.

COMPACT DISCS AND LASER VIDEO DISCS. Nice Prices — free llists. MC/VISA. SIGHT & SOUND, INC. 18 Bennett Street, Dept. HF, Boston, MA 02135. (617) 787-4465.

Miscellaneous

HI FI IN LONDON WILL COST YOU LESS—Tax free export—mail, phone, personal visit (Visa/Mastercard). K J Leisuresound, 48 Wigmore Street, London W1H 9DF. ENGLAND 01-486-0552.

1960-70's country music transcriptions, \$3.00 each. Quality tape dubbings from original 78's, \$5.00 to \$15.00 each. Satisfaction guaranteed. Long SASE for lists. George Collings, 22909 Baltar Street, Canoga Park, CA 91304.

Old and rare record catalogs & supplements at auction. Closing soon. Long SASE for list. George Collings, 22909 Baltar St., Canoga Park, CA. 91304.

Business Opportunities

YOUR OWN RADIO STATION! AM, FM, Licensed, unlicensed, low cost transmitters! Free information. BROADCASTING, Box 130-D2, Paradise, CA 95069.

ELECTRONIC REPRESENTATIVES NEEDED!! Lowest Possible Prices!! Over 100 Brands! Audio-Video-Car Stereo-Computers Electronic Experts. 1000 Orange Ave., West Haven, CT 06516.

Computer Software

IBM PC/XT PROGRAM TO TRACK RECORDS/TAPES. Store up to 32,000 records. Requires 128K or more memory, DOS 2.10, BASICA. \$79.95. Information: MICROWARE ASSOCIATES-H, 763 Taft Drive, Suite G, Arlington, TX 76011.

Video

CONVERT VIDEOTAPES PAL-SECAM-NTSC (OVERSEAS). 110-220 Audio, Video recorders, Televisions, Apple Audio, 74-18 37th Avenue, Jackson Heights, New York, 11372 (718) 507-5800.

Wanted to Buy

We . . . BUY . . . by . . . PHONE
America's largest . . . USED . . .
HI-END . . . inventory . . . STEREO
EXCHANGE . . . (800) 833-0071 . . .
(212) 505-1111.

**FIGHT
HEART
DISEASE,
KIDNEY
DISEASE
AND
BLINDNESS.**

Support
the American
Diabetes
Association.

BACKBEAT REVIEWS

(Continued from page 92)

last year's *Heavy Heart*, one could only wonder how long it would be before she released something on a par with her impressive work of the previous two decades. Bley had in fact engendered enough goodwill over the years to inspire some of her longtime fans to rationalize *Heart's* banal professionalism by viewing it as a concept album, an uncompromisingly modern, post-Andy Kaufman prank wherein the hand is never tipped. But with the release of *I Hate to Sing*, even the die-hard fans are going to be hard put to come up with a convincing explanation of Bley's motives.

Most of Side 1, recorded live in San Francisco in '81, dedicated to milking yuks from the acting out of performance anxiety, is a repetitious medley whose tackiness, heightened by drummer D. Sharpe and pianist Arturo O'Farrill's abysmal warbling, may elicit a few chuckles. Unfortunately, the joke sinks in too quickly and hangs around for too long. Bley also relies too much on her by-now-familiar repertoire of humorous moves: the Kurt Weill/Nino Rota homage (the title cut), the spoof of the avant-garde's use of childlike, singsong, thematic material ("Piano Lesson"), the attempted reclamation of the patriotic song ("Battleship"). On this last one, which closes the album, Bley comes closest to recapturing the spirit of her earlier work: Borrowed and original material are well integrated, and when trumpeter Mike Mantler takes an invigorating free form solo (his only turn on the album), the old fire is glimpsed. But mainly one is reminded that Bley has done this sort of pastiche before and done it better.

Richard C. Walls

JOHN SCOFIELD:

Electric Outlet.

① Steve Swallow and John Scofield, prods. Gramavision GRCD 8405. □ □

Best known for his recent appearances with Miles Davis, electric guitarist John Scofield has also worked with Charles Mingus and Gary Burton and has recorded under his own name. *Electric Outlet* is his most attractive set, it seems to me, because he mixes his own brand of fusion with a wistful countryish tune, "Best Western"; a graceful, understated tribute to the blues, "King for a Day"; and a ballad, "Thanks Again." The imaginative instrumentation helps, too: Some of the live-

liest moments, for example, are created by trombonist Ray Anderson.

Perhaps because of his jazz connections, Scofield prefers his guitar light and relatively undistorted, and he phrases his statements effectively, avoiding the endless strings of sixteenth notes of other players. The LP, more than the Compact Disc, gives the bass (overdubbed by Scofield) a warmer though less defined sound. The imaging, however, is more faithful on CD, bringing out one of his strengths—the clever, inventive ways he varies textures. He uses Anderson and alto saxophonist David Sanborn sparingly, to add depth or bite to an ensemble as well as to solo passages, and he enlivens the bass line of "Just My Luck," for instance, with Peter Levin's additions on synthesizer. Scofield can't sustain my interest over the five minutes of funk on "Big Break," but when the beat is springy and the soloing spacious, *Electric Outlet* has a light, sophisticated charm. Michael Ullman

BRUCE NOVACK:

Time Slabs.

① Bruce Novack, prod. Crevice 11. (Distributed by New Music Distribution Service, 500 Broadway, New York, N.Y. 10012.)

To my ears, the five improvised piano solos on Bruce Novack's *Time Slabs* do not echo their attractively whimsical titles. They seem instead to be organized around thudding chords, especially in the case of opener "Digging for Windows." Novack has an impressive technique and a fertile imagination; he rarely seems at a loss for notes. But he also has heavy hands. His playing—leaping, single-note lines as well as two-handed statements—has a weighed-down, percussive quality that is relieved only in the relatively lyrical sections of "Old and Nameless," with its welcome melancholy.

Which is not to say that *Time Slabs* is all crude thumping. "Amphibious Feet" begins with a few leapfrogging notes played presto, somewhat like Cecil Taylor. This movement slows little by little, bringing us to a long pause, which the pianist gradually fills up with thick-textured ten-finger chords. "Musical Chairs/Chasing Amnesia" fluctuates between a muddy moodiness in its dark, low-pitched clusters and a rocking beat. What these pieces lack is forward motion. For all their instrumental virtuosity, they're neither carefully shaped nor rhythmically compelling. Michael Ullman

DISCOVERING GERSHWIN

(Continued from page 72)

Watson, his editor at New World Music, that he was unhappy with the orchestration. After the composer's death, New World apparently took this as a cue to do what they wished with a piece that was fairly dead in the water, even though Gershwin "was very passionate about the fact that he did his own orchestrations," Shirley says. The version in common use today was arranged by Robert McBride in the early 1950s, and while it's more transparent, it's also full of clichés and is generally more common.

"George's version is much more contrapuntal, and the harmonies more dissonant and unusually voiced," explains Thomas. "The style . . . was so virtuosic, so daring for its time . . . , the reaction was to simplify it, to make it more practical. It was like taking *The Magic Fire Music* and saying, 'This is impractical—the instruments have to play all of these chromatic notes. Let's change all this. . . .' Only in recent years has our evaluation of Gershwin increased to the point where we realize that so much of what he did was right on the nose."

Gershwin partisans sensed just that for years, but the proof—in original manuscripts—was closely guarded by the Gershwin estate. Of course, materials were available to certain scholars, but when performance rights could be controlled, they were granted selectively. The uncut, original orchestrations of *Porgy and Bess* lay dormant until the mid-1970s when permission to use them was granted to such reputable institutions as the Cleveland Orchestra and the Houston Grand Opera. If one is to compare Gershwin to Mussorgsky (who also defined a national identity in music and was criticized for being technically inept), then one might also speculate that Ira wished to bypass those wanting to play Rimsky-Korsakov to his brother's music, and held out instead for a less self-serving champion, a Shostakovich, so to speak.

Ira asked to meet Thomas, who was one of the few major conductors interested enough in the *Second Rhapsody* to want to make a new set of parts from the Library of Congress manuscript. Their meetings had mostly a social air and continued so casually that Thomas can't recall any single time when Ira conferred on him the duty to revise his brother's standing in the music world by

bringing out the unheard material.

"They were nice afternoons. I'd stay a couple hours until he got tired," Thomas recalls. "We had a kind of routine. I'd go in and first give him greetings from my father and uncle. We'd talk about the old Jewish theater and old Broadway-vaudeville reminiscence stories for a while. I'd play some of the Gershwin things I was working on or talk about performances. I'd play things for Ira that my father played for me. Ira would say, 'Oh, God, where did you hear that?' Then he would have recordings brought out—unusual recordings, air checks—and he would gradually ask questions like, 'Do you know this piece?'"

And of course Thomas didn't. Nobody outside the very core of the Gershwin circle did. The first such find was *Sleepless Night*, a musical monologue with distant jazz riffs wafting in and out, and from there the others on the new CBS album followed. Thomas was surprised at how quickly these works ingratiated themselves to him.

"It was almost disconcerting at times because you recognize the hand of the master . . . but you think, where do I know this from? It's perplexing. And after you've heard it a few times, it's fascinating how easily the music becomes woven into the web of your life. I've lived with these pieces a year or so, and for me, they're just as potent as any of George's other pieces."

Meanwhile, there were a number of important questions to be answered about the existing Gershwin works, beginning with the *Rhapsody in Blue*. "I played through [the piano part] for Ira . . . piecing it together . . . saying, 'What about this place? That place? Do the grace notes go in? Go out?' After a while, you start seeing how the hand combination was. It's just lying there underneath your hand. Your ear helps you find it, and your hand helps you find it. Often, I'd listen to the music and say, that chord just doesn't sound right to my innate Gershwin gyroscope.

"The sense of the dance step is inseparable from the true nature of these pieces. With an 'up' tempo and style of articulation, they have a certain kind of clean, driving, and ultimately more moving effect. There are the big Hollywood moments, the big Broadway moments, the big composer-on-his-way-up moments, but they're checked in the taut, concentrated line. . . ."

Perhaps America has been slow in giv-

ing Gershwin his due because the music has been so distorted and taken for granted. "Nothing drives me crazier," says Thomas, "than being at a party where somebody plays *Summertime* as a 12-bar blues. Instead of all the perfectly exquisite spare notes of the song, they're putting in all these garden-variety chords and thinking they're making *Summertime*."

With uncharacteristic reticence, Thomas admits that "coming into classical music, it was almost kind of a secret that I played all of this Gershwin music. The attitude was, 'Be careful, you won't be able to conduct Beethoven.' As the years went on, I thought, 'Wait a minute! This is a great treasure. This is one of the things I'm proudest of in my whole life.'"

Thomas's personal library is that of an ultraserious musician, with a *Boris Godunov* poster dominating the wall, the complete works of Brahms lining the bookshelves, and a large desk—rather than an armchair—next to the stereo. On the piano, though, is a small, gray photograph of him leaning over the edge of a stage to clasp hands with his elderly father. And during an absent-minded moment, Thomas gazes across the room, humming Gershwin's lovely ballad, *Liza*.

"Recently, pop music's values have been so much focused on electronics . . . [when] what we really need are great songs. When you really need those great songs is when you're walking down the street by yourself late at night. It's not so important if singers X, Y, or Z did this rubato. What's important is that you understand the line of the song and that the words have a place in your heart that comes to comfort you when you need it.

"The beauty of many of [Gershwin's] songs is that they're designed to encapsulate particular emotions. . . . We have to really look at ourselves in America and say we really do have a tradition, and we have to see to it and minister to it and all realize how important it is.

"There's an interesting parallel in Vienna. The performance of Strauss waltzes in the original version is an exalted purpose. I feel just that way about Gershwin's music and this project. We have to maintain it so people do understand what these pieces were and how the composer's voice speaks through them, while we're still close enough to the [original] time." ●

READER ACTION PAGE

Advertising Index

RS #		Page #
48	Acoustic Research, Teledyne	24
13	Akai America, Ltd.	29
8	Carver Corp.	12
10	DALI	89
9	D'Ascanio	14
	DBX Inc.	60, 61, 62, 63
22	Denon America, Inc.	Cover II, 1
6	Denon America, Inc.	Cover IV
2	Discwasher, Inc.	22
1	Discwasher, Inc.	10
17	Fujitsu Ten Corp. of America	19
18	Genesis Physics Corp.	45
30	Hitachi Sales Corp.	40
34	Illbruck	92
	Illinois Audio	79
43	Infinity Systems Inc.	15
20	J & R Music World	75
32	Kyocera International, Inc.	32, 33, 34, 35
14	LaBelle Camera & Stereo	93
	Maxell Corp.	26
42	McIntosh Laboratory, Inc.	77
19	NAD Electronics	9
49	NEC Home Electronics, Inc.	Cover III
	Onkyo U.S.A. Corp.	25
27	Perreaux	51, 52, 53
35	Polk Audio Inc.	13
40	S & W Electronics	91
28	Sansui Electronics Corp.	8
41	Sawafuji	11
3	Sherwood	3
24	Sony Corp. of America	6, 7
15	Stereo Corp. of America	87
21	Tandberg of America, Inc.	18
12	TDK Electronics Corp.	17
25	TEAC Corp. of America	21
5	Technics	5
16	3D Acoustics	19
7	Wisconsin Discount	91

Many manufacturers who advertise in HIGH FIDELITY offer additional literature on their products free of charge to our readers. For more information on specific products advertised in this issue, drop a postcard, care of Dept. HF-685 unless otherwise noted, to the addresses listed below. If an address does not appear, literature is available through the company's dealers only.

Acoustic Research,
330 Turnpike Street, Canton, Mass. 02021,
Att: Dept. HF 685

Akai America LTD,
800 W. Artesia Blvd., Compton, CA 90020,
Att: Dept. HF 685

Carver Corporation,
P.O. Box 1237, Lynnwood, WA 98046,
Att: Dept. HF 685

DALI,
P.O. Box 55386, Valencia, CA 91355,
Att: Mike Gerutto, Att: Dept. HF 685
805-252-7203

D'Ascanio Audio,
11450 Overseas Highway, Marathon,
Fl. 33050, Att: Dept. HF 685

DBX, Inc.,
71 Chapel Street, Newton, MA 02195,
Att: Dept. HF 685

Discwasher,
1407 North Providence Rd., P.O. Box 6021,
Columbia MO 65205, Att: Dept. HF 685

Fujitsu Ten,
19281 Pacific Gateway Dr., Torrance,
CA 90502, Att: Dept. HF 685

Hitachi Sales Corporation,
401 West Artesia Blvd., Compton,
CA 90220, Att: Dept. HF 685

Illbruck USA,
3800 Washington Avenue North, Minneapolis,
Minnesota, 55412, Att: Russ Leighton,
Att: Dept. HF 685 (612) 521-3555

Illinois Audio,
12 East Delaware Pl., Chicago, Illinois
60611, 800-621-8042, Att: Dept. HF 685

Infinity Systems Inc.,
7930 Deering Ave., Canoga Park, CA. 91304,
Att: Dept. HF 685

J&R Music World,
23 Park Row, New York, NY 10038,
Customer Service Dept. HF 685

Kyocera International Inc.,
7 Powder Horn Drive, P.O. Box 4227,
Warren, NJ 07060, Att: Dept. HF 685

LaBelle Camera & Stereo of Maine,
155 Main Street, Biddeford, MA 04005,
800-341-0783, In ME, HI, AK
207-281-1401, Att: Dept. HF 685

Maxell Corp. of America,
60 Oxford Dr., Moonachie, NJ 07074,
Att: Dept. HF 685

McIntosh Laboratory Inc.,
East Side Station, P.O. Box 96,
Binghamton, NY 13904, Att: Dept. HF 685

NAD,
675 Canton Street, Norwood, MA 02062,
Att: Dept. HF 685

NEC,
1401 Estes Ave., Elk Grove Village, IL 60007,
(312) 228-5900, Att: Dept. HF 685

Perreaux LTD,
875 Merrick Ave., Westbury, NY 11590,
Att: Dept. HF 685

Polk Audio Inc.,
1915 Annapolis Rd., Baltimore, MD 21230,
301-837-4300, Att: Dept. HF 685

S&W Electronics,
187 Ross Street, Brooklyn, NY 11211,
Att: Dept. HF 685

Sansui Electronics Corp.,
Lyndhurst, NJ 07071, 201-604-7300,
Att: Dept. HF 685

Sawafuji,
23440 Hawthorne Blvd., Torrance,
CA 90505, (213) 373-0620

Sherwood,
13845 Artesia Blvd., Cerritos, CA 90701,
Att: Dept. HF 685

Sony Corp. of America,
Sony Drive, Park Ridge, NJ 07656,
Att: Dept. HF 685

Stereo Corp. of America,
1629 Flatbush Ave., Brooklyn, NY 11210,
718-338-8555, Att: Dept. HF 685

Tandberg of America Inc.,
1 Labriola Court, Armonk, NY 10504,
Att: Dept. HF 685

TDK Electronics Corp.,
12 Harbor Park Dr., Port Washington,
NY 10050, Att: Dept. HF 685

TEAC Corp. of America,
7733 Telegraph Rd., Montebello, CA 90640,
Att: Dept. HF 685

Technics,
One Panasonic Way, Secaucus, NJ 07094,
Att: Dept. HF 685

3D Acoustics,
652 Glenbrook Rd., Stamford, CT. 06906,
Att: Dept. HF 685

Wisconsin Discount Stereo,
2417 W. Badger Rd., Madison, WI 53713,
800-356-9514, Att: Dept. HF 685

Yamaha Electronics Corp., USA,
660 Orangethorpe Ave., Buena Park,
CA 90620, Att: Dept. HF 685

Advertising Offices

New York: ABC Leisure Magazines, Inc., 825 7th Ave., 7th Floor, New York, N.Y. 10019. Tel: (212) 265-8360. James A. Casella, Advertising Director; Richard J. Marino, National Accounts Manager; Michael Goldberg, Eastern Advertising Manager; James R. McCallum, Record Advertising Manager; Candice Leyden, Classified Advertising Manager; Kathleen Davis, Director of Production; Janet Cermak, Advertising Production Manager. **Midwest:** High Fidelity, Hitchcock Building, Wheaton, Ill. 60187. Tel: (312) 653-8020. Star Lane, Midwest Advertising Manager. **Los Angeles:** ABC Leisure Magazines, Inc., 2020 Avenue of the Stars, Suite 245, Century City, Calif. 90067. Tel: (213) 557-6482. Rita Weitzen, Western Advertising Manager. **National Reps:** Kathleen Charla, Kathleen G. Charla Associates, 21000 W. Fourteen Mile Road, Birmingham, Mich. 48010, Tel: (313) 642-3482. **Tokyo:** Japan Advertising Communications, Inc., New Ginza Bldg., 7-3-13 Ginza, Chuo-ku, Tokyo 104, Japan. Tel: (03) 571-8748. Shigeru Kobayashi, President.

Stereo TV. Not stereotype TV.



"Give My Regards To Broad Street" is available on Beta and VHS Stereo Hi-Fi Videocassettes from CBS/FOX VIDEO. © 1985 CBS/FOX VIDEO.



The NEC CT-2020A offers all the features of the CT-2505A plus a flat square (FS) black stripe picture tube for increased image area and a linear, undistorted picture, 142 channel CATV-ready quartz synthesized PLL tuner and on-screen time display.

With almost 50% of U.S. TV stations planning to broadcast stereo this year, naturally many manufacturers are jumping on the stereo TV bandwagon. That's why NEC wants to remind you of something before you buy any TV, stereo or otherwise. The TV itself.

NEC Stereo Receiver/Monitors incorporate decades of the Company's industrial and professional video experience. In fact, the 20" CT-2020A and 25" CT-2505A offer *all* the features that make NEC a favorite among serious video users.

Besides receiving stereo or Second Audio Program (SAP) Multiplex Broadcasts directly and playing them back through built-in stereo amps and speakers, the CT-2020A/2505As feature CATV-ready tuners with full function wireless remote control and Skip Memory; and a complete assortment of antenna, video and audio connection facilities. These stereo NEC Receiver/Monitors also incorporate comb filters, auto flesh control, black stripe matrix picture tubes and smoked glass anti-glare shields for the utmost in picture sharpness, contrast and resolution.

No matter how good the idea of stereo TV may sound, combining stereo with an NEC Receiver/Monitor sounds even better.

NEC

NEC Corporation, Tokyo, Japan

NEC Home Electronics (U.S.A.) Inc.,
1401 Estes Avenue, Elk Grove Village, Illinois 60007, (312) 228-5900.

Circle 49 on Reader-Service Card

IF CD PLAYERS DO SOUND DIFFERENT, ONE CD PLAYER MUST SOUND BEST.

As audiophiles listen to different Compact Disc players, they're hearing more and more differences. And one CD player has emerged as a cut above.

In Germany, *Audio* magazine chose Denon over Philips and Revox to be their reference CD player. "For the ultimate in laser technology, there is only one choice—the Denon DCD-1800, the reference player."

In the U.S.A., *Digital Audio* "compared the Denon with an oversampling player and judged the DCD-1800's sound superior in cleanliness, accuracy, and detail."

What has Denon done to deserve such praise? They started off by inventing digital recording in the first place. Then they gained

experience recording an extensive library of Denon PCM master tapes, and pressing Denon Compact Discs. Finally, they produced the DCD-1800's Direct Digital-to-Analog Converter. It's the world's only D/A converter that's hand-tuned for reduced crossover distortion.

Now Denon raises the CD reference even higher. Introducing the new Denon DCD-1800R, with new high-convenience remote control and high-performance tracking servos. In fact, the editorial board of Japan's *Stereo* magazine has already voted the new Denon CD player "best" in its class!

The Denon DCD-1800R. Officially, the "R" stands for Remote. But to critical listeners, it stands for Reference.



DENON

D E S I G N I N T E G R I T Y

Circle 6 on Reader-Service Card

Denon America, Inc., 27 Law Drive, Fairfield, N.J. 07006 (201) 575-7810