

HIGH FIDELITY

A "new" Tchaikovsky piano concerto

HFDBUCMHHAZGREDZO C DEC 72
MR DAVID BUCHANAN
HAZEL GREEN ACADEMY
HAZEL GREEN KY 41332

Light on Cassettes and 8-Track Cartridges

How New Cassette Tapes - Lead to Better Performance

How Their Defects Have Been Corrected

The Top Equipment and Their Special Features



precision parts
synchronous motors



high-performance electronics

new tape formulations

multiple heads
variable bias

multiple motor

narrow-gap heads

heavy-duty construction

read capacitor drive

automatic programming

THE FISHER PHILOSOPHY OF EQUIPMENT DESIGN. PART 3.

THE FISHER PERSONALITY IN AMPLIFIERS.

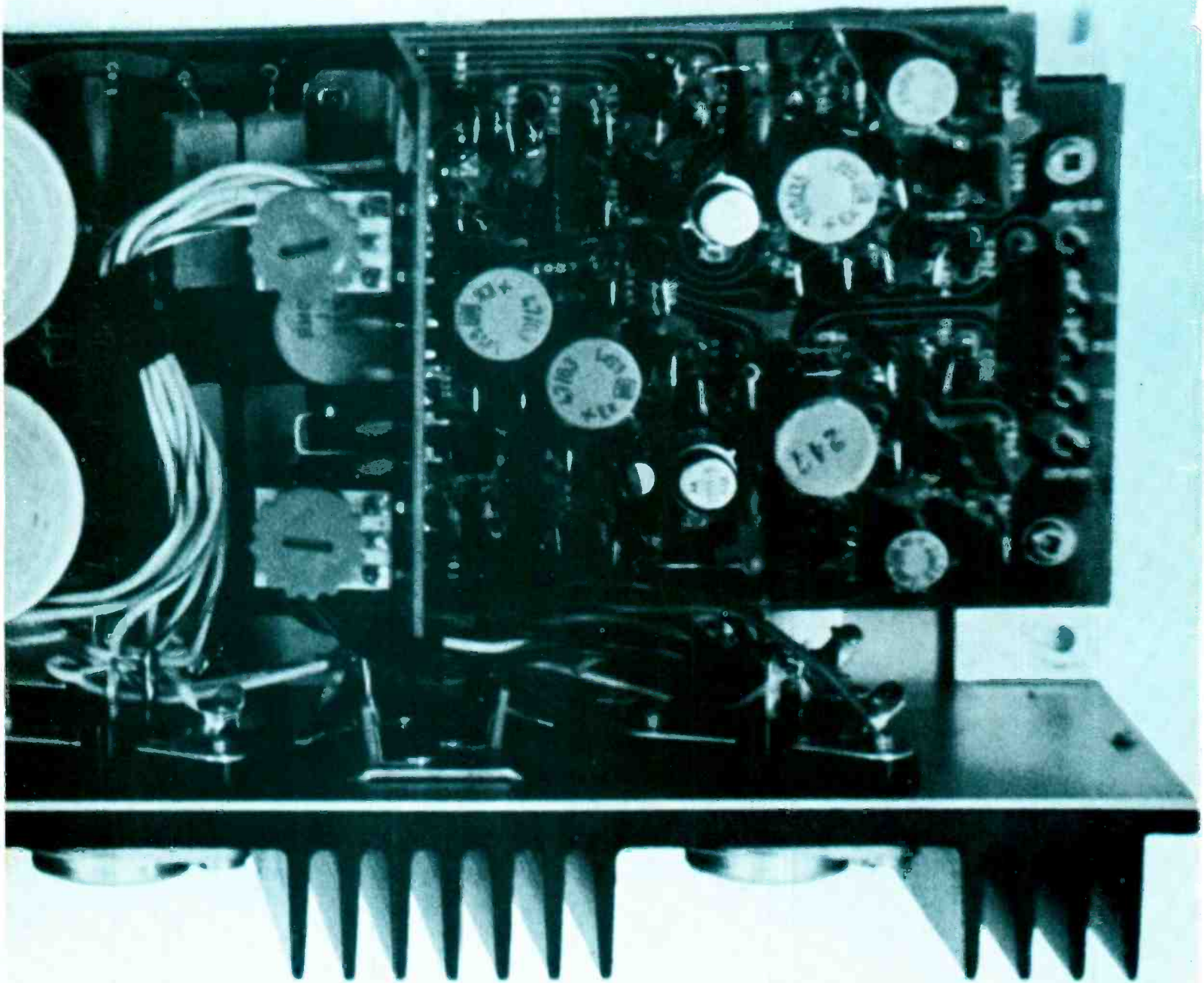

This is the third of a new series of ads about the major conceptual differences between Fisher components and other makes. It is not necessary to have read the first two ads before reading this one, but see footnote in italics below.

In an ideal world, the ideal amplifier would do absolutely nothing to its input except amplify it. (As long as all controls are in a neutral or "out" position.) The same criterion applies, of course, to the amplifier section of a receiver.

In real life, however, amplifiers not only amplify their input but also change it. They add harmonic and inter-modulation products, they slow down the transients, they create new transients, they fill in the background with hum and hiss. Today's highly perfected amplifiers do these non-functional things ever so slightly, certainly to a lesser degree than even the finest pick ups, tape recorders or loudspeakers. But that does not mean the design approach to amplifiers can be more casual now than to other components.

In fact, amplifier design has become such an exact science that the leading manufacturers are all using state-of-the-art circuitry, so that quality differences in a given price range are the result of rather sophisticated engineering details. That is where the Fisher philosophy of the "balanced component" comes in.

Fig. 1. Block diagram of the circuit stages in a Fisher amplifier channel. (Multiply by two for stereo, by four for 4-channel.)

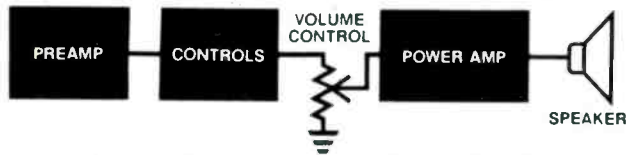

A balanced component, as engineered by Fisher, is one in which all design elements affecting basic listening quality are treated without the slightest compromise, even at the lowest price. The negotiable performance factors and convenience features, on the other hand, are maximized in proportion to the price, each to the proper degree, neglecting none and overemphasizing none.

In the case of amplifiers and the amplifier section of receivers, only power output and control versatility are negotiable. Freedom from audible distortions and noise is a non-negotiable requirement, regardless of price.

Fig. 1 shows the four basic stages of an amplifier circuit. Since controls, switches, equalizers, filters, etc., will be the

Fig. 2. The new Fisher TX-2000 stereo amplifier, incorporating the most powerful of all Fisher amplifier circuits: 50 watts continuous power (rms) per channel or 75 watts music power per channel.



subject of the next ad in this series, let us consider each of these stages from the point of view of amplification alone.

1. The preamplifier stage takes an input of a few millivolts (from a phono cartridge) and brings it up to a level of about one volt. That means a gain of roughly 50 dB, which is a lot. High gain is always accompanied by the danger of excessive background noise, so there is very little room for tolerance in the noise level of the input transistor and its associated network. On the other hand, the next transistor in the circuit must handle all that signal without overload, so it must be operated at sufficiently high voltage. Unlike some other manufacturers, Fisher is uncompromising on these points even in bottom-of-the-line components. A noisy preamp or a preamp that can be overloaded by a high-output cartridge does not belong in high fidelity equipment.

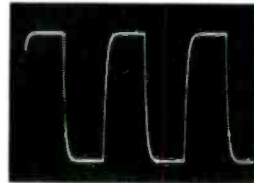

Fig. 3. Square wave response at 10 kHz of a typical Fisher amplifier circuit. The square corners and flat top indicate virtually perfect response to at least 60 kHz.

2. The tone control stage, considered purely as a stage of amplification, presents relatively few problems from the point of view of noise or distortion, since it has only a few dB of gain. The important engineering decisions are related to the design of the control networks.

3. The volume control, which controls the amount of amplification, can be placed almost anywhere between the output of the preamp stage and the speaker, and this is one of the major areas of disagreement among competing makers. Fisher firmly believes in placing it just ahead of the power amplifier stage. Placing it further up toward the speaker could result in overload of the power amplifier circuit by the unattenuated input signal. Placing further back toward the preamp would allow more circuits to run at full gain at all times, resulting in higher residual noise level at normal listening volumes.

4. The power amplifier stage must, to begin with, be able to take any input passed on to it by the volume control without overload of its first transistor, the so-called predriver. That means the predriver must be operated at sufficiently high voltage, a point sometimes overlooked by amplifier designers. The rest of the power amplifier stage is largely dictated by the maximum power output aimed for, which of course is where price becomes an important factor. Heavy-duty output transistors and power supplies cost money. However, even the least powerful Fisher amplifier circuit performs just as perfectly within its rated power as the most powerful. There is only one standard of Fisher amplifier performance.

It must be added that all Fisher amplifier designs use large amounts of feedback without the slightest instability, resulting in outstandingly wide frequency range and power bandwidth (see Fig. 3).

These are the major design considerations that give a Fisher amplifier circuit its individual personality. In most other respects Fisher simply follows the best standard practice to produce a balanced component.

FISHER

We invented high fidelity.



The next ad in this series will explore in detail how the Fisher design philosophy applies to controls, filters and switches. Others will follow. Don't miss any of them. But just in case you do, you may want to get on the mailing list for a free reprint of the entire series. To obtain this valuable booklet, or to receive free technical literature on any of nearly a hundred Fisher products, write to Fisher Radio, Dept. HF-3, 11-44 45th Road, Long Island City, N.Y. 11101.

The Pick-Up Pros.



Artie Altro makes the WOR-FM sound, while Eric Small, Sebastian Stone and Promotion Director, Kim Olian look over a new album.

WOR-FM, the country's leading FM/Stereo rock station, has been using Stanton cartridges since its inception.

Program Director Sebastian Stone likes the smooth, clean sound the Stanton delivers; the way it is able to pick up everything on the record so that the station can assure high quality transmission of every recording.

Eric Small, Chief Engineer for WOR-FM, likes the way that Stanton cartridges stand up under the wear and tear of continuous use. "We standardized on Stanton a couple of years back," Small said, "and we haven't had a cartridge failure since. Studio Supervisor Artie Altro concurs.

Whether you're a professional or simply a sincere music lover, the integrity of a Stanton cartridge delivers the quality of performance you want.

There are two Stanton professional cartridge series. The Stanton 681 Series is engi-

neered for stereo channel calibration in record studios, as well as extremely critical listening. The 500 AL Series features design modifications which make it ideally suited for the rough handling encountered in heavy on-the-air use. In fact, among the nation's disc jockeys it has become known as the "industry workhorse."

All Stanton cartridges afford excellent frequency response, channel separation, compliance and low mass and tracking pressure. And every Stanton cartridge is fitted with the exclusive "longhair" brush to keep grooves clean and protect the stylus. They belong in every quality reproduction system—broadcast or high fidelity.

For complete information and specifications on Stanton cartridges, write Stanton Magnetics, Inc., Terminal Drive, Plainview, L.I., N.Y. 11803.



All Stanton cartridges are designed for use with *all* two and four-channel matrix derived compatible systems.

CIRCLE 68 ON READER-SERVICE CARD

music and musicians

| | | |
|---|--|-----|
| Edward Greenfield | THE PRIME MINISTER AS MUSICIAN | 25 |
| | Behind the scenes in London | |
| Michael Ponti | A "NEW" TCHAIKOVSKY PIANO CONCERTO | 14 |
| George R. Marek | THE "TOSCANINI NINTH" | 58 |
| | The twentieth anniversary of a legendary recording | |
| Charles and Mary Jane Matz | VERDI'S REVENGE | 62 |
| | Was Traviata's premiere really a fiasco? | |
| Dale Harris | THE SILLS TRAVIATA | 66 |
| | | |
| | audio and video | |
| | TOO HOT TO HANDLE | 20 |
| | NEWS AND VIEWS | 28 |
| | What happened to Hi-Fi Music Shows? | |
| | EQUIPMENT IN THE NEWS | 30 |
| | EQUIPMENT REPORTS | 39 |
| | Ampex AX 300 tape deck . . . Sony STR-6045 receiver | |
| | ADC 303B speaker system . . . Teac AN-80 & AN-50 Dolby units | |
| | Crown D-150 power amplifier | |
| | Herbert Friedman | |
| CARTRIDGES AND CASSETTES—TRIUMPH OF UPGRADING | | 48 |
| | Herbert Friedman | |
| NEW CASSETTE TAPES, KEY TO BETTER PERFORMANCE | | 50 |
| TOP CASSETTE AND CARTRIDGE EQUIPMENT | | 54 |
| | A picture gallery | |
| | | |
| | recordings | |
| | FEATURE REVIEWS | 69 |
| | Michael Ponti: ten pianists in one | |
| | 20th-century masterpieces from Vienna | |
| | The complete Bach cantatas, Vols. 1 and 2 | |
| | CLASSICAL REVIEWS | 76 |
| | Karajan's Boris . . . A Cliburn festival | |
| | POP REVIEWS | 108 |
| | Alice Cooper . . . The Doors . . . Bob Dylan hits | |
| | JAZZ REVIEWS | 114 |
| | Count Basie . . . Stan Kenton . . . Gary Burton | |
| | TAPE DECK | 118 |
| | Czech delicacies . . . Strauss blockbusters | |
| | etc. | |
| | LETTERS TO THE EDITOR | 4 |
| | Bartók, antifascist . . . Scriabin and the mystics | |
| | THOSE WERE THE DAYS | 16 |
| | A nostalgic romp through our old issues | |
| | PRODUCT INFORMATION | 35 |
| | An "at home" shopping service | 85 |
| | ADVERTISING INDEX | 84 |



Her Majesty's conductor. See page 25.

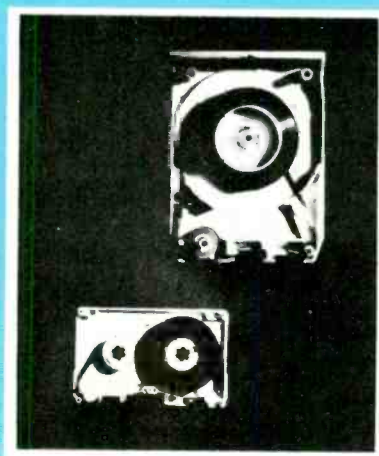

Snappy tapes. See page 48.



Verdi vs. Venice. See page 62.

lpi Published at Great Barrington, Mass. 01230 by Billboard Publications, Inc. Copyright © 1972 by Billboard Publications, Inc. The design and contents of High Fidelity Magazine are fully protected by copyright and must not be reproduced in any manner. Second-class postage paid at Great Barrington and at additional mailing offices. Authorized as second-class mail by the Post Office Department, Ottawa and for payment of postage in cash. High Fidelity/Musical America Edition is published monthly. Subscription in the U.S.A. and its Possessions, \$14; elsewhere, \$15. Subscription including Concert Artist Directory published in December, \$20 in the U.S.A. and its Possessions; elsewhere, \$21. Regular issues \$1.25 a copy. National and other editions published monthly. Subscription in the U.S.A. and Possessions, \$7.95. Air Mail rate to Japan: one year, 12,000 yen; Air Mail rate to Germany: one year, 1-3 DM. Subscription rates for all other countries available on request. Regular issues 75¢ a copy. Indexed in the Reader's Guide to Periodical Literature. Current and back copies of High Fidelity and High Fidelity/Musical America available on microfilm from University Microfilms, Ann Arbor, Michigan 48106. Change of address notices and undelivered copies (Form 3579) should be addressed to High Fidelity, Subscription Department, P.O. Box 14156, Cincinnati, Ohio 45214. Please state both old and new addresses when requesting a change.

letters

Bartók and the Anti-Fascists

Leonard Marcus' diary in the December issue ["Journey to Judgment"] was fascinating and frustrating. About Bartók's early anti-Fascist activities—more detail, please.

Garry Margolis
Los Angeles, Calif.

One such example of Bartók's disgust with Fascist tactics is shown in his defense of Toscanini after the conductor had been physically attacked by Fascist youths in Bologna on May 15, 1931 (see "Those Were the Days," November 1971). The following is a resolution drafted by Bartók for the UMZE (New Hungarian Music Society) as translated by Joseph Szigeti: "The UMZE is deeply shocked and roused to indignation by the news of the grave assault that has been made on Arturo Toscanini. The Society wishes to assure him of its most wholehearted sympathy and solidarity and salutes him with the utmost admiration.

"The UMZE views with concern the ever more numerous brutal intrusions into artistic life by factors that have nothing to do with the domain of art. These intrusions don't make a halt even before the worldwide authority of a Toscanini. Therefore the UMZE considers it timely to give thought to the problem of defensive action. Accordingly the Society will address a circular letter to every member of the ISCM (International Society for Contemporary Music) and will urge them to work out propositions tending to defend the integrity and autonomusness of art and to present these for discussion at the July meeting in Oxford.

"The UMZE will ask the Presidency of ISCM to prepare this discussion after having contacted other musical and perhaps fine arts and literary organizations, in order to bring about a world federation capable of safeguarding the freedom of arts."

Record Cleaning Solution

We at Discwasher, Inc. were gratified to see a report on our new record cleaning product in your December issue. This review, however, quoted a chemist as saying that Discwasher fluid contains silicones. There is *no form* of silicone compounds in our fluid.

We do not doubt the integrity of HIGH FIDELITY Magazine, but we must suggest that your chemist has guessed at—not studied—the composition of the fluid. Silicones are not used in it because they are counter-productive to long-term record care. With the cleaning system we manufacture, Discwasher fluid can be used repeatedly with total safety to the record surface. Scrubbing across the grooves is not recommended because (as you pointed out) the Discwasher's bristles are somewhat harder than the disc surface. In proper use (with, rather than across, the grooves) the lateral and vertical compliance of the backing allows the bristles to "track" the grooves, and disc wear ceases to be a consideration.

Bruce R. Maier, Ph.D.
Discwasher, Inc.
Columbia, Mo.

The chemist in question has a varied back-

ground in laboratory work and for the last few years has been involved specifically in the identification of trace impurities—often including silicones—in his particular work. We therefore accepted his statement that silicones, which often are used as an antistatic agent, can easily be identified without formal analysis and that they are in fact present in the Discwasher fluid. In the face of Dr. Maier's letter, however, he admits that he may have been overhasty. The identification of silicones would not appear to be as simple a matter as we had been led to believe. As we said in the review, the solution leaves only the slightest residue—much less than tap water for example—and we're satisfied that it poses no threat to records.

Scriabin and the Critics

How gratuitous of Royal S. Brown in the November issue to attack viciously Faubion Bowers' jacket notes to Ruth Laredo's new Scriabin recording. Having read Bowers' notes, which I consider extremely well written, I fail to see any example of "dime-store" mysticism as Brown charges.

Bowers simply states facts in his notes—that Scriabin was born on Christmas day (by the Russian calendar of the time) and died at Easter. The resurgence of a Scriabin trend in the West today after a long period of disinterest was just another point of fact noted by Bowers. What then is Brown's reason for getting so upset and unnecessarily nasty? It seems to me that he is displaying some sort of personal prejudice which has absolutely no place in a serious review.

I also object to Brown's inadequate, see-saw criticisms of both the Laredo and Szidon recordings of the Scriabin sonatas. Brown's style, it seems, stems from his own singularly "precious" ideas which combine (usually in the same sentence) with any first thoughts of harsh criticism that might cross his mind. For example, he says that Roberto Szidon's momentum "arises particularly from his uncanny comprehension of Scriabin's interlacing and interlocking formal patterns and thematic ideas." He then continues by saying that Szidon is "jerky, overimpetuous, and rather artificial." I'd like to know then how is it possible to "interlace" formal patterns with thematic material if one is rhythmically out of order?

In the same paragraph, Brown says that Miss Laredo, while "tending to drown the themes and lose sight of the over-all conception . . . marvelously captures the inherent rhythmic movement of Scriabin's compositions. She also brings out subtle harmonic shifts. . . ." Just what is it that Brown implies here, considering that in the previous paragraph he mentioned that Miss Laredo "occasionally tends to hammer a melodic line to death, without integrating the theme into the over-all work. . . ."? How can Brown possibly say that Miss Laredo brings out "subtle harmonic shifts" and has "inherent rhythmic movement" if she "loses" the conception of the piece as a whole? After all, rhythmic movement would bind the work together very well if it is as well done as Brown claims it is.

Brown, in my opinion, lets his reader know

LEONARD MARCUS
Editor

NORMAN EISENBERG
Executive Editor

PETER G. DAVIS
Music Editor

ROBERT LONG
Audio-Video Editor

SHIRLEY FLEMING
Editor, Musical America Section

EDITH CARTER
Associate Editor

SHEILA SCHULTZ
Assistant Editor

ROY LINDSTROM
Art Director

ROBERT MADDOCKS
Associate Art Director

RUTH W. DUNTON
Production Editor

JUDITH WEST
Assistant Production Editor

MORGAN AMES
R. D. DARRELL
ALFRED FRANKENSTEIN
HARRIS GOLDSMITH
DAVID HAMILTON
MIKE JAHN
PAUL HENRY LANG
GENE LEES
ROBERT C. MARSH
GEORGE MOVSHON
H. C. ROBBINS LANDON
Contributing Editors

STANLEY BINDER
Circulation Manager

CLAIRE N. EDDINGS
Associate Publisher and
Director of Advertising Sales

WARREN B. SYER
Publisher

Cover photograph by Roy Lindstrom

ADVERTISING

Main Office: Claire N. Eddings, The Publishing House, Great Barrington, Mass. 01230. Telephone: 413-528-1300.

New York: 165 W. 46th St., New York, N.Y. 10036. Telephone: 212-757-2800. Seymour Resnick, Eastern Adv. Mgr.

New England: The Publishing House, Great Barrington, Mass. 01230. Telephone: 413-528-1300. Russell Gilchrist.

Chicago: Billboard Publications, Inc., 150 North Wacker Dr., Chicago, Ill. 60606. Telephone: 312-236-9818. Leonard Levine.

Los Angeles: Billboard Publications, Inc., 9000 Sunset Blvd., Los Angeles, Calif. 90069. Telephone: 213-273-7040. Andrew Spanberger.

Nashville: Billboard Publications, Inc., 1719 West End Ave., Nashville, Tenn. 37203. Telephone: 615-329-3925. Robert Kendall.

London: 7 Carnaby St., London W.1, England. Telephone: (01) 437-8090. Andre de Vekey.

Frankfurt/Main: Eschersheimer Landstrasse 69, Frankfurt/Main, West Germany. Telephone (0611) 590805-6. Walter B. Rios.

Milan: Piazzale Loreto 9, Milan 20131, Italy. Telephone: 28.29.158. Germano Rusclito.

Tokyo: Japan Trade Service, Ltd., Ikejiri 3-1-1-1008, Setagaya-ku, Tokyo, Japan. Telephone: 413-2871. Kanji Suzuki.

We enjoy telling you how each aspect of the 12 year basic research program on sound reproduction contributed to the unconventional features found in the Bose 901 and 501 DIRECT/REFLECTING® loudspeakers.* We also take pride in quoting from the unprecedented series of rave reviews because to us they are like awards won for the best design. †

However, it is important to realize that the research and the reviews are of only academic interest unless the speakers really are audibly superior. It is equally important to realize that YOU are in every sense the ultimate judge, for you are the one who lives with the sound you choose.

So—forget the rave reviews and the research and sit in judgement of two fascinating experiments. Take your most exacting records to any franchised BOSE dealer and:

1. Place the BOSE 901's directly on top of any other speakers, regardless of their size or price, and

make an A-B listening test with your records.

2. Place the BOSE 501's beside (with at least 2 feet clearance) any other speaker using woofers, tweeters and crossovers and perform the A-B listening test. (Don't ask the price of the 501 before the test!)

Then, just enjoy your records. When you finish you will know why we get much more satisfaction from our work than could ever be derived from profits alone.

P.S. If you already own expensive speakers, many dealers will lend you a pair of BOSE 901's for an A-B in your living room, where the acoustics are generally far superior to those of the speaker-lined showroom.

* Copies of the Audio Engineering Society paper, 'ON THE DESIGN, MEASUREMENT AND EVALUATION OF LOUDSPEAKERS', by Dr. A. G. Bose, are available from the Bose Corp. for fifty cents.

† For copies of the reviews, circle our number on your reader service card.

You can hear the difference now. **BOSE**®

Unless they're audibly superior it's all academic.

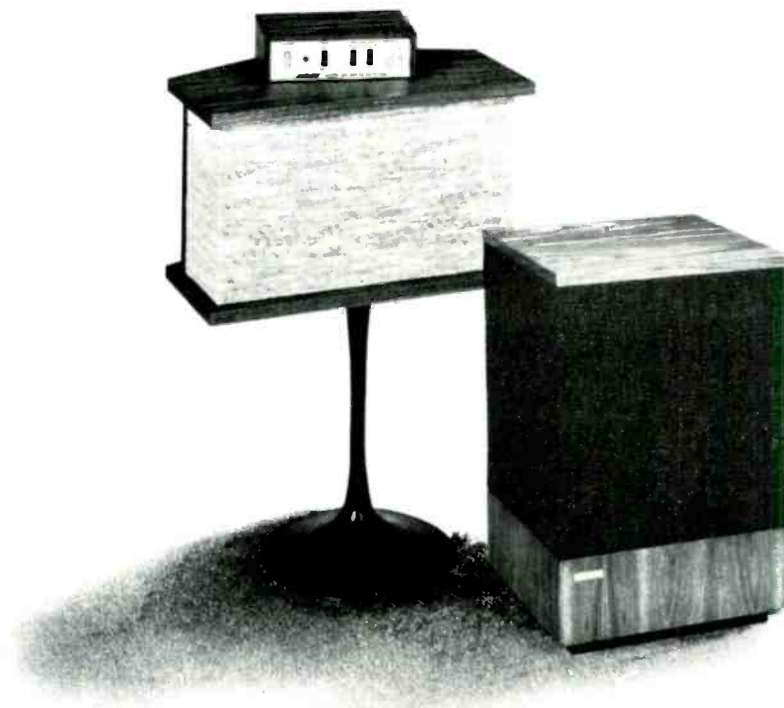

The BOSE 901 and BOSE 501 are covered by patent rights, issued and pending.

NOW—YOURS FROM COLUMBIA—AT TRULY Any 8 stereo



209239

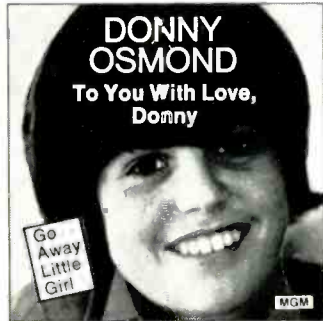

210211



210229

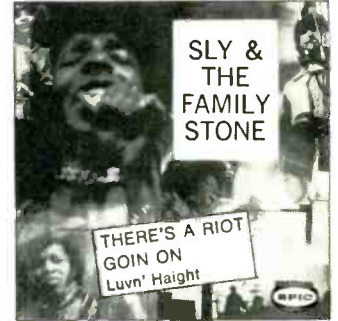

210237



209114



209668



210260



210609



207522



203919



207571



207662



208363



206573



195727



203372



209981



209932



198986



206755



210780



207563



210203

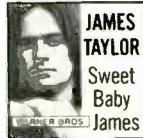

188367



209973



196246



206995



209544 *



207993



196444



207373



203539



209536



207084 *



208868



207977 *



207456 *



202713



204743



206409



210195



186809



205450 *



206771



207381



209163 *

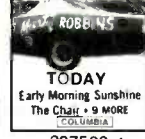

207589 *

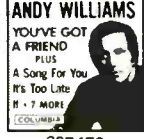

207472



209791 *



210179



208397 *



201251 *



209957 *



199158



208306 *



202135



209445



203885

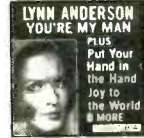

206631 *



202523



172411



181909



210112



210252



196725



210161



210161

* Selections marked with a star are not available in reel tapes

GREAT SAVINGS...

tapes for only \$2.86 plus processing and postage

if you join now and agree to buy seven selections (at regular Club prices) during the coming year

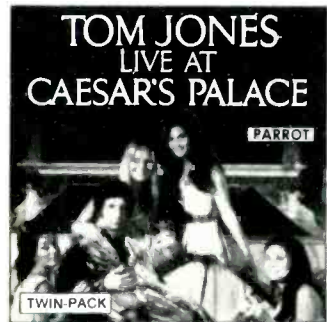

210138



209726

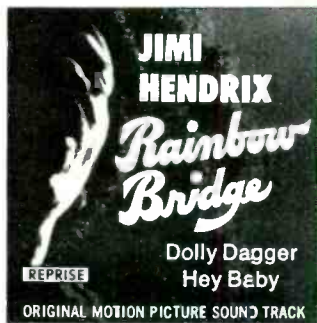

210153

Take your pick

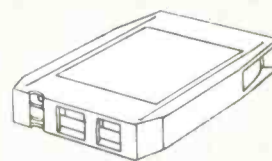

8-track cartridges

OR



tape cassettes

OR



7" reel-to-reel tapes

Yes, it's true! — if you join right now, you may have ANY 8 of these stereo tapes for only \$2.86. Just mail the postpaid application (be sure to indicate whether you want cartridges, cassettes or reel-to-reel tapes). In exchange . . .

You agree to buy just seven tapes (at regular Club prices) in the coming year — and you may cancel membership any time after doing so.

Your own charge account will be opened upon enrollment . . . and the selections you order as a member will be mailed and billed at the regular Club prices: cartridges and cassettes, \$6.98; reel tapes, \$7.98 . . . plus a processing and postage charge. (Occasional special selections may be somewhat higher.)

You may accept or reject tapes as follows: every four weeks you will receive a new copy of the Club's music magazine, which describes the regular selection for each musical interest . . . plus hundreds of alternate selections from every field of music.

. . . if you do not want any tape in any month, just return the selection card always provided by the date specified

. . . if you want only the regular selection for your musical interest, you need do nothing — it will be shipped to you automatically

. . . if you want any of the other tapes offered, just order them on the selection card and return it by the date specified

. . . and from time to time we will offer some special selections, which you may reject by returning the special dated form provided . . . or accept by simply doing nothing.

You'll be eligible for our bonus plan upon completing your enrollment agreement — a plan which enables you to save at least 33% on all your future purchases! This is the most convenient way possible to build a stereo tape collection at the greatest savings possible!

Cut along dotted line — seal (paste or tape) and mail as Business Reply Envelope. No stamp needed.

Please accept my membership application in the Club. I am interested in this type of tape: (check one only)

Send these 8 selections for only \$2.86

Be sure to check one box only

- 8-Track Cartridges (PG-W)
- Tape Cassettes (PH-X)
- Reel-to-Reel Tapes (ME-Y)

CJ1

Send me the eight selections indicated at the right, for which I will be billed only \$2.86, plus processing and postage. I agree to buy seven selections (at regular Club prices) during the coming year, and may cancel membership any time thereafter. If I continue, I will be eligible for your bonus plan. All selections will be described in advance in the Club magazine, sent every four weeks. If I do not want any selection, I'll return the selection card by the date specified — or use it to order any selection I do want. If I want only the regular selection, I need do nothing — it will be sent automatically. From time to time, I'll be offered special selections which I may accept or reject by using the dated form.

MY MAIN MUSICAL INTEREST IS (check one box only)

- Easy Listening
- Young Sounds
- Country

- Mr.
- Mrs.
- Miss.

(Please Print) First Name Initial Last Name

Address

City State Zip

Do you have a telephone? (check one) YES NO

APO, FPO addressees: write for special offer

FOLD IN HALF ON THIS LINE, SEAL AND MAIL

FIRST CLASS
Permit No. 1050
Terre Haute, Ind.

BUSINESS REPLY MAIL

No Postage Stamp Necessary If Mailed in the United States

Postage will be paid by

COLUMBIA TAPE CLUB
1 Music Lane
Terre Haute, Indiana
47808



Columbia Tape Club
a service of
Columbia House
Terre Haute, Indiana 47808

A130/S72

practically nothing about these two excellent and important recordings: he could learn a lot about writing himself from someone like Faubion Bowers.

Whitney Phoenix
Oberlin, Ohio

Mr. Brown replies: Faubion Bowers is not simply "stating facts" in his notes, since he specifically says, unless the copy on my record jacket is different from that on Mr. Phoenix's, that "our present decade has seen a resurrection that is not exactly incommensurate with the odd fact that Scriabin was born on Christmas and died on Easter." That sentence is charged with loaded words: "resurrection," "odd fact," "incommensurate" ("not exactly incommen-

surate," mind you!), etc. Mr. Phoenix is quite correct: My attack on Bowers does stem from a personal prejudice—against the kind of flowery biographical style in which the author drowns his "hero" in a sea of ornate stylistic ramblings that try to capture the "essence" of a composer's art while actually saying nothing meaningful at all. Bowers seems to be more of a hagiographer than a biographer, much less a musicologist. Compare Bowers' notes with those by Arthur Cohn for Hilde Somer's recording of the Seventh and Ninth Sonatas and tell me who has the most cogent comments to make about Scriabin and his music.

As for Mr. Phoenix's complaint of my "see-saw" criticisms, I will fully admit that my re-

view was a see-saw, and that precisely reflects my reaction. Although I was quite annoyed by what I considered flaws on both recordings, I found many assets in each pianist's approach. Mr. Phoenix has a talent for interpreting a writer according to his own lights: Whereas he praises Bowers for simply stating facts, he takes me to task for saying that Szidon is "rhythmically out of order"—when I merely stated that I found Szidon's playing to be overly headstrong in places; this does not in the least prevent the pianist from communicating, in an intangible way that depends on a lot more than projecting rhythmic detail, the formal intricacies of Scriabin's music. The same holds true for my comments on Laredo's playing: The fact that she does not reveal the thematic structure as well as Szidon in no way hampers her perfect understanding and performance of Scriabin's rhythmic patterns and harmonic configurations. Needless to say, rhythmic movement does indeed bind the work together very well in Laredo's performances; but her readings lack the additional, and essential, unity that Szidon is able to create within the thematic structure. I am sorry if Mr. Phoenix feels that music criticism must be either black and white—or, as with Bowers, rainbow oriented; to me, there are occasions when gray is not only permissible, but unavoidably appropriate.

Bernard Herrmann and His Reviewer

Hats off for the intelligence you showed in using a "classical" ("modern," actually) reviewer for the recent Bernard Herrmann disc ["Music from Great Film Classics," November 1971]. I don't wish to put down your pop staff, but merely to show my gratitude that the classical listener, seeing their friend R.S.B.'s byline in the "Lighter Side" section, will read it and perhaps be curious enough to buy the Herrmann disc.

Royal S. Brown has impressed me more and more since he joined HIGH FIDELITY a few years ago. Here, at last, is a writer on contemporary serious music who judges according to how original and inventive a work is and *not* according to how up-to-the-minute it sounds. Here is a critic intelligent enough to see that a Shostakovich, conservative as his vocabulary may be, reflects his time (and transcends it) as vividly as a Stravinsky. In short, here is a reviewer who knows what every critic should know (but rarely does): It's not how old the composer's techniques are that matters, but how he makes these techniques his own. Any Poulenc lover will tell you that.

Music is "dated" only when no one wants to hear it again. Which is by way of saying that I'm not the only listener who derives pleasure from repeated hearings of minor masters like Herrmann. Not only do I have Mr. Brown on my side, but quite a few friends of both "pop" and "classical" persuasion.

I disagree with Mr. Brown on only one point. He disliked the earlier Phase 4 disc of Herrmann's film music because of its "claustrophobic sound quality." Actually, I find the dryer acoustic quite appropriate for the tauter Hitchcock scores, while the greater resonance of the newer release is perfect for the more lushly scored *Jane Eyre* and *Kilimanjaro* music.

More Herrmann would be welcome. How about the music from *The Ghost and Mrs. Muir*, *Hangover Square*, *Fahrenheit 451*, *The Man Who Knew Too Much*, and *The Bride*



Dust and dirt can sound like boulders through your Hi-Fi.

If you've been hearing thuds and thumps when you play your records, in most cases it's not your equipment that's at fault, but the polluted condition of your records.

Today's precision turntables with their ultra sensitive cartridges and stylus require impeccably clean records. Otherwise when they travel through the micro-grooves and encounter microscopic dust, dirt, and grit, the sound they magnify seems as though you're going through a falling rock zone.

Uncover the original brilliant sound of your records with Watts Record Care

equipment. Ideal for transcription and automatic turntables, it's the only positive way to revitalize old records and keep new records new. The Watts Record Care Kit contains everything you need to: remove deep down dirt and static charge, apply the proper humidity, keep your stylus clean. And we even include Watts' classic book on record care. Only \$19.95 See your hi-fi dealer for the Watts Record Care Kit, and you'll never hear things that go bump in the night.

Elpa Marketing Industries, Inc.,
New Hyde Park, New York 11040



**Record
Care Kit**

CIRCLE 29 ON READER-SERVICE CARD

The end of the fidelity gap between cassette and open reel.

Our RS-275US brings the low-noise, wide-response performance of open reel to a cassette deck. Frequency response: 30-15,000 Hz. Signal-to-noise ratio: better than 45 dB. Those are numbers you've probably never seen before in cassette.

The biggest reason for our lower noise and wider response is also the smallest. Panasonic patented a Hot Pressed Ferrite head with one of the world's narrowest, most precise gaps. You get a 25% broader frequency response with ten times the life of conventional heads.

A separate fast-forward and rewind motor means we don't

have to spin wheels with our drive motor. The motor that drives the tape drives it directly. No belts to give you the slip. No gears to start fluttering and wowing. The speed is constant. So is the lack of noise. Our patented drive motor is DC and brushless. No AC hum. No brushes to spark up static.

We're quiet in other ways, too. There's a special noise suppression circuit with its own switch. And a tape equalization switch for the newest low-noise super tapes.

Nobody else has all these low-noise, wide-response features in one great cassette deck.

And that's just for starters.

You'll find solenoid push-button operation for electrical, not mechanical switching. A "memory rewind" button that pre-sets the tape to stop right where you want it to. Two big VU meters. Separate output volume level controls before the signal goes into your amplifier. Optional remote control. And a walnut base as part of the deal.

When you're ready to get serious about a stereo cassette deck, see your franchised Panasonic Hi-Fi dealer for the RS-275US. The one that gives you reel sound.



Panasonic®
just slightly ahead of our time.

200 Park Ave., N. Y. 10017. For your nearest franchised Panasonic Hi-Fi dealer, call 800 633-1971. In N. J., 800 962-2803. We pay for the call.

Wore Black. It would be even more fascinating to hear one of Mr. Herrmann's symphonies.

Stephen C. Hillyer
Chicago, Ill.

Missing Bars

Query for Robert C. Marsh. In their complete edition of the Mahler symphonies, has DGG seen fit to replace the few bars they (inadvertently, it would seem) omitted from the opening of the *Burleske* movement of Mahler's Ninth Symphony when it was released separately?

Paul Turok
New York, N.Y.

Mr. Marsh replies: *When I first heard the Kubelik set of the Ninth, I wondered if this change of text was one of the corrections promised us in the society edition of the score (reputed to fix hundreds of old errors), but apparently it was simply a slip in editing and the version on hand from the complete edition appears to reinstate the passage in accord with the new text. If that sounds vague, it's because I am still obliged to use the Universal Edition score. I lack the new material at the moment.*

Aida and the Canal

In the December 1971 issue Dr. E. W. Biles comments on George Movshon's review of RCA's new *Aida* recording. He states that

The Oxford Dictionary of Opera and *Victor Book of the Opera* fail to give the name of the opening opera for the Cairo Opera House in 1869.

If he will consult *Famous Verdi Operas* by Spike Hughes, he will learn that *Rigoletto* was given the honor. On page 377 of the above-mentioned book, Mr. Hughes says: "The story that *Aida* was performed either at the Suez Canal opening, or the opening of the new Cairo Opera House, or both, is still oddly prevalent. The fifth and latest edition of *Grove's Dictionary* (volume II, page 895) states that Cairo's opera house 'opened with Verdi's *Aida* (1871), specially composed for it.' The passage in *Grove's* is corrected in the supplementary volume where on page 120 it says that 'Verdi's *Aida* was commissioned for its inauguration (1871), but the house was actually opened with Meyerbeer's *Huguenots*.' This is still not right: for although *Aida* was commissioned for the new theater and was produced there in 1871 it was never intended for its inauguration. The Cairo Opera House opened on 1 November, 1869 with *Rigoletto*; the first performance there of *Les Huguenots* was some time in 1870; and the Suez Canal was opened on 16 November, 1869."

William S. and Irma L. Hillman
San Diego, Calif.

Klose in America

In his review of the Preiser *Lohengrin* recording [December 1971], Conrad L. Osborne refers to mezzo Margarete Klose as a strictly European artist, known only to record collectors here. Actually she sang Brangäne (*Tristan und Isolde*) and Fricka (*Die Walküre*) in both San Francisco and Los Angeles in 1953.

Stephen Eriksen
Los Angeles, Calif.

The Versions of Tannhäuser

Though I share Peter G. Davis' enthusiasm for the Solti *Tannhäuser* [December 1971], especially in the long-awaited "Paris" version, I feel a few words should be added to his explanation of the version (or versions) used in the new recording.

As the late Herbert Weinstock pointed out in his notes to the London album, the Paris version as we know it is actually the Vienna version of 1872, in which Wagner connected the Overture with the Venusberg Ballet and touched up several other spots in the score. The Vienna version is used in Solti's performance except for the sizable chunk of the Act II finale beginning with Tannhäuser's "*Zum Heil den Sündigen zu führen*" (page 251 of the B & H piano score of the revised version). Here the conductor chooses the Dresden version of the ensemble, in which the tenor solo is fully supported by soloists and chorus. It is interesting to note that whatever version the Metropolitan Opera elected to do in the past forty years, this passage was always performed in the (for once) simpler Paris edition without chorus.

However, all the published editions of Act III that I have seen are always Parisian. Toscanini once performed the Dresden Act III Prelude with the NBC Orchestra (a longer and more dramatic version), but this music has not found its way into contemporary scores, nor, for that matter, has the original



Model 1710 Electret Condenser Omnidirectional Microphone

All of the great condenser advantages are here without compromise. Flat, extended range, excellent transient response, high output, low noise, and ultra-clean sound. But the new E-V electret condenser microphones need no high voltage power supply. Just an AA penlite battery to operate the built-in FET impedance converter. The result is studio performance without complications and at a dramatically lower price.

There are 4 new E-V electret microphones, including cardioid models, from \$39.75 to just \$75.00, audiophile net. Second-generation designs with unusually high resistance to heat and humidity. Hear them today at your nearby Electro-Voice soundroom. Or write for details.

More U. S. recording studios use Electro-Voice microphones than any other brand.

*Suggested retail price. Microphones shown on Model 421 Desk Stand, \$12.00 each.

ELECTRO-VOICE, INC., Dept. 322H,
619 Cecil Street, Buchanan, Michigan 49107
In Europe: Electro-Voice, S.A., Lyss-Strasse 55,
2560 Nidau, Switzerland

Electro-Voice
a GULTON subsidiary

CIRCLE 28 ON READER-SERVICE CARD



dynaco 4-d amp kit

Value—the SCA-80Q is the only 4-D amplifier in kit form and for the same cost as a similar two channel amplifier. From a built-in de-matrix circuit at the output of the amplifier, connect four speakers (such as the very popular DYNACO A-25s). Uncover hidden concert hall ambience in many conventional two channel discs, tapes and FM broadcasts and recreate the original sonics with new 4-D recordings. Or use two speakers now for stereo and add others later. 40 watts RMS per channel, simple assembly, careful engineering, low distortion and superb versatility go together to give traditional DYNACO excellence.

A special 4-D DYNACO/Vanguard LP is available now. See your DYNACO dealer or send \$2.95 to us.

\$169.95 kit; \$249.95 assembled

DYNACO INC. 3060 Jefferson Street, Philadelphia, Pa. 19121

of the rest of the act. Wagner's additions—for instance the bass clarinet solo in Elisabeth's Prayer and the revised stage-band music (to say nothing of the choral finale, which more than one astute Wagner scholar insists was completely rewritten)—exist both in the published Dresden and Paris versions of Act III. The strange metamorphosis of the *Tannhäuser* scores over the years would indeed be a fascinating study. Only *Messiah* sports comparable *Urtext* problems.

William Zakariasen
San Francisco, Calif.

Gilels Vendetta

I can contain myself no longer! For years

I have put up with Harris Goldsmith's sneers at that great pianist Emil Gilels. I have taken it as a matter of course that since Mr. Goldsmith is your pianistic pundit Gilels' solo records will never receive a fair review in your magazine.

Now Mr. Goldsmith has even got his hands on a Gilels chamber music recording. His remarks on the Gilels/Amadeus rendering of Brahms's G minor Piano Quartet [October 1971] take his absurd vendetta against Gilels one step further. I read that Gilels' phrasing is "sober, slightly archaic . . ." as well as "stiff and careful. . . ." Apparently he exhibits a "hard, flinty sonority. . . ." Apart from being poppycock, all the foregoing is an insult to those who revere Gilels. Am I to understand

that since I can find no fault in Gilels' playing, I am an ignoramus who needs to be corrected by Mr. Goldsmith?

Mr. Goldsmith is entitled to his views, but when he puts them in a critique he should surely remember that as a journalist he is writing for *all* his readers—not just for those who agree with him. He should surely judge a performance by the standards of what the artist was trying to do—he should not expect an artist to change his performing style just to suit one critic! The readers who generally like Gilels' approach should be told whether, taking that approach into consideration, Gilels has given a good performance.

I can usually see what Mr. Goldsmith is getting at when he praises the musical extravagances of such pianists as Hofmann and Rachmaninoff. To me, there are good points to every great pianist, though my own taste veers towards Gilels, Serkin, Lipatti, Edwin Fischer, and Clara Haskil. I cannot for the life of me think where Mr. Goldsmith gets some of his ideas about Gilels. Hard, flinty sonority? Mr. Goldsmith must be thinking of the sound he himself makes when his embittered fingers bite into the keys of his typewriter en route to another anti-Gilels diatribe.

Tully Potter
Basildon, Essex,
England

Szigeti Tribute

Ronald C. MacDonald ["Letters," November 1971] has voiced the sentiments of many Joseph Szigeti admirers. Szigeti's impeccable intonation was beyond comparison—not merely pyrotechnics and the hitting of notes, but an insight and intensity of interpretation that probed the depths of the composers' thoughts. To have heard him in the 1920s and early 1930s when he was in his prime was an unforgettable experience.

I have felt for some time that it is a tragedy that the record companies have not reissued the Brahms concerto with Hamilton Hartly conducting the Hallé Orchestra, the Mendelssohn concerto with Sir Thomas Beecham and the Royal Philharmonic, as well as the Bach unaccompanied sonatas and partitas.

Oscar I. Posner
Brooklyn, N.Y.

High Fidelity, March 1972, Vol. 22, No. 3, Published monthly by Billboard Publications, Inc., publisher of Stereo, Stereo International, Modern Photography, American Artist, Billboard, Vend, Amusement Business, Merchandising Week, Music Labo, Photo Weekly, Gift & Tableware Reporter, Record & Tape Retailer, Record Mirror, Discografia Internazionale, World Radio TV Handbook.

High Fidelity/Musical America, Edition published monthly, Member Audit Bureau of Circulations.

Editorial correspondence should be addressed to The Editor, High Fidelity, Great Barrington, Mass. 01230. Editorial contributions will be welcomed. Payment for articles accepted will be arranged prior to publication. Unsolicited manuscripts should be accompanied by return postage.

Subscriptions should be addressed to High Fidelity, 2160 Patterson St., Cincinnati, Ohio 45214. Subscription rates: High Fidelity/Musical America: In the U.S.A. and its Possessions, 1 year \$14; elsewhere, 1 year \$15. National and other editions published monthly: In the U.S.A. and its Possessions, 1 year \$7.95. Subscription rates for all other countries available on request.

Change of address notices and undelivered copies (Form 3579) should be addressed to High Fidelity, Subscription Fulfillment Dept., P.O. Box 14156, Cincinnati, Ohio 45214.



You have 4 channels in your present stereo. Utah's STUDIO 4 and two more speaker systems will reveal the other 2 channels



Size: 3 $\frac{7}{8}$ " high, 9 $\frac{7}{8}$ " wide, 4 $\frac{5}{8}$ " deep

There are 4 channels in your present Stereo System. Studio 4 and two more speakers will reveal them. Use your present amplifier. Use your regular stereo records or tapes. Use your present FM stereo broadcasts. For the first time your room will come completely, fully alive. Impossible? STUDIO 4 has a switch for both 2 channel and 4 channel sound. Switch easily from your present 2 channel great sound, to 4 channels. Your great sound becomes twice as good.

NET \$39.95

For complete information write:

UTAH ELECTRONICS

1124 East Franklin Street
Huntington, Indiana 46750



CIRCLE 73 ON READER-SERVICE CARD

We doubt that anyone will be overly surprised to learn that our newest loudspeaker sounds terrific. Most people really expect KLH to make terrific sounding things. But at \$62.50[†] a piece, our new Model Thirty-Eight delivers an amount and quality of sound that we think will astonish even our most avid fans. The bass response is absolutely staggering; the transient response is flawless; and the Thirty-Eight's overall smoothness matches anything we've ever heard. Most important, you can use a pair of Thirty-Eights with virtually any mod-

estly priced receiver. (What good is an inexpensive pair of loudspeakers that need a \$400 receiver to effectively drive them?)

The Thirty-Eights are at your KLH dealer now. After hearing them, we think you'd pay \$125 for just one. But \$125 buys you two. Which has got to make the Thirty-Eights the biggest stereo bargain since ears.

For more information, visit your KLH dealer or write to KLH Research and Development, 30 Cross Street, Cambridge, Mass. 02139.

The New KLH Model Thirty-Eight. Two for \$125.[†]

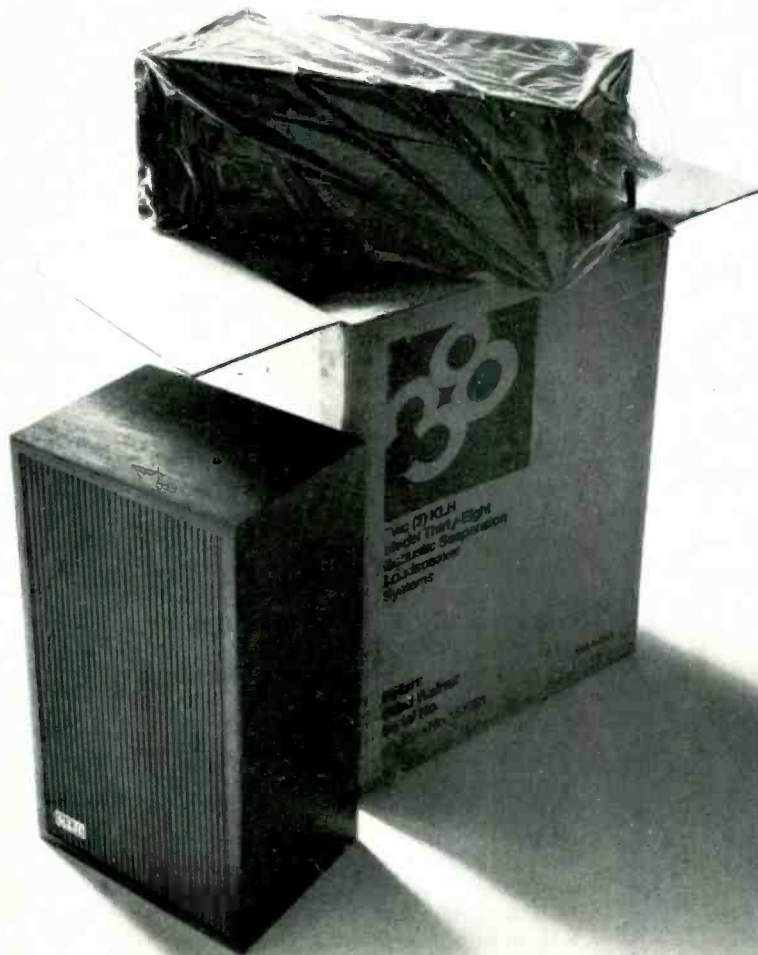

KLH RESEARCH AND DEVELOPMENT
A Division of the Singer Company

[†]Suggested east coast retail price. Slightly higher in the south and west. *A trademark of The Singer Company.



A "New" Tchaikovsky Piano Concerto

by Michael Ponti

speaking of records

A BIT MORE than three years ago, when I signed a contract to record for Vox records, one of the projects I agreed to undertake was the recording of Tchaikovsky's complete piano music. I thought I knew what Tchaikovsky had written for piano and orchestra: three concertos—the Third a one-movement piece—and the Concert Fantasy, Op. 56. But I didn't know all of the solo piano music and wanted to be sure that I didn't overlook anything. I began a little research on my own. I was shocked at how much music for solo piano I found in musical encyclopedias that I hadn't known of before. I was also surprised to find, while casually making lists of solo works, a reference to Tchaikovsky's Andante and Finale, Op. 79. Although I had never played the one-movement concerto, Op. 75, the closeness of the opus numbers made me wonder, especially since the later Andante and Finale *could* serve as the two final movements to the Third Concerto. It also seemed strange to me that Tchaikovsky would write two three-movement concertos and then, for no apparent reason, turn out a one-movement concerto. The single-movement concerto is not that much of a rarity now (Scriabin, Rimsky-Korsakov, Bartók's First), but there were few pieces in Tchaikovsky's time that he might have had in mind as precedents. I wondered about this for a while, but I couldn't find a score anywhere and gradually I gave up the pursuit—at least temporarily.

Then about a year later I was in Munich playing the Scriabin Concerto with Kiril Kondrashin when he mentioned, over lunch, that he thought the Tchaikovsky Third Concerto, in its three-movement form, was even better than the Second. I remember getting quite excited and asking him if he would send me a score from the Soviet Union. He said he would—but I never received it.

After a time, not having heard from Kondrashin, I mentioned the work to a young editor and writer in New York, Donald Garvelman. Garvelman is a wonder at finding forgotten Romantic works. We had already established contact by mail with regard to other Romantic projects I had either already undertaken or had planned to undertake. He had helped me find many of Scriabin's early and unpublished pieces as well as works by Henselt, Thalberg, and Moscheles. Somehow he found a score of Op.

79 and sent it to me, and finally I had a chance to look at the Andante and Finale firsthand. As soon as I had studied the work, my earlier suspicions about its relationship to Op. 75 were confirmed; I now was convinced that the two additional movements were intended to complete the Third Concerto.

I wouldn't necessarily agree with Kondrashin that the Third Concerto is better than the Second, but it is certainly a more effective audience piece. In Seoul, Korea I recently performed both works at the same concert and while the Second was well received the audience tore the place apart at the end of the Third.

As to the relationship of the Third Concerto to the so-called "Seventh Symphony," it seems as though Tchaikovsky couldn't decide for a time whether he wanted to compose another symphony or finish another concerto. What he finally did decide, I believe, was that he didn't want to do a seventh symphony. Then he probably couldn't decide whether to leave the Third Concerto as a one-movement piece or to complete it with the two additional movements he had already drafted.

Apparently, he wasn't quite satisfied with the second and third movements and allowed the work to be performed only as a one-movement piece. But as far as I am concerned, this work, which Tchaikovsky himself was not completely satisfied with, is still more important than many of the completed works of lesser composers.

The Seventh Symphony is really the same work, except of course for the omission of the piano. However, it also contains an added scherzo movement which is a transcription of the Scherzo Fantasy, Op. 72, No. 10. (I happen to think the Scherzo Fantasy is much better in its original solo piano version anyway.)

Our performance in Seoul (with the Seoul Philharmonic Orchestra under David Epstein) must be one of the first that the piece has had: it was my first, at least, and I would be interested to know if someone has heard of other specific performances. The only other time I played the work was for the recording sessions with the Luxembourg Radio Orchestra under Louis de Froment. There, without an audience, at least the orchestra loved it. [To find out how our reviewer H.G. liked it, see page 76.—Ed.]

When it comes to fine stereo systems... a Marantz is a Marantz is a Marantz.

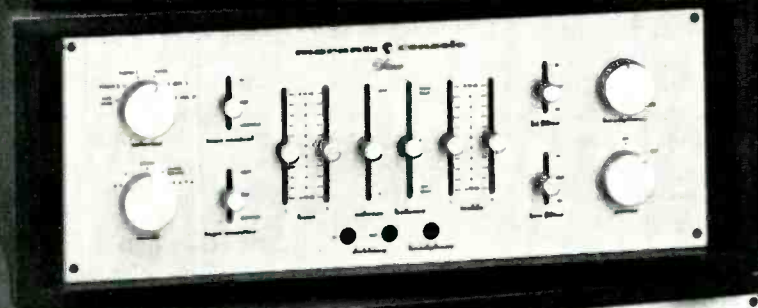

That means that Marantz not only makes the finest most expensive stereo equipment in the world but also the finest least expensive stereo equipment in the world. Our \$1319 Marantz stereo component system for example includes the Marantz Model 120 stereophonic tuner featuring the exclusive Gyro-Touch tuning and built-in oscilloscope for \$429; the Model 3300 preamplifier/control center that offers you full control facilities at \$395; plus the Marantz Model 250, a 250 watt RMS power amplifier priced at \$495. Put them all together they spell Marantz — a total of \$1319 worth of the best stereo equipment available for the connoisseur.

\$1319

For the budget-minded music lover, Marantz also makes the finest, least expensive stereo equipment in the world. Marantz offers a component system that includes the Marantz-Model 110 FM/AM stereophonic tuner featuring Gyro-Touch tuning for only \$179.95, and beautifully complemented by the Marantz Model 1030 stereo preamp-amplifier with 15 watts RMS per channel priced at only \$149.95. A great system for the budding stereo enthusiast and the best buy for the money in the audio world.

\$329.90



Same name, same quality — regardless of price. That's Marantz' superior quality, inherent in the full line of components. And to complete your system choose a Marantz Imperial speaker system. **marantz**

We sound better.

This is not a speaker.

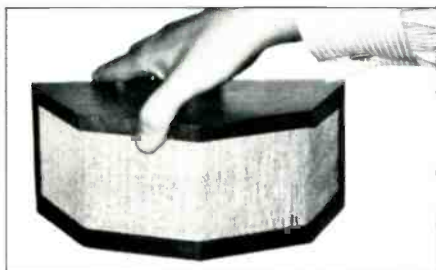

It's the missing part of your speaker.

What's missing from your speaker, no matter how much you paid for it, is a high-frequency response that remains genuinely flat off axis. (The 15-kHz output of a top-rated \$250 speaker, for example, is down 12 dB at 60° off center.)

The new Microstatic high-frequency speaker system is designed to give you this missing response when you connect it to any medium or low-efficiency speaker of any size or design. And we mean ± 2 dB from 3.5 kHz to 18 kHz over a 180° angle!

Microstatic won't change the sound quality of a top-rated speaker on axis, but it will make a dramatic improvement in the stereo image and overall transparency from any listening position in the room.

Don't just take our word for it. Read the Hirsch-Houck report in *Stereo Review*. Or Ivan Berger in *Saturday Review*. Or E.T. Canby in *Audio*.

For copies of these rave reviews plus detailed literature, write us directly. Microstatic is priced at \$117 a pair (slightly higher in the West).

MICROSTATIC™*
a product of
MICRO/ACOUSTICS® CORP.
8 Westchester Plaza
Elmsford, N.Y. 10523

* Patent Pending

CIRCLE 75 ON READER-SERVICE CARD



those were the days

A nostalgic romp through the pages of High Fidelity and Musical America

60 YEARS AGO

The Boston Opera's performance of *Il Trovatore* on March 18 was delayed for fifty minutes because of the "methodical and relentless descent of the asbestos fire curtain in the middle of an act. . . . Few will forget that slow descent, while the singers tried their best to keep on singing. . . . The cause of all this was the leaking in a valve in the high pressure water pipe under the stage. This pipe is so connected with the fire curtain that if owing to any sudden flame the pipe commences to give its water the curtain will at the same moment automatically descend. The curtain obeyed. The leak was not large enough to make it descend quickly. . . it took between five and ten minutes to arrive at the bottom. Laughter commenced to sweep over the house and there was a roar as the curtain landed."

At a recent New York performance of *Madama Butterfly*, pianist Wilhelm Backhaus was asked how he enjoyed the work of the popular Italian composer. "I like it very much," said the great Beethovenian virtuoso, "but I admire his *Fanciulla del West* much more." When asked whether he took Puccini seriously, the pianist seemed surprised and answered that of course he took Puccini seriously!

40 YEARS AGO

On March 16 the Philharmonic Symphony presented the world premiere of Respighi's "concert tryptic" *Maria Egiziaca*, conducted by the composer and starring Nelson Eddy in two roles with Charlotte Boerner as Maria. Respighi has written "page upon page that are musical dramatic writing of a high order . . . far more so than in those of his stage works with which we are acquainted."

On March 2 the Metropolitan Opera staged a "Grand Operatic Surprise Party," enlisting the services of virtually the entire company. The "party" was given for the benefit of the Musicians Emergency Aid and reportedly raised \$28,000. The first part of the program consisted of a number of ensembles taken from works in the current repertoire. The second part of the program (the "surprise party") opened with an "International Overture," which included "familiar strains of at least four

operas and *The Star-Spangled Banner*, conducted simultaneously by eight maestros." In scene two, the Gallic contingent of the roster presented "A Bootlegging of French Champagne" during which a box purportedly containing bottles of champagne opened and out came Lily Pons singing the "Bell Song." Next, a brass band, led by Kapellmeister Michael Bohnen flourishing a red umbrella, marched down the aisle followed by a dancing bull—later disclosed to be Lohengrin's swan—and led by Lauritz Melchior dressed in Alpine togs and asserting that he was Tannhäuser! And finally, Beniamino Gigli, dressed as Carmen, sang the *Habanera*, amid much glee.

20 YEARS AGO

The Voice of America has recorded the first complete performance of Schoenberg's *Gurrelieder* to be given in the western hemisphere. In this gala event, Belgian soprano Suzanne Danco made her first appearance with an American orchestra. The presentation, led by Thor Johnson, was "a musically magnificent and a historically important event for Cincinnati"—where it was brilliantly played by the Cincinnati Symphony augmented by students from the Cincinnati Conservatory and College of Music.

With the reissuing of the historic Felix Weingartner recordings of the nine Beethoven symphonies, originally produced in connection with the Beethoven anniversary year in 1927, Columbia Records is celebrating the rounding out of a quarter-century in the record industry. After twenty-five years, the record industry "has attained full maturity." Today, it is perhaps "healthier than it has ever been before. In addition to such large corporations as Columbia and RCA Victor, half a hundred smaller companies are issuing a flood of recordings covering almost every phase of both familiar and unfamiliar music. Contemporary music is finally obtaining a hearing on records." Twenty-five years ago, the epoch-making experiment of placing all the Beethoven symphonies on the market (soon followed by the four Brahms symphonies, also conducted by Weingartner) coincided with the development of electrical recording, which provided for the first time "a means of capturing relatively undistorted orchestral tone."

New Heathkit AR-1500 stereo receiver... the critics say it all:

"...the most powerful and sensitive receiver we have ever measured..." — JULIAN HIRSCH — *Stereo Review*

"...a stereo receiver easily worth twice the cost (or perhaps even more)..." — *Audio Magazine*

"Great new solid-state stereo receiver kit matches the demands of the most golden of golden ears..."
— *Radio Electronics*

Mr. Hirsch goes on to say: "The FM tuner section of the AR-1500 was outstandingly sensitive. We measured the IHF sensitivity at 1.4 microvolts, and the limiting curve was the steepest we have ever measured... The FM frequency response was literally perfectly flat from 30 to 15,000 Hz... Image rejection was over 100 dB (our measurement limit)..."



The Heathkit AR-1500 AM/FM/FM-Stereo Receiver... 349.95* (Kit, less Cabinet)

"The AM tuner was a pleasant surprise... It sounded very much like the FM tuner, with distinct sibilants and a quiet background, and was easily the best-sounding AM tuner we have had the pleasure of using..."

"... all input levels can be matched and set for the most effective use of the loudness compensation. This valuable feature is rarely found on high-fidelity receivers and amplifiers..."

"The phono equalization was perfectly accurate (within our measuring tolerances)... The magnetic phono-input sensitivity was adjustable from 0.62 millivolt to about 4.5 millivolts, with a noise level of -66 dB, which is very low... When properly set up, it would be impossible to overload the phono inputs of the AR-1500 with any magnetic cartridge..."

"... it significantly bettered Heath's conservative specifications. Into 8-ohm loads, with both channels driven, the continuous power at clipping level was 81.5 watts per channel. Into 4 ohms it was 133 watts per channel, and even with 16-ohm loads the receiver delivered 46.5 watts per channel. Needless to say, the AR-1500 can drive any speaker we know of, and with power to spare..."

"At 1,000 Hz, harmonic distortion was well under 0.05 per cent from 1 to 75 watts per channel... The IM distortion was under 0.05 per cent at a level of a couple of watts or less, and gradually increased from 0.09 per cent at 10 watts to 0.16 per cent at 75 watts... The heavy power transformer is evidence that there was no skimping in the power supply of the AR-1500, and its performance at the low-frequency extremes clearly sets it apart from most receivers..."

"Virtually all the circuit boards plug into sockets, which are hinged so that boards can be swung out for testing or servicing without shutting off the receiver. An 'extender' cable permits any part of the receiver to be operated 'in the clear' — even the entire power-transistor and heat-sink assembly! The 245-page manual has extensive tests charts that show all voltage and resistance measurements in key circuits as they should appear on the receiver's built-in test meter..."

"With their well-known thoroughness, Heath has left little to the builder's imagination, and has assumed no electronic training or knowledge on his part. The separate packaging of all parts for each circuit board subassembly is a major boon..."

"In sound quality and ease of operation, and in overall suitability for its intended use, one could not expect more from any high-fidelity component..."

From the pages of *Audio Magazine*: "... the AR-1500 outperforms the near-perfect AR-15 in almost every important specification..."

"The FM front end features six tuned circuits and utilizes three FETs, while the AM RF section has two dual-gate MOSFETs (for RF and mixer stages) and an FET oscillator stage. The AM IF section features a 12-pole LC filter and a broad band detector. The FM IF section is worthy of special comment. Three IC stages are used and there are two 5-pole LC filters..."

"... IHF FM sensitivity... turned out to be 1.5 uV as opposed to the 1.8 uV claimed. Furthermore, it was identical at 90 MHz and 106 MHz (the IHF spec requires a statement only for IHF sensitivity at 98 MHz but we always measure this important spec at

three points on the dial). Notice that at just over 2 microvolts of input signal S/N has already reached 50 dB. Ultimate S/N measured was 66 dB and consisted of small hum components rather than any residual noise. THD in mono measured 0.25%, exactly twice as good as claimed! Stereo THD was identical, at 0.25% which is quite a feat..."

"... the separation of the multiplex section of the AR-1500 reaches about 45 dB at mid-band and is still 32 dB at 50 Hz and 25 dB at 10 kHz (Can your phono cartridge do as well?)..."

"The real surprise came when we spent some time listening to AM... This new AM design is superb. We still have one classical music station that has some simultaneous broadcasting on its AM and FM outlets and that gave us a good opportunity to A-B between the AM and FM performance of the AR-1500. There was some high-frequency roll-off to be sure, but BOTH signals were virtually noise-free and we were hard pressed to detect more THD from the AM than from the FM equivalent. Given AM circuits like this (and a bit of care on the part of broadcasters), AM may not be as dead as FM advocates would have us believe!..."

"Rated distortion [0.24%] is reached at a [continuous] power output of 77.5 watts per channel with 8 ohm loads (both channels driven). At rated output (60 watts per channel) THD was a mere 0.1% and at lower power levels there was never a tendency for the THD to 'creep up' again, which indicates the virtually complete absence of any 'crossover distortion' components. No so-called 'transistor sound' from this receiver, you can be sure. We tried to measure IM distortion but kept getting readings of 0.05% no matter what we did. Since that happens to be the 'limit' of our test equipment and since the rated IM stated by Heath is 'less than 0.1% at all power levels up to rated power output' there isn't much more we can say except that, again, the unit is better than the specification — we just don't know how much better..."

"As for the amplifiers and preamplifier sections, we just couldn't hear them — and that's a commendation. All we heard was program material (plus some speaker coloration, regrettably) unencumbered by audible distortion, noise, hum or any other of the multitude of afflictions which beset some high fidelity stereo installations..."

"As always, construction instructions are lucid enough for the inexperienced kit-builder and there is enough technical and theoretical information to satisfy even the most knowledgeable audio/RF engineer..."

The Heathkit AR-1500... its performance speaks louder than words. Order yours now.

Kit AR-1500, less cabinet, 53 lbs. 349.95*

ARA-1500-1, walnut cabinet, 8 lbs. 24.95*

See and hear the new AR-1500 at your nearest Heathkit Electronic Center... order direct from the coupon below... or send for your free Heathkit catalog.

| | |
|---|---|
| | <p>HEATHKIT Schlumberger</p> |
| | <p>HEATH COMPANY, Dept. 8-3 Benton Harbor, Michigan 49022</p> <p><input type="checkbox"/> Please rush my free Heathkit Catalog.</p> <p><input type="checkbox"/> Enclosed is \$_____ plus shipping. Please send my AR-1500 by return mail.</p> <p><input type="checkbox"/> Enclosed is \$_____ plus shipping for ARA-1500-1 walnut cabinet.</p> <p>Name _____</p> <p>Address _____</p> <p>City _____ State _____ Zip _____</p> <p>Prices & specifications subject to change without notice. *Mail Order Prices; F.O.B. Factory. HF 256</p> |
| <p>FREE CATALOG... describes AR-1500, plus over 350 other fun-to-build home and hobby kits.</p> | |

CIRCLE 35 ON READER-SERVICE CARD



too hot to handle

How would the rumble level of the Sony TTS-3000, which you measured at -77 dB by the RRLM method in 1967, compare with turntables you have measured more recently by the ARLL method—specifically the Thoren TD-125 (-62 dB) and the Empire 598 (-63 dB)? What is the difference between the two measurements techniques?—William D. Gray, Valley Center, Calif. None—except the name. RRLM stood for Relative Rumble Loudness Level and raised the question: relative to what? To answer that question, CBS Labs altered the term to ARLL for Audible Rumble Loudness Level. In other words, the "weighting" of the data is on the basis of (that is, relative to) audibility factors, the lowest frequencies being less audible than those a bit higher in pitch. Therefore you can compare our 1967 figures directly with those for current models.

I have just purchased a \$500 receiver, a \$500 open-reel tape deck, and an Advocate 101 Dolby noise-reduction unit. All the equipment is hooked up, calibrated, and ready to go. But I can't find any open-reel Dolbyized recorded tapes to play on my system. You've mentioned Dolbyized cassettes from Ampex and others; how about us open-reel users?—F. J. Casey, Youngstown, Ohio.

Yours is one of several letters we've received recently bewailing the lack of open-reel recorded tapes of one sort or another. And it looks as though you're out of luck. The tape duplicators show less interest in open-reel issues all the time and none at all in Dolby for this purpose. Apparently the Dolby open-reel system (and there are two decks now available with built-in Dolby circuits) is to be a home-recording medium only if things continue as they now are going, and you'll just have to live with the hiss on the dwindling assortment of recorded tapes that you can still buy.

In comparing receivers, is there any way to convert IHF power output figures to rms values?—Gary Mattson, Owatonna, Minn. No. An amplifier (including one built into a receiver) that has a really fine power supply can produce very similar results under either test procedure—though IHF power output normally is expressed as the sum of the two channels, while "rms" or continuous power output most commonly is expressed as a per-channel figure. When the power supply section is not so good, the difference between the two power measurements can be considerable. The loading resistors used during the test can alter results too. Continuous power normally

is measured into an 8-ohm load; IHF power often is measured at 4 ohms if that load will produce a higher reading. (Sometimes it won't.) And IHF power usually is measured with only one channel driven, the resulting per-channel reading being doubled mathematically to derive the total power rating; continuous power ratings may be measured with only one channel driven or, most stringently, both driven simultaneously.

I've been considering buying a Teac or a Revox A-77 open-reel deck. I called both companies to find out what tape their products work best with and they both said Scotch 203. Now I'm confused about Scotch 207. What is the difference between these two tapes and which one is better for these recorders?—Paul Agbadian, Los Angeles, Calif.

When the 3M Company introduced its 207 it said that this new tape would match any recorder set up for 203, but do a better job than 203. More recently, however, it has allowed that still better performance (though only slightly better) can be obtained with 207 if the equipment is optimized specifically for it. So while those Revox and Teac products that are set up for 203 should perform even better with 207, strictly speaking they are not optimized for 207. Both Teac and Revox have told us, however, that you can order their open-reel products optimized for any tape you like. If you want to get maximum advantage from 207 (or any other tape), that's the way to go about it.

I'm planning to convert my stereo system to four channels and would appreciate some help in choosing the components I will need. First, do you think I will be better off getting a good stereo deck and picking up a decoder (E-V Stereo-4, for instance), or should I buy a four-channel deck? Eventually I'd like to record in four channels. If I have a stereo deck I could use something like the Kenwood processor so that I could make my own matrixed tapes on a stereo recorder. Also, I'm looking for a quality automatic turntable. The Garrard Zero 100 is said to have almost no tracking error. Does this make it the best choice for quadrasonic records?—Nicholas I. Oshana, Ft. Gordon, Ga.

These are real toughies, and any decision you make now could prove to be the wrong one in a few years—or even months. The problem revolves around program material. You can now buy some discrete (not matrixed) four-channel eight-track cartridges, and discs matrixed by a number of different systems: CBS, E-V, and Sansui. Discrete four-channel discs (JVC CD-4 system) may

be on the market later this year, but nobody's making any promises. A few discrete open-reel tapes have been offered, but the supply is extremely limited and no new titles have been added recently. You would need different equipment to play each of these types of recordings. FM stations occasionally broadcast some of them or special material (such as the Boston Symphony Orchestra concerts) matrixed in one way or another. The technology of quadrasonics is young, and the young are subject to unpredictable changes. Until four-channel sound has achieved more maturity you should be prepared to make corresponding changes in any quadrasonic system you put together. For one thing, time may demonstrate that minimum horizontal tracking error is particularly important in playing quadrasonic discs; at present we know of no specific evidence to indicate that it is.

I have a stereo system now, based on the Harman-Kardon 520 receiver. I plan to convert to four-channel sound, using Citation Eleven and Citation Twelve as the extra preamp and amplifier. What tuner would be most suitable for use with these components? I'm not looking for a bargain tuner, but I'm also not interested in unnecessary features, such as a variety of tuning methods.—William F. Bennett, Trumbull, Conn.

Since nobody now knows what direction the FCC and the broadcasters may take in this respect, we'd advise against allowing your choice to be seriously swayed by models that claim to be "four-channel-ready." At the present time, four-channel broadcasts may be made by a station using some type of matrix or by two stations transmitting simultaneously on two different carrier frequencies. The former method requires not another tuner, but a suitable decoder at the output of your present tuner. The latter method is strictly experimental and temporary. But if you want to sample it, any competent basic stereo-FM tuner will do the job. The AR tuner, for one, would be a fine choice. Or, if you prefer an all H-K system, you might wait for the Citation tuner we're told is in preparation.

I've been told in looking for a high-quality portable stereo FM/AM radio/cassette recorder that I shouldn't expect to find one with built-in Dolby circuits at this time. Is this so?—Frank H. Gravell, Long Island City, N.Y.

Yes. In fact we don't even know of a battery-powered Dolby unit that could conveniently be used as an add-on with such a portable.



ZERO 100 Garrard's newest model, is the only automatic turntable achieving zero tracking error. Modestly priced at \$189.50, this most advanced record playing unit is a fabulous array of imaginative, responsible innovations: Variable speed control; illuminated strobe; magnetic anti-skating (an entirely new principle); viscous-damped cueing; 15° vertical tracking adjustment; the patented Synchro-Lab synchronous motor; and Garrard's exclusive two-point record support. An engineering triumph, the articulating tone arm, is demonstrated below.

True Tangent Tracking

First time in an automatic turntable!

The diagram over the photograph shows how the tone arm articulates, constantly adjusting the angle of the cartridge, and keeping the stylus perpendicularly tangent to the grooves throughout the record. Space-age pivots and computerized design have made it possible to play the record at exact the same angle as it was cut. Reproduction is truer, distortion sharply reduced, record life lengthened.

Consider that there are 3,600 seconds of arc in a degree—and that a conventional tone arm will produce up to 4 degrees tracking error—or 14,400 seconds at full playing radius. Compare this to the Zero 100 tracking error, calculated to measure a remarkable 90 seconds (160 times lower!) and you will see why this Garrard development obsoletes the arm geometry of every other automatic turntable.

□ Test reports by some of the industry's most respected reviewers have already appeared, expressing their enthusiasm. These reports are now available with a 12-page brochure on the Zero 100 at your dealer. Or, you can write to British Industries Company, Dept. C-22 Westbury, New York 11590.

Mfg. by Plessey Ltd. Dist. by British Industries Co.

CARTRIDGE ANGLE ADJUSTS AS TONE ARM MOVES...KEEPS STYLUS ALWAYS TANGENT AT 90° TO GROOVES

**GARRARD
ZERO 100**
\$189.50
(less base and cartridge)

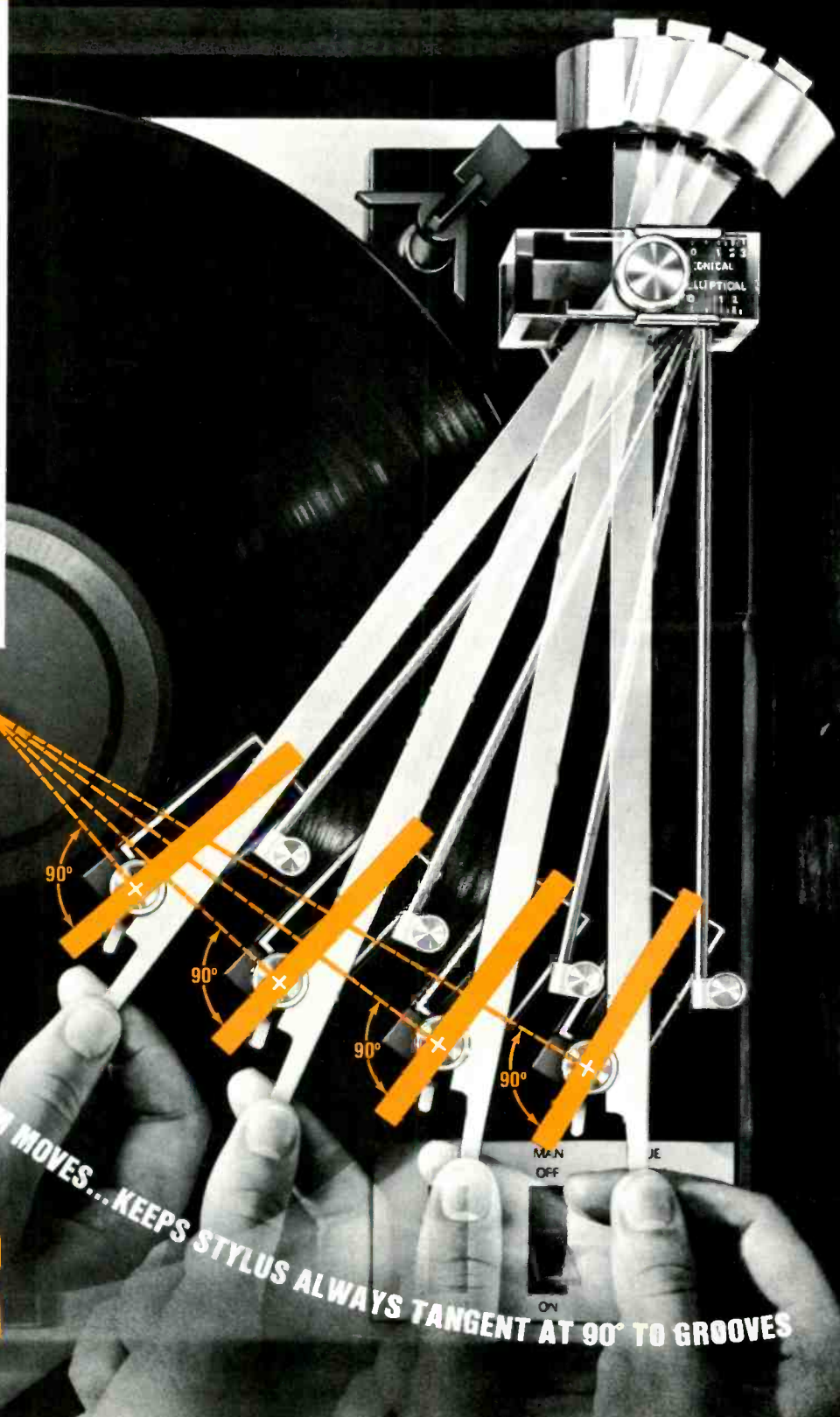

Wednesday for piano. Thursday for horns.

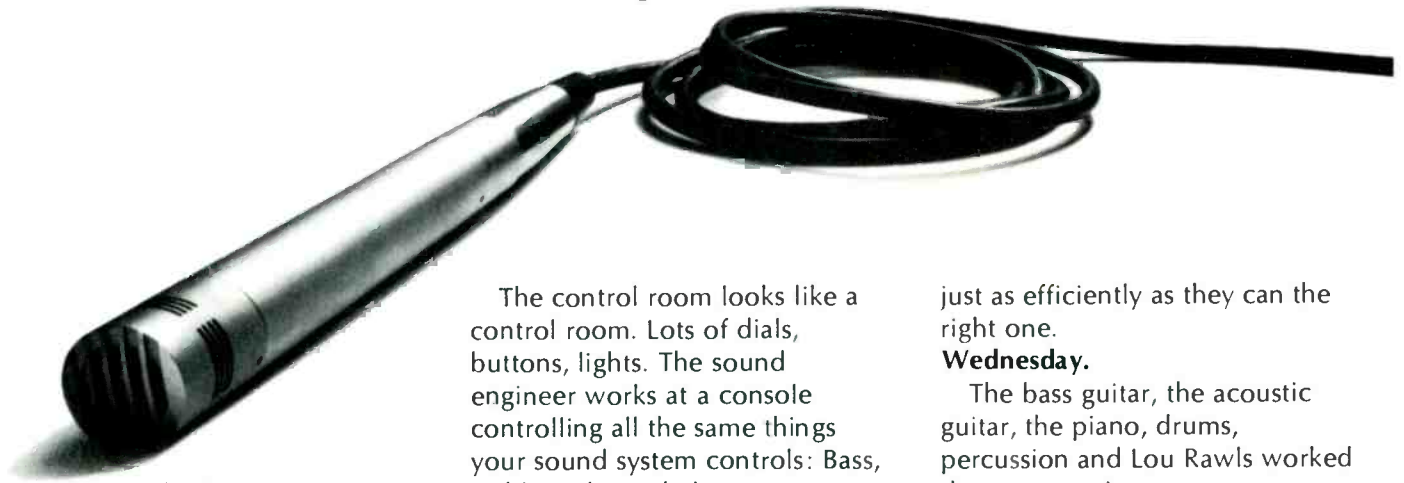

►Close your eyes.

Lou Rawls is singing. He says, "Believe in me." And you do.

An acoustic guitar, way off to the left somewhere, scratches the back of your ear. Trap drums hug the bass guitar in the center of the sound. Strings, woodwinds, percussion, trombones, fourteen different pieces of pure sound come together.

And you're there with them— hearing, sharing, capturing a moment that never happened.

They don't make records like they used to.

Until very, very recently the goal of any musical recording was to recreate an event that had happened somewhere. The "live" performance was perfection; the only purpose of recording was to record.

It's not that way any more. Not with the new music.

The last album you bought, the one with fifteen or twenty artists performing together, likely took a month to record, another month to mix. Many of the musicians performed as soloists, the rest in small groups. Only three people were there from the first day to the last: The arranger, the producer and the sound engineer.

The control room looks like a control room. Lots of dials, buttons, lights. The sound engineer works at a console controlling all the same things your sound system controls: Bass, treble, volume, balance, etcetera. The only difference between your system and this one is a little more sensitivity, capacity, precision and maybe two or three hundred thousand dollars.



The control room and the studio are acoustically isolated. Very important. The only way sound can come out of that studio is through a speaker in the control room. See those beauties all in a row? JBL speakers, thank you.

Out in the studio, there are yards and yards of cloth hung here and there between musicians, over instruments and next to microphones. The cloth dampens sound. It keeps each instrument's sound near the microphone assigned to it. That's important. Musical instrument microphones are very precise and very literal and can pick up the wrong sound

just as efficiently as they can the right one.

Wednesday.

The bass guitar, the acoustic guitar, the piano, drums, percussion and Lou Rawls worked the same session.

The tambourines start in the big studio but are banished to the isolation booth because their sound is leaking into other microphones.

Look at the five microphones on the drums; three for the traps and two for the bass drums. Each is there to retrieve a particular tonal quality.

See the mike inside the piano, under the top, over the sound? If you really want to hear good piano, that's the place.

Thursday.

Horns, woodwinds, strings— each takes his turn until all have had their say.

Finally, fourteen channels are filled, each with a component of the total sound, ready to be blended.

Monday.

The mix-down begins. Fourteen tracks heading toward two.

Each monitor speaker holds a separate sound. And now each is heard in turn, solo and then in unison.

The sound engineer steps to the podium and brings up the bass guitar for rhythm. It goes in the center of the stereo perspective. He tightens it slightly, adding equalization at 50 Hz.





L100 CENTURY

A runaway best seller. The beautiful twin of JBL's compact professional studio monitor. Now the mightiest bookshelf ever produced. Easily handles 50 watts of continuous program material, although it takes only 1 watt to produce 78db sound pressure level at 5 feet. Oiled walnut enclosure and a new dimensional grille that's more acoustically transparent than cloth and happens in colors like Ultra Blue, Burrt Orange or Russet Brown. 14"x24"x14". \$273.

L200 STUDIO MASTER

Just like JBL's professional studio monitor only more so. High acoustic output, uniform spatial distribution, smooth frequency response and the extraordinary capability of handling a full 100 watts of continuous program material, yet produces 80db sound pressure level at 15 feet with only 1 watt input. Graceful tapered form, oiled walnut enclosure and sculptured Crenellex grille in Smoke or Raven or Aegean or Burgundy. 33"x24"x21". \$597.

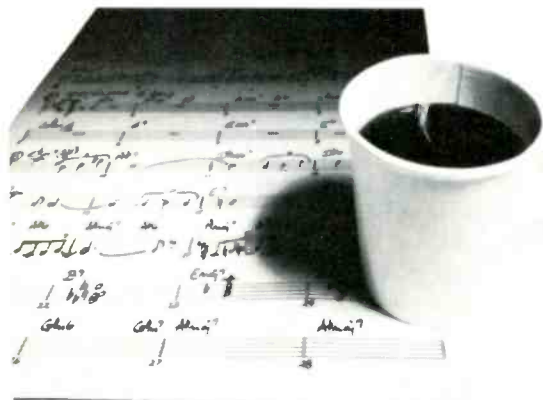

Guitars over there. Woodwinds here. How do they do that? Besides the left-channel and right-channel placements, the sound engineer uses tiny delays in sound and drops in volume to place the sound "away" from you or "near" you. Your brain does the rest, putting each sound in stereo perspective.

center with a bit of echo to make it fuller. French horns left and right and the sweetening process: Bass trombones for resonance. An oboe solo for delicacy and a room full of strings — violins, cello, viola — to make the whole thing smooth and round.

And, finally, all monitor speakers are in agreement. One last button is pushed, and the master recording is made.

That's all there is to it.

The art of recording is changing. The business is changing. More creative scope, more ideas, more discipline. A whole new incredibly complex art form has emerged.

We're glad to be a part of it. In fact, most major recording studios in the world produce their records mastered on JBL monitors.

James B. Lansing
Sound, Inc.
3249 Casitas Avenue
Los Angeles 90039
A subsidiary of
Jervis Corporation



Traps left and traps right. A little equalization to brighten them; some echo to give them depth.

Now the bass drum; then the acoustic guitar on the left with the piano on the right to balance it.

Wednesday, again.

The tambourine comes into the

CIRCLE 45 ON READER-SERVICE CARD

Our thanks to Lou Rawls and MGM Records for allowing us to document the recording, mixing and mastering of the title song from the MGM movie, Believe in Me.

The new ADC-XLM



**Superb performance.
Lowest mass.
Unbeatable price.
And it's guaranteed for 10 years.**

If you're like most audiophiles, you've probably spent a great deal of time, effort and money looking for the "perfect" cartridge.

We know what you've been through. After all, we've been through it ourselves.

That's why we're especially enthusiastic about our newest cartridge, the ADC-XLM. It does everything a well designed cartridge should do. It may not be perfect, but we don't know of any that are better, and few that even come close.

Now, we'd like to tell you why.

The lighter, the better.

To begin with, it is generally agreed that the first consideration in choosing a cartridge should be low mass. And as you may have guessed by now, the LM in our model designation stands for low mass.

Not only is the overall weight of the ADC-XLM extremely low, but the mass of the all-important moving system (the stylus assembly) is lower than that of any other cartridge.

Translated into performance, this means effortless tracking at lighter pressures with less distortion.

In fact, used in a well designed, low mass tone arm, the XLM will track better at 0.4 gram than most cartridges at one gram or more.

A new solution for an old problem.

One of the thorniest problems confronting a cartridge designer is how to get rid of the high frequency resonances common to all cartridge systems.

Over the years, various remedies have been tried with only moderate success. Often the cure was worse than the disease.

Now thanks to a little bit of original thinking, ADC has come up with a very effective solution to the problem. We use the electromagnetic forces generated within the cartridge itself to damp out these troublesome resonances. We call this self-correcting process, "Controlled Electrodynamic Damping," or C.E.D. for short.

And if it seems a little complicated, just think of C.E.D. as a more effective way of achieving lower distortion and superior tracking, as well as extending frequency response.

Naturally, there's much more to the new ADC-XLM, like our unique induced magnet system, but let's save that for later.

Guaranteed reliability plus.

At ADC we've always felt that reliability was just as important as any technical specification. That's why we now guarantee every ADC-XLM, exclusive of stylus, for a full ten years.

But this unprecedented

guarantee involves something more than just an assurance of quality. It is also an expression of our conviction that the performance of this cartridge is so outstanding that it is not likely to be surpassed within the foreseeable future.

And something more.

In addition to the superb ADC-XLM, there is also a new low mass ADC-VLM, which is recommended for use in record players requiring tracking pressures of more than one gram. The cartridge body is identical for both units, and so is the guarantee. Only the stylus assemblies are different. Thus you can start out modestly and move up to the finest and still protect your investment.

And that brings us to the important question of price, which we are happy to say is significantly lower than what you might reasonably expect to pay for the finest. The suggested list price for the incomparable ADC-XLM is \$50 and the runner-up ADC-VLM is only \$40.

But no matter which low mass ADC you choose, you can be certain that they share the same outstanding characteristics... superb tracking, very low distortion and exceptionally smooth and extended frequency response.

*We guarantee (to the original purchaser) this ADC cartridge, exclusive of stylus assembly, to be free of manufacturing defects for a ten year period from the date of factory shipment. During that time, should a defect occur, the unit will be repaired or replaced (at our option) without cost. The enclosed guarantee card must be filled out and returned to us within ten days of purchase, otherwise this guarantee will not apply. The guarantee does not cover damage caused by accident or mishandling. To obtain service under the guarantee, simply mail the unit to our Customer Service Department.



CIRCLE 8 ON READER-SERVICE CARD

The Prime Minister as Musician



Photo courtesy London Symphony Orchestra

LONDON

"Where's your assistant conductor?" I asked André Previn at a recent session in EMI's studio. Previn and the London Symphony Orchestra were there to provide in double quick time a coupling for the most exclusive record of the season, Elgar's *Cockaigne* Overture conducted by Her Majesty's Prime Minister and First Lord of the Treasury, Rt. Hon. Edward Heath. I assumed that Previn's "assistant conductor" was at a cabinet meeting.

The story of how Edward Heath came to conduct the London Symphony at its gala concert in the Royal Festival Hall last November was something I followed keenly from the start. During the LSO's tour of Russia and the Far East, when as attendant music critic I had every chance over the weeks to talk with Previn, the conductor casually remarked how professional he felt Heath's musicianship was. He and Mia Farrow had on a number of occasions been guests of the Prime Minister both at Downing Street and at the official country home, Chequers. He had had a chance to discuss music with Heath in more than dinner-table terms and was convinced that the Prime Minister would make an excellent job of conducting the orchestra. Would it be feasible, he wondered, to have him conduct at the gala? I certainly thought so. Knowing

the PM from my political journalist days (when, incidentally, he used to quote my own record reviews at me without attribution), I was confident he would rise to the challenge. He was after all of two minds at Oxford whether to make music or politics his career.

Rise to the challenge he did, and on November 25 he appeared on the rostrum of the Royal Festival Hall, pink-faced and a little more tense than when speaking in the House of Commons. Elaborate security arrangements surrounded the occasion. Not even reporters were allowed in as the Prime Minister wanted merely "the usual press facilities" meaning critics only (in fact I had to double on both jobs). The first test came in bar three when there is a tricky pause to negotiate, and though his head was down in the score Heath managed it well. This is one of the most difficult overtures in the repertory because almost every page brings a modification of tempo in a sequence of sharply contrasted sections. Though we were all aware of the PM's tension, it was plain that this was no mere run-through and that he was putting over a very positive interpretation. It was more like the Elgar of Barbirolli rather than of Boult, warm and expressive and luxuriating—surprising from the rather chill character that Heath presents to the political world. The performance was recorded in stereo by the BBC, and EMI planned to put it on one side of a gala LSO disc with Previn and the

orchestra in three "lollipops" on the other side. That was where the rapidly arranged Previn session came in, and the pieces chosen included—to my personal delight—two of the regular encores that the orchestra had used on the Russia/Far East tour. Already I had found myself incapable of hearing Leonard Bernstein's overture to *Candide* or the Vaughan Williams *Greensleeves* Fantasia without feeling nostalgic.

But before those two comparatively brief pieces Previn recorded a work that he had led with tremendous success on television a month or so earlier—Enesco's *Rumanian Rhapsody No. 1*. The first run-through was rather stiff and one could hardly escape the fact. At the playback Gervase de Peyer, the LSO's distinguished first clarinet and himself a conductor, came into the control room and whispered to me that he himself had been conducting the same piece in Norwich only three days earlier. He knew how he liked it to go. We didn't tell Previn, but Previn himself had ideas, and in the following two complete takes (all that was needed to complete the recording) we noticed the places where—as Previn himself put it—he was "doing a Zorba the Greek," edging into an oompah rhythm or squeezing a tempo. By the end the LSO might have passed as Rumanian trained except that I doubt if Bucharest has ever heard a native orchestra as brilliant as this.

It was an exhilarating session with

Previn and the EMI recording manager, Christopher Bishop, doing their usual double act of sharp American wit against feignedly bored British comment. The Bernstein overture has now become one of the orchestra's favorite party pieces, scintillatingly brilliant, and I was worried that the Prime Minister's highly creditable effort on the reverse side might seem less than sparkling by contrast. What the final verdict will be I can only leave to critics and public, but two days later (and only a week before the disc was available in the shops for Christmas) I heard the BBC tape as tailored by EMI. To my amazement the PM's Elgar performance sounded better than in the hall, even more emotional, and a tremendous credit not only to the conductor (even his political opponents reluctantly agreed) but particularly to the LSO.

EMI had wondered whether it would be best to have Previn's well-chosen words of introduction as a preface to the performance ("It is untrue that I am now aiming to be Prime Minister for fifteen minutes"), but the PM decided otherwise. He wanted the performance judged on its merits, and not for curiosity value—and who can blame him?

EDWARD GREENFIELD

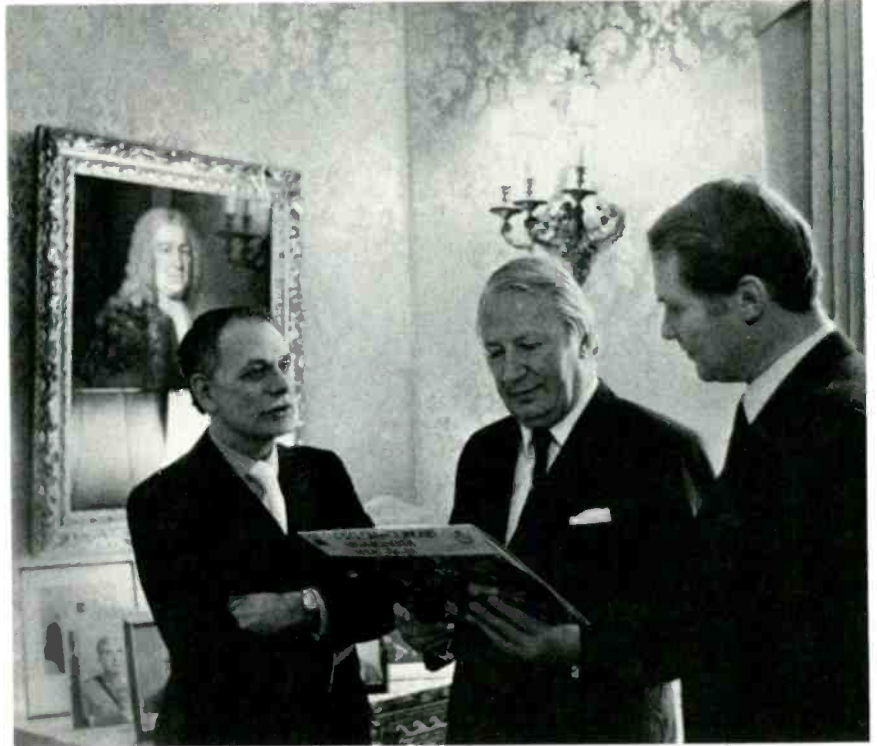

Back in the familiarity of 10 Downing Street, the PM receives the first recorded copy of his performance from the LSO's general manager Harold Lawrence (left) and EMI's Peter Andry.

Other Musical Politicians

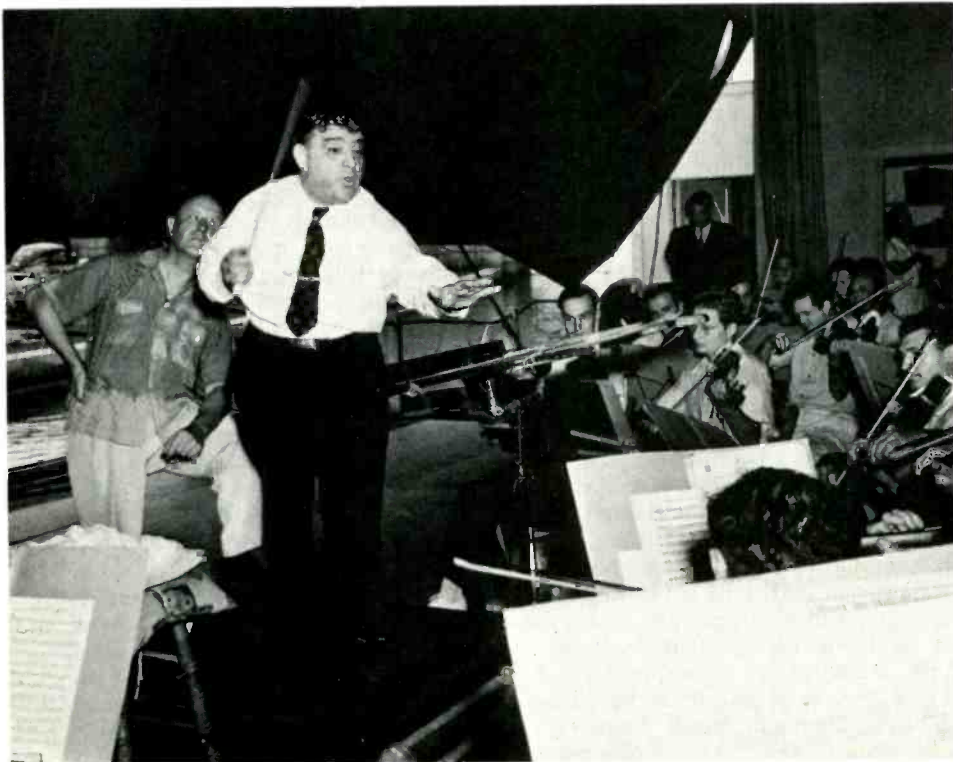

New York City's Mayor Fiorello LaGuardia, another conductor/politician, rehearses the National Symphony for a 1941 Washington performance of the National Anthem and two Sousa marches.



The young man with violin is Richard Nixon.



Il Duce Benito Mussolini was another notorious Roman fiddler.



Could it have been Anne Boleyn's talent with a lute that composer Henry VIII found so irresistible?



Soprano Margaret Truman greets her pianist father after one of her recitals.



Former Supreme Court Justice Abe Fortas—also a violinist.



Frederick the Great of Prussia was a composer and flutist but "the Great" refers to other exploits.

High Fidelity Music Shows—Again

Not so many years ago, *the* event of the high fidelity season was "the hi-fi show" in midtown Manhattan, usually in early fall. No longer. Last fall came and went with no really major show anywhere in the country. (The biggest was in Montreal.)

Things are beginning to pick up again, however. Anaheim, California had its Fifth Regional Hi-Fi Show late in January. Mrs. Teresa Rogers, best known for her Washington and Philadelphia shows in alternate years through much of the Sixties, has planned one to take place in Atlanta just after this issue appears. It will run February 18 through 21 at the Merchandise Mart. And during the first week in March New Yorkers will have a chance to hear a special collection of quadraphonic sound systems at the SEE 70 exhibition at 443 Park Avenue South.

Other shows in other cities now are in the planning stage. There even has been some speculation about the possible revival of the major-metropolis gala by extending the CES (Consumer Electronics Show—presently open only to the trade) so that the public can have a day or two to view the goodies. The next CES is scheduled for Chicago in June, but so far the public days are no more than talk.

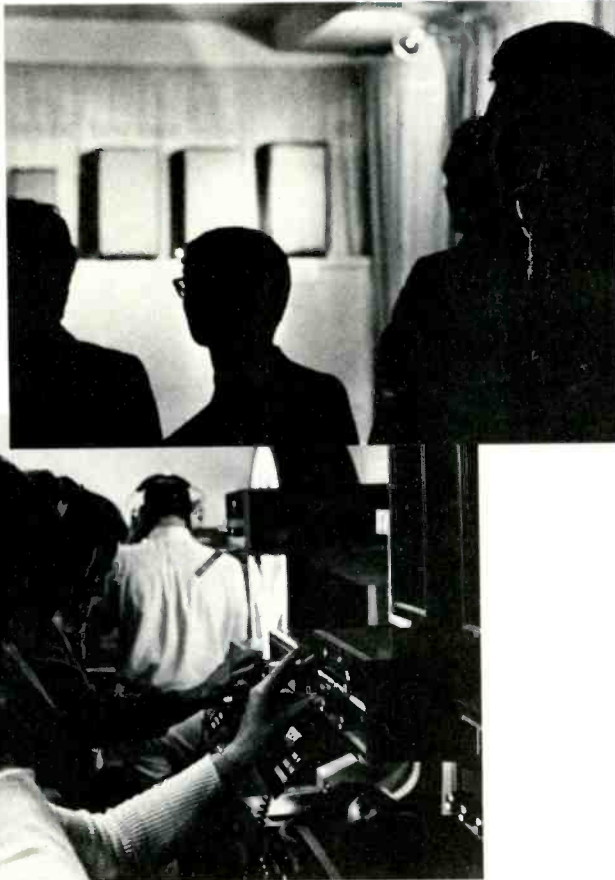

In Search of Specifics

One of our readers wrote recently to complain about our advertisers. He is disgruntled, he says, because of the vague and/or inflated statements that they make about the output power of their amplifiers, and he is frustrated by their omission of selling prices.

The first of these complaints seems justified to us—as we've said so often over the years. It's hard to understand why a company will coo about "150 watts of thrilling power" when it knows that our test report will rate the unit at 40 watts per channel (or less) under standard test conditions. And the practice is even harder to understand now that the Federal Trade Commission has made it clear that exaggerated claims no longer will be tolerated.

The FTC ax will be slow to fall, however. Its proposed rules for stating output-power claims are not expected to make themselves felt until late 1972 or even early 1973. By that time power not only will have to be tested on a continuous basis—rather than under one of the "music-power" systems only—but it must be referred to bandwidth. Meaningless 1-kHz output figures (and the even more nonsensical "peak-power" ratings used in the stereo console industry) will be banned.

On the subject of prices we find it easier to sympathize with the advertisers. A magazine doesn't get thrown together overnight; ads are produced months in advance of the on-sale date. At a time when currency

reevaluation is very much in the air but its effect on prices impossible to predict with any certainty, advertisers—and especially importers—can't afford to state a price that may be impossible to meet by the time the ad is read. All of the ads our correspondent singled out featured imported products, and there are others he might have mentioned. Even domestic manufacturers don't know which way to turn if their products are designed around imported parts.

Oh yes—there was one other complaint in the letter. Our reader pointed out that one ad made no mention at all of power output. A fine paradox! This particular advertiser has refused to get caught up in the wattage-numbers race—the race that precipitated the initial complaint—and our friend still is unhappy. While we agree with him that output power is an important piece of information, so are many other items that are seldom if ever played up in ads. How about some expression of loudspeaker efficiency, for example? If he had that specific, he'd have real use for reliable power ratings.

Unsafe at Any Frequency

A recent announcement from RCA reads like something out of Detroit, and unlike anything we have (yet) seen in the home-entertainment industry. But times are

Nobody ever made a great cassette deck by adding Dolby to an ordinary one.

One way to improve a cassette deck is by adding Dolby. A better way is to make a cassette deck that doesn't need much help to begin with.

Take the Harman-Kardon CAD5.

Like all Dolbyized cassette decks, ours eliminates tape hiss.

But that's only one of the reasons you should buy it.

The CAD5 was designed to give you recordings that are as good as the original program material. Wow and flutter is an extremely low 0.15%. And frequency response is an extremely wide 30 to 12,500 Hz with standard tape. (30 to 15,000 Hz with chromium dioxide tape.) So you not only hear more music, but more overtones, and, therefore, more of the music.

Of course, there are times when you can't use Dolby. (When you play non-Dolbyized, pre-recorded tapes, for example.) But even with the noise suppressor switched off, the CAD5 has very little noise to suppress.

The signal-to-noise ratio without Dolby is 45 dB.

With Dolby, the signal-to-noise ratio is 55 dB. Which means noise is suppressed virtually to the point of non-existence.

Finally, the outside of the CAD5 is just as sophisticated as the inside. It comes with two VU meters, an overload indicator, automatic shut-off and two sliding record-level potentiometers.

In all, the only thing the CAD5 doesn't have in common with higher-priced decks is their higher prices.

As Popular Electronics pointed out, the CAD5 is "a lot of recorder for \$229.95." Which isn't quite correct. The CAD5 now costs only \$199.95.

That's perhaps the one CAD5 feature that isn't very advanced.

For more information, write us: Harman-Kardon, 55 Ames Court, Plainview, N.Y. 11803.

harman kardon

A subsidiary of Jervis Corporation

The Music Company



CAD5
with Dolby

CIRCLE 33 ON READER-SERVICE CARD

changing. One RCA consumer model is being recalled for modification to prevent a possible hazard. According to the announcement, some 27,000 units of Model RZD-422, a \$20 AM clock radio, were produced. Of that number, three suffered some damage as a result of two unrelated failures—in a capacitor and a diode respectively. Under this "extraordinary combination of circumstances" the radio can develop enough heat to burn a small hole in the plastic case, RCA says.

Apparently no further damage or overt threat to the owner has been involved, but RCA is urging anyone who has that model (the number is marked on the back) to unplug it at once and to return it to the dealer or distributor for modification.

Make Your Own Matrixed Tapes

Sound Systems International—designers of the SSI wireless, straight-line tone arm—now produces the Quadrasizer, a circuit intended for home use in capturing four-channel sound on conventional stereo tape recorders.

The Quadrasizer I (\$59.95) has four mike inputs: left, center (front), right, and back. Left and right inputs are fed unaltered to the tape recorder's left and right inputs respectively. The center input feeds equally and in phase to both, while the back input feeds both equally but out of phase.

Note that this microphone configuration differs from the "usual" quadraphonic arrangement, which presupposes left- and right-front and left- and right-back prime signals. In this respect the Quadrasizer is similar to the original Hafler Dynaquad setup—the so-called

diamond speaker pattern. Another aspect of the Quadrasizer system also suggests Dynaquad: The dematrix circuitry—essentially a differential speaker hookup—can be put between power amplifiers and speakers, allowing use of a regular (two-channel) stereo amp. For this purpose SSI is making the Quadrasizer III (\$119.95), an integrated stereo amplifier with the dematrix circuitry built in and output taps for the four speakers.

CIRCLE 159 ON READER-SERVICE CARD

Gimme an F and an M . . .

What with packaged programming, mass-appeal pap, and endless replays of the Tchaikovsky First Piano Concerto, the concept of FM as a showcase for exciting sounds has become something of a bad joke over the last few years. There are oases, to be sure; but now New Yorkers have a choice of two FM programs designed to fill the void.

One is "Adventures in Sound" on WQXR-FM, hosted by Larry Zide—often a contributor to HIGH FIDELITY. The other is "Experiments in Sound" on WNYC-FM. Harry Maynard, its co-producer (with Jack Garner), also presents "Men of Hi-Fi," an interview program that has featured important sound demonstrations over the years and is currently heard on WNYC-FM.

Using demonstrations of such audio phenomena as Dolby noise reduction (the feature of the debut broadcast of "Adventures in Sound" in October) and quadraphonics (a favorite subject of Mr. Maynard's), these programs are making a bid to re-establish audio *qua* audio on the airwaves. More power to them.

equipment in the news



Unconventional speaker system from ESS

Electrostatic Sound Systems' Trans-Static I is a three-way loudspeaker with an electrostatic tweeter, plastic-diaphragm cone mid-range driver, and a flat, aluminum-stressed plastic-diaphragm woofer. The crossover is equipped with midrange and treble controls, and it has provision for bi-amplification. The transmission-line baffling is said to make the system's response unusually flat and wide-range—from woofer resonance at below 15 Hz to beyond 32 kHz. List price per pair is \$1,095 in oiled walnut or \$1,135 in rosewood.

CIRCLE NO. 146 ON READER-SERVICE CARD

Kenwood upgrades its top receiver

The Kenwood KR-7070A retains many of the features of the KR-7070. Its bidirectional remote tuning control now includes a volume-control knob. Other unusual controls include switching for three pairs of speakers, monitor switching for two tape recorders (one can be plugged into a front-panel jack), a presence control, a three-position loudness control, and a three-position phono sensitivity switch. Continuous power is rated at 65 watts per channel into 8 ohms with both channels driven. List price is approximately \$550, subject to reevaluation charges.

CIRCLE NO. 147 ON READER-SERVICE CARD



Think of
everything you've ever wanted
in a stereo receiver.

The new SX-E28 and SX-727 are Pioneer's top two entries in a new, dynamic line-up of four AM-FM stereo receivers with increased performance, greater power, unsurpassed precision and a wide range of features for total versatility.

If you lust for power, here it is — to spare. SX-828, 270 watts IHF; SX-727, 195 watts IHF. Employing direct-coupled amplifiers and dual power supplies, you'll hear improved bass while transient, damping and frequency responses are greatly enhanced. Distortion is infinitesimal.

Whichever model you select, advanced FM sensitivity deftly plucks out those stations a hairline away from each other on the dial, and excellent selectivity zeros in on your program choice.



At Pioneer, we believe our engineers have really outdone themselves by designing features like: a new and exclusive circuit that protects your speakers against damage and DC leakage, ultra wide linear dial scale, boldness contour, FM muting, mood lights, click-stop tone controls, high & low filters, dual tuning meters, audio muting, plus a

full range of connections for turntables, tape decks, headphones, microphones, speakers — and even 4-channel connections, when you're ready.

To top this total combination are Pioneer's sensible prices — SX-E28, \$429.95; SX-727, \$349.95, including walnut cabinet. If all this doesn't impress you, listening to them will. See and hear these magnificent new receivers; as well as the new moderately priced SX-626 and SX-525, at your local Pioneer dealer.

U.S. Pioneer Electronics Corp.,
178 Commerce Road,
Carstadt, New Jersey 07072

 **PIONEER**[®]
when you want something better

Pioneer has more of everything.



WEST: 13300 S. ESTRELLA AVE., LOS ANGELES, CALIF. 90248 • CANADA: S. H. PARKER CO., ONTARIO

Lafayette stereo/quadrasonic receiver/recorder



In one unit the Lafayette LRK-855 combines a low-power stereo FM/AM receiver, an eight-track stereo cartridge recorder/player with front-panel mike inputs, an "adapter" circuit to derive quadrasonic effects (via an extra pair of speakers) from stereo program sources, and a "composer" circuit to derive or decode four-channel effects (via an extra stereo power amplifier and pair of speakers) from stereo or matrixed quadrasonic program sources. The eight-track recorder stops automatically when the last pair of tracks on the cartridge has been recorded. The LRK-855 costs \$219.95.

CIRCLE NO. 148 ON READER-SERVICE CARD

Two Farnsworth speaker systems

Marice Stith Recording Services of Ithaca, New York has announced two floor-standing loudspeakers: the Farnsworth Model 12, 24 $\frac{3}{4}$ inches high, on the left; and the Model 15, 29 $\frac{3}{4}$ inches high. The cabinets are made of dense particle board finished with a walnut laminate and walnut-veneer edge trim. Both are rated by the manufacturer for response to 22 kHz; low-end response is said to extend to 20 Hz in the smaller model, to 15 Hz in the larger. The per-pair prices are \$395 for the Model 12, \$495 for the Model 15.

CIRCLE NO. 149 ON READER-SERVICE CARD

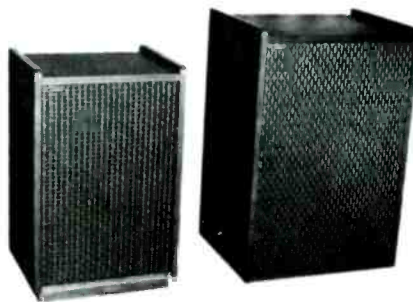

New Pioneer integrated amplifier



As a possible companion piece to its recently announced TX-800 tuner, Pioneer offers the SA-800 integrated amplifier, rated at 34 watts per channel continuous power into 8 ohms with both channels driven, for less than 0.5% THD. Among its features are monitor switching for two tape decks, dual phono inputs (one switchable for either moving-magnet or moving-coil cartridges, preamp/amp jumpers, three-second muting when the power is turned on (to eliminate turn-on noise and protect speakers), a "muting" switch that decreases output by 20 dB, and a front-panel mike input. The SA-800 lists at \$259.99.

New record-care kits from Robins

Robins Industries has introduced the PK-9 kit, with Touch of Velvet applicator and cleaning mitt, antistatic cleaning solution, the Robins tone arm brush and finger lift (a single assembly that attaches to the cartridge shell), and a fixed-mount stylus brush. The kit sells for \$5.00. The simpler PK-2, containing only a velvet wiping cloth and a bottle of the cleaning fluid, lists at \$2.00.

CIRCLE NO. 150 ON READER-SERVICE CARD



Remote control for Panasonic cassette deck

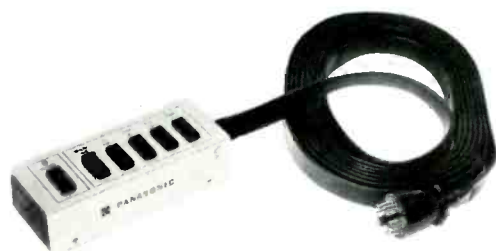

An accessory normally found only with some relatively elaborate solenoid-operated open-reel decks now is available for Panasonic's top-of-the-line RS-275 cassette deck. It is the RP-9275 remote-control unit, with buttons for recording interlock, rewind, fast forward, stop, play/record, and pause. Its 12-foot interconnect cable plugs directly into the RS-275 and requires no modification of the deck. The remote unit is priced at \$34.95.

CIRCLE NO. 151 ON READER-SERVICE CARD

After the monthly breakthroughs and revolutions in speaker design, how come the Rectilinear III still sounds better?

Figure it out for yourself.

More than five years ago, without much fanfare, we came out with a very carefully engineered but basically quite straightforward floor-standing speaker system. It consisted of six cone speakers and a cross-over network in a tuned enclosure; its dimensions were 35" by 18" by 12" deep; its oiled walnut cabinet was handsome but quite simple.

That was the original **Rectilinear III**, which we are still selling, to this day, for \$279.

Within a year, virtually every hi-fi editor and equipment re-

viewer went on record to the effect that the **Rectilinear III** was unsurpassed by any other speaker system, regardless of type, size or price. (Reprints still available.)

Then came about forty-seven different breakthroughs and revolutions in the course of the years, while we kept the **Rectilinear III** unchanged. We thought it sounded a lot more natural than the breakthrough stuff, but of course we were prejudiced.

Finally, last year, we started to make a **lowboy** version of the **Rectilinear III**. It was purely a cosmetic change, since the two versions are electrically and acoustically identical. But the

new **lowboy** is wider, lower and more sumptuous, with a very impressive fretwork grille. It measures 28" by 22" by 12¼" deep (same internal volume) and is priced \$20 higher at \$299.

The new version gave *Stereo Review* the opportunity to test the **Rectilinear III** again after a lapse of almost five years. And, lo and behold, the test report said that "the system did an essentially perfect job of duplicating our "live music" and that both the original and the **lowboy** version "are among the best-sounding and most 'natural' speakers we have heard." (Reprints on request.)

So, what we would like you to figure out is this:

What was the real breakthrough and who made it?

For more information, including detailed literature see your audio dealer or write to Rectilinear Research Corp., 107 Bruckner Blvd., Bronx, N. Y. 10454.

Rectilinear III

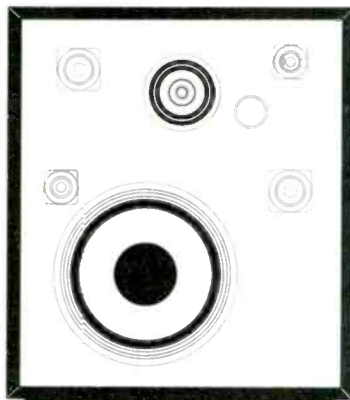
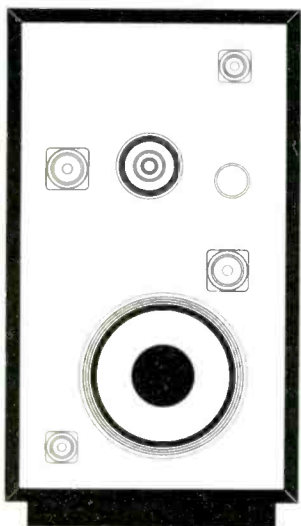

CIRCLE 57 ON READER-SERVICE CARD

How far ahead is the Beomaster ? 3000-2

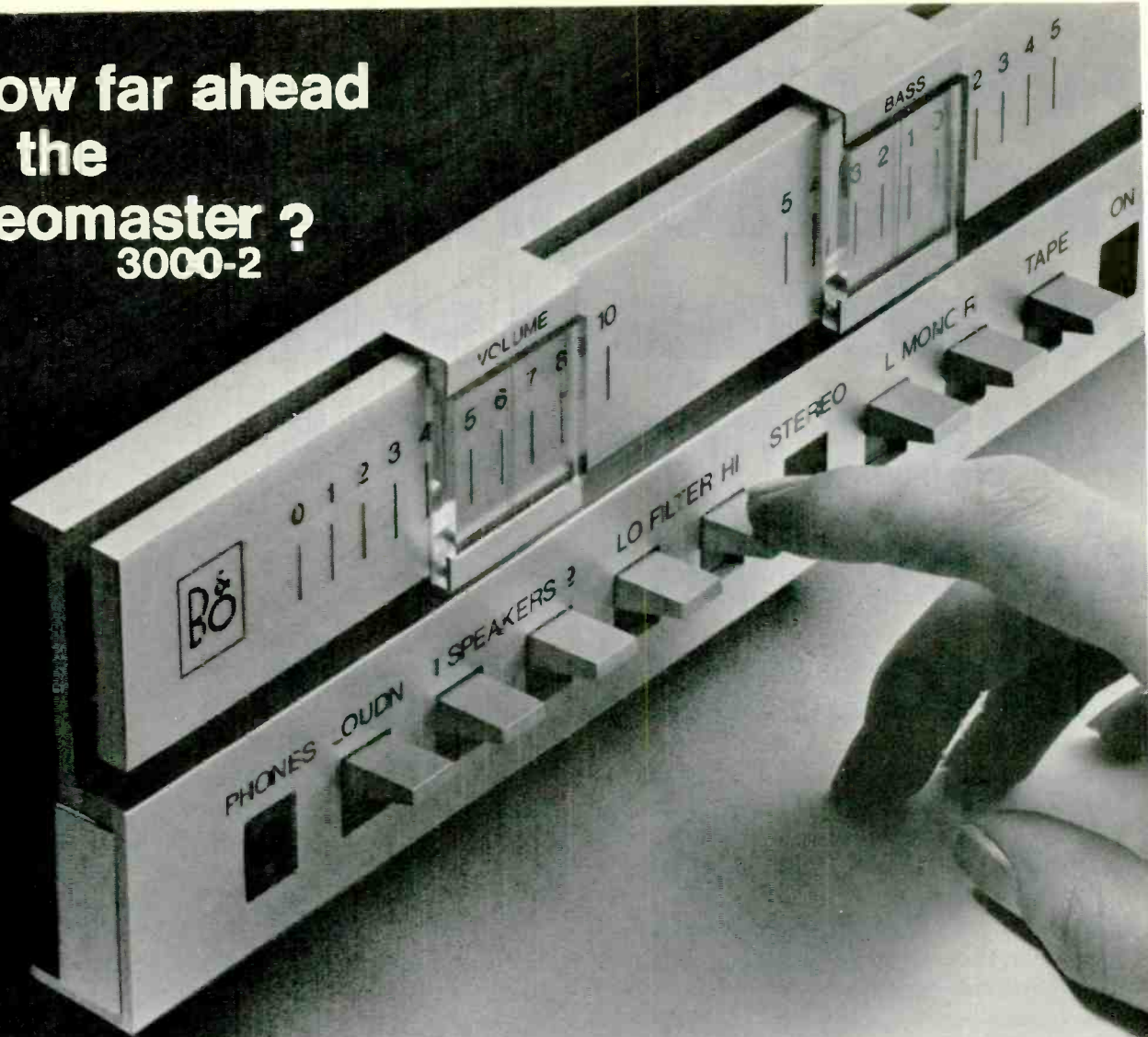

Three Years? Five Years?

When do you think you'll see another receiver with such sophisticated styling and so many functions (and not a single knob)?

The Beomaster 3000-2 gives you less than .6% total harmonic distortion at full power (40/40 RMS into 4 ohms). Tuner features varactor diodes for pre-select tuning of 6 FM stations (each covers the full band). Field effect transistors (FET), ceramic filters and integrated circuits combine with slide rule tuning for super-critical station selection.

Ask your dealer for a demonstration. Push the buttons; slide the controls . . . and listen. Then you'll know the feel of quality as well as the sound. Or write today for complete details.

Beomaster 3000-2 Receiver \$330



Bang & Olufsen of America, Inc.

2271 Devon Ave., Elk Grove Village, Illinois 60007

In Canada: Musimart, Ltd. / Montreal

Here's your **FREE**

HIGH FIDELITY

“at home” shopping service!

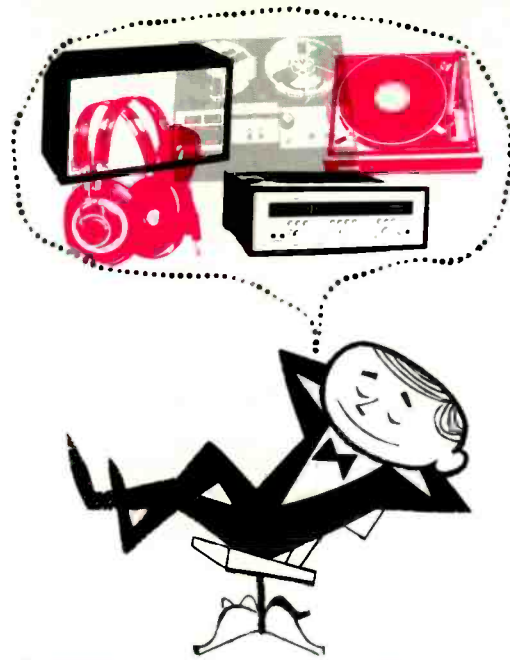

It's easy! All you do is use the Reader Service card at right . . .

HIGH FIDELITY's Reader Service Department will take it from there. It's as simple as 1, 2, 3!

1 Just circle the number on the card that matches the number below the ad or editorial mention that interests you.

You'll also find the key numbers for advertised products in the Advertiser's Index.

2 Then type or print your name and address. Don't forget your zip code, it's important!

3 Drop the card into the mail. No postage is needed if mailed in the United States.

You'll receive literature, colorful brochures and specifications about the products that interest you . . . free and without obligation!

Subscribe today by filling out the subscription order card on the reverse side of this page.

First Class
Permit No. 111
Cincinnati, Ohio

BUSINESS REPLY MAIL

No postage stamp necessary if mailed in the United States

Postage will be paid by—

HIGH FIDELITY

Subscription Dept. 72
P.O. Box 14156
Cincinnati, Ohio 45214



| | | | | | | | | | | | | | | |
|-----|-----|-----|-----|-----|-----|-----|-----|-----|-----|-----|-----|-----|-----|-----|
| 1 | 2 | 3 | 4 | 5 | 6 | 7 | 8 | 9 | 10 | 11 | 12 | 13 | 14 | 15 |
| 16 | 17 | 18 | 19 | 20 | 21 | 22 | 23 | 24 | 25 | 26 | 27 | 28 | 29 | 30 |
| 31 | 32 | 33 | 34 | 35 | 36 | 37 | 38 | 39 | 40 | 41 | 42 | 43 | 44 | 45 |
| 46 | 47 | 48 | 49 | 50 | 51 | 52 | 53 | 54 | 55 | 56 | 57 | 58 | 59 | 60 |
| 61 | 62 | 63 | 64 | 65 | 66 | 67 | 68 | 69 | 70 | 71 | 72 | 73 | 74 | 75 |
| 76 | 77 | 78 | 79 | 80 | 81 | 82 | 83 | 84 | 85 | 86 | 87 | 88 | 89 | 90 |
| 91 | 92 | 93 | 94 | 95 | 96 | 97 | 98 | 99 | 100 | 101 | 102 | 103 | 104 | 105 |
| 106 | 107 | 108 | 109 | 110 | 111 | 112 | 113 | 114 | 115 | 116 | 117 | 118 | 119 | 120 |
| 121 | 122 | 123 | 124 | 125 | 126 | 127 | 128 | 129 | 130 | 131 | 132 | 133 | 134 | 135 |
| 136 | 137 | 138 | 139 | 140 | 141 | 142 | 143 | 144 | 145 | 146 | 147 | 148 | 149 | 150 |
| 151 | 152 | 153 | 154 | 155 | 156 | 157 | 158 | 159 | 160 | 161 | 162 | 163 | 164 | 165 |

• PLEASE TYPE OR PRINT •

NAME _____

ADDRESS _____

CITY _____ STATE _____ ZIP _____

I am a subscriber I am not a subscriber

P 3 4

USE THIS POSTAGE-FREE CARD TO

DOUBLE

YOUR LISTENING
AND READING ENJOYMENT

Now you can enjoy
the best in both musical
worlds — in one colorful magazine:
HIGH FIDELITY/MUSICAL AMERICA.



SUBSCRIPTION ORDER FORM

- Please enter a one year subscription to HIGH FIDELITY/MUSICAL AMERICA in my name. I'll receive 12 issues of HIGH FIDELITY, plus about 32 pages per issue of news and reviews of important musical happenings throughout the world — concert, opera, etc. — for only \$14.
- Please enter my subscription to HIGH FIDELITY only. I want to take advantage of your special offer of 15 issues for only \$9.47.

New Subscription

Payment enclosed

Renewal

Bill me

Name _____

Address _____

City _____ State _____ Zip Code _____

For postage outside U.S.A., Possessions: Add \$1.00 for HIGH FIDELITY/MUSICAL AMERICA subscription (12 months); add \$2.00 for HIGH FIDELITY subscription (15 months).



For the full story of music and music makers today, be sure to include MUSICAL AMERICA as part of your HIGH FIDELITY subscription.

In 32 sparkling pages, MUSICAL AMERICA covers the live musical scene *completely*. You'll get news, reviews and reports of important musical events all over the world — written by critics who know the score and how to write about it with wit as well as authority. You'll meet today's outstanding conductors, composers and performers... learn how they work and live... what they think and say about music — and about each other.

MUSICAL AMERICA adds a new dimension to HIGH FIDELITY — and to your enjoyment of music. Use the postage-free card to start copies coming your way regularly.

(MUSICAL AMERICA is available only by subscription... and only with HIGH FIDELITY. It is not sold on newsstands. Another important reason for you to use the subscription card now.)

First Class
Permit No. 111
Cincinnati, Ohio

BUSINESS REPLY MAIL

No postage stamp necessary if mailed in the United States

Postage will be paid by —

HIGH FIDELITY

P.O. Box 14306
Annex Station
Cincinnati, Ohio 45214

Reader Service 72



Judy Collins uses AR-4x speaker systems in her home. Their smoothness and uncolored musical quality make them an excellent choice.



Folk singer Judy Collins's performances in concert and on Elektra Records are widely known and highly praised. The cabinet in the background contains her AR-4x speaker systems. Although the AR-4x is the

least expensive speaker system offered by Acoustic Research, it is nonetheless built and tested to the same strict standards of craftsmanship and accuracy as apply to other AR speaker systems.



ACOUSTIC RESEARCH, INC.

24 Thorndike St., Cambridge, Mass. 02141, Dept. HF-3

Please send me a free copy of your illustrated catalog, as well as technical specifications and measured performance data for the AR-4x speaker systems.

Name _____

Address _____

All cartridges are different. Empire cartridges are more different than others! Take a technical look for yourself.

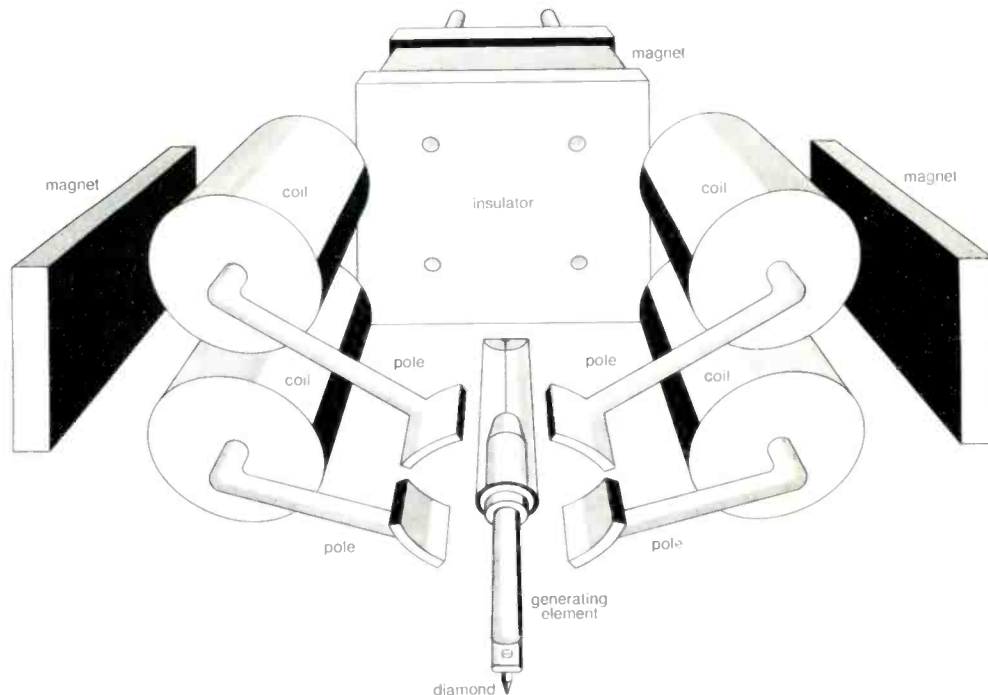

How it works.

If you know how moving magnetic cartridges are made, you can see right away how different an Empire variable reluctance cartridge is. With others, a magnet is attached directly to the stylus, so that all the extra weight rests on your record. With Empire's construction (unique of its type), the stylus floats free of its three magnets. So naturally, it imposes much less weight on the record surface.

Less record wear.

Empire's light-weight tracking ability means less wear on the stylus, and less wear on your records. Laboratory measurements

show that an Empire cartridge can give as much as 50 times the number of plays you'd get from an ordinary cartridge without any measurable record wear! HI-FI SOUND MAGAZINE summed it up very well by calling the Empire cartridge "a real hi-fi masterpiece ... A remarkable cartridge unlikely to wear out discs any more rapidly than a feather held lightly against the spinning groove."

Superb performance.

The light-weight Empire cartridge picks up the sound from the record groove with amazing accuracy. Distortion is minimal. (None at all could be measured at normal sound levels with Empire's

1000ZE/X and 999VE/X.) AUDIO MAGAZINE said of the Empire cartridge "outstanding square waves ... tops in separation." HIGH FIDELITY noted "... the sound is superb. The performance data is among the very best." While STEREO REVIEW, who tested 13 different cartridges, rated the Empire tops of all in light-weight tracking.

X Designates newest improved version.

World Famous Long Playing Cartridges



For further details write:
 Empire Scientific Corp.,
 Garden City, N.Y. 11530. Mid. USA

CIRCLE 30 ON READER-SERVICE CARD

HIGH FIDELITY MAGAZINE

Best Yet from Ampex



The Equipment: Ampex AX-300, an automatic-reverse open-reel three-speed (7½, 3¼, 1½ ips) stereo tape deck, including recording and playback preamps. Dimensions: 16½ by 15 by 8½ inches. Price: less than \$650 with wood case. (Optional RC-204, a remote-control unit with 10-foot interconnect cable for the AX-300 or similarly equipped decks. Dimensions: 6½ by 2½ by 1½ inches. Price: \$39.95.) Manufacturer: Ampex Corporation, 2201 Estes Ave., Elk Grove Village, Ill. 60007.

Comment: This is the most impressive recorder we have yet seen from the Consumer Products group of Ampex. It is unequivocally a consumer product, yet it includes so many features adapted from professional equipment that, despite the convenience of automatic reversing, it can be taken seriously as a hobbyist recorder. In concept and appearance the AX-300 is radically different from anything that has come out of Elk Grove Village in the last few years.

The automatic threading system and dual capstan drive of the earlier premium models has been abandoned along with the styling. The AX-300 has a central capstan flanked by the three heads for forward tape motion (to its left) and those for reverse motion (to the right) which permit monitored recording in both directions. All the controls are on the front panels or sides below the head cover (assuming vertical use of the deck, for which rubber reel hold-downs are supplied). Just below the tape-loading slot are the counter, speed-change switch, recording interlock button, and the main solenoid controls: pause, fast reverse, reverse play/record, stop, forward play/record, and fast forward.

Across the bottom of the panel are the mike and headphone jacks, dual sliders for the mike/aux inputs, and those for the line inputs (also used for sound-on-sound and tape echo). Line inputs can be mixed with mike or aux. Next come the VU meters, a five-position mode switch (which includes special positions for sound-on-sound recording), and a continuously variable noise filter calibrated at 16, 10, 6, and 3 kHz—representing in each case the frequency at which high-end playback response is rolled off by 3 dB. (Lab

tests proved these indications to be very near exact, with typical slopes above the 3-dB points of about 12 dB per octave). Below the last two knobs are a series of switches: output and meter monitoring (source/tape), echo, sound-with-sound/sound-on-sound, reversing signal, automatic operation (out-and-back/continuous), and AC power.

In a well at the left of the deck are screwdriver controls for bias adjustment; in a similar well at the right are those for meter adjustment. On the back are pairs of phono jacks for the inputs and outputs: aux input with screwdriver level controls, line input, tape/source monitor output (depending on the position of the front-panel monitor switch position), and tape-only monitor. Next to this last pair of jacks is a switch that will convert the meters to read source only, regardless of the front-panel monitor-switch position.

The full ramifications of all these controls cannot be dealt with in detail here. Note, however, that the echo circuit can be applied independently to either or both channels of a stereo input arriving via the mike or aux connections; also the sound-with-sound feature does not provide precise syncing (it is intended for language-lab use rather than music) though recording and playback heads are so close together that the lag is barely audible at 7½ ips. The unusually thorough instruction manual provides a number of alternate hookup schemes and explains the relevance of the various control possibilities to each. At first it takes a good deal of thought and care to master the more intricate configurations, but most users will want to standardize on a single basic hookup. Once that is done the controls are relatively easy to use by comparison to those on some multi-feature decks.

So is the remote-control unit, which plugs into a

REPORT POLICY

Equipment reports are based on laboratory measurements and controlled listening tests. Unless otherwise noted, test data and measurements are obtained by CBS Laboratories, Stamford, Connecticut, a division of Columbia Broadcasting System, Inc., one of the nation's leading research organizations. The choice of equipment to be tested rests with the editors of High Fidelity. Manufacturers are not permitted to read reports in advance of publication, and no report, or portion thereof, may be reproduced for any purpose or in any form without written permission of the publisher. All reports should be construed as applying to the specific samples tested; neither High Fidelity nor CBS Laboratories assumes responsibility for product performance or quality.

jack on the back panel (or another beneath the solenoid control panel, as we shall explain) and duplicates all the solenoid controls: pause through fast-forward. These controls handle smoothly and are unusually sophisticated in design for a home unit. The deck includes a memory circuit that operates in combination with a motion sensor on the righthand reel turntable. Let's say you are winding into the tape and want to find a passage on the second side. You press the reverse play button. First the reel brakes are applied; but until tape motion stops altogether the play mode will not be activated. Then the tape lifters and pinch roller push forward and playback begins.

The pinch roller is held in a pivoted mount so that it is self-aligning when it is pressed against the tape and capstan. (The usual arrangement, with a rigidly aligned pinch-roller mount, may not press both edges of the tape with equal firmness, according to Ampex, and can cause problems in using triple- and quadruple-play tapes.)

In the pause mode the capstan continues to turn (aiding fast start-up, which we found unusually smooth for a solenoid-operated deck) and the tape lifters do not retract. As a result the tape can be cued and edited (mechanically or by re-recording) easily in either direction of tape motion. As a further aid to such undertakings, the entire head cover slips off (exposing the clearly marked gap-position indices on the six heads), and by slipping the speed-change knob off its switch shank the entire upper section of the control panel can be removed, leaving ample room around the heads for marking edit points on the tape itself. This is practical only if you have bought the remote-control unit, however, because you otherwise have no way of starting and stopping the tape. The remote unit can be attached to a socket from which you have unplugged the normal control panel in removing it.

The automatic reversing system is the only one in which the AX-300 retains a recognizable feature of previous Ampex home models—the subaudible 20-Hz cue tone. It can be recorded onto any tape by using the spring-loaded button on the front panel. This tone already is recorded on all Ampex Stereo Tapes, of course, which therefore will reverse (or even repeat) automatically on this unit.

CBS Labs' data show the AX-300 to perform unusually well for a home deck, and exceptionally well for one with the automatic-reverse feature. The separate, fixed heads for each direction of tape travel undoubtedly contribute to this excellence. Performance in the two directions is virtually indistinguishable, so we have included graphs and figures only for the forward direction.

Note that the playback curves are for the EIA equalization rather than the NAB specification that we normally use. The two actually are identical except in the extreme bass; at 7½ ips they differ by only 3 dB at 100 Hz, while the difference is even less at 3¾ ips. The AX-300 (and many other new units) appears to be designed to the EIA specification, which presently looks as though it will replace the NAB specification in home equipment. The curves appear to reflect Ampex's "controlled bandwidth" philosophy that response should be as flat as possible, without arbitrary attempts to extend response upward at the expense of over-all linearity, distortion, and noise factors. The AX-300 curves show unusually little tendency to peak at the high end, and they drop off rapidly above maximum useful response.

Considering both features and performance, the new model is among the most exciting to be offered for the open-reel enthusiast in some time. While it makes no attempt at the ultimate in either ruggedness or simplicity of operation, its finish and general construction are good for a home unit and its controls are not difficult to use. At long last it looks as though Ampex has a winner for the serious recordist.

CIRCLE 144 ON READER-SERVICE CARD

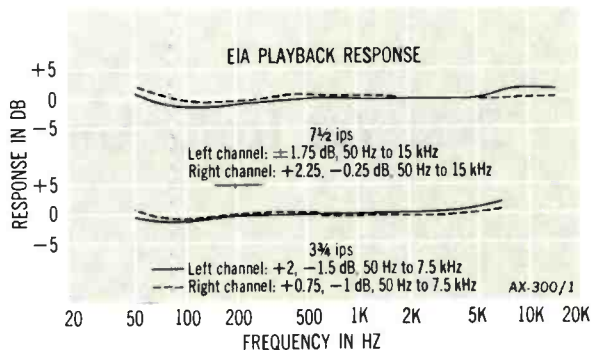

Ampex AX-300 Tape Deck Additional Data

| | |
|--|-----------------------------|
| Speed accuracy 7½ ips | 105 VAC: 0.23% fast |
| | 120 VAC: 0.23% fast |
| | 127 VAC: 0.23% fast |
| 3¾ ips | 105 VAC: 0.53% fast |
| | 120 VAC: 0.53% fast |
| | 127 VAC: 0.53% fast |
| 1⅞ ips | 105 VAC: 0.40% fast |
| | 120 VAC: 0.40% fast |
| | 127 VAC: 0.40% fast |
| Wow and flutter 7½ ips | playback: 0.07% |
| | record/playback: 0.08% |
| 3¾ ips | playback: 0.08% |
| | record/playback: 0.09% |
| 1⅞ ips | record/playback: 0.17% |
| Rewind time, 7-in. 1200-ft. reel | 1 min. 6 sec. |
| Fast forward time, same reel | 1 min. 6 sec. |
| S/N ratio (ref. 0 VU): | |
| playback | L ch: 52.5 dB R ch: 54.0 dB |
| record/playback | L ch: 50.5 dB R ch: 51.5 dB |
| Erasure (400 Hz at normal level) | 55 dB |
| Crosstalk (at 400 Hz) | |
| record left, playback right | 54.0 dB |
| record right, playback left | 52.5 dB |
| Sensitivity (for 0-VU recording level) | |
| line input | L ch: 51.0 mV R ch: 51.0 mV |
| aux input | L ch: 14.0 mV R ch: 15.0 mV |
| mike input | L ch: 0.43 mV R ch: 0.43 mV |
| Accuracy, built-in meters | externally adjustable |
| IM distortion (record/play, -10 VU) | |
| 7½ ips | L ch: 2.3% R ch: 2.0% |
| 3¾ ips | L ch: 3.5% R ch: 3.0% |
| 1⅞ ips | L ch: 4.0% R ch: 4.0% |
| Maximum output (preamp or line, 0-VU) | |
| | L ch: 0.6 V R ch: 0.6 V |

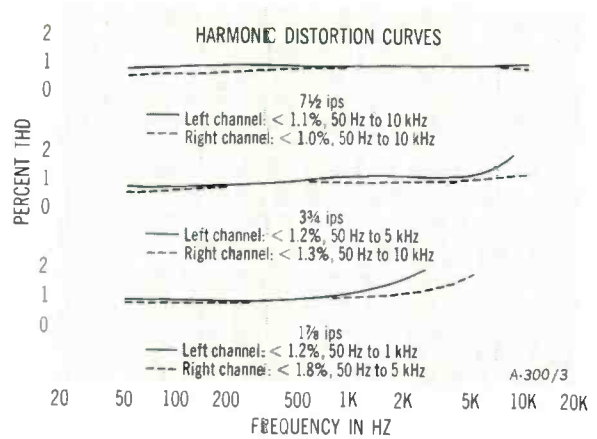
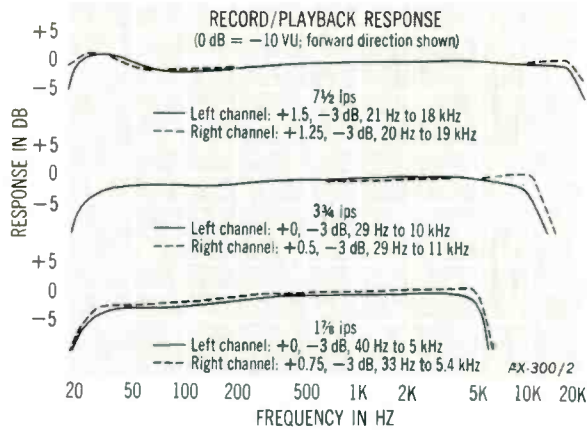

Excellent Value in Sony Receiver

The Equipment: Sony STR-6045, a stereo FM/AM receiver. Dimensions: 15 3/4 by 5 1/4 by 11 1/4 inches. Price: \$237.50. Manufacturer: Sony Corporation, Japan; U.S. distributor: Sony Corp. of America, 47-47 Van Dam St., Long Island City, N.Y. 11101.

Comment: The Sony STR-6045 is impressive—one of the best receivers we have seen in the under-\$250 bracket. The finish of the front panel and knobs is appealingly suggestive of careful manufacture, while measured performance confirms that the appeal is more than skin deep.

A double, clutched volume/balance knob and the tuning knob flank the AM/FM dial with its single (signal-strength) tuning meter and stereo indicator. Below these elements are the power switch, headphone jack (live at all times), speaker switch, loudness and high-filter switches, bass and treble controls, mode and monitor switches, and the rather complex selector group: a knob for automatic-stereo FM, mono FM, and AM, and a three-position switch to select either the tuner (via the knob control), phono, or aux.

On the back panel are thumbscrew terminals for 300-ohm FM antenna lead, long-wire AM antenna, and ground. Screwdriver terminals are used for the output

to two pairs of speakers. The front-panel switching permits the two pairs to be used simultaneously, individually, or not at all—as in headphone listening. There are phono inputs for magnetic phono, aux, and tape monitor, and similar connections for the output to a tape recorder. There also is an unswitched AC convenience outlet.

So far the 6045 is fairly Spartan. Almost all of its features are virtual necessities in most stereo systems, but all the important controls are there (unless you consider a center-of-channel FM tuning meter to be particularly important).

The amplifier section, at an honest 25 watts per channel, has more muscle than you would expect in a budget receiver these days and certainly is adequate for almost any pair of moderate-priced speakers in most rooms. When this power rating is compared to distortion figures, however, we are reminded of more expensive equipment. Both IM and THD run under 0.5%—often well under 0.5%—over most of the unit's operating range. Power bandwidth is excellent; frequency response is not ruler-flat, but its variations across the audible range can hardly be considered excessive. S/N ratios—in both amplifier and tuner sections—are more than adequate. Full-range THD figures are <0.41% (<0.35%

in the right channel) at 25 watts, <0.19% (<0.16% in the right channel) at half power.

It is in the tuner section, particularly, that the Sony behaves like a more expensive unit. The quieting curve descends unusually steeply, dropping below the 44-dB point (maximum quieting on many budget units) before input has reached 10 microvolts. Beyond 10.5 microvolts the quieting is at least 45 dB and reaches maximum at 47 dB in a broad input range centered around 1,000 microvolts. Sensitivity is excellent, for the price, at 2.3 microvolts; capture ratio, at less than 2 dB, is excellent for any price class.

The FM response curves are particularly unusual. Not only are they very flat, but the stereo response in the two channels is so close that the two curves cannot be distinguished. Even the separation curves are almost identical. This matching of the two channels, while not particularly important in itself, again suggests a care in manufacture that we seldom encounter even in relatively expensive equipment.

Our FM cable tests demonstrate the importance of the 6045's steep quieting curve. We received about forty stations, which is close to par; but 31 of them were judged appropriate for long-term listening or recording—an unusually narrow spread. All things considered, the STR-6045 must be rated as a top receiver in the moderate-cost field, and one that should be considered carefully even by purchasers who can afford to spend more.

CIRCLE 143 ON READER-SERVICE CARD

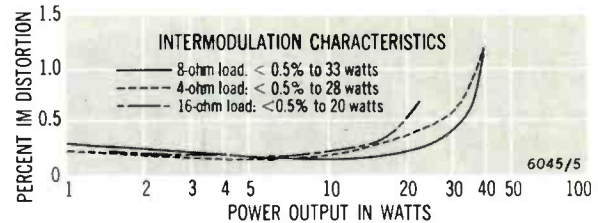
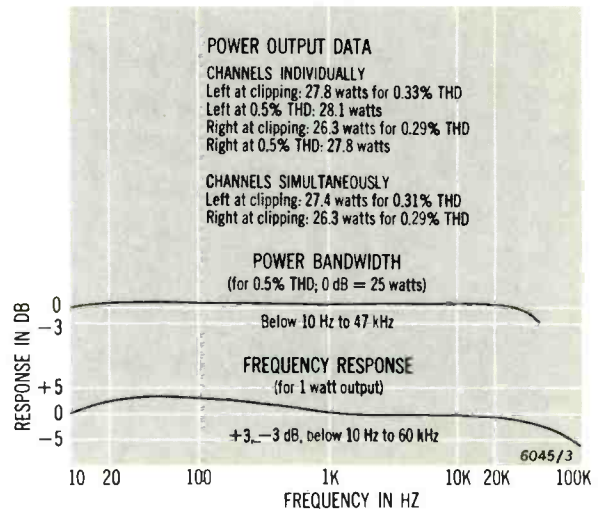
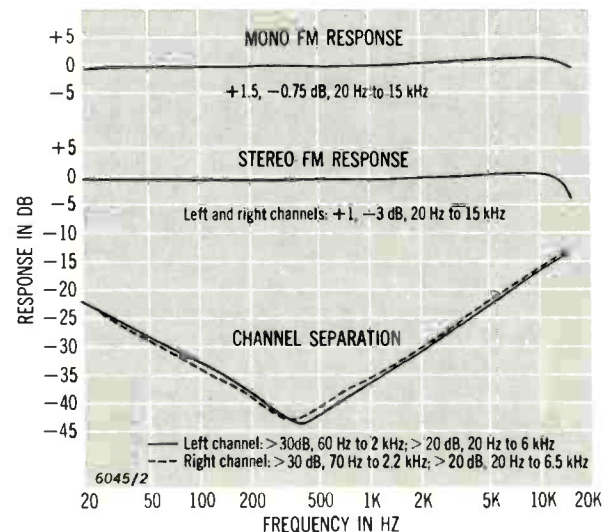
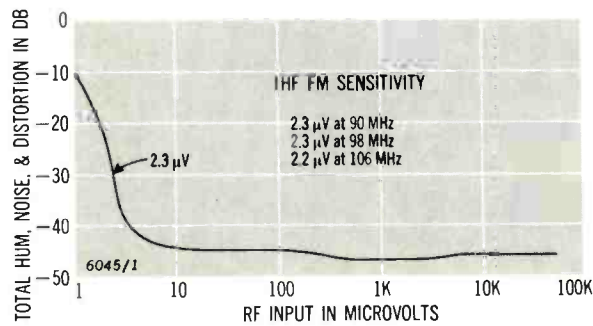

Sony STR-6045 Receiver Additional Data

| Tuner Section | | | |
|---|-------------|-----------|-------|
| Capture ratio | 1.7 dB | | |
| Alternate-channel selectivity | 78.0 dB | | |
| S/N ratio | 68.5 dB | | |
| IM distortion | 0.6% | | |
| THD | Mono | L ch | R ch |
| 80 Hz | 0.16% | 0.45% | 0.33% |
| 1 kHz | 0.55% | 0.54% | 0.52% |
| 10 kHz | 0.30% | 4.3% | 5.0% |
| 19-kHz pilot | -58 dB | | |
| 38-kHz subcarrier | -66 dB | | |
| Amplifier Section | | | |
| Damping factor | 30 | | |
| Input characteristics (for 25 watts output) | | | |
| | Sensitivity | S/N ratio | |
| phono | 3.5 mV | 65.0 dB | |
| tape | 220 mV | 77.0 dB | |
| aux | 425 mV | 61.5 dB | |

REPORTS IN PROGRESS

Sherwood SEL-300 tuner
Harman-Kardon CAD-5 cassette deck
Marantz 2270 receiver



If you're getting into 8-track this Wollensak 2/4 channel deck deserves your stereo system

All four channels of the new Wollensak will help keep your stereo system as updated tomorrow as it is today.

True quadrasonic sound coming right at you and all around you through your 4-channel system.

If you're already into 8-track with a unit in your car, this Wollensak 8054 pre-amp deck also plays your present 2-channel stereo cartridges. Either way, its precise engineering and component design make it a perfect match for your stereo system. And a sound 4-channel investment for its future.

With the Wollensak 8054's fast-forward control, you can

quickly find the selection you want to hear. This deck also features a special channel selector key, automatic programming for 2-channel or 4-channel playback, illuminated program and track indicators and special long life high torque AC motor. Full frequency response is rated at 30-15,000 Hz with a truly outstanding signal-to-noise ratio of 52 db.

Sound expensive? Not at all. This 4-channel deck is so reasonably

priced, you won't have to wait any longer to enjoy true quadrasonic sound.

Nobody knows more about sound-on-tape or has more experience in tape recording than 3M Company.

So, make tracks to your nearest dealer and hear why the Wollensak 8054 deserves your stereo system.

Wollensak 3M
COMPANY
3M CENTER • SAINT PAUL, MINNESOTA 55101



ADC Modifies Its 303 Speaker System

The Equipment: ADC 303B, a compact full range speaker system in enclosure. Dimensions: 21½ by 11¾ by 10 inches. Price: \$80. Manufacturer: Audio Dynamics Corp., Pickett District Rd., New Milford, Conn. 06776.

Comment: Sometimes it seems as if speaker manufacturers have more fun than anybody. They can take drivers and crossovers and experiment with them in various configurations and in different sizes and styles of enclosure, a kind of audio-exploratory activity plainly beyond the ability of most of us plain mortals. By way of which, here is ADC's new bookshelf speaker system, the model 303B, which employs the same elements as the earlier model 303AX (see HF test report, March 1970) but in a slightly smaller cabinet and minus the tweeter level control. The result is a price reduction of \$20 (the 303AX now costs \$100) and a slight reduction in output of the extreme bass.

Supplied in an oiled-walnut sealed enclosure, the 303B is an air-suspension system using a high-compliance woofer nominally 10 inches in diameter. This unit is crossed over gradually via an internal network (nominal dividing frequency is 1,500 Hz) to a small cone tweeter, the latter element being viscous-impregnated and having an effective radiating surface of 1½ inches. Rated input impedance is 8 ohms, and recommended power is at least 10 watts (sine-wave power) per channel. The 303B, which weighs about 33 pounds, may be positioned horizontally or vertically.

Frequency response data taken at CBS Labs shows an average omnidirectional response within plus or minus 6.5 dB from 40 Hz to 17,000 Hz, which is a very good mark for a speaker in the \$80 price class. On audible test tones we detected some doubling at about 75 Hz, a bit more at 50 Hz, and then a gradual rolloff in level to just about 35 Hz. Obviously, the useful response of the 303B does indeed make the 40 Hz claimed for it by the manufacturer. The upper midrange sounds relatively bright but with good transient definition. Moderately directional effects do not become evident until above 8,000 Hz, and they do not become more pronounced as you up the scale; tones out to 12,000 Hz remain clearly audible well off-axis; tones above this frequency sound stronger more on axis, with an obvious slope to inaudibility beginning at just above 16,000 Hz. White noise response is generally smooth, with a trace of midrange emphasis and some directivity.

A fairly efficient speaker, the 303B needed only 3.5 watts to produce an output level of 94 dB, and it could take steady-state power inputs up to 100 watts without buzzing or distorting excessively. At the 100-watt input level, it produced an output of 105 dB. This data indicates the 303B's ability to work well with the great ma-

jority of amplifiers and receivers on the market; it also testifies to a good dynamic range. Pulse tests at both low and high frequencies show excellent transient response except for a slight ringing at 3,000 Hz which doubtless contributes to the brightness sensed in the upper midrange. The loudspeaker's impedance curve averages slightly higher than 8 ohms across the audio band, with the characteristic low-frequency dip occurring at 6.4 ohms. On the basis of this data, plus actual use-tests, we would say that the 303B is safe for hook-ups with other similar impedance loudspeakers in multiple arrays driven from the same solid-state amplifier or receiver.

All told, the 303B is a generally smooth, well-balanced, uncolored reproducer that is very reminiscent of the 303AX except for the few bass tones in the 35 to 40 Hz region that the 303AX projects more forcefully. A pair of 303Bs, on stereo or mono, can fill an average-size room with very listenable sound, and their relatively compact size and moderate weight should enable them to be positioned in any number of possible locations.

CIRCLE 145 ON READER-SERVICE CARD

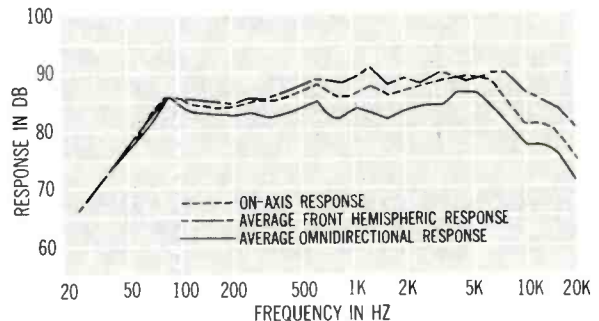

ADC 303B Harmonic Distortion^a

| Output Level (dB) | Frequency | | | |
|----------------------|-----------|-------|--------|-------|
| | 80 Hz | | 300 Hz | |
| | % 2nd | % 3rd | % 2nd | % 3rd |
| 70 | 0.17 | 0.25 | 0.10 | 0.17 |
| 75 | 0.25 | 0.40 | 0.17 | 0.18 |
| 80 | 0.43 | 0.62 | 0.75 | 0.19 |
| 85 | 0.67 | 1.10 | 0.45 | 0.52 |
| 90 | 0.95 | 1.70 | 0.85 | 0.70 |
| 95 | 1.50 | 2.70 | 1.30 | 0.75 |
| 100 | 3.50 | 4.50 | 2.50 | 0.60 |
| 105 | — | — | 3.50 | 0.65 |

^aDistortion data is taken on all tested speakers until distortion exceeds 10 per cent level, or the speaker produces the spurious output known as buzzing, whichever occurs first.



Dolby by Teac

The Equipment: Teac AN-80, a Dolby noise-reduction unit. Dimensions: 3½ by 16 by 10¾ inches. Price: \$149.50, including open-reel and cassette test tapes. (Also: AN-50, a similar unit specifically for use with Teac A-23 and A-24 cassette decks. Dimensions: 3 by 5½ by 9 inches. Price: \$64.50.) Manufacturer: Teac Corp., Japan; U. S. distributor: Teac Corp. of America, 7733 Telegraph Rd., Montebello, Calif. 90640.

Comment: The Dolby "B" circuit (as we all know—or should know—by now) reduces tape hiss and other high-frequency noise by compressing dynamic range in the upper frequencies during recording and re-expanding it during playback. It may be used in making and reproducing one's own Dolby tapes or in playing commercially produced Dolby cassettes. It also can be used to "decode" Dolby-processed FM broadcasts, though few stations have adopted the Dolby broadcast technique so far and then only on an experimental basis.

The AN-80 and AN-50 each contains a pair of Dolby circuits, one per channel. The units have a no-nonsense appearance, with black front panels and metal cases. The controls on the AN-80 are divided into several groups. On the left are the recording level controls (one for each channel), then the recording calibration controls: a spring-loaded pushbutton to trigger the 400-Hz test tone, and screwdriver level adjustments for each channel. Next are four switches: left-channel play/record, right-channel play/record, Dolby on/off, and meter signal selector (left/right). Since the meter, which is to the right of these switches, is used only for calibration purposes, no simultaneous left-plus-right metering is necessary. After the meter comes a recording-check pushbutton, then the playback-calibration screwdriver adjustments for each channel, and finally the power on/off switch.

The recording-check button allows you to make use of the monitor head if the recorder you are using has one. During recording, with your amplifier or receiver switched to tape monitor, you normally will hear the incoming signal fed back to the monitor connections by the AN-80. When you press the spring-loaded recording-check button the output of the playback head will be heard instead. But since the mode switches on the AN-80 will be set for recording, the Dolby action will be effective in the recording—rather than the monitor-circuit, so the playback output you hear will not be Dolby-corrected. As a result, tonal balance cannot be checked with this switch, though you will be able to tell if there is a serious malfunction in the recording.

The AN-80 has no provision for mike inputs. Since mike connections on the recorder will bypass the Dolby circuitry, live sounds fed to the AN-80 for Dolby processing must come via your stereo system's amplifier or receiver.

The AN-50 is very similar, eliminating all features of the AN-80 that are unnecessary when used with Teac's

own non-Dolby cassette decks. Its controls are in two groups—record-level knobs for each channel on the left and on the right a group of switches: record calibrate on/off, mode (record/play), Dolby on/off, and power on/off. On the back there is another switch, matching the level of the deck to be used (high for the A-23, low for the A-24) to the Dolby operating level of the AN-50.

The basic circuitry of the AN-80 and AN-50 being alike, we used only the AN-80 for our lab tests. A Dolby-level signal proved to be 0.46 volts at the AN-80's line connections—a comfortable figure with most tape equipment. The frequency-response curves show the effect of 19-kHz filtering to keep any FM pilot signal at that frequency from being audible and interfering with the level-sensitive Dolby circuit. Some units include a filter that is switched in only while recording from FM; the AN-80 has a fixed filter for this purpose. It reduces response at the pilot frequency by some 10 dB, but also decreases a 15-kHz audio signal (the top frequency of merit in FM broadcasting and indeed the top limit of hearing in most adults) by about 1.5 dB. Therefore while the curves are not as flat as one would desire in, say, a preamplifier, they are close to flat and excellent for Dolby purposes. And—except at the extreme top—expansion during playback comes within 1 dB of matching compression during recording.

Harmonic distortion in the AN-80 runs lower than that to be expected even in a first-class tape recorder. CBS Labs measured it at less than 0.7% in the upper midrange, with average values of around 0.4% above and below that range. Channel separation and over-all S/N ratio both are more than adequate.

The AN-80—even used with a tape deck having a monitor head—will do almost everything that a full Dolby unit (one with simultaneous Dolby monitoring) will do, but at a somewhat lower price. (Teac's AN-180, with provision for Dolby monitoring, costs about \$320.) The AN-80 will do an admirable job of adding Dolby processing. So will the AN-50, buy only for those who plan to use it with Teac's non-Dolby cassette decks of course.

CIRCLE 141 ON READER-SERVICE CARD

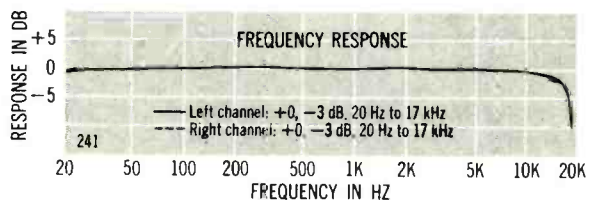

Teac AN-80 Dolby Processor Additional Data

| | | |
|--|---------------|---------------|
| Sensitivity (record Mode; 400 Hz at Dolby level) | L ch: 28.5 mV | R ch: 28.5 mV |
| Output (400 Hz at Dolby level) | L ch: 0.46 V | R ch: 0.46 V |
| S/N ratio (ref. Dolby level) | 67 dB | |
| Max. noise reduction (record/playback, -40 VU) | | |
| at 1 kHz | 5.5 dB | |
| at 10 kHz | 11 dB | |
| Channel separation | 55 dB | |

Crown's Latest Superamplifier



The Equipment: Crown International D-150, a stereo power amplifier. Dimensions: 16½ by 5 by 8 inches. Price: \$399; optional decorative front panel, \$30; optional wood case, \$33; rack-mount panel also available. Manufacturer: Crown International (Div. of International Radio & Electronics Corp.), Box 1000, Elkhart, Ind. 46514.

Comment: Whether one should consider Crown International to be a manufacturer of consumer equipment that meets or surpasses professional standards, or as a professional-equipment manufacturer that is yet willing to cater to the more demanding portion of the consumer market, is a moot point. Once again the company has given us a unit that will be of intense interest to private users whose prime concern is the best possible reproduction of music in the home.

The basic amplifier looks formidable when you first unpack it: an irregular black hulk with only four rubber feet to tell you which side is supposed to be the bottom. It can be connected and hidden away without further embellishment or it can be dressed more formally in its wood case and tailored faceplate, which is styled to match the appearance of Crown's IC-150 preamplifier (HF test reports, December 1971). There are no controls or connections on the faceplate. At the back are two phone jacks for the inputs (each coupled to a screwdriver level control) and a set of output connections that can be used as binding posts but will also accept single or double banana plugs. Accessory fuseholders also are supplied, together with complete instructions for fusing the speaker leads—a setup recommended by Crown and highly desirable in view of the D-150's high power capability. The fusing and the input level controls work together to protect the speakers.

As in testing the IC-150 CBS Labs found itself working close to the limits of its test equipment. Every harmonic distortion measurement the lab made—even those for extremely low output power—was below 0.05%. Were

the figures ten times as high we would still consider them to be excellent in most equipment. At half power most of the figures are below 0.02%.

In measuring IM distortion, many readings fell below the 0.01% limit of the test equipment. The curve for 8-ohm loads is particularly spectacular, staying below 0.02% everywhere from the milliwatt output range right up to the limits of power output at 104 watts. And although the curve takes off steeply from that point, IM distortion at 113.4 watts still is under 0.1%—again no more than a tenth of the values one would expect in terms of normal "excellence." In order to represent these figures graphically we had to expand the vertical IM scale (otherwise the curves would have been squeezed against the bottom of the graph) and compress the horizontal power scale (which normally runs only to 100 watts). The finely dotted portions of the curves indicate the borderline areas where the test equipment is close to its limits; where the curves are discontinuous, the values are immeasurably low.

In all respects this is an amplifier that beggars the usual terms of reference in home equipment; a superlative achievement.

CIRCLE 142 ON READER-SERVICE CARD

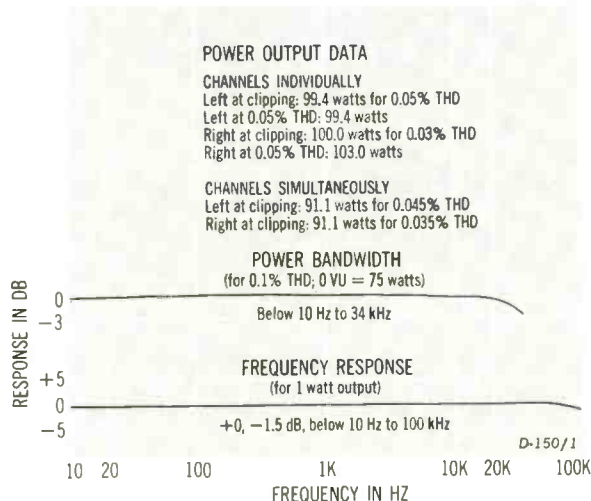
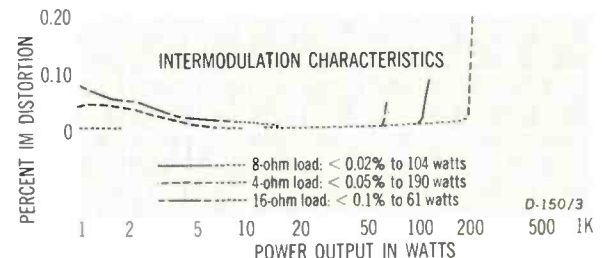
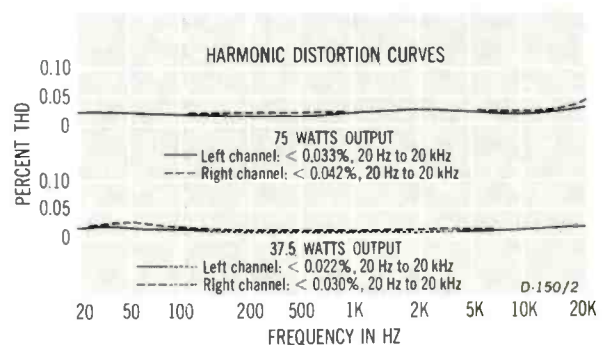

Crown D-150 Amplifier Additional Data

| | |
|---|---------------|
| Damping factor | more than 100 |
| Input characteristics (for 75 watts output) | |
| Sensitivity | 1.2 V |
| S/N ratio | 103 dB |

CIRCLE 16 ON READER-SERVICE CARD →

it really comes alive...

It would be silly to ask if you dig real live sound. Of course you do. The same holds true for **quality** — for things that are **really** made, and **really** perform.

Our objective in developing the B-301 (**Tempo 1**) was to give you the best, most lifelike sound obtainable, in a well-engineered, well-constructed bookshelf system. The fact that performance fully met expectations, and that we could furnish full-fledged BOZAK construction quality for a modest price, were the real measures of its success.

The BOZAK B-301 is a three-way system based on a long-throw, high-compliance bass driver with a solid low-bass response. The high-compliance midrange unit with its well-damped aluminum cone was developed especially for this loudspeaker system: its clear definition, or transient response, is remarkable and we know of no other that can equal it. The latest version of the BOZAK high-frequency driver, originally introduced over twenty years ago, is highly regarded for its wide dispersion and silky-smooth response. All three drivers are of standard BOZAK quality — sturdily constructed, with generous magnet structures and unique BOZAK-made cones assembled on solid cast frames.

You will have to compare this speaker system to really appreciate it. And its price is very modest — especially for a real BOZAK!

the facts:

Bass Speaker: 12" high-compliance, long-throw/**Midrange:** 4½", with 2⅝" damped aluminum cone on high-compliance suspension/**Treble:** 2", with foam-damped diaphragm and wide dispersion/**Crossovers:** 1200 and 3600 Hz
Frequency Response: 40-20,000 Hz

Impedance: 8 Ohms/**Power Handling:** 40 Watts

Program average/**Acoustical-Environmental Switch:**

3-position/**Enclosure:** oiled walnut, 14½" x 23⅞" x 11½" deep

Grille: snap-out/**Weight:** 40 pounds.



Bozak, Darien, Connecticut, 06820
Overseas Export by Elpa Marketing Industries Inc.,
New Hyde Park, New York, 11040, USA



there's nothing

What's Wrong with Tape Cartridges and Cassettes?

Their basic principles may have been faulty from a high fidelity viewpoint, but the defects have now been engineered out of them.

by Herbert Friedman

WHEN THE EDITORS of HIGH FIDELITY asked me to write an article about all that's wrong, technically speaking, with the convenience tape formats—meaning endless-loop cartridges and cassettes—I jumped at the idea. It seemed to give me carte blanche to poke holes in a couple of sacred cows (assuming that commercial success bestows sanctity), and each of us likes to think he has a little of the matador in him.

In the quiet of my workshop the project started to look a little different, however. It's true that I've seen a lot of cassette and cartridge equipment that I would recommend only as a form of revenge; but going over the samples of the latest and the best on my workbench I found it impossible to make a case against the formats, as formats, stick. For every shortcoming there was at least one exception. And the more I considered, the more I became convinced that we really are faced with a state of the art in which cassette and cartridge equipment can be called high fidelity without qualification or reservation. The real story, then, is not what's wrong with convenience tape formats, but what's right with them.

It's difficult to imagine really good performance from the convenience formats because both started out as compromise designs far removed from any thought of use in really high-quality sound systems. The eight-track cartridge, the most difficult to bring up to high fidelity standards of wow and flutter, originated as a cheap imitation of the broadcaster's cartridge system. The tape drive mechanism was intended for automobile installation at prices well under \$100. Hence it was stripped down to the bare essentials: a head, a capstan drive, and some means to move the head from track to track. The capstan pinch roller was placed inside the cartridge itself to avoid a complex mechanism of the older pop-up roller, and the entire drive system depended on a small spring that forced the cartridge forward,

pressing the pinch roller against the capstan. The idea of depending on the cartridge itself to provide proper pinch-roller pressure is something of a mechanical disaster: under best-case conditions the eight-track cartridge produced around 0.3% wow and flutter.

The mechanically similar broadcast cartridge system, using the best available lubricated tape and rather expensive electronics, provided some 50 dB of signal-to-noise ratio even on the equivalent of four tracks. Dividing down to eight tracks on cheaper tape, and cutting a few dollars off the cost of the electronics resulted in a best-case signal-to-noise ratio of 35 dB—a value unacceptable for critical listening (though it might be satisfactory in a moving vehicle where the ambient noise level is almost a roar).

The cassette system fared even worse from the high-fidelity viewpoint because it was never intended for the recording of music. It started out as a portable mono system with wow-and-flutter and frequency-response standards appropriate only for speech use. The low tape speed of 1 7/8 ips, the reduced width of the tape, and the lack of a supply-reel holdback seemed to put a very low ceiling on further development, limiting quality and promising frequent sound dropouts and tape alignment problems. Also, the mechanical motion needed to get heads and pinch roller into position once the cassette had been dropped into the machine ran exactly counter to the basic tenet of recorder design: Make everything rock-steady at the heads, then align the rest of the system to suit.

Unfortunately for the sales of reel machines, the public was ready to buy convenience even without high fidelity; but it also seemed stereo crazy. One of the hottest selling consumer items became the automobile eight-track stereo system, for which an enormous catalogue of pops and light music was created. Once motorists had a substantial invest-

ment in eight-track cartridges, the next logical purchase was a device that could play the cartridges through a "console hi-fi" or a component system. But though second-class sound could be tolerated in a car, it could not through \$500 worth of stereo gear.

Meanwhile the younger set was having a ball with the \$29.95 cassette player: and like cartridges, cassettes created their own demand for quality home equipment—both for playback and for recording. The cassette system faced a more difficult upgrading task than eight-track.

Upgrading eight-track

The basic problem of the eight-track cartridge—the pinch roller built into the cartridge—cannot be mitigated; therefore the only way to hold wow and flutter to acceptable limits is to beef up the capstan drive so that it, at least, does not add to the problem. This is easily accomplished through an induction or hysteresis motor and a relatively heavy flywheel. The fact is, a modern eight-track or Q-8 machine can hold wow and flutter to 0.25% (assuming the cartridge isn't damaged), and 0.25% is an acceptable value for many a good automatic turntable.

Frequency response is not a major problem. Fairly good response has been available at 3¼ ips for a long time: all it takes is good electronics. The remaining problems are signal-to-noise ratio and tape skewing. Improved electronics and tapes have made their contribution toward improved S/N ratios. Noise is easily handled by Dolby processing, of course, and while the technique is not presently employed in eight-track cartridges, it would be no more difficult to do so than it would in cassettes. Considering the large number of eight-track receivers scheduled for introduction this year it would be unwise to assume that Dolby circuitry, whose manufacturing cost is being reduced by the use of integrated circuits, will not be used in the near future.

The skewing of eight-track tape is due primarily to the cartridge design. As the tape feeds out of the cartridge there is plenty of room for it to twist and slip out of the ideal path. The result is that the tape skews across the head causing frequencies from about 8,000 Hz up to drift in and out of alignment and producing a sort of sh-oo-shing sound. Skewing has been eliminated in broadcast cartridge systems through the use of tape guides at the head, and you now can find even moderate-cost eight-track cartridge mechanisms with guides that protrude into the cartridge itself.

Many eight-track cartridge players and recorders deliver response to 12,000 Hz; reaching 15,000 Hz is simply a matter of a good playback head and precise tape guides. Thus, since it had the inherent capacity for high fidelity recording and repro-

duction, the eight-track cartridge has evolved from a "cheapie" source of prerecorded music for the motorist into a home music system featuring full frequency response, acceptable wow and flutter, and a signal-to-noise ratio equal to or approaching that of most home reel recorders.

Cassettes were a headache, but . . .

The original cassette player had nothing going for it as a hi-fi component. Primarily, I think, the problem was caused by the Philips specifications, which left little room for modifications. (Philips—represented by Norelco in this country—invented the cassette, licenses all manufacturers of cassettes and cassette equipment, and understandably insists on uniformity and interchangeability of the products manufactured under that license.)

The first major overhaul of the cassette system was the motor drive. Early cassette recorders used battery-powered DC motors. Usually an optional AC power supply was available, one that plugged into a wall outlet and into a jack built into the recorder: but even with a good regulated power supply, it was still the same lightweight DC motor.

Early so-called hi-fi cassette recorders employed the same basic drive system and simply improved the electronics. This arrangement was used as late as 1971, and though it worked, the slightest extra tape tension—due, typically, to binding of the tape within the cassette—was sufficient to change the drive speed. Simply upgrading the cassette's drive motor to an induction or hysteresis type was enough to insure a constant drive speed—say, 0.2% to 0.25% wow and flutter, an acceptable value. A relatively large flywheel could also be used to bring tape-motion specifications up into the high fidelity range. In some late-model cassette recorders a beefed-up motor and/or flywheel puts the wow and flutter in the 0.15-to-0.2% range, and that's high fidelity by any standards.

For the true perfectionist there is the closed-loop or dual-capstan drive adapted from high-performance data processing tape equipment, with wow and flutter in the 0.1-to-0.15% range. The extra capstan, which is slightly smaller (and therefore drives the tape a shade slower) than the main capstan is positioned on the opposite side of the record/play head, which therefore is flanked by the two capstans. Sony/Superscope and Ampex both offer units of this type at present. Aside from providing a steadier tape drive than conventional designs, it causes a tight wrap around the record/play head, producing sharply reduced sound drop-outs and less tape skewing, which in turn increases the potential for extended high-frequency response.

Unfortunately the basic cassette drive is a total mechanical system that is prone to wear. Even a machine that is well above average when it's new

can produce intolerable speed variation after a few months of heavy use. To avoid wear problems, the best of the new high fidelity models now employ a heavier deck, solenoid operation, and even multi-motor drive systems. The Panasonic RS-275US, for example, has a brushless DC capstan motor plus a separate hub-drive motor. None of these factors contribute much to improved performance; they rather insure that the performance level will remain constant even under heavy use.

Getting the electrical performance of cassette equipment up to high fidelity standards was the

same as starting from scratch because there was no foundation on which to build. First there was the inherent limitation imposed by the tape speed. In spite of a few noble attempts in rather expensive reel recorders, 1 $\frac{7}{8}$ ips could not be considered potentially a high fidelity medium with available tape. Top frequency response (at the -3-dB point) fell somewhere in the 5,000-to-8,000-Hz range. More important, noise levels were typically 35 dB below 0 VU, which is only 25 dB below average sound levels: a very loud hiss indeed. Finally, there

Continued on page 52

The New Cassette Tapes

Key to Performance in the New Recorders

While I was working on the accompanying article, a terrific new piece of test equipment came my way—a sweep generator and oscilloscope system that allows me to run off the whole audio-frequency spectrum on a sample of tape and observe the results, comparing one setup directly with another. Don't get me wrong: This method won't give you comparative tape tests. There's too much that it doesn't show—distortion and S/N in particular. But what it does show it shows clearly, and it demonstrates a number of points made in the article.

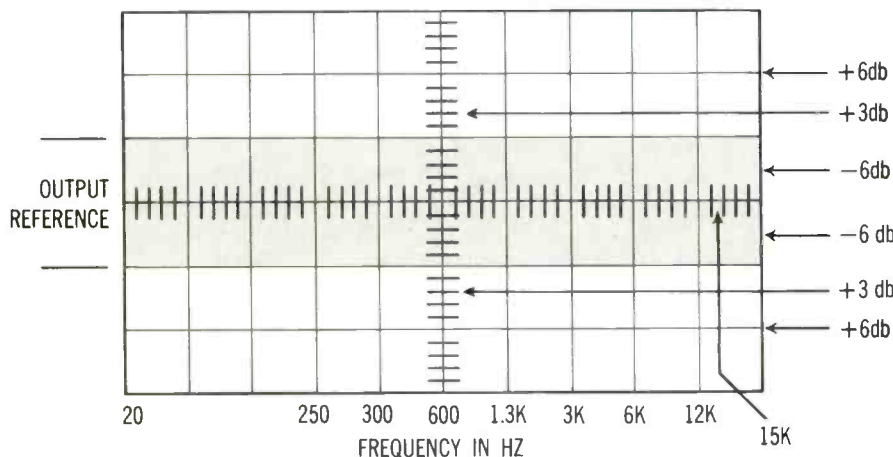

Here's the basic "scope" grid pattern marked off to help you "read" the scope pictures that will follow. Frequency check points below 1.3 kHz are accurate to within 50 Hz; those above 1.3 kHz, to within 300 Hz. The photograph next to the grid drawing is the basic sweep-generator signal before it is recorded on tape.

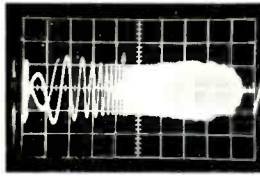

TDK SK, Teac 350, -20 VU

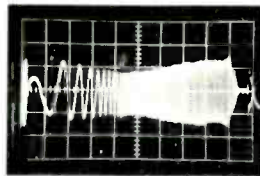

Maxell UD, Teac 350, -20 VU

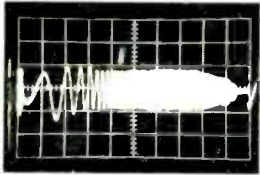

Keystone, Teac 350, -20 VU

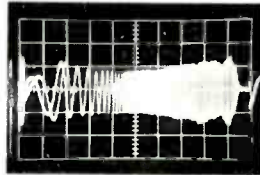

Lafayette UD, Teac 350, -20 VU

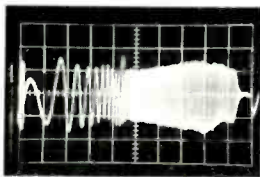

Memorex CrO₂, Teac 350, -20 VU

This group of photographs shows the performance of several different tapes, all recorded on a Teac 350 at -20 VU with the Dolby circuit turned off. The playback was adjusted so that the midband output of the TDK SD sample provided the reference level. Notice that although all the samples are roughly comparable in the midrange, they differ considerably at the high end—in both response levels and in -3-dB frequency limits. All of the major-brand tapes easily reach 12 kHz; the Keystone tape (sold in camera stores) barely makes it to 8 kHz. Dropouts show up as "niches" at the edges of the sweep envelope, though they are somewhat blurred due to the fact that I photographed two successive sweeps in each case in order to get a good, strong image. Remember that each picture represents only one small portion of a single cassette. Results can vary from one part of a cassette to another or from one batch to another of the same brand and type. The better the tape, the smaller the variations; but that's something a single picture can't document. The point here is if you choose the right tape for your machine you can get response that is both wide-range and flat; another equally "good" type can play tricks on you.

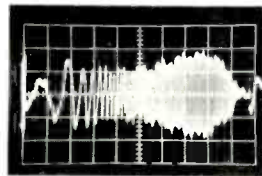

Maxell UD, Sony 160, -20 VU

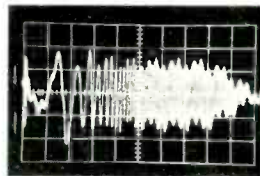

Keystone, Sony 160, -20 VU

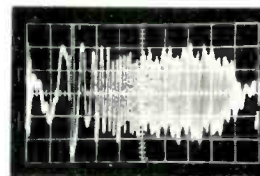

Lafayette UD, Sony 160, -20 VU

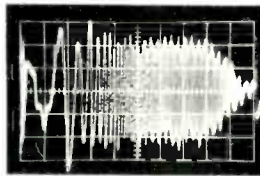

TDK SD, Sony 160, -20 VU

Those tricks will depend on the bias setting and equalization of the recorder, among other things. This set of pictures, made with the same tapes as before and at the same level, but on a Sony TC-160, helps to show what I mean. The traces in this group are somewhat smeared by noise and extraneous oscillation in my test hookup; the rough edges are not dropouts and are totally unrelated to the performance of the Sony. Here I set the reference level to the midband of the Maxell UD. Notice particularly that although the Maxell and Lafayette traces were almost identical on the Teac they are quite different on the Sony. With this recorder the Lafayette has 6 dB more output in the midband and flatter response.

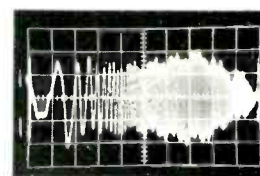

Memorex CrO₂, Sony 160, -20 VU

This time I used a Wollensak 4750 with the TDK and Maxell samples, again setting recording levels at -20 VU. With both the Teac and the Sony, the TDK showed a flatter response than the Maxell. Now the traces are almost identical.

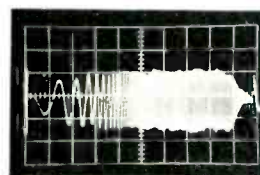

TDK SD, Wollensak 4750, -20 VU

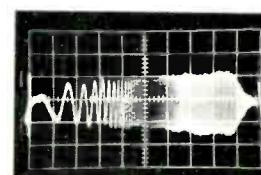

Maxell UD, Wollensak 4750, -20 VU

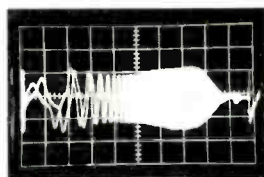

Maxell UD, Teac 350, 0 VU

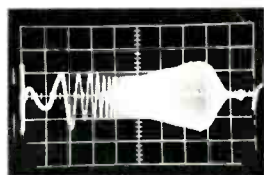

Maxell UD, Sony 160, 0 VU

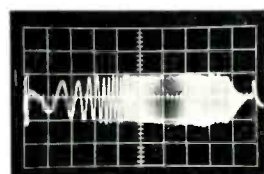

Maxell UD, Wollensak 4750, 0 VU

Here I took the same three recorders and ran the Maxell UD sample through again at 0 VU instead of -20 VU, adjusting the scope for equal midband response in each case. Now we begin to see how tape saturation limits frequency response at high recording levels. At the bass end of the Teac trace we also see the distortion (as "spiked" wave forms) due to the high recording level. At the high end, the trace for the Wollensak is the most linear; it shows very little saturation, indicating considerable headroom above the usual 0-VU indication. Notice the lack of dropouts with the Teac and Sony—another evidence of saturation, since it tends (like a limiter) to even out response variations. The reason that saturation affects the top frequencies more than the midband or bass is of course because of treble pre-emphasis in the recording equalization. That's one reason the equalization (as well as the bias) of the recorder influences the results you can get from any tape. And it further illustrates the point that modern cassette equipment is as good as it is only because—and to the extent that—the engineering accomplishments embodied in the tape and those built into the recorder are made to complement each other and work together precisely. H.F.

Continued from page 50

was the recording head—not necessarily noted for constant specifications from unit to unit. Yet the cassette's slow speed requires almost a precision bias value, something difficult to obtain without simultaneous playback. A minute change in bias current—which can go unnoticed in the factory, where bias levels are checked with a simple voltage measurement—can destroy a tape's high-frequency performance. It can produce considerable distortion as well, though high-frequency losses are more apparent. Since the cassette system is locked into the 1 $\frac{7}{8}$ -ips tape speed, all electronic improvements had to come about primarily through the recording tape and head.

Cassette tape is a notable triumph of engineering. When open-reel recorders still ruled the tape roost, there was little pressure for manufacturers to make really substantial improvements. But cassette tape response has zoomed from an 8,000-Hz high end to 15,000 Hz in less than a year. Chromium-dioxide tape, which was touted as the savior of the cassette system for high fidelity use, initially suffered from the bugs to be expected in any new technology. By the time it could exterminate them there were at least fifteen brands of ferric tape that could get out to 13,000 or 15,000 Hz with "standard" bias.

The new ferric-oxide tape also improved the cassette system's signal-to-noise ratio, bringing it into the 48-to-51-dB range—very close to that of many home open-reel recorders. The final step to true high fidelity signal-to-noise ratios—that is, in the

60-dB range—is easily taken care of with Dolby electronics.

A minor problem to some (and a major concern to Philips) is that Dolby tapes have unnaturally bright highs when played on a non-Dolby machine. To maintain the basic cassette playback equalization standards so that any cassette tape can be played on any machine, Philips has introduced the DNL—basically a dynamic noise suppression system. DNL (and similar dynamic noise suppressors from other companies) allows all frequencies to pass when the signal level is high; at low signal levels, where the ratio between sound and hiss becomes annoying, the highs are attenuated. In short, the listener is presented with hi-fi at high volume levels and medium-fi at low volume levels. In actual practice the high-frequency attenuation may be noticeable only to the most critical listeners; and while it is no Dolby, this type of noise suppressor does allow interchange of cassettes recorded on all standard recorders. So does a straight noise filter. While some companies have adopted this approach, it has the even more severe shortcoming of cutting high-frequency response no matter what the program material is doing, limiting fidelity even in high-level passages.

With low wow and flutter, broad frequency response, and a good signal-to-noise ratio, all the cassette system requires for true high fidelity capacity is a combination of record head and bias circuit that can be factory-set (or better yet, user-set) for optimum performance. While it is true that the

newest heads are precision devices, the slight variation in characteristics that does remain from unit to unit is enough to alter effective bias, causing a recorder designed for response to 14,000 Hz, say, to come off the production line with a 12,000-Hz top.

If all cassette equipment had separate heads for recording and playback the optimum bias adjustment could be obtained as it is on professional open-reel equipment by checking the output during recording. While there is no room in the cassette itself for an extra head, Ampex has introduced a single head that provides individual gaps for erase, record and play, and comparable heads have been designed by other companies.

And, of course, the tape

If the separate playback gap does indeed make it easier to get precise matching between tape and recorder, it will be a welcome improvement. I've already mentioned the startling advances that have been made in cassette tapes in the recent past. The question is whether we really are making the best possible use of those advances.

Both cassettes and cartridges represent a complete system in which neither tape nor recorder can be considered alone—mechanically, magnetically, or electrically. Tape and machine must work together if either is to work at all. That's where budget cassettes and cartridges generally fall down. The tape is too inconsistent magnetically—having too many dropouts and requiring varying bias from batch to batch—to allow the recorder to perform as it ought to. And by cutting corners in mechanical design the cheap tape product sets up the user for problems with wow, jammed tapes, and broken leader. To prevent those problems, even with the best tape products, the recorder must walk a narrow line between being too rough and being too gentle; with substandard cassettes and cartridges the line can be nonexistent, and no recorder will be able to handle them.

The good tape products do work. Manufacturers have spilled a lot of ink in the last year trying to tell you why their tape products behave as they should and why other brands don't. Frankly I can't get very excited about the design of the tape guides inside a cassette, for instance, because I've used many different "good" brands with different types of guides and got good results with a wide variety of recorders.

The magnetic coating on the tape is something else again. Philips' specifications were written with what we still call "standard" tape in mind. Then came low-noise tapes. Actually the coating on standard cassettes in many cases is what we would expect to find on low-noise open-reel tapes, and many of the low-noise cassettes are more like the

low-noise, high-output open-reel tapes, so terminology gets imprecise when you try to describe a given tape. And the emphasis, particularly in cassettes as opposed to cartridges, has been on the most recent premium formulations like TDK's SD, Maxell's UD, 3M's High Energy and so on. Fortunately bias requirements in this group of tapes are similar, generally falling within a few dB of each other, so that a machine set for one of them usually will do well with any.

Seeing the potential of these recent formulations, recorder manufacturers have begun adding bias switches to their products, allowing you to optimize either for standard or for premium. This is fine as long as the bias is exact; again, it may not be even when the recorder is new, and it can change as the recorder ages. That's why some means of checking bias is important if the convenience formats are to continue to improve.

Bias is not the only consideration in getting the best out of the new tapes—premium ferric oxide and chromium dioxide alike. Equalization too must be considered; and there is some evidence that recorder manufacturers are fudging equalization to try for best performance with premium tapes. That is, the equalization they build into their machines may no longer match strict Philips specs. Perhaps the time has come to reconsider what is to be "standard" in cassettes (and cartridges for that matter) and rethink the whole subject from the ground up.

Where does chromium-dioxide tape fit into this rethinking? It does offer some increase in frequency response over ferric-oxide tapes; but at present, and based on average performance among the better brands on the market, I'm not convinced that chromium-dioxide tape is worth the extra money. Perhaps it can be developed to the point where it will be, but ferric oxide seems to be improving more rapidly than chromium dioxide.

Summing up

We're now at the point where eight-track cartridges are potentially a high fidelity medium (though much of the less expensive equipment on the market has yet to catch up with the fact), while the best cassette equipment already has achieved that status—with certain possible, but easily avoided, reservations. Assuming a drive system that is state-of-the-art, excellent electronics, Dolby circuitry, and careful adjustment of bias and equalization, cassettes can be made to match the standards of open-reel. We're now seeing cassette equipment that keeps wow and flutter to 0.25% or less, is flat within 3 dB to 12 or 13 kHz, and has a signal-to-noise ratio of 58 dB or better; and that's true high fidelity. 

A Gallery of Top Cassette and Cartridge Equipment



Hysteresis synchronous motors have made their appearance in many of the better cassette models now on the market—some at fairly moderate prices. The Kenwood KX-7010A and Pioneer T-3300, shown here, both sell for about \$150 and claim wow-and-flutter ratings of 0.2% or better. Kenwood offers a dual-position bias adjustment and high (hiss) filter, while Pioneer's unit comes with an automatic stop-and-eject system.



A two-motor drive system that includes a direct-coupled brushless DC capstan motor is built into the Panasonic RS-275US cassette deck (\$250). The bias switch matches either low-noise or standard ferric-oxide tapes. Among the unit's unusual features is a "memory rewind" that will return the tape to a preselected point. The built-in noise-reduction system is Panasonic's own (non-Dolby) design.



Among the earliest of high-quality basic cassette decks was the Teac A-24, which doesn't look very different from some models selling for half of its \$200 price tag. The features that set the A-24 apart include a hysteresis drive motor, output level controls, and solenoid operation, making possible an automatic shutoff system that completely disengages the tape drive when the cassette comes to an end or has become fouled.



Sony/Superscope's state-of-the-art dual-capstan cassette recorder is the \$260 Model 165. It records and plays back automatically in either direction. A built-in peak limiter avoids overload while recording, and there's an automatic shutoff system. The similar Model 160, which does not include the reversing feature, costs \$200.

Harman-Kardon CAD-5



Opposing views of noise reduction are taken by Harman-Kardon in the CAD-5 (\$230) and Norelco in the 2100 (\$220). The former embodies Dolby circuits, which operate in recording as well as in playback; the Norelco DNL (Dynamic Noise Limitation) circuit is used in playback only. The CAD-5 has a two-position bias adjustment switch (for ferric-oxide or chromium-dioxide tapes); the Norelco 2100 has a three-position bias switch (standard ferric oxide, low-noise ferric oxide, and chromium dioxide).

Norelco 2100



Standard Radio PRO 3000



Wollensak 4760

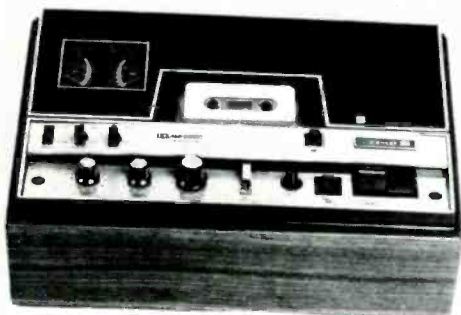

The Standard Radio SD/NS noise-suppression system is built into the company's \$190 PRO 3000 cassette deck (also called the SR-T180DK). Other switches on the top plate are for an automatic level control system (on/off) and bias adjustment (normal/chromium dioxide). The unit has a hysteresis drive motor, an automatic shutoff system, and a hot-pressed ferrite record/play head.

Advent 201

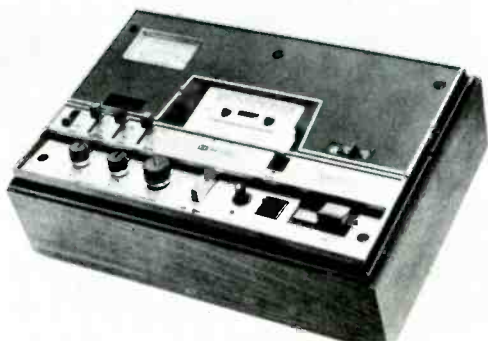

These two Dolby-circuit cassette decks look similar because both are based on the same Wollensak transport. Wollensak's own version is the Model 4760 (\$300); Advent's is the Model 201 (\$280). Each has a two-position bias switch. That on the Wollensak selects regular or high-performance iron oxide; that on the Advent is for iron oxide or chromium dioxide. The extra switch on the Advent controls the signal to be monitored by the unit's single VU meter.

JVC 1660-2



The 1660-2 (\$120) is JVC's first model for the cassette enthusiast. It incorporates JVC's own noise-suppression system, of the dynamic type that is used in playback only. The deck will eject the cassette automatically at the end of play.



Among the first wave of Dolby-circuit cassette decks to appear on the U.S. market was the Fisher RC-80. The latest version is the RC-80B (\$230), which adds to the features of the original model a bias switch (regular ferric oxide or chromium dioxide) to take advantage of the newer tape type. Microphones are not included in the price of the RC-80B.



A synchronous capstan motor plus two tape-wind motors, all controlled by a solenoid operation system, power the Astrocom Model 307 (\$500). It has a two-position bias switch, plays or records in either direction, and is equipped with an automatic-reverse system. Its most unusual feature: It can record on all four tracks of the cassette simultaneously. You thus can use it to make your own quadraphonic recordings, the first model with this capability to be marketed to date.

Two major approaches to the automatic changing of cassettes are embodied in the vertical feed system of the Benjamin/Lenco RAC-10 (\$300) and the horizontal drop of the Akai CC-60, (\$315). Both units have hysteresis drive motors. Belgian inventor Theo Staar developed the "Staar system" slot-load, automatic-reverse tape mechanism on which the Lenco design is based. The entire cassette tray lifts out and can be replaced with another, much like magazines of photographic slides in an automatic projector. Cassettes are stacked in the center well of the Akai, which turns over the entire cassette (rather than reversing the capstan drive) to play the second side.



One of the most unusual cassette decks to appear recently is the Concord Mark IX (under \$300). In addition to dual (ferric oxide/chromium dioxide) bias switching, automatic stop and shutoff, and a narrow-gap head, it features Dolby noise-reduction circuitry, pop-up illuminated VU meters, and a three-mike mixing system.

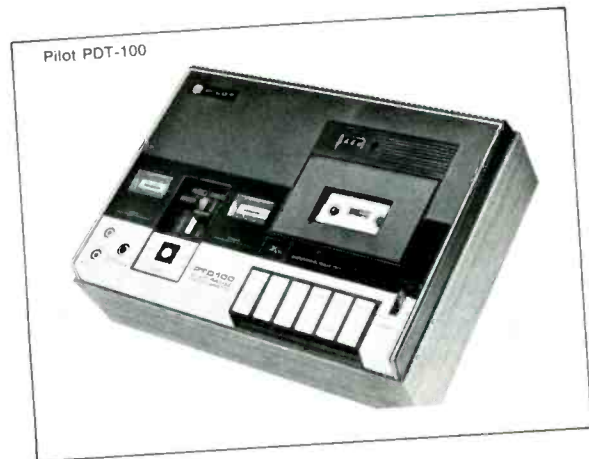

The Pilot PDT-100 (shown here) and PDT-100A are equipped with automatic shutoff and a recording system with both manual and automatic level controls. Either version costs \$170. The PDT-100 offers output level controls for playback; the PDT-100A has a three-position bias switch for normal or low-noise iron oxide or chromium dioxide.



This Staar-type automatic-reversing cassette deck from Ampex is the first to combine all four playback elements for stereo forward and reverse operation in a single record/playback head. Since erase gaps also are provided on this head, the Micro 155 uses the space normally reserved for a separate erase head to house a second capstan drive. Other features include sound mixing and bias adjustment for chromium-dioxide tapes. The Micro 155 costs \$300.



A pioneer among component-quality eight-track cartridge recorders is the Telex (originally Viking) 811-R (\$190). The deck incorporates a "logic" system in both recording and playback to determine automatic stop, repeat, or advance when the head reaches the end of one "program" (or pair of tracks).



This quartet of cartridge recorders includes the Akai CR-80 (\$190), Mikado HZ8000 (\$130), Sony/Superscope TC-228 (\$170), and Wollensak 8050 (\$150). The Wollensak and Sony models offer front-panel microphone inputs and stereo headphone outputs. The Akai also has a headphone jack plus provision for continuous play. The Wollensak will repeat either a single program or the entire cartridge. It and the Sony are equipped with a pause control; all but the Mikado have a fast-forward control.

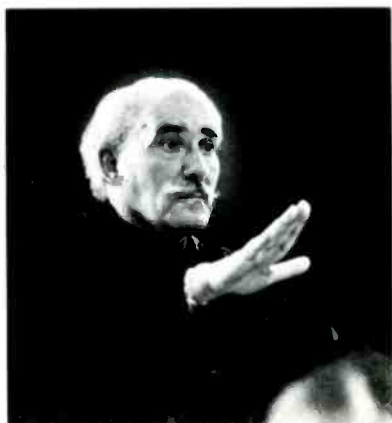

by George R. Marek

“The Toscanini Ninth”

Twenty Years Later

A reminiscence by the then Director of RCA Red Seal
on the twentieth anniversary of a legendary recording

TOSCANINI was nervous of course, very nervous. The greater the artist, the wider his vision, the deeper his imagination, the *more*—not the less—nervous he becomes when faced with his task. Technical security only heightens tension; the artist knows all the things that can go wrong, and he sees the distance between what he wants and what he can produce. If that is true of a performance it is doubly true of a recording session; such a session carries with it a feeling of now or never—“this is for keeps.” Imagine then Toscanini’s state of mind on that day twenty years ago when he decided to record Beethoven’s Ninth—that brontosaurus of a symphony, perhaps music’s most difficult challenge to interpretation. He had, of course, conducted the symphony many times in his career, which then spanned more than half a century, but he had never before attempted to record it, having acknowledged how formidable were the obstacles. He said, “The Ninth is difficult. Sometimes the orchestra is stupid; sometimes the chorus is stupid; sometimes the soloists are stupid; and sometimes I am stupid.”

The recording dates were Monday, March 31, and Tuesday, April 1, 1952. He was to record the symphony in two sessions, but as it turned out, overtime was required, so that total recording time was nine hours for the one hour and five minutes of the symphony’s duration. The recording had been preceded the day before by a broadcast performance which those of us who heard it felt was exceptionally inspired, even for Toscanini. Memories of performances are always faulty, being highly subjective. I for one had heard Toscanini conduct the Ninth with the NBC Symphony Orchestra in 1948, and before that in 1945, 1942, 1939,

and 1938; and with the New York Philharmonic in 1936 and 1934. Yet it seemed to me that he had infused the 1952 performance with a new conviction, a new Dionysian inebriation—what Shelley called “drunk with divine enthusiasm.” Toscanini, however, was not satisfied, and he went home grumbling and cursing, and refused to listen to the off-the-air tapes of the broadcast.

When he appeared for the recording, dressed as usual in his black alpaca rehearsal jacket, head bowed, oblivious of the technical staff around him, and jumping onto the podium, he plunged once more into a re-rehearsal of the first movement. He went over the beginning five or six times, and he took an hour and a half to go over various expressive details of that movement; for example, at the very beginning he wanted the chord for the horn sufficiently “mysterious,” the crescendo which follows soon thereafter sufficiently marked to prepare for the fortissimo entrance of the full orchestra at bar 16. In a passage of the development (bar 171 on) he stopped to say, “I am never satisfied with that passage,” and rehearsed the lower strings separately, then all the strings separately, then the whole orchestra, in an effort to achieve clarity. Then he said, “That’s not bad.” At the ritardando cadenza he rehearsed the woodwinds seven times; he told them to play “*stanco*” (tired). All of his remarks were sparse and technical; he sang and he marked the rhythm and he shouted “*piano*” into the music, but only three times during the entire first movement did he allow himself verbal elaboration or simile. Once he said, “How beautiful this is,” as if he were hearing the passage for the first time, and at the beginning of the great coda which rises murmuring from the lower depths he said, “Play it like the sea.” The entire coda, he said, was like Dante, and quoted some of the poet’s lines from memory: *Io ritorni dalla santissim’ onda/ Rifatto si come piante novelle./Rinnovellate di*

Mr. Marek, who went on to become the long-time Division Vice President at RCA Records, now serves the company as a consultant.

novella fronda./ Puro e disposto a salire alle stelle.
(I returned from the holy shadows/ Refreshed like
new plants,/ Covered with young leaves,/ Cleansed
and prepared to alight to the stars.)

He did not entirely succeed in getting what he wanted, and there were occasional cries of rage as spontaneous and elemental as the cries of an offended child. "Poltroni (sluggards)," he called them, and "Go to the Hell," and to a woodwind player, "I am astonished; I thought you were an artist," and to another musician, "Go and play someplace else—you don't play for me." Yet in spite of these outcries, which perhaps should not be cited out of context and which each musician understood and which none took amiss because of the love they bore him, it was a fairly calm session. Toscanini was *not* temperamental in the ordinary sense; he was both patient and reasonable when he felt that everybody was attempting his utmost. The sessions were particularly difficult because in those days recording was still done in separate, comparatively short, takes—each lasting about seven or eight minutes. During the playback the orchestra would sit and rest, but Toscanini would conduct all over again, comparing what he heard coming out of the loudspeaker to what he was trying to achieve.

The Scherzo went comparatively easily, except that the drummer did not play "savagely" enough. The third movement, surely one of the most beautiful lyric discourses conceived in music, was done with the tenderness that a father summons. Toscanini watched particularly for the alternation between the *adagio* and the *andante*, the flow of the music to be continuous. In the 12/8 section (*Lo stesso tempo*) he rehearsed the violins alone to play "all the notes precisely" and "sweetly," (it is marked *dolce*) and a few bars afterwards he exhorted them to play "elegant and light."

The finale was tackled the next day, a Tuesday morning. As expected, it presented the greatest difficulty, yet it brought out new resources of patience on Toscanini's part. There were no tantrums, but merely his insistence on getting what he wanted, particularly in the statement of the "*Freude*" melody. To the double basses he said, "Sing, sing, sing—sing together." It reminded me of an entry by Schindler in one of Beethoven's Conversation Books. Schindler helped to rehearse the sections of the orchestra for the first performance of the Ninth. He wrote:

"The recitatives for the double basses are enormously difficult. . . . They cannot execute them in tempo. You can play them with twenty [musicians] but not the way you want.

"How many double basses are to play the recitatives?"

"Is it possible? All! In strict tempo that would cause no difficulty. But to play them

in a singing style will cost great patience at the rehearsals. If the old Kraus were still living, one would not need to worry, because he was able to conduct twelve basses and they had to do what he wanted."

Beethoven then proposed to explain to the double-bass players the poetic meaning of the text in order to guide their phrasing. Schindler: "As if the words were written underneath?" Beethoven must have replied, "Exactly so." Schindler: "If necessary I will write the words into the parts so that they can learn to 'sing.'"

Robert Shaw's chorus was well-nigh perfect, but Toscanini rehearsed the soloists eight times, until finally Eileen Farrell's voice gave out. Then he let them go, and the chorus gave them a round of applause.

In the half-hour intermissions Toscanini would march up to his dressing room, doff his perspiration-soaked jacket, and don a terry cloth bathrobe. He drank a little orange juice and chewed his favorite hard candy, imported from Italy. At the last intermission, ten-thirty Tuesday night, he remained on the podium, passed out hard candy to the orchestra, and swapped stories with the violinists who crowded around him. The technical crew was on the verge of a nervous breakdown. At this moment Toscanini decided to make that finale of the first movement once more. It was done—and everybody heaved a sigh of relief. Too soon. He then repeated the first two takes of the final movement up to the entrance of the bass. He left at midnight. I had the impression that he would have liked to do the whole thing over again, and had enough stamina left to do so. (He was then eighty-five years old.) Nevertheless, he did say, "This time I am almost satisfied," a sentence which was later used in the advertising.

The reviews were for the most part ecstatic, though of course there were one or two critics who felt it was too Italian, whatever that may mean. John M. Conly wrote an article about the recording session for the *Atlantic Monthly* (October 1952) which was reprinted in the *Readers Digest*. That helped firm the fame of the recording.

The sound on the recording has obviously become obsolete; there are seventeen subsequent *stereo* versions available. Yet in its way the recording remains, after twenty years, a unique achievement, a testimony to a great conductor's great accomplishment. About a million copies of the recording have been sold, which means, I suppose, that some four or five million people have heard it (not counting those who heard it on the radio). These days new recordings have a way of appearing quickly—and dying just as quickly. After twenty years this recording of the Ninth Symphony still lives. The word "unique," too often and too carelessly applied, may be used here. ●



Introducing
the Fisher 801.
If you want
four channels,
very high power
and wireless
remote tuning,
you have no
other choice.





The 801 is Fisher's new top-of-the-line 4-channel receiver. It costs \$749.95. Everything that Fisher knows about receivers has gone into its design. Which leaves out very little.

Discrete and matrixed 4-channel, 250 watts music power ± 1 db (44 watts rms per channel), electronic FM tuning with no moving parts and a separate wireless remote tuning unit are only the beginning of its features.

To appreciate the full quality of this new flagship of the Fisher line, you must read the detailed technical literature. There's no other way. For your free copy, write to Fisher Radio, Dept. HF-3, 11-44 45th Road, L.I.C., N.Y. 11101.

FISHER
We invented high fidelity.



by Charles and
Mary Jane Matz

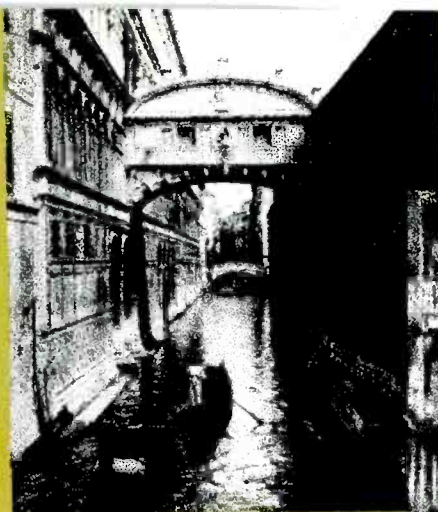

Verdi's Revenge

La Traviata's legendary fiasco at its premiere was a myth created by its composer, claim two noted Verdi scholars. Their fictionalized re-creation of the event is based on what actually happened on the day of the first performance.

Why in Venice?

Why a modern opera, with a controversial and money-making theme, in a dead or dying city like Venice?

Verdi knew. He had chosen the city himself.

He came up from Rome, fresh from the success of *Il Trovatore* at the Teatro Apollo there. And it was midwinter in Venice, long days of thick fog. Rehearsals had begun, for the singers at least, some weeks before. Verdi was still working on the orchestration, spending a large part of each day in his little apartment at the Hotel Europa. Right down to the dress rehearsal. That had been two days ago. Today was Sunday, March 6, 1853. Clear and cold, and the premiere of *La Traviata* was ready.

So thought Carlo Marzari, president of the Gran Teatro La Fenice. Verdi did not think so. He had told everyone he knew that the company of singers put at his service was unfit for a great opera theater like La Fenice. But as everyone in the theater world knew, Verdi was difficult. The foremost composer in Europe, he demanded fat fees and got them; he required special conditions for the choice of singers and usually got them; he stipulated the number of rehearsals, the possession of the manuscript score, and the ownership of the work. His popularity—the very times were Verdian—made it impossible for theaters to refuse. But—and there were so many buts on this day.

Venice was a dead city. Old, paper-shuffling archivist Emanuele Cicogna scribbled in his diary that hundreds of political activists had been exiled to the Piedmont. Or jailed by the Austrian authorities who governed the city. The port had died too. Only a few ships came and went. One of the reasons

that Venice was dead was this Austrian government. The Austrians had returned after having been thrown out during the uprisings of 1848 and the brief Manin Republic, so very brief, in 1849. Now Daniele Manin was in exile in Paris, where he would die. After its thousand years of history, Venice was rotting.

What a city for the premiere of any opera! And certainly an irony for this new work of Verdi's. Modern. Verdi had written Giovanni Ricordi, his publisher in Milan, that he had something "new and good" to present. Then he wrote to his friend and librettist Francesco Maria Piave—Big Tomcat, Lion Cat, Big Devil Piave, Venetian—that with a little effort ("Get your legs moving," Verdi said) an arrangement could be made with the management of the Teatro La Fenice. No other theater, Verdi said, had co-operated with him as La Fenice had for the *Rigoletto* premiere. This, then, was one of the main reasons for Verdi's return to Venice. Piave was the other.

Verdi, in the years before 1853, had taken on far more work than he could handle: too many contracts for too many operas. He thought of himself as a galley slave, a prisoner serving a term, and had had to lean on others in order to meet his obligations. Among the men who had helped Verdi most was Piave, the poet-journalist who had first worked for the composer as librettist on *Ernani*.

Piave was a versatile fellow. And a friend, a good friend. Verdi had no other close friend then. Piave could organize, could choose settings and costumes, could versify, could be a good patriot (patriotism sometimes disrupted the careers of composers and librettists who got caught in the maelstrom of revo-

lution). As a general legman, entrepreneur, and stage director, Piave had become very valuable to Verdi.

With his help, contract and libretto and opera were all finally realized. *Amore e morte*, Piave called the work. Love and death. *Violetta*, said Verdi; but he had to choose another title because another composer's *Violetta* had been given in Naples the year before. So the work became *La Traviata*. But it remained for the dynamic conductor Angelo Mariani, "beautiful angel of the huge dark eyes," to give the opera a true baptism: *Il Traviatissimo*. What Mariani meant was this: Composer, production, and singers all seemed to have lost their way somewhere on the road to success. Everything, it seemed, had gone wrong.

Verdi had had misgivings about *La Traviata* long before his own arrival in Venice. Friends who often sent him reports on various singers had warned him about the cast he would be working with. Especially about the soprano hired for the season: portly Fanny Salvini-Donatelli, wrong in every way for the role of Violetta. The crux of the matter was that she was an old-style soprano, what was known as an "aria-and-cabaletta" singer, accustomed to the rigid, closed musical forms of Verdi's predecessors. Verdi was groping toward a new kind of musical drama, one which would flow continuously, one which would not be broken by full-orchestra chord-stops and applause. More, he wanted to create a total theater, where all the elements worked in perfect harmony.

For *Violetta*, he said, "I want a woman with a good figure, elegant, young, and capable of singing passionately." This to Piave and to the management of La Fenice. Instead he had to face "La Salvini," as Verdi called her, who was incapable of understanding his new approach to opera.

For this *La Traviata* is not Verdi's first venture in contemporary drama. Three years ago, in the nearby city of Trieste, Verdi and Piave gave *Stiffelio*, a pre-Ibsenesque problem play, in contemporary dress. Its theme was modern morality, with divorce and adultery the keystone of its action. Like *La Traviata*, a domestic drama. The poor reception given *Stiffelio* (for the Italian, Catholic audience in Trieste could never have understood an opera about a German Lutheran minister who forgives his wife her adultery and guides her hand while she signs a decree of divorce) did not discourage Verdi from an equally difficult subject: middle-class morality and the crucifixion of Violetta, whom he called "The Woman Who Has Lost Her Way."

Here is Verdi caught between his aspirations and his reality. Not only "La Salvini," with her lack of comprehension; but a baritone who despises his role and a tenor in poor voice, who also is unsympathetic to what Verdi needs. Felice Varesi, who will sing Germont, has known Verdi for years. Both

Rigoletto and *Macbeth* were, in fact, written for him. But now Varesi is finished—or so Verdi has heard. Even before coming to Venice, Verdi has tried to get another baritone. What about the tenor then? Lodovico Graziani. "Marmoreal," rages Verdi, "like a figure carved from stone. *This is Alfredo!*"

For nearly three weeks now, Verdi's grimness has persisted. He is nearly mad with pain from his rheumatism. How can a man of thirty-nine suffer so? Only a month ago he could not even write letters. The rehearsals have gone badly, for the singers, according to Verdi, are absolutely incompetent. This is not true, of course; the soprano Salvini is a great artist. Her silvery voice and her agility in the rapid, difficult coloratura passages have aroused the admiration of everyone in the theater. And while it is true that Varesi feels cheated—relegated to second place as Father Germont—he at least makes an attempt to present himself with dignity and style. How could a veteran of so many performances do less? But no matter how much they have done, these singers, Verdi has continued to reproach them for not doing enough.

He sits in the cafés with his friends, discussing his problems, whenever he has a free moment. Piave, who is never far away, always takes part in the discussions. The other members of Verdi's circle in Venice are a doctor, Cesare Vigna, specialist in mental disorders; a music shop owner, Antonio Gallo—"Sior Toni," they all call him—who also produces opera at the Teatro San Benedetto. In the weeks of rehearsal they have spent most of their coffee hours in Florian's in Piazza San Marco. Talking, talking, sometimes about politics (but this is dangerous in a police state, and Piave is a known radical who had been a common foot soldier in the revolution); sometimes indulging in backstage gossip (but not often, because Verdi has always held himself aloof from the people he works with in the theater). Most frequently they talk of books, plays, poetry. Right now, the talk of Venice is *Uncle Tom's Cabin*, which is running as a serial on the front page of the *Gazzetta Ufficiale*. Little Eva's death is imminent. It will, in fact, come in the Monday installment, where the *Gazzetta's* readers will also see the review of Verdi's new opera.

What will happen to it? The performances of *Ernani* given at La Fenice to warm up the public for *La Traviata* have proved a failure. Not even the voice of Salvini could save the work, which had been written for this same public, this same theater, in 1844. "We didn't remember it as being this bad!" snapped the critic Tommaso Locatelli. "Verdi may be a great cook, but the salt and pepper are missing." Verdi, as usual, blamed the singers and the theater.

When would he get what he wanted? When would anyone ever understand what he was trying to do? The Italian theater was a shambles, he railed

at Piave. It needed valid modern dramas, a new approach to music, and most of all, a complete renovation of acting and production techniques. A labor roughly comparable to the cleaning of the Augean stables. Piave promised, he always promised, to do what he could, then complained in turn to Marzari that Verdi was in a hellish bad humor. Marzari didn't need to be told. But Piave was easy-going and Verdi impossible to satisfy.

How many times in these last weeks had Verdi refused to go on with *La Traviata*? First, there was his disappointment over the settings and costumes. The composer wanted the opera set in contemporary dress, with all the trappings of the mid-nineteenth century. But La Fenice had pasted together a production which is (according to the posters announcing *La Traviata*) in the "period of Louis XIV of France, about 1700." Marzari of La Fenice and his secretary, Guglielmo Brenna, are congratulating themselves right now on having saved money and preserved the dignity of the theater as well. Who ever heard of an opera in contemporary dress? Historical and Biblical settings are the best, they say.

As if this disappointment were not enough, Verdi has had to face, daily, for the last ten days, something far worse: A smart impresario at the Teatro Apollo, only a five-minute walk from La Fenice, has put on Dumas' *La Dame aux camélias* in an Italian translation. What does this mean? Someone has stolen Verdi's thunder and robbed him of what he prizes most highly: his right to be first on the stage with a given idea. Nothing is more dear to Verdi, the Bear of Busseto, this irascible genius, than his originality.

Now his whole dream has been blasted apart: He will not be first on the scene with the drama of Marguerite-Violetta and Armand-Alfredo; he will not be able to give it in contemporary dress, as he wishes; and he will not have singers who are, as he says, "worthy" of his musical drama. Yet he has stuck with the production, instead of taking back his score and leaving Venice. No opera he has ever written has meant so much to him as this one. For many reasons. One of them, his involvement with Peppina Strepponi, his mistress, who has lived with him since 1847. The story of *La Traviata* is like the story of Peppina, former operatic soprano, mistress of several men before Verdi, mother of three or more illegitimate children, who was redeemed by love, as Dumas' Marguerite and Verdi's Violetta were redeemed. "I don't like to see whores portrayed on the stage," Verdi had confided to a friend some ten years ago. But now he has changed his mind, and has written an opera about a woman who thought herself damned, yet lived long enough to discover that even the damned can find salvation in love.

This is Peppina's drama, certainly; but she is not here. Verdi has left her behind, at his new country house, at Sant' Agata near Cremona. "Mixed up,"

she calls herself, and "Pest," and she is ill now. But even if she had been well, Verdi would not have brought her here. She had begged him to let her come to Rome for the world premiere of *Il Trovatore*, two months ago.

"No," Verdi had said.

Peppina pleaded. "But everyone thinks I am there with you anyway. Isn't that true?"

It was true. Everyone knew that Verdi was living with "La Strepponi," as she was called in the opera world; but still he would not take her with him. She is apprehensive, and imagines the worst. Piave will lead Verdi astray. "Don't play panderer to Verdi," she warns the librettist in a letter. And to Verdi: "I kiss you on your pure heart, which, I hope, is mine forever; as for the rest of your body, I wouldn't swear to anything, not even as I write this—not with Piave at your side."

Peppina could be helping Verdi now. He is, for the first time in his life, thinking about letting someone write a biography of him. Luzzati, the Venetian printer, an acquaintance of Piave's, has asked for the honor.

"He can do it if he wants," Verdi has told Piave. "Just let him print the truth. *Tutta la verità*. The whole truth. I want him to include all the praise and honor due my father-in-law, and a blast at those *coglioni* of priests who didn't want me to be the music teacher here." Verdi's whole preoccupation in this matter is with the bitter disappointments suffered in his early years, when the Catholic hierarchy of his home town repeatedly kept him from getting jobs he badly wanted and needed.

All these details could be smoothed out by Peppina, who is a secretary par excellence. But Verdi, when he most needs her, does not have her. He often punishes himself this way, uselessly. And as his frustration feeds upon itself he lashes out at others, punishing them too. The chief targets of his rage, his singers, will suffer even after this premiere is over. Verdi has already decided to get back at them for what he sees as *their* massacre of *his* opera. He has his revenge all plotted out. If the final rehearsals had gone better he might have changed his mind, but the last rehearsals have been for Verdi the ultimate disappointment. He has kept the theater closed for several days, rehearsing day and night, as he did in Florence six years ago when he put on *Macbeth*. But he is still not satisfied.

And it is the evening of the premiere. Piave has called for Verdi at the Europa and the two men walk along Calle Delle Veste toward the theater. Sunday. Bad luck, Sunday. Dead Domenega in Venice, when the city sleeps off Saturday's wine. Saturday night audiences are better, and Verdi had hoped to go onstage yesterday but was not able to get his company in shape in time.

The stage door of the Gran Teatro La Fenice. Shabby. The theater needs renovating. That will come next year. Right now a committee is meeting



Giuseppina Strepponi—Verdi's Peppina. Their relationship gave *La Traviata* a special meaning for its composer.

to discuss the renovation. So much of Venice is crumbling; at least La Fenice will be rebuilt. In fact, it will be closed as soon as the run of *La Traviata* ends, for the Carnival-Lent season is almost over; Verdi's opera is the last production on the calendar. It is the fourth time that Verdi has put on a world premiere in Venice in March. But he has never been as unhappy as tonight.

He is sharp with the stage-door porter, shorter still with Piave. Even in his best moments Verdi is often curt. After twenty years of being obedient son and protegee to father and patrons, years of applying rigid control to his feelings, Verdi has finally begun to be himself. Now rich and famous, he says just about what he thinks, all the time.

He and Piave are backstage, among the flats and props, waiting for eight o'clock and the beginning of the performance. Verdi looks out front. A good house. But he cannot forget the Dumas play at the Apollo. Probably everyone here tonight knows every line by heart. So, at least, says the critic of the *Gazzetta Ufficiale*.

The composer gathers his cast around him for a few last-minute orders.

"Ready!" he says. He sends the conductor into the pit. Here, at least, is someone he can count on: Mares, first violinist, conductor. He has done for the orchestra what Verdi has done for the stage. Perhaps he is the only one in the company who knows what Verdi wants tonight.

The prelude begins. A tissue of spinning gold in the strings, those perfectly tuned strings of La Fenice. The audience sits in silence, ravished with the beauty of the piece. At the end, a roar of enthusiasm.

"Bravo! Maestro! We want the composer! Verdi! Verdi!"

But although Verdi comes before the curtain, which he does not always do, he is not happy. The whole of *La Traviata* lies ahead, and Verdi is never reassured by applause which comes early in the performance.

Now the orchestra breaks into the party music of the first act. The curtain goes up: a Louis XIV

setting. Nothing here to shock anyone into thinking about the moral problems posed by *La Traviata*—about the destruction of a woman by respectable hypocrites. This is the problem Verdi lives with at home: the crucifixion of Peppina by middle-class friends and relatives.

Although the tenor is hoarse, he begins the Drinking Song with a flourish. He passes the melody to the soprano, who carries it triumphantly. She is in fine voice tonight, and wants to prove to Verdi that she can live up to his expectations. She and the tenor touch glasses.

Again an ovation from the audience and Verdi has to come out once more, this time on the open stage, following the operatic tradition which demands the composer's presence among his singers if a certain piece of music pleases the public. He acknowledges the applause with a faint, ironic smile, but he will not accept it as sufficient salve for his injuries. He will extract his own satisfaction.

The duet between soprano and tenor causes a furor, for both Salvini and Graziani have risen to the occasion, and Verdi has to show himself again.

Backstage, and in their boxes, the men who own and run La Fenice ask themselves why Verdi has been so dissatisfied. This looks like a success.

Now Fanny Salvini is face to face with her great *scena*, the "*E strano*" and "*Sempre libera*." It has been whispered around the theater that Verdi actually wrote this music for her, but he has not admitted it.

She sings the scene matchlessly.

"Marvelous," says the critic Locatelli, who heard her two days ago in the dress rehearsal and knows what she can do. "A miracle."

The public goes mad over her, and wants Verdi again. He comes out from the wings and puts his slender hand in her plump one and bows with her. Not even he could withhold his admiration for such a performance.

If the second act could only go as well as this one, Verdi thinks.

But of all the singers, baritone Felice Varesi is the one Verdi mistrusts the most. And the second act is sustained by him. Although he is singing well enough, he understands little of what Verdi expects from him in terms of style. The old bombast, that is Varesi's technique: kings, corsairs. Verdi got him through *Rigoletto*, true. But Varesi has drawn the line at being a middle-class father onstage. Never before, and never again. By accident (he says) or by design (Verdi says) Varesi wrecks one phrase of the second act. Verdi, backstage, explodes. But the audience doesn't notice, and Varesi is applauded.

Two men in the theater, though, are not applauding. One is the impresario-music dealer Antonio Gallo, who is thinking that he could stage this opera with more style—more Verdian style, especially—than La Fenice. The other is the physician Cesare Vigna who, perhaps more than anyone else, knows



Sills and Ceccato—another *Traviata* astray.

by Dale Harris

The Sills *Traviata*

Verdi's indestructible score once again eludes the perfect recording.

ON THE SUBJECT of *La Traviata*, time, as Charles and Mary Jane Matz aptly put in their adjoining article, has told. Despite Verdi's initial uncertainty the opera has proved indestructible; the work lays hold of our emotions at every performance. It's hardly possible to imagine a production of *Traviata* that wouldn't move us—and this despite the overfamiliarity of the score. Recordings, however, are a different matter. What comes easily in the theater sometimes proves elusive in the studio, where satisfaction, a sense of fulfillment, is harder to achieve. It may be simply that without the empathy induced by live performers our purely musical demands are increased. Certainly, something more than adequacy is called for in order to bring such well-known music to life on records.

Traviata has been recorded often and never with real success. Every performance seems to have had a fatal flaw: a droopy heroine (Sutherland, who sounds fatally ill from the start), a weak supporting cast (Carlo Del Monte and Mario Sereni on Angel), an unidiomatic approach (Lorengar and Fischer-Dieskau on London). Usually, though, the conductor is the culprit. On RCA, Prêtre's eccentric tempos undermine the fine work of Caballé, Bergonzi, and Milnes. On London, Maazel keeps the adrenaline flowing too unremittingly. On Angel, Serafin takes everything too benignly. And now this new Angel *Traviata* is badly served by its conductor.

Aldo Ceccato's view of the opera is crude. He seems to feel that sadness has to be very slow and passion or gaiety very fast. The prelude to Act I is sluggish, whereas Violetta's anguished response to Germont ("*Ah, il supplizio è sì spietato*") is frenetic. Again, "*Addio del passato*" is dispiritingly slow and the party music remorselessly hurried. The latter also demonstrates Ceccato's coarse handling of textures and balances. Though Verdi always has recourse to a street-band idiom for his social gatherings, Ceccato conducts the music as if it actually were

street-band music. The brass section is so stertorous that Act I seems to be taking place not at a soiree in a Parisian salon but on a Sunday afternoon in the middle of the Piazza San Marco. After Act I matters improve somewhat, but Ceccato never does find a convincing emotional shape for any of the opera's great moments: "*Dite alla giovine*," "*Addio del passato*," "*Amami, Alfredo!*," all tend to meander without being fashioned in a definitive form.

Beverly Sills suffers from a lack of true musical guidance. She has many of the qualities needed to make a fine Violetta—intelligence, a sensitive feeling for the text, a responsive voice—and she carries off much of the music with distinction. "*Sempre libera*" is technically brilliant and the reading of the letter in Act III is very touching. But then, Sills's forte is intimacy. Despite some of her recent roles she is most at home in filigree, not in large-scale effects. When Violetta has to utter a passionate cry, to reveal her soul in one of Verdi's grand melodic arcs, Sills tends to disappoint. She has neither the amplitude of voice nor the right kind of tonal color for "*Amami, Alfredo!*" It is just conceivable that, despite vocal limitations, Sills's intelligence might enable her to carry off this kind of music with an air of conviction, but here she can do little because she has to contend with Ceccato's plodding gait and insensitively balanced accompaniments. But even where Sills is most at ease as in "*Dite alla giovine*," the voice is never quite attractive enough: The upper reaches are tonally impure and a persistent slow quaver mars much of her sustained singing.

Nicolai Gedda, on the other hand, is in full command of his role both vocally and interpretively. Though the voice is no longer always mellifluous, he sings with so much elegance that he creates an impression of beauty. Gedda pays scrupulous attention to musical niceties; every detail is in place, dynamics are finely adjusted. He makes "*De' miei bollenti spiriti*" more interesting than it deserves, and he projects the cabaletta, "*Oh, mio rimorso*," with masterful élan. Despite the competition of the admirable Bergonzi this is now the most musical Alfredo on discs.

Panera's Germont seems insensitive by comparison. Though unlike Merrill he avoids blandness, he falls into bluster. The scale of his performance is too large, at least initially. His entrance in Act II is unnecessarily strenuous, more like an Ernani than a bourgeois father. In "*Dite alla giovine*" he hectors Violetta unmercifully. He does better with the opening of "*Di provenza*," though it soon deteriorates into a braying session. Germont is clearly not a role in which this usually enjoyable artist can find much sympathy.

The chorus and the supporting artists are thoroughly competent. Among the latter there is a striking young bass voice, that of Robert Lloyd who sings the role of the Doctor.

In sum, a wonderful Alfredo, and a recording that Sills fans will doubtless find irresistible.

VERDI: *La Traviata*. Beverly Sills (s), Violetta; Delia Wallis (s), Flora; Mirella Fioentini (ms), Annina; Nicolai Gedda (t), Alfredo; Keith Erwen (t), Gastone; Mario Carlin (t), Giuseppe; Rolando Panerai (b), Germont; Richard Van Allen (b), Marquis D'Obigny; Terence Sharpe (b), Baron Douphol; Robert Lloyd (bs), Doctor Grenvil; William Elvin (bs), Commissioner and Servant; John Alldis Choir; Royal Philharmonic Orchestra, Aldo Ceccato, cond. Angel SCL 3780. \$17.94 (three discs).

what Verdi is trying to do with this *La Traviata*. He is perfectly equipped, as scientist, psychiatrist, musician, and *littérateur*, to recognize and appreciate what Verdi has done.

First, Verdi has taken a difficult subject and has put it on the opera stage, where realism has never had a toe hold. More, Verdi has captured the essence of the drama by subtly altering Dumas' statement, by strengthening the piece. For neither in Dumas' book nor in his play is there an overriding statement as there is in this music. That's it, Vigna thinks. The music is the statement. That rise of emotion, that flux of sound and tension all reflect the agony of a woman whose body has been sold, whose beauty is the staple of her business. Now she has found love. Hope and redemption through selfless love. Yes, Vigna thinks. Hope and damned redemption. She pays the price, not of love, but of being in the nineteenth century. As Peppina Strepponi pays the price in Verdi's home town. She will ruin him, people say. His family. Think of them. This Violetta, Vigna thinks, has found the man who understands her—Verdi.

Peppina writes from Sant' Agata—she sitting alone with her pets in the cold house, with snow lying over the garden outside the French windows; she, like Violetta, an outcast: "*O mio redentore!* My savior, my redeemer!" Violetta has no such luck. She cannot be permitted to love her savior, to be with him. That is the rush of the strings, the poised sweetness of the sustained phrase, rush and suspense, rush and suspense, rush and stop. Damned genius, he gets to you. Vigna sits back in his chair.

Now for the confrontation between Violetta and Alfredo's middle-class father.

"You do not know what you are asking me to do," she insists. "I love only him. I am dying. I have only a few months left. . . ." She thinks that Germont does not understand.

But he does understand, "A great sacrifice," he says. "Yes, I know." He is always full of platitudes. And worse. Rotten with immorality. "You are still young and beautiful. Give yourself time. . . ." She does not let him finish the phrase ". . . to get back into your profession."

Violetta understands all too well. "Don't say any more," she interrupts him. "But it is impossible for me to sleep with other men, for I love only Alfredo."

But Germont does not give up. He keeps after her and, finally, "Do with me what you will."

The drama is there, but Verdi, behind the scenery, is enraged. What the devil is Varesi thinking about? He isn't even trying to give the lines any meaning. Germont is a pious villain. Hypocrite. Destroyer of love and life.

The last act opens with another prelude, so magnificently played that the whole audience comes to its feet, clapping, roaring, shouting its joy. Once more, Verdi is summoned for solo bows. But this, for him, is small compensation for what he con-

siders the slaughter of his opera. Not even the applause given Varesi at the end of the aria "*Di Provenza il mar*" placates the composer. Indeed, he considers it a kind of betrayal. And the reception given the final act is a complete rout. One person laughed, one single titter, which Verdi will never forget. He cannot bear to be laughed at.

All over now, with Violetta dead and Alfredo saved, the pure boy and his father properly grieving in the accepted nineteenth-century manner. Family honor saved, too. All the décor of the century is missing, but not the spirit.

"Well, it might have gone better, but on the whole it was not too bad," Marzari says to Brenna. "At least the censor gave us no trouble. And we saved money. That is the best thing. We did save money."

Brenna replies: "Singers were passable, at least."

"Of course. Composers are never satisfied. Especially Verdi." Marzari and Brenna have stayed on at the theater to watch the performance of the ballet *La lucèrna maravigliosa* which follows *La Traviata*. Later they are invited to a party at Palazzo Mocenigo.

Verdi walks back to his hotel. To his revenge. He sits at his piano, then moves nervously to his writing stand. Letters. Letters planned some time before. Letters to be passed among friends. One which he wants to be published in a theatrical journal, though Verdi has never gone into print before.

"*La Traviata*, fiasco. Is it my fault or that of the singers? Time will tell." This to the conductor Emanuele Muzio.

"*La Traviata* was a fiasco. Let us not seek the causes. That is the story." To the publisher Ricordi.

"Complete fiasco. *Fiascone*, monster fiasco. And worse, they laughed," Verdi wrote to Angelo Mariani, who replied giving Verdi what he wanted to hear. Pity. Compassion. Understanding of the composer's plight. *Il Traviatissimo*, Mariani said, *that* should be the name of the opera.

Was the failure of *La Traviata* a fantasy of its composer? Revenge taken on a stingy and uncooperative management, on singers and public not up to his challenge, on fate which brought the Dumas play to Venice just as Verdi arrived score in hand?

"Time will tell," said Verdi. The Monday reviews were very, very good. Mariani and Gallo vied with each other for the right to stage the work next. Fiasco? Time has told.

The sweetest satisfaction, sweeter perhaps than Verdi's own, came to Cesare Vigna. When the published score came out, when the packets of bound volumes were unwrapped in the back room of Gallo's music shop in Piazza San Marco, the physician saw that Verdi had dedicated *La Traviata* to him.

Yes, of course.

For he alone had understood. ●



Care to hear that high note again, my dear?

You rascal, you've got it all together. Beverage chilled just right, lights romantically dim, zebra pillows fluffed and gorgeous Miss Schrimpf of the typing pool. Now, music. Perfect music on Ampex Extended Frequency Cassettes, a fantastic new listening experience.

Is she impressed? Heh, heh, heh. However, Miss Schrimpf was never particularly known for a fine musical ear. But, you are. And now you've got quality sound with cassette convenience. Less noise because of super-smooth Ferrosheen[®] tape. Higher output due to an exclusive formula that produces more

magnetic energy per square inch of tape. To swingers like you, Miss Schrimpfs are a dime a dozen, but Extended Frequency Cassettes are a bit more than 2 dollars each.

Ask your Ampex dealer about new, extra-listening Extended Frequency Cassettes, another quality product in a full line of recording tapes; open reel, 8-track cartridges and standard cassettes.

**AMPEX**

Ampex Corporation
Magnetic Tape Division
401 Broadway, Redwood City,
California 94063

by Harris Goldsmith

Ten Pianists in One



Michael Ponti's burgeoning discography inspires a bit of pontification.

FOR THE PAST YEAR or so, it would almost seem that one out of two new piano records featured a young American named Michael Ponti. Many of these discs have been reviewed in *HIGH FIDELITY*; now, on the occasion of Ponti's New York debut this month (it turns out that he *is* but one pianist even though he does the work of ten), the editor has asked me to pass judgment on the balance of this artist's unreviewed discography, to bring it all together and (forgive the pun) to pontificate a little.

It strikes me as a little odd to assess a pianist's work without hearing him play Bach, Mozart, Beethoven, Chopin, Schubert, Schumann (Robert, that is). Nor have there been Ponti recordings of Liszt or Brahms, Bartók or Prokofiev. About the closest Ponti has come to "standard" repertoire is Rachmaninoff (and that, interestingly enough, is probably his least convincing effort to date). So while one can agree with Vox's blurb that "it is Michael Ponti's all-encompassing repertory which makes him unique among the pianists of his generation," we must accept on faith that "it covers the whole spectrum of piano literature from pre-Bach to the most recent contemporary compositions." In the main, I would say that the biggest question mark is his musical probity and ability as a classicist, for I would generally be willing to give him the nod vis-à-vis Schumann, Chopin, and Liszt on the basis of his admirable work in dealing with the substantially similar phrases and configurations found in the music of Henselt, Alkan, Moszkowski, Tausig, and the like.

Ponti is obviously a big technician. Generally, he espouses the modern, no-nonsense school of pianism, although his phrasing is often marked by a vein of pleasing nuance and flexible lyricism. His ability as a colorist is a bit harder to pinpoint: While a great deal of his work is indeed full of delicacy and refinement, it can at times verge on tanklike stolidity and plangent, metallic percussiveness. It is difficult to ascertain how much of that brittleness is attributable to Ponti and how much is simply the unfortunate result of tacky, unsympathetic recorded sound. On the whole there is enough truly outstanding pianism on these discs to make me want to give Ponti the benefit of the doubt. His interpretations are usually bright-eyed and alert, with a pleasing absence of coy sentimentality (always a danger in the sometimes insipid forgotten music of the nineteenth century) and an equally commendable avoidance of technical fakery

and overpedaling. Even if Ponti has yet to "prove" himself in standard works, never does he seem to be hiding faulty wares behind the anonymity of unknown music.

The newest and most ambitious of the new Ponti projects are his complete cycle of the Scriabin sonatas and his completion of the Tchaikovsky piano music (Vol. I of which was reviewed by Peter G. Davis in these pages a year ago). The Scriabin marathon comes hard on the heels of Connoisseur Society's cycle with Ruth Laredo, and Roberto Szidon's substantially complete effort for Deutsche Grammophon. As a matter of fact, followers of transatlantic recording activity will know that HMV/EMI have released the ten sonatas with John Ogdon, and these too might very well make their appearance on the domestic Angel label. With but one installment of the Laredo cycle at hand, with few scores and only real familiarity with the sonatas 3, 5, 9, and 10, I would not do Ponti justice by hastily reviewing his album. More detailed comparison reviews of this set will be forthcoming from my colleague Royal S. Brown, who knows this literature inside out and has all the competing recordings at his disposal. For now, let it be said that Ponti has a big, muscular way with this music, that he does more than most to bring out the structural qualities, and that his playing sometimes has a great deal of exciting bravura thrust. At the same time, I thought his tone rather threadbare and hard to take (Miss Laredo gets far plusher, more resonantly mellow sound), and I also found his reading of the Ninth Sonata somewhat stolid, angular, and metronomic. These are not, for all their earnest musicianship, readings that will make me willingly part with my treasured accounts by Horowitz, Richter, and (in No. 3) Glenn Gould. Ponti's biggest plus here, it seems to me, is his inclusion of two early, posthumously published sonatas not contained in the competing sets.

The Tchaikovsky box gave me real pleasure. Ponti plays the student sonata posthumously published as Op. 80: the cycle known alternately as *The Seasons* or (more accurately, since it contains twelve *morceaux*) *The Months*; the *Children's Album*, Op. 39; Six Pieces, Op. 51; another five (which have no opus numbers assigned to them); and the eighteen pieces of Op. 72 which were composed, along with the *Pathétique* Symphony, in the last year of Tchaikovsky's life. These last are truly exquisite works; Ponti's performances of them leave no

doubt that they are an important and inexplicably neglected segment of great piano music, full of charm, melodic and harmonic inspiration, and attractive originality. He does a fine job with the early sonata, played in a bold, scurrying, forthright style; and his account of Op. 37a has many high points (one of them a deliciously breezy, unaffected rendering of the famous "November" *Troïka en vaineaux* so often mauled and distorted by pianists of yesteryear). In the children's pieces however Ponti seems to me deficient in one important ingredient, charm; his efforts in this direction result in some unforgivable mannerisms (the delightful and well-known little waltz in E flat, No. 8 of the set, sounds stiff and graceless because the dotted rhythms are played with such unpleasant bumpy sharpness).

The other new Ponti disc devoted to Tchaikovsky's music is even more of a curio. It gives us the first recorded performance of the third and last piano concerto in its reconstructed three-movement version. Usually this relatively little-known work is heard in the one-movement format first presented by the New York City Ballet, and later on disc by the late Noel Mewton-Wood (Concert Hall Society) and Gary Graffman with Ormandy and his Philadelphians (still available on a Columbia disc, coupled with the Siloti version of the Second Piano Concerto). This reworking by Tchaikovsky's pupil Taneyev recently came to light, and many will recognize the music as that of the conjectured Seventh Symphony [see page 25] also recorded by Ormandy for Columbia—a not very successful project. The work is pleasing despite its spotty history and Ponti's performance, if a bit flinty-toned and harshly energetic, does have fine spirit. The second side of this disc is filled out with Rimsky-Korsakov's short one-movement Concerto in C sharp minor—a work I have liked since I first encountered it on a wretchedly recorded Soviet performance by Sviatoslav Richter. Ponti and his associates are far more realistically reproduced, but the performance—for all its sturdy impulses—simply lacks any comparable degree of line or poetic impulse. Still, it's good to have the music in a modern, stereophonic documentation.

Alkan's Op. 39 is a huge collection containing a three-movement solo concerto, a four-movement piano "symphony," and a theme with twenty-five variations depicting Aesop's beasts. Pianists attempting this treacherous, eccentrically difficult music will find it a pretty hefty mouthful. Raymond Lewenthal's Alkan debut record for RCA included both the symphony and the Aesop fables. These were strong, temperamental readings, and when I heard a subsequent recording of the symphony (by Ronald Smith on the British Unicorn label) I thought it competent but by no means competitive with Lewenthal's for sweep and temperament. Ponti's challenge is a stronger one. The contrast between the two performances is interesting. Lewenthal, one might say, plays the symphony as a conductor scanning the score on a keyboard. He is interested in power and profile, occasionally impatient with niceties of detail. Ponti, on the other hand, treats the giant opus just as he might approach any big sonata—Liszt's B minor, for example, or Beethoven's *Appassionata*. In other words, he is much more the lapidary, appreciative of the *pianistic* possibilities inherent in the music. Since Ponti's rendition is by no means lacking in excitement, I must prefer his to Lewenthal's for its finer nuance and perfection of execution.

The third movement with its fearsome slurred note figurations especially gains from Ponti's more painstaking treatment. A similar contrast between Ponti and Lewenthal in the Aesop fables, however, leaves the latter still an undefeated champion. Here Ponti's neat, precise, well-regulated work by no means captures the grotesquerie and pre-Mahleresque irony as well as Lewenthal's more fiercely blocked-out effort to stride the colossus. In the remaining pieces—most particularly in the first etude which is marked "like the wind—as fast as possible," Ponti leaves little or nothing to be desired.

The Scharwenka collection is highly recommended. The B flat minor Concerto (No. 2) here is far preferable to the earlier No. 1, which Earl Wild recorded for RCA, if only because it lacks that other work's abysmally banal chromatic first theme. Here the writing is pliant, very virtuosic, and somewhat reminiscent in its sunny folksiness to Dvořák's G minor Piano Concerto (though the last movement's theme is obviously derived from Chopin's F minor). The various solo pieces overside are certainly derivative, but just as certainly charming and worth hearing. Scharwenka, of course, was a virtuoso pianist like most of the forgotten nineteenth-century romantics, and that fact is thoroughly documented by the technically complex, even ornate, style of the keyboard writing. The recorded sound here is a bit tacky and the orchestra, in the concerto, makes rather scrawny, disreputable sounds (though the conductor seems to know what he is about).

Another startling discovery is the piano music of Carl Tausig. We all know that this arranger of songs was a brilliant pianist and one of Liszt's most inspired students (alas, he died—the victim of typhus—in his thirtieth year). Two of the works Ponti revives here, the Ballade in A minor (entitled *The Ghost Ship*) and the *Halka* Fantasy have striking originality. These works exude a brooding power and intensity which bring to mind the menacing turmoil of Wagner's *Fliegende Holländer* Overture. The piano writing is more Wagnerian than Lisztian, if you understand the fine distinction I am attempting to make, with a richness and pathos that are utterly compelling. The transcription of the Strauss waltz *One Lives but Once* is well enough known (Rachmaninoff once recorded it), but the other caprice waltzes after Strauss are welcome revivals. The two etudes, Op. 1 are more academic but thoroughly exhaustive of keyboard potential. As for the song *Hope*, Op. 3 and the longer *Hungarian Gypsy Melodies*, both are rather conventional examples of Lisztiana but no less attractive for that. This disc is superbly reproduced, and Ponti is in particularly good form.

I'm beginning to think that Clara Schumann may have been little more than a self-appointed saint. Certainly her editorial suggestions on behalf of her late husband's music are an abomination, and of late I have come upon some rather unflattering comments about her playing from those who heard it. One thing is certain—she was no composer! Rarely have I heard such watery stuff: The harmonic progressions are conventional and lacking direction, the melodies—if you can call them that—are undistinguished, the orchestration (in the concerto) is inept, and worst of all an unpleasant cloying *kitsch* element runs through all of her music on this record like treacle. Ponti plays it well, but he can't make the music any less depressing.

After this debacle, it was quite refreshing to discover

the concentrated ideas and skillful writing in the concertos of Joachim Raff and Ferdinand Hiller. Since all that I previously knew of Hiller was woefully linked to a dreadfully long-winded set of variations by Max Reger, I found special delight in his Op. 69 in F sharp minor and especially its passionate first movement and its finale with a second theme midway between Franck's *Symphonic Variations* and *Happy Birthday to You*. The Raff C minor would have come out as well but for the orchestra (once again the Hamburg Symphony) which is distinctly less adroit than the Luxembourg Radio Orchestra under Louis de Froment which performs in the Hiller.

H.G.

B **ALKAN:** Etudes, Op. 39: No. 1 (*Comme le vent*); No. 2 (*En rythme molossique*); No. 3 (*Scherzo diabolico*); No. 12 (*Le Festin d'Esopé*); Nos. 4, 5, 6, and 7 (*Symphony*). Michael Ponti, piano. Candide CE 31045, \$3.98.

B **HILLER:** Concerto for Piano and Orchestra, in F sharp minor, Op. 69. **RAFF:** Concerto for Piano and Orchestra, in C minor, Op. 185. Michael Ponti, piano; Luxembourg Radio Orchestra, Louis de Froment, cond. (in the Hiller); Hamburg Symphony, Richard Kapp, cond. (in the Raff). Candide CE 31058, \$3.98.

B **SCHARWENKA:** Concerto for Piano and Orchestra, No. 2, in B flat minor, Op. 56; Scherzo, Op. 4; Erzählung am Klavier, Op. 5, No. 2; Novelette, Op. 22, No. 1; Polonaise,

Op. 42. Michael Ponti, piano; Hamburg Symphony, Richard Kapp, cond. (in the concerto). Candide CE 31046, \$3.98.

B **SCHUMANN, CLARA:** Concerto for Piano and Orchestra, No. 1, in A minor, Op. 7; Scherzos: No. 1, in D minor, Op. 10; No. 2, in C minor, Op. 14; Four Fugitive Pieces; Variations on a Theme of Robert Schumann, Op. 20. Michael Ponti, piano; Berlin Symphony, Voelker Schmidt-Gertenbach, cond. (in the concerto). Candide CE 31038, \$3.98.

B **SCRIABIN:** Sonatas for Piano (12). Michael Ponti, piano. Vox SVBX 5461, \$9.95 (three discs).

B **TAUSIG:** Two Concert Etudes, Op. 1; Ballade in A minor (*Ghost Ship*); Hope, Op. 3; Caprice Waltz after Johann Strauss (*One Lives but Once*); Hungarian Gypsy Melodies; Caprice Waltzes on Themes of Johann Strauss; Fantasy on Themes From Moniuszko's Halka. Michael Ponti, piano. Candide CE 31031, \$3.98.

TCHAIKOVSKY: Concerto for Piano and Orchestra, No. 3, in E flat, Op. 75/79. **RIMSKY-KORSAKOV:** Concerto for Piano and Orchestra, in C sharp minor, Op. 30. Michael Ponti, piano; Luxembourg Radio Orchestra, Louis de Froment, cond. (in the Tchaikovsky); Hamburg Symphony, Richard Kapp, cond. (in the Rimsky-Korsakov). Candide CE 31056, \$3.98.

B **TCHAIKOVSKY:** Piano Music, Vol. 2: Sonata, Op. 80; The Months, Op. 37a; Children's Album, Op. 39; Six Pieces, Op. 51; Eighteen Pieces, Op. 72; Five Pieces without Op. Michael Ponti, piano. Vox SVBX 5459, \$9.95 (three discs).



The LaSalle Quartet—remarkable renditions of Schoenberg's early works.

by David Hamilton

Twentieth-Century Masterpieces from Vienna

A flurry of recordings featuring seminal works by Schoenberg, Berg, Webern

THE MAJOR EVENT in this flourish of recordings devoted to the Second Viennese School (DGG calls it the "Neue Wiener Schule," but "new" seems a less-than-appropriate adjective to use in respect of three composers whose work spans a half century that is now two decades behind us) is the first really qualified presentation of the Schoenberg string quartets since the Juilliard Quartet's mono set of the early 1950s (still available from Columbia as CML 4735/7). That the present set also includes the first-ever disc version of the posthumously published

D major String Quartet from 1897, and that the Fischer-Dieskau record of songs by the same trio of composers also contains some first recordings of Schoenberg, reminds us that important works by this towering figure of twentieth-century music still await recording. Let us hope that by the time the Schoenberg centenary rolls around in 1974, these remaining gaps will be filled, and that works not adequately represented at present (most notably the opera *Moses und Aron*) will be made available in first-rate modern recordings.

The D major Quartet is the earliest substantial work of Schoenberg's to survive. It predates the well-known *Verklärte Nacht* by two years—years that will be perceived by the listener to have been marked by a remarkable growth, for the 1897 work is very much in the Brahms-Dvořák orbit, quite removed from the Wagnerianisms of the sextet. The string writing is already very skillful, with some exceptionally delicate touches of instrumentation in the second movement (labeled "Intermezzo"), a typically Brahmsian harmonic plan in the first movement, and a concern with two-against-three rhythmic relationships altogether characteristic of the older Viennese composer.

Two years later comes the first of the songs on the Dieskau record, and we hear a new kind of harmonic treatment altogether, with a striking chromatically altered chord assuming a major role in the texture. Here and in the songs from Opp. 3 and 6, the style of declamation and piano writing owes a good deal to Richard Strauss, but by September 1905, when the first of the canonical four quartets was finished, the idiom is entirely personal and developed to an intensity of compositional development that makes greater demands on the auditor. It was the opening of this quartet, in fact, that Berg discussed in his famous essay, *Why is Schoenberg's Music so Difficult to Understand* (which I gather is reprinted in the booklet that accompanies the DGG album). Not only the concentration of detail, but also the elaborate four-movements-in-one form, make this quartet one of the "largest" works in the composer's catalogue, calling for the longest span of unbroken attention; only the 1903 tone poem *Pelleas und Melisande*, with its still greater elaboration of orchestral counterpoint, makes greater demands. But the same sonic imagination that distinguishes *Verklärte Nacht* is still very much in evidence (indeed, it remained so throughout Schoenberg's career), and the fluency and color of the writing provides a firm handle to grasp while one is sorting out the thematic and structural threads.

Before the remarkable turning point of the Second Quartet, the two songs from Opp. 12 and 14 show the continuing direction of Schoenberg's thought, weaving together the extension of post-Brahmsian phrase irregularities and post-Wagnerian chromaticism. The Second Quartet, completed in 1908, itself incorporates two songs, settings of Stefan George, and in its final movement reaches out into tonally indeterminate regions, with the soprano uttering the famous line, "*Ich fühle Luft von anderem Planeten*" ("I feel air from another planet"). And the next year, with the piano pieces of Op. 11, the borderline is crossed altogether, to a music where every piece makes its own harmonic rules without reference to any external context.

Schoenberg did not return to the string-quartet medium again until 1927, when the twelve-tone technique of organization had been thoroughly worked out. In the interim, the solo piano pieces embody significant turning points. The Six Little Pieces, Op. 19, are the closest that he came to Weberian compression; the Op. 23 pieces are studies for the new technique (No. 5 of this set was the first piece to use a "row" of twelve tones); and Op. 25 is the first full-length work to use a row throughout—while at the same time reverting, for the first time in many years, to "classical" forms (in this case, as with much of Stravinsky's contemporary "neoclassical" music, actually baroque forms).

The two remaining quartets, written in 1927 and 1936

respectively, represent major attempts to re-establish links with the great Viennese musical tradition. The effort is quite opposite in direction from Stravinsky's at the same time: Whereas the latter is purposefully exploiting the dichotomy between traditional forms and contemporary materials, Schoenberg is trying to paper over the differences—to write, in some sense, the same kind of music as Haydn, Mozart, Beethoven, and Brahms. The tension is much subtler and under the surface (with Stravinsky, it is always right up on top), and one frequently feels that these pieces hold together almost in spite of the technique's harmonic imperatives, willed by Schoenberg's powerful command of phrase structure and articulative sensitivity. The tensions that underlie the forms of the classical quartet are not operative under the twelve-tone discipline, and although the melodic-contrapuntal unities imposed by the row fulfill a very significant structural role here, the massive effort to overcome the centrifugal force of the rotating vertical sonorities is what makes these pieces so gripping both intellectually and emotionally—in significant respects a parallel with Beethoven's enormous struggles with form in his last quartets. The intervening Op. 33 piano pieces, on the other hand, are freely shaped and owe more to the row structure.

The achievement of the LaSalle Quartet in these five works is something truly remarkable, for their command of shape and color, their ability to project at once the individual lines and the total texture, their ability to sustain the long-range line of every piece, all bespeak profound study and understanding. If the intonation, particularly of the first violin, is occasionally suspect, this seems a very minor flaw in the context of the above-mentioned virtues: these readings do far more for Schoenberg than any since the Juilliard versions, and are far more comfortable to hear. The acoustical ambience is, happily, not a spaciouly overresonant one, and I find it more than satisfactory for home listening—which is what records are for, after all. One minor quibble is with the balancing of the voice in the Second Quartet: as usual, DGG overemphasizes the voice; Margaret Price is splendidly sure-throated if a shade bland in tone.

When we come to the piano music, the news is less good. The Turnabout disc will pass muster as a bargain-basement account of the complete solo piano music, in which the only current competition is Glenn Gould's much more actively mannered disc (Columbia MS 7098). But Vintschger is not a strong performer, except perhaps in the miniatures of Op. 19. He is, at least, better recorded than Miss Chamberlain, whose left hand sounds distant and fuzzy, nor does she project with much confidence. In this literature I still return to Edward Steuermann's out-of-print Columbia disc, and perhaps *Odyssey* will some day oblige us with a reissue. In the meantime, Dover 7285 contains Beveridge Webster's solid readings of Opp. 11, 19, and 23. (The verso of Miss Chamberlain's record is valuable for its presentation of three pieces by Stefan Wolpe, among which is a surprisingly Gallic *Pastorale* dating from 1939. The 1959 *Form* is altogether more characteristic of Wolpe's recent style, although it never develops the momentum and vivacity of some other pieces. The other two composers on this disc are associates of Wolpe at C. W. Post College: their pieces are more conventionally knotty and not without a certain rather opaque force.)

Turning now to Fischer-Dieskau's record, we find not

only the early Schoenberg songs mentioned above, but also two from the 1933 group of three that was published only much later, under the misleading opus number 48. They are his only twelve-tone songs, with a spare contrapuntally oriented piano accompaniment. In general on this record, the singer sounds most comfortable in the early material, although throughout his voice is in typical current condition, somewhat dry and hard, especially in the upper register where a certain amount of pitchless shouting sometimes obtrudes. With the exception of Op. 2, No. 1, none of these Schoenberg songs are otherwise currently available (and that one only in an unintentional arrangement for soprano, whiskey tenor, and piano, with Glenn Gould taking both latter parts, in Columbia M2S 736). All the Webern songs listed without opus numbers are also "firsts," from the recently discovered corpus of early material: nice late-Romantic stuff, but unexceptional. The Berg Op. 2 songs are the best performances of the lot, but Heather Harper generates a still stronger sense of line (Angel 36480). (Incidentally, this is the first time a male singer has recorded any of these songs.)

I have left myself no space to consider the Berg and Webern chamber works that fill out the LaSalle Quartet set, but they have been more widely and satisfactorily disseminated on records. They are all admirably performed, and I prefer these readings of the Webern to the recent Quartetto Italiano disc even though that included one other early work, the not-very-interesting *Langsamer Satz*. The Juilliard Quartet has also recorded most of this music, and theirs are the versions to go for if you

don't want to invest in the Schoenberg—but I think you should, and you will not be disappointed by the other discs in the set.

SCHOENBERG: Quartets for Strings: in D (1897); No. 1, in D minor, Op. 7; No. 2, in F sharp minor, Op. 10; No. 3, Op. 30; No. 4, Op. 37. **BERG:** Quartet for Strings, Op. 3; Lyric Suite. **WEBERN:** Quartet for Strings (1905); Five Movements for String Quartet, Op. 5; Six Bagatelles for String Quartet, Op. 9; Quartet for Strings, Op. 28. Margaret Price, soprano (in Schoenberg Op. 10); LaSalle Quartet, Deutsche Grammophon 2720 029, \$34.90 (five discs).

SCHOENBERG: Erwartung, Op. 2, No. 1; Die Aufgereagten, Op. 3, No. 2; Geübtes Herz, Op. 3, No. 5; Verlassen, Op. 6, No. 4; Der verlorene Haufen, Op. 12, No. 2; Ich darf nicht dankend, Op. 14, No. 1; Sommermüd, Op. 48, No. 1; Tot, Op. 48, No. 3. **BERG:** Four Songs, Op. 2. **WEBERN:** Vorfrühling; Gefunden; Bild der Liebe; Am Ufer; Dies ist ein Lied, Op. 3, No. 1; An Bachesranft, Op. 3, No. 3; Noch zwingt mich Treue, Op. 4, No. 2; So ich traurig bin, Op. 4, No. 4; Ihr tratet zu dem Herde, Op. 4, No. 5. Dietrich Fischer-Dieskau, baritone; Aribert Reimann, piano, Deutsche Grammophon 2530 107, \$6.98.

B **SCHOENBERG:** Three Piano Pieces, Op. 11; Six Little Piano Pieces, Op. 19; Five Piano Pieces, Op. 23; Sulte for Piano, Op. 25; Piano Piece, Op. 33a; Piano Piece, Op. 33b. Jürg von Vintschger, piano, Turnabout TV 34378, \$2.98.

SCHOENBERG: Three Piano Pieces, Op. 11; Six Little Piano Pieces, Op. 19; Piano Piece, Op. 33a. **WOLPE:** Pastorale; Presto Agitato; Form. **ROVICS:** Three Studies for Piano. **PLESKOW:** Piece for Piano. Anne Chamberlain, piano, Ars Nova Ars Antiqua AN 1007, \$4.98.

by Clifford F. Gilmore

A Massive Long-Range Recording Project

Telefunken's ten-year plan to record all the Bach cantatas makes an auspicious beginning.



The Concertus Musicus—starting something big.

IN ALL OF WESTERN MUSIC is there another body of works so universally regarded as masterpieces yet still so sparsely represented in the record catalogues as the cantatas of Bach? Well over 200 of them have come down to us intact, yet the current issue of Schwann lists only eighty-six titles. The Musical Heritage Society (which is not listed in Schwann because of its strictly mail-order policy) has hitherto been a prime source for collectors: its current catalogue lists fifty-five titles, twenty-two of which cannot be found in Schwann (MHS also hopes to have a complete set ready in due course). If we include European companies and go back to the advent of the LP (I haven't attempted to research anything before that), we still find that about a third of the extant cantatas have never been commercially recorded. Clearly here's a wonderful opportunity for someone to make phonographic history, and Telefunken has just taken up the gauntlet. The two boxes at hand are labeled Vols. 1 and 2 of "The Complete Cantatas." Of the eight cantatas in this first

release, three represent first recordings anywhere, and four titles make their debut in Schwann.

It is roughly estimated that the project will take about ten years to complete at the rate of about twenty cantatas per year. DGG (and many other companies as well) honored Beethoven's 200th birthday by filling in many discographic gaps, and now Bach is assured of the same honor by his 300th birthday in 1985.

Any number of systems could have been devised to bring order to a recording project of this size, and Telefunken has made what at first seems to be a logical choice; namely to record the cantatas in numerical sequence. This first release therefore consists of Nos. 1 through 8. The numerical sequence was not established however until more than a hundred years after Bach's death and represents nothing more than the random order in which the cantatas were first published by the Bach-Gesellschaft beginning in 1851. Now, a great deal has happened since the Bach-Gesellschaft completed its historic project in 1899. Because so much new information has come to light, a new collected edition of Bach's works was begun in 1954—the *Neue Bach Ausgabe sämtlicher Werke*, edited by the Bach Institute in Göttingen and the Bach Archive in Leipzig. At present only about half the cantatas have been published in the new edition, and these in a totally different sequence from the Bach-Gesellschaft. This means that by following the Gesellschaft sequence Telefunken will have access only to the older edition in many cases. (Of these first eight cantatas, only No. 6, *Bleib' bei uns*, has been newly published.) Of course these musicologist/performers will have access to many of the same sources as the *Neue Ausgabe* editors, so serious discrepancies are unlikely; but how much nicer it would be if Telefunken had co-ordinated its efforts with the edition in progress. Telefunken, by the way, has included in these two boxes (and hopefully will in the future) photographic reproductions of the Gesellschaft scores for these eight cantatas. The print is small—about 25% smaller than the Kalmus or Lea pocket scores which are also photo copies of the Gesellschaft—but easily legible.

Though many of us have long lamented the large gaps in the cantata discography, now that this project is under way I am forced to the realization that it really couldn't have begun until now. Only in the last few years have enough of the conditions been met to make possible performances as historically accurate and thoroughly satisfying as we have here. Many factors are involved: accurate performing editions, proper instruments (and players to play them!), an understanding of the performance style appropriate to this music, and of course experience. Until recently no record company had under contract a group of musicians who not only possessed all this "textbook" knowledge and technical facility but had also the ability to communicate these ideas in vivid, expressive, and meaningful performances. There are now two such groups: Both are recorded exclusively by Telefunken and both are participating in this mammoth venture. The Vienna Concentus Musicus has earned the larger reputation at this point for their earlier successful recordings of the *St. Matthew* and *St. John* Passions, the B minor Mass, the *Brandenburgs*, orchestral suites, and several other orchestral or chamber works, as well as two discs of five cantatas. The other group hails from Amsterdam, and is comprised of outstanding "baroque specialists" gathered around harpsichordist

Gustav Leonhardt. The two choruses involved in the current release are the Vienna Choir Boys and the Choir of King's College, Cambridge. Both are among the best ensembles of their kind, and both have participated in earlier Bach recordings with the Concentus Musicus. Hopefully they will be retained for the entire project.

The Amsterdam and Vienna groups approach their task with identical intentions, but of course each achieves a very different end result. The Concentus Musicus is based in Vienna, and the city's long string-playing tradition, rich and very expressive, is emphasized by Harnoncourt's musicians. In the north, on the other hand, there exists a stronger keyboard tradition. The finest organs and harpsichords ever constructed are by Dutch and North German builders. Leonhardt and his players reflect this sterner, more austere keyboard orientation. In an age of superinternationalism it is gratifying to see signs that some of these historic national individualities are still present. None of this is intended as a qualitative comparison of the two groups: I find it impossible to prefer one to the other, and fortunately in a project of this magnitude we will have both viewpoints. There are of course many other superb cantata recordings (from Karl Richter, to mention only one of my favorites), but these are all in a very different category and cannot really be compared with the Telefunken project.

On the matter of soloists, little need be said: In my opinion a casting director has finally achieved perfection. Equiluz and Van Egmond have appeared on most of these groups' earlier vocal recordings and I know of no one better equipped to handle this music vocally or interpretively. It's a small point, actually, but I can't resist mentioning that Van Egmond is the only singer of my acquaintance to sing all the low Es in the bass aria of No. 4, *Christ lag in Todesbanden* (including the spectacular five-note final cadence spanning two octaves) and still handle the upper baritone range with ease. Alto arias are sung magnificently by countertenor Paul Esswood, who first appeared on the Concentus Musicus' recent *St. Matthew* Passion. On earlier recordings the group had employed both boy altos and adult female altos, but Esswood's cool, pure tone and mature musicianship now represent the ideal solution. Soprano arias are taken by unnamed boys from the Vienna Choir Boys and the Regensburger Domspatzen. The one from the Vienna group who appears in Nos. 1, 3, 4, 5, and 6 sounds to me like the same boy who heart-meltingly sang the *Coro I* arias in the same recent *St. Matthew* recording. We can only hope that this ideal ensemble of soloists will also be retained as long as possible.

While I am always wary of the word "definitive," the performances we have in this initial release are about as close to it as we're ever likely to come.

BACH: "The Complete Cantatas, Vols. 1 and 2": No. 1, *Wie schön leuchtet der Morgenstern*; No. 2, *Ach Gott, vom Himmel sieh darein*; No. 3, *Ach Gott, wie manches Herzeleid*; No. 4, *Christ lag in Todesbanden* (on SKW 1); No. 5, *Wo soll ich fliehen hin?*; No. 6, *Bleib' bei uns, denn es will Abend werden*; No. 7, *Christ unser Herr zum Jordan kam*; No. 8, *Liebster Gott, wann werd' ich sterben?* (on SKW 2). Paul Esswood, countertenor; Kurt Equiluz, tenor; Max van Egmond, bass; Vienna Choir Boys; Chorus Viennensis (in Nos. 1-6); King's College Choir, Cambridge (in Nos. 7 and 8); Vienna Concentus Musicus, Nikolaus Harnoncourt, dir. (in Nos. 1-6); Leonhardt Consort, Gustav Leonhardt, dir. (in Nos. 7 and 8). Telefunken SKW 1/2, \$11.96 each (four discs).



Mr. Horowitz has just recorded an album of particular interest to lovers of Chopin and collectors of truly unique performances.

Any new Horowitz recording is something of an event. But this one is a special event for a number of reasons.

It's the first all-Chopin recording by Horowitz in a number of years.

It's got a performance of the "Polonaise in A-Flat Major" that will make you think you're hearing it for the first time—**incredible!**

And it includes Horowitz performances of the great "Polonaise Fantaisie" and a much-neglected Chopin gem: "Introduction and Rondo, Op. 16."

Altogether a brilliant record.

**On Columbia Records
and Tapes**



M 30613

classical

reviewed by

ROYAL S. BROWN
 R. D. DARRELL
 PETER G. DAVIS
 SHIRLEY FLEMING
 ALFRED FRANKENSTEIN
 CLIFFORD F. GILMORE
 HARRIS GOLDSMITH
 DAVID HAMILTON
 DALE S. HARRIS
 PHILIP HART
 DONAL J. HENAHAN
 PAUL HENRY LANG
 ANDREA MCMAHON
 ROBERT C. MARSH
 ROBERT P. MORGAN
 H. C. ROBBINS LONDON
 SUSAN THIEMANN SOMMER

BACH: "The Complete Cantatas, Vols. 1 and 2." Soloists; Vienna Concentus Musicus, Nikolaus Harnoncourt, dir. For a feature review of these recordings, see page 73.

BACH: Suites for Orchestra: No. 1, in C, S. 1066; No. 2, in B minor, S. 1067; No. 3 in D, S. 1068; No. 4, in D, S. 1069. Academy of St. Martin-in-the-Fields, Neville Marriner, cond. Argo ZRG 687/8, \$11.96 (two discs).

These suites were among the very last recordings made by harpsichordist/musicologist Thurston Dart before his untimely death in March 1971, and his name on the jacket automatically lends an air of authority to the set. As a British colleague said of Dart's participation in any performance: "His very presence was like a Seal of Good Housekeeping. . . ." Dart was always a controversial musicologist, partly because in the final analysis he refused to allow dogma to stand in the way of an "enjoyable" performance. In his excellent jacket notes accompanying this Argo release, he suggests the possibility that the First Suite was written for a court ball at Cöthen and that the dance movements were actually danced to. Hence his insistence on good, quick, buoyant dance tempos. Marriner and his St. Martin-in-the-Fields group collaborate willingly and capably, and the result is a collection of vivid, very sharply focused, and energetic performances that are simply irresistible.

Marriner, undoubtedly with Dart's approval, has handled Bach's orchestration with a very free hand. Many of the dance movements are varied in the repeats by omitting the oboes or the strings, or by reducing the strings to a solo ensemble. Similarly, in the Third and Fourth Suites the trumpets and drums are occasionally silenced. The authority in the case of the Fourth Suite—if indeed an authority is

needed—is the fact that the suite exists in an earlier version scored for strings, oboes, bassoon, and continuo without the trumpets or drums. Matters of ornamentation, double-dotting, and the like are handled with excellent taste throughout, and Marriner consistently observes the first repeat in each of the overtures but not the second. Of course all the repeats in the dance movements are taken.

Actually, these performances are very similar to those by Raymond Leppard with the English Chamber Orchestra on Philips (reviewed in the September 1970 issue). Bach frequently has his oboes playing in unison with the violins for the particular color produced by that combination. Leppard's recorded balance always permits the oboe color to be heard along with the strings, whereas Marriner's oboes are usually inaudible in tutti passages. Dart's imaginative harpsichord continuo playing is also too often obscured, while Leppard's even more elaborate filigree work is always nicely balanced. The famous Air from the Third Suite is the movement I like least in the Marriner set and the very one I like best in Leppard's version. Marriner heaves and sighs with grandiose crescendos and decrescendos in the style we expect from Klemperer. Leppard treats it much more delicately, and for the repeats a solo violin plays a beautiful and elaborately embellished version of the tune.

In general, though, I rather prefer Marriner's performances, largely because of the crisp and buoyant tempos and energetic spirit, though Leppard's are never slack and he does score more highly on several details. My favorite recording of the suites is one of the most remarkably fine recordings of the decade—the original-instrument version by the Concentus Musicus on Telefunken. Not only do they play the old instruments superbly and handle all the stylistic details with authority, but they also manage to turn in enthusiastically exciting performances. C.F.G.

BACH, C.P.E.: Concerto for Two Pianos and Orchestra, in F, Wq. 46; Sonatinas: for Piano and Orchestra, in D minor, Wq. 107; for Two Pianos and Orchestra, in D, Wq. 109. Ingeborg and Reimer Küchler, pianos; Capella Academica Wien, Eduard Melkus, cond. Archive 2533 078, \$6.98.

You can't keep a good man down, they say, and for that reason the unquenchable spark and originality of Carl Philipp Emanuel emerges here in spite of the cloddish, utterly insensitive orchestral contributions led by conductor Eduard Melkus. (And the orchestra takes part in all three works—the term "sonatina" in this case is a synonym for concerto.) Each piece has its special assets. The Concerto in F for two pianos is distinguished by a long, impressive, minor-mode slow movement with serious implications in which the soloists engage in a stately *pas de deux* and the spirit is searching and somber. The two eighteenth-century pianos (one of them the instrument in Mozart-Haus in Salzburg) have an attractive, thunky quality and differ in tone quality from one another just enough to make the contrast interesting.

The Sonatina in D minor (single piano) is a somewhat paler work, but it is followed by a very strong opus indeed: The two-piano Sonatina in D involves a beefed-up orchestra (including three trumpets and timpani) which makes a very nineteenth-century kind of stir, while the pianos gradually increase the density of their collaboration until the texture is thick and alive with pleasant clatter. Pianists Ingeborg and Reimer Küchler deserve better accompaniment than they get. S.F.

BEETHOVEN: Symphony No. 6, in F, Op. 68 (*Pastoral*). Vienna Philharmonic Orchestra, Karl Böhm, cond. Deutsche Grammophon 2530 142, \$6.98.

Karl Böhm is one of the few surviving elder statesmen of the podium, and it is only just that he too should record all the Beethoven symphonies (even though it is highly problematic whether there is a market today for yet another set). In England the series was launched with Symphony No. 5 (glowingly reviewed in our counterpart, *The Gramophone*), but for some reason, DGG thought it best to start with the *Pastoral* in this country. I must admit that the engineering is outstandingly fine here: The placement is very close and immediate, revealing all sorts of felicities in Beethoven's scoring.

Böhm eschews the lushness and fat often associated with the Viennese and he gets his orchestra to play with robust, linear, and slightly astringent sonority. One or two little tempo hobbles strike me as precious (not to say mannered): For example, why must so many conductors encourage those little ritardandos from the bassoon in the first movement's development section? But in all fairness, Böhm's leadership here is more often classically pure than it is self-indulgently romantic. He observes both the first-movement exposition repeat and the crucial one in the third movement; the rhythmic pulse is sturdily conveyed; and the whole reading rather reminds me of the Klemperer (albeit with much more vibrance and animation).

Those who recall the wonderfully flowing, serene simplicity that Toscanini achieved in the "Scene by the Brookside" or that conductor's winged elementalism and poise in the other movements may well find Böhm a bit dogged and unsmiling. His reading, nonetheless, has real quality and stature and the disc—benefitting as it does from the superlative engineering—belongs near the top of the list. H.G.

Explanation of symbols

Classical:

B Budget
H Historical
R Reissue

Recorded tape:

●● Open Reel
 ●● 8-Track Cartridge
 ●● Cassette

The cycle that began in 1918.

Sir Adrian Boult met Ralph Vaughan Williams in 1918. They worked closely together until the composer's death in 1958.

In the 1960's, Vaughan Williams' family chose Sir Adrian and Angel to record a wealth of his works, giving priority to the symphonies.

Now with the release of Symphony No. 2 "London," the symphonic cycle has been completed—with all nine newly recorded since 1968. Angel's detailed sound is rich, spacious, pervasive.

The performances themselves glow with Vaughan

Williams' peculiar vitality, with his unique blending of British tradition and radical harmonic structures.

The Sea Symphony splashes and sprawls. The Pastoral flows with serene introspection. The Sixth stuns us with all the terrors of war. The Antartica broods with an ageless mystery.

Only a great conductor could span such extremes. Only a great conductor who had shared so much with the composer—his heritage, his musical commitment, and 40 years of friendship—could give us such a cycle as this.



by Harris Goldsmith

Van Cliburn—True to Form on Six New Releases

IN ONE FELL SWOOP, RCA has released six new Van Cliburn discs. In addition to the four under review, there is a coupling of sonatas by Barber and Prokofiev, reviewed in the January 1972 issue, and the inevitable excerpt collection. The emphasis on a single artist is nothing new in the record industry: Columbia has featured Rudolf Serkin in this manner at least twice, while RCA has held blasts for the prodigal Philadelphiaans, for Artur Schnabel, for Toscanini, and only a few months ago for Jascha Heifetz.

Hearing so large a dose of Cliburn is not invariably flattering to his art, but most assuredly proves enlightening. To get the reservations out of the way, I find that Cliburn's prevailing relaxed, lyrical style works better in small quantities. Listened to intensively, the performances seem a bit tame, laggard in rhythm, not sufficiently differentiated dynamically. Cliburn is not and never has been a dramatist in the Horowitz or Rachmaninoff manner, and it is to his eternal credit that he has, despite his feverish popularity, remained true to his own best instincts. Generally, I find Cliburn to be most satisfactory in the free-wheeling Romantic literature. His Prokofiev is too mild-mannered, lacking in caustic punch; his classical music (except for a surprisingly excellent Mozart Sonata, K. 330, on LSC 2931) lacks tensile urgency and dynamic intensity. In many ways Cliburn's keyboard manner is akin to Rubinstein's: There is the same unforced tone, the same patient perfection of detail, the same down-to-earth, healthy style.

Rubinstein's Beethoven has of late grown in stature and stylistic perception. For all that, it remains an acquired rather than an innate affinity. Cliburn may similarly gain the knack of turning a brusquely Beethovenian phrase someday, but as yet he sounds uncomfortable in the idiom. The recording of the Third Concerto shows scrupulous attention to detail (e.g., the patiently articulated, on-the-beat treatment of the third-movement appoggiaturas could serve as a lesson for many other pianists). It boasts, moreover, a fidelity to the printed text that leaves Rubinstein (even in his reformed state) far to the rear. Yet there is an indefinably prosaic quality to the performance: It's too slow and square in the first movement; the Largo's opening statement is mauled by a rubato that suggests Cliburn is trying to be expressive by rote. I suspect that he doesn't really

quite understand the harmonic content of what he is playing. Similarly, portions of the Rondo tend to lose impetus and basic tempo. Ormandy's support is serviceable but not terribly stimulating, and the sound—cleanly registered though it is—is a shade heavy and long of reverberation for so crisp and hotheaded a score. Needless to say, Beethoven's own cadenza is used in the first movement and Cliburn wisely refuses to change a note of it.

The first movement of the *Moonlight* starts out with surprising briskness but seems to settle down as it progresses (actually, though, it's an illusion: Cliburn's pace, for all its rubato structuring, is consistent from beginning to end). The Allegretto second movement of this sonata is pleasantly genial but also rhythmically dubious. The Finale is even worse—loose and plodding. Cliburn's fingers hit all the right notes, yet sound inexplicably stumbling here. The *Pathétique* too receives a lethargic reading. It fails to cohere; the rhythmic pulse is again vague and disjunct; the dramatic episodes lack thrust; the lighter ones (e.g., the opening theme of the third-movement Rondo) lack charm. There is also a prevailing tonal grayness, a dearth of true rapt pianissimo so necessary in Beethoven to ignite the dramatic combustion of the fortissimos. I suspect that Cliburn has been playing the *Appassionata* longer, or at any rate more extensively, than he has the others. For whatever reason, this work gets a better performance than its disc mates. Despite this, the Rubinstein and Arrau versions are but two that beat Cliburn at his own lyrical game. I'm afraid this isn't a very lyrepossessing addition to the catalogue.

The Brahms disc, on the other hand, is a triumph. Cliburn not only piles into the two rhapsodies with magnificent sonority and luscious robust lyricism, he also achieves a rare refinement and whispered introspection in the gentler essays of this collection. The E flat minor Intermezzo of Op. 118, for instance, has a delicacy equal to anyone's—a rarefied, beautifully achieved reading. Cliburn's way with the "Myra Hess" Intermezzo, Op. 119, No. 3 is less breezy than that great lady's celebrated account, but has a consoling grace and limpid beauty all its own. The solid, choralelike Op. 116, No. 6 is wonderfully sturdy, with a steady, forward progress and a firm, marching bass line. The B flat minor Intermezzo, Op. 117, No. 2 has romantic

ardor that never lapses into either sentimentality or callow objectivity. Perhaps one would like a little more passion and sweep in the stormy selections like Op. 118, No. 1 or Op. 118, No. 3, but even that is a moot point. It's a pleasure to recommend an outstanding collection like this. The piano sound here, by the way, is outstandingly rich and firm.

Finally, the concerto record. Cliburn's Liszt A major has a vernal freshness. Pianistically, it is of a very high order with smooth chording and supple, even trills. The performance has been well gauged, with the important orchestral concertante detail always meaningful and clearly audible. Still, I have heard finer Liszt A majors from Arrau and Richter. The former will undoubtedly record the work since he is currently engaged in a Liszt project for Philips; Richter, of course, has already made his version available, and Philips has just reissued that unsurpassed edition in a beautifully smooth imported pressing (835474). The Rachmaninoff Rhapsody gets an extraordinarily easygoing treatment from Cliburn and Ormandy. The demoniac *Dies Irae* element so stunningly realized by William Kapell (RCA Victorla should reissue this superb reading). Gary Graffman (Columbia MS 6634), and Rachmaninoff himself (RCA LM 6123) is here subordinated to a vein of expansive solidity and warmth. One suspects that Cliburn (like Rubinstein in his earlier version with Susskind—the present Reiner-led Chicago edition is altogether brisker) regards the famous eighteenth variation as the score's focal point. He makes his view reasonably convincing, but I'll still stick with the laconic approach. The sound is clear and fairly detailed.

BEETHOVEN: Concerto for Piano and Orchestra, No. 3, in C minor, Op. 37. Van Cliburn, piano; Philadelphia Orchestra, Eugene Ormandy, cond. RCA Red Seal LSC 3238, \$5.98. Tape: ● R8S 1216, \$6.95.

BEETHOVEN: Sonatas for Piano: No. 8, in C minor, Op. 13 (*Pathétique*); No. 14, in C sharp minor, Op. 27, No. 2 (*Moonlight*); No. 23, in F minor, Op. 57 (*Appassionata*). Van Cliburn, piano. RCA Red Seal LSC 4013, \$5.98. Tape: ● R8S 1200, \$6.95; ●● RK 1200, \$6.95.

BRAHMS: Rhapsodies, Op. 79: No. 1, in B minor; No. 2, in G minor; Intermezzos: in B flat minor, Op. 117, No. 2; in C, Op. 119, No. 3; in A minor, Op. 118, No. 1; in A, Op. 118, No. 2; in E flat minor, Op. 118, No. 6; in E, Op. 116, No. 6; Capriccio in G minor, Op. 116, No. 3; Waltz, in A flat, Op. 39, No. 15; Ballade, in G minor. Op. 118, No. 3. Van Cliburn, piano. RCA Red Seal LSC 3240, \$5.98. Tape: ● R8S 1215, \$6.95.

LISZT: Concerto for Piano and Orchestra, No. 2, in A. **RACHMANINOFF:** Rhapsody on a Theme of Paganini, Op. 43. Van Cliburn, piano; Philadelphia Orchestra, Eugene Ormandy, cond. RCA Red Seal LSC 3179, \$5.98. Tape: ● R8S 1199, \$6.95; ●● RK 1199, \$6.95.

From Julian Hirsch's Review of the Advent Model 201 Cassette Deck:



"The Advent 201 easily met its specifications, and established itself—at least for now—as *the* best cassette recorder we know of. Having used it to evaluate the forty types of cassette tapes in a survey report, we have a familiarity with, and a respect for, its capabilities."

"With Advocate Crolyn tape, the response variation was less than ± 2 db from 31 to 15,500 Hz."

"It should be noted that the noise was totally inaudible, even at extremely high playback levels... If the 3 per cent distortion level is taken as the reference point for signal-to-noise specification (as is the case with most open-reel machines), the Advent 201 could fairly be rated at 60 db!"

"It is difficult to restrain our enthusiasm for the Advent 201. The unit came with a demonstration tape that had been dubbed onto

Crolyn tape by that specific machine from a Dolby "A" master tape. The sound quality, especially with the finest playback amplifiers and speakers, was literally awesome, as was the total absence of hiss or other background noise."

"Summarizing, the Advent 201 is a tape deck of superlative quality. It is difficult to imagine how its sonic performance could be substantially improved... this is the one that sets the standard for cassette recorders."

We will be happy to send you a reprint of the complete review from the October issue of Stereo Review, which also compares the Model 201 favorably against the best open-reel tape machines, and a list of Advent dealers who will be happy to let you see and hear the Model 201 for yourself. Please write:

Advent Corporation, 195 Albany Street, Cambridge, Massachusetts 02139.

NEW ON LONDON RECORDS

Her first concerto recording
ALICIA DE LARROCHA
**Falla: NIGHTS IN THE GARDENS
OF SPAIN**
**Chopin: PIANO CONCERTO NO. 2
IN F MINOR**
L'Orchestre de la Suisse Romande
—Sergiu Comissiona
CS-6733

HUGUETTE TOURANGÉAU— ARIAS FROM FORGOTTEN OPERAS

Arias by Balfe, Bizet, Donizetti,
Auber, Massenet, Verdi, Vaccai,
Maillart
L'Orchestre de la Suisse Romande
—Richard Bonyngé
OS-26199

VIENNESE NEW YEAR'S CONCERT

Music by the Strauss family
The Vienna Philharmonic Orches-
tra—Willi Boskovsky
CS-6707

R. Strauss: SALOME—Highlights
Birgit Nilsson, Eberhard Wächter,
Gerhard Stolze, Grace Hoffman—
The Vienna Philharmonic Orches-
tra—Georg Solti
OS-26169

Donizetti: THE DAUGHTER OF THE REGIMENT—Highlights

Joan Sutherland, Luciano Pava-
rotti, Spiro Malas, Monica Sinclair
—Orchestra of The Royal Opera
House, Covent Garden—Richard
Bonyngé
OS-26204

R. Strauss: DER ROSENKAVALIER—Highlights

Régine Crespin, Yvonne Minton,
Helen Donath, Manfred Jungwirth,
Luciano Pavarotti—The Vienna
Philharmonic Orchestra—Georg
Solti
OS-26200

Mozart: DON GIOVANNI— Highlights

Joan Sutherland, Pilar Lorengar,
Marilyn Horne, Gabriel Bacquier,
Werner Krenn, Donald Gramm—
The English Chamber Orchestra—
Richard Bonyngé
OS-26215

Commemorating the
Scriabin centenary
VLADIMIR ASHKENAZY
**Scriabin: PIANO CONCERTO IN
F SHARP MINOR**
**PROMETHEUS—THE POEM
OF FIRE**
The London Philharmonic
Orchestra—Lorin Maazel
CS-6732

BERG: Quartet for Strings, Op. 3; Four Songs, Op. 2. LaSalle Quartet; Dietrich Fischer-Dieskau, baritone. For a feature review of these recordings, see page 71.

BUXTEHUDE: Prelude, Fugue, and Ciacona, in C; Preludes and Fugues: in G minor; in D minor; in F sharp minor; Ciacona In E minor; Suite: Auf meinem lieben Gott; Chorale Fantasy: Wie schön leuchtet der Morgenstern; Chorale Preludes: Lobt Gott, ihr Christen; In dulci júbilo; Puer natus in Bethlehem. Lawrence Moe, organ (D. A. Flentrop organ, St. Mark's Cathedral, Seattle, Washington). Cambridge CRS 2515, \$5.98.

Here's a record I would have liked to recommend highly for its several outstanding features. To the best of my knowledge, this is the first generally available recording of the new Flentrop organ in Seattle, and a magnificent instrument it is. The Dutchman Dirk Flentrop is one of the two or three finest organ builders in the world today; perhaps his best-known instrument in this country is the one in the Busch-Reisinger Museum in Cambridge, Massachusetts that E. Power Biggs has recorded on so frequently. The four-manual instrument in Seattle is much larger, however, and if possible even more impressive. Cambridge has recorded it beautifully with what seems to me to be the ideal balance between close-up clarity and plenty of "room" sound or reverberation.

Buxtehude fans will be attracted by this recording too, since it contains a fine assortment of some of the best pieces from each of the several categories of Buxtehude's organ music. To mention only a few: the C major Prelude, Fugue, and Ciacona; the G minor Prelude and Fugue; and the E minor Ciacona are among the absolute masterpieces of "pre-Bach" organ music, and without them Bach, as we know him, could not have existed.

Lawrence Moe, however, frustrates and disappoints us on nearly every band. To begin with, there are simply more wrong notes, fumbled runs, and awkward rhythms than Cambridge Records should have allowed out of its editing rooms. And even when he isn't having technical difficulties, Moe's playing is too often just plodding and dull and utterly lacking in conviction. Both Buxtehude and Flentrop deserve better. In case you haven't heard, the Musical Heritage Society now has a seven-record box of all of Buxtehude's extant organ music flawlessly played (and well recorded) by Marie-Claire Alain on three organs by Marcussen, Frobenius, and Von Beckerath. This record, then, is strictly for the Flentrop fans. C.F.G.

B **CHOPIN:** Etudes: in E, Op. 10, No. 3; in F minor, Op. 25, No. 2; Impromptu No. 1, in A flat, Op. 29; Mazurkas: in B flat, Op. 7, No. 1; in A minor, Op. 7, No. 2; in F minor, Op. 7, No. 3; Polonaise No. 3, in A, Op. 40, No. 1 (*Military*); Waltzes: in A flat, Op. 34, No. 1; in A minor, Op. 34, No. 2; in D flat, Op. 64, No. 1 (*Minute*); in C sharp minor, Op. 64, No. 2; in A flat, Op. 69, No. 1; in G flat, Op. 70, No. 1. José Iturbi, piano. Seraphim S 60186, \$2.98.

How the mighty have fallen! José Iturbi's fame used to be so widespread that even the anti-bourgeois novel *Portnoy's Complaint* gave him a mention. In the Forties and Fifties, the mantle of "World's Most Famous Piano Player"—previously the property of "Paderowski" and more recently passed on to Van Cliburn—rested comfortably on Iturbi's broad shoulders. Alas! Now it takes ten years for his records to be issued domestically and on an economy label at that! (This Chopin recital was taped in France in 1959).

Many intellectual snobs have never forgiven Iturbi for his sojourn into commercialism. To be sure, other artists before and since have also flirted with Hollywood, but Iturbi was the most successful at it (and presumably that accounted for his being the most maligned). I must say this in Iturbi's defense: To be sure, his pianism tended to lose some of its erstwhile subtlety and artistry; but even at his crassest, he did have the self-respect to keep up his technique. Hard-toned though some of his worst performances were, they nevertheless always boasted a modicum of class and style, much more than a modicum of dazzling fingerwork and clean technique. And at his best, Iturbi was—and is—one of the world's foremost pianistic talents.

The present collection reflects the best of the post-cinema Iturbi. A trace of percussiveness remains, but it is just enough to add a welcome snap and astringency to the playing. The Chopin style he employs is the "traditional" one—e.g., with certain salon rubatos and sundry other mannerisms—but within this style the playing is nothing short of first-class. The more brilliant waltzes and of course the A major Polonaise have breadth and passionate drama, the A flat Impromptu (taken a bit more broadly than customary) is gracious and scintillating. The same might be said for the F minor Etude, again done with slower than usual tempos and a maximum of clarity. The mazurkas fare well enough, though the one in B flat could stand a bit more rhythmic firmness. Best of all, in my opinion, is the first Op. 69 waltz (the one subtitled *Les Adieux*). In this, Iturbi opts for the harmonically and ornamentally richer original manuscript in lieu of the bowdlerized and more frequently encountered Fontana version.

Iturbi's pianism is given a resonant frame it didn't always have on records in the old days. A highly recommended disc—and not just to the man on the street with sentimental memories. H.G.

B **DEBUSSY:** Piano Music (complete): Préludes, Book I (OR D 131); Préludes, Book II (OR D 132); Etudes, Books I and II (OR D 133); Images, Books I and II; Images inédites (OR D 134); Arabesques I and II; Children's Corner Suite; Suite bergamasque; Masques (OR D 135); La Boîte à joujoux; Berceuse héroïque; D'un cahier d'esquisses (OR D 136); Estampes; L'Isle joyeuse; La plus que lent; Page d'album; Pour le piano (OR D 137); Ballade; Danse; Danse bohémienne; Hommage à Haydn; Le petit nègre; Mazurka; Nocturne; Réverie; Valse romantique (OR D 138). Jörg Demus, piano. Orpheus OR D 131/8, \$2.98 each

Half of ours equals the whole of theirs.

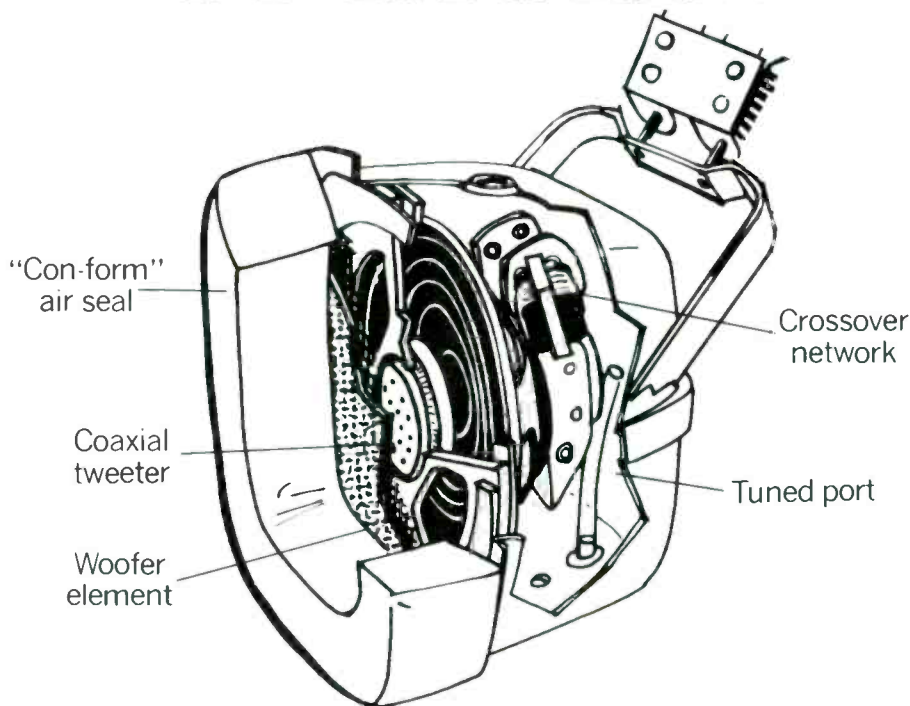

Just about every dynamic stereo-
phone on the market today operates the
same way. Except ours.

Their stereophones have a conven-
tional single speaker for each ear. Ours
have a two-way speaker system for each
ear. A dynamic woofer for rich low fre-
quencies, and a separate tweeter for
sweet, clear and sharp highs. And, of
course, a full crossover network. Just like
the high quality speakers in your conven-
tional stereo system.

The benefits of two speakers in

reproducing the entire frequency range
free of distortion are so obvious that we
wonder why everyone hasn't copied us.

If you don't think two are better than
one, bring your favorite record to your
dealer and listen to
our stereophones.
We think you'll agree
that ours sounds
better than theirs.

*Model PROB-V, \$59.95.
Other woofer/tweeter models
from \$29.95. Single driver
models from \$19.95*



Superex Stereophones

Superex Electronics Corp., 151 Ludlow Street, Yonkers, New York
In Canada: William Cohen Corp., Montreal.

CIRCLE 67 ON READER-SERVICE CARD

(eight discs). (Available by mail only from The Musical Heritage Society, 1991 Broadway, New York, N.Y. 10023.)

DEBUSSY: Piano Music (complete): Etudes, Books I and II; Ballade; Mazurka; Berceuse héroïque; Preludes, Books I and II; Arabesques Nos. I and II; D'un cahier d'esquisses; Danse bohémienne; Masques; Six Epigraphes antiques; Valse romantique; Hommage à Haydn; L'Isle joyeuse; Images, Books I and II; Children's Corner Suite; Le petit nègre; Danse; La plus que lent; Estampes; Pour le piano; Réverie; Suite bergamasque; Nocturne; Page d'album. Beveridge Webster, piano. Desto DC 7111/5, \$29.90 (five discs, not available separately).

B **DEBUSSY:** Etudes, Books I and II. Yvonne Loriod, piano. Musical Heritage Society MHS 1063, \$2.98. (Available by

mail only from The Musical Heritage Society, 1991 Broadway, New York, N.Y. 10023.)

DEBUSSY: Estampes; Arabesques I and II; Images, Books I and II. Ilja Hurnik, piano. Supraphon 1 11 0699, \$6.98.

At last a few interpreters are beginning to take cognizance of the fact that Debussy loathed the words "vague" and "impressionistic" when indiscriminately applied to his music. "I am trying," he wrote, "to achieve something different: the effect of reality." And on more than one occasion, the laconic composer let forth at those "imbeciles—mostly critics—who utterly misapprehend the term 'impressionism.'" Notwithstanding all this clear evidence, people for years persisted in bracketing the works of Debussy and his strikingly

dissimilar younger contemporary Ravel under the rubric "French Impressionism." An even greater problem—and one still very much with us—is the "traditional" (i.e., wishy-washy) approach to Debussy's music, early or late, that takes little notice of its diversity and emotional power. At the risk of sounding overly simplistic myself, I would say that how the four very different pianists here approach the problem of "impressionism" lies at the heart of these varied recorded performances. Webster is wary of the tag and generally keeps his distance by way of a "modern" outlook; Demus, obviously an intelligent musician in many ways, has not in this instance acquired proper perspective and falls for the "impressionist" routine to a distressing degree. The two other pianists, as we shall see, fall somewhere between these two extremes.

When Beveridge Webster presented the Debussy cycle *in toto* at three New York Town Hall recitals in 1968, many were undoubtedly surprised that this master interpreter of Schubert and Beethoven should venture into such remote territory. As the concerts (and now these subsequent recordings) proved, the American artist has some striking and valid things to say about this music. In fact, his credentials as a Debussyan are impressive and authentic, since he spent a great deal of time in Paris under the aegis of Nadia Boulanger. But even if Webster hadn't ever set foot in Debussy's native and beloved France, his acute musical intelligence would undoubtedly have saved the day. Some may feel that Webster is a trifle angular and tonally bleak for this kind of music, but I heartily disagree. Naturally any comprehensive survey will contain certain things to cavil at (a rather tight-fisted, hard-driven *Children's Corner*, for instance, or a *Jardins sous la pluie* that sounds just a trifle ungainly and unevenly articulated), but the general level is magnificently high.

What I so like about Webster's Debussy is his refusal to fall into convenient routine. Individualistic strokes abound: a *Masques* that is crisply deliberate, sparsely pedaled and vibrantly rhythmic; a *Danseuses de Delphes* that is brisker, firmer, and much less elephantine than usual; a *Suite bergamasque* with ostinatos that are tempered with sagacious mood and metrical freedom. I would hazard a guess that the Debussy Webster loves most is that of the cryptic late period. He is splendid in the *Etudes*, the second book of *Préludes* and the very special *Epigraphes antiques* (actually reworkings of early unpublished songs, re-designed for piano duet, and again later reduced to solo proportions). There are marvelous characterizations in some of the earlier *morceaux* too: If the *Poissons d'or* (like the aforementioned *Jardins sous la pluie*) emerges a little ferocious and flawed in articulation, the *Cloches à travers les feuilles* and the *Ei la lune descend sur le temple qui fut* are uncommonly vibrant and expressive. The chief regret I have about this album is that the records themselves seem carelessly processed: One does not like to hear little scrapes, pops, and ticks in any music, but in literature such as this such flaws are particularly aggravating. The basic reproduction, I might add, is quite good: sometimes a shade dry and tinny but mostly rich and grandly impactive.

It might seem slightly arbitrary of Musical Heritage to entrust this uniquely Gallic repertoire to an Austrian, but Demus—like Webster—has his papers in order. For one thing, the

PHILIPS PRESENTS



THE FIRST FAMILY OF MUSIC

MAHLER: SYMPHONY NO. 8 "SYMPHONY OF A THOUSAND" Cotrubas; Harper; van Bork; Finnila; Dieleman; Cochran; Prey; Sotin; Collegium Musicum; Concertgebouw Orchestra of Amsterdam/Haitink 6700.049 (2 record set)

MAHLER: LIEDER EINES FAHRENDEN GESELLEN; KINDERTOTENLIEDER Prey, baritone; Concertgebouw Orchestra of Amsterdam/Haitink 6500.100

BLOCH: SCHELOMO; BRUCH: KOL NIDREI; SCHUMANN: CELLO CONCERTO IN A MINOR, OP. 129 Walevska, cello; Monte Carlo Opera Orchestra/Inbal 6500.160

DVORAK: CELLO CONCERTO NO. 1 IN B MINOR, OP. 104; TCHAIKOVSKY: VARIATIONS ON A ROCOCO THEME, OP. 33 Walevska, cello; London Philharmonic Orchestra/Gibson 6500.224

SMETANA: PIANO TRIO IN G MINOR, OP. 15; CHOPIN: PIANO TRIO IN G MINOR, OP. 8 Beaux Arts Trio 6500.133

PURCELL: DIDO AND AENEAS Veasey; Donath; Shirley-Quirk; Academy of St. Martin-in-the-Fields/Davis 6500.131

BEETHOVEN: SYMPHONY NO. 3 IN E FLAT, OP. 55 "EROICA" B.B.C. Symphony Orchestra/Colin Davis 6500.141 Cassette: 7300.105

GRIEG: PIANO CONCERTO IN A MINOR, OP. 16; SCHUMANN: PIANO CONCERTO IN A MINOR, OP. 54 Bishop, piano; B.B.C. Symphony Orchestra/Davis 6500.166

BEETHOVEN: PIANO CONCERTO NO. 1 IN C, OP. 15; SONATA NO. 5 IN C MINOR, OP. 10 NO. 1 Bishop, piano; B.B.C. Symphony Orchestra/Davis 6500.179 Cassette: 7300.116

LISZT: FANTASIA AND FUGUE ON "AD NOS, AD SALUTAREM UNDAM"; WEINEN, KLAGEN, SORGEN, ZAGEN: VARIATIONS ON BACH'S CANTATA Chorzempa, organ 6500.215

The Quietest Revox

One of the most compelling reasons for buying a Revox is the sounds it doesn't make.

No spurious pops or clicks. No wavering, fluttering tones. No distracting hum. And best of all, virtually noise-free electronics.

Take our new A77 Mk III for example. We manufacture it to such close tolerances and with such exacting attention to detail, that it is generally regarded as one of the quietest tape recorders ever made.

Unfortunately, no matter how quiet our electronics are, there is still the inherent problem of tape hiss.

And that's where our new Revox A77/Dolby B recorder comes in.

By now, the virtues of the Dolby Noise Reduction system are too well known to require any elaboration on our part.

Suffice it to say, for all practical

purposes the last major stumbling block to quality, noise-free recording has finally been eliminated.

Listening to tapes on the new Revox/Dolby B is a revelatory experience. Tape hiss is virtually non-existent. The music seems to emerge from a background of velvety silence. And at 3-3/4 i.p.s. the absence of extraneous noise is truly startling.

But no mere description of the Revox/Dolby B can adequately convey the experience awaiting you the first time you listen to a tape made on this remarkable machine.

Your nearest Revox dealer will be delighted to audition the Quietest Revox

for you. Once you've heard it, you'll understand why we say...

Revox delivers what all the rest only promise.



two most renowned Debussys of yesteryear were Cortot, a Frenchman with roots in Bayreuth, and Gieseking, a German of French parentage and training. Demus, it so happens, studied a time with Gieseking: The taste and delicacy of his Debussy gives evidence of that fact. A patrician nimbleness, an exquisite touch, a certain classical reserve are definitely a legacy from the master. Demus plays impressively well in almost all the pieces and there are just a very few places where he could be called unidiomatic. His most emphatic *gaffe* is the fourth étude which he somehow conspires to turn into a late Brahms intermezzo.

For all its merit, though, Demus doesn't hold my interest as Webster or Gieseking did. In the *Children's Corner*, to cite one example, Demus has individualized his reading since last recording it for DGG in the early Sixties,

but the change, unfortunately, is for the worse. Must *Dr. Gradus* sound so foggy? Must the *Gollivog's Cakewalk* be so uniltingly prim and precise? In the *Images*, to cite another example, Demus, like Gieseking before him, lacks the dynamic strength urgently called for by this provocative music. The discs, however, are uniformly well recorded and the MHS processing is superior to Desto's.

The most valuable things in his anthology (which like all the others is not really "complete") are the early, unpublished set of *Images* and the piano version of the projected orchestral score *La Boîte à joujoux*, better known in its orchestration by André Caplet. The *Joujoux* have been done before on solo piano (very well by Peter Frankl in the Vox Box anthology), but the early *Images*, if I am not mistaken, make their first appearance on record.

The \$300⁰⁰ Concert Hall

With all the "great", "new", "fantastic", "innovative" things everyone's claiming, how do we prove we've got something remarkable?

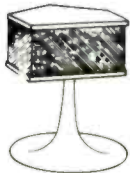

Lend us your ear. And eyes.

Walk into an authorized LDL high fidelity dealer with a favorite record or tape—hopefully, a demanding one. Ask him to hook up your present (or future) amplifier or receiver and a pair of LDL 749 reflecting speakers. And listen.

Listen to the "speakerless" clarity of a multiple-transducer crossoverless system using the finest components. If your record's got fundamental bass, the fundamental's what you'll hear, up to and including the *attack* of drums and strings. And as for highs, you won't just listen to them—you can pick them apart: violins, trumpets, piccolos and more—each clearly defined.

But good stereo (or quad) is more than

frequencies and transients put in their place: it's a spatial phenomenon. Which is where the LDL 749 really excels. Precisely combining forward-radiated sound from the front of the enclosure with panoramically-reflected sound from the rear. Result: the kind of acoustical environment you used to need a concert hall to get.

Need more convincing? A-B LDL 749's against other speakers—even the \$1000-a-pair variety. We honestly think you'll prefer ours.

Where do your eyes come in? To appreciate the speakers' compact size and elegant looks. Beginning with the \$299.95 pricetag ... for the pair. Now, where can you get a concert-hall for that?

For the name of your nearest dealer, write or call:

LDL LINEAR DESIGN LABS, INC.
114 Wilkins Avenue, Port Chester, N.Y. 10573 • Phone (914) 937-0622

Dealer inquiries invited



**\$300.
Not For One... For Both!!!**

CIRCLE 47 ON READER-SERVICE CARD

ADVERTISING INDEX

| Key No. | | Page No. |
|---------|--|---------------------|
| | Acoustical Mfg. Co., Ltd. | 111 |
| 1 | Acoustic Research, Inc. | 37 |
| 2 | A.D.R. Audio | 114 |
| | Advent Corp. | 79 |
| 4 | Allied Radio Shack | 107 |
| 5 | Altec Lansing | 89 |
| 3 | Ampex Stereo Tapes | 104 |
| | Ampex Tape | 68 |
| 6 | Angel Records | 77 |
| 8 | Audio Dynamics Corp. | 24 |
| 9 | Audionics, Inc. | 92 |
| 11 | Audio Sales | 110 |
| 10 | Audio Unlimited | 112 |
| 12 | Baltimore Stereo Wholesalers | 112 |
| 13 | Bang & Olufsen | 34 |
| 14 | Bose Corp. | 5 |
| 15 | Boston Audio | 114 |
| 16 | Bozak | 47 |
| 103 | British Industries Co. | 21 |
| 19 | Carston Studios | 110 |
| | Classified Ads | 117 |
| | Columbia Records | 75 |
| | Columbia Tape Club | 6, 7 |
| 20 | Concord Division/ Benjamin Electronic Sound Corp. | 97 |
| 21 | Continental Audio, Inc. | 112 |
| 23 | District Sound, Inc. | 116 |
| 22 | Deutsche Grammophon Records | 106 |
| 26 | Downtown Audio | 116 |
| | Dressner | 116 |
| 27 | Dynaco Inc. | 11 |
| 28 | Electro-Voice, Inc. | 10 |
| 29 | Elpa Marketing Industries, Inc. | 8 |
| 30 | Empire Scientific Corp. | 38 |
| 31 | Empire Scientific Corp. | 102 |
| | Fisher Radio | Cover II, 1, 60, 61 |
| 103 | Garrard | 21 |
| 33 | Harman-Kardon, Inc. | 29 |
| 35 | Heath Co. | 17-19 |
| 37 | Icelandic Airlines | 113 |
| 38 | Illinois Audio | 115 |
| 39 | International Hi Fi Distributors | 110 |
| 76 | Irish Recording Tape | 88 |
| 36 | Kenwood | Cover IV |
| 40 | King Karol Records | 117 |
| 41 | KLH Research and Development | 13 |
| 42 | Kilpsch & Associates | 94, 95 |
| 44 | Lafayette Radio Electronics Corp. | 105 |
| 45 | Lansing, James B., Sound, Inc. | 22, 23 |
| 47 | Linear Design Labs, Inc. | 84 |
| 48 | London Records | 80 |
| 49 | Magnum Opus Electronics | 88 |
| 43 | Marantz | 15 |
| 50 | McIntosh | 96 |
| 52 | Mercury Records | 82 |
| 75 | Micro/Acoustics Corp. | 16 |
| 21 | Midwest Hi Fi Wholesalers | 112 |
| 53 | Olson Electronics | 116 |
| | Panasonic | 9 |
| 22 | Polydor, Inc. | 106 |
| 54 | Ponder & Best | 98 |
| 55 | Rabsons-57 St., Inc. | 112 |
| 56 | RCA Records | 91 |
| | Record Mart | 117 |
| 57 | Rectilinear Research Corp. | 33 |
| 58 | Redwood Stereo | 92 |
| 59 | Revox | 83 |
| 60 | Sansui Electronics Corp. | 93 |
| 61 | Sherwood Electronics Laboratories, Inc. | 109 |
| 62 | Shure Brothers, Inc. | 87 |
| 64 | Sony Corp. of America | 103 |
| 63 | Sony/Superscope, Inc. | 100, 101 |
| 65 | Sony/Superscope, Inc. | 92, 113 |
| 66 | Sound Reproduction, Inc. | 110 |
| 68 | Stanton Magnetics, Inc. | 2 |
| 69 | Stereo Corp. of America | 115 |
| 67 | Superex Electronics Corp. | 81 |
| 71 | TDK Electronics Corp. | 99 |
| 70 | Teac Corp. of America | Cover III |
| 72 | Toyo Radio Co. of America, Inc. | 90 |
| | U.S. Pioneer Electronics Corp. | 31 |
| 73 | Utah | 12 |
| 29 | Watts | 8 |
| 74 | Wollensak | 43 |

Here's your **FREE**

HIGH FIDELITY

“at home” shopping service!



It's easy! All you do is use one of the Reader Service cards at right... HIGH FIDELITY's Reader Service Department will take it from there. It's as simple as 1, 2, 3!

1 Just circle the number on the card that matches the number below the ad or editorial mention that interests you.

You'll also find the key numbers for advertised products in the Advertiser's Index.

2 Then type or print your name and address. Don't forget your zip code, it's important!

3 Drop the card into the mail. No postage is needed if mailed in the United States.

You'll receive literature, colorful brochures and specifications about the products that interest you... free and without obligation!

Use HIGH FIDELITY's "at home" shopping service today!

| | | | | | | | | | | | | | | |
|-----|-----|-----|-----|-----|-----|-----|-----|-----|-----|-----|-----|-----|-----|-----|
| 1 | 2 | 3 | 4 | 5 | 6 | 7 | 8 | 9 | 10 | 11 | 12 | 13 | 14 | 15 |
| 16 | 17 | 18 | 19 | 20 | 21 | 22 | 23 | 24 | 25 | 26 | 27 | 28 | 29 | 30 |
| 31 | 32 | 33 | 34 | 35 | 36 | 37 | 38 | 39 | 40 | 41 | 42 | 43 | 44 | 45 |
| 46 | 47 | 48 | 49 | 50 | 51 | 52 | 53 | 54 | 55 | 56 | 57 | 58 | 59 | 60 |
| 61 | 62 | 63 | 64 | 65 | 66 | 67 | 68 | 69 | 70 | 71 | 72 | 73 | 74 | 75 |
| 76 | 77 | 78 | 79 | 80 | 81 | 82 | 83 | 84 | 85 | 86 | 87 | 88 | 89 | 90 |
| 91 | 92 | 93 | 94 | 95 | 96 | 97 | 98 | 99 | 100 | 101 | 102 | 103 | 104 | 105 |
| 106 | 107 | 108 | 109 | 110 | 111 | 112 | 113 | 114 | 115 | 116 | 117 | 118 | 119 | 120 |
| 121 | 122 | 123 | 124 | 125 | 126 | 127 | 128 | 129 | 130 | 131 | 132 | 133 | 134 | 135 |
| 136 | 137 | 138 | 139 | 140 | 141 | 142 | 143 | 144 | 145 | 146 | 147 | 148 | 149 | 150 |
| 151 | 152 | 153 | 154 | 155 | 156 | 157 | 158 | 159 | 160 | 161 | 162 | 163 | 164 | 165 |

• PLEASE TYPE OR PRINT •
 NAME _____
 ADDRESS _____
 CITY _____ STATE _____ ZIP _____
 I am a subscriber I am not a subscriber P 3 4

| | | | | | | | | | | | | | | |
|-----|-----|-----|-----|-----|-----|-----|-----|-----|-----|-----|-----|-----|-----|-----|
| 1 | 2 | 3 | 4 | 5 | 6 | 7 | 8 | 9 | 10 | 11 | 12 | 13 | 14 | 15 |
| 16 | 17 | 18 | 19 | 20 | 21 | 22 | 23 | 24 | 25 | 26 | 27 | 28 | 29 | 30 |
| 31 | 32 | 33 | 34 | 35 | 36 | 37 | 38 | 39 | 40 | 41 | 42 | 43 | 44 | 45 |
| 46 | 47 | 48 | 49 | 50 | 51 | 52 | 53 | 54 | 55 | 56 | 57 | 58 | 59 | 60 |
| 61 | 62 | 63 | 64 | 65 | 66 | 67 | 68 | 69 | 70 | 71 | 72 | 73 | 74 | 75 |
| 76 | 77 | 78 | 79 | 80 | 81 | 82 | 83 | 84 | 85 | 86 | 87 | 88 | 89 | 90 |
| 91 | 92 | 93 | 94 | 95 | 96 | 97 | 98 | 99 | 100 | 101 | 102 | 103 | 104 | 105 |
| 106 | 107 | 108 | 109 | 110 | 111 | 112 | 113 | 114 | 115 | 116 | 117 | 118 | 119 | 120 |
| 121 | 122 | 123 | 124 | 125 | 126 | 127 | 128 | 129 | 130 | 131 | 132 | 133 | 134 | 135 |
| 136 | 137 | 138 | 139 | 140 | 141 | 142 | 143 | 144 | 145 | 146 | 147 | 148 | 149 | 150 |
| 151 | 152 | 153 | 154 | 155 | 156 | 157 | 158 | 159 | 160 | 161 | 162 | 163 | 164 | 165 |

• PLEASE TYPE OR PRINT •
 NAME _____
 ADDRESS _____
 CITY _____ STATE _____ ZIP _____
 I am a subscriber I am not a subscriber P 3 4



See Reverse Side for
FREE "at Home" shopping service!

There's more pleasure
in store for you every
month with **HIGH FIDELITY**...

First Class
Permit No. 111
Cincinnati, Ohio

BUSINESS REPLY MAIL

No postage stamp necessary if mailed in the United States

Postage will be paid by—

HIGH FIDELITY

P.O. Box 14306
Annex Station
Cincinnati, Ohio 45214



Reader Service 72

First Class
Permit No. 111
Cincinnati, Ohio

BUSINESS REPLY MAIL

No postage stamp necessary if mailed in the United States

Postage will be paid by—

HIGH FIDELITY

P.O. Box 14306
Annex Station
Cincinnati, Ohio 45214



Reader Service 72

**OUR NEW STORE,
Celebration values at all**

best AM/FM stereo re-
gh power to meet the
sic lover. Plenty of fea-
y Hi-Fi enthusiasts. The
changer the best value
ith base, dust cover and
Shure M91E stereo
cartridge.

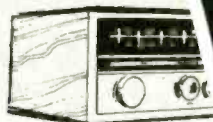

Mfg. List \$359.95 NOW **\$279.95**

er systems in oiled walnut



\$499.95

How to read a hi-fi ad

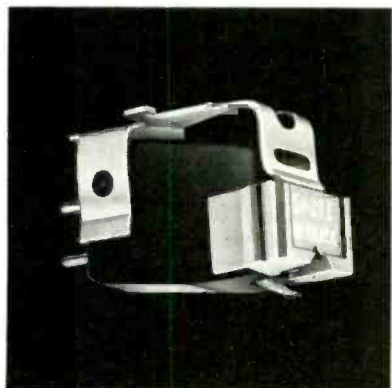

Puzzle picture: find the clue that tells you how good the advertised system probably is. Our advice is to check the one component that is the *source* of the sound—the phono cartridge. We say this because we know that the dealer who's assembled a superior package at a fair price is going to complete it with a superior cartridge within the available price range. This dealer ad above, for example, includes a Shure M91E Hi-Track. Even if you weren't aware of the effortless way it meets your most rigorous trackability demands, you should know that it, as well as virtually every Shure cartridge, has been acclaimed by hi-fi critics and authorities as best in its class, or best for the cost. That's why you see so many of them teamed with "best-in-their-class" components, and why they invariably mean a more-for-the-money total system that's going to make you very happy.

Shure Brothers Inc.,
222 Hartrey Ave., Evanston, Ill. 60204

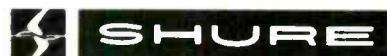

CIRCLE 62 ON READER-SERVICE CARD

FOR OVER 25 YEARS IRISH TAPE HAS BEEN BREAKING THE SOUND BARRIER.



Confused about tapes? You're not alone. We're out to end cassette tape confusion by telling it as it is: "good," "better" and "best." Buy the quality of tape you need and save your money. We've got over 25 years of know-how and expertise at making quality tapes. That's why every major recording company uses Irish.

"BEST." Our extended range, high density, low noise Irish 262 series. There isn't a better tape available at any price!

"BETTER." The Irish 261 series—a professional quality premium tape, at a popular price. Available in 30, 60, 90 and 120 minute cassettes.

"GOOD." Is quite good and at a great price. Our 199 series is perfect for experimental work and recording conversation.

All Irish cassettes are precision made and fully guaranteed. Irish also offers a complete line of chromium dioxide cassettes, video tapes and reel-to-reel tapes.

Try Irish. You'll hear the difference with just one test.

IRISH TAPE

270-78 NEWTOWN ROAD
PLAINVIEW, N. Y. 11803
EXPORT: MORHAN EXPORTING CORP.

CIRCLE 76 ON READER-SERVICE CARD

Total of 48 SPEAKERS in Stereo MAGNUM OPUS ELECTRONICS, LTD.

proudly introduces a new era in loudspeaker technology,
patent and patent pending "Infinite dynamic damping."



FLOOR MODEL—OPUS 24

24 speakers per system

Two 12" woofers, two 10" woofers, four 5" mid-range, and sixteen super-tweeters. 15—20,000 HZ. Power: 10—200 watts.
24"H x 28"W x 18"D on 6" pedestal.
PRICE: \$595 ea. 5 yr. warranty.

SHELF MODEL—OPUS 7

7 speakers per system

One 12" woofer, one 10" woofer, one 5" mid-range, and 4 tweeters. 20—20,000 HZ. Power: 10—100 watts.
25"W x 15"H x 13"D.
PRICE: \$250 ea. 5 yr. warranty.

WERNER KLEMPERER. Film and T.V. actor.

"No shelf speaker I have ever heard comes even close to the Opus-7 in authenticity and delineation of individual instruments. Large orchestral passages are overwhelming. As to the Opus-24 . . . unbelievable . . . I forgot I was listening to speakers."

BARBARA COOK. Broadway actress and singing star.

"The sound is gorgeous. Voices and instruments are completely natural. Orchestral crescendos are so solid they seem organic — you can feel the air around each instrument."

These speakers will become available to select dealers after March 5, 1972. They are currently available in the New York City area at our beautiful showroom with gaslighted entrance at:

MAGNUM-OPUS ELECTRONICS, LTD.

111 E. 35th (between Park and Lexington Aves.), New York, N. Y. 10016

Tel.: (212) 684-3997

Demonstrations: Mon.-Fri. 10 A.M.—6 P.M. Sat. 1—5 P.M.



The second of these, by the way, uses the same thematic material as the *Sarabande* from *Pour le piano* (the earlier piece is entitled *Souvenir de Louvre*), and is somewhat more robust than its more famous counterpart. I have the sneaking suspicion that perhaps I have done Demus an injustice by listening to his performances all at once: Whereas Webster gains as one goes from disc to disc—the individual flaws receding into unimportant flecks—Demus, a gentler player, might well be more impressive in smaller doses. Fortunately Musical Heritage has issued his discs as singles, so one can savor them one by one. Whatever my reservations, the music is never—or (recalling that étude) rarely—misrepresented.

The Loriod collection of the *Etudes* ought to have stylistic validity since the pianist is married to Messiaen, whose own compositions (which she plays so brilliantly) are obviously descended from Debussy's keyboard style. Actually, her work is remarkable for its methodical technical ease as pianism per se, but for my taste she is just a wee bit methodical and lacks the enlivening contours which Webster brings out so convincingly. Mme. Loriod reminds me somewhat of our own Nadia Reisenberg—like that lady, she is a remarkably secure pianist but one who tends toward excessive relaxation and arm weight. She solves the digital problems brilliantly but rounds off too many of the jagged edges that give the music character. The MHS sound—originally a product of French Erato—is deep and resonant, beautifully suave and cushioned.

The Supraphon disc with Ilja Hurnik, on the other hand, is a winner in every way. His performances are wonderfully masculine and firmly contoured. He has logic, clarity, and color. Hurnik, a composer himself, treats the works with obvious reverence for their structure and content, but shows a performer's gift and potency of imagination. There is a certain straightness, let's call it a "rightness," about his *Soirée dans Grenade* that makes me think of Riccardo Viñes' taut, firmly rhythmic reading (reissued on a special Debussy memorial record for Pathé). I also welcome the crisp snap and lilt of the two arabesques, which sound far more substantial and delightful than they usually do. Supraphon's vibrantly alive piano reproduction furthers an approach that veers more to Roualt's expressionism than to the hazy, delicate Renoir tints usually deemed appropriate for this music. The fact that it works so well gives ample evidence that Debussy can often benefit from more assertive treatment. H.G.

DONIZETTI: Maria Stuarda. Beverly Sills (s), Maria Stuarda; Eileen Farrell (s), Elisabetta; Patricia Kern (ms), Anna; Stuart Burrows (t), Leicester; Louis Quilico (b), Talbo; Christian du Plessis (b), Cecil; John Aldis Choir; London Philharmonic Orchestra, Aldo Ceccato, cond. ABC Audio Treasury ATS 20010/3, \$17.94 (three discs).

This new recording of *Maria Stuarda*, together with the San Francisco production last fall and the New York production this spring, signifies the emergence in America of yet another of Donizetti's "lost" operas. *Roberto Devereux* and *Anna Bolena* (still to come on the stage in New York, but well known through recordings), though hardly current until recently, nevertheless did lead shadowy

CIRCLE 49 ON READER-SERVICE CARD

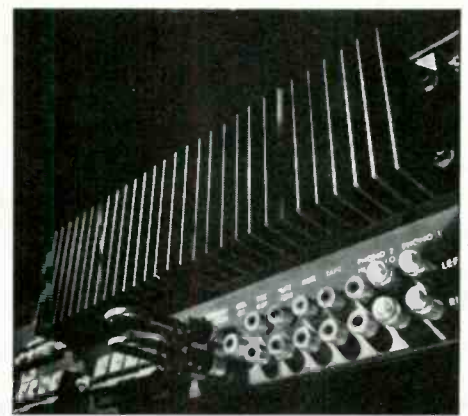
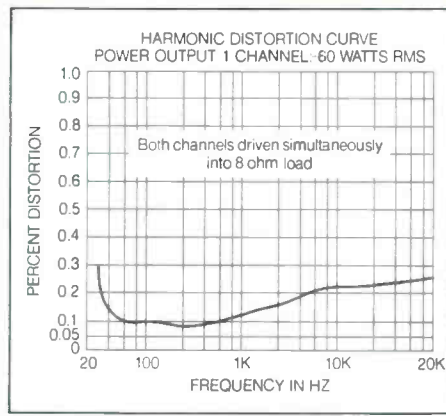
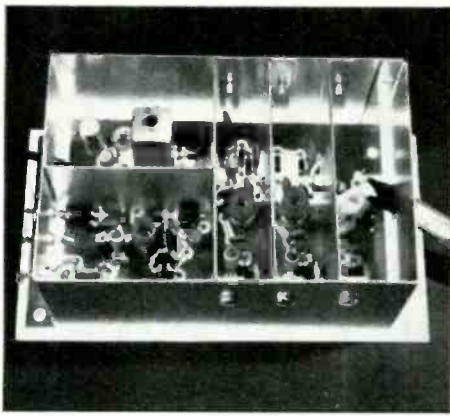

It's the only receiver with the Varitronik™ FM tuner—with 4 FET's and balanced Varicap tuning for lower distortion and for higher sensitivity. By using 4 FET's instead of ordinary bi-polar transistors, cross modulation problems are virtually eliminated. And by using 4 double Varicaps instead of a conventional mechanical tuning capacitor, a better balanced circuit performance is achieved with perfect linear tracking. The 725A's FM tuner also uses a combination of Butterworth and crystal filters for better selectivity and stereo separation. And, it features an advanced muting circuit with full muting at 2.5 μ V for quiet tuning without loss of stations. Specifically, here's how the new Altec 725A receiver performs. Harmonic distortion is a low 0.3%, IHF sensitivity is 1.8 μ V and capture ratio is 1.3 dB.

Altec's new 725A AM/FM stereo receiver gives you 60/60 watts of RMS continuous power. The 60 watts of power per channel you hear with the new Altec 725A receiver is not IHF music power at 4 ohms for just an instant. It's not music power (plus or minus 1 dB) either. And it's not peak power, or EIA power or any other rating. Instead, it's 60 watts of RMS continuous power per channel with both channels driven simultaneously at 8 ohms from 30 to 20,000 Hz—rated in the same manner used exclusively by the professional audio field and by quality testing labs. With this much power you hear clean, accurate sounds at all frequencies from even the lowest efficiency speakers. And you always have enough power in reserve to hear that extra-low bass.

And it includes many extra features to make it the most versatile receiver on the market. The new Altec 725A receiver includes a long list of standard features like 2 separate tuning meters, spring-loaded speaker terminals, and 100 percent modular construction. In addition, it includes these "extras" for more versatility and convenience.

- Pushbutton controls for stereo reverse, mono L & R, low and high filter.
- Indicator lights on all functions — AM, FM, phono 1 & phono 2, tape, auxiliary, tape monitor and FM stereo.
- Tape recorder input & output on front panel.
- A heavy-duty fluted aluminum heat sink.
- Accessory jacks for the Altec Acoustavoicette Stereo Equalizer.

Altec's new 725A AM/FM stereo receiver sells for \$699.00. It's built a little better than anything else you can buy. Hear it at your Altec dealers. Or, write for a new, complete 25-page catalog: Altec Lansing, 1515 S. Manchester Ave., Anaheim, CA 92803.

Built a little better.



A QUALITY COMPANY OF LTV LING ALTEC, INC.
CIRCLE 5 ON READER-SERVICE CARD

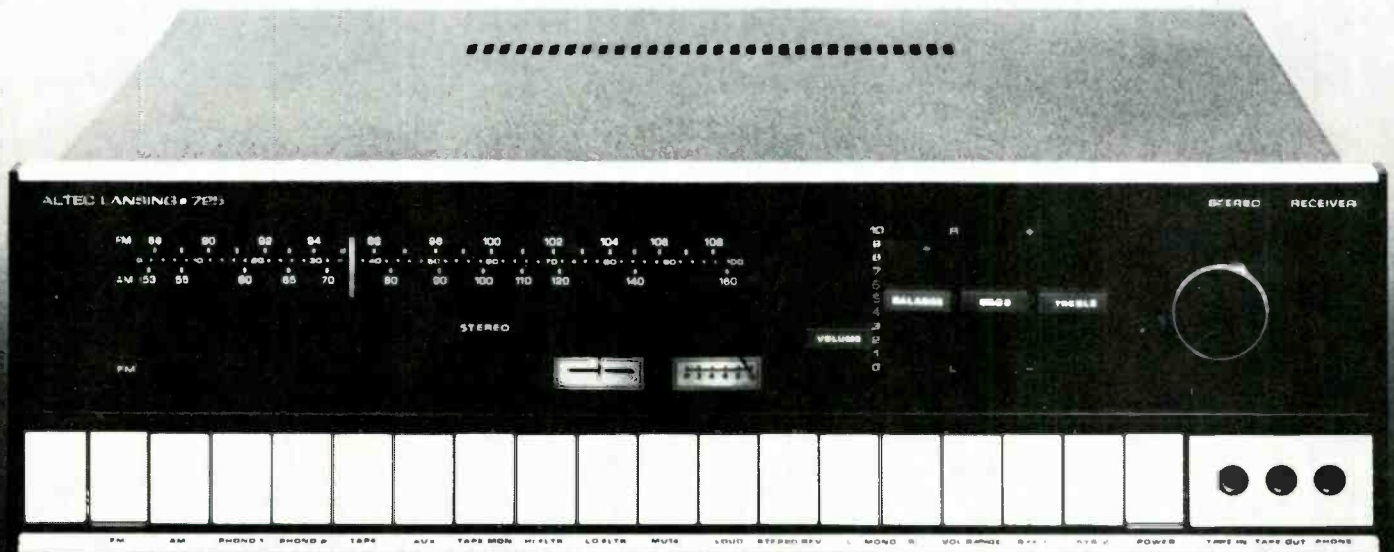

Altec's new 725A receiver.
It's built a little better.

existences in various Italian opera houses while waiting to be summoned back to international life. *Maria Stuarda*, on the other hand, languished in total oblivion for nearly a hundred years after a Neapolitan revival in 1865.

Maria Stuarda was dogged by ill luck from the very start. During the dress rehearsal at the San Carlo in 1834 Queen Christina of Naples was so overcome by emotion at Maria's confession scene that she fainted and had to be carried from the theater. Next day the King placed an embargo on all subsequent performances of the work, and the entire matter seemed to be closed. However, in line with the more casual attitudes of the time, Donizetti was persuaded to undertake a complete reworking of the opera, and in a mere few days a completely new libretto was cobbled together, set not in Elizabethan England but in Renaissance Italy. The result was presented under the title *Buondelmonte*, though with only moderate success. The following year (1835) the opera was given in its original form at La Scala with the celebrated Malibran who, being out of voice, incurred the displeasure of the audience. After the seventh performance the Milanese censors sought to impose alterations on the text and action: Maria's defamation of Elisabetta as a "vil bastarda" was objected to and so was the confession scene. After the eleventh performance the opera, having been mutilated, was heard no more at La Scala. The revival in 1958 at the Bergamo Festival was the occasion for the work's return to currency in our time.

The revival of interest in bel canto operas that succeeded the phenomenon of Maria

Callas has upset many of our received ideas about these works. Because of what late nineteenth-century prima donnas like Meïba, Sembrich, Tetrizzini, and Galvany made of this music it was easy to believe that bel canto meant nothing but vacuously beautiful vocal art. Any contemporary account of Malibran, Pasta, or Pauline Viardot, however, is enough to reveal that different standards obtained during the time when these works were being written. Then, unlike later, vocal imperfections counted for little beside truthfulness, intensity, and tragic power.

After Callas it once again became possible to appreciate the dramatic rather than pyrotechnical potentialities of Donizetti's music. *Lucia* became reborn as drama, and gradually *Anna Bolena*, *Roberto Devereux*, *Lucrezia Borgia*, *Il Duca d'Albe*, and *Maria Stuarda* are being revealed as splendid vehicles for vocal actors. At this stage of Donizettian appreciation the quality of his music seems a minor consideration. Beverly Sills had an enormous success in *Roberto Devereux* despite the opera's serious musical deficiencies. It looks as if the same will be true of *Maria Stuarda*, which is like *Devereux* in being at the same time very uneven and very effective. Both works, in addition, provide superb opportunities for singers with dramatic talents. The long neglect of *Maria Stuarda* seems less a comment on its musical value than on the taste of prima donnas—who don't always know what's good for them.

In this particular case Beverly Sills clearly does. The Schillerian rewriting of British history that brings the two rival queens, Elizabeth and Mary Queen of Scots (*Maria Stuarda*),

into direct stage conflict and concludes with the once-proud Maria being led repentant to the scaffold is a golden opportunity for Sills to exploit her best gifts. In this role she can depict despair, hopeless love, thwarted power, spiritual fervor, and the pathos of emotional desolation. In the long final scene with its elaborate heartfelt aria of earthly renunciation she is really splendid. The words are meaningfully enunciated, the melodic line is skillfully managed and intensely phrased. Vocally, Sills is at her current best in this recording. The voice, though appealing, is not essentially a very beautiful instrument. Its tonal impurity is a serious impediment to one's pleasure in slow passages, especially where a cleaner sound is demanded by the music. But in this *Maria Stuarda* she sings with greater security than she has commanded for some time. On the whole her line is fairly taut and her upper register is free and firm. After so many recent disappointments from Sills it is a pleasure to hear her intelligence once again matched by vocal control of this sort. She can here bring off nearly everything she attempts. The result is very powerful, and in the final scene, where Donizetti rises to an eloquence he cannot achieve elsewhere in the opera, she is very moving. Only in the famous confrontation of the Queens does Sills fall short. She cannot hurl the insults—"Figlia impura di Bolena . . . vil bastarda!"—with the requisite force. It is not a matter of acting skill. As with her *Traviata* Sills cannot summon up the blaze of tone to bring off highly dramatic effects that depend on vocal weight and propulsion. She is a light soprano, a creature of pathos, not a heavyweight tragedienne.

True 4-Channel Sound

[\$43.75 per 20-watt channel]

There are several components on the market that you can take home and get true 4-channel sound out of today.

All are expensive.

Except ours.

We call ours QAUDIO. It's an amplifier and player with 4 discrete channels. And we designed it primarily to play the new 8-track 4-channel cartridges.

But we also give it the capability of playing ordinary 8-track stereo cartridges, because there are a lot more of them around today than there are 4-channel cartridges. And QAUDIO makes even ordinary stereo cartridges sound fuller and richer than they ever have before.



DECODER QC-1

MODEL 707

But of course it takes a specially recorded 4-channel cartridge to give you the real QAUDIO experience, and there's no point in trying to describe what *that's* like. It's simply something that has to be experienced.

And you can experience it—at a price that's almost as unbelievable as the sound: \$174.95. (That's \$174.95 for a true 4-channel amplifier-player with 80 watts of total music power.) Add a TOYO DECODER

Model QC-1, \$49.95 for 4-channel derived and matrix sound from all stereo program sources.

For brochure: Toyo Radio Co. of America, Inc., 1842B W. 169th St., Gardena, Calif. 90247.

QAUDIOTM

BY TOYO[®]

CIRCLE 72 ON READER-SERVICE CARD



**WHEN THIS CONCERTO
WAS SIX YEARS OLD,
RUBINSTEIN WAS BORN.
NOW, WITH ORMANDY,
HE GIVES IT THE
PERFORMANCE
OF A LIFETIME.**

RCA **RED SEAL**
ARTUR RUBINSTEIN 
BRAHMS: PIANO CONCERTO NO. 2
EUGENE ORMANDY /
THE PHILADELPHIA ORCHESTRA



LSC-3253



LSC-3252



VCS-7091



LSC-4016

RCA Records and Tapes

CIRCLE 56 ON READER-SERVICE CARD

**When you make
the number one
tape recorder,
you make the
number one
recording tape.**

Sony!

Cassette. Reel-to-reel. 8-track.

SONY SUPERSCOPE

You never heard it so good.®

CIRCLE 65 ON READER-SERVICE CARD

What we knew,® when we introduced the SPA50 Power Amplifier and SC24 Graphic Control Center, is now becoming common knowledge among a growing number of informed music lovers... these units are the most outstanding power amplifier and preamplifier available.



SC24 and SPA50

Write for additional information about these instruments. Better yet, ask an authorized dealer for a demonstration. Compare them with any other preamp and power amplifier combination regardless of cost. We're confident that you will agree.® THE SC24 AND SPA50 ARE THE FIRST PROFESSIONAL COMPONENTS THAT MEET THE REQUIREMENTS OF THE MOST CRITICAL HOME MUSIC INSTALLATION.

RADFORD

distributed in the USA by
Audionics, Inc., 8600 NE Sandy Blvd.
Portland, Ore. 97220 1 (503) 254-8224

CIRCLE 9 ON READER-SERVICE CARD

Hear it like it is:

**RSC
REDWOOD
STEREO
COMPANY**

DISCOUNTS

ON NATIONALLY ADVERTISED

**HI-FI STEREO
COMPONENTS**

ONLY RSC OFFERS:

- Lowest Possible Prices
- Lowest Shipping Costs
- Fastest Delivery

Write for a Rush Quote:

RSC

P.O. BOX 2794
SAN RAFAEL, CA. 94902
Telephone (415) 472-2255

RSC—Best in the West

CIRCLE 58 ON READER-SERVICE CARD

Eileen Farrell is made of sterner stuff. She commands, even this late in her career, just the sort of vocal displacement to bring the majestic Elisabetta to convincing life. From her first recitative and aria to the ensemble that follows the confrontation with Maria, she is clearly in psychological command. At every point, even when she is racked by jealous love, she never loses her air of imperial magnificence. There is never any doubt about who is on the throne—or why. The music given to Elisabetta is not particularly distinguished. It is mostly formulaic (though with momentary exceptions) and mostly uninspired. It is well crafted, but not thrilling. Farrell creates an impression of grandeur out of musical thin air by means of personality, temperament, and (though her tone is rather frayed nowadays) vocal timbre. What she cannot do, though, is manage the awesome technique in which Elisabetta's music has been conceived. Vocally the role makes constantly fearsome demands on the singer's ability to throw off fioriture and rapid divisions in a large-scale manner. A Norma or Donna Anna voice would be ideal for this role, and even in her prime Farrell was not the possessor of that sort of equipment. All she can do today is get through the vocal hazards as deftly and dramatically as possible. It is sad to hear Farrell sounding so hard pressed vocally when she is otherwise so much in command of the situation.

None of the other characters is as important as the two *grandes dames*. Leicester, the object of their rivalry in love, is hardly more than a stock figure. His music, moreover, is less ardent in actuality than in intention. At best it attains a certain gracefulness. Stuart Burrows, a young Welsh tenor of as yet limited experience, gives a promising performance. The voice is a pure high tenor, sweet in tone but somewhat lacking in body and apt to develop a whine when, as occasionally happens, the tone is insufficiently supported. Though Burrows makes a few slips in diction he tries, commendably, to throw himself into his role with suitably Italianate fervor and commitment. Unfortunately the effort results in a certain degree of sentimentality since Burrows as yet confuses feeling and tearfulness.

Louis Quiiro is a forthright Talbo, here a Roman Catholic priest in disguise who confers the last rites on Maria before her execution. There isn't much to do in the part but be dependable, though I suspect the music could yield more eloquence. Patricia Kern is a good Anna and the young Christian du Plessis makes a striking Cecil, Maria's enemy, who ends up being impressed by her dignity at the scaffold. The London Philharmonic plays well for Aldo Ceccato, who whips up plenty of excitement though, as with the Sills *Traviata*, he tends to be crude in his effects. If he could only bring some elegance to the strength he finds in this music his performance would be tremendously improved.

The recording, though it sounds a bit crowded at extremes of volume and pitch, is generally good and untricky. But there was an unconscionable amount of pre-echo on my review copy. D.S.H.

GERSHWIN: Concerto for Piano and Orchestra, in F; Rhapsody in Blue; Variations on I Got Rhythm (arr. William C. Schoenfeld). Werner Haas, piano; Monte Carlo Opera Or-

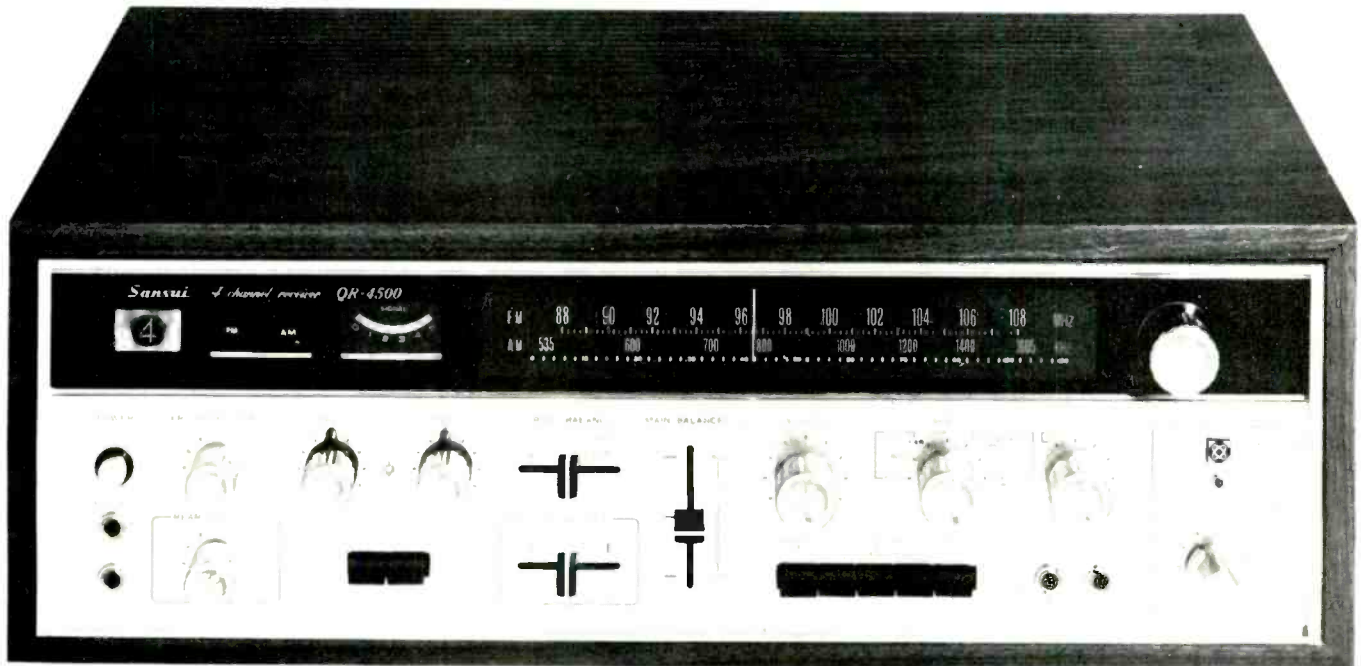

THIS WAY

If the four-channel merry-go-round has you confused, you have lots of company. Discrete or matrixed. Compatible or non-compatible. This system or that one.

Now Sansui offers you total-capability QR Receivers that will transport you into the four-channel world to day and can handle every variation to the four-channel game that anyone's dreamed up for tomorrow.

Take the QR4500 AM/FM Two-Channel and Four-Channel Stereo Receiver-Synthesizer-Decoder-Amplifier-and-Control-Center. It can decode any compatibly matrixed four-channel recording or FM broadcast, or it can synthesize two rear channels from any two-channel source. Exclusive Sansui phase-shift matrixing prevents the sound dropouts and false dislocations that plague many matrixed systems. And exclusive phase modulators duplicate the live sound field.

It can handle any tape or other discrete source and accepts adaptors, converters or other accessories for any four-channel technique anyone's hinted at.

It boasts 240 watts of total IHF power (continuous power per channel of 38 watts at 4 ohms, 27 watts at 8 ohms) with less than 0.5% TH or IM distortion at rated output and normal response of 20 to 30,000 Hz \pm 1dB. In a walnut cabinet, \$599.95.

You'll find the same universal four-channel versatility in all Sansui QR Quadphonic Receivers, including the QR1500, with 100 watts of total IHF power (20 watts continuous per channel at 4 ohms). With walnut cabinet, \$299.95.



Sansui®

SANSUI ELECTRONICS CORP.

Woodside, New York 11377 • Gardena, California 90274
SANSUI ELECTRIC CO., LTD., Tokyo, Japan • Sansui Audio Europe S. A., Antwerp, Belgium

© COPYRIGHT BY SANSUI

CIRCLE 60 ON READER-SERVICE CARD

chestra, Edo de Waart, cond. Philips 6500 118, \$5.98.

GERSHWIN: Concerto for Piano and Orchestra, in F; Rhapsody in Blue; An American in Paris. London Symphony Orchestra, André Previn, piano, cond. Angel S 36810, \$5.98.

Good as it is to find European musicians and recording companies demonstrating a growing interest in the music of Gershwin, particularly in his too-often underrated Piano Concerto, it's unfortunate that they are unable to profit more from studying the best American versions. The German virtuoso Haas has only a relatively slight idiomatic accent, but he seems quite incapable of appreciating the music's quintessentially American humor and swagger; while the Dutch conductor and the Monte Carlo Orchestra players are

awkwardly heavy-handed in the lively passages, languid in the lyrical ones. The extremely strong and vivid recording cruelly highlights general orchestral coarseness, especially that of the percussion: I've never heard a tinnier gong! But it does justice to the big, ringingly brilliant tonal qualities of the soloist, and it is the formidable Herr Haas's precisely articulated and genuinely bravura playing that gives this release distinctive interest to connoisseurs of virtuoso pianism.

The musical polymath Previn, born in Berlin but a thorough American from early youth and a onetime jazz and pop pianist, is of course much more at home in the Gershwin repertory and he succeeds in schooling his fine British orchestral players into avoiding any overtly foreign accents. Their tonal qualities are uncommonly attractive too, all cap-

tured in an admirably warm, pure, ungingimicked recording. So if the Previn/LSO *American in Paris* may be more dapper than rowdy, it can be ranked close to, if not quite with, the long-favorite Fiedler and Bernstein versions. There is fine insouciance, verve, and fluency in the piano works as well, but for me Previn's distinctive mannerisms sometimes verge embarrassingly on archness and seldom achieve complete dramatic conviction. His many fans are sure to be completely delighted, and there is much here to please as well as interest all Gershwinians. But for myself I'll stick with the Wild/Fiedler versions for RCA. That pair's Concerto and *I Got Rhythm* Variations are the best I know on records, while their *Rhapsody in Blue* is one of the best of a list that no longer includes my personal favorite, the unpretentious but interpretatively authentic 1958 Kapp version by Roger Williams with the Symphony of the Air under Willis Page. R.D.D.

HAYDN: Five Trios for Baryton, Viola, and Cello. János Liebner, baryton; Gábor Fias, viola; László Mezö, cello. Hungaroton LPX 11478, \$5.98.

HAYDN: Five Divertimentos for Harpsichord and Strings. János Sebestyén, harpsichord; Vilmos Tátrai and György Konrad, violins; Ede Banda, cello. Hungaroton LPX 11468, \$5.98.

As the world must know by now, Haydn's patron Count Miklós Esterházy was addicted to the baryton, a gambalike instrument with six or seven principal strings and a set of secondary nonbowed strings that vibrate sympathetically and can also be plucked by the player's thumb. Under firm instructions, Haydn wrote some two hundred pieces for his patron's amusement. They are modest but respectable little works, embodying considerable variety—the selection here boasts a fugue, a lovely folkish melody in one C major Adagio, a lively Polonaise, and several lusty finales. One can easily understand the Count's pleasure in them. The performances are all one could wish: skillful, shapely, and rhythmically alive.

The five divertimentos for harpsichord and strings represent some of Haydn's earliest output: they date from just before and during his first years at Esterházy, where he went in 1761 at the age of twenty-nine. They are trim and accomplished. Though he was a slow bloomer, Haydn knew by his late twenties how to keep a basically thin texture from developing holes, how to manage modulations in a textbook manner, and how to handle the three strings so that they corroborate, punctuate, and in general provide a framework for the harpsichord. And he does more, for these are quite attractive pieces, with some joyous fast movements and some dark-hued turns into the minor by way of contrast. They are performed with utmost rhythmic precision and a lightness of touch that is appropriate. S.F.

HOVHANESS: Lady of Light. Patricia Clark, soprano; Leslie Fyson, tenor; Ambrosian Singers; Royal Philharmonic Orchestra, Alan Hovhaness, cond. Poseidon Society 1006, \$5.95.

The cover of this set is a drawing of a ruined Romanesque tomb. Just what it has to do with Poseidon or with Hovhaness' composition it would be difficult to say. I bring up the point

How to Reproduce the Original Blood Stirring Sound Levels of a Full Symphony Orchestra.

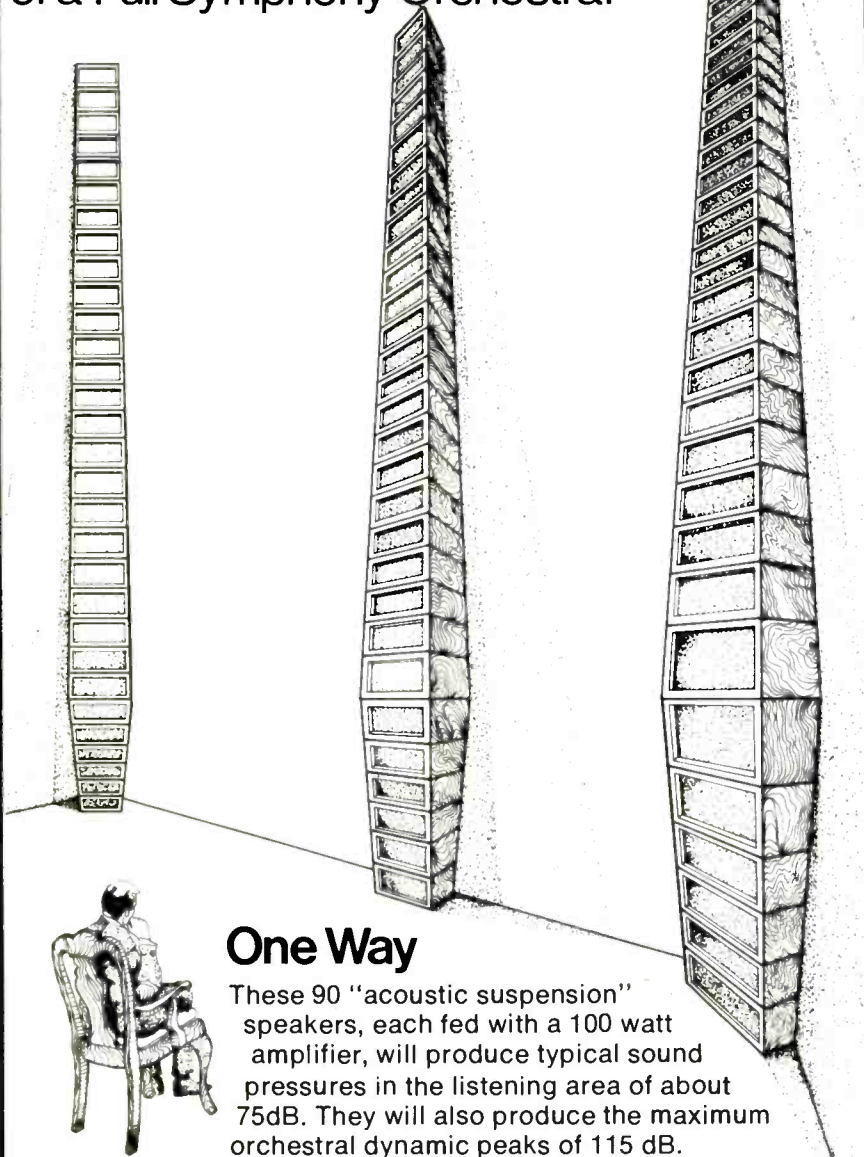

One Way

These 90 "acoustic suspension" speakers, each fed with a 100 watt amplifier, will produce typical sound pressures in the listening area of about 75dB. They will also produce the maximum orchestral dynamic peaks of 115 dB.

Total amplifier cost about \$20,000
Total speaker cost about \$25,000

But, you have an alternative.

CIRCLE 42 ON READER-SERVICE CARD

simply because it underlines the curious mixture of elements here.

The work is a choral piece employing a poem by the composer himself which contrasts light and darkness, hate and love, etc., etc. in rather crude and obvious imagery. The music is not so crude or obvious. The "luminous pillars" with which the score opens and closes have a great lift to them, not unlike that of the first movement of Ives's Third Symphony. There is a lovely episode taken right out of Hovhanness' own raindrop music for *The Flowering Peach*, and a war-god enters to music grotesque enough for a Mayan idol. But nothing seems to hang together very well, and there is something a little grotesque when a chorus keeps reiterating "we are dawncing, we are dawncing, we are dawncing" to a very obvious dawnc rhythm. The recording is not bad and the performance is apparently as good as Hovhanness could get. A.F.

B **KODÁLY:** *Psalmus Hungaricus*; *Te Deum*. Endre Rosler, tenor (In the *Psalmus*); Iren Szecsödy, soprano; Magda Tiszay, alto; Tibor Udvardy, tenor; András Farago, bass (in the *Te Deum*); Budapest Chorus; Hungarian Concert Orchestra; Zoltán Kodály, cond. Turnabout TV 4351, \$2.98 (mono only).

For once one can agree with the promotional copy on the record cover: This is indeed "An Historic Recording," for it presents an important contemporary composer's interpretations of two of his finest works. In fact, the *Psalmus Hungaricus* and *Te Deum*, traditional in basic approach but highly national and individual in idiom, must rank among the best examples of choral literature this century has produced.

Kodály was a master of the chorus, a medium that engaged his best efforts as a composer and stimulated him to develop his own system of music education based on ensemble singing. The better known of these two works is the *Psalmus Hungaricus*, a paraphrase and commentary on the fifty-fifth Psalm for tenor, chorus, and orchestra. Composed in 1923, like Bartók's *Dance Suite*, to celebrate the fiftieth anniversary of the union of Buda and Pesth, its first performance quite overshadowed Bartók's contribution. In later years, Bartók gradually gained greater renown than his friend and colleague, primarily because of his more highly individual modernism, but Kodály's more conservative style holds up well thanks to its deep sincerity and fine craftsmanship.

Thirteen years later, Kodály wrote another major choral work of similar proportions, to the traditional Roman Catholic *Te Deum* text. Less intensely national in text and style, the *Te Deum* nonetheless conveys its composer's strong Hungarian style. It too was composed for a festive occasion, the 250th anniversary of the liberation of Buda from the Turks.

Obviously neither performance is new, for Kodály died in 1967. The lack of truly high quality reproduction hampers the full impact of such massively scored music: it sounds very much as if it had been recorded in a small studio, for the sound is generally cramped and muddy. Kertész's performance of the *Psalmus Hungaricus*, recently issued on London, which I have not heard, doubtlessly sounds much better, but the direction of the composer himself here is of more than mere documentary value.

A major shortcoming of this production is the total lack of texts, either in Hungarian or English; such "An Historic Recording" deserves better treatment. P.H.

LISZT: *Fantasia on Hungarian Folk Tunes*; *Totentanz*. **SAINT-SAËNS:** *Concerto for Piano and Orchestra, No. 4, in C minor, Op. 44*. Michele Campanella, piano; Monte Carlo Opera Orchestra, Aldo Ceccato, cond. Philips 6500 095, \$6.98.

At first glance it seemed that the manufacturers of this Liszt/Saint-Saëns collection had forgotten to identify the artist. On further scrutiny, of course, I realized that Campanella was a pianist, not one of the compositions! The twenty-four-year-old Neapolitan lives up to

his name with amazingly even bell-like trills and a bright, incisive cantabile tone. He goes about these brilliant, extroverted scores with a thorough sense of relish and gusto, but for all that, he keeps his cool attractively. In the Saint-Saëns, for example, the more introspective portions (e.g., the opening of the first movement) have a beautiful crystalline reserve and an almost Mozartian elegance that keep the music shapely and cogently expressive. To be sure, there are expressive liberties but they show a certain breeding, a patrician purity.

When I heard Aldo Ceccato, son-in-law of the renowned Victor de Sabata, with the New York Philharmonic last year, he impressed me as a virtuoso conductor. That impression is revived by the evidence now at hand. Although the Monte Carlo Orchestra has a clear,

How to Reproduce the Original Blood Stirring Sound Levels of a Full Symphony Orchestra.

The Best Way

This Klipsch Wide Stage Stereo array will reproduce anything a full symphony orchestra can produce. To do it requires no more than 60 watts. Each speaker, being horn loaded, requires only a 20 watt amplifier. But, most important, total modulation distortion is minimal, less than one tenth that of "acoustic suspension" speakers.

Total amplifier cost about \$750

Total speaker cost about \$2580

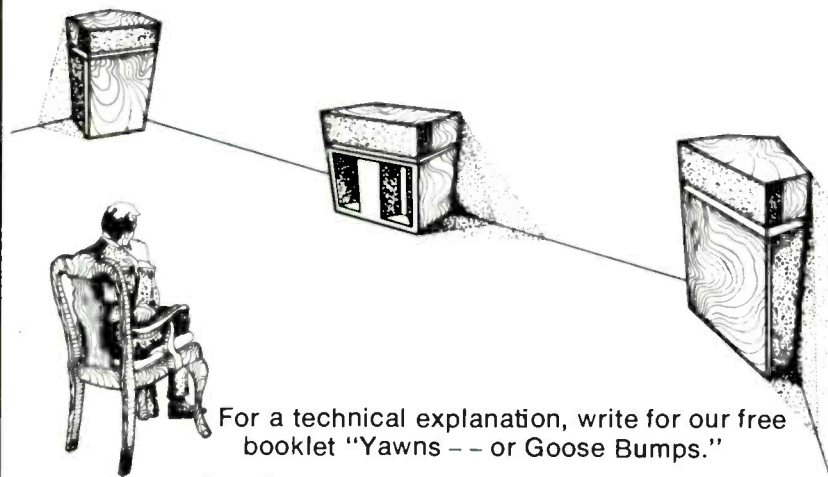

For a technical explanation, write for our free booklet "Yawns -- or Goose Bumps."



KLIPSCH & ASSOCIATES, INC.,
Box 280 Hope, Arkansas 71801

get the NEWS FREE!

The new McIntosh 36 page catalog gives you all the details on the new McIntosh solid state equipment. In addition, you'll receive absolutely free a complete up-to-date FM Station Directory.

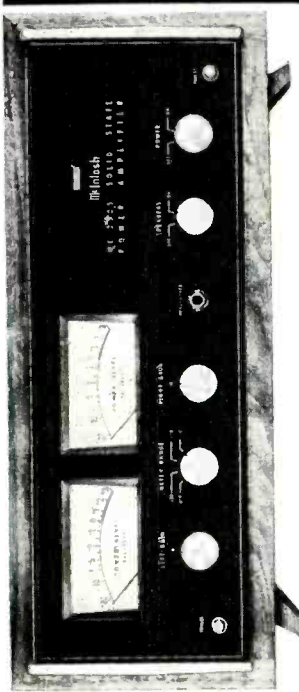

**MC 2505
SOLID STATE POWER AMPLIFIER**

FREE SEND TODAY

McIntosh

2 Chambers St., Dept. A-3
Binghamton, N.Y. 13903

Please Send FREE CATALOG and DIRECTORY

NAME _____
ADDRESS _____
CITY _____
STATE _____ ZIP _____

CIRCLE 50 ON READER-SERVICE CARD

rather raw sound. Ceccato gets them to perform with hair-trigger precision and fantastic controlled drive. All the accompaniments, especially that of the Saint-Saëns, are spotted with the soloist and in addition boast wonderful detail. As the youthful maestro reveals point upon point, you realize that he too is a soloist in his own right. And happily Ceccato would seem to be one young conductor who has managed to avoid the Furtwängler virus: He isn't afraid to dig in with a sforzando blast, and there is none of that sluggish, spready sonority that is the inevitable result of always striving for "long notes." Philips' engineering and processing are of demonstration class.

H.G.

B MAHLER: Symphony No. 4. Heather Harper, soprano; Berlin Radio Orchestra, Lorin Maazel, cond. Nonesuch H 71259, \$2.98.

There are two sides to the Mahler coin. On one hand his music is ultraromantic, ultralush, the quintessence of mighty, full-blown orchestral sound. On the other hand it is structured with the same attention to counterpoint as a Beethoven string quartet. Lorin Maazel's interpretation puts too much emphasis on the first element and gives far too little attention to the second.

This is Mahler painted with a thick brush, or drawn with a blunt pencil. Maazel's interest is focused mainly on the high points: He is better at climaxes than at details, more at home in codas than in developments. While the recording definitely has virtues, it is marred by flaws occasionally serious and sometimes merely annoying.

One problem that crops up in each movement is a monotonous dynamic level. While the major, climactic crescendos and diminuendos are there, more subtle nuances are lacking, and one has the impression that the music stays mostly at a dull mezzo forte. The lack of attention to soft passages is especially troublesome in the slow movement. Paralleling this is a general neglect of complex contrapuntal interplay. Important lines in the woodwinds, for instance, often get lost in over-generous waves of string sound.

The first two movements lack incisiveness. The first—a gay piece set in classical sonata form with some late-romantic twists—opens with a percussive repeated figure for small bells and flute, a motive that should sound really biting. Here it is timid. Occasionally the rhythm is imprecise and entrances uncertain. The eerie Scherzo is punctuated with a violin solo, played on an instrument tuned one step higher than usual. The movement's twisted, chromatic theme, when given to the solo, should have a dance-of-death quality. Its entrances need the character of forceful intrusions, but it is too subdued here to be startling.

Maazel's control is somewhat surer in the last two movements. His tempo in the poco adagio is leisurely but moving, without the tendency to drag that can be heard in some other versions. The rich, romantic sound he elicits is pure pleasure to hear.

Miss Harper is warm and appealing in the finale, which incorporates the *Wunderhorn* song *Das himmlische Leben*. Her interpretation of the text's naive description of heaven is thoroughly charming, and technically she

is excellent. The orchestra turns in a fine performance here; the playing at last achieves the sharp focus and precision that would have greatly enhanced previous movements. A.M.

MAYUZUMI: Music with Sculpture—See Penderecki: Pittsburgh Overture.

MUSSORGSKY: Boris Godunov (ed. Rimsky-Korsakov). Galina Vishnevskaya (s), Marina; Najejda Dobrianowa (s), Xenia; Olivera Miljakovic (ms), Feodor; Biserka Cvejic (ms), Nurse; Margarita Lilowa (ms), Hostess; Ludovic Spiess (t), Dimitri; Aleksei Maslenikov (t), Prince Shuisky and Simpleton; Milen Paunov (t), Mis-sail; Zoltan Kélemen (b), Rangoni; Nicolai Ghiaurov (bs), Boris Godunov; Martti Talvela (bs), Pimen; Anton Diakov (bs), Varlaam; Vienna Boys' Choir; Sofia Radio Chorus; Vienna State Opera Chorus; Vienna Philharmonic Orchestra, Herbert von Karajan, cond. London OSA 1439, \$23.92 (four discs).

The checkered discographic representation of Mussorgsky's masterpiece continues, if at a slower pace—when Conrad L. Osborne reviewed Columbia's Bolshoi recording (M4S 696) in October 1964, he reported rumors of a planned Decca/London version with Ghiaurov, which has only now materialized. With all the attention that has been lavished on Rimsky-Korsakov's revision—not simply a reorchestration, it must be noted—one might hope at last for a disc version of Mussorgsky's original work (or, strictly speaking, of one of the two versions he made of it), but what London and Karajan give us here is once again essentially Rimsky (I'll explain the qualification in a minute).

Details of what Rimsky did, aside from providing a more resonant orchestral panoply, have been recited on numerous occasions, so I will not go over that ground again (Arthur Jacobs gave a good summary in *Opera*, May 1971), and the relevant scores are now readily available, so there is no excuse for performers to plead ignorance: Oxford University Press recently republished a vocal score of the Lamm edition, incorporating both of Mussorgsky's versions (but, alas, with only an English translation, no Russian original), and an orchestral score will be forthcoming shortly, while the second Mussorgsky version is also available in vocal score from Bessel (this has Russian, French, and German texts). For purposes of comparison, one may use the Kalmus vocal score, which represents Rimsky's second (and more complete) revision used in all the recordings; a very handsome orchestral study score of this version was published in Moscow in 1959, also incorporating Ippolitov-Ivanov's orchestration of the scene before St. Basil's Cathedral.

That brings us back to the qualification in my description of the text used by Karajan. Like Melik-Pashayev in the Columbia recording, he incorporates the St. Basil Scene, although it is obvious that the composer never intended both it and the Kromy Forest to be



Hisssss

The Concord Mark IX cassette deck starts with an extremely low signal-to-noise ratio — better than 50 dB down. The Dolby Noise Reduction system reduces hiss by another 10 dB, and that's just the beginning. The deluxe Concord Mark IX has switch selected bias for standard and chromium dioxide tape cassettes. The narrow head gap and better than 100 kHz bias frequency provide extended frequency response from 30 to 15,000 Hz.

The Mark IX looks like a studio console and performs like one too. With pop-up VU meters, studio type linear sliders for individual control of input and output levels, third mike input for mixing in a center channel microphone, a 3-digit tape counter and a stereo/mono switch for more effective mono record and playback. And this brilliant panel lights up for power on, record and for Dolby.

And when the cassette is finished, Endmatic, a Concord exclusive, disengages tape and transport and returns the pushbuttons to off. And best of all, it's now available at your Concord dealer at a fair price for all of this quality, \$249.79.

If you already have a cassette, open-reel or 8-track deck, the Concord DBA-10 Dolby tape adaptor can

reduce hiss and improve performance. It will also improve your receiver's performance in playing back Dolbyized FM programs, \$99.79.

Your Concord dealer also has a complete line of 8-track and open-reel decks, stereo receivers and cassette portables. Concord Division, Benjamin Electronic Sound Corp., Farmingdale, N.Y. 11735/
subsidiary of Instrument Systems Corp.

**BENJAMIN
CONCORD**

Prices subject to change without notice.



Concord Mark IX Dolby Cassette Deck

The world's smallest electronic 35 mm camera

This incredibly compact and precise camera will please those hard-to-please people who like the simplicity of automatic operation but demand superior quality pictures. The Olympus 35EC uses standard 35mm film and a professional type 5 element Zeiko lens. You'll notice the difference whether you shoot slides, color prints or want really big black and white enlargements. And the 35EC is pocket-size. Always ready in your pocket or purse to take pictures automatically in sunlight, dim light, candlelight. Even with flash it's automatic. The EC's computer brain selects shutter speed and lens aperture automatically to guarantee perfect exposures everytime, day or night. How? Electronically. See a demonstration at your photo dealer. The Olympus EC is under \$80. Part of a complete line of quality Olympus compact cameras.

Marketed exclusively in the U.S.A. by Ponder & Best Inc. 11201 W. Pico Blvd., Los Angeles, Calif. 90064.

OLYMPUS 35EC

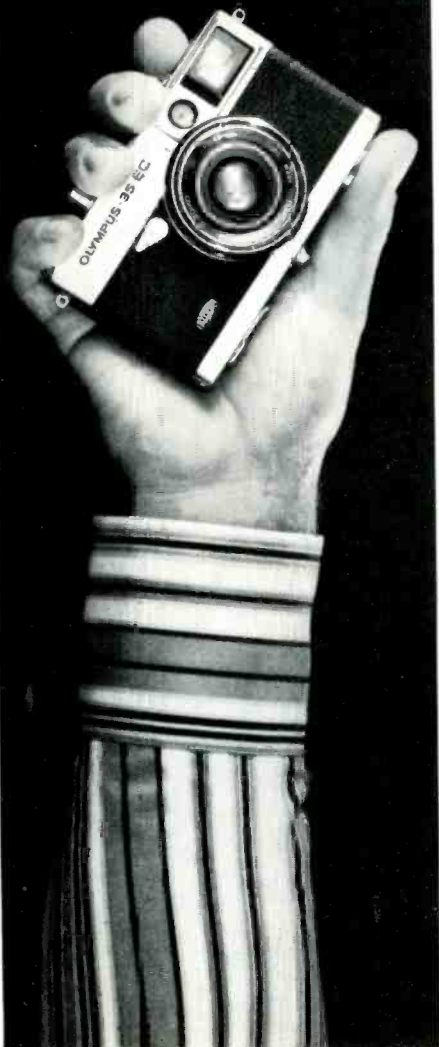

CIRCLE 54 ON READER-SERVICE CARD

used together—they belong to different recensions of the work and utilize identical musical material: the scene of the boys teasing the Simpleton and two stanzas of the Simpleton's song. Even Rimsky realized this, after all—that's why he omitted St. Basil's from his versions (and it's how the composer of the *Caucasian Sketches* comes into the picture). Both conductors are sensible enough to omit the "repetition" of the Simpleton and the boys in the Kromy Forest, but they cannot evade the incredible solecism of ending two scenes (within the same act!) with the Simpleton's lament for Russia. (For the record, Cluytens' Angel version omits St. Basil, and also eschews the cuts that Melik-Pashayev makes elsewhere; he gives us Rimsky complete, whereas Karajan presents it "too complete," as it were.)

Before passing on to the new recording as a performance, let me mention briefly the only substantial recordings using Mussorgsky's original for the benefit of those interested in a direct comparison. A deleted RCA set (LM 6063) contains two records' worth of the Karol Rathaus edition that the Metropolitan Opera favored in the early 1950s sung in English—not very impressively recorded unfortunately. Musically much more distinguished is a Eurodisc single (72765 KR), sung in German by a cast including Gottlob Frick and Martti Talvela; this is well worth picking up if you come across it.

What about the new Karajan recording? Well, I must begin by saying that it is very beautifully played, recorded, and—for the most part—sung. If surface polish were the *sine qua non* of operatic performance, this would win hands down. Desirable as it may be, however, that sables-and-diamonds sound is not really enough, and as with other recent Karajan recordings, there is a curiously static character to the proceedings here which effectively fillets out the drama. It's mostly a matter of rhythmic impetus: The phrases don't seem to be shaped with a strong sense of destination—they just lie there. Only in the Kromy Forest do things get off the ground, although the scene in Pimen's cell, where a certain repose is dramatically and musically justifiable, is pretty hard to resist given Talvela's smooth, rich emission and the gorgeous orchestral playing. This will doubtless be a minority report, but I can't help it; I was bored by a good deal of this performance, which concerns itself so exclusively with tonal sheen that it ends up having very little to do with opera as theater.

One specific example: In Boris' monologue in the second act, after describing his happy children, the Tsar tells how death struck down Xenia's fiancé: at this point a menacing brass chord, marked *ff* and accented, replaces the gentle string accompaniment. Normally, this chord really bites in, a big textural disruption, but with Karajan it's a smooth, subdued sound, more suitable for, say, Sieglinde's recollection of Wotan than Mussorgsky's purpose (or, rather, Rimsky's, since the chord does not exist in the original).

As I have suggested, the singing is on a high level, the only conspicuous exceptions being the two Jesuits in the last scene. However, Ghiaurov, for all his vocal clout, hardly projects the character of Boris with the vividness that Christoff commands in the Angel recording—the difference between a good singer and a good singing actor. It is an ad-

vantage, of course, to have distinct voices for Pimen and Varlaam, particularly at the point of confrontation between Pimen and Boris in Act IV—especially when they are as good as Talvela and Diakov (who was the Rangoni of the Cluytens set), although the doubling of Shuisky and the Simpleton by Maslennikov involves a similar self-confrontation in the St. Basil's scene. In the Polish act, Vishnevskaya makes a very positive Marina, occasionally prone to jumping beats (one sympathizes with her impulse, and others share it on occasion, notably the Shchelkalov); Spiess is a fine Dimitri, vastly superior to the painful Uzunov in the Angel set.

It's disappointing that all this excellence—including superior choral singing and superb orchestral detail—should not add up to more than it does. Of course, if this recording had used Mussorgsky's original, it would have been enormously valuable despite its shortcomings. Next time, will somebody please make the effort? D.H.

PENDERECKI: Pittsburgh Overture. **MAYUZUMI:** Music with Sculpture. **WILLIAMS:** Sinfonietta for Wind Ensemble. Eastman Wind Ensemble, Donald Hunsberger, cond. Deutsche Grammophon 2530 063, \$6.98.

This is just about the most sensationally perfect recording I have ever heard. Every subtlety of timbre—and subtlety of timbre is what most of this music is about—is superbly caught, and you would swear the timpani in the Penderecki were right there in the room with you.

For Penderecki uses lots of timpani in this piece: in fact, his "wind ensemble" calls for thirty-nine different percussion instruments grouped into eighteen families. It is all so cleverly done—percussion against woodwind and brass and ten-thousand varieties of color disclosed in each—that you almost forget that the music has practically no other substance. The work derives its title from the fact that it was written for the American Wind Symphony Orchestra in Pittsburgh.

Mayuzumi's work derives its title from nothing: it is totally meaningless, but the music is very nice. The piece is extremely short, quiet, and impressionistic, as if the wind parts of *La Mer* or some other orchestral work of Debussy were being played without the strings.

John T. Williams' Sinfonietta is too modestly titled; it is a real symphony in size and scope—rather Hindemithian, but full of life and juice on its own. The performances of all three pieces seem to be altogether in keeping with the wonderful recording. A.F.

PLESKOW: Piece for Piano. Anne Chamberlain, piano. For a feature review of this recording, see page 71.

ROVICS: Three Studies for Piano. Anne Chamberlain, piano. For a feature review of this recording, see page 71.

SAINT SAËNS: Concerto for Piano and Orchestra, No. 4, in C minor, Op. 44—See Liszt: Fantasia on Hungarian Folk Tunes.



YOU CAN'T HEAR OUR TAPE FOR THE MUSIC



When you listen to a TDK tape, all you can hear is the living sound, just the way it reached the tape. No background hiss. No distortion. No dropouts or fluctuations in output level. Nothing added, nothing left out.

Whether your thing is cassette or open-reel recording, TDK has *the* tape that will give you the best results with your deck or recorder. The only sounds you will hear are the sounds you put on the tape.

Super Dynamic Reels. Gamma ferric (SD) oxide for response beyond 20,000 Hz. 1200' and 1800' lengths on 7" reels; 3600' lengths on 10½" NAB reels.

Deluxe Low-Noise Reels. "Standard" tape superior to most other premiums. Extended range. 1200', 1800' and 2400' lengths on 7" reels.

Super Dynamic Cassettes. Gamma ferric (SD) oxide for response to 20,000 Hz. "The tape that turned the cassette into a high-fidelity medium." 30 minute, 60 minute, 90 minute and 120 minute lengths.

Deluxe Low-Noise Cassettes. High-output, extended-range tape on the TDK ultra-reliable cassette. 30 minute, 60 minute, 90 minute and 120 minute lengths.

Maverick Cassettes. Economy plus TDK's ultra-reliable cassette. 30 minute, 60 minute and 90 minute lengths.

World's leader in tape technology.

TDK ELECTRONICS CORP.
LONG ISLAND CITY, NEW YORK 11103



TDK



SCHOENBERG: Quartets for Strings (complete); Lieder; Piano Works. LaSalle Quartet; Dietrich Fischer-Dieskau, baritone; Jürg von Vintschger and Anne Chamberlain, piano. For a feature review of these recordings, see page 71.

SCHUBERT: Impromptus, D. 899: No. 1, in C minor; No. 2, in E flat; No. 3, in G flat; No. 4, in A flat; Moments Musicaux, D 780: No. 1, in C; No. 2, in A flat; No. 3, in F minor; No. 4, in C sharp minor; No. 5, in F minor; No. 6, in A flat. Andor Foldes, piano. Odeon C 063 29037, \$6.98.

Andor Foldes seems a natural for Schubert's piano music and it seems strange that he should, until now, have refrained from recording any of it. The Hungarian pianist's style has a natural sobriety, a very controlled sense of form, phrasing, and tonal weight. He uses the pedal sparingly to produce all sorts of ravishing coloristic interplay. He is aware of detail, as one must be in this precisely transparent music, but never hits you over the head with it. Some of the tempos are very leisurely and yet most of them work admirably: The C minor Impromptu, for example, builds in a cathedral-like manner, while the runs of the following one in E flat unfold with added clarity. The only place where the deliberation seems really misjudged is in the G flat Impromptu: Here the double *alla breve* is lost. Foldes, I hasten to point out, is never afraid to depart from his easygoing norm when he feels the music calls upon him to do so: The first *Moment Musical* is, if anything, on the hasty side. There are a few trivia which can be questioned throughout

these respectful readings. Why, for example, the complete lack of legato in the celebrated *Moment Musical* No. 3? Why are the dynamic extremes so flattened out in No. 6 from that set? And isn't the version of the text which has an F flat rather than F natural in the trio of No. 4 more sensible? Foldes apparently doesn't think so.

For all that, these performances seem "right" in so many ways, and I recommend them highly. Odeon's piano sound is a pleasure: round, full, not excessively plangent nor excessively mushy. Is the piano used one of those great Hamburg Steinways? H.G.

SCRIABIN: Etudes, Op. 8. Viktor Merzhanov, piano. Melodiya/Angel SR 40176, \$5.98.

Scriabin's Op. 8 études, composed in 1894 and 1895, offer a perfect example of finger-breaking virtuosity put to the service of pure musical expressivity. Indeed, one might say that these études represent "studies" mainly in the sense that anyone who can work them up to performance caliber is bound to be a better pianist for it. For, unlike the Chopin études written earlier, or those by Debussy composed twenty years later, the Scriabin pieces do not generally pose any specific technical difficulties, and in the abstractness of their intentions they are perhaps more akin to the various études by Liszt. Nonetheless, it is the musical language of Chopin that informs these early Scriabin works, especially in the extraordinary dynamism both composers were able to achieve from harmonic movement. Where Scriabin's musical idiom is at its most distinctive—and, one might

add, most Russian—is in the richness of the composer's highly developed chordal style. Chopin usually stresses melody, while Scriabin is often able to get away with pure chordal progressions that have only the feeblest thematic justification (such as in the breath-taking Etude No. 7); even so, Scriabin's lyrical gifts do appear occasionally, such as the famous *Paterico* Etude No. 12.

What immediately strikes me about Viktor Merzhanov's performances on this new release is how the pianist's style contradicts, on at least two points, the flowery praise given the artist in Faubion Bowers' liner notes. Where Bowers talks of the "limpidity of tone [Merzhanov] brings to Scriabin," I found a harsh, percussive tone that almost always seemed too loud. Where Bowers mentions "the shadowy shadings obeyed yet still individual and original," I found a number of examples of total disregard for Scriabin's dynamic markings, not to mention rather frequent, quasi-romantic indulgences in rhythmic liberties (particularly flagrant in No. 6). Not that Merzhanov does not have his strengths—he is much better in bringing out the various thematic lines (an asset Bowers does point out) than, for instance, Morton Estrin on the only other currently available complete recording (on Connoisseur Society). Merzhanov also tends more closely to details, whereas Estrin seems to bury a good deal of his notes at times. Yet the latter more often than not creates what I would consider to be a more genuinely Scriabinesque movement than his Russian counterpart, and he generally remains more faithful to the music's written indications.

Thus, in No. 4, Merzhanov plays the nasty

Wow and flutter 0.1%, lowest of any stereo cassette deck at any price.

Sony's exclusive closed loop dual capstan tape drive system solves a major cassette problem—pronounced wow and flutter. This system (shown here) helps make the Sony 160 and 165 stereo cassette decks perform better than any other. Why? Because it drives the tape at a constant speed, exerting the *same amount of tape-to-head pressure from one end of the tape to the other.* (Not only a steady pressure but the correct amount of pressure to reduce modulation distortion drastically.)

In addition, both Sony decks are equipped with a built-in Peak Limiter. A unique first, it automatically monitors the recording level preventing tape saturation and distortion without audibly altering the dynamic range while you're recording.

There is also a tape select switch that enables you to change the record equalization for either standard or the new chromium dioxide cassette tapes.

Sony keeps the

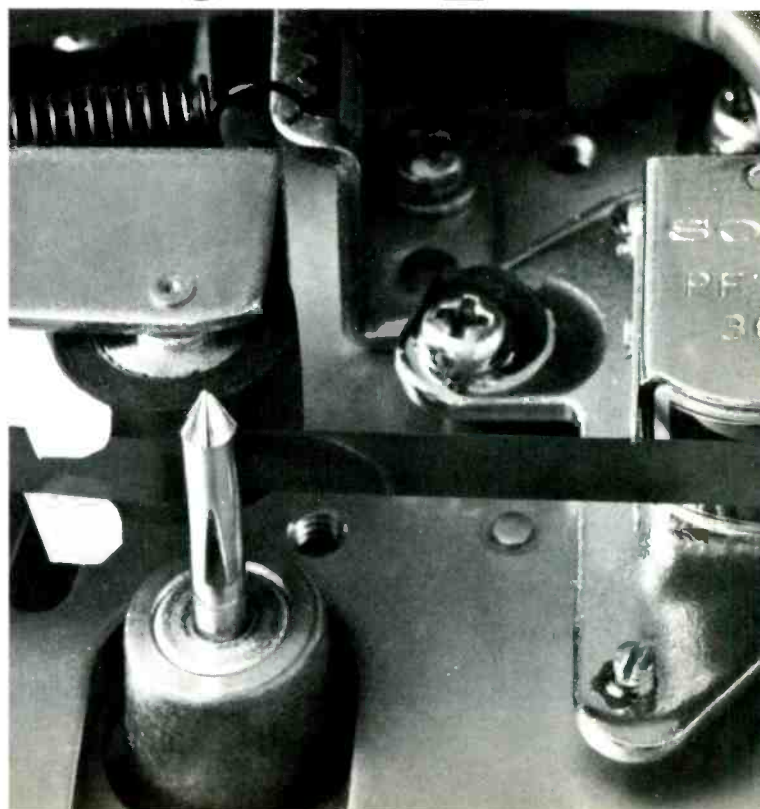

three (or four)-against-five passages with much greater accuracy than Estrin; yet Estrin's lyrical quiescence strikes one as more suitable to the work's *piacevole* indication than Merzhanov's spasmodic but rather artificial romanticism. Only in his exhilarating performance of No. 7 does Merzhanov really outdo Estrin. The latter's infinitely more skillful octave work, on the other hand, helps produce a genuinely dramatic sweep, in Nos. 9 and 12, that is sadly lacking in the Merzhanov interpretations. Furthermore, the sonics on the Estrin disc are so far superior to the flat, unresonant, depthless (the stereo effect is almost nil), and often distorted sound on the Melodiya /Angel release that Merzhanov would really have had to play circles around Estrin (which he does not) to make his recording the choice. A domestic transfer of the mono-only disc of Vladimir Sofronitsky's almost complete performance of the études would have been preferable. The last word on these remarkable pieces will never be said, but a few more syllables—from, say, Horowitz, Gilels, Richter, Laredo for starters—would be welcome. R.S.B.

STRAUSS, R.: Sonata for Piano, in B minor, Op. 5; *Stimmungsbilder*, Op. 9. Carol Colburn, piano. Orion ORS 7147, \$5.98.

Richard Strauss began his musical life with piano studies at the age of four. His father, the wise and kindly Franz, espoused all that was good (e.g., establishment) in music and saw to it that the lad's musical education consisted of nothing harder to digest than Mendelssohn, with a judicious selection of Mozart, Haydn,

and Beethoven. Inevitably, little Richard ran away from his moralistic background and fell into some "bad" company—most specifically a violinist named Von Ritter who filled the boy's head with Wagner and the other demoralizing influences his father had shielded him from.

The compositions heard on this disc are from Strauss's sixteenth and nineteenth years respectively and thus antedate his coming of age. I once said of the early Violin Sonata that it sounded like Don Juan before puberty, but the even earlier sonata recorded here gives nary a hint of Strauss's future eroticism. If you want to baffle your musical friends, put on this record and ask them to guess the composer. The first movement sounds like a cross between Mendelssohn and Brahms (the former's gentility and the latter's chordal, solid textures) while the Adagio cantabile bears an uncanny resemblance to, of all things, the Fairy Queen's big number in the G&S Operetta *Iolanthe* (which came into being at just about the same time as this juvenile opus).

The *Stimmungsbilder* of three years later, on the other hand, show a real advancement: Whereas the sonata is innocuous and rather academic, these short pieces have lilt, grace, and touches of harmonic ingenuity. One hears more than a trace of the later Lieder. In other words, Strauss had a formidable talent, and gifts of his magnitude would inevitably show up despite imposed parental blinders.

The performances are very serviceable. Carol Colburn is especially attractive in the *Stimmungsbilder* where her singing tone and gentle gracefulness are put to very agreeable advantage. In the sonata, though, a magician's rather than a pianist's hand is needed: Perhaps

a bona fide soloist with flair and snap, fantastic power, imagination, and tonal variety could transform this piece of pedantry into burgeoning poetry. Miss Colburn's tasteful, flexible reading lacks that requisite daredevil brilliance, and it seems that she pulls out all her technical stops without giving the impression of having more in reserve. But she, Orion, and the Yehudi Menuhin Foundation who sponsored this unusual repertory definitely earn a round of applause for making it available to us. The sound is agreeably resonant.

H.G.

B **VERDI:** "Golden Age Rigoletto," Questa o quella; Veglia, o donna; È il sol dell' anima; Gualtier Maldè . . . **H** Caro nome; Ella mi fu rapita . . . Parmi veder; Povero Rigoletto . . . Cortigiani; Tutte le feste; Piangi, fanciulla; La donna è mobile; Quartet; O mia Gilda . . . Lassù in cielo. Amelita Galli-Curci (s), Gilda; Enrico Caruso (t, in the quartet only); Tito Schipa (t), Duke of Mantua; Giuseppe de Luca (b), Rigoletto; various choruses and orchestras. RCA Victorla VIC 1633, \$2.98 (mono); from originals recorded 1913-1928).

This formula for packaging gems from the old Victor catalogues is so obvious that I'm not surprised it has hardly been used before; aside from the Caruso-Farrar *Faust* material on an old LCT disc and the Farrar *Carmen* disc in the Camden series, I don't recall earlier RCA collections that attempted to assemble a consistent cast in the same opera until the current spate.

©1972 Superscope, Inc., 8144 Vineland Ave., Sun Valley, Calif. 91352. Prices subject to change without notice.

pressure on!

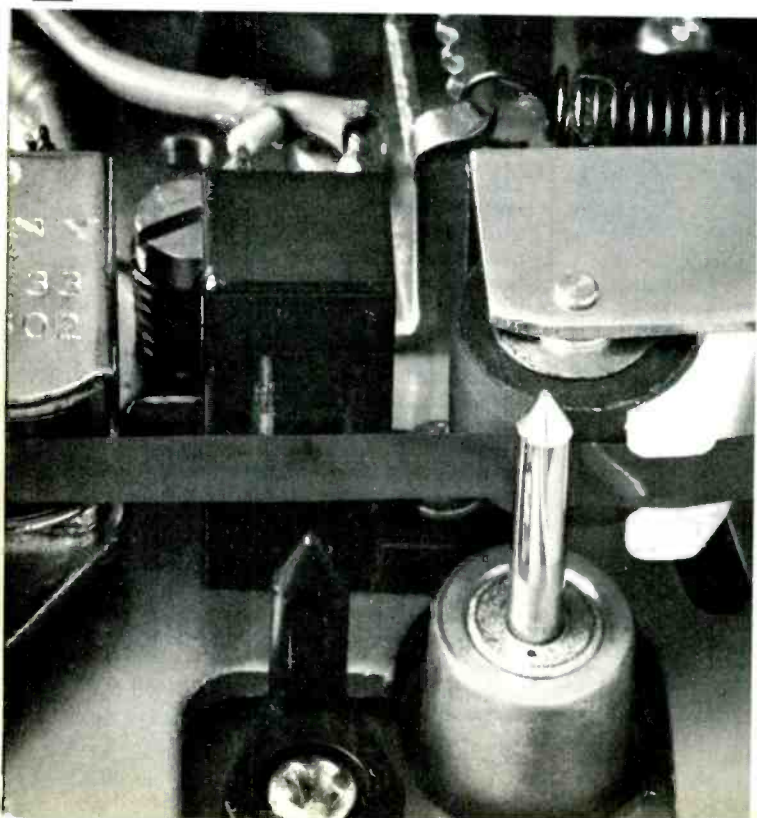

Brilliant Sony engineering and outstanding reliability guaranteed by Superscope make these two stereo cassette decks the best buy bar none. Choose the Sony model 160 for just \$199.95. Or own the Sony model 165 with automatic reverse. It permits both sides of a cassette to be recorded or played back without turning the cassette over, then shuts off automatically; or it can be programmed for continuous play. The price—\$259.95.

At your Sony/Superscope dealer you'll see the full line of superior Sony stereo cassette decks from Superscope starting as low as \$99.95.



SONY SUPERSCOPE

You never heard it so good.®

CIRCLE 63 ON READER-SERVICE CARD

"Golden Age *Rigoletto*" is not quite as coherent as the *Butterfly* and *Aida* collections however. For one thing, the recordings shift back and forth from acoustic to electric, the difference being more one of tonal character than actual quality, since the early electrics (the Schipa solos, the first Gilda-Rigoletto duet, and the big scene for *Rigoletto*) are hardly FFRR. And since Schipa never recorded the quartet, the stentorian tones of Enrico Caruso suddenly obtrude following the younger tenor's light if mannered "*La donna*." An alternative quartet (1927) with Galli-Curci and De Luca was available, but, at that, Caruso's labored phrasing is probably preferable to Gigli's even more strenuous imitation thereof. I'd rather have heard De Luca's early Fonotipia "*Pari siamo*," which he never recorded for Victor.

That Enrican intrusion aside, this is de-

cidely a light-voiced team, but does not suffer for it: they were all singers of great accomplishment and knew how to make their points by other means than dynamics. I am most impressed by De Luca's ability to shape a legato line, carrying to a climax and back down to almost nothing at all without ever altering the sound quality or color; the warm phrasing of his "*Piangi, fanciulla*" is never impeded by vocal gear-shifting, and the impact of "*Cor-tigiani*" is all the greater because he can give and take dynamically in what is recognizably the same voice (this track, by the way, has a chorus and subsidiary singers, including a Marullo who muffs an entry).

Galli-Curci has a few spots of poor intonation here and there, but when true the sound is very lovely, the style a bit droopy. Schipa's light elegance does not make for a vigorous gay blade of a Duke, and his "*Parmi veder*"

seems more concerned with technique than emotion, but he does know where the accents go in "*La donna*" (on the even-numbered measures, not the odd ones), even though he spares himself on the sustained notes near the end of each verse.

An interesting—and often pleasurable—collection then, and made more desirable for the collector in that the final duet has never been previously published. In all cases but one where there is alternate material in the Victor files, the earlier take has been chosen; the exception is "*Caro nome*," where the recitative from Galli-Curci's first acoustic version has been tacked on to the recitative-less second version. The technical work seems competent, although I do not have originals at hand for comparison. D.H.

VERDI: *La Traviata*. Beverly Sills, Nicolai Gedda, Rolando Panerai, et al.; John Alldis Choir; Royal Philharmonic Orchestra, Aldo Ceccato, cond. For a review of this recording, see page 66.

WEBERN: *Music for String Quartet; Lieder*. LaSalle Quartet; Dietrich Fischer-Dieskau, baritone. For a feature review of these recordings, see page 71.

WILLIAMS: *Sinfonietta for Wind Ensemble*—See Penderecki: *Pittsburgh Overture*.

WOLPE: *Music for Piano*. Anne Chamberlain, piano. For a feature review of this recording, see page 71.

Going 4channel?



Four channel sound means four speakers in one room... It's no problem when they look like these... Empire's world-famous speaker systems fit everywhere and reproduce everything.

They thrill you to the kind of sound no box-type speaker can deliver. In Empire's stereo cylinder, the woofer faces down for bass so live it gives you goosebumps.

There is no ugly grill cloth, the handsome finish goes all the way around, and the marble top is meant to be used.

Available in satin walnut or antique oak finish. Priced from \$109.95. For information and further details, write Empire Scientific Corp., 1055 Stewart Ave., Garden City, New York 11530.



recitals and miscellany

B "**AMERICANA.**" **RUGGLES:** *Men and Mountains; Angels*. **IVES:** *From the Steeples and the Mountains*. **COPLAND:** *Quiet City*. **MASON:** *Quartet for Strings, on Negro Themes, in G minor, Op. 19*. Kohon Quartet (in the Mason); Buffalo Philharmonic Orchestra, Lukas Foss, cond. Turnabout TVS 34398, \$2.98.

The title of this disc, "*Americana*," and its sampler motive would lead one to expect a tour of our quaint musical past by some Colonial tea-cozy collector or DAR librarian. In fact, it is full of fresh-sounding music, some of it even "modern" by 1971 standards. The program offers a neat balance: the brassy complexities of Ruggles and Ives against the sophisticated simplicities of Copland and Daniel Gregory Mason. From Ruggles, there is the low-tension *Lilacs*, which has had some exposure in extract form, like Mahler's *Adagio*. Here, however, *Lilacs* is restored to its proper place at the keystone of the three-movement *Men and Mountains*, between the annunciatory *Men, A Rhapsodic Proclamation for Horn and Orchestra*, and the finale, *Marching Mountains*. Foss performs Ruggles' revision, first in 1936, of the 1924 suite, so we hear the addition of great thudding drums in the first and last movements and other recasting of parts, including the elimination of the piano. One can understand why orchestras



Introducing a **SONY**® turntable for the lazy perfectionist

If you're a perfectionist, you wince at the thought of stacking records, naked and defenseless, or dropping them onto each other. So you wind up with a single-play component turntable, and hold your breath to raise and lower the arm gently and perfectly.

If you're lazy, though, you resent having to dash across the room at 20-minute intervals to lift the stylus from the run-out groove. And you wind up with an automatic turntable. (Which perfectionists still call "changers.")

But if you're a lazy perfectionist, where can you turn?

To Sony, of course. And to our new PS-5520.

Just give its control lever a lazy little nudge, and things start happening — things to delight the perfectionist in all of us.

The hysteresis motor starts the 12-inch non-magnetic platter turning at precisely 33-1/3 or 45 rpm. (Belt drive keeps wow and

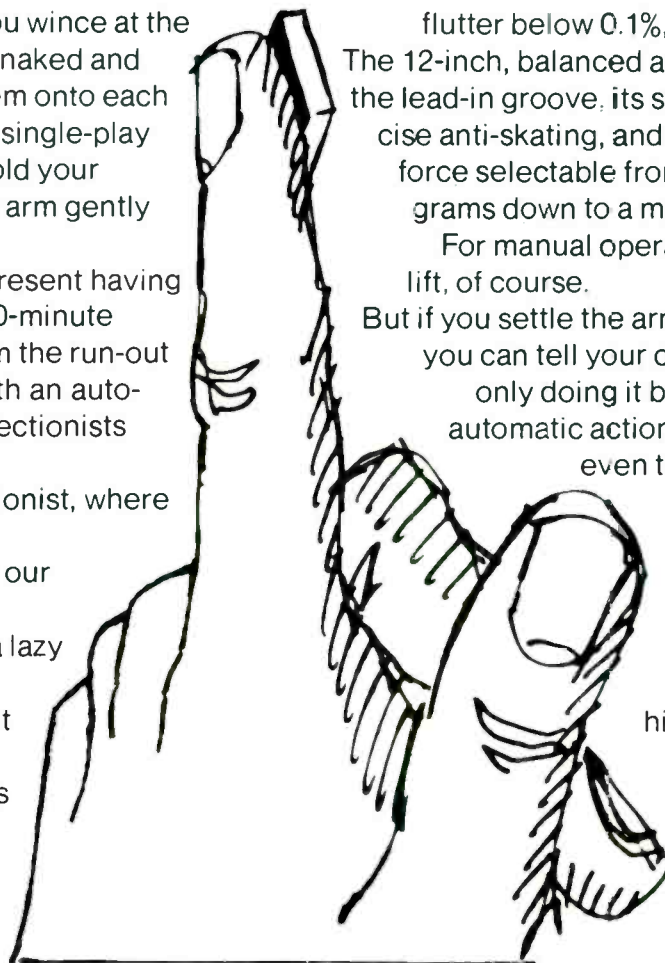

flutter below 0.1%, rumble down 42 dB.) The 12-inch, balanced arm settles precisely in the lead-in groove, its stylus centered by precise anti-skating, and its calibrated tracking force selectable from a maximum of three grams down to a mere fraction of a gram.

For manual operation, there's a cueing lift, of course.

But if you settle the arm down automatically, you can tell your conscience that you're

only doing it because the PS-5520's automatic action is so gentle. Gentler, even than you are when you

hold your breath and brace your elbow. The Sony PS-5520 turntable. Complete (less cartridges) with walnut base and hinged dust-cover. See it at your Sony dealer. Or write Sony Corporation of America, 47-47 Van Dam Street, Long Island City, New York 11101.

New SONY® PS-5520 Turntable

CIRCLE 64 ON READER-SERVICE CARD

have not been quick to take up the complete *Men and Mountains*: The orchestral forces required are enormous, and the granitic strength of the music can only be grasped once the listener gets past its rather Hindemithy, hobnailed lack of grace.

Still, along with *Sun-Treader*, which in its revised form *Men and Mountains* strikingly resembles, this work represents the greater Ruggles, and if he is important at all, it should be played often. This listener cannot follow Virgil Thomson in his placing of Ruggles over Ives in the American music pantheon, but there is really no point in denigrating either composer—we have had too few to afford that.

Angels, originally intended as part of an epic-scale work embracing both *Men and Mountains* and *Sun-Treader*, is played here

in the 1939 revision for four muted trumpets and three muted trombones (the 1921 original was for five trumpets and a bass trumpet). As in other music on the disc, the Buffalo Philharmonic brass responds reasonably well to the difficulties, though without the ultimate virtuosity and tonal beauty needed at some points.

In Ives's *From the Steeples and the Mountains*, the Foss interpretation tries for the moon and misses. A marvelously characteristic piece that was probably completed by 1901, though not published for more than sixty years. *From the Steeples and the Mountains* has been getting a modicum of attention lately. The Buffalo version is the third in the last couple of years, and it takes a radically different path from the others.

Foss, always the imaginative experimenter,

begins with a genuinely Ivesian idea that, however, misfires because of practical recording and listening problems. Possibly because of his own preoccupation these days, as a composer, with barely audible or actually inaudible music, he opens *From the Steeples and the Mountains* with a long build-up from subliminal bell tones to a most audible clangor (if you protest that music cannot be inaudible, take that up with Mr. Foss, please). The first five measures of bells, however, before the entry of the brass, are marked (in the 1965 edition, at least) nothing more subliminal than mezzo-piano and pianissimo, and in fact the brass is asked to enter more softly than bells or chimes, in *ppp*. Most damaging of all, Foss's bells lose out badly in the balancing, being almost buried under the brass, which takes up front prominence until the final two measures.

The other versions of this score (by the American Brass Quintet on Nonesuch and Gunther Schuller's group on Columbia) begin quietly but definitely. The Nonesuch offers the color and range of genuine church bells (the Riverside Church carillon in New York City), while Columbia provides the richest brass-and-bell sonorities. Partly owing to Schuller's slower tempos, his performance also offers the more accurate playing.

Despite minor reservations, however, this Turnabout disc can be commended to anyone curious about the growth of an American style in music. Both Ruggles and Ives, we now can plainly hear, were after a totally different aural and emotive experience in their music from that sought by later Americans. In both these Yankees there is a fierce ecstasy to reckon with (leavened in Ives's case by humor), a grandly open gesture, an innocent bravado, and a nostalgic sadness whose greatest power often lies in its lack of calculation. These qualities, whether composed into the music or imposed on it by us, have given their music a staying power that some superficially better scores may not find. In such close contrast, Copland's *Quiet City*, with its expertly managed mood and scene-painting, and the Mason quartet, with its Debussy and Dvořákian transformations of spirituals, can seem only ingratiating traveling companions for Ives and Ruggles. D.J.H.



FREE
FREE
FREE
FREE
FREE
FREE
FREE

The Ampex Stereo Tape Catalog...

Most important accessory for your tape player/recorder.

It's all here . . . the most complete selection of pre-recorded stereo tapes ever put between two covers . . . for your open reel, 8-track cartridge or cassette player-recorder.

This entertainment guide lists over 6000 selections. Pop, rock, folk, soul, jazz, classical and spoken word selections too; all categorized by type of music and listed alphabetically by artist for easy reference. Remember . . . the harder they are to get the easier they are to find in the Ampex Stereo Tape Catalog.

Get yours today! For your free copy send 25¢ for postage and handling now!

Someone beat you to the coupon?

Write Ampex Stereo Tapes, 2201 Lunt, Elk Grove Village, Illinois 60007, Dept. 172

Ampex Stereo Tapes
2201 Lunt, Elk Grove Village, Illinois 60007
Attention: Dept. 172

Gentlemen: Please send your free Ampex Stereo Tape Catalog. I enclose 25¢ for postage and handling.

My preference in music is: Pop Rock
 Jazz Folk Soul Country and Western Classical All kinds of music

Name _____

Address _____

City _____

State _____ Zip _____

AMPEX
STEREO TAPES

"MUSIC FROM THE COURT OF BURGUNDY."

Secular chansons by Dufay, Morton, and Anon. Musica Reservata, John Beckett, cond. Philips 6500 085, \$5.98.

The Schubert of the fifteenth century, Guillaume Dufay distinguished himself in an age of emerging melody by his extraordinary lyric gifts. A craftsman of the first rank, his technique was the envy of the time, but it is his spontaneous melodic writing that makes him so immediately attractive to twentieth-century listeners. Nowhere, unless it is in his hymn settings, is his talent for song more obvious than in the sure simplicity of his secular chansons, so one welcomes a disc devoted to this appealing repertoire. Unfortunately these blessings are not unmixed; the recording suffers from an uneven performance which makes it impossible to recommend it without reservation.

Musica Reservata is an odd organization. On the record sleeve one learns that the group was "founded by Michael Morrow, harpsichordist John Beckett, and recorder player

Only LAFAYETTE has the Ultimate in 4-Channel

OUR NEW RECEIVER CAN PLAY

DISCRETE 4-CHANNEL SQ 4-CHANNEL DERIVED 4-CHANNEL



DELUXE LAFAYETTE LR-440 4-Channel 200-Watt AM/FM Stereo Receiver

4-channel stereo comes on tape, on records, and over the air via FM stereo broadcasts. There are 3 basic types of 4-channel sound: Discrete, SQ Matrix, and Derived (electronically created from your regular stereo records, tapes, and FM broadcasts with Lafayette's exclusive "Composer" Circuit). With the new Lafayette LR-440 AM/FM Stereo Receiver you can play these 3 basic types of 4-channel program sources. The LR-440 features a superb solid-state 4-channel amplifier that delivers 200 watts of IHF music power for life-like 4-channel sound or to power two independent stereo systems with remote speakers using two different sound sources such as a tuner and record player. Full 4 and 2-channel controls permit customizing the sound you hear to your room(s) and taste. For those who prefer tape, there are convenient outputs on both front and rear panels. For quiet people, front panel headphone jacks allow stereo or 4-channel headphone listening at full volume without disturbing others.

with built-in Columbia



Decoder Circuitry

ONLY **369⁹⁵**

4-Channel Sound is the latest advancement in recording technology. 4-channels makes recorded sound more natural and realistic. Four-channel stereo makes you more of a participant in music than has ever been possible before. There are sounds and dimensions you did not know existed. Never before could you actually reproduce in your home the original recorded performance as it happened—you can have the spatial quality of the original concert hall right in your own living room—or you can literally be placed in the middle of a folk or rock session with your favorite singer or group.

*TM Columbia Broadcasting System, Inc.



NEW!
FREE!
1972
Spring Catalog

Lafayette Radio Electronics
Dept. 19032, Box 10
Syosset, New York 11791

Please send my Free 1972 Catalog 723 19032

Name.....

Address.....

City..... State..... Zip.....

John Sothcott" and that it is currently "directed" by Morrow and "conducted" by Beckett. No mention is made of the only other steady member and the one who gives the ensemble its curious color. Jantina Noorman is a mezzo-soprano with no voice. She has two styles of vocalism: in one she hollers à la Ethel Merman and in the other she emits a pinched bleat. She is also featured on at least half the numbers included on any single recording by Musica Reservata. There is no getting around her no matter how many expensive professionals are added to the ensemble. On this disc she bleats and Grayston Burgess. Heaven help him, has chosen to match his countertenor to her style. Nigel Rogers wisely throws consistency to the winds and sings with his usual forthright tone.

Nevertheless, the instrumental works are a

lot more pleasant to listen to: paradoxically the most successful performances are of the few works on the disc not by Dufay. John Beckett's snappy organ playing is delightful especially on the basse danse *Collinette*, and the subtly molded phrasing of David Munrow on the alto shawm is a joy to hear. James Tyler's elegant lute stands out among the particularly fine performers of an instrumental version of Robert Morton's lovely chanson *Le souvenir de vous*. S.T.S.

"MUSIC FOR THE SAXOPHONE." DUBOIS: Concerto for Alto Saxophone and String Orchestra. VILLA LOBOS: Fantasia for Soprano Saxophone, Three Horns, and String Orchestra. IBERT: Concertino da Camera for Alto Saxophone and Eleven Instruments. GLAZUNOV:

Concerto for Alto Saxophone and String Orchestra, in E flat, Op. 109. Eugene Rousseau, alto and soprano saxophone; Paul Kuentz Chamber Orchestra, Paul Kuentz, cond. Deutsche Grammophon 2530 209, \$6.98

Although the saxophone has never been fully integrated into the standard "classical" orchestra because of its peculiar tone quality, it has added its distinctive color to chamber ensembles in works by composers from Villa Lobos to Webern. Furthermore, the melodic expressivity of the saxophone has made it an ideal instrument for solo work—in Ravel's orchestration of *Pictures at an Exhibition*, for instance, and in the four works on this disc.

The Ibert Concertino da camera takes full advantage of the jazzy side of the saxophone's nature in a lighthearted, highly syncopated work which ranges stylistically from those Bachish configurations characteristic of French composers from Michel Legrand to Pierre Boulez to an almost dance-band idiom (in the middle of the first movement). The concerto by Pierre Max Dubois (born in 1930), while displaying some of the same Gallic lightness of touch, is a more serious work: The first movement opens with an extended virtuoso cadenza (with occasional orchestral accompaniment) that is eventually followed by a dialogue between sax and strings where the modal themes and slightly caustic wit are reminiscent of Honegger's Concerto da camera. Only the third movement, with its stereotyped "finale" writing, fails to convince in this otherwise brilliantly and sensitively composed concerto.

The lively rhythms and characteristically rich harmonies immediately identify Villa Lobos as the composer of the short Fantasia, while there can be no mistaking the Russian origins of the Glazunov concerto: Its mournful, recitativelike opening theme seems to come straight out of *Boris Godunov* and dominates the entire work. Indeed, the Glazunov concerto, with its longer melodic lines and more romantic orientation, stands in strong contrast to the basically neoclassical leanness of the other three pieces.

Although classical saxophone playing generally differs in many ways from the "pop" style, the works recorded here would not be unimaginable with, say, a Paul Desmond tone. Eugene Rousseau, on the other hand, seems to have made such an effort to "de-pop" his tone that he arrives at something occasionally approaching a clarinet style, and the somewhat harsh and strained tone he produces is a far cry from the fluid smoothness of Rousseau's compatriot, Marcel Mule. Rousseau has a superb technique, however, and he gives extraordinary life to these works through the sheer appropriateness of his rhythmic and dynamic nuances, and he is generally well seconded by Paul Kuentz's Chamber Orchestra. The sound is excellent, save the somewhat overly reverberant recording of the saxophone, which becomes a bit too "atmospheric." But this imaginatively produced release offers strong performances of some off-beat works that definitely merit attention. R.S.B.

MICHAEL PONTI: Concertos and solo piano music by Alkan, Hiller, Raff, Scharwenka, Clara Schumann, Scriabin, Tausig, Tchaikovsky, and Rimsky-Korsakov. For a feature review of these recordings, see page 69.

2530 215
CHARLES IVES
Piano Sonata No. 2 "Concord" (1890-1891) Three Page Sonata
ROBERTO VASCON, PIANO
WALTER STANGL, VIOLA DIETER SCHNITZ, FLUTE

2530 214
ANTONIN DVORAK
String Quintet in G major, Op. 77 (orig. Op. 18)
Original Version with 3 Horns
BOSTON SYMPHONY CHAMBER PLAYERS

2530 216
FRANZ SCHUBERT
Symphonies No. 1 & No. 2
BERLINER PHILHARMONIKER - KARI BOHLM

2530 207
LUDWIG VAN BEETHOVEN
PIANO TRIOS OP. 70, NO. 1 "GROUPE-TRIO" AND NO. 2
Kempff - Seeryng - Fournier

2530 213
JOSEPH HAYDN
The Seven Last Words of our Saviour on the Cross
AMADEUS-QUARTETT

2530 198
TSCHAIKOWSKY
Symphonie Nr. 5
LONDON SYMPHONY ORCHESTRA - CLAUDIO ARRABO

2530 185
ROBERT SCHUMANN
Fantasie Cdur in C major op. 17 Carnival op. 9
WILHELM KEMPF, PIANO

2530 200
KARAJAN - OPERNBALLETT
Pulsation Dance, Dance of the Hours, etc. others
BERLINER PHILHARMONIKER

2530 218
GEORGES HIZET
Symphonie No. 1 "C'est un Cimetière" Trois d'enfants
Quatre Symphonies de la suite (de la suite de l'op. 10)
ORCHESTRE NATIONAL DE L'O.B.E. - J. S. MARTINON

2530 219
KARAJAN - CONCERTO FOR ALTO SAXOPHONE AND STRING ORCHESTRA
EUGENE ROUSSEAU, ALTO AND SOPRANO SAXOPHONE
PAUL KUENTZ CHAMBER ORCHESTRA - PAUL KUENTZ, COND.

2530 217
VILLA LOBOS
Fantasia for Soprano Saxophone, Three Horns, and String Orchestra
PAUL KUENTZ CHAMBER ORCHESTRA - PAUL KUENTZ, COND.

2530 211
GLAZUNOV
Concerto for Alto Saxophone and String Orchestra
EUGENE ROUSSEAU, ALTO AND SOPRANO SAXOPHONE
PAUL KUENTZ CHAMBER ORCHESTRA - PAUL KUENTZ, COND.

2530 210
IBERT
Concertino da Camera for Alto Saxophone and Eleven Instruments
PAUL KUENTZ CHAMBER ORCHESTRA - PAUL KUENTZ, COND.

2530 209
GLAZUNOV
Concerto for Alto Saxophone and String Orchestra
EUGENE ROUSSEAU, ALTO AND SOPRANO SAXOPHONE
PAUL KUENTZ CHAMBER ORCHESTRA - PAUL KUENTZ, COND.

2530 208
GLAZUNOV
Concerto for Alto Saxophone and String Orchestra
EUGENE ROUSSEAU, ALTO AND SOPRANO SAXOPHONE
PAUL KUENTZ CHAMBER ORCHESTRA - PAUL KUENTZ, COND.

2530 207
GLAZUNOV
Concerto for Alto Saxophone and String Orchestra
EUGENE ROUSSEAU, ALTO AND SOPRANO SAXOPHONE
PAUL KUENTZ CHAMBER ORCHESTRA - PAUL KUENTZ, COND.

2530 206
GLAZUNOV
Concerto for Alto Saxophone and String Orchestra
EUGENE ROUSSEAU, ALTO AND SOPRANO SAXOPHONE
PAUL KUENTZ CHAMBER ORCHESTRA - PAUL KUENTZ, COND.

2530 205
GLAZUNOV
Concerto for Alto Saxophone and String Orchestra
EUGENE ROUSSEAU, ALTO AND SOPRANO SAXOPHONE
PAUL KUENTZ CHAMBER ORCHESTRA - PAUL KUENTZ, COND.

2530 204
GLAZUNOV
Concerto for Alto Saxophone and String Orchestra
EUGENE ROUSSEAU, ALTO AND SOPRANO SAXOPHONE
PAUL KUENTZ CHAMBER ORCHESTRA - PAUL KUENTZ, COND.

2530 203
GLAZUNOV
Concerto for Alto Saxophone and String Orchestra
EUGENE ROUSSEAU, ALTO AND SOPRANO SAXOPHONE
PAUL KUENTZ CHAMBER ORCHESTRA - PAUL KUENTZ, COND.

2530 202
GLAZUNOV
Concerto for Alto Saxophone and String Orchestra
EUGENE ROUSSEAU, ALTO AND SOPRANO SAXOPHONE
PAUL KUENTZ CHAMBER ORCHESTRA - PAUL KUENTZ, COND.

2530 201
GLAZUNOV
Concerto for Alto Saxophone and String Orchestra
EUGENE ROUSSEAU, ALTO AND SOPRANO SAXOPHONE
PAUL KUENTZ CHAMBER ORCHESTRA - PAUL KUENTZ, COND.

2530 200
GLAZUNOV
Concerto for Alto Saxophone and String Orchestra
EUGENE ROUSSEAU, ALTO AND SOPRANO SAXOPHONE
PAUL KUENTZ CHAMBER ORCHESTRA - PAUL KUENTZ, COND.

2530 199
GLAZUNOV
Concerto for Alto Saxophone and String Orchestra
EUGENE ROUSSEAU, ALTO AND SOPRANO SAXOPHONE
PAUL KUENTZ CHAMBER ORCHESTRA - PAUL KUENTZ, COND.

2530 198
GLAZUNOV
Concerto for Alto Saxophone and String Orchestra
EUGENE ROUSSEAU, ALTO AND SOPRANO SAXOPHONE
PAUL KUENTZ CHAMBER ORCHESTRA - PAUL KUENTZ, COND.

2530 197
GLAZUNOV
Concerto for Alto Saxophone and String Orchestra
EUGENE ROUSSEAU, ALTO AND SOPRANO SAXOPHONE
PAUL KUENTZ CHAMBER ORCHESTRA - PAUL KUENTZ, COND.

2530 196
GLAZUNOV
Concerto for Alto Saxophone and String Orchestra
EUGENE ROUSSEAU, ALTO AND SOPRANO SAXOPHONE
PAUL KUENTZ CHAMBER ORCHESTRA - PAUL KUENTZ, COND.

2530 195
GLAZUNOV
Concerto for Alto Saxophone and String Orchestra
EUGENE ROUSSEAU, ALTO AND SOPRANO SAXOPHONE
PAUL KUENTZ CHAMBER ORCHESTRA - PAUL KUENTZ, COND.

2530 194
GLAZUNOV
Concerto for Alto Saxophone and String Orchestra
EUGENE ROUSSEAU, ALTO AND SOPRANO SAXOPHONE
PAUL KUENTZ CHAMBER ORCHESTRA - PAUL KUENTZ, COND.

2530 193
GLAZUNOV
Concerto for Alto Saxophone and String Orchestra
EUGENE ROUSSEAU, ALTO AND SOPRANO SAXOPHONE
PAUL KUENTZ CHAMBER ORCHESTRA - PAUL KUENTZ, COND.

2530 192
GLAZUNOV
Concerto for Alto Saxophone and String Orchestra
EUGENE ROUSSEAU, ALTO AND SOPRANO SAXOPHONE
PAUL KUENTZ CHAMBER ORCHESTRA - PAUL KUENTZ, COND.

2530 191
GLAZUNOV
Concerto for Alto Saxophone and String Orchestra
EUGENE ROUSSEAU, ALTO AND SOPRANO SAXOPHONE
PAUL KUENTZ CHAMBER ORCHESTRA - PAUL KUENTZ, COND.

2530 190
GLAZUNOV
Concerto for Alto Saxophone and String Orchestra
EUGENE ROUSSEAU, ALTO AND SOPRANO SAXOPHONE
PAUL KUENTZ CHAMBER ORCHESTRA - PAUL KUENTZ, COND.

2530 189
GLAZUNOV
Concerto for Alto Saxophone and String Orchestra
EUGENE ROUSSEAU, ALTO AND SOPRANO SAXOPHONE
PAUL KUENTZ CHAMBER ORCHESTRA - PAUL KUENTZ, COND.

2530 188
GLAZUNOV
Concerto for Alto Saxophone and String Orchestra
EUGENE ROUSSEAU, ALTO AND SOPRANO SAXOPHONE
PAUL KUENTZ CHAMBER ORCHESTRA - PAUL KUENTZ, COND.

2530 187
GLAZUNOV
Concerto for Alto Saxophone and String Orchestra
EUGENE ROUSSEAU, ALTO AND SOPRANO SAXOPHONE
PAUL KUENTZ CHAMBER ORCHESTRA - PAUL KUENTZ, COND.

2530 186
GLAZUNOV
Concerto for Alto Saxophone and String Orchestra
EUGENE ROUSSEAU, ALTO AND SOPRANO SAXOPHONE
PAUL KUENTZ CHAMBER ORCHESTRA - PAUL KUENTZ, COND.

2530 185
GLAZUNOV
Concerto for Alto Saxophone and String Orchestra
EUGENE ROUSSEAU, ALTO AND SOPRANO SAXOPHONE
PAUL KUENTZ CHAMBER ORCHESTRA - PAUL KUENTZ, COND.

2530 184
GLAZUNOV
Concerto for Alto Saxophone and String Orchestra
EUGENE ROUSSEAU, ALTO AND SOPRANO SAXOPHONE
PAUL KUENTZ CHAMBER ORCHESTRA - PAUL KUENTZ, COND.

2530 183
GLAZUNOV
Concerto for Alto Saxophone and String Orchestra
EUGENE ROUSSEAU, ALTO AND SOPRANO SAXOPHONE
PAUL KUENTZ CHAMBER ORCHESTRA - PAUL KUENTZ, COND.

2530 182
GLAZUNOV
Concerto for Alto Saxophone and String Orchestra
EUGENE ROUSSEAU, ALTO AND SOPRANO SAXOPHONE
PAUL KUENTZ CHAMBER ORCHESTRA - PAUL KUENTZ, COND.

2530 181
GLAZUNOV
Concerto for Alto Saxophone and String Orchestra
EUGENE ROUSSEAU, ALTO AND SOPRANO SAXOPHONE
PAUL KUENTZ CHAMBER ORCHESTRA - PAUL KUENTZ, COND.

2530 180
GLAZUNOV
Concerto for Alto Saxophone and String Orchestra
EUGENE ROUSSEAU, ALTO AND SOPRANO SAXOPHONE
PAUL KUENTZ CHAMBER ORCHESTRA - PAUL KUENTZ, COND.

2530 179
GLAZUNOV
Concerto for Alto Saxophone and String Orchestra
EUGENE ROUSSEAU, ALTO AND SOPRANO SAXOPHONE
PAUL KUENTZ CHAMBER ORCHESTRA - PAUL KUENTZ, COND.

2530 178
GLAZUNOV
Concerto for Alto Saxophone and String Orchestra
EUGENE ROUSSEAU, ALTO AND SOPRANO SAXOPHONE
PAUL KUENTZ CHAMBER ORCHESTRA - PAUL KUENTZ, COND.

2530 177
GLAZUNOV
Concerto for Alto Saxophone and String Orchestra
EUGENE ROUSSEAU, ALTO AND SOPRANO SAXOPHONE
PAUL KUENTZ CHAMBER ORCHESTRA - PAUL KUENTZ, COND.

2530 176
GLAZUNOV
Concerto for Alto Saxophone and String Orchestra
EUGENE ROUSSEAU, ALTO AND SOPRANO SAXOPHONE
PAUL KUENTZ CHAMBER ORCHESTRA - PAUL KUENTZ, COND.

2530 175
GLAZUNOV
Concerto for Alto Saxophone and String Orchestra
EUGENE ROUSSEAU, ALTO AND SOPRANO SAXOPHONE
PAUL KUENTZ CHAMBER ORCHESTRA - PAUL KUENTZ, COND.

2530 174
GLAZUNOV
Concerto for Alto Saxophone and String Orchestra
EUGENE ROUSSEAU, ALTO AND SOPRANO SAXOPHONE
PAUL KUENTZ CHAMBER ORCHESTRA - PAUL KUENTZ, COND.

2530 173
GLAZUNOV
Concerto for Alto Saxophone and String Orchestra
EUGENE ROUSSEAU, ALTO AND SOPRANO SAXOPHONE
PAUL KUENTZ CHAMBER ORCHESTRA - PAUL KUENTZ, COND.

2530 172
GLAZUNOV
Concerto for Alto Saxophone and String Orchestra
EUGENE ROUSSEAU, ALTO AND SOPRANO SAXOPHONE
PAUL KUENTZ CHAMBER ORCHESTRA - PAUL KUENTZ, COND.

2530 171
GLAZUNOV
Concerto for Alto Saxophone and String Orchestra
EUGENE ROUSSEAU, ALTO AND SOPRANO SAXOPHONE
PAUL KUENTZ CHAMBER ORCHESTRA - PAUL KUENTZ, COND.

2530 170
GLAZUNOV
Concerto for Alto Saxophone and String Orchestra
EUGENE ROUSSEAU, ALTO AND SOPRANO SAXOPHONE
PAUL KUENTZ CHAMBER ORCHESTRA - PAUL KUENTZ, COND.

2530 169
GLAZUNOV
Concerto for Alto Saxophone and String Orchestra
EUGENE ROUSSEAU, ALTO AND SOPRANO SAXOPHONE
PAUL KUENTZ CHAMBER ORCHESTRA - PAUL KUENTZ, COND.

2530 168
GLAZUNOV
Concerto for Alto Saxophone and String Orchestra
EUGENE ROUSSEAU, ALTO AND SOPRANO SAXOPHONE
PAUL KUENTZ CHAMBER ORCHESTRA - PAUL KUENTZ, COND.

2530 167
GLAZUNOV
Concerto for Alto Saxophone and String Orchestra
EUGENE ROUSSEAU, ALTO AND SOPRANO SAXOPHONE
PAUL KUENTZ CHAMBER ORCHESTRA - PAUL KUENTZ, COND.

2530 166
GLAZUNOV
Concerto for Alto Saxophone and String Orchestra
EUGENE ROUSSEAU, ALTO AND SOPRANO SAXOPHONE
PAUL KUENTZ CHAMBER ORCHESTRA - PAUL KUENTZ, COND.

2530 165
GLAZUNOV
Concerto for Alto Saxophone and String Orchestra
EUGENE ROUSSEAU, ALTO AND SOPRANO SAXOPHONE
PAUL KUENTZ CHAMBER ORCHESTRA - PAUL KUENTZ, COND.

2530 164
GLAZUNOV
Concerto for Alto Saxophone and String Orchestra
EUGENE ROUSSEAU, ALTO AND SOPRANO SAXOPHONE
PAUL KUENTZ CHAMBER ORCHESTRA - PAUL KUENTZ, COND.

2530 163
GLAZUNOV
Concerto for Alto Saxophone and String Orchestra
EUGENE ROUSSEAU, ALTO AND SOPRANO SAXOPHONE
PAUL KUENTZ CHAMBER ORCHESTRA - PAUL KUENTZ, COND.

2530 162
GLAZUNOV
Concerto for Alto Saxophone and String Orchestra
EUGENE ROUSSEAU, ALTO AND SOPRANO SAXOPHONE
PAUL KUENTZ CHAMBER ORCHESTRA - PAUL KUENTZ, COND.

2530 161
GLAZUNOV
Concerto for Alto Saxophone and String Orchestra
EUGENE ROUSSEAU, ALTO AND SOPRANO SAXOPHONE
PAUL KUENTZ CHAMBER ORCHESTRA - PAUL KUENTZ, COND.

2530 160
GLAZUNOV
Concerto for Alto Saxophone and String Orchestra
EUGENE ROUSSEAU, ALTO AND SOPRANO SAXOPHONE
PAUL KUENTZ CHAMBER ORCHESTRA - PAUL KUENTZ, COND.

2530 159
GLAZUNOV
Concerto for Alto Saxophone and String Orchestra
EUGENE ROUSSEAU, ALTO AND SOPRANO SAXOPHONE
PAUL KUENTZ CHAMBER ORCHESTRA - PAUL KUENTZ, COND.

2530 158
GLAZUNOV
Concerto for Alto Saxophone and String Orchestra
EUGENE ROUSSEAU, ALTO AND SOPRANO SAXOPHONE
PAUL KUENTZ CHAMBER ORCHESTRA - PAUL KUENTZ, COND.

2530 157
GLAZUNOV
Concerto for Alto Saxophone and String Orchestra
EUGENE ROUSSEAU, ALTO AND SOPRANO SAXOPHONE
PAUL KUENTZ CHAMBER ORCHESTRA - PAUL KUENTZ, COND.

2530 156
GLAZUNOV
Concerto for Alto Saxophone and String Orchestra
EUGENE ROUSSEAU, ALTO AND SOPRANO SAXOPHONE
PAUL KUENTZ CHAMBER ORCHESTRA - PAUL KUENTZ, COND.

2530 155
GLAZUNOV
Concerto for Alto Saxophone and String Orchestra
EUGENE ROUSSEAU, ALTO AND SOPRANO SAXOPHONE
PAUL KUENTZ CHAMBER ORCHESTRA - PAUL KUENTZ, COND.

2530 154
GLAZUNOV
Concerto for Alto Saxophone and String Orchestra
EUGENE ROUSSEAU, ALTO AND SOPRANO SAXOPHONE
PAUL KUENTZ CHAMBER ORCHESTRA - PAUL KUENTZ, COND.

2530 153
GLAZUNOV
Concerto for Alto Saxophone and String Orchestra
EUGENE ROUSSEAU, ALTO AND SOPRANO SAXOPHONE
PAUL KUENTZ CHAMBER ORCHESTRA - PAUL KUENTZ, COND.

2530 152
GLAZUNOV
Concerto for Alto Saxophone and String Orchestra
EUGENE ROUSSEAU, ALTO AND SOPRANO SAXOPHONE
PAUL KUENTZ CHAMBER ORCHESTRA - PAUL KUENTZ, COND.

2530 151
GLAZUNOV
Concerto for Alto Saxophone and String Orchestra
EUGENE ROUSSEAU, ALTO AND SOPRANO SAXOPHONE
PAUL KUENTZ CHAMBER ORCHESTRA - PAUL KUENTZ, COND.

2530 150
GLAZUNOV
Concerto for Alto Saxophone and String Orchestra
EUGENE ROUSSEAU, ALTO AND SOPRANO SAXOPHONE
PAUL KUENTZ CHAMBER ORCHESTRA - PAUL KUENTZ, COND.

2530 149
GLAZUNOV
Concerto for Alto Saxophone and String Orchestra
EUGENE ROUSSEAU, ALTO AND SOPRANO SAXOPHONE
PAUL KUENTZ CHAMBER ORCHESTRA - PAUL KUENTZ, COND.

2530 148
GLAZUNOV
Concerto for Alto Saxophone and String Orchestra
EUGENE ROUSSEAU, ALTO AND SOPRANO SAXOPHONE
PAUL KUENTZ CHAMBER ORCHESTRA - PAUL KUENTZ, COND.

2530 147
GLAZUNOV
Concerto for Alto Saxophone and String Orchestra
EUGENE ROUSSEAU, ALTO AND SOPRANO SAXOPHONE
PAUL KUENTZ CHAMBER ORCHESTRA - PAUL KUENTZ, COND.

2530 146
GLAZUNOV
Concerto for Alto Saxophone and String Orchestra
EUGENE ROUSSEAU, ALTO AND SOPRANO SAXOPHONE
PAUL KUENTZ CHAMBER ORCHESTRA - PAUL KUENTZ, COND.

2530 145
GLAZUNOV
Concerto for Alto Saxophone and String Orchestra
EUGENE ROUSSEAU, ALTO AND SOPRANO SAXOPHONE
PAUL KUENTZ CHAMBER ORCHESTRA - PAUL KUENTZ, COND.

2530 144
GLAZUNOV
Concerto for Alto Saxophone and String Orchestra
EUGENE ROUSSEAU, ALTO AND SOPRANO SAXOPHONE
PAUL KUENTZ CHAMBER ORCHESTRA - PAUL KUENTZ, COND.

2530 143
GLAZUNOV
Concerto for Alto Saxophone and String Orchestra
EUGENE ROUSSEAU, ALTO AND SOPRANO SAXOPHONE
PAUL KUENTZ CHAMBER ORCHESTRA - PAUL KUENTZ, COND.

2530 142
GLAZUNOV
Concerto for Alto Saxophone and String Orchestra
EUGENE ROUSSEAU, ALTO AND SOPRANO SAXOPHONE
PAUL KUENTZ CHAMBER ORCHESTRA - PAUL KUENTZ, COND.

2530 141
GLAZUNOV
Concerto for Alto Saxophone and String Orchestra
EUGENE ROUSSEAU, ALTO AND SOPRANO SAXOPHONE
PAUL KUENTZ CHAMBER ORCHESTRA - PAUL KUENTZ, COND.

2530 140
GLAZUNOV
Concerto for Alto Saxophone and String Orchestra
EUGENE ROUSSEAU, ALTO AND SOPRANO SAXOPHONE
PAUL KUENTZ CHAMBER ORCHESTRA - PAUL KUENTZ, COND.

2530 139
GLAZUNOV
Concerto for Alto Saxophone and String Orchestra
EUGENE ROUSSEAU, ALTO AND SOPRANO SAXOPHONE
PAUL KUENTZ CHAMBER ORCHESTRA - PAUL KUENTZ, COND.

2530 138
GLAZUNOV
Concerto for Alto Saxophone and String Orchestra
EUGENE ROUSSEAU, ALTO AND SOPRANO SAXOPHONE
PAUL KUENTZ CHAMBER ORCHESTRA - PAUL KUENTZ, COND.

2530 137
GLAZUNOV
Concerto for Alto Saxophone and String Orchestra
EUGENE ROUSSEAU, ALTO AND SOPRANO SAXOPHONE
PAUL KUENTZ CHAMBER ORCHESTRA - PAUL KUENTZ, COND.

2530 136
GLAZUNOV
Concerto for Alto Saxophone and String Orchestra
EUGENE ROUSSEAU, ALTO AND SOPRANO SAXOPHONE
PAUL KUENTZ CHAMBER ORCHESTRA - PAUL KUENTZ, COND.

2530 135
GLAZUNOV
Concerto for Alto Saxophone and String Orchestra
EUGENE ROUSSEAU, ALTO AND SOPRANO SAXOPHONE
PAUL KUENTZ CHAMBER ORCHESTRA - PAUL KUENTZ, COND.

2530 134
GLAZUNOV
Concerto for Alto Saxophone and String Orchestra
EUGENE ROUSSEAU, ALTO AND SOPRANO SAXOPHONE
PAUL KUENTZ CHAMBER ORCHESTRA - PAUL KUENTZ, COND.

2530 133
GLAZUNOV
Concerto for Alto Saxophone and String Orchestra
EUGENE ROUSSEAU, ALTO AND SOPRANO SAXOPHONE
PAUL KUENTZ CHAMBER ORCHESTRA - PAUL KUENTZ, COND.

2530 132
GLAZUNOV
Concerto for Alto Saxophone and String Orchestra
EUGENE ROUSSEAU, ALTO AND SOPRANO SAXOPHONE
PAUL KUENTZ CHAMBER ORCHESTRA - PAUL KUENTZ, COND.

2530 131
GLAZUNOV
Concerto for Alto Saxophone and String Orchestra
EUGENE ROUSSEAU, ALTO AND SOPRANO SAXOPHONE
PAUL KUENTZ CHAMBER ORCHESTRA - PAUL KUENTZ, COND.

2530 130
GLAZUNOV
Concerto for Alto Saxophone and String Orchestra
EUGENE ROUSSEAU, ALTO AND SOPRANO SAXOPHONE
PAUL KUENTZ CHAMBER ORCHESTRA - PAUL KUENTZ, COND.

2530 129
GLAZUNOV
Concerto for Alto Saxophone and String Orchestra
EUGENE ROUSSEAU, ALTO AND SOPRANO SAXOPHONE
PAUL KUENTZ CHAMBER ORCHESTRA - PAUL KUENTZ, COND.

2530 128
GLAZUNOV
Concerto for Alto Saxophone and String Orchestra
EUGENE ROUSSEAU, ALTO AND SOPRANO SAXOPHONE
PAUL KUENTZ CHAMBER ORCHESTRA - PAUL KUENTZ, COND.

2530 127
GLAZUNOV
Concerto for Alto Saxophone and String Orchestra
EUGENE ROUSSEAU, ALTO AND SOPRANO SAXOPHONE
PAUL KUENTZ CHAMBER ORCHESTRA - PAUL KUENTZ, COND.

2530 126
GLAZUNOV
Concerto for Alto Saxophone and String Orchestra
EUGENE ROUSSEAU, ALTO AND SOPRANO SAXOPHONE
PAUL KUENTZ CHAMBER ORCHESTRA - PAUL KUENTZ, COND.

2530 125
GLAZUNOV
Concerto for Alto Saxophone and String Orchestra
EUGENE ROUSSEAU, ALTO AND SOPRANO SAXOPHONE
PAUL KUENTZ CHAMBER ORCHESTRA - PAUL KUENTZ, COND.

2530 124
GLAZUNOV
Concerto for Alto Saxophone and String Orchestra
EUGENE ROUSSEAU, ALTO AND SOPRANO SAXOPHONE
PAUL KUENTZ CHAMBER ORCHESTRA - PAUL KUENTZ, COND.

2530 123
GLAZUNOV
Concerto for Alto Saxophone and String Orchestra
EUGENE ROUSSEAU, ALTO AND SOPRANO SAXOPHONE
PAUL KUENTZ CHAMBER ORCHESTRA - PAUL KUENTZ, COND.

2530 122
GLAZUNOV
Concerto for Alto Saxophone and String Orchestra
EUGENE ROUSSEAU, ALTO AND SOPRANO SAXOPHONE
PAUL KUENTZ CHAMBER ORCHESTRA - PAUL KUENTZ, COND.

2530 121
GLAZUNOV
Concerto for Alto Saxophone and String Orchestra
EUGENE ROUSSEAU, ALTO AND SOPRANO SAXOPHONE
PAUL KUENTZ CHAMBER ORCHESTRA - PAUL KUENTZ, COND.

2530 120
GLAZUNOV
Concerto for Alto Saxophone and String Orchestra
EUGENE ROUSSEAU, ALTO AND SOPRANO SAXOPHONE
PAUL KUENTZ CHAMBER ORCHESTRA - PAUL KUENTZ, COND.

2530 119
GLAZUNOV
Concerto for Alto Saxophone and String Orchestra
EUGENE ROUSSEAU, ALTO AND SOPRANO SAXOPHONE
PAUL KUENTZ CHAMBER ORCHESTRA - PAUL KUENTZ, COND.

2530 118
GLAZUNOV
Concerto for Alto Saxophone and String Orchestra
EUGENE ROUSSEAU, ALTO AND SOPRANO SAXOPHONE
PAUL KUENTZ CHAMBER ORCHESTRA - PAUL KUENTZ, COND.

2530 117
GLAZUNOV
Concerto for Alto Saxophone and String Orchestra
EUGENE ROUSSEAU, ALTO AND SOPRANO SAXOPHONE
PAUL KUENTZ CHAMBER ORCHESTRA - PAUL KUENTZ, COND.

2530 116
GLAZUNOV
Concerto for Alto Saxophone and String Orchestra
EUGENE ROUSSEAU, ALTO AND SOPRANO SAXOPHONE
PAUL KUENTZ CHAMBER ORCHESTRA - PAUL KUENTZ, COND.

2530 115
GLAZUNOV
Concerto for Alto Saxophone and String Orchestra
EUGENE ROUSSEAU, ALTO AND SOPRANO SAXOPHONE
PAUL KUENTZ CHAMBER ORCHESTRA - PAUL KUENTZ, COND.

2530 114
GLAZUNOV
Concerto for Alto Saxophone and String Orchestra
EUGENE ROUSSEAU, ALTO AND SOPRANO SAXOPHONE
PAUL KUENTZ CHAMBER ORCHESTRA - PAUL KUENTZ, COND.

2530 113
GLAZUNOV
Concerto for Alto Saxophone and String Orchestra
EUGENE ROUSSEAU, ALTO AND SOPRANO SAXOPHONE
PAUL KUENTZ CHAMBER ORCHESTRA - PAUL KUENTZ, COND.

2530 112
GLAZUNOV
Concerto for Alto Saxophone and String Orchestra
EUGENE ROUSSEAU, ALTO AND SOPRANO SAXOPHONE
PAUL KUENTZ CHAMBER ORCHESTRA - PAUL KUENTZ, COND.

2530 111
GLAZUNOV
Concerto for Alto Saxophone and String Orchestra
EUGENE ROUSSEAU, ALTO AND SOPRANO SAXOPHONE
PAUL KUENTZ CHAMBER ORCHESTRA - PAUL KUENTZ, COND.

2530 110
GLAZUNOV
Concerto for Alto Saxophone and String Orchestra
EUGENE ROUSSEAU, ALTO AND SOPRANO SAXOPHONE
PAUL KUENTZ CHAMBER ORCHESTRA - PAUL KUENTZ, COND.

2530 109
GLAZUNOV
Concerto for Alto Saxophone and String Orchestra
EUGENE ROUSSEAU, ALTO AND SOPRANO SAXOPHONE
PAUL KUENTZ CHAMBER ORCHESTRA - PAUL KUENTZ, COND.

2530 108
GLAZUNOV
Concerto for Alto Saxophone and String Orchestra
EUGENE ROUSSEAU, ALTO AND SOPRANO SAXOPHONE
PAUL KUENTZ CHAMBER ORCHESTRA - PAUL KUENTZ, COND.

2530 107
GLAZUNOV
Concerto for Alto Saxophone and String Orchestra
EUGENE ROUSSEAU, ALTO AND SOPRANO SAXOPHONE
PAUL KUENTZ CHAMBER ORCHESTRA - PAUL KUENTZ, COND.

2530 106
GLAZUNOV
Concerto for Alto Saxophone and String Orchestra
EUGENE ROUSSEAU, ALTO AND SOPRANO SAXOPHONE
PAUL KUENTZ CHAMBER ORCHESTRA - PAUL KUENTZ, COND.

2530 105
GLAZUNOV
Concerto for Alto Saxophone and String Orchestra
EUGENE ROUSSEAU, ALTO AND SOPRANO SAXOPHONE
PAUL KUENTZ CHAMBER ORCHESTRA - PAUL KUENTZ, COND.

2530 104
GLAZUNOV
Concerto for Alto Saxophone and String Orchestra
EUGENE ROUSSEAU, ALTO AND SOPRANO SAXOPHONE
PAUL KUENTZ CHAMBER ORCHESTRA - PAUL KUENTZ, COND.

2530 103
GLAZUNOV
Concerto for Alto Saxophone and String Orchestra
EUGENE ROUSSEAU, ALTO AND SOPRANO SAXOPHONE
PAUL KUENTZ CHAMBER ORCHESTRA - PAUL KUENTZ, COND.

2530 102
GLAZUNOV
Concerto for Alto Saxophone and String Orchestra
EUGENE ROUSSEAU, ALTO AND SOPRANO SAXOPHONE
PAUL KUENTZ CHAMBER ORCHESTRA - PAUL KUENTZ, COND.

2530 101
GLAZUNOV
Concerto for Alto Saxophone and String Orchestra
EUGENE ROUSSEAU, ALTO AND SOPRANO SAXOPHONE
PAUL KUENTZ CHAMBER ORCHESTRA - PAUL KUENTZ, COND.

2530 100
GLAZUNOV
Concerto for Alto Saxophone and String Orchestra
EUGENE ROUSSEAU, ALTO AND SOPRANO SAXOPHONE
PAUL KUENTZ CHAMBER ORCHESTRA - PAUL KUENTZ, COND.

2530 99
GLAZUNOV
Concerto for Alto Saxophone and String Orchestra
EUGENE ROUSSEAU, ALTO AND SOPRANO SAXOPHONE
PAUL KUENTZ CHAMBER ORCHESTRA - PAUL KUENTZ, COND.

2530 98
GLAZUNOV
Concerto for Alto Saxophone and String Orchestra
EUGENE ROUSSEAU, ALTO AND SOPRANO SAXOPHONE
PAUL KUENTZ CHAMBER ORCHESTRA - PAUL KUENTZ, COND.

2530 97
GLAZUNOV
Concerto for Alto Saxophone and String Orchestra
EUGENE ROUSSEAU, ALTO AND SOPRANO SAXOPHONE
PAUL KUENTZ CHAMBER ORCHESTRA - PAUL KUENTZ, COND.

2530 96
GLAZUNOV
Concerto for Alto Saxophone and String Orchestra
EUGENE ROUSSEAU, ALTO AND SOPRANO SAXOPHONE
PAUL KUENTZ CHAMBER ORCHESTRA - PAUL KUENTZ, COND.

2530 95
GLAZUNOV
Concerto for Alto Saxophone and String Orchestra
EUGENE ROUSSEAU, ALTO AND SOPRANO SAXOPHONE
PAUL KUENTZ CHAMBER ORCHESTRA - PAUL KUENTZ, COND.

2530 94
GLAZUNOV
Concerto for Alto Saxophone and String Orchestra
EUGENE ROUSSEAU, ALTO AND SOPRANO SAXOPHONE
PAUL KUENTZ CHAMBER ORCHESTRA - PAUL KUENTZ, COND.

2530 93
GLAZUNOV
Concerto for Alto Saxophone and String Orchestra
EUGENE ROUSSEAU, ALTO AND SOPRANO SAXOPHONE
PAUL KUENTZ CHAMBER ORCHESTRA - PAUL KUENTZ, COND.

2530 92
GLAZUNOV
Concerto for Alto Saxophone and String Orchestra
EUGENE ROUSSEAU, ALTO AND SOPRANO SAXOPHONE
PAUL KUENTZ CHAMBER ORCHESTRA - PAUL KUENTZ, COND.

2530 91
GLAZUNOV
Concerto for Alto Saxophone and String Orchestra
EUGENE ROUSSEAU, ALTO AND SOPRANO SAXOPHONE
PAUL KUENTZ CHAMBER ORCHESTRA - PAUL KUENTZ, COND.

2530 90
GLAZUNOV
Concerto for Alto Saxophone and String Orchestra
EUGENE ROUSSEAU, ALTO AND SOPRANO SAXOPHONE
PAUL KUENTZ CHAMBER ORCHESTRA - PAUL KUENTZ, COND.

2530 89
GLAZUNOV
Concerto for Alto Saxophone and String Orchestra
EUGENE ROUSSEAU, ALTO AND SOPRANO SAXOPHONE
PAUL KUENTZ CHAMBER ORCHESTRA - PAUL KUENTZ, COND.

2530 88
GLAZUNOV
Concerto for Alto Saxophone and String Orchestra
EUGENE ROUSSEAU, ALTO AND SOPRANO SAXOPHONE
PAUL KUENTZ CHAMBER ORCHESTRA - PAUL KUENTZ, COND.

2530 87
GLAZUNOV
Concerto for Alto Saxophone and String Orchestra
EUGENE ROUSSEAU, ALTO AND SOPRANO SAXOPHONE
PAUL KUENTZ CHAMBER ORCHESTRA - PAUL KUENTZ, COND.

2530 86
GLAZUNOV
Concerto for Alto Saxophone and String Orchestra
EUGENE ROUSSEAU, ALTO AND SOPRANO SAXOPHONE
PAUL KUENTZ CHAMBER ORCHESTRA - PAUL KUENTZ, COND.

2530 85
GLAZUNOV
Concerto for Alto Saxophone and String Orchestra
EUGENE ROUSSEAU, ALTO AND SOPRANO SAXOPHONE
PAUL KUENTZ CHAMBER ORCHESTRA - PAUL KUENTZ, COND.

2530 84
GLAZUNOV
Concerto for Alto Saxophone and String Orchestra
EUGENE ROUSSEAU, ALTO AND SOPRANO SAXOPHONE
PAUL KUENTZ CHAMBER ORCHESTRA - PAUL KUENTZ, COND.

2530 83
GLAZUNOV
Concerto for Alto Saxophone and String Orchestra
EUGENE ROUSSEAU, ALTO AND SOPRANO SAXOPHONE
PAUL KUENTZ CHAMBER ORCHESTRA - PAUL KUENTZ, COND.

2530 82
GLAZUNOV
Concerto for Alto Saxophone and String Orchestra
EUGENE ROUSSEAU, ALTO AND SOPRANO SAXOPHONE
PAUL KU

When Radio Shack Says "Everything" You Get The Works – Tape, FM-AM, Phono AND a Big Price Cut!

Realistic puts together "total stereo" at over 12% off! Each piece is engineered for magnificent listening, each is designed for modern good looks. We include the oiled walnut cases and bases — usually "extra cost" options with our competitors. And even blank cassettes, mikes, and FM antenna to get you started. An investment that will bring you years of happy returns. System #34-2013, exclusive at every one of our 1300 stores across the country. Convenient credit terms available.

**SEPARATE ITEMS
TOTAL \$628.60**

**You Get Complete
System For Only**

550⁰⁰

**SAVE \$78.60 OFF
OUR ALREADY LOW PRICE**



Available at All Radio Shack and Allied Radio Stores We're in the Yellow Pages. If there's not a store near you, order by mail. Add applicable sales taxes and \$10 for shipping.

radio shack

AND ALLIED RADIO STORES

A TANDY CORPORATION COMPANY

2725 W. 7th Street, Fort Worth, Texas 76107

CIRCLE 4 ON READER-SERVICE CARD

the lighter side

reviewed by

MORGAN AMES

R. D. DARRELL

HENRY EDWARDS

MIKE JAHN

JOHN S. WILSON

 **GEORGE HARRISON AND FRIENDS:** The Concert for Bengla Desh. Ravi Shankar, sitar; Ali Akbar Khan, sarod; George Harrison, vocals and guitar; Leon Russell, vocals and piano; Bob Dylan, vocals and guitar; Ringo Starr, vocals and drums; Billy Preston, vocals and organ; Eric Clapton, guitar; vocal and instrumental accompaniment. *Wa-Wa; While My Guitar Gently Weeps; My Sweet Lord; Here Comes the Sun; Jumpin' Jack Flash; Young Blood; Blowin' in the Wind; A Hard Rain's A-Gonna Fall; Mr. Tambourine Man; Just Like a Woman; Something; Bengla Desh;* others. Apple STCX 3385, \$12.98 (three discs).

Since the Bengla Desh benefit concert held at New York's Madison Square Garden last summer was of monumental proportions, any reasonably edited and engineered recording of it must be monumental as well. This three-LP set is. The "acoustic" segments are sparkling, particularly the magnificently reproduced interplay between Ravi Shankar and Ali Akbar Khan which opens the performance. Never have I heard a recording that illustrates so well the dynamics of Indian music. The second acoustic segment, George Harrison singing *Here Comes the Sun* followed by Bob Dylan's reading of several familiar songs, is similarly dynamic. Dylan's voice seems a bit odd—when doesn't it?—but the audience was so taken with his presence that any oddities went unnoticed. Appropriate to the occasion, he sang his two major protest songs, *A Hard Rain's A-Gonna Fall*, and *Blowin' in the Wind*.

But the major force of the recording lies in the electric segments. Considering the presence onstage of some thirty musicians and singers, the recording is beautiful. Seldom is a lead voice buried, seldom is an important piece of instrumentation lost in the general clamor. Rock is at its best when it's lively, when the virtuosity of the individual musicians is subservient to the spirit of the moment. This is precisely how the album sounds. Best for me are George Harrison's *My Sweet Lord* and Leon Russell singing the Rolling Stones's *Jumpin' Jack Flash* mixed in with the old Leiber & Stoller hit, *Young Blood*.

The quality of the performance and the ability of the recording to capture it are an

achievement, no doubt. But more important than it all was the awesome nature—for rock—of having so many of its major figures gathered in one spot for such a cause. In social significance the Bengla Desh concert may not rival the Woodstock Festival, but in the spirit of the audience, the magnificence of the performances, and the excellence of the recording, this affair dwarfs Woodstock. The ultimate if cliché-ridden test of an LP is whether it's one of the five albums you would take to a desert island with you. I would not leave this one behind. M.J.

ALICE COOPER: *Killer.* Alice Cooper, vocals and harmonica; Neal Smith, percussion; Michael Bruce, guitar, piano, and organ; Dennis Dunaway, bass; Glen Buxton, lead guitar. *Under My Wheels; Be My Love; Halo of Flies; Desperado; You Drive Me Nervous;* three more. Warner Bros. BS 2567, \$4.98.

Who would have ever thought that Alice Cooper would have a hit single? Cooper, with his orange and black vinyl bell bottoms, black vinyl bra-like top, long, girlish hair, and heavy eye shadow and lipstick, seems to be the kind of performer that would appeal to FM freaks rather than AM adolescents. However, when the guttersnipe, transvestitelike star growled *I'm Eighteen*, he succeeded in capturing the imaginations of young adolescents, no matter what their musical tastes, all over the country. The performer not only sings about the confusion and torture that comes of being young but also looks like the most hideous visual representation of maladjusted and misunderstood youth the imagination can conjure up. He also possesses the gravelly but keen voice of an authentic rock-and-roll star, and his four-man band (also called Alice Cooper) proficiently plays the basic rock chords with plenty of flash, volume, feedback, and distortion.

"I'm a killer, and I'm a clown," sings Cooper on his new LP. The clown is a morbid one. His fantasies are filled with his own destruction; his images deal with the destruction of others. The reasons for this morbidity are stated in *You Drive Me Nervous*. Here, a teenager is about to run away because he is being persecuted about his hair, clothes, and attitudes. Only in fantasy does an adolescent who feels he is being treated like human debris have moments of triumph. *Under My Wheels* presents a triumphant Cooper as a lady killer; *Desperado* and *Killer* illustrate Cooper's search for an identity and his emergence as an acknowledged enemy of conventional society.

Thumping march rhythms, a kaleidoscope of insane metaphors, and an eerie segueing from image to image are used by Cooper to help portray his themes.

There's a wacky Grand Guignol quality hanging over the entire enterprise. "Nervous!" Alice Cooper shrieks and stutters twelve times at the end of *You Drive Me Nervous*. Mr. Cooper is living proof that we live in a nervous age. H.E.



Bonnie Raitt—purity with toughness.

 **BONNIE RAITT.** Bonnie Raitt, vocals and acoustic and slide guitar; rhythm accompaniment. *Might Tight Woman; Big Road; Finest Lovin' Man;* eight more. Warner Bros. WS 1953, \$4.98.

Miss Bonnie Raitt has struck the music scene carrying her own special world. She is a young, white, country blues singer who plays fine slide guitar and writes strong, tight lyrics. Her light, sure voice rings with sweetness and gentle authority. One reviewer wrote, "She combines purity with a certain toughness. . . ."

One wonders how Miss Raitt found her direction so surely and so soon in life. She is, after all, the daughter of John Raitt and must have grown up hearing dad sing *Carousel* and *Pajama Game*. Not a trace of her father's style exists in Miss Raitt's voice or approach—other than in her sheer professionalism. On the other hand, one must remember that at his height, John Raitt was squarely in the center of his era's popular music. Bonnie Raitt is dead center in her era's pop music too.

The album was recorded live on four-track in a place called Enchanted Island on a lake outside Minneapolis in a wood frame garage turned studio by Dave and Sylvia Ray, who engineered the disc. Miss Raitt used several musician friends from the area plus Junior Wells and A. C. Reed (brother of Jimmy), who drove in from Chicago. Recording was interspersed with fishing, ping pong, and hanging out. Miss Raitt writes: "We wanted a more spontaneous and natural feeling in the music—a feeling often sacrificed when the musicians know they can overdub their part on a separate track until it's perfect. It also reflects the difference between music made among friends living together in the country and the kind squeezed out trying to beat city traffic and studio clocks."

The group got what they went after: The album quality is sweet and easy, the level of musicianship excellent, the style authentic and heartfelt.

Miss Raitt does not imitate the great blues singers, although hearing her one thinks fondly of another era. Instead, she extends an elegant and earthy tradition into the present. Miss

When Sherwood puts us together, you get a great line of receivers.

VERSATILITY. Sherwood receivers perform all kinds of tricks. But they're not tricky. We don't go in for gimmicks.

Just watch our S-7300 juggle a pair of mikes, two turntables, up to four tape recorders and any four channel system. It's amazing.

POWER. In our line, we're very big on muscle. So all our receivers have power to spare for any speaker system.

Sherwood's powerful receivers were the first to have all silicon construction.

In fact, Sherwood delivers such clean, distortion free power, that we were recently top-rated over all other receivers by a leading consumer testing publication.

SENSITIVITY. We've always made beautiful music, because our FM sections are unexcelled for sensitivity and selectivity.

We build our own tuning coils which helps give us the lowest FM distortion in the industry—0.15%.

RELIABILITY. Sherwood components are reliable as your neighborhood Scout. Our quality control and inspection parameters are the most stringent in the industry. And our heat, life and drop tests insure reliability.

STYLE. We want to be as beautiful as we can for you. So we take the classic approach to receiver design: form should follow function.

For example, our SEL-200 has an uncluttered brushed aluminum and glass face, with illuminated meters and "stereo" indicator. But no more. Just the basic good looks you'd expect from a classic Sherwood receiver.



THE S-7100. When the S-7100 receiver was introduced last year, it re-defined receiver quality in the \$200.00 price range.

With 25 + 25 watts R.M.S. at 8 ohms, 1.9 μ v FM sensitivity and amplifier distortion of 0.2% at listening levels, the S-7100 remains an extraordinary value. A walnut case is included too. The S-7100 is fully compatible with all four channel systems.

THE S-7300. The first really high powered, high styled receiver at a medium price.

There's 42 + 42 watts R.M.S. at 8 ohms (1 kHz); 34 + 34 watts R.M.S. at any frequency from 20-20,000 kHz at 0.6% THD. 1.8 μ v FM sensitivity. Walnut case included. It's fully compatible with all four channel systems.

THE S-8900. Recently top rated over all other receivers by a leading consumer testing publication. The best in the \$400.00 range. It has the industry's lowest

FM distortion, sensitivity of 1.7 μ v, 48 + 48 watts R.M.S. at 8 ohms, exclusive FET side-band FM interchannel hush circuit. It's fully compatible with all four channel systems.

THE SEL-200. Our finest receiver has an incredible 85 + 85 watts R.M.S. at 4 ohms or when driving two pairs of 8 ohm speakers. Exclusive 9-pole "Le Gendre" toroidal FM IF filter yields alternate channel selectivity in excess of -70 dB, at 0.15% distortion.

And the SEL-200 is fully compatible with all four channel systems. Sherwood Electronic Laboratories, Chicago, Ill. 60618.

Sherwood sounds expensive

CIRCLE 61 ON READER-SERVICE CARD

BIG DISCOUNTS

STEREO COMPONENTS

Largest selection of top name brands... try us and see...

It's worth a call
(301) 288-1710



2029 MERRITT AVE.
Baltimore, Md. 21222

All mail answered within 24 hours
Phone (301) 288-1710 Daily 9AM to 10PM
Sat. 9AM to 6PM
Saturday Pick Up 9AM to 6PM

CIRCLE 39 ON READER-SERVICE CARD

WRITE FOR QUOTATION

FACTORY SEALED CARTONS
FRANCHISED DISTRIBUTOR
QUICK SHIPMENT

WE GIVE DISCOUNTS ON HI-FI COMPONENTS

SOUND REPRODUCTION INC.

460 CENTRAL AVENUE
East Orange, New Jersey 07018
(201) 673-0600

CIRCLE 66 ON READER-SERVICE CARD

WE CAN SELL FOR LESS

Nationally Advertised Brands

- Hi-Fi Stereo Components
- Tape Recorders
- Record Changers
- Home & Car Stereo Tapes
- Speaker Systems
- Radio & TV Sets
- Electronic Equipment

BRAND NEW AND FULLY GUARANTEED

WE CAN SAVE YOU MONEY

SEND: for FREE Listing of 1000's of items...

LOWEST PRICES ANYWHERE!

• Factory Sealed Units • Fast Service

AUDIO Sales
2745 ERIE BLVD. EAST
SYRACUSE, NEW YORK 13224

CIRCLE 11 ON READER-SERVICE CARD

DISCOUNTS

HI-FI SYSTEMS COMPONENTS

- KITS • COMPACTS
- TUNERS • AMPLIFIERS
- RECEIVERS • TURNTABLES
- SPEAKERS • TAPE RECORDERS

- Franchised Distributors for over 70 mfrs.
- Largest selection in the country
- Full manufacturers warranty protection
- Only brand new, factory sealed components
- Fast, fully insured shipments
- Double-boxed cartons where possible
- Same day reply to your inquiry
- Extra savings on complete systems
- Lowest possible prices

WRITE FOR OUR QUOTE AND SPECIALS BULLETIN
VISIT OUR NEW MODERN WAREHOUSE
FREE AMPLE PARKING AT PREMISES

ARSTON *Stores*
146 OLD BROOKFIELD RD. (NORTH)
DANBURY, CT. 06810
DANBURY, CT. (203) 744-6421
N. Y. CITY (212) 369-6212

CIRCLE 19 ON READER-SERVICE CARD

Raitt sounds her age, fresh and new and ready on Stephen Stills's energetic *Bluebird* and her own gentle *Thank You*.

Welcome in, Bonnie Raitt. M. A.

RITA COOLIDGE: *Nice Feelin'*. Rita Coolidge, vocals; instrumental accompaniment. *Family Full Of Soul; You Touched Me in the Morning; Nice Feelin'; Only You Know and I Know; I'll Be Here; Lay My Burdon Down; Most Likely You Go Your Way and I'll Go Mine; Journey Through the Past*; two more. A & M SP 4325, \$5.98.

This second LP by the lady who inspired the Leon Russell song *Delta Lady* is worth purchasing simply for one song: the title track, *Nice Feelin'*. It's a slow blues by guitarist Marc Benno, sung breathtakingly by Rita Coolidge. In all, her slow songs are best. She does things to a slow blues that can get you ten years in some states. The uptempo songs are often a bit predictable: *Only You Know and I Know* is an example.

One wishes she could grab hold of the magnificent concept embodied in *Nice Feelin'* and extend it to encompass a variety of songs. This isn't done, but still the album rates serious consideration. M.J.

BOB DYLAN: *Greatest Hits, Vol. II*. Bob Dylan, vocals, guitar, and harmonica; rhythm accompaniment. *Watching the River Flow; Don't Think Twice, It's All Right; Lay Lady Lay; Stuck Inside of Mobile with the Memphis Blues Again; I'll Be Your Baby Tonight*; sixteen more. Columbia KG 31120, \$6.98 (two discs).

Bob Dylan is the most important American pop composer and musician of the last decade. I know of no other musical personality whose work has been subjected to the same unending scrutiny. Dylan is a pop star, a poet, a moral arbiter, a consummate creator of romantic ballads. His songs have helped politicize an entire generation. "Bob Dylan's Greatest Hits, Volume II" presents a sprinkling of unreleased material, a few new versions of old tunes, and an interesting sampling of the composer-performer's work over the past eight years. Dylan scholars will have a field day. Others will get a fair idea of the provocative Dylan talent.

The selections chosen for the album include political songs, early folk rock numbers, songs that illustrate Dylan's rustic calm after his motorcycle accident and his hiatus in Woodstock, numbers that reflect Dylan's carefree excursion into a pure country-and-western vein, and the recent songs that express the star's attempt to redefine himself as a man without a message who possesses a matured vision. Dropped into the middle of the collection is *A Hard Rain's A-Gonna Fall*, the searing protest song that first appeared on the second Dylan album, "Freewheelin'" Bob Dylan." The next selection, *If Not for You*, first appeared on Dylan's most recent album, "New Morning," and is a song in which Dylan feels that it is no longer necessary to state the harshness of his former expression. These fascinating juxtapositions occur throughout the two-record set.

The new material includes the touching ballad, *Tomorrow Is a Long Time*, *When I Paint My Masterpiece*, which was featured on the Band's "Cahoots" album, new versions of *You Ain't Going Nowhere* and *The Mighty*

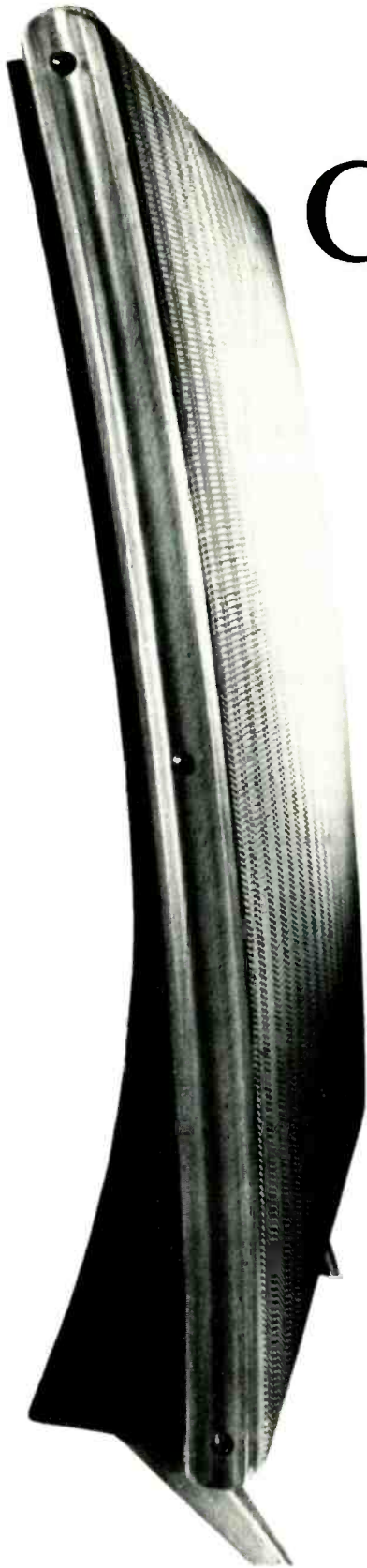

Completely LACKING IN CHARACTER

The depth probing Ad-men will shudder at the use of such a title but we can think of no better description for a good loudspeaker.

Character in the music; character in the instruments; character in the artist—yes, but no character in the loudspeaker, please!

Hear Quad at these dealers

Harmony House Inc.,
New York.
Murray Newton—
Custom Audio,
New York.
Transcendental Audio,
Buffalo, New York.
Advanced Electro Acoustics
Kenmore, New York.
Paul F. Heath,
Livonia, New York.
The Audiolab,
New Brunswick,
New Jersey.
Music & Sound Ltd.,
Jenkintown, Pa.
Interiors Plus Sound,
Fort Lauderdale, Fla.
Music Hall High Fidelity,
Miami, Fla.
Audiophile Imports,
Chicago, Ill.
Carter Thomas,
Mission, Kansas.
Iowa Sound Service,
Des Moines, Iowa.
Bill Case Sound,
San Antonio, Texas.

Audio Specialties,
Austin, Texas.
Frederick Amigo,
San Francisco, California.
Jonas Miller,
Beverly Hills, California.
Electrostatic Sound
Systems,
Sacramento, California.
Lafayette Radio Electronics
of Pasadena,
Pasadena, California.
The Golden Ear,
Santa Rosa, California.
The Golden Ear,
San Anselmo, California.
Hi-Fi Center of Fairfield
County,
Bridgeport, Conn.
R. Benevides,
Indianapolis, Indiana.
Stereo Sales,
Tallahassee, Fla.
Audio Consultants,
Evanston, Ill.
DS Audio,
Lebanon, Pa.
Opus 2,
Memphis, Tennessee.
Anderson's Hi-Fi,
Columbus, Ohio.
Gill Custom House,

Chicago, Ill.
Hi-Fi Audio Inc.,
Cincinnati, Ohio.
Hoffman's House of Stereo,
Cleveland, Ohio.
House of Hi-Fidelity,
Madison, Tennessee.
Ott's Radio,
Meadville, Pa.
Stereo Place,
Washington, D.C.
Ace Electronics,
Terre Haute, Indiana.
Sound Productions,
West Lafayette, Indiana.
Audio Mart,
Kansas City, Missouri.
Dodd Music,
Covington, Kentucky.
Douglas Dynamics,
Minneapolis, Minnesota.
Audio East,
New York.
Failane Electronics,
Cedar Rapids, Iowa.
or send postcard for
illustrated leaflet
to Dept. HU
Acoustical
Manufacturing Co. Ltd.,
Huntingdon, England.

QUAD

QUAD is a registered trade mark

for the closest approach to the original sound.

THIS
 OVER **67** YEARS
 OF RELIABILITY
 IS WHY STEREO & HI-FI
 BUYERS CAN BE SURE OF
SAVINGS
 AT RABSONS

At Rabsons Competitive Prices, Reliability and Personal Service have been bywords for over 67 years.

It's so EASY and SAFE to deal with Rabsons. As close as your telephone — as near as your mailbox • Fast Air Mail Response on Quotation Requests • Franchised Distributor for Hi Fi Lines • All merchandise brand new in factory sealed cartons, shipped double-packed, fully insured promptly from our warehouse • Greater savings on complete systems • Export packing • 220 Volts, 50 Cycle merchandising a specialty • Free list of monthly specials.

BEFORE YOU BUY GET A RABSONS QUOTE... YOU'LL BE GLAD YOU DID!

RABSONS

57 ST. INC.
 119 West 57th Street, New York, N. Y. 10019
 Tel. Area Code 212-247-0070

CIRCLE 55 ON READER-SERVICE CARD

GET
 LOWEST PRICES
 FAST, FAST SERVICE
 FACTORY SEALED CARTONS
 FULLY INSURED SHIPMENTS
 EXTRA SAVINGS ON PACKAGE DEALS

AUDIO UNLIMITED

Serving Audio Enthusiasts

Since 1955

GIVES YOU

MORE FOR YOUR MONEY

Write For FREE Listing Today

SEND US YOUR LIST FOR

OUR AIR MAIL QUOTE TODAY

Visit Our Store Warehouse

CLOSED MONDAYS

IT WILL PAY YOU
 TO WRITE US FIRST

AUDIO UNLIMITED, INC.

396 Third Ave. (Nr. 28), N. Y.,
 N. Y. 10016 • (212) MU 2-3836-7-8

CIRCLE 10 ON READER-SERVICE CARD

check with the
East-Coast Stereo
Discounters...
 ...then **BUY** from

MIDWEST HI-FI

WHOLESALE

4N270 Mill Rd. (Box 182)
 Addison, Illinois 60101

Write for our new
WHOLESALE price list
 & catalog. You'll
 be glad you did!

OVER 50 NAME BRANDS
FACTORY - SEALED CARTONS
WHOLESALE PRICES
 • **SAVE ON TIME**
 & **FREIGHT CHARGES**

CIRCLE 21 ON READER-SERVICE CARD

BALTIMORE

STEREO WHOLESALE

Now, from the comfort of your home you can buy almost any Stereo Component at Special Discount Prices, from one of the East Coast's Leading Wholesalers...Your order shipped promptly in factory-sealed cartons. Write for quote today.

7126 Ambassador Road

Building S-4, Security Industrial Park
 Baltimore, Md. 21207
 1—(301) 265-8617

CIRCLE 12 ON READER-SERVICE CARD

Quinn (*Quinn, the Eskimo*), and *Down in the Flood*, a blues number.

The Dylan legend has its roots in the Dylan songs. Twenty-one reasons for that legend appear in this album. H.E.

* **BILLY PRESTON:** *I Wrote a Simple Song*. Billy Preston, vocals and keyboards; vocal and rhythm accompaniment; sweetening by Quincy Jones. *You Done Got Older*; *God Is Great*; *The Bus*; eight more. A & M 3507, \$5.98. Tape: 8T 3507, \$6.95; CS 8507, \$6.95.

This may be Billy Preston's moment. It deserves to be. Everyone who is into pop music knows who Preston is, and many who don't know his name have heard and reacted to him. Twenty-five-year-old Preston has toured with Mahalia Jackson, Little Richard, Ray Charles, and others. Later his music charmed the Beatles to the extent that he became the first American musician, also the first black artist, to work with them (*Let It Be* and *Get Back*). George Harrison signed Preston to Apple and the two produced an excellent album that died in distribution and red tape. In England, Preston worked with people such as Eric Clapton and Ginger Baker.

It seems that the stars of music haven't let Billy Preston alone long enough to get rolling on his own. Back in Los Angeles, Preston has spent the last couple of years recording for such people as Quincy Jones, Carole King, Barbra Streisand, Stephen Stills, Merry Clayton, and Aretha Franklin, most of whom dislike working without him.

Preston has found a new home at A&M Records and the company is anxious to promote him as his own man. While Preston is most sought as a pianist, organist, and all-round group catalyst, he is an equally fine singer and songwriter. It all comes through on this album. Many of the songs were co-written by Preston and veteran lyricist Joe Green. Preston's impressive friends have come through for him too, including Quincy Jones, David T. Walker, George Harrison, and Merry Clayton.

Preston includes a unique version of Vincent Youmans' *Without a Song*, as well as a heartfelt *My Country 'Tis of Thee*, plus originals such as *Should've Known Better* and the title tune.

This is a beautiful album. It burns, as they say. And if it doesn't hit, the next one will. Billy Preston is a natural. M. A.

THE DOORS: *Other Voices*. Robby Krieger, guitars and vocals; John Densmore, drums; Ray Manzarek, keyboards and vocals; rhythm accompaniment. *In the Eye of the Sun*; *Variety Is the Spice of Life*; *Ships with Sails*; *Tightrope Ride*; *Down on the Farm*; three more. Elektra EKS 75017, \$4.98.

"Other Voices" is the Doors's first album since the death over a year ago, of their lead singer, rock superstar Jim Morrison. The Doors have not attempted to replace Morrison; they now rotate lead among themselves. In addition, they have amplified their famous sound through the use of a bass and a rhythm guitarist. The result is a pleasing album that captures the Doors's essential musicality while presenting them in a much more positive frame of mind. "Other Voices" is a far cry from the

Morrison days when the band sang about lizards and blood and evil and the influences of LSD seemed to be everywhere.

Always a hypnotic sound, the Doors's use of repetitive melody is still just as fascinating. This driving repetition is evident on *In the Eye of the Sun* and *Hang onto Your Life*. The album also contains a country-and-western flavored number, *Down on the Farm*, and a hard rocker, *Tightrope Ride*. The ballad *Ships with Sails* is the perfect pop song. A faultless combination of perceptive lyric and sensuous melody, the song erupts into a series of brilliant percussive effects. Even a song of frustration, *I'm Horny, I'm Stoned*, sounds happy.

Vocally, none of the Doors's individual voices equals the compelling power of Jim Morrison at his best. Manzarek is even forced to imitate some of Morrison's more dramatic effects. The Doors, however, sing earnestly, and their vocals should improve with time.

The Doors were a powerhouse operation during the Sixties. Enough of their musical drive appears on this album to enable one to foresee a happy and successful future for this still potent musical organization. H.E.

* **PAUL WILLIAMS:** Just An Old Fashioned Love Song. Paul Williams, vocals; Tom Scott and David Spinozza, arr. *Waking Up Alone; I Never Had It So Good; Gone Forever*; eight more. A & M 4327. \$5.98.

Paul Williams can be found nearly every day at A&M somewhere between his office and the recording studios, walking around, working, hanging out, making people feel better. He is one of a kind: sunny, funny, and touching. His work, sad or joyous, bears the precious quality of Life Affirmation. All this shines through in his new album.

Williams was not a born songwriter. First he was a comedy writer (Mort Sahl), an actor (*The Loved One* and *The Chase*), and a professional skydiver. Songwriting changed from a hobby into a fulfillment about the time Williams ran into Roger Nichols, the superb composer with whom he has written his best songs.

The breakthrough point was a song called *We've Only Just Begun*. It began as a TV commercial for a bank and ended up a hit song for the Carpenters, making everyone involved famous. By now it is heard at weddings, used as a theme for school yearbooks, and has been recorded over a hundred times.

A rush of Williams-Nichols hits followed, including *Rainy Days and Mondays* (Carpenters); *Out in the Country* (Three Dog Night); *Cried Like a Baby* (Bobby Sherman); and *Talk It Over in the Morning* (Anne Murray). At present, two Williams-Nichols songs are on the charts: *Just an Old Fashioned Love Song* (Three Dog Night) and *So Many People* (Chase).

So much for credits, but never mind. Paul Williams continues to be his delightful, accessible, open, and talented self. He also sings his nose off.

The album was not designed to wow the charts but rather to be an intimate, good-times statement. Much of its charm comes from the fact that Williams has used one of the finest rhythm sections in the business, drummer Russ Kunkel and bassist Leland Sklar, best known for their work with James Taylor. Kunkel has a singular feeling for space as he plays, making things feel warm, solid, and spare.

When you make the number one tape recorder, you make the number one recording tape.

Sony!

Cassette. Reel-to-reel. 8-track.

SONY SUPERSCOPE

You never heard it so good.®

CIRCLE 65 ON READER-SERVICE CARD

LOWEST AIR FARES TO EUROPE



Thingvellir, where Iceland's parliament was founded in the year 930 A.D.

The unphotographed country. Hurry!

Here where the air is clear as a lens, you get pictures never seen before. Fjords, geysers, waterfalls, volcanic islands. Whaling stations. Farm and fishing villages. The Uninhabited Areas. Even the names are magic. Thingvellir. Langjokull. Siglufjordur. You'll find birds like the Great Skua. And a people descended from the Vikings. This is Iceland, the unphotographed country. Stopover Tours for under \$20 a day. Hurry to Iceland before it gets all snapped up. Then continue on to Luxembourg, England, Scotland, Norway, Sweden or Denmark. See your Travel Agent, or contact us in New York, Chicago, San Francisco, Los Angeles, Miami, Houston, Washington, D. C. or Mexico City. Write for folder HF to Icelandic Airlines, 630 Fifth Ave., New York, N. Y. 10020.

ICELANDIC  **LOFTLEIDIR**

LOWEST AIR FARES TO EUROPE

CIRCLE 37 ON READER-SERVICE CARD

RECEIVERS
TUNERS
AMPLIFIERS

TAPE
RECORDERS
DECKS

**LOW
PRICES**

ON FAMOUS BRAND
NATIONALLY ADVERTISED

**STEREO
COMPONENTS**

FAST DELIVERY
FACTORY SEALED CARTONS
WRITE TODAY FOR OUR QUOTE

**A. D. R.
AUDIO**

6200 CHILLUM PLACE N.W.
WASH., D.C. 20011
(202)
291-3000

SPEAKERS
CARTRIDGES
COMPACTS

ALL
STEREO
SYSTEMS

CIRCLE 2 ON READER-SERVICE CARD

*you're shopping
discounts
because you want
the most system
for your money.*



KOSS
dynaco **SHURE**

Before you buy, be sure to
check our price list. You'll be
glad you did.

Write us for our new catalog including
bulk tape prices, DEPT. F, or check our
number on the reader service card.

Boston / **AUDIO
COMPANY**

1 Discount Drive, Randolph, Mass. 02368
(East Randolph Industrial Park.)

CIRCLE 15 ON READER-SERVICE CARD

It is interesting to hear Williams sing versions of his own several hits. *We've Only Just Begun* uses only piano (Craig Doerge), guitar (David Spinozza), and bass, emerging poignantly and spare. *Old Fashioned Love Song* begins with Dixieland overtones and collapses into a party you wish you'd gone to, with Williams breaking up on kazoo.

This is a biased review. I am for Paul Williams. He is an advertisement for the best side of the music business. Carry on. M. A.

THE WAY TO BECOME THE SENSUOUS WOMAN BY "J." Connie Z, narrator. Atlantic SD 7209, \$4.98.

ALL IN THE FAMILY. Carroll O'Conner, Rob Reiner, Jean Stapleton, Sally Struthers, and Mike Evans, narrators. Atlantic SD 7210, \$4.98.

There are 650,000 hard-cover copies of *The Sensuous Woman* in print as well as over six million copies of the paperback edition. Atlantic Records must be aware of these figures because they have just turned the book into a record. I cannot believe they have done this because of a sincere interest in the nation's sexual education.

Connie Z possesses one of those B-movie starlet's voices. She eagerly relates the most extravagant portions of the best-selling love manual. It all adds up to the stag record of the year, geared more for the middle-aged male than the novice female.

Television's "First Family" also makes its recorded debut on the Atlantic label. Yes, here's Archie Bunker with all his "soft" racial epithets intact. Those who love the TV show will not be able to resist this well-produced and truly amusing recording.

Is there any truth to the rumor that Atlantic is planning a new recording entitled "The Sensuous Woman Meets All in the Family?" It wouldn't surprise me in the least. H.E.

jazz

GARY BURTON: Alone at Last. Gary Burton, vibes, piano, electric piano, and organ. *Moonchild; The Sunset Bell; General Mojo's Well Laid Plan*; four more. Atlantic SD 1598, \$5.98.

Gary Burton takes on the ultimate challenge on one side of this disc—unaccompanied vibraphone solos (on the other side, he has dubbed in his piano or organ accompaniment to his vibes). Working with his quartets, Burton has often played one or two unaccompanied selections and they have invariably been the high points of the set. But almost twenty minutes of unaccompanied vibraphone? With nothing for change of pace? Would you believe it really works? And beautifully. Burton's combination of technique and creativity produces pieces that are filled with fascinating colors, delightful rhythms, charming melodies, and inner currents that keep everything flowing, pulsing, and swinging.

The unaccompanied side was performed live at the Montreux Jazz Festival so there was no opportunity for gimmicks or studio repairs. It was all done out in the open, which only makes the consistent brilliance of these

performances all the more impressive. The second side, studio made, does not have the unalloyed, pristine qualities of the unaccompanied side, but it allows Burton to get into some things that possibly could not be carried off by vibes alone—a three-way, gospelish bit with vibes, piano, and organ, for instance. And, happily, he winds up the studio side with a lively, light and airy unaccompanied vibes treatment of Jobim's haunting *Chega de Saudade*. J.S.W.

Bobby HACKETT: Live at the Roosevelt Grill. Bobby Hackett, cornet and flugelhorn; Vic Dickenson, trombone and vocals; Dave McKenna, piano; Jack Lesberg, bass; Cliff Leeman, drums. *Undecided; It's so Peaceful in the Country; Constantly*; eight more. Chiaroscuro 105, \$4.98 (Chiaroscuro Records, 15 Charles St., New York, N.Y. 10014).

Possibly because he plays everything with such casual ease, Bobby Hackett is apt to be taken too much for granted. This has been compounded by unimaginative record producers who have turned out endless grooves that offer a very limited view of Hackett. Left to his own devices, Hackett can be a stirring, enthralling, and very varied performer. This set, made during a long stay at the Roosevelt Grill in New York in the spring of 1970 with an excellent quintet, is the hard-core, basic Hackett. That gorgeous tone, mellow and burnished, which has been profligately poured out on so many pointless mood albums, is heard here in a context that has vitality and sensitivity.

His *Meditation* is sheer elegance and a warm contrast to his rambunctious drive on *Swing That Music*, which precedes it on the disc. But along with Hackett on these pieces is Dave McKenna, a pianist who manages to find out-of-the-way places in which to bury himself from view (most recently, Cape Cod). His touch, his beat, his phrasing, and his marvelous sense of fitness help to make this collection a unique collaboration. Add the joyously incorrigible Vic Dickenson and very perceptive rhythmic backing from Jack Lesberg and Cliff Leeman. The setting is informal—comments by Eddie Condon, the comfortable sound of a happy audience, the clink of dishes and glasses—and the flavor of the situation comes through along with some very lovely music. J.S.W.

COUNT BASIE: Have a Nice Day. *The Plunger; Scott's Place; Doin' Basie's Thing*; eight more. Daybreak 2005, \$4.98.

MAYNARD FERGUSON. *Fire and Rain; Stoney End; Aquarius*; six more. Columbia C 31117, \$4.98.

STAN KENTON: Live at Brigham Young University. *Kaleidoscope; Theme from Love Story; A Step Beyond*; seven more. Creative World ST 1039, \$11 (two discs) (Creative World, Inc., Box 35216, Los Angeles, Calif. 90035).

BUDDY RICH: A Different Drummer. *Superstar; Domino; Paul's Tune*; four more. RCA Victor LSP 4593, \$5.98. Tape: ● PS8 1819, \$6.95; ●● PK 1819, \$6.95.

Big-band buff's can take heart when a single month produces new albums by four major bands—and representatively good albums at that. The Kenton set is the most specifically representative since it is a recording of a con-

cert by the Kenton band at Brigham Young University last August and, in general, follows the format of the concert performances the band was giving then. Those concerts, like this recording, were a mixture of top-flight Kenton and some of the banality that has always dogged Stan's footsteps. The real meat of the set is concentrated on the first two of the four sides. In such pieces as *Malaga*, *What Are You Doing the Rest of Your Life*, and *Bogota*, the rich colors, the vitality, and the characteristic Kentonian ensemble sounds of the band come through brilliantly. The third side starts promisingly with Willie Maiden's delicate *April Fool* but becomes bogged down in a heavy-handed version of Hank Levy's *Hank's Opener* and winds up with the surprisingly routine and thin-toned baritone saxophone solo by Chuck Carter on *Rhapsody in Blue* that Kenton was featuring strongly at the time. The fourth side is pure disaster—Ken Hanna's pretentious *Macumba Suite*, an anthology of some of the more trite aspects of Kenton's past.

Maynard Ferguson, who has often seemed tied down by some of the same clichés that have haunted Kenton, gets away from them completely on his new disc, played by his current English band. At the same time, he gets into contemporary pop material more successfully than any other big jazz band has. It is not all just a hammer-and-tongs approach, which Buddy Rich tends to use in this kind of material. Rather, Ferguson's imaginative set of arrangers has found ways of approaching tunes by James Taylor, Elton John, Laura Nyro, and Ian Anderson that extend the basic feeling of the material to the musical personalities of Ferguson and his sidemen. Yet, with all this, the best piece on the disc turns out to be an original—Keith Mansfield's *The Serpent*—which has some glorious valve trombone by Maynard, full band ensembles that really rock, and a use of electronic echo in the brass that makes valid sense. Unfortunately, the sleeve contains not a word of credit for soloists or, for that matter, not a word of any kind that might help a listener fill in the background of band, personnel, or tunes.

Buddy Rich's "A Different Drummer" is the best of his band's records so far—a better balanced, deeper showing of the band as a whole. The material is an interesting mixture—the currently inevitable bow to *Jesus Christ Superstar* in a pair of pieces that are justified through driving solos by Jimmy Moshier on alto saxophone and Pat LaBarbara on soprano; an exhilarating mass attack on Thelonious Monk's *Straight No Chaser*; Phil

Wilson's superb arrangement of *Chelsea Bridge*, which allows Moshier to take an extended alto solo that stands on its own without memories of either Ben Webster or Johnny Hodges; and one of the long "suites" that Rich has made a standard finish for his discs—this one with a bit more variety than his past followups to the *West Side Story* medley that started the whole thing.

As for the Basie set, it is quintessentially Basie, utterly predictable from note to note (the entire disc is made up of originals by Sammy Nestico who has the Basie formula down pat). Yet the material is so good of its kind and played with such aplomb and polish that, with the exception of Basie's recent *Afrique* (which had more guts), this is Basie's best recording in years. J.S.W.

FREDDIE KEPPARD: Freddie Keppard, cornet, with Jimmy Blythe and His Ragamuffins, Freddie Keppard's Jazz Cardinals, Jasper Taylor and His State Street Boys, Cookie's Gingersnaps, Frankie "Half Pint" Jaxon, Richard M. Jones's Jazz Wizards, Erskine Tate's Vendome Orchestra, Herwin 101, \$5.50 (Herwin Records, P.O. Box 306, Glen Cove, N.Y. 11542).

If one can believe the musicians quoted in Peter Whelan's liner notes for this collection, Freddie Keppard was long past his peak when these records were made in 1926 and 1927. On that basis, he must have been an overwhelming cornetist when he still had it. On these acoustical recordings, Keppard, who was eleven years older than Louis Armstrong and one of Armstrong's challengers when he first reached Chicago, comes through as a cornetist with a clearly defined personal style and a vitalizing authority. This enterprising collection helps to put a perspective on Keppard and makes him accessible to a general public rather than those persistent diggers among the jazz archives. J.S.W.

*** COLEMAN HAWKINS AND LESTER YOUNG:** Classic Tenors. Coleman Hawkins, tenor saxophone; Eddie Heywood, piano; Oscar Pettiford, bass; Shelly Manne, drums. *The Man I Love*; *Sweet Lorraine*, two more. Bill Coleman, trumpet; Andy Fitzgerald, clarinet; Ellis Larkins, piano; Al Casey, guitar; Pettiford; Manne; Hawkins. *Stumpy*; *How Deep Is the Ocean*; two more. Lester Young, tenor saxophone; Dickie Wells, trombone; Freddie Greene, guitar; Al Hall,

SAVE!

MONEY • TIME • FREIGHT

- ♪ QUALITY STEREO EQUIPMENT AT LOWEST PRICES.
 - ♪ YOUR REQUEST FOR QUOTATION RETURNED SAME DAY.
 - ♪ FACTORY SEALED CARTONS—GUARANTEED AND INSURED.
 - ♪ SAVE ON NAME BRANDS LIKE:

| | |
|--------|-------|
| A.D.C. | KLH |
| A.R. | SHURE |
| DYNACO | KOSS |
- AND MORE THAN 50 OTHERS

BUY THE MODERN WAY
BY MAIL—FROM

illinois audio

Department 217H
1019 North Dearborn Street
Chicago, Illinois 60610
312-664-0020

CIRCLE 38 ON READER-SERVICE CARD

| | |
|---|--|
|  FISHER |  KOSS |
|  SONY |  GARRARD |
|  SHURE |  DYNACO |

SAVE MORE BY MAIL FROM DIXIE!

ON NATIONALLY ADVERTISED BRANDS • HI-FI COMPONENTS!

Send for our New '72 Wholesale Price List! Wholesale Prices!! *Dixie, one of the largest Stereo Wholesalers will fill all your mail orders promptly — at prices actually LOWER than "Discounters". See our 16-page Wholesale Price Brochure for yourself! Recognize Famous Brand Names AND choose the stereo equipment and accessories you desire. Everything shipped factory-sealed! Master Charge / BankAmericard Honored on Mail Orders.

***NO MEMBERSHIP FEE REQUIRED FOR DIXIE'S LOW, LOW PRICES!**

DIXIE HIGH-FIDELITY WHOLESALE
10530 Detrick Ave.
Kensington, Md.
20795 Dept. HF-3
Phone:
301-933-7600

CIRCLE 24 ON READER-SERVICE CARD

Lowest of the LOW!

Shamelessly Low Prices . . .

As one of America's largest wholesale distributors, we're guilty of shamelessly low prices. Our buying volume has made our prices the lowest. We seriously doubt you can find one lower . . . and that we're proud of. What's more, at S.C.A. you can select from hundreds of NEW, Factory Sealed, Full Warrantee, Brand name, Hi-Fi Stereo components. If its in the Hi-Fi, Audio field . . . we have it!

Write for a lowest of the low quote . . . we're not ashamed.



STEREO CORPORATION of AMERICA



2122 UTICA AVENUE, BROOKLYN, NEW YORK 11234 (212) 338-8555

CIRCLE 69 ON READER-SERVICE CARD

DISCOUNTS

WASH, D.C.
HAS NO FAIR
TRADE
LAWS!

ON STEREO COMPONENTS

PLEASE REQUEST
Prices for your choice of
Changers, Receivers, Tape
Recorders, Speakers, etc.

PROMPT DELIVERY
IN FACTORY
SEALED
CARTONS.

DISTRICT SOUND INC.

2316 Rhode Island Ave. N.E.
Washington, D.C. 20018
202-832-1900

CIRCLE 23 ON READER-SERVICE CARD

ANOTHER SUPERB VALUE from **Olson** Electronics

ONLY \$22⁹⁸



SOLID STATE STEREO AMPLIFIER

Low priced stereo amplifier that looks and sounds great. An ideal unit for office, children's room, or second stereo system. Has separate volume and tone controls with inputs for phono and tuner.

Olson Electronics, Dept. G-3
260 S. Forge St., Akron, Ohio 44308

I enclose \$22.98 plus \$1 for postage and handling. Send me the AM-400 Stereo Amplifier.

Send me the next seven issues of the Olson Catalog, without cost or obligation. **FREE**

Name _____

Address _____

City _____

State _____ Zip _____

CIRCLE 53 ON READER-SERVICE CARD

HEAR HERE

FOR THE UTMOST IN

DISCOUNTS

ON NATIONALLY
ADVERTISED

HI-FI STEREO COMPONENTS

WRITE FOR OUR QUOTE
All Merchandise Shipped
Promptly Fully Insured From
Our Warehouse.

DOWNTOWN AUDIO, INC.

17 WARREN ST.
NEW YORK, N.Y. 10007
267-3670-1-2

CIRCLE 26 ON READER-SERVICE CARD

HI-FI COMPONENTS TAPE RECORDERS

TAPES, ACCESSORIES
SLEEP LEARN KITS
MERITAPE

SAVE MONEY

- LOWEST PRICES
- INTEGRITY • SERVICE
- FRANCHISED DISTRIBUTORS

WRITE FOR OUR VERY LOW
PACKAGE QUOTATIONS
Nationally Advised Brands

Factory Sealed Cartons

Write for **FREE CATALOG**
Visit Our Showrooms

DRESSNER

1523-K JERICHO TPKE.
NEW HYDE PARK, N. Y.
11040

bass; Jo Jones, drums; Larkins; Coleman. *I Got Rhythm; Linger Awhile*; two more. Flying Dutchman FD 10146, \$5.95.

An awful lot of jazz is summed up on this disc. Hawkins and Young, the two basic tenor saxophonists (practically every saxophonist since has descended from one or the other), were both at a peak of their performing careers when these sides were made, all within a period of two weeks in December 1943. Hawkins was, in fact, filled with new, energetic interest from listening to the new music that was being worked up then by Dizzy Gillespie, Charlie Parker, and Thelonious Monk, and it shows in the thoughtful depth and powerful flow of his solos. Although Lester Young's four selections (originally released under Dickie Wells's name) appear to have been made just after his shattering Army experience, his playing is typically warm and beautifully structured. Four of the Hawkins selections have some of Eddie Heywood's brightly stylized, good-time piano, and Dickie Wells swaggers lustily through the Young pieces. J.S.W.

in brief

LIVINGSTON TAYLOR: Liv. Capricorn SD 863, \$4.98.

This artist doesn't like to be reminded that he is James Taylor's brother, but this album makes it crystal clear that he is. While James is the family original, I like them all, including sister Kate and brother Alec. M.A.

BARRY MANN: Lay it All Out. New Design Z 30876, \$5.98.

Barry Mann, along with Carole King, is another of the early-Sixties songwriters who turned out dozens of hits for the Aldon Music Publishing Company. On this album, Mann sings two of his golden oldies, *You've Lost That Lovin' Feelin'* and *On Broadway*. Miss King plays piano on two numbers, and joins Mann on *I Heard You Singing Your Song*. Mann's performance lacks energy, but those Aldon people certainly learned how to knock out a tune. H.E.

BREWER AND SHIPLEY: Shake Off the Demon. Kama Sutra KSBS 2039, \$4.98.

Good group, disappointing new album. All the elements are present but they do not come together. The project sounds hasty. Wait till next time. M.A.

BOOMERANG: Boomerang. RCA LSP 4577, \$5.98.

Mark Stein, who pounded the organ for the Vanilla Fudge, has created a new four-man band that plays basic rock-and-roll with lots of energy and style. H.E.

MUDDY WATERS: Live. Chess CH 50012, \$4.98.

This album was recorded live at Mr. Kelly's, a plush, rather touristy club in Chicago. Whether Muddy Waters felt out of place there is a reasonable question as his performance seems rather by rote. The harmonica of Paul Oscher, however, is quite good. Notable is the instrumental, *Mudeat*. M.J.

NEIL DIAMOND: Stones. Uni 93106, \$4.98. Neil Diamond continues to be one of the country's most important and unique composer/artists. Over half of his new album is devoted to favorite songs by other people. But the tracks getting airplay are Diamond's own, including *Stones*, *Crunchy Granola Suite*, and the hit *I Am I Said*. Which tells you how his fans feel about him. M.A.

MIKE & TINA TURNER: 'Nuff Said. United Artists UAS 5530, \$5.98. Another searing set of vocals from the tempestuous Miss Turner. This lady has the vocal energy of legions. H.E.

MERRY CLAYTON. Ode SP 77012, \$5.98. Merry Clayton, one of the world's finest back-up singers, pulled out all the stops on her solo LP debut, "Gimme Shelter." This time around, she tackles her material with much too much restraint. The talent still shows through, but the result is less interesting. H.E.

BILL HALEY AND THE COMETS: Razzle-Dazzle. Janus JX2S 7003, \$9.98 (two discs). Recorded live in Sweden, this two-LP set contains most of Haley's familiar songs. Despite the fact that he must have played them all ten thousand times, the old excitement remains. M.J.

THE MAMAS AND THE PAPAS: People Like Us. ABC Dunhill DSX 50106, \$5.98. This album brings together the Mamas and the Papas three years after they went their separate ways, six years after their first hit. They are out of shape. The songs are not very interesting; the throbbing harmonies that made the group famous in the first place seem to have been left at home. H.E.

TRAFFIC: The Low Spark of High Heeled Boys. Island SW 9306, \$5.98. Steve Winwood has produced this album himself, and it contains plenty of the Winwood vocal and keyboard magic. Traffic fans will be especially enamored of the mysterious twelve-minute title cut. H.E.

RECORD MART Advertisement

R
E
C
O
R
D
S



T
A
P
E
S

Free mailing anywhere in USA, APO & FPO for mail orders from world's largest choice of records, tapes! The low price of the record or tape is all you pay. King Karol's prices lowest, service fastest and inventory largest—we have everything! For FREE CATALOG write: King Karol Records, Dept HF3 Box 629, Times Sq. Sta., NYC 10036

CIRCLE 40 ON READER-SERVICE CARD

HIGH FIDELITY CLASSIFIED

165 W. 46th St., New York, N. Y. • Phone (212) 757-2800

Rates: \$1.00 per word. Minimum \$10.00. Words in caps at 10c extra ea.

Full Payment Must Accompany All Copy for Classified Ads except those placed by accredited advertising agencies.

Name _____
Address _____
City _____ State _____ Zip _____

DEADLINE: 1st day of the month; 2 months preceding the date of issue.

Please run my ad as shown below:

for sale

"HARD TO GET" RECORDS—ALL SPEEDS, RECORD Exchange, 842 Seventh Avenue, New York, N.Y. 10019.

SCOTCH RECORDING TAPE, LOWEST PRICES. TAPE CENTER, Box 4305C, Washington, D.C. 20012.

RADIO SHOWS CATALOG FREE. BOX 724, DEPT. HF, Redmond, Wash. 98052.

OPERA TAPE BARGAINS!—\$3.50—(REELS & CASSETTES). BOX 1101, WOODHAVEN, NEW YORK 11421.

"LIVE OPERA PERFORMANCES ON REEL-TO-REEL TAPES. Incredible performances dating back 40 years. from PONSELLE-CALLAS. Catalog: MR. TAPE, Box 138, Murray Hill Station, N.Y.C. 10016".

JBL THEATRE SYSTEM-TWO \$375 DRIVERS with horn and lens. Four D-150 woofers with special crossovers. Excellent for Stereo or P.A. \$1200.00. Thomas Dwyer, 35 Maple St., Bangor, Maine 04401.

PROTECT YOUR RECORDS—POLY SLEEVES FOR jackets 5c; inner sleeves 4c; Poly lined paper sleeves 10c; White jackets 25c; Postage \$1.00. Record Supply House, Hillburn, N.Y. 10931.

NEW AMPEX CATALOG OF 6,000 STEREO TAPES, 25c. Includes Pop, Rock, Jazz, Opera, Folk, Country and Western, Classical, Spoken Word, catalogued by category and artist. A complete new entertainment guide that's a must for every owner of an open reel, 8-track cartridge, or cassette player/recorder. Send coin, check, or money order to Ampex Stereo Tapes, ATTN: Dept. 120, 2201 Lunt, Elk Grove Village, Illinois, 60007.

services

RENT 4-TRACK OPEN REEL TAPES—ALL MAJOR labels—3,000 different—free brochure. Stereo-Parti, 57 St. James Drive, Santa Rosa, Cal. 95401.

STEREO TAPE RENTAL FOR PARTICULAR PEOPLE, Free catalog. Gold Coast Tape Library, Box 2262, Palm Village Station, Hialeah, Fla. 33012.

new equipment for sale

BUY DIRECT FROM ENGLAND'S HI-FI MAIL ORDER SPECIALISTS! Save money on British and Continental units. Write today for free lists and shipping quotes, or send \$2.00 bill to include catalog (air post \$3.00). Goodwins HiFi, 7 Broadway, Woodgreen, London N. 22, England.

LOW, LOW, PRICES, ON AUDIO EQUIPMENT, L.P. Records and Tapes. All factory fresh, 1st quality items. Trained personnel at your disposal for audio consultation. We accept Mastercharge. Write for FREE CATALOGS to Mr. A, Dept. AMH at SMG DISTRIBUTORS, INC., 46-35 54th Road, Maspeth, N.Y. 11378, or call (212) 786-3337.

OVER 20 YEARS SUCCESSFUL DISCOUNTING OF AUDIO EQUIPMENT insures best value and service. Specialize in Stereo Components, Tape Recorders, Cassettes, Magnetic Cartridges, Sleep Learn Equipment, etc. LOW QUOTES, FREE CATALOG. DRESSNER, 1523B, Jericho Turnpike, New Hyde Park, New York 11040.

miscellaneous

SLEEP-LEARNING—HYPNOTISM! TAPES, RECORDS, books, equipment. Also Alpha Brainwave Feedback devices. Free catalog. Autosuggestion, Box 24-F, Olympia, Washington 98501.

SCOTCH TAPES. CASSETTES—CARTRIDGES—REELS. Catalog 10c. Tower, Lafayette Hill, Pa. 19444.

OPERA TAPES—GREAT PERFORMANCES OF PAST 35 years. Free catalog. Ed Rosen, P.O. Box #97, Freeport, N.Y. 11520.

OLD RADIO PROGRAMS ON CASSETTES OR REELS. THOUSANDS OF YOUR FAVORITES LIVE AGAIN. LOW PRICES, HIGH QUALITY. CATALOG 50c. REMEMBER RADIO, INC., BOX 2513, NORMAN, OKLA. 73069.

GOLDEN AGE RADIO—Your best source for radio tapes. Box 8404-J, Olivette, Missouri 63132.

KLIPSCH, JBL, TANNOY, MARANTZ, THORENS, RABCO. No discounting. Superior Sound, 1801 Brewerton Rd., Syracuse, N. Y. 13211.

SCOTCH TAPE #150, 1800 Foot, 7 inch reel, Polyester, \$1.95 postpaid, 22.50 DOZEN (48 @ 1.75). Recorders, Cassettes, Open Reel Music Tapes (100-page DISCOUNT CATALOG 25c). SAXITONE TAPE SALES, 1776 Columbia Road, Washington, D.C. 20009.

Most amazing show ever produced for Radio. Now on Cassette. Free brochure. "Incredible, But True!" Sawyer. Michigan 49125.

Stereo needles diamond needles \$3.95 postpaid. Don Galade Music, P.O. Box 563, Hazelton, Pa. 08201.

MEMOREX recording tape; audio & video, lowest prices. Write for free information. BERGETZ SYSTEMS CO., Box 1181, Melrose Park, Ill. 60161.

LET'S PRETEND and other full length old radio programs on LP records. RADIO; Dept. HF; Box 844; Orange, Conn., 06477.

RENT STEREO TAPES \$1.50 week, Postpaid—new. Catalog 25c. Tape Library, Box 8126, Washington, O.C. 20024.

ANY RECORD, ANY TAPE AT LOWEST DISCOUNT PRICES. Enroll in Saturnian Record Club. \$1.00. Lifetime Membership Fee brings you a Free Schwann Catalogue and Forms for immediate ordering of any record at unmatchably low prices. No minimum, no limit. Write Saturnian Record Club, 507 Fifth Ave., N.Y.C. 10017, Box H F.

AUDIO BUFFS who build their own are wildly enthusiastic about The Audio Amateur, new quarterly exclusively dedicated to audio as craft. \$5.00 a year; prospectus free. Audio Amateur, 307B Dickinson, Swarthmore, Pa. 19081.

wanted to buy

CASH FOR UNWANTED STEREO LPS AND PRECORDED TAPES. Reder, 81 Forshay Road, Monsey, New York 10952.

WANTED: University Model S-8 "Classic" or Model S-7 Dean 3-Way Deluxe Speaker System. Phone 717-246-1121 Collect.

the tape deck

BY R.D. DARRELL

My (Other) Country. The late President Kennedy's claim to co-citizenship in beleaguered Berlin may have been partly political in motivation. But aesthetic or spiritual affinities must primarily explain why so many American musicians and music lovers feel truly "at home" in Paris or Vienna—cities they may or may not have visited in the flesh but where they regularly live in their imaginations. Often such affinities are inherited or implanted by teachers or friends, but in my own case I can't offer a logical reason for the overpowering sense of *déjà connu* that I experienced when I visited the city of Prague for no more than a few days a couple of years before World War II. I knew no one there or from there; as far as I know I can't claim that any Czech blood flows in my veins; yet ever since then the conviction that I had found a second homeland has poignantly enhanced the very special magic always exerted on me by the music of Dvořák, Janáček, and other Czech composers, but most especially Bedřich Smetana.

In this country Smetana's works, apart from his operas, may not have fared too badly on discs, but the tape repertory is wretchedly inadequate except for Artia's Prague-produced *Bartered Bride* in a 1968 Ampex reel edition which is still in print. While there are several tape versions of the ever popular *Vltava* (*The Moldau*), most of them are unidiomatic; and in any case no performance of this tone poem in isolation suggests the greater stature it achieves when heard in proper context as the second section of Smetana's orchestral masterpiece, *Má Vlast* (*My Country*). This cycle of six musical poems begins with the arrestingly bardic *Vyšehrad* (*The High Castle*), which is followed by *Vltava*; then by a saga of the Czech Amazon *Sárka*; the pastoral *Z českých luhů a hájů* (*From Bohemia's Meadows and Forests*); and the linked *Tábor* and *Blaník* epiphanies of the ancient Hussite warriors who will emerge sometime from their mountain fastness to free their (now again!) enslaved country.

My certainty that this great cycle deserves to be far more widely known, as well as my personal admiration of it, prompts my welcoming the first complete tape version (Deutsche Grammophon 3581 008, double-play cassette, \$10.95) with only *pro forma* mention of what are for me only relatively minor blemishes in the present recorded performance. Rafael Kubelík's reading is as authoritative as ever, if scarcely as infectiously spirited as in his still well-remembered Chicago mono-LP set of

1953. Similarly, the Bostonians play beautifully if often more dutifully than enthusiastically. And some listeners may be more bothered than I am by the unnatural combination of markedly close-up vividness and highly reverberant acoustic spaciousness in what is nevertheless highly impressive recording. No one needs to close his ears to such flaws, or to the un-Dolbyized cassette's characteristic surface noise. But anyone who allows these trifles to prevent his owning—and coming to know by heart—Smetana's masterpiece is cheating himself right out of an incomparable musical experience.

Straussian Personae: Lover, Rogue, Philosopher. Confirming an earlier recording success, Henry Lewis again proves that it's still possible for a young conductor to find and exploit distinctively individual new approaches to such symphonic "standards" as the Richard Strauss tone poems—works which one had thought played and recorded to death by all the supreme maestros of our times. This time Lewis tackles *Don Juan* and *Till Eulenspiegel's Merry Pranks*, and again his readings are highly personal, ultraromantic, and sometimes dangerously leisurely. For some tastes his *Don* may have grown too portly and his *Till* too sophisticated. But whatever

ADVERTISING INDEX
is on page 84.
READER SERVICE CARDS
appear on pages 35 and 85.

one's reactions to the interpretative novelties here, every true audiophile will surely be intoxicated by the sheer sonic richness with which the Phase-4 engineering apotheosizes the master orchestrator's color and sonority alchemies (London/Ampex L 75054, 7½-ips reel, \$7.95; also M 94054, Dolbyized cassette, and M 95054, 8-track cartridge, \$6.95 each).

The Lewis/Phase-4 Dolbyized version of Strauss's *Also sprach Zarathustra* (included in my August 1971 selection of outstanding "demonstration" cassettes) was the slowest reading I've ever encountered, requiring a couple of minutes more than the Eulenberg miniature score's estimate of thirty-three to thirty-four. In startling contrast, the fastest record now is set well below that norm—some seven minutes less than Lewis requires—by William Steinberg with the Boston Symphony (Deutsche Grammophon 3300 185, cassette; also 89 436, 8-track cartridge; \$6.98 each). Yet, oddly enough, Steinberg's performance is so sober in most respects, so tautly controlled, and so free from any impression of hurry that one realizes it is "fast" only by actual timing. For many impression-

able audiophiles it will lack the specularity they found in the Lewis and other earlier versions; and many Straussians may miss at least some of the dramatic grandeurs of the ever incomparable Reiner/Chicago versions. But seldom has any interpretation been better integrated or made a more convincing case for the work's protagonist as a Nietzschean philosopher. And, apart from the perspective ambiguities noted in R. C. M.'s review of the disc edition last December, the recording does justice to some magnificent Bostonian playing. Here, for once, even the first of the midnight chimes is clearly audible in the thunderous tutti just before the enigmatic ending. And the cassette processing seems to have lost none of the mastertape's brilliance and power, although its admission of some surface noise in the quietest passages makes one regret the absence of Dolbyization.

Filmscore Classics—of Sorts. The famous early stereophonic soundtrack of Disney's *Fantasia* still has some historical interest despite its aging and the abominable editing of its Buena Vista disc (and cassette) edition. But to release other performances of the *Fantasia* selections—authentic even to limiting the Beethoven *Pastoral* to three movements and Stravinsky's *Sacre* to Part I as in the film—is ridiculous. Yet RCA goes on to delete even these two already truncated major items, along with a couple of Tchaikovsky *Nutcracker* Suite movements, in trimming their original two-disc edition for single-length tape editions (RCA Red Seal RK 1214 cassette, R8S 1214 8-track cartridge; \$6.95 each). Yet even as I righteously anathematize such shenanigans, I must admit that any sucker-buyer of these "Greatest Hits from *Fantasia*" will get—in jarring juxtaposition and maddening miscellaneity—a superb Dukas *Sorcerer's Apprentice* (by Steinberg and the Bostonians), plus the impressively brilliant Ozawa/Chicago Mussorgsky *Night on Bald Mountain*, the Ormandy/Philadelphia Ponchielli *Dance of the Hours*, and the Bach-Ormandy Toccata and Fugue in D minor. Also included are the Shaw Chorale's Schubert *Ave Maria* and Fiedler's technically aged *Nutcracker* excerpts. So, proceed at your own risk!

Of all scores written specifically for films, those by Bernard Herrmann must be ranked near if not at the top. His best undoubtedly are those for Hitchcock thrillers, but he is well, if more unevenly, represented in "Music from the Great Film Classics" (London/Ampex M 14144, 8-track cartridge, \$6.95), in which the composer conducts the London Philharmonic in selections from his scores for *Citizen Kane*, *The Snows of Kilimanjaro*, *The Devil and Daniel Webster*, and *Jane Eyre*. ■

Sound like the pro you'd be if you were recording for money instead of love.

If you're serious about tape, the TEAC 3300 is a tape deck you can take seriously.

It'll accept 10½-inch reels, like a professional deck, for up to 6 hours of recorded material. And it has professional features you won't find on any other tape deck for the price. \$499.50.

Like the new Front Panel Bias Switch for the proper selection of bias current and recording equalization for either conventional tapes or the new low noise/high output tapes.

And expanded scale professional-type VU meters for each channel. The wide excursion scales simplify recording at higher (up to 6dB) signal levels, a must when using the new tapes, assuring better signal-to-noise ratio and an expanded dynamic range.

Another is TEAC's unique Edi-Q, an electronic pause control; it interrupts taping but keeps the recording amplifiers on and ready, eliminating recording clicks and tape bounce during quick-start operation.

Of course the 3300 has the kind of professional specs you'd expect from TEAC (after all, we make the professional

systems too) — S/N: 58dB, wow and flutter: 0.06% and frequency response: 25–24,000Hz (± 3dB; 30–20,000Hz) at 7½ ips.

Before you spend your money on any tape deck, spend some time with the TEAC 3300. At your dealer's.



TEAC

TEAC Corporation of America, 7733
Telegraph Road, Montebello, California 90640
TEAC Corporation, 1-8-1 Nishi-Shinjuku,
Shinjuku-ku, Tokyo, Japan
TEAC EUROPE N.V., Kabelweg 45-47,
Amsterdam — W.2, Holland In Canada:
White Electronic Development Corp., Ltd., Toronto

Various head configurations and speeds are available to fit every need.

CIRCLE NO. 70 ON READER SERVICE CARD



The Pacesetter

KENWOOD KR-7070A

**300-WATT (IHF) ■ 3-FET ■ 4-IC ■ XTAL FILTER ■ FM/AM
STEREO RECEIVER with Automatic Tuning and Remote Control**

KENWOOD sets the pace again with this remarkable new stereo receiver that features . . . new automatic tuning with front panel tuning bar and remote tuning with volume control . . . 300 watts (IHF) power to drive three sets of stereo speakers simultaneously with distortion-free, incredibly faithful sound reproduction . . . FM/AM broadcast reception with superb selectivity, capture ratio, sensitivity and spurious response ratio . . . and provisions for expansive sound system with terminals for two tape decks, two record players, aux, mic, three sets of stereo speakers with front panel switch, center channel, separate preamp output and main amp input.

OTHER FEATURES:

- 2 dB Step-type Tone Control and Presence Control ■
- FET, Mechanical Filter AM Tuner Section ■
- Inter-station Muting ■
- Front Panel Dubbing and Headphone Jacks ■
- 20 dB Muting Switch for temporary quiet ■
- Exclusive Phono Inputs for Low Level Output Cartridges of 2mV, .06mV ■
- Exclusive Transistor Protection Circuit (U. S. Pat.) ■

SPECIFICATIONS: AMPLIFIER SECTION — RMS Power Output:

- 110/110 watts @ 4 ohms, 90/90 watts @ 8 ohms, Each Channel Driven □
- 0.5% Harmonic Distortion □ 0.5% IM Distortion □ 12-40k Hz ± 1.5 dB Frequency Response □
- 10-30k Hz Power Bandwidth □ 50 @ 8 ohms Damping Factor □ MAX: +10 dB @ 100 Hz, +5 dB @ 10k Hz; MID: +6 dB @ 100 Hz Loudness Control □ +6 dB @ 800 Hz Presence Control ■
- FM TUNER SECTION: 1.5 uV Sensitivity (IHF) □ 0.4% Harmonic Distortion □ 70 dB Signal-to-Noise Ratio □ 1.5 dB Capture Ratio □ 75 dB Selectivity (IHF) □ 35 dB @ 1k Hz Stereo Separation ■
- AM TUNER SECTION: 15 uV Sensitivity (IHF) □ 30 dB Selectivity (IHF) ■
- DIMENSIONS: 17"W, 6½"H, 15"D □ WT: 40 lbs □ Oiled Walnut Cabinet: SR-77 (optional) □

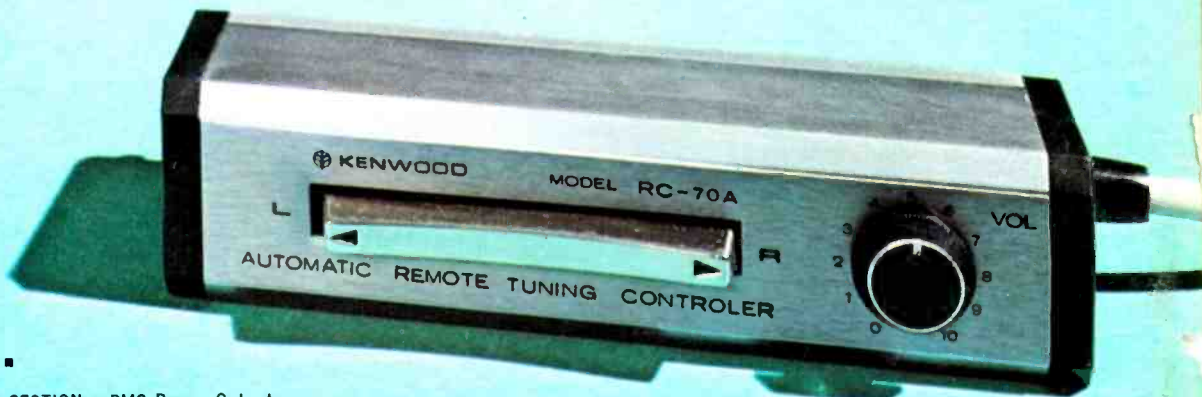

A masterpiece of stereo engineering now
at your nearest Authorized KENWOOD Dealer



the sound approach to quality

KENWOOD

CIRCLE 36 ON READER-SERVICE CARD

15777 So. Broadway, Gardena, Calif. 90248
72-02 Fifty-first Ave., Woodside, N.Y. 11377
In Canada: Magnasonic Canada, Ltd., Toronto,
Ontario; Montreal, Quebec; Vancouver, B.C.