

HIGH FIDELITY®

SEPTEMBER 1971 75¢

LAB TEST REPORTS
 Teac A-24 cassette deck
 Bose 501 speaker system
 Fisher 4-channel receiver
 E-V 4-channel decoder
 Garrard Zero 100 changer

HECNRBUCHHAZGREDZO I DEC 72
 MR DAVID BUCHANAN
 HAZEL GREEN ACADEMY
 HAZFL GREEN KY 41332

Power What You Should Know About Amplifiers

view The Coming Season's Recordings

The New JFK Center
 A Federal Commitment to the Arts at Last?





The new Fisher 401. \$449.95.

a button and move across the FM dial, electronically, silently. Lift up your finger and stop in the exact center of a channel. What could be easier than that?

Remote control is easier.

Remote control isn't new, either. It's available with either the Fisher 500-TX or the Fisher 450-T stereo receivers. But the remote control on those receivers isn't wireless. There's a wire that leads from the receiver to the control unit you hold in your hand.

Tuning a stereo receiver by wireless remote control is new.

Now Fisher is introducing the 401, which ultrasonically extends the push buttons that operate the AutoScan, doing away with the need for wires. We feel that with this innovation we have given the audiophile the best of all possible tuning methods. But of course there's more to a receiver than its tuning conveniences.

The rest of the tuner section.

The tuner section of the 401 is extremely sensitive, thanks to some sophisticated circuitry that uses IC's and FET's to good advantage. And we didn't neglect the AM section. It's capable of making AM sound so close to FM mono that there'll be times when your ears won't be able to tell which band you're listening to.

4-channel compatibility.

The Fisher 401 was designed with the idea that 4-channel stereo is rapidly coming into its own. So we made it easy to adapt to the 4-channel stereo broadcasts we expect will become more and more common in the next year or so. The entire FM multiplex section is com-

plete on a plug-in circuit board, which will be easy to replace with an FM 4-channel adapter, when one of the systems for 4-channel FM transmission now being considered is adopted as an industry standard.

Power.

Fisher receivers have always been known to deliver a lot of power for their price class, and the 401 is no exception.

It has 150 watts of clean, undistorted power, which will drive both a main and a remote pair of speakers (four speakers in all) at concert volume without distorting the music.

Controls.

As you would expect of the world's first receiver with wireless remote-control tuning, the other controls are also quite sophisticated.

Bass and treble controls are of the Baxandall type, allowing you to boost or cut back the extremes of the frequency spectrum without affecting the mid-range.

Even the volume control is special. Instead of turning, it slides, like the kind you'd expect to find in a broadcast or recording studio.

There's also a loudness contour switch, an FM muting switch, a high filter, a balance control and a speaker selector switch.

One convenience feature that you don't often find in a stereo receiver is a front-panel tape-recorder output jack, which lets you hook up a recorder without having to turn the receiver around to get at the back.

The cabinet.

Since the 401 is probably the most luxurious receiver Fisher makes, it

stands to reason it would have a beautiful cabinet. It does. The cabinet, which is included in the \$449.95 price, has an attractive wood-grain finish.

We feel that you should be able to have as attractive a cabinet when you listen to stereo as when you watch TV.

The Fisher 
We invented high fidelity.

Other receivers with remote control.

The Fisher 401 costs \$449.95. But you can buy a Fisher receiver with remote control for even less money than that, if you don't insist on its being wireless. We're talking about the 180-watt Fisher 450-T, at \$399.95. (We're not the only ones who are talking about it. It has received the kind of reviews from High Fidelity, Stereo Review and Audio magazine that we like to quote in an ad.)

If you want a little more power than the 401 can give you, you want the Fisher 500-TX. It has 200 watts of power, provides four methods of tuning: manual, AutoScan, remote control (not the wireless kind), and Tune-O-Matic® push-button electronic tuning that remembers your four favorite stations so you can tune them by pressing a button. The price, \$499.95.

Introducing the worlds first stereo receiver with electronic tuning by wireless remote control.

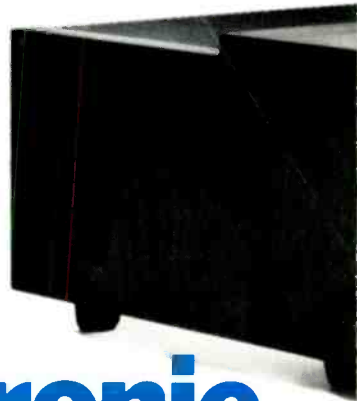

In the past, it has been the makers of television sets who have placed the greatest emphasis on convenience features like wireless remote control.

The hi-fi manufacturers have concentrated their efforts, by and large, on reproducing sound with top fidelity.

But at Fisher we feel that making a product a pleasure to use is almost as important as making it a pleasure to hear. Which is why we created the 401.

A word about automatic push-button electronic tuning.

Electronic tuning is not new. Fisher has been using it for some time now on several Fisher receivers. But though AutoScan® (our name for automatic push-button electronic tuning with no moving parts) is convenient, conveni-

ence was not the reason for including it in a receiver.

The real reason for AutoScan was (and is) that you can tune more accurately with it than you could tune manually, even if you used a meter or a scope. We quote Audio magazine: "AutoScan is probably more accurate in tuning to center of desired channel than can be accomplished manually... Station lock-in is flawless. That is, when the AutoScan stops on a station, it stops on the exact 'center' of that channel."

But the AutoScan, besides being more precise than any other tuning method, is also more convenient. Press



Only 25¢! \$2 value! Send for your copy of The Fisher Handbook, a fact-filled 80-page guide to high fidelity. This full-color reference book also includes complete information on all Fisher stereo components. Enclose 25¢ for handling and postage.*

Fisher Radio, Dept. HF-9, P.O. Box 1367
Long Island City, N.Y. 11101

Name _____

Address _____

City _____

State _____

Zip _____

*Please glue or tape coin on picture of handbook above.

0109711



Introducing the Fisher 390, \$349.95.

Now there's a receiver for less than \$350 that has push-button electronic tuning with no moving parts.

The Fisher 390 has the same FM sensitivity and almost as much power as the 401 (the 390 has 140 watts; the 401 has 150 watts).

And it has Tune-O-Matic push-button tuning which makes it possible for you to pre-select five of your favorite stations, and tune to them instantly, electronically. (Of course the 390 also has the smooth fly-wheel tuning featured in all Fisher stereo receivers.)

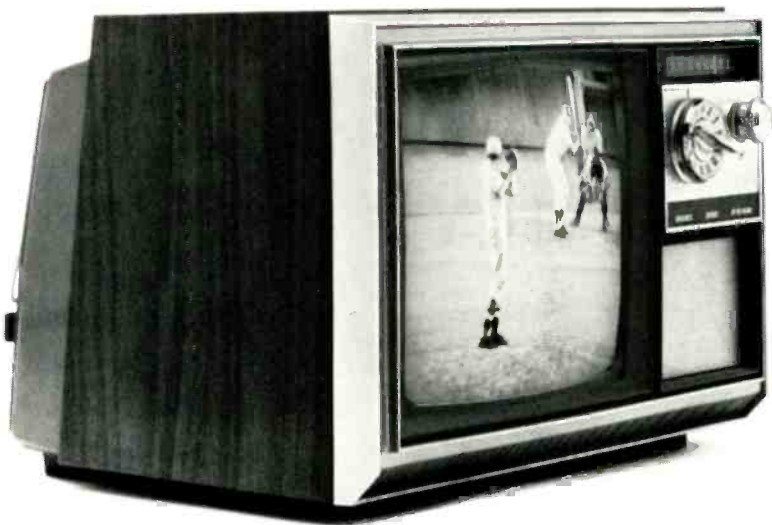

**Fisher believes
you should be just as
comfortable when
you listen to FM as when
you watch TV.**



Playing records with some cartridges is like listening to Isaac Stern play half a violin.



The trouble with some stereo cartridges is that they don't offer even reproduction across the entire musical spectrum. In the important upper audio frequencies, some cartridges suffer as much as a 50% loss in music power.

So, there's a lack of definition in the reproduction of violins, as well as clarinets, oboes, pianos, the organ and other instruments which depend on the overtones and harmonics in the upper frequency range for a complete tonal picture.

The Pickering XV-15 cartridge delivers 100% music power 100% of the time. Which is why we call it "The 100% Music Power Cartridge." At 100% music power, all the instruments are distinct and clear, because the XV-15's

have no music-robbing output drop anywhere in the entire audio spectrum.

Pickering XV-15 stereo cartridges are priced from \$29.95 to \$65.00, and there's one to fit anything you play records with. For more information write: Pickering & Co., Inc., 101 Sunnyside Boulevard, Plainview, N.Y. 11803.

A 50% music power cartridge can mask some musical instruments

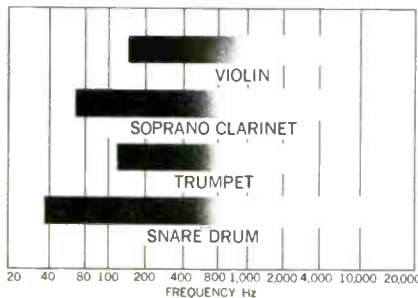

The Pickering XV-15 gives you 100% music power 100% of the time.

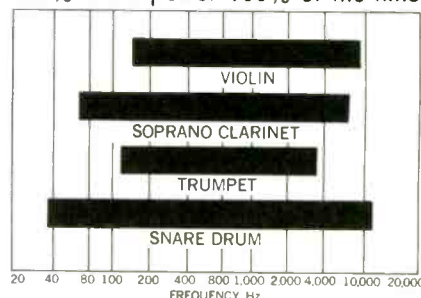

Pickering. The 100% music power cartridge.

"for those who can hear the difference"



September 1971

VOL. 21

NO. 9

music and musicians

- Leonard Marcus **AN INTERNATIONAL CALAMITY** 4
Edward Greenfield, David Hamilton, Karen Monson
BEHIND THE SCENES: LONDON AND LOS ANGELES 13
PREVIEW OF THE NEW FALL RELEASES 24
Byron Belt **JFK CENTER FOR THE PERFORMING ARTS** 52
A Federal commitment to culture?
Charles Briefer **WQXR—THE ANATOMY OF A CASUALTY** 74
A pioneer classical station falls on sorry times

audio and video

- NEWS AND VIEWS** 32
At last: the CBS Stereo/Quadraphonic disc
EQUIPMENT IN THE NEWS 34
EQUIPMENT REPORTS 37
Fisher 701 4-channel receiver . . . Electro-Voice EVX-4 decoder . . .
Garrard Zero 100 turntable . . . Teac A-24 cassette deck . . .
Bose 501 speaker system
Robert Long **INSTANT QUADRIPHONY** 42
How Fisher's 4-channel receiver and E-V's decoder work together
Robert Berkovitz **POWER AMPLIFICATION** 58
It doesn't merely make the signal louder

recordings

- FEATURE REVIEWS** 83
Haydn and Mozart quartets from Hungary
A recorded history of the phonograph
The Met's first Butterfly
Gould, Newman, and Kipnis play Bach
CLASSICAL REVIEWS 88
The other Engelbert Humperdinck . . . Liszt choral music
Peter G. Davis **PHILIPS CONVERTS TO IMPORTS** 100
IN BRIEF 120
POP REVIEWS 122
Blood, Sweat and Tears . . . The Mothers . . . Fiedler and the Pops
JAZZ 129
Stan Kenton's alumni . . . The Original Salty Dogs
R. D. Darrell **THE TAPE DECK** 132
Imported Dolby cassettes . . .
The incomparable Horowitz and Heifetz

etc.

- LETTERS TO THE EDITOR** 8
That extra stereo channel . . . Slighted sound effects
PRODUCT INFORMATION 19
An "at home" shopping service 115
ADVERTISING INDEX 114



Marble monument or musical memorial? See p. 52.



Pumping wattage. See p. 58.

WHAT WILL YOU DO
IN THE
LONG, COLD, DARK, SHIVERY EVENINGS,
WHEN YOUR HEALTH AND CONVENIENCE COMPEL YOU TO STAY
INDOORS?
WHY!!! HAVE A PHONOGRAPH, OF COURSE.



See p. 84.

lpi Published at Great Barrington, Mass. 01230 by Billboard Publications, Inc.
Copyright © 1971 by Billboard Publications, Inc. The design and contents
of High Fidelity Magazine are fully protected by copyright and must not be
reproduced in any manner. Second-class postage paid at Great Barrington and at additional
mailing offices. Authorized as second-class mail by the Post Office Department, Ottawa and
for payment of postage in cash. High Fidelity/Musical America Edition is published monthly.
Subscription in the U.S.A. and its Possessions, \$14; elsewhere, \$15. Subscription including
Concert Artist Directory published in December, \$20 in the U.S.A. and its Possessions; elsewhere,
\$21. Regular issues \$1.25 a copy. National and other editions published monthly. Subscription
in the U.S.A. and its Possessions, \$7.95. Subscription rates for all other countries available on
request. Regular issues: 75¢ a copy, indexed in the Reader's Guide to Periodical Literature.
Current and back copies of High Fidelity and High Fidelity/Musical America available on
microfilm from University Microfilms, Ann Arbor, Michigan 48106. Change of address notices
and undelivered copies (Form 3579) should be addressed to High Fidelity, Subscription
Department, P.O. Box 14156, Cincinnati, Ohio 45214. Please state both old and new addresses
when requesting a change.

An International Calamity

DEAR READER:

As of this coming January 1, according to a New York Public Library announcement, scholars, teachers, students, writers, and researchers from all over the world (and just simply the curious) will find the NYPL's research doors closed. From that date, and barring a miracle, there will be no public access to the music library, the Rodgers and Hammerstein Archives of Recorded Sound, the theater library, or the dance library—all now housed in Lincoln Center—or the science and technology libraries in the main building at Forty-second Street and Fifth Avenue. (The main circulating and branch libraries will remain open.)

This would be a calamity of international proportions, comparable to the destruction of the Alexandria libraries a millennium and a half ago. The New York tragedy may hopefully be less permanent than the Alexandrian, but the NYPL's use, and usefulness, is infinitely greater than the ancient institution's.

The root of this looming evil is, of course, money—not the love of it but the lack of it. Frank Campbell, chief of the Music Division, wrote to us that “the Research Libraries draw their support from three major endowments, i.e., the Astor, Lenox, and Tilden Foundations. (It is a popular misconception that the Library is supported entirely by the City of New York.) Although the Library has annually raised large sums to meet its deficit, it was never enough to avoid dipping into the principal of the endowments.” As a result, “each year the rate of income has been reduced.” The endowments' income is now down to little more than \$3 million annually. New York City provides some \$600,000 a year for maintenance of the central building, New York State has been appropriating \$2.8 million, and fund-raising generally brings in another \$800,000. This still leaves the NYPL some \$2 million short each year. Thus the dip into principal. Last year the City University of New York provided another million dollars, but as of this writing there is doubt that it will continue to do so. Unless CUNY, or someone, can scrape up the million for operating expenses, foundations are loath to give anything to modernize the facilities or conserve the treasures. (Operating expenses themselves are apparently not glamorous enough to entice foundations.)

Although the NYPL is not encouraging donations earmarked for any particular research library, it can hardly refuse them—although there is little likelihood that any of the Lincoln Center arts libraries will open unless the music library, its major component, also operates. This would take \$250,000 annually. The R&H Archives of Recorded Sound would need another \$100,000 and the theater and dance libraries \$200,000 and \$100,000 respectively.

Certainly the billion-dollar record business, through its spokesman, the Recording Industry Association of America (RIAA), should be able to come up with \$100,000 to keep the R&H Archives alive. It is the permanent documentation of their best efforts, their jewel, their immortality. (And just think of the promotional benefits that would accrue to such an action.)

Of course if the Federal Government would contribute the equivalent of, say, two tanks, the entire international calamity of the NYPL's research bibliocide could be averted.

Next month is our annual **NEW PRODUCTS ISSUE**. And if you are willing to go in for some older equipment for yourself or your children, you can learn how to **AMASS A STATE-OF-THE-ART COMPONENT SYSTEM FOR \$10**. The October issue will also contain a publishing coup: **THE UNPUBLISHED MEMOS OF CHARLES IVES**. And if you've never read any of the old Yankee iconoclast's Menckenesque diatribes—you ain't read nuthin'.



LEONARD MARCUS
Editor

NORMAN EISENBERG
Executive Editor

PETER G. DAVIS
Music Editor

ROBERT LONG
Audio-Video Editor

SHIRLEY FLEMING
Editor, Musical America Section

EDITH CARTER
Associate Editor

SHEILA SCHULTZ
Assistant Editor

ROY LINDSTROM
Art Director

ROBERT MADDOCKS
Associate Art Director

RUTH W. DUNTON
Production Editor

MORGAN AMES
R. D. DARRELL
ALFRED FRANKENSTEIN
JOHN GABREE
HARRIS GOLDSMITH
DAVID HAMILTON
PAUL HENRY LANG
MICHAEL JAHNS
GENE LEES
ROBERT C. MARSH
GEORGE MOVSHON
H. C. ROBBINS LANDON
Contributing Editors

MILTON GORBULEW
Circulation Director

STANLEY BINDER
Circulation Manager

CLAIRE N. EDDINGS
Assistant Publisher and
Director of Advertising Sales

WARREN B. SYER
Publisher

ADVERTISING

Main Office: Claire N. Eddings, The Publishing House, Great Barrington, Mass. 01230. Telephone: 413-528-1300.

New York: 165 W. 46th St., New York, N.Y. 10036. Telephone: 212-757-2800. Seymour Resnick, Eastern Ad. Mgr.

Chicago: Billboard Publications, Inc., 150 North Wacker Dr., Chicago, Ill. 60606. Telephone: 312-236-9818. Leonard Levine.

Los Angeles: Billboard Publications, Inc., 9000 Sunset Blvd., Los Angeles, Calif. 90069. Telephone: 213-233-1555. Andrew Spanberger.

Nashville: Billboard Publications, Inc., 1719 West End Ave., Nashville, Tenn. 37203. Telephone: 615-329-3925. Robert Kendall.

London: 7 Carnaby St., London W.1, England. Telephone: (01) 437-8090. Andre de Vekey.

Frankfurt/Main: Eschersheimer Landstrasse 69, Frankfurt/Main, West Germany. Telephone (0611) 590805-6. Walter B. Rios.

Milan: Piazzale Loreto 9, Milan 20131, Italy. Telephone: 28.29.158. Germano Ruscitto.

Tokyo: Japan Trade Service, Ltd., Ikejiri 3-1-1-1008, Setagaya-ku, Tokyo, Japan. Telephone: 413-2871. Kanji Suzuki.



A Marantz speaker system breaks up that old gang of yours.

Separation of sound is a true test of a speaker system. And to put Marantz—or any speaker—to the test you should listen to something you are already familiar with so you'll be able to hear for yourself that it's the speaker and not the recording that makes the difference. Oh, what a difference Marantz makes! What you thought were two oboes are now clearly an oboe and a flute and that barbershop quartet... well, they're really a quintet.

Let's face it: most speakers look the same, most speakers have an impressive list of specifications and ALL—ALL—ALL speakers claim to be the very A-1 HOT SHOT MOSTEST BEST.

But the proof is in the listening. And that's where the Marantz Imperial 5 comes in. The Imperial 5 is engineered to handle a plethora of continuous RMS power and has an acoustic

suspension woofer and tweeter with a fantastic off-axis response and a 3-position high frequency control and costs just \$89 and gives you true stereo separation anywhere in the room and is, for the money, truly the very A-1 HOT SHOT MOSTEST BEST.

But on paper so is theirs.

However keep this in mind. Marantz speaker systems are built by the makers of the most expensive stereo equipment in the world. And exactly the same quality that goes into Marantz receivers and Marantz amplifiers goes into the Marantz Imperial 5 speaker system.

To find out how much better it sounds, listen. That's all we ask. Listen. Then ask about the big savings on a complete Marantz system.

marantz.
We sound better.



Free... ANY 3 STEREO LP's or WITH ABSOLUTELY NO OBLIGATION

 41213 JESUS CHRIST SUPERSTAR Superstar (2 record set) Decca LP, 8TR, CASS	 68030 CROSBY, STILLS, NASH & YOUNG 4 Way Street (2 record set) Atlan LP, 8TR, CASS	 66838 ELTON JOHN 11-17-70 Uni LP, 8TR, CASS	 66760 JAMES TAYLOR Original Flying Machine Eupho LP	 33184 DIONNE WARWICK Very Dionne Scept LP, 8TR, CASS	 66738 NEIL DIAMOND Tap Root Manuscript Uni LP, 8TR, CASS	 68023 WOODSTOCK Two (2 record set) Cotil LP, 8TR, CASS
 67517 THREE DOG NIGHT Golden Biscuits Dunhi LP, 8TR, CASS	 48801 JAMES GANG Thirds ABC LP, 8TR, CASS	 50506 BUFFY SAINTE-MARIE Wanna Be A Ballerina Vangu LP, 8TR, CASS	 33179 DIONNE WARWICK I'll Never Fall In Love Again Scept LP, 8TR, CASS	 41217 BERT KAEMPFERT Orange Colored Sky Decca LP, 8TR, CASS	 33185 JOSEPH & THE AMAZING TECHNICOLOR DREAMCOAT Scept LP, 8TR, CASS	 38373 IKE & TINA TURNER Workin' Together Liber LP, 8TR, CASS
 33093 IAN & SYLVIA Greatest Hits (2 record set) Vangu LP	 44214 FOUR SEASONS 2nd Gold Vault of Hits Philii LP, 8TR, CASS	 33108 FLIP WILSON Pot Luck Scept LP, 8TR, CASS	 44776 FERRANTE & TEICHER Music Lovers UniAr LP, 8TR, CASS	 44761 BOBBY GOLOS-BORO Watching Scotty Grow UniAr LP, 8TR, CASS	 33092 BEST OF BUFFY SAINTE-MARIE (2 record set) Vangu LP	 44384 PAUL MAURIAT El Condor Pasa Philii LP, 8TR, CASS
 44383 MYSTIC MOODS Country Lovin' Folk Philii LP, 8TR, CASS	 75002 JACKSON 5 Maybe Tomorrow Motow LP, 8TR, CASS	 66782 BILL COSBY When I Was A Kid Uni LP, 8TR, CASS	 12121 3 CENTURIES OF MILITARY MUSIC Pirou LP, 8TR, CASS	 34526 PATTON Original Soundtrack TweCe LP, CASS	 42989 EL CHICANO Revolucion Kapp LP, 8TR, CASS	 33186 GUESS WHO In Canada Scept LP, 8TR, CASS
 33134 B. J. THOMAS Greatest Hits Vol. 1 Scept LP, 8TR, CASS	 42780 LED ZEPPELIN III Atlan LP, 8TR, CASS	 21551 BEETHOVEN Piano Sonatas Yorks LP, 8TR, CASS	 44773 VENTURES New Testament UniAr LP, 8TR, CASS	 33182 SUSAN SINGS SESAME STREET Scept LP, 8TR, CASS	 28082 TREASURY OF GREGORIAN CHANTS Yorks LP, 8TR, CASS	 33183 B. J. THOMAS Most of All Scept LP, 8TR, CASS
 65793 BREWER & SHIPLEY Tarkio KamSu LP, 8TR, CASS	 33099 PDQ BACH The Stoned Guest Vangu LP, 8TR, CASS	 42784 STEPHEN STILLS Atlan LP, 8TR, CASS	 44757 BEST OF GORDON LIGHTFOOT UniAr LP, 8TR, CASS	 65775 VERY BEST OF LOVIN' SPOONFUL KamSu LP, 8TR, CASS	 21537 TCHAIKOVSKY 1812 Overture Yorks LP, 8TR, CASS	 67519 STEPPENWOLF Gold Dunhi LP, 8TR, CASS
 21633 RED ARMY ENSEMBLE Yorks LP, 8TR, CASS	 42988 ROGER WILLIAMS Love Story Kapp LP, 8TR, CASS	 37833 ROD MCKUEN In The Beginning Sunse LP, 8TR	 65784 MELANIE Leftover Wine Budda LP, 8TR, CASS	 65796 CAL TJADER Tjader-Ade Budda LP, 8TR, CASS	 21597 RIMSKY-KORSAKOV Scheherazade Yorks LP, 8TR, CASS	 33065 JOAN BAEZ David's Album Vangu LP, 8TR, CASS

RECORD CLUB OF AMERICA - The World's Lowest Priced Record and Tape Club

ANY 1 TAPE Cartridge or Cassette SHOWN HERE Worth up to \$20.94 TO BUY ANYTHING EVER!

Yes, take your pick of these great hits right now! Choose any 3 Stereo LPs (worth up to \$20.94) or any 1 Stereo Tape (cartridge or cassette, worth up to \$13.96) FREE... as your welcome gift from Record Club of America when you join at the low lifetime membership fee of \$5.00. You can defer your selection of FREE items and choose from an expanded list later if you can't find 3 LPs or 1 Tape here. We make this amazing offer to introduce you to the only record and tape club offering guaranteed discounts of 33 1/3% to 79% on all labels—with no obligation or commitment to buy anything ever. As a member of this one-of-a-kind club you will be able to order any record or tape commercially available, on every label—including all musical preferences. No automatic shipments, no cards to return. We ship only what you order. Moneyback guarantee if not satisfied.

See for yourself why over 1 1/4 million record and tape collectors paid \$5 to join Record Club of America when other record or tape clubs would have accepted them free.

Compare and see!	Citadel Record Club (as adv. in TV Guide Oct. 3, 1970)	Columbia Stereo Tape Cartridge Service (as adv. in Esquire Nov. 1970)	Capitol Record Club (as adv. in Look Jan. 26, 1971)	Columbia Record Club (as adv. in Playboy Feb. 1971)	RCA Stereo 8 Tape Club (as adv. in Esquire Oct. 1970)	RECORD CLUB OF AMERICA
CAN YOU CHOOSE FROM ALL LABELS* LPS OR TAPES INCLUDING CARTRIDGE AND CASSETTE TAPES?	NO	NO	NO	NO	NO	YES! Choose any LP or tape on any label! No exceptions! Over 300 different manufacturers including Capitol, Columbia, RCA, Anzani, London, etc.
MUST YOU BUY A "MINIMUM" NUMBER OF RECORDS OR TAPES? HOW MANY?	12	12	12	10	6	NONE! No obligations! No yearly quota! Take as many, as few, or nothing at all if you so decide!
HOW MUCH MUST YOU SPEND TO FULFILL YOUR LEGAL OBLIGATION?	\$59.76 to \$71.75	\$83.76 to \$95.40	\$59.76 to \$71.76	\$49.80 to \$59.80	\$41.70 to \$47.70	ZERO DOLLARS You don't have to spend a penny—because you're never "legally obligated" to buy even a single record or tape!
CAN YOU BUY ANY RECORD OR TAPE YOU WANT AT A DISCOUNT?	NO	NO	NO	NO	NO	ALWAYS! Your discount up to 79% OFF! Guaranteed never less than a third! No exceptions!
DO YOU EVER RECEIVE UNORDERED RECORDS OR TAPES?	YES	YES	YES	YES	YES	NEVER! There are no cards which you must return. Only the records and tapes you want are sent—and only when you ask us to send them.
HOW LONG MUST YOU WAIT FOR SELECTIONS TO ARRIVE?	5 to 6 weeks	5 to 6 weeks	5 to 6 weeks	5 to 6 weeks	5 to 6 weeks	NO LONG WAITS! Your order processed same day received. No shipping on cycle.

AT LAST A RECORD AND TAPE CLUB WITH NO "OBLIGATIONS"—ONLY BENEFITS!

Ordinary record and tape clubs make you choose from a few labels—usually their own! They make you buy up to 12 records or tapes a year—usually at list price—to fulfill your obligation. And if you forget to return their monthly card—they send you an item you don't want and a bill for \$4.98, \$5.98, \$6.98, or \$7.98! In effect, you may be charged almost double for your records and tapes.

BUT RECORD CLUB OF AMERICA ENDS ALL THAT!

We're the largest all-label record and tape club in the world. Choose any LP or tape (cartridges and cassettes), including new releases. No exceptions! Take as many, or as few, or no selections at all if you so decide. Discounts are GUARANTEED AS HIGH AS 79% OFF! You always save at least 33 1/3%. You get best sellers for as low as 99¢.

NO AUTOMATIC SHIPMENTS

With our Club there are no cards which you must return to prevent shipment of unwanted LPs or tapes (which you would have to return at your own expense if you have failed to send written notice not to ship). The postage alone for returning these cards each month to the other clubs cost almost an additional \$2.40. We send only what you order.

HOW CAN WE BREAK ALL RECORD AND TAPE CLUB RULES?

We are the only major record and tape club NOT OWNED... NOT CONTROLLED... NOT SUBSIDIZED by any record or tape manufacturer anywhere. Therefore, we are not obliged by company policy to push any one label. Nor are we prevented by distribution commitments from offering the very newest LPs and tapes.

SPECIAL INTRODUCTORY MEMBERSHIP OFFER

Join RECORD CLUB OF AMERICA now and take advantage of this special Introductory Membership Offer. Choose any 3 LPs or any 1 tape shown here (worth up to \$20.94) and mail coupon with check or money order for \$5.00 membership fee

(a small handling and mailing fee for your free LPs or tapes will be sent later). If you can't find 3 LPs or 1 tape here, you can defer your selection and choose from expanded list later. This entitles you to LIFETIME MEMBERSHIP—and you never pay another club fee. Your savings have already more than made up for the nominal membership fee.

HOW YOU CAN CHARGE IT

If you prefer, you may charge your membership to one of your credit cards. We honor different plans. Check your preference and fill-in your account number on the coupon.

LOOK WHAT YOU GET

- **FREE Lifetime Membership Card**—guarantees you brand new LPs and tapes at discounts up to 79%... Never less than 1/3 off.
- **FREE Giant Master LP and Tape Catalog**—lists thousands of all readily available LPs and tapes (cartridges and cassettes) of all labels (including foreign)... all musical categories.
- **FREE Disc and Tape Guide**—The Club's own Magazine, and special Club sale announcements which regularly bring you news of just-issued new releases and "extra discount" specials.
- **FREE ANY 3 Stereo LPs or any 1 Tape** shown here (worth up to \$20.94) with absolutely no obligation to buy anything ever!

GUARANTEED INSTANT SERVICE

All LPs and tapes ordered by members are shipped same day received (orders from the Master Catalog may take a few days longer). ALL RECORDS AND TAPES GUARANTEED—factory new and completely satisfactory or replacements will be made without question.

MONEY BACK GUARANTEE

If you aren't absolutely delighted with our discounts (up to 79%)—return items within 10 days and membership fee will be returned AT ONCE! Join over two million budget-wise record and tape collectors now.

TYPICAL "EXTRA DISCOUNT" SALE

\$4.98 LPs average as low as \$1.96
\$5.98 LPs average as low as \$2.25
\$6.98 LPs average as low as \$2.56

Savings of 63% or more from recent Club sales up to \$4.42 per LP. Start these giant savings now... not after you fulfill your obligation like the other clubs.

	Label	List Price	Average Club Price
Andy Williams—Love Story	Colum	5.98	2.25
Anne Murray	Capit	5.98	2.25
Ed Ames—This Is	RCA	6.98	2.56
2001—A Space Odyssey	MGM	6.98	2.56
Mary Travers—Mary	WarBr	4.98	1.96
Creedence Clearwater Revival			
—Pendulum	Fanta	4.98	1.96
Miles Davis—Bitches Brew	Colum	5.98	2.25
Love Story—Soundtrack	Param	5.98	2.25
Perry Como—It's Impossible	RCA	5.98	2.25
Bloodrock—3	Capit	5.98	2.25

NOW YOU CAN CHARGE IT, TOO!



RECORD CLUB OF AMERICA
CLUB HEADQUARTERS
YORK, PENNSYLVANIA 17405 X9107

Yes—Rush me a lifetime Membership Card, Free Giant Master LP & Tape Catalog, and Disc & Tape Guide at this Special Membership Offer. Also send me the 3 FREE LPs or 1 FREE tape which I have indicated below (with a bill for a small mailing and handling charge). I enclose my \$5.00 lifetime membership fee. This entitles me to buy any LPs or tapes at discounts up to 79%, plus a small mailing and handling charge. I am not obligated to buy any records or tapes—no yearly quota. If not completely delighted I may return items above within 10 days for immediate refund of membership fee.

3 FREE LPs

or 1 FREE TAPE 8 track cassette

or Defer Selection—send expanded list.

Mr. _____
Mrs. _____
Miss _____
Address _____
City _____ State _____ Zip _____

All Servicemen write Soc. Sec. # _____
CHARGE IT to my credit card. I am charging my \$5.00 membership (mailing and handling fee for each FREE LP and tape selected will be added).
Check one: Diners Club Master Charge
 American Express BankAmericard
Acct. # _____ Expiration Date _____
Signature _____

Canadians: mail coupon to above address. Orders to be serviced from Canada.

© Record Club of America #57

RECORD CLUB OF AMERICA—The World's Largest Record and Tape Club

CIRCLE 46 ON READER-SERVICE CARD

An infinite choice of speeds.

The variable control Lenco manual turntables offer an infinite selection of speed—a continuous sweep from 30 to 86 rpm. At the standard 16-2/3, 33-1/3, 45 or 78.26 rpm, there are click stops that can be precisely set or adjusted at any time.

With this, you can slow down a complex rush of notes, the better to appreciate the inner voices when you listen next at normal speeds. You can tune a recorded orchestra to match the instrument you play, and join in. Your tuning is not restricted to a paltry fraction of a note, either. You can exercise your urge to conduct, choosing whatever tempo suits you. And you can use it to extend your knowledge of the dance or language, or to accompany your slide or movie shows.

And at every one of these speeds, Swiss precision takes over. For example, the Lenco L-75's sleekly polished transcription tonearm shares many design concepts (such as gravity-controlled anti-skating, hydraulic cueing, and precision, knife-edge bearings) with arms costing more alone than the entire L-75 arm and turntable unit. And the dynamically balanced 8.8 lb. turntable reduces rumble, wow and flutter to inaudibility.



The L-75 complete with handsome walnut base at \$99.50 offers professional quality and versatility but at far less than studio-equipment prices. The B55 (lighter platter and an arm of almost equal specification) is only \$85.00 with base. Both are available now at your Benjamin/Lenco dealer. Benjamin Electronic Sound Corporation, Farmingdale, N.Y. 11735, a division of Instrument Systems Corporation.

Lenco turntables from Benjamin

CIRCLE 15 ON READER-SERVICE CARD

letters

Dynamic Dynaquad

I am writing in reference to the fine article by Morley Kahn, "Uncover Extra Stereo Channels" [June 1971]. I have been following the progress of quadrisonic stereo for some time, and I must admit the so-called Dynaquad method appeared to be the least promising. Your January 1971 issue described Dynaquad, along with its counterparts, and encouraged experimentation. I had been meaning to do just that, but was finally prodded into experimenting with the method after reading Mr. Kahn's article.

To my surprise the results were fascinating. I had never realized how much I had been missing by playing my records through a conventional (two-speaker) system. Mr. Kahn mentioned the Blood, Sweat and Tears *Spinning Wheel* as being a particularly effective cut. I was not especially impressed with this selection, but the entire first album by the group, "Child is Father to the Man," exhibited a whole new dimension when played through the Dynaquad system. Others I found to be effective were "On the Threshold of a Dream" by the Moody Blues, particularly *Are You Sitting Comfortably?*; the Crosby/Stills/Nash *Wooden Ships*, and *49 Bye-Byes*; *Tommy* by The Who; and finally, the cut that I found to be the most enhanced, George Harrison's *What Is Life?* from his "All Things Must Pass."

I noticed, however, that there are a few drawbacks. First, on certain records the amplitude of the vocal track was cut considerably (usually when it was recorded monophonically and not being reproduced in the rear speaker). When I disconnected the differential speaker, the volume returned to normal. I would appreciate your thoughts on this.

Second, the differential effect of reproducing the left-minus-right signal has a nullifying effect with records that make use of a dynamic, or moving stereo effect (shooting the signal or portions of the recording from the left channel to the right, and vice versa). The Dynaquad method reproduces the "movement" as if it is coming from one source only, the rear speaker. The effect is distracting—as in *Whole Lotta Love* or "Led Zeppelin II," for example.

These flaws notwithstanding, the Dynaquad method is a fascinating concept. If nothing else, it opens a previously unknown dimension to those of us who will not be able to convert our present systems to four-channel stereo.

Lewis T. Rogers
Albany, N. Y.

Without knowing more specifically what program material Mr. Rogers was using and what techniques may have been employed in preparing it for disc—or about his room and the placement of his speakers within it—it's difficult to determine just why he hears the effects he reports. Our experience with Dynaquad hook-ups does not tend to confirm those impressions; indeed the "bumble bee" that flies through the room in one cut of the Pink Floyd album cited in Mr. Kahn's article really does move with startling realism in a good room with good speaker placement and balance. We don't wish

to imply from this that our setup was right and Mr. Rogers' was wrong, however, The techniques with which we are dealing here are still essentially experimental, and their results largely unpredictable in many details. Therein lies their fascination for anyone willing to go beyond a purely passive approach to high fidelity. Since Mr. Rogers is one such reader, we say more power to him.

Opera for the People

I would like to second the recommendations for new Strauss opera recordings made by Mr. Córdova in his letter to HIGH FIDELITY published in May 1971. I only wish he had included a plea for *Die schweigsame Frau*, another score that deserves a recorded performance.

Thinking over the implications of Mr. Córdova's letter, it occurs to me that despite the fact that records are supposed to be a consumer product, the consumer's wishes are never solicited. When a recording company embarks on a worthwhile project with enthusiasm and taste (witness the recent *Troïens* of Berlioz), the results seem to be financially successful, but these enterprises are all too few. Why don't we have a *Benvenuto Cellini*, or a *Vespri Siciliani*, a good modern recording of *Guillaume Tell* or *The Flaming Angel*? And what possible logic is there behind another RCA *Aida* or another *Ballo in maschera* from London?

I would like to suggest that HIGH FIDELITY take up the function of serving as a regular channel for consumer suggestions for new recordings. Responsible and imaginative suggestions made to your editorial board by readers for specific recordings could be screened and presented to a panel of a & r men representing the major classical recording labels once or twice a year at a round-table discussion; the discussion itself could be published as an article in the magazine. In that way we might all learn a good deal about the realities of the recording business, and the companies might hopefully come to take an increased responsibility toward satisfying the public's desires.

J. Thomas Rimer
Clayton, Mo.

Slighted Sound Effects

Re the article on sound effects by Eugene Endres in your June 1971 issue ["There's a Tweeter in My Tweeter"], we feel that Mr. Endres did our company a great disservice by glossing over our contribution to the sound-effects industry. For that reason we think that some points in the article should be corrected.

1) Gennett Records was the first in the industry to produce sound effects on records, not Folkways Records. Gennett began in 1931 and produced until 1936. It should be noted that Thomas J. Valentino, Sr., did most of the recording for them during this time.

2) Our label, Major Records, started producing sound-effects records in 1934 before companies like Folkways, Audio Fidelity, and Elektra were formed.

3) We do not produce "some" sound-

Continued on page 12

NOW... YOUR CHOICE!

7 RECORDS OR CASSETTES OR 8-TRACK CARTRIDGES

\$1.87 (up to \$48.86 Club value)
for only

when you join a Capitol Stereo Music Club and agree to buy only one selection now and just 10 more during the next 12 months.

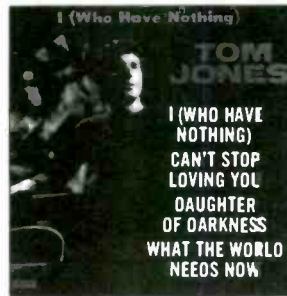

937-48

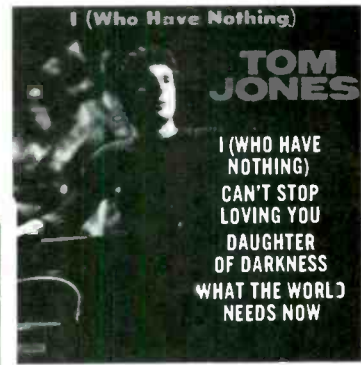

937-48

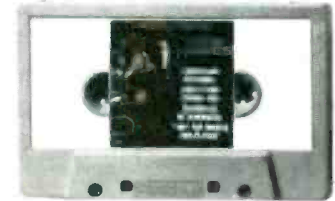

937-48

ENJOY THESE OUTSTANDING MEMBERSHIP BENEFITS!

Start with a fabulous musical bargain... build your collection the convenient way with this terrific introductory package of records, cassettes or 8-track cartridges! Shop for your favorite music in the comfort of your own home!

Top artists for every musical taste. Tom Jones, Glen Campbell, Jeannie C. Riley, Johnny Cash, Mantovani, Engelbert Humperdinck, Bobbie Gentry, Grand Funk Railroad, Dean Martin, The Lettermen, Buck Owens and many more!

Choose your favorite music from each issue of the Club magazine, sent FREE every 4 weeks. There you will find a review of the Selection-of-the-Month in your musical division plus scores and scores of other selections from which you may choose. If you wish to take alternate or additional selections... or no selection at all... simply mark the Selection Notice appropriately and return it by the date specified. From time to time, the Club will offer some special selections, which you may reject

by returning the special dated form provided—or accept by doing nothing. The choice is always yours! All selections, with the exception of occasional money-saving clearance sales, will count toward fulfillment of your enrollment agreement.

Special merchandise and music offers several times per year... for members only. As with all your selections, you can charge these purchases to your Club credit account.

Earn FREE records or tapes. Here's how to cash in on great savings. Once your membership agreement is completed you become eligible for the Club's special bonus program. Every selection counts toward additional FREE selections... this means you can save up to 50%! Start now to build your stereo music collection at substantial savings!

CHOOSE YOUR SELECTIONS FROM THESE TOP HITS!

 804-93	 804-06	 937-42	 934-42	 934-97	 937-20	 937-00	 804-84	 933-99
 934-93	 807-35	 934-22	 933-72	 931-36	 *920-85	 937-38	 804-30	 932-32
 935-00	 934-30	 804-63	 931-72	 934-94	 934-41	 934-67	 933-69	 806-37
 934-58	 934-43	 934-96	 806-67	<p>SEND NO MONEY! JUST DETACH AND MAIL THIS COUPON TODAY!</p> <p>CAPITOL STEREO MUSIC CLUBS, Member Service Center, Thousand Oaks, Calif. 91360</p> <p>Please accept me for membership and send all selections in: <input type="checkbox"/> Check one only <input type="checkbox"/> Records <input type="checkbox"/> Cassettes <input type="checkbox"/> 8-Track Cartridges</p> <p>Send my first selection and bill me at regular Club price plus shipping-handling. Bill me just \$1.87 plus shipping-handling and send my 7 enrollment selections. I agree to buy just 10 more selections during the next 12 months at the regular Club price plus shipping-handling (Club price never exceeds manufacturer's suggested retail price)... and I may cancel my membership anytime thereafter. If I continue, I am eligible for the Club's special bonus: all purchases count toward additional FREE selections. All orders subject to acceptance at Club headquarters. This offer not available in Canada.</p> <p>IMPORTANT: Please check one. The music I like best is: <input type="checkbox"/> Classical (records only) <input type="checkbox"/> Movies & Shows (records only) <input type="checkbox"/> Jazz <input type="checkbox"/> Now Sound <input type="checkbox"/> Easy Moods <input type="checkbox"/> Popular Vocalist <input type="checkbox"/> Country Sound</p> <p><input type="checkbox"/> Mr. _____ <input type="checkbox"/> Mrs. _____ (please print) <input type="checkbox"/> Miss _____</p> <p>Address _____</p> <p>City _____ State _____</p> <p>Zip _____ Tel. No. _____</p> <p>APO, FPO addresses, please write for additional information.</p>				
 935-02	 934-70	 920-40	 804-98					

*Electrically re-channelled to simulate stereo

CIRCLE 17 ON READER-SERVICE CARD

C96A TL6A TL6B

get the NEWS FREE!

The new McIntosh 36 page catalog gives you all the details on the new McIntosh solid state equipment. In addition, you'll receive absolutely free a complete up-to-date FM Station Directory.

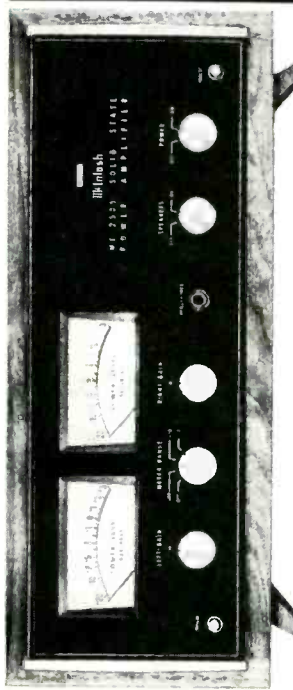

**MC 2505
SOLID STATE POWER AMPLIFIER**

FREE SEND TODAY

McIntosh

2 Chambers St., Dept. A-9
Binghamton, N.Y. 13903

Please Send FREE CATALOG and DIRECTORY

NAME _____
ADDRESS _____
CITY _____ STATE _____
ZIP _____

CIRCLE 34 ON READER-SERVICE CARD

Continued from page 8

effects records as was noted in the article. Sound effects account for 60% of our catalogue and production music for the remainder. We offer a standard package of 500 sound effects on fifteen LP albums. We also have a backup library of 150 78-rpm records containing over 300 sound effects which are used for play productions throughout the entire country. We also offer an entire production music library for both amateurs and professionals which contains over seventy-three hours of music on 115 LP albums.

We therefore feel that Mr. Endres unduly slighted Major Records, probably the largest producer of sound-effects records in the world.

Francis T. Valentino
Executive Vice President
Thomas J. Valentino, Inc.
New York, N.Y.

Mr. Endres replies: I regret that Major Records feels I have done them a great disservice. I thought I had given them courteous mention in the article. But there is that matter of being "first." Indeed they were first in the area of production sound effects, but then, Fulton did not make the first steamboat and many dispute DeForest's primacy in making the first triode amplifier. Such claims are the meat for litigations that can extend over decades.

In my article, I was writing from the standpoint and interest of the average record buyer. While it is true that Major was first, their product was and is aimed at the professional user of recorded sounds, not at the casual listener—who sometimes listens to just sound instead of music—not even at the home movie-maker who wants the recorded sound of a baby crying.

The sound effects on Folkways, Audio Fidelity, and Elektra were the first specifically marketed for the general record buyer, and were also the first to be marketed through normal consumer channels. Major's records are still found in very few record stores, or sold only by mail direct from the company (at 150 West 46th Street, New York, N. Y. 10036). This is not to say that one company's records are better than another's or that I was paid off with a free barrel of records (though I'm open to negotiation). Perhaps I'm a victim of advertising, since I've rarely seen published ads for Major Records. Suffice it to say, they have a good, complete library of sounds, and so do other companies mentioned.

As for the qualification that Major produces "some" sound-effects records, I will stick by what I said in the article. Their library is reasonably complete, but I can conceive of more sounds than anyone could hope to fit on fifteen LPs. Don't forget that the whole of the Schwann catalogue is devoted to the manipulations of a mere twelve tones of the tempered scale (at least until electronic music came along).

So I concede Mr. Valentino's claim to firstness. I only wish that he could find time to write a history of the sound-effects business, which he has obviously been close to. I, for one, would be interested to see it.

Manon and Maturity

What a plethora of critical comments concerning soprano Victoria de los Angeles the June 1971 issue contained. On page 95 ("Recitals and Miscellany"): "Another delight from this charming artist" (her new "Spanish Folk Songs" disc). On page 13 of *Musical America*: "... full, rich, even soprano that reminds [italics mine] me often (in this role)

of Victoria de los Angeles" (Adriana Maliponte's Met debut). Then one comes to page 73 and the review of the Sills *Manon*: "To check my own judgment I played the 1956 EMI mono set of *Manon* (now on Seraphim) in which the heroine, the well-remembered and loved Victoria de los Angeles, gives a fine performance in her secure and melodious fashion." But now the consistency suddenly turns decidedly murky. "It was for long the standard by which I judged; but it is no longer *Manon* to my ears—just a very fine singing job by a mature lady." The enigma here is that George Movshon wrote all three reviews—same soprano, same critic (a man should never review for the same magazine wearing two faces: it draws attention). Mr. Movshon continues: "Comparison with some of the great *Manons* of the past—Fanny Helder, Ninon Vallin, Geraldine Farrar, and Galli-Curci—confirmed the stature of Miss Sills's achievement" which was tremendous, to judge by the critical betrayal contained in the quoted passages. I frankly refuse to discuss what anyone should be able to hear for himself. Whatever merits one derives from Miss Sills's achievement need not lead one to the caddish conclusions espoused so smoothly by Movshon. But perhaps I chide him churlishly: Mr. Movshon is an appointed arbiter on maturity. I cite this same review: "Miss Sills, to be ungallant, is no chicken." By George, you've said it!

Oh well. Angel has reissued the De los Angeles/Monteux *Manon* on Seraphim regardless. Should we fear lest everyone has his fond memories erased by renewed contact with this superseded set? Should we, Mr. Movshon? Even superstars will have to bear such scrutiny some day. Soon.

Robert Archdeacon
New York, N. Y.

*Mr. Movshon replies: Mr. Archdeacon has a cute way with words and a needling disposition, but I am not sure what grave charge he levels at me. Miss De los Angeles is a superb artist and my admiration for her has long been unbounded. It is a measure of my praise for Miss Sills that her way of singing Massenet's *Manon* (in the new recording) reveals the character of the heroine more deeply and perceptively than even Miss De los Angeles was able to. Youth is one of the attributes of *Manon*, an important element in any interpretation. The American soprano conveys it, the Spanish one (for all the loveliness of her singing) does not.*

High Fidelity, September 1971, Vol. 21, No. 9. Published monthly by Billboard Publications, Inc., publisher of Stereo, Stereo International, Modern Photography, American Artist, Billboard, Vend, Amusement Business, Merchandising Week, Photo Weekly, Gift & Tableware Reporter, Record Retailer, Record Mirror, Discografia Internazionale, World Radio TV Handbook.

High Fidelity/Musical America. Edition published monthly. Member Audit Bureau of Circulations.

Editorial correspondence should be addressed to The Editor, High Fidelity, Great Barrington, Mass. 01230. Editorial contributions will be welcomed. Payment for articles accepted will be arranged prior to publication. Unsolicited manuscripts should be accompanied by return postage.

Subscriptions should be addressed to High Fidelity, 2160 Patterson St., Cincinnati, Ohio 45214. Subscription rates: High Fidelity/Musical America: In the U.S.A. and its Possessions, 1 year \$14; elsewhere, 1 year \$15. National and other editions published monthly: In the U.S.A. and its Possessions, 1 year \$7.95. Subscription rates for all other countries available on request.

Change of address notices and undelivered copies (Form 3579) should be addressed to High Fidelity, Subscription Fulfillment Dept., P.O. Box 14156, Cincinnati, Ohio 45214.

behind the scenes

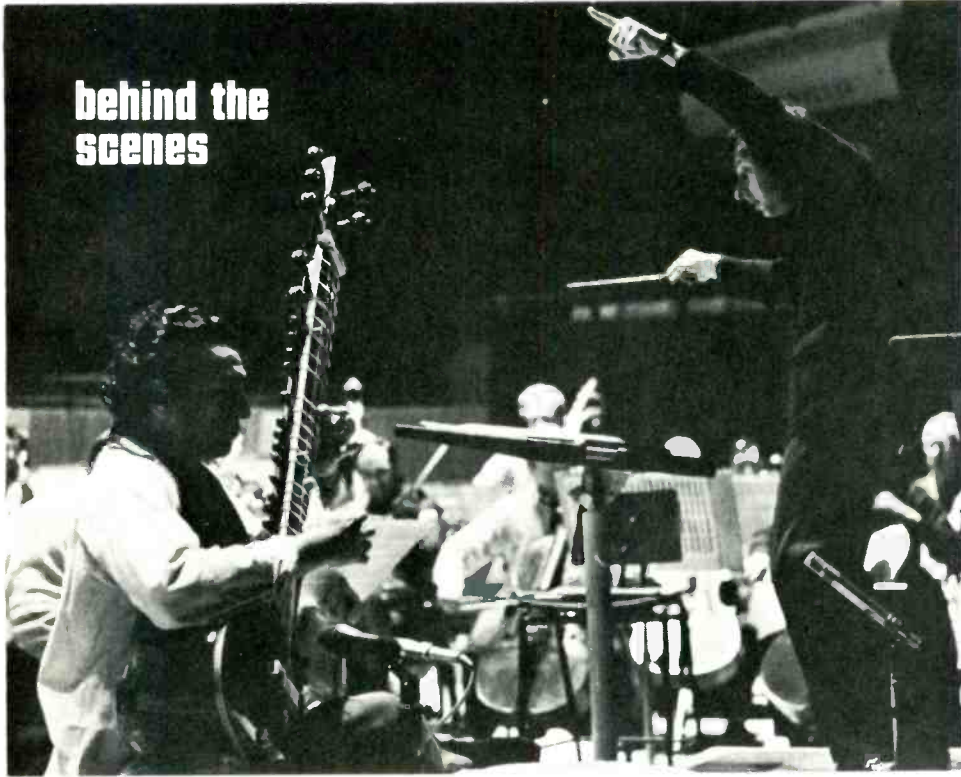

David Farrell

Previn Meets Shankar

LONDON

André Previn, fresh from his month-long tour of Russia and the Far East with the London Symphony Orchestra, has been busy in the studio not just for his old record company, RCA, but for EMI, with whom he has now signed an exclusive contract. Exclusive is a relative word because he is still free to conduct concertos for any company that can track him down (he is accompanying Kyung-Wha Chung in several discs for Decca very soon) and the EMI contract does not cover his piano playing (classical or jazz). All the same, the EMI men are delighted with the agreement and have lined up a busy schedule, including the complete *Nutcracker* ballet and a Walton disc with *Belshazzar's Feast* and the new *Impromptu on an Improvisation of Benjamin Britten*.

Previn's first EMI job was conducting the LSO in the Sitar Concerto of Ravi Shankar, with the composer as soloist. The problems of bringing two cultures together were formidable (especially considering that Shankar does not read Western notation), but the world premiere in London earlier this year revealed the work as sweet and amiable, nicely calculated to give Western listeners a painless lesson in raga forms.

The recording sessions in EMI's Abbey Road studio had their problems, since it was a bit difficult to get the composer's authoritative opinion on disputed notes in the score. The work has also grown considerably longer since its premiere (and not just because of freer improvisations from the soloist). It will now fill two LP sides. Christopher Bishop was the recording manager, and Previn was delighted to find a collaborator who shares his own dry sense of humor. Bishop's finely tuned impressions of certain recording artists (generally kind rather than malicious) always provide ample control-room entertainment at this producer's sessions.

Creepy Tuba. Previn's relations with RCA are still of the most cordial, and naturally he will complete the cycle of Vaughan Williams symphonies. The latest to be recorded is No. 5—taped just after a live performance at the Royal Festival Hall—and the four-session stint took in as well the rarely heard Vaughan Williams Tuba Concerto as well as *The Wasps* Overture. The soloist was the LSO's principal tuba—a Cambridge graduate still in his twenties—John Fletcher. I quoted Previn's recent comment that Fletcher's virtuosity on his unwieldy instrument is "creepy." After one of the more fantastic takes in these concerto sessions Previn suggested to

Continued on page 17

HEAD STRONG



The Ampex AX-50 stereo tape deck has three of the strongest heads money can buy. Deep-Gap heads made to last 10,000 hours, without variance in gap or frequency response. Which is about 10 times longer than regular heads. That's strong!

The AX-50 is also strong on capabilities. With a heavy-duty hysteresis synchronous motor. Direct tape monitor. Pause/edit control. Echo effect. Function programmer for sound-or-sound and sound-with-sound. Stereo headphone jack. Plus many more features you must see... and hear.

You need a strong deck to pick up today's heavy sounds. And the AX-50 is the strongest in its price range.

\$249.95
(Suggested retail price)

AMPEX

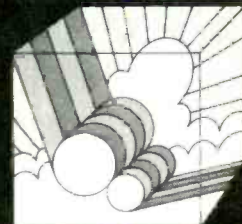

THE SOUND IDEA PEOPLE

CIRCLE 9 ON READER-SERVICE CARD

In 1968 almost every stereo enthusiast knew:

1

You couldn't reproduce bass notes through small speakers.

2

All the sound should come from the front of the speaker and none should be directed rearward toward the wall.

3

A speaker should never have associated electronics such as an active equalizer.

4

All good speakers should have crossovers, woofers and tweeters.

5

All speakers should be designed to give flat frequency response on axis.

By 1971 almost every stereo enthusiast has heard the BOSE 901.

A speaker which violates every one of the concepts above. Born out of 12 years of university research,* the 901 has become the *most highly reviewed speaker, regardless of size or price.*

Today we have a theoretical basis that explains why these concepts limit the performance of conventional speakers. But no theory can tell you how much better a new design will sound. To appreciate this, ask your dealer for an A-B comparison of the BOSE 901 with the largest and most expensive speakers he carries.

*For those interested in the 12 years of research that led to the design of the 901, copies of the Audio Engineering Society paper "ON THE DESIGN, MEASUREMENT AND EVALUATION OF LOUDSPEAKERS," by Dr. A. G. Bose, are available from BOSE Corporation for fifty cents.



Covered by U.S.
and foreign
patents issued
and pending.

You can hear the difference now.

BOSE[®]
Natick, Mass. 01760

BOSE 901 DIRECT/REFLECTING[®] Speaker System—\$476 the Stereo pair, including Active Equalizer. Slightly higher south and west. Pedestal base optional extra.

CIRCLE 5 ON READER-SERVICE CARD

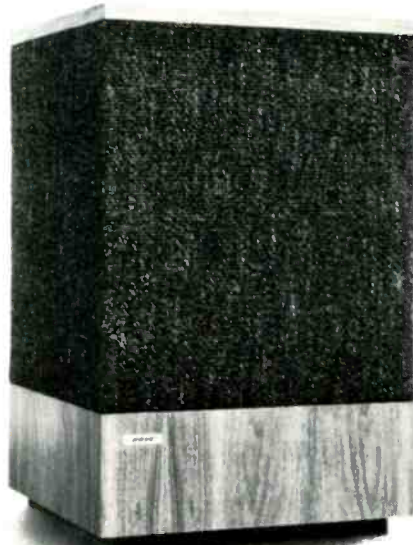

Ask your franchised dealer* to A-B the BOSE 501 with any speaker he carries that uses woofers, tweeters and crossovers.

There is an important reason why we ask you to make this test. There are inherent limitations of performance in the use of a woofer, a tweeter and a crossover—limitations covered in detail in earlier issues. The bypassing of these limitations played a large part in the advances which have made the BOSE 901 the most highly reviewed speaker, regardless of size or price.

We set out to design a lower priced speaker which would preserve as much as possible of the performance of the 901. Most important, we were able to design into the 501 much of the 901's great advance in spatial properties. The BOSE 501 is the second DIRECT/REFLECTING® speaker system.

But it became evident that there was no way to keep the advantages of multiple small full-range drivers and equalization. The cost problem was too great. We were forced to accept the woofer-tweeter-crossover combination as the only feasible compromise and set out to achieve the fullest possible realization of this design approach.

Our engineers designed a unique woofer with an unusually long voice coil which provides tight control of bass transients. They developed a new and different approach to crossing over the outputs of the woofer and the two tweeters. In the process they became convinced that \$125 is about the limiting price for improving the performance of a speaker containing woofers, tweeters and crossovers.

The design goal of the 501 was to outperform any other woofer-tweeter-crossover speaker. You be the judge. If we have succeeded, the results will be obvious to you when you make the comparison.

*Literature sent in answer to your request will include a list of franchised BOSE dealers in your area who are capable of demonstrating BOSE speakers to their full performance.

BOSE 501 DIRECT/REFLECTING® Speaker System
\$124.80 ea. Patents applied for.

NATICK, MA. 01760 **BOSE**®

You can hear the difference now.

CIRCLE 6 ON READER-SERVICE CARD

GARRARD ZERO 100

The only automatic turntable with ZERO TRACKING ERROR!

This is the most advanced record-playing unit available today. The name Zero 100 stands for Zero Tracking Error —up to 160 times less than with any conventional tone arm. The diagram below shows how the tone arm articulates, keeping the stylus always perpendicularly tangent to the groove as it moves across the record. This exciting development obsoletes the arm geometry on every other automatic turntable! With its articulating tone arm and other major features (see illustration), this imaginative, revolutionary Garrard unit, priced at \$189.50, sets a new standard of performance for all record playback equipment. The Zero 100 was introduced less than three months ago. Test reports by two of the industry's most respected reviewers have already appeared, expressing their enthusiasm. Let us send you their comments, with a full and detailed explanation.



Zero 100
12 page brochure



Hirsch-Houck Report
Stereo Review —
July 1971



Equipment Profiles
Audio Magazine —
July 1971

A genuine step upward in automatic turntables!

For published reports and full details on the Zero 100 and the entire Garrard series mail to British Industries Company, Dept. I 21, Westbury, N. Y. 11590.

Name _____

Address _____

City _____ State _____ Zip _____

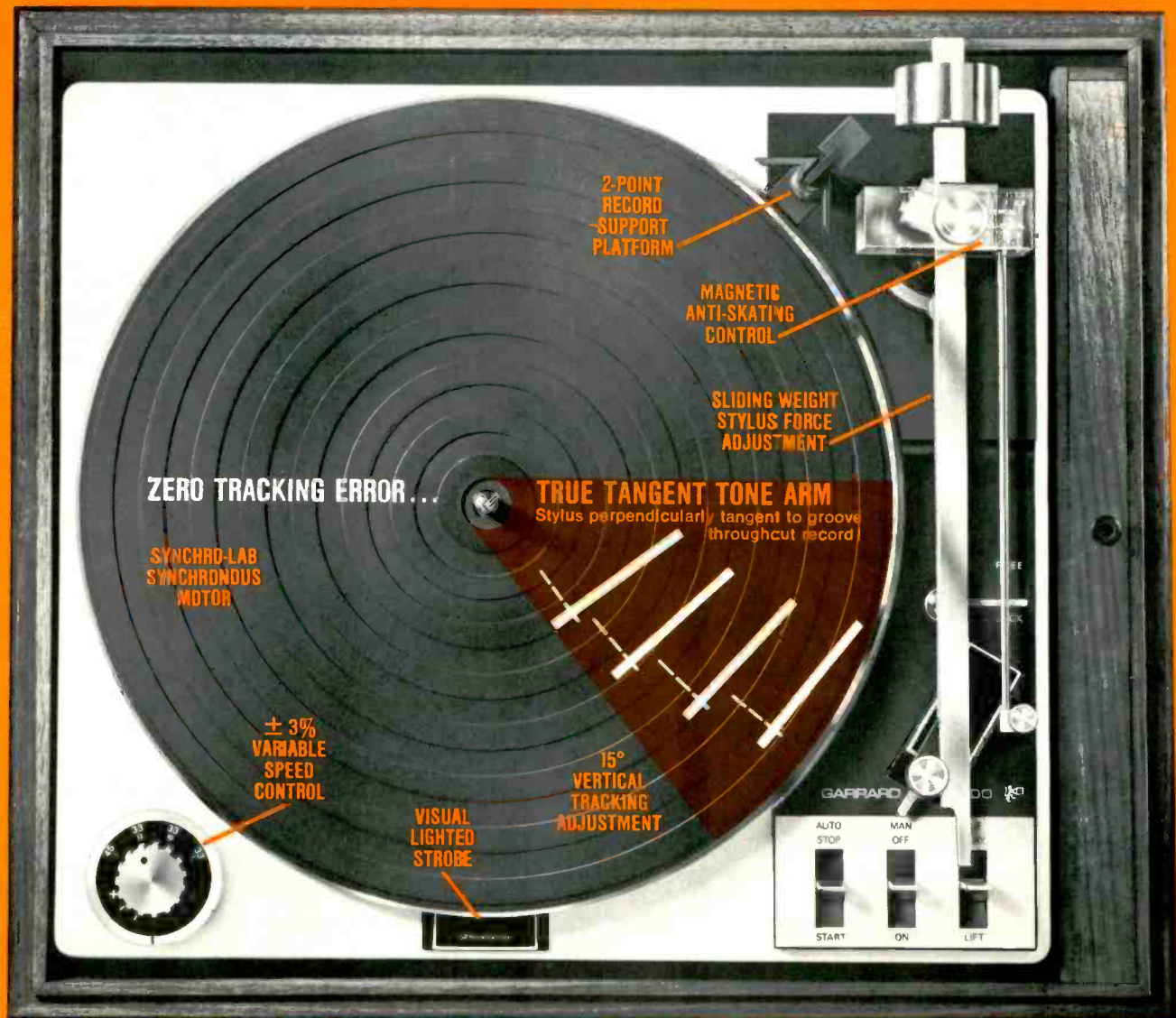

Continued from page 13

Fletcher, "I'll get you to do the horn part next time we have *Till Eulenspiegel*."

Tippett's Vision. Even more taxing RCA sessions took place in the Walthamstow Assembly Rooms, when Sir Michael Tippett conducted the LSO and LSO Chorus in a first recording of his *Vision of St. Augustine*, a magnificently complex and intense cantata nearly forty minutes long. This difficult piece marks a meeting point between Tippett's earlier opulent manner and his later, more rarefied but hardly less complex style. The performance was taped in a mere two sessions: both composer and recording manager agreed that long takes were essential in a work of such complexity, feeling that it would be impossible to sustain full concentration over short snippets.

The aim of the cantata, with an important part originally written for Dietrich Fischer-Dieskau but here sung by John Shirley-Quirk, is nothing less than to simulate St. Augustine's vision of heaven itself. The Latin text (prepared by Tippett) takes not only the words of St. Augustine but a Biblical commentary from the Vulgate.

EDWARD GREENFIELD

Friends of "The Boy Friend." It was the morning after a concert of the International Society for Contemporary Music's Festival, at which Peter Maxwell Davies had directed his chamber ensemble, The Fires of London, in a brilliant performance of his *Revelation and Fall*. I made my way to a recording studio in the Bayswater district of London where Davies was rehearsing an ensemble that included several familiar faces from the Fires—the remarkable clarinetist Alan Hacker, American pianist Stephen Pruslin—and a number of other London players. Harpist Sidonie Goossens of the BBC Symphony (sister of oboist Leon and conductor Eugene) was dressed in her Sunday best, an elegant contrast to most of the others (a range of London gear from moddy to shoddy), lending an air of dignity and classical repose to the proceedings.

What was the occasion? Perhaps the recording of Davies' latest startling and news-making concert work? Not at all—rather, a session devoted to the soundtrack of Ken Russell's next film, *The Boy Friend*, based on the Sandy Wilson musical hit of the '50s that first introduced Julie Andrews to America. The connection? Davies, who recently composed the score for Russell's film *The Devils of Loudun*, is responsible for the orchestrations of the musical, which will star (among others) the most famous clothes-horse of modern Britain, none other than the angular young lady known as Twiggy; the scuttlebutt is that she is very

good in her new role as a song-and-dance girl.

What the session (devoted exclusively to the orchestral tracks, with the singing to be overdubbed later) demonstrated immediately was that Davies is a dab hand at 1920-style orchestration, complete with banjo, slide whistle, and dirty trombone. There is more to it than that, of course; in his recent music the fox trot has been used on occasion as a stylistic background (rather as popular dances of earlier centuries served earlier composers), and *The Boy Friend* scoring is full of very subtle and personal touches. At one point during the first series of takes, devoted to a thirty-two bar segment of *Sur la plage*, a tricky descending chord arpeggiation for the brass proved difficult to synchronize. The brass players were mostly jazzmen, and Davies observed to Russell that this particular effect would have been child's play to, say, the New Philharmonia (which, conversely, would have found other passages decidedly out of its range).

Those thirty-two bars took nearly an hour before everybody was satisfied. A major difficulty was tempo—this was dance music, and it had to be danceable. Unfortunately, someone had forgotten to remind the choreographic department about the session, but eventually a lissome redhead, not yet quite awake, arrived and graced the studio floor with some fetching steps to certify the tempo.

The next sequence, an overture-medley, was recorded in three segments. The first was code-named "Elgar" for purposes of reference, and I quickly learned why: the opening fanfare led to a richly scored climax in which the title tune was decked with Enigmatic and Pompous-Circumstantial counterpoints before breaking into dance tempo. There was some difficulty about balancing all these lines clearly, but Russell (whose BBC-TV biographies of musical figures, as well as the feature film *The Music Makers*, demonstrate a finely-tuned sense of the editorial uses of music) was insistent about their importance. As the section was being worked up, pianist Pruslin could be observed taking lessons on the slide whistle—a sight that would doubtless have surprised the audiences who attend his formidable and imaginative recitals of Byrd, Beethoven, and Xenakis at the Queen Elizabeth Hall. Eventually "Elgar," followed by "Sousa" (another reference that was clear enough when heard) and "Rolls-Royce" (I'll have to see the film to figure that one out, however) were taken and sent off for copying.

Russell, a stocky, elegantly dressed man with a sort of shaggy greying page-boy haircut, and Davies, a thin intense figure in bright red tunic and blue trousers, make an oddly assorted pair, but their collaboration is obviously more

ADC: WORLD'S MOST PERSNICKETY SPEAKER MAKER.

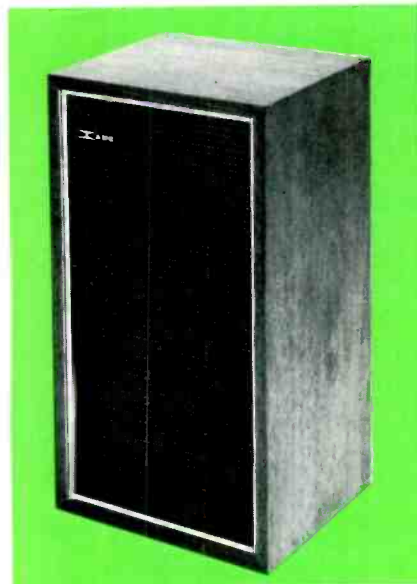

We make 303AX speakers for fussy audiophiles. Each one is crafted by hand and contains a two-way acoustic suspension system that's accurate enough to please even the most discriminating listener. The ADC 303AX lacks the distortion and coloration often found in speakers in its price range. Which makes it a superb value in a full-sized bookshelf speaker.

Of course, there's only one way to find out how really accurate our speaker system is. Go to your nearest ADC dealer and compare it to other models. After all, hearing is believing!

SPECIFICATIONS

- Type . . . Bookshelf.
- Cabinet . . . Oiled Walnut.
- Dimensions . . . 23 $\frac{3}{4}$ " H x 13" W x 11 $\frac{3}{4}$ " D.
- Weight . . . 37 lbs. each.
- Frequency Response . . . 33Hz—20kHz ± 3 db (measured in average listening room).
- Speakers (2) . . . High accuracy, wide dispersion tweeter with Hi Flux Magnet and 10" high compliance woofer.
- Nominal Impedance . . . 8 ohms.
- Power Required . . . 10 watts min.
- Price . . . \$110 suggested resale.

Write for details about other ADC speaker systems. From \$55-\$350.



AUDIO FOR AUDIOPHILES

CIRCLE 11 ON READER-SERVICE CARD

Continued on page 22

Practice may make him perfect. But it can test your tolerance.

To help yourself through his formative years, we recommend Koss Stereophones. So you can listen to the great ones before your son becomes one. And he can practice without disturbing you.

With Koss Stereophones you'll hear sounds so real that you can close your eyes and be there.

With the Koss ESP-9 Electrostatic Stereophone the entire audible spectrum of ten octaves comes alive. With a greater

range than even the finest loud speaker system.

With the Koss PRO-4AA Professional Dynamic Stereophone you can escape to the crisp sounds of the Tijuana Brass, two full octaves beyond the range of ordinary dynamics.

To get all the inside information on

the complete line of Koss Stereophones, write for our free full-color catalog, c/o Virginia Lamm, Dept. HF-3.

Or, if you just want to get outside, go to your favorite Stereo Dealer or Department Store. There you can learn how to live and let live . . . from \$19.95 to \$150. Then go home and face the music.

KOSS STEREOPHONES

Koss Corporation, 4129 N. Port Washington Ave., Milwaukee, Wis. 53212

Koss Corporation S.r.l., Via Vallorta, 21 20127, Milan, Italy

CIRCLE 59 ON READER-SERVICE CARD

Live and let live

10-20,000 Hz

400-2,500 Hz



MEET THE FIRST QUADRAPHONIC RECORD COMPANY

Ovation Records invites you to get acquainted now at a special low price.

*AMPEX, the world's leader in pre-recorded tapes, joins with Ovation Records, the world's leader in Quadraphonic Sound, in presenting the first complete catalog of Quadraphonic Tapes and Records.

Enjoy the complete listening involvement of 4-channel sound with **Discrete Q-8 Cartridges** and **Discrete Quadraphonic Open-Reel Tapes** or . . .

If you haven't gone quadraphonic yet listen to improved 2-channel stereo on Ovation's new **Compatible Stereo/Quadraphonic Records**. When you finally convert to quad you'll already have an excellent library of Quadraphonic records.

Ovation President, Dick Schory, was one of the great pioneers in stereo. He began researching and developing 4-channel sound in 1962. Today Schory has assembled the finest contemporary artists and creative technicians to form Ovation Records. Meet Ovation now and experience our experience.

These special preview tapes, cartridges and records contain a broad sampling of Ovation's complete catalog of jazz, rock, country, easy listening, big band sounds and much more.

SPECIAL PREVIEW OFFER

- Q-8 Cartridge regular \$7.95 list now \$5.95 with coupon
- Open Reel regular \$9.95 list now \$7.95 with coupon
- LP regular \$5.98 list now \$2.98 with coupon

WORLD'S PIONEER IN
QUADRAPHONIC SOUND

ovation
RECORDS

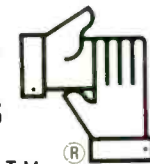

T.M. ®

Produced by OVATION RECORDS on **EV STEREO-4** system



ovation
RECORDS



1249 Waukegan Road
Glenview, Illinois 60025

Enclosed is check; money order for

_____ Compatible Stereo/Quadraphonic Record(s) at \$2.98 each
(quantity)

_____ 4-Channel Open-Reel Tape(s) at \$7.95 each
(quantity)

_____ Q-8 Cartridge(s) at \$5.95 each
(quantity)

Enclosed is 25¢ for handling and postage
* for a free AMPEX STEREO AND QUADRAPHONIC TAPE CATALOG.

Total remittance \$ _____
(Illinois residents add 5% sales tax)

(TYPE OR PRINT)

_____ Name

_____ Address

_____ City State Zip

THE REVOLUTION IN SOUND BRINGS YOU THE ULTRA ONE THAT CAN'T HELP BUT SATISFY EVERYONE!

A speaker system to satisfy everyone. **ULTRA I** A new concept in sound reproduction. This revolutionary linear-reflective transducer is the product of years of intensive design and testing. The **ULTRA I**, using nine full range, long throw, high compliance, low distortion speakers in a unique configuration which eliminates the use of any form of accessory controls or equalizing devices. In any room, large or small, bright or dull, a pair of **ULTRA I**'s will deliver a clean, transparent delicately balanced sound which can only be justly compared to the original live source.



Frequency Response: 20-20,000 Hz
Nominal Impedance: 8 Ohm
Power Handling: 5-200 Watts

Overall Size: 13"H, 23.5"W, 11.5"D
Weight: 35 Lbs.
Cabinet: Walnut

Warranty on the **ULTRA I**'s reflects our complete confidence in the speakers to withstand normal use. Warranty applies on parts and labor for five years.

The sound of the **ULTRA I** has never been achieved before at its prices.

You must hear the difference now for only \$399.95 a pair.

We welcome dealers inquiry

**ULTRA-TONE
SOUND SYSTEMS, LTD.**

Suite #403/A-131 Bloor St. W.
Toronto 5, Ont., Canada
Phone 416—921-7754

Continued from page 17

than a casual one. Ken Russell Productions has underwritten the recording of two recent Davies works (negotiations for American release are in progress), and the director will stage the composer's opera *Taverner* at Covent Garden next summer, with Colin Davis conducting. And there will no doubt be soundtrack albums of *The Devils* and *The Boy Friend* at the appropriate times. It promises to be a partnership that will enliven more than one art form for some time to come.

DAVID HAMILTON

LOS ANGELES

A Varèse Sonic Spectacular

Each April, when the Los Angeles Philharmonic subscription series ends and the Decca/London recording sessions begin, the orchestra moves out of its home in the Music Center Pavilion and onto the huge UCLA campus. This spring, from April 19 to 27, the orchestra and its music director Zubin Mehta were in residence in the university's old, large Royce Hall for over twenty-seven hours of sessions with producer John Mordler and three Decca/London engineers.

Generally filled with students during the day, the corridors around the auditorium were quiet and relatively empty; the hall itself, its lobby, and its backstage area were off-limits to the unauthorized. Only once did I hear a barking dog (the campus has a notable canine population), and the only extramusical audio trouble during the sessions came from a thump-grind that was attributed to the aging elevator.

A room that generally hosts postconcert receptions housed London's mobile control panel (which Mehta once used as a footrest, obviously without thinking), a closed circuit TV, playback equipment, and both loudspeaker and phone systems through which conductor and producer communicated. The stage was extended out over the seats, exactly halfway between proscenium and balcony, to put Mehta in the middle of the most resonant part of the hall. UCLA officials would like to believe that recording takes place in Royce Hall because the acoustics are so good. Actually, aside from the Philharmonic, very little recording has been done there, and some of the musicians seemed eager to be back in their familiar quarters. Several other players could be heard reminiscing nostalgically over the old days when the Hollywood Bowl Symphony recorded in the Goldwyn Studios.

These sessions filled three quarters of the Mehta/L.A. Philharmonic annual obligation to Decca/London. An all-Varèse disc took care of the one-record-a-

year-of-modern-music clause, and Holst's *Planets* and a Liszt triple-bill (*Mazeppa*, *Orpheus*, and *Battle of the Huns*) filled up the schedule. Mehta prefers to perform works with the Philharmonic before he records them, and he did so in this case.

The most interesting hours were spent on Varèse's *Arcana* (*Integrales* and *Ionisation* complete the record), when Nicolas Slonimsky, who conducted the first performance of the work, and Gerhard Samuel, the orchestra's associate conductor and ex officio twentieth-century specialist, were on hand for consultation with Mehta. Samuel had been in charge of the preliminary rehearsals for *Arcana*, back before the orchestra began its 1970-71 season. During one of the breaks, the three conductors compared beat techniques for this difficult work. Slonimsky, the oldest of the trio, was going at it wildly. "You'll be ready for the revolution," Mehta praised him. "I've already been through that," retorted the Russian-born lexicographer/composer/former conductor.

On each recording day, but particularly when recording Varèse, Mehta was intent on as few splices and as little tampering as possible—yet the takes still exceeded 200 by a healthy margin at the end of the penultimate day of sessions. Mehta wastes very little time rehearsing, gets almost everything on tape, and knows quickly what he wants or doesn't want during playbacks (sometimes he even recalled the exact number of the take that took). Though hampered occasionally by recurring back trouble, the conductor still seems to exert even more energy in recording than he does in concert—he moves more, turns to the first violins or cellos more directly, offers more coaxing or warning facial expressions. But he too was under strain from the schedule. He impatiently waited for Mordler to announce "take 67" or whatever, and as the days passed he mimicked the producer's British accent less frequently, moved faster, got more music played.

The Varèse works are more troublesome by nature than the Liszt or the Holst—percussion balance is crucial, textures tend to get too thick, a quintuplet can't be a triplet plus a duplet. But at the point when Mordler asked for more Chinese block, the musicians seemed to have a hard time taking it seriously, and Mehta concluded that the producer just happened to like Chinese blocks.

"This is the only music where you can't hear a high C on the trumpet," Mehta said during one of the *Arcana* playbacks when transparency was still a problem. Then he summed up the work—facetiously—and threw it into historical perspective: "Varèse the Wagnerian got himself overly influenced by Stravinsky this time around?" KAREN MONSON



Music lovers, the times they are a changin'.

Only yesterday music lovers swore nothing could ever replace the reel-to-reel tape recorder for true high fidelity sound reproduction. They were right, of course.

Today. The buffs are changing their tune. Now Sony has the first and only stereo cassette tape deck that gives you the best of both worlds. Gives you the true fidelity of reel-to-reel with pop-in cassette convenience.

This major breakthrough has been accomplished by Sony's technical wizardry in their new 160 Stereo cassette deck. (Your Sony/Superscope dealer will be happy to explain the innovations). You'll also be interested to know that the 160 allows you to switch from standard cassettes to

the new advanced chromium dioxide cassettes for optimum high fidelity recording.

Price? Only \$199.55.

Or. If a tight purse string is holding you back, let your Sony/Superscope dealer turn you loose on the full line of great Sony stereo cassette decks starting at under \$100.

And for fun on wheels, take along the stereo cassettes recorded on your Sony deck at home and play them back in your car with the Sony TC-20 — the most powerful automobile stereo on the road. Just \$119.50. See the Sony stereo cassette decks for a change. At your **SONY SUPERSCOPE** dealer. You never heard it so good.



CIRCLE 63 ON READER-SERVICE CARD.

Preview of the Coming

speaking of records

continued defiantly to plan and record—at least as far ahead as next year.

Most of these forthcoming releases are listed below, and a glance tells us that some companies so far seem undaunted by the prophets of doom. Angel and DGG lead the pack with more projected releases than the other major labels and they are offering their customary quota of operatic undertakings, the most economically asphyxiating of recording projects. Many are of unusual interest: from Angel's Soviet affiliate, Melodiya, comes a complete recording of Mussorgsky's *Sorochinsky Fair*; on Angel itself, Klemperer's controversial *Marriage of Figaro*, plus Karajan's *Fidelio*, and a new *Meistersinger* recorded in Dresden with the famous Staatskapelle also under Karajan. This will be, incredibly, the only available stereo version of the opera. From London comes *Boris Godunov*, again with the ubiquitous Karajan; a *Tannhäuser* led by Solti; two Britten operas, *Owen Wingrave* and *The Rape of Lucretia*, both with the composer conducting; and the expected Italian opera vehicles—this time *Un Ballo in maschera* for Tebaldi and *L'Elisir d'amore* for Sutherland. DGG, aside from their praiseworthy Wagnerian enterprises of *Lohengrin*, and a live *Parsifal* from Bayreuth, also gives us the first stereo recording of Weber's *Oberon*, with Kubelik, and Böhm's *Salome*, also recorded live in Hamburg. Philips, showing no sign of leaving the field to their older competitors, will serve up a Colin Davis *Marriage of Figaro*; American Columbia, generally not an "operatic" company, will release Bernstein's *Rosenkavalier*.

And in this age of *Gesamtaufnahmen* just about everybody's *Gesamtkunstwerk* stands a good chance of reaching vinyl. London continues their various complete-symphony cycles with Schubert (Kertesz), Haydn (Dorati), and Mahler (Solti). Kubelik's complete Mahler symphonies will also be available in a special limited edition from DGG, and the same company will issue the complete Mozart piano sonatas and piano concertos by Eschenbach and Anda respectively, again in a limited edition series.

But a few notes of caution have been sounded amidst all

this ambitious activity. Talks with the English officials at EMI and Decca indicate that their involvement with recording in this country will soon cease entirely. (If you could record the Beethoven *Emperor* with Ashkenazy and Solti in Chicago at \$96 a minute as opposed to \$19 in Vienna, which would you choose?) While Decca and Philips were generally pleased with the profits and growth of European sales last year, they shook their heads ruefully at mention of the American market. American Decca, long a significant voice in serious music here, will record "little at all in the way of classical music from now on." And RCA has fallen to a plethora of "So-and-So's Greatest Hits," and a repackaging of old material. But Vox Productions (Vox, Turnabout, Candide), one of the smaller American companies, feels that "people haven't stopped buying records, but are buying more. . . ." So they intend to produce more, not less. Which American company's assessment of the situation will prove correct is a moot question right now, contingent on the general economic climate. However, financial difficulties in the classical recording industry existed long before the current economic setback. Certainly the attitude expressed by Vox indicates a healthy approach to the problems indigenous to the industry if coupled—emphatically—with wise production of the familiar and intelligent extension into interesting, untried repertoire. But even more outstanding and important is the urgent need to re-evaluate the strangulating distribution problems which beset the industry in the United States (see "FIND—A Radical Solution" last month), and the suicidal demands of the musicians' unions.

Until the seriousness of those last two points is accepted as a reality, Europe will (hopefully) continue to supply hungry Americans with a generous array of music and talent, with catalogues brimful of "something for everyone," including large amounts of reissues of old recordings (indicated in the listings by a ●): a plentiful collection of new names like Christopher Parkening, John Lill, Roberto Szidon, Michael Tilson Thomas, and Kyung-Wha Chung. And of course an abundance of "superstars" such as Karajan, Davis, Bernstein, Price, Nilsson, Richter, Ashkenazy, and Heifetz. And it goes without saying that the omnipresent Mr. Fischer-Dieskau, the "insuperable Superstar," will echo endlessly from every corner, on every label, in every guise, to remind us that his output alone can support the entire classical record industry!



Angel

Bach: *Harpichord Concertos, Vol. 2*. George Malcolm; Menuhin Festival Orch., Menuhin, cond.
Baker and Fischer-Dieskau: *An Evening of Baroque Duets*. George Malcolm, organ and harpsichord; Kenneth Heath, cello.
Bartók: *Piano Concerto No. 2*. Prokofiev: *Piano Concerto No. 5*. Richter; London Symphony Orch., Maazel, cond.
Beethoven: *Fidelio*. Dernesch, Vickers, Riederbusch; Berlin Philharmonic Orch., Von Karajan, cond.

Beethoven: *Symphony No. 7*. Chicago Symphony Orch., Giulini, cond.
Brahms: *Die schöne Magelone*. Fischer-Dieskau; Richter.
Britten: *Saint Nicholas*. Tear, Russell; Academy of St. Martin-in-the-Fields, Willcocks, cond.
Bruckner: *Symphonies Nos. 4 and 7*. Berlin Philharmonic Orch., Von Karajan, cond.
Caballé and Martí: *Great Opera Duets*. London Symphony Orch., Mackerras, cond.
Delius: *A Mass of Life*. Harper, Tear, Luxon; London Philharmonic Orch., Charles Groves, cond.
Dvořák: *Cello Concerto; Silent Woods*. Du Pré; Chicago Symphony Orch., Barenboim, cond.

Elgar: *Sea Pictures*. Mahler: *Five Songs from Rückert*. Baker; London Symphony and New Philharmonia Orch., Barbirolli, cond.
● Grieg: *Peer Gynt Suites Nos. 1 and 2; Norwegian Dances*. Sheila Armstrong, Patricia Clark; Hallé Orch., Barbirolli, cond.
Mahler: *Symphony No. 1* (New Critical Edition). Chicago Symphony Orch., Giulini, cond.
Mozart: *The Marriage of Figaro*. Berganza, Evans, Bacquier; New Philharmonia Orch., Klemperer, cond.
John Ogdon: *Piano Concerto No. 1*. Shostakovich: *Piano Concerto No. 2*. Ogdon; Royal Philharmonic Orch., Lawrence Foster, cond.
Saint-Saëns: *The Complete Piano Concertos*.

Season's Recordings

Ciccolini: *Orchestre de Paris*. Baudo. cond.
 Satie: *Piano Music, Vol. 6*. Ciccolini.
An Elisabeth Schwarzkopf Songbook, Vol. 3.
 Geoffrey Parsons and Gerald Moore,
 pianos.
 Shankar: *Concerto for Sitar and Orchestra*;
Raga Improvisations. Shankar; London
 Symphony Orch., Previn, cond.
 Sibelius: *Kullervo*; *Swanwhite Suite*; *Scene
 with Cranes from Kuolema*. Raili Kostia,
 Usko Viitanen; Bournemouth Symphony
 Orch., Paavo Berglund, cond.
 Strauss, R.: *Songs, Vol. 2*. Fischer-Dieskau;
 Moore.
 Tchaikovsky: *Symphony No. 4*. Orchestre de
 Paris, Ozawa, cond.
 Vaughan Williams: *Fantasia on Green-
 sleeves*; *Folksong Suite*. Elgar: *Enigma
 Variations*. London Symphony Orch.,
 Boult, cond.
 Verdi: *Don Carlo*. Caballé, Verrett, Domingo;
 Royal Opera House Orch., Giulini, cond.
 Wagner: *Die Meistersinger von Nürnberg*.
 Donath, Adam, Kollo; Dresden State
 Orch., Von Karajan, cond.



Bach: *Suites for Orchestra*. Dart, harpsichord;
 Academy of St. Martin-in-the-Fields. Mar-
 riner, dir.
 Beethoven: *An die ferne Geliebte*. Brahms:
Songs. Shirley-Quirk; Martin Isepp, piano.
 Janáček: *Diary of One Who Disappeared*.
 Tear; Philip Ledger, piano.
 Messiaen: *Visions de L'Amen*. John Ogdon
 and Brenda Lucas, pianos.
 Monteverdi: *Madrigals*. Purcell Consort of
 Voices; Grayston Burgess, dir.
 Mozart: *Eine kleine Nachtmusik*; *Sinfonia
 concertante*. Academy of St. Martin-in-the-
 Fields. Marriner, dir.
Music of the Crusades. The Early Music Con-
 sort. David Munrow, dir.
 Rachmaninoff: *Cello Sonatas*. George Isaacs,
 cello; Valerie Tryon, piano.
Radcliffe Award Winning Quartets. Allegri
 String Quartet.
 Schütz: *The Christmas Story*. Ian Partridge;
 Heinrich Schütz Choir, Norrington, dir.
 Schütz: *Cantate Domino* (Double Choir
 Motets). Heinrich Schütz Choir; Sym-
 phoniae Sacrae Chamber Ensemble, Nor-
 rington, dir.

CAMBRIDGE RECORDS

Bach: *Cantata No. 202*. Handel: *Silite venti*.
 Carole Bogard; Chamber Orchestra of
 Copenhagen, John Moriarty, cond.
 Handel: *Agrippina condotta a morire: Arias
 from the Opera Agrippina*. Carole Bogard.
 Works for Percussion by Verèse, Lylloff, and
 Norgaard. Bent Lylloff, percussionist.



Berlin Theater Music of the 1920s. Soloists;
 Members of the Berlin Symphony Orch.,
 Arthur Gruber, cond.
 De Pablo: *Modulos V for Organ*; *Organum I
 for Organ*. Xavier Darasse.
 Hubay: *Violin Concerto*. Ernst: *Violin Con-
 certo*. Ysaÿe: *Chant d'hiver for Violin*.
 Aaron Rosand; Radio Luxemburg Orch.,
 De Froment, cond.
 Xenakis: *Terretektorh*; *Nomos Gamma*. Radio
 O.R.T.F. Philharmonic Orch., Charles
 Bruck, cond.



Beethoven: *String Quartet, Op. 130*. Yale
 Quartet.
 Beethoven: *String Quartet, Op. 135*; *Grosse
 Fuge*. Yale Quartet.
 Handel: *Judas Maccabaeus*. Harper, Watts,
 Young; English Chamber Orch., Somary,
 cond.
 Tchaikovsky: *Serenade*. Arensky: *Variations*.
 Prokofiev: *Classical Symphony*. English
 Chamber Orch., Somary, cond.
Trumpet Concertos. Works by Haydn, Hum-
 mel, Albinoni, Torelli. Martin Birnbaum;
 English Chamber Orch., Somary, cond.



Album of Marches. New York Philharmonic
 Orch., Bernstein, cond.
 Bartók: *2 Violin Sonatas*. Stern.
 Beethoven: *Hammerklavier Sonata*. R. Serkin.
 Bruckner: *Symphony No. 9*. New York Phil-
 harmonic Orch., Bernstein, cond.
 Copland: *Appalachian Spring*; *Lincoln Por-
 trait*. Henry Fonda; London Symphony
 Orch., Copland, cond.
 Debussy: *String Quartet*. Ravel: *String Quar-
 tet*. Juilliard String Quartet.
 Mahler: *Songs*. Fischer-Dieskau; Bernstein,
 piano.
 Ravel: *Daphnis et Chloë Suite No. 2*; *Rapsodie
 espagnole*; *Pavane*; *Alborada*. Cleveland
 Orch., Boulez, cond.
A Festive Christmas. Ivan Rebroff, bass.
 Strauss, R.: *Der Rosenkavalier*. Ludwig, Jones,
 Berry. Vienna Philharmonic Orch., Bern-
 stein, cond.
 Subotnick: *Sidewinder* (electronic composi-
 tion). Subotnick.



Crumb: *Black Angels for Electric String Quar-
 tet*. Jones: *String Quartet No. 6: Sonata*.
 Zukofsky, etc.
*Electronic Music Center of Columbia-Prince-
 ton: Tenth Anniversary Album*. Works by
 Varèse, Luening, Babbitt, etc.
 Hamilton: *Voyage, Epitaph for This World*.
 Choirs of Trinity Church, Cathedral of St.
 John the Divine, Princeton; London Sin-
 fonietta, David Atherton, cond.
 ● Riegger: *Symphony No. 3*. Foss: *The Song
 of Songs*. Jennie Tourel; Eastman-Roches-
 ter Symphony Orch., New York Philhar-
 monic Orch., Hanson and Bernstein, cond.
 Riegger: *Variations for 2 Pianos*. Berezowsky:
Fantasy for 2 Pianos. Perischetti: *Sonata
 for 2 Pianos*. Yarbrough and Cowan.
 ● Sessions: *Symphony No. 2*. Mennin: *Sym-
 pany No. 3*. New York Philharmonic
 Orch., Mitropoulos, cond.
 Shapey: *Rituals*. Shifrin: *3 Pieces for Orchestra*.
 London Sinfonietta. Jacques Monod, cond.
 Weisgall: *The Stronger*; *Fancies and Inven-
 tions*. Johanna Meier, Julian Patrick,
 Aeolian Chamber Players.



Brahms: *Gesänge für Frauenchor, Op. 17*. Kate
 Hurney, Joy Blackett, Leo Goeke; Musica
 Aeterna, Waldman, cond.
Brubeck and Mulligan. Dave Brubeck and
 Gerry Mulligan; Cincinnati Symphony
 Orch., Kunzel, cond.
 Charpentier: *La Pesta di Milan*. Musica
 Aeterna, Waldman, cond.



Baroque Trumpet Concertos. Works by Tele-
 mann, Torelli, L. Mozart, Haydn. Pierre
 Thibaud; Bamberg Symphony Orch.,
 Gerdes, cond.
 Beethoven: *Symphony No. 6*. Vienna Phil-
 harmonic Orch., Böhm, cond.
 Berg: *Alienberg Songs*; *3 Pieces for Orches-
 tra*; *Symphonic Suite from Lulu*. Margaret
 Price; London Symphony Orch., Abbado,
 cond.
 Bizet: *Carmen Suite No. 1*; *L'Arlesienne
 Suites Nos. 1 and 2*. Berlin Philharmonic
 Orch., Von Karajan, cond.

Brahms: *Piano Quartet No. 1 in G minor*.
 Gilels: *Members of the Amadeus Quartet*.
 Brahms: *Symphony No. 2*. Berlin Philharmonic Orch., Abbado, cond.
 Cornelius: *Lieder*. Wolf: *Lieder*. Prey; Leonhard Hokanson.
Contemporary Wind Music. Works by Penderecki, Mayuzumi, Williams. Eastman Wind Ensemble, Donald Hunsberger, cond.
 Debussy: *Images; Afternoon of a Faun*. Boston Symphony Orch., Thomas, cond.
 Dvořák: *Symphony No. 7*. Berlin Philharmonic Orch., Kubelik, cond.
 Ferrari: *Presque rien No. 1; Société II*. Contemporary Instrumental Ensemble of Paris, Konstantin Simonovitch.
 Foss: *Paradigm*. Hiller: *Algorithms I, Versions I and IV*. Schwartz: *Signals*. Various performers.
 Kayn: *Cybernetics III*. Nono: *Contrapunto dialettico alla mente*. Various performers.
 Lalo: *Namouna: Rhapsodies Nos. 1 and 2; Namouna: Cigarette Waltz; Norwegian Rhapsody*. Orchestre National de l'O.R.T.F., Martinon, cond.
 Mendelssohn: *Symphony No. 3; Hebrides*. Berlin Philharmonic Orch., Von Karajan, cond.
 Mozart: *Requiem*. Mathis, Hamari, Ochmann, Ridderbusch; Vienna Philharmonic Orch., Böhm, cond.
 Mozart: *Serenade No. 10, K. 361*. Winds of the Berlin Philharmonic Orch., Böhm, cond.

Portrait of Birgit Nilsson. Arias by Mozart, Weber, Beethoven, Wagner.
 Rossini: *Overtures*. Berlin Philharmonic Orch., Von Karajan, cond.
 Scriabin: *Piano Sonatas Nos. 4-10*. Roberto Szidon.
 Smetana: *My Fatherland*. Boston Symphony Orch., Kubelik, cond.
Spanish Guitar Music. Works by Albéniz, Granados, Falla, Turina. Yepes.
 Strauss, J.: *Waltzes, Polkas, and Marches*. Berlin Philharmonic Orch., Von Karajan, cond.
 Strauss, R.: *Also sprach Zarathustra*. Boston Symphony Orch., Steinberg, cond.
 Strauss, R.: *Salome*. Jones, Fischer-Dieskau, Cassilly; Hamburg Staatsoper Orch., Böhm, cond.
 Tchaikovsky: *Piano Concerto No. 1*. Argerich; Royal Philharmonic Orch., Charles Dutoit, cond.
 Tchaikovsky: *Romeo and Juliet*. Scriabin: *Poem of Ecstasy*. Boston Symphony Orch., Abbado, cond.
 Villa Lobos: *12 Etudes for Guitar*. Narcisco Yepes.
 Wagner: *Lohengrin*. Janowitz, King, Stewart; Bavarian Radio Symphony Orch., Kubelik, cond.
 Wagner: *Parsifal*. Jones, King, Crass; Bayreuth Festival Chorus and Orch., Boulez, cond.
 Weber: *Oberon*. Nilsson, Domingo, Prey; Bavarian Radio Symphony Orch., Kubelik, cond.



- Bruckner: *Symphony No. 3*. Vienna Philharmonic Orch., Knappertsbusch, cond.
- Martinů: *Symphony No. 6; Memorial to Lidice*. Czech Philharmonic Orch., Ančerl, cond.
- Martinů: *Symphony No. 5*. Soloists, Chorus of the Army Ensemble; Czech Philharmonic Orch., Ančerl and Bohumir Liška, cond.
- Messiaen: *The Nativity of Our Lord; Nine Meditations for Organ*. Ferdinando Klinda, organ.
- Schumann: *Symphony No. 1*. Orchestre de la Suisse Romande, Ansermet, cond.
- Shostakovich: *Symphony No. 11*. Houston Symphony Orch., Stokowski, cond.
- Tchaikovsky: *The Seasons*. Czech Film Symphony Orch., Neumann, cond.

LONDON[®]
 RECORDS

Beethoven: *Piano Concerto No. 3; 32 Variations on an Original Theme*. Radu Lupu; London Symphony Orch., Lawrence Foster, cond.
 Britten: *The Rape of Lucretia*. Baker, Luxon;

It's anything but standard.



How could it be standard (with a small "s") with 100/100 RMS both channels driven at 8 ohms. With a THD of less than 0.3% at rated output. Or an FM sensitivity of 1.5 uV. Or separate pre and main amplifiers. Or direct-coupled circuitry.

It's all there in our handsome SR-4500 stereo receiver. With plus features like center tuning and signal strength meter, lever-action controls for Hi and Low filters, tone cancel, loudness, tape monitor, FM muting and audio muting. Up front dubbing in and out, microphone jack and mixing control. Dual speaker system selector. Automatic stereo switching. And much, much more. All in a walnut cabinet that looks as great as what's inside sounds.

The difference between standard and Standard? Come in and hear us out.

SR **STANDARD**[®]

STANDARD RADIO CORP., 60-09 39TH AVENUE, WOODSIDE, N.Y. 11377; 13518 SOUTH NORMANDIE AVENUE, GARDENA, CALIF. 90249

CIRCLE 53 ON READER-SERVICE CARD

Sousa lives in the new Altec Segovia

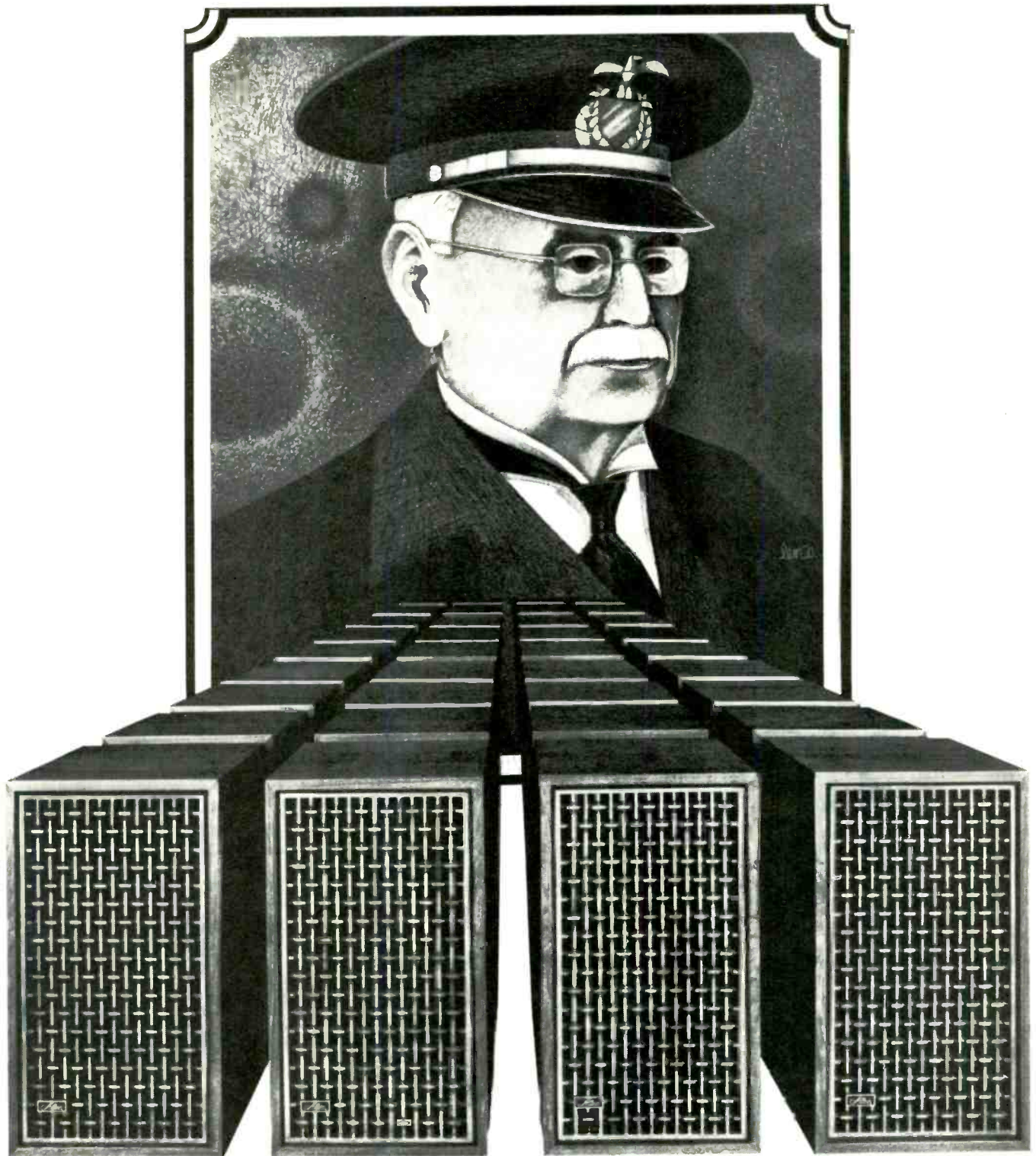

If you're going to listen to Sousa, it should sound like Sousa. Oom-pa, oom-pa, oom-pa-pa. It should be so real that you can reach over and nudge the tuba player when he gets out of step.

The new Altec Segovia is the first bookshelf speaker system that lets you hear every sound clearly and distinctly and naturally. Oom-pa. From bass drum to triangle. There's nothing added and there's nothing taken out. Oom-pa. All you hear is what Sousa wanted you to hear. Oom-pa-pa.

Ask your dealer to put on some Sousa when you listen to the new Altec Segovia speaker system. You've never heard him so good.



ALTEC DIVISION OF LIV-LING ALTEC, INC.

The new Altec Dynamic Force Segovia sells for \$250.00. It's the culmination of years of building professional sound equipment and working with room acoustics and equalization while developing the proven Altec Acousta-Voicette Stereo Equalizer. Hear it at your local Altec dealer today. He's in the Yellow Pages under "High Fidelity & Stereo Sound Equipment" under Altec Lansing.

English Chamber Orch., Britten, cond.
 Britten: *Owen Wingrave*. Baker, Pears. Luxon;
 English Chamber Orch., Britten, cond.
 Bruckner: *Symphony No. 3*. Vienna Philharmonic
 Orch., Böhm, cond.
 Donizetti: *L'Elisir d'amore*. Sutherland, Pavarotti;
 English Chamber Orch., Bonyngé, cond.
 Liszt: *Piano Music*. Vladimir Ashkenazy.
 Mahler: *Symphony No. 7*. Chicago Symphony
 Orch., Solti, cond.
 Mussorgsky: *Boris Godunov*. Vishnevskaya,
 Ghiaurov, Talvela; Vienna Philharmonic
 Orch., Von Karajan, cond.
 Schubert: *Symphonies*. Vienna Philharmonic
 Orch., Kertész, cond.
 Verdi: *Un Ballo in maschera*. Tebaldi, Resnik,
 Pavarotti; Santa Cecilia Orch., Bartoletti,
 cond.
 Wagner: *Tannhäuser*. Dernesch, Ludwig, Kollo;
 Vienna Philharmonic Orch., Solti, cond.

phase 4 stereo

Bernstein: *Music from Fancy Free, West Side
 Story*, etc.; Royal Philharmonic Orch., Eric
 Rogers, cond.
 Franck: *Symphony in D minor*. Hilversum
 Radio Philharmonic Orch., Stokowski, cond.
The Impressionists. Works by Debussy, Ravel,
 Fauré, and Honegger. London Philharmonic
 Orch., Hermann, cond.
 Ives: *Second Orchestral Set*. Messiaen: *L'Ascension*.
 London Philharmonic Orch., Stokowski, cond.
 Ravel: *Bolero; La Valse; Pavane*. Royal Philharmonic
 Orch., Claude Monteux, cond.
 Tchaikovsky: *Symphony No. 4*. Royal Philharmonic
 Orch., Fistioulari, cond.
 Wagner: *Great Moments*. David Ward; New
 Philharmonic Orch., George Hurst, cond.



Adam: *Giselle*. U.S.S.R. Symphony Orch.,
 Algis Zuraitis, cond.
 Glazunov: *Raymonda Suite*. Bolshoi Theatre
 Orch., Svetlanov, cond.
 Kalinnikov: *Symphony No. 1*. Moscow Philharmonic,
 Kondrashin, cond.
 Mussorgsky: *Sorochinsky Fair*. Soloists;
 Moscow Radio Orch., Yuri Aranovich,
 cond.
 Scriabin: *Etudes, Op. 8*. Merzhanov.
 Shostakovich: *Symphony No. 4*. Moscow Philharmonic,
 Kondrashin, cond.
Songs and Dances of the Red Army. The Soviet
 Army Chorus and Band; Boris Alexandrov, dir.
 Tchaikovsky: *Francesca da Rimini; Hamlet*.
 U.S.S.R. Symphony Orch., Svetlanov,
 cond.
 Tchaikovsky: *Romeo and Juliet; The Tempest*.
 U.S.S.R. Symphony Orch., Svetlanov, cond.
 Tchaikovsky: *Suite No. 3*. Moscow Philharmonic,
 Kondrashin, cond.
Trumpet Concertos. Works by Arutyunian,
 Kryukov, Vainberg, Dokshtitser; Bolshoi
 Theatre Orch., Rozhdestvensky and
 Zuraitis, cond.

Vlasov: *Concerto No. 1 for Cello*. Saugué;
Mélodie concertante. Rostropovich; Mos-
 cow Radio Symphony Orch., Rozhdestven-
 sky and Saugué, cond.
The World of the Balalaika. Osipov Balalaika
 Orch.; vocal soloists.



Bolcom: *Black Hosts for Organ, Percussion and
 Tape*. Albright: *Organ Work*. Albright,
 organ; Hodkinson, percussion.
 Buxtehude: *Solo Cantatas*. Donath, Altmeyer,
 Stämpfli; Bach-Collegium, Stuttgart, Ril-
 ling, cond.
 Josquin des Prez: *Vocal and Instrumental
 Music*. The Nonesuch Consort, Rifkin,
 cond.



- Brahms: *Variations on a Theme by Haydn;
 Academic Festival Overture; Tragic Over-
 ture*. Columbia Symphony Orch., Walter,
 cond.
- Grieg: *Piano Concerto*. Schumann: *Piano
 Concerto*. Fleisher; Cleveland Orch.,
 Szell, cond.
- Mahler: *Symphony No. 2*. Cundari, Forres-
 ter; New York Philharmonic Orch., Walter
 cond.
- Schubert: *Symphony No. 9*. Cleveland
 Orch., Szell, cond.
- Schumann: *The Four Symphonies*. Cleve-
 land Orch., Szell, cond.
- Tchaikovsky: *Symphony No. 5*. Cleveland
 Orch., Szell, cond.
- Wagner: *Overture and Venusberg Music;
 Siegfried Idyll; Prelude to Lohengrin*.
 Columbia Symphony Orch., Walter, cond.



Avison: *Concertos from Op. 6*. Hurwitz Cham-
 ber Ensemble, Emanuel Hurwitz, dir.
 Stuart Burrows *Recital*. Arias and Songs by
 Handel, Scarlatti, Schubert, Fauré, Quilter.
 John Constable, piano.
 Stuart Burrows. *Songs of Love and Sentiment*.
 Constable, piano.
 • Rameau: *Hippolyte et Aricie (excerpts)*.
 Baker, Shirley-Quirk; English; English
 Chamber Orch., Anthony Lewis, cond.



- Beethoven: *Symphonies Nos. 1 and 8*. Con-
 certgebouw Orch., Jochum, cond.
 Couperin: *Keyboard Music*. Puyana.

Mozart: *Clarinet Quintet, K. 581; Trio, K.
 498*. Bishop, piano; Brymer, clarinet; Alle-
 gri Quartet.
 Mozart: *Concert Arias*. Werner Hollweg,
 tenor.
 Mozart: *Divertimentos, K. 186, 253, 289*. Neth-
 erlands Wind Ensemble. De Waart, cond.
 Mozart: *Flute Quartets*. Bennett, flute;
 Grumiaux Trio.
 Mozart: *The Marriage of Figaro*. Freni, Gan-
 zaroli; Wixell; BBC Symphony Orch.,
 Davis, cond.
Music from the Court of Burgundy. Musica
 Reservata, John Beckett, dir.
 Paganini: *Violin Concerto No. 3*. Szeryng;
 London Symphony Orch., Alexander
 Gibson, cond.
 Schumann: *Sonata No. 1, Op. 11; 3 Fantasies,
 Op. 111*. Arrau.
 Smetana: *Piano Trio in G minor, Op. 15; Piano
 Trio in G minor, Op. 8*. Beaux Arts Trio.
 Stravinsky: *Le Sacre du printemps*. London
 Symphony Orch., Davis, cond.
 Tchaikovsky: *Symphony No. 6*. Concert-
 gebouw Orch., Haitink, cond.
 Vivaldi: *The Four Seasons*. I Musici.
 Wolf: *Lieder*. Ameling; Baldwin.



Beethoven: *6 String Quartets, Op. 18*. Bartók
 Quartet.
 Hoffmeister: *Concerto for Flute in D*. Albrechts-
 berger: *Partita in F for Harp and String
 Orchestra*. Szabenyi, flute; Lelkes, harp;
 Győr Philharmonic Orch., Sándor, cond.
 Kodály: *Choral Works, Vol. 5*. Kodály Girl
 Chorus, Andor, cond.
 Kodály: *Choral Works, Vol. 6*. Choir of Hun-
 garian Radio.
 Mozart: *6 String Quintets*. Anna Mauthner;
 Tátrai Quartet.
 Mozart: *Tenor Arias*. József Réti; Philharmonic
 Society Orch., Jancsovics, cond.
 Tardos: *Various Works for Piano, Winds, and
 String Quartet*. Andre Gertler, violin; D.
 Andersen, D. Ranki, pianos; Tátrai Quartet.
 Werner: *Introductio Oratoria*. Haydn, M.:
Sinfonia in D. Gassmann: *Sinfonia in A*.
 Süßmayr: *Overture*. Hungarian Chamber
 Orch., V. Tátrai, cond.

RED SEAL STEREO



Alkan: *Concerto for Solo Piano*. Ogdon.
 Beethoven: *Concerto in D, Op. 61a*. P. Serkin;
 New Philharmonia Orch., Ozawa, cond.
 Handel: *Messiah (highlights)*. Shaw Chorale
 and Orch., Shaw, cond.
 Mozart: *The Piano Quintets*. Rubinstein;
 Guarneri Quartet.
 Penderecki: *Entombment of Christ*. Philadel-
 phia Orch., Ormandy, cond.
 Leontyne Price: *I Wish I Knew How it Would
 Feel to Be Free*. Rust College Choir, Mrs. L.
 van Buren Holmes, dir.
 Leontyne Price: *5 Great Operatic Heroines*.

For \$279 we give you engineering. For an extra \$20 we throw in some furniture.

To call the **Rectilinear III** a piece of engineering is a rather vigorous understatement.

The equipment reviewers of leading hi-fi and other technical publications have gone on record that there's nothing better than this \$279 floor-standing speaker system, regardless of type, size or price. (Reprints on request.)

But engineering is all you should expect when you buy this



original version of the **Rectilinear III**. Its cabinet is 35" by 18" by 12" deep, handsome but utterly simple. For \$279, you get quality and taste but no frills.

However, if you're the last of the big-time spenders, you can now escape this austerity for an extra \$20. Because, for \$299, there's the stunning new lowboy version of the **Rectilinear III**, 28" by 22" by 12¼" deep, with a magnificent fretwork grille.

Mind you, the actual internal volume of the enclosure is the same in both versions. So are the

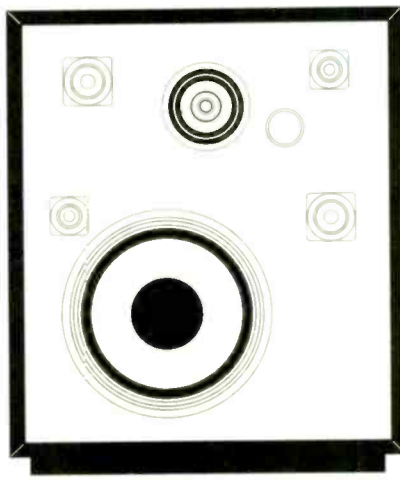

drivers and the crossover network. Only the cabinet styles and the dimensions are different. In the dark, you can't tell which **Rectilinear III** is which. They sound identical.

That's engineering.

(For more information, including detailed literature, see your audio dealer or write to Rectilinear Research Corp., 107 Bruckner Blvd., Bronx, N.Y. 10454. Canada: H. Roy Gray Co. Ltd., Markham, Ont. Overseas: Royal Sound Co., 409 N. Main St., Freeport, N.Y. 11520.)

Rectilinear III

The world's smallest electronic 35mm camera

This incredibly compact and precise camera will please those hard-to-please people who like the simplicity of automatic operation but demand superior quality pictures. The Olympus 35EC uses standard 35mm film and a professional type 5 element Zuiko lens. You'll notice the difference whether you shoot slides, color prints or want really big black and white enlargements. And the 35EC is pocket-size. Always ready in your pocket or purse to take pictures automatically in sunlight, dim light, candlelight. Even with flash it's automatic. The EC's computer brain selects shutter speed and lens aperture automatically to guarantee perfect exposures everytime, day or night. How? Electronically. See a demonstration at your photo dealer. The Olympus EC is under \$80. Part of a complete line of quality Olympus compact cameras.

Marketed exclusively in the U.S.A. by Ponder & Best, Inc. 11201 W. Pico Blvd., Los Angeles, Calif. 90064.

OLYMPUS 35EC

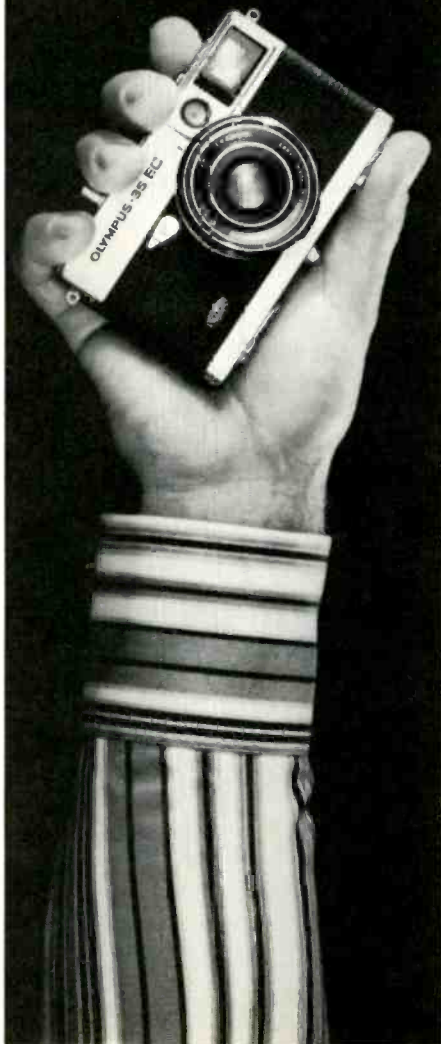

CIRCLE 42 ON READER-SERVICE CARD

Arias from *Traviata*, *Onegin*, *Don Carlo*, *Ariadne*, *Fidelio*. London Symphony Orch., Clevea, cond.

- Rachmaninoff: *Piano Concertos Nos. 2 and 3*. Cliburn: Symphony of the Air. Chicago Symphony Orch., Kondrashin and Reiner, cond.

Scriabin: *Poem of Ecstasy*, *Poem of Fire*. Philadelphia Orch., Ormandy, cond.

Schuman: *Symphony No. 9*; *Quartet No. 3*. Juilliard String Quartet; Philadelphia Orch., Ormandy, cond.

VICTROLA STEREO

- Bartók: *Concerto for Orchestra*. Chicago Symphony Orch., Reiner, cond.

● Beethoven: *Symphony No. 3*. Boston Symphony Orch., Munch, cond.

Bizet: *Symphony in C*. Mendelssohn: *Midsummer Night's Dream*. Chicago Symphony Orch., Martinon, cond.

Schumann: *Fanfares and Fantasy*. Goldsmith, piano; Wright, clarinet; Imai, viola.



- *Barbirolli in Vienna*. Works by Lehar, Johann Strauss Jr. & Sr., Richard Strauss. Hallé Orch.

Beethoven: *The Nine Symphonies*; *Coriolan and Egmont Overtures*. Berlin Philharmonic Orch., Cluytens, cond.

The Comic Beethoven. Rothenberger, Gedda, Berry; Chorus of the Bavarian State Opera, Convivium Musicum, etc.

- Delius: *Music of Delius*. Royal Philharmonic Orch., Sir Thomas Beecham, cond.

● *The Art of Giuseppe di Stefano*. Operatic arias. La Scala Chorus and Orch.

● Beniamino Gigli. *Italian Classical Arias*. José Iturbi. *Music of Chopin*. (Released in celebration of the pianist's 75th birthday.)

Rossini: *William Tell (highlights)*. Gedda, Guiot, Blanc; Paris Opera Orch., Lombard, cond.

- *The Seraphim Guide to German Lieder*. Baker, Fischer-Dieskau, Schwarzkopf, etc.

● Stravinsky: *Capriccio*; *Serenade in A*; *Duo concertant*; *Piano Rag-music*. Stravinsky, piano; Samuel Dushkin, violin; Straram Concerts Orch., Ansermet, cond.

STEREO Treasury SERIES

Haydn: *Symphonies, Vol. 3*. Philharmonia Hungarica, Dorati, cond.



Bach: *Cantatas Nos. 1-10*. (First in a series which will comprise all the cantatas.) Esswood, Equiluz, Van Egmond; Vienna Choir

Boys; King's College Choir; Concentus Musicus; Leonhardt Consort; Willcocks, Harnoncourt, Leonhardt, cond.

Baroque Horn Concertos. Works by Telemann, Forster, L. Mozart; Concentus Musicus, Harnoncourt, cond.

Biber: *Bauernkirchfahrt*; *Sonatas for Trumpet and Strings*. Concentus Musicus, Harnoncourt, cond.

Monteverdi: *Il Ritorno di Ulisse*. Baker, Lerer, Hansmann; Concentus Musicus, Harnoncourt, cond.



Beethoven: *Symphony No. 4*; *Coriolan*. Berlin Symphony Orch., Furtwängler, cond.

Brahms: *The Complete Orchestral Works*. Vienna Symphony Orch., Sawallisch, cond.

Brahms: *The Complete Organ Works*. Kurt Rapf, organ.

Brahms: *A German Requiem*. Concertgebouw Orch., Mengelberg, cond.

Contemporary Music from Sweden. Works by Wren and Rosenberg. Stockholm Philharmonic Orch., Herbert Blomstedt, cond.

Gershwin: *Rhapsody in Blue* (original orchestration); *Concerto in F*; *Preludes*. Eugene List; Berlin Symphony Orch., Samuel Adler, cond.

A Gotschalk Festival. Eugene List and Brady Millican, pianos; Berlin Symphony and Vienna State Opera Orchs., Igor Buketoff and Samuel Adler, cond.

Josquin des Prez: *Missa de Beata Vergine*; *Motets*; *Psalm 92*. Dessoif Choirs, Paul Boepple, cond.

Liszt: *Piano Music*. Louis Kentner and Joan Havill, pianos.

Schuman: *Symphony No. 7*. Rorem; *Symphony No. 3*. Utah Symphony Orch. Abravanel, cond.

Schumann: *Carnaval, Op. 9*; *Fantasia, Op. 17*. Simon.

The World of Adam de la Halle. Music of the 12th- and 13th-Century Minstrels. Cambridge Consort, Joel Cohen, dir.



The Early String Quartet in Europe. Works by M. Haydn, Dittersdorf, Tomasini, etc. Schäffer Quartet.

Fauré: *Chamber Music*. Jacqueline Eymar, piano; Loewenguth Quartet.

Haydn: *String Quartets, Vol. 9*; *Divertimento, Op. "O"*. Fine Arts Quartet.

Mendelssohn: *Chamber Music, Vol. 3*. Trio Bell'Arte; Bamberg String Quartet; Collegium con Basso.

Tchaikovsky: *Piano Music, Vol. 2*. Ponti.

The World's Greatest Organ Music, Vol. 1 (France). André Isoir, Xavier Darasse. Claude Terrasse.

The World's Greatest Organ Music, Vol. 2 (France). André Isoir, Xavier Darasse, René Saorgin.

The World's Greatest Organ Music, Vol. 7 (Germany). Helmuth Rilling.

THE SANSUI QS-1 QUADPHONIC SYNTHESIZER®



SANSUI QS-1

4-CHANNEL SOUND FROM ANY 2-CHANNEL SOURCE

Senses and recovers the ambient information hidden in your stereo discs, tapes and broadcasts

After having discovered that the ambient components of the original total sound field are already contained in hidden form, in conventional stereo records, tapes and broadcasts, Sansui engineers developed a method for sensing and recovering them. These subtle shifts and modulations, if re-introduced, breathtakingly recreate the total of the original sound as it existed in the recording or broadcast studio.

The heart of the Sansui Quadphonic Synthesizer* is a combination of a unique reproducing matrix and a phase modulator. The matrix analyzes the 2-channel information to obtain separate direct and indirect components, then redistributes these signals into a sound field consisting of four distinct sources.

This type of phase modulation of the indirect components, applied to the additional speakers, adds another important element. It sets up a complex phase interference fringe in the listening room that duplicates the multiple indirect-wave effects of the original field. The result is parallel to what would be obtained by using an infinite number of microphones in the studio (M1 through Mn in the accompanying illustration) and reproducing them through a corresponding number of channels and speakers.

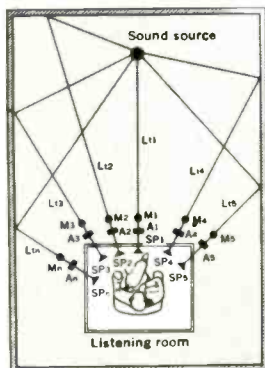
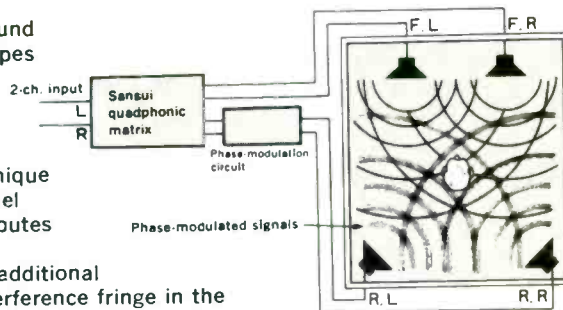

The startling, multidimensional effect goes beyond the four discrete sources used in conventional 4-channel stereo, actually enhancing the sense of spatial distribution and dramatically expanding the dynamic range. Also, the effect is evident anywhere in the listening room, not just in a limited area at the center. And that is exactly the effect obtained with live music! This phenomenon is one of the true tests of the Quadphonic system.

The Sansui Quadphonic Synthesizer QS-1 has been the talk of the recent high-fidelity shows at which it has been demonstrated throughout the country. You have to hear it yourself to believe it. And you can do that now at your Sansui dealer. Discover that you can hear four channels plus, today, with your present records and present stereo broadcasts. \$199.95.

*Patents Pending



SANSUI ELECTRONICS CORP.

Woodside, New York 11377 • Gardena, California 90274

SANSUI ELECTRIC CO., LTD., Tokyo, Japan • Sansui Audio Europe S. A., Antwerp, Belgium

CIRCLE 48 ON READER-SERVICE CARD

CBS Demonstrates Compatible Four-Channel Disc

The CBS dark horse in the quadriphonic sweepstakes finally stepped up to the starting gate as CBS Laboratories vice-president Benjamin B. Bauer and his associates demonstrated their version of a four-channel disc at the recent Montreux, Switzerland international conclave of the music and high fidelity industries. Sponsored jointly by CBS and Sony Corporation, the new disc is called SQ and is compatible with existing stereo (or mono) playback equipment. That is to say, it will render four separate sound channels when played on an existing stereo system to which has been added a special decoder, another stereo amplifier, and two more loudspeakers. Played on a system without the added hardware, the SQ disc will sound like any conventional stereo disc.

This compatibility also extends to broadcast use: for quadriphonic transmission, the SQ disc may be played in the normal manner at the station and sent out as a mono or stereo signal in the usual way. If the broadcast is in stereo, listeners at home can hear it that way or—with the added hardware—in a four-channel presentation.

In listening tests that permitted instant comparison of the master four-channel tape and the four-channel disc processed from it, we seldom were able to detect differences between the two formats. We also could cut out the rear loudspeakers and hear a normal "up front" stereo version of the matrixed program; it sounded comparable to good regular stereo, with appropriate channel separation and full-range tonality.

The CBS process uses a double-helical modulation concept that permits the record-cutting head to engrave the record-groove walls in the normal stereo manner while simultaneously encoding the groove with the two additional "back" signals. The technique is suitable for all kinds of music including classical and "surround-sound" pops; and Columbia Records plans

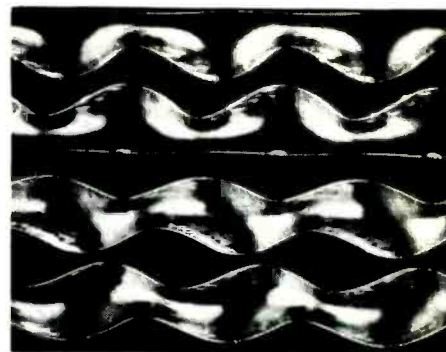

Groove shapes representing four basic signals of quadriphonic sound look like this on SQ disc: (from the top) left-front, right-front, left-back, and right-back. Full four-channel sound combines all four in a single groove.

to release fifty titles in the new format by the year's end. The new SQ discs will list for \$1.00 more than conventional stereo discs.

Sony is involved in the SQ project in two ways. CBS/Sony Records (a venture jointly owned by Columbia Records and Sony Corp.) will be distributing the SQ discs in Japan. Sony also is making the necessary hardware, and SQ decoding components are expected on the American market this fall.

Also scheduled for early release are the first Columbia four-channel tapes—both on open reels and in eight-track cartridges. Like tapes previously released in these formats by other companies, the Columbia issues will play on the four-channel tape equipment that is now available. (For recent announcements in this field, see our report in this column last month.) That is to say, the tapes will represent discrete—rather than encoded—four-channel sound.

CIRCLE 147 ON READER-SERVICE CARD



Do-it-all cassette head: elements for forward direction of tape travel are at bottom; those for reverse at top.

Ampex: New Head, New Tape, New Format

Ampex Corporation has, in rapid succession, made three announcements recently that will be of interest to high fidelity equipment owners. All three concern a product that has not previously been available from Ampex, and one in fact features a product that has never been marketed before in the consumer products field.

This last is a six-element cassette head, containing

two erase gaps and two pairs of record/play elements. The head is intended for use in the new Ampex bi-directional cassette equipment and does not require repositioning when tape-travel direction is reversed. By mounting the erase elements on the same head and using a dual capstan drive (one capstan uses the "window" in the cassette normally occupied by a separate, single-direction erase head), Ampex says it achieves greater stability of motion and accuracy of erase-head tracking than can be achieved by conventional designs.

Then there is Ampex's new tape, with a chromium-dioxide (rather than iron-oxide) magnetic coating. It will be available as the 363 Series of blank cassettes and, according to Ampex, will be appropriate for use on all equipment provided with compensation for chromium-dioxide tapes. Among the newer units with this compensation are several now being introduced by Ampex itself.

The new format is the eight-track tape cartridge for which Ampex had not previously made any equipment. Among the models the company is now introducing are some designed to play four-channel cartridges for discrete (nonencoded) quadriphonic sound.

CIRCLE 148 ON READER-SERVICE CARD

The experts agree on the Citation Eleven Preamplifier.



Citation Eleven (wired) \$295.00

Stereo Review:

... The Citation Eleven is unquestionably one of the best preamplifiers we have measured. It would take better ears — and instruments — than ours to find any unintentional signal modification in the output of the Citation Eleven. As a rigorous test of the Citation Eleven's "wire with gain" properties, we connected it up so that a signal could be led either around it or through it on the way to the power amplifier. Any response aberration introduced by the Eleven would then be audible during A-B comparisons. Perhaps needless to say, the Eleven left the signals (including white noise) completely unaffected in any way detectable by our ears. It is an ideal companion for any really good basic power amplifier. In combination with the Citation Twelve, it would be hard to beat.

... unquestionably one of the best preamplifiers we have measured.

High Fidelity:

... Using and listening to the Eleven is a music-lover's delight: the unit does nothing to the source material that you don't want it to do. It is one of those superior audio devices that functions without seeming to be in the circuit; it lets you listen through the system back to the program material. We have no doubt, in fact, that the performance capabilities of Citation equipment exceed the response capabilities of commercial program material. Just to nail home this point we played a stereo tape that had been dubbed from master tapes containing a variety of orchestral and vocal selections which we could now hear several generations earlier than we normally would in their commercial-release versions. Their superiority was clearly audible on Citation equipment, once again demonstrating that "Citation sound" is nothing more or less than accurate reproduction of musical sound.

... accurate reproduction of musical sound.

Audio:

... Having made all the measurements, we were champing at the bit to try it out. We have been using the Citation Twelve as a power amplifier for some months, and from the moment it was put into service, we noted a definite improvement in our sound quality. The Eleven does away with the need for any frequency shaping devices, since it has practically all that anyone could desire. With music, you can correct for recording miscalculation, if it exists, or you can add your own. You can compensate for room acoustics to a remarkable degree, increasing the bass to make up for speaker deficiencies, and boosting or cutting the highs — extreme or middle — to make up for room furnishings. In short, there is very little that you cannot do with the Citation Eleven. It is a worthy addition to the already distinguished reputation that the name Citation has achieved over the many years since they first made their appearance.

... very little that you cannot do with the Citation Eleven.

Stereo & Hi-Fi Times:

Let me say it right out. The Citation Eleven is a fitting companion to the power amp I wrote about last time. That is, the pair of units represent no-compromise audio. The Citation Eleven ... does everything a separate preamp is expected to do, it does things with finesse, and it does things no other preamp does. ... I started off heaping praise on the Citation Eleven. That praise is unqualified. Granted, there are not too many separate preamplifiers left on the market. But of these, the Citation Eleven must be the best — and more important — it will not be bettered in the near future. At \$295, it represents the culmination of a purist's dream.

... represents the culmination of a purist's dream.

Record Guide:

The state of the amplification art moves inexorably on. Just as I get to a point when I begin to believe that preamps hardly can be improved, some manufacturer proves me utterly wrong. Harman-Kardon has done it this time — and not for the first time, either. ... I might add that the Citation Eleven is now the preamp that acts as the control of my own music system. And there it will stay for the foreseeable future. What more can I say?

*... acts as the control of my own music system ...
What more can I say?*



We're eager to send complete information.

Write Harman-Kardon, 55 Ames Court, Plainville, N. Y. 11803

CIRCLE 26 ON READER-SERVICE CARD

harman kardon

A subsidiary of Jervis Corporation

equipment in the news



Citation circuitry in H-K receiver

Harman-Kardon's premium line of Citation components has given some of its circuit design to a new stereo receiver, the 930, according to the company. Two separate power supplies deliver regulated voltage independently to left and right channels of the receiver's power-amplifier section. The FM/AM tuner section includes dual tuning meters. Monitoring is provided for two tape recorders. Price is \$369.95.

CIRCLE 149 ON READER-SERVICE CARD

Panasonic's deluxe cassette deck

Among the unusual features of the Panasonic RS-275U stereo cassette deck are separate capstan and "reel" motors, a (non-Dolby) noise suppression system, Panasonic's Hot Pressed Ferrite heads (claimed to outlast and outperform conventional heads), a "memory" system that allows you to return to a preselected point in the cassette, and a high-density/standard tape bias switch. The unit sells for \$249.95.

CIRCLE 150 ON READER-SERVICE CARD



Fairfax offers Wall of Sound speaker system

Within its unusual proportions (4 ft. high, 2½ ft. wide, 6 in. deep) the Fairfax Wall of Sound contains twelve drivers: two for the low bass, two for the low midbass, two for the upper midbass, four for the midhigh range, and two wide-dispersion tweeters. The internal construction of the enclosure is described as containing eight separate chambers and an "integrated cyclone labyrinth system," plus crossover networks with unusually sharp roll-off characteristics. The system sells for \$399.50.

CIRCLE 151 ON READER-SERVICE CARD

Dolby units from Teac

Several versions of the Dolby noise-reduction circuitry (Type B, for home use) have been announced by Teac Corp. Shown here is the Model AN-180 with four separate Dolby circuits, allowing recording through one pair and simultaneous off-the-tape monitoring through the other pair. The unit includes mike preamps and sells for \$289.50. A simplified model, the AN-80, contains only one pair of Dolby circuits and sells for \$129.50. A compact version of the AN-80 is planned, as the AN-50, for use with Teac's A-23, A-24, and A-25 cassette decks. In addition, the new Model 350 cassette deck contains built-in Dolby circuitry and sells for \$279.50.

CIRCLE 152 ON READER-SERVICE CARD



Sherwood's digital FM tuner

Sherwood Electronic Laboratories has announced availability of the SEL-300 stereo FM tuner featuring dual tuning meters and crystal-controlled digital-tube frequency readout. Sherwood rates the SEL-300's sensitivity at 1.5 microvolts (IHF). The unit has direct outputs for two tape recorders. It sells for \$579.

CIRCLE 153 ON READER-SERVICE CARD

THE CRITICS HAVE PUT THE COMPETITION IN THEIR PLACE

Specifically, the leading consumer testing publications have continually top-rated Sherwood receivers over all others. Our S-8900 shown here leading the pack is no exception.

Of course, we worked hard to get those ratings.

The S-8900 has a powerful 225 watt ($\pm 1\text{dB}$) amplifier (48 watts RMS per channel at 8 OHMS). FM distortion is the lowest in the industry—0.15%. There's an impressive 3 year parts warranty, plus 1 year labor, too.

The S-8900 features solid-state ceramic FM IF filtering. Exclusive FET FM interchannel hush control. A zero-center tuning meter.

There's an extra front panel tape record/dubbing jack. And six pushbuttons for every effect you could possibly want.

At \$399.95, our S-8900 gives more top-rated quality than any comparable or lower priced model.

That's what we've always said.

Only now you don't have to take our word for it.

For more information and complete specifications, write us today. Sherwood Electronic Laboratories, Inc., Dept. A, 4500 North California Avenue, Chicago, Illinois 60618.

**SHERWOOD
SOUNDS EXPENSIVE**

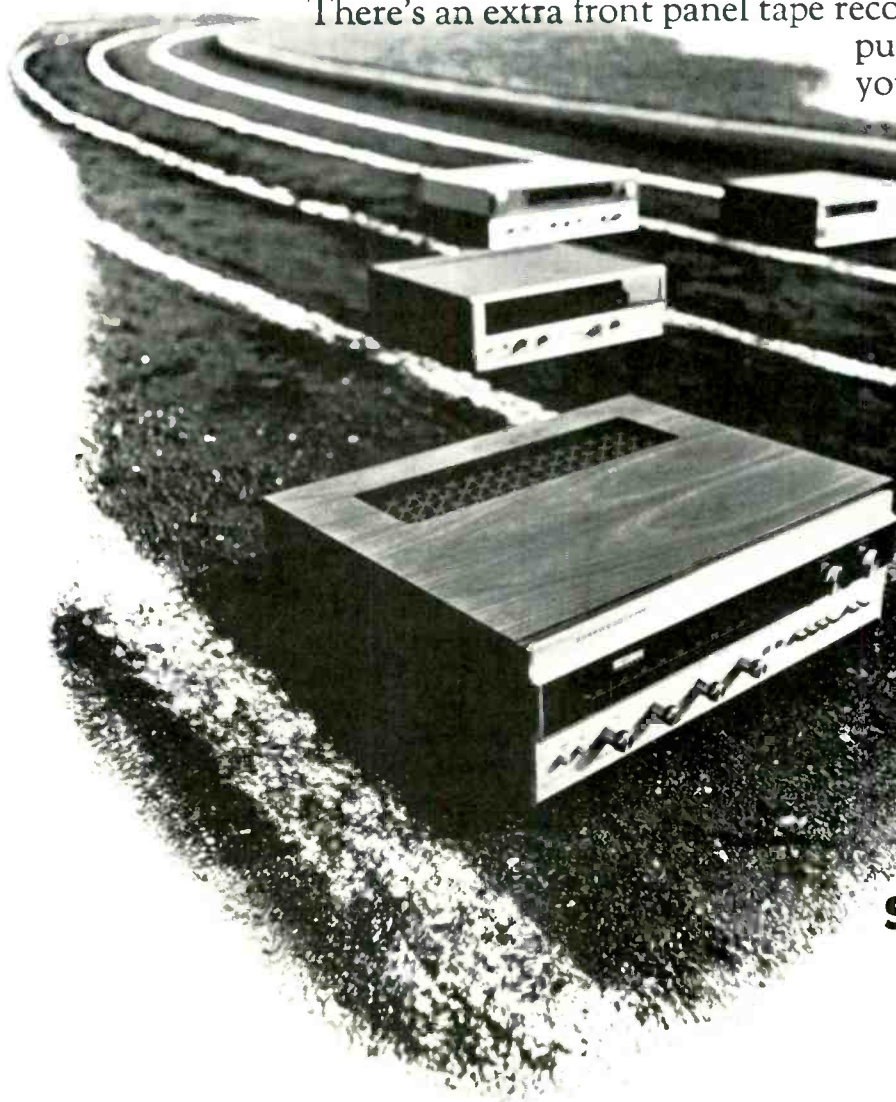

Approved for 4 channel

Empire's top of the line cartridges now feature new high performance parameters designed for 4-channel capability. With even greater frequency response and compliance than ever before, these cartridges will track at forces so low they barely touch your records.

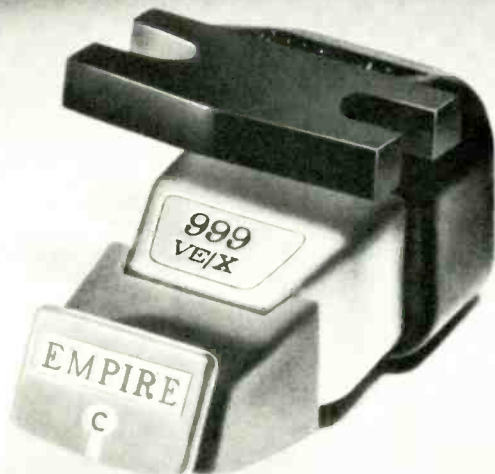

999VE/X Professional—Recommended tracking force ¼ to 1¼ grams. List price \$79.95.



1000ZE/X Measurement Standard—Tracks as low as .1 gram in laboratory playback arms. List price \$99.95.

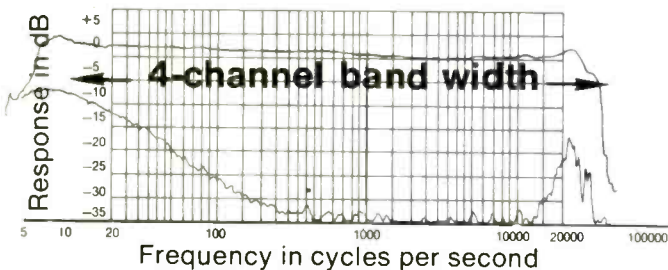

Each 1000ZE/X and 999VE/X cartridge is individually adjusted to have a flat frequency response within ± 1 dB from 20-20,000 Hz. Stereo separation is better than 35 dB at 1 Hz and remains 25 dB or better all the way out to 20,000 Hz. Overall frequency response is a phenomenal 4-40,000 Hz. There are no electrical or mechanical peaks and total 1M distortion at the standard 3.54 cm/sec groove velocity does not exceed .05% at any frequency within the full spectrum. Uses a .2 x .7 hand polished miniature diamond for exceptionally low mass.

Empire cartridges are enthusiastically acclaimed by the experts; for example:

Stereo Review Magazine who tested 13 different cartridges rated the 999VE tops in lightweight tracking ability.

Hi Fi Sound Magazine called the 999VE "a real

hi-fi masterpiece... a remarkable cartridge unlikely to wear out discs any more rapidly than a feather held lightly against the spinning groove."

High Fidelity Magazine said of the 1000ZE "the sound is superb. The performance data among the very best."

Records and Recording Magazine stated emphatically that the 999VE stereo cartridge is "a design that encourages a hi fi purist to clap his hands with joy."

FM Guide wrote "...using the 1000ZE. It works beautifully... giving great results."

Audio Magazine observing a remarkable 35 dB stereo spread between left and right channels in the 999VE said "Outstanding square waves. Tops in separation."

Popular Science Magazine picked the 999VE hands down as the cartridge for "the stereo system I wish I owned" designed by Electronic Editor Ronald M. Benrey.

X designates newest improved version.

For further details write: Empire Scientific Corp., 1055 Stewart Avenue, Garden City, N. Y. 11530.

empire

Mfd. U.S.A. 

World Famous Long Playing Cartridges



First Quadriphonic Receiver Does Fine Job in Stereo Too

The Equipment: Fisher 701 four-channel FM/AM receiver with automatic remote-control FM tuning. Dimensions (including rear-mounted AM antenna): 16 15/16 by 5 1/4 by 14 1/4 inches. Price: \$699.95; optional case, \$22.95. Manufacturer: Fisher Radio Corp., 11-35 45th Rd., Long Island City, N.Y. 11101.

Comment: The Fisher 701 differs from conventional stereo receivers in two respects: it has four amplification channels (rather than the usual two), and it incorporates the extra switching facilities to handle four-channel sound (matrixed or "discrete") or to feed four speakers from stereo or mono sources in a variety of ways. No dematrixing circuitry is built in; a suitable accessory decoder must be used to reconstruct the intended four-channel effects from "4-2-4" matrixed program material. The FM tuner section similarly includes no provision for receiving four-channel broadcasts by any of the proposed special multiplex techniques. Should such a broadcast method be approved by the FCC, Fisher says it will make available a special multiplex board to adapt the 701 to receive these transmissions.

Since the control functions are the key to the 701's

operation, let's examine the faceplate. In the upper section from left to right are a signal-strength tuning meter with mode indicators and Stereo Beacon (stereo FM indicator) above it, the tuning dial, tuning knob, two horizontal sliders for front and rear volume settings, and (below them) four Autoscanning tuning buttons—whose functions will be explained later. On the bottom section of the front panel are a headphone jack, a four-position tape monitor switch ("front and rear" for monitoring four-channel tapes, "off" for monitoring other program sources, "front" to pick up the normal stereo pair of tape tracks, and "rear" for hearing only the other two tracks), and the selector (phono, FM, AM, and two aux positions). Next comes the mode switch: mono (identical signals fed to all four speakers), two-channel stereo (both left speakers receive left signal, both right speakers the right signal), four-channel stereo (all four channels are independent of each other), four-channel reverse (front-right and back-left signals are interchanged), and two-plus-two-channel (back signals are derived from front signals on the same side, but reduced in level by 3 dB to simulate reverberant sound coming from the rear of the hall). Next are the bass and treble controls and the left-to-right balance control. (The

REPORT POLICY

Equipment reports are based on laboratory measurements and controlled listening tests. Unless otherwise noted, test data and measurements are obtained by CBS Laboratories, Stamford, Connecticut, a division of Columbia Broadcasting System, Inc., one of the nation's leading research organizations. The choice of equipment to be tested rests with the editors of HIGH FIDELITY. Manufacturers are not permitted to read reports in advance of publication, and no report, or portion thereof, may be reproduced for any purpose or in any form without written permission of the publisher. All reports should be construed as applying to the specific samples tested; neither HIGH FIDELITY nor CBS Laboratories assumes responsibility for product performance or quality.

previously mentioned volume sliders double as the front-to-back balance control.) Bass, treble, and balance all have separate sections for adjusting front and back channel pairs. The last knob controls outputs: to headphones, main speakers, remote speakers, or all speakers. At the end of the bottom section are separate high-filter buttons for front and back, an FM-muting defeat button, and separate loudness buttons for front and back channel pairs.

At first glance the back panel is somewhat intimidating: aside from the antenna connections at the top of the right end, all connections are made along the bottom. First, beginning at the left, are the AC line cord and fuse, then a pair of convenience outlets. Next is a DIN socket used for plug in the remote tuning control, then all sixteen (!) speaker connections: hot and common terminals for four main speakers plus four remote speakers. Finally, ranged in the usual left-and-right pairs, are the input and line output connections: tape monitor in, back and front; recorder output, back and front; aux 2 in, back and front; aux 1, back and front; and phono in—a total of eighteen jacks. Oh yes, there's also a connection for ground from turntable or tape recorder.

The FM tuning system is like that of any conventional receiver unless the Autoscan button (the first of the four we passed over in our description of the front-panel controls) is pressed. When it is pressed, the station may be selected in either of two modes (continuous or one-station) by using the appropriate buttons on the front panel or their equivalent on the remote-control unit that plugs into the rear panel. In either case the tuning meter now becomes a tuning dial, and special calibration for that purpose lights up. If you press the "continuous" button, the tuning system will scan the FM band from bottom to top until you release the button; then it will zero in on the next station of sufficient strength to pass the circuit's threshold. The "one-station" button changes tuning one station at a time. The fourth button in the Autoscan group switches in an AFC (automatic frequency control) feature.

In performance, both AM and FM sections of the 701 are at least the equal of the tuner portion of a very good two-channel stereo receiver. IHF sensitivity was measured as 1.9 microvolts, and for stronger input signals the quieting descends rapidly to better than -48 dB and remains there. And lab findings further confirm the tuner's excellence in terms of capture ratio and freedom from noise and distortion. In our cable-FM test we logged some fifty-five stations, of which thirty-nine were received well enough for long-term listening or recording—a very good count. AM reception was clear and trouble-free.

For purposes of stereo listening, the 701's amplifier section may be rated at a conservative 40 watts per channel into 8-ohm speakers with low distortion. In four-channel operation the extra demands on the power supply reduce this per-channel figure to something closer to 30 watts per channel, but they're still good, clean watts and power is sufficient for just about any four speaker systems in just about any room—or a full complement of eight speakers if they are reasonably efficient and/or the rooms in which they are used are neither too large nor too "dead."

The front-panel switching is complex, but it is well thought out and we could see no way in which it could be simplified significantly without hampering flexibility of operation. That flexibility—really excellent in the 701—will be of paramount importance in any four-

channel product of this sort, in our view, until the present welter of competing technologies has been thinned out.

The multiposition monitor switch on the 701 is particularly significant since it allows the receiver to be used in conjunction with such accessory four-channel devices as the EVX-4 decoder. (See separate story.) In using the 701, we developed a number of quite different hookup schemes, combining stereo, decoded four-channel, and discrete four-channel operation in various ways, and even working a separate Dolby unit into the system in different configurations. At no point did the 701's controls let us down by preventing any reasonable and desirable setup; the limiting factors, when we encountered them, invariably were elsewhere in the system. But these systems were complicated and frequently produced no sound simply because a monitor or decoder switch somewhere had been left in the wrong position—a price one simply must pay if one wants to experiment with quadriphonics as they now exist.

Before leaving the subject of controls, we should mention the 701's balancing system. Much four-channel equipment has two balance controls: left-right and front-back. The second of these is handled in the 701 by the relative positions of the front and back volume sliders, an arrangement we tended to favor because we found that we altered front-back balance frequently and often killed back response altogether—either for purposes of comparison or to remove an unwanted four-channel effect. Once set for the room the left-right balance remained untouched. Perhaps if quadriphony becomes standardized the front-back balance also will remain untouched; until then, the Fisher system seems appropriate.

Of the various possible modes of operation with the 701 we found we used regular stereo, discrete four-channel, and encoded four-channel (via an accessory decoder) most frequently. Desirability of both the two-left-plus-two-right and left-and-right-plus-simulated-ambience modes would appear to depend to a large extent on room acoustics. These modes might be desirable in solving specific acoustic problems, but offered relatively little in a normal room.

All things considered, Fisher has done a remarkable job of solving the problems of so new an equipment format. The 701 offers excellent performance in either stereo or any of the quadriphonic modes suggested in this report (to say nothing of mono, of course). But there is a price to be paid both in terms of the added complexity of the system and in dollars: the 701 costs considerably more than a stereo receiver of comparable quality. Some readers will prefer to invest the extra money in better stereo; but those bent on exploring the wonderful world of quadriphony have, in the 701, a product that really will do the job.

CIRCLE 142 ON READER-SERVICE CARD

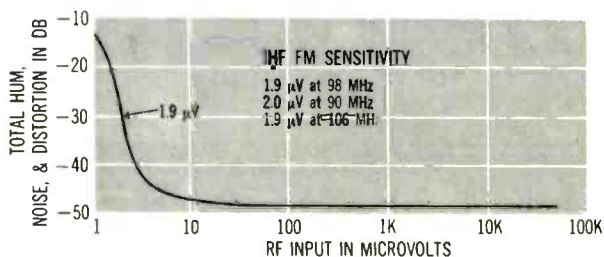

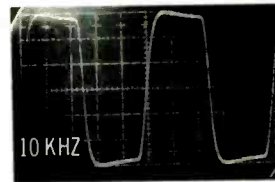
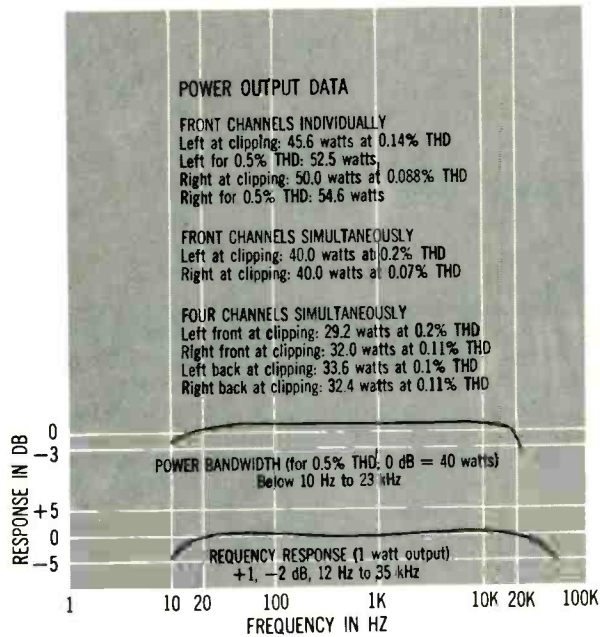
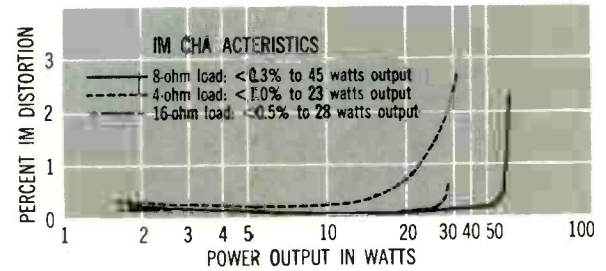
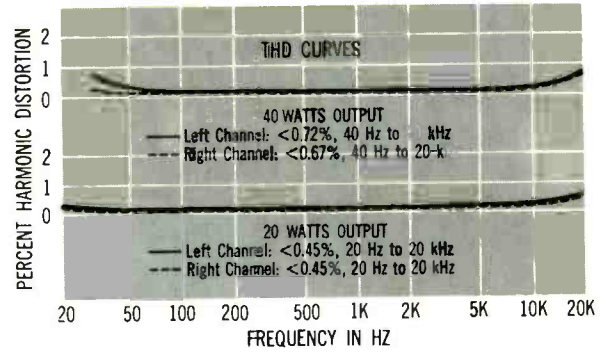
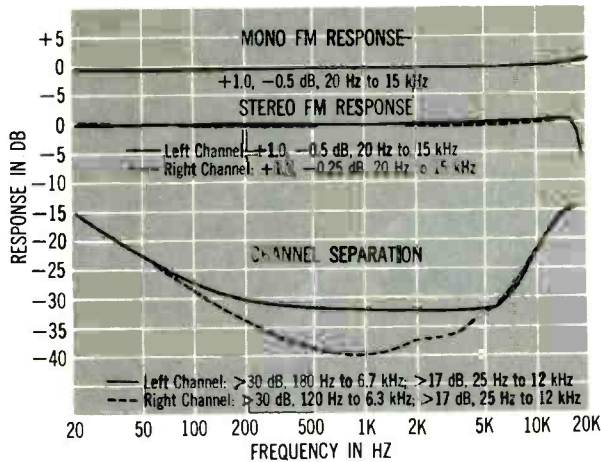

Square-wave response.

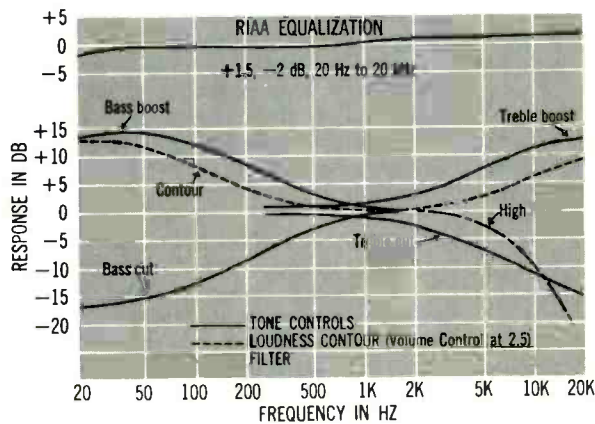

Fisher 701 Additional Data

Tuner Section			
Capture ratio	1.5 dB		
S/N ratio	-71 dB		
IM distortion	0.2%		
THD	Mono	L ch	R ch
40 Hz	0.45%	0.49%	0.41%
400 Hz	0.37%	0.25%	0.33%
1 kHz	0.30%	0.25%	0.25%
19-kHz pilot	-47 dB		
38-kHz subcarrier	-52 dB		
Amplifier Section			
Damping factor	61		
Input characteristics (for 40 watts output)			
	Sensitivity	S/N	
phono	2.7 mV	58.0 dB	
aux 1	200 mV	67.5 dB	
aux 2	193 mV	67.0 dB	
tape mon	290 mV	70.0 dB	



E-V's Quadriphonic Decoder

The Equipment: Electro-Voice EVX-4 Stereo 4 decoder for recovering quadriphonic signals from matrixed two-channel program sources or for producing quadriphonic effects from stereo program sources. Dimensions: 5¼ by 2½ by 6 inches. Price: \$59.95. Manufacturer: Electro-Voice, Inc., Carroll & Cecil Sts., Buchanan, Mich. 49107.

Comment: The EVX-4 is an accessory device designed to be inserted between a stereo control preamplifier and a four-channel power amplifier—or between the appropriate sections of a receiver, using either the preamp/amp jumpers sometimes provided for that purpose or the tape monitor circuit. It can be used with a four-channel receiver (such as the Fisher 701 reviewed above) or with any stereo receiver supplemented by a separate stereo power amplifier and an additional pair of speakers. (In any four-channel system, of course, a total of four speakers will be needed, no matter how they are driven.)

The basic purpose of the E-V decoder is to reconstruct four channels of information from recordings that had previously been appropriately matrixed into the two channels of a stereo disc or a stereo FM broadcast. Program material so matrixed will reproduce as stereo on conventional equipment; with the EVX-4 or equivalent circuitry they can be used as four-channel source material. Electro-Voice also makes the necessary encoder, which has been used by several recording companies and a number of stations to prepare discs and FM broadcasts for public consumption.

Unencoded recordings and broadcasts also contain relationships between the two signals of the stereo pair that, as it happens, will be "read" as four-channel encoding by the EVX-4 circuit, producing quadriphony where none was intended. Hence the decoder can be

used as a way of synthesizing four-channel effects from your present stereo library and regular stereo broadcasts—an interim road to quadriphony until such time as "the real thing" may become commonplace.

Bench tests confirm the circuit to be well designed in terms of the usual criteria. The frequency-response curve is virtually flat across the audible range. The slight droop between 10 and 20 kHz (less than 0.3 dB) is visible only because we have expanded the usual scale in drawing the curve. At more than 68 dB, the signal-to-noise ratio is greater than you are likely to find in most other components of your system and better than you will find in commercially available program materials. (The over-all S/N ratio of good, "clean" FM reception, for example, generally will be no better than 50 dB, if that.) And distortion is very low. Note that here, like E-V in its published specs, we have chosen 0.25 volts as the reference level. Actual levels of the loudest musical passages may run higher or lower than this figure depending on the program source and the design of your preamplifier. If loud passages actually deliver the nominal one volt of tape recorder line connections on your equipment, for example, you can expect a working S/N ratio of 80 dB. Input voltages, however, should not run higher than the 2.5 volts at which clipping begins.

The accompanying table of relative output values per channel gives some indication of the effects that can be expected when playing conventional stereo program materials through the decoder to provide a simulated quadriphonic effect. When both channels are driven equally the input represents that from a mono source—for example, a soloist centered in the original stereo perspective; the left-only input represents a sound source at one extreme side of the stereo image. That centered soloist continues to appear front-center in the

simulated quadraphonic image, with the signal intended for the back speakers some 17 dB lower than that for the front speakers. When the source is at one side (at the left in this test) the two outputs (front and back) for that side will deliver a higher level than the outputs for the opposite side. The back speaker on the side toward the original source will be fed by a signal only 2 dB higher than that feeding the back speaker on the far side, however. This minimal separation between back speakers appears to be the reason for the vagueness or instability of location that we noted on listening to sound sources located at the extreme sides in stereo recordings, heard via the decoding circuitry.

The back panel of the EVX-4 contains the AC line cord plus ten phono jacks, left and right pairs for each of five functions: input, tape out, tape in, front out, and back out. (Note that here, as elsewhere in HIGH FIDELITY, we have used the word "back" instead of the actual marking, "rear," to simplify the process of abbreviation—otherwise "R" would have to do double service for both "right" and "rear.") On the front panel there are two controls: master gain and mode (source decode, tape decode, and two-channel tape monitor).

These designations presuppose that normal use will be in conjunction with the tape-monitor facility in the stereo system. Leads are run from the tape monitor output on the preamp or receiver to the input connections on the EVX-4, from the line output on the tape recorder to the tape-in connections on the EVX-4, and from the decoder's tape-out jacks to the line inputs on the tape recorder. If you are using a four-channel receiver, all four outputs on the EVX-4 would be connected to the appropriate monitor jacks on the receiver; if separate amplifiers or power amplifier sections are used, as in adapting a stereo system to four-channel use, the front outputs of the EVX-4 would be connected to the monitor jacks on the main stereo system, and the back outputs to the added power amplifier.

With either type of system you may listen to decoded sound by setting the main system's switch to the tape monitor position and switching the EVX-4 to source decode. (If the source is a two-channel stereo tape, you would, of course, use the tape decode setting.) Should you want to return to conventional stereo, you need only turn off the monitor switch (or switch to the two-channel monitor position). While you are listening to quadraphony, the master gain on the EVX-4 will control all four speakers. We found ourselves leaving this control set to the maximum-gain position, however, since the output level then matches that of the input ("unity gain") and hence the levels produced by the system in the regular stereo mode. Otherwise a return to stereo operation can entail a startling (and, from the speakers' point of view, dangerous) increase in levels. But note that the master control must be used in systems in which a simple stereo power amplifier, without volume control, is used on the rear speakers. If you plan such a system, we would advise that you choose an accessory amplifier somewhat less powerful than that in your main stereo system so that you can use the volume control of the latter to balance front and back outputs.

A conventional two-channel tape recorder can be used effectively in conjunction with the EVX-4's tape terminals, and can even make quadraphonic recordings under some circumstances. Since the pair of signals that enter the input terminals of the EVX-4 are fed unaltered to its tape output connections (that is, they are not decoded regardless of switch position on the EVX-4), you can continue to make stereo recordings in the

usual way. If what you are recording happens to be encoded four-channel sound—meaning, normally, that the program source is either matrixed four-channel discs or FM—the recording you produce also will be so encoded. Either the original source or the recorded signal from the tape can be monitored quadraphonically, although the signals handled by the tape deck are, from its point of view, indistinguishable from conventional stereo.

Real quadraphony buffs, if the breed exists, may find one point to disparage. The EVX-4 does not adapt easily to a system including sources for both encoded and discrete four-channel sound. By discrete we mean, of course, a system in which all four signals retain their separate identities, unencoded, throughout the reproduction chain. Since there are no connections for the back channels of a discrete (four-channel four-track open-reel or four-channel eight-track cartridge) tape recorder, extra switching normally will be needed to select either the output of the tape deck or that of the EVX-4 as the source for the back-speaker amplifiers. The difficulty of managing this extra switching will vary considerably with the equipment chosen for the system, of course, but it could have been solved altogether by adding extra jacks to the back of the EVX-4 and extra contacts to its mode switch. Since quadraphonic tapes can be made from encoded sources on a conventional deck using the method described above, however, the ability to play four discrete channels from tape likely will be of interest only in working from commercially recorded tape or, in the case of the no-holds-barred home recordist, four-channel tapes made "live" using four microphones.

CIRCLE 145 ON READER-SERVICE CARD

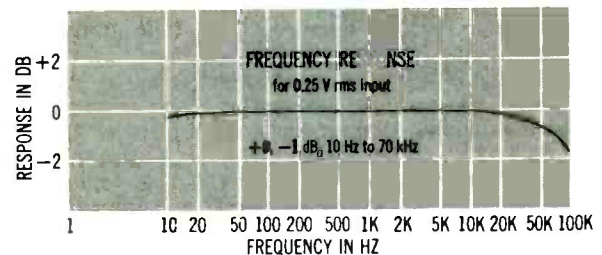

EVX-4 Decoder Additional Data

Maximum gain (at 1 kHz, both channels driven)	unity
Maximum input at clipping	2.5 V rms
S/N ratio (ref. 0.25 V rms output)	> 68 dB
IM distortion (at 0.25 V rms input)	0.10%
THD (at 0.25 V rms input)	0.07%
Relative signal distribution in decode mode (at 1 kHz; 0 dB equals 0.25 V)	
	Output
both inputs driven (0 dB)	LF ch: 0 dB LB ch: -17.5 dB RF ch: 0 dB RB ch: -16.5 dB
left input only (0 dB)	LF ch: -1.5 dB LB ch: -4.0 dB RF ch: -15.5 dB RB ch: -6.0 dB

Instant Quadriphony

How the Fisher and E-V Worked Together

by Robert Long

What good, you might ask, are the four-channel products reviewed in this issue if so few broadcasts and recordings are available in quadriphonic form? The question obviously has bothered manufacturers as well as consumers. All quadriphonic equipment is designed to be used for regular stereo as well, and the "compatibility" of quadriphonic recordings and broadcasts with respect to stereo reproduction systems has been a major concern of companies venturing into four-channel program material.

And yet four-channel equipment continues to appear much more rapidly than four-channel recordings. It is with a certain air of glee, then, that manufacturers of decoding equipment capable of sorting out four channels of sound from two-channel matrixed program material have discovered that quadriphonic effects can be derived from conventional stereo recordings and broadcasts as well. "Now you can enjoy the wonders of four-channel sound even without the real thing to play on our equipment," they say to us. Copout? Stoppap? Snowjob? I decided to find out.

The system I set up in my living room consists of the Fisher 701 four-channel receiver with the EVX-4 Stereo 4 decoder inserted between preamp and power amp sections via the tape-monitor connections. The front-channel amplifier pair drive Heathkit AS-38 speaker systems, the rear pair feed AR-6s. For source material I used a number of open-reel (Sony and Ferrograph) and cassette (Harman-Kardon and Teac) decks, with and without Dolby circuitry (Advent's), and a turntable (usually a Lenco L-75 with a B&O SP-12 cartridge)—in addition to the FM tuner section of the Fisher 701.

Since my living room is on the large side and fairly live, tending to blur stereo images, the normal listening area is toward one end. I set up the speakers in this area with the "back" pair toward the unused end of the room. The speakers ended up spaced approximately in a square. The "front" wall is the deadest, being solid bookshelves, while the open space at the back seems to produce some ambience simulation, increasing the sense of front and back by contrast to the more usual demonstration setup with speakers in the room's four corners. Whether or not this is the cause, the effect is appreciably more spacious than that in similar demonstrations I have heard elsewhere.

For over a month now I have been living with this setup and playing my regular stereo records and tapes through it. But before describing what I hear let me point out that my experience may or may not be a valid index to what you will hear if you set up a similar system. For one thing, we are talking only of *conventional* stereo recordings, never intended for playback in this fashion. The quadriphonic effects they display are accidental and vary drastically from recording to recording; if you play different recordings, all bets are off. The room, the speakers, and so on can and do influence the end result. Most important of all is the question of what you expect from your recordings. Some effects that delight one listener may offend another. Would-be conductors

will revel in a wraparound orchestra; the more passive may prefer the musicians to keep their distance.

One of the first recordings I tried was Maazel's reading of Stravinsky's *Firebird Suite* (DGG 138006). The expected bass reinforcement was evident in the opening section, the perspective solidly up front with only a subtle sense of extra space added by the rear speakers: a convincing concert-hall effect in fact. If this is the way stereo recordings were going to sound through the EVX-4, I began to think, those who complain of being in the center of the orchestra need have no fear. But then came the explosion at the beginning of King Kaschei's dance. Percussion instruments rattled from the back speakers or jumped about from one speaker to another. The serene concert-hall mood was destroyed.

This instability of placement is in evidence from time to time in playing many classical records, and is one of the less attractive aspects of instant quadriphony. (Again, the recordings were not made for quadriphonic playback; the effect therefore is unpredictable.) In many cases, however, there is very little sense of specific instrument location—just an impression of being surrounded by music. How pleasurable the impression is depends to a large extent on the music. In the elegant formality of a Haydn symphony, for example, I find it quite out of place. In the late Romantics I don't. Particularly striking is the way the opening section of Haydn's *Creation* (Karajan, DGG 270 7044) came across in synthetic quadriphony. His carefully placed dissonances—so evocative of the chaos described in Genesis when heard in the normal stereo context—seem more like an inept attempt to prefigure Berlioz. When the listener finds himself in the orchestra, the natural order of things—an order that Haydn intentionally violates to create his "chaos"—is broken and the effect destroyed.

Would this also be true of stage music—opera for instance? Some operatic recordings are hurt or enhanced little by "decoding," but Puccini and his contemporaries tend to come out clearly the better for it. To be on stage *with* Tosca as she kills Scarpia is far more effective than peering at her through opera glasses. Magda Olivero's recordings of *Fedora* (London OSA 1283) and scenes from *Francesca da Rimini* (London 26121), galvanizing enough in conventional stereo, are overwhelming heard this way. The voices, incidentally, keep their front perspective since they are normally centered in the original stereo. The effect is like that of sitting on the hood of the prompter's box during a performance. (Having some open space, rather than a dead wall, behind the back speakers may contribute to this impression.)

Chamber music lends itself to instant quadriphony less gracefully. On some recordings (the Beethoven woodwind pieces in Vox Box SVBX 580, for example) the instability of placement is all too apparent at times. Occasionally an individual note from a particular player may show an affinity for one speaker, while the instrument otherwise seems to be located elsewhere. Re-

cordings with a more spacious sound generally are more pleasing, though here the effect is of several musicians at some distance from each other in a large room. (Perhaps they "aren't speaking.")

Pops—and particularly rock—by and large come off best of all in decoded sound. The more conventional the recording (a singer backed by a fairly large orchestra with strings, for example) the less obvious is the effect. Often it is no more than an added, but unspecified, sense of space. The Band, which had annoyed me in its best-selling LP (Capitol STAO 132) by the acoustic vagaries of the recording (the epitome of multiple mono, as opposed to true stereo), was aided little by contrast to some of the bigger groups recorded in a more natural-sounding way. Individual tracks on some of The Band's cuts bear no sonic relationship to each other, being much deader, much livier, or what have you. Spreading the sound around the room doesn't help it coalesce into a united whole. The advantages of quadriphonic listening lie more in the opposite direction: the disentanglement of tracks that tend to obscure each other in stereo. Even on The Band's record this sorting-out adds transparency to some of the more massive effects.

It pays off in a really big way for Simon and Garfunkel. On Columbia CS 9363, *Scarborough Fair/Canticle* is utterly spellbinding with the four-channel setup. The

Silent Night cut, which had struck me as a bit gimmicky in stereo with its radio announcer droning news of war, assassination, and depravity against the sotto-voce carol, is deeply moving in expanded form. The room fills with quiet singing, while the radio—sharply in focus near the right front speaker—seems to have been left on by accident, making its bitter contrast to the song far more poignant than when the sound is collapsed into a single wall. That one cut alone is worth the fuss.

This has been a fascinating month—and full of surprises, not all of them pleasant. The playing of stereo recordings through a Stereo 4 decoder obviously is no thoroughgoing substitute for true four-channel sound. At no time—either in my own living room or in the public demonstrations I've heard—has this way of listening to records struck me as approaching the convincing spatial ambience or the specific, detailed localization of the best discrete four-channel demonstrations (using four-channel tape equipment). But it presents some provocative possibilities that give me reason for both hope and fear: hope that quadriphony eventually can be worked out in terms that will make it a viable (meaning, among other things, affordable) commercial reality, and fear that the temptation to record gimmicky effects in order to sell recordings and to compromise technical standards in order to keep costs low may undermine, rather than enhance, the listening experience.

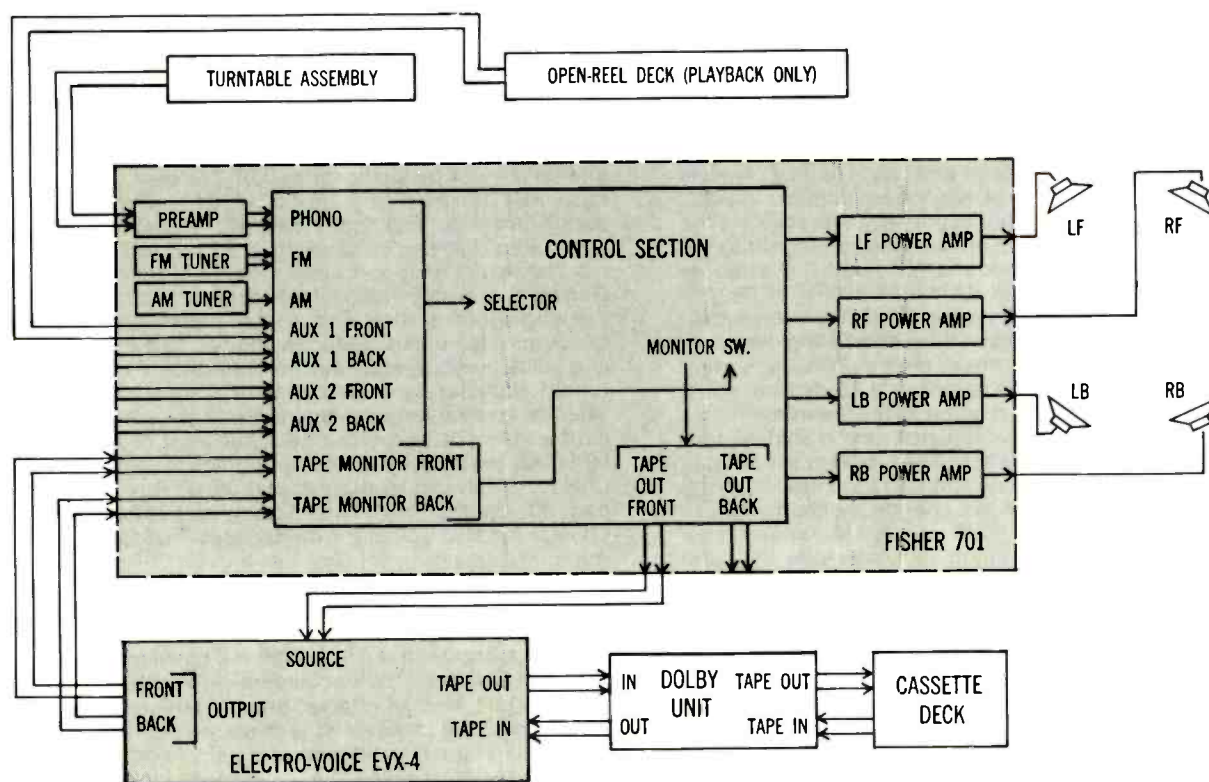

One of a number of interconnection setups used to derive quadriphonic effects from stereo program sources, using the Fisher 701 receiver and Electro-Voice EVX-4 Stereo 4 decoder. Open-reel and cassette decks can be interchanged; discrete-four-channel (Q-8 cartridge or open-reel) playback equipment can be connected to aux. 2 inputs for comparison purposes.



First Automatic to Offer Tangent Tracking

The Equipment: Garrard Zero 100, a two-speed automatic turntable with integral tangent-tracking arm. Dimensions: 15 5/16 by 14 1/4 inches. Clearance required below chassis, 2 15/16 inches; above, 4 3/8 inches. Price: \$189.50. Manufacturer: Garrard Engineering, Ltd., England. U.S. representative: British Industries Co., Westbury, N.Y. 11590.

Comment: Newest and best of the Garrards is the Zero 100 which, for the first time, offers the advantages of tangent tracking in an automatic record player. The trick is accomplished by an articulated arm/head system: parallel to the tone arm and linked to it by pivots is an auxiliary arm. As the pickup moves across a record, the head or shell pivots (in response to movement of the auxiliary arm) so that the stylus remains tangent to the record groove. This action is not quite the same as radial tracking but its effect is very similar: it permits the playback stylus to traverse the disc while remaining tangent to the groove, thus eliminating tracking-angle error. The actual "error" read by CBS Labs using this arm was within plus or minus 0.25 degree which is the accuracy limit for reading its test instrument.

The use of a pivoted/articulated arm to achieve tangent tracking permits its combination with a turntable for automatic changer use since it is the inward swing of an arm that triggers the change mechanism. The Zero 100 thus may be used as a full automatic for a stack of records, as an automatic single-play unit, and as a completely manual player, including the option of letting the platter rotate first and cueing the disc at will. In the latter two modes, the short spindle rotates with the record, a desirable feature that eliminates possible enlarging of center holes. A built-in cueing device permits raising and lowering the arm in any mode, and a locking device secures the arm when the unit is turned off.

Aside from tangent tracking, the new arm has many other worthwhile and advanced features. A platform slides out of the shell for convenient installation of the pickup; a gauge supplied with the unit permits adjusting the pickup position for correct stylus overhang. Another adjustment, on the front of the shell, sets the vertical angle for manual or automatic play; in the latter mode the pickup angle is optimized for the third record in a pile, which is the generally accepted compromise setting for changer use. The arm is balanced initially by a

movable rear counterweight; vertical stylus force then is set by moving a sliding weight along the underside of the arm, measuring the stylus force applied against an engraved scale. CBS Labs found this adjustment to be absolutely accurate; there was no measurable error in the arm's scale when checked against laboratory instruments.

Antiskating compensation is applied in an ingenious and effective way by means of a built-in magnetic system: a pair of opposing ceramic magnets are mounted in the arm pivot together with a magnetic shield. The shield, which may be moved by a topside control, regulates the amount of magnetic repulsion, and thus the amount of antiskating, exerted on the tone arm. The antiskating control itself has two scales, one for elliptical styli, the other for conicals. Again, CBS Labs found that the amount of force applied was correct across the diameter of a record. In passing, we also might note that the absence of springs—and the use of precision sliding members—for these adjustments tends to make them more accurate and more stable over long periods. Arm friction laterally measured 0.1 gram—not the lowest ever measured but low enough. Vertically, the friction was very low, below 20 milligrams. Stylus force needed to activate the automatic trip was 0.3 grams. Tested with a Shure V-15 Type II Improved cartridge, the arm showed a resonance at 6 Hz, with a 7-dB rise—lower (better) than average. Altogether, this new arm strikes us as an excellent piece of engineering; it probably is the best arm yet offered as an integral part of an automatic player.

The two-speed (33 and 45 rpm) platter is driven by Garrard's synchronous motor which proved, in CBS Lab tests, to run absolutely accurate, with no measured speed error, at test-line voltages of 105, 120, and 127 volts AC. To deliberately vary the speed (and thus the pitch of recorded music) there's a control that permits modifying either speed by 3.5 per cent either way. Average flutter was insignificant at 0.07 per cent. Rumble, measured as -56 dB by the CBS-ARLL method, compared favorably with that measured in other top-line automatics. For record stacking, the Zero 100 employs the "two-point" support system found in other recent Garrards: a combination of the retracting member in the long center spindle and a small plastic platform at the outer edge of the platter. In addition to the controls and adjustments already described, the Zero 100 has a record-diameter selector concentric with the speed selector and vernier adjustment. An illuminated built-in strobe indicator peeps out near the front of the turntable. An escutcheon at the right holds three tab controls for automatic stop/start, manual off/on, and cue play/lift. Operation is simple, quiet, and reliable. The change cycle in automatic mode takes 7 seconds with the turntable set for 33 rpm.

All told, we feel that Garrard has come up with a real winner in the Zero 100. Even without the tangent-tracking feature of the arm, this would be an excellent machine at a competitive price. With the novel (and effective) arm, the Zero 100 becomes a very desirable "superchanger" with, of course, manual options.

The Zero 100 is supplied with stereo signal cables, a short spindle, a long spindle, and a single-play 45-rpm doughnut adapter. Available accessories include three optional bases: Model WB-2, walnut, \$19.95; Model B-2, molded plastic, \$6.50; Model B2P Powermatic (controls power to system), \$15.95. A hinged dust cover, Model D-2, \$6.50, fits any of these bases. Also available is a mounting board, Model MB-11, \$2.25, for custom built-ins. An automatic 45-rpm doughnut spindle, Model LRS-100, lists for \$3.80; additional cartridge slideholders, Model C-3, are priced at \$1.75 each.

CIRCLE 141 ON READER-SERVICE CARD

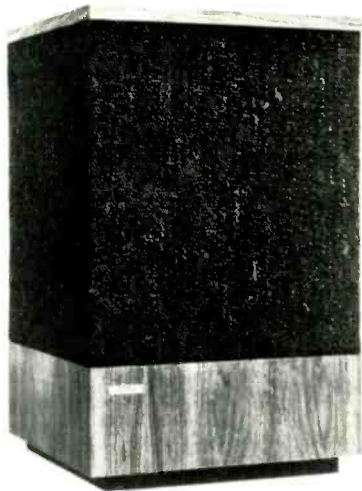

Bose Offers Reflected Sound in Low-Cost Version

The Equipment: Bose 501, a full-range speaker system in enclosure. Dimensions: 24 by 14½ by 14½ inches. Price \$124.80. Manufacturer: Bose Corporation, 1 Strathmore Rd., Natick Industrial Center, Natick, Mass. 01760.

Comment: The much acclaimed Bose 901 speaker system (see HF test report, August 1968) now has a lineal descendant that shares some of the original's features but which costs much less, can be placed flat against a wall, uses no equalizer, and operates on lower amplifier power. The new Model 501 uses three speakers in an arrangement that is, vis-à-vis Bose's original design, a compromise but which nevertheless does present a blend of direct and reflected sound and which, regardless of design theory, sounds superb for a speaker in its price class.

A two-way system, the 501 employs a 9-inch woofer installed in a sealed chamber. On the topside of this chamber are mounted two tweeters, angled so as to radiate "backwards" against the wall, from which the sound is reflected into the listening area. A dividing network provides frequency crossover at 1,500 Hz, with a fairly broad overlap of coverage on both sides of the nominal dividing frequency. Rated input impedance is 4 ohms. Efficiency is moderate, and Bose recommends at least 15 watts continuous power per channel, with a maximum rated capacity of 100 watts per channel.

When judged against the 901, the 501 sounds—as expected—second-best. The bass response of the lower-priced model is not as deep or as distinct, and its clarity on complex orchestral passages is not quite as open. But compared with other speakers in its own price class, the 501 emerges as distinctly above average.

The impedance curve measured at CBS Labs shows a 5.3-ohm value following a small bass rise; the curve across the audio band is unusually smooth and never goes below 5 ohms. Over-all frequency response was clocked as within plus or minus 6.5 dB from 37 Hz to 17.5 kHz and a comparison of the three curves shown here indicates that the middles and highs are indeed strongest in the "omnidirectional" mode, which of course confirms the system's design aim. In supplemental listening tests we found the bass doubling slightly at about 45 Hz, although at 40 Hz the response was still strong and clear. Doubling did not increase as we went down the scale, and a 30-Hz tone, while sounding weaker, remained as clear as the 40-Hz tone. Middles and highs were of course beautifully dispersed;

there was no evidence of beaming at any frequency. A slope toward inaudibility began at 15.5 kHz. White noise response was very smooth and similarly very well dispersed. The Bose 501 has no tone adjustment con-

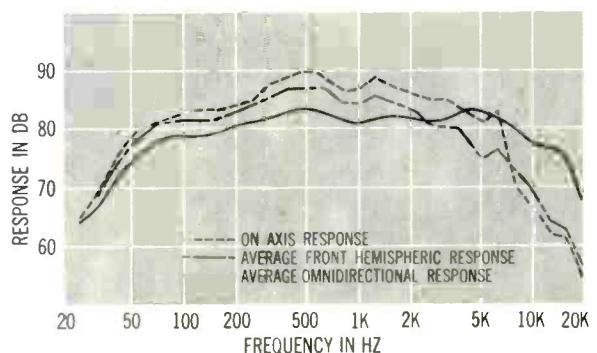

Bose 501 Harmonic Distortion*

Output Level (dB)	Frequency			
	80 Hz		300 Hz	
	% 2nd	% 3rd	% 2nd	% 3rd
70	0.14	0.15	0.095	0.25
75	0.21	0.12	0.12	0.33
80	0.45	0.085	0.22	0.45
85	0.85	0.1	0.4	0.48
90	1.7	0.2	0.95	0.60
95	3.5	0.6	2.2	0.65
100	8.0	1.6	5.0	1.0
105			7.0	1.5
108.5			8.5	2.0

*Distortion data is taken on all tested speakers until a level of 100 dB is reached, or distortion exceeds the 10-per-cent level, or the speaker produces the spurious output known as buzzing, whichever occurs first.

trols and indeed none are needed: the system is inherently well balanced and sounds good in various sizes and types of rooms. Any minor touching up for tonal preference can be accomplished by the controls on one's amplifier.

Speaking of amplifiers, the Bose 501 is not nearly as power hungry as its predecessor, the 901. It needed only 6.25 watts input to produce a level of 94 dB at 1 meter. It also is quite robust and could take steady-state power of 100 watts to produce an output of 108.5 dB without distorting significantly.

Installing a pair of the new 501s is simply a matter

of standing them on the floor against or away from a wall, and then adjusting their relative positions from each other and from the adjacent walls, the only proviso here being to leave at least 18 inches on either side of each 501 so that the sound from the tweeters can follow the optimum path for the bounce-and-reflect pattern. The 501 thus offers above-average performance for average requirements in terms of cost, amplifier power, and installation. As such it can bring a good measure of the superior sound of its costlier prototype to a wider listening public.

CIRCLE 143 ON READER SERVICE CARD



Teac Produces a Cassette Deck— and a Superior One

The Equipment: Teac A-24 stereo cassette deck, with built-in recording and playback electronics (no power amplifiers or speakers). Dimensions: 13¾ by 9¾ by 4¾ inches. Price: \$179.50 (includes dusting cloth, head-cleaning swabs, demonstration tape). Manufacturer: Teac Corporation (Japan); U.S. supplier: Teac Corporation of America, 2000 Colorado Ave., Santa Monica, Calif. 90404.

Comment: Teac's reputation in this country is founded almost exclusively on a series of solidly built open-reel tape decks whose performance characteristics average well above those of most tape recorder lines. It was with particular interest, therefore, that we approached the A-24, a first-generation cassette model from the same company. Teac had let it be known in the trade several years ago that cassette hardware was in preparation, but actual availability was repeatedly postponed "until we are entirely satisfied with the product." With what would Teac be entirely satisfied?

The answer, presumably, is the A-24. It is a deck of quiet excellence that contains some unusual features but no frills—that is, no Dolby circuitry, bias switching, or similar technical elaborations. The A-24's performance specifications don't match those of Teac's open-

reel equipment, of course—that would be too much to expect of cassettes as they now exist—but the unit resembles the open-reel decks in its solidity of construction, handsomely subdued styling, and excellent performance with respect to other cassette equipment.

The three controls at the right of the top panel betray some differences between Teac's thinking and that of other companies on the subject of cassette hardware. To the rear of this panel is a four-position mode switch: record from mike or DIN connections, record from tuner, record from line, and play. This multiplicity of inputs (all easily accessible on the back panel) offers considerably more flexibility in hooking the A-24 into your stereo system than one usually finds on cassette equipment. Most users probably will make their connections only to the line inputs (and the output jacks, of course), so the extra flexibility will be of limited value to them. Of value to all users, we think, is the separate playback position on this switch, a feature that prevents accidental erasure, even in using cassettes on which the erasure-prevention key has not been punched out. These keys or tabs—one for each direction of play—are at the back of the cassette. When they are pushed firmly with an appropriate instrument they will break off, allowing a record-defeat switch on the A-24 and equipment

\$30* DYNACO QUADAPTOR

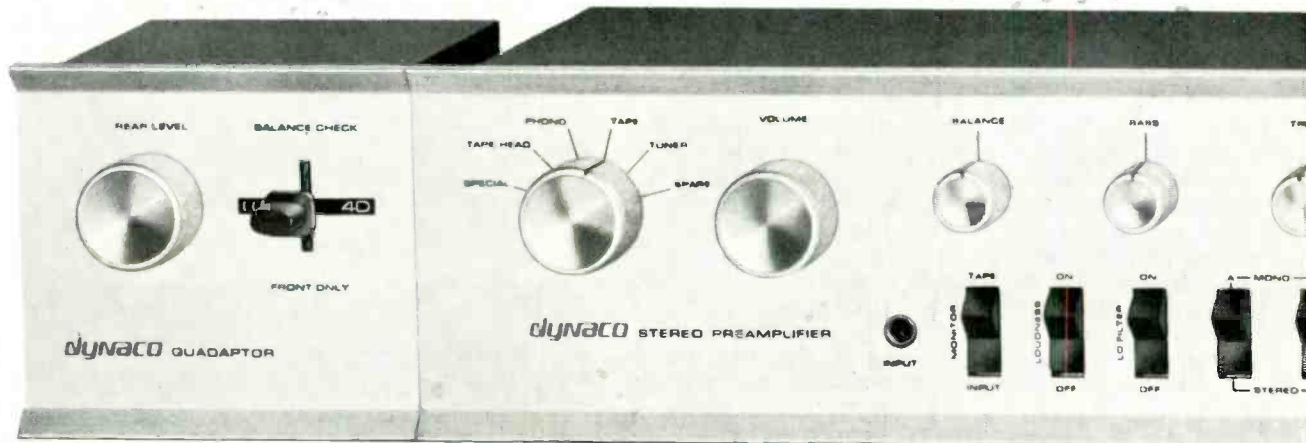

NEEDS NO NEW AMPLIFIER FOR 4-DIMENSIONAL SOUND

Connect the inexpensive Dynaco Quadaptor™ to your existing stereo amplifier (or receiver). Keep your present two speakers in front. Then add just two matched, eight ohm speakers in back. That's it. Now you can enjoy four-dimensional stereo—a significant increase in realism.

The Quadaptor™ provides four directions of sound from new material specifically recorded for the purpose. Equally important you can presently enjoy all the depth and concert-hall sound **already** on your existing stereo recordings but which have not been audible until now due to the limitations of conventional two-speaker playback. The manner in which the Quadaptor™ sorts out the four different stereo signals unmask this hitherto hidden information to utilize **everything** that has been present on your stereo recordings all along. The Quadaptor™ adds nothing to the recording. It is not a synthesizer. It brings out directional information which has previously been hidden in the recording.

The Quadaptor™ provides four-dimensional stereo from today's FM stereo broadcasts and tapes as well as discs. No modifications are required on any of your existing stereo equipment.

Most satisfying results are derived when high quality, full-range speakers are used in back, since it is faithful reproduction of all the audio frequencies that provides the greatest sense of spatiality. Fortunately, you do not have to spend a lot of money to buy good speakers. At \$79.95, the compact Dynaco A-25 provides highly accurate reproduction, so much so that the *Stereophile Magazine* calls them "probably the best buy in high fidelity today."

Write now for the name of the nearest dealer where you can now hear the Quadaptor™ and four-dimensional stereo.

THE SIMPLE HOOKUP FOR 4-DIMENSIONAL STEREO

All four loudspeakers are connected to the Quadaptor™, which in turn is connected to the amplifier's (or receiver's) speaker outputs. No AC line voltage is required because the circuitry of the Quadaptor™ is passive.



*\$19.95 kit,
\$29.95 factory-
assembled.

dynaco inc.

3060 JEFFERSON STREET, PHILA., PA. 19121

like it to trip and preventing erasure. The play-only position on the A-24 is a more easily reversible way of achieving the same end.

The other two knobs in this top-panel group control recording level and output level. Each is a double knob allowing individual control of front and back channels. Many cassette decks do not have the output level control, relying on a master gain control or input level control on the associated equipment to achieve appropriate listening levels. In terms of matching the A-24 to the levels presented by other program sources, we find its output control a valuable addition. Since it influences meter readings when the deck is switched to the playback mode, the meters can be used as a quick check of levels being fed to the listening system.

When the mode switch is in any of the recording positions the meters read the incoming signal, making it possible to preset recording levels without pushing the record button on the so-called piano-key control bank. Controls in this group are fairly standard: record, stop/eject, rewind, fast-forward, "play" (actually the forward-motion control for either recording or playback), and pause. The action of these controls is solid and positive—noticeably better in this respect than most cassette equipment. To the right of the piano-key group, beyond the meters, is the power on/off switch. At the far left corner of the top plate is a three-digit index. Microphone inputs (miniature phone jacks) and headphone jack are on the bottom front panel below the meters.

The meters, because their two scales are close together, allow the eye to evaluate a stereo pair of signals with exceptional ease. They are designed for a peak-reading action whose overload point falls where one would expect the "0-VU" indication; i.e., where the white section of the dial joins the red section. (Actually there is no 0-VU point, since the meters are uncalibrated. Teac says simply that the recording level should be chosen so that the needle "has maximum swing in the white area of the scale, but does not enter the colored area.")

In testing the A-24, CBS Labs used TDK type SD cassettes, recommended by Teac for use with the deck. The results of those tests show the A-24 to be a deck of excellent quality. Particularly striking is the flatness of the response curves. Totally absent is the peak in high-end response sometimes designed into playback electronics in an attempt to overcome the limitations of cassettes in this area. Teac's approach has two advantages: an intrinsic naturalness to the sound it produces, and avoidance of the exaggerated tape hiss that goes with a peak in playback response. The A-24 is, in fact, one of the quietest non-Dolby decks we've used, approaching even the Dolbyized equipment.

Mechanically too it is excellent. The hysteresis drive motor is uninfluenced by normal fluctuations in line voltage (though Teac recommends adding a voltage regulator where the AC power is particularly erratic). When the tape runs out, the transport automatically stops and retracts the pinch roller—an important feature if mechanical parts are not to be damaged by static contact. And even in playing piano passages in cassettes whose tape previously had exhibited a tendency to bind, introducing serious wavering of the tone, the sound was full and true, devoid of audible wow. The solidity of the A-24 is particularly welcome since this is a point on which manufacturers generally seem most willing to skimp. In sum, the A-24 is an excellent choice for a well-built basic cassette deck.

CIRCLE 144 ON READER-SERVICE CARD

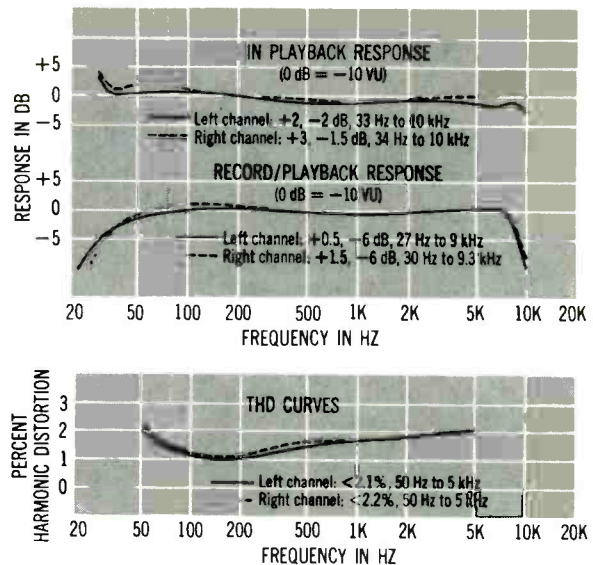

Teac A-24 Additional Data

Speed accuracy, 1% ips	105 VAC: 0.3% fast 120 VAC: 0.3% fast 127 VAC: 0.3% fast
Wow and flutter, 1% ips	playback: 0.15% record/playback: 0.20%
Rewind time, C-60 cassette	1 min. 7 sec.
Fast-forward time, same cassette	1 min. 7 sec.
S/N ratio (ref. 0 VU, test tape)	
playback	L ch: 52.5 dB R ch: 52.0 dB
record/playback	L ch: 49.0 dB R ch: 47.0 dB
Erasure (400 Hz at normal level)	56.0 dB
Crosstalk (400 Hz)	
record left, playback right	35.0 dB
record right, playback left	35.0 dB
Sensitivity (for 0 VU recording level)	
line input	L ch: 89.0 mV R ch: 89.0 mV
tuner input	L ch: 85.0 mV R ch: 85.0 mV
mike input	L ch: 0.27 mV R ch: 0.27 mV
Accuracy, built-in meters	Left: exact Right: exact
IM Distortion (record/play)	
1% ips, -10 VU	L ch: 5.5% R ch: 7.5%
Maximum output at 0 VU	L ch: 0.84 V R ch: 0.84 V

REPORTS IN PROGRESS

Scott 433 Digital FM Tuner
B & O SP-12 Phono Cartridge
Telex 811R Eight-track Recorder

The Scott Innovators have done it again with 18 exciting new models



for 1971-72

4 channel stereo Quadrant® components

443 AM-FM 4 or 2 channel receiver 4 x 18 or 2 x 35 watts*	319.90
444 AM-FM 4 or 2 channel receiver 4 x 25 or 2 x 50 watts	449.90
495 4 or 2 channel amplifier 4 x 25 or 2 x 50 watts	349.90
499 4 channel amplifier 4 x 40 watts	459.90

AM-FM stereo receivers

357 AM-FM stereo receiver 2 x 25 watts	199.90
367 AM-FM stereo receiver 2 x 32 watts	259.90
377 AM-FM stereo receiver 2 x 40 watts	319.90
387 AM-FM stereo receiver 2 x 55 watts	359.90
477 AM-FM stereo receiver 2 x 70 watts	399.90

AM-FM stereo tuners and amplifiers

431 AM-FM stereo broadcast monitor tuner	219.90
433 FM stereo digital frequency synthesizer tuner	549.90
490 stereo amplifier 2 x 70 watts	299.90

Controlled impedance full range speaker systems

S-41 two-way speaker system, 8" woofer	69.90
S-51 two-way speaker system, 10" woofer	89.90
S-11C three-way speaker, 10" woofer	99.90

Console stereo systems

Salem AM-FM stereo console 140 watts IHF	749.90
Carlisle AM-FM stereo console 80 watts IHF	549.90
Decorator AM-FM stereo control console with pair of S-10 speakers 90 watts IHF	499.90

All Scott stereo consoles feature Garrard automatic turntables and Pickering V-15 AT2 cartridges.

Before you buy any stereo component or system, ask your dealer to show you the new Scott line for 1971-72.

*Unless otherwise stated, power ratings are continuous (RMS) per channel into 8 ohms, all channels driven.

SCOTT®
where innovation is a tradition

H.H. Scott, Inc., 111 Powdermill Road
Maynard, Massachusetts 01754

These are the new KLH Model Eighty Professional Headphones.



This is their frequency response.

Response of Model Eighty measured via a specially constructed 1/16" condenser microphone placed at the entrance of the Auditory Meatus, with the bail correctly placed on the subject's head and the cushion completely enclosing the Pinna.

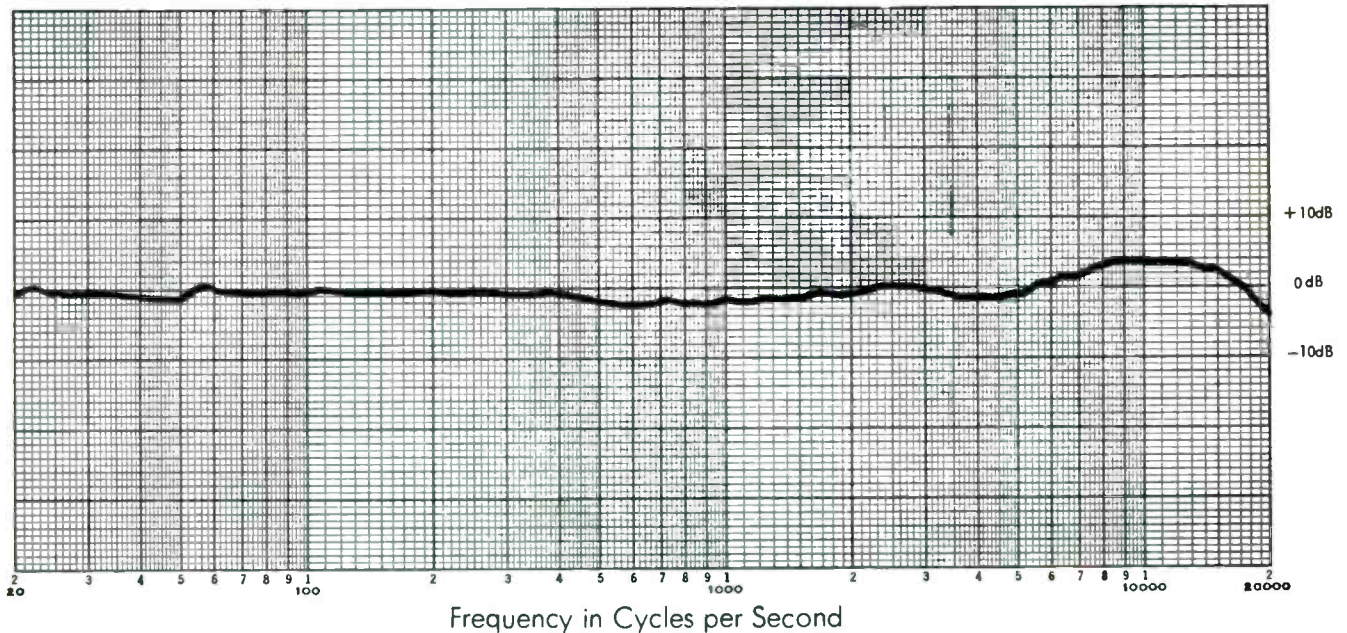

Naturally. We're sure that you're not surprised that our headphones are virtually distortion-free. What probably surprises you is that you can get KLH headphones in the first place. Actually, it makes a great deal of sense. We know that many people who own our loudspeakers also listen to headphones. Why shouldn't they be able to get the same quality of sound from their headphones as they get from their speaker systems? So we've introduced the new KLH Model Eighty Professional Headphones. We call them "professional" because you can actually plug them into a 600 ohm studio line, as well as use them with practically any home music system. Also, you can wear them for hours without any strain because they are much lighter and sleeker than conventional headphones.

But what really makes our Model Eighty Professional Headphones so unique is their sound. If you can imagine headphones that sound more musical than electronic, you've got a pretty good idea of what ours are all about. Stated simply, they sound like our loudspeakers. And that has got to make them the most unique headphones you've ever heard.

The Model Eighty Professional Headphones cost \$49.95.† They're at your KLH dealer now. Hear them soon. We think you'll love them a lot.

Naturally.

For more technical information on the Model Eighty, write to KLH Research and Development, 30 Cross St., Cambridge, Mass. 02139. Or visit your KLH dealer.



†Suggested retail price.
*A trademark of The Singer Company

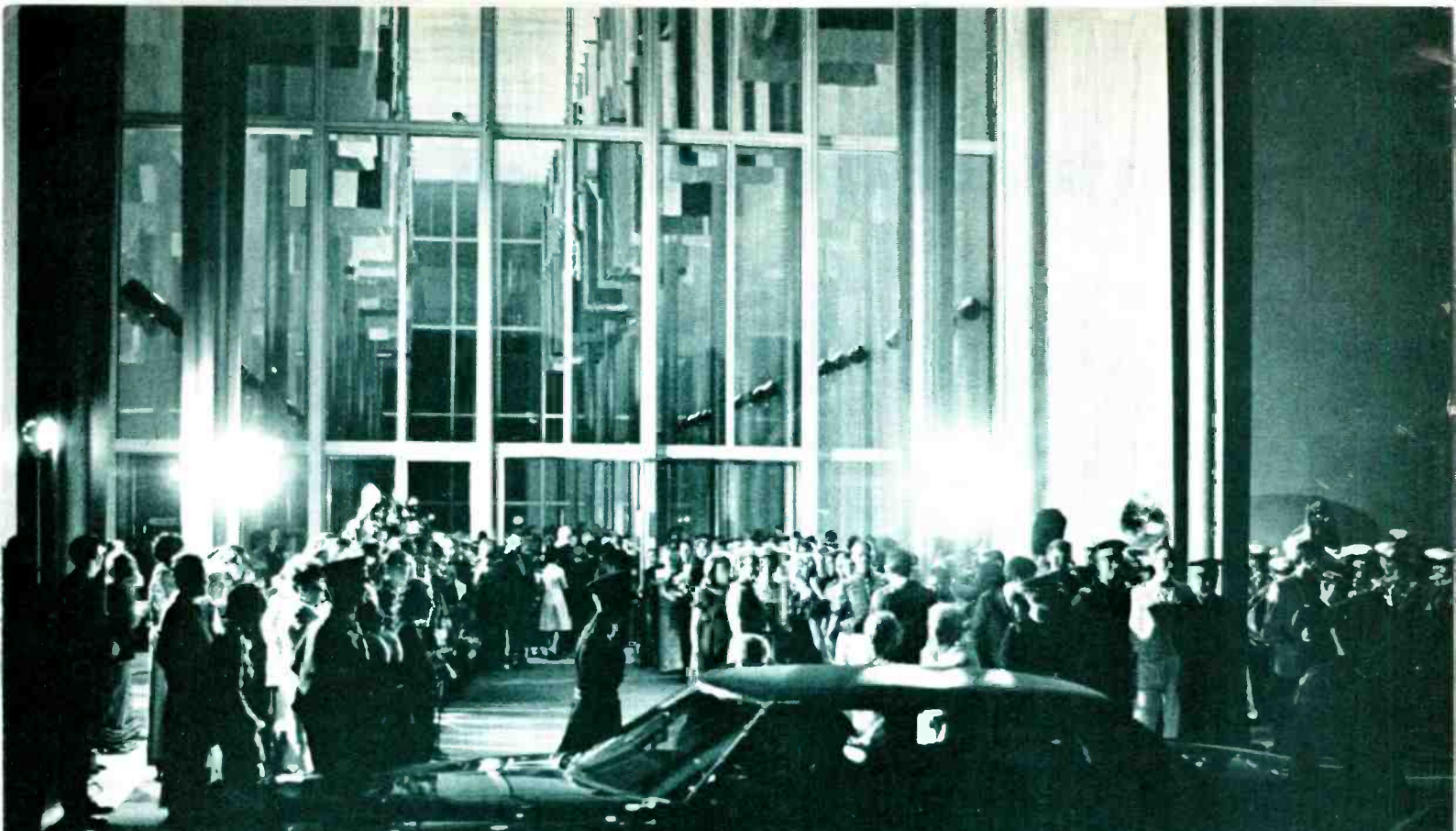

Guests arriving at preview party last spring.

It took an assassination to bring it about, but there is finally a Federal commitment to the arts, as exemplified by the opening this month of

The JFK Center for the Performing Arts

by Bryon Belt

CRYSTAL AND CARPET, even marble and mirrors do not culture make; yet they may prove harbingers, if Washington's new John F. Kennedy Center for the Performing Arts does indeed reflect a new commitment to the latest American revolution. Life and liberty through the pursuit of the arts may not bounce fully formed from Edward Durrell Stone's monumental Kennedy memorial construction, but it is certain that the arts in America are destined for considerable change, and probably for the better.

The massive one-building complex of four auditoria will debut starting on September 8 with a gala month-long festival that will surpass the cultural binges associated with Chicago's famed Columbia

Exposition and the multi-event openings of Lincoln Center.

More importantly, the sort of governmental disinterest and neglect that have impoverished our arts to a degree unknown in any other wealthy nation should never again be possible. The JFK Center alone can never reconcile Congress or the people to the sort of commitment envisioned by Anyas Ames and his associates in "Partnership for the Arts," whose aim is an annual Federal provision for the performing and fine arts equal to 6½ miles of superhighway construction (\$200 million). The new center is, however, a pretty vivid example of the kind of co-operation between government, foundations, business, and individuals that is nec-

essary if the arts are to survive, much less thrive, in an age desperately in need of their insights and inspiration.

America has traditionally been more willing to build grand monuments to art than to support the spirit or sustain the intellect, but Washington—for all its edifice complex—has been sadly lacking in providing even minimal physical facilities for the performing arts.

President John Adams made the first official pronouncements in favor of a national center for culture, but not until Dwight D. Eisenhower signed the authorization for the National Cultural Center Act on September 2, 1958, did another American President attempt anything concrete. In spite of Eisenhower's statement that the challenge of the cultural center's development "offers each of us a noble opportunity to add to the aesthetic and spiritual fabric of America," sheer public lethargy required President John F. Kennedy to extend the fund-raising deadline in 1963. Only the assassination of President Kennedy, and the subsequent bipartisan designation of the center as the sole official memorial in Washington, provided sufficient impetus for the project to get under way financially.

President Lyndon B. Johnson turned the first shovel at the magnificent 17-acre Potomac River site in 1964, and construction was begun in 1966. Presiding opening night in the President's Box (a pretentiously regal feature of each of the three major auditoria) will be Richard M. Nixon, whose political mentor had begun it all a baker's dozen years before.

The man given greatest credit for bringing the JFK Center from planning to fruition is Roger L. Stevens, the millionaire businessman and Broadway producer who has been the nonpaid chairman of the board of trustees since his appointment by President Kennedy in 1961.

Stevens, who was special assistant to the President for the arts from 1964 to 1968, and chairman of the National Council on the Arts from 1964 to 1969, is seen by everyone in Washington as the difference between complete disaster for the project and its glistening completion this month.

In talking with congressmen, artists, business leaders, and the JFK staff, I found the admiration for Stevens almost worshipful. The quiet, unpretentious man hardly appears the dynamo he is reputed to be, but he has stamped his imprint indelibly on the entire project.

Stevens' first task, and surely the one for which he was better equipped than the usual arts-society leader, was to win the trust of Congress. His down-to-earth simplicity and easy, straight answers to all

questions seemed to calm the fears of those members of both the Senate and House less than dedicated to the role of the arts. An astute ability to maneuver and apply appropriate pressures has enabled Stevens to build successfully on the confidence he inspires.

As originally conceived in the Eisenhower era, there was a rather naive assumption that the national cultural center would be built and supported entirely by private money. The government was willing to provide the land, but no real funding.

The location and financing of the proposed facilities offered the bloodiest and most time-consuming battles. Washington business generally favored a midtown site, and struggled to make the center a part of urban renewal plans. Congress, however, strongly favored the river location with its dramatic setting, and Congress won.

Since Washington hosts more than seventeen million visitors every year, and the JFK memorial will be a prime goal of nearly every one of them, the Potomac setting offers practical as well as scenic advantages. Parking, for example, a horror in the center of town, should be ample, with a 1,600-car garage facility augmenting nearby space. The garage itself was financed by a special Congressional loan of some \$20 million, with repayment to begin in 1978. Months before the center's debut, the garage was already paying its way by renting space during the day to Federal workers at the State Department and other agencies who park at the river front and are bused to their overcrowded office areas in town.

Basic financing of the JFK Center was, of course, not quite so easy, nor expected to be reimbursed in financial terms. Until the death of President Kennedy, the efforts to raise funds were only marginally effective. When designating the center as the official national memorial, Congress was able to rationalize a major investment, and approved \$15.5 million as a challenge to matching funds from nongovernmental sources. At the time, this was the largest grant of any kind to the arts, and happily it helped establish a pattern for more. In October 1969, as inflation boosted costs, President Nixon signed a bill authorizing \$7.5 million more in matching funds, in addition to the loan for the underground parking facility.

All of the government funds have been matched privately. Five million dollars came from the Ford Foundation, one million from the Rockefeller Foundation, and half a million each from the Old Dominion and Joseph P. Kennedy, Jr. foundations. Another five million dollars or so have been contributed by some 400 firms, and the remainder from smaller foundations and individuals.

William McCormick Blair, Jr., the JFK Center's general director since 1968, is currently in charge of raising another three million dollars or more to

Byron Belt is a syndicated critic for the combined Newhouse/Chicago Daily News-Sun-Times Service. He served as the first Director of Performing and Fine Arts for Nassau County, New York.

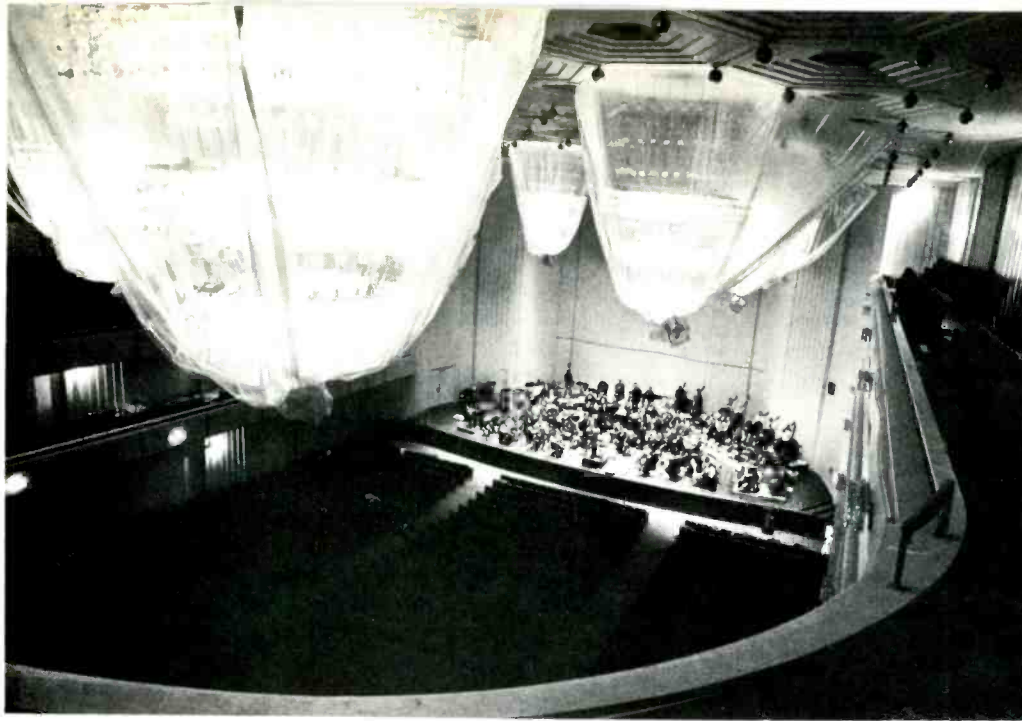

With the chandeliers still covered with plastic, Antal Dorati and the National Symphony Orchestra test the acoustics in the concert hall.

wind up all the building and initial launching expenses, and to assure large blocks of seats at modest prices for senior citizens, students, and such.

The dapper, witty former ambassador to Denmark and the Philippines seems to have the knack of putting the touch on potential benefactors, and Blair has already supervised receipt of gifts from more than thirty countries that have made unsolicited major contributions in honor of the slain president.

Among the gifts, none was more important than 3,500 tons of Carrara marble, cut to specifications (and worth in excess of a million dollars), donated by Italy. Others of the more spectacular gifts include eighteen crystal chandeliers (which viewers will either love or loathe) provided by Sweden for the Grand Foyer; a handsome red and gold curtain for the Opera House from Japan, and other major furnishings from Denmark, Ireland, Israel, Germany, and Norway. All the fancy trimmings are, or should be, incidentals. The facility itself is valid only insofar as it meets the serious needs of people and the arts.

That Washington was in dire need of appropriate space for the performing arts none but the dullest Philistine could deny. While the city is blessed with splendid art museums, the performing aspects have been seriously neglected. Constitution Hall, with its 3,800 seats, has been the home of the National Symphony and other concert groups. It has frequently proven too large, its acoustics and ambience less than conducive to audience development.

Because the Arena Stage now has two superb facilities, the needs of local theater are well provided for; but there is little other than the aging National Theater available for touring attractions and big musicals. Opera and ballet have been relegated to make-shift halls, and resident organizations have suffered accordingly.

The new facilities include an opera house seating 2,322, a concert hall for 2,762, a theater named in

honor of President and Mrs. Eisenhower in appreciation of their having provided the initial plans (and to soften the objections of some potential contributors less than enthusiastic over giving to anything named for a Kennedy) and a film theater for 500.

Each of the three larger halls features, in addition to a Presidential Box accommodating twelve people, separate reception areas which connect with the Grand Foyer. The latter, described in promotional material as "one of the largest rooms in the world," runs along the entire 630-foot length, overlooking the Potomac. In spite of personal reservations about the severe but gaudy chandeliers, the Grand Foyer, with its windows soaring six stories, may well prove the greatest joy of the massive edifice.

The building designed by Edward Durrell Stone has been termed everything from awe-inspiring to awful, magnificent to moribund, "Miami Beach on the Potomac" to "the jewel of the city." There is some truth in almost anything one may say about Stone's creation. It is certainly glittering *nouveau riche*. But in considering its size and that the design strives for grandeur, it must be recognized that in a city of monuments, if the arts were to make any real impact, their symbol in stone would have to be just a bit more impressive than anything nearby.

Thanks to a spectacular natural setting, reflecting pools and elaborate plantings outside, and shiny marble and crystal within, the John F. Kennedy Center for the Performing Arts cannot help but make a big impression. Stone, whose architecture displays not a hint of fancy or humor, revealed a touch of each during a conversation when he noted that he didn't know about death and taxes, but "fountains and chandeliers, along with sex, are surely here to stay."

The architect's decision and execution of a complex of four theaters under one roof will provide lasting fuel for argument, but his contention that

each of the auditoria was designed to "provide for the needs of the art, artists, and audience" and not the box office should earn praise from everyone but commercial managers.

The opera house, for example, has a stage and backstage area comparable in size to the Met's Lincoln Center home, but the seating capacity is over a thousand less. It is thus likely that acoustical properties and sightlines will be more satisfactory than a larger hall could provide, and performers should be able to deliver their best with greater comfort and consistency.

The concert hall, which in shape and atmosphere is very akin to Boston's famed Symphony Hall, is larger than the opera house, with most of the capacity on the large, oval orchestra level. Its 2,762 seats, in contrast with the 3,800 in Constitution Hall, mean that the National Symphony's subscription concerts will each be given three times, as opposed to twice previously.

Antal Dorati, whose first year as music director of the much-troubled National Symphony has already indicated his capacity to mold an orchestra of major caliber, likes the "feel" of the new hall and was most excited after testing the acoustics with the orchestra on stage several weeks prior to the opening. Dorati, an admitted "perfectionist," very much approves of the idea of playing each concert at least three times. Dorati indicated during a lively discussion that he hopes to "train the critics" to come to the second or third performances rather than the traditional firsts. With Inge Borkh singing Elektra and Yvonne Loriod pianoing in the American premiere of Messiaen's *La Transfiguration de Notre Seigneur* among the highlights, Dorati's problems may be keeping the critics away from the repeats!

Dorati, like nearly everyone associated with the JFK project, is delighted with the local potentialities of the center's facilities, but also realizes the importance of broader national implications. "Every week should be dedicated to one state or another, featuring their performing talents from student ensembles to professional symphony, opera, and dance," the conductor noted. "It isn't my role to plan over-all policies, but what member of Congress could refuse funds when his own area would be represented? Just think, Utah alone could provide a first-rate symphony, choral groups, and an important new dance troupe—and automatically two senators and two representatives are on the arts bandwagon."

The Dorati logic is very much what Roger Stevens and his associates are counting on to win continued support, not only for the Washington center but for the arts in general. Once rural representatives in government (and they remain dominant, even in this urban age) see that support for the arts touches their own people and not merely big-city folk, it will be politically expedient to provide the necessary funds.

The Eisenhower Theater, which will not open formally until January, is similar to a major Broadway house in size and facilities. Its 1,142 seats will offer a comfortable place for drama, and a small pit had this former producer dreaming of intimate musicals and chamber opera. Prior to the opening, the theater has first claims to assured excellence.

While all the halls are equipped for films, television, and recording, the movie theater, with its 500 seats, demonstrates the increasing recognition of American cinema as a major art form. If something more than presidential favorites are shown there, the film activity could be of tremendous importance.

September 8 is the night when the opera house opens with a work by Leonard Bernstein, commissioned by the JFK Center. The peripatetic composer/conductor will be in charge, along with choreographer/director Jerome Robbins. The piece has been described by Bernstein as a "kind of Mass—not a Requiem, but a Celebration—with underlying Latin text, with elements of blues and rock." Performances of the large-scale Bernstein opus will share opera-house dates with Alberto Ginastera's new opera, *Beatriz Cenci*. The Argentinian's work, like his *Bomarzo*, was commissioned by the Opera Society of Washington, and will be conducted by Julius Rudel on September 10, 12, and 13.

Rudel, who already heads the New York City Opera, Cincinnati May Festival, Caramoor Festival, and is programming consultant for the Wolf Trap Farm Park for the Performing Arts (about twenty-five minutes from the White House), is music director for the JFK Center, serving with the

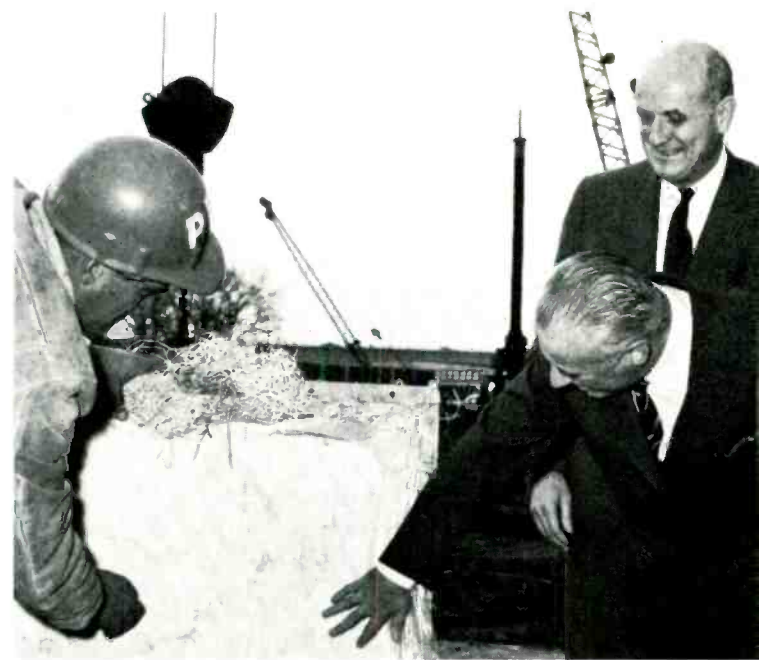

Roger L. Stevens, who "has stamped his imprint indelibly" on the Center, is shown here looking on as Italian Ambassador Sergio Fenoaltea examines his country's gift of Carrara marble.

man-on-the-spot, artistic administrator George London.

In addition to conducting the world premiere of the Ginastera, Rudel is producing for the center itself a fully staged presentation of Handel's rarely performed opera *Ariodante*, which will be given on September 14 and 16 with a cast headed by Beverly Sills and Shirley Verrett.

The ubiquitous Rudel also expects his City Opera to be a frequent guest in the opera house, resulting in an obvious blur of identity on the part of the Opera Society, which would clearly prefer being the major as well as the "resident" ensemble. With a suitable stage available for the first time, the Washington Opera should be able to secure the financing and audience which its acknowledged artistic excellence has long warranted.

The American Ballet Theater is the "official company" of the center, and will present two gala performances on September 11 and 15. The company's international stars include Carla Fracci, Natalya Makarova, and the incomparable Erik Bruhn.

The fact that ABT was given the "official" title, and has always been the special darling of the National Endowment for the Arts, means that it will present three two-week seasons each year in the opera house, while Frederick Franklin's nine-year old National Ballet will be an outside guest when it uses the facilities.

As *Washington Post* writer Jean Battey Lewis put it, "The difference that the Kennedy Center's beautiful sweep of clean, soaring stage space is going to make for dance is difficult to overestimate." The National Ballet will present five weeks in the opera house, with Dame Margot Fonteyn among the guests.

In addition to the opera-house activities (which will include Bernstein's revised *Candide* and other musicals later), the concert hall will be dedicated on September 9 and 10, with Dorati leading the National Symphony in its new home for the first time.

When Isaac Stern, Eugene Istomin, and Leonard Rose join in one of their stellar trio performances on the 11th, they will be the first solo performers to officially become Founding Artists. In seeking to encourage and honor the entire spectrum of performing arts as inexpensively as possible, it was decided to inscribe as Founding Artists those musicians donating services for the dedicatory events. Starting with Bernstein, Rudel, and the Stern/Istomin/Rose Trio, the names include Nicolai Gedda, Blood, Sweat and Tears, Peggy Lee, André Watts, the New York Pro Musica, and Count Basie—to list only those appearing during the festival period. Other Founding Artists will come later, and include Marlene Dietrich, Joan Sutherland, Richard Tucker, Van Cliburn, Birgit Nilsson, Rudolf Serkin, Leopold Stokowski, and the Chicago Transit Authority. André Watts gets enshrined for do-

nating his services for a September 19 concert with Pierre Boulez and the New York Philharmonic, who, being paid, are not similarly honored. And so the quest for immortality stops at the bill-paying middle class.

For all the glamour of the shining new facilities and glittering, personality-crammed opening weeks, the importance of the John F. Kennedy Center for the Performing Arts lies not in buildings and local events, appropriate as they may be for the capital of the world's greatest power.

What is important to Manhattan (New York and Kansas varieties), the Golden Gate, Big D, the Windy City, and points minuscule from Vermont to Idaho, is how the center plays its role as a cultural catalyst for the nation as a whole. What about any educational programs that might justify the center's "charge" to serve all the people, to provide a national showcase, and to develop new audiences for the arts? These aspects, after all, are what will turn a marble monument into a living memorial worthy of the man whose vision included an America "which commands respect throughout the world not only for its strength but for its civilization as well." I was surprised to learn from Julius Rudel that in addition to his obvious enthusiasm for new facilities and opportunities to produce his special brand of opera and concerts, he envisioned a major



Walter E. Washington, Mayor of Washington, D.C.; William McC. Blair, Jr., General Director of the Center; Julius Rudel, Music Director; and George London, Artistic Administrator shown witnessing the topping-out ceremony, September 1968.

music conservatory in conjunction with the JFK Center.

"Why not have an arts academy to which qualified students are recommended much as young men are for the various military academies?" he proposed over a scarcely touched lunch. (Rudel is not the man with whom to have a leisurely chat. Our various conversations were invariably squeezed in between trips in and out of Washington or New York, and between breaks in the usual crisis-plagued world of the City Opera.) "With every state involved in the selection," the dynamic musician went on, "education—even education for the arts—would be a high priority thing instead of just a frill!" Students and stars would benefit mutually from such an arrangement, Rudel insists.

Again, with the insistence on nation-wide participation, and the encouragement of mutual exchange programs between Washington and elsewhere, Rudel was reiterating the Kennedy Center staff theme: Washington must be a generative force for new activities throughout the country as well as the first showcase for the best the nation has to offer.

While Rudel admits his National Conservatory (already chartered by Congress in the 1890s when Antonin Dvořák was expected to become its head) is "at least five years away," the JFK staff has not been idle.

During the nebulous years when the primary activities were funding and construction, Stevens and London had already got their people busy generating educational programs. In at least two areas—the American College Theater Festival and the related American College Jazz Festival—the two-way relationship between Washington and the nation's schools has already borne impressive results.

Through a series of regional drama festivals and jazz events, many of the country's finest collegiate drama companies and musical ensembles have been brought to national audiences, and thousands have been involved in a vital interchange of ideas and experiences. Handsomely restored Ford's Theater was the setting for a portion of this year's American College Theater Festival; the performance I witnessed of George Buchner's *Woyzeck*, by the University of North Carolina was strikingly effective and enlivened by a postperformance discussion.

The national finals of the College Jazz Festival were held in May at the Krannert Center at the University of Illinois in Urbana. While the national festivals will be held in the new JFK facilities next year, the regional events will continue to spread the activities throughout the country.

At a time when funds for any worthy activity are difficult to come by, George London noted that the sum of \$300,000 provided by a powerful AAA—American Airlines, American Express, and American Oil—to underwrite the drama and jazz projects

Ezra Stoller Associates

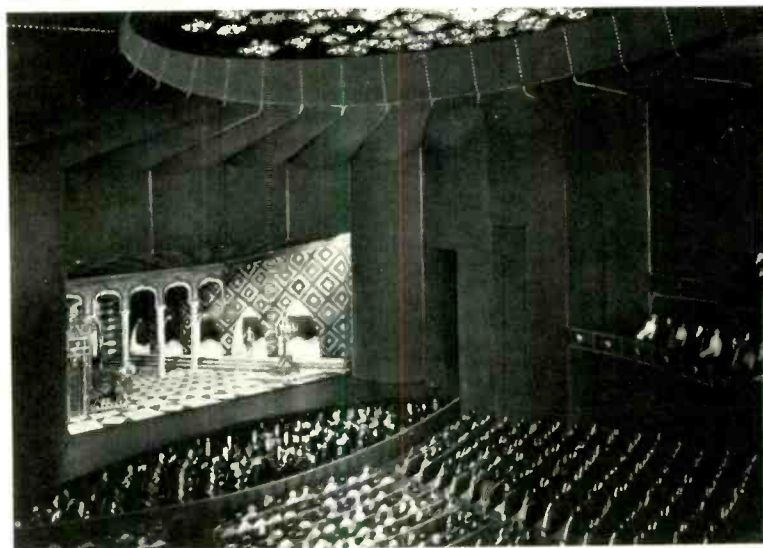

Model of the opera house, which will be opened on September 8 with a new rock-blues religious work by Leonard Bernstein.

was the "largest and most comprehensive involvement in the performing arts ever undertaken on the college campuses of our nation by American business."

Such large-scale events can be tackled only with appropriate national sponsorship, and Washington is the logical center for such programs.

Education, tapping what Julius Rudel describes as the "fantastic reservoir" of American talent, and generally encouraging local arts throughout the country, will obviously provide the ultimate justification for the people's involvement, via the Federal government, in the Kennedy Center.

The first severe political tests will probably come when some shocking social comment is expounded during a performance, or the first break is made with the sort of safe. Establishment artists dominating the opening season—or when the first nude dancer makes an entrance onto the opera-house stage. Then will come the understanding that the arts require a climate of freedom as well as financial support and handsome facilities.

When dedicating a library at Amherst College in 1963, President Kennedy remarked, "I see little of more importance to the future of our country and our civilization than full recognition of the place of the artist. If art is to nourish the roots of our culture, society must set the artist free to follow his vision wherever it takes him. . . . Art is not a form of propaganda, it is a form of truth. Art establishes the basic human truths which must serve as the touchstones of our judgment."

More than the building, the programs of the John F. Kennedy Center for the Performing Arts can honor the man by helping to make his dream of the arts for the American people come true a little more than they might had he never lived and never been so honored.

by Robert Berkovitz

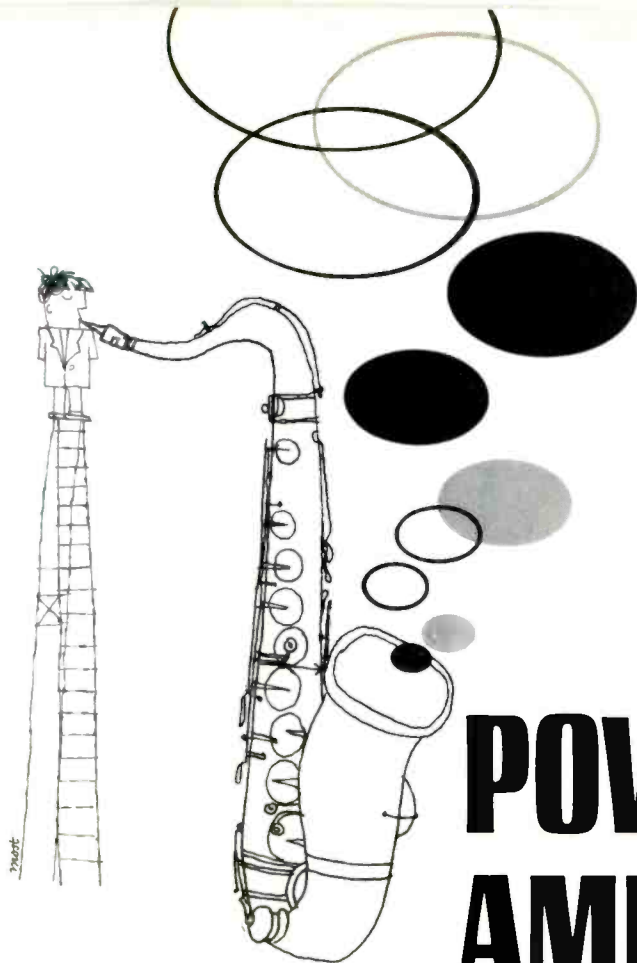

POWER AMPLIFICATION

It doesn't merely make a signal louder.

MANY ASPECTS OF SOUND REPRODUCTION are easily explained, and some require no explanation at all. This accessibility, however, often is deceptive and especially so for amplifier power—the key criterion by which amplifiers are compared to one another.

The most sensible way to approach the concept of amplifier power is to begin with the question, “What is an amplifier?” The answer will bring to light more than a definition of power; for in formulating an answer we must also consider the way in which power is delivered to speaker systems and how these systems use it. For openers, let's abandon old definitions that confuse, rather than illuminate, the subject.

What Is an Amplifier?

One common definition—even, perhaps, the most widely quoted of all—is incorrect: “An amplifier is a device that takes the signal from the cartridge and strengthens it until it has enough power to operate the loudspeaker and produce sound.” We might just as well define an automobile as “a device that takes the movements of the accelerator pedal and

strengthens them until they have enough power to turn the wheels.” What makes such a definition sound silly is our knowledge that the accelerator is connected to a mechanical linkage ending in a valve held by a small spring. Obviously the spring cannot possibly turn the wheels; it is the engine that does so. The movement of the throttle valve is really a *control signal*. When we push the valve open we allow the engine to deliver its power to the wheels, and when we let the spring push the pedal back we shut off this power. We are really supplying the engine with *information*. The engine in turn is supplying *energy*, which does not come from the foot on the pedal but from the engine's own store of chemical potential energy—the fuel tank. The speed of the car is a rough measure of the rate at which the energy is being delivered, and it is this rate that, in the lexicon of physics, we call “power.”

In an amplifier the applied control signal needs to do little or no work. In fact the less work done by the input signal the better. It is easier to design good pickup cartridges and tape heads, for example, if these transducers are only required to “read” the recording, rather than to move physical mass or create heat at the same time. The most important property of an amplifier is its ability to deliver the required power (its “fuel tank” is its power supply) exactly corresponding to the control signal applied

Mr. Berkovitz, formerly an executive of Acoustic Research, is now with Dolby Laboratories in England.

to its input, so that the *information* in both the input and output signals is the same.

This correspondence is assured automatically in all high fidelity amplifiers by a type of circuit that is the cornerstone of the science of cybernetics: the feedback loop. The loop brings the information pattern of the output of the amplifier back to the input, but altered in a very important way: its phase is inverted, so that whenever the input signal becomes more positive in voltage, the feedback loop becomes more negative. When the signal in the feedback loop is combined electrically with a duplicate of the input signal, the result should then be perfect cancellation, because the feedback signal is an exact mirror image of the input signal. And it could be but for one fact: the output of the amplifier is *not* a perfect replica of the input because no amplifier is perfect. These imperfections are left over when the signals cancel, and they act as a new control signal. Since this error signal is now of *opposite* polarity with respect to the errors in the output signal, the feedback cancels them out. In the best amplifiers, this cancellation technique is remarkably effective so that the net imperfection (distortion) is less the product of circuit design deficiencies, and more the result of the inevitable imperfections of the circuit elements used, or the manner in which they have been assembled.

Where Feedback Cannot Help

If what the amplifier receives at its input is to be defined as information, where does the power come from? From the electrical wall outlet, of course. This AC power is used to keep the amplifier's own power reservoir—usually one or more large capacitors—charged sufficiently to provide as much energy as is needed. If the electric power from the

wall outlet were direct current to begin with, the reservoirs would not be needed; but alternating current has its own built-in "signal" as it comes from the wall. It swings from maximum positive voltage to maximum negative voltage and back again sixty times each second—fine for the electric company's purposes, but useless to an audio amplifier, at least in that form. Therefore the alternating current from the wall is passed through circuitry—known as rectifiers and filters—changing it to DC so it can charge the "reservoir" capacitors, which are connected more or less directly to the loudspeaker through the power transistors in the final stage of the amplifier. Acting on the information originally supplied at the input to the amplifier, these output transistors open and shut like valves to allow current to flow to the loudspeaker.

There are several circumstances of great importance to the music listener that prevent this nice process from taking place according to plan, however. To repeat, power is the rate at which energy is passed from the amplifier to the load. Normally it is proportional to the square of the value of the input signal in volts. But normality implies a perfection rarely found in the real world—including amplifiers.

If the input signal calls for more power than the amplifier is able to deliver, the amplifier simply does not respond proportionately. There are several ways in which this can happen. The most obvious occurs when energy is drained from the amplifier so heavily that the power supply runs dry, electronically speaking. An analogy will make this clear.

Imagine a village served by a pumping station that supplies water in periodic spurts. Clearly, the differing needs of the gardener, the housewife, the man taking a shower, and the village firemen could not be met satisfactorily by such a pumping system. A practical solution might be the installation of a

Power-supply capacitors, like storage tanks in a water-supply system, assure constant supply no matter how intermittent the input. But even this system can run into trouble. See text.

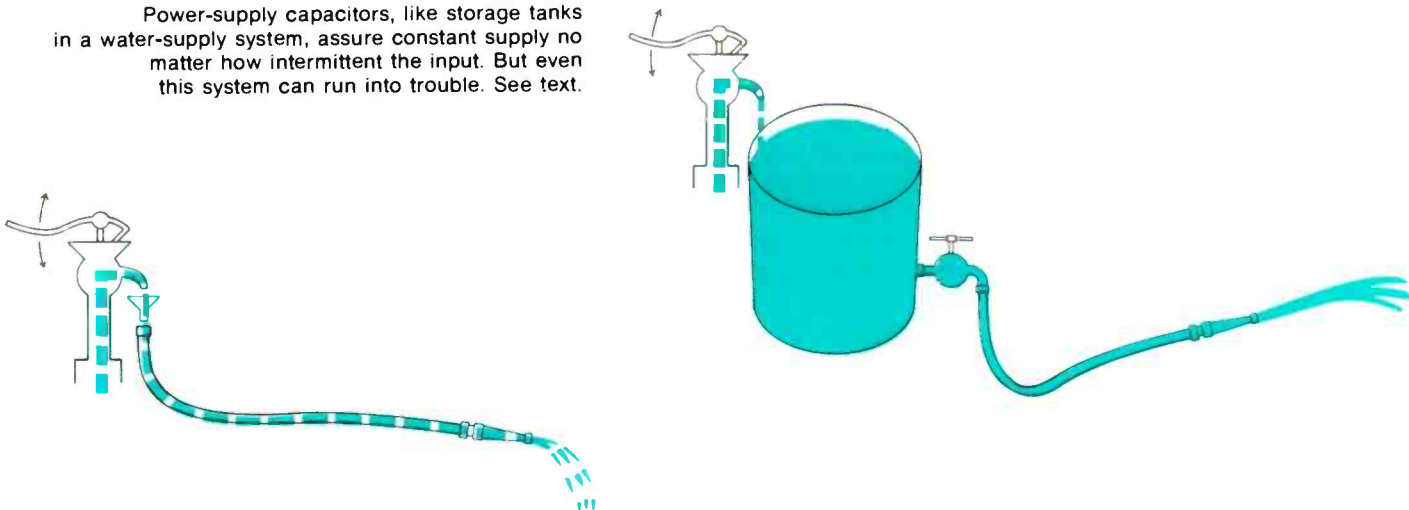

reservoir in each location—a tank that would be filled continuously by the spurts of water from the central station and drained for use through a valve to which the user could connect his hose. Everyone could then have just the water pressure he needs—and in a steady flow. But this kind of system could break down in just the same way as an amplifier, so the analogy is worth closer study.

First, consider the matter of draining the supply by heavy power demand. It is easy to see that the nature of the reservoir itself can limit the amount of continuously available water. For one thing, if the pipe from the pumping station is too small, replenishment of the reservoir will be too slow. This is roughly analogous to the use of an undersize power transformer in an amplifier, thereby restricting the transfer of current from the pulsating source (the wall outlet) to the reservoir (the capacitors in the power supply). Then too these capacitors may literally lack adequate capacity and so will become “empty” when too much power is drawn through the output transistors. This condition leaves available only the pulsating supply current, and its intermittently delivered energy will create hum.

The load on the amplifier—that is, the loudspeaker—has an impedance that changes with frequency, sometimes as a result of the characteristics of the speaker itself, sometimes as a result of the way in which the crossover network is designed. This corresponds to a leak in the hose that is evident, let's say, only when the nozzle is pointed in a certain direction. The sudden increase in power drain when the signal moves into the frequency range where impedance is lowest can quite overcome an amplifier, as anyone who owned one of the first transistor amplifiers and used it with an electrostatic speaker can tell you. Such loudspeakers have a characteristically low impedance at low frequencies; merely rubbing the stylus of the pickup cartridge with one's finger resulted in catastrophic failure of output transistors.

The same kind of power drain occurs, of course, with the addition of extension speakers in parallel to an existing amplifier, except that today's improved transistor amplifiers will merely blow fuses or trip circuit breakers rather than self-destruct under such conditions. The newest of high-power amplifier designs incorporate special protective circuits that allow overload signals to pass through without interrupting operation at all: current limiting or clipping, while usually inaudible, protects the amplifier effectively.

Little Transistors, Big Amplifiers

In the early days of transistor high fidelity equipment, many enthusiasts envisioned a revolution in the size of high-powered amplifiers. Two power transistors took up no more space than a pair of

overcoat buttons, as opposed to the massive glass tubes they replaced; obviously we could look forward to an unprecedented compactness in the design of new equipment. What these prophets were forgetting—or perhaps had not yet learned—was that transistors, while efficient and small, built up enormous temperatures within their tiny cases even when operated at low power levels unless provided with some means of removing heat. Otherwise the transistor's junction would melt, disabling the amplifier. The heat produced in a transistor is a function of the current through it; so the more powerful the amplifier, the larger the heat sinks needed to dissipate the heat and save the transistors.

The feedback circuits described earlier are as much a feature of transistor amplifiers as they were of the best tube designs. Feedback assures that when a given output voltage is called for by the input signal, that voltage will be maintained accurately regardless of changes in the behavior of the speaker system. As most of us learned in high school, a man called Ohm gave his name to a very important basic electrical relationship: the current (I) through a load or resistance (R) is calculated by dividing the voltage (E) across the load by its resistance ($I = E/R$). Suppose that an amplifier is delivering ten volts but that no speaker system is connected to it. If it is a good amplifier it will do its best to continue delivering ten volts no matter what we do to its output terminals, and by examining the amplifier's innards we can confirm somewhat tediously what Ohm was trying to tell us: ten volts divided by infinity (*no current flows through the air separating the speaker terminals, so we can say that the resistance is infinite*) equals zero, and so no current is being drawn through the output transistors and no power is being drained from the power supply. This is why transistor amplifiers are not usually hurt by removing the speakers; they simply have no work to do. (This was not true of vacuum-tube power amplifiers, nor is it true of those few transistor amplifiers that use matching or output transformers. These circuits need to be loaded by a speaker system or load resistor at all times for safety.)

Now let's connect an 8-ohm resistor to the amplifier output terminals. What is the current through the resistor? Applying Ohm's Law (10 volts divided by 8 ohms) we get 1.25 amperes; and this current must flow to the output terminals through the output transistors. To calculate the power in this example, we can use the simplified formula, power equals voltage times current. It is therefore 10×1.25 or 12.5 watts. Now let's reduce the load to 4 ohms. The current goes up to 2.5 amps, the power to 25 watts! Remember, we have not touched the amplifier, just the value of the load connected to its output. Here is the most interesting part of all: if we want to deliver 25 watts to the 8-ohm load, how much current will be going through the output

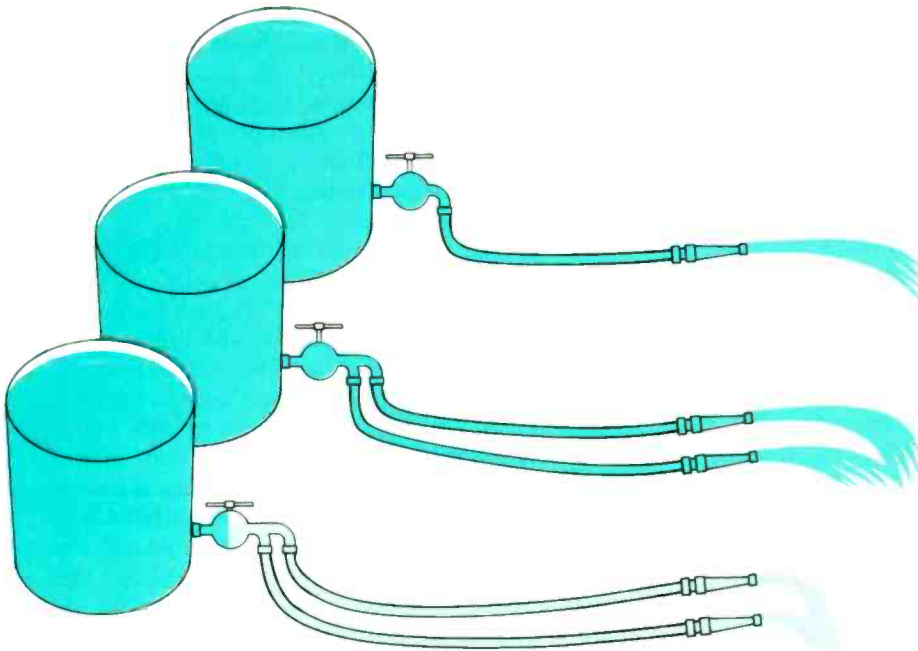

Adding a second hose (or paralleled speaker system) to the output of a supply system doubles the flow of water (current) drawn from it. If the flow becomes excessive, a valve (circuit-protection device) can be used to limit it, but full output from each line may no longer be possible.

transistors? The answer, surprisingly, is 1.77 amps at 14.14 volts—a full 30% less than when the same amount of power is being delivered to a 4-ohm load. Since current through (and heat in) the transistors limits their ability to handle power—at least in many cases—it is necessary to set a limit on the power available to a 4-ohm load from the amplifier. Many manufacturers specify, in fact, that *less* power is available to 4-ohm loudspeakers than to 8-ohm units because output transistor current, rather than power supply design, determines the limit.

Since doubling up similar speakers in parallel will cut the load impedance or resistance in half, the speaker hookup may seriously compromise the fidelity of the system unless matching transformers or other techniques are used to prevent excess current drain from the amplifier. For example, take an amplifier rated for 100 watts at 8 ohms, and for 60 watts with 4-ohm loads. Adding 8-ohm extension speakers in parallel with existing 8-ohm main speakers will divide the available power in half (half to the main systems and half to the extension), and it also will reduce the total power the amplifier can deliver from 100 to 60 watts (by reducing the effective load from 8 ohms to 4 ohms because two 8-ohm loads in parallel act as a single 4-ohm load). On the other hand, if two 4-ohm speaker systems are used in *series* in each channel of such a system, the total available power may be greater than it would be for the 4-ohm main speakers because series impedances add—in this case, they would total 8 ohms per channel. The general rule to follow when hooking up extension speakers is to *keep the impedance of the combination as close as possible*

to that for which the amplifier has its highest power rating. The exact method of wiring such a combination can be worked out by consulting the section on series and parallel resistances in any elementary book on electricity or electronics; while simple in substance, it is too lengthy a subject to repeat here.

What Kind of Power is Best?

Stereo owners frequently ask how much power (in watts) is needed for adequate listening. To answer this question we must raise another: what *kind* of watts?

First, how much power? Experiments using typical acoustic-suspension bookshelf systems, for example, indicate that duplicating chamber music at its original sound level requires no less than a 120-watt system: that is, 60 watts per channel. In principle, the reproduction of an orchestra at its true sound level would require at least several kilowatts. Fortunately, we need not reproduce the source in our homes—only the sound level we might expect to hear at a live concert. That level is comparatively low, as concertgoers learn to their annoyance when there are noisy whispers during a performance. To achieve even relatively high concert levels in a typical living room may require no more than 15 or 20 watts per channel, if reasonably efficient systems are used. And the sound is aided by the much smaller volume of the living room by comparison to the concert hall: the small space requires proportionately less power to fill it.

An interesting experiment, first suggested by

G. A. Briggs of Wharfedale, can be used to calibrate one's ears in terms of relative sound levels. The next time you go to a concert, hold a dollar bill a few inches from one ear and rub it between two fingers lightly pressed against the bill, observing its loudness with respect to the music; then do the same at home while playing back a recording of the same music. Most listeners probably will find that they tend to listen at unnaturally high levels when playing back orchestral music. Perhaps some reader has an explanation for this psychoacoustic peculiarity.

The power output figures mentioned above are *continuous* power ratings, and they denote the actual rate at which energy can be transferred from amplifier to load on a continuous basis—for a millisecond or an hour. Some years ago it was suggested that amplifiers with skimpy power supplies might, in fact, be better than their relatively low continuous-power ratings suggested. The reasoning went something like this: music consists of short, unpredictable bursts of sound, each lasting for only a small fraction of a second; therefore amplifier power supplies are never really called upon to deliver continuous power during music reproduction but need only satisfy these brief power demands, between which the power supply will have adequate time to replenish itself. The doctrine was as appealing to advertising and sales personnel as it was disgusting to engineers, and although the basic hypothesis was never substantiated it quickly was embraced by many companies and later officially sanctioned and entitled "music power" by the Institute of High Fidelity.

You should understand clearly that, despite the existence of "tests" to determine the so-called music power of an amplifier, it never has been demonstrated that such capability exists in other than a theoretical sense. If high-level musical sounds "do not last long," how long *do* they last—that is, how

long must the amplifier be expected to continue producing full power? Music-power testing procedures never have answered this question, so music that can produce sustained high-level passages—organ music, choral music, symphonic music, band music, and the live-level playback of chamber music for example (to say nothing of rock)—simply is not taken into account.

Nor does the music-power testing procedure determine how long the amplifier actually *will continue* to produce full power. Theoretically the official method involves application of input signal and measurement of power output instantaneously—before the power supply has had time to become depleted. In practice, however, the amplifier's own power supply is simply disconnected and an external power supply substituted. Since the stand-in power supply can be as big as a house, it need never run short of power; and the manufacturer may be tempted to carry the measurement well beyond the rather generous margin for exaggeration that already is built into it. In principle an amplifier capable of delivering no more than one watt on a continuous basis might be rated at 100 watts music power as long as the output transistors did not fail during the test. The test can therefore be considered more a measure of the manufacturer's ingenuity in applying it than an index of his product's capabilities. HIGH FIDELITY and most other publications in the field do not even bother to measure amplifiers this way, since the results are meaningless, and I don't know of a single item of professional audio equipment that is given a music-power rating. If there were, it is not likely that any responsible engineer would requisition such apparatus for his recording studio or development laboratory. But if music power is a joke among engineers, there is a rating that is even funnier: *peak power*, a figure obtained by multiplying the normal power rating by

Continued on page 73

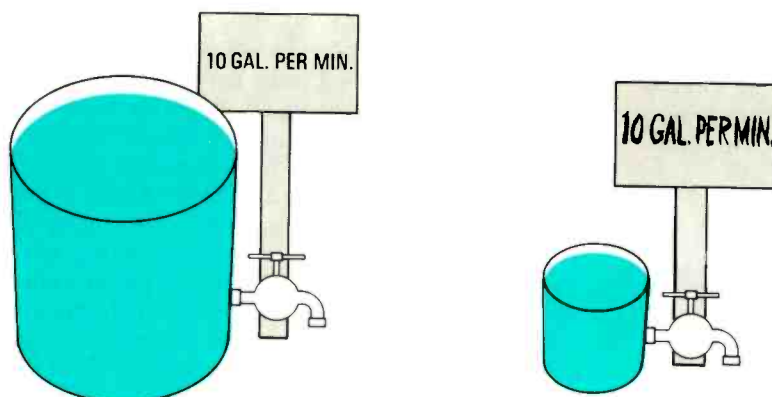

Just because the numbers are the same on the ratings for two supply systems doesn't mean they really have the same capability. The Federal Trade Commission is hoping to see standardized ratings for amplifiers, reflecting true capabilities.

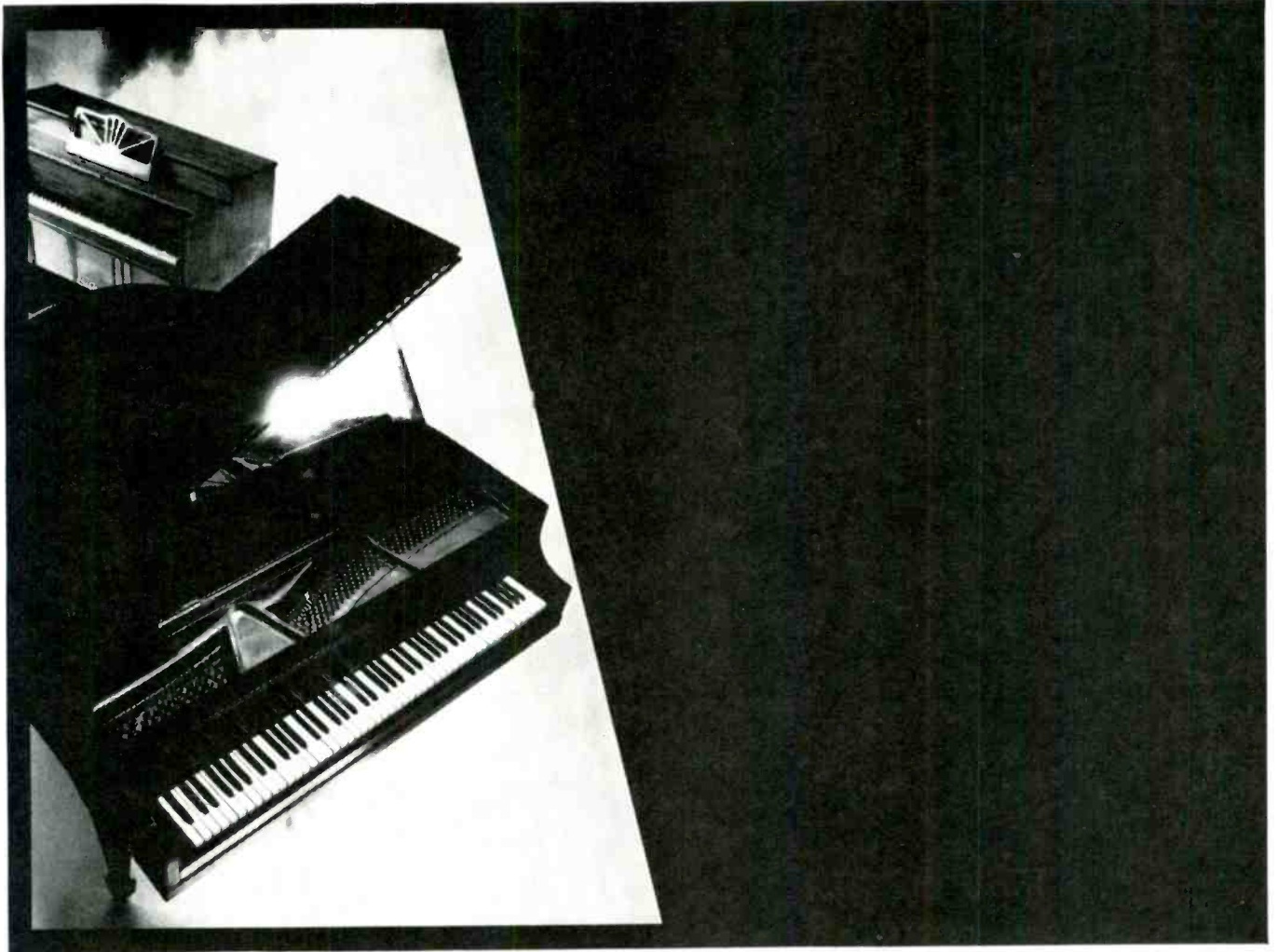

To each his own.

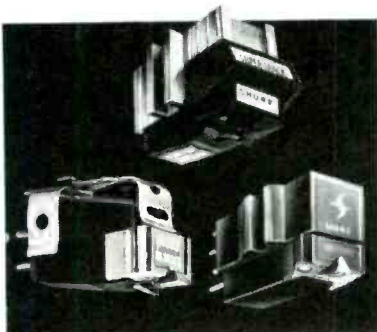

Not *everybody* needs a concert grand piano, nor does *everybody* need the best cartridge Shure makes to enjoy his kind of music on his kind of hi-fi system. Eventually, you'll want the renowned *V-15 Type II Improved*, the peerless cartridge for advanced systems and ample budgets. But, if your exchequer is a little tight, consider the *M31E*, widely acclaimed as the *second best* cartridge in the world. With a sharply circumscribed budget, all is *far* from lost. Choose any of the four models in the *M44 Series*, built for optimum performance in the easy-to-take \$18-25 price range. Write for a complete catalog:

Shure Brothers Inc.,
222 Hartrey Ave., Evanston, Illinois 60204.



SHURE

CIRCLE 50 ON READER-SERVICE CARD

**On the
next eight pages
you will see
the most advanced
engineering in
turntable design
for 1972.**

**Every record you buy is one more reason
to own a Dual.**





The 1218: It will probably become the most popular turntable Dual has ever made.

There's a lot of the 1219 in the new 1218, bringing even more Dual precision to the medium-price range. Most notable of these features is the twin-ring gimbal of the tonearm suspension. The 1218's motor also combines high starting torque with synchronous-speed constancy.

Anti-skating scales are separately calibrated for conical and elliptical styli, thus assuring equal tracking force on each wall of the groove. (When Dual first introduced this feature, we said it provided "more precision than you may ever need." With four-channel records on the way,

such precision is no longer a luxury.

Perfect vertical tracking in the single-play mode is provided by the Tracking Angle Selector, designed into the cartridge housing.

Other 1218 features: Vernier counterbalance with click-stops. Feather-touch cue-control with silicone damping. Single-play spindle rotates with platter to prevent center-hole enlargement. Pitch-control for all three speeds. One-piece cast platter weighs 4 lbs. Will track at as low as 0.5 gram. Chassis dimensions less than 11" x 13". \$139.50.



Your records probably represent the biggest single investment you have in your entire component system. And the most vulnerable.

It's important to know that your records can remain as good as new for years, or begin to wear the very first time you play them. And since your collection may be worth hundreds or even thousands of dollars, you don't want to worry every time you play a record.

How to protect your investment.

The turntable is where it all happens. It's the one component that actually contacts your records and tracks their impressionable grooves with the unyielding hardness of a diamond. If the tonearm performs the way it should, your records can last a lifetime.

The tonearm must apply just the right amount of pressure to the stylus, keep this pressure equal on both walls of the groove, and follow the stylus without resistance as the groove spirals inward.

Then the stylus will be able to respond freely to all the twists and turns in the record groove, without digging in or chopping away. And your records will sound brand new every time you play them.

How Dual does it.

Dual turntables are designed with great ingenuity and engineered to perfection. In every aspect of performance.

For example, the tonearms of the 1218 and 1219 pivot exactly like a gyroscope: up

and down within one ring, left and right within another. This system is called a gimbal, and no other automatic arms have it.

Both these models also provide perfect 15° tracking in single play and virtually perfect tracking throughout multiple play.

The professionals' choice.

Your favorite record reviewer probably owns a Dual. So do most other high fidelity professionals, such as audio engineers, hi-fi editors and hi-fi salesmen.

It's their business to know every type of equipment available, and they have easy access to whatever they need or want for their own system.

For many years, their personal choice in record playback equipment has been Dual. Not only for the way Duals get the most out of records (without taking anything away) but for their ruggedness and simplicity of operation.

Which Dual for you?

It's not an easy decision to make. There's such a wealth of precision built into every Dual that even the testing labs can measure only small differences in performance among them.

Even our lowest priced turntable, the 1215, boasts features every turntable should have, and few do. The 1218 and 1219 have even more features and refinements. All three models are described on the following pages.

If this brochure doesn't help you decide which one is best for you, perhaps a visit to your dealer will.



The 1219: For the purists who insist upon a full-size professional turntable.

Ever since its introduction, the 1219 has been widely acclaimed as the "no-compromise" turntable. Although measuring less than 15" x 12", the 1219 offers a full-size, dynamically balanced platter that weighs 7 lbs.

The gimbal-mounted tonearm is 8 $\frac{3}{4}$ " long from pivot to stylus tip. This unusual length, combined with correct engineering geometry, reduces horizontal tracking error to the vanishing point while maintaining one-piece stability.

Further, the highly sophisticated Mode Selector achieves perfect 15° tracking in single play by shifting the entire tonearm base—down for single play, up for multiple play. Maximum vertical tracking error in multiple play is only 1.5°.

Other major features of the 1219 include: powerful continuous-pole/synchronous motor, cue-control damped in both directions, and pitch-control. Will track at as low as 0.25 gram. \$175.00.





Unique gyrosopic gimbal suspension centers and balances tonearm within two concentric rings. All four pivots have identical low-friction, hardened steel-point bearings. Vertical friction less than 0.007 gram, horizontal friction less than 0.015 gram.

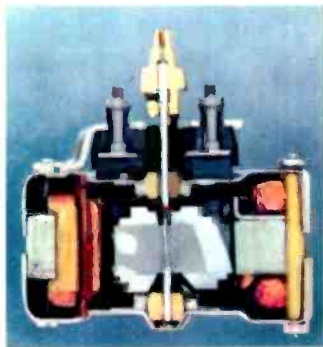

The 1219's powerful continuous-pole/synchronous motor easily brings massive 7 lb. platter to full speed in less than a half turn. 1218 has similar motor for its 4 lb. platter. Both motors maintain precise speed independently of line voltage.



Anti-skating control is calibrated separately for elliptical and conical styli. (Each skates differently.)

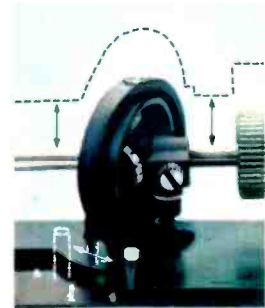
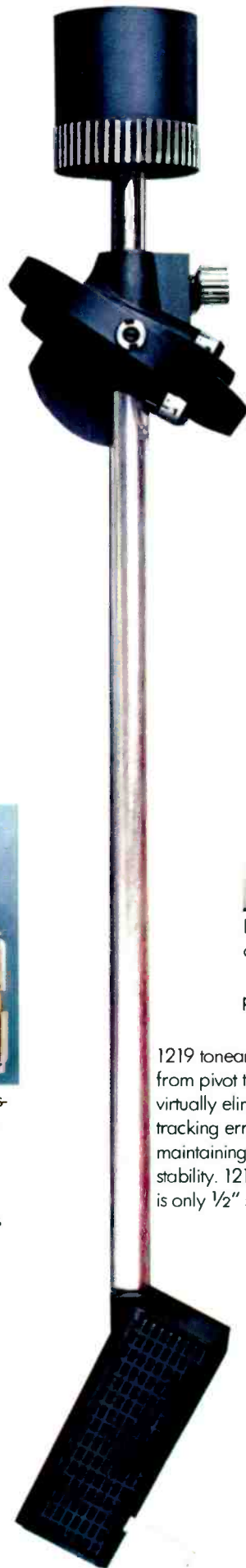

Mode Selector of 1219 provides perfect 15° vertical tracking in single-play mode by lowering entire tonearm base to parallel tonearm to record. Base lifts to parallel tonearm at center of stack in multiple-play.

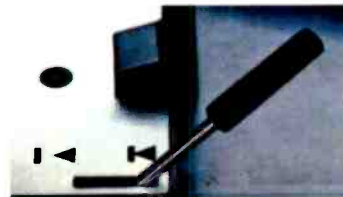

Feathertouch cue-control is silicone-damped for ultra-slow descent. In 1219, ascent is also damped to prevent bounce.

1219 tonearm is 8¾" from pivot to stylus, virtually eliminating tracking error while maintaining one-piece stability. 1218 tonearm is only ½" shorter.



Tracking Angle Selector of 1218 provides perfect vertical tracking in single play and at center of stack in multiple play. Selector knob is designed into cartridge housing.



The 1215: The choice of many professionals, even though the least expensive Dual.

At \$99.50, we don't suggest that the 1215 is a low-cost turntable. However, despite this modest price, it provides the precision engineering, reliable operation and special features that the most critical users insist upon.

The low-mass tonearm tracks flawlessly at as low as 0.75 gram, and gets the most out of high compliance cartridges. Among the 1215's many features are: Vernier-adjust damped

counterbalance, tracking force and anti-skating applied simultaneously by a single control, feather-touch cueing, hi-torque constant-speed motor, 3¾ lb. platter and interchangeable multiple-play spindle that holds up to six records.

Like all Duals, the 1215 also provides a pitch-control that lets you match the pitch of recorded music to live musical instruments or compensate for off-pitch records. \$99.50.



Dual

United Audio Products, Inc., 120 So. Columbus Ave., Mt. Vernon, N. Y. 10553

**And on
the next page:
another new Dual,
for those who want
total convenience
along with
Dual precision.**

This new Dual integrated module comes just as you see it: with base, dust cover and cartridge.

But that's not why you should buy it.

We can give you many reasons for buying the new Dual CS 16. The least important is the convenience of its being complete with base, dust cover and Shure magnetic cartridge. And with all tonearm settings for this cartridge — balance, tracking pressure and anti-skating — set at the factory for optimum performance.

A much better reason is that the CS 16 is a Dual, with many of the precision features that have long made Dual first choice of hi-fi experts. For example: Dynamically-balanced low-mass tonearm that tracks flawlessly at as low as 0.75 gram. Constant-speed hi-torque motor. Pitch-control to compensate for off-

pitch records. Silicone-damped feathertouch cue-control. 'Elevator action' changer spindle.

When you think of your investment in records — which may be hundreds or even thousands of dollars — we think you'll agree that the component that handles those records should do so with the utmost care and precision.

Now you know the most important reason of all for buying the Dual CS 16. There is still one more, however. Its modest price: \$119.00.

United Audio Products, Inc., 120 So. Columbus Ave., Mt. Vernon, N.Y. 10553.



Continued from page 62

two. Thus, a manufacturer who advertises "200 watts music power" can, with a stroke of his pen, convert the circuit to "400 watts peak music power." It does happen.

Enter, the FTC

Amplifier power measurements moved from the abstract and theoretical to the specific and practical recently when the Federal Trade Commission, apparently in response to consumer complaints about power advertising, asked industry technicians to meet informally and consider ways in which some degree of order and reason might be brought to the many contending claims of manufacturers. The Commission's suggested rules produced predictable reactions from trade groups—complaints about the dangers of "government interference" and the suggestion that the matter of ratings was best left to professionals in the measurement-standards-invention business. All of the magazines in the high fidelity field supported strict continuous-power measurements, as did a few manufacturers; undoubtedly other manufacturers who are not members of IHF and EIA (Electronics Industries Association) would have been present had they known of the meeting. At this writing there has been no FTC action, nor any sign of organized, industry-wide reform. Well-known manufacturers of high-quality amplifiers still tend to stick to continuous-power ratings; manufacturers of low-power equipment are more likely to quote music-power numbers. A common compromise practice chooses some variant of the music-power figure in the headlines, saving the qualifiers and continuous-power ratings for the fine print.

The crucial question of course is whether—given *any* type of music that the listener is likely to choose—the power rating quoted by the manufacturer will be applicable. If the rating is of continuous power (also called sine wave, average, or rms power—though this last term is technically a solecism), the answer is an unqualified yes. Whatever kind of music is fed to it, the amplifier can produce the rated power level. Music-power ratings and their derivatives, on the other hand, must always be quoted with the secret reservation, "... but not with all music."

Is Unlimited Power Desirable?

As it happens, amplifiers can be made arbitrarily powerful when cost is no object; you can buy units capable of delivering hundreds of watts per channel. Why should anyone need so much power? The answer is that certain speaker systems demand high power because of their use of equalization, just as

amplifiers may be required to deliver very high power output if treble and bass controls are boosted liberally.

An equalizer of the type used with the Bose 901 speaker system, for example, can boost bass response by a factor of about 100 at 40 Hz. Therefore, if the volume control on the preamplifier is set to play at a level requiring 1 watt at mid-frequencies, the 40-Hz component of a drumbeat no louder than the midrange signal on the original recording can push (or try to push) about 100 watts out of the amplifier. Separate equalizers, such as those made by Altec and Advent, may make similar demands on the amplifier, if boosts are introduced to the same extent.

This may be a good place at which to restate the point that loudspeaker efficiency as such has no relevance to fidelity, nor does lack of efficiency imply superiority. It is likely, however, that future speaker system designs will tend more toward relatively low efficiency because power is cheap and there are space-saving advantages to be gained by its free use. Relationships between efficiency, bass response, and cabinet size could tempt designers to try for even deeper bass in even smaller enclosures than those with which we are familiar, but at the expense of efficiency. If this course is followed, other problems will have to be solved as well—particularly the dissipation of the heat produced when so much of the energy poured into a speaker system is not converted to sound.

What is the likelihood that extrapowerful amplifiers might soon become available without greatly increased cost to the consumer? The type of output transistor used in most of today's high fidelity power amplifiers (the 2N3055 family) limits simple circuits to outputs of about 60 watts of continuous power per channel across the audio band, although amplifiers that are marginally more powerful are available with similar distortion specifications. In view of the effort expended during the last five years by semiconductor manufacturers trying to produce a supertransistor for power amplifiers, and taking into account that such efforts have borne little fruit to date, it would appear that a major step forward in basic technology will be needed before amplifiers change in any drastic way.

Circuit developments also promise little at this point, although a few years ago there was considerable excitement about exotic circuits—pulse width modulation amplifiers, Class D circuits, and other mysterious-sounding configurations. A more immediate need, in my opinion, is for recordings that truly match the performance capabilities of the amplifiers we already have. Possibly some future revolution in playback media will use the capability of the modern amplifier fully—or even force the development of still better amplifiers. ●

by Charles Briefer



How New York's pioneer classical station has fallen upon sorry **Times**

ON APRIL 26, 1971, the *New York Times* made an impassioned plea on its editorial page. Under the title, "Let WNYC Live," it said:

It is hard to imagine New York City without WNYC. The municipal radio station has been broadcasting since 1924; it is one of the least of the city's frills. With an operating cost annually of \$500,000, WNYC-AM and FM brings news of the city and hearings of its agencies, sessions of the United Nations and reviews of the world press, Shakespeare's plays and Gilbert and Sullivan operettas and, most important, a daily aural feast of classical music If the city's station were silenced altogether, there would be a giant hole in the air.

A touching gesture, but the *Times* did not extend its sympathy to another New York City station in much the same circumstances, WQXR-AM and FM, a mere dozen years younger than WNYC, with a yearly business loss equal to the municipal station's operating cost. They too bring news of the city, the state, and the nation as gathered and edited by the *Times*'s own superlative newsroom, and they too offer a daily aural feast of classical music. But the *Times* cannot ask anyone to "Let WQXR Live" since the stations are wholly-owned subsidiaries of the *Times* itself—and although the paper does not seem to mind suggesting that the debt-ridden city take on an additional burden in the name of Culture, it has been loath to follow its own advice: on April 5, three weeks before the editorial, the trade magazine *Broadcasting* leaked the news that the *Times* was considering the sale of one or both stations. Shortly thereafter, Walter Neiman, WQXR's general manager, spelled it out for his staff: the *Times* would try to get at least \$8 million for the pair; something less than that for the AM or FM alone—a bargain as stations go; WINS and WMGM, AM-only services, previously had gone for roughly \$10.5 million each. If no one came forward with at least an \$8 million offer, the *Times* would continue to broadcast or, if things got too bad, shut down.

Whatever one might think of WQXR today, there is no question but that the station was a pioneer in classical music broadcasting, and a vital force for many years. How had it come to this sorry point?*

WQXR's early history is fascinating. The founding father was John Vincent Lawless Hogan, a near-genius in electronics who cut his teeth as an assistant to the quixotic Lee de Forest between 1906 and 1907. Hogan knocked around the infant broadcasting industry for the next twenty years and earned one mighty claim to fame: he invented the single-dial tuning system for radio receivers.

In 1926 Hogan, along with a few others, began experimenting with television. The phosphor-coated electron tube had not been invented as yet, so Hogan used the Nipkow disc—a spinning disc punctured with holes in a spiral pattern which mechanically scanned a signal-modulated neon bulb. Seated in front of this Rube Goldberg contraption, viewers could watch an orange, inch-high *Felix the Cat* and similar cultural wonders. The government licensed Hogan as an experimental "visual broadcaster"—video at a number of frequencies (he preferred 2012 kHz), audio at 1550 kHz, just 10 kHz below the present AM setting. The assigned call letters were W2XR. When Hogan wasn't broadcasting *Felix* soundtracks, he left the audio on and gave whoever happened to be listening a generous measure of his favorite music—the classical standards. W2XR wasn't easy to get: most AM tuning dials stopped at 1500 kHz, and not many set owners

*I'd come to my own sorry point just two weeks before the *Broadcasting* episode when WQXR's management told me that after sixteen years, half of them as continuity editor, my services no longer would be required (five employees were laid off that day; our total tenure came to just under three-quarters of a century). I returned to WQXR's offices on the Monday after my last Friday and began a week-long series of interviews. These expanded eventually to include outside agencies that deal with WQXR, and this article is a distillation of many facts, thoughts, opinions, complaints, and quite a bit of useless grousing. I expected variety and dissension and I got it, but the number of points on which nearly everyone agreed surprised me.

could squeeze up to 1550. Still, Hogan received a great deal more mail from enthusiastic *listeners* than from the few experimenters who were able to watch his video signal, and when Vladimir Zworykin doomed Nipkow television in the mid-Thirties, with his new, completely electronic iconoscope, the basis of all present picture transmission, Hogan's thoughts turned to those listeners. He requested FCC permission to establish a wide-band AM channel near his old frequency; when the license—for a double-width channel that went up to 15,000 Hz!—was granted in 1934, New York City had its first high-fidelity, classical music station. (When the AM band eventually became too crowded, WQXR's bandwidth was reduced to the normal 7,500 Hz.)

The station attracted the attention of Elliott M. Sanger, a graduate of the Columbia School of Journalism who had drifted into advertising. Temperamentally, the two men were worlds apart: Hogan, an easy-going experimenter who liked to work with his hands; Sanger, a hard-headed, ambitious businessman. They did share a love of good music, however, and Sanger was able to convince Hogan that W2XR might be viable as a commercial enterprise. They incorporated in 1936, changed the "2" to a "Q," and very quickly attracted a small but intensely loyal audience of upper- and upper-middle-class music lovers. These were to be the hard core of the station's support—financially comfortable dilettantes of whom an executive wit once said, "They like Beethoven's Fifth and Tchaikovsky's Fifth, but they can't quite tell you which is which."

The station format and its audience attracted an equally small but appropriate nucleus of advertisers—corporate, institutional, restaurants, brokerage houses, investment firms, and two very long-term "fringe" customers, the Ritz Thrift Shop (second-hand furs) for people on the way up, and the Empire Diamond and Gold Buying Service for people on the way down.

Hogan found WQXR as a business not to his liking. He left it to Sanger, and moved back to pure electronics. After wartime work on radar, guided missiles, and the proximity fuse, he dabbled in facsimile transmission, then retired to his home in Forest Hills, New York, where he died in 1960, a few months short of his 71st birthday.

Until its incorporation in 1936 as the Interstate Broadcasting Company, WQXR—office, studio, 250-watt transmitter and all—was located over a commercial garage in Long Island City. After incorporation, a new 1,000-watt transmitter was built in Maspeth (now a "suburb" of Long Island City), and the offices and studios were moved to 730 Fifth Avenue at 57th Street, across from Tiffany's. Here, Sanger and a small staff struggled to turn out a respectable product and make ends meet. They *did* turn out a respectable product, but somehow there was always a gap between the ends. The struggle

went on for eight years till it was obliterated by an event of terrific impact—an event that was at once WQXR's salvation and doom: the stations (FM simulcasts began in 1939) were purchased by the *New York Times*.

Arthur Hays Sulzberger was the very model of a WQXR listener: he knew what he liked, even if he didn't know what it was, and he was vociferous about what he didn't like. As publisher of the *Times* he communicated his likes (few) and dislikes (many) on blue memo paper; these are still recalled with awe by the older *Times* staffers. And under the rather transparent pseudonym "A. Aitchess" he publically vented his wrath in pungent Letters to the Editors.

AHS had married into the *Times*'s founding Ochs (pronounced *Oaks*) family, but he bore himself with the imperious dignity of a full-blooded sovereign. He had been keeping a watchful ear on WQXR for some time, and his purchase was motivated for the noblest reasons: he believed that the best newspaper in the world should have the services of the best radio station. He appreciated WQXR's cultural leadership in the broadcasting field, and he recognized the promotional value of having it identified as "The Radio Station of the *New York Times*" every half hour. Furthermore, AHS was a true romantic—a crabby romantic, but a romantic. Who else would have uprooted the tree under which he'd proposed to his wife and replanted it on the family grounds as a wedding anniversary present? The man was a benevolent despot, and he made it clear that WQXR was his fairhaired child. The station's offices and studios were moved from Fifth Avenue to the *Times*'s mighty castle on West 43rd Street, and although the corporate structures were always kept distinctly separate, AHS made it clear that he saw no difference between a worker on one side of a wall and a worker on the other. Understandably eager to share the castle goodies, WQXR's staff voted to be represented by the *Times*'s white-collar union, the New York Newspaper Guild, and it received as a result equal pay and equal fringe benefits—life insurance, annuities, hospitalization, the works.

And something else happened. WQXR's executives began, in the words of one sardonic observer, to "play radio." Creeping Departmentalization, which had begun when Sulzberger first expressed his interest in the station, mushroomed, and each department was staffed to the teeth. There were half a dozen programmers and half a dozen writers; writers were not allowed to program and programmers were not allowed to write. In addition there was a Press and Promotion Department, a Traffic Department, a Program Guide Department complete with its own Varitype make-up crew, a Merchandising Department, a Sales Department, a Commercial Continuity Department, an Accounting Department, some one-man bands such

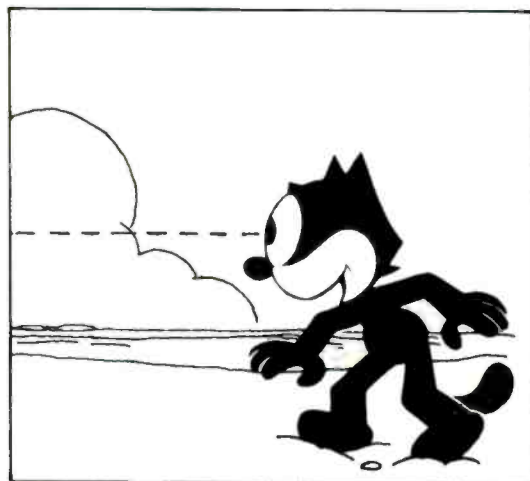

© King Features Syndicate

John Vincent Lawless Hogan and Felix the Cat, progenitors of a New York classical music station.

as a Director of New Business and a Co-ordinator of Educational Activities, the usual announcing and engineering forces, and an unusually large gaggle of secretaries and clerks. By the early Sixties, the total staff numbered close to one hundred people—and held there!

Some things did not change. Although Elliott Sanger lacked the Sun King demeanor of Arthur Hays Sulzberger, he was every bit as autocratic, and he was determined to preserve WQXR's musical levels and the refined advertising atmosphere in which they grew. He even managed to resist, by rolling with the punches, AHS's unaccountably virulent dislike of Haydn and Mozart ("Mozart—tinkle tinkle!" was the total content of one morning-after blue memo, but everybody understood the depth of feeling behind it). Sanger laid down rigid rules governing advertising acceptability, his most famous being a total ban on singing commercials. The Madison Avenue Goliaths bowed to the Times Square David, perhaps because Sanger's white-glove approach really did seem to point the way to a higher-quality audience. Companies went out of their way to prepare special nonsinging copy for use on WQXR, the most notable example being Pepsi-Cola. In place of the Pepsi Boys singing about the Sheik of Araby ("... into your tent I'll creep—with the big, big bottle. . ."), Pepsi presented WQXR with an almost neoclassic version of its standard number ("Pepsi-Cola hits the spot: twelve full ounces, that's a lot. . ."), tastefully recorded by a celeste. It was an incredible act of understanding and good will on the part of a national corporation, and it was a WQXR "standard" for years. No doubt its continued presence bolstered the station's position with other companies.

Meanwhile, WQXR continued to lose money, albeit gracefully. In good years the books hovered

near the break-even point; in bad ones the losses were palpable but tolerable, and station executives could always say that the *Times* would have had to shell out much more than WQXR's deficit to purchase as much promotional air time. But always, in the end, the station's right to exist came from the fact that Arthur Hays Sulzberger liked it, and that was that. Given this master-and-concubine relationship, it is understandable that a minor panic erupted when, in 1961, Sulzberger, feeble and ailing, relinquished active control of the newspaper.

But life went on much as before. The upper echelons of the *Times* management were too busy bumping and jostling each other to pay really close attention to the station, and everything just coasted along. There were changes of personnel, some of them important, and a few impressive but abortive experiments such as the QXR Network, but basically WQXR was still the station Connecticut executives turned on for a genteel background at the cocktail hour. In the middle 1960s, however, there came a succession of events, most of which were so catastrophic that almost any one of them alone could, at first glance, be considered the fatal thrust: the New York Newspaper Guild organized WQXR's salesmen, the FCC decreed that AM and FM affiliates of the same radio station would have to program separately at least fifty per cent of the time, rock music became a craze, and a new corps of young, bright-eyed businessmen, headed by Arthur Hays's son, Arthur Ochs ("Punch") Sulzberger, took control of the *Times*.

The unionization of WQXR's salesmen was devastating. Suddenly every salesman was earning full pay in the top Guild category *plus* his sales commissions, which meant that as of June 1, 1969, most of them received a minimum of \$16,000 per year *before making a single sale!* The utterly predictable

result, according to insiders, was that they loafed. Those who understand the sales mystique far better than I do are unanimous in their belief that a salesman has to fear hunger to be effective. Selling is a highly competitive business, and the Guild took the competition out of the game. With very few exceptions, I was told, WQXR salesmen won't bother with anything less than big institutional deals—*Symphony Hall* to General Telephone and Electronics; *First Hearing* to Texas Gulf Sulphur, or spot positions to Pan Am; they wouldn't be caught dead scratching up the little bread-and-butter accounts, and even the scrappy little sales trainee who once outsold everybody on the force has settled down now that he's making it. The rule today, in the words of one embittered top executive, is long lunch hours and chatting in the halls.

As for the FCC decision, that will be a bone of contention for a long time to come. My own opinion, which is shared by many of those I talked to, is that what might be beneficial in a one-, two-, or three-station city is at best ineffective in a city with as many stations as New York, and at worst downright harmful. Splitting WQXR's AM and FM facilities added little to New York's already fantastic variety of radio fare, but the physical conversion and staff additions cost the station an arm and a leg, while the new formats confused loyal listeners and unnerved advertisers. After careful consideration of the many possibilities, WQXR—with a blaze of trumpets—decided to offer straight classical music on FM, and a veritable pink froth of light music on AM during the requisite fifty per cent of its broadcast day. The concept proved so unacceptable to the public that it was abandoned in a matter of months. In its place WQXR offered its old heavy and light mix on FM, followed by delayed rebroadcast on AM a week later. The bleeding was stopped, but the wound never healed. WQXR-FM, which in 1966 had been, with 1.5 million listeners, according to the American Research Bureau, the number one FM station in New York City, began to slide.

The phenomenon of rock never could have been predicted, and certainly WQXR is not alone in the tumbrel. Classical record sales are slipping, concert and opera seats go begging, and classical broadcasting is in trouble: in New York City, WQXR is up for sale, WNYC has cut its staff in half. WRVR this month abandons its classical music format, and the major networks have abandoned serious music. Only WNCN is thriving: we'll see why later. Without a doubt the current economic slump has accelerated the degenerating process, but it was unquestionably under way before the market began its descent.

All of these factors primed the gun: the trigger was cocked when Punch Sulzberger and his new, computerized administration eradicated the last traces of AHS's visceral autocracy. Under Punch, the *Times's* dispersal of its energies and finances

are determined by a brain trust specially hired for the purpose. The collective, unlike AHS, has no emotional attachment to WQXR—emotion would pollute its effectiveness in raising productivity and lowering costs. With the paper's net profits for the first quarter of 1971 approximately half of what they'd been for the first quarter of 1970, the *Times* could see WQXR in only one way—as \$8 million that could, if invested, earn ten per cent a year instead of losing six. And when the FCC suddenly proposed that no newspaper should own a second medium in the same market, the firing pin slammed home. Already burdened with several expensive purchases from Cowles Communications, the *Times* opted to get out from under WQXR as quickly as possible. It is conceivable that had the station shown the ability to sustain even a modest profit, the *Times* would have fought the FCC through the courts, but nothing in the picture gave the *Times* administration the slightest incentive to do so.

This, then, is where WQXR stands at thirty-five—the age at which, the Serutan people tell us, things begin to come apart at the seams. Since the first alarms of the 1960s, WQXR's management has been trying to recapture audience and advertisers, but its efforts have been severely hampered by a lack of informational feedback. WQXR has no way of really knowing what sort of people are listening, how many of them there are, or what they want or don't want. The surveys of Pulse and the American Research Bureau are horrendously complicated, often ambiguous, and so contrived as to be open to a wide variety of interpretations—which may be the



Elliott M. Sanger, determined and autocratic.



In better times—the WQXR String Quartet (Harry Glickman, Hugo Fiorato, Harvey Shapiro, and Jack Braunstein).

whole idea. The whole survey business was scrutinized by the Federal Trade Commission some time ago, with the result that every report carries a statement disclaiming accuracy in just about every area the very same report covers. For WQXR, the problem is even more complex, for the likelihood of an interviewer intercepting a WQXR household is rather remote. Surveys in metropolitan areas must, of necessity, channel into low- and middle-income housing; the interviewers are normally blocked from the guarded luxury apartments and the Connecticut estates where WQXR has always claimed that its listeners dwell. If all this is true, media surveys are badly distorted, and WQXR is being penalized unfairly.

Penalized by whom? Enter the media buyer—a small but crucial cog in the advertising machine. Media buyers perch on the lowest rung of the agency ladder; they are usually young and green—probably fresh out of college. When a company tells its agency it has X dollars to spend on advertising, and the basic decision is made that part of those dollars will go into broadcast advertising (as opposed to print advertising), the media buyer runs to his survey chart. He distributes the company's dollars proportionately among the front-runners, and that's that. The fact that the poll may be inac-

curate is far beyond the horizon of his responsibility, as is the fact that it can only measure *quantity* of audience, not *quality*. He is, after all, a fledgling—a trainee with no tenure or status, and he is not being paid to be imaginative or adventurous. Nobody will fault him for sticking to the book. As a result, many specialized companies with thoroughbred customers may actually lose, because the media buyers are putting their money where lots of potential customers are—but not *that company's* potential customers.

Over the years, WQXR has struggled gallantly against these odds, trying to discover for itself what the people "out there" really want. It has its own panel of four thousand listener-respondents which it polls regularly, but this only gives it the views of its withering population of old-timers, and in the face of the mid-Sixties' youth revolution, management feels that survival depends on its ability to attract at least a portion of this vital new generation. Robert Sherman, WQXR's aggressive young program director, took the bull by the horns one day and went right out into the high schools. He asked questions and got answers, some of them eye-opening. One girl had nothing against WQXR, but she compared it to her mother's friends: "I like them, I say hello to them when I walk in the house, but

they have nothing to do with my life." From these talks was born the award-winning hit *Woody's Children*, a fifty-minute program of contemporary folksong, hosted by Sherman himself.

There have been other suggestions: classical on FM, news on AM; classical on AM, light on FM; classical on both, one reinforcing the other; classical on FM, sell the AM. The trouble is, nobody knows, or can even confidently guess, what will work. One thing that *has* worked is cutting staff. The late-Fifties, early-Sixties roster of about 100 was more than double the staff of the next most elaborate and complicated classical music station. When all those terrible things happened in the mid-Sixties, management did something it had never done before—it lopped away big chunks of personnel fat and began to show a profit. The books stayed black till the next round of contract negotiations, which is not surprising inasmuch as the contracts were whoppers and the station was still grossly overstaffed. The second round of heavy personnel cuts—the one that caught me—came last April. Counting retirements, the staff is now down to forty-nine, which is still too big, but if the economy gives any sign of a real revival, WQXR could find itself making a profit again.

If it all sounds like petty bookkeeping, consider this: nonclassical WRFM, which has the third highest sales billing among New York City's FM stations, operates with a staff of twenty-five; WFMT in Chicago, considered by many to be the finest classical music station in the country, makes it with twenty-one; and KFAC, Los Angeles, a 24-hour-a-day AM-FM station with totally separate programming, gets along with thirty-five—fourteen fewer than WQXR, which is on the air only eighteen hours a day, and with only nine of them programmed separately.

Suppose, just suppose, that back in '43 somebody had *not* decided to "play radio" and had managed to see it through with a staff of twenty-five. How many years of profit making would now be past history—years which the *Times* management might have taken into account during this presumably temporary period of economic depression? Simple arithmetic gives a clue: if the average WQXR salary in the late '50s and early '60s had been only \$5,000 (a ridiculously conservative estimate), the station's payroll for 100 employees would have been half a million dollars, not counting fringe benefits. A staff of thirty would have saved \$350,000 annually.

During my week of interviewing, people expressed some very definite opinions and a lot of "should haves" to me: management should have inspired a sense of trust in the staff—should not have been so aloof, because all those restrictive union clauses came from a need for protection; WQXR should have had a public relations representative—Abram Chasins (music director in the Fifties) had

one, with the result that the station was mentioned in Leonard Lyons' column at least once a week; WQXR should have been more adventurous; WQXR should have been more conservative; WQXR should have had more personalities; should have had less talk; should never have lowered its advertising standards; should have taken on Preparation H years ago. But although there will be no easy answers, a few points must be considered. Clearly, classical music broadcasting will always be a marginal operation calling for the strictest frugality. And the evidence would seem to suggest that a station should find a definite niche and stay in it: trying to be all things to all people causes alienation at all levels. After the success of *Woody's Children*, WQXR considered a revolutionary format for the entire day—a mixed-media approach combining classical, folk, non-acid rock, jazz, and theater music, all bound up in a framework of personality hosts. This, it was felt, would appeal to culturally aware people of all ages. WQXR's management presented the idea to a random selection of 100 listeners; it says all ages reacted badly—an attitude that is supported pretty well by today's stratified listening habits. We have classical stations and rock stations and pop stations and background music stations and news stations, which means that once you've decided what you want to hear you know where to tune. WPAT, which is commercially successful, has gotten there with a pure wallpaper format; WNCN, also a success, is almost purely classical—and if anybody wants to put any credence in those questionable radio surveys, the successes have been at the expense of WQXR, which has lost audience as the others have gained. WNCN, catering almost exclusively to the serious music lover, has kept its staff and budget compact and economical. Everybody there is grimly devoted to the station and its welfare, and frankly they work like dogs. The small sales staff is in by 8:30 a.m. and on the road by 9:00; and it utilizes sales techniques of unbelievable sophistication. The end result has been a little money in the bank each month—not much, but enough. Of course WNCN is only thirteen years old, and has had a chance to profit from everybody else's mistakes.

Finally, listeners must be encouraged to write to stations—a particularly hard job with a sophisticated, classically oriented audience. Obviously, stations need to know when they please and displease, and what might be wanted that is not already being provided. In the absence of any trustworthy sampling methods, managements rely heavily on listeners' letters as long as the letters are rational, sincere, and free of obvious animus or excessive bias. Also, letters in impressive quantity are often great persuaders when dumped on an advertiser's desk. In the end the survival of classical radio may very well depend on communications which run the other way—to the stations, and not *from* them. ■

highest sound quality

"Dust free" means highest sound quality

It's a well-known fact that adhesion of dust and magnetic particles to tape recorder heads cause 90% of sound deterioration in recording and playback. You won't have to clean AKAI's revolutionary GX (glass and single crystal ferrite) HEAD as often as conventional heads. Its core is made of single crystal ferrite, and the inner circumference of the head shield is mounted and set in glass. Dust and magnetic particles do not adhere to the "dust free" GX HEAD because of its hard and smooth ceramic-like head surface. Thus, it's guaranteed for highest sound quality.

"Wear free" means 100 times longer service life

The GX HEAD is also "wear free" because of its hard and smooth surface and is guaranteed for highest sound quality for over 100 times the service life of conventional permalloy heads!

Changing heads costs 10% of tape recorder cost

Have you ever stopped to think what it costs to replace a worn-out head? Approximately 10% of the original cost of your tape recorder! Conventional permalloy heads last only for about 1,000 hours. Have you ever realized that they start wearing out the minute you start using them? It means sound quality actually deteriorates every time you use your tape recorder. But AKAI's GX HEAD doesn't even start to wear out after 1,000 hours of use! That's why you can enjoy highest sound quality longer.

GX HEAD guarantees preeminent recording

The focused field recording system is possible only with a single crystal ferrite head. On the new GX HEAD, AKAI engineers were successful in focusing the magnetic bias field so that the influence of the bias is drastically lessened. Thus, highest quality recording sounds are now available to you.

The sharply contoured shape of the GX HEAD permits low frequency signals to be recorded smoothly without distortion. 20 to 30kHz super low frequencies can be recorded and played back with maximum stability.

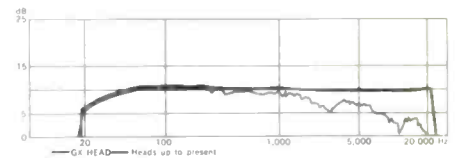

Change in the characteristics of frequency response due to adhesion of dust.

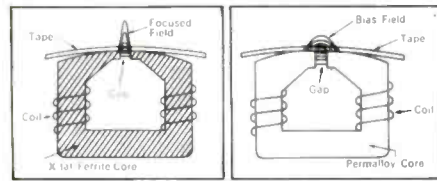

GX Head

Heads up to present

"dust free",

... guaranteed with Akai's GX tape decks



GX-220D Stereo Tape Deck

Features 3 GX Heads, automatic continuous reverse with sensing tape, manual reverse, 3 speeds, 3 motors, automatic stop/shut off, instant pause control, sound-on-sound button, and Super Range Tape (SRT) button for use when using low noise tapes. The two 7-inch reels can be completely covered with an optional plastic dust cover.

GX-280D Stereo Tape Deck

Features 3 GX Heads, 3 motors, automatic continuous reverse with sensing tape, manual reverse, automatic stop/shut off,



pause button with lock, sound-on-sound button, remote control socket for optional Remote Control Unit RC-16, and Super Range Tape (SRT) button for use when using low noise tapes. The two 7-inch reels can be completely covered with an optional plastic dust cover.

GX-365D Professional Stereo Tape Deck

Features 3 GX Heads, world's only automatic continuous reverse (Reverse-O-Matic), sensing tape reverse, 3 motors, 3 speeds, automatic volume control (Compute-O-Matic) magnetic brake, automatic stop/shut



off, instant stop/pause control, Super Range Tape (SRT) button for use when using low noise tapes, remote control socket, and sound on sound, sound with sound, sound over sound.

AKAI's GX-220, GX-280 and GX-365 Stereo Tape Recorders are also available.

Audio & Video

AKAI

AKAI AMERICA, LTD.

2139 East De Anza Boulevard/Compton, California
90220/(213) 537-3880

Manufacturer

AKAI ELECTRIC CO., LTD.

P.O. Box 21, Tokyo International Airport, Japan

CIRCLE 3 ON READER-SERVICE CARD

"wear free" GX Head



Some of the most serious conductors and musicians of our time present five of the most enjoyable albums of the year.

E. Power Biggs
Plays
Bach in the Thomaskirche

Passacaglia and Fugue in C Minor
Prelude and Fugue in C Major
Tocatta and Fugue in D Minor
Prelude and Fugue in G Major ("The Great")



M 30648*

SZELL CONDUCTS HAYDN
SYMPHONIES NO. 97 IN C.
AND **NO. 98** IN B FLAT
THE CLEVELAND ORCHESTRA

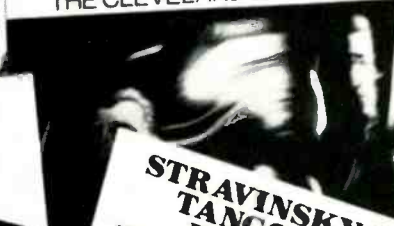

M 30646

Pinchas Zukerman
Wieniawski:
Violin Concerto
No. 2 in D Minor
Kabalevsky:
Violin
Concerto
Bloch:
Nigun from
"Baal Shem"

The Royal
Philharmonic
Orchestra
Lawrence
Conductor



M 30644

STRAVINSKY CONDUCTS:
TANGO/PRELUDE/
EBONY/CONCERTINO/
PASTORALE/CONCERTO/
FOR 12 INSTRUMENTS/
OCTET FOR WIND
INSTRUMENTS/RAGTIME
THE COLUMBIA
JAZZ COMBO
THE COLUMBIA
CHAMBER ENSEMBLE
BENNY GOODMAN, SOLOIST



M 30579

Rumanian Rhapsody
Leonard Bernstein
New York Philharmonic
Liszt/Hungarian Rhapsodies Nos. 1 and 4
Enesco/Rumanian Rhapsody No. 1
Brahms/Hungarian Dances Nos. 5 and 6
and more



M 30645

Magnificent enjoyment
from Columbia Records

*Also available on tape

© COLUMBIA MARCAS REG. PRINTED IN U.S.A.

by Harris Goldsmith

Eighteen Chamber Masterpieces, Gloriously Performed

Two string quartets from Hungary play Haydn and Mozart.



The Tátrai Quartet

THE RELATIONSHIP that flourished between Josef Haydn and Wolfgang Mozart, mutually beneficial to both geniuses, is one of the more warming chapters in the annals of human behavior. Mozart wrote of his senior by two dozen years, "It was from Haydn that I first learned the true way to write string quartets," and in gratitude dedicated six of his "children" (Quartets Nos. 14-19) to his colleague with the following inscription:

To my dear friend Haydn. A father who had decided to send his sons into the great world thought it his duty to entrust them to the protection and guidance of a man who was very celebrated at the time and who, moreover, happened to be his best friend.

In like manner I send my six sons to you, most celebrated and very dear friend. They are, indeed, the fruit of a long and laborious study; but the hope which many friends have given me that this toil will be in some degree rewarded, encourages me and flatters me with the thought that these children may one day prove a source of consolation to me.

During your last stay in this capitol [Vienna], you yourself, my very dear friend, expressed to me your approval of these compositions. Your good opinion encourages me to offer them to you and leads me to hope that you will not consider them wholly unworthy of your favor. Please, then, receive them kindly and be to them a father, guide, and friend! From this moment I surrender to you all my rights over them. I entreat you, however, to be indulgent to those faults which may have escaped a father's partial eye, and, in spite of them, to continue your generous friendship towards one who so highly appreciates it. Meanwhile I remain with all my heart, your most sincere friend. W. A. Mozart.

The "approval" Mozart wrote of refers to the remark which a deeply moved Haydn had made to Mozart's father during a 1785 soirée at which the last three of the new quartets were played: "Before God and as an honest man, I tell you that your son is the greatest composer known to me either in person or by name. He has taste, and what is more, the most profound knowledge of composition."

That Haydn continued to grow, and was in fact deeply influenced by Mozart, is amply demonstrated by the older composer's many quartets penned after Mozart's mighty six. The twelve works contained in Opp. 17 and 20, however, date from 1771 and 1772, at least a decade before, and probably are the very ones which "taught" Mozart how to go about his task. Though only a year separates the two collections, each displays a markedly dissimilar facet of Haydn's personality. The six quartets of Op. 17, while thoroughly mature and masterful of design, tend to be relaxed, gracious, and expansive. The six of Op. 20 (sometimes called the *Sun Quartets*), on the other hand, belong to the master's *Sturm und Drang* period. Here the style of writing is very taut, contrapuntally complex, and harmonically active (many of the finales, in fact, are fugal). With the exception of the two unbelievably great works of Op. 77, Haydn never surpassed and rarely equaled the chamber music inspiration and sheer mastery of the *Sun* cycle. Mozart's quartets dedicated to Haydn, on the other hand, represent along with the so-called *Hoffmeister Quartet*, K. 499, his pinnacle in this medium. (For all their loveliness, the three later *Prussian Quartets* are by no means so intensely inspired or incandescent in content.) Haydn's praise was absolutely to the point. But not only is every one of the six a flawless masterpiece, each has a remarkably unique profile of its own.

The pathos-tinged gaiety of the G major, K. 387, for example, is worlds removed from the demonic, yet reserved intensity of the D minor, K. 421. The E flat, K. 428 and the A major, K. 464 are both expansively lyrical, but while the first is all compactness and brevity, the latter is full-blown, almost Beethovenian in its vast dimensions. And the first movement of the famous *Hunt* K. 458 has few rivals for sheer bouncing ebullience.

The best music deserves the finest presentation: both the quality of performance and recorded sound one encounters on these imported Hungarian discs are calculated to raise reviewers' spirits. I am especially drawn to the wonderful playing of the Bartók foursome (whose personnel are Péter Komlós and Sándor Devich, violins; Géza Németh, viola; and Károly Botvay, cello—all young Hungarian-trained musicians). Their first concerts here in 1967 led me to believe that the Bartók would be the true successor to the glory of the lamented Budapest Quartet—and this glorious set confirms that impression. These performances are on the whole richly expressive and lyrical. Indeed, some Mozarteans may conceivably

find them tonally a bit *too* ripe and inflected for their taste, too romantic and yielding. But as with the Budapest, the Bartók players have a rich tradition and culture behind everything they do. All of their interpretations are structured, firmly nuanced, and quite without the occasional touch of preciousness that sometimes blemishes the work of our own first-class Guarneri foursome. They differ from the Budapest, though, in one particular: they are scrupulously mindful of repeats. The reproduction is ultralifelike, with satin-smooth surfaces and plenty of amplitude and bite. The acoustics, I imagine, were those of a fairly large but intimate room. If you want the verisimilitude of a quartet in your living room, that's what you'll hear on these superb records.

The Tátrai Quartet (Vilmos Tátrai, Mihály Szücs, György Konrád, and Ede Banda play in the Op. 20; István Várkonyi replaces Szücs as second violin in the Op. 17) are an older foursome than the Bartók, and have already achieved international fame, though I believe that they have never appeared in our own concert halls. As with the Haydn *Erdödy* quartets of Op. 76 released here a few years ago, the new Tátrai albums top all stereo competition (alas—the equally distinguished but utterly different Schneider mono editions are no longer available). The Tátrai plays with impeccable intonation. Rarely have I heard such flawless ensemble or such incredibly dead-center chording. I daresay there is no quartet known to me “either in person or by name” that can approach the Tátrai on purely technical grounds. Musically, however, their style may take some getting used to. All the players opt for a very narrow, practically non-

existent vibrato and that trait—combined with very tight, disciplined rhythm and clipped phrasing—makes for an ultra-assertive, almost brazen impact. At times, the bite of the fortes almost sounds like a brass ensemble or medieval consort. For some reason, be it the new second fiddle, more spacious microphone placement, more genial character of the music, or whatever, the Op. 17 sounds a trace gentler and less strait-laced in concept.

Still these performances, whatever one might think of them stylistically, offer string-quartet playing of consummate distinction and finesse. Scholars might note that the numbering of Op. 20 is somewhat different from that given in standard editions. Haydn himself is reputed to have changed the order around several times (in any case, he did not specify performance as a cycle). Moreover, the Tátrai have, for this recording, gone back to the 1772 manuscript and the edition first printed in 1800-1 by Artaria, making a scholarly composite of the best features in both sources. The reproduction and processing are fine, though I preferred to subdue the slight stridency of Op. 20 by reducing the highs a bit on that set.

HAYDN: Quartets for Strings, Op. 17: No. 1, in E; No. 2, in F; No. 3, in E flat; No. 4, in C minor; No. 5, in G; No. 6, in D. Tátrai Quartet. Quallton LPX 11382/4, \$17.94 (three discs).

HAYDN: Quartets for Strings, Op. 20: No. 1, in E flat; No. 2, in A; No. 3, in F minor; No. 4, in D; No. 5, in C; No. 6, in G minor. Tátrai Quartet. Qualiton LPX 11332/4, \$17.94 (three discs).

MOZART: Quartets for Strings: No. 14, in G, D. 387; No. 15, in D minor, K. 421; No. 16, in E flat, K. 428; No. 17, in B flat, K. 458 (*The Hunt*); No. 18, in A, K. 464; No. 19, in C, K. 465 (*Dissonant*). Bartók Quartet. Hungaroton LPX 11400/2, \$17.94 (three discs).

by George Movshon

The Wonder of the Age

A British history of the early
phonograph via the phonograph.

“This tongueless, toothless instrument, without larynx or pharynx, mimics your tones, speaks with your voice, utters your words: and centuries after you have crumbled into dust may repeat every idle thought, every fond fancy, every vain word that you choose to whisper against the iron-thin diaphragm.”

THE QUOTATION is attributed to Edison but it smacks of some Victorian copywriter plying his pen in the cause of commerce. Nevertheless, Edison's philosophy is there: the phonograph was to be a toy, a scientific instrument, a tool of business, a source of musical entertainment and cultural elevation—but it was also to be a device for freezing actuality in the service of history. And indeed

the talking machine has been and done all these things, and much else besides, ever since the day in August 1877 when Edison, so the legend has it, spoke the words “Mary had a little lamb” and the tinfoil-coated cylinder spoke them back.

It was apparent from the start that an instrument now existed to capture and hold in perpetuity the voices of great ones. Edison and his agents (and soon afterward his competitors) rushed to record presidents, prime ministers, prelates, and poets. Gladstone spoke into the horn, and Robert Browning and Arthur Sullivan; later Oscar Wilde was to recite for preservation his *Ballad of Reading Gaol*—in so mincing and effeminate a fashion that the

WHAT WILL YOU DO
IN THE
LONG, COLD, DARK, SHIVERY EVENINGS,
WHEN YOUR HEALTH AND CONVENIENCE COMPEL YOU TO STAY
INDOORS?

WHY!!! HAVE A PHONOGRAPH, OF COURSE.

It is the **PINNEST** ENTERTAINER in the WORLD.
There is nothing equal to it in the whole Realm
of Art.
It imitates any and every Musical Instrument,
any and every natural sound, faithfully:
the HUMAN VOICE, the NOISE OF THE
CATARACT, the BOOM OF THE GUN,
the VOICES OF BIRDS OR ANIMALS.



From
£2 2s.

THE GREATEST MIMIC.
A Valuable Teacher of Acoustic Music. Most Interesting to Old or Young. A Pleasure
and Charm to the Listener, bringing to them the Brightness and Amusement of
the entire World by its faithful reproduction of Speech, Song, Speeches, &c.
EVERY HOME WILL desire or later have a PHONOGRAPH as a NECESSITY.
HAVE YOURS NOW; you will enjoy it longer.

Three North American Keyboard Virtuosos Give Bach A

Glenn Gould: The Well-Tempered Clavier

Anthony Newman: The Goldberg Variations

by Robert P. Morgan



Anthony Newman



Glenn Gould

THESE TWO RECENT recordings of Bach keyboard works have much in common, despite the fact that Gould performs Bach on the piano while Newman does so on the harpsichord. Both players belong to the younger school of Bach interpreters, and both approach the music with a strikingly original conception, which is never doctrinaire and yet is solidly based on sound knowledge of baroque performance practices. Further, both players come equipped with a rare combination of really exceptional technique and musicality.

The Gould disc, which contains the last eight preludes and fugues of the second volume of the *Well-Tempered Clavier*, represents the final disc (there are now six in all) of his integral recording of the complete set. I have written at length in these pages about my admiration for earlier discs in the series and will confine myself here to noting that I am equally enthusiastic about the present offering. If anything, it is in fact superior to the others in that it seems less mannered, without however losing any of Gould's usual flair for the unexpected.

As for the Newman, it is equally impressive; his playing, in fact, reminds me considerably of Gould's—not so much in particulars as in his general outlook. He plays with consummate virtuosity—some of the passages in the

variations are performed at such high speed that the listener is apt to suffer disorientation until he sufficiently familiarizes himself with this reading. There are many interesting features: although not all repeats are observed, when they are taken they are frequently varied through the use of dotted rhythms (the so-called *notes inégales*). Also, Newman handles the tricky problem of registration most convincingly, producing sufficient variety without making it seem overly fussy. It is a first-rate performance of a difficult work, one which places Newman clearly among our foremost Bach interpreters.

Both albums belong to Columbia's recent set of Bach releases, all five of which come with a large poster of the illustration on the album cover. Each of the illustrations I received is a "portrait" of Bach, done in an aggressively "mod" manner which completely misses the spirit of the music it "accompanies." One wonders what they will think of next to sell records (now that the music itself is apparently insufficient). Perhaps dancing girls?

BACH: The Well-Tempered Clavier, Book II: Preludes and Fugues: No. 17, in A flat; No. 18, in G sharp minor; No. 19, in A; No. 20, in A minor; No. 21, in B flat; No. 22, in B flat minor; No. 23, in B; No. 24, in B minor. Glenn Gould, piano. Columbia M 30537, \$5.98.

BACH: Goldberg Variations, S. 988. Anthony Newman, harpsichord. Columbia M 30538, \$5.98.

Igor Kipnis:
The Harpsichord Concertos

by Clifford F. Gilmore

IT IS HARDLY NEWS to anyone that for the last decade or two the younger generation has been leading a revolution in present-day performance styles of old music. On the one hand musicologists have unearthed vast quantities of material, giving us a much clearer (though still approximate) idea of how those early musicians themselves played their music; and on the other there is an increasing desire, especially among our younger generation of performers, to play the music of all periods in the style current at the time of its composition. In the

Young Look



Igor Kipnis

case of baroque music and Bach in particular, it had seemed for quite some time as if practically all this activity were going on only in Europe. Now in the last few years, however, a few American performers have moved into the front ranks of this still highly specialized area, not by imitating their European predecessors, but by developing a uniquely American approach, equally well-informed on matters of stylistic accuracy and typically virtuosic, spontaneous, and often controversial or "experimental" in nature.

Igor Kipnis is not exactly a newcomer to the field, having made his New York debut in 1959, but this four-disc set of ten harpsichord concertos is his most formidable contribution to the American record catalogue to date. And let me say straight off, it is a spectacularly successful contribution. His grasp of the special idiomatic requirements is unsurpassed by even the best of his European counterparts, his performances are exciting, and he is joined here by one of the world's great chamber ensembles.

Before getting down to specifics, however, let's see just what is in this box with that invariably ambiguous label "complete." The usual collection includes the seven concertos for one harpsichord, the three for two harpsichords, two for three harpsichords, and one for four harpsichords. The A minor Triple Concerto (for flute, violin, and harpsichord) is often included as well. Kipnis omits the concertos for two, three, and four harpsichords but adds a No. 8 to the seven canonical works for one instrument. Bach left a nine-measure fragment for the piece indicating that the first movement was an arrangement of the opening *sinfonia* of Cantata No. 35. Kipnis has used a second *sinfonia* from the cantata as a third movement for the concerto and arranged the opening *alto aria* for the second movement. Others have also completed this fragment, including Gustav Leonhardt, who recorded his version for Telefunken. Kipnis also includes the Triple Concerto and the fifth *Brandenburg* Concerto.

Telefunken has only recently completed its five-disc integral version of the harpsichord concertos (including the multiple concertos) with Gustav Leonhardt. I found those performances well-nigh perfect in every detail, so I decided to play through the records again, compar-

ing them concerto by concerto with Kipnis' new set: the American proved to be every bit as conscientious about the details and consistently even more exciting and adventurous. Kipnis seems to realize a fact about these concertos that has escaped nearly every other performer in my experience. Bach was still working pretty much in the standard baroque concerto-grosso format, with its regular, predictable, and symmetrical alteration of solo and tutti. However, he is also hinting at a later generation's concept of the concerto: that of conflict between the solo and tutti and final resolution. Each concerto opens with a straightforward statement of the material, then instead of merely alternating subsequent statements, Bach builds the intensity and sense of conflict by means of a rudimentary kind of thematic development (also foreshadowing a later time) which becomes increasingly more complex up to the final resolution—the unison statement of the main material. This is the facet of the concertos that Kipnis brings out most convincingly by employing all the devices available to the baroque harpsichordist—especially by means of steadily increasing the complexity of the ornamentation, climaxed by a brief but dazzling cadential flourish at the appropriate spot in several of the concertos. Leonhardt's ornamentation, on the other hand, while just as accurately employed, is not used to build the excitement layer by layer as Kipnis does, and he declines every one of Bach's invitations to supply a cadenza. Marriner shares Kipnis' ideas and all ten performances achieve a very clearly recognizable architectural shape and direction.

My only reservations are very slight and in no way detract from my enthusiastic recommendation of this set as a whole. Marriner's string players number seventeen (6, 6, 2, 2, 1)—considerably larger than Leonhardt's five (one player per part)—although this complement is probably very close to what was available to Bach in the Collegium Musicum. However, I still miss the incisiveness and neat articulation that Leonhardt's players provide. Marriner's seventeen, I feel, could have articulated their parts more clearly, especially such typical figurations as pairs of slurred sixteenths.

Aside from an occasional harshness in the upper strings (the pizzicatos in the slow movement of the F minor concerto are especially unpleasant), this is one of Columbia's best recordings. Stereo separation and placement and clarity of detail are excellent. The harpsichord, for once, is recorded in perfectly realistic perspective and the three instruments Kipnis uses (Dowd, Rutkowski & Robinette, and Rubio) are reproduced beautifully. Only the flute sounds too close and too large, especially in the *Brandenburg*.

Again, let me emphasize, these are very minor criticisms. The set should be on everybody's Bach shelf regardless of how many versions he already owns, and all hats should be off to Mr. Kipnis for his remarkable accomplishment.

BACH: "The Complete Concertos for Harpsichord and Orchestra": No. 1, in D minor, S. 1052; No. 2, in E, S. 1053; No. 3, in D, S. 1054; No. 4, in A, S. 1055; No. 5, in F minor, S. 1056; No. 6, in F, S. 1057; No. 7, in G minor, S. 1058; No. 8, in D minor, S. 1059 (reconstructed by Igor Kipnis); Triple Concerto for Violin, Flute, and Harpsichord, in A minor, S. 1044; Brandenburg Concerto No. 5, in D, S. 1050. Igor Kipnis, harpsichord; Hans-Martin Linde, flute; Jeanne and Marguerite Dolmetsch, recorders; Janet Craxton, oboe; Neville Marriner, violin; London Strings, Neville Marriner, cond. Columbia M4 30540, \$23.92 (four discs).

classical

reviewed by

ROYAL S. BROWN
 R. D. DARRELL
 PETER G. DAVIS
 SHIRLEY FLEMING
 ALFRED FRANKENSTEIN
 CLIFFORD F. GILMORE
 HARRIS GOLDSMITH
 DAVID HAMILTON
 PHILIP HART
 DONAL J. HENAHAN
 PAUL HENRY LANG
 ROBERT C. MARSH
 ROBERT P. MORGAN
 GEORGE MOVSHON
 H. C. ROBBINS LONDON
 SUSAN THIEMANN SOMMER

BACH: "The Complete Concertos for Harpsichord and Orchestra." Igor Kipnis, harpsichord; London Strings, Neville Marriner, cond. For a feature review of this recording, see page 86.

BACH: Goldberg Variations, S. 988. Anthony Newman, harpsichord. For a tenure review of the recording, see page 86.

BACH: The Well-Tempered Clavier, Book II: Preludes and Fugues Nos. 17-24. Glenn Gould, piano. For a feature review of this recording, see page 86.

BACH, C.P.E.: "Odes, Psalms, and Lieder." Dietrich Fischer-Dieskau, baritone; Jörg Demus, Tangentenflügel. Archive 2533 058, \$6.98.

Fischer-Dieskau is not exploring absolute virgin territory on this disc—Flagstad and Souzay each recorded a handful of C.P.E. Bach's songs about twenty years ago—but this is certainly the most extensive selection of the composer's 300 Lieder yet to appear. Each of the seventeen songs offered here is on a religious theme (nine to texts by Gellert, whose odes were also set fifty years later by Beethoven), they are all strophic (one, *Trost der Erlösung*, contains twelve verses repeated note for note—although Dieskau, and the published Peters edition only offer three), and the collection as a whole provides a valuable glimpse of the German Lied in its formal infancy.

Perhaps the most remarkable aspect of these songs is their expressive variety—they range from the straightforward chorale setting of Psalm 130 (*Aus der Tiefe ruf ich dich*—but

compare this with the totally different chorale technique of Father Bach) to the fully developed accompanimental patterns of *Wider den Uebermut*, and from the cheerful harmonic simplicity of *Der Frühling* to the chromatic pathos of *Jesus in Gethsemane*. The melodic content tends to be rather dull and probably for this reason neither Fischer-Dieskau's sophisticated art nor the beguiling sound of Demus' 1793 Tangentenflügel (an instrument "between the clavichord and hammer-clavier" according to Archive's detailed notes) can keep us involved for more than a few songs at a time. But if German Lieder is your thing, here is a rare chance to hear the form (as we have come to know it) in one of its earliest stages of evolution. P.G.D.

B **BEETHOVEN:** Wellington's Victory, Op. 91; Musik zu einem Ritterballett, WoO. 1. **WITT:** Symphony in C (*Jena*). Westphalian Symphony Orchestra, Hubert Reichert, cond. Turnabout TV 34409, \$2.98.

More footnotes to the birthday year—and mostly footnotes to the appendix, at that. This version of the poor old *Battle Symphony* has little to recommend it save sobriety, and if that's what you want in a recording of this piece, the Scherchen (now Music Guild S 801) is both better played and more responsive to the admittedly slim musical content. Beethoven's requirements are met in the matter of percussion, but Reichert's lugubrious three-to-the-bar speed in the final allegro is simply disastrous.

The pleasant "Knightly Ballet" of 1791 is rather more successfully handled, although lacking somewhat the style of Müller-Brühl's imported recording (Schwann/Musica Mundi VMS 700/1, with the best complete *Prometheus*). Connoisseurs of influence will wish to note the Romance (No. 4 in the score), a close relative of Pedrillo's little serenade in Mozart's *Entführung*.

Finally, as Anna Russell might say, "D'you remember the *Jena* Symphony?" For years, this innocuous if well-made classical symphony bounced around among the experts, on the basis of Fritz Stein's discovery that Beethoven's name was written on some of the parts in the Jena archives. There was even a 78-rpm recording at one time (by Werner Janssen), but nobody ever seemed convinced, and all were greatly relieved recently when another source turned up bearing an ascription to Friedrich Witt (1770-1837). The latter now takes his place in Schwann (somebody up there must be on the ball, since Turnabout has done its best to keep the re-attribution a secret: nowhere except in the small print of Egon Kenton's excellent linear notes is there the least hint for the unwary buyer that the *Jena* is any less *echt* than say, the *Éroica!*), and if you are the sort of collector who goes in for "might-have-beens" this record is for you. It's sort of amiable sub-Mozart—but be warned that "Witt" in German does not mean what you might think it does. Reichert and his

band are more comfortable here than on the battlefield. D.H.

BOTTESINI: Grand Duo for Violin, Double Bass, and Orchestra—See Paganini: Concerto for Violin and Orchestra, No. 4, in D minor.

BRAHMS: Concerto for Piano and Orchestra, No. 2, in B flat, Op. 83. John Lill, piano; U.S.S.R. Radio Symphony Orchestra, Gennady Rozhdestvensky, cond. Deutsche Grammophon 2530 111, \$6.98.

Since the catalogue is crowded with versions of the Brahms B flat featuring the likes of Serkin, Arrau, the Cleveland, NBC, Concertgebouw, and Berlin Philharmonic, it strikes me as slightly perverse for DGG to come forth with this recording featuring a promising but relatively inexperienced soloist and an ill-rehearsed second-string orchestra. (The performance is Mr. Lill's prizewinning one at the Tchaikovsky Competition in Russia.) That said, however, I did find John Lill's reading rather refreshing in its manly directness and musical integrity. And conductor Rozhdestvensky, handicapped though he is by the cramped sound and ragged forces entrusted to his command, gives another example of his really exceptional musicianship.

In the main the performance is unusual for younger-generation interpreters: fast-paced, unstreamlined, cumulative in its rock-solid phrasing—on the whole it reminds me of Backhaus' way with the music. You might say that the Lill/Rozhdestvensky contribution is negligible, but their potential in this music is very great indeed. However, it should have been offered on a low-priced label. H.G.

BRITTEN: Les Illuminations, Op. 18; Serenade, Op. 31, Heather Harper, soprano (in Op. 18); Robert Tear, tenor; Alan Civil, horn (in Op. 31). Northern Sinfonia Orchestra, Neville Marriner, cond. Angel 36788, \$5.98.



Two very competent performances, but not really comparable to the brilliantly sustained and finely detailed readings by Peter Pears and the composer (recently recoupled on London OS 26161, as have been their respective flip sides, the *Bridge* Variations and the *Young Person's Guide*, now on CS 6671).

Explanation of symbols

Classical:

-  Budget
-  Historical
-  Reissue

Prerecorded tape:

-  Open Reel
-  8-Track Cartridge
-  Cassette

The great Salzburg collaboration.

For a Herbert von Karajan, the problem of surpassing past efforts becomes increasingly difficult. That is especially true in his recordings for Angel, where he has accumulated 25 years of superlatives.

But his recent, more aggressive schedule with us has only proved his claim to those superlatives. Last year brought the monumental Beethoven Triple, with Czibak, Rostropovich, and Richter. Next, a superb Franck D Minor Symphony, with the Orchestre de Paris. Then, a masterful Tchaikovsky First Piano Concerto, with Alexis Weissenberg.

Yet to come this year: the dazzling promise of Die Meistersinger and Fidelio.

And now, Salzburg's greatest conductor pays happy tribute to his home town's greatest composer. With his Berlin Philharmonic, Karajan has recorded *The Last Six Symphonies of Mozart*.



S-36770

S-36771

S-36772

What takes these albums beyond mere beauty? Karajan's titanic discipline. His unswerving dedication to the music. His desire—indeed, his insistence—that each member of the orchestra contribute his own emotions, his own insights to the performance.

Finally, in this Salzburg collaboration, Karajan must also have been driven by chauvinism. The world is clearly the winner.



Heather Harper reminds us, as did Janice Harsanyi before her, that *Les Illuminations* was originally conceived for soprano, and she sticks to the original vocal line at several places that Britten evidently modified for Pears, but the singing has much less point and variety—Pears, even subject to the vocal limitations of his sixth decade, remains one of the age's great vocal interpreters. Tear manages a good imitation, in the *Serenade*, but it is still palpably an imitation. I would be very happy to hear either of these performances in concert, but (especially at full price) they are simply not competitive as recordings.

The sound on the review acetates was excellent, and texts (and translations of *Les Illuminations*) are promised. D.H.

BUSSOTTI: ultima rara for guitar and speaking voice—See Castelnuovo-Tedesco. Romancero gitano, Op. 152.

CASTELNUOVO-TEDESCO: Romancero gitano, Op. 152. (Seven poems of Federico Garcia Lorca for Chorus and Guitar) **BUSSOTTI:** ultima rara (pop song) for guitar and speaking voice. **HARTIG:** *Perché* for Guitar and Chorus. Siegfried Behrend, guitar; Sylvano Bussotti, speaker (in the Bussotti); NCRV Vocal Ensemble, Marinus Voorberg, cond. Deutsche Grammophon 2530 037, \$6.98.

Beginning at the end of this program: Heinz Friedrich Hartig's *Perché* for guitar and chorus, composed in 1959 ten years before his death, is an expressive lamentation on the word "why"—why misfortune, why tears, why war, why the dead and wounded. Each short movement, addressing these subjects in turn, is pointed and complete, ranging in mood from an ecclesiastical serenity to incisive, Britten-like vocal pressing and prodding, to a small gem of picture-painting in the guitar introduction to the war episode. The work escapes classification; one movement is based on a tone row, and is no less lofty in its melancholy because of that fact; another is pure diatonic melody bent to expressive purposes. Through all this, the guitar introduces, complements, reflects, expands, punctuates. It is an effective work, though the danger in live performance of the chorus overwhelming the guitar would seem to be insurmountable without amplification.

Sylvano Bussotti (born in Florence in 1931) has, in his own words, endeavored to "raise the technique of breathing onto a dramatic level" in *ultima rara* (1969), a "pop song" for electronically modified voice and guitar. The guitar part is spiky, fragmented, rhythmically complex, and demands a virtuosic control of dynamics and tone; it also calls for some special effects that expand the instrument's resources by another notch or two. The vocal interjections—phrases, syllables, breath—are mostly low-keyed, sporadically spaced, and dart from alternate speakers, or each overlapping. It is, I find, hard to listen to breathing as pure sound; thoughts of an interesting variety of physical acts that might accompany these sighs and grunts keep intruding. Still, an individual and uncompromising piece.

The Castelnuovo-Tedesco settings of the Spanish folk poetry of Lorca are undistinguished—neither popularized enough to be

popular nor unique enough to be provocative. The NCRV Vocal Ensemble, which does splendidly by the Hartig, seems to feel the same way, dragging its feet through much of the eighteen-minute work.

Siegfried Behrend is one of today's most generous instrumentalists: he cares far less about your listening to him than to the repertoire he has unearthed, and he is far and away the most adventurous programmer among contemporary guitarists. He is also extremely adept at meeting modern demands upon technique, and he continues to enliven the scene with each new recording. S.F.

ERKEL: *Bánk bán*. Karola Agay (s), Melinda; Erszébet Komlóssy (c), Gertrude; József Simándy (t), Bánk bán; József Réti (t), Otto; Imre Jöky (t), Majordomo; Sándor Nagy (b), Andre II; András Farago (b), Petur bán; László Palócz (b), Biberach; György Melis (b), Tibor; András Rajna (b), Officer; Chorus of the Hungarian State Opera House; Budapest Philharmonic. János Ferencsik, cond. Hungaroton LPX 11376/8, \$17.94 (three discs).

This set, the second complete recording of *Bánk bán* to appear within fifteen years, may seem like a needless duplication to Westerners, but in Hungary the opera is standard fare—evidently it is performed there with the same ritualistic regularity and patriotic fervor that attends Glinka's *A Life for the Tsar* in Russia. Almost every European country had one composer writing strongly nationalistic operas in the mid-nineteenth century and Ferenc Erkel was Hungary's answer to Verdi, Wagner, Smetana, and Mussorgsky. *Bánk bán*, in fact, was considered so incendiary that its first performance had to wait until 1861—ten years after the score had been completed—when the local political climate became more settled. One can easily see why: the opera's key scene depicts the melodramatic assassination of the evil (German) Queen Gertrude by the Hungarian hero and patriot Bánk bán. Not only would the situation be provocative in itself in a foreign-dominated country, but Erkel, a thoroughly accomplished operatic professional, has handled the scene with the kind of canny theatrical know-how that Puccini would have appreciated.

Actually the entire work is full of attractive, effectively written music and anyone with a healthy taste for red-blooded nineteenth-century opera should enjoy this one hugely. Much of it recalls Italian and German models but is none the worse for that, and one decidedly original touch—Western-flavored music for the "bad guys" and Hungarian *verbunkos* strains for the "goodies"—works far better for Erkel than a similar procedure (Polish polonaises vs. Russian folk tunes) did for Glinka in his *Tsar*. One problem, raised here by the notes to Hungaroton's new recording, is a textual one. Evidently *Bánk bán* was revised extensively in the 1930s per order of the Budapest Opera because "the original libretto was not worthy of Erkel's music." Not only were the words rewritten, but the musical revision "omitted certain voice parts, turned trios into duets, and choral sections into orchestral interludes, etc." This all sounds rather drastic, but without the two versions on hand for comparison one can only hopefully assume that the Hungarians knew what they were up to.

The unquestioned point of superiority in the new recording is of course its sonics, which are clear, solid, and well balanced compared to the rather foggy reproduction on the 1956 edition. The cast here is completely different (György Melis, Biberach in 1956, now sings the peasant Tibore), but the vocal problems are apparently endemic. Simándy displays the remains of a robust tenor now sounding rather frayed, while Karola Agay's disembodied coloratura and Erszébet Komlóssy's ubiquitous wobble are something of a trial. The cast generates plenty of dramatic authority and enthusiasm and the orchestra under Ferencsik's sure leadership does a fine job, but the dearth of strong voices really tells in this music. For the opera itself, though, you may find critical forbearance worthwhile. Unlike the older set, the new one is provided with a complete translation of the libretto into English and German. P.G.D.

FRANCK: Complete Works for Organ. Fantaisie in A; Cantabile; Pièce héroïque; Choral No. 1, in E (on STS 15103). Choral No. 2, in B minor; Fantaisie in C, Op. 16; Grande pièce symphonique, Op. 17 (on STS 15104). Prélude, fugue, et variation, Op. 18; Pastorale, Op. 19; Prière, Op. 20; Final, in B flat, Op. 21; Choral No. 3, in A minor (on STS 15105). Jeanne Demessieux, organ (Cavaillé-Coll organ at the Church of the Madeleine, Paris). Stereo Treasury STS 15103/5, \$2.98 each (three discs, available separately).

FRANCK: Complete Works for Organ. Listing as above. André Marchal, organ (Great Organ of the Church of Saint-Eustache, Paris). Orpheus OR 299/301, \$8.67 (three discs); available by mail from Musical Heritage Society, 1991 Broadway, New York, N.Y. 10023.

It's been a number of years since we've had anything like a complete recorded edition of these twelve pieces—many of them staples in most organists' repertoires—and here we have two at once, both of which deserve serious consideration. Jean Langlais' three-record set on the sometimes hard to find Gregorian Institutes label is the only other complete version around, though many of Dupré's



Jeanne Demessieux—striking performances of Franck, played in the grand French manner.

Pioneer's new SE-L40 stereo headphones flabbergasted the experts.

High fidelity dealers are probably the most blasé guys in the world. They've seen everything. They've heard everything. You really have to have something extraordinary to impress them. So when we introduced the new Pioneer SE-L40 stereo headphones at a recent home entertainment electronics show for dealers, we were overwhelmed at its enthusiastic reception. We expected applause. We received an ovation.

These super critics marveled at the new open-air design which enhances the intimacy of personalized listening. They enthused over the incomparable bass reproduction achieved by a combination of technological advances and newly developed speakers nestled into each ear-piece. They lauded the extreme light weight, nearly one third less than present headphones. Their conclusion: the SE-L40 is a complete departure from conventionality.

If you're still skeptical and believe that Pioneer high fidelity dealers went overboard with their acclaim for SE-L40, there's only one way you're going to be convinced.

Visit a Pioneer dealer and listen SE-L40 stereo headphones, \$39.95, with carrying case. Other

quality Pioneer headphones from \$24.95.

U.S. Pioneer Electronics Corp.
178 Commerce Road, Carlstadt,
New Jersey 07072

 **PIONEER**
when you want something better



legendary accounts are still with us on Mercury and Philips. Both Demessieux and Marchal are authoritative players who are equally at home in this repertory, and both have made their recordings on organs well suited to Franck's almost mystical, highly serious works. Marchal plays on the organ of Saint-Eustache in Paris, an instrument that Franck himself helped to inaugurate in 1854. It has since undergone several restorations, most notably by Bonzalez in 1967. Demessieux, though, plays on the genuine article—the Cavallé-Coll organ in the Church of the Madeleine in Paris, where she presided for about ten years until her untimely death in 1968 at the age of 47 (her predecessors there included both Saint-Saëns and Fauré). The organ is a truly remarkable instrument, similar in layout to the Cavallé-Coll at Sainte-Clotilde. Franck's home-organ for more than thirty years and the instrument on which he composed all twelve of these pieces. Listening to Cavallé-Coll's broad, incredibly rich foundation tone and the smothered brilliance of its reeds is like swimming in a pool of chocolate fudge—if you have that kind of sweet tooth, it's sheer ambrosia.

Having heard Marchal's records first, I was prepared to give them an unqualified recommendation. He approaches his tasks with seriousness of purpose, and he handles the instrument in a colorful and inventive manner. In short, everything is in order and anyone out to buy three records of Franck organ music should be altogether satisfied with his account. My first reactions on hearing Demessieux, though, were that I preferred her organ and that it was more clearly recorded—some of the passage work obscured in the Marchal set may be more easily distinguished here. Further listening revealed again that Jeanne Demessieux was a truly striking performer in the grand French manner. In the smaller, more meditative pieces, there is little to choose between her and Marchal, but in the larger pieces, especially the more dramatic ones, she really generates an astonishing amount of electricity, excitement, and drama. One can almost see the flames licking out from around the swell box as she unleashes the powerful reeds, at first just a little, teasingly, then finally all the way, in full glory, so vivid is the impact of her *Pièce héroïque* or *A minor Choral* or *Grande pièce symphonique*. There's now no question in my mind that hers is the set of Franck to own. (Incidentally, two discs in the Demessieux series were released on London CS 6220/1 several years ago, but in a different coupling sequence. Owners of those records will still have to purchase all three Stereo Treasury discs in order to complete their set.)

C.F.G.

Fux: Serenada a 8; Rondeau a 7; Sonata a Quattro—See Schmelzer: Sonata Natalitia a 3 Chori.

GODOWSKY: Piano Works: Renaissance Tambourin (Rameau); Wienerisch; Humoresque; Etude for Left Hand Alone, Op. 10, No. 6 (Chopin); Badinage (Chopin); Die Fledermaus (J. Strauss, Jr.); Sonata for Piano, in E minor: First movement; Java Suite: Gamelan; Chattering Monkeys—See Herz: Piano Works.

HANDEL: Sonatas for Flute and Continuo, Op. 1: No. 1a, in E minor; No. 5, in G; No. 9, in B minor; Sonatas for Flute and Cembalo: No. 1, in A minor; No. 2, in E minor; No. 3, in B minor. Hans-Martin Linde, flute; Karl Richter, harpsichord; Johannes Koch, viola da gamba. Archive 2533 060, \$6.98.

Handel's grab bag Op. 1, published in 1731, includes fifteen sonatas, of which eight are for flute (three are included here). His other flute sonatas are three without opus numbers, always listed as "with cembalo" rather than "with continuo," and they round out this very respectable recital. There is a big dose of the minor mode here, to be sure, and it might have made more sense to mix in a few of the major-mode examples of Op. 1. Still, Linde commands sufficient rhythmic vitality to keep us interested, though he might have done more with dynamic shaping—everything is a comfortable *mezzo voce*. The flute is placed very much forward, and as a result the occasional imitation and other happy bits of interplay between it and the continuo instruments are not as emphasized as they might be. Sometimes, though, as when the harpsichord breaks into unexpected runs in the third movement of Op. 1, No. 9, the sheer force of the figuration focuses the ear on what's going on below the decks, and that is as it should be.

S.F.

HARTIG: *Perché* for Guitar and Chorus—See Castelnuovo-Tedesco: *Romancero gitano*, Op. 152.

HAYDN: Quartets for Strings: Op. 17 (complete); Op. 20 (complete). Tátrai Quartet. For a feature review of these recordings, see page 83.

HAYDN: Symphonies: No. 57, in D; No. 58, in F; No. 59, in A (*Feuersymphonie*); No. 60, in C (*Il Distratto*); No. 61, in D; No. 62, in D; No. 63, in C (*La Roxolane*); No. 64, in A. Philharmonia Hungarica, Antal Dorati, cond. Stereo Treasury STS 15131/4, \$11.92 (four discs).

The promise of Dorati's first volume in this Haydn series (reviewed last April) is more than fulfilled by this second group of symphonies. A decade ago only half of these works had ever been recorded, and although things have improved since then, the price, packaging, and over-all quality of the Dorati set make it stand out from even limited competition. Let's survey these works briefly in order of composition, recalling that the numbering of Haydn symphonies is often chronologically misleading.

Nos. 58 and 59 date from 1766–68. The former work is, as H. C. Robbins Landon observes, a near perfect example of the classical chamber symphony. It is most attractive. The fire to which the *Feuersymphonie* refers is not the celebrated blaze that destroyed the opera house at Eszterházy in 1779, but the one that figures in G. F. W. Grossmann's play *Die Feuersbrunst*. Haydn reworked the symphony to provide incidental music for that drama when it was played at Eszterházy in 1774. Did Haydn calculate that no one would remember a six-year-old symphony? Possibly, or he may



Antal Dorati—Volume 2 of the conductor's complete Haydn symphonies is up to snuff.

simply have been a practical eighteenth-century musician in a hurry. In any case, the music has a dramatic quality that makes it well suited for a stage work.

Nos. 57 and 60 both date from 1774. The first is a virtuoso piece for chamber orchestra with Haydn exploiting every likely instrumental resource. The second, one of the most familiar works of this period, was written as incidental music to a play. The bridge into the finale anticipates the famed Rossini crescendos to come, and the work reveals the theatrical Haydn at his best.

No. 64 comes from around 1775. It is another chamber symphony of extraordinary charm. No. 61 is dated 1776, and one may give a thought that while Jefferson was drafting the Declaration of Independence, Haydn was entertaining his autocratic master with theater music of infectious high spirits.

Both the final works, Nos. 62 and 63, are from 1780, after the great fire at Eszterházy and represent Haydn once more ingeniously reworking material he has used before and found promising. The second movement of No. 63, named *La Roxolane* after the heroine of a then popular play, is a musical portrait of a Wateau-like ingénue.

R.C.M.

HERZ: Piano Works: Variations on the March from Bellini's "I Puritani"; Etude in A flat, Op. 153, No. 2 (*Au bord du lac*); Variations on the National March "La Parisienne"; Op. 53. **HUENTEN:** Piano Works: Etude in C, Op. 81, No. 1; Variations on an Aria from Donizetti's "L'Elisir d'amore"; Grand Valse Brillante, Op. 120 (*Les bords du Rhin*); Variations on the March from Bellini's "Norma"; Op. 94; Galop in A (*Un Moment de recreation*); Variations on the Duo from Donizetti's "Belisario"; Op. 148. Frank Cooper, piano. Genesis GS 1006, \$5.98.

GODOWSKY: Piano Works: Renaissance Tambourin (Rameau); Wienerisch; Humoresque; Etude for Left Hand Alone, Op. 10, No. 6 (Chopin); Badinage (Chopin); Die Fleder-



You can tell a record by its cover.

The bright yellow label that says where you're at. What makes our label what it is? Its music. Artists. Sound. Technical mastery. And quality. And the ability to know just where your head is. In our ears. Never before has "classical music" been such an integral part of the new culture because of super-stars like Karajan, Kubelik, Abbado, Böhm, Anda, Eschenbach, Fischer-Dieskau, Argerich, Tilson Thomas, the Amadeus Quartet, and more. And such orchestral giants as the Boston Symphony, the Berlin Philharmonic and the



Bavarian Radio Symphony are finding brand new audiences. We'd like to turn you on to what we consider some of our best albums. We have a full-color catalog that's outta sight. It's called 71 OF THE BEST and you can have it for the asking. Just walk into your local record store and say, "Hey, how about laying that new Deutsche Grammophon catalog on me?" If they've run out of them, just send your name and address to: Deutsche Grammophon c/o Polydor Incorporated 1700 Broadway, New York, N.Y. 10019 and we'll send you one free of charge.

Deutsche Grammophon

Deutsche Grammophon Records. MusiCassettes and 8-Track Stereo Cartridges are distributed in the USA by Polydor Incorporated; in Canada by Polydor Records Canada Ltd.

SOLTI

the world's
most honored
conductor

This summer he completes his monumental cycle of the symphonies of Gustav Mahler

Already available:
with The Chicago
Symphony Orchestra
SYMPHONY NO. 5

CSA-2228

SYMPHONY NO. 6

CSA-2227

with The London
Symphony Orchestra
SYMPHONY NO. 1

CS-6401

SYMPHONY NO. 2
("Resurrection")

CSA-2217

SYMPHONY NO. 3

CSA-2223

SYMPHONY NO. 9

CSA-2220

with The
Concertgebouw
Orchestra of
Amsterdam
SYMPHONY NO. 4

CS-6217

Next Release:
SYMPHONY NO. 7
with The Chicago
Symphony Orchestra

CSA-2231

LONDON
RECORDS

CIRCLE 33 ON READER-SERVICE CARD

maus (J. Strauss, Jr.); Sonata for Piano, in E minor: First Movement; Java Suite: Game-fan; Chattering Monkeys. Doris Pines, piano. Genesis GS 1000, \$5.98.

RHEINBERGER: Sonata for Piano, in F sharp minor, Op. 184 (*Romantic*). **JENSEN:** Sonata for Piano, in F sharp minor, Op. 25. Adrian Ruiz, piano. Genesis GS 1005, \$5.98.

Like the baroque craze of the '50s, the current Romantic revival is being amply documented on disc by a number of small independent labels, the latest being Genesis, a newcomer from the West Coast. These three initial releases open up an unexplored piano repertory that is rarely less than entertaining on one level and an instructive guide to changing musical fashions on another.

One of the moving spirits in this new series (and the records at hand are evidently only for starters) is Frank Cooper, a professor at Butler University in Indianapolis and the impresario of that institution's annual Romantic Music Festival. On his solo disc Cooper offers a generous selection of music by Henri Herz (1806-1888) and Franz Hünten (1793-1878), both exceptionally accomplished pianists and indefatigable composers of operatic fantasias and once fashionable salon *morceaux*. These pieces are so superbly tailored for the keyboard that one wonders why pianists did not continue to play them, for practice exercises if for no other reason, so beautifully do they lie under the fingers. Cooper obviously relishes playing with these trinkets and he polishes them off with crystalline articulation and warm affection. An extra measure of virtuoso dash for the flamboyant Herz variations and elegant charm for the more puckish Hünten would have been welcome, but Cooper makes a good case for his two heroes and the recorded sound of his Bösendorfer is full and vibrant.

I don't think anyone would care to make extravagant claims about the staying power of this music—it was written to titillate another age, did its job to perfection, and died a natural death. In his liner notes, however, Cooper rather desperately casts about for an actual murderer. He comes up with Schumann, who is pictured as rabidly jealous of Herz and Hünten ("He wanted to be like them and was miserably equipped for the task"), and who eventually managed to convince the world that the two were totally worthless. Of course Schumann had no use for Herz and Hünten and wrote deprecatingly of them; but if the two have passed from favor it was the poetical and intellectual superiority of Schumann's music that dealt the blow, not his critical writing. I'm happy that Cooper is resurrecting these composers for our inspection and re-evaluation, but let's try to keep some sort of perspective.

Doris Pines's recital is devoted to Godowsky: judging from the occasional bursts of applause, this is the live concert she gave in New York last winter to celebrate the pianist/composer's 100th birthday. And a fascinating disc it is. Most of the music here consists of paraphrases and genre pieces, but Godowsky really apotheosized the art with incredible contrapuntal elaboration, thematic metamorphoses, and multilayered textures—the *Fledermaus* and Chopin étude transcriptions recorded here are not only ingenious but, in their own way, fully as creative as the originals. Less successful is the first movement of the im-

mense five-part E minor Sonata, a sixteen-minute ramble that sounds rather like a paraphrase in search of a theme. Considering the complexity and difficulty of the music, Miss Pines pulls off a Herculean assignment with disarming ease and very real accomplishment: not only does she keep these vast structures in firm, accurate proportion, but her plump, ripe tone and care for musical detail often illuminate the music with startling clarity.

The third disc pairs two sonatas in F sharp minor by Josef Rheinberger (1839-1901) and Adolf Jensen (1837-1879). The Rheinberger strikes me as a dull, predictable, derivative piece, but Jensen's effort shows a more original mind at work. Each movement is quite long, but the rich melodic invention—and there are some aching beautiful ideas here—rarely flags and the purposeful musical direction is never lost. There are few large-scale Romantic piano sonatas after Beethoven; this is one of the best and deserves a revival. Adrian Ruiz dispatches each work with crisp technical efficiency, but they both would benefit from a less literal approach and more tonal color.

P.G.D.

HUENTEN: Piano Works: Etude in C, Op. 81, No. 1; Variations on an Aria from Donizetti's "L'Elisir d'amore"; Grand Valse Brillante, Op. 120 (*Les bords du Rhin*); Variations on the March from Bellini's "Norma"; Op. 94; Galop in A (*Un Moment de recreation*); Variations on the Duo from Donizetti's "Belisario"; Op. 148—See Herz: Piano Works.

HUMPERDINCK: Hänsel und Gretel. Renate Hoff (s), Gretel; Renate Krahmer (s), Sandman and Dew Fairy; Ingeborg Springer (ms), Hänsel; Gisela Schröter (ms), Gertrud; Peter Schreier (t), Witch; Theo Adam (b), Peter; Boys Choir of the Dresden Kreuzchor; Dresden Staatskapelle, Otmar Suitner, cond. Telefunken SAT 22521/2, \$11.90 (two discs).

Like so many operas, *Hänsel und Gretel* works for all the wrong reasons. Here is a simple folk story, part of everyone's childhood, turned into Wagnerian music drama complete with a large orchestra and a complex contrapuntal web of leitmotifs. Yet it does work thanks to Humperdinck's dewy-fresh melodies, deft technique, honest sentiment, and utter lack of pretense. This is definitely not a children's opera, but an opera about children for nostalgic adults.

Telefunken's new recording from East Germany is a pleasant performance, but conductor Suitner rather shortchanges us by holding back when there is an expansive musical point to be made. I suppose the general idea, a mistaken one it seems to me, was to keep everything as light and restrained as possible. Karajan's old mono recording on Angel is still the paradigm: the conductor's warm, glowing presentation of the score does not attempt to apologize for the music's rich symphonic quality, while Schwarzkopf and Grümmer, two very sophisticated children, paradoxically capture the flavor of the piece more accurately and movingly.

There are no great voices here, but all the singers perform stylishly and unaffectedly—only Renate Hoff's slightly pinched soubrette occasionally disappoints. It has always been

CIRCLE 19 ON READER-SERVICE CARD →

Hiss

The Concord Mark IX cassette deck starts with an extremely low signal-to-noise ratio -- better than 50 dB down. The Dolby Noise Reduction system reduces hiss by another 10 dB, and that's just the beginning. The deluxe Concord Mark IX has switch selected bias for standard and chromium dioxide tape cassettes. The narrow head gap and better than 100 kHz bias frequency provide extended frequency response from 30 to 15,000 Hz.

The Mark IX looks like a studio console and performs like one too. With pop-up VU meters, studio type linear sliders for individual control of input and output levels, third mike input for mixing in a center channel microphone, a 3-digit tape counter and a stereo/mono switch for more effective mono record and playback. And this brilliant panel lights up for power on, record and for Dolby.

And when the cassette is finished, Endmatic, a Concord exclusive, disengages tape and transport and returns the pushbuttons to off. And best of all, it's now available at your Concord dealer at a fair price for all of this quality, \$249.79.

If you already have a cassette, open-reel or 8-track

deck, the Concord DBA-10 Dolby tape adaptor can reduce hiss and improve performance. It will also improve your receiver's performance in playing back Dolbyized FM programs, \$99.79.

Your Concord dealer also has a complete line of 8-track and open-reel decks, stereo receivers and cassette portables. Concord Electronics Corporation, 1935 Armacost Avenue, Los Angeles, California 90025. A subsid / Ehrenreich Photo-Optical Industries, Inc. 



Concord Mark IX

ALLIED RADIO SHACK ISSUES A
NEW
AND DIFFERENT CATALOG!

ELECTRONICS FROM A-Z
ANTENNAS
BATTERIES
CAPACITORS
DIODES
EDUCATIONAL KITS
FIBER OPTICS
GRILLE CLOTH
HI-FI SPEAKERS
IC'S - JACKS
KNOBS - L-PADS
MIXES - NEEDLES
OSCILLOSCOPE - P-BOXES
QUADRACS - RESISTORS
SEMICONDUCTORS
TELEPHONES
ULTRASONIC ALARMS
VHF ANTENNAS - WIRE
XENON STROBE LIGHT
"Y" ADAPTERS
ZENER DIODES
AND MUCH MORE!

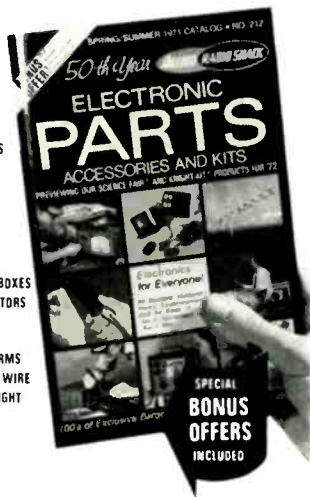

1000'S OF ITEMS,
100'S OF
EXCLUSIVES!

PREVIEWS OUR COMPLETE
SCIENCE FAIR® AND
KNIGHT-KIT® LINES FOR '72!

a valuable "FIRST EDITION"
...and it's **FREE!**

The new buying Guide for kit builders, Hams, hobbyists, do-it-yourselfers, "fix-it men"! Lists thousands of handy and wanted "little things" most stores don't stock. Like tubes and transistors, cables and plugs, adapters and antennas—you name it—the things that keep equipment working. Or make it work even better. Or DO MORE. If you own anything electronic or electrical, you need this catalog!

950 STORES NATIONWIDE!
EVERYTHING IN THIS BOOK
AVAILABLE FAST & EASY!

ALLIED RADIO SHACK HF-5
—A RADIO CORPORATION COMPANY—

2725 W. 7th St., Fort Worth, Texas 76107

Send me your FREE Spring/Summer Cat. 212

Name (print) _____

Route No. _____ Box No. _____

Street _____ Apt. No. _____

City _____ State _____ Zip _____

CIRCLE 4 ON READER-SERVICE CARD

considered fair play to assign the Witch to a male singer and *Spieltenor* Peter Schreier does a superb job: not only is he hysterically funny, but he sings every note—not many Witches can claim that. P.G.D.

JANACEK: Sinfonietta. **LUTOSLAWSKI:** Concerto for Orchestra. Chicago Symphony Orchestra, Seiji Ozawa, cond. Angel S 36045, \$5.98. Tape: ●● 4XS 36045, \$7.98.

Both these pieces can seem, in performances below the level of the Chicago's under Ozawa, fairly tiresome excuses for beating on orchestral kitchenware and raising the dubious flag of modernity between one reading of a nineteenth-century symphony and the next. But Ozawa brings a lightly bounding stride to the usually hobnailed Janáček and races it along brilliantly, achieving a sparkle and exuberance not found even in such conductors as Ančerl or Szell, whose interpretations can claim to be rooted in Middle European authenticity. Ozawa, always at his best in complex, brilliantly colored music, sweeps aside reservations, taking what might be called a jet-propelled, internationalized view of Janáček. The Chicago brass rings out heroically, all choirs beautifully in tune, and the entire orchestra follows Ozawa's elastic beat with breath-taking precision.

The Lutoslawski, written more than thirty years after Janáček's score, is not significantly more advanced in its percussive approach, though technically far more sophisticated. The Chicagoans play throughout on the tip of the conductor's stick as if responding directly to it rather than to one another's sound.

Angel's engineers have been looking for ways to make Chicago's Medinah Temple, where the orchestra records, sound like a first-rate music hall, which it is not. On this disc they achieve spaciousness that particularly suits such densely orchestrated pieces, and a depth of focus (in photography terms) that lets nuances of voicing and registral color be heard. There are few depths of any other sort in the Janáček or the Lutoslawski, but Ozawa and Chicago compensate for that lack with performances that place this record on the top shelf for sound and musicality. D.J.H.

JENSEN: Sonata for Piano, in F sharp minor, Op. 25—See Herz: Piano Works.

LISZT: Choral Works I: Hymne de l'enfant à son réveil; Tantum ergo; O salutaris hostia; Psalm 137; Sankt Christoph Legende; O heilige Nacht; Quasi cedrus, Pater Noster. Eva Andor (s), Margit László (s), József Réti (t), György Melis (b), Female Choir of Győr; Choir of the Hungarian State Folk Ensemble; Gábor Lehotka, organ; chamber ensemble, Miklós Szabó, cond. Hungaroton LPX 11381, \$5.98.

LISZT: Choral Works II: Mass for Male Chorus and Organ (Szekszárd Mass); Mihi autem adhaerere; Ave maris stella; Anima Christi sanctifica me; Ossa arida. József Réti (t), Sándor Palcsó (t), György Melis (b), József Gregor (bs); Gábor Lehotka and Imre Kiss, organ; Male Chorus of the Hungarian People's Army, István Kis, cond. Hungaroton LPX 11447, \$5.98.

Without needing to hold a damp ear aloft,

one can detect that the winds of fashion are blowing a Liszt Revival our way. The decision of Pierre Boulez to program a number of the lesser-known works in his first season at the head of the New York Philharmonic suggests that records will be forthcoming and that in consequence brows will be knit over the issue of yet another neglected nineteenth-century master. Liszt neglected? Can any composer be said to be anything but popular when the current Schwann lists some 200 albums under his name? Is this revival trip necessary?

Well, in one area, perhaps. Who, indeed, knows much of his choral music beyond that contained in the *Faust* Symphony, one or two infrequently performed Masses, and the *Psalm 13* that once found its way onto programs of the more enterprising sort? These two discs from Hungaroton, then, come at a good moment to throw light into one of the few obscure corners of Liszt's output, and they do so quite effulgently.

Considering the two records in sum, a listener with no prior awareness of Liszt's ecclesiastical leanings might be hard put to reconcile these thirteen pieces with his floridly dramatic piano music and his bombastic orchestral music. The connection might be betrayed by the harmonic daring, which often takes Liszt up to the brink of atonality, as for instance in *Ossa arida*. But the four-part Mass for male chorus and organ, more characteristic of the sacred works, sounds almost ostentatiously austere and pious. The Mass, heard here in a revised version from the Abbé Liszt's Roman period, launches itself with a marvelous Kyrie, but soon falls off in interest. For one reason or another, a strange enervation pervades many of these pieces, both those composed in old age and such earlier efforts as the *Pater Noster* from the oratorio *Christus*. To some, of course, it may sound like the peace that passeth understanding, but the fact is that in very little of the music on either record does Liszt show much joyful vigor or strength. Rather, he is generally applying a skillful but genteel chromatic gloss on older sacred styles such as the church modes and organum.

Liszt being a man of genius, there are times when the innovator comes to the fore, as in the *Psalm 137*, with its eccentric but effective use of disjunct arpeggios for harp and violin to punctuate the vocal line. Here, for a moment, we have virtually an operatic scene, foreshadowing Massenet or Godard. Much of this music, in fact, seems to apotheosize the French theatrical and liturgical style of La Belle Epoque: one can imagine how impressed Gounod or Fauré must have been by the possibilities Liszt suggested for merging the secular and the sacred into one glamorized manner, at once capable of implying sensuality and piety. The modernity of Liszt's vision in this regard is accurately reflected in these performances, which are correct and painstaking, even though the chorus, on Choral Music II, sometimes delivers a rather hard, white tone, and one tenor soloist can turn shrill. The style's characteristic choral *mesura di voce*, so well parodied in our time by Fred Waring and college glee clubs, is impressively managed by the massed voices.

Choral Music I, which won a Grand Prix du Disque in 1969, is worth acquiring for, in particular, its one purely secular piece, the ironic (though unabashedly sentimental) setting of Lamartine. *Hymne de l'enfant à son réveil*. Liszt puts a patina of calculated musical

CIRCLE 29 ON READER-SERVICE CARD—>

Now you can record your favorite artists on 8 track cartridges. No matter who they are.



The great thing about 8 track stereo cartridges is the convenience they offer.

The not-so-great thing is the expense of having to buy pre-recorded tapes of everything you want to hear.



JVC's new 8 track stereo deck changes all that.

With this unit you can buy blank cartridges and record anything from your favorite rock group's concert to your favorite Aunt's solo.

And if you're not as crazy about your Aunt's solo as she is, you can even erase the tape and use it again.

This unit also gives you things like an automatic eject button, continuous automatic program play, and a high quality outer rotor motor.

In addition, there's an indicator light that goes on automatically when a cartridge is put in to show the program number being played, a fast forward function and a stereo/mono switch.

With all those features, and a suggested retail price of just \$149.95, it's the kind of unit that anything will sound good on.

Even your favorite Aunt's solo.

JVC

JVC America, Inc.

50-35 56th Road, Maspeth, New York 11378

These
imaginative new
recordings of
España,
Bolero,
Carmen
and Malagueña
have all the
boing-boings,
bwa-bwas,

M 30383

**Everything
You Always Wanted
to Hear on the Moog**
but were afraid to ask for
Bolero/España/Malagueña/Carmen
*Semi-conducted by Andrew Kazdin
and Thomas Z. Shepard*



wall-waits,
doeey-doeys
and
pyeow-pyeows
that the
composers
intended.

After almost two years of one of the hardest fought battles between man and machine emerge two sides of the most stirring, innovative and enjoyable performances of some of the most brilliant orchestral showpieces.

The men: Andrew Kazdin and Thomas Z. Shepard.

The machine: the Moog Synthesizer. ("A real musical instrument.")

Aside from the fact that a collection of these pieces has never been recorded before on the Moog, there is still another reason why this album is unique: you'll never see it or hear it performed in live concert. It exists entirely and exclusively as a recording.

"Everything You Always Wanted to Hear on the Moog (but were afraid to ask for)" has all the passion, fury, vigor, turbulence, splendor, color and intensity of the originals, with a few things added: nee-nees, wah-wahs and yong-yongs.

**On Columbia Records •
and Tapes**

naiveté over the child's words, mixing touchingly the innocent soprano voice with obliquely the harp. This song is a masterpiece of its genre, precariously but successfully balanced on the knife edge between genuine sweetness and saccharinity.

Tastes must be argued, of course, but there can be little disputing over the skill and elegance of the works on these discs, or the authority with which they are presented. If even a few of the releases in the impending Liszt exhumation were to prove as interesting, the digging could be justified as more than antique-hunting.

D.J.H.

B LISZT: "Satanic Piano Music": Czárdás Macabre; En Rêve; Etude d'exécution transcendante d'après Paganini, G. 140, No. 2; Funérailles; Mephisto Waltzes: No. 1; No. 3; Trauervorspiel und Trauermarsch. John Ogdon, piano. Seraphim S 60170. \$2.98.

An enterprising Liszt recital, ranging from the conventional "macabrisms" of the first *Mephisto Waltz* and *Funérailles* written during the composer's middle period to the distant and abstract mysticism of the late years. The latter period is amply documented in all its diversity by the demonic third *Mephisto Waltz* and *Czárdás Macabre*, the cryptic *Trauervorspiel und Trauermarsch*, and the pellucid delicacy of *En Rêve*. Ogdon plays everything with breadth and low-keyed poetry. Although not a slick, sharpshooting pianist of the every-note-in-its-place school nor an intense lyricist on the order of Arrau or Richter, the English artist's adroitly concealed pyrotechnics are nevertheless capable of sublime delicacy (the trills in the first *Mephisto*, the limpid bell-tones of *En Rêve*) and also blockbusting decibels (the magnificent weighty sonority without a trace of harshness in the opening measures of *Funérailles*). Ogdon's Liszt, scholarly and reserved though it is, wins me over because it is completely without treacle or artifice. These sober, dry-eyed, meticulously gauged and yet free-wheeling performances interestingly emphasize the pre-Bartók and impressionistic strains which were to influence music history tremendously in the years following Liszt's death.

Seraphim's recording is exceptional for its natural, ungimmicked brilliance: the piano's treble has champagnelike sparkle, but the glitter is complemented by a full, resonant bass. An excellent bargain in every way.

H.G.

LUTOSLAWSKI: Concerto for Orchestra—See Janáček: Sinfonietta.

B **MASCAGNI:** *Cavalleria rusticana*. Zinka Milanov (s), Santuzza; Margaret Roggero (ms), Mama Lucia; Carol Smith (c), Lola; Jussi Bjoerling (t), Turiddu; Robert Merrill (b), Alfio; RCA Chorus and Orchestra, Renato Cellini, cond.

R **ZINKA MILANOV:** "Opera Recital!" **BEL-LINI:** *Norma*: Mira, o Norma (with Margaret Harshaw). **VERDI:** *Il Trovatore*: *Miserere* (with Jan Peerce); *D'amor sull'ali rosee*; *La Forza del destino*: *Pace, pace, mio Dio*. Zinka Milanov,

Herbert von Karajan has led the world's great orchestras and opera companies in their own halls and theatres. At home, he listens to them with Acoustic Research equipment.

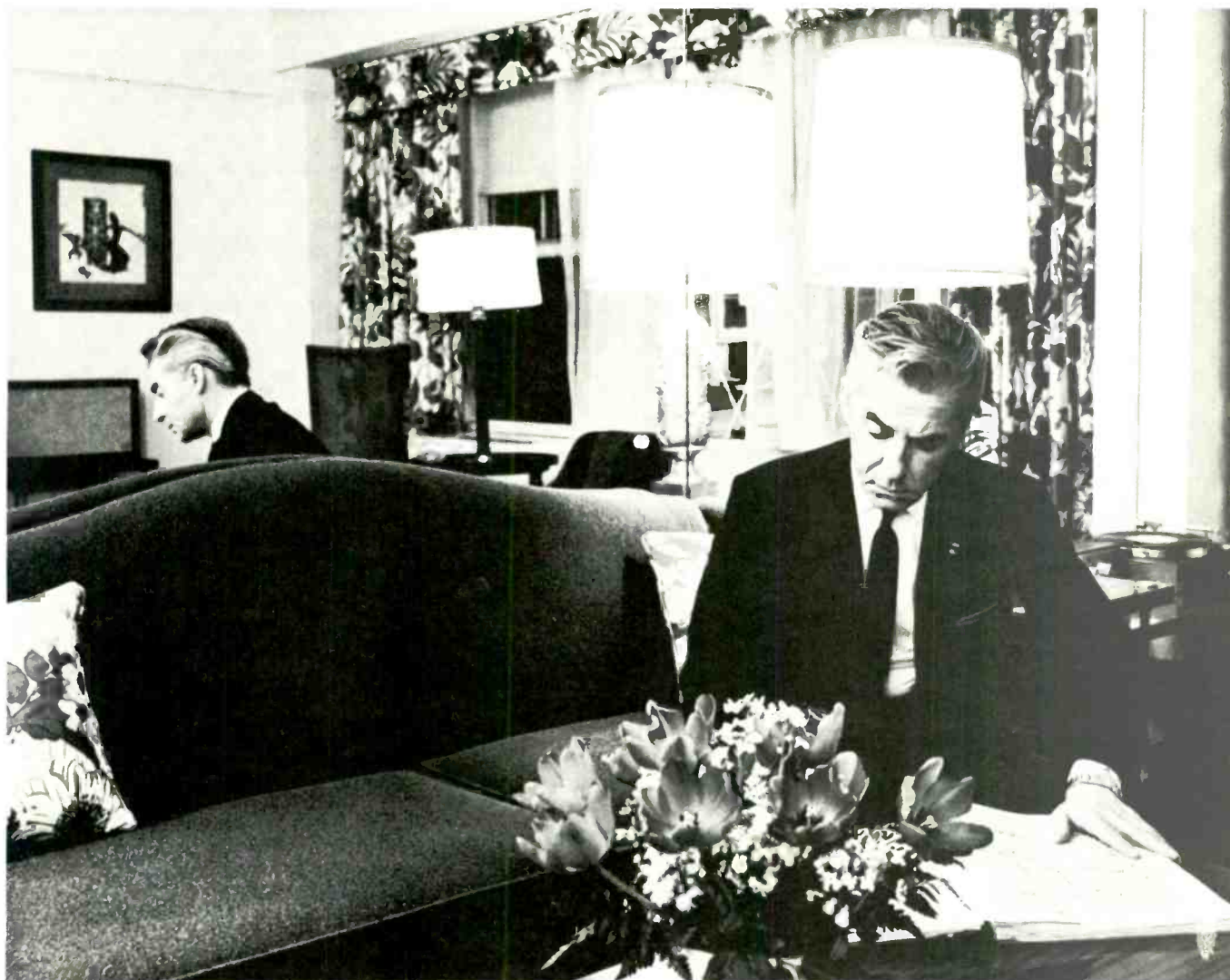

Few musicians have achieved the international distinction accorded Herbert von Karajan. His performances of Wagner's *Der Ring des Nibelungen* cycle at The Metropolitan Opera parallel his remarkable series of recordings of the same cycle, released by Deutsche Grammophon. These recordings, together with a large number of others of the classical symphonic literature, stand as a musical landmark to the world's listeners.

Herr von Karajan is also a man of unusual technical pro-

ficiency, being thoroughly familiar with the engineering aspects of recording and sound reproduction. His technical understanding is not limited to books, either; he is an adept jet airplane pilot, for example.

At his home in St. Moritz and in his Essex House suite in New York, he uses a high-fidelity system consisting of an AR turntable, AR amplifier, two AR-3a speaker systems, a Sony TAH-10 headphone adapter and Sennheiser HD-414 headphones.



Acoustic Research, Inc.

24 Thorndike Street
Cambridge, Massachusetts 02141, Dept. HF-9

Please send a free copy of your illustrated catalog, as well as specifications of AR components, to

NAME _____

ADDRESS _____

CIRCLE 1 ON READER-SERVICE CARD

soprano; RCA Orchestra, Frieder Weissmann, cond. RCA Victrola VIC 6044, \$4.96 (two discs, mono only) [the *Cavalleria* from RCA Victor LM 6106, 1953; the arias from various RCA Victor originals, recorded 1945-46].

The Milanov voice was at its most luscious and velvety in the early Fifties when this *Cavalleria* was recorded. Although the tempestuous Santuzza was not one of her most congenial roles (Verdi's statelier heroines suited her better both vocally and temperamentally). Milanov

fills out the notes with generous amounts of rich, plummy tone, while Bjoerling and Merrill similarly offer sumptuously sung interpretations. It's all a trifle bland perhaps, but for sheer vocal quality this performance would be hard to beat.

Side 4 will be of particular interest to Milanovians, for these four selections have never before appeared on LP. The *Trovatore* and *Forza* arias are especially instructive: certainly nothing to be ashamed of, by any means, but the tone is harder, the phrasing less expansive and assured than on the definitive versions of

1951 and 1953 (both dubbed on Victrola 1336). "*Mira, o Norma*" contains some brave sounds from both ladies, but the runs are gusty and the ensemble a bit sloppy: the "*Misere*" emerges as rather nonsensical in this "concert" version with Peerce and the male chorus right on top of the microphone—the whole musical point of the piece is its shrewdly devised off-stage perspectives. Even if this little recital is not vintage Milanov, Victrola deserves a vote of thanks for restoring it to the catalogue and rounding out our picture of this important singer. P.G.D.

Philips' Import Conversion—the First 28 Releases

by Peter G. Davis

CLASSICAL RECORD buyers have little enough to be thankful for these days, but now and then a favor is thrown their way. Two years ago Philips made everyone happy with their decision to import all new releases from Holland—before then the chances of finding a domestically pressed Philips disc free of gritty grooves, pops, clicks, etc., were virtually nil. Now, of course, U.S. purchasers have access to the same high-quality processed records that European collectors have been enjoying for years.

Converting past releases into imports was the next logical step and Philips is presently doing precisely that. Most (but not all) of the 100 or so domestically pressed Philips discs currently listed in Schwann will be replaced by imports before the end of October. After spot-checking about twenty-five of them in both formats, I can report that the improvements are pretty dramatic. Not only did each import track flawlessly and silently (as opposed to the frequent skips and explosions on the domestic versions), but the sound quality also proved to be superior in almost every case. The problem with the local pressings, I suspect, was that American engineers, during the tape-to-disc transfer, tried to "rectify" the traditional European preference for more distant perspectives and conservative miking by adding phony resonance and cutting the disc at too high a level—hence the blasting grooves and artificial sound of these records when played on quality equipment. (There were some exceptions—the closer, "punchier" sonics of the Richter/Kondrashin Liszt piano concertos and the Colin Davis Mozart Requiem, for instance; but these performances were produced for Philips by an American team of engineers from Mercury, and even they sound sharper and cleaner in their new format.)

The upgrading in quality also ex-

tends to the packaging: each disc has its own polyethylene sleeve, boxed sets are much sturdier, and the accompanying literature is often far more elaborate—the Telemann Passion, previously presented in a flimsy double-fold jacket, now comes in a handsome box with a profusely illustrated and notated trilingual booklet. As for the performances, virtually all the discs listed below (with their new catalogue numbers) were well received on their initial release—Colin Davis' Berlioz and Mozart, Haitink's Bruckner and Mahler, the Bayreuth *Parsifal*, Markevitch's Tchaikovsky, and Souzay's Poulenc carry their own strong recommendations (and for my money, no one has ever equaled Richter in the Liszt concertos or Szell and the Concertgebouw in the Sibelius Second). These are all eminently distinguished discs and one can only be grateful that the technical quality now matches the high level of musical excellence.

BACH: Sonatas for Flute and Continuo (complete). Maxence Larrieu, flute; Wieland Kuijken, viola da gamba; Rafael Puyana, harpsichord. Philips SC 71 AX 203 (two discs).

BEETHOVEN: Serenades, Op. 8 and 25. Grumiaux Trio. Philips 6500 167.

BEETHOVEN: Symphony No. 5. **MOZART:** Symphony No. 34. Concertgebouw Orchestra, George Szell, cond. Philips 802 769.

BERLIOZ: Overtures. London Symphony Orchestra, Colin Davis, cond. Philips 835 367.

BRUCKNER: Symphonies: No. "O"; No. 3; No. 4; No. 9. Concertgebouw Orchestra, Bernard Haitink, cond. Philips 802 724, 835 217, 835 381, 835 385 (four discs, available separately).

DEBUSSY: Quartet for Strings. **RAVEL:** Quartet for Strings. Quartetto Italiano Philips 835 361.

DVORAK: Concerto for Cello and Orchestra; Rondo for Cello and Orchestra; Waldesruhe. Maurice Gendron, cello; London Philharmonic Orchestra, Bernard Haitink, cond. Philips 802 892.

DVORAK: Symphonic Variations; Serenade in E. London Symphony Orchestra, Colin Davis, cond. Philips 839 706.

LISZT: Concertos for Piano and Orchestra: No. 1; No. 2. Sviatoslav Richter, piano; London Symphony Orchestra, Kiril Kondrashin, cond. Philips 835 474.

MAHLER: Symphony No. 4. Elly Ameling, soprano; Concertgebouw Orchestra, Bernard Haitink, cond. Philips 802 888.

MOZART: Divertimento in E flat, K. 563. Grumiaux Trio. Philips 802 803.

MOZART: Masses: in C, K. 220; in C, K. 317. Vienna Choir Boys; Vienna Cathedral Orchestra, Ferdinand Grossmann, cond. Philips 835 187.

MOZART: Requiem. Helen Donath (s), Yvonne Minton (ms), Ryland Davies (t), Gerd Nienstedt (bs); BBC Chorus and Symphony Orchestra, Colin Davis, cond.

MOZART: Symphonies: No. 25; No. 29; No. 32. London Symphony Orchestra, Colin Davis, cond. Philips 835 262.

POULENC: Songs. Gérard Souzay, baritone; Dalton Baldwin, piano. Philips 802 765.

RAVEL: Bolero; La Valse; Ma Mère L'Oye. London Symphony Orchestra, Pierre Monteux, cond. Philips 835 258.

SIBELIUS: Symphony No. 2. Concertgebouw Orchestra, George Szell, cond. Philips 835 306.

TCHAIKOVSKY: Symphonies: No. 2; No. 5. London Symphony Orchestra, Igor Markevitch, cond. Philips 835 390 and 802 703 (two discs, available separately).

TCHAIKOVSKY: Swan Lake (excerpts). London Symphony Orchestra, Pierre Monteux, cond. Philips 835 142.

TELEMANN: St. Mark Passion. Soloists, Munich Pro Arte Orchestra, Kurt Redel, cond. Philips 835 229/30 (two discs).

VIEUXTEMPS: Concerto for Violin and Orchestra, No. 4. **RAVEL:** *Tzigane*.

CHAUSSON: Poème. Arthur Grumiaux, violin; Lamoureux Orchestra, Manuel Rosenthal, cond. Philips 802 708.

WAGNER: *Parsifal*. Soloists and Chorus of the Bayreuth Festival, Hans Knappertsbusch, cond. Philips 835 220/4 (five discs).

RAYMOND LEPPARD: "Eighteenth-Century Overtures." New Philharmonia Orchestra, Raymond Leppard, cond. Philips 802 893.

GERARD SOUZAY: "French Song Recital." Gérard Souzay, baritone; Dalton Baldwin, piano. Philips 835 201.

AMPEX GETS INTO YOUR SYSTEM

Listen to one of these new Ampex tape decks and it's bound to get into your system. It's like experiencing sound in a pro studio. Pure sound. Smooth. Powerful. Funky. All the highs and lows. As close to audio perfection as possible. And like our professional models, these machines have everything you need, and nothing you don't. Made to complement the most sophisticated sound system. Yours.

Like the AX-300, an innovation-packed reel-to-reel stereo deck. 6 heads. 3 motors. Bi-directional record/play. Motion sensing. 4-source mixing. "Function programmer." Stereo echo. Pause/edit. Logic circuitry. Auto reverse. 55 second fast wind time.

Or the AX-50. This reel-to-reel stereo deck has 3 heads. Direct tape monitor. Stereo echo. Noise filter. Pause/edit. Auto shutoff.



AX-50

Auto tape lifters. Sound-on-sound. Sound-with-sound.

Micro 335. The most advanced cassette deck in the industry. Can play/record 12 cassettes in any order. Has Ampex's new patented

bi-directional head for play/record in both directions. You never have to turn a cassette over. Pause control. Fast wind. Automatic shutoff. Two V.U. meters. Record level controls. Two motors.

AX-300



Micro 155 also contains our patented bi-directional head. Features scientific assisted controls. Four-source mixing for reel-to-reel versatility. Chromium dioxide tape selector switch. Automatic reverse. Hysteresis synchronous motor. Pause control. Noise reduction switch. Ampex/Starr slot-load system.

The Dynamic Duo. The Micro 54 and the HCR8. The 54 is a stereo cassette deck, slot loading. Auto eject. Pause control. Hysteresis synchronous mo-

tor. Noise filter. The works. Its look-alike, the HCR8, is a stereo 8-track

MICRO 54



HCR8

deck with automatic track advance. Track indicator lights. Power assisted eject. And much more. As you can see, they're a perfect match. Ideal for the audiophile who wants both cassette and 8-track capabilities.

You've knocked yourself out building a beautiful sound system. So it's only right that you get the best when you're ready for a tape deck. And the best tape decks are Ampex. Period. Ampex. Get it into your system.



MICRO 155

AMPEX



MICRO 335

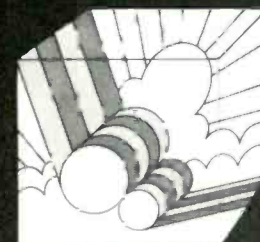

THE SOUND IDEA PEOPLE

You don't have to
buy a new stereo
to get a new sound.

Just get Hitachi's
Ultra Dynamic
cassette tapes.

The Ultra Dynamic is engineered especially for stereo recordings. It has the depth and range that's necessary to reproduce every stereo sound with sensitivity and clarity.

Hitachi also has a complete line of low noise cassettes for all purpose recordings. These standard type cassette tapes are the world's best sellers.

Now you don't have to spend a lot for a new sound. Just spend a little on Hitachi cassette tapes.



Quality always comes first at
HITACHI

Hitachi Sales Corp. of America,
48-50 34th Street, Long Island City, N. Y. 11101

CIRCLE 28 ON READER-SERVICE CARD

B **MENDELSSOHN:** Symphony No. 3, in A minor, Op. 56 (*Scotch*). Prague Symphony Orchestra, Dean Dixon cond. Nonesuch H 71254, \$2.98.

Had Dean Dixon been born a generation later, it is quite possible that he would not have had to go to Europe and Australia to pursue the major portion of his career. But, in the immediate postwar years, when an American conductor should have been taking root with a resident orchestra, the climate was simply not conducive to the idea of a black conductor giving orders to an orchestra of white musicians. Happily for Dixon, and for American audiences, he has in the past couple of years been again conducting in this country.

From his occasional records for various smaller record companies, we know Dixon to have developed into a conductor of fine musical sensitivity with a complete technical ability to get orchestras to play as he wishes. The present record of the Mendelssohn Third Symphony shows these qualities well, but it also betrays a certain reticence, a lack of intensity and drive that may be inherent in Dixon's temperament or may result from a certain caution in working with an excellent but understaffed orchestra.

The Prague Symphony Orchestra, at least as recorded here, must be nearly twenty-five per cent smaller than a major U.S. or European orchestra. This is especially evident in the sound of the strings, which play with exemplary tone, intonation, and ensemble, but lack strong over-all impact. Within these limitations, and possibly aided by the recording engineers, Dixon scrupulously avoids overwhelming the strings with the woodwinds and brass to a point that sometimes seems over-cautious in terms of the rhythmic and expressive requirements of the score. One misses the soaring melodic line that a numerically adequate string section should produce when called for by Mendelssohn's score. Similarly, in rhythmic accent and tutti power, not only are the strings sonically inadequate, but the woods and brass seem unduly restrained. However, within this smaller scale, the orchestra plays with a very good range of dynamics, good ensemble blending, and under Dixon's direction, a sweetness and sensitivity lacking in many more dynamic performances.

Without comparing this record with the higher-priced issues by Bernstein or Klemperer, one finds that it competes well with the Victrola reissue of Munch's rather hectic but orchestrally sumptuous reading with the Boston Symphony and with Peter Maag's beautifully poised performance with the London Symphony Orchestra. Sonically, this record produces a well-balanced concert-hall sound. P.H.

MOZART: Quartets for Strings: No. 14, in G, K. 387; No. 15, in D minor, K. 421; No. 16, in E flat, K. 428; No. 17, in B flat, K. 458 (*The Hunt*); No. 18, in A, K. 464; No. 19, in C, K. 465 (*Dissonant*). Bartók Quartet. For a feature review of this recording, see page 83.

MOZART: Symphonies: No. 36, in C, K. 425 (*Linz*); No. 41, in C, K. 551 (*Jupiter*). New York Philharmonic, Leonard Bernstein, cond. Columbia M 30444, \$5.98.

These are fair performances by a good musician conducting a fine orchestra, but no particular distinction attaches to them. Bernstein's healthy musical instincts carry him through almost any task, though in this instance without real identification with the works. He makes music with gusto, but without matching his engaging verve with stylistic finesse. Basically a romantic, he latches on to opportunities offering nineteenth-century expressive possibilities, as, for instance, in the introduction to the *Linz* Symphony. On such occasions the string tone gets a little fat and the crescendos soulful; but the allegro goes well, the sound is leaner, and there is a good propulsive quality. The second movement is also well done except for a couple of un-called-for *Luftpausen*. The trio in the minuet could have been a little more aristocratic, though this movement too will pass muster. The presto finale calls for the utmost clarity and precision and the New York Philharmonic, abundantly capable of both, obliges most of the time. When it does not, as in the inelegant slurring of some fast legato passages, the conductor is to blame, because without a firm concept of the melodic quality of such runs he cannot enforce their proper execution, even with an excellent orchestra.

The first movement of the *Jupiter* calls for a highly festive mood, and all of it allegro vivace. To maintain the balance of mood, articulation, and speed is difficult, and though the playing is fair, Bernstein is aware of only half the truth; he is festive, but with a trifle too much deliberation. The magnificent andante was bound to bring out the romantic in the conductor; he puts a little icing on the melodies and things become somewhat sentimental, especially when he slows down before the reprise; but the woodwinds play so attractively that we are not unduly disturbed. The minuet is a bit stodgy, while the finale lacks virtuosity, and is simply proper rather than exciting. At the end Bernstein slows down considerably, recalling the Beecham tradition. This sort of thing robs the triumphant movement of its strength. Mozart never relaxes his symphonic élan, why should he be forced to do so? Throughout the recording there is excellent orchestral balance and the winds are never swamped. There is a little echo fore 'n' aft, but on the whole the sound is very good. P.H.L.

PAGANINI: Concerto for Violin and Orchestra, No. 4, in D minor; Le Streghe. **BOTTESINI:** Grand Duo for Violin, Double Bass and Orchestra. Ruggiero Ricci, violin; Francesco Petracchi, double bass (in the Bottesini); Royal Philharmonic Orchestra, Piero Bellugi, cond. Columbia M 30574, \$5.98.

For some reason, the Concerto No. 4 seems to be one of the also-rans among Paganini's five works in the medium: Ricci's new recording stands alone in the current catalogue, and if there have been intervening recordings since Grumiaux's in the early Fifties I cannot find them. (Nor do I understand the comment in the jacket notes that No. 4 has often been assigned the No. 3 position among the concertos, but has in the past few years been accepted as No. 4. It was accepted as such on Grumiaux's disc, and there is no question of its designation in the G. I. C. de Courcy biography of Paganini of 1957.) In any case, the piece is representative

Lift this page and drop it... you'll see how gently the Miracord 50H treats your records.



A gentle touch of the push-buttons brings forth a gentle reaction from the Miracord 50H. The dynamically balanced arm responds gently with its frictionless bearing system, faithfully and flawlessly tracking the intricate record grooves. Gentleness, however, is just one attribute of the 50H, a clue to its superior performance is found in its features.

Stylus overhang adjustment is essential for optimum tracking. Another automatic turntable does feature this adjust-

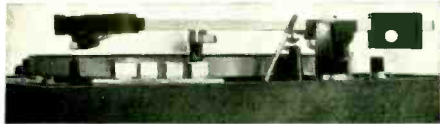

ment, but it's internal and difficult to set. The Miracord 50H offers external overhang adjustment with built-in gauge

no shifting, no guesswork, no templates.

Other turntables offer a kind of synchronous motor. The 50H uses a *Papst hysteresis synchronous* motor with outer rotor for unvarying speed accuracy regardless of the voltage fluctuation or loads. The Papst motor is usually found in professional studios.

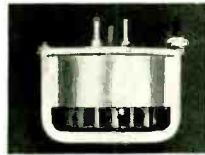

Consider cueing: in one leading automatic turntable, cueing does not operate in the automatic mode. In automatic, cueing is the ideal way to interrupt play for a moment when there is a stack of records on the spindle. The 50H provides silicone-damped cueing in both automatic and manual modes.



Another important feature is the 50H turntable. It is a heavy, one-piece, non-ferrous metal casting, lathe-turned to precise dimensions and then individually dynamically balanced. This contributes to the smooth, steady motion of the turntable, free of rumble, wow and flutter.

Nothing we can say short of experiencing it yourself can better describe the gentle way in which the Miracord responds and preserves the best in your records. Find out for yourself. Miracord 50H, \$175 less cartridge and base. Miracord feathertouch automatic turntables start at less than \$100. Benjamin

Electronic Sound Corporation,
Farmingdale, N.Y. 11735/a
div. of ISC/available
in Canada.



Miracord 50H





Ruggiero Ricci—a masterful fiddler for Paganini's Fourth Violin Concerto and *Le Streghe*.

of the composer and his art, and its wallflower position is hard to account for. There is, in the first movement, the customary ingratiating lyric line that provides moments of repose between exhibitions on the high wire: there is a lovely singing slow movement which Ricci warms up with at least one prominent operatic Italian-tenor sob; there is a scintillating finale, decked out in the orchestra with tambourine and notable for one very delicately orchestrated passage accompanying the violin in its double-stopped harmonics. Ricci is master of it all, except for some moments when his rhythmic pace does not seem to me rock-solid. His intense vibrato, even in stretches of lyric ease, struck me at first as too much of a good thing, but eventually I saw the point—to maintain the tension consistently throughout—and it proves its validity.

Le Streghe (Witches' Dance) begins in that deceptively simple vein of pure song at which the Old Wizard was adept—introducing us to a very ingenue witch indeed—but before long the high jinks fire off in earnest, the left-hand pizzicatos run wild, the passages in octaves flash by. The piece doesn't do for me what certain of the caprices do, but perhaps it's a question of familiarity.

The Grand Duo for Violin and Double Bass by one Giovanni Bottesini (1821–1889) is a find, of sorts: much of it is sheer dueting between this unlikely pair of instruments, which turn out to be, in each other's company, as cozy as any pair of operatic lovers you could name. At times the violin flies like a bird in exuberant circles over the sober accompaniment of the big bass, at times the tender motion of parallel thirds shapes a sweet melody, at times the violin rhapsodizes over the faithful galumping of contrabass arpeggios. Don't miss it. The Royal Philharmonic provides stolid partnership to all three works, not dazzling but at least B-plus. S.F.

PUCCINI: *Madama Butterfly* (excerpts). Geraldine Farrar (s), Louise Homer (c), Enrico Caruso (t), Antonio Scotti (b). For a feature review of this historic recording, see page 84.

RHEINBERGER: Sonata for Piano, in F sharp minor, Op. 184 (*Romantic*)—See Herz: Piano Works.

SAINT-SAËNS: Symphony No. 3, in C minor, Op. 78. Anita Priest, organ; Los Angeles Philharmonic Orchestra, Zubin Mehta, cond. London CS 6680, \$5.98.

Except for a 1968 Benzi/Hague Philharmonic version for Vox (which I haven't heard nor ever seen reviewed), the hardy *Organ* Symphony has been given a well-earned rest in recent years. Perhaps it's in expectation of an upcoming "quadro" era that we now have the first of what well may be a new series of spectacular display versions. If so, the present British engineering is all the more remarkable for its un gimmicked naturalness. The stereoism here is transparent yet sonically warm, smoothly spread and balanced (including an ideal equilibrium between organ and orchestra), and it captures well-nigh to perfection the aural perspective of a listener located half-way back in UCLA's Rovec Hall. My only technical complaints, and they're piddling ones, are that (as usual), I can't hear some of the soft triangle strokes (like those on pp. 84ff of the Durand pocket score), and that I do just barely hear a strange left-channel burble (an organ pedal-tone resonance or entirely extraneous motor noise?) which appears and almost immediately disappears—p. 67 shortly before the end of Side 1.

The Los Angeles players demonstrate again the progress they're making under Mehta, and the conductor himself is wholeheartedly intent on exhausting the work's full expressive and impressive potentials. After a comparative re-playing of the generally acclaimed favorite older version, by Munch for RCA, I discovered that the 1960 recording remains the more exciting sonically by virtue partly of its more vivid presence and spaciousness, but mainly by its more refined, indeed elegant tonal qualities. Interpretatively too Munch remains unsurpassed for dramatic grip as well as for crisper, tauter control of the orchestra. R.D.D.

SCHMELZER: Sonata Natalitia a 3 Chori; Sonata II a 8; Sonata a 4 (La Carolietta); Sonata I a 8; Sonata a 3; Sonata IV a 6; Sonata a 5; Sonata a 3; Sonata a 3 Violini. **FUX:** *Serenada a 8* (from *Concentus musico instrumentalis*, 1701); *Rondeau a 7*; *Sonata a Quattro*. *Concentus Musicus Wien*, Nikolaus Harnoncourt, cond. Telefunken SAWT 9563/4, \$11.90 (two discs).

Titled—somewhat misleadingly—"Music at the Hapsburg Kaiserhof, Vienna during the time of Leopold I" (it actually encompasses three generations of emperors), this set may provide more about Hapsburgian entertainment than you will ever want to know. Taken in large chunks, it becomes inexpressibly tedious, but heard selectively it will demonstrate the variety of instrumental color at the command of Johann Heinrich Schmelzer,

who served at the Vienna court for thirty years (commencing in 1649), and the contrapuntal skill of Johann Joseph Fux, whose activities fell for the most part into the reign of Charles VI.

Schmelzer goes in for a great amount of individual work for each of his instrumentalists, which from the modern listener's point of view is all to the good: you will hear some laboriously earnest solo excursions by trumpet and trombone (the first Sonata a 3 listed above), by bassoon and trumpet (Sonata a 5), and showers of scales for strings in the rather curious Sonata IV. The uphill task in appreciating all this, from my own point of view, is the short-breathed nature of individual phrases, so often tossed predictably from one instrument to another. Harnoncourt's written commentary about each piece is, in fact, often more enticing than the piece itself. If you happen to be a baroque nut, all well and good. Otherwise, a little goes a long way.

Fux, whose famous *Gradus ad Parnassum* made his name as a contrapuntist for all ages, provides some refreshment in the *Rondeau*, with surprising independence on the part of the bassoon, and the Sonata a 4, where the astringent sonority and the clarity of contrapuntal texture are a challenge to the ear. The sixteen-movement suite, *Serenada a 8*, is mostly baroque wallpaper.

The Harnoncourt players tend to sound stodgy in most of the works featuring brass and woodwind solos, but the fault is probably not entirely theirs: the sixteenth-century instruments do not have the flexibility and facility of the modern counterparts: the going is rough and sounds it. The string playing is much smoother, and the solo violin in Schmelzer's Sonata a 3 for violin, viola, and gamba is especially good. On the whole, a set primarily for the dedicated. S.F.

SHOSTAKOVICH: Symphony No. 14, Op. 135. Phyllis Curtin, soprano; Simon Estes, bass; Philadelphia Orchestra, Eugene Ormandy, cond. RCA Red Seal LSC 3206, \$5.98.

If there is one word that can be used to characterize Shostakovich's Fourteenth Symphony, it is "poetic." Where in some of his other symphonies Shostakovich creates a novel-like movement, sacrificing certain immediate details to a broad, over-all momentum (a technique the composer's detractors see as a major flaw), in the Fourteenth, as in a poem, every detail is of utmost importance. Each of the symphony's eleven, songlike movements forms an individual, lyrical cell sunken into the foundation of a subliminal, cubistic superstructure whose separate elements both form and destroy the concept of an integrated whole. As in most of the composer's work, the general tone of the Fourteenth Symphony is both personal and humanitarian. But whereas Shostakovich has tended to stress the latter element in the past, such as in the monumental Thirteenth Symphony, it is the former that stands out, almost obsessively, in the Fourteenth. It is, in fact, in this manner that the Fourteenth Symphony seems to form a kind of grim trilogy with its two immediate predecessors, the Twelfth Quartet and the extraordinary Violin Sonata.

In comparing this new release with the premiere recording by Barshai and the Moscow

oh?

This is what people say when they hear the price of the Sony 6200

ah!

This is what people say when they hear the Sony 6200

The unusually high price of the new Sony 6200 receiver is a come-on. For once you know it, you can hardly resist the temptation to hear it perform and justify its lofty price. And once you hear it perform, you'll have to own this superb component.

The real joy of the 6200 lies in its performance. Balanced positive and negative power supplies permit direct coupling all the way through to the speakers for unusual clarity. There is power to spare by whatever measure: 360 IHF watts into 4 ohms. 70+70 watts *continuous* power into 8 ohms with both channels driven; a minimum of 60+60 at all frequencies from 20 to 20,000 Hz.

FM performance is equally distinguished. The FET front end raises the sensitivity to its theoretical limit (1.2 μ V for 20 dB quieting; 1.8 μ V IHF), while retaining the ability to handle strong local stations without overload and spurious response. Solid state i.f. filters ensure that the superb performance you hear today you'll enjoy many years later.

However, the true revelation of the 6200 is your own listening experience and the "ah" of your reaction to it. For many that "ah" will prevail over the "oh" engendered by its price. See it at your Sony dealer or write: Sony Corporation of America, 47-47 Van Dam Street, Long Island City, New York 11101.



New SONY® 6200 Stereo Receiver

You pay for what Thorens leaves out.

And you'll never miss them. Like rumble. Or wow and flutter. Irregular turntable speed. Damaged records, chipped stylus.

The Thorens TD-150 Mark II is for people who refuse to accept the many imperfections of ordinary sound reproduction.

**Record wear reduced . . .
Stylus life extended**

Several Thorens features provide this. Positioned at the front is the Cueing Synchronizer. It lowers the tonearm gently and precisely into the groove. The Anti-Skate Control then makes certain the stylus is positioned exactly on both walls of the groove. And when you change turntable speeds (33 $\frac{1}{3}$ and 45 rpm) the Speed Glide Adjustment does it rapidly and smoothly

**Rumble, wow and flutter
are eliminated**

The flywheel action of the 12-inch, precision balanced, non-magnetic platter absorbs the slightest variations in speed and eliminates wow and flutter. The long and resilient drive belt system of the synchronous motor in combination with a unified suspension system routs rumble effectively.

Constant Turntable Speed

A 16-pole synchronous motor always maintains its speed regular-

ity, providing constant, smooth, in-phase precise speed.

**Plays records the way
they were recorded**

Records are cut at a 15° tracking angle. The best performance is achieved when they're played back at this angle. The low-mass plug-in shell permits you to adjust the tracking angle of a cartridge accordingly. The tonearm can be adjusted to track as low as $\frac{1}{2}$ gram.

So you see, when you pay for what Thorens leaves out, you receive superb performance and reliability. But then you expect unexcelled quality from Thorens. And you get it.

TD-150 Mark II, complete with tonearm and walnut base — \$140. See your Thorens dealer, or send coupon for further details.

**Elpa Marketing Industries, Inc.
New Hyde Park, N.Y. 11040**

Please send additional information on the complete line of Thorens Transcription Turntables and the name of my nearest dealer.

Name _____
Address _____
City/State _____ Zip _____



THORENS

Chamber Orchestra on Melodiya/Angel. I was immediately struck by the un-Russianess of the Ormandy performance, a quality which has both its strengths and its drawbacks. On the one hand, neither Phyllis Curtin nor Simon Estes has the somewhat cavernous vocal quality characteristic of so many Slavic singers. On the other hand, Phyllis Curtin, in particular, is beautifully expressive, much more so than her Russian counterpart (Margarita Miroschnikova). I have rarely heard anything as chilling as the climactic outcry attained by both Miss Curtin and the orchestra in the fourth movement (at the verse. "The third is tearing my mouth apart with its roots"), and I could mention any number of nuances, both in the texts and the music, that are admirably communicated by Miss Curtin's limpid voice.

Furthermore, Ormandy leads a controlled and yet warm performance that offers an interesting foil to the much more headstrong Russian version. I particularly like Ormandy's handling of the fourth and fifth movements, although he does have a tendency to emphasize the right things in the wrong places—his deliberate tempo in the second movement (*Malaguena*) seems totally inappropriate, while his heavy-handed treatment of the ninth movement (*O Delvig. Delvig*) is hardly suited to the elegaic character of this part of the symphony. Furthermore, the frenzy that Barshai is able to work up with his forces on occasion is often much more suited to the more neurotic aspects of Shostakovich's style. As for the playing, the Moscow Chamber Orchestra, surprisingly enough, comes off a strong first to the Philadelphia Orchestra's highly touted string players, who are guilty of more than one annoying slip in this recording.

The sound on the Ormandy release is marginally better than that of the Barshai. The stereo effect is also more extreme than on the better-balanced Barshai disc, thus allowing for an appropriately dramatic separation of the voices, in the third (*Lorelei*) movement for instance. Perhaps for reasons of continuity in the taping the voices, which are more closely miked than in the Barshai version, are illogically placed at left-right extremes for certain of the solo movements, while they return to the middle for others.

At any rate the personal, anguished intimacy of Shostakovich's Fourteenth makes it an ideal work for phonographic listening. If I had to choose between the Barshai and the Ormandy interpretations, I would take the former. But frankly, I would not want to be without either one. A loud bravo, by the way, for the macabre and thoroughly apropos cover art by Ted Coconis. R.S.B.

STRAVINSKY: *Petrushka* (1911 version). New Philharmonia Orchestra, Erich Leinsdorf, cond. London Phase 4 SPC 21058, \$5.98.

STRAVINSKY: *Petrushka* (1947 version); *Firebird Suite* (1919 version). New York Philharmonic, Leonard Bernstein, cond. Columbia MG 30269, \$6.98 (two discs).

To the proliferation of *Petrushkas* there is, it seems, no end—and as I write these words Pierre Boulez is at work with the New York Philharmonic recording the 1911 version. If the results are anything like the concert performances that preceded it, the Boulez version should be worth waiting for, which is more than I can say on behalf of either of the current entries: both are efficient, moderately

How Tandberg's engineers designed a \$330 tape deck practically as perfect as our \$500 tape deck.



When Vebjorn Tandberg called in his Oslo engineers, they expected congratulations. Justifiably. Their \$500 tape deck—the 6000X—had just taken American audiophiles by storm.

But Vebjorn Tandberg is a man who expects perfection. So instead of a commendation, they got a new challenge: to make a \$330 tape deck as perfect as their \$500 tape deck.

Impossible! Except to these stubborn, dedicated Norwegians.

They knew that any \$330 tape deck that tried to do all the things their 6000X does would have to do them less than perfectly. Making it, quite possi-

bly, the world's second-finest tape deck—but hardly solving the problem.

Instead, they chose the logical alternative: a \$330 tape deck that does fewer things than their 6000X—but does them magnificently.

That's our model 3000X.

It has the same four-head design—including our unique Crossfield bias application—that gives the 6000X its heretofore unmatched fidelity, frequency response and s/n ratio.

It doesn't have about a dozen professional extras that our 6000X provides.

Like dual input level controls for stereo mixing, and an

electrically-operated start/stop mechanism for remote control, and simultaneous A-B test capacity for add-a-track, and VU-meters that register playback level as well as recording level.

In brief, our model 3000X is exactly what Vebjorn Tandberg ordered.

The world's finest tape deck. Simplified.

For recordists who demand audio perfection but don't require complex professional capacities.

As perfect as our 6000X? Practically.

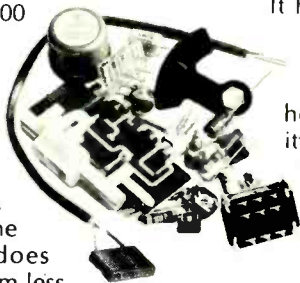

TANDBERG 3000X

(Would you put your name on anything less than the best?)

Three-speed (7½, 3¾, 1⅞ ips) stereophonic tape deck. Quarter- or half-track. Four heads (record, playback, erase and Crossfield bias). Frequency response (±2 db) 40-20k Hz @ 7½ ips, 50-16k Hz @ 3¾ ips. Vertical or horizontal mounting. Walnut cabinet.

TANDBERG OF AMERICA, INC., 8 THIRD AVENUE, PELHAM, NEW YORK 10803

well played, and unconvincingly recorded. The Leinsdorf has some notably poor balances despite the Phase 4 multimike techniques, while the Bernstein is boomy and without perspective: one need only compare the sound and playing on the bonus *Firebird* to see that neither Columbia nor the Philharmonic are operating these days at the level of more than a decade ago (this *Firebird* is a reissue from Columbia MS 6014, where it was coupled with Tchaikovsky's *Romeo and Juliet*). As for the side devoted to Bernstein discussing Stravinsky, it is a mostly folksy, occasionally vulgar narrative of the plot of *Petrushka*, with musical illustrations—and does Mr. Bernstein, of all people, not yet know the difference between atonal, twelve-tone, and serial?

The best buy in the Stravinsky ballet category is still the composer himself—you can

get *Firebird* (complete ballet), *Petrushka* (complete 1947 score), and *The Rite of Spring* in Columbia D3S705 for \$11.98—and if you must have the richer 1911 version of *Petrushka*, wait for Boulez.

Both of these recordings come in double-fold jackets, but all of the extra space thus made available is devoted to photos of puppets. The London notes are ungrammatical and downright inaccurate: "the piano . . . in the 1911 score plays very little after the Russian Dance." What, then, is that instrument I hear throughout the second scene? Since the notes are signed by the "Recording Director," perhaps it's a wonder that one can hear anything at all. D.H.

TAKEMITSU: "Miniature Art." Various instru-

mentalists, Hiroshi Wakasugi, cond. Deutsche Grammophon 2530 088, \$6.98.

This record contains four works for small combinations. It begins with *Stanza 1*, for mezzo-soprano, guitar, harp, vibraphon, celesta, and piano. Next is *Sacrifice*, for alto flute, lute, and vibraphone. The second side opens with *Ring*, for flute, terzgitarr (whatever is a terzgitarr?), and lute. Last of all is *Varelia*, for two piccolos, violin, cello, guitar, and electronic organ. The performers are all Japanese: a list of them would be endless and, since they are mostly unknown in this country, pointless. The keyboard performer, however, is Yuji Takahashi, who is exceedingly well known in the West, and all the other artists are clearly of his very high quality. The recording is superb, but in spite of everything this release is a ghastly bore.

The reason is that there is no rhythmic propulsion in it, and no variety of tempo either. Everything is played at the same ambling pace, with long pauses which do not integrate silence into the sound but merely break it up into disjointed fragments, and with a general air of pompous solemnity confirmed by the fact that in *Stanza 1* the singer uses a text from Ludwig Wittgenstein's *Tractatus Logico-Philosophicus* assisted into nonsense by Jasper Johns. The coloristic effects of this music are marvelous, but except for a brief bit of violin solo in *Varelia* nothing really tells as substance. A.F.

TCHAIKOVSKY: Symphony No. 1, in G minor, Op. 13 (*Winter Dreams*). New York Philharmonic, Leonard Bernstein, cond. Columbia M 30482, \$5.98.

Bernstein's reading of this symphony is quite different in many respects from that of Michael Tilson Thomas which so favorably impressed me recently [July 1971]. This is one of Bernstein's best performances, full of dynamic energy and completely characteristic of his unique musicianship. My impressions are best summarized by noting that this is a basically symphonic approach with strong emphasis on the dramatic rhetoric implicit in the score. Thomas, on the other hand, projects the music with a fluid lyricism and balletic grace without searching out the rather slight foreshadowings of the Tchaikovsky of the last three symphonies. The other major difference between the two records lies in the radically opposed approaches of the recording producers, with the DGG recording of the Boston Symphony offering, to my ears at least, a more truly orchestral sound. To be sure, one does not hear the instrumental detail—solo or section—with such overwhelming clarity as on the Columbia/New York Philharmonic disc, but the Boston sounds more like a live orchestra than a phonographic conception. Within this technical framework, the Boston Symphony plays with a more beautifully blended sound and with an inherently lighter over-all tone, especially in the case of the strings which are wonderfully warm and translucent here. In the second movement of the symphony one can relish the superb oboe playing of the Gombert brothers—Ralph in Boston and Harold in New York. Final choice rests on two factors—the different approaches of the two conductors and the contrasting recording techniques employed. Both musical approaches are realized to their full extent, and each recording technique will have its own adherents. P.H.

TANGENTIAL TRACKING ...WHO NEEDS IT?

WHO NEEDS IT! ...YOU DO.

Why? Because a record is engraved by a cutter that moves across the record, always tangent to the record groove. So it's only common sense to play a record the way it's made.

Now, there are many complicated and expensive ways to do that, but RABCO has come up with the remarkably simple ST-4. The tone arm is supported by a rubber wheel resting on a constantly rotating shaft. As the record is played, the record groove "pulls" the stylus towards the center of the disc.

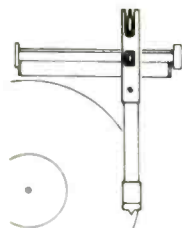

When the arm deviates the slightest fraction of a degree from tangency to the groove, the rubber wheel responds and "pushes" the rear of the tone arm along after the stylus, bringing the arm back to tangency.

This "push-pull" action continues across the entire record, but on such a minute scale that the movement is perfectly smooth and uniform. And it sounds that way, too! Clean and distortion-free.

Now, a sophisticated instrument like this sounds pretty expensive. Well, guess again. The remarkable engineering simplicity of the ST-4 means a price tag that's simply remarkable. Only \$159.00 for tone arm and synchronous motor-driven turntable. For the complete ST-4 story, write RABCO, 11937 TECH ROAD, SILVER SPRING, MD. 20904.

RABCO
Manufacturers of THE Servo Control Arm

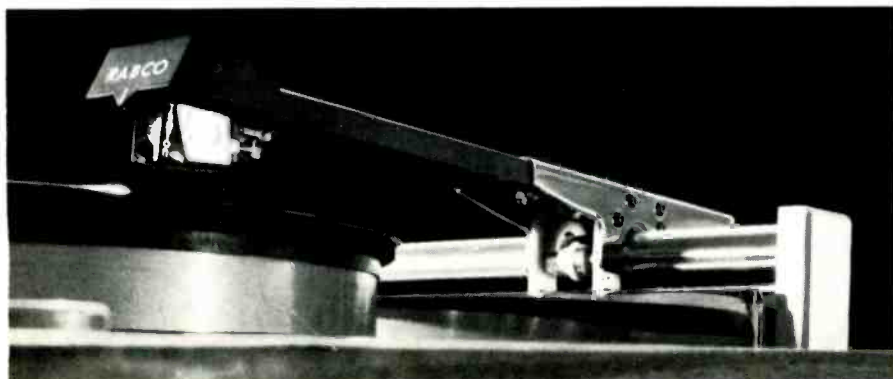

CIRCLE 44 ON READER-SERVICE CARD

New from Heath



New Heathkit® Cassette Deck with reel performance

The new Heathkit AD-110 brings out the best in cassettes, whether conventional mono or stereo. Compatible with any quality mono or stereo system, it offers a wide range response and low noise level that easily matches or surpasses many open reel machines operating at 3¾ ips. Features adjustable record bias utilizing a built-in reference and the panel meter. There's no need for external equipment in setting up from chromium dioxide play.

The AD-110 has a DC motor with 2-transistor regulator for stable, precise tape speed and a minimum of "wow" and "flutter." An IC voltage regulator in the amplifier circuit and low-distortion push-pull oscillator for erase and record bias make possible a -45 dB minimum hum and noise factor.

Separate level controls and meters let you tape any "high level" input from less than 100 mV to 10 V. Features include electronic motor shut-off, counter, record interlock to prevent accidental erasing, jet black cabinet with walnut end panels and smoked transparent cassette cover. Kit includes preassembled and aligned transport mechanism, one blank 60-minute cassette. Order the cassette player that does justice to the finest audio equipment — the Heathkit AD-110!

Kit AD-110, 10 lbs. 119.95*

A practical & economical new approach to 4-channel reproduction

The new Heathkit AD-2002 Stereo-4 Decoder brings you 4-channel sound while letting you retain your present FM receiver, stereo amplifier and turntable. Decodes Stereo-4 matrixed signals now being encoded on conventional 2-channel discs and being broadcast by a number of FM stations across the country. In addition, the AD-2002 enhances your current stereo records, tapes and standard FM/Stereo with a simulated, but amazingly realistic 4-channel effect! Assembles in an evening, installs between separate stereo preamp and amplifier, or can be used with integrated stereo amplifiers or receivers via their

AD-110 SPECIFICATIONS — Frequency Response (record-play): ±3 dB from 30 Hz to 12 kHz typical. Inputs: Aux. 70 mV to 10 V. Mike 0.2-6 mV. Hum and Noise: -45 dB. Bias and Erase Frequency: 110 kHz. Wow and Flutter: Less than 25% WRMS record and playback. Motor: Solid-state regulated DC. Speed: 17⅞ in./s. Fast Forward-Rewind Time: Less than 120 sec. Tape: C-30, C-60, C-90 cassettes. Controls: Power switch, record level (left and right channel), record, rewind, stop-eject, play, fast forward, pause. Transistor Complement: 13 transistors and 1 IC. Output: Greater than ½ volt from low impedance amplifier stage. Finish: Black with walnut end panels. Dimensions (overall): 3⅜" H x 13⅝" L x 11" D. Power: 120-240 volts, 50-60 Hz, 7 watts.



tape monitor jacks (no internal wiring needed). Requires additional stereo amplifier and speakers for left and right rear channels when used with existing stereo system.

Kit AD-2002, includes audio cables and record, 4 lbs. 29.95*

HEATHKIT
Schlumberger

HEATH COMPANY, Dept. 8-9
Benton Harbor, Michigan 49022

Enclosed is \$ _____, plus shipping.
Please send model (s) _____

Please send FREE Heathkit Catalog. Please send Credit Application.

Name _____

Address _____

City _____ State _____ Zip _____

*Mail order prices; F.O.B. factory.
Prices & specifications subject to change without notice. HF-250

The look & the sound.

Black-out glass and brushed aluminum. IC's, FET's, crystal filters, and triple-mesa silicon transistors for more power and cleaner sound. Nikko's exclusive circuit breaker protection system. These are only a few of the exciting new features on the new Nikko products—see them at your nearest Nikko dealer, or write today for full information. And don't worry. We haven't changed our reliability and value. It takes a long time to improve something that good.

Now it's



NIKKO

From top to bottom: FAM-400 AM/FM Stereo Tuner, \$109.95; TRM-400 Stereo Pre-Amp/Amplifier, \$109.95; STA-6010 AM/FM Stereo Receiver, \$199.95; STA-8010 AM/FM Stereo Receiver, \$239.95; FAM-1200 AM/FM Stereo Tuner, \$239.95; TRM-1200 Stereo Pre-Amp/Amplifier, \$239.95.



NIKKO ELECTRIC CORPORATION OF AMERICA
5001 Lankershim Blvd.
North Hollywood, California 91601
CIRCLE 37 ON READER-SERVICE CARD

VAUGHAN WILLIAMS: Symphony No. 4, in F minor; Concerto Accademico for Violin and String Orchestra, in D minor. James Buswell, violin (in the concerto); London Symphony, André Previn, cond. RCA Victor LSC 3178, \$5.98.

These two works go well together. The *Concerto Accademico* is one of Vaughan Williams' shorter, lighter pieces and the Fourth Symphony is the most strenuous, dramatic, even violent work that he ever produced; but both are tributes to Bach, the concerto in its texture, the symphony in that a major element of its towering fabric is a four-note motif clearly patterned after the B-A-C-H theme in *The Art of Fugue*.

The concerto dates from the early Twenties, when everybody was writing neobaroque pieces; in his *Essays in Musical Analysis* Sir Donald Francis Tovey does not consider it among concertos at all but deals with it in a section called "Orchestral Polyphony" along with concertos by Bach and Handel themselves. Be that as it may, this brief, pointed, vigorous score is full of modal and folksy tunes in the best Vaughan Williams tradition and affords soloist and orchestra alike ample opportunity for transparent, unsentimental, straightforward virtuosity of a most refreshing kind. Hindemith, Copland, and other theorists of the Twenties wrote at length about the need of the composer to level with his audience; Vaughan Williams here suggests that the performer had a similar need, and both Buswell and Previn understand him perfectly. This is the only recording of the *Concerto Accademico* now in the American lists, but it is difficult to imagine why there ought to be another.

Previn's performance of the symphony competes on discs with recent versions by Leonard Bernstein and Sir Adrian Boult. Bernstein's has more drive and climactic excitement; Boult's is more broadly Olympian. But Previn's way with the work, especially in its quieter, moodier episodes, has its virtues. After all, this is one of the most important symphonies of the twentieth century, and various interpretative views of it are therefore to be welcomed. A.F.

R **WAGNER:** *Der fliegende Holländer*. Leonie Rysanek (s), Senta; Rosalind Elias (ms), Mary; Karl Liebl (t), Erik; Richard Lewis (t), Steersman; George London (b), The Dutchman; Giorgio Tozzi (bs), Daland; Chorus and Orchestra of the Royal Opera House, Covent Garden, Antal Dorati, cond. London OSA 1399, \$17.94 (three discs) [from RCA Victor LSC 6156, 1961].

Rysanek and London made a specialty of this opera at the Met and at Bayreuth during the Sixties. Their recording is a fine memento of the occasion—it is, in fact, the choice top-price version and easily bests both rival Angel editions.

Of course the discs can only hint at the theatrical electricity that these two singers generated in the house: the sheer physical presence of Rysanek's obsessed Senta and London's grim Dutchman invariably made an exciting impact, and when all went well vocally it added up to a thrilling operatic experience. The Ry-

sanek voice has always sounded best given the space and distance of an open auditorium; on records she sometimes sounds a bit inhibited, but fortunately this one comes very close to capturing the soaring, ecstatic quality of her portrayal. London's defiant, brooding, virile sailor is beautifully sung and characterized, while the supporting cast is, on the whole, a uniformly strong one. Dorati gets solid, weighty Wagnerian textures from the orchestra—a bit too turgid and drawn out early in the opera, but an impressive reading in every respect from Act II to the end. London's remastered discs differ very little from RCA's line-sounding original. P.G.D.

WITT: Symphony in C (*Jena*)—See Beethoven: Wellington's Victory, Op. 91; Musik zu einem Ritterballett, WoO. 1.

recitals and miscellany

E. POWER BIGGS: "Historic Organs of England." Music by Dunstable, Aston, Tallis, Tye, Byrd, Dowland, Purcell, Holborne, Clarke, Handel, and Stanley. E. Power Biggs, organ (various historic organs by Father Smith, John Snetzler, Richard Bridge, and George England, and a regal by Noel Mander). Columbia M 30445, \$5.98.

E. POWER BIGGS: "The Biggs Bach Book." Organ music by Bach from the Anna Magdalena Bach Notebook, the Wilhelm Friedemann Bach Little Clavier Book, and the cantatas. E. Power Biggs, organ (Flentrop Organ, Cambridge, Mass.; Andreas Silbermann Organ, Arlesheim, Switzerland). Columbia M 30539, \$5.98.

In these twilight years of his long and tremendously productive career, E. Power Biggs remains an unfailingly entertaining, lucid, and imaginative performer. Occasionally we are aware that he is now having some technical difficulties, but a more noticeable feature of his recent recording activity is his avoidance of that part of the repertoire where the difficulties would be most apparent. These two most recent releases are good cases in point, of a superb musician turning to literature that is almost invariably ignored by artists who must build their careers by concentrating entirely on the "big" pieces.

If you're in a relaxed, unbuttoned mood, I'm sure you'll find "The Biggs Bach Book" an utterly charming aid in whiling away an hour or so. As a point of departure Biggs has taken the *Anna Magdalena Bach Notebook*, a kind of Bach family musical diary into which members of the family and friends entered their favorite songs and dances. On Side 1 Biggs plays eleven of these dances, an aria (*Bist du bei mir*), and two four-voice chorales, plus a *gigue* from the *Wilhelm Friedemann Bach Little Clavier Book*. His enthusiastic performances are just as charming and light-hearted as the music itself. The eleven dances are played on Biggs's own 1958 Flentrop in Cambridge, Massachusetts, perhaps the most beautiful organ in America today. Everything else is played on the Andreas Silbermann organ in Arlesheim, familiar from his earlier "Historic Organs of Switzerland" record and



Which of these two new Wollensak stereo cassette decks is worthy of your sound system?

One is Dolby. One is not.

The one on the left is the Wollensak 4760 cassette deck featuring the new Dolby System® of noise suppression. It reduces the level of background tape hiss by 10 db at 4,000 Hz or above, while greatly increasing dynamic range. To enhance fidelity, bias for both standard and high performance tapes can be selected by a tape selection switch. Frequency response of the Model 4760 is 35-15,000 Hz plus or minus 2 db. This deck is the ultimate in cassette decks; the finest you will ever buy. It is equal

® A TRADEMARK OF DOLBY LABORATORIES, INC.

to the best and most expensive open reel recorders.

For the man who wants many of the same high qualities of the 4760 without the attributes of the Dolby System, we have also invented the Wollensak 4755 cassette deck. Both of these unique decks feature a massive, counter-balanced bi-peripheral drive responsible for one of the lowest wow and flutter characteristics you'll find anywhere. The precise heavy-duty tape transport mechanism is considered the finest by many audio experts. This mechanism includes the only full-size flywheel and capstan available to assure constant tape

speeds. Fast-forward and rewind speeds are about twice as fast as any other. Interlocked controls allow you to go from one function to another without first going through a stop or neutral mode. End-of-tape sensing stops the cassette, disengages the mechanism and prevents unnecessary wear. The "Cassette Guardian" automatically rejects a stalled cassette in play or record position.

Either the Wollensak 4760 or the 4755 can complement your present component system with cassette advantages. Hear them both at your nearby dealer. Then answer the question: Dolby or not Dolby?

Either way...it's worth it **Wollensak 3M** COMPANY

3M CENTER • SAINT PAUL, MINNESOTA 55101

**BOTH
DIRECTION RECORDING**

**IF THIS ISN'T
EXACTLY
WHAT YOU'RE
LOOKING FOR...**



Dokorder 6020 Tape Deck is tailored to the needs of sophisticated audiophiles. A quality deck with Continuous Automatic Reverse, 3 motors, 4 heads.

Dokorder®

AMERICAN DOKORDER

Box 2494 Main P.O. Culver City,
Calif. 90230, U.S.A.

CIRCLE 8 ON READER-SERVICE CARD

from Lionel Rogg's Bach records formerly available on Epic. If we ignore its unsteady wind, it too is an attractive instrument.

Side 2 continues in exactly the same mood, extending the *Anna Magdalena Bach Notebook*, as it were, with organ transcriptions of five all-time favorite cantata movements (one done by Bach) plus a miscellaneous setting of *Ein feste Burg*. If we were to insist on an effortlessly accurate performance of the Schübler chorale, *Wachet auf*, or of the movement from Cantata No. 79, *Gott, der Herr, ist Sonn' und Schild*, we should have to look elsewhere—Biggs just isn't getting over the keys as easily as he once did. But no matter. The right spirit is here as it is on all of Biggs's records, and all in all it amounts to a treasureable collection of little gems. I am reminded of the young bride-to-be who approached her church organist and announced she had decided she wanted her wedding "all in Bach . . . but not heavy Bach, just light Bach." I'm forwarding a copy of this record to that organist and recommend it especially to brides and/or organists who find themselves in a similar situation.

I'm afraid one would have to be a pretty ardent Anglophile, though, to find much of interest in the "Historic Organs of England," the latest installment of Biggs's historic organ series. The six old organs are really terribly dull instruments and much of the period English music is of the sort found in books for first-year piano students (none of these organs seems to have any pedals at all). Actually we hear very little about historic English organs and practically no English organ music besides Handel's is very well known. This record, then, does help fill in that gap and at the same time sets our minds at rest with the realization that we haven't been missing a thing.

Side 1 presents two Father Bernard Smith organs—the one in Adlington Hall in Cheshire is thought to have been built around 1670 and claims to be the oldest of original English organs. Handel himself was a visitor at Adlington, and undoubtedly entertained his hosts on this relatively large two-manual instrument with fourteen stops. The other (a one-manual instrument with divided registers) is now in the chapel of Staunton Harold in Leicestershire and is even more hooty and flat sounding.

Side 2 is more diverse, opening with one piece on a very small Father Smith organ now owned by the English organ builder Noel Mander. I would guess Mr. Mander has done some tonal work on the instrument, because it offers the most attractively bright sounds on the disc. Next, a Mander-built replica of an ancient regal buzzes vigorously for us and is followed by a John Snetzler organ built in 1769 and now relocated in the Church of St. Andrew-by-the-Wardrobe. Two John Stanley pieces are cautiously played on an instrument at Danson Mansion in Kent built by George England in 1776, and some inconsequential Handel dances are played on the so-called Handel organ at Great Packington, on which Biggs has already recorded extensively, and which remains utterly without vitality or distinction.

Perhaps it is unfair of me to dismiss these organs and the music so completely, but when one considers who was active on the continent at the same time (Schnittger, Müller, Buxtehude, and Bach), we see just what a meager contribution the English made. C.F.G.

"THE COMPOSERS STRING QUARTET CONTEST WINNERS:" GRIFFITH: One String Quartet. EDWARDS: String Quartet (1967). POLLOCK: Movement and Variations. THIMMIG: Seven Profiles. Composers String Quartet. Composers Recordings CRI SD 265, \$5.95.

These four string quartets were the winning compositions in the First Annual Composers String Quartet Composition Contest, sponsored by the New England Conservatory in conjunction with the Composers String Quartet. In addition to the present recording, two of the works (the Pollock and the Thimmig) were selected for publication by E. C. Schirmer and its affiliate, Lone Press. The four works are remarkably impressive in their seriousness and maturity, despite the fact that the oldest of the composers, all American-born, is now only twenty-eight; and all of the pieces were written some three or four years ago. There are other common points: each work is roughly ten minutes long, and with the exception of the Thimmig, each is in one movement (the Pollock, despite its title, is essentially one unified gesture). Finally, all belong to that category of new music which, despite the use of a nontonal pitch language, still works within traditional notions of phrase structure and musical development, although these are extended in some cases (particularly in the Griffith *One String Quartet*) nearly to the breaking point.

Youngest of the composers is Robert Pollock, whose *Movement and Variations* was written in 1967 when he was only twenty-one. Although there are certain indications that this is still a student work—particularly a tendency to overuse rather obvious strings devices (e.g., tremolo), it is a work of considerable technical subtlety and emotional warmth, which already reveals a strong musical personality. Leslie Thimmig's *Seven Profiles* consists of seven miniature pieces, each strongly articulated as to character and associated with a particular compositional technique. Despite its fragmentary structure, it is a work which makes a strong over-all impression. George Edwards' String Quartet differs from the others in that it consists of one continuously unfolding musical idea that spans the entire movement. Its lack of textural variety is compensated for by its long, flowing lines and continuous structure. Finally, Peter Griffith's *One String Quartet* is the most dramatic of the group and features sudden, sharply defined contrasts. Sections of great density, at times reminiscent of Xenakis' "global" textures, are played off against cadenzalike solo passages. This is a solid group of works that speaks well for the present state of musical education in the country.

Considering the usual level of performance of student compositions, the Composers Quartet turns in surprisingly finished accounts of the pieces. This quartet is unquestionably one of the few really excellent ensembles for the performance of new music, and the group, along with CRI and E.C. Schirmer, should be warmly thanked for furthering the cause of serious new music in this three-way project.

R.P.M.

BRACHA EDEN AND ALEXANDER TAMIR: "Two Piano Encore;" ARENSKY: Suite for Two Pianos,

WHY

AREN'T YOU LISTENING TO THE 2 EXTRA CHANNELS IN YOUR STEREO RECORDS, TAPES, AND FM BROADCASTS?

There is four channel material already present on your stereo records, tapes and FM broadcasts but you are only listening to two of them. Add the Lafayette 4-Channel Adapter to your present stereo receiver or amplifier (such as the Lafayette LR-1500TA or LA-125TA) and you will experience the dramatic difference of four channel sound NOW!

During a stereo recording session, the microphone picks up two types of sounds: direct and reflected, both of which are always included on a stereo recording. When playing back stereo records, tapes, and FM broadcasts in a conventional 2-channel stereo system, the reflected sounds are masked by the louder direct sounds coming from each of the two front speakers. The great importance is that reflected sounds create the depth and spatial breadth one associates with a performance given in a concert hall rather than in the downstairs closet! The Lafayette 4-Channel Adapter recovers and separates a substantial amount of this reflected sound from the direct sound. This is not produced artificially as in the case of reverberation units, and synthesizers. The result is a dramatic new sound.



dimension to all existing stereo program sources without the need for any additional amplifiers!

So . . . why listen to only two channels when you can hear music the way it was meant to be heard with FOUR CHANNEL STEREO by LAFAYETTE? Price \$29.95!!!

THE RENOWNED LR-1500TA Ideal MATCH FOR NEW 4-CHANNEL SOUND!

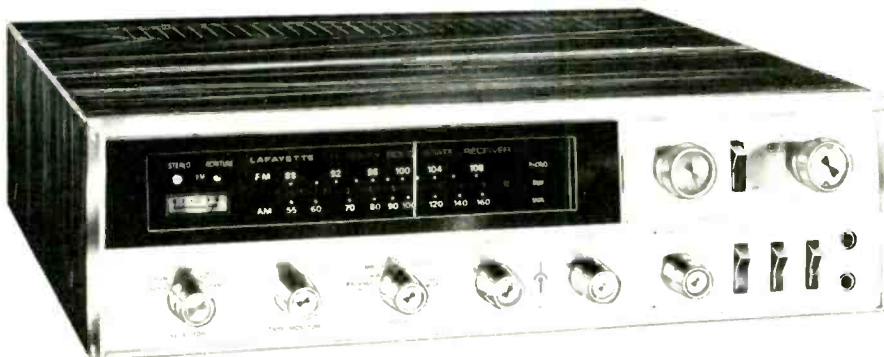

"High performance and an abundance of features . . . an excellent buy on today's market."
High Fidelity

"We found the performance of the LR-1500TA FM tuner to be excellent in all respects . . . The LR-1500TA is a lot of receiver for the money."
Stereo Review

The perfect matchmate for the Lafayette Dynaquad Adapter. Widely acclaimed by critics and consumers alike, the Lafayette LR-1500TA 240 watt AM/FM stereo receiver combines excellence in design, performance and operating convenience with the latest advances in solid-state circuitry. Four Integrated Circuits and five Field Effect Transistors in the FM front end assure you of pulling in the weak stations as well as the strong with noise-free clarity and tonal purity. "Acritune," our precision tuning circuit, activates a light on the front panel when your station is perfectly tuned, and Computer-Matic®, our

exclusive overload protection circuit, insures against amplifier damage. In addition, the LR-1500TA features a complete set of automatic and manual controls such as automatic FM stereo/mono switching, interstation muting circuit to silence the receiver when you're tuning between stations, an illuminated D'Arsonval signal strength meter, front and rear panel tape output jacks, direct tape monitor switch, and a dual system speaker switch which permits you to enjoy stereo in one or two rooms separately or simultaneously. Price \$299.95!!!

LAFAYETTE®

LAFAYETTE RADIO ELECTRONICS CORP., DEPT. 19091, BOX 10, SYOSSET, N.Y. 11791



Write Today For Your Big
FREE 1972 Catalog.
468 Pages!

Send me FREE Lafayette Catalog 720		19091
Name.....		
Address.....		
City.....		
State.....	Zip.....	

ADVERTISING INDEX

Key No.	Page No.
1	Acoustic Research, Inc. 99
2	A.D.R. Audio 128
3	Akai Electric Co., Ltd. 80, 81
4	Allied Radio Shack 96, 127
57	Alzheimer Audio Electronics 125
7	Altec Lansing 27
8	American Dokorder 112
9	Ampeg Corp. 13, 101
10	Angel Records 89
11	Audio Dynamics Corp. 17
12	Audio Sales 118
13	Audio Unlimited 118
14	Baltimore Stereo Wholesalers 126
15	Benjamin Electronic Sound Corp. 8, 103
5	Bose Corp. 14, 15
58	Boston Audio 125
	Bozak 121
103	British Industries Co. 16
16	Cambridge Camera 124
17	Capitol Cassettes 9-11
18	Carston Studios 128
	Classified Ads 131
	Columbia Records 82, 98
19	Concord Electronics Corp. 95
41	Deutsche Grammophon Gesellschaft 93
20	District Sound, Inc. 128
21	Dixie Hi Fidelity Wholesalers 129
22	Downtown Audio, Inc. 128
	Dressner 126
23	Dual 64-72
24	Dynaco Inc. 47
60	Elpa Marketing, Inc. 106
25	Empire Scientific Corp. 36
	Fisher Radio Cover II, 1
103	Garrard 16
26	Harman-Kardon, Inc. 33
27	Heath Co. 109
28	Hitachi Sales Co. 102
29	JVC America, Inc. 97
36	Kenwood Cover IV
30	King Karol Records 131
31	KLH Research and Development 50, 51
59	Koss 18
32	Lafayette Radio Electronics Corp. 113
33	London Records 94
43	Marantz 5
34	McIntosh 12
35	Memorex Corp. 117
	Minnesota Mining and Mfg. Co. 111
37	Nikko Electronic Corp. of America 110
38	North American Philips Co., Inc. 119
39	Ovation Records 21
40	Pickering & Co. 2
	Pioneer Electronics U.S.A. Corp. 91
41	Polydor Records 93
42	Ponder and Best 30
44	Rabco 108
45	Rabsons-57 St., Inc. 130
46	Record Club of America 6, 7
	Record Mart 131
47	Rectilinear Research Corp. 29
48	Sansui Electronics Corp. 31
100	Scott, H. H., Inc. 49
49	Sherwood Electronics Laboratories 35
50	Shure Brothers, Inc. 63
51	Sony Corp. of America 105
63	Sony/Superscope, Inc. 23
52	Sound Reproduction, Inc. 129
53	Standard Radio 26
56	Stereo Corp. of America 125
54	Tandberg of America, Inc. 107
67	Teac Corp. of America Cover III
60	Thorens 106
57	Ultra-Tone Sound Systems, Ltd. 22
23	United Audio Products, Inc. 64-72
55	Wollensak 111

Op. 15; Waltz. **BRAHMS:** Waltzes, Op. 39: Nos. 9, 10, 11, 15, and 16. **KHACHATURIAN:** Three Pieces for Two Pianos: No. 3 (*Fantastic Waltz*). **POULENC:** L'Embarquement pour Cythère. **RACHMANINOFF:** Suite No. 1, Op. 5: Barcarole. **SCHUBERT:** Rondeau, Op. 138. **SCHUMANN:** Etudes en forme de canon (6), Op. 56: Nos. 2, 3, and 4. **WEINBERGER:** Schwanda: Polka and Fugue. Bracha Eden and Alexander Tamir, pianos. London CS 6694, \$5.98.

Eden and Tamir are probably the slickest duo-piano team I have ever heard: their togetherness verges on the uncanny, with the subtly gauged rubatos and intricate tonal balance and blend approaching supernatural perfection. For all the cultivation, however, the playing remains singing and very musical, without the hardness and glitter that so often blight duo pianism. The Schumann etudes, originally composed for pedal piano and unfortunately rarely heard in any form since that instrument's obsolescence, are beautifully played in the excellent Debussy transcriptions. The Schubert is tender, gracious simplicity itself here, and the Brahms waltzes (his own arrangement of some of the piano solo originals) are interpreted with freedom and an aptly vigorous bass line. The Rachmaninoff excerpt almost makes one regret that the whole suite wasn't performed, and the Weinberger (another composer transcription) sounds remarkably clear-textured when reduced to the relative monochrome of two keyboards. Only the Arensky, Khachaturian, and Poulenc offer any cause for disappointment: the Khachaturian, because it is a trashy piece, the Arensky because the reading lacks the ease and flow of the unforgettable old Harold Bauer/Ossip Gabrilowitsch version, the Poulenc because the present, overlangorous, underenergized treatment misses the fun and swinging rhythm this charmer must have. Superb, suave piano reproduction. H.G.

"THE GUITARS OF SERGIO AND EDUARDO ABREU." ANON.: Drewries Accordes; Le Rossignol. **TELEMANN:** Canon. **SCARLATTI:** Pastorale. **BACH:** Well-Tempered Clavier, Book I: Prelude No. 3. **SCHIEDLER:** Sonata in D. **SOR:** Theme and Variations. **GRANADOS:** Goyescas: Intermezzo. **RODRIGO:** Tonadilla. **ALBENIZ:** Iberia: Evocations. **FALLA:** La Vida Breve: Spanish Dance. Sergio and Eduardo Abreu, guitars. Columbia M 30575, \$5.98.

Here is one of the pleasantest guitar recitals to come along in many moons—a splendid introduction to the Abreu brothers, a pair of Brazilian siblings in their early twenties who are formidably adept and play music with joy, precision, and a virtuosic gift for intermeshing delicate instrumental lines. Each is in total control of color and articulation, yet the control never gets in the way of a free-flowing impetus—the main ingredient of which is a built-in rhythmic pulse, evident from the beginning of Side I with the two seventeenth-century selections. Among the highlights is the Scarlatti transcription, pure and bell-like in tone; and Rodrigo's *Tonadilla* of 1964 is one of the best traditional guitar works to come out of the past decade—both sonorous and piquant in timbre, with discreet dissonances and much effective writing for the instruments. The sonata by Christian Gottlieb Scheidler

(c.1752–1839) sounds as if the composer came home to write it after attending a performance of *Don Giovanni*—the second movement takes as its point of departure "Là ci darem la mano," with no apologies. The recording as a whole makes me much regret missing the Abreu brothers on their debut North American tour. Next time. S.F.

JAMES KING: "Sings the Falcon Scene from Die Frau ohne Schatten." **STRAUSS, R.:** Die Frau ohne Schatten: Falke, du wieder-gefundener. **WAGNER:** Parsifal: Amfortas! Die Wunde!; Die Meistersinger: Am stillen Herd. **VERDI:** Otello: Niun mi tema. **PUCCINI:** Turandot: Non piangere, Liu; Nessun dorma; Manon Lescaut: Donna non vidi mai. **GIORDANO:** Fedora: Amortì vieta. James King, tenor; Orchestra of the Bavarian Radio, Kurt Eichhorn, cond. Angel S 36715, \$5.98.

King "Sings the Falcon Scene from *Die Frau ohne Schatten*" and sings it very well, with a ringing voice that fits strongly in this Siegfried-like role. The aria is very noisy and powerful, but does not make its best effect as an isolated showpiece: it seems to need, as a launching-pad, the preceding material of Act II. However, if you want the thing alone, it is as well done here as anywhere else in the catalogue.

There follows not anything you could dignify with the title of an "operatic recital" or whatever, but simply an ill-assorted hodge-podge of matter from all over the German and Italian repertoire. The blinding revelation of Parsifal as he divines the cause of Amfortas' agony is blithely followed by Stolzing's Trial Song. Suddenly we are switched to Otello in his death throes, then quickly on to Calaf, Des Grieux, and Loris. Most of it is sung quite decently, though Mr. King has a way of sounding detached from his material at times, as though he were being programmed from headquarters. The fault in this case is compounded by what may laughingly be called "program-building." There's nothing wrong with the orchestra or the recorded sound. G.M.

"MUSIC FOR CLARINET AND PIANO:" **HONEGGER:** Sonatine in A. **DEBUSSY:** Petite pièce. **MILHAUD:** Sonatine, Op. 100. **BERNSTEIN:** Sonata. **BAX:** Sonata in D. Stanley Drucker, clarinet; Leonid Hambro, piano. Odyssey Y 30492, \$2.98.

With the exception of the short Debussy *Pièce*, none of the works on this attractive release is currently available—indeed, the Bax Sonata is a recording premiere. To me (and perhaps my biases are showing), the most successful work here is the Honegger *Sonatine*. It is a lean, understated piece that moves from a highly contrapuntal, neoclassical style in the first movement (which is also highlighted by some haunting, bittersweet harmonies typical of Honegger) to the melodic and rhythmic language of jazz in the last. The Bernstein Sonata likewise offers a fascinating array of rhythmic and instrumental effects, although it would perhaps be a more welcome guest on some variety show than in the concert hall, since it does marvelous imitations of Paul Hindemith (in the opening measures) and of Aaron Copland (later on). By

Here's your **FREE**

HIGH FIDELITY

“at home” shopping service!



It's easy! All you do is use one of the Reader Service cards at right... HIGH FIDELITY's Reader Service Department will take it from there. It's as simple as 1, 2, 3!

1 Just circle the number on the card that matches the number below the ad or editorial mention that interests you.

You'll also find the key numbers for advertised products in the Advertiser's Index.

2 Then type or print your name and address. Don't forget your zip code, it's important!

3 Drop the card into the mail. No postage is needed if mailed in the United States.

You'll receive literature, colorful brochures and specifications about the products that interest you... free and without obligation!

Use HIGH FIDELITY's "at home" shopping service today!

1	2	3	4	5	6	7	8	9	10	11	12	13	14	15
16	17	18	19	20	21	22	23	24	25	26	27	28	29	30
31	32	33	34	35	36	37	38	39	40	41	42	43	44	45
46	47	48	49	50	51	52	53	54	55	56	57	58	59	60
61	62	63	64	65	66	67	68	69	70	71	72	73	74	75
76	77	78	79	80	81	82	83	84	85	86	87	88	89	90
91	92	93	94	95	96	97	98	99	100	101	102	103	104	105
106	107	108	109	110	111	112	113	114	115	116	117	118	119	120
121	122	123	124	125	126	127	128	129	130	131	132	133	134	135
136	137	138	139	140	141	142	143	144	145	146	147	148	149	150
151	152	153	154	155	156	157	158	159	160	161	162	163	164	165

• PLEASE TYPE OR PRINT •

NAME _____

ADDRESS _____

CITY _____ STATE _____ ZIP _____

I am a subscriber I am not a subscriber

1	2	3	4	5	6	7	8	9	10	11	12	13	14	15
16	17	18	19	20	21	22	23	24	25	26	27	28	29	30
31	32	33	34	35	36	37	38	39	40	41	42	43	44	45
46	47	48	49	50	51	52	53	54	55	56	57	58	59	60
61	62	63	64	65	66	67	68	69	70	71	72	73	74	75
76	77	78	79	80	81	82	83	84	85	86	87	88	89	90
91	92	93	94	95	96	97	98	99	100	101	102	103	104	105
106	107	108	109	110	111	112	113	114	115	116	117	118	119	120
121	122	123	124	125	126	127	128	129	130	131	132	133	134	135
136	137	138	139	140	141	142	143	144	145	146	147	148	149	150
151	152	153	154	155	156	157	158	159	160	161	162	163	164	165

• PLEASE TYPE OR PRINT •

NAME _____

ADDRESS _____

CITY _____ STATE _____ ZIP _____

I am a subscriber I am not a subscriber



See Reverse Side for
FREE "at Home" shopping service!

There's more pleasure
in store for you every
month with **HIGH FIDELITY** . . .

First Class
Permit No. 111
Cincinnati, Ohio

BUSINESS REPLY MAIL

No postage stamp necessary if mailed in the United States

Postage will be paid by—

**HIGH
FIDELITY**

P.O. Box 14306
Annex Station
Cincinnati, Ohio 45214

Reader Service 71



First Class
Permit No. 111
Cincinnati, Ohio

BUSINESS REPLY MAIL

No postage stamp necessary if mailed in the United States

Postage will be paid by—

**HIGH
FIDELITY**

P.O. Box 14306
Annex Station
Cincinnati, Ohio 45214

Reader Service 71

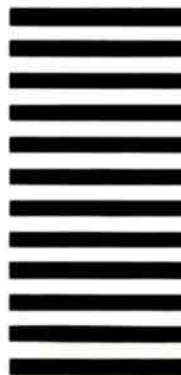

way of contrast, the Milhaud *Sonatine* is completely characteristic of its composer, with its jaunty rhythms and melodies, its big blocks of contrary motion, polytonal chords, and a lovely, *berceuse*-like second movement. Unlike Honegger, however, Milhaud seems to have been reluctant to thin out the piano part when the clarinet is playing, and the result is sometimes a bit heavy-handed.

The Debussy *Petite pièce*, an exquisite, dancelike vignette, would alone be worth the price of the record. The Bax sonata, on the other hand, offers no such satisfaction. Whereas the other works on this release all manifest a tightness of structure and texture perfectly suitable to the idiom, Bax creates a diffuse architecture in which the respective timbres of the piano and the clarinet seem to have been used rather gratuitously. There are a couple of nice melodies (the second of which seems to have been lifted from Chausson's *Symphony in B flat*) in the first movement; but even these tend to get lost in developmental rambling that communicates no sense of inevitability.

The over-all efforts of Stanley Drucker and Leonid Hambro—and of Odyssey's engineers—are admirable. One might wish for a bit more dynamic variety here and there, particularly since Drucker seems to remain at a mezzo-forte level a good deal of the time, and the clarinet tone is not as full-bodied as one might like. And the Honegger *Sonatine* has a more vital, if less pensive, interpretation on an old London release with Ulysse and Jacques Delécluse. Nonetheless, this disc reveals the enticing combined sonorities of the clarinet and piano in excellently balanced stereo sound, and it contains two gems—the Honegger and the Debussy—that should be in everybody's collection. R.S.B.

LUCIANO PAVAROTTI: "Primo Tenore." ROSSINI: William Tell: O muto asil. **BELLINI:** I Puritani: A te, o cara. **DONIZETTI:** Don Pasquale: Com'è gentil. **BOITO:** Mefistofele: Giunto sul passo estremo. **VERDI:** Il Trovatore: Ah! sì, ben mio... Di quella pira! **PONCHIELLI:** La Gioconda: Cielo e mar! **PUCCINI:** La Bohème: Che gelida manina. **CILEA:** L'Arlesiana: E la solita storia. **PIETRI:** Io conosco un giardino. Luciano Pavarotti, tenor; Vienna Opera Chorus and Orchestra, Nicola Rescigno, cond. (in the Rossini, Bellini, Verdi, and Cilea); New Philharmonia Chorus and Orchestra, Leone Magiera, cond. (in the others). London OS 26192, \$5.98.

He does not bleat. He smears not, neither does he sob. He has a sense of style. He has taste. He has, what's more, a ring at the top of his voice that dilates the pupils: yours, as well as his. If you are unaccustomed to such a constellation of virtues, especially in this voice category, then meet Luciano Pavarotti. He is all tenor and a yard wide. (Alas!) You may already have met him on records, for he sings the tenor roles in London's *Daughter of the Regiment* and EMI's *L'Amico Fritz*—both charmingly, to my taste. And now he comes packaged in this rousing and generally excellent recital.

Mr. Pavarotti would be less than human if he failed to exploit his own principal asset, that clarion top, and who would want it otherwise? It blazes out firmly in the *William Tell* aria and in the *Trovatore* scene. (These are no snippets, but ten-minute chunks each.) Other qualities

How new Memorex Recording Tape shattered glass and why it will make your favorite music sound better.

To shatter glass with the human voice, a singer must reach and hold the pitch it takes to make a given glass vibrate. That pitch must then be projected with enough volume to vibrate the glass to its shatter point.

We figured if we could capture that precise pitch on our new Memorex Recording Tape and play it back at the same volume, we'd dramatically demonstrate the exactness with which our tape can reproduce music.

So that's exactly what we did.

Memorex has increased tape sensitivity, increased high-frequency response, and improved signal-to-noise ratio; so much, that now you can record your favorite music, then play it back the same way it sounded live.

You should hear us.

MEMOREX Recording Tape
Reproduction so true it can shatter glass.

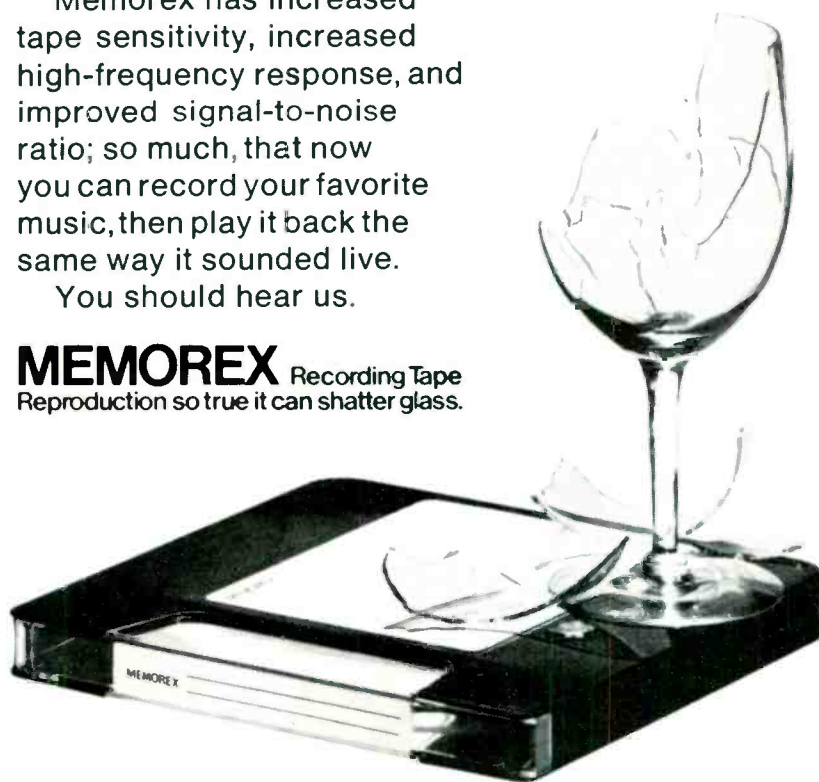

Incidentally, our cassette tape also shatters glass.

© 1970, MEMOREX CORPORATION

CIRCLE 35 ON READER-SERVICE CARD

WE CAN SELL FOR LESS

Nationally Advertised Brands

- Hi-Fi Stereo Components
- Tape Recorders
- Record Changers
- Home & Car Stereo Tapes
- Speaker Systems
- Radio & TV Sets
- Electronic Equipment

BRAND NEW AND FULLY GUARANTEED

WE CAN SAVE YOU MONEY

SEND: for FREE Listing
of 1000's of items...

LOWEST PRICES ANYWHERE!

• Factory Sealed Units • Fast Service •

AUDIO Sales

2745 ERIE BLVD. EAST
SYRACUSE, NEW YORK 13224

CIRCLE 12 ON READER-SERVICE CARD

GET

LOWEST PRICES
FAST, FAST SERVICE
FACTORY SEALED CARTONS
FULLY INSURED SHIPMENTS
EXTRA SAVINGS ON PACKAGE DEALS

AUDIO UNLIMITED

Serving Audio Enthusiasts
Since 1955
GIVES YOU

MORE FOR YOUR MONEY
Write For FREE Listing Today
SEND US YOUR LIST FOR
OUR AIR MAIL QUOTE TODAY
Visit Our Store Warehouse
CLOSED MONDAYS

IT WILL PAY YOU
TO WRITE US FIRST

AUDIO UNLIMITED, INC.

396 Third Ave. (Nr. 28), N. Y.,
N. Y. 10016 • (212) MU 2-3836-7-8

CIRCLE 13 ON READER-SERVICE CARD

show up in some of the gentler music, especially the Donizetti and the Cilea. This last song is known as Federico's lament and has often been slurred to death by other Italian tenors. Pavarotti's restraint and his clean line are admirable.

Pass indulgently over Faust's final aria from *Mefistofele*, for it is taken so slowly that it falls apart. Condone a few inelegancies in the *Bohème* aria and a "square" touch here and there in the Bellini. He may not be as subtle as Tito Schipa, but be grateful for the splendid nummies we are given.

Finally compare the work of Maestros Rescigno and Magiera, so instructively juxtaposed here. The first knows his stuff and steers the ship; the second conforms entirely to what he thinks the singer wants—or to what the singer thinks he wants. No prize awarded for guessing which system works better. G.M.

R

LEONIE RYSANEK: "Leonie Rysanek Sings Richard Strauss;" Excerpts from *Die Frau ohne Schatten* and *Ariadne auf Naxos*. Leonie Rysanek, soprano; other singers; Vienna Philharmonic Orchestra, Karl Böhm, cond. (in *Die Frau*); Erich Leinsdorf, cond. (in *Ariadne*). London OS 26205, \$5.98 [the *Frau* excerpts from Richmond SRS 64503, 1956; the *Ariadne* excerpts from RCA Victor LDS 6152, 1960].

It will be interesting to see if the "extra mileage" principle that produced this disc succeeds or not. Rysanek is unlikely to attract a new audience through repackaging previously released recordings, while her admirers undoubtedly already have the two complete sets that yielded the material for this record. As a result, the disc will probably have few takers and those who espouse the Rysanek-just-doesn't-sell-records theory will have scored another point.

Whatever her vocal flaws, Rysanek can be a brilliant exponent of Strauss's soprano roles. She proves the point time and again on the present disc and could surely do so in a freshly recorded recital. I suppose a complete Rysanek *Aegyptische Helena* or *Liebe der Danae* would be too much to hope for, but the final scene of the latter and monologues from the former could make a thrilling disc. Who knows, it might even sell. P.G.D.

B

LEOPOLD STOKOWSKI: "The Best of Stokowski." **VIVALDI:** Concerto Grosso in D minor, Op. 3, No. 11. **BACH:** Jesu, Joy of Man's Desiring; Sheep May Safely Graze. **MOZART:** Serenade No. 10, in B flat, K. 361. **THOMSON:** The Plow That Broke the Plains; Suite. **STRAVINSKY:** L'Histoire du soldat; Suite. Various instrumentalists and orchestras, Leopold Stokowski, cond. Vanguard VSD 707/8, \$5.98 (two discs) [from various Vanguard originals, 1961-67].

The "best" performance on this misnamed collection is that of the Mozart serenade, a warm, lyrical, friendly reading by wind players from Stokowski's American Symphony orchestra. But in order to fit the piece on one side, Vanguard (without so much as a word to the unwary) has omitted the first minuet and the

theme-and-variations movement—both could easily have been included on the Thomson side which lasts under fourteen minutes. That latter bit of classic Americana is played far too suavely and slickly here, while the Stravinsky, despite a first-rate septet of musicians, has little of the music's implied tightly coiled rhythmic thrust. Even the doctored-up Vivaldi sounds uncharacteristically bland. P.G.D.

H

LAWRENCE TIBBETT: "Recital, Vol. II" Lawrence Tibbett, baritone; various accompaniments. Rococo 5324, \$5.98 (mono only).

Lawrence Tibbett often sang on radio broadcasts in the '30s and the selections on this disc are undoubtedly airchecks from that period. What we have here is Tibbett the showman, exercising the charm, vitality, and vibrant baritone that made him a "star" even to non-opera-goers. He definitely had a way with pop material—there's no question that an operatic voice is at work, but his easy delivery, down-to-earth sincerity, and sheer vocal quality make these performances of *Tommy Lad*, *I Dream of Jeannie*, *Drink to Me Only with Thine Eyes*, and *Through the Years* more than mere curiosities. Also included is *The Rogue Song*, first heard in Tibbett's 1930 film of the same name, with a spoken introduction by the singer.

Ironically, the operatic part of this disc is less representative: first Tibbett ventures into tenor territory with "*Vesti la giubba*" (down a tone) and then helps himself to the bass's "*Le Veau d'or*" from *Faust* (up a half tone if the dubbing is correct). The latter scene actually begins with Wagner's truncated "Song of the Rat" and continues up to the Sword Chorus with Tibbett taking all the roles except Siebel. Both excerpts are sung to the hilt, but the baritone flavor sounds decidedly out of place. Side 2 seems to be a half-hour condensation for radio of Louis Gruenberg's *Emperor Jones*, an opera that Tibbett managed to sustain at the Met for two seasons in 1933-35. Most of the piece is spoken against a weak musical background—even O'Neill's dialogue is pretty hard to take nowadays. One listens primarily for Tibbett's skillful acting as he builds tensions by ingeniously maneuvering his voice from speech through half-song to full vocal outburst. It's quite a tour de force. For a more typical and consistent view of this singer though, try Rococo 5266 or RCA Victrola 1340. P.G.D.

B

LEONARD WARREN: "The Great Hits of a Great Baritone." **LEONCAVALLO:** *Pagliacci*: Si può? **ROSSINI:** *Il Barbiere di Siviglia*. Largo al factotum. **BIZET:** *Carmen*. *Notre Toast*. **GOUNOD:** *Faust*: Avant de quitter ces lieux. **OFFENBACH:** *Les Contes d'Hoffmann*: Scintille, diamant. **VERDI:** *Rigoletto*: *Pari siamo!*; *Cortigiani, vil razza dannata*; *Il Trovatore*: *Il balen del suo sorriso*; *La Traviata*: *Di Provenza*; *Un Ballo in maschera*: *Eri tu*; *Otello*: *Credo*. **PUCCINI:** *Tosca*: *Te Deum*. Leonard Warren, baritone; various orchestras and cond. RCA Victrola VIC 1595, \$2.98. (mono only) [from various RCA Victor originals, recorded 1941-57].

R

Warren was only a few weeks shy of his forty-ninth birthday when he collapsed and died on the stage of the Met during a performance of *La Forza del destino* on March 4, 1960. His rich, powerful baritone showed a few frayed edges that last year—even this sturdy instrument had trouble sustaining itself over two decades of steady singing and Warren was never one to stint.

All the better, then, that this collection concentrates on his earliest recordings, and as such the disc makes a fine companion to Victor's last Warren reissue (LM 2453) which contained material recorded in the Fifties. Aside from the *Otello* "Credo" and *Tosca* "Te Deum" (the latter clumsily excerpted from the 1957 complete set), all the items here date from the Forties and show the singer reveling in the easy production of a fat, warm, steady tone and a brilliant, ringing top. Virtually every selection is delivered in sheer vocal terms. Warren grew slowly as an interpreter, and his Verdi singing in this collection tends to be rather neutral while the French arias and Figaro's show-piece are unidiomatic to say the least. The voice is the thing though, and Victrola's reissue captures all of its natural beauty and robust vibrancy. P.G.D.

FELICIA WEATHERS: "Italian Opera Arias." **VERDI:** Aida: Ritorna vincitore!; I Vespri Siciliani: Mercè, dilette amiche; Il Trovatore: Tacea la notte placida . . . Di tale amor; Ernani: Ernani, involami. **GIORDANO:** Andrea Chénier: La Mamma morta. **PUCCINI:** Tosca: Vissi d'arte; La Rondine: Chi il bel sogno di Doretta. **CILEA:** Adriana Lecouvreur: Io son l'umile ancella. Felicia Weathers, soprano; Munich Radio Orchestra, Kurt Eichhorn cond. Telefunken SLT 43122, \$5.95.

Not a wise venture for this trim and talented lyric soprano who possesses a voice of winning clarity and timbre but only moderate power. What is she doing shopping over in the Matron's Department where everything is three sizes too big for her?

The anonymous writer of the sleeve notes points out (and with a sense of satisfaction yet) that five of the nine arias are from roles that Miss Weathers doesn't sing on stage. Nor should she sing them on disc, for she has neither the thrust nor the agility they need. There is a rudimentary trill, shown off in the *Vespri* piece and again in "*Ernani, involami*"; but the climaxes and most of the dramatic coloratura music gets faked or approximated. There is little sense of the word content in any of the songs and a general air of discomfort in most of them.

As might be expected, Miss Weathers does best in the two Puccini arias and the closing Cilea. Here she is on home ground, with no discomfort whatever and a chance to display the elegant sonorities she commands. The Chénier narration is also managed well, except for one moment above the stage. Mr. Eichhorn's work is discreet. G.M.

"THE WONDER OF THE AGE: MISTER EDISON'S NEW TALKING MACHINE." The story of sound recording 1877-1925 compiled from contemporary writings and illustrated by archive recordings. For a feature review of this historic recording, see page 84.

If one cassette could do it all, we'd only make one cassette.

When we first introduced the cassette a few years ago, one type of cassette did everything. Now, however, the cassette has grown up. You've found more uses for it. Some demanding greater range and frequency. Others which are just for fun. One cassette can't do it all anymore, and that's why we're introducing an entire line of cassettes. It takes four grades of tape: speech to symphony.

The Challenger: For voice recording and other work that doesn't demand wide range and frequency. A quality cassette . . . at a surprisingly low price. P.S. The Challenger is perfect for your children in school.

The Norelco 100: Here is a good all-around cassette for people who enjoy recording but don't want to spend the time and money for high fidelity. It comes with a factory lifetime guarantee.

The Norelco 200: This is the famous Norelco cassette that is the standard of the industry. It's perfect for fine music recording. The finest quality Low Noise tape most people will ever need. Of course, it comes with a factory lifetime guarantee.

The Norelco 300: This is the highest quality tape cassette we've ever designed. For those who demand sound perfection. It's a High Output-Low Noise cassette with extended frequency and dynamic range. Plus a factory lifetime guarantee. If you really appreciate fine quality sound, you'll love it.



Cassettes by the people who invented them. *Norelco*

North American Philips Corporation, 100 East 42nd Street, New York, New York 10017

CIRCLE 38 ON READER-SERVICE CARD

in brief

R **BARTOK: Suite No. 2, Op. 4; Dance Suite.** Minneapolis Symphony Orchestra (in the Suite); Philharmonia Hungarica (in the Dance Suite), Antal Dorati, cond. Mercury SR 90533, \$5.98 [the Suite from Mercury SR 90098, 1956; the Dance Suite from Mercury SR 90183, 1960].

An enjoyable disc. Neither orchestra may be a world-beater, but Dorati achieves a pair of colorful performances nonetheless, full of vigor and vitality. The Second Suite is especially well done, easily superior to its Qualiton rival, and the *Dance Suite* has all the requisite thrust and rhythmic definition. The sonics in both works are still remarkably vivid. P.G.D.

GRIEG: Sonata for Cello and Piano, in A minor, Op. 36. SCHUMANN: Fantasiestücke for Cello and Piano, Op. 73. Gilbert Reese, cello; Ralph Linsley, piano. Crystal S 134, \$5.98.

These West Coast musicians give the Grieg a vigorous, unaffected, idiomatic treatment. The playing is assertive and rhythmic, full of resilience, and with a welcome refusal to dwell unduly upon the lyrical second themes in order to give them more "significance" than they deserve. Perhaps the version of this piece by Rostropovich and Richter (on a semiprivate Parnassus issue) is conceived on a grander, more individualized scale than this, but in many ways the simple elementalism of Reese and Linsley seems more appropriate. In the Schumann, the playing remains expert and satisfactory, but I find tempos a bit dragged out and the phrasing somewhat indulgent. Actually, I feel that the cool, flowing sound of the clarinet is more poignant in this music (Schumann specified either alternative). Sharply etched, resonant sound and a good balance. H.G.

RACHMANINOFF: Concerto for Piano and Orchestra, No. 2, in C minor, Op. 18. Ivan Davis, piano; Royal Philharmonic Orchestra, Henry Lewis, cond. London Phase 4 SPC 21057, \$5.98.

A stiff, awkward, slow-moving and heavyhanded reading that fails by a wide margin to rise from the launching pad of mediocrity. Davis, in an overzealous and misdirected effort to combine brilliance with a singing line, fractures his phrases with all sorts of inhibited stop-go mannerisms and produces a sonority of almost unbelievable brittleness and petulance. Even the superluous engineering cannot soften the unpleasant truths told by the pianist's pistonlike digits. The interpretation, one might say, is penetrating: indeed, it goes right through your skull! H.G.

B **RIMSKY-KORSAKOV: Scheherazade.** Paris Conservatoire Orchestra, Ernest Ansermet, cond. Stereo Treasury STS 15126, \$2.98 [from London LL 1162, 1956].

HF's *Scheherazade* expert, R. D. Darrell, has often sung the praises of Ansermet's London recording in these columns, both for its colorful performance and high technical quality. Don't be confused by the present reissue on London's budget line—this performance is an earlier Ansermet version and a drab job by all concerned. The conductor's later Suisse Romande edition is still tops. P.G.D.

SATIE: "Piano Music, Vol. 5." Jack in the Box; Six pièces de la période 1906–1913; Prélude de la Porte héroïque du ciel; Musiques intimes et secrètes; Carnet d'esquisses et de croquis; Premier Menuet; Nocturnes Nos. 4 and 5. Aldo Ciccolini, piano. Angel S 36774 \$5.98.

If you think Aldo Ciccolini must be getting bored with Satie after having gone through four previous releases of the composer's inimitable piano music, then listen to his lulling interpretation of the diaphanous Nocturne No. 4 (which is marked *mystérieux et tendre*), with its strange and haunting progressions of open fifths. Not only is this a side of Satie one rarely hears, but it offers further proof of Ciccolini's extraordinary ability to fathom Satie's many styles. After the nocturne, try the marvelous bit of vintage Satie, *Jack in the Box*. Or the primitivistic chordal progressions of the *Prélude de la Porte héroïque du ciel*. Or the fascinating collection of bits and pieces assembled from various manuscripts by Robert Caby in the *Carnet d'esquisses et de croquis*. Few superlatives remain to be added to what has already been said about the Ciccolini/Satie recordings, save that the engineering on the present disc is by far the best, in spite of some extra hiss, of the five volumes. Satie always has something different to say, even if it is in a tiny nuance, and nobody says it for him better than Ciccolini. R.S.B.

STRAUSS, R.: Also sprach Zarathustra, Op. 30. New York Philharmonic, Leonard Bernstein, cond. Columbia M 30443. \$5.98. Tape: ●● MT 30443, \$6.98.

One might expect that Bernstein would give this music a highly charged performance to rival his former mentor Fritz Reiner. Nothing of the sort occurs. The playing is quite deliberate to the point of sluggishness, a considerable lapse in a score that needs a strong line and a firm sense of propulsion to keep everything rolling. Among the more recent versions, that of Henry Lewis and the Royal Philharmonic Orchestra remains the most notable. Lewis, moreover, is given quite spectacular sound. Considering the possibilities the music offers the recording engineer, the Bernstein album is distinctly run-of-the-mill. R.C.M.

B **TCHAIKOVSKY: Symphony No. 2, in C minor, Op. 17 ("Little Russian").** Paris Conservatoire Orchestra, Georg Solti, cond. Stereo Treasury STS 15120, \$2.98 [from London CS 6118, 1957].

Not one of Solti's more persuasive early stereo efforts. The performance is nervous and charmless, the French orchestra sounds tonally scrawny, and the sonics are claustrophobic. Since there is no other budget version of this symphony, Abbado's excellently played edition on DGG remains the choice. P.G.D.

CAMARATA CONTEMPORARY CHAMBER ORCHESTRA: "Through a Looking Glass." SATIE CAMARATA: Gymnopédie; Gnossiennes Nos. 4, 5, and 6; Le Fils des étoiles: Prelude to Act I; Prélude de la Porte héroïque du ciel; Sarabandes Nos. 2 and 3; Through a Looking Glass; Parade. SATIE-POULENC: Deux préludes posthumes. Deram DES 18052, \$4.98.

The only things worth listening to on this release are the sumptuously recorded Poulenc-orchestrated *Deux préludes posthumes*. But since these are already available on the excellent Abravanel/Vanguard "Homage to Satie," there is certainly no good reason to buy this disc. Camarata's "orchestrations" of the other pieces are irretrievably mushy, while his cinematic collage, "Through a Looking Glass," grates in every possible way. As for the bloated reworking of *Parade*, Camarata justifies this in a series of "when-I-hear-this-it-makes-me-think-of" liner notes. What Camarata probably heard was ringing cash registers taking in money from people naive enough to think this record is "mod." It is even a loss as a demonstration disc, since most of the extraneous noises (from 100 men reciting the Lord's Prayer to an atom bomb . . . an atom bomb?) sound as if they were taken from 78-rpm sound-effects records. Even the "rock" insert is strictly pre-Bill Haley. R.S.B.

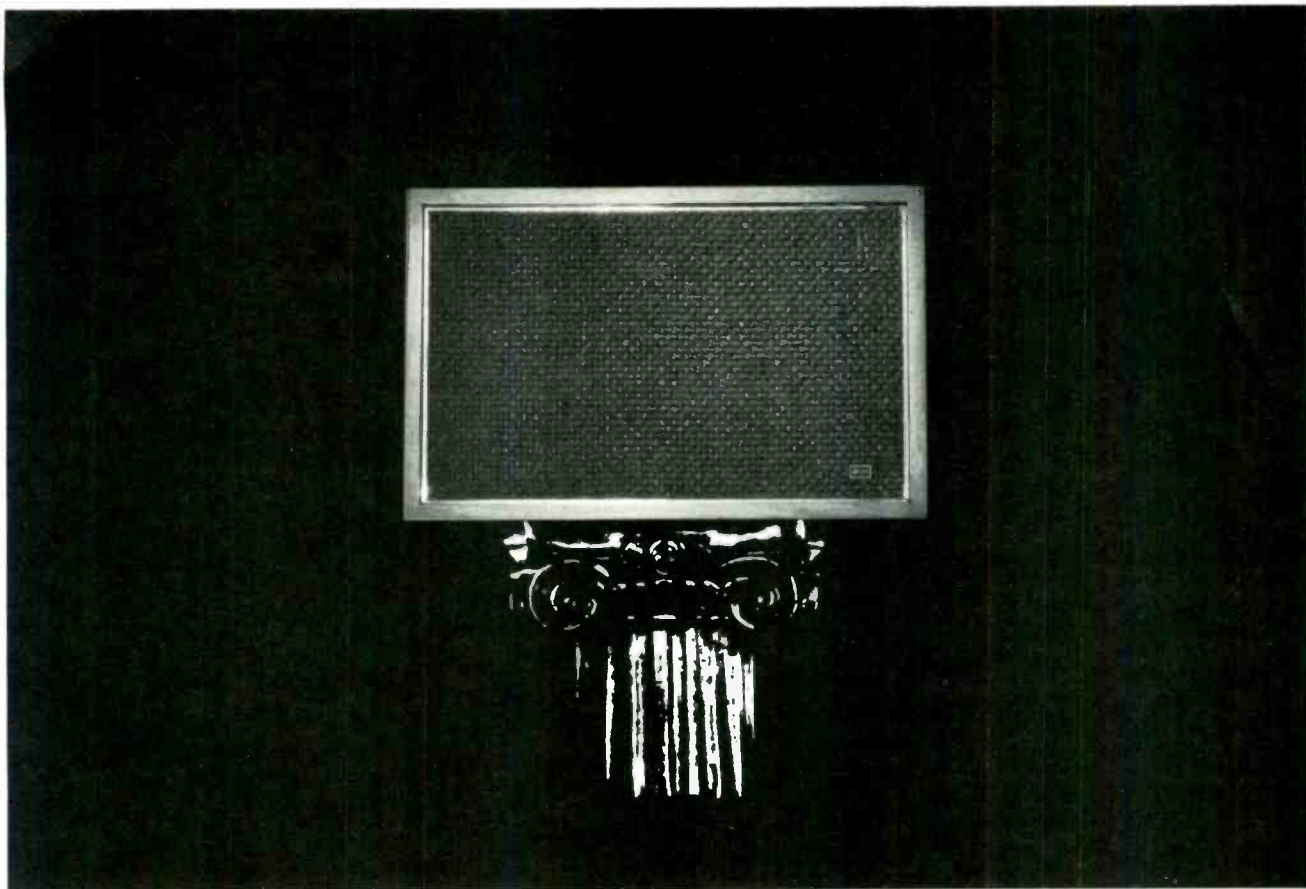

No need to Compromise

Bozak Quality Costs Very Little More

Of course you can always trade-in for a TEMPO 1, later. — But why?

When you buy a first-rate stereo system, you expect first-rate sound — rich, vibrant bass, smooth crystal-clear strings and voices, the open flow of all the music without tonal coloration.

For very little more you can have it to start with — in a Bozak TEMPO 1.

TEMPO 1 inherits the superior qualities of its larger ancestors. It is a true Bozak in every way. Every part that could make the slightest tonal difference is made only at the Bozak factory. Bozak, for example, is one of the very few manufacturers who make all of their own loudspeaker cones rather than settling for commercially-available units.

This fine three-way bookshelf loudspeaker has the same costly drivers found in the most luxurious Bozaks. The variable-density bass cone, developed by Bozak, is made from a unique highly-damped material processed into a lightweight but structurally-rigid piston that is free of coloration. In the midrange

speaker there is a critically-damped aluminum cone with excellent transient response. The entire diaphragm of the treble speaker, of thin spun aluminum, rests on a bed of soft resonance-damping foam. All cones, together with their generous ceramic magnets and precision-machined pole structures, are assembled on solid cast frames — not sheet-metal stampings.

Bozak's traditional excellence in craftsmanship is further apparent in the smart enclosure, where the warm beauty of select wood grain is brought out by careful hand finishing.

Quality tells. TEMPO 1 gives you rich big-Bozak sound from a superbly engineered bookshelf system. The longer you live with this fine speaker the more you will appreciate what a difference true quality makes.

Not every dealer is permitted to sell TEMPO 1. If you can't locate your authorized Bozak Dealer, write for our list of the fine audio showrooms in your area. The R. T. Bozak Manufacturing Company, Darien, Conn. 06820, USA. Overseas Export by Elpa Marketing Industries Inc., New Hyde Park, New York 11040, USA.





symbol denotes
an exceptional recording

the lighter side

reviewed by

MORGAN AMES

R. D. DARRELL

JOHN GABREL

MICHAEL JAHN

JOHN S. WILSON



BLOOD, SWEAT & TEARS: B, S & T 4. David Clayton-Thomas, lead vocals and guitar; Lewis Soloff, trumpet, flugelhorn, and piccolo trumpet; Chuck Winfield, trumpet and flugelhorn; Dave Barger, trombone, tuba, bass trombone, baritone horn, and acoustic bass; Fred Lipsius, alto saxophone, piano, organ, and clarinet; Dick Halligan, organ, trombone, piano, and flute; Steve Katz, guitar, harmonica, mandolin, and vocals; Jim Fielder, bass and guitar; Bobby Colomby, drums and percussion; Don Heckman, clarinet and bass clarinet; Michael Smith, congas. *Go Down Gamblin': Redemption; Mama Gets High*; nine more. Columbia KC 30590, \$5.98. Tape: ●● CR 30590, 7½ ips, \$6.98; ●● CA 30590, \$6.98; ●● CT 30590, \$6.98.

This is undoubtedly one of BST's better efforts, ranking only slightly below the group's dynamic second LP, "Blood, Sweat & Tears," in over-all imagination and drive. Of the twelve songs, ten are originals by band-members. These include several uptempo ravers designed for the outraged blues-holler voice of David Clayton-Thomas: *Go Down Gamblin'*, *Redemption*, and *Mama Gets High* are prominent among them. *Go Down Gamblin'* is a high-speed blues featuring Clayton-Thomas playing guitar for the first time with the band. Since he is such a good blues guitarist, you might think that he would not fit into the smooth jazz-rock of *Blood, Sweat & Tears*. But in this case—the first time the group has had a really prominent guitar—it works perfectly, a welcome change for the band. *Mama Gets High* is a semi-Dixieland number, which is perhaps prophetic of a shift toward Dixie influence by some rock musicians. *Redemption* is the band's open-end, improvisational song, running just over five minutes and encompassing some of the most exciting, spontaneous music heard from the group.

There are several good slow songs: *Cowboys and Indians* begins as a charming piece about a city kid pretending to be a cowboy. It ends with a message about the treatment of Indians in this country, turning the charming quality

into a slight shiver. *Lisa. Listen to Me* is a touching, dynamic love song. There are others of note, including three dramatic songs written by Steve Katz, one of which (*Valentine's Day*) he sings himself. The only points that fall short are the two nonoriginal songs, *Take Me in Your Arms* by the Isley Brothers—the heavy rhythm doesn't seem to blend well with the band's almost delicate horns—and *John the Baptist (Holy John)* by Al Kooper and Phyllis Major, which just doesn't gel.

Over-all, this LP is tight, well-structured, and bold. And again, as BST has done so many times, it proves that you do not have to sacrifice musicianship in order to rock hard. M.J.

BRAVE BELT. Hard rock quartet. *Lifetime: I Am the Man; French Kiss; It's Over; Holy Train; Scarecrow*; six more. Reprise 6447, \$4.98. Tape: ● M 86447, \$6.95; ●● M 56447, \$6.95.

THE HOLY MODAL ROUNDERS: Good Taste Is Timeless. Folk-rock sextet. *Boobs a Lot; Melinda; Generalonely; City Blues; Once a Year; Black Bottom*; six more. Metromedia MD 1039, \$4.98.

PAPA NEBO. Hard rock septet. *Lazy Day; Live in Missouri; Judson Queen; Smooth Pat; Feel It Inside*; six more. Atlantic SD 8280, \$4.98.

SIMPSON. Hard rock quartet. *100 Much Help; Take in Your Own; Cemetery Hill; Crime and Misfortunes; Black Betty; Mama, on My Way*; six more. Columbia C 30476, \$5.98.

Three albums by new groups, and one that might as well be called new. *Brave Belt* is headed by Randy Bachman, former lead guitarist of the Guess Who. As with his former group, this band's music is influenced by West Coast groups—the Byrds this time instead of the Doors and the Airplane—with a good admixture of Canadian gentleness and cool. All the songs, by Bachman or vocalist/keyboardist Chad Allan, are marked by solid melodies and lyrics that rework a lot of the favorite pop clichés (*I Wouldn't Trade My Guitar for a Woman, Rock and Roll Band*, etc.). Fans of the Guess Who and anyone else who likes high-level bubble-gum will dig the album.

The Holy Modal Rounders have been around for ages, in the persons of Steve Weber and Peter Stampfel, putting out scruffy little albums of homemade folk music; but since this is their first outing with this personnel and on this label, and with a format that they clearly imagine has mass appeal, this effort deserves a spot among first albums. Which is about all it deserves. The disingenuous attempt to disarm criticism with the title fails to mask the numerous lapses of taste that grace the album, especially the sophomoric humor of *Boobs a Lot*. In the rest of the numbers a pretentiousness has crept in where before there was only charm and good fun. It ain't 1962 any more.

Papa Nebo is best on Poco-like rocking country, worst on straight rock. The most

frequent lead vocalist, probably Michael Packer, has a grating voice that doesn't grow on you; but the septet's instrumental work—especially Ann Leathers' violin and Bob Mintzer's reeds alone and in combination—is very good. Packer and guitarist Brenden Markin each write pleasant songs, especially as showcases for the band, and when the several vocalists are singing together they get a very nice sound. This is a good rousing set; if they hold together, the second release should be terrific.

The new band led by vocalist/songwriter/keyboardist Bland Simpson also draws much of its inspiration from c & w, especially the leader's Nashville-inspired piano. Simpson's songs are only slightly better than average, but he receives excellent support from his three sidemen, especially guitarist David Olney, and studio men Bill Keith and Eric Weissberg. Simpson is a group to watch. Yeah, another one. J.G.

THE MOTHERS: The Worst of The Mothers. The Mothers, vocals and rhythm accompaniment; *Motherly Love; Mom and Dad; Flower Punk*; seven more. MGM SE 4754, \$4.98.

People don't appreciate The Mothers (of Invention). They don't dare. The group's outrageousness reaches dizzying proportions. They mock not only the establishment but also the youthful fans who love them. In a way, they are doing the job that many parents don't know how to do—restoring perspective by reminding the kids that they can be as foolish as the old folks.

No one is safe from The Mothers. It can be argued that such profound irreverence is its own defeat. On the other hand, it is insanely refreshing in the face of countless idiot albums in every field of pop music.

All the music is written by group-founder Frank Zappa, a self-acknowledged madman (and incidentally, a keen producer and formidable businessman). Zappa likes to write in the '50s' style, a particularly stupid era of music as displayed in such songs as *Status Back Baby* ("I'm losing status at the high school, I used to think that it was my school"). Zappa is a genius at titles. New songs include: *Flower Punk, Take Your Clothes Off When You Dance, Wowie Zowie, and Help I'm a Rock*. Past album titles include: "Burnt Weeny Sandwich," "Hot Rats," "Weasels Ripped My Flesh," and "We're Only in It for the Money."

For all Zappa's madness and sometimes meanness, he is a beautiful writer. What's more, every member of the group is an excellent musician. It is one thing to quarrel with what The Mothers do—but only the deafest and/or most bigoted will question the professionalism with which the dastardly deed is done. All Frank Zappa albums require intensive listening. He works neither for the weak-



Arthur Fiedler and his Boston Pops are here again in exhilarating form.

stomached nor the lazy-headed, types to be found among both young and old. Zappa tests us.

Try this album. See if you're as open-minded as you think you are. See if your sense of humor about yourself and the world is authentic or restricted. The Mothers make an entertainment of alienation and are thus pop music's most accurate reflection of the times we try to live in. They are one of a kind, and we need them. M.A.



ARTHUR FIEDLER: Encore! (Fiedler's Greatest Hits). Boston Pops Orchestra, Arthur Fiedler, cond. Polydor 24-5005, \$5.98. Tape: ● 8S5 005, \$6.98; ●● CS5 005, \$6.98.

Skip the mostly lugubrious first half of Side 1 unless you want to believe that Honorary Chief Fiedler has been chasing so many fires lately that he's lost his zip. He livens up in the following: *Do You Know the Way to Santa Fe*, the Israeli *Hava Nagila*, and a reprise of the *Aquarius* from an earlier *Hair* medley. Everything is arranged with characteristic skill, if not any special imagination, by Richard Hayman, and recorded in the same impressively big, Pops-authentic sonics achieved by the American-producer/German-engineers team in the "Fiedler's Broadway" release of last December. But throughout this first side there is some annoying background noise that I'd be inclined to ascribe to built-in amplification "roar" rather than a disc-processing flaw if it were not for the fact that it disappears entirely on Side 2.

In any case, the real musical, as well as executant and technological, attractions are concentrated in the second side. Fiedler is in his most exhilarating form in thrillingly bravura readings of the high-powered Ginastera *Malambo*. Sousa *Stars and Stripes Forever*, and Khachaturian *Sabre Dance*. And for effective contrast he proffers also Leroy Anderson's toe-tickling medley of Richard Rodgers' waltzes and one of the most mellifluously seductive *Blue Danubes* one is ever likely to hear on or off records. R.D.D.



SHA NA NA. Scott Powell, Jonny Costardo, Frederick Greene, Don York, and Rich Joffe, vocals; Elliott Cahn and Chris Donalds, guitars; Bruce Clarke, bass; Screamin' Scott Simon, piano and bass; Jon Bauman, piano; Lennie Baker, saxophone; Jocko Marcellino, drums. *Yakety Yak*; *Jailhouse Rock*; *Tell Laura I Love Her*; *Rock & Roll Is Here to Stay*; *Top Forty of the Lord*; nine more. Buddah 2034, \$5.98.

Sha Na Na is the Columbia University-spawned band that performs 1950s' rock songs complete with clothing and choreography from the period. Side 1 of their second LP is a live recording and is fascinating for its blend of frenzied old rock songs with the reactions of a frenzied audience. The group's versions aren't always perfect, but considering that the point of their act was always more visual-emotional than strictly musical, this record captures their flavor amazingly well. Side 2 consists of six original songs, studio-recorded, most of them falling into a mainstream, pop-rock vein (non-Fifties). The outstanding tune is *Top Forty of the Lord* ("Are you on the Top Forty of your Lordy, Lordy, Lordy?"), a satirical country-and-western song. This is excellent, and even rivals some of the classical overdone country songs, such as the little-known but stunning *There Ain't No Instant Replay in the Football Game of Life*. This LP does show that Sha Na Na has more going for it than greased hair and momentary amusement. Side 1 is really a great deal of fun, and *Top Forty* alone is worth the price. M.J.

THE HUMBLEBUMS: Open Up the Door. The Humblebums, vocal duo; rhythm accompaniment. *My Apartment*; *Steamboat Row*; *Mother*; *Cruisin'*; *Oh No*; *Harry*; *Shoeshine Boy*; seven more. Liberty LST 7656, \$4.98.

GORDON LIGHTFOOT: Summer Side of Life. Gordon Lightfoot, vocals and guitar; rhythm accompaniment. *Miguel*; *Go My Way*; *Redwood Hill*; *Cabaret*; *Cotton Jenny*; five more. Reprise MS 2037, \$5.98. Tape: ● 8XT 765, \$6.95; ●● 4XT 765, \$6.95.

BOB LIND: Since There Were Circles. Bob Lind, vocals and guitar; rhythm accompaniment. *City Scenes*; *Loser*; *Anymore*; *Spilling Over*; *Love Came Riding*; six more. Capitol ST 780, \$5.98.

It is probably a personal failing, but I continue to find myself attracted to releases that come out of what used to be known as the folk-rock bag. The Humblebums, for example, are British folk-rockers whose sound falls somewhere between the Sarstedt brothers and Cat Stevens. Their songs all combine interesting lyrics, usually with a story line, and sprightly melodies—and what a treat to get a new album with seven tunes to a side, 22:30 and 20:05.

With "If You Could Read My Mind," Gordon Lightfoot finally began to achieve some of the fame and riches that he has deserved for so long. More than almost any other pop musician, certainly more than most artists denied recognition, Lightfoot has maintained a steady, reliable course amid the twists and turns of popular taste in the last decade. His new album is not going to disappoint the new fans he picked up with the single nor those who have been with him all along. Recorded in Nashville, "Summer Side of Life" is one of the strongest efforts of his career. Although none of the songs immediately springs out as singles material, all of them are rewarding. Lightfoot's vocalizing receives solid support not only from Red Shea, his regular guitarist, but from such Nashville heavies as Chip Young, Charlie McCoy, Kenny Buttrey, etc., etc., etc. If you dig Lightfoot, don't miss this one.

Bob Lind is another in that long, long line of rock-and-rollers who have tried to get "back to the roots" after a period (often short-lived) of commercial success (in Lind's case, *The Elusive Butterfly of Love*). Although one is inclined to sympathize with his situation, this album could have been better. It is overproduced, Lind's songs sound half-written with good ideas (some of them) half-realized, and his singing tends to go off key every once in a while. Lind obviously has talent but he has yet to really get down and get it on. Too bad. J.G.



LOUDON WAINWRIGHT III: Album II. Loudon Wainwright III, vocals, guitar, and piano. *Motel Blues*; *Nice Jewish Girls*; *Be Careful*; *There's a Baby in the House*; *Saw Your Name in the Paper*; *Samson and the Warden*; seven more. Atlantic SD 8291, \$4.98.

His voice is high and raspy. His guitar playing is sparse and a bit desolate. Lyrically, Wainwright resembles Leonard Cohen—less dramatic in his imagery perhaps, but pregnant with the same glorious isolation from the everyday, take-it-for-granted playthings of man. He mixes sharp insights with droll frivolity and blank portraits of his surroundings in a way that is ever fascinating. For example, there's "Be careful, there's a baby in the house/And a baby will play for real/If your 'I love you' is an I.O.U., don't expect to get a good deal."

Motel Blues and *Plane, Too* are clinical descriptions of surroundings. *Nice Jewish Girls* and *Samson and the Warden* are light numbers, the first about the fatal attraction of Jewish girls for an Episcopalian youth; the latter about being arrested and having one's long hair cut. *Saw Your Name in the Papers* is a

restatement and elaboration on the theme dealt with by Phil Ochs in his *Chords of Fame*—the drive toward stardom and its attendant problems.

Loudon Wainwright III is the latest in the fashionably bored school of contemporary folk song. His concerts are marked by extreme facial contortions, tongue-lolling, and by a string of giggles and odd smiles, all of which play off well against the desolate, boring world he sees. This exceptional LP should be heard, listened to closely, and appreciated for its extremely good word slinging. M.J.

* **ROD STEWART:** Every Picture Tells a Story. Rod Stewart, vocals; rhythm accompaniment. *Reason to Believe*; Man-

dolin Wind; *That's All Right Mama*; *Maggie May*; four more. Mercury SRM 1-609, \$5.98. Tape: ● MC8 1-609, \$6.95; ●● MCR4 1-609, \$6.95.

* **STEVIE WINWOOD:** Winwood. Stevie Winwood, vocals, guitars, and keyboards; rhythm accompaniment. *Crossroads*; *I'm a Man*; *Paper Sun*; *Dealer*; *Sea of Joy*; *Keep on Running*; fifteen more. United Artists UAS 9950, \$5.98 (two discs). Tape: ● 04002, \$7.98; ●● C 7002, \$7.98.

In differing ways, these two albums attest to rock's continuing vitality. Rod Stewart's third album, "Every Picture Tells a Story," demonstrates once again that the *longueurs* with which we have been afflicted of late are not the

fault of the form, but stem rather from too little talent or effort on the part of most people making records. And "Winwood" offers a rare opportunity to examine closely the whole career of an important rock exponent.

Stevie Winwood was only eighteen when he burst upon the scene in 1966 as lead singer and guitarist of the Spencer Davis group. *Keep on Running*, *Somebody Help Me*, *Gimme Some Lovin'*, and *I'm a Man*, with Winwood's tentative, blues-edged vocals and funky instrumental work, gave AM radio in the period some vital raunch that otherwise would have been missing amid the flowering of acid and ars rock. Stevie must have felt confined in the down-homey limitations of Spencer Davis, because he struck off and into two supergroups, the much underrated Traffic, and the much overrated Blind Faith. He then made short stays in Ginger Baker's Air Force and as one of Joe Cocker's friends, and put in an appearance on record with Leon Russell before turning up with the reconstituted Traffic. All phases of his career are represented on this two-record set, some mercifully more than others. Most of the material, quite rightly, comes from the Spencer Davis and Traffic days. To one who has never been an especial Winwood fan—I find his voice a bit grating over the long haul—the album came as a pleasant surprise. By selecting (for the most part) his best efforts, sometimes from otherwise dreary albums, the producers have done the artist and the audience a considerable favor.

By now one is at a loss for words to describe Rod Stewart. His skills as a producer, and taste as a performer, have become so predictable that it would be news if he had made a bad album instead of another good one. Guitarist Ron Wood is on board again, and as usual Stewart's other sidemen are impeccable. The material includes three originals, a Motown number, Tim Hardin's *Reason to Believe*, Arthur Crudup/Elvis Presley's *That's All Right Mama*, and Dylan's *Tomorrow Is Such a Long Time*. Another weird cover. A great LP. J.G.

ALBERT KING: Lovejoy. Albert King, vocals and guitar; rhythm accompaniment. *Bay Area Blues*; *Corina Corina*; *Lovejoy, III*; *Going Back to Luka*; five more. Stax STS 2040, \$4.98.

FREDDIE KING: Getting Ready. Freddie King, vocals and guitars; rhythm accompaniment. *Same Old Blues*; *Dust My Broom*; *Going Down*; *Tore Down*, *Five Long Years*; five more. Shelter SHE 8905, \$5.98.

MEMPHIS SLIM: Blue Memphis. Memphis Slim, vocals and piano; rhythm accompaniment. *Chicago*; *Handyman*; *Boogin' and Bluesin'*; *Wind Gonna Rise*; *Mason Dixon Line*; eight more. Warner Bros. WS 1899, \$4.98.

I have never been much of an Albert King fan, but even I was surprised at how "Getting Ready" by Freddie King (usually considered an easy third to B.B. and Albert) topped Albert's "Lovejoy." Part of Albert's problem is his uninspired vocalism, but producer and arranger (?) Don Nix has compounded the trouble. For one thing, he has had Albert do mostly Don Nix compositions—which you probably didn't know he wrote *Corina Corina*—a pretty trite and mediocre lot, and has surrounded him with musicians who, at least on this trip, don't earn their keep.

Freddie King's album is another matter

INCREDIBLE DISCOUNTS AT CAMBRIDGE CAMERA

"World-Famous Photo Mail Order House And Retail Center"

**AT 21 WEST 45th STREET
NEW YORK, N.Y. 10036**

on the world-famous "Audio Alley" of New York City, on West 45th Street! On the same block that houses the most respected stores of the Audio Industry: Lafayette, Heathkit, Harvey Radio . . .

MAIL YOUR CHECK WITH ORDER—VISIT OUR STORES—OR ORDER C.O.D.!

BRAND NEW SPECIALS!



Honeywell Pentax Spotmatic II 1.8	224.95	Olympus 35EC with case	59.95
same with 1.4	244.95	Olympus 35RC with case	69.95
Mamiya 500 DTL with f2 and case	124.95	Pentax Spotmatic f2	169.95
Mamiya 1000 DTL with f1.4 and case	164.95	Canon FTB 1.8 with case	229.50
		Canon F1 with 1.4	399.95
		Minolta SRT 101 f1.7	164.95
		Sawyers 550R Projector	49.95

BRAND NEW NIKON F PHOTOMIC TN with 50/2 Auto Nikkor 278⁹⁵

Nikon F Photomic TN with 50/1.4 Auto Nikkor	324.50	Nikkormat FT body	137.50
Nikon F Photomic TN w/55 1.2 Auto Nikkor	359.50	50/2 AUTO NIKKOR	197.50
NIKON F PHOTOMIC TN BODY	218.50	Nikkormat FT 50/1.4 Auto	239.50
		Nikkormat FT 55/1.2 Auto	274.50



BRAND NEW KONICA AUTO REFLEX-T2 OUTFIT 184⁹⁵

- 1.8 lens, case, strap, pad, lens brush, skylite filter
- Same with 1.4 lens . . . add 20.00

KOWA SETA-2, 1.8 w case	83.50
MECABLITZ 196	64.95
BAUER E-160 AUTOBLITZ	49.95
BAUER E-200 AUTOBLITZ	59.95
Kako Hi-Beam II	17.95
Capro FL-5 Strobe	13.95
Capro FL-7 Quick Charge	32.95
Durst M301, 50mm	64.95
B&H/Canonet QL-1.7, w/case & Canon electronic flash	\$97.50
Camecon Wireless Remote Control	29.95

ALL BRAND NEW MIRANDA SENSOREX OUTFIT

With 50/1.8 Auto Miranda, deluxe case, 135/2.8 tele Lens, 35/2.8 wide angle lens, 2 lens cases, Lens shade, electronic flash and flash bracket. All for 209.95

10 Piece KONICA AUTO S-2 Outfit \$799⁹⁵

- Camera • Case • Strap • Shoulder Pad • Flash • Bracket • Cable Release • Plus X-36 Film • 2 Lens Tissues

10 pc. MINOLTA HI-MATIC 11 Outfit	82.95	10 pc. EKAKTA VX-500 f/2.8 AUTO SLR Outfit	49.95
10 pc. MINOLTA HI-MATIC 7-5 Outfit	72.95	10 pc. MAMIYA 1000-DTL f/1.8 SLR Outfit	144.95
10 pc. YASHICA ELECTRO TLX-1.7 SLR Outfit	144.95		

(All 10 piece outfits include same items as in Konica Auto S-2 outfit above)

Please! Write for our quotes on thousands of other specials. We promise to send you our lowest possible prices on brand new, latest, high quality brands.

WRITE TODAY—DON'T DELAY—YOUR LETTER IS ANSWERED WITHIN A DAY!

FRESH FILMS SPECIALS!

10 Rolls of Fresh Film of:	
• KODACHROME II or X 135-36 exp. with Kodak Processing and Mtg.	33.65
• KODACHROME II or X 135-20 exp. with Kodak Processing and Mtg.	24.80
• KODACHROME II Super 8 with Kodak Processing	33.85
• AGFACHROME CT 18 135-20 exp. with Agfa Processing and Mtg.	20.90
• AGFACHROME CT 18 135-36 exp. with Agfa Processing and Mtg.	30.94
• ANSCOCHROME ASA 500 70 with Anaco Process & Mtg.	32.50
• 10 pkg. C-120 Cassettes	7.50
• 10 pkg. of flash cubes	7.50
• 10 pkg. of X magcube	11.90
• 10 pkg. Polacolor 108 film	38.50

CAMBRIDGE INC.

*21 West 45th St., N.Y., N.Y. 10036
Between 5th & 6th Ave. Tel: 212-245-8050
9-6 Daily—Sundays 10-3

- ORDERS are promptly shipped.
- If you don't see it advertised . . . please WRITE for a discount quote on the equipment you desire.
- C.O.D. Mastercharge. BankAmericard.
- DOWNTOWN RETAIL STORE: 45 Seventh Ave., N.Y.C. 10011. between 13th & 14th Streets. Tel.: 212-675-8600.

entirely. Don Nix had a hand here too, but I suspect a minor one, since the coproducer is Leon Russell and the album is marked by the considerable care that he has taken in past production efforts. Also, despite four Don Nix tunes (two cowritten with Russell), the material is much better, including songs by Elmore James, Big Maceo, Eddie Boyd, Bill Broonzy, and King himself. And although Freddie isn't as accomplished a player as Albert, he is more direct and emotional, and his singing really has his heart in it. "Getting Ready" is easily Freddie King's best LP and one of the best blues records of the year.

On "Blue Memphis" Memphis Slim pulls off a blues autobiography, something that has very rarely, if ever, worked before. Usually such efforts are too cute and lack depth and variety, but Slim makes it all convincing verbally, and he comes up with a number of expressive melodies. Side 2 features several new compositions, mostly first-rate, including one called *Chicago Seven* that ironically describes the furor raised over the harassment of a few whites while the same and worse happens to black people every day. The album was recorded in England and Slim profits from the presence of such veteran British rockers as Peter Green, Chris Spedding, Duster Bennett, and John Paul Jones. Slim seems to have been up for the sessions and there is more fire here than I remember ever having heard from him. A fine and memorable album. J.G.

RANDY SPARKS: Hazy Sunshine. Randy Sparks, vocals and guitar; unidentified arranger, chorus, and musicians. *Mountains of Glass: Gypsy Woman; Bremerton*; nine more. MGM SE 4759, \$4.98.

Remember Randy Sparks? He dreamed up the New Christy Minstrels during the folk boom and later sold them for an incredible amount of money.

When the naive folk period of the Fifties and early Sixties gave way to rock, Sparks had a rough time. He was comfortable writing songs about bows and ribbons, checkered shirts, and nice folks, singing them in his clear and simple tenor. The new music, ultrapersonal and aimed embarrassingly at people's true feelings, left Randy high and dry. Through the years Sparks made an occasional album, aimed at a Kingston-Trio type of audience that was no longer there. But Randy Sparks has a tenacious kind of personality. He doesn't like to let go. Here he is again, having done enough homework to find his way in the back door of the present market. Sort of.

A few of his songs have a certain personal depth, particularly the gentle *And I Love You* and *Whiskey*. One begins to wonder if Randy is getting interested in internalizing his music after all. But then there are the other songs, retreating to the old familiar ain't-it-fun-folks attitude—only a surface swipe at real issues. Some performers tend to feel safest and best in their early roles, leaving experimentation to newer artists. So we hear *A Song of Hope*: "Don't tell me, friends, what's wrong with this world; let's make it a better place." A most revealing line. How does one improve things if one cannot say what's wrong? But that's not Sparks's department. He sees his place as revving up Hope and getting on to the next song.

It is true that Sparks has something of a new look in this album. It is largely due to the use

Lowest of the LOW!

Shamelessly Low Prices . . .

As one of America's largest wholesale distributors, we're guilty of shamelessly low prices. Our buying volume has made our prices the lowest. We seriously doubt you can find one lower . . . and that we're proud of. What's more, at S.C.A. you can select from hundreds of NEW, Factory Sealed, Full Warrantee, Brand name, Hi-Fi Stereo components. If its in the Hi-Fi, Audio field . . . we have it!

Write for a lowest of the low quote . . . we're not ashamed.



STEREO CORPORATION of AMERICA



2122 UTICA AVENUE, BROOKLYN, NEW YORK 11234 (212) 338-8555

CIRCLE 56 ON READER-SERVICE CARD

USE THIS FORM FOR CHANGE OF ADDRESS OR TO SUBSCRIBE

Please include a High Fidelity address label to insure prompt service whenever you write us about your subscription.

Mail to: High Fidelity
Subscription Service
P.O. Box 14156
Cincinnati, Ohio 45214

To subscribe mail this form with your payment, and check:

- new subscription
 renew my present subscription

Subscription rates in the United States, its Possessions and Canada 1 year, \$7.95; 2 years, \$14.90; 3 years, \$20. Subscription rates for all other countries available on request.

ATTACH LABEL HERE

CHANGE OF ADDRESS

If you're moving, please let us know six weeks before changing your address. Place magazine address label here, print your new address below. If you have a question about your subscription, place your magazine address label here and clip this form to your letter.

name

address

city

state

zip code

SAVE NOW

On World Famous
Ferrograph series 7

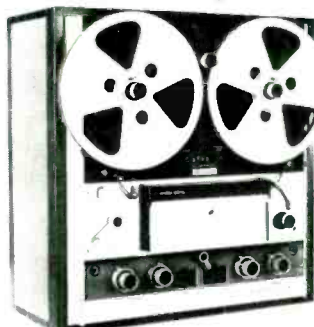

Mfg's fair trade \$650.

Special purchase

Allows you fantastic savings.

Write for special quotation.

Trade-ins accepted.

Write for reviews

AAE Asher Audio Equipment
2122 Utica Avenue, Brooklyn, N.Y. 11234

CIRCLE 57 ON READER-SERVICE CARD

you're shopping discounts because you want the most system for your money.



KOSS AR INC. DYNACO SHURE

Before you buy, be sure to check our price list. You'll be glad you did.

Write us for our new catalog including bulk tape prices, DEPT. F, or check our number on the reader service card.

Boston AUDIO COMPANY

1 Discount Drive, Randolph, Mass. 02368
(East Randolph Industrial Park.)

CIRCLE 58 ON READER-SERVICE CARD

BALTIMORE

STEREO

W
HOLE-
SALERS

Now, from the comfort of your home you can buy almost any Stereo Component at Special Discount Prices, from one of the East Coast's Leading Wholesalers...Your order shipped promptly in factory-sealed cartons. Write for quote today.

118 BALTIMORE-ANNAPOLIS BLVD.
GLEN BURNIE, MD. 21061
(301) 323-6233

CIRCLE 14 ON READER-SERVICE CARD

HI-FI
COMPONENTS
TAPE
RECORDERS

TAPES, ACCESSORIES
SLEEP LEARN KITS
MERITAPE

SAVE MONEY

- LOWEST PRICES
- INTEGRITY • SERVICE
- FRANCHISED DISTRIBUTORS

WRITE FOR OUR VERY LOW
PACKAGE QUOTATIONS
Nationally Advertised Brands
Factory Sealed Cartons

Write for **FREE CATALOG**
Visit Our Showrooms

DRESSNER

1523-K JERICHO TPKE.
NEW HYDE PARK, N. Y.
11040

of a rock-oriented rhythm section. But no credit is given—neither arranger, chorus, nor musicians.

Essentially Sparks is still in the same place: his pleasant, floaty voice is still in good shape; his melodies are based on the same few folk-chord changes; his lyrics are sunny and shallow and occasionally good.

And the beat goes on. M.A.

* **JONI MITCHELL:** Blue. Joni Mitchell, vocals, dulcimer, guitar, and piano; rhythm accompaniment. *All I Want*; *Little Green*; *A Case of You*; seven more. Reprise MS 2038, \$4.98.

Thank you, Reprise, for the bright and gentle light of Joni Mitchell. She is an artist for whom I stop everything else, turn up the stereo, and sit with album in hand in order to read the printed lyrics as she sings. Miss Mitchell's words are hard to catch. It's a minor flaw.

This is Joni Mitchell's fourth album. Once again she gives all, leaving herself no place to hide. She writes, sings, plays, with only an occasional hint of outside help. Thus the listener receives an intimate portrait. It leaves me wondering how she can do it all again next time. How will she change and how will she stay the same? Will the new balance of growth be as pleasing as the last?

Yes. Again Miss Mitchell has expanded without altering her essence. Her new songs are even more personal. They are also more wordy, with lyrics sprawling gracefully across the artist's singular sense of harmonics. Melodies are less important this time. The impact has more to do with the relation of thoughts to harmony and rhythm. A few of the songs, such as *Little Green*, sound as if they were written some time ago in a more ethereal mood.

Miss Mitchell's voice sounds even younger and more pure. At the same time, she takes more chances with it now, jumping around vocal octaves with amazing accuracy, balancing long groups of words in one breath, alternately tightening and releasing her rhythmic sense. Miss Mitchell makes extensive use of the dulcimer in this album. The instrument was made for her by a friend and she has learned to make more music with it than one would have thought possible.

Several new musical influences show up. James Taylor plays guitar on three tracks, and other friends make occasional backup contributions: Sneaky Pete (pedal steel guitar), Stephen Stills, and Taylor's drummer, Russ Kunkel. Several tracks feature Miss Mitchell's voice and piano playing only.

Joni Mitchell's songs have gotten sadder and her music has gotten freer. While she is no more or less troubled in life than most of us, she is in rare creative touch with her pain, her questions, and her joys. If you don't have any of her albums, start with this one and work your way backward. But don't deny yourself a trip through Joni Mitchell's world. M.A.

AMBROSE AND HIS ORCHESTRA. *Half Caste Woman*; *You're Blasé*; *When Your Lover Has Gone*; eleven more. Monmouth-Evergreen 7032, \$5.98.

JACK HYLTON AND HIS ORCHESTRA. *The King's Horses*; *I May Be Wrong*; *Little White Lies*; nine more. Monmouth-Evergreen 7033, \$5.98.

Possibly because the records made by Ray

Noble's English band in the early 1930s received better distribution in the United States than did those by Bert Ambrose, Noble was much better known over here. But the Ambrose orchestra, at its best, was on a par with Noble, which meant that it was one of the best dance bands in the world during the pre-Swing years.

The simultaneous release of these reissues by Ambrose and Jack Hylton (Hylton preceded Ambrose and Noble by a few years as a top-flight English band) makes for an interesting contrast because both bands show the influence of Paul Whiteman. Hylton picked up the pretentious side of Whiteman and the Ferde Grofé arranging style, while Ambrose followed the jazz side—the Bill Challis arrangements that were sparked by solos by Joe Venuti, Frankie Trumbauer, and Bix Beiderbecke. One result is that much of the Hylton set sounds trite and dated, with the notable exceptions of his big showcase, Whitemanesque arrangements of *Handsome Gigolo*, *You Are My Heart's Delight*, *Body and Soul*, and *Goodnight Sweetheart*; although dated, these performances retain the charm of period pieces.

Ambrose, on the other hand, is full of brightness and sparkle, particularly on the sprightly *Rain on the Roof*, the lively *Little Girl*, and his exhilarating *Mona Lisa*. The arranging is consistently interesting, the performances crisp, and the recording superb. One of the minor joys of both sets is the liner comment by Bill Borden (producer of the discs) who notes with refreshing honesty that Hylton's *The Wind in the Willows* has a "dreadful vocal but the band is quite loose" and describes Ambrose's *Paradise* as a "good, clean waltz arrangement of a good, clean, dirty song." J.S.W.

LOUIE ROBERTS. Louie Roberts, vocals; Bill Walker and Don Tweedy, arr. *Sandy*; *Melissa*; *Connie*; nine more. Decca DL 75279, \$4.98.

HEINTJE: Best of All. Heintje, vocals; orchestra, Jefferson Daily, cond. *A Happy Lad*; *Giddy Up My Pony*; *Those Happy Times*; seven more. MGM SE 4772, \$4.98.

People of the jury, we give you these two albums in one ill-directed lump. Both feature boy singers. Each one looks about twelve in his photo, but considering our social climate, let's say they are somewhere between the ages of eight and twenty.

These two hapless singers represent an old man's world of music and attitudes. They are groomed to appeal to people who have given up on dealing with the real world. The obvious commercial problem, it would seem, is that such people do not buy albums. They leave that to the children and grandchildren who so mystify them. Albums like these make the elder generation comfortable about the young, eliminating the gap by denying it: dress the children in old-time clothes, as it were, feed them outdated values (including new songs written with old attitudes). Encourage them, put them on stages, and clap at them—thus working on every child's need for adult approval. Then hold them up proudly to the world to prove that all the creaky values still work. What has all this to do with reality?

Young Louie Roberts arrives via Decca with a liner-note endorsement from Eddy Arnold, distinguished representative of a past generation of country music. Mr. Arnold's praise

Radio Shack has a revolution on its hands!

All because of our Realistic/E-V Stereo-4™ Adapter we've got true 4-channel sound at over 1000 stores NOW!



add 4-channel sound to your stereo system at low cost!



SAVE 24⁴⁸

Regular Separate Items Price \$173.48

149⁰⁰ Post Paid



Includes Realistic/E-V Stereo-4 Adapter, Realistic 24-Watt Modular Stereo Amplifier (only 7x10x4"!), Realistic SOLC-103 Speakers plus Two 4-Channel Demo Records, All Audio Cables & Plugs

59⁹⁵ Post Paid

It's True *REALISTIC* 4-Channel Sound!

NOT a gimmick! NOT designed just to enhance ordinary 2-channel stereo (which it does beautifully!), but designed to let you play original 4-CHANNEL records, tapes and FM broadcasts by the new STEREO-4 method!

Get our Realistic/E-V Stereo-4 Adapter and choose your own add-on components for your present stereo outfit. All you'll need are an extra stereo amplifier and 2 more speakers. The speakers need not match the ones you have and there's nothing to replace. Or — get the Add-On System shown here . . . it has the Stereo-4 Adapter and everything else you need. It's easy to join this "bloodless" revolution — act now!

- ✓ 4-Channel Stereo LP's Available NOW!
- ✓ 4-Channel Cartridge Tapes Available NOW!
- ✓ 4-Channel FM Stations on the Air NOW!

FREE!
Hi-Fi
Catalog

Find Us in the Phone Book. Or we'll ship postpaid anywhere in the USA (address below). Add State & Local Taxes If Applicable Where You Live

ALLIED RADIO SHACK

A TANDY CORPORATION COMPANY

2725 W. 7th St. Fort Worth, Texas 76107

DISCOUNTS
WASH. D.C.
HAS NO FAIR
TRADE
LAWS!

ON
STEREO
COMPONENTS

PLEASE REQUEST
 Prices for your choice of
 Changers, Receivers, Tape
 Recorders, Speakers, etc.

PROMPT DELIVERY
 IN FACTORY
 SEALED
 CARTONS.

DISTRICT
SOUND INC.
 2312 Rhode Island Ave. N.E.
 Washington, D.C. 20018
 202-832-1900

CIRCLE 20 ON READER-SERVICE CARD

RECEIVERS
 TUNERS
 AMPLIFIERS

TAPE
 RECORDERS
 DECKS

LOW
PRICES
 ON FAMOUS BRAND
 NATIONALLY ADVERTISED
STEREO
COMPONENTS
 FAST DELIVERY
 FACTORY SEALED CARTONS
 WRITE TODAY FOR OUR QUOTE

A. D. R.
AUDIO

5200 CHILLUM PLACE N.W.
 WASH., D.C. 20011
 (202)
 291-3000

SPEAKERS
 CARTRIDGES
 COMPACTS

ALL
 STEREO
 SYSTEMS

CIRCLE 2 ON READER-SERVICE CARD

HEAR HERE

FOR THE UTMOST IN
DISCOUNTS
 ON NATIONALLY
 ADVERTISED
HI-FI STEREO
COMPONENTS

WRITE FOR OUR QUOTE
 All Merchandise Shipped
 Promptly Fully Insured From
 Our Warehouse.

DOWNTOWN
AUDIO, INC.
 17 WARREN ST.
 NEW YORK, N.Y. 10007
 267-3670-1-2

CIRCLE 22 ON READER-SERVICE CARD

DISCOUNTS
HI-FI SYSTEMS
COMPONENTS

KITS • COMPACTS
 TUNERS • AMPLIFIERS
 RECEIVERS • TURNTABLES
 SPEAKERS • TAPE RECORDERS

- Franchised Distributors for over 70 mfrs.
- Largest selection in the country
- Full manufacturers warranty protection
- Only brand new, factory sealed components
- Fast, fully insured shipments
- Double-boxed cartons where possible
- Same day reply to your inquiry
- Extra savings on complete systems
- Lowest possible prices

WRITE FOR OUR QUOTE AND SPECIALS BULLETIN
 VISIT OUR NEW MODERN SHOWROOM/WAREHOUSE
 FREE AMPLE PARKING AT PREMISES

ARSTON Sales

146 OLD BROOKFIELD RD. (NORTH)
 DANBURY, CT. 06810
 DANBURY, CT. (203) 744-6421
 N. Y. CITY (212) 369-6212

CIRCLE 18 ON READER-SERVICE CARD

reaches the following depth of understanding:
 "Louie is a very normal boy—he likes sports
 of all kinds."

Louie Roberts has a nice big voice and a
 simple, impersonal style. He has been taught
 such songs as *Little White Cloud That Cried*
 (popularized by its composer, Johnny Ray,
 nearly twenty years ago), *Lonely Street*, *How*
Great Thou Art, and a precious thing called
A Letter to the President, capitalizing on weepy
 sentiment in the manner of baby Shirley
 Temple.

Poor Louie Roberts. The grownups he trusts
 are using him to soothe their anxieties, to fix
 the mess they're in with the kids. Record men
 wish to make a profit on the boy as well. In a
 few years, if Louie has any sensitivity, he will
 suffer a severe identity crisis and accompanying
 cynicism. Or he himself will retreat into a false
 adult world and blindly find his audience in
 them.

The other boy is named Heintje. The usually
 active promo department at MGM has fallen
 down on this one. Maybe they didn't know
 how to sell him. At any rate, I know nothing
 about him and no information is given on the
 album. He appears to be a charming, clean-
 cut, and upstanding youngster, all blond hair
 and big smile. It is a European project. The
 music is pure Swiss Alps and Heintje's singing
 falls neatly in line—it could easily be coming
 from the soundtrack of a Sonja Henie movie
 of the Forties.

Children are not the only dreamers. Parents
 condemn and punish their young for burrow-
 ing into escapes—grass, long hair, "unanswer-
 able" questions—then turn around and lock
 out reality by creating, for their own selfish
 comfort, fantasies represented by Louie
 Roberts and Heintje. Since nobody is right,
 nobody feels good in the end, neither children
 nor parents.

What can parents do when they read such
 thoughts as these? Rush to their own defense,
 go deaf, have a beer, condemn this review,
 hotly explain points I have "deliberately ig-
 nored," reflexively and relentlessly deny any
 chance of self-inquiry. Or shall they listen to
 their real children instead of these two little
 puppets?

Whose responsibility is it that the games
 go on, generation to generation? M.A.

JOHN BALDRY: *It Ain't Easy*. John Baldry, vocals
 and guitar, rhythm accompaniment. *Don't Try*
to Lay No Boogie-Woogie on the King of Rock
and Roll: Black Girl: It Ain't Easy; Morning,
Morning: Let's Burn Down the Cornfield: Rock
Me When He's Gone; three more. Warner
 Brothers 1921. \$4.98.

Six-foot-seven John Baldry has been a primal
 figure on the British blues and rock scene for
 over a decade. A lot of now well-known per-
 formers started in his various bands: Mick
 Jagger was his back-up vocalist; Charlie Watts
 his drummer; Rod Stewart, Elton John, Brian
 Auger, and Julie Driscoll also worked for him.
 He is successful throughout Europe, but until
 recently unknown in America.

His singing is coarse, and like so many of
 the better rock singers derivative of Ray
 Charles. Side 1 of this LP was produced by
 Rod Stewart, and consequently sounds rather
 like Stewart's rocked-up country blues. Side
 2 was produced by Elton John, and con-
 sequently sounds rather like Elton John's

classical gospel rock. I prefer the Stewart side: it's looser, more dynamic and sprightly, and lacks the ponderous quality that marks the John side. *Boogie-Woogie* is especially powerful, and throughout the L.P. Baldry makes good use of a soul choir, counterpointing his low, rough voice against the high, tense choral harmony. Leadbelly's *Black Girl* casts Baldry in an exquisite vocal duet with Maggie Bell. *Morning, Morning*, the too-little appreciated song by poet and fug Tuli Kupferberg, likewise moves well.

Baldry has been around so long one wonders if he will ever get the recognition he clearly deserves. He is a rock singer's singer, and that doesn't always add up to popularity. Also, the Ray Charles style has been done by many people (Stewart, Richie Havens, and Joe Cocker, to name three) and is hardly an unfamiliar sound. M.J.

jazz

STAN KENTON: The Fabulous Alumni. Various Kenton bands. *Rhythm Incorporated; Easy Street; Adios*; eight more. The Creative World of Stan Kenton 1028, \$5.50.

STAN KENTON: Some Women I've Known. Anita O'Day, June Christy, Chris Connor, Jerri Winters, Ann Richards, and Jean Turner, with various Kenton bands. *Jeepers Creepers; Warm Blue Stream; Are You Livin' Old Man*; nine more. The Creative World of Stan Kenton 1029, \$5.50 (Creative World, Inc. Box 35216, Los Angeles, Calif., 90035).

Stan Kenton, who sells all his records by mail now, has put together two survey sets that ought to warm the nostalgic cockles of Kenton fans. "Fabulous Alumni" is made up of previously unissued material from 1945 to 1956, while "Some Women," which ranges from 1944 to 1963, includes five heretofore unissued tracks. The "Alumni" set traces some of the changes in the Kenton approach over the band's most fertile eleven-year period, opening with an Anita O'Day vocal and winding up with a section of Johnny Richards' *Cuban Fire Suite* that was not included on Kenton's original Capitol L.P. In between there are the beginnings of the big, open Kenton recording sound of the late Forties on a piece which includes a strong appearance of the marvelously muscular saxophone sound of Vido Musso. Bud Shank's flute, Frank Rosolino's trombone, and Lee Konitz' alto saxophone are featured on other cuts, along with a representation of Kenton singers—June Christy, Jerri Winters, Chris Connor, and Ann Richards, as well as Miss O'Day.

"Some Women" involves these same five singers, plus Jean Turner. Because they are lined up chronologically on both sides of the disc it is interesting to follow the persistence of a specific sound in Kenton singers (as in his trombonists) stemming from Miss O'Day, polished by Miss Christy, opened up by Miss Connor, and finally given an exotic throatiness by Miss Winters. Miss Richards breaks away from the mold to an extent but Miss Turner is the only one who manages to find a voice

WRITE FOR QUOTATION

FACTORY SEALED CARTONS
FRANCHISED DISTRIBUTOR
QUICK SHIPMENT

WE GIVE DISCOUNTS ON HI-FI COMPONENTS

SOUND REPRODUCTION INC.

460 CENTRAL AVENUE
East Orange, New Jersey 07018
(201) 673-0600

CIRCLE 52 ON READER-SERVICE CARD



SAVE MORE BY MAIL FROM DIXIE!

ON NATIONALLY ADVERTISED BRANDS • HI-FI COMPONENTS!

Today! Send for our Wholesale Price List!

Wholesale Prices!! *Dixie, one of the largest Stereo Wholesalers will fill all your mail orders promptly — at prices actually LOWER than "Discounters". See our 15-page Wholesale Price Brochure for yourself! Recognize Famous Brand Names AND choose the stereo equipment and accessories you desire. Everything shipped factory-sealed!

*Dixie guarantees satisfaction or your money back!



HIGH-FIDELITY WHOLESALERS

10530 Detrick Ave.
Kensington, Md.
20795 Dept. HF9
Phone:
301-933-7600

CIRCLE 21 ON READER-SERVICE CARD

Did you miss any issues?

If you did, here's what we have left:



High Fidelity Back Copies
2160 Patterson St., Cincinnati, Ohio 45214

Circle what you missed, then send this coupon with payment to the above address.

High Fidelity
(60c each)

January 1970
February 1970
March 1970
April 1970
May 1970
June 1970
August 1970
October 1970
December 1970

Stereo
(\$1.25 each)

Summer 1970
Fall 1970
Winter 1971

Concert Artist Directory
(\$6 each)

1970 MA Directory
1971 MA Directory

Musical America
(\$1.25 each)

January 1970
February 1970
March 1970
April 1970
May 1970
July 1970
August 1970
September 1970

Please send me the issues I missed. I enclose a check money order for \$_____.

Name _____

Address _____

City _____ State _____ Zip _____

5354

ADVERTISING INDEX

is on page
114
in this issue.

Reader Service
cards appear on
pages 19 and 115.

THIS
OVER **66** YEARS
OF RELIABILITY
**IS WHY STEREO & HI-FI
BUYERS CAN BE SURE OF
SAVINGS
AT RABSONS**

At Rabsons Competitive Prices, Reliability and Personal Service have been bywords for over 66 years.
It's so EASY and SAFE to deal with Rabsons. As close as your telephone — as near as your mailbox • Fast Air Mail Response on Quotation Requests • Franchised Distributor for Hi Fi Lines • All merchandise brand new in factory sealed cartons, shipped double-packed, fully insured promptly from our warehouse • Greater savings on complete systems • Export packing • 220 Volts, 50 Cycle merchandising a specialty • Free list of monthly specials.

**BEFORE YOU BUY GET A RABSONS
QUOTE... YOU'LL BE GLAD YOU DID!**

RABSONS 57 ST. INC.
119 West 57th Street, New York, N. Y. 10019
Tel. Area Code 212-247-0070

CIRCLE 45 ON READER-SERVICE CARD

of her own. This collection is primarily for Kenton vocal buffs but the "Alumni" set is a fascinating and valuable summation of one of the important postwar jazz developments. J.S.W.

* **ORIGINAL SALTY DOGS:** Free Wheeling. Lew Green, cornet; Jim Snyder, trombone; Kim Cusack, clarinet and tenor saxophone; John Cooper, piano; Bob Sundstrom, banjo and vocal; Mike Walbridge, tuba; Wayne Jones, drums. *All by Myself; Creole Belles; Wild Man Blues;* seven more. GHB 58, \$5.98 (GHB Records, P.O. Box 748, Columbia, S.C. 29402).

As the number of traditionalist jazz bands has increased, the general level of performance has steadily risen. But despite this overall upgrading, the Salty Dogs remain in a class by themselves as blithe, distinctively at-home practitioners of the traditional repertory. Man for man—front line and rhythm section—there is not a weak spot in the line-up. The rhythm section, normally the prime danger area in such groups, is one of the Salty Dogs's great strengths. Built around the sturdy core of Mike Walbridge's impeccable tuba, with sensitive but potent drumming by Wayne Jones and loose, precise work in banjo and piano by Bob Sundstrom and John Cooper, the group could probably get away with a front line that was simply adequate. But Lew Green, Jim Snyder, and Kim Cusack have the easy assurance and the brash exuberance that give these performances a constant lift.

Armstrong, Oliver, Noone, and Beiderbecke are the primary sources but this band treats the material as though it were all its own stuff, with none of the cringing before sacred traditions that often inhibits groups of this type. The title tune, *Free Wheeling*, will sound surprisingly familiar. This, according to annotator Mike Schwimmer, was Hoagy Carmichael's original title for the tune Bix Beiderbecke recorded as *Riverboat Shuffle*. It's typical of the Salty Dogs's deadpan humor not only to sneak in the original title on the label but also to emblazon it all over the album. J.S.W.

* **ROY ELDRIDGE:** The Nifty Cat. Roy Eldridge, trumpet and vocals; Benny Morton, trombone; Budd Johnson, tenor and soprano saxophones; Nat Pierce, piano; Tommy Bryant, bass; Oliver Jackson, drums. *Jolly Hollis; Cotton; 5400 North;* three more. MJR 8110, \$5.50 (Master Jazz Recordings, Inc., Box 579, Lenox Hill Station, New York, N.Y. 10021).

Here is one of the warmest, most fulfilling small-group recordings I have heard in a long time. These musicians play in jazz spots around New York fairly often, but because of the dispiriting conditions which exist in most clubs (graphically outlined in Bill Weilbacher's excellent liner notes), they convey far more life and immediacy on this disc—the performances are electrifying.

Eldridge sounds like the burning flame of thirty years ago: Budd Johnson is simply overpowering on both tenor and soprano saxophones; Benny Morton spreads out in a broad, sweeping, lyrical attack that sounds for all the world like Lawrence Brown; and the sextet

is completely together—so much so, in fact, that one piece from Eldridge's big-band days with Gene Krupa (*Ball of Fire*) actually does convey the sound and feeling of a big band. Add to this a long, building, strongly projected vocal by Roy on *Wineola*, a blues that moves at just the right, aching swinging tempo.

It is as though time had stood still for this marvelously seasoned team of jazzmen and each had been caught at the peak of his powers. Weilbacher, who produced the disc, deserves at least as much credit as the musicians—we have years and years of evidence of how routine such a recording session might have turned out. This collection is basic evidence that the fire and spirit of jazz still live. J.S.W.

in brief

JOHNNY CASH: The Man, The World, His Music. Sun 2-126, \$9.96 (two discs).

A two-LP set containing much of Cash's early work, including *I Forgot to Remember to Forget; Goodnight Irene; Fools (Hull of Fame); and Blue Train*. Not up to the recording standards of his Columbia releases, but open and funky. M.J.

BO DIDDLEY: Another Dimension. Chess CH 50001, \$4.98. Tape: ● 8033-50001M, \$6.98; ●● 5033-50001M, \$6.98.

Poor Bo Diddley can't get enough work to hold a band together and so is reduced to studio efforts like this one, mostly of hits by white musicians like The Band, Al Kooper, Creedence, and Elton John. It's not bad, really, but not what it used to be. J.G.

HELEN REDDY: I Don't Know How to Love Him. Capitol ST 762, \$5.98. Tape: ●● 8XT 762, \$6.98; ●● 4XT 762, \$6.98.

This is a pleasant albeit bland set by the performer of the hit song from "Jesus Christ Superstar." She sings material by the likes of Graham Nash, Van Morrison, the Rascals, Leon Russell, and Tim Hardin. The best: Mac Davis' *I Believe in Music*. J.G.

PEARLS BEFORE SWINE: City Of Gold. Reprise S 6442, \$4.98. Tape: ● M 86442, \$6.95; ●● M 56442, \$6.95.

I really intended to give Tom Rapp's group's new album a feature review last month or this, but ran out of space and time. The earlier LPs were good, but this one is the best yet. If you've never heard him/them, take my word for it: this is a terrific record. J.G.

ARETHA FRANKLIN: Live at Fillmore West. Atlantic SD 7205, \$5.98. Tape: ● M 87205, \$6.95; ●● M 57205, \$6.95.

Aretha is joined by Ray Charles, King Curtis, and Billy Preston. It's a purely joyful noise. Ninety stars. M.A.

STONEGROUND. Warner Bros. WS 1895, \$4.98. Stoneground is Sal Valentino's superb new ten-person band. This group has been receiving a lot of hype, but so far it lives up to every word. With seven lead singers, how could they go wrong? J.G.

ELVIS PRESLEY: Love Letters From Elvis.

HIGH FIDELITY CLASSIFIED

RCA Victor LSP 4530, \$5.98. Tape: ● P8S 1748, \$6.95; ●● PK 1748, \$6.95.

Don't be put off by the title or cover or liner of Elvis Presley's latest album. "Love Letters" is his best effort in some time: *Got My Mojo Working, Cindy Cindy, When I'm Over You*, etc. One minus: only eleven songs. J.G.

RAY CHARLES: Volcanic Action in My Soul. ABC ABCS 726, \$4.98.

Ray Charles' new release is surprisingly weak coming from the man who was rightly called the genius of soul. Soupy arrangements of silly songs. J.G.

RED SKY AT MORNING. Original film soundtrack by Billy Goldenberg. Decca CL 9180, \$5.98.

This album establishes young Billy Goldenberg as an important film composer. He's in the league of Johnny Mandel, Dave Grusin, and Jerry Goldsmith. But Goldenberg has a beautiful bag of tricks all his own. M.A.

THE MANHATTAN TRANSFER: Jukin! Capitol ST 778, \$5.98.

These re-creations—of c & w, Fifties r & b, Fats Waller, Thirties band pop, and so forth—are funny at first but don't wear very well. Still, you may want to give a listen to a first-rate pop group in the making. J.G.

DAVID POMERANZ: New Blues. Decca DL 75274, \$4.98.

Another new talent to keep your eye on. Some heavy songs, a lot of fine and honest singing. M.A.

EDDIE FLOYD: Down To Earth. Stax STS 2041, \$4.98.

The leading proponent of the Memphis Sound has a new album. Take note. J.G.

FRED NEIL: Other Side Of This Life. Capitol ST 657, \$5.98.

Singer/songwriter Fred Neil doing some of his most famous numbers—the title tune, *The Dolphins, Everybody's Talkin'*, etc.—in rare live performance. Sidemen on Side 2 are Les McCann, Vince Martin, and Graham Parsons. J.G.

RECORD MART Advertisement



Free mailing anywhere in USA, APO & FPO for mail orders from world's largest choice of records, tapes! The low price of the record or tape is all you pay. King Karol's prices lowest, service fastest and inventory largest—we have everything! For FREE CATALOG write: King Karol Records, Dept HF9, Box 629, Times Sq. Sta., NYC 10036

CIRCLE 30 ON READER-SERVICE CARD

for sale

LIVE OPERA PERFORMANCES ON REEL-TO-REEL tapes. 37 years, from PONSILLE-CALLAS. Catalog: Mr. Tape, Box 138, Murray Hill Station, N.Y.C. 10023.

"HARD TO GET" RECORDS—ALL SPEEDS. RECORD Exchange, 842 Seventh Avenue, New York, N.Y. 10019.

PROTECT YOUR RECORDS. CARDBOARD REPLACEMENT covers, plastic lined sleeves, 78 and 45 heavy sleeves, hinged record set boxes, 12", 10", 7". Cabco 300, 89 East Woodruff, Columbus, Ohio 43201.

OLD-TIME RADIO PROGRAMS ARE STILL AVAILABLE. Six hour tape only \$7.00 or catalogue 25¢. Nostalgic Radio, Box 29F, Peoria, Illinois 61601.

INFINITY SYSTEMS, CROWN, RABCO, DUAL, TRANSTATIC, Bose, Quad, Sony, KLM, trades accepted. Stereo Center, 218 Columbia St., Utica, N.Y. 13502.

THE ALPHAPHONE™ HEADSET PRESENTS YOUR brainwaves in hi-fi—wire up and relax. Free booklet. Aquarius Electronics, Box 627-D, Mendocino, CA 95460.

KLIPSCH, TANNOY, MARANTZ, THORENS, RABCO, IMF and More—No discounting. Superior Sound, 1801 Brewerton Rd., Syracuse, N.Y. 13211.

SHOW ALBUMS—RARE, OUT-OF-PRINT LPS. LARGE List 10¢. Broadway/Hollywood Recordings, Georgetown, Connecticut 06829.

NATIONALLY ADVERTISED AUDIO EQUIPMENT. Cost Plus 10%. Stereo World, 3250 Duke Street, Alexandria, Virginia 22314.

STEREO TAPES \$4.95 POSTPAID. CAG, 3606 Nanton Place, Philadelphia, Pa. 19154.

services

RENT 4-TRACK OPEN REEL TAPES—ALL MAJOR labels—3,000 different—free brochure. Stereo-Parti, 57 St. James Drive, Santa Rosa, Cal. 95401.

employment opportunities

EUROPEAN-FOREIGN EMPLOYMENT OPPORTUNITIES —Interesting work, excellent pay. Detailed listing, currently available jobs—Europe, Africa, Australia, \$3.00. EJROJOB REPORT, Box 52643-F, Lafayette, Louisiana 70501.

books & literary services

JAKE TRUSSELL'S AFTER HOURS POETRY. \$1.00. Box 951, Kingsville, Texas 78363.

miscellaneous

McINTOSH 2505 VERSUS MARANTZ 32 CITATION Twelve, and Dynaco Stereo 120. The winner? Send \$1 today for test report, refundable with \$7.50 yearly subscription. The Hi-Fi Newsletter, Box 593, Hialeah, Fla. 33011.

SLEEP-LEARNING—HYPNOTISM TAPES, RECORDS, books, equipment. Also Alpha Brainwave Feedback devices. Free catalog. Autosuggestion, Box 24-F, Olympia, Washington 98501.

MAKE FRIENDS WORLDWIDE THROUGH INTERNATIONAL correspondence. Illustrated brochure free. Hermes, Berlin 11, Germany.

Classified Adv. Mgr., Miles T. Killoch

High Fidelity, 165 W. 46th St., New York, N. Y. 10036

Please run the following ad copy under the heading _____

_____ in _____ issue(s):

NAME _____

ADDRESS _____

CITY _____ STATE _____ ZIP _____

_____ Words Total @ \$1.00 ea. (\$10.00 min.) = \$ _____

_____ Words in Caps @ .10 extra ea. = \$ _____

Total = \$ _____

Discount* 5% for 6 consecutive issues, 10% for 12 consecutive issues. *Cash must accompany order.

Closing dates: 2 mos. prior to issue date. For example: Oct. 1971 issue deadline is Aug. 2, 1971

FULL PAYMENT MUST ACCOMPANY ALL COPY FOR CLASSIFIED ADS
except those placed by accredited advertising agencies.

the tape deck

BY R.D. DARRELL

Dolby Cassettes Direct from London. In their enthusiasm for Dolbyized cassettes, English Decca has begun exporting some of them directly to this country where currently only relatively few are being released in domestic Ampex processings. The importations also bear the London label, of course (to distinguish them from productions of the unrelated American Decca company), and are priced at the standard \$6.95 each, but they differ most notably from the domestic processings by including liner notes (like imported Deutsche Grammophon and Philips musicassettes).

The most distinctive program in the first batch of importations is a superb Szell memorial, that outstanding Beethoven bicentenary recording of the complete incidental music for *Egmont*. The Vienna Philharmonic, soprano Pilar Lorengar, and Klausjürgen Wussow as the vivid narrator (in German) are under Szell's magisterial direction and the superlative performance is presented in almost palpably solid recorded sound (London 5CS 6675). There are five other inaugural releases, but of these I've been able to hear (as yet) only the Richard Strauss *Heldenleben* by Mehta and the Los Angeles Philharmonic (London 5CS 6608). Like the previous two tapings by Von Karajan and Barbirolli, this reading will probably be of interest only to the conductor's devotees. Mehta's richly romantic performance lacks disciplined control and the turgid orchestral sonorities would seem to be more the conductor's responsibility than that of the engineers. But here, as in the *Egmont* cassette, Dolbyization achieves substantial if not absolutely complete surface-noise reductions.

Revitalized Bostonians. If you've been skeptical about either young Michael Tilson Thomas' claims to Instant Fame or of Deutsche Grammophon's engineering triumphs in Boston, just listen to their two latest releases. The first is a coupling of two contemporary American works, where one might expect Thomas to shine; but the other is an example of very early Tchaikovsky romanticism, an area in which he might not be expected to show such ready affinity.

The program of American music turns out even better than expected: Walter Piston's Second Symphony is an eloquent, exhilarating, skillfully constructed and orchestrated work, while William Schuman's Violin Concerto is an impressive addition to the scanty repertory of

American virtuoso-display vehicles. Both works are tape firsts, and the Schuman also marks the tape debut of that amazing young specialist in contemporary works for the violin, Paul Zukofsky (DGG/Ampex L 3103, 7½-ips reel, \$7.95).

In Tchaikovsky's endearing G minor Symphony (*Winter Dreams*) Thomas demonstrates the rare ability to recognize the boundary between sentiment and sentimentality, and here he completely realizes, with the aid of DGG's vital and transparent engineering, the young composer's exuberant tonal imagination. There have been several quite good recordings of early Tchaikovsky symphonies, but this one is outstanding—and not least for the realistic facsimile of Symphony Hall ambience and the silent, pre-echoless tape processing (DGG/Ampex L 3078, 7½-ips reel, \$7.95). There is also an imported DGG cassette edition (3300 107, \$6.95) which is almost as good—even the surface noise is slight by normal non-Dolbyized cassette standards.

Horowitz and Heifetz: Hors de Concours! Despite the appearance of many exceptionally talented young instrumentalists in recent years, it's good to be reminded that two incomparable Old Masters have lost none of their fabulous skills. The latest release in Horowitz' Columbia series is one of the best yet—both for its gleamingly bright yet solidly substantial piano recording (notable too for its wide dynamic range) and for its demonstration of the soloist's apparently illimitable digital dexterity. His Schumann *Kreisleriana* was recorded in 1969 and sounds considerably fresher than the dull-toned 1964 Rubinstein version which I greeted in its RCA cassette and 8-track cartridge editions last December. Rubinstein's reading is perhaps a bit more genial and "Schumannesque" in some respects, but it is scarcely as scintillating and exciting as the Horowitz version, which has the added attraction of more novel coupling material: Schumann's generally *semplice* Variations on a Theme by Clara Wieck, Op. 14 (Columbia cassette 16 11 0214, \$6.95; no notes).

"Heifetz on Television" is a must for everyone interested in fiddling at its finest. This audio-only documentation (RCA Red Seal 8-track cartridge R8S 1181, \$6.95; no notes) of last April's memorable NBC-TV program includes a number of little transcription encores (some of them arranged by the soloist

himself), thus perpetuating for a probably puzzled posterity the now fast-dying vogue for such recital divertissements. Diverting enough as naive showpieces, these translations of the March from Prokofiev's *Love for Three Oranges*, *It Ain't Necessarily So* from Gershwin's *Porgy and Bess*, etc., are in dubious taste. But most listeners will surely be spellbound by the sheer bravura of the present performance of the mighty Bach unaccompanied *Chaconne* (scarcely idiomatic, to be sure, but what phenomenal fiddling!) and by the magical melodic warmth of Bruch's *Scottish Fantasia*, Op. 46. Here the abbreviated televised performance has been wisely replaced by the beloved earlier (c. 1962) recording with the New Symphony Orchestra under Sir Malcolm Sargent—now out of print in its January 1963 RCA open-reel tape edition.

Cassette Opera House: Sills's Lucia. There is considerable new interest as well as artistic and technical merit in the latest complete opera to appear in cassette format, Donizetti's *Lucia di Lammermoor*. Beverly Sills stars in the title role, with Carlo Bergonzi and a strong supporting cast, the Ambrosian Opera Chorus, and the London Symphony Orchestra all under Thomas Schippers (ABC-Audio Treasury/Ampex D 2006, two-cassette set, \$14.95; libretto on request, even though there is no printed notice to that effect).

Although I haven't been a whole-hearted Sills devotee in the past, I am irresistibly captivated here, not only by her deft vocalism but by her genuinely dramatic vitalization of a too often flaccid heroine. I also relish the use of the glass harmonica in the Mad Scene, as the composer himself requested. The rest of the cast does well, and the entire production is powerfully and vividly recorded—a few uncomfortably intense moments are probably a result of the conductor's occasional overvehement beat. The present taping has been processed at an admirably high modulation level, thus preserving the marked brilliance and wide dynamic range (and also some sonic imbalances) of the master recording, but it is marred by occasional slight spillovers and the considerable surface noise one usually encounters in non-Dolbyized cassettes. Anyone seriously bothered by such minor annoyances undoubtedly will prefer the open-reel edition, which I have not yet heard (ABC-Audio Treasury/Ampex R 2006, \$21.95; libretto enclosed). ●

Introducing the definitive Dolby: the TEAC 350

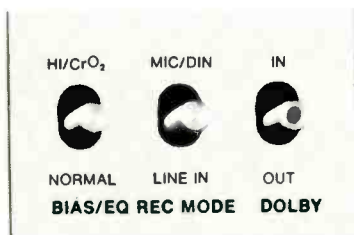

This stereo cassette deck represents the best of TEAC's two worlds of tape technology — bred from the combined talents of our Audio Products and Data Products Divisions.

The result: a new standard in Dolby decks. In fact, we're so certain this is the Dolby cassette of the decade, that its high-density ferrite TEAC heads carry an original-owner lifetime guarantee.

Every facet of the 350 sparkles with sophistication. We've integrated a factory-calibrated Dolby type "B" system with all new computer-designed solid-state, ultra wide-band, low-noise circuitry. Switch-in the Dolby circuit and the overall S/N improvement is 6 dB, rising to 10 dB at 4000 Hz and above.

As the deck of the future, the TEAC 350 delivers superior performance with all tapes: conventional, high-density, high-energy and chromium dioxide. And its independent linear, studio-style input and output controls assure precise level adjustments.

The VU meters on this deck are another TEAC exclusive. We've designed them with expanded scales, so that in high-scale mode, you actually record a +3 dB signal at 0 VU on high-output tape. This feature, combined

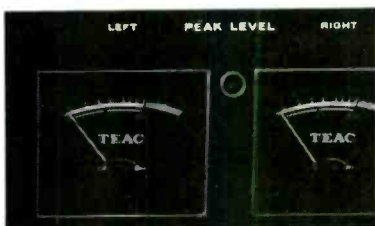

with the on-line, real-time "OR circuit" peak-level indicator assures distortion-free recording at optimum levels and signal-to-noise.

The 350 is packed with user convenience: strobe-type tape-run indicator... standard phone jacks for professional 600 ohm mics and 8 ohm headphone monitoring... light-touch fingertip pushbuttons...

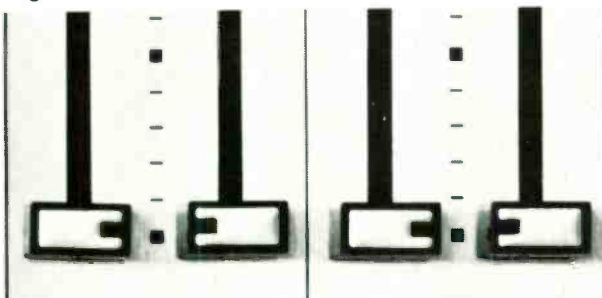

electronic end-tape sensor and automatic stop. All this and more for only \$279.50.

Write for complete information. Then test the 350 at your local authorized TEAC dealer's. You'll see (and hear) why we think the 350 is the definitive Dolby.

- Frequency response: 30–16,000 Hz with cobalt, chromium dioxide and super dynamic tapes
30–13,000 Hz \pm 3 dB (measured at -20 dB)
- Signal-to-noise: 58 dB (with Dolby)
- Wow and flutter: 0.13%
- Tape speed: 1 7/8 ips



THE "CLOSE-UP" SOUND

KENWOOD KR-6160

with CONTINUOUSLY VARIABLE PRESENCE CONTROL

The MID-RANGE TONE CONTROL featured on the KR-6160 will add astonishing sound realism to any speaker system. You can now bring the intimate sound of a musical group or a vocalist "close-up" with continuously variable presence control. Other features include:

- SUPERABUNDANT POWER OF 220 WATTS (IHF) ▪ ITS OWN DYNAMIC MICROPHONE FOR "MIKE-MIXING" IN ANY MODE WITH FRONT PANEL SOUND LEVEL CONTROL ▪ TERMINALS FOR 3 SETS OF STEREO SPEAKERS PLUS CENTER CHANNEL ▪ FRONT PANEL SPEAKER SELECTOR SWITCH ▪ JACKS FOR 2 PHONOS, 2 AUX, TAPE DECK ▪ SEPARATE PREAMP OUTPUT, MAIN AMP INPUT ▪ AND A HOST OF OTHER OUTSTANDING FEATURES

SPECIFICATIONS: Power Output, (IHF) 220 watts @ 4 ohms; (RMS) 110/110 watts @ 4 ohms, 90/90 watts @ 8 ohms ▪ Frequency Response, 14-40k Hz (± 1.5 dB) ▪ Power Bandwidth (IHF), 12-30k Hz ▪ Sensitivity (IHF), 1.6 μ V ▪ Capture Ratio, 1.5 dB ▪ Selectivity (IHF), 55 dB ▪ Stereo Separation, 35 dB @ 1k Hz
 ▪ Price, \$379.95; Walnut Cabinet, optional



KENWOOD KR-6160
 220 WATTS ▪ FET ▪ IC ▪
 FM/AM STEREO RECEIVER
 with DYNAMIC MICROPHONE

For complete information write:



CIRCLE 36 ON READER-SERVICE CARD

15777 So. Broadway, Gardena, Calif. 90248
 72-02 Fifty-first Ave., Woodside, N.Y. 11377
 In Canada: Magnasonic Canada, Ltd., Toronto,
 Ontario; Montreal, Quebec; Vancouver, B.C.