

What's New in Tone Arms

60 Cents X

# high fidelity

APRIL  
1962

THE MAGAZINE FOR MUSIC LISTENERS

THE TRIUMPHS

AND TROUBLES

OF THE MET

By Martin Mayer

# Only these FM Stereo Receivers have Pilot's unique signal-sampling multiplex circuit\*

You get the best possible FM Stereo reception because PILOT's unique signal-sampling multiplex circuit gives you maximum separation (30 db or better) across the entire audio spectrum. It is the simplest, most effective, most trouble-free circuit presently being manufactured for stereo demodulation. There are no troublesome frequency separation filters and matrices or extra controls as are required by other multiplex circuits. This is just one of the many features that make PILOT Stereo Receivers the perfect electronic "heart" for your high-fidelity system.

\*Patent Pending



PILOT 602M...30 watts music power...frequency response 20-20,000 cycles, 1 db...harmonic distortion 1% at full power...12-control flexibility...FM sensitivity 3 uv IHFM...wide band RF and IF circuits for undistorted reception at full modulation...6 inputs...5 1/8" high x 14 3/8" wide x 10 3/4" deep. With cover... **249<sup>50</sup>**

(Also available with added AM as Model 602S. Complete, 299.50)



PILOT 654M...60 watts music power (IHFM mid-band rating)...frequency response 10-50,000 cycles plus 0.5 db or minus 1 db...hum and noise: completely inaudible (80 db below full output)...intermodulation distortion: less than 0.3%...14 controls, including rumble and scratch filters...6 inputs...plus a fully automatic stereo indicator that lights on stations broadcasting FM stereo...5 1/8" high x 14 3/8" wide x 12 3/4" deep. Black and brass styling. With cover... **329<sup>50</sup>**



PILOT RADIO CORPORATION, 37-18 36TH STREET, LONG ISLAND CITY 1, NEW YORK

CIRCLE 67 ON READER-SERVICE CARD

# CARE TO LEAD A CULTURE-MAD LIFE AT EUROPE'S LEADING MUSIC FESTIVALS?



WIN EMPIRE'S ROUND-THE-WORLD MUSIC CONTEST! Imagine—you, and the guest of your choice, will be attending such greats as the Athens, Dubrovnik, Bregenz, Salzburg, Bayreuth and Edinburgh Festivals. You'll witness the world's finest presentations of opera, ballet, drama, symphony concerts, chamber music, and even "le jazz hot" at a Parisian cellar club. You'll be taken on personalized tours through many world-famous cultural centers, like Rome, Paris, Munich. Complete trip...21 days. Transportation, rooms, meals, tickets and tours are pre-paid by creators of the Empire "Troubador"...world's most perfect and cultural record playback system.

.....  
IF YOU'RE CULTURE-MAD  
AND WANT TO LIVE DARINGLY, VISIT YOUR NEAREST HI FIDELITY DEALER FOR COMPLETE ITINERARY AND ENTRY FORMS ... OR WRITE: EMPIRE TROUBADOR DEPT.ETA, GARDEN CITY, N.Y.  
.....

CIRCLE 41 ON READER-SERVICE CARD

**empire**  
SCIENTIFIC CORP.

# RUSHING...



to get to his...

## STANTON

stereo fluxvalve pickup

PICKERING & COMPANY INC. offers the stereo fluxvalve pickup in the following models: the Calibration Standard 381, the Collector's Series 380, the Pro-Standard Mark II and the Stereo 90. Priced from \$16.50 to \$60.00, available at audio specialists everywhere.

"FOR THOSE WHO CAN HEAR THE DIFFERENCE."

Pickering and Company—Plainview, Long Island, New York

CIRCLE 66 ON READER-SERVICE CARD



Page 49



Page 42

# high fidelity



Page 38

## Music and Musicians

- 37 The Met—Present, Future, and Past: an editorial
- 38 The Triumphs and Troubles of the Met *Martin Mayer*
- 46 No Funeral Taps for Delius *Peter J. Pirie*
- 49 When the Big Bands Played Swing *Martin Williams*
- 20 Notes from Abroad—London, Munich
- 28 Teresa Stich-Randall: an interview *Martin Bernheimer*
- 59 Music Makers *Roland Gelatt*

## Sound Reproduction

- 42 Improvements in Arms *Joseph Marshall*
- 52 Equipment Reports
  - Grado Laboratory Series Stereo Cartridge
  - EICO ST-96 FM-AM Tuner and MX-99 Multiplex Adapter
  - H. H. Scott LK-72 Stereo Amplifier Kit
  - Audax CA-70 "Sonoteer" Speaker System
- 105 High Fidelity Newsfronts

## Reviews of Recordings

- 61 Feature Record Reviews
  - Strauss: *Salome* (Birgit Nilsson *et al.*, Georg Solti)
  - Ives: Sonata for Piano, No. 2 (*Concord*)  
(George Pappa.stavrou)
- 63 Other Classical Reviews
- 75 The Imports *Gene Bruck*
- 85 The Lighter Side
- 93 Jazz
- 97 The Tape Deck

APRIL 1962 • VOLUME 12 NUMBER 4

Published monthly at Great Barrington, Mass. by The Billboard Publishing Co. Copyright © 1962 by The Billboard Publishing Co. The design and contents of High Fidelity Magazine are fully protected by copyright and must not be reproduced in any manner. Second-class postage paid at Great Barrington and at additional mailing offices. One year subscription in U. S., Possessions, and Canada \$6.00. Elsewhere \$7.00. Indexed in the "Reader's Guide to Periodical Literature." Change of Address notices and undelivered copies (Form 3579) should be addressed to High Fidelity, Subscription Dept., 2160 Patterson St., Cincinnati 14, O.

# LAFAYETTE RADIO

presents

Its Most Popular Stereo Phono System featuring  
The FAMOUS LA-250A 50-WATT STEREO AMPLIFIER



LAFAYETTE LA-250A  
50-WATT STEREO AMPLIFIER



GARRARD AT-6

CHOICE OF  
DIAMOND STEREO  
CARTRIDGE



PICKERING  
380C



SHURE M7D



LAFAYETTE SK-58  
12" COAXIAL SPEAKERS

OUR BEST STEREO SYSTEM BUY  
MATCHED COMPONENTS

Lafayette LA-250A 50-Watt Stereo Amplifier	99.50
Garrard AT-6 4-Speed Record Changer	54.50
Pickering 380C Diamond Stereo Cartridge	29.85
Lafayette Wood Base	3.95
2 Lafayette SK-58 12" Coaxial Speakers @ 29.50 each	59.00
<b>Total Price if Purchased Separately</b>	<b>246.80</b>

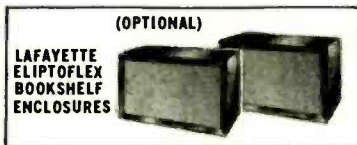

(OPTIONAL)  
LAFAYETTE  
ELIPTOFLEX  
BOOKSHELF  
ENCLOSURES

LAFAYETTE  
SPECIAL PRICE **199.50**

YOU SAVE **47.30**

HI-FI STEREO SYSTEM, as above, with choice of  
Pickering 380C or Shure M7D Cartridge and Walnut,  
Mahogany or Blonde Changer Base (specify finish)  
LS-252WX ..... Only 199.50

Same as LS-252WX but includes 2 Lafayette Elip-  
toflex Series Bookshelf Enclosures in Walnut, Oiled  
Walnut, Mahogany or Blonde (specify finish)  
LS-254WX ..... Only 265.50

LAFAYETTE'S  
CRITERION LINE

*Pacesetter of the High-Fidelity in-  
dustry . . . renowned for its perfor-  
mance. The ultimate for those who  
demand the finest.*

NEW! KT-550 100-WATT  
BASIC STEREO AMPLIFIER KIT

KT-550 In Kit Form **134.50**

LA-550  
Completely Wired  
**184.50**



NO  
MONEY  
DOWN

- Rated at 50-Watts per Channel
- Response from 2-100,000 cps, 0, -1db at 1-Watt
- Grain Oriented, Silicon Steel Transformers
- Multiple Feedback Loop Design
- Easy-To-Assemble Kit Form

Made in  
U.S.A.

A new "Laboratory Standard" dual 50-watt ampli-  
fier guaranteed to outperform any basic stereo  
amplifier on the market. Advanced engineering  
techniques plus the finest components ensure  
flawless performance. Distortion levels so low  
they are unmeasurable. Hum and noise better than  
90 db below 50-watts. Complete with metal en-  
closure. 9 1/4 x 12 1/2" D. Shpg. wt., 60 lbs.

KT-600A PROFESSIONAL  
STEREO CONTROL CENTER

KT-600A In Kit Form **79.50**

LA-600A Completely Wired **134.50**

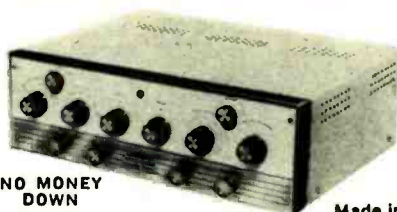

NO MONEY  
DOWN

Made in  
U.S.A.

- Response 5-40,000 cps  $\pm$  1 db.
- Precise "Null" Balancing System
- Unique Stereo and Monaural Control Features
- Concentric Input Level Controls
- Easy-To-Assemble Kit Form.

Sensitivity 2.2 mv for 1 volt out. Dual low im-  
pedance "plate follower" outputs 1500 ohms. Less  
than .03% IM distortion; less than .1% harmonic  
distortion. Hum and noise 80 db below 2 volts.  
14x10 1/2 x 4 1/2". Shpg. wt., 16 lbs.

Lafayette Radio, Dept. WD2-1, P. O. Box 10, Syosset, L. I., New York

Name \_\_\_\_\_  
Address \_\_\_\_\_  
City \_\_\_\_\_ Zone \_\_\_\_\_ State \_\_\_\_\_

FREE!

NEW  
1962  
CATALOG  
340 PAGES



LAFAYETTE  
RADIO  
LOCATIONS ▶ JAMAICA 33, NEW YORK

NEW YORK 13, N.Y.

BRONX 58, N.Y.  
PLAINFIELD, N.J.  
PARAMUS, N.J.

NEWARK 2, N.J.  
BOSTON 10, MASS

CIRCLE 58 ON READER-SERVICE CARD

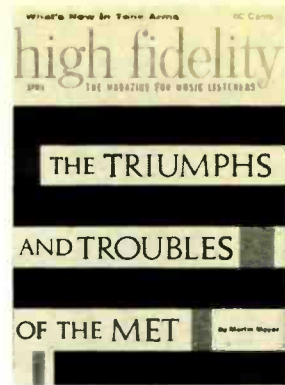

Cover Design: by Roy Lindstrom

Roland Gelatt  
Editor in Chief

Joan Griffiths  
Executive Editor

Norman Eisenberg  
Audio Editor

Sue Severn  
Managing Editor

Shirley Fleming  
Assistant Editor

H. C. Robbins Landon  
European Editor

Roy Lindstrom  
Art Director

Nathan Broder  
John M. Conly  
R. D. Darrell  
Alfred Frankenstein  
John F. Indcox  
Robert C. Marsh  
Contributing Editors

Claire N. Eddings  
Advertising Sales Manager

Walter F. Gruening  
Circulation Director

Warren B. Syer  
Publisher

## ADVERTISING

### Main Office

Claire N. Eddings, The Publishing House  
Great Barrington, Mass. Telephone 1300

### New York

1564 Broadway, New York 36  
Telephone: Plaza 7-2800  
Seymour Resnick, Andrew Spanberger

### Chicago

740 N. Rush St., Chicago 11  
Telephone: Michigan 2-4245  
P. H. Dampers, Thomas Berry,  
Allen Campbell

### Los Angeles

1520 North Cower, Hollywood 28  
Telephone: Hollywood 9-6239  
George Kelley



## slurp

Remember when the most delicious part of an ice cream soda was that last resounding sip? The magic years of youth are sprinkled with a thousand and one such noisy delights—accepted simply, appreciated instinctively and forgotten quickly.

These transient pleasures and simple sounds soon give way to more enduring enthusiasms, to richer and more meaningful sounds. Such as recordings on Audiotape. This tape gives you superb clarity and range, minimum distortion and background noise. Because of its remarkable quality, Audiotape has the timeless gift of offering pleasure to everyone from juvenile soda slurpers to mature twisters. Try it.

Remember, if it's worth recording, it's worth Audiotape. There are eight types, one exactly suited to the next recording you make. From Audio Devices, for 25 years a leader in the manufacture of sound recording media—Audiodiscs\*, Audiofilm\*, and



\*TRADE MARKS

**audiotape**  
*"it speaks for itself"* TRADE MARK

**AUDIO DEVICES INC.**, 444 Madison Ave., New York 22, N.Y.  
Offices in Los Angeles • Chicago • Washington, D. C.

CIRCLE 11 ON READER-SERVICE CARD

From Scott . . . the 1st RELIABLE Stereo Multiplex Indicator

# New Scott Tuner/Amplifier with Revolutionary Sonic-Monitor\*

Push the Switch . . . Tune to the Tone! New Scott Invention Audibly Signals when Stereo is on the Air

Once again Scott engineering leads the way . . . brings you a new 60 watt FM tuner/amplifier equipped with unique Sonic-Monitor\*, a completely reliable audible tone that signals you quickly, simply and definitely when a stereo program is actually on the air.

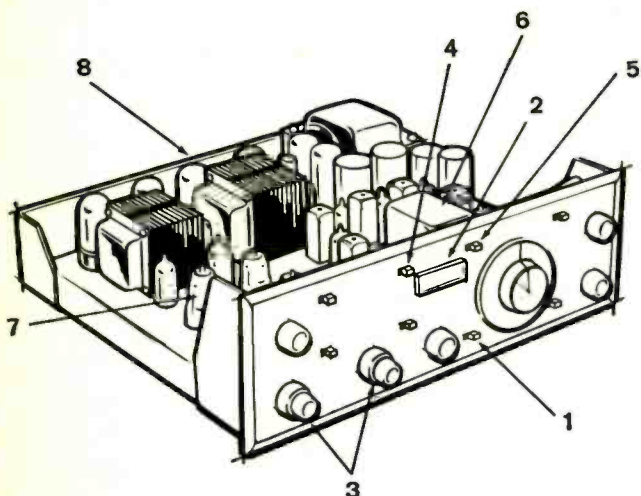

The 340 60-watt Tuner/Amplifier Combination is a new kind of component. Even though tuner, preamplifier and power stages are all on one compact chassis, Scott's outstanding engineering group has been able to incorporate all the features and superb performance of separate Scott units. No compromises have been made. No corners have been cut. No specifications have been inflated.

For example, the Time Switching multiplex section, like all Scott FM Stereo tuners, contains 4 tubes and 9 diodes. It is *not* stripped to 2 or 3 tubes like many compromise tuner/amplifiers. The power stages provide 60 watts at low frequencies where it really counts and where conventional tuner/amplifiers rated at 1000 cps fall down badly. Feature after feature, the 340 fulfills the Scott promise of superb performance.

Obvious features and innovations tell only part of the story. All Scott components include refinements and intangibles which you will find pay off in years of trouble-free performance. As leaders in technical innovation, implacable quality control and remarkable value, Scott stands alone.

1. Unique Sonic-Monitor tunes to the tone to tell you when stereo FM programs are on the air. Completely eliminates guesswork and misleading indications.
2. Precision meter insures accurate tuning — a must for low distortion stereo reception.

CIRCLE 75 ON READER-SERVICE CARD





TUNE TO THE TONE  
STEREO STEREO  
TUNE TO THE TONE  
STEREO STEREO



**HOW UNIQUE SONIC-MONITOR\* WORKS**

To find FM stations broadcasting stereo multiplex simply push the Sonic-Monitor Switch to "Monitor" and tune across the dial. When you hear the monitor tone from your speakers, you know positively that you have tuned to a stereo broadcast. Then simply push the monitor switch back to "listen", lean back and enjoy FM stereo. The Scott Sonic-Monitor\* provides a positive, reliable indication of FM stereo broadcasting. It is never activated by spurious signals as are most visual systems.

\*Patent Pending

3. Separate bass and treble controls.
4. Sub-Channel Noise Filter for reduced noise.
5. AGC switch for best reception of weak multiplex signals.
6. Scott silver-plated front end to assure sensitivity better than 2.5  $\mu$ v by IHFM standards.
7. Special filters insure flawless off-the-air stereo tape recording.
8. Inputs for tape recorder, TV, phono cartridge and tape deck.
9. Compact! Size in handsome accessory case only 17 1/2" W x 6 1/2" H x 16 3/4" D.
10. Plus, of course, all the hidden design and construction refinements that make Scott components your wisest long-term investment.

The new 340 is in the proud tradition of the famous Scott 355 tuner/amplifier so widely acclaimed by audio authorities. The 340 offers you superb performance and amazing flexibility at modest cost. If your power requirements are more demanding, however, and you wish to receive AM as well as FM, we suggest that you see and hear the 355 80 watt Tuner/Amplifier at your dealer. Price of the 355 with separate 208 80 watt stereo power amplifier is \$449.90. The new 60 watt 340 is only \$379.95, and will be available in late April. Prices do not include case, and are slightly higher west of the Rockies.

\*Patent Pending



H. H. Scott, Inc., 111 Powdermill Rd., Maynard, Mass. Dept. 226-04  
 Export: Morhan Exporting Corp., 458 Broadway, N. Y. C.  
 Canada: Atlas Radio Corp., 50 Wingold Ave., Toronto

Rush me complete details on your new 60 watt 340 Multi-plex Tuner/Amplifier Combination.

Name .....

Address .....

City ..... State .....

**CIRCLE 75 ON READER-SERVICE CARD**

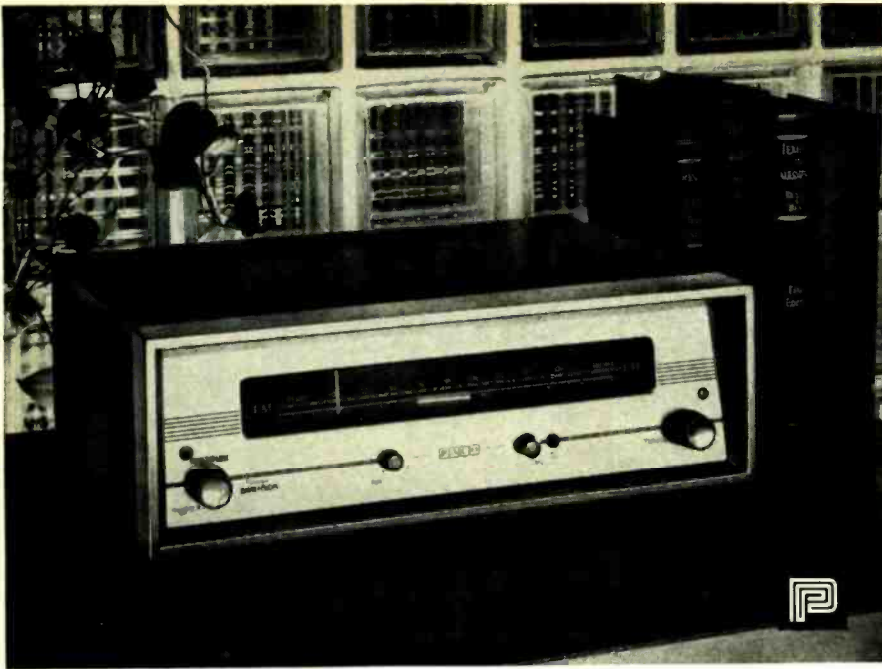

**FM • STEREO • MULTIPLEX**  
*All on One Chassis and in* **KIT FORM**

That's Right — No external Multiplex Adapter required... PACO introduces the new model ST-35MX FM Stereo Multiplex tuner, featuring the finest multiplex circuitry, ALL ON ONE CHASSIS... ALL IN ONE CABINET AND IN KIT FORM (with factory pre-aligned multiplex section).

The ST-35MX FM Stereo-multiplex tuner is designed for the discriminating Audiophile who demands the ultimate in distortionless FM Stereo reception. Its incomparable features include ultra high sensitivity, rock-stable AFC, pin point selectivity combined with broad band response.

The ST-35MX has been engineered to meet the most critical standards. Highly styled in a handsome black and gold case... it is the perfect companion to Paco's popular SA-40 Stereo preamp-amplifier or any other fine quality stereo system.

AVAILABLE THREE WAYS IN HANDSOME GOLD AND BLACK ENCLOSURE

**MODEL ST-35MX (Kit)** with full pre-aligned multiplex circuitry and PACO detailed assembly—operating manual.

NET PRICE \$99.95

**MODEL ST-35PAMX (Semi-Kit)** with both tuner and multiplex sections factory-wired and completely prealigned for hairline sensitivity. Complete with PACO detailed assembly — operating manual.....NET PRICE \$119.95

**MODEL ST-35WMX (ready to operate).** Factory-Wired, aligned, calibrated and assembled complete with operating manual.....NET PRICE \$139.95

by **PACO**



**Model SA-40**  
**STEREO PREAMP-AMPLIFIER KIT**  
 Kit Net Price: \$79.95  
 Factory Wired Net Price: \$129.95



**Model ST-25 MX**  
**FM STEREO TUNER KIT**  
 Kit Net Price: \$69.95  
 Factory Wired Net Price: \$99.95



**Model MX-100**  
**STEREO MULTIPLEX ADAPTER**  
 Kit Net Price: \$49.95  
 Factory Wired Net Price: \$69.95

The general public probably knows **Martin Mayer** best as author of carefully documented and somewhat controversial explorations of such American phenomena as *Wall Street and Madison Avenue*, and of last year's formidably researched volume on education entitled *The Schools*. The more select company of music listeners know him too as long-time record reviewer for *Esquire*, author of *A Voice That Fills the House* (a novel—some people say a *roman à clef*—about opera-behind-the-scenes in Italy and New York), and occasional contributor to *HIGH FIDELITY*. Mr. Mayer's first article for us was a profile of Maria Callas, way back in 1954, when he, she, and we were all somewhat younger. His latest has a larger canvas: see "The Triumphs and Troubles of the Met," p. 38.

Two decades ago, **Joseph Marshall**—who this month gives us "Improvements in Arms," p. 42—was among the adventurers in the then unexplored realms of high-fidelity sound at home. Unlike some other kinds of early settlers, however, he looks to the future, not to the past. In fact, Mr. Marshall not only has done a good deal to help chart audio territory for later-comers (he's author of *Maintaining High Fidelity* and *Stereo Hi Fi Handbook*, in addition to many magazine pieces); he welcomes having new worlds to conquer. If stereo has brought problems to designers of components, Mr. Marshall sees their solution as simply adding to sound fanciers' delights.

**Peter J. Pirie** emerged from London's Guildhall School of Music and Drama, where he studied piano, conducting, and composition, hoping that he could avoid the contemporary mania for specialization ("see music whole," in his own phrase). He discovered that specialization was unavoidable, he says, but he has at least managed to keep his professional activities ranging over the period from Haydn to Webern. Mr. Pirie has devoted much time to English music, but here the labor is more of love than of duty: witness "No Funeral Taps for Delius," p. 46.

In the era "When the Big Bands Played Swing" (see p. 49), **Martin Williams** was seduced by jazz. The spell has lasted. Onetime coeditor of the *Jazz Review* and editor of an anthology called *The Art of Jazz*, Mr. Williams is a regular contributor of articles on jazz matters to *Down Beat*, *Metronome*, the *Evergreen Review*, and *The American Record Guide*. In a former life (as a college instructor in English) he followed academic protocol by writing for the learned journals (subjects: Joyce and Marlowe); latterly, he writes TV criticism for Manhattan's *Village Voice*.

**PACO Electronics Co., Inc.**

a division of **PRECISION Apparatus Co., Inc.**

Subsidiaries of Paelectronics, Inc.

70-31 84th Street, Glendale 27, Long Island, New York

*Manufacturers of Fine Electronic Equipment for over 30 years.*

CIRCLE 65 ON READER-SERVICE CARD

See the full line of PACO Hi-Fi Stereo components on display at all leading distributors throughout the world.

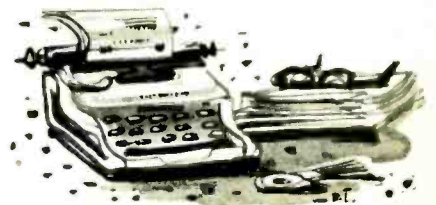

***small speakers  
for  
small rooms?***



These two AR-3 speakers provided Christmas music last year for Grand Central Terminal's main concourse, whose capacity is several million cubic feet. Carols and organ music were played in stereo at natural concert volume. Passers-by were often seen looking around for a live chorus or pipe organ.

Relative size does not determine the suitability of small, medium, or large speakers to small, medium, or large rooms. The only criterion by which performance may be judged is the ability of the speaker to reproduce music naturally, without coloration.

The price of AR speakers ranges from \$89 for an unfinished AR-2 to \$225 for an AR-3 in walnut, cherry, or teak. A five-year guarantee covers parts, labor, and reimbursement of any freight charges to and from the factory. Catalog and a list of AR dealers in your area are available on request.

**ACOUSTIC RESEARCH, INC., 24 Thorndike Street, Cambridge 41, Massachusetts**

CIRCLE 1 ON READER-SERVICE CARD

# ARE YOU BEING CHEATED?

We at GRADO are constantly asked "How does a consumer know which ads are truthful?" "How can the consumer be sure that what he buys is really good?" "What protection does the consumer have after he spends his money?" He couldn't be sure until now!

**100% CONSUMER PROTECTION.** Proof of GRADO integrity and superb product quality is what we offer you with absolutely no risk on your part!!

## GRADO SENATOR CARTRIDGE A Genuine Moving Coil Stereo Cartridge \$24.95

**CERTIFIED SPECIFICATIONS.** After carefully controlled Laboratory tests the New York Testing Laboratories certifies the following specifications to be completely accurate. (Note: These specifications will be recertified at various intervals to assure you, the consumer, of consistent quality).

### SPECIFICATIONS — CERTIFIED (New York Testing Laboratories)

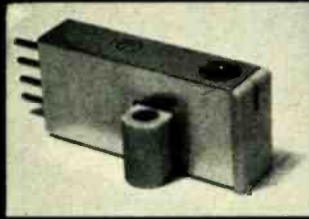

### FREQUENCY RESPONSE:

20CPS—1KC—  
± 1DB  
1KC—10KC—  
± 1.5DB  
10KC—22KC—  
± 2DB

### APPLICATION:

Tone Arm or  
Record Changer  
Excellent for  
Monaural Records

### CHANNEL SEPARATION:

Vertical—Lateral  
30DB—1KC  
18DB—15KC  
45°—45° } 1KC  
30DB } 15KC  
14DB }

Output—  
8MV @ 10CMV  
Tracking Force—  
3 grams  
Diamond Stylus

**ONE YEAR UNCONDITIONAL GUARANTEE** (From date of purchase). If the cartridge becomes defective for any reason (including children) you will receive a brand new cartridge FREE!!

**5 YEAR DIAMOND STYLUS GUARANTEE.** If the diamond wears from playing within 5 years of the purchase (even in a recrd changer) GRADO will replace it FREE!!

**ADDITIONAL PROTECTION.** You may return the cartridge to your dealer for a full refund if you are not completely satisfied after ten days of close listening in your own home.

### THE EXPERTS SAY:

"Provided a tape like stereo effect with no instrument wander."  
Larry Zide . . . American Record Guide  
"Superb sound at any price."  
Chester Santon . . . Adventures in Sound, WQXR

If the cartridge becomes defective after the warrantee period expires, for a flat fee of \$15.00, you will receive a brand new cartridge.

**ONLY GRADO CAN BE PURCHASED WITH COMPLETE SECURITY!!**  
The above guarantee also covers:

Laboratory Stereo Cartridge \$49.50 • Classic Stereo Cartridge \$37.50

For Ultimate Results Use The **TOP RATED** Laboratory Series Tone Arm \$39.50

ASK YOUR DEALER ABOUT THE **GRADO DUSTAT \$6.95**  
**VELVET TOUCH RECORD CLEANER • NO MESSY FLUIDS**

FOR FURTHER  
INFORMATION WRITE: **GRADO LABORATORIES, INC.**  
4614 Seventh Ave., Brooklyn 20, N.Y. • Export—Simontrise, 25 Warren St., N.Y.C.

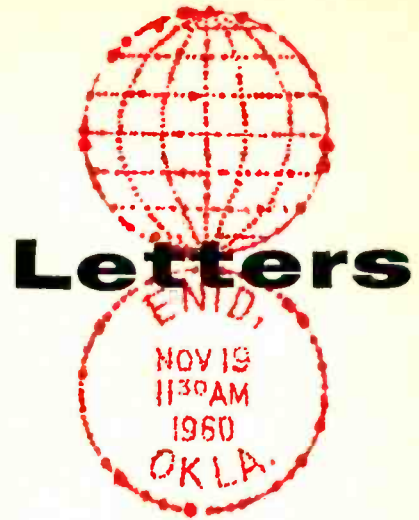

### The Imports

SIR:  
Your new column "The Imports" is the best thing that's happened to HIGH FIDELITY since you expanded the "Equipment Reports" section. Short of subscribing to a plethora of foreign record-review magazines, there has been no way in the past to get informed opinion on imported releases.

I don't know about Odeon labels, but in the case of imports from Pathé-Marconi the Pathé labels on the records can be soaked off with water, revealing the original "La Voix de Son Maître" label with the familiar gramophone and dog.  
Bernard A. Engholm  
Del Mar, Calif.

SIR:  
It was with great pleasure that I noted the introduction of a section on imported recordings. A feature of this sort has long been overdue, and I am happy to see that you are now providing this service for your readers.

Edmond Mignon  
Los Angeles, Calif.

### A Pox on High Fidelity

SIR:  
I have just received a renewal notice from you and I think that you ought to know the reason for my decision not to renew. It is the direct result of an obnoxious piece called "A Pox on Manfredini" [HIGH FIDELITY, June 1961]. There is no excuse for this kind of article.

Thomas W. Parsons  
Brooklyn, N. Y.

### Way Out West

SIR:  
Thanks sincerely for your accurate coverage in the issue devoted to "Music in California" [HIGH FIDELITY, January 1962]. We have needed this for some time. Those who don't live here in California would have no way of knowing that we sometimes have music worth listening to. It is gratifying that finally

Continued on page 14

CIRCLE 47 ON READER-SERVICE CARD

HIGH FIDELITY MAGAZINE

# What do today's great musicians have that Paganini and Paderewski didn't?



## This!

Isaac Stern, Eugene Ormandy, Victoria de Los Angeles, Claudio Arrau and scores of other world-famous musical artists today have Fisher high fidelity equipment in their homes. What's more—whether or not any of them transcend the legendary Paganini or the spell-binding Paderewski—they all have an advantage that is strictly of our time: totally lifelike reproduction of their artistry in thousands and thousands of private living rooms through Fisher stereo.

Now the same kind of engineering that makes Fisher rank supreme among the most advanced stereo perfectionists is available to all music lovers regardless of technical inclination. The Fisher 500-B Stereo Receiver shown here combines in a single unit all of the elec-

tronic components of a 'no-compromise' stereo system, but its operation is child's (and wife's) play. The elegant chassis takes up no more shelf space than a dozen books, yet it incorporates an ultra-sensitive FM Stereo Multiplex wide-band tuner, a 65-watt stereo power amplifier, and a stereo control pre-amplifier of grand-organ flexibility.

The Multiplex section is a built-in part of the 500-B—you need no adapter to receive the thrilling new FM Stereo broadcasts. And the exclusive Fisher Stereo Beam shows you instantly whether or not an FM station is broadcasting in stereo.

Simply connect a pair of fine loudspeakers to the Fisher 500-B and you

have an integrated stereo installation that ranks with the world's finest. Price, less cabinet, \$359.50.\* The Fisher 800-B (virtually identical but with high-sensitivity AM tuner), \$429.50.\*

FREE! Write for the 1962 Fisher Handbook, a 40-page illustrated reference guide and component catalogue for custom stereo installations.

Fisher Radio Corporation  
21-25 44th Drive  
Long Island City, N. Y.

Please send free 40-page Handbook, with complete specifications on the Fisher 500 B and 800-B.

Name \_\_\_\_\_  
Address \_\_\_\_\_  
City \_\_\_\_\_ Zone \_\_\_\_\_ State \_\_\_\_\_



HF 401

\* Prices slightly higher in the Far West. Export: Fisher Radio International, Inc., Long Island City 1, N. Y.

CIRCLE 43 ON READER-SERVICE CARD

**There are only three  
finer Stereo Control  
Amplifiers than this  
\$159.50\* Fisher X-100.**

(the three on the right)



Single-chassis, integrated Stereo Control Amplifiers are one of the great Fisher specialties. The special design problems of combining the power amplifier section with the preamplifier and audio control system in one space saving unit have been solved by Fisher engineers to an unprecedented degree of technical sophistication.

As a result, even the moderately priced, 36-watt X-100 offers a performance standard that is uniquely Fisher—and, at the other end of the scale, the 110-watt X-1000 is by far the most powerful and advanced Control Amplifier in existence. Between the two, the 56-watt X-101-B and the 80-watt X-202-B are the world's finest for their size and cost.

**There are only two  
finer Stereo Control  
Amplifiers than this  
\$189.50\* Fisher X-101-B.**

(the two on the right)



Each of these remarkable stereo amplifiers has virtually non-measurable distortion right up to the limit of its power rating. The superb listening quality of each is instantly apparent but will be even more appreciated after long hours of completely fatigue-free listening.

The top three models incorporate the exclusive Fisher internal tape switching system, which permits the full use of all audio controls and switches during tape playback immediately after monitoring—**without any changes in cable connections.** The same models also provide a center-channel speaker connection, which eliminates the need for an extra power amplifier when an optional third loudspeaker system

CIRCLE 43 ON READER-SERVICE CARD

**There is only one  
finer Stereo Control  
Amplifier than this  
\$249.50\* Fisher X-202-B.**

(the one on the right)

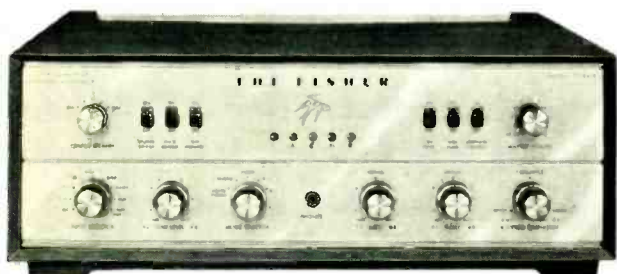

**There is no finer  
Stereo Control Amplifier  
than this \$339.50\*  
Fisher X-1000.**

(that's right!)



is installed. These three amplifiers also have suitable jacks to accommodate the Fisher K-10 'Spaceexpander' reverberation unit or a pair of earphones for private listening. The X-202-B and the X-1000 offer, in addition, built-in facilities to accept the Fisher RK-1 remote control system.

No one who is at all serious about stereo should miss the opportunity to hear these Control Amplifiers demonstrated by an authorized Fisher dealer. Even a brief listening session will prove conclusively that no high fidelity component can surpass a Fisher — except another (and more elaborate) Fisher.

**The Fisher**

FREE: Write for 1962 Fisher Handbook — a 40-page illustrated guide and component catalogue for custom stereo installations.

Please include complete specifications on the  X-100  X-101-B  X-202-B  X-1000

**Fisher Radio Corporation**

21-25 44th Drive, Long Island City, N. Y.

Name \_\_\_\_\_

Address \_\_\_\_\_

City \_\_\_\_\_ Zone \_\_\_\_\_ State \_\_\_\_\_

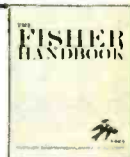

HF405

\*Less cabinet: prices slightly higher in the Far West. EXPORT: Telesco International Corp., 171 Madison Ave., New York 16, N.Y. Canada: Tri-Tel Associates, Ltd.  
**CIRCLE 43 ON READER-SERVICE CARD**

BOBBY HACKETT SAYS...

“ I USE KOSS STEREPHONES  
AND THEY MAKE MY  
TAPE RECORDER SOUND GREAT

*As a traveling man, I  
couldn't carry two stereo  
speakers around with me.* ”



**ADD PERSONALIZED LISTENING AND  
STEREO PERFECTION TO YOUR EQUIPMENT.**

With Koss Stereophones, you can hear stereo records and tapes as perfectly as they can be recorded. The secret lies in large 3½" sound reproducers and complete separation of stereo channels regardless of your position in the room. Now you can listen to your equipment at full volume without disturbing anyone else in the house, because Koss Stereophones provide you with personalized listening. Koss Stereophones connect easily to any phono or tape system, either stereo or mono. **\$24.95**

**Koss**

INC., • 2227 N. 31st Street • Milwaukee, Wisconsin  
CIRCLE 57 ON READER-SERVICE CARD

LETTERS

*Continued from page 10*

one of our leading music magazines has reported so well on the state of music in California. Congratulations.

*Dick Claus*

Program Director. KHIQ  
Sacramento, Calif.

SIR:

I read with great relish your articles dealing with the music scene in California, and I am in complete agreement with the appraisal of your authors. My only complaint is that you failed to mention specifically the persons who are doing most to block musical advancement in California.

*M. Cam Miller*

Daily Blade-Tribune  
Oceanside, Calif.

**The First-Balcony Ideal**

SIR:

Even given a fine performance, a fine hall, and a "first-balcony seat," the high fidelity enthusiast mentioned in "Letters," HIGH FIDELITY, January 1962, by Mr. Slome (i.e. the man who found a concert by the great Philadelphia Orchestra "lacking bass and highs") might not have been so wrong after all. The Philadelphia Orchestra most probably did play the "bass and highs," but the acoustics of the hall or the seat of the listener, though one of the best, may yet not have allowed him to hear them. Here is where the advanced—not the overdone—technique of recording and reproducing may indeed offer artistic advantages beyond what you can hear in the concert. The acoustical conditions of hall or seat all too often detract so much from tone and tone balance even of a superior performance in one of our famous halls that only a greatly attenuated image reaches the ear(s) of the concertgoer.

The ultimate goal of music reproduction is no longer "to approach the values of the concert hall," but to render to the truest and fullest the production of the performers, so as to bring out the best of the music. Of course, there is no absolute standard for what is "best." There are concert halls—like London's new Festival Hall—that some listeners consider too "clear" and "cold," and there are recordings and reproducing equipment too "pointed" to please. However, high-fidelity reproduction has advanced to a stage where it may not only equal the perception available in the concert hall but, at its best, excel it. I, for one, though mindful of some shortcomings of even the best radio or phono transmissions, have not only once but many times enjoyed music more when listening to a fine FM station than to "the real thing" in Chicago's Orchestra Hall.

*Otto R. Wormser*  
Oak Park, Ill.





# If you can't afford a Fisher tuner...



## build one!

### Introducing the newest Fisher StrataKit: the KM-60 FM-Stereo-Multiplex Wide-Band Tuner

Fisher FM tuners have always been reasonably priced considering their unsurpassed sensitivity and matchless overall design—but, even so, not everyone can afford them. If economics have thus far deterred you from buying the very finest, the new Fisher KM-60 StrataKit solves all your problems in exchange for a few evenings of entertaining and instructive work. It incorporates Fisher FM engineering at its most advanced, including built-in Multiplex and sophisticated wide-band circuitry—yet it costs almost one-third less than the nearest equivalent Fisher-built tuner, which it also matches in physical appearance.

This spectacular saving involves absolutely no risk, even if you are 'all thumbs.' The StrataKit method of kit construction has eliminated the difference between the expert technician and a totally unskilled person as far as the *end result* is concerned. You assemble your StrataKit by easy, error-proof stages (strata), each stage corresponding to a particular page in the Instruction Manual and to a separate transparent packet of parts. Major components come already mounted on the chassis, and wires are *pre-cut* for every stage—which means every page! You can check your work stage-by-stage and page-by-page, before you proceed to the *next* stage. There can be no last-minute 'surprises'—success is automatic.

In the KM-60 StrataKit, the front-end and Multiplex circuits come pre-aligned. The other circuits are aligned by you after assembly. This is accomplished by means of the tuner's laboratory-type d'Arsonval signal-strength meter, which can be switched into each circuit *without soldering*.

**The KM-60 is the world's most sensitive FM tuner kit**, requiring only 0.6 microvolts for 20 db quieting! (IHFM-standard sensitivity is 1.8 microvolts.) Capture ratio is an unprecedented

2.5 db; signal-to-noise ratio 70 db. The famous Fisher 'Golden Cascade' RF stage, plus four IF stages and two limiters, must take most of the credit for this spectacular performance and for the superb rejection of all spurious signals. Distortion in the audio circuits is virtually non-measurable.

An outstanding feature of the Multiplex section is the exclusive Stereo Beam, the Fisher invention that shows at a glance whether or not an FM station is broadcasting in stereo. It is in operation at all times and is completely independent of the tuning meter. Stereo reception can be improved under unfavorable conditions by means of the special, switchable sub-carrier noise filter, which does not affect the audible frequency range.

Everything considered, the Fisher KM-60 StrataKit is very close to the finest FM stereo tuner that money can buy and by far the finest you can build. Price \$169.50.\*

The ideal companion unit is the Fisher KX-200 80-watt stereo control amplifier StrataKit, \$169.50.\*

\*Walnut or Mahogany cabinet, \$24.95. Metal cabinet \$15.95. Prices slightly higher in the Far West.

#### USE THIS COUPON FOR FURTHER INFORMATION

Fisher Radio Corporation  
21-25 44th Drive, Long Island City 1, N. Y.  
Please send me without charge the complete Fisher StrataKit catalogue.



Name \_\_\_\_\_

Address \_\_\_\_\_

City \_\_\_\_\_ Zone \_\_\_\_\_ State \_\_\_\_\_

HF413

CIRCLE 43 ON READER-SERVICE CARD

# THE NEW ELECTRO-ACOUSTIC...



Records show no discernible wear, keep their fidelity through hundreds of playings on this unique player.



Tracks at less than 3 grams... the 4-speed Electro-Acoustic 7000 series stereophonic record player with diamond stylus is certified to apply less than 3 grams tracking pressure. Your fine recordings show no discernible wear or tonal deterioration even after years of playing. Its laboratory-tested pickup maintains perfect fidelity and incomparable realism throughout the entire recorded range.

The dynamically-balanced 4-pole, 4-coil motor and turntable, the micro-honed motor spindle, precisely machined bearings, and the custom-fitted turntable drive limit rumble to -40 db, wow to less than 0.15% RMS and flutter to 0.06% RMS (better than NARTB standards). Turntable speed is certified to be within  $\pm 1\%$  of absolute. \$69.50 Audiophile Net. Write today for free illustrated literature and the name of your nearest dealer.

**ELECTRO-ACOUSTIC PRODUCTS COMPANY**  
2135 South Bueter Road, Fort Wayne, Indiana



#### CERTIFIED QUALITY

Each record player is laboratory tested and is sold with a written test report coded to the serial number of that particular record player, certifying that performance is within specification limits.

CIRCLE 38 ON READER-SERVICE CARD

I knew your mother.  
She was bulky and boxy...

Your father was  
clumsy and awkward.

... a misfit, she didn't  
belong anywhere.

Your father was  
an eyesore, the ladies  
despised him.

Yet I love you. I never saw  
a stereo speaker so  
graceful, so slim. Tell me,  
what do you think of me?

We can make  
beautiful music  
together!

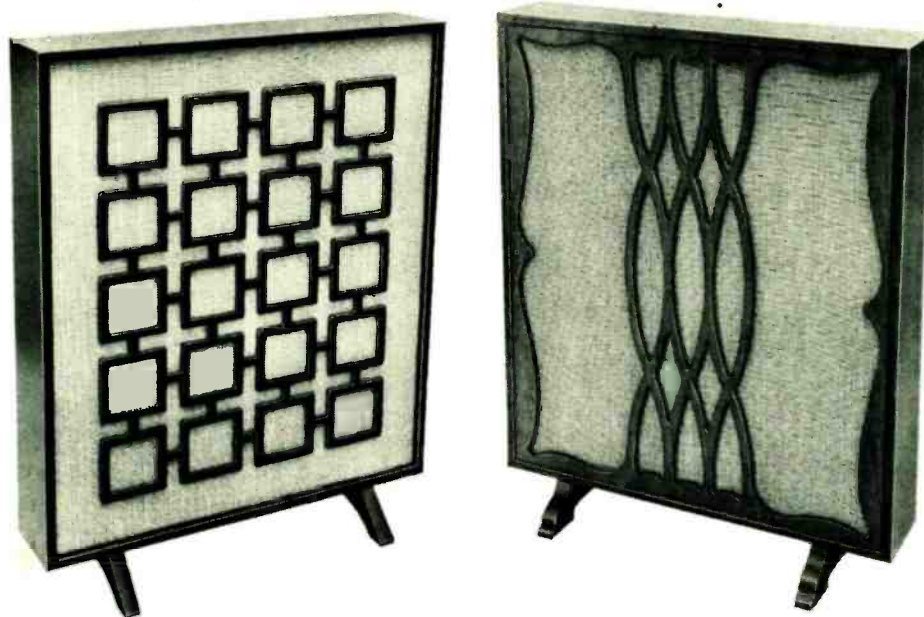

The ugly duckling has turned into a graceful swan—the SONOTEER. This is the first speaker system your wife will be proud to make a part of her home decor. The SONOTEER has five true high fidelity speakers that project a full circle of sound...both front and back. The effect is overwhelming! Hang SONOTEERS on walls, place them in room dividers...anywhere in your home. See them now at your high fidelity dealer's. Write for decorator booklet and technical specifications. *Models Shown:* Left: CA-70 Contemporary, genuine walnut—\$79.95 (CA-70E Mandarin, same style as Contemporary, satin ebony finish—\$89.95). Right: CA-70P Provincial, fruitwood finish—\$89.95.

## SONOTEER

Dept. H-S

Rek-O-Kut / Audax, 38-15 108th St., Corona 68, N.Y.

Export: Morhan Exporting Corp., 458 Broadway, N.Y.C. Canada: Atlas Radio, 50 Wingold Ave., Toronto 19.  
CIRCLE 9 ON READER-SERVICE CARD

# Professionals—Specialists—Publications—Users

## PROFESSIONALS



**IRVING M. FRIED**

Author of Electronics Newsletters and provocative articles:

"In summary, the ADC-1 represented, and represents, a new standard for stereo disc playback; one which we are proud to associate with our reference standard equipment. Other manufacturers are beginning to catch up, but the ADC is still, in our opinion, the same kind of product that our amplifiers, tone arms and speakers are—the standard by which the others can be judged."



**RICHARD L. KAYE**

Station manager WCRB multiple pioneer in New England:

"This is just a note to let you know how pleased we are with the performance of the ADC-2 cartridges you brought us. They work beautifully—as a matter of fact, the low frequency response is such an improvement over what we were previously using that now we have to replace a turntable that turned out to have excessive rumble."

## SPECIALISTS



**DAVID C. BOYNTON**

President of the Audio Lab, Inc., noted Hi-Fi Shop in Cambridge, Mass.

"The ADC-1 is one of the best sounding cartridges I have ever listened to, and its extremely high compliance and low tip mass cause less record wear than any other pick-up. The new Pritchard Tone Arms are a perfect match for the ADC-1. Using this combination, we have tracked heavily modulated records at less than 3/4 of a gram. Incidentally, the arm can be installed in five minutes."



**ERWIN W. GRAMAM**

President of Audio Craft Company, Cleveland, Ohio's outstanding music center.

"Our customers have used the ADC with perfect satisfaction. The ADC tracks the most difficult records with excellent fidelity through the full dynamic range. The ADC arm incorporates all the desirable features; ability to track at low pressure, short back overhang, low arm resonance, attractive, clean design."



**R. COLL**

Audio Consultant of Harvey Radio, one of the nation's leading High Fidelity stores.

"We have found the AEC-1 and ACC-2 cartridges to be outstanding performers. In fact, it has become habit here at Harvey Radio to recommend these units in our finest systems because they reproduce music naturally. We congratulate Audio Dynamics on their contribution to the industry and fine standards they represent."

High Fidelity Magazine, November, 1961 "United States Testing Company, Inc. characterizes the ACC-2 as a superb sounding cartridge, which would complement the finest sounding high fidelity systems." Hi-Fi Stereo Review, November, 1961 (on the ADC-1) "This cartridge deserves—almost requires—the finest loud-speaker systems for its qualities to be fully appreciated." Hi-Fi Magazine, June, 1961 (on the ADC-1) "Listening quality proved to be superb . . . a cartridge that merits being used with the finest reproducing equipment." Audio Magazine, May, 1961 "It does . . . reveal shadings and nuances we had not known were in the recording." American Record Guide, Larry Zide, June, 1961 "Insofar as my ears tell me what is good and bad, the ADC-1 cartridge is the one to have."

## PUBLICATIONS

# ... all acclaim Audio Dynamics' components

**A** LOT OF PEOPLE have been saying nice things about Audio Dynamics components. To find out why, we recommend you take a few additional minutes to read the following paragraphs.

Quality stereo cartridges are designed to suppress undesirable peaks and distortion in the high frequency range. These occur when the stylus mass resonates with the vinyl disc. To suppress resonance, since mass cannot be readily reduced, most cartridges are heavily damped.

But this solution creates problems of its own. High tracking forces are required to prevent mistracking and breakup. The suspension becomes non-linear, resulting in distortion.

Then, in one remarkable stroke, Audio Dynamics engineers broke the vicious circle. They lowered the stylus mass to just 1/2-milligram, lowest stylus mass available in a cartridge today.

Now the low mass made it possible to have a highly compliant stylus. In the ADC-1 cartridge compliance is at least  $20 \times 10^{-6}$  cms/dyne. Linear suspension is restored, tracking force reduced to less than 1 gram! Whatever resonances remain are either too high or too low for the human ear to perceive.

With tracking force lowered to less than 1 gram, the problem of record wear and distortion disappeared once and for all!

Now with resonances removed from the audible range, there was nothing to prevent the stylus from following the groove walls direction of motion.

Finally, the absence of resonances results in greatly reduced surface noise. Absence of surface noise is considerably implemented by the use of a super polished diamond stylus with sides oriented so that only the hardest surfaces touch the grooves.

#### **NOW THE PRITCHARD TONE ARM THAT TRACKS AT LESS THAN 3/4 GRAM**

In a sense, Audio Dynamics engineers had,

at this point, exceeded themselves. They had produced a cartridge of such excellence, no tone arm could do it full justice. True, it would play with unparalleled quality in fine tone arms, but its full potential could not be realized.

With this "happy" problem in mind, Peter Pritchard, of Audio Dynamics, designed a tone arm that would enable the ADC-1 to track at the low forces for which it was constructed.

Here are the features which, when combined with the ADC-1, make up the Pritchard Pickup System

1. **A heavy adjustable counterweight** which, unlike other systems, occupies minimal space behind the pivot.
2. **A side thrust compensator** permits the stylus to maintain even pressure on the groove walls by stabilizing the force created between the disc and arm.
3. **An accurately machined and treated wooden tone arm** that suppresses extraneous resonances.
4. **Precision ball bearings** on gimbals which minimize friction.
5. **Low inertia** which insures perfect tracking.
6. **Entire unit** comes completely assembled and wired with cable ready to plug in.

(Should you be happy with your present cartridge, the plug-in head in the tone arm will accommodate it.)

The combination of the ADC-1 in the Pritchard tone arm achieves results that amazes even experts. A few minutes spent at your dealers listening to this truly remarkable system will convince you that rewards that you never thought possible can be yours. Listen to them. Hear for yourself why the response to Audio Dynamics components won so much acclaim, and why it was merited!

Audio Dynamics also manufactures the ADC-2 cartridge, a cartridge with the same characteristics as the ADC-1, designed for use with quality tone arms and record changers.

For more information on the ADC-1 stereo cartridge for quality tone arms, the Pritchard Pickup System, and the ADC-2 stereo cartridge for quality tone arms and record changers, return the coupon today.

**USERS**  
WASHINGTON, D. C. "I could not find a record in my collection that could make this pickup distort. As hard as I listened I could not recollect EVER hearing such perfect reproduction from a pressed record."  
NEWPORT, R. I. "I hope you continue to offer such fine products in the future."  
BALTIMORE, MD. "The performance of this pickup has destroyed my faith in my lack of faith in advertising claims. So far the ADC-1 has performed as well as I had been led to expect. In my experience, this is highly unusual. I congratulate you."  
SAN MATEO, CALIF. "The effortless grace of the ADC-1 is amazing. It gives me clean sound from many problem pressings, and has revealed groove damage in at least one pressing."

ADC-1 cartridge for high quality tone arms \$49.50  
ADC-2 cartridge for high quality tone arms and record changers \$37.50  
Pritchard Pickup System Model ADC-85 \$85.00  
Pritchard Tone Arm Model ADC-40 \$39.50

## **AUDIO DYNAMICS CORPORATION**

1677 Cody Avenue, Ridgewood 27, N. Y.

Please send me descriptive literature on ADC cartridges and the Pritchard Pickup System.

Name \_\_\_\_\_

Address \_\_\_\_\_

City \_\_\_\_\_

Name of My Dealer \_\_\_\_\_



Only General Electric gives you this:

## New Orthonic Stereo Cartridge



*Purest musical response...  
even beyond 20,000 cycles!*

Breakthrough in musical reproduction! General Electric's new VR-1000 ORTHONETIC Cartridge gives precise, undistorted reproduction of every note on your high-fidelity records—even at frequencies above the normal range of human hearing!

*Even the most subtle overtones  
come through...*

Ordinary cartridges shave off the higher harmonic frequencies that give orchestral instruments their characteristic color.

Thanks to a revolutionary new suspension and damping system, the VR-1000 ORTHONETIC Cartridge fully reproduces these harmonic frequencies, with barely measurable loss or distortion.

This means that every instrument has its true coloration; even the most sensitive ear can listen without the fatigue caused by musical distortion.

*Tracks at pressures as low as one  
gram—prolongs record life...*

The low-moving mass of the ORTHONETIC assures highest fidelity even on the fastest passages, minimizes record wear.

Provides up to 30 decibels per channel stereo separation. Ask your General Electric cartridge dealer for full specifications or write VR-1000, General Electric Co., Audio Products Dept., Decatur, Ill.

*Progress Is Our Most Important Product*

**GENERAL ELECTRIC**

CIRCLE 44 ON READER-SERVICE CARD

## NOTES FROM ABROAD

### LONDON

After Decca-London's annual conference in Paris to decide upon forthcoming repertory, the company's executives went around with padlocked lips like Papageno in Act. I. As one whose sole aim in life is to applaud all prospective recording ventures, I find this iron reticence sardonically amusing. The only information I pried from Decca's chairman, Sir Edward Lewis, was the fact that the United States counts rather more heavily in his considerations than ever before. The explanation, in Sir Edward's own words:

"Ever since the LP revolution the American market has been increasingly significant for us. Americans have a bigger appetite for culture and strive after it more earnestly than we do. They are more prepared to take classical music by the yard. I expect I shall get into trouble for saying this, but that's the picture as I see it. Taking into account that British record prices [retail] are a little higher than in America and that we pay Purchase Tax on top, it takes the average man here two or three times longer to earn the price of a record than it takes the average American. I would say that America buys thirty per cent of our LP output."

**The Queen's Musick.** Stirring in its sleep, the old guard is beginning to murmur "Hands off *God Save the Queen!*" Why? Mainly because at Kingsway Hall the London Symphony Orchestra and their associated choir recorded Benjamin Britten's arrangement of the National Anthem (first publicly heard at big London and provincial concerts last autumn). Coupled on a low-priced 45-rpm disc with the *Trumpet Voluntary* ascribed to Purcell, it is being distributed all over the world.

In conformity with what is tacitly understood to be Buckingham Palace policy, Mr. Britten's version omits the verse which calls upon God to confound the politics and frustrate the knavish tricks of the Queen's enemies. The two verses that remain are set as a long crescendo, starting with unaccompanied voice *ppp* and ending in a *fortissimo* blaze of voices, drums, and brass. My-

self, I find the effect a bit theatrical. But there is no mistaking the Britten touch in scoring the harmony.

Trouble was not long delayed. An anonymous spokesman of Britten's publishers was reported as saying that the new version looked on paper as if composed by a beginner who couldn't pass a Royal College composition examination to save his life—but that in performance it was marvelous and moving. Next day the head of the firm went around wringing his hands at what he considered an unhappily worded compliment.

Sir Arthur Bliss, Master of the Queen's Musick (official spelling), praised Britten's setting. He went on to say that so long as there was no tampering with words and tune—"which are as unalterable as the Union Jack; a green and yellow Union Jack is unthinkable"—he was very much in favor of new versions which in harmony, dynamics, and tone color express the spirit of new ages. Because of these and other sentiments of an equally exceptionable sort, Sir Arthur received, I understand, a number of "mildly abusive" letters.

**Berganza and Babies.** Also at Kingsway Hall, the Spanish mezzo Teresa Berganza perched on a chair, looked a degree more charming than ever, and—at four sessions accompanied by her husband, Felix Lavilla—completed a recital disc for Decca-London: Italian arias (Scarlatti, Pergolesi, Cesti, Cherubini) for one side; for the other, a string of Spanish songs—Granados, Turina, Guridi, and four of her husband's folk-song settings. The Lavillas had left their little ones (two-year-old boy, five-months-old girl) in charge of nanny and nurse in Spain. Everybody here is awed by the calm resolution with which Señora Lavilla combines the duties of art and motherhood. A few months before the birth of her second child, she was playing Cherubino as piquantly and convincingly as ever. Three years ago she told a member of Decca's staff that her ambition was to have six children. Thinking of the recording schedules that were being penciled, he shrugged despairingly. The schedules have worked just the same.

*Continued on page 22*

HIGH FIDELITY MAGAZINE

**Now it's BELL STEREO**

**Professional performance, priced for everyone**



## **BELL Model T-337 4-Track Stereo Tape Transport with 3-motor professional tape drive**

**3-MOTOR DRIVE**, acknowledged by professionals as the best way to build a tape-handling mechanism, is a key feature of Bell's T-337. There are no belts, pulleys, friction clutches. Each motor has only one job to do, does it better. Result: Extremely low wow and flutter (0.2% @ 7½ ips), fewer moving parts, extremely long and trouble-free life. Other T-337 features:

**High-speed tape handling**—speeds up to 30 feet per second in Rewind and Fast-Forward.

**Electrodynamic braking**—brings tape to a swift but gentle stop from high speeds, without stretch or strain to even the thinnest mylar tapes. Precision-acting Memory Switch provides differential braking to eliminate any possibility of looping.

**Piano-key controls**—all in a row—by far the most functional, easiest to operate.

**Separate 2- and 4-track heads** of optimum gap width—precision-adjusted at the factory, switched electrically for perfect azimuth and track alignment.

**Automatic stop** turns off take-up motor to safeguard your tapes completely when they finish playing.

**Two record-level meters**—provide positive visual indication of record level on each channel.

**Positive record interlocks and lighted indicators**—assure correct operation by even inexperienced users.

**Integrated RP-320 stereo record/playback preamplifier**, with carefully engineered circuit, assures professional-quality recordings. Complete facilities provided for precise adjustment of meter calibration, bias, record equalization. Mike inputs are conveniently located in front; with high-level inputs, outputs, stereo headphone monitor jack on rear panel.

**Professional 4-track recording characteristics** are assured with two-speed equalization-bias switching. 4-track stereo and monophonic, 18-15,000 cps ± 3 db @ 7½ ips; 18-15,000 cps ± 3 db @ 3¾ ips. 50 db signal to noise ratio. (Also records 2-track stereo and monophonic with blank or bulk-erased tapes.)

**Mounts in horizontal or vertical plane** to fit every type of installation. Matches the Bell Amplifiers in styling and color, for a perfect decorator-approved custom installation. See your Bell Dealer NOW! Bell Sound Division, Thompson Ramo Wooldridge Inc., 6325 Huntley Road, Columbus 7, Ohio.



**BELL STEREO**

**Thompson Ramo Wooldridge Inc.**

CIRCLE 17 ON READER-SERVICE CARD

Now is the time  
to come to the aid  
of your <sup>outdoor</sup> party!



**Electro-Voice®**

High-Fidelity Speaker System  
...it's Weather-Proofed!

Now you can easily add the luxury of high-fidelity music to your outdoor fun!

Whether you're dancing under the stars, swimming in the pool or relaxing around the barbecue... the new Electro-Voice Musicaster provides high-fidelity music from your present hi-fi system, radio, phonograph or TV set.

Specially designed for indoor-outdoor use, the E-V Musicaster features a heavy-duty weather-proofed speaker mounted in a rugged aluminum die-cast enclosure. It's easy to connect for permanent use outside. And you simply move it into the recreation room for year-'round pleasure.

Send now for full information... plus the name of your nearest E-V sound specialist!

The E-V Musicaster® is also a "sound" buy for church, school, or club!



ELECTRO-VOICE, INC., Buchanan, Mich.

ELECTRO-VOICE, INC., Dept. 424H  
Buchanan, Michigan  
Please send me your free booklet, "How to Enjoy High-Fidelity Outdoors" and E-V sound specialist list.

Name \_\_\_\_\_

Address \_\_\_\_\_

City \_\_\_\_\_

State \_\_\_\_\_

CIRCLE 40 ON READER-SERVICE CARD

## NOTES FROM ABROAD

Continued from page 20

From Vienna's Musikverein. Victor Olof (EMI-Angel) recently came home with a promising clutch of Vienna Philharmonic tapes. Under Paul Kletzki the orchestra had recorded Mahler's Symphony No. 1. The principal double bass was given an ovation by his fellow musicians and everybody else in the hall after his playing of the hair-raising *Frère Jacques* solo in the third movement, an episode which, in the hands of an unnerved player, can be a squeaky calamity. Under Sir Malcolm Sargent the men turned to Sibelius, a composer who for most of them has been a closed or, at any rate, rarely opened book. *En Saga*, a *Karelia* suite, *Finlandia*, and the *Swan of Tuonela* will appear on one disc.

Under Carl Schuricht, now in his eighty-second year, they recorded Bruckner's Symphony No. 9. Although Schuricht's arthritis makes him shuffle painfully, he is still lively of beat, cue, and glance when he reaches the podium. At the last session he kissed Victor Olof and, with tears in his eyes, said the performance had been among the high-water marks of a conducting career, mainly on German platforms, that goes back to a time when Bruckner's music was still hotly controversial.

CHARLES REID

### MUNICH

On the last day of 1961 a Westminster recording team safely stored away a couple of tapes which contain musical documents unique in their

way. When the canon quartet from Beethoven's *Fidelio* ("Mir ist so wunderbar"), left for the very last take, had been completed, all those who had taken part in the recording felt properly gratified at the harvest brought in before the chiming of the New Year bells. "Wunderbar," said Hans Knappertsbusch (Kna for short), when he put down his baton. [What HIGH FIDELITY's reviewer has to say about the finished album appears on p. 64.]

*Fidelio* was the first large-scale recording of the seventy-four-year-old conductor had embarked on since recovering from a prolonged illness, but the sessions found him in his characteristic form. Kna has, for instance, a well-known aversion to rehearsals, and hence to recordings made by joining together a series of carefully edited separate takes. As usual, he insisted on creating something nearer to



Jurinac, Kna: almost religious fervor.

KURT BLAUPF

a live performance. This self-confidence—together with the conductor's economy of gestures and his often unusually slow tempo—can create difficulties for both singers and instrumentalists. Fortunately, the scene of operations was Munich.

**Sostenuto Assai.** The men of the Bavarian Opera Orchestra and the members of the Munich Opera Choir have long been familiar with the intricacies of Kna's style. "I got my job here thirty years ago, when Kna engaged me," one of the bassoon players said, and members of the choir assured me that over many years they had had plenty of opportunity to practice the unbelievably "long breath" which Kna demands for the *sostenuto assai* passage in the second finale.

*Sostenuto assai* is the hallmark of Kna's *Fidelio* reading. His art of retaining the energy of the music by imposing a *sostenuto* that will make the ensuing *allegro* appear like the bursting of a dike is unique. The singers had no doubt about the problems this would pose. "I had been warned beforehand," Jan Peerce confided to me. "I knew that Kna's tempos would tend to be the very opposite of those I had followed in my first recording of the Florestan part more than a decade ago, under Toscanini." Peerce insists, however, that the very lesson he learned with Toscanini ("to fit in with the artistic concept of the conductor, to surrender unconditionally and convincingly") made it possible for him not only to follow Kna's baton, but to appreciate his manner of interpretation. After the recording of Florestan's great aria, Peerce said triumphantly: "You see, it is all a one-take affair. No splicing. It was the same with Toscanini."

**Sopranos Jurinac and Stader.** Kna's style seems to impart to the music a kind of religious fervor, and this could be felt throughout the sessions. Sena Jurinac's voluptuous, dramatic soprano, for example, at times had the ring of an ardent prayer. I still cherish the memory of Miss Jurinac's appearances in lighter and less dramatic mezzo roles such as Octavian (notably in the old Kleiber recording of *Der Rosenkavalier*), but after listening to her Munich Leonore I fully understand her statement that "she was always meant to be a soprano."

The part of Don Pizarro in the Munich recording was taken by Gustav Neidlinger (who sang Alberich in London's *Rheingold*); Murray Dickie sang Jaquino; Deszo Ernster was Rocco; and Frederick Guthrie was assigned to Don Fernando. The role of Marzelline went to Maria Stader, the Swiss soprano who started her career as an oratorio and Lieder singer and later entered the operatic field mainly through recordings. Miss Stader sang Constanze, Donna Elvira, and Pamina in Deutsche Grammophon's complete recordings of *Die Entführung, Don Giovanni*, and *Zauberflöte*, and thus took on roles which in the opera house seem to be denied her because of her tiny stature. Her voice betrays nothing of her physical appearance, but rather impresses by a vivid roundness of the tone.

HIGH FIDELITY MAGAZINE





don't start with  
a scratch...

## PROTECT YOUR RECORD COLLECTION WITH AUTO-POISE ...first self-powered automatic tonearm

Record scratch is a thing of the past with REK-O-KUT Auto-Poise—the first self-powered automatic tonearm. □ For the first time, the flawless performance of the single-play turntable and independent tonearm is combined with convenient push-button operation. □ Auto-Poise, the first automatic self-powered independent tonearm, pays for itself by protecting your record collection and high-compliance cartridge. □ You get ■ *unequaled record protection* ■ *fully automatic operation* ■ *unexcelled single-play turntable and independent tonearm performance* □ Ask for a demonstration of Auto-Poise at your high fidelity dealer. Write for free literature today.

AUTO-POISE AUTOMATIC TONEARM, Model AP-320—\$74.95 net. □ AUTO-POISE CONVERTER, MODEL APK, converts existing Rek-O-Kut Tonearms to automatic tonearms—\$49.95. □ REK-O-KUT STEREO TONEARM, Model S-320, with exclusive Omni-Balance and Micro-poise, for perfect balance and tracking with high-compliance cartridges—\$34.50 net.

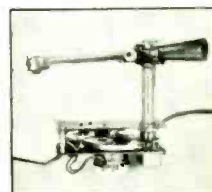

**REK-O-KUT**

Co., Inc., Dept. HF-4, 38-19 108th St., Corona 68, N.Y. Export: Morhan Exporting Corp., 458 Broadway, N.Y.C. Canada: Atlas Radio, 50 Wingold Avenue, Toronto 19.

CIRCLE 71 ON READER-SERVICE CARD

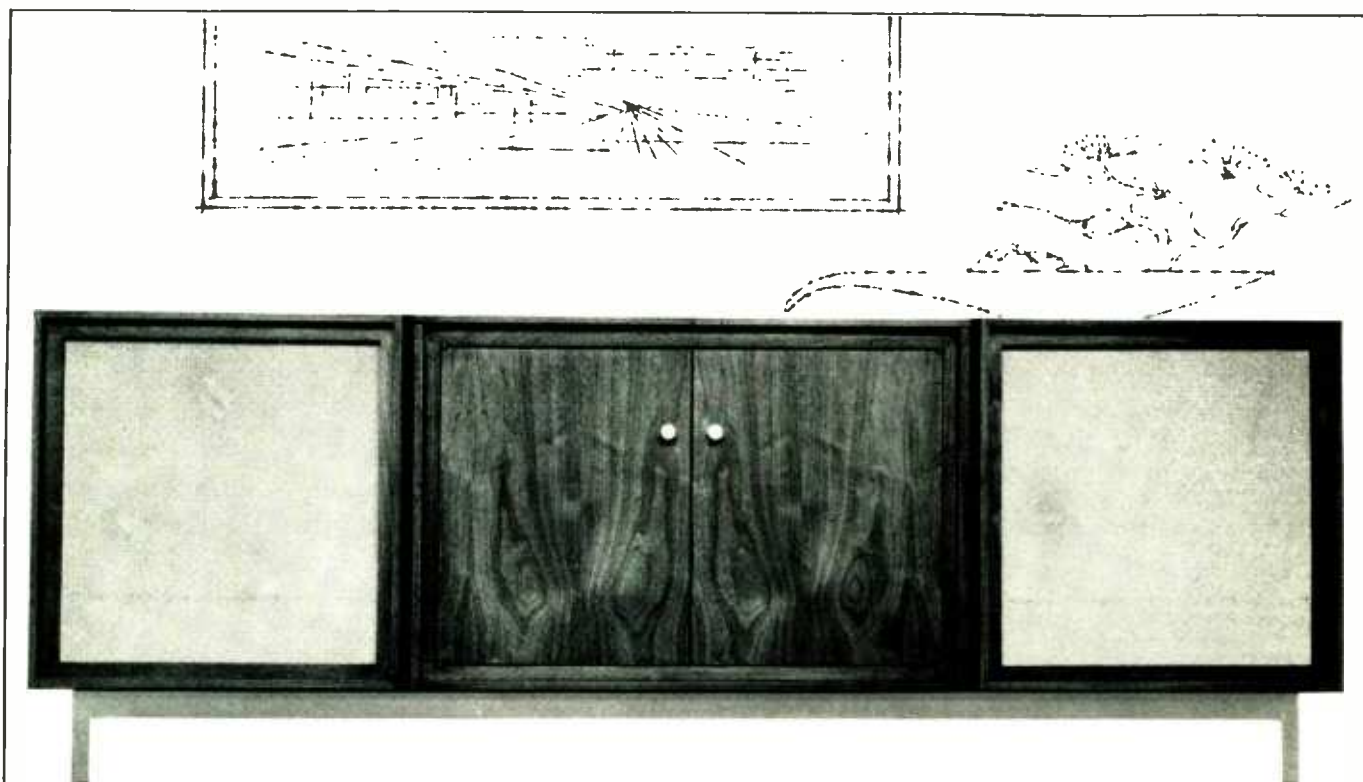

Bozak B-5002 ensemble combines two famed B-302 speaker systems with matching cabinet to house electronic components of your choice.

**Component High Fidelity Musical Integrity  
Packaged Radio-Phonograph Appearance**

**THE BEST OF BOTH IN  
BOZAK CUSTOM ENSEMBLES**

The choice between a pre-packaged radio-phonograph which compromises musical quality (and they all do to some extent) and a component high fidelity music system which can compromise your room decor is no longer necessary.

With Bozak's new line of custom music ensembles you get the best of both.

Musically you combine the unsurpassed ability of Bozak loudspeaker systems to convert electrical signals into exact reproductions of musical

performances with electronic components you choose.

Visually Bozak ensembles integrate separate fine furniture speaker enclosures with matching equipment cabinets to give the appearance of a single unit. But there's no mechanical feedback of vibration from the speakers to the phono pickup arm, and there's no compromise with proper speaker spacing for stereophonic reproduction.

There are Bozak custom ensembles for every room size and decor and to suit every budget.

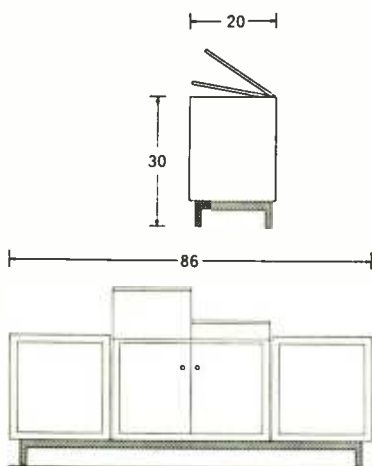

**Want to know more?**

See your Bozak dealer, or write:



587 Connecticut Avenue  
CIRCLE 19 ON READER-SERVICE CARD

South Norwalk, Connecticut

# IT'S SOUNDCRAFT IN THE GREAT MOTION PICTURES!

FROM METRO-GOLDWYN-MAYER SAMUEL BRONSTON'S PRODUCTION OF "KING OF KINGS"



If you believe that all recording tapes are the same . . . read these facts about Soundcraft: today's great motion pictures depend on the most extensive stereophonic techniques and effects. To achieve them requires a magnetic product capable of satisfying the most critical demand. For years one name has consistently won virtually 100% acceptance of the uncompromising technicians of this industry. That name—Soundcraft. The fact is the development of the Soundcraft Magna-Stripe Process revolutionized the course of the entire industry—led to the advent of the stereo sound tracks of the great wide screen films. For this, Soundcraft was awarded the only Academy Award "Oscar" ever given to a recording tape manufacturer. Today the sound you hear in the great MGM (Camera 65), Todd AO, Cinemascope and other wide screen productions is reproduced on Soundcraft magnetic products. Motion picture producers investing millions of dollars can't afford to take chances. That's why "It's Soundcraft in the great motion pictures!" You, too, can have this same measure of superior performance and reliability in your own recordings by switching to Soundcraft—where professional performance is the standard and satisfaction the guarantee. See your Soundcraft Dealer today and let him put you on the right "sound" track with Soundcraft.



REEVES **SOUNDCRAFT** CORP.

Main Office: Great Pasture Road, Danbury, Connecticut • New York: 10 East 52nd St.  
Chicago: 28 E. Jackson Blvd. • Los Angeles: 342 N. LaBrea • Toronto: 700 Weston Rd.

CIRCLE 70 ON READER-SERVICE CARD

What  
do you  
hear  
from  
**LEONTYNE?**



on **SCOTCH** BRAND  
Recording Tape  
you hear it all!

Critics search for adjectives to describe the sound of Leontyne Price's voice ("unfurling like a bright banner", "pure velvet", "rings out from C to shining C", etc.). This "supreme soprano" stamps an exciting personal signature on every note of every role she creates. Her new and opulent soprano sound is another of the many musical worlds whose highest peaks, widest ranges, most individual accents are completely capturable on "SCOTCH" BRAND Recording Tape.

One important reason for the sensitivity and responsiveness of "SCOTCH" Recording Tape: its unique uniformity. The fifty years' experience of 3M in precision coating techniques makes this tape the uniform standard of the industry.

And microscopic uniformity—in oxide thickness, in backing, in tape width—is more important than ever in today's four-track stereo recording (for full frequency response and proper alignment of narrow quarter-width tracks). "SCOTCH" Recording Tape is dependably uniform from track to track, from reel to reel, whether in stereo or monaural recording. Exclusive Silicone lubrication minimizes head wear, maximizes tape life. See your dealer!

"SCOTCH", "TARTAN" AND THE PLAID DESIGN ARE REGISTERED TRADEMARKS OF MINNESOTA MINING AND MANUFACTURING CO., ST. PAUL 6, MINN. EXPORT: 99 PARK AVE., NEW YORK, CANADA: LONDON, ONTARIO. ©1962, 3M CO.

**Magnetic Products Division**

CIRCLE 63 ON READER-SERVICE CARD



## SOUNDTALK

*...from the world's most  
experienced manufacturer  
of recording tapes*

### How "four-track" stereo challenges tape quality . . .

The dramatic improvement in sound and new economy in tape use that four-track stereo promises, make new demands on tape . . . make the quality you find in "SCOTCH" BRAND Tartan® Series Recording Tapes four times as important! For not every brand of tape will work satisfactorily on 4-track.

Quality starts with high potency oxides, applied in a thin coating that provides a wide dynamic range of true highs and lows. The thin yet powerful coating makes a more flexible tape, with optimum tape-to-head contact for sharp resolution.

The narrower tracks used make highest consistency of oxide coatings a must. Now even minute irregularities can cause signal loss, which in two-track recording, the ear might "overlook".

From the tape manufacturer's point of view slitting the tape to correct width becomes an extremely critical operation. Nothing less than the close-tolerance precision that characterizes "SCOTCH" BRAND Tartan Tapes will provide optimum performance for four-track.

When you go "four-track" select Tartan Series Tapes—the number one choice of top stereo tape-machine makers. Available in: No. 141, plastic, standard play, 600' and 1200'; No. 140, plastic (50% extra play) and No. 142 (50% extra play on super-strong polyester backing), both in 900' and 1800'; and No. 144, double length, double strength on tensilized polyester backing, 1200' and 2400'. From \$1.75 at retail dealers.

**FREE!** With each Tartan Series Tape—a handy clip that prevents spillage in mailing or storage.

*new proof*

# McIntosh is the best!

Only McIntosh of all amplifiers made and advertised today has such low distortion with such reserve power. You can see the combination of low distortion and great reserve of the MC-240 in this graph and remember both channels are operating, both channels of the MC-240 are operating at full power, both channels are operating at full power at the same time.

**40 watts GUARANTEED POWER 20 cycles thru 20KC.**

**50 watts TYPICAL PERFORMANCE**

**60 watts IHFM MUSIC POWER**

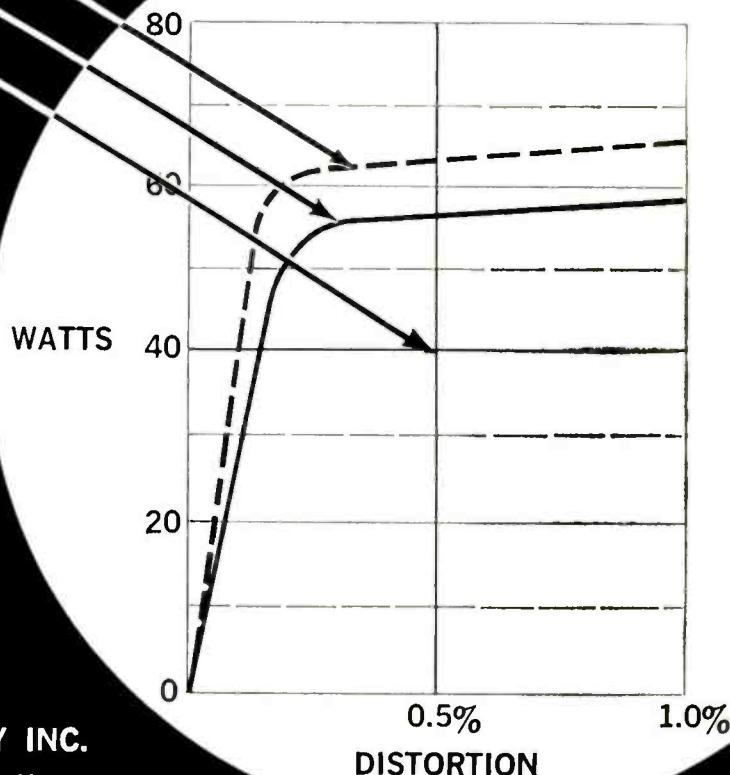

**McIntosh** LABORATORY INC.  
2 CHAMBERS STREET, BINGHAMTON, N. Y.

NOW  
YOU CAN BUILD  
A FINE  
*Schober Organ*  
FOR ONLY  
\$550



You can assemble this new Schober Spinet Organ for \$550 — or half the cost of comparable instruments you have seen in stores. The job is simplicity itself because clear, detailed step-by-step instructions tell you exactly what to do. And you can assemble it in as little as 50 hours.

You will experience the thrill and satisfaction of watching a beautiful musical instrument take shape under your hands. The new Schober Electronic Spinets sounds just like a big concert-size organ — with two keyboards, thirteen pedals and magnificent pipe organ tone. Yet it's small enough (only 38 inches wide) to fit into the most limited living space.

You can learn to play your spinet with astounding ease. From the very first day you will transform simple tunes into deeply satisfying musical experiences. Then, for the rest of your life, you will realize one of life's rarest pleasures — the joy of creating your own music.

For free details on all Schober Organs, mail the coupon now. No salesman will call.

THE *Schober Organ* CORPORATION

43 West 61st Street, New York 23, N. Y.

Also available in Canada and Australia.

MAIL THIS COUPON TODAY

The Schober Organ Corporation  
Dept. HF-10  
43 West 61st Street  
New York 23, New York

- Please send me FREE booklet and other literature on the Schober Organs.  
 Please send me the Hi-Fi demonstration record. I enclose \$2 which is refundable when I order my first kit.

Name.....

Address.....

City..... Zone... State.....

CIRCLE 74 ON READER-SERVICE CARD



## Teresa Stich-Randall

A Connecticut-born soprano who became a Mozart specialist on European opera stages comes home to the Met.

OTTO LUENING'S *Evangeline*, which was produced by the Columbia University Opera Workshop back in 1948, has long been forgotten, but one of its cast members hasn't. Reviewing the opera's premiere, Virgil Thomson took special notice of the girl in the title role — a nineteen-year-old soprano with a rather odd name. "Teresa Stich," he wrote in the *Herald Tribune*, "sang beautifully and moved with a semblance of star quality."

Much has happened to the pretty prima donna from Connecticut since then, including the addition of her mother's maiden name to her stage name. This was done partly because it sounds more American (despite her European career, the singer is very conscious of her national heritage) and partly because "it just sounds better." By whatever name, however, she still sings beautifully; and the "star quality" will be manifest to anyone who listens to the Met's *Così fan tutte*, to be broadcast on April 14 from Boston. This performance will introduce the Hartford-born Mozart specialist to the largest audience yet to hear her.

Miss Stich-Randall declares that her Metropolitan debut this season was "the greatest thing that ever happened to me," but — after a dozen or so years abroad — she would have been perfectly willing to make a career in Europe alone. Even now she likes to think of Vienna (where she has been appointed "*Kammersängerin*") as her "home house," where she can sing all kinds of roles, big and small. At the Met, on the other hand, she will confine herself to the roles that are her specialty. She takes pleasure in this prospect, naturally, and only smiles when she speaks of the long detour that she made en route to 39th Street.

The soprano's first American career

proceeded swiftly. She created leading roles in the Thomson-Stein *Mother of Us All*, Bloch's *Macbeth*, and Méhul's *Stratonice*, in addition to Luening's *Evangeline*; sang in the Met Auditions of the Air; and eventually landed two prized assignments from Toscanini — the *Aida* Priestess and Nannetta in *Falstaff* (both performances are still available on RCA Victor records). It was Toscanini, in fact, who advised the young singer to try the Old World. "I went," she says, "because I needed training more advanced and concentrated than I was able to get in this country."

She got it — and experience too. By 1951, the twenty-three-year-old American soprano was turning up in musical news from Europe. She won some crucial vocal contests (Geneva and Lausanne) and made a big splash — quite literally, as will be seen — at the Maggio Musicale in Florence. Because she was attractive visually as well as vocally, and because she happened to be an excellent athlete, Miss Stich-Randall was signed for Herbert Graf's spectacular *Oberon* production at the Boboli Gardens. Cast as a Daughter of the Sea, she had to swim a gentle breast stroke across a 100-foot lagoon, climb to land for a hymn to the night, and then plunge back into the water for a vigorous crawl to the other side. "The swimming forced me to develop my breath control," she recalls, "but something else pleased me even more about this engagement. I got the part before the Italian officials even learned of my previous experience with Maestro Toscanini."

Soon, Miss Stich-Randall became a permanent fixture not only at the Florence Festival, but also at Salzburg and Aix-en-Provence. In fact, she is consid-

Continued on page 32

HIGH FIDELITY MAGAZINE



## BY 1965 YOU MAY SEE OTHER STEREO TUNER/AMPLIFIERS LIKE THE NEW ALTEC "ASTRO"

### NEW CIRCUITRY, NEW FEATURES, NEW IDEA IN STEREO

"Modern" is not the word. Perhaps "ahead-of-its-time" is a bit more descriptive of the new Altec 708A "Astro." How else would you describe an all-in-one stereo center full of features and facilities never before available in a single package?

For example, consider its circuitry. Transistors are combined with new frame grid tubes to gain the best qualities of each. As another example, consider its unique stereo headphone facilities. The output receptacle is in the rear; you may leave the headphones plugged in permanently, out of sight when not in use. The headphone switch, however, is located conveniently on the front panel.

Or, consider the unique tape recording monitor that functions much like monitors in professional recording studios. Namely, it permits you to monitor any source material two ways *during* recording: the instant signal enters the record head or directly from tape, the moment it is recorded. And these features are only a sampling. Truly, the "Astro" is "ahead-of-its-time" even down to the smallest details such as the exclusive friction-lock controls that obsolete awkward dual knobs found on conventional stereo equipment.

### COOLNESS OF TRANSISTORS— PRECISION OF FRAME GRID TUBES

For cool operation, Altec makes judicious use of transistors. For highest sensitivity and quietest performance imaginable, new ultra-precise frame grid tubes are used. This proper combination of transistors and tubes in the "Astro" has produced results that are just this side of miraculous.

The "Astro" is sensitive, stable and completely consistent in its performance (top-notch!) and utterly free of drift. Indeed, it is the first truly practical stereo center because transistors in the power stage make it run cool for hours on end. Unlike ordinary "hot boxes," the "Astro" secures peak operating efficiency and maximum life from resistors, capacitors, and other sub-components in its circuitry. And, because it runs cool, the "Astro" is the first practical unit for built-in installations.

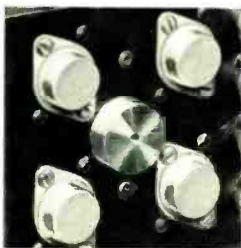

**50 watts from an area the size of a postcard!**

That's the magic of transistors: the four shown at left make up the power stage of the "Astro."

In all, 12 transistors and 17 tubes are used in this entirely new stereo center that is rated several years ahead of its time.

CIRCLE 4 ON READER-SERVICE CARD

### WHAT MAJOR COMPONENTS ARE INCLUDED IN THE NEW "ASTRO"?

Five integrated stereo components are packaged in a compact 6" x 15" x 13½" cabinet: FM, FM multiplex, AM, dual-channel preamplifiers, dual-channel power amplifiers. The wide band FM tuner features 1.5 microvolt sensitivity (equivalent to 0.75 microvolts with matched 72 ohm antenna) to assure highest gain, lowest noise. A built-in FM stereo multiplex receiver provides 30 db stereo separation between channels over the entire audio range. To take all guesswork out of tuning, a monitor light goes on automatically when stereo signal is received. The AM tuner provides high sensitivity and excellent image and IF rejection.

The preamplifier section features a complete complement of controls and includes facilities for everything from record and tape player to the stereo headphones. Powerful dual-channel amplifiers deliver 25 watts each down to 20 cycles (IHFM standard) with ± 1 db, 20-20,000 cps frequency response.

### YOU MUST SEE & HEAR THE "ASTRO"

Feel it, too, for that all-important coolness. At your Altec Distributor's now. Or, for information, write Dept. HF4

© 1962 ALTEC LANSING CORP.



A Subsidiary  
of Ling-Temco-  
Vought, Inc.

## ALTEC LANSING CORPORATION

1515 S. Manchester Ave., Anaheim, California  
161 Sixth Avenue, New York 13, New York

**NEW**

# SONY<sup>®</sup> FM/AM PORTABLE

RESEARCH MAKES THE DIFFERENCE



## ...doubles as a car radio, too!

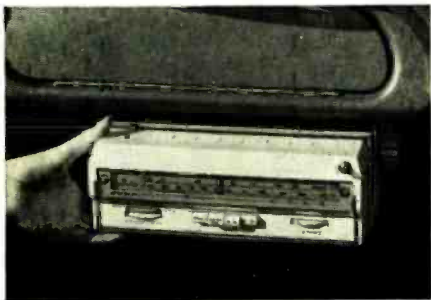

Only 5 lbs. light, SONY TFM-95 is removed from dashboard bracket (optional) in a matter of seconds.

Only imaginative SONY design and engineering can pack so much versatility into an FM/AM all transistorized battery operated radio. The dual-purpose TFM-95 not only serves as an exceptionally high quality portable, but also doubles as a uniquely sensitive automobile radio, easily slipping into the optional rack which may be mounted below the dashboard. A special jack will accept the auto antenna. Instant button band selection and tuning, volume and AFC controls are conveniently mounted on top. Automatic gain control and automatic frequency control eliminate distortion and drift while 9 transistors and built-in ferrite bar and telescoping antennas provide unusual fringe reception. **Terminal for stereo multiplex adapter.** In handsome black, green or ivory case, it comes complete with batteries, earphone and auxiliary antenna lead. SONY TFM-95 at \$79.95 list.

### OUTSTANDING SONY FM / AM RADIOS

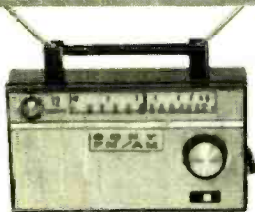

SONY TFM-121A Portable and only 3 lbs. in weight, built to the finest SONY standards with FM/AM reception, automatic frequency control and provision for stereo multiplex adapter. 12 transistors for ultra-sensitive reception. SONY TFM-121A list \$99.95.



SONY TFM-122 Cordless FM/AM table radio adds beauty to every room with its handsome genuine walnut cabinet. Twin baffled speakers and automatic frequency control provide unmatched sound quality. With 12 transistors, tone control, record player input and provision for stereo multiplex adapter. SONY TFM-122 list \$129.95

*Civil Defense recommends a battery-operated radio in every home. Every SONY radio clearly shows the two Conelrad frequencies.*

**SONY CORPORATION OF AMERICA 514 Broadway, New York 12, N. Y.**  
CIRCLE 79 ON READER-SERVICE CARD



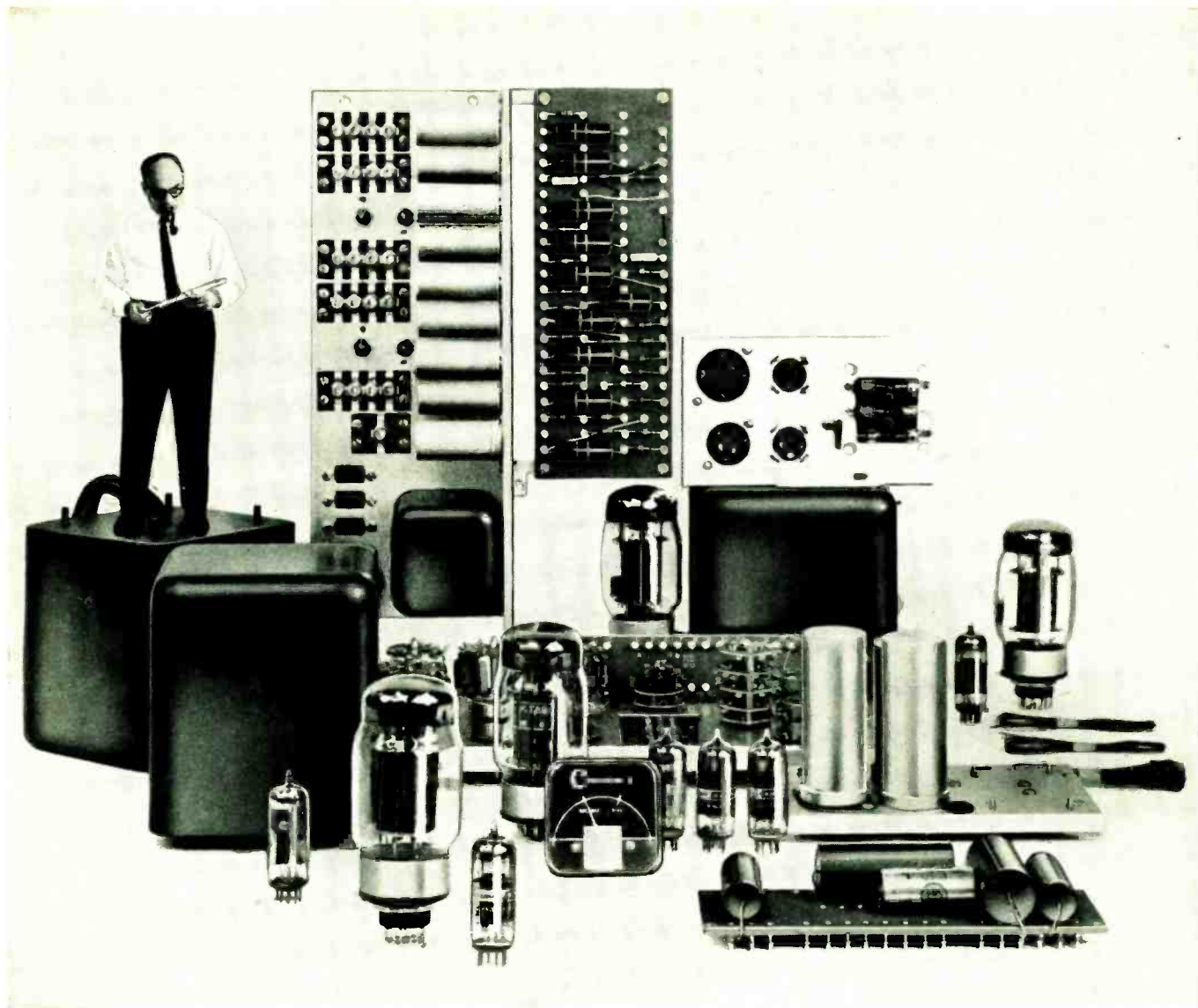

## We don't pack an engineer into each new Citation Kit but...

...the engineering built into each kit is so precise that the unit constructed in the home will be the equal of the factory-produced instrument.

It is far more difficult to design a kit than to produce a completely manufactured product. In the plant the engineer can control his design from the moment of inception until the final packaging. The kit builder has only his tools, his ingenuity and little, if any, test equipment.

Therefore, the complex process of in-plant production and control which guarantees the fine finished product must somehow be *embedded* in the kit design. The Citation engineering group at Harman-Kardon, headed by Stewart Hegeman, has succeeded in doing just this in the design of all Citation instruments.

Heavy duty components, operating at tight tolerances, have been selected for the Citation Kits. As a result, even if every component is operated at its limit—remote as this possibility is—the instruments will perform well within their specifications.

Only Citation provides rigid terminal boards for mounting resistors and condensers. Once mounted, these components are

suspended tightly between turret lugs. Lead length is sharply defined. The uniform spacing of components and uniform lead length insure the overall stability of the unit.

Improper routing of leads, particularly long leads, can result in unstable performance. To prevent this, the Citation II is equipped with a template to construct a Cable Harness. The result: each wire is just the right length and in just the right place to achieve perfect performance.

To meet the special requirements of the Citation III X, FM Stereo tuner, a new tuner cartridge was developed. This embodies most of the critical tuner elements in one compact unit. The cartridge is completely assembled at the factory, totally shielded and perfectly aligned—eliminating the difficult problems of IF alignment, oscillator adjustment and lead definition.

All resistors and condensers have been uniformly mounted and labeled on special component cards to eliminate hunting through paper bags. All of the small parts have been packaged in cellophane bags which are mounted on cardboard for ease of identification and handling. The unique

Citation packaging techniques save much unnecessary time searching and sorting out parts.

These truly remarkable achievements in Control Engineering are only a few of the many exciting new developments in kit design from the Citation Division of Harman-Kardon.

Send for free reprints of independent laboratory test reports plus a Citation catalog. Write Dept. HF-4, Citation Kit Division, Harman-Kardon, Inc., Plainview, N.Y. (Export Office, EMEC, Plainview, N.Y.)



Citation III

HK-64

**harman kardon**

# In All the World Never a Hi-Fi Kit Value Like This

FM STEREO BY **knight-kit**<sup>®</sup>

ONLY **\$19<sup>95</sup>**  
NO MONEY DOWN

**STEREO FM  
MULTIPLEX KS-10A  
ADAPTER KIT**



a pleasure  
to build...  
a revelation  
in performing  
quality

*enjoy beautiful Stereo FM reception at unbelievably low cost...* Now you can have the pleasure of an easy kit-building experience. Now you can add the tonal beauty and realism of Stereo FM broadcasts to your present music system. The savings simply can't be duplicated. The quality can't be matched for anywhere near the price. Order the KS-10A Knight-Kit Multiplex adapter today—no money down (just check coupon). **\$19<sup>95</sup>**  
An unbeatable value at only.....

**PROOF OF SUPERIOR VALUE:** • Self-powered—installs out of sight • Separation control for precise stereo adjustment (23 db separation) • Input sensitivity 0.2 volts • Frequency response 50-15,000 cps, ± 1 db • Noise filter (switchable) for use in weak signal areas • Top-performing circuit using 2 dual and 1 triple-purpose tubes • Power supply is transformer-operated; uses selenium rectifier • Pi-filter network for ripple-free B+ voltage—hum is practically inaudible • Prealigned coils • AC on-off switch • Three 36" connecting cables included... Simply plugs into your tuner's Multiplex output and your amplifier's tuner inputs. With all connecting cables, tubes, parts, and famous Knight-Kit step-by-step instructions. 3 1/2 x 8 1/2 x 4". For 110-125 v. 60 cycle AC. 4 lbs.

**Satisfaction  
guaranteed  
or your  
money back**

MARTIN BERNHEIMER

typical of the value  
and quality of over  
100 other KNIGHT-KITS

order from

**KNIGHT ELECTRONICS  
DIVISION  
ALLIED RADIO**

**ORDER TODAY**

**KNIGHT ELECTRONICS DIVISION  
ALLIED RADIO, Dept. 12-D2  
100 N. Western Ave., Chicago 80, Ill.**

Ship me KS-10A Knight-Kit Adapter(s) 83YX656V

Ship on Allied's Credit Fund Plan—no money down

\$.....enclosed (check) (money order)

Send Free 1962 Allied 444-Page Catalog

Name \_\_\_\_\_

Address \_\_\_\_\_

City \_\_\_\_\_ Zone \_\_\_\_\_ State \_\_\_\_\_

CIRCLE 3 ON READER-SERVICE CARD

TERESA STICH-RANDALL

Continued from page 28

ered something of a *prima donna assoluta* at the last-named, where each of Mozart's major operas has been revived for her. It is Vienna, however, that remains closest to her. "Mozart is my first musical love," she says—and it was in the Austrian capital that she made her reputation as a Mozart specialist, a singer who at the flick of a baton can switch from Countess Almaviva to Fiordiligi to Donna Anna to Pamina.

Mozart is not, of course, Miss Stich-Randall's only interest. She also does the standard lyric and coloratura parts in Verdi and Puccini, and recently Strauss's music too has begun to make its mark on her. She has recorded Sophie for Angel's *Rosenkavalier*, sung Ariadne at several festivals, and not long ago turned successfully to the difficult role of Aithra in *Die Aegyptische Helena*. She avoids, however, the heavier assignments frequently offered her. "Karajan wanted me to sing Elsa in *Lohengrin*," she says, "but no, thank you!"

Vienna has left its mark on Miss Stich-Randall in a number of ways. Her speech is now faintly flavored with Germanisms, and her singing adheres rather closely to the manner of the so-called Viennese school. This means that she is a singer whose greatest pride is vocal finesse. Pianissimos emerge in various shades and degrees, all meticulously controlled, and purity of tone may take precedence over emotional projection. The actual tonal quality is almost flutelike. For a light soprano, her top voice especially has extraordinary cutting power and directness.

Singing *Così* at the Met presents only one problem for this onetime New Englander. Miss Stich-Randall has sung the opera most often in Italian, occasionally in German. The Met, however, utilizes an English translation, and once or twice this has threatened to confuse the new Fiordiligi. Nevertheless, professionalism has triumphed, as Paul Henry Lang's review of her debut testifies: "Teresa Stich-Randall is a singer of extraordinary musicianship. The way she phrases, makes elisions, bends a little cadenza, or negotiates a complicated bit of coloratura is just wonderful to hear..."

**High Fidelity**, April, 1962, Vol. 12, No. 4. Published monthly by The Billboard Publishing Co., publishers of Billboard Music Week, Vend, and Amusement Business. Telephone: Great Barrington 1300. Member Audit Bureau of Circulations. **Editorial Correspondence** should be addressed to The Editor, High Fidelity, Great Barrington, Mass. Editorial contributions will be welcomed. Payment for articles accepted will be arranged prior to publication. Unsolicited manuscripts should be accompanied by return postage. **Subscriptions:** Subscriptions should be addressed to High Fidelity, Great Barrington, Mass. Subscription rates: United States, Possessions, and Canada, 1 year, \$6; 2 years, \$11; 3 years, \$15; 5 years, \$20. Elsewhere \$1 per year extra. Single copies 60 cents. **Change of Address** notices and undelivered copies (Form 3579) should be addressed to High Fidelity, Subscription Fulfillment Department, 2160 Patterson Street, Cincinnati 14, Ohio.



## no two are alike

Look at a row of Miracords, and take note of the turntable platters. They appear as identical as peas in a pod. Yet, no two are alike. They all started out as heavy, one-piece aluminum alloy castings bearing only slight resemblance to the finished product. Each was then secured to a precision lathe, and cut to shape. Layer after layer of metal was shaved from the form until the precise design dimensions were obtained. At this point, the turntables were as identical in shape, size, weight, finish and appearance as modern technology can achieve. We could have stopped here, pleased as punch with the smooth, glistening results of our efforts. But, the standards of Miracord performance demand more than apparent quality—greater accuracy than dimensional measurements alone can reveal. And so, each individual gleaming platter was put to test for dynamic balance. And each was individually corrected to assure the balanced distribution of mass

that gives the Miracord turntable its smooth, unwavering motion. Remove the turntable of any Miracord, and examine the under-side. You will see where metal discs were affixed, adding just a little more weight to one point or another to achieve this perfect balance in motion. Now, look at another Miracord platter. This one may have more or fewer discs, and at different points. You can look at a thousand. Each will reveal the individual attention it received. No two will be alike.



# MIRACORD

The Miracord is a modern, high quality record playing instrument—the only one with dynamically balanced turntable and mass-balanced transcription arm which you can play manually or as automatically as you please. The 10H with hysteresis-synchronous motor is \$99.50; model 10 with 4-pole induction motor, \$79.95. Prices do not include cartridge or base.

Make it a point to see the Miracord at your high fidelity dealer soon. For complete details, write to:

# for magnificent sound

## TARZIAN TAPE

*engineered for highest fidelity*

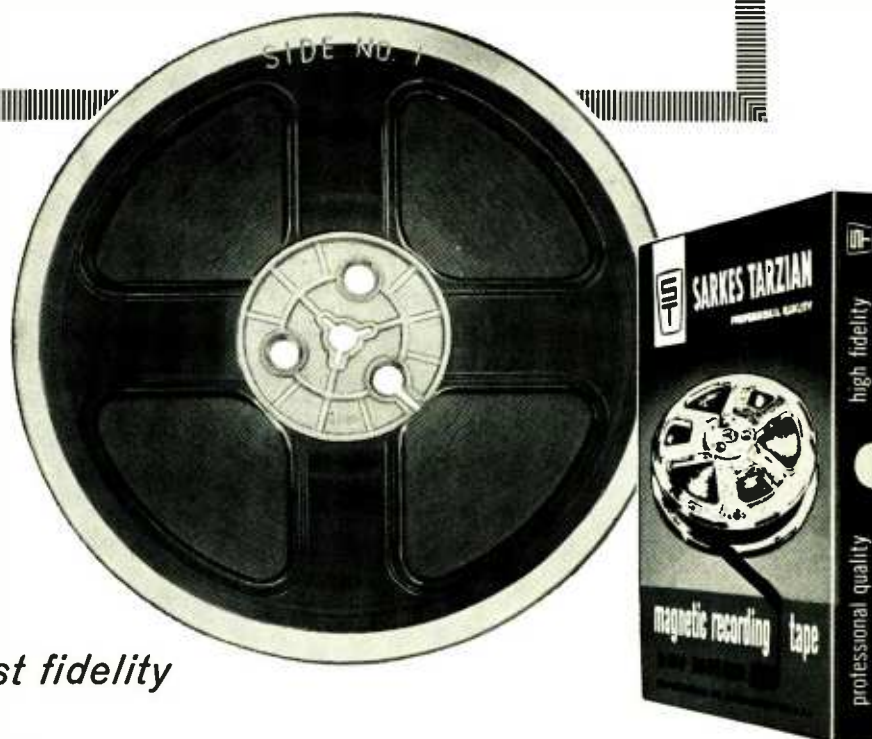

### Check these outstanding characteristics

- **High Output**—can accept signals with dynamic range to realize the full potential of even the finest professional equipment.
- **Wide-Range Response**—virtually flat response for all recording frequencies.
- **Low Distortion**—distortion is less than 2½% at maximum record level as measured by Navy Specification W-T-0061.
- **High Uniformity**—uniformity within a 1200-foot reel is within plus or minus ¼ db. A new oxide formula and special selectivity of oxides protect recording heads from wear and prevent abrasion.
- **Humidity and Temperature Protection**—special coating, priming, and binding techniques help keep Tarzian tape in new condition longer in ordinary good tape storage conditions.

■ Given great sound in the first place, Tarzian Tape will keep it for you, and give it back undiminished and undistorted. It is a tape of truly professional fidelity, worthy of your most valued recordings, at a price that lets you use it for all your work (or play).

The proof is in the listening...of course. But you can see the smooth, tightly bonded oxide surface that doesn't flake, that does run smoothly without abrasion and without contributing to wow or flutter. Hold a reel to the light. You can see that Tarzian Tape is wound on the reel at perfect tension. You'll find a written replacement guarantee in every box. The box is well made, with ample identification space. You'll see that the tape is factory sealed in a plastic bag, with labels and a tape-end clip included.

Try Tarzian Tape...let it speak for itself. Available on standard 3-, 5-, and 7-inch reels and in professional lengths on reels or hubs, 1½ and 1 mil acetate, and 1 mil Mylar.\* Ask your dealer. If he cannot supply you, send us his name and we will see that your needs are promptly supplied.

Helpful new booklet free on request: "The Care and Feeding of Tape Recorders."

\*Du Pont trademark for polyester film.



### SARKES TARZIAN, Inc.

World's Leading Manufacturers of TV and FM Tuners • Closed Circuit TV Systems • Broadcast Equipment • Air Trimmers • FM Radios • Magnetic Recording Tape • Semiconductor Devices

**MAGNETIC TAPE DIVISION • BLOOMINGTON, INDIANA**

Export: Ad Aurlema, Inc., N.Y. • In Canada, Cross Canada Electronics, Waterloo, Ont.

CIRCLE 73 ON READER-SERVICE CARD

*this  
small, bright  
light indicates  
a whole new  
world of  
listening  
pleasure*

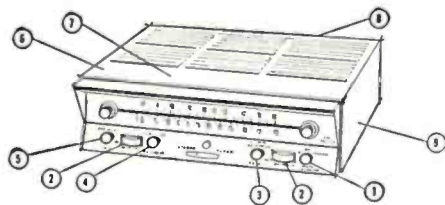
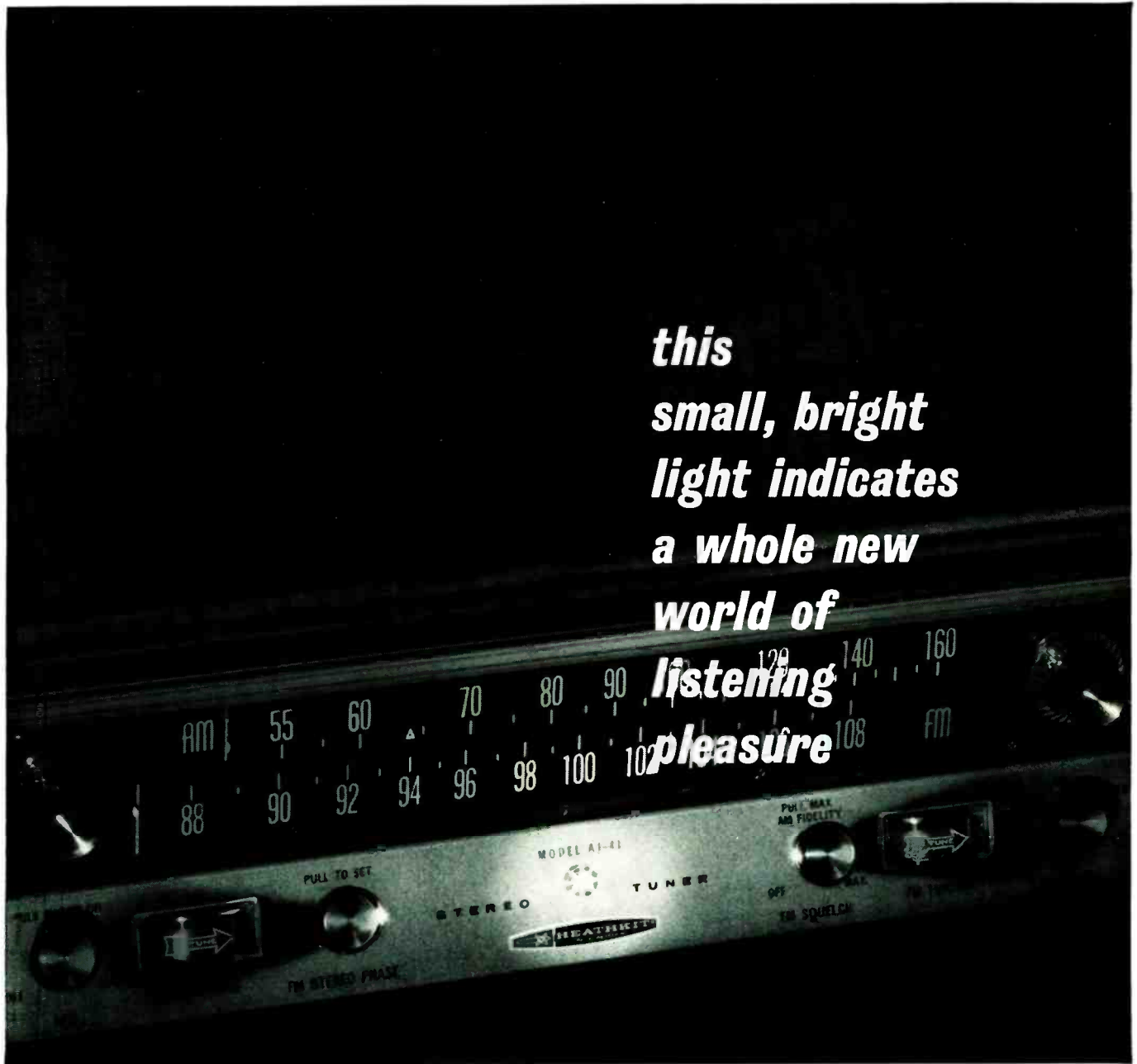

1. Listen 3 Ways; AM, FM, or FM Stereo 2. Separate Tuning Meters (AM & FM) Insure Precise Station Settings 3. "Squelch" eliminates noise between FM Stations 4. Phase Control for distortionless stereo reception 5. Automatic Frequency Control "locks-in" station signals 6. Factory-Assembled, pre-aligned FM front end 7. Circuit Board Construction for easy assembly 8. Built-In AM and FM Antennas 9. Multiplex Circuit an integral part of unit

*Let it guide you to the wonders of stereo music being broadcast by FM Stations throughout the country. With this all new Heathkit Stereo tuner you can enjoy AM, FM, or FM Stereo... listening unlimited (and when your FM station shifts to stereo, the light turns on; automatically alerting you). Throughout this amazing unit, both professional and hobbyist will appreciate the design, performance, durability, and styling that has made Heathkit the world leader in high fidelity electronic kits. And, as always, this superb engineering is accomplished within a price range that makes this truly remarkable instrument available to anyone really interested in fine music.*

**Kit AJ-41.... \$119.95 Assembled AJW-41.... \$189.95**



**THE HEATH COMPANY**  
Benton Harbor 8, Michigan

The remarkable AJ-41 is just one of over 200 different electronic luxuries available from Heathkit. To see all of these economical units, don't fail to write for your free copy of the giant 100-page Heathkit Catalog.

Please send me a free copy of the Heathkit 1962 Catalog

Name \_\_\_\_\_

Address \_\_\_\_\_

City \_\_\_\_\_ Zone \_\_\_\_\_ State \_\_\_\_\_

CIRCLE 50 ON READER-SERVICE CARD



**GARRARD'S  
NEWEST...**

# AT6

## AUTOMATIC TURNTABLE

Here, in its brilliant tone arm, you see a striking example of the calibre of Garrard design and engineering. For up to now, you would have had to buy this type of arm as a separate component. A cast aluminum tubular tone arm, dynamically balanced and counter-weighted—it is a professional arm in every respect—yet it comes integrated with the AT6, assuring perfect installation. This is just one of the precision features that enable the AT6

to deliver the quality performance required of a Garrard Automatic Turntable, built for knowledgeable, critical listeners. All the skill, the experience and the established facilities which the Garrard Laboratories have put behind the development of the Type A (most desired of all record players) have also gone into the AT6. Yet this new automatic turntable is **\$5450** so compact in design that it has been possible to price it at only



The AT6 arm is balanced and tracking force adjusted in two easy steps: First... It is set on zero tracking pressure, by moving the counter-weight until the arm is level, in perfect equal balance.



Now... you fix the tracking force desired, on the built-in stylus pressure scale conveniently mounted in upright position at the side of the arm.



The AT6 will now track each side of the stereo grooves accurately at the lowest pressure specified, even for cartridges labeled "professional", and even if the player is intentionally tilted.



The plug-in shell will accommodate any stereo cartridge you favor, and the bayonet fitting with threaded collar, assures rigidity, banishes resonance.



The turntable is oversized, heavy, and balanced. Torque is high, yet there is no noise, no wow, no waver, no interference with the sound of your records.



Garrard's Laboratory Series motor, in a version designed and built especially for the AT6, delivers perfect speed with complete silence—and it's double-shielded against magnetic hum.



The convenient short spindle for single play is interchangeable with the automatic center-drop spindle, which removes for safety in handling records.



While on automatic play, AT6 will accept a mixed set of records—any size, any sequence. For in addition to its other features, AT6 is an intermix changer, affording complete record-playing luxury.

FOR LITERATURE WRITE DEPT. GD 22 GARRARD SALES CORP., PORT WASHINGTON, NEW YORK.

There's a Garrard for every high fidelity system... all engineered and wired for Stereo and Monaural records.



**Type A**  
Automatic  
Turntable  
\$79.50



**AT6**  
Automatic  
Turntable  
\$54.50



**Autoslim**  
Intermix  
Changer  
\$39.50



**Model T/II**  
Manual  
Player  
\$32.50



**Garrard**  
World's Finest

Canadian inquiries to Chas. W. Pointon, Ltd., 66 Racine Road, Rexdale, Ontario. Territories other than U.S.A. and Canada to Garrard Engineering & Mfg. Co., Ltd., Swindon, Wilts., England

## The Met—Present, Future, and Past

THE METROPOLITAN OPERA as an institution occupies a shadowy no man's land between private enterprise and public service. It was at one time the former—a purely commercial venture which perforce had to make its own way in the marketplace of entertainment. It may at some future date become the latter—an official enterprise, akin to the Library of Congress, dependent upon public funds for its support. But at the moment it is neither. Theoretically, the Metropolitan is responsible only to itself; if it wants to lock the doors, nobody can prevent it. Practically, as the events of last summer demonstrated, the Metropolitan is responsible to the American public, which has been asked time and again to assist in its financial rescue; if matters go askew at 39th Street and Broadway, even the President of the United States eventually gets into the act.

Being a semipublic institution, the Metropolitan Opera is properly open to the careful scrutiny of its friends and supporters. And it was in a spirit of friendship that we commissioned, and Martin Mayer undertook to write, the article on "The Triumphs and Troubles of the Met" which begins overleaf. Friendship does not necessarily demand, however, that we view the object of our affections through rose-colored glasses, and Mr. Mayer—a writer noted for his candid and perceptive reporting—has not produced a whitewash. We make no apologies for this. It seems to us extremely important, now that some sort of state subsidy for the Met appears increasingly likely, to face up squarely to the problems of our celebrated opera company. The Met belongs to all of us, and we have a duty as well as the privilege to coach from the sidelines.

Mr. Mayer concerns himself primarily with the Metropolitan's present and future. There remains the problem of the Metropolitan's past—specifically, the incredibly rich recorded documentation of Saturday afternoon broadcasts, stretching back to the regime of Gatti-Casazza, which has been left dan-

gling in a curious and unfortunate limbo. The response to Mr. Charles G. Massie's suggestion that the Metropolitan itself issue some of these recorded broadcasts as a means of soliciting contributions ("Letters to the Editor," HIGH FIDELITY, October 1961) has been—on the part of our readers—enthusiastic and widespread. Letters have poured in from all parts of the country endorsing the proposal, and they have been brought to the attention of the Metropolitan management. The Met's position, unfortunately, is that "the obstacles of clearance [from the artists and the unions] are simply too great." The matter was first broached, we were informed, fifteen years ago; it has come up several times since; and the answer has always been the same: insurmountable legal obstacles.

Is this sonic legacy from the past then to disappear by default? If so, it will be a great loss. We have heard a few of these recorded broadcasts—Flagstad's debut performance in 1935, the Rethberg-Martinelli-Tibbett *Otello* of 1938, the Pinza *Figaro* of 1940—and we can testify that they are documents of incalculable importance. It is true that limited editions of these recordings have been circulated through private collectors' clubs, but this is at best a limited answer to the problem. The preservation of the Metropolitan's past is an enterprise that deserves the strongest official sanction, unstinted coöperation, and the most accomplished technical *expertise*. Specifically, we feel that the enterprise merits the sponsorship and support of a large foundation. The need is two-fold: first, to locate and transfer to tape all available acetate recordings of past Metropolitan broadcasts (principally from network archives); second, to find some means of making these recordings available to interested students and amateurs. If money can be found for the wholesale microfilming of important paper documents, surely it should be found as well for the recorded documents of these unique performances.

ROLAND GELATT

AS high fidelity SEES IT



# THE TRIUMPHS AND TROUBLES OF THE MET



BY MARTIN MAYER

*A candid appraisal of America's celebrated opera company—its artistic standing, its financial problems, its future prospects.*

**I**N 1884 the doors of New York's then yellow, now brown, Metropolitan Opera House clanged shut on one of the most catastrophic first seasons ever experienced by any opera company anywhere. The net loss was \$600,000, a third as much as the theatre had cost to build, and Italian opera was therefore dropped for the next season. The singers, of course, were furious. Italo Campanini, the company's star tenor, gave the *New York Times* an exclusive interview, in which he announced that "the house is not fit for music."

When a tenor says "music" he always means "singing" (especially singing by tenors); and the house is notoriously difficult for singers. Its audi-

torium is the largest of any of the world's major opera houses, and its acoustics are erratic: most singers find there are only three or four places on the stage where they can hear themselves sing. (Dead center is not one of them, and among the crosses Met soloists have to bear is the director who does not know the house, and insists on balancing his tableaux around a singer at the center of the stage.) "To be thrown on that stage for the first time," as General Manager Rudolf Bing once put it, "is a shock few survive."

In predicting for the Met a future of vocal futility, though, Campanini was spectacularly wrong. As a house for opera—for the presentation of the



most complicated and most humanly satisfying kind of theatre—the Met has little to recommend it. There is not enough backstage area for a sensible physical organization of opera productions; the stage is inflexible; the lighting facilities, though much improved in the last half-dozen years, are still archaic by European standards; the rehearsal space is inadequate. But since the turn of the century the Met has offered in almost every peacetime season the best singing in the world. Though vocal artistry today is probably not what it was fifty years ago, the artistry that exists is most heavily concentrated at the Met. No European house comes close.

It is a question of depth. Nilsson's Turandot is for sale to any opera house (at a price: the Met pays her something like \$2,000 per performance), but only the Met can casually alternate a Tucker, a Corelli, and a Konya as Calaf or a Price, a Moffo, and an Amara as Liù. Artists about whom Metropolitan subscribers bitterly complain are headliners in London and Vienna, Rome and Palermo. And the *comprimario* casts, the occupants of smaller roles, though not quite so dependable as they were in the years before European opera houses found out how good our kids were, are still head and shoulders above what any other house can offer.

Singers come to the Met from Europe because, as everyone knows, the streets in America are paved with gold. Rather surprisingly, the legend turns out to be true for a fair number of visitors. A success at the Met—as Bing's European agent, Roberto Bauer, can demonstrate—may be worth television appearances at \$5,000 and up, and concert dates at more than \$3,000 each. (Sutherland, for next season, is asking \$6,000 for joint appearances with her accompanist-conductor husband.) And the Met itself, though its top fees for a single performance are not so high as the occasional top at Chicago or Dallas or a La Scala "gala," pays more on a day-to-day basis than any other opera house in the world. Its budget for soloists per performance averages almost \$6,000, probably half again as much as any other company that keeps the lights on a full season. American singers stay at the Met, even when they could have juicier parts abroad, simply because *comprimario* roles on 39th Street can pay better than a season of starring parts at Cologne or Brussels or even Vienna. Moreover, the risks of leaving are considerable, for the Met's God is a jealous God and will have no other God before Him; *comprimario* singers who try their luck in Europe during the season usually come back as stars or do not come back at all.

No house that gives 240 performances a year, as the Met does (including the tour), can hope to avoid vocal embarrassment completely. The world suffers an acute shortage of baritones who can go to G with Verdi, and the Met may feel for another decade the death of Leonard Warren, incomparably the greatest "Italian" baritone of recent memory, available to this house alone all season long. Even the Met runs short of tenors and dramatic sopranos

on occasion, and must make do with singers who may be heroes elsewhere but simply cannot fill this cavernous hall. Only the mezzos and basses are rock-solid every night—a phenomenon which Met customers take for granted, though inflexibility in the low voices makes ensemble trouble almost everywhere else. But whatever the occasional vocal gaps—however much one may miss a Valletti, unceremoniously removed in 1961 to make room for Formichini; or a Callas, scared away by her own repertory; or a Del Monaco, refusing in pique to sing at a house where Corelli also sings—the Met in an ordinary season can be counted on for glorious voices.

Opera patrons come to hear voices. Thus the Met, operating in a house where 744 of the 3,615 seats are behind posts or so far to the side of the horseshoe that they have an officially "inadequate" view of the stage, can sell 97% of its tickets through a 25-week New York season, most of them by subscription for eight or twelve or twenty-four "Monday evenings," etc. In the 1960-61 season, at a 97% sale, the Met's ticket income from 179 New York performances averaged a little over \$21,000 a night. The costs of putting on opera in New York averaged out at about \$31,000. The price of glory is high.

**I**N ADDITION to great voices, Rudolf Bing's Met has offered the most efficient operatic management the world has ever seen. A career opera bureaucrat, first in Germany, then in England, Bing came into a house where most productions were a dozen years old and more, and looked it. (When Bing's predecessor Edward Johnson revived Mussorgsky's *Boris Godunov*, Richard Tucker studied the part of the false Dmitri with the man who had created it at the Met thirty years before; he also wore the same costume, dusted off and cleaned.) There was no inventory of the costumes in the 129th Street warehouse which the Met shared with the Radio City Music Hall. Much of the stage equipment was in profound disrepair, and the lighting facilities were roughly those of a high-school auditorium. "I started in 1920 in Freiburg, a tiny provincial German house," Max Rudolf said in 1955, when he was the Met's chief conductor, Artistic Administrator, and Assistant Manager; "the equipment was ultramodern next to what's here." Many of the singers came to rehearsals only when a strong conductor insisted on it—and not even then. "Why should I rehearse?" Lauritz Melchior would say. "Let the understudy rehearse." Though the very best productions of the Johnson regime were triumphs of a kind Bing's Met has never quite achieved, the average was disgracefully sloppy.

Today the average is first-rate, far higher than day-to-day performances at houses like Covent Garden and Paris, both of which receive more than a million dollars a year in government subsidies. The stability of Met performances takes incalculable amounts of hard work from the management. Everything has a time slot and a place slot, and a budget

## THE MET



that is just about right. Rehearsal and performance dates are set as much as a year in advance, and are kept. Trucks roll back and forth on schedule between the warehouse and the Met (which has not enough backstage space to store a single complicated opera if another fairly complicated opera must be played or rehearsed the same day); flats are to be seen out in the rain far less often than they were in the Johnson days. It still happens occasionally that replacement singers find themselves on stage before sets they have never seen before, playing opposite singers with whom they have never rehearsed (one *Forza* a few years back had four principals none of whom had ever been on a stage before with any of the others). But such horrors are now mostly a matter of memory. Though the Met only rarely keeps a complete cast together for more than a few performances, most of the substitutes these days are people who participated in the general rehearsals prior to first performance, or have had at least piano rehearsals in a room with the other principals.

Everything on stage looks much better than it used to look (off stage is not so good; with the new theatre at Lincoln Center always just around the corner, the management has done little to improve the dirty rabbit warren of the dressing rooms, and has let public areas go to seed). This season's *Tales of Hoffman* was as shiny bright in sets and costumes as it had been at its premiere in 1955; even Lee Simonson's sets for Wagner's *Ring*, which go back to 1948, had none of the tired feeling one used to associate with Met revivals. New lighting has been installed, and the stage has had a new floor every other year or so. Business and Technical Administrator Herman Krawitz, a stout young New Yorker, very Broadway, who organized the Falmouth Playhouse on Cape Cod and came to the Met in 1954, has put the physical side of the house on a we-work-harder-than-anybody basis. The costumes are not only inventoried now, they are under the Met's own roof, in the old rented studios from which Krawitz evicted bitterly complaining tenants. The stagehands, some of whom can make up to \$500 a week (working at overtime rates after 4:30 p.m.), may even be worthy of their hire these days. At any rate, they handle sets gently, and can be trusted not to drop a crowbar or drag chairs along the floor while some poor tenor is singing "*Il mio tesoro*" before the drop curtain.

But the Met has to be more efficient than other opera houses, because it runs on a preposterous

combination of the "repertory" and "*stagione*" systems of staging opera, gaining the benefits of neither. In the *stagione* system of the Latin countries, which is also used in the short seasons of other American opera companies, each opera is a separate theatrical event with its own gala first night; and the cast that did the first night plays the work again four, five, or six times in the course of the next month, after which the opera is withdrawn. Each production has its own integrity, which is maintained; often, each singer is appearing only in this production, though perhaps rehearsing something else during the day. Only emergency substitutes are ever allowed; in case of illness, the performance may be postponed to another evening—though not in America.

In the repertory system of Germany, casts and even conductors change around, according to what talents are needed for other productions. The essence of the system is a stable company, with singers who work together not only through a single season but often through a span of years—the pension plans of German opera houses are designed to discourage too much moving about. Conductors and stage directors, too, are semi-permanently attached to the house (at the better houses, historically, the *Generalmusikdirektor* has had a tenure of about a decade). Ideally, there should be a school attached to the house to train singers, and stars should rise from the ranks. The outstanding example of a true repertory company today is the Royal Opera in Stockholm, which protects its purity by performing operas in Swedish, a language in which possible guests are unlikely to be fluent.

Even at its best—in Vienna under Mahler, in Munich under Walter, in Dresden under Busch—the repertory system has severe drawbacks. Productions tend to be frenzied and to fall to pieces during a season; anything which does not command the talents of the *Generalmusikdirektor* and the principal *régisieur* may be clumsily done. Not to be too personal about the matter, I have seen in Frankfurt and Vienna productions so discreditable that even the placid, flaccid New York audience might have hissed them off the stage. In his autobiography, Fritz Busch recalled that he had once run into an American musician describing to his colleagues the glories of Busch's reign at Dresden. "Looking back," Busch wrote, "I ask myself why there were so few moments when I felt completely happy. . . . This was leading to what I later learned by my experience abroad, in particular at the Teatro Colón in Buenos Aires, namely, that *stagione* work has artistic advantages over the clumsy organization of a German theatre."

It is a matter of faith and morals at the Met that a *stagione* system cannot be combined with the sale of tickets by subscription for six or seven performances a week, but the argument eventually gets too complicated for mere mortals to follow. This mortal cannot understand, for example, why

*Lucia* has to be given after Sutherland leaves, or why the Met's *Boris Godunov* must use three different Borises, even if there are other operas which must be given all season long, with inevitable cast changes. (A few seasons ago, Risè Stevens sang eight *Carmens* under three conductors, with four Don Josés, four Escamillos, and five Michaelas.) The Met by its nature cannot capitalize on the advantages that a repertory system does offer. It cannot afford any longer to produce large numbers of operas (as it once did: forty-seven in one season in the 1920s, including four brand-new contemporary works, as against twenty-six this season, the newest of them half-a-century old). It cannot make much of the opportunities a repertory system offers for the training of young singers (viz., Gedda, Nilsson, and Soederstrom, schooled to a wide variety of excellences at Stockholm). The Met's audience and acoustics demand singers of international caliber; young artists must come to major roles at the Met mostly as scheduled cast substitutes for world-famous singers, in productions which have lost some of their artistic tension and audience interest by the removal of their star. It cannot maintain a stable company, because artists of international caliber by definition divide their time among many houses.

During the 1940s when a performance was in the hands of a really strong conductor and of singers who had learned to live with each other's styles, the Met occasionally came up with evenings that seemed to justify the repertory system. The conductors included such luminaries as Beecham, Reiner, Szell, and Walter. Europe was first at war and then in chaos, so the singing company was stable; the Met could employ to the full such resident immigrants as Lehmann, Milanov, Sayão, Albanese, Melchior, Brownlee, Pinza, and Baccaloni, while developing American talents like Peerce and Tucker, Warren and Hines, Traubel, Steber, Stevens. Great performances at the Met in those days were doubtless, as Virgil Thomson once wrote, "the result

of spontaneous accord among musical artists." Planning was second-rate or nonexistent, and buying a ticket for any given evening was much more of a gamble than it has been under Bing. But the pay-offs were bigger, too, because war-enforced stability, quality conducting, and audience patience with not-quite-great singing enabled a repertory system to produce its best efforts every once in a while.

Much has been gained through Bing's efficiency, but something has been lost too. Art is inevitably inefficient, and Bing has built his smooth-running machine by squeezing out artists. There is nobody in the top management of the Met today who has ever waved a baton in anger or set foot professionally on a stage. It is axiomatic that the repertory system works best when the house is controlled by conductors and *régisseurs* who work as teams, adjusting to each other's styles and fitting their work to the company. At the Met, conductors are not encouraged even to suggest directors with whom they might like to work: "the planning committee likes to control these matters itself," says Robert Herman, the tall young Artistic Administrator, who came to the Met from Carl Ebert's workshops at Southern California, and worked his way up backstage. Casting, too, is the prerogative of the management, and conductors are only rarely consulted—which may in fairness mean that the casting is a little better than it would be otherwise, though there are still horror stories like the attempt to persuade Leontyne Price to sing Abigail in *Nabucco*.

Everyone at the Met admits that the conducting staff is weak, replying only that good conductors are hard to find. Yet the Met offers a conductor less authority than any other opera house (less money than most, too: in 1960-61, the average conductor's fee was only \$600 per performance in New York, \$275 on tour, though individuals doubtless did better: planned, frequent money-saving substitution by assistant conductors and the chorus master brings down the averages). A more art-minded management might find conductors a little less scarce, and might not lose its best so rapidly as the Met lost Perlea, Szell, Reiner, Stokowski, and Kempe.

The weakness of the Met's conducting staff produces repercussions throughout the building. The orchestra, despite the management's pride in it, plays adequately for only a few conductors, and the brass section does not play very well for anybody. (A singer was told this season that she could not sing an aria at the tempo she liked because the brass couldn't handle it at that speed.) The chorus, after some years of improvement, is deteriorating again. And the labor troubles are worse. Reiner and Szell managed to make a number of personnel changes in the Metropolitan's orchestra without provoking strikes, but last spring's negotiations stuck for months on the question of dismissing a French horn player. One cannot imagine Al Manuti of the musicians' union insisting that a player was good enough for the Met

*Continued on page 106*



*General Manager Bing, Association President Bliss.*



## IMPROVEMENTS IN

# arms

New designs in tone arms can mean longer life for your records and cleaner sound for your ears

BY JOSEPH MARSHALL

**H**IGH-FIDELITY TONE ARMS have been appearing of late in novel and even bizarre mutations. A few designs are deceptively simple in appearance, such as the Dynaco B & O, which is intended to meet the electrical and mechanical requirements of one specific cartridge and no other. At the opposite extreme are studies in complexity, such as the SME arm, which is designed to meet the installation and performance needs of all current (and possibly future) pickups. Between these two extremes are many more examples, differing in their knobs, dials, levers, outriggers, shape, size, and even the material of which they are made—with wood showing up as a rival to the traditional metal body.

Actually, each new arm represents its designer's solution to some very real problems in the reproduction of sound. Interestingly enough, these problems came to the fore largely because of the demands of satisfactory stereo playback, yet the resultant improvements in arms have permitted better reproduction of monophonic recordings too. One of the most familiar difficulties, for instance—and one whose solution has lent itself to dramatic exhibition—is that of the need for balance in all planes. Most visitors to high-fidelity shows have seen a tone arm tracking a record on a turntable suspended upside down. Though this phenomenon might be thought to bear little relation to the normal function of a tone arm, arms capable of it can—because of their balance—improve the performance of a phonograph system and reduce wear on records.

The new tone arms generally provide an unprecedented variety of means for making this component no more nor less than what it always was intended to be: a neutral, passive, silent servant carrying the pickup across the record. They also offer the means for neutralizing certain harmful tendencies of the cartridge, for compensating for a turntable that is not level, and even for correcting some errors in installation. The new arms, in a word, can exploit the capabilities of most pickups more completely than has ever before been the case.

One reason for the development of new tone arms has, of course, been the interest in low tracking force promoted by stereo. The smaller stylus tip—0.5-mil to 0.7-mil—used in stereo cartridges, as compared with the 1.0-mil tip used for mono pickups, means that the stereo model used at the same pressure as a mono cartridge necessarily exerts a greater downward force against the record groove. But stereo or mono, many high-fidelity designers have become convinced that lower tracking forces, combined with very high compliance, can permit the stylus to follow the groove wiggles more faithfully, improve high frequency response, and even possibly reduce record wear. The big proviso here, however, remains the tone arm: a new arm fitted with one of the recent high compliance pickups can provide good performance with stylus pressures between 1 and 2 grams and possibly less than 1 gram; an older arm fitted with such a pickup and set to track at such low pressures may very easily result in distor-

tion or even groove-skipping. For this reason, a cartridge designer may insist that his pickup be used only in a specific arm, in much the same manner, for instance, that a speaker may be matched to a particular enclosure. This trend accounts for the "integrated" or "unitized" pickup-and-arm combinations, such as the London-Scott, the Shure Studio, the Pickering Unipoise, the EMI, as well as for the tendency of cartridge manufacturers to offer arms of their own design (which presumably will accept not only their own pickups but others as well). Some excellent performers can be found in both groups; while the integrated models represent a foregone conclusion, the "universal" arms boast a new, high order of versatility and dangle the promise of limitless experimentation for the restless audiophile as well as for the record critic and equipment evaluator.

**I**ntegrated" or "universal," a tone arm's most obvious problem stems from the fact that its very weight or mass can "load" the pickup stylus, which itself has extremely small mass. Thus, the pickup's ability to follow the record groove can be severely limited. Fortunately, it has been found quite simple to neutralize the weight of the arm by balancing its forward part, which supports the pickup, with an adjustable counterweight at the opposite end. This counterweight can be set so that the gravitational pull on the arm is neutralized and the arm becomes, in effect, weightless. But since an arm in such a state would not permit the stylus to maintain firm contact with the record groove, the arm must now be adjusted to permit gravity to pull it down so that the desired pressure is applied to the stylus. This can be done by a slightly unbalanced counterweight or by a delicate built-in spring. In either case, the adjustment can be calibrated in grams to enable the user to set the pressure quite exactly.

Although most arms made in the past ten years can be adjusted to provide pressures down to zero, difficulties may arise when an attempt is made to reduce pressure below 2 grams. For one thing, an arm that is balanced only vertically may keep the stylus in proper contact in the groove at very low pressures, but only if the turntable is absolutely level and immune to shocks. And it doesn't take much shock to overcome 1 or 1½ grams of stylus pressure. In many a household in which a tone arm has been exquisitely balanced to such a low pressure, the family must walk on tiptoe or avoid the vicinity of the turntable entirely, lest an incautious step cause the needle to skip or skate. Furthermore, though the arm may be weightless in the vertical plane, it may not be so in the lateral plane. Then, if the turntable is not level, the arm can apply its full weight downhill to defeat the compliance of the stylus. One of the design aims of the newer arms, therefore, has been to neutralize the weight of the arm in *both* the lateral and the vertical planes.

One way to obtain lateral balance is to add another smaller counterweight on an outrigger, as has

been done with the SME, Grado, and Rek-O-Kut arms, for instance. The added counterweight can also be made a part of the main counterweight by drilling an off-center hole in the latter so that when it is turned more weight can be thrown to one side or the other. Yet another way of obtaining lateral, as well as vertical, balance is to displace the arm's vertical pivots, a method used in the Weathers, Empire, and Acoustic Research arms, among others. In some arms, such as the ESL and 12-inch Ortofon models, lateral balance is achieved simply by the "S" curve of the arm's body. Once the arm is balanced in both planes, by whatever method, it becomes free of gravitational effects and will not load the stylus with its own mass. Then, if the compliance of the cartridge is high enough, it will track a recording with pressures as low as 1 gram or less. It also becomes far less susceptible to shock and vibration, and it will play when the turntable is out of level, or tilted, or turned upside down.

Beyond these considerations, some—though not all—designers hold that even the most perfectly balanced tone arm is subject to another external influence. The spiral of the groove, as it pulls both pickup and arm towards the center of the record, causes the stylus to exert slightly more force against the inside wall of the groove than the outside wall. This force is said to cause unequal pressure on the sides of the stylus itself, as well as unequal contact with the two walls of the groove. Although little actually is known as to how this "skating" thrust affects the sound we hear, several of the new arms provide a means for neutralizing it and thus eliminating any degrading influence it may have. The new Fairchild arm has a delicate spring which can be adjusted to pull the arm outward to exactly the same degree that the skating thrust would pull it inward. In the Dynaco and the new Thorens arms, the same spring used for establishing stylus pressure also is intended to pull the arm outward to neutralize skating thrust. The outrigger on the Grado arm, the "bias adjuster" on the SME arm, the small weight at the end of a string on the ADC arm—these are some of the solutions recently advanced to neutralize "skating." On the other hand, Ortofon and others consider the matter of skating force to be negligible, and do not bother to compensate for it.

Another problem of the tone arm is that of its natural resonant frequency at which "sympathetic vibrations" occur. These vibrations, if sent to the stylus, will distort the sound. To prevent this, arms are designed so that their resonance remains as far below the normal audio range as possible. This is largely a question of the arm's structure. Most arms are made of tubular metal, whose resonance is kept below 20 cycles by a careful choice of the material, as well as its shape and cross section, and sometimes also by the addition of some damping material such as plastic inserts between the arm and the counterweight. The viscous fluid used in the pivot of the Gray arm is another method of damping, or neutralizing, spurious vibrations. The growing attraction of

*“to permit the stylus to follow the groove wiggles more faithfully”*

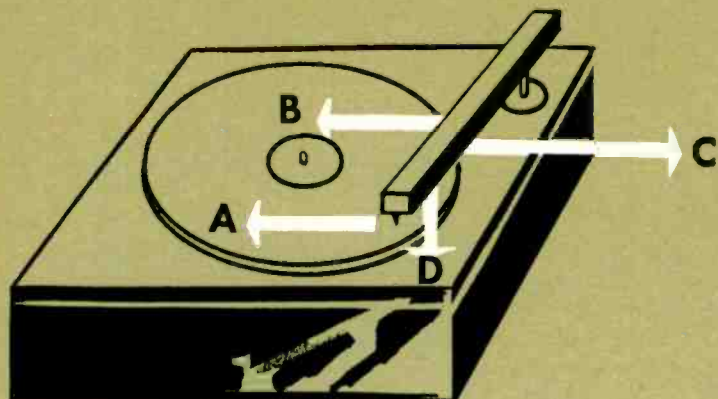

The external forces which affect stylus movement include: A) the inward pull of the stylus, exerted by the spiral of the groove, and exerted largely against the inner wall of the groove; B) the lateral mass of the arm, which pulls the arm downhill when the turntable is not level; C) the drag of the arm and the friction of its bearings, which tend to pull the stylus against the outer wall of the groove; D) the vertical mass of the arm, which bears down on the stylus. In a well-designed and correctly installed arm, these forces are neutralized so that the stylus is permitted to trace the groove freely, with the least amount of distortion and of record wear.

When viewed from above, the axis of the stylus (longitudinal axis of the cartridge) should remain as close as possible to a 90-degree angle with respect to the radius of the record. Although this angle prevails when a record is cut, today's methods of playback can only approximate it.

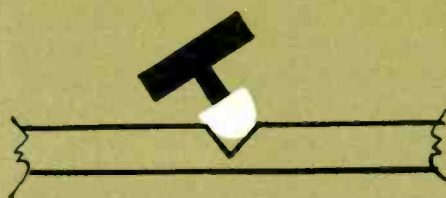
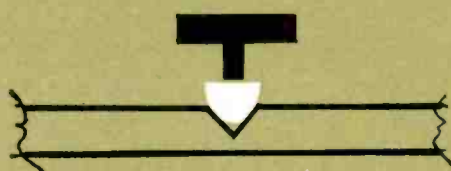
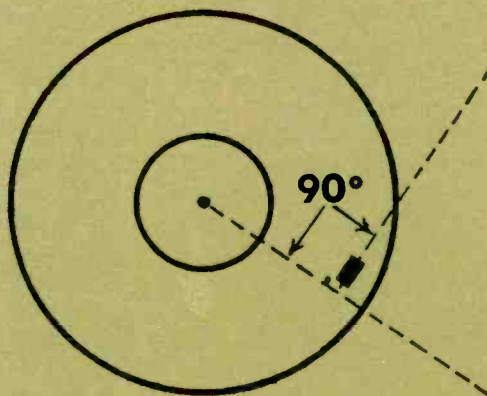

When viewed from front of cartridge, the stylus should be perpendicular to the record to fit the groove perfectly. When the stylus is canted, it makes unequal contact with the groove walls, causing distortion and increasing record wear. In stereo, it also degrades channel separation.

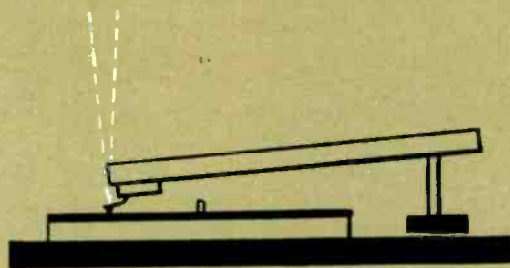
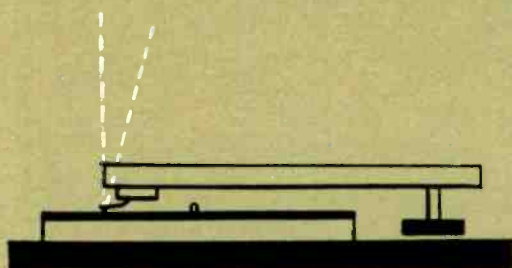

When viewed from the side, the stylus should "lead" by a slight angle. When the stylus "lags," as shown at right, it can add to the mass of the cartridge and increase record wear and distortion. Stylus "lag" can be caused by an imperfect cartridge, or an incorrect installation.

wood is fairly apparent, since at the dimensions needed for a tone arm, a wooden member's resonance can be kept very low. A special problem in arm resonances is presented by such turntables as the Weathers, Stromberg-Carlson, and the new Acoustic Research which use synchronous motors whose rumble frequencies are in the region of 10 cycles. For this rumble to remain harmless and not distort the audible range, arms used with such turntables should have resonances below 10 cycles. Significantly, therefore, these turntables all are offered with integral arms of the same manufacture.

Aside from holding the stylus in the record groove with the proper pressure to assure good tracking, the tone arm must also provide for three angles that should exist between the complex movement of the stylus and the sidewalls of the record groove. First, the stylus should vibrate at an exact right angle to the length of the groove, or, in other words, travel across the record in a perfect radius. This is the way the stylus of the cutter-head vibrates when the original master disc is cut. The cutter travels on a screw which is the disc's radius. To date, it has not been practical to produce a playback arm which also travels on the radius (although there are rumors of such arms in the offing). Present-day arms swing on a pivot which is necessarily outside the groove's spiral, and this means that the theoretical ideal of a right angle between stylus vibration and length of the groove can be achieved at only one or two points along the entire record groove. The difference, in angular degrees, between the ideal radial path and the arc actually described by an arm is called the "tracking error." By using a properly shaped and offset arm and by positioning the stylus so that it overhangs the center of the groove circle by a critical distance, it is possible to reduce this error to a relatively insignificant one to three per cent. All good modern arms manage to do this if the stylus point is positioned in the arm at exactly the position the designer intended; but the new arms provide adjustments to insure correct positioning and to maintain the optimum stylus-to-groove angles.

Once installed correctly, the new breed of tone arm manages the almost magical feat of making itself unfelt to the stylus. Virtually frictionless and weightless, such an arm removes all influences on the stylus except the desired influence of the record groove. This high order of performance exacts its payment, however, in terms of the delicate handling the arm requires. The record listener who had no trouble using a pickup with 3 to 6 grams of pressure now finds himself clumsy when handling one with less than 2 grams, and an occasional fumble which results in dropping the pickup on the record is not uncommon. A final concern of arm designers is, then, to provide some mechanical help to the fingers in placing the arm on the record, or lifting it off, or both. A few cuing devices have been put on the market which can be used with most arms. Some arms come with built-in aids. The SME, for instance, has a lever-operated mecha- *Continued on page 109*

### If You Install Your Own . . .

When you are installing a cartridge and arm, three critical dimensions should be kept in mind for best results. The first of these is "stylus overhang," or the distance between the stylus tip and the turntable's center spindle. Overhang is determined by two other related distances. One is the position of the cartridge mounting holes with respect to the stylus tip. Although this distance is generally standardized, it may vary from model to model. Its importance is indicated by the opinion of some authorities that a discrepancy of  $\frac{1}{4}$  inch from the recommended overhang distance can double the tracking error and the distortion.

The other factor relating to stylus overhang is the position of the arm on the turntable base. Here, an error of a few tenths of an inch can increase tracking error by 100%. For this reason, it is important to drill the mounting hole with care and precision, admittedly not always easy on a plywood board with the tools available in the average household. Short of using a drill press to fashion the mounting holes, or buying the pre-drilled mounting platforms offered by many manufacturers, the do-it-yourself audiophile can rely on the means of compensating both for the difference in cartridges and any small error in mounting which most new arms themselves provide. Since overhang can be set either by the arm's position on the mounting board or by the cartridge's position in the arm, either—or both—adjustments usually are described in the instructions accompanying a new arm. Among the foolproofing methods presently used may be found, for instance, the use of an off-center mounting post that can be revolved to provide for exact overhang. At the other end, the slide on which the cartridge is mounted may be designed to be movable so that the stylus tip can be positioned correctly.

The second critical dimension in a pickup installation is the vertical angle of the stylus to the record groove as viewed from the front. The stylus should be exactly perpendicular to the surface of the record. With many arms, however, if the mounting hole is not drilled exactly perpendicular to the base, the stylus will be canted to one side or the other. And, again, it is difficult to drill a perpendicular hole in a base  $\frac{1}{2}$  to  $\frac{3}{4}$  inches thick unless a drill press is used. Fortunately, several of the new arms provide an adjustment to insure a perpendicular needle angle, or to minimize the possibility of a canted needle. The specific methods used differ from model to model, yet all are effective. With an arm that has no vertical stylus angle adjustment, the best thing to do is to drill the mounting holes slightly wider than necessary and then tighten the mounting bolts, using shims if necessary, to achieve that ideal vertical stylus angle.

The third critical dimension is the vertical angle of the stylus to the groove when viewed from the side. Unfortunately, this angle is not standardized in the recordings themselves. In current stereo discs as well as in their monophonic counterparts, a small forward or "leading" angle appears to be most common. This angle can be adjusted in virtually any tone arm simply by raising or lowering the arm. Although a precise angle may be difficult to establish, it should in any event be set so that the stylus leads and never lags. If in doubt, adjust the height of the arm so that the main part of its body remains parallel to the surface of a record placed on the turntable.

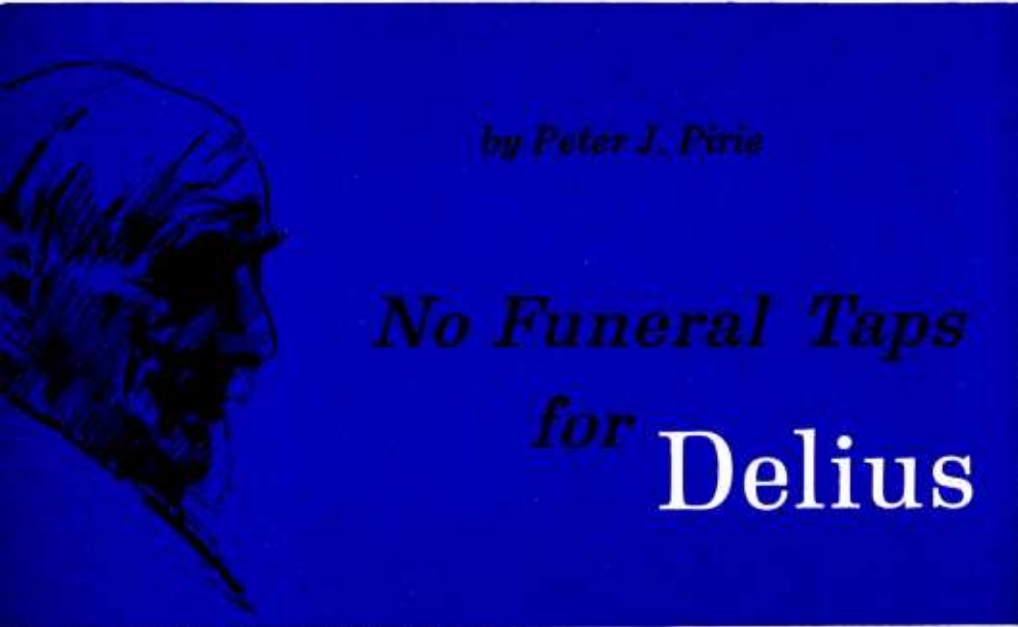

by Peter J. Pirie

# No Funeral Taps for Delius



Bettmann Archive

**The death of Sir Thomas Beecham need not mean oblivion for the music of Frederick Delius. Quite the contrary...**

**T**HAT MELANCHOLY OCCURRENCE, the death of Sir Thomas Beecham, has brought to the test one of the most curious problems of twentieth-century music: can the writings of Delius survive their staunchest supporters? The identity of the two men, it would seem, was complete, and the general public has made clear that it will listen to Delius only when conducted by Beecham. Indeed in the early days of the partnership it was speculated that this music might perhaps be the work of Sir Thomas himself: he was known to be a composer—whose mysterious compositions no one ever heard; he alone could interpret Delius convincingly! Delius himself, in his few statements about his work, has shown that he understood it about as much as a hen understands her eggs. What more natural, then, than that these pieces should be Sir Thomas' own?

Very natural so to suppose, but the fact is that many of Delius' works had been performed in Germany and even in England before he came to Sir Thomas' notice. It was a performance of *Appalachia* in 1907 that convinced Beecham of the composer's stature. From that time Sir Thomas devoted himself wholeheartedly to propagating the work of Delius. I propose to study Delius' music in relation to Sir Thomas' readings of it, and in relation to the legend of Delius as the sunset of romanticism; and I shall put forward some personal views on both counts.

The careers of the two men ran roughly parallel in time, but diverged widely in development. It is

most interesting to see how Sir Thomas' readings of Delius changed as he grew older, but first we must consider how Delius' style itself changed. There is a third dimension, that of changing musical fashion. Let us deal with the composer first, and relate the other two factors to him. In this way we begin at the beginning, since no matter how skilled the interpreter, no matter how arrogant fashionable opinion, without the composer both are lost.

It was a long time before Delius found himself, and even when he began to write with mastery, his style underwent a series of drastic changes as he grew old. This can be observed by anyone who takes the trouble to study the music, and as we shall see later, it lays an ax at the root of one of the most persistent Delius legends. His first music was insipid in the extreme; he found himself in *Appalachia*, *Paris*, and possibly *Over the Hills and Far Away*. Before these works are the juvenilia (juvenilia, it might be added, written by a man in his thirties) including those jejune early operas which Sir Thomas was lovingly resurrecting in his last years. The first mature works are characterized by something of the brilliance of the late Impressionist painters, and in particular by the sheer panache of Gauguin, who was Delius' close friend. *Paris*, a score quite brilliant in its color, its extrovert energy, and its mastery of orchestration, in these respects can be compared with the symphonic poems of Richard Strauss. There is little in it of retrospective brooding, but there is a



slightly mineral darkness, like the implied darkness in some of the stark paintings of Toulouse-Lautrec. His color is post-Impressionist, not Impressionist—even a little Fauve—but too dark, too little innocent, to be French. It is as well to remember that the drinking companion of Gauguin was a hard-bitten Bohemian like the painter himself; both died of the same disease, and it was not acquired in innocence.

These works of this period take their inspiration from America, Paris, Scandinavia, anywhere but England. It was not until Delius married and settled in Grez-sur-Loing that the nostalgic, specifically English works began, the music that Sir Thomas interpreted best. Then, beginning with the *North Country Sketches* of 1913-4, a further change comes over Delius' work. It darkens, takes on an equivocal air; it is more evasive in expression, there are fewer notes. If his first mature pieces can be compared with the paintings of Gauguin, his middle period work to something more English—Samuel Palmer of the Shoreham period, perhaps—his later work recalls Edvard Munch and returns to Scandinavia for inspiration. Its most typical aspects are found in the bitter and cynical *An Arabesque* and the mysterious Nordic *Eventyr*, the first a setting of words by Jacobson, the second inspired by the stories of Asbjornsen. There are a few pieces like sketches for his earlier efforts (*A Song of Summer*) and the almost final *Songs of Farewell*, oddly square and massive. And there are several works that stand out from all this music, by reason of their special quality; chief of these are *A Mass of Life*, *A Village Romeo and Juliet*, and *A Song of the High Hills*. These

writings have a monumental quality. In the *Mass* we find a rugged strength of massive choral writing that would be unusual from any composer, and which does not fit into the legend of the dreamy voluptuary Delius at all. In *A Village Romeo* we see a transitional work, one with some of the early vacuity, a motley of styles, and a last act that is one of Delius' masterpieces, rising to a mystical intensity that even he seldom attained. *A Song of the High Hills* I wish to single out for special attention.

A work for very large orchestra and chorus divided into many parts, *A Song of the High Hills* is often described (when it is mentioned at all) as botched and formless. Now the only compositions of Delius that have a traditional form are dismal failures. His best work creates its own form out of the emotional elements it presents, or is a loosely constructed set of variations. (*Sea Drift*, for example, is formless, and it is a masterpiece.) We are left with the accusation of botching. Let us examine it; the Delius problem lies here, under our hands. "*Il n'y a pas de solution parce qu'il n'y a pas de problème,*" wrote Marcel Duchamp; consider only the elements comprising the situation and the pattern will disclose itself. There are two crucial points in the score of *A Song of the High Hills*, the second of which illustrates both my point and the supposed difficulty. The first comes six bars before reference 18 in the score, the passage marked "Very slow. The wide, far distance—the great solitude." It is here that the chorus enters for the first time. Its difficulties are mainly interpretative. It is one of the most inspired moments in the whole of Delius, and the marking above gives some idea of its emotional quality. The strings are divided into seventeen parts, against which the chorus enters *ppp* decrescendo to *pppp*. A solo horn initiates this unearthly sound, and the woodwinds, each playing solo, enter after ten bars of this very slow time. The effect might be thought to be almost inevitably muddy; in fact these are possibly the most disembodied sounds in all music.

The parts are so very wide apart and are laid out with such skill that the conductor's task is not to maintain balance but to keep the music moving in spite of the incorporeal, breathless stillness of the sound and to let the awe-inspiring majesty be made manifest. Sir Thomas, in his performances and recordings, did keep the music moving with consummate skill, but, let us face it, awe-inspiring majesty was not his strong suit, at any rate in the closing years of his life. Am I criticizing Sir Thomas Beecham in Delius? Shocking as it may sound, I am. The gravamen of my criticism, and its bearing on the Delius problem, will be made clear when we consider the second difficult passage in this score, but first we must pause to consider the art of Sir Thomas Beecham in its own right.

How many people today realize that this seeming archconservative, fulminating at all modern music as worthless, was one of the most daring pioneers of contemporary music before the First World War and extended his efforts on its behalf for many years

### The Delius Centenary

Although Mr. Pirie does not mention the fact in his article, this year marks the hundredth anniversary of Delius' birth. Ordinarily, record companies like nothing so much as a centenary to provide an excuse for issuing new versions of familiar (or even not-so-familiar) repertoire. But Delius' reputation is at the moment so eclipsed that even his centenary is being allowed to pass practically unnoticed. The only important centennial project that has come to our attention is the reissue, in England, on two LPs of several out-of-print Beecham recordings. Volume I contains the 1946 recording of *A Song of the High Hills*, to which Mr. Pirie refers (not altogether enthusiastically) in his article, the *Dance Rhapsody* No. 1, *Summer Evening*, the *Irmelin* Prelude, and the *Intermezzo* and *Serenade* from *Hassan*. Volume II contains the Violin Concerto and the Piano Concerto, with Jean Pougnet and Betty Humby Beecham as the respective soloists. Angel Records has no present plans to issue these discs in the United States, but they may be ordered directly from England by dealers who specialize in imports.

R. G.

after? Yet he was. One of the first champions of the then execrated *Elektra*, he also fought the Lord Chancellor for the right to stage *Salome*. His campaigns on behalf of Sibelius and Delius, although not quite the pioneering efforts they are sometimes made out to be, were decisive in turning the tide in both cases. But caution and conservatism slowly took over, until at the end of Beecham's career he played little music that could not, at a stretch, be contained in the description "light music," or, as he would say, "lollipops." His style followed suit; the blazing and adventurous Beecham of the early years of the century, the dancing aristocrat of the Thirties, master of Mozart, still able to give fine hard performances of Sibelius—this man had changed by the Fifties into a dreaming hedonist, whose tempos became slower and slower, more and more sensuous, and whose repertoire was increasingly filled with soporific trifles.

A good illustration of this progress is afforded by Beecham's three recorded versions of Delius' *Over the Hills and Far Away*. The first (issued in the 1930s for the Delius Society) is an extrovert affair of rattling drums and taut rhythms, crisp, bouncing, the very spirit of Sir Thomas. His second, released in the early days of microgroove, is much more subdued; the drums have almost disappeared, the climaxes are toned down, the tempos are slightly slower. His last version, made not long before he died, takes these things to extremes. Here the tempos are much slower, the sensuous strings swoon, the drums have vanished; the whole thing is no more a young man's vision but an old man's dream.

ONE MUST realize that the present tremendous popularity of the gramophone record is of very recent origin, and also that the break caused by the last world war changed (and hardened) the whole face of music. Young people of the postwar era no longer have much use for music like that of Delius—and to make things worse, the Delius they hear is the softened Delius of Beecham's latter-day recordings, full of the vapid works of the composer's prentice years. Today's listeners do not buy ancient 78s; if they did, they would hear a very different Delius, greater music more tensely performed.

Again I turn to *A Song of the High Hills*, to the second difficult passage from the score, beginning at reference 30. Although this passage is the usual source of adverse criticism, in my opinion it is the most tremendous thing in the work. I hope to show that it is not *A Song of the High Hills* that is at fault, but one or two unfortunate mishaps in Sir Thomas' recording. The passage begins with chorus *a cappella*, divided into eight parts, beginning very quietly, and culminating in a tremendous climax, an outburst of overwhelming intensity and searing exultation. When it dies down, after being joined by the orchestra for the final moments, there follows a long orchestral coda, itself achieving a climax of some weight. The common complaint is that this

choral climax does not come off and that the coda is an anticlimax.

Behind this misguided view is one simple circumstance: within memory no one performed this work except Sir Thomas, and no one else recorded it. The recording is one in which a man at the control board was allowed to panic, which he does at the choral climax (which certainly looks terrifying in the score), thus spoiling Sir Thomas' mighty crescendo. After this Sir Thomas himself takes a hand, suddenly deciding to linger over the orchestral coda. The climax in the coda, much smaller than the one preceding, does not look formidable on paper, and the engineers allow it its full weight. Result: the choral climax doesn't come off, an overlong orchestral coda follows, and its climax is much louder than the one which should be the climactic point of the work. All just what the critics say. The conclusion is inescapable, the modern critic being himself above criticism: Delius bungles. And if one appeals to the score, then the composer writes effects that are viable only on paper. In fact, if the score is observed, the performance will make its effect.

Blunders like this—together with Sir Thomas' revival of early pieces best left in obscurity and the general hardening of the musical climate—all account for such things as the British critic Donald Mitchell's easy dismissal of Delius as "The only German Impressionist." Now, it is true that Delius was of German extraction and that the Impressionist painters (or rather, I reiterate, the post-Impressionists—the distinction is important) were his great liberating influence. But let us consider the music itself. German music is formal, intellectual; and what is not linear is sonata. The music of Delius, on the contrary, is improvisatory, harmonic, and emotional. Impressionist music has static harmony, based on one chord used on many steps of the scale, and is at once aloof and decorative, rendering the facts of nature, detached from human experience, into formal patterns of arabesque derived from the Oriental conception of art. But the music of Delius is an exploitation of the pathetic fallacy; sea, woods, hills, flowers, birds, are all enrolled in the service of human emotion.

There is no human observer in Debussy's *La Mer*; the lonely waves freeze into formal patterns and the storms are void of human sympathy. Delius' *Sea Drift* is not about the sea at all, and only at second hand about birds. The external world furnishes an elaborate symbolism for a boy's discovery of the tragic and exclusively human facts of emotional growth, love, and loss. The shattering impact of this wonderful work is not for the coarse-fingered analyst, proud of an insensitive approach to music. The harmony too is at the furthest possible remove from Debussy; instead of moving a single chord through all possible positions in a single key, Delius' harmony moves daringly from one strange chord to another, and his sense of modulation is here like that of the great masters. The tremendous, heart-shattering turn to the major at the end *Continued on page 108*



By Martin Williams

# When the Big Bands Played Swing

**I**N THE FALL of 1939 a fist fight broke out between two boys in the corridor of a New Jersey high school. The fracas soon spread to half the student body, and took all available faculty members to quiet. The bone of contention was not baseball or girl friends. It seems that Benny Goodman and Artie Shaw were both appearing in Newark during the same week and one young man had declared Goodman the best. The other young man wasn't having any of that. As hostilities spread, the belligerents formed themselves into firm battalions: one group shouted that neither Shaw nor Goodman but Tommy Dorsey was "the greatest"; another (smaller but no less vocal) declared for Bob Crosby; still another group (highly excitable, mostly composed of freshmen and therefore indicating adulation to come) shouted for Glenn Miller. And so events marched.

It was all a part of what jazz writers call (somewhat pompously perhaps) "the swing era," the

period of greatest mass popularity that any jazz style has ever had.

The accounts usually say that everything started in March 1937 when the Benny Goodman band played an engagement at the Paramount Theatre in New York. From the moment the musicians came on stage, there was shouting from the seats, dancing in the aisles, panic followed by resignation from the ushers and the management—and 11,500 paid admissions the first day.

Of course, a few rumbling voices declared at the time that this "swing music" was not really anything new, that it was just "another name for jazz"; and, as if to prove their contention, the hit group of 1917, Nick La Rocca's Original Dixieland Jazz Band, was revived at the New York World's Fair. These dissidents notwithstanding, the fact was that between 1917 and 1937 jazz had been through a major revolution affecting not only the size of the jazz

# When the Big Bands Played Swing



orchestra but the jazzman's basic ideas of rhythm and melody. Among the early contributors was one man whose name is indeed well known—Louis Armstrong—and two whose names are not so well known—pianist-leader and arranger Fletcher Henderson and alto saxophonist and arranger Don Redman.

Actually, the teen-age swing fans described above were fighting a battle about very little. There was not really very much difference between the Goodman and Shaw styles. Goodman had a disciplined brass section and the scores leaned heavily on it; Shaw's band was, in contemporary parlance, "cooler" and depended on its highly disciplined sax section. Both were simply popularizing a kind of music that had begun in the early Twenties and had already reached its maturity by 1933. Tommy Dorsey and Bob Crosby, as we shall see, were also derivative, if from different sources. And as for Glenn Miller, however good his music was as dance music, it is rather hard to take it seriously as jazz. For one thing, Miller never had any really good soloists except Bobby Hackett, and Hackett spent most of his time striking guitar chords in the rhythm section. Second, the Miller band's ideas of rhythm frequently reflected the archaic phrasing of commercial "hillbilly" music. On the other hand, two of the great creative big bands of the late Thirties, Duke Ellington's and Count Basie's, didn't even raise a voice among our high-school devotees.

But we are getting ahead of our story. As I have already indicated, the roots of big-band swing style go back to the Twenties. Three major forces that shaped it came together in 1924, when Louis Armstrong, a shy young man wearing red underwear and big-toed work shoes, joined Fletcher Henderson's orchestra in New York. Don Redman, Henderson's chief arranger, has said, "Louis, his style and his feeling, changed our whole idea about the band musically." To the layman, Armstrong's contribution is perhaps at once the most nebulous and the easiest to recognize. It was he who first dramatized the phrasing, the ideas of rhythm and melody—in short the *swing*—that was to dominate the music, and the mode of improvising that was to influence every jazz player no matter what his instrument.

But before Armstrong arrived, Redman and Hen-

derson had already given this music a basic framework and style in their orchestrations. Before the improvising soloist gets to it, swing music belongs to the composers and arrangers, and the first successful arranger for big bands was Redman, working for Henderson's orchestra.

Like most "second-generation" jazzmen, Don Redman came from a middle-class background. He was born in 1900 in Piedmont, West Virginia, and it is said that he played trumpet at three. His father was a member of a brass band and young Redman learned every instrument, as well as elementary harmony and theory, before settling for alto saxophone. Later he attended conservatories in both Boston and Detroit. When he came to New York after making a reputation as a player and arranger in Pittsburgh, he went to work in recording studios, accompanying singers, generally finding himself in the company of a young pianist from Georgia named Fletcher Henderson. Gradually, a kind of semipermanent "house band" began to gather around Henderson and Redman for these sessions, and it usually included tenor saxophonist Coleman Hawkins and drummer Kaiser Marshall. On one occasion, these men—still leaderless at this point—were asked to record some instrumentals, one of them called *Dicty Blues*. Later that same day they auditioned for the Club Alabam', using the same piece, and got the job. Then they decided to make Henderson the leader because he was nice-looking and a college graduate (in chemistry and mathematics).

Redman as arranger first shaped the style of the Henderson orchestra. Apparently he saw that the future of jazz lay with more control over the group yet more freedom for the individual soloist. The "collective" improvising of New Orleans jazz seemed to have gone as far as it could—at any rate, more and more often such groups were using soloists with rhythm backing. What Redman did was to abandon the New Orleans approach almost entirely. He took a conventional American dance band of the time—with its separate sections of saxophones (doubling on clarinets), trumpets, trombones, and rhythm—and managed to convert it into a new kind of jazz band. He even made some use of the dance band's basic style, but the rhythms had to be jazz

rhythms, the solo passages had to be jazz improvisations, and the written variations had to be in the jazz style. One more thing became characteristic: Redman borrowed the "call and response" patterns heard in Negro church services. When the familiar biting brass of a swing band plays a brief musical phrase and the saxophones answer with another short phrase and an exciting back-and-forth of these phrases follows, the music echoes the preacher's prodding question, "Do you want to be saved?" and the congregation's, "Yes, Lord!" Some of the early arrangements by the Henderson band seem crude today, and some few imitate the style of King Oliver's New Orleans band or the New York Dixielanders of the time. But in the best of them can be heard the style that was to become a national and world craze in the late Thirties.

By 1927, Armstrong had left the Henderson band, and Redman and Henderson were also going their separate ways. Redman first led the famous McKenney's Cotton Pickers around Detroit. Later, he returned to New York to lead his own band in competition with Henderson's orchestra. Basically, both groups played the style their leaders had earlier worked out together.

Henderson, however, continued to get the soloists. At various times in the Twenties and Thirties, in addition to Redman, Henderson had Hawkins, Armstrong, and Kaiser Marshall; pianists and arrangers Fats Waller and brother Horace Henderson; trumpeters Joe Smith, Rex Stewart, Tommy Ladnier, Henry "Red" Allen, and Roy Eldridge; clarinetist Buster Bailey; saxophonists Russell Procope, Benny Carter (who also arranged), Hilton Jefferson, Ben Webster, and Chu Berry; trombonists J. C. Higginbotham, Benny Morton, and Dickie Wells; drummer Sidney Catlett—to name only the best known.

In the early Thirties, Henderson had just about formed his band's style: the arrangements and soloists worked together beautifully, the fire and the phrasing Armstrong had inspired were in both the individuals and the group, and many of the famous arrangements that Goodman was to use were already in the books. By 1935, Henderson had recorded *Sugarfoot Stomp*, *King Porter Stomp*, *Henderson Stomp*, *Somebody Stole My Gal*, *Honeysuckle Rose*, *Down South Camp Meeting*, *Big John Special*, *Wrappin' It Up*, and *Rug Cutter's Swing* in virtually the same scorings that Goodman played later. Even the Henderson soloists sometimes directly inspired Goodman's—compare Red Allen's *Wrappin' It Up* improvisation to Harry James's with Goodman, for example. Later Henderson organizations, between 1936-38, recorded *Christopher Columbus*, *Sing, Sing, Sing* (which the Goodman band ad-libbed into a marathon grandstander), *Blue Lou*, and *Stealin' Apples*—music still well worth listening to.

At the very time—in 1932-33—when the style was finally perfected, however, work began to get very scarce (Columbia's recent four-disc documentation of Henderson's recorded career, C4L19, is

aply titled "A Study in Frustration"), and through producer John Hammond, Henderson was introduced to Benny Goodman. Goodman's new orchestra needed arrangements, and Hammond thought Henderson the man to provide them. Goodman agreed and Henderson became chief Goodman arranger, although for some years he also tried to keep together a band of his own.

Perhaps the best single introduction to the Redman-Henderson style is the celebrated Henderson arrangement for Goodman of *Sometimes I'm Happy*. It begins with muted brass instruments carrying the familiar melody; they play it fairly straight but with phrasing that makes it swing. Every time the brass pause, however, the saxophones interject a phrase that is now part of the tune; clearly that musical phrase is saying, "Yes, indeed!" After one chorus, the jazz soloists enter—first a trumpet, then a tenor saxophone with the brass answering his phrases quietly behind him. Next, the saxophones play a written variation on the theme which sounds as natural and fluent as a good improvised jazz solo. Then the trumpets join the variation. Finally, the record ends with a two-part conversation for the brass and the clarinet improvising against them.

There were many highly talented big-band arrangers during the swing period, of course, but they all owed a basic conception and many of the details of the music to the work of Redman and Henderson. Some arrangers put the ideas to a very personal use, to be sure, and one such particularly worth mentioning here is Sy Oliver. Oliver was chief arranger for the later Tommy Dorsey band, after having worked for several years for Jimmy Lunceford. Today one can also hear the influence of Redman and Henderson in the work of such diverse talents as Gil Evans, Quincy Jones, and such current arrangers for Count Basie as Ernie Wilkins and Neal Hefti.

**R**edman and Henderson made a big swing band out of a conventional dance band, but there were other approaches employed in the Thirties. One of these was the idea of a big "Dixieland" band. Both Goodman and Tommy Dorsey had toyed with this notion in their earliest days, using the help of a talented arranger named Deane Kincaide. The early Woody Herman band was also such a big "Dixieland" group. But the most successful was the Bob Crosby orchestra. Crosby himself was the front man—he stood there and smiled and waved a stick and his real function was an occasional song. The Crosby book was provided by the band's director, Gil Rodin, and the arrangers, including clarinetist Matty Matlock and Deane Kincaide.

The earliest band to achieve any national identity using an expanded Dixieland format was New Orleans trumpeter King Oliver's 1926 group, and at about the same time Jelly Roll Morton was flirting with the same idea. Oliver did what Redman did not do: he tried to build on the jazz band and style that already existed. He expanded his two-trumpet New Orleans group by sub-

*Continued on page 109*

The consumer's guide  
to new and important  
high-fidelity equipment

high fidelity

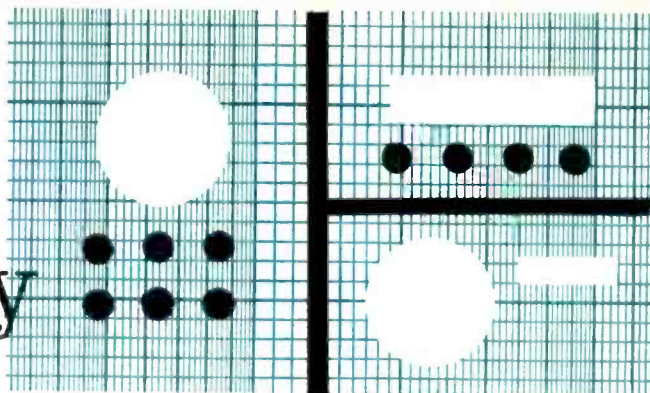

## EQUIPMENT REPORTS

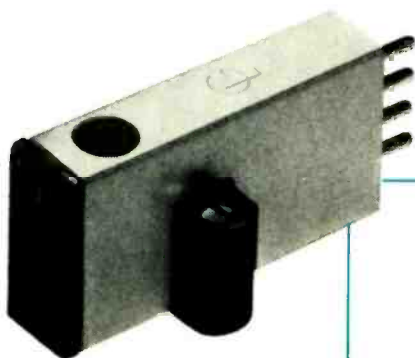

**Grado Laboratory Series  
Stereo Cartridge**

**AT A GLANCE:** Grado Laboratories, Inc., of Brooklyn, N. Y., well known in monophonic high fidelity for its excellent cartridges and novel wooden tone arm, has been offering stereo versions of its products which merit serious consideration by the quality-minded discophile. The stereo arm was reported on in an earlier issue (November 1960). Of the three stereo cartridges now in the Grado line, the "Lab Series" is the costliest and designed for use in a professional arm such as Grado's own. Tests made at United States Testing Co., Inc., supplemented by extensive listening tests, indicate that the Grado Laboratory cartridge is, without a doubt, one of the finer magnetic pickups available, with very low distortion, excellent tracking, and smooth "effortless" response. Price: \$49.50.

**IN DETAIL:** The Grado cartridge is the only one manufactured in the United States that employs the moving coil principle. Its signal-generating system is activated by a plastic arm to which the diamond stylus is attached. Compliance of the "Lab Series" model is rated at  $12 \times 10^{-6}$  cm/dyne. These cartridges, by the way, are produced largely by hand, and one at a time.

In making performance measurements on a cartridge, it is customary to observe the cartridge's output waveform on an oscilloscope as an aid in determining qualitatively how much distortion is present in the signal, and how well the cartridge tracks the test record.

The Grado cartridge had extremely low distortion at all frequencies, as well as excellent tracking ability, resulting in a clean output signal and a high, favorable signal-to-noise ratio. Needle talk was very low, as was susceptibility to hum pickup.

The frequency response curves for the Grado cartridge were obtained using the Westrex 1A test record, which is cut at a constant peak velocity of 5 cm/sec. These curves show the cartridge's smooth response with a gentle downward slope, with the right channel approximately 2 db higher in output than the left channel. Measurements indicated that the cartridge's output is uniform within plus or minus 4 db from 35 cps to 15 kc, and within plus or minus 2 db from 100 cps to about 12 kc.

Channel separation remained above 16 db from 1 kc to 11 kc, and was maintained to better than 12 db up to 15 kc. The cartridge's output at 5 cm/sec and 1,000 cps was 3.5 mv, which is adequate for use with all high quality preamplifiers. The Grado is designed to work well into any preamplifier input load above 5,000 ohms. Its recommended tracking force is 3 grams.

For many of our listening tests, we used the Grado cartridge fitted to a Grado 12-inch arm. Once the business of drilling the mounting holes on the turntable platform and adjusting the arm's various balancing features is done with, this arm proves to be a genuine pleasure to use. It has a very easy "handling" quality,

### REPORT POLICY

Equipment reports are based on laboratory measurements and listening tests. Data for the reports, on equipment other than loudspeakers, is obtained by the United States Testing Company, Inc., of Hoboken, New Jersey, a completely independent organization which, since 1880, has been a leader in product evaluation. Speaker reports are based on controlled listening tests. Occasionally, a supplementary agency may be invited to contribute to the testing program. The choice of equipment to be tested rests with the editors of HIGH FIDELITY. No report, or portion thereof, may be reproduced for any purpose or in any form without written permission of the publisher.

probably because of its fine balance and low pivot height which make it simple to cue a record. This is one arm which doesn't seem to elude your fingers to make you feel the need for an external cueing device to set it down or lift it off the record. It also has an obviously high resistance to acoustic feedback, and its pre-soldered cable and ground lead harness is as helpful during installation as it is immune to hum pickup during use.

A cursory glance at the response curves would lead one to expect that the Grado cartridge has a rich and full bass response and a comparatively "light" or "thin" high frequency response. Yet, in listening to it, one becomes more aware of its excellent definition of musical tones rather than of anything "missing" at the high end. To be sure, some listeners felt it lacked what they called "enough brilliance," but others disagreed and averred that the sound of the Grado was superb and eminently musical, that it was indeed reproducing "everything" but with such cleanliness and fine transient characteristics that it only seemed as if some of the highs were missing. In connection with this point, by the way, Grado Laboratories allows that its cartridge logically should be expected to exhibit a sloping treble response since it is designed deliberately *not* to respond

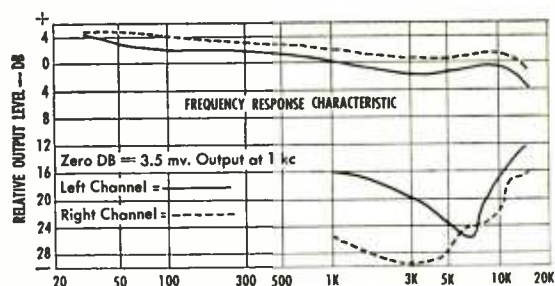

to what Grado terms the "plastic resonance" effects of commercial records, which tend to "peak" a cartridge's high-end response unnaturally. It is beyond the scope of our evaluation program to prove or disprove this theory, but this much seems certain: the Grado's audible response is among the smoothest we have heard, and it seems particularly good at de-emphasizing record surface noise which shows up as short tone bursts that can become exaggerated with a cartridge whose high-end response is peaked or which lacks good transient ability. The Grado is a very easy cartridge to listen to for hours on end. Its lack of listener fatigue and quality of response merit careful audition by the critical discophile.

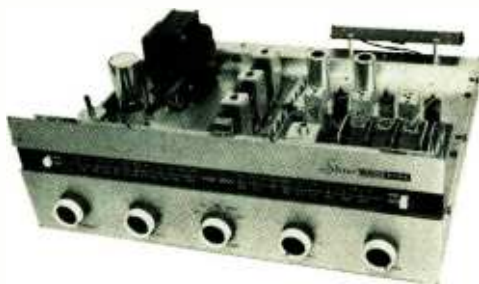

### EICO ST-96 FM-AM Tuner and MX-99 Multiplex Adapter

**AT A GLANCE:** EICO's Model ST-96 is a twin FM-AM tuner available in kit form for \$89.95 or factory-wired for \$129.95. The MX-99 is a self-powered FM multiplex adapter, intended for connection to the FM section of the ST-96 to convert it to FM stereo reception. The adapter, as a kit, is priced at \$39.95; factory-wired, \$64.95. The tuner tested at United States Testing Co., Inc., was built from a kit; the adapter was a wired model, although subsequent experience with a kit-built adapter indicates that similar performance can be expected with the do-it-yourself version. In general, USTC feels that both the tuner and the adapter represent good value for the cost. Both kits are fairly easy to build and should provide satisfactory mono and stereo reception in all but the weakest of fringe areas.

**IN DETAIL:** By way of explanation, it should be pointed out that until the advent of FM stereo multiplex, the ST-96 type of tuner was known as a "stereo tuner," since it provided independent and simultaneous reception of both FM and AM signals. For the newer FM stereo, the ST-96 must be used with a multiplex adapter, such as the MX-99.

Construction of the FM-AM tuner was very easy, due in part to EICO's completely prewired and prealigned FM "front end" and IF strip and AM IF strip.

The FM "front end" incorporates an ECC85 dual triode housed in a completely shielded aluminum-zinc casting.

The FM IF strip incorporates three IF and limiting stages using 6AU6s, and a broadband ratio detector using a 6AL5. The AM section has a built-in ferrite loop antenna and uses two 6BA6s and one 6BE6 in its IF strip, which has a tuned RF stage at the front end. The output from the AM IF strip is fed through a 10-kc whistle filter on its way to the audio output stages. Both FM and AM signals are boosted through a 12AU7. Separate volume controls are provided for FM and AM. The output signals will drive any external amplifier.

Separate electronic eye tuning indicators are used for FM and AM. These are located on sliding brackets behind the frequency scale to indicate the tuning position. When tuned to a station, the tuning eye opens slightly to form an inverted exclamation point, and although the eyes apparently worked as they should, they were considered to be rather small and hard to see. Including the two DM70 tuning eyes and the one EX80 power supply rectifier, the ST-96 has thirteen tubes.

The MX-99 adapter uses six tubes and six crystal diodes. It features a convenient visual indication when tuned to a multiplex station.

The MX-99's filtering, of the multiplex pilot signal and 38-kc subcarrier, is very effective, and assures that

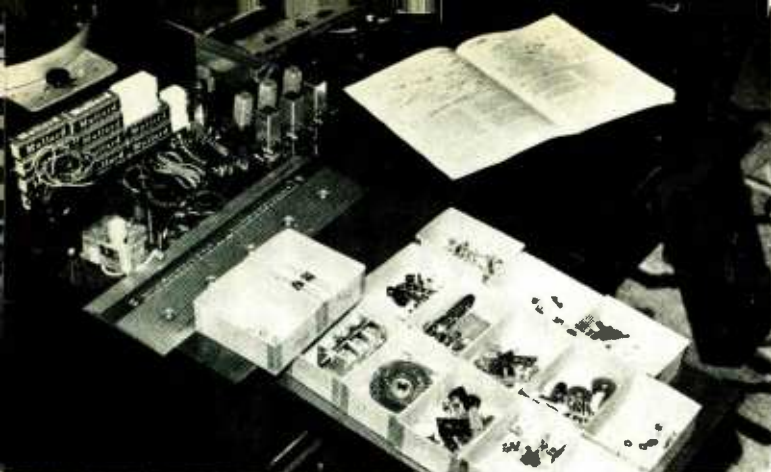

## How It Went Together

The ten hours required for assembling the ST-96 tuner, and the additional five hours for the MX-99 adapter, were quite painless, as kit-building goes, and in the builder's view anyone who can follow printed instructions should be able to complete these units successfully. No previous technical knowledge is required. Much of the tuner actually comes prewired, so that a good portion of the work involves fairly simple mechanical assembly. In fact, about as much time was spent handling a screwdriver and a nutdriver as wielding the soldering iron. The only snag encountered was in the adapter kit, where the nuts supplied for holding the front panel switches did not match the nuts pictured in the manual. The solution was to use ordinary hex nuts on hand. These held the switches all right, but were too big to permit fitting of shields over the rear of the switches. The instruction manuals were found to be very clearly written and carefully prepared, so that diagrams and printed directions for a given portion of the work all were contained in the same page folds. There was no need, in other words, to flip pages to locate a drawing referred to in the text. And EICO also has managed to eliminate the need for tacking large blowups on the wall: the detailed illustrations are there, but contained within the instruction manual. All told, a pair of neat and efficient kit packages.

no beat notes will develop when feeding the output signals into a tape recorder.

The adapter's operating controls consist of an off-on switch, a channel separation control, and a sub-carrier oscillator control switch to permit turning off the internal oscillator when listening to mono FM stations that transmit subscription multiplex programs.

The ST-96 tuner was assembled in accordance with the instructions furnished, and performance tests run on it without further alignment. The IHFM sensitivity of the tuner was measured to be 20 microvolts at 98 mc, 23 microvolts at 90 mc, and 27 microvolts at 106 mc, all shown on the "A" sensitivity curve in the accompanying graph. As is fairly common with tuner kits, a professional touch-up alignment [here, of the ratio detector] improved the tuner's sensitivity. Before making such alignment, however, USTC measured the tuner's various operating parameters. The total harmonic distortion at a high signal strength level (1,000 microvolts) was 2.2% at 40 cps, and 1.2% at 1,000 cps. The IM distortion was 0.4%, which was rather low, and the capture ratio was 18 db, which was quite high. The over-all signal-to-noise ratio was 51.7 db, and volume sensitivity was 12.5 microvolts. The alternate channel selectivity of the tuner was 36.9 db at 98 mc, which is fair.

The audio frequency response rolled off at about 40 cps at the low end, and was down by -3.7 db at 20 kc. The response at the multiplex output jack was flat at the low end, but dropped off to -3 db at 20 kc and -14.6 db at 50 kc.

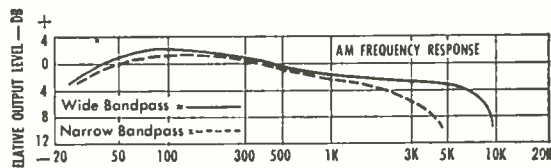
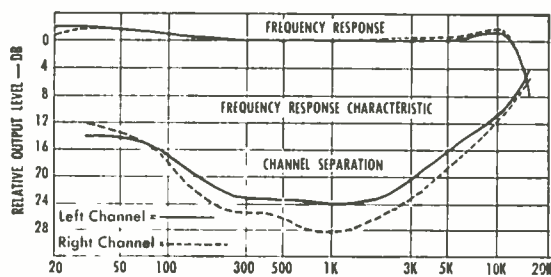
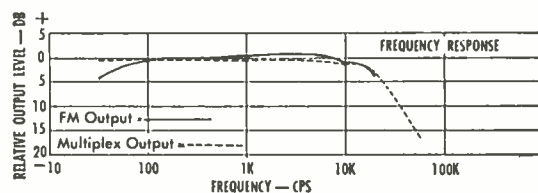
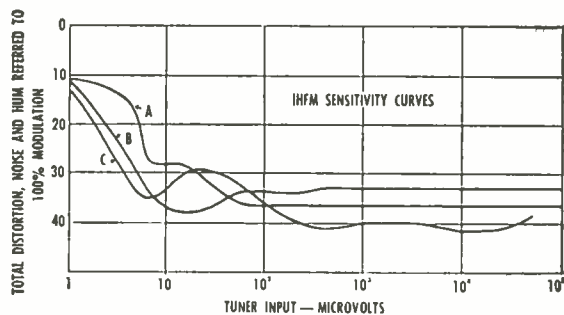

The FM section of the ST-96 then was given a professional alignment by USTC to determine whether its performance could be improved over that provided by the original prealignment. It was first aligned using a relatively low input level, which resulted in the "B" sensitivity curve. As can be seen, the IHFM sensitivity increased from 20 microvolts to 4.7 microvolts, but the distortion at high signal strength increased over that of the "A" curve. A second realignment resulted in the "C" curve, indicating an IHFM sensitivity of 3.5 microvolts, and low distortion at high signal strength. There was, however, a large hump in the curve at the 20-microvolt level. Actually, these widely varied curves are somewhat characteristic of ratio detectors. Depending on the particular alignment given such a tuner, its performance will be good at some input levels and poor at other input levels. The harmonic distortion at the 1,000-microvolt level was fairly low when the tuner was aligned as indicated by the "C" curve, with 1.3% distortion measured at 40 cps, and 0.8% at 1,000 cps.

On AM, the IHFM usable sensitivity was 12 microvolts. After tuning it up slightly the sensitivity increased to 6.5 microvolts. The THD on AM was 1.75% at 400 cps. The audio frequency response was fairly good with the "wide" IF bandwidth, with usable response up to about 9 kc. With the "narrow" bandwidth, it cut off at about 4.5 kc. As was expected, the AM sound was distinctly poorer than the FM.

In normal operation the ST-96 provided approximately 2.6 volts rms at the multiplex output jack for



operation of a multiplex adapter. This is a relatively high level signal for an adapter to handle, but the MX-99 handles it fairly well. The MX-99 has a gain of unity, with each output jack identical in output level to the input level. Operation of the adapter is automatic; there is no need to use any switches to change from mono to stereo. The frequency response of our adapter was quite good up to about 13 kc. after which the response of each channel dropped off sharply. At 15 kc. the response of each channel was down 8 db. The channel separation was only fair in comparison to some adapters we have seen, but was entirely adequate for a good stereo effect. Separation was maintained above 12 db from 30 cps to 9 kc, and dropped to 8 db at 13 kc.

On stereo operation at 40 cps. USTC measured 6% THD on the left channel and 4% on the right channel. At 1,000 cps. the THD was 4% on the left channel and 3.8% on the right channel. (The designations "left" and "right" are not used by EICO and it will be necessary for the owner of the MX-99 to determine by ear which output is left and which is right.)

The MX-99 was very susceptible to overmodulation by FM broadcast stations (some of which do over-modulate occasionally), causing noticeable distortion of

the audio output. Operating from the ST-96's 2.6-volt output, the MX-99 operates at just under the maximum level at which it functions well. Furthermore, it was found that if the level of the composite signal into the multiplex adapter was less than 1.2 volts, the 38-kc oscillator in the adapter went out of synchronization, causing high distortion. Therefore, for satisfactory operation, the input level to the adapter must be in the range of 1.2 volts to 2.6 volts rms. Because of this, the MX-99 is best used—in USTC's view—with the EICO ST-96 tuner. Taken together, the two units form a satisfactory receiving system, available at a very reasonable price. The significance of the 20-microvolt sensitivity obtained before professional alignment is relative to receiving conditions. This figure indicates less than full limiting with weak incoming signals. In a normally good signal area, this factor is of minor importance, and has little bearing on the sound. However, in USTC's view, professional alignment can increase the ST-96's usable sensitivity to enable the set to be used at greater distances from stations, and to become less critical of reception conditions. For the best results on FM stereo, such alignment—which generally costs about \$10—is recommended.

### H. H. Scott LK-72 Stereo Amplifier Kit



**AT A GLANCE:** The Scott LK-72 is a high-powered, high quality stereo control amplifier available in kit form. United States Testing Co., Inc., points out that the unit is handsomely styled, relatively small, and weighs a mere 26 pounds. Nevertheless, it contains a full complement of controls, and will develop 40 watts of clean audio power per channel over most of the audio spectrum. Price: \$159.95.

**IN DETAIL:** The LK-72 has separate bass and treble controls for each channel, a single volume control for both channels, a channel balance control, a seven-position function selector, a three-position input selector (phono or tape, tuner, and "extra" or auxiliary input), loudness switch, and scratch filter. A separate front panel switch is also provided for selecting either the NAB tape head input or the RIAA magnetic phono input. On the rear panel, terminals are provided for connecting either 4-, 8-, or 16-ohm speakers to the amplifier. Additionally, there are two low level input pairs, and two high level input pairs, as well as a high level tape recorder input which is connected when the tape monitor switch is on. A center channel output jack is included, as well as tape recorder output jacks. An AC convenience outlet is also furnished on the rear panel. Provision is made for adjusting the DC balance of each channel without using test instruments.

In USTC's tests, a kit-built LK-72 developed 40 watts rms of clean audio power per channel at 1,000 cps with one channel operating, and 32 watts per channel with both channels operating. The decrease in power is due to the loading on the amplifier's power supply, which uses a GZ34/5AR4 rectifier tube and SR1 selenium rectifier. At that, the power still available is, in USTC's opinion, quite ample for most installations.

The amplifier's power bandwidth extends from about 30 cps to about 20 kc. At the 1-watt output level, frequency response was found to be flat within +0.6 and -1.0 db from 16 cps to 29 kc. Response continued well beyond this point and was checked, in fact, out

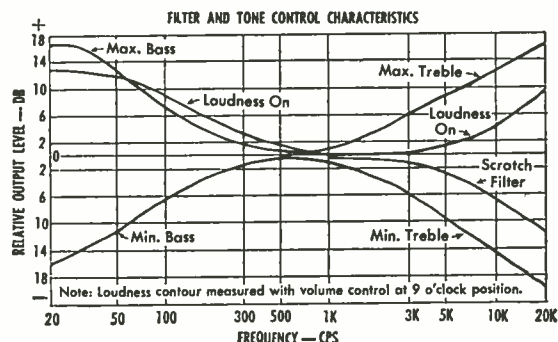

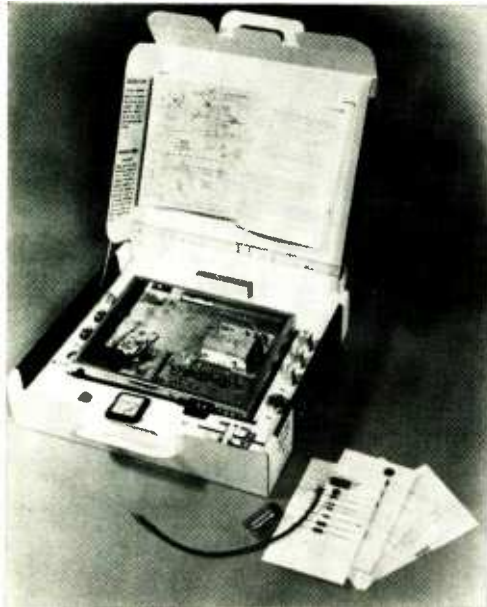
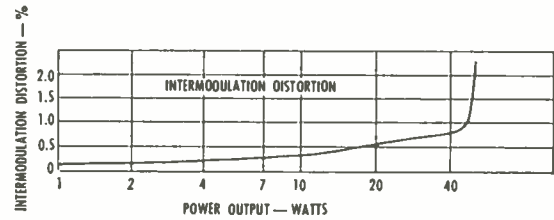
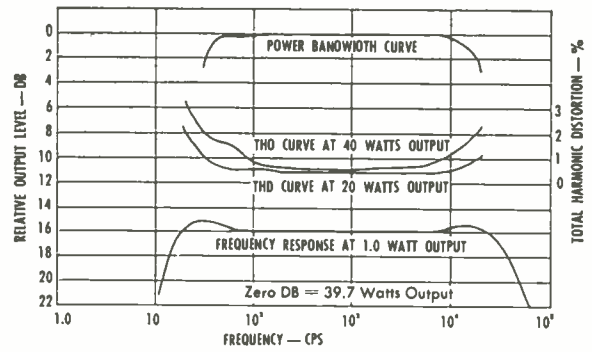
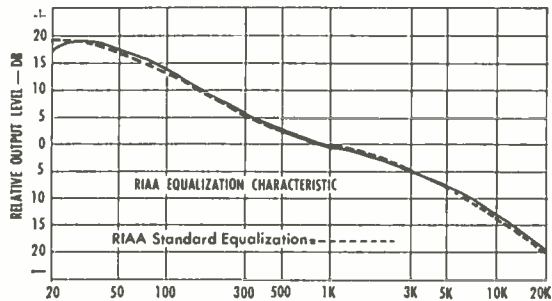
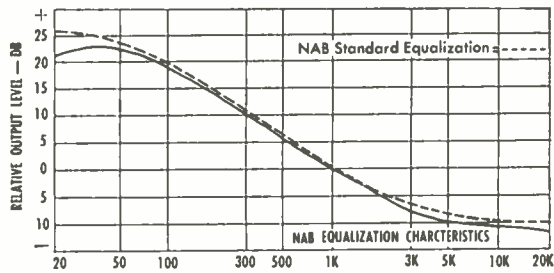

### How It Went Together

The packaging and instruction manual for the Scott LK-72 kit help make the assembly and wiring of this amplifier painless and even pleasurable. Each stage of the work is carefully explained, with text and illustrations that leave little or no room for error, and which were obviously prepared with more than a passing sense of humor. There are no outsize "blowups" to hang on the wall, but rather meticulously detailed drawings, in color, of each stage of the work, and all contained in the manual in the normal sequence of steps used by the builder. The instructions are prefaced with helpful hints on how to unpack the kit, what tools to select, correct soldering procedures, and so on. For those who are interested, there also is a section explaining how the amplifier operates, stage by stage. All told, this is a neat, attractive, very well-designed kit, and one which gives every assurance of successful completion even in the hands of the inexperienced or first-time kit builder.

to 41 kc where it was down only 3 db.

Total harmonic distortion at 40 watts output was only 0.45% at 1,000 cps and remained below 2% from 30 cps to 18 kc. At half power (20 watts rms), the THD remained below 1% from 30 cps to 19 kc, which also is quite good considering the size and weight of the LK-72. Intermodulation distortion was very low on the LK-72, with only 0.73% IM at 40 watts rms output. At 10 watts, the IM distortion was less than 0.4%.

The sensitivity of the LK-72 for 40 watts output was 0.85 volts on the high level inputs, 16 mv on the RIAA phono input, and 7.6 mv on the NAB tape head input. In USTC's view, higher gain on the two low level inputs might be desirable to realize the full potential of some recent high quality, low-level pickups. This is not critical, however, for many other pickups. Signal-to-noise ratio was very good, being 79 db on the high level inputs and better than 60 db on the low level inputs at maximum gain. Channel separation was better than 50 db below 1 kc, and was 39 db at 10 kc.

RIAA equalization was generally accurate from 25 cps to 20 kc, varying no more than 1.0 db from the RIAA standard curve. NAB equalization was slightly poorer, but did remain within 2 db of the NAB standard curve from 35 cps to 20 kc. The tone control, loudness, and scratch filter all operated quite well and exhibited what one might term "tasteful characteristics" from a musical standpoint.

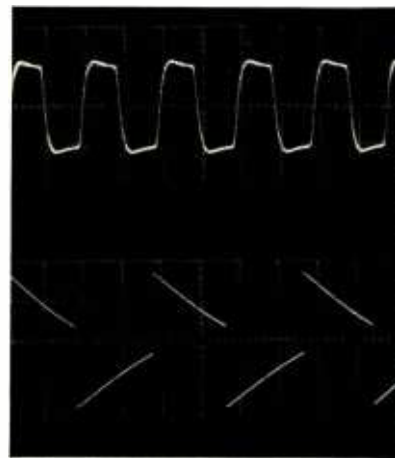

Square wave response, LK-72 kit.

Square wave tests were made at 10 kc and at 50 cps. As shown in the accompanying photos of the square wave oscillograms, the 10-kc response is fairly representative of a good control amplifier, and relates actually to the high frequency rolloff measured in the extreme fringe area of the spectrum. The oscillogram also shows, by the way, fairly good transient response. The 50-cps response shows the effect of a "lagging" phase shift which relates to the steep drop in response below 20 cycles and which, again, seems fairly typical of many

integrated amplifiers. The LK-72's damping factor was 14.6, indicating good stability with varying loads.

All indications are that the LK-72, with ample power output to drive virtually any speaker system, will perform very well in a home high-fidelity system. Its very low distortion makes for clean, sweet sounds. Not to be overlooked is its compactness, which enables it to be put on a bookshelf or in any cabinet. For those willing to spend the time building it, the LK-72 represents good value on today's market.



### Audax CA-70 "Sonoteer" Speaker System

**AT A GLANCE:** The Audax "Sonoteer" represents a departure from the usual type of compact speaker system in that it is quite slim, with an enclosure which measures only four inches in depth. Other dimensions are 21 inches wide by 25 inches high. The legs—which may be used or not, depending on the type of installation desired—add another two inches to the height. The model reported on here was the CA-70, styled in contemporary mode and finished in oiled walnut. Its general character could be summed up as modest but fairly smooth. Price is \$79.95. Other cabinet designs, incorporating the same basic system, also are available.

**IN DETAIL:** The CA-70 "Sonoteer" weighs only 18 pounds. It is an 8-ohm system rated at 45 watts power-handling capacity. Within the strikingly styled enclosure are installed four 6-inch, 8-ohm speakers in a series-parallel hookup, and one 3-inch tweeter which is connected across the line in series with a capacitor which serves as a high-pass filter for treble tones. Two of the 6-inch speakers are treated to serve as woofers; the other pair, as midrange units. All the speakers are mounted on the front baffle board and face directly forward. However, the rear panel of the enclosure has two large openings which permit much of the sound to leave the system from the rear.

This type of design makes for a certain amount of doublet operation, in which sound is radiated in more or less of a "figure 8" pattern from the nominal front and rear of the housing. A doublet speaker is, of course, relatively critical of placement in a room since a good deal of what is heard depends on the "bounce and spread" effect from that side of the system away from the listener. This is particularly true of the upper mid-range and high frequencies, which often sound better when not heard "directly," a fact which suggests speaker placement at some distance from a wall. (The surface of the wall, incidentally, also will affect the sound, since a "soft" wall absorbs more of the highs than a "hard" wall.) On the other hand, the bass response is reinforced by placement near adjacent walls. Juggling

these two apparently opposite concepts, and working within the framework of a high order of compactness, Audax designers have come up with a reasonably good compromise which might be useful in a number of compact installations.

The system's response, while not phenomenal, seemed generally smooth throughout most of the audio range. There was little serious harshness or distortion evident until the "Sonoteer" was driven with some really husky amplifiers in the 40-watt or higher class. There is, in high fidelity lore, an old adage about it being best to use an amplifier whose power rating is half that of the speaker's—and this idea seemed to be borne out here. In any case, at the modest power levels furnished by a typically good, but compact, integrated amplifier, the CA-70 provided fairly clean, "normal room level" type sound. Its range was checked from 50 to 15,000 cps, with peaks observed at 250, 700-800, and 3,000 cps. Aside from these, response was generally smooth from about 100 to 4,000 cps. Below 100 cps, response rolled off gently but was still apparent at 50 cps.

Admittedly, the "Sonoteer" will not satisfy the acoustic demands of the most critical listener, but it does have the unique virtues of its generic class of "thin-line" speakers. These are: fairly clean sound within its somewhat limited range, an ability—because of its doublet action—to produce a very pleasing "spread" on stereo and mono, and its adaptability to virtually any type of installation, including floor, wall, or room divider.

#### COMING REPORTS

**KLH-9 Electrostatic Speaker**  
**Shure M33 Cartridge**  
**Sherwood S-3000-IV FM Stereo**  
**(Multiplex) Tuner**

**Bernstein Conducts Mahler**

A first in stereo: Maestro Leonard Bernstein, the New York Philharmonic, soloist Martha Lipton, a boy's choir and women's chorus scale the heights of Mahler's towering Third Symphony.



THE

**Strauss and The Philadelphia**

The sumptuous sound of The Philadelphia Orchestra under Eugene Ormandy is revealed afresh in this stereo recording of Richard Strauss' stunning tone poems.



COLLECTOR'S

**The Casadesus—Four Hands**

Virtuosi Robert and Gaby Casadesus combine four hands and their special wit in a program of two-piano music by Debussy, Satie, Chabrier and Fauré.



CHOICE

**Richter Plays Rachmaninoff**

"Rachmaninoff himself could hardly have played these (preludes) more feelingly," said the N. Y. Herald Tribune of master pianist Sviatoslav Richter in his Carnegie Hall concert. This is the third complete concert in the historic Richter series, recorded live at Carnegie.



IS ON

**Superb Duo**

A superb chamber music team: violinist Joseph Fuchs and his sister, Lillian, violist, lend special lustre to Mozart's appealing but rarely-recorded Duos.



COLUMBIA

**Music From an Unknown Century**

Arias, anthems and chorales of the Moravian Church—from a neglected but fascinating era in American musical history. Second in a Columbia LP series, it is recorded with affection as well as authority by the Moravian Festival Chorus and Orchestra.



RECORDS

CHOOSE SPECTACULAR STEREO OR MATCHLESS MONAURAL

© "COLUMBIA" MARCAS REG. PRINTED IN U.S.A.

# Music Makers

by ROLAND GELATT

BRUNO WALTER, who died at his home in Beverly Hills on February 17, was the last of the great conductors firmly rooted in the musical soil of nineteenth-century Germany. He belonged—by right of birth and force of temperament—to the late-Romantic ambiance. At the outset of his conducting career, Brahms and Bruckner were alive and still productive, Wagner and Liszt had only recently gone to their graves, while Mahler and Strauss were just emerging as promising talents. Walter's death breaks the last remaining link with this distant era. Others, of course, will carry on the tradition he exemplified, but as re-creators of a style rather than as participants in a movement. Even such elder citizens as Otto Klemperer and Hans Knappertsbusch belong to a different, and appreciably more up-to-date, generation.

How fortunate we are that this nineteenth-century man lived long enough to record the bulk of his repertoire in unassailable sonic splendor! Walter had a lively appreciation of stereo sound, and he realized full well that he was leaving a legacy far more vividly recorded than either Toscanini's or Furtwängler's. The last years of his life he devoted almost exclusively to the making of records. Much of this work has already been published, but a good deal more is still to come. Although Walter's last sessions took place over a year ago, there is a surprising amount of unreleased material in Columbia's vaults.

Mahler lovers will be especially heartened to know that Walter re-recorded both the First and Ninth Symphonies for the stereo microphones. These are yet to be released, as are new tapings of the Bruckner Seventh, Brahms's *Song of Destiny* and *Alto Rhapsody* (with Mildred Miller), and various works of Mozart, Haydn, Beethoven, Dvořák, and Wagner. The Mahler Ninth is due to be issued later this month as part of a Bruno Walter memorial album. The symphony itself occupies four sides; the



Bruno Walter

fifth side is given over to excerpts from the rehearsals for the symphony, the sixth to a recorded conversation (dating back several years) between the conductor and Arnold Michaelis.

Inevitably, there are some tantalizing might-have-beens. In February and March of this year Bruno Walter was to have made another big batch of recordings on the West Coast. Chief item on the agenda was a complete *Fidelio* with Gré Brouwenstijn (Leonore), Wilma Lipp (Marzelline), James McCracken (Florestan), George London (Pizarro), and Otto Edelmann (Rocco). Unfortunately, the cast had to be released from their contracts early in January when it became evident that Walter's health would not permit so arduous an undertaking. John McClure, Columbia's classical recording director, had also hoped to schedule Walter sessions this year for the Mahler Fourth and Fifth Symphonies and also for a coupling of Debussy's *La Mer* and Ravel's *Tombeau de Couperin*, two works of which the conductor was particularly fond even though they lay outside his usual orbit.

A Walter recording of *Fidelio* seems to have been as jinxed from the start as a Bjoerling recording of *Un Ballo in maschera*. He was originally to have made it in Austria with Lotte Lehmann and the Vienna Philharmonic. Hitler's *Anschluss* in-

tervened. Then in the mid-Forties there was talk of his doing it with Metropolitan Opera forces. This project too came to naught. So we are left with only one largish opera recording by a conductor who devoted a major part of his life to the lyric theatre. This is the 1936 waxing of *Die Walküre*, Act I, with Lehmann, Melchior, Emanuel List, and the Vienna Philharmonic. Angel should lose no time in restoring it to circulation as a Great Recording of the Century.

**ODDMENTS:** When you see the Tchaikovsky Seventh Symphony on a record jacket later this year, don't assume that some monstrous typographical error has been perpetrated. We can testify that the music really exists, having heard it performed in the Academy of Music by Ormandy and the Philadelphia Orchestra (who will make the recording). Tchaikovsky began work on this symphony in 1892, prior to composing the *Pathétique*, but gave it up as a bad job after several abortive months. "I have decided to scrap it and forget about it," he wrote to a friend. But his sketches were preserved, and now a Soviet composer with the tongue-twisting name of Semyon Bogatyryev has reconstructed the abandoned work for our edification.

Tchaikovsky's sketches were used for the first, second, and last movements. The third movement, a scherzo, is taken from the composer's Opus 72 set of piano pieces. The Seventh Symphony is recognizably Tchaikovskian and has some lovely moments, particularly as played by the Philadelphians. No long-lost masterpiece, however. . . . RCA Italiana officially opened its new recording studios—said to be the most modern in the world—early in March. They are located at the company's headquarters in Rome and have been designed specifically with large-scale opera recordings in mind. An on-the-spot report will appear in this space next month.

# HEAR! HEAR!

...the Stereophonic  
Curtain of Sound<sup>®</sup>  
recording technique!

Recognized for years by discriminating listeners for true stereophonic reproduction and the highest standard in high fidelity!

# on **AF** AUDIO FIDELITY

new releases!

### STRINGS FOR A SPACE AGE, Bobby Christian & His Orch.

SPACE SUITE: The Call • Count-Down • Flight Into Orbit & Epyrean • The Call • Re-Entry • Finale • Midnight Sun • Out Of This World • Blue Star • Autumn In New York • Out Of Nowhere • How High The Moon  
AFLP 1959 • AFSD 5959



### NICKEL MUSIC, The Sound of the Nickelodeons at

Paul Eakins' Gay Nineties Village  
King Cotton • Dixie • Patriotic Medley • Georgia Camp Meeting • Hands Across The Sea • The Jolly Coppersmith • The Irish Washerwoman • Battle Hymn Of The Republic • My Wild Irish Rose • March Medley • Carry Me Back To Old Virginny • Yankee Doodle • Ta Ra Ra Boom De Ay • Over The Waves  
AFLP 1960 • AFSD 5960



### MEXICO WITH LOVE, Jo Basile, Accordion & Orch.

La Bamba • Jarabe Tapatio • Malaguena • Chiapanecas • La Raspa • Ay Jalisco No Te Rajas • El Rancho Grande • La Cucaracha • Cielito Lindo • Guadalajara • La Golondrina • Las Mananitas  
AFLP 1946 • AFSD 5946



### CARNAVAL DO BRASIL, MARCHAS, FREVOS, SAMBAS

Tumba Le Le • Levanta Mangueira • Pra Seu Governo, Recordar • Na Base Do Amor • Se Eu Errei, Me Da Um Dinheiro Ai • Indio Quer Apito • A Lua E Dos Namorados, Evocacao • Vassourinha, Madalena Vai Casar • Cacareco E O Maior, Piada De Salao • Maria Escandalosa • Paie, Quem Me Ve Sorrir • Nao Me Diga Adeus • General Da Banda, Qual E O Po • Vai Ver Que E • and others  
AFLP 1953 • AFSD 5953

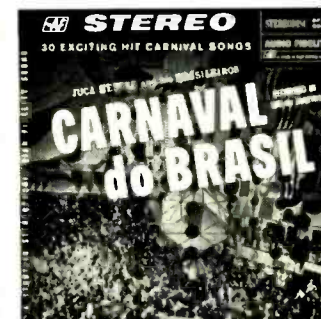

▶ **NEW! FREE!** ▶▶

Complete catalog—fully illustrated with complete selection listings for each record—mono and stereo. Complete stereo tape listing.



**A DATE WITH EDDIE CANTOR,**  
Songs, Stories and  
Anecdotes from his Carnegie  
Hall One Man Show  
Makin' Whoopie • If You Knew Susie •  
Ida • Ma, He's Making Eyes At Me •  
There's No Business Like Show  
Business • Dinah • Is It True What  
They Say About Dixie? • Margie •  
Josephine Please Don't Lean  
On The Bell • and others  
AFLP 702



**SOUND EFFECTS, Volume 3**  
Teletype Machines • Facsimile  
Wirephoto Machines • Cuckoo Clocks •  
Grandfather Clock • Clock Ticking  
(time-bomb effect) • Army Pistol Range  
• Heavy Artillery • 'Vulcan' Aircraft  
Machine Gun • M48 Medium Tank •  
Close Order Drill • Police Car  
Passing Thru Traffic • Pedestrians  
In City Street • Thunder And Rain •  
Rain On Pavement • N. Y. Subway •  
Model T Ford Starting, Idling, Passing •  
Electronic Effects • many others  
DFM 3011 • DFS 7011



**BRASIL, BOSSA NOVA,  
SAMBAS, MARCHAS**  
O Apito No Samba • Mulata Assanhada  
• Poema Do Adeus • Covarde •  
Arrasta A Sandalia • Marcha: Mundo  
De Zinco • Eu Chorarei Amanha •  
Lata D'Agua • Nao Me Diga Adeus •  
Chora Tua Tristeza • Implorar • O Amor  
E A Rosa • Recordar • Marcha: Madeira  
De Lei • E Com Esse Que Eu Vou  
AFLP 1954 • AFSD 5954



REG. APP. FOR  
Mono (AFLP, DFM)—\$4.98 / Stereo (AFSD, DFS)—\$5.95  
AVAILABLE AT YOUR RECORD SHOP, OR WRITE TO:  
**AUDIO FIDELITY RECORDS**  
Dept. HF4, 770 Eleventh Avenue, New York 19, N. Y.

CIRCLE 13 ON READER-SERVICE CARD

reviewed by

PAUL AFFELDER  
NATHAN BRODER  
O. B. BRUMMELL  
R. D. DARRELL  
ALFRED FRANKENSTEIN  
HARRIS GOLDSMITH  
JOHN F. INDCOX  
ROBERT C. MARSH  
CONRAD L. OSBORNE  
JOHN S. WILSON

## Records in Review



*Nilsson: an infinite variety of subtleties.*

by Herbert Glass

## There's No Longer Any Trouble With *Salome* . . .

AFTER the Dresden premiere of *Salome* in 1905, most critics agreed that Richard Strauss's vocal music was written in a hopelessly unvocal manner. The orchestra, the sages contended, indulged in such barbarous cacophony that it actually made little difference what the singer did. Henry Finck, a highly influential critic in the early years of this century, capped his opinion of *Salome* with heavy-handed irony: "Who can fail to see the stupendous originality and advantage of this new style of opera? What composer before him [Strauss] was clever enough to write music in which it makes no difference whether you sing or play correctly?" Today *Salome* has achieved something of the status of a repertory piece, but I suspect that the late Mr. Finck's dim view of the opera is still tacitly shared by many listeners today.

The reason is hardly obscure, considering the inadequate performances *Salome* has received on stages both in this country and abroad, as well as on

records. Singers capable of meeting Strauss's great demands have, I assume, always been in short supply, and in my experience several prima donnas granted the role of *Salome* have been virtually incapable of singing the printed notes. This situation, however, has not deterred opera companies from retaining the work in their repertoires. One thinks, by contrast, of other important operas—*Norma* comes immediately to mind—for which a lack of fully qualified singers has meant, in our time, comparatively few productions. I realize, of course, that Strauss's ability to create tension on stage and in the pit makes it possible even with a sloppy performance to create "compelling theatre" of a kind that Bellini's more "chaste" concept of opera does not permit. And it is true that the vocal line of *Salome* is far less exposed than that of *Norma*. Nevertheless, finding a good *Salome* is at least as difficult as finding a good *Norma*; in my opinion, it should be as important.

I do not mean to suggest that superior interpreters of the role have been totally absent in recent years. We have had, for instance, Ljuba Welitsch and Inge Borkh (the best *Salomes* I personally have encountered), although unfortunately neither artist recorded the work in its entirety. Now, however, this opera has been committed to discs in a version that supports my contention that the trouble with *Salome* has been not Strauss but some of its singers. Hereafter, listeners should remain forever convinced that Strauss was at all times able to, and at all times did, write a "vocal" line. Clearly, Birgit Nilsson, in the title role, firmly believes that *Salome* was meant to be sung with the same precision as a "singer's opera." Nilsson simply does not have to resort to the vocal tricks employed by lesser artists. For once, that throaty sound so favored by many *Salomes* is totally discarded, as are countless other little cover-ups for trouble which have come to be considered ineluctable parts of the

approach to Salome. Furthermore, Nilsson is able to create the headiest excitement without ever sacrificing that lyricism which should be as much part of the role as its inherent intensity. Her ability to hurl out a *fortissimo* high note with the greatest of ease is well known. But in *Salome* much more is required. Listen to Nilsson's exquisitely delicate A flat on the final word of "*Gewiss ist er keusch wie der Mond*" and you will be sampling the astounding completeness of this singer's technique. Again, with the reiterated requests for "*den Kopf des Jokanaan's*," Nilsson is able to find a different shading, a different degree of intensity every time the phrase is uttered; then, when it comes at us for the last time, there is such monomaniacal resolution in the voice that Herod's deathly fear of the girl becomes fully believable. At the end the famous apostrophe to Jokanaan's head emerges, as it should, as the culmination of a totally chilling experience. In short, in this performance we encounter one of those rare artists who can display an infinite variety of subtleties within the framework of a firm and at all times appealing vocal production.

Nilsson's magnificent work would alone be reason for gratitude at the appearance of this set, but there is more. Gerhard Stolze, a performer new to records, is easily the most convincing Herod I have encountered. What a pleasure it is to hear a singer with a healthy voice in this great role rather than the usual superannuated *Heldentenor*. In spite of moments which come perilously close to caricature, Stolze's Herod fills the stage,

or, if you prefer, the living room, with the very stench of decay. It is to be hoped that we will hear much from this gifted artist in the future. As for the Jokanaan, most singers have, of necessity, taken pretty much the same dramatic approach to this role, but it would be unusual indeed to find another with Eberhard Wächter's glorious vocal endowments. Jokanaan's sickening righteousness can turn into farce when handled by a singer perpetually on the brink of collapse beneath the burden of Strauss's staggering demands of range and volume within an extended phrase. Wächter carries it all off with a voice that is superbly solid and beautiful in tone. Waldemar Kmentt repeats the gorgeously sung, passionate Narraboth which was one of the chief joys of the deleted Columbia set (SL 126), while Grace Hoffman brings her splendid voice and theatrical awareness to the part of Herodias. And so it goes; each contribution is flawless.

Solti's leadership of the Vienna Philharmonic and the intelligence of London's engineers are other factors which contribute immensely to the over-all success of this production. *Salome* is a natural for a conductor of Solti's dynamic temperament. This *Salome* is, however, by no means a hurly-burly. The performance is impeccably organized, while retaining all of its built-in excitement. The engineers have, I feel, here surpassed even their previous technical wonders of *Rheingold* and *Orello*. An ideal sonic relationship—the unique relationship demanded by the score—has been created: i.e., the singers are vir-

tually interwoven with the orchestra. Although the orchestra is allowed to swamp the singers when the score so requires, the dominant impression is one of a large, generally loud orchestra in balance with large, generally loud voices; and an astounding clarity and fullness of sound is maintained from the highest squeak of flute or violin down to the deepest rumblings of double bass. It should also be mentioned that stage action is faithfully reflected throughout the course of this recording. Most important, however, is the fact that these qualities of technical expertness are not superimposed upon the performance; they are requisites of a true presentation of the opera.

I think that I can safely call this new *Salome* one of the greatest opera recordings ever made; and it is without doubt a performance which makes all previous recordings obsolete.

#### STRAUSS, RICHARD: *Salome*

Birgit Nilsson (s), Salome; Liselotte Maikl (s), A Slave; Grace Hoffman (ms), Herodias; Josephine Veasey (c), Page of Herodias; Gerhard Stolze (t), Herod; Waldemar Kmentt (t), Narraboth; Nigel Douglas (t), Second Nazarene; Kurt Equiluz (t), Aron Gestner (t), Paul Kuen (t), Stefan Schwer (t), Jews; Eberhard Wächter (b), Jokanaan; Tom Krause (b), First Nazarene; Heinz Holecek (bs), Second Soldier; Theodor Kirschbichler (bs), A Cappadocian; Zenon Koznowski (bs), First Soldier; Max Proebstl (bs), A Jew. Vienna Philharmonic Orchestra, Georg Solti, cond.  
 ● LONDON A 4247. Two LP. \$9.96.  
 ● ● LONDON OSA 1218. Two SD. \$11.96.



George Papastavrou

by Alfred Frankenstein

## Ives's *Concord Sonata*— A Great Day for American Music

CHARLES Ives's *Concord Sonata* has finally been issued in a technically adequate recording. It was released on 78s many years ago, and an LP dubbing circulated briefly before it was withdrawn and forgotten. To all intents and purposes, the new disc marks the Sonata's first appearance on microgroove. This is a great day in the history of American music, but one can readily understand why it has been postponed so long. The work—officially entitled *Second Pianoforte Sonata "Concord, Mass., 1840-1860"*—strains everything to the limit: musical notation, the piano,

the pianist, and the hearer's receptivity. It is worth all the trouble, though; many years ago Lawrence Gilman called this work "the greatest music composed by an American," and it still stands up as the greatest of American piano sonatas.

Ives himself described the piece in the following terms: "The whole is an attempt to present one person's impression of the spirit of transcendentalism that is associated in the minds of many with Concord, Mass., of over half a century ago. This is undertaken in impressionistic pictures of Emerson and Thoreau, a sketch of the Alcotts, and a scherzo sup-

posed to reflect a lighter quality which is often found in the fantastic side of Hawthorne. . . . The first edition, together with the *Book of Essays*, was published in 1920. This sonata was composed mostly in 1909 and 1910, the last movement fully completed in 1915. . . ."

The "*Book of Essays*" to which Ives refers, published under the title *Essays Before a Sonata*, is as remarkable an achievement in the domain of aesthetics, philosophy, and literary expression as is the music itself in the domain of sound. Extensive extracts from the essays are reprinted in the second edition of the



score and on the inside paper jacket of the new recording.

The Sonata is not at all easy to describe. It employs familiar Ives devices, but in a much more closely integrated and creative fashion than usual. One device, for instance, is quotation, specifically the quotation of the opening bar of Beethoven's Fifth Symphony, which rings throughout the whole work, often paired with or played off against a more lyrical motif of Ives's own. Regarding his use of the Beethoven motif, Ives says, "We would place its translation above the relentlessness of fate knocking at the door, above the greater human message of destiny, and strive to bring it towards the spiritual message of Emerson's revelations . . . the Soul of humanity knocking at the door of the Divine mysteries, radiant in the faith that it will be opened, and that the human will become the divine."

Closely linked to Ives the Transcendentalist is Ives the musical historian of New England manners. Thus *The Alcotts* recalls family hymn singing and the playing of sentimental songs on the piano in the parlor, and there are the inevitable Ives marches and barn dances in *Hawthorne*. But all of this is absorbed into the personal, mystical, Heaven-storming, Transcendental style which is the other side of Ives; the two are really one here, as they seldom are in other works. There is little or no folklore in the immense, rugged *Emerson* or the profound *Thoreau*, which for me is the most satisfactory movement of the four. Towards the end of the *Thoreau*, which is also the end of the opus, Ives combines his two basic motifs into a new theme and, with typical unconcern for practicalities, directs that these few bars be played on a flute. This direction is followed on the new record and the effect is electrifying. But the few notes in the first movement which Ives suggests be played on a viola are not so played.

The performance is by George Pappa-stavrou who, one gathers, is a recent graduate of Juilliard just starting on his career. He plays the Sonata magnificently, with full understanding of its formidable rhythmic and technical problems, fine appreciation of its big line, and splendid tone. He is going to have trouble if he insists upon spelling his last name with a dot in the middle of it; otherwise he would appear to be launched on a very remarkable career. The little flute solo is beautifully played by Bonnie Lichter, and the whole is superbly recorded. Ives makes much of overtones and undertones and all the secondary sound energies that the piano stirs up in its commotion; the old 78-rpm recording was incapable of dealing with these at all, but the new techniques capture them well, and that makes a considerable difference. In fact, the new recording makes me feel that I have really heard the *Concord* Sonata for the first time.

**IVES: Sonata for Piano, No. 2 ("Concord")**

George Pappa-stavrou, piano; Bonnie Lichter, flute.

• COMPOSERS RECORDINGS CRI 150. LP. \$5.95.

## CLASSICAL

### BACH: *Brandenburg Concertos* (complete)

New York Sinfonietta, Max Goberman, cond.

• OF • LIBRARY OF RECORDED MASTERPIECES. Three LP or SD. \$25.50.

Still another set of *Brandenburgs*? Yes, but this one offers some things not available in any other recording. Before we mention the unique aspects of this album, however, let us see how it compares with other versions now available. It compares very well, on the whole. The instrumentation is almost exactly that called for by Bach, and Goberman, as usual, has taken pains to secure expert performers. His tempos for the fast movements are generally somewhat more rapid than the customary ones, but they come off well, except perhaps in the finale of No. 1, which seems a bit hurried in spots, and in that of No. 3, which does not have the dancelike character that appears to be imminent in the music. The slow movements, on the other hand, at least in Nos. 2 and 4, while broader and more deliberate than in some other recordings, are not permitted to sag. There are many felicitous details. The first movement of No. 1 is clean and crisp. The trumpet in No. 2 is extremely well played by Melvin Broiles—only one of his high notes is off pitch. Franz Rupp, who plays the harpsichord in No. 5, builds up considerable tension in the course of his long cadenza. The difficult problem of balances in Nos. 1, 2, and 5 has been successfully solved almost throughout. Even the recorder in No. 2 can be heard most of the time, despite the penetrating, and often dominating, tone of the trumpet. All in all, one of the better complete *Brandenburgs*.

And now for the extras. The most important of these is a facsimile of the entire score in Bach's handwriting. Second is a recording of two sections from the Sinfonia in F (S. 1071), which is now thought to be an earlier version of the First *Brandenburg* Concerto. The excerpts given are the Adagio, in which there is no *violino piccolo* and the strange minor-second rubbings between bass and upper parts are smoothed out; and the second Trio of the Minuet, where instead of the later part for unison oboes there is an entirely different, but effective, one for unison violins. Finally, there is an earlier and shorter version of the elaborate harpsichord cadenza in the first movement of No. 5. N.B.

**BACH: Concerto for Two Pianos and Orchestra, in C, S. 1061—See Haydn: Sonata for Piano, No. 52, in E flat.**

**BACH, JOHANN CHRISTIAN: Symphony in G minor, Op. 6, No. 6; Quintet in F**

†Bach, Johann Christian: *Sextet in C*

†Bach, Wilhelm Friedemann: *Symphony in D minor*

Instrumentalists (in the chamber works); Chamber Orchestra of the Sarre, Karl Ristenpart, cond. (in the Symphonies).

• MUSIC GUILD 14. LP. \$4.12 to members; \$5.50 to nonmembers.  
• • MUSIC GUILD S 14. SD. \$4.87 to members; \$6.50 to nonmembers.

The symphony by Bach's son Johann Christian (who became the English Mr. John) is an eye opener. Most of his music on records has an Italianate songfulness, and is transparent in texture and uncomplicated in facture. Now comes this G minor Symphony, written about 1767, to knock on the head all our preconceived notions about its composer. Here is a work with a dramatic first movement, a tragic Andante, and a finale that sweeps tempestuously along—to end in a *pianissimo*. There is as much *Sturm und Drang* here as in any work by brother Philipp Emanuel. The Quintet, on the other hand, conforms to the usual generalizations about John Christian—this is beguiling entertainment music.

So is the Sextet by his older brother, Johann Christoph Friedrich, though it is somewhat less distinguished in materials and workmanship. Finally there is the two-movement symphony by the oldest brother, Wilhelm Friedemann. Its Adagio breathes a gentle melancholy, there are soft dissonances, and here and there an anticipation of Gluck. This is followed by a fugue that is at first vigorous and expressive but after a while begins to wander and become repetitious. All of these works, especially the symphonies, are ably performed, and the sound is satisfactory. N.B.

**BACH, JOHANN CHRISTOPH FRIEDRICH: Sextet in C—See Bach, Johann Christian: Symphony in G minor, Op. 6, No. 6.**

**BACH, WILHELM FRIEDEMANN: Symphony in D minor—See Bach, Johann Christian: Symphony in G minor, Op. 6, No. 6.**

**BARTOK: Miraculous Mandarin: Orchestral Suite**  
†Shostakovich: *Age of Gold, Op. 22: Orchestral Suite*

Philharmonia Orchestra, Robert Irving, cond.

• CAPITOL P 8576. LP. \$4.98.

• • CAPITOL SP 8576. SD. \$5.98.

The polka from Shostakovich's *Age of Gold* is one of his most popular pieces; unfortunately the rest of the score is by no means up to it in interest. Since *The Miraculous Mandarin* does not come off as a concert work, the total effect of this disc is fairly dreary, despite good recording and performance. One good point: the notes provide a synopsis of the action of *Age of Gold*, and it is beyond belief—all about Soviet heroes and a Negro from a capitalist country being cheated at an international sport festival. A.F.

**BEETHOVEN: Concerto for Piano and Orchestra, No. 1, in C, Op. 15; Sonata for Piano, No. 22, in F, Op. 54**

Sviatoslav Richter, piano; Boston Symphony Orchestra, Charles Munch, cond. (in the Concerto).

• RCA VICTOR LM 2544. LP. \$4.98.

• • RCA VICTOR LSC 2544. SD. \$5.98.

Richter's muscular Beethoven and his apparent refusal to acknowledge different



For *Fidelio*, in Munich: cast, conductor, and recording staff.

styles for the composer's early, middle, and late music can dull the listener's perception of what the pianist is actually doing.

It is obvious in this recording that the Sonata—a powerful, rocklike work in two movements which lies between the *Appassionata* and the *Waldstein*—has received an extraordinarily strong statement. Only after some comparison with other versions, however, does it become clear that Richter has given us the most potent account of this music since the Schnabel edition. That alone ought to be the making of the present album, but we have still the Concerto to deal with.

On first hearing this work, I was troubled by the sound and such aberrations as an opening C sharp in place of a C. I now have a copy of the tape edition and this stays on pitch. It also provides a superior quality of ensemble sonorities. Even the first impression of the Concerto, however, is that of an exceptional solo performance, but here too playing this recording against an alternate version serves to pinpoint misconceptions. For example, on the basis of the opening phrases one's natural assumption is that in the Largo movement the recent Fleisher set is much slower. Not so. Richter takes a faster tempo in the opening phrases (thereby giving them somewhat greater continuity), but the stop watch shows his performance to be only about forty-five seconds faster than Fleisher's over-all. Similarly in the finale, when Richter first seems to be playing in more of a "middle period" manner than the young American, it turns out that Richter's is actually the lighter and more playful account, the one more in keeping with the *Allegro scherzando* marking of the composer. Further, although Fleisher has a closer microphone pickup than Richter was given, it is the Russian pianist whose personality registers more forcefully in the end. It is a warm, outgoing personality that puts the necessary *brío* in the opening movement and makes one ask whether the Beethoven of Op. 15 should be less of a titan than that of Op. 73. (Young titans are titans too. They do not walk on tiptoe.)

In short, the more I hear of this record, the more I am convinced that it is one we are fortunate to possess. R.C.M.

### BEETHOVEN: *Fidelio*

Sena Jurinac (s), Leonore; Maria Stader (s), Marzelline; Jan Peerce (t), Florestan; Murray Dickie (t), Jacquino; Gustav Neidlinger (b), Pizarro; Deszo Ernster (bs), Rocco; Frederick Guthrie (bs), Don Fernando. Chorus and Orchestra of the Bavarian State Opera, Hans Knappertsbusch, cond.

• WESTMINSTER XWN 3318. Three LP. \$14.94.

• • WESTMINSTER WST 318. Three SD. \$17.94.

Whether one will or won't take to Westminster's new *Fidelio*, which marks that company's welcome return to operatic recording, depends almost entirely on how one reacts to the concept of the work so compellingly projected by Hans Knappertsbusch. I should like to emphasize that my own first feelings are by no means definite—it will take a number of playings, I am sure, to "set" my attitude towards this rendition—and I will try to content myself here with a description of the effect, together with the most tentative of conclusions.

The most obvious thing to say about the Knappertsbusch reading is that it is slow. Moreover, the faster sections are slow in proportion to the rest of the work: that is, Knappertsbusch has, it would seem, deliberately put a rein on things just where we expect them to pick up. Thus, though Florestan's aria "*In des Lebens Frühlingstagen*" is taken only slightly more broadly than is the custom, the duet "*O namenlose Freude*" is sung so much more slowly than usual that the proportions we have taken for granted are seriously altered. Of course, when we speak of "custom" we are guilty of sloppy terminology. One of the nice things about *Fidelio* is that it attracts the attention of the greatest conductors; among those who have already recorded the work are Toscanini, Furtwängler, Böhm, and Fricsay, with Klemperer in the offing—an impressive line-up of maestros, each of them having definite and individual things to say about the score. But none has proportioned the work in the Knappertsbusch fashion, as if to say, "Now I'm laying it all out for you—and when the big moments come,

you're going to calm down and listen to the notes." And so "*O namenlose Freude*," instead of being the usual desperate scramble for tenor and soprano, is the most painstakingly articulated number in the opera. The performance's high point—which in many readings tends to occur with Florestan's melodramatic salvation and the arrival of Fernando, or even with the *Leonore No. 3*—is saved for the finale, which is as broad and grand as one will ever hear it. It takes time for this sort of approach to sink in, and many listeners may not have the patience to sit through such a deliberately paced performance very often.

The soloists work beautifully with the conductor. Sena Jurinac, who was the Marzelline of the old Furtwängler set, is a persuasive, womanly Leonore. She is not a dramatic soprano of the Flagstad or Nilsson type, and wisely chooses to convey the heroine's courage and faith with musical and vocal directness. Her phrasing is almost ideal, the quality of her voice firm and round. She hasn't quite the resources for the most imperious "*Abscheulicher*"—but neither do her competitors on the other complete recordings. Maria Stader is a splendid Marzelline, bright but full and never coy; she is given plenty of room to breathe in her aria, and makes a lovely thing of it.

Jan Peerce turns in his best recorded work in many a year with a surprisingly fine Florestan. I prefer Torsten Ralf's really superb work on the Böhm recording; but Peerce brings vocal freshness and interpretative dignity to the role, and surmounts the viciously difficult solo scene with admirable poise. Neidlinger seems to me a bit wrong—certainly we want a Pizarro whose voice moves, rather than one who produces only wooden, hollow sound above the staff, especially in view of the fact that Knappertsbusch's pacing demands that the singer sustain tones longer than usual. I suppose the idea is that the "*Ha, welch' ein Augenblick*" will crush us with sheer weight, but instead it stands almost still. Neidlinger sounds dark and ringing below middle C, however, and contributes a convincing characterization. The veteran basso Deszo Ernster hasn't the personality to make Rocco's "Gold Song" bearable (a tough trick in any case), but he has precisely the right vocal quality for the role—black and just slightly ill-defined—and sings with an enviable ease. It is a blessed relief to hear again a true bass who is not ashamed to use his instrument to some lyric purpose. Murray Dickie is a top-drawer Jacquino, but the Don Fernando of Frederick Guthrie is sadly weak, however laudable from a stylistic standpoint. The chorus is really excellent (including two good soloists for the Prisoners' Chorus), and the orchestra, though it may not be a great one, responds to Knappertsbusch with some splendidly warm, pliant playing.

The stereo staging is thorough and most convincing—nothing splashy, but no opportunity missed, either. The dialogue has apparently been assigned to a separate cast of actors; this works well enough except in the case of Peerce, whose timbre is so individual as to be instantly recognizable. There is nothing to complain of in the sound, which is clear and deep. All told, an imposing presentation of this conductor's unique concept of a troublesome masterpiece; the set is thoroughly competitive with the other available versions. C.L.O.

Continued on page 66

METRO-GOLDWYN-MAYER ANNOUNCES U. S. DISTRIBUTION FOR



# Deutsche Grammophon Gesellschaft

Since 1896, DEUTSCHE GRAMMOPHON GESELLSCHAFT has created and maintained the highest possible standards of recorded performance. These are exemplified not only by the peak level of artistic creativity and rich, vibrant sound but also by contributing elements such as:

- Flawless, quiet record surfaces
- New inner envelopes with factory-sealed plastic linings
- Double factory-sealing, inside and out
- Newly-designed, hard and sturdy outer jackets

These albums are further distinguished by handsome artwork and elegant typography. New releases of DEUTSCHE GRAMMOPHON, produced in Europe, will be distributed exclusively by MGM RECORDS.

Specialists in many fields have contributed their skills to make each DEUTSCHE GRAMMOPHON GESELLSCHAFT album worthy of a permanent, distinctive place in your library. Naturally, these splendid imported recordings, now available at your record shop, cost a little more. They are well worth the difference.

*premier release*



Recording Premiere of the Complete Opera, scored for Voices and 97 Percussion Instruments. Supervised by the Composer (and in Sensational Stereo Sound)

Carl Orff: ANTIGONAE — Inge Borkh, Ernst Haefliger, Kim Borg, others. Members of the Bavarian Radio Symphony Orchestra cond. Ferdinand Leitner — Sung in German. Three 12" records, boxed, with illustrated libretto. LPM 18 717/19 Stereo: SLPM 138 717/19

*The Fabulous Richter's Newest!*  
SVIATOSLAV RICHTER: Chopin Ballade No. 3 in A flat; Haydn Sonata No. 44 in g; Prokofiev Sonata No. 8 in B flat; Debussy selections from Preludes, Book I. LPM 18 766 Stereo: SLPM 138 766

*Exciting New Directions in Modern German Music*  
WERNER EGK: Quattro Canzoni (Irmgard Seefried, Bavarian State Radio Orchestra cond. by the composer).

GOTTFRIED VON EINEM: Piano Concerto, Op. 20 (Gerty Herzog & Berlin Symphony Orchestra cond. Ferenc Fricsay).

BORIS BLACHER: 13 Ways Of Looking At A Blackbird (Ernst Haefliger & the Droic Quartet). LPM 18 759 Stereo: SLPM 138 759



A Brilliant New "Bohème"

Puccini: LA BOHEME — Renata Scottò, Gianni Poggi, Tito Gobbi, others. Chorus & Orchestra of the Florence May Festival cond. Antonino Votto.—Sung in Italian. Two 12" records, boxed, with libretto.

LPM 18 764/5  
Stereo: SLPM 138 764/5

BRAHMS: Violin & Piano Sonata No. 2 in A; Scherzo from the F-A-E Sonata; FRANCK: Violin & Piano Sonata in A.—Wolfgang Schneiderhan, Violin; Carl Seemann, Piano. LPM 18 633 Stereo: SLPM 138 633

HAYDN: Symphony No. 94 in G, "Surprise"; Symphony No. 101 in D, "The Clock"—Berlin Philharmonic Orchestra cond. Karl Richter. LPM 18 782 Stereo: SLPM 138 782

MOZART: Piano Concerto No. 17 in G, K.453; Piano Concerto No. 21 in C, K.567—Geza Anda, Piano, and cond. the Camerata Academica Orch. LPM 18 783 Stereo: SLPM 138 783

MOZART: Symphony No. 29 in A, K.201; Symphony No. 41 in C, K.551, "Jupiter"—Vienna Symphony Orchestra cond. Ferenc Fricsay. LPM 18 709 Stereo: SLPM 138 709

DIRECT IMPORT • FACTORY SEALED

For further information, write: **MGM RECORDS** 550 Fifth Avenue, New York 36

(A Division of Metro-Goldwyn-Mayer, Inc.)

CIRCLE 31 ON READER-SERVICE CARD

## BEETHOVEN: *Overtures*

*Die Ruinen von Athens, Op. 113; Coriolan, Op. 62; Egmont, Op. 84; Fidelio, Op. 72; Leonore No. 3, Op. 72a.*

Bamberg Symphony, Berlin Philharmonic, and Hamburg State Philharmonic, Joseph Keilberth, cond.

- TELEFUNKEN TC 8049. LP. \$1.98.
- • TELEFUNKEN TCS 18049. SD. \$2.98.

When Keilberth has a first-class orchestra at his disposal he produces solid, straightforward Beethoven with the familiar merits of the German tradition. With a lesser band of instrumentalists, the results can be leaden, lethargic, or lackluster.

You will find such variation here, and with it variation in engineering technique. *Coriolan* and *Fidelio*—both Bamberg productions—pair the worst engineering and the weakest orchestra. They are not recommended. The best stereo is in the excerpts (which include the *Turkish March*) from *The Ruins of Athens*, products of a Hamburg session and vigorously attractive performances. The *Egmont* and *Leonore No. 3* come from Berlin. The perspective is that of the front-row balcony, with resonance replacing intimacy, but the performances are good and the excellence of the ensemble always apparent. R.C.M.

## BERLIOZ: *L'Enfance du Christ, Op. 25*

Elsie Morison, soprano; Peter Pears, tenor; Edgar Fleet, tenor; John Cameron, baritone; Joseph Rouleau, bass; John Frost, bass; St. Anthony Singers; Goldsborough Orchestra, Colin Davis, cond.

- OISEAU-LYRE OL 50201/02. Two LP. \$9.96.
- • OISEAU-LYRE SOL 60032/33. Two SD. \$11.96.

Hélène Bouvier, contralto; Jean Girardeau, tenor; Louis Noguera, baritone; Michel Roux and Henri Médus, basses; Raymond St. Paul Chorus; Orchestre de la Société des Concerts du Conservatoire de Paris, André Cluytens, cond.

- Vox VUX 2009. Two LP. \$5.95.

*L'Enfance du Christ*, Berlioz's musical description of Herod's dream, the murder of The Innocents, the flight into Egypt, and the arrival of the Holy Family at Saïs, is one of his most delicate and sensitive works. There are no gigantic forces here, no heaven-storming climaxes, no brass bands—just a simple Biblical tale simply told.

With the Oiseau-Lyre recording, the work makes its stereo debut, and we find soloists, chorus, and orchestra well spaced in the aural spectrum. That, however, is about the extent of this album's merits. Briefly, there seems to have been an unwise choice of performers, most of whom have acquitted themselves admirably elsewhere. Davis' approach is often coarse and insensitive, often overdramatic, often just plain matter-of-fact. All those under his direction seem to reflect this attitude, resulting in a performance that has plenty of sincerity but little refinement either of style or tone quality. Vox's version is an inexpensive reissue of its earlier and still highly commendable recording. It is a thoroughly French performance, tender and sensitive, and is interpretatively superior to the prosaic Davis reading. The quality of the solo voices

is far better than average, as is that of the reproduction, which remains clear and unforced.

Actually, it will probably be many years before anyone approximates the exquisite interpretation by Charles Munch, available in RCA Victor mono for several years. This is one of the instances where it is more rewarding to forego the wonders of stereo for the glory of a great performance. Though nothing can surpass Munch, the Cluytens is a good buy for the budget-minded. P.A.

## BERNSTEIN: *Jeremiah Symphony* †Harris: *Symphony No. 3*

Jennie Tourel, mezzo (in the Bernstein); New York Philharmonic, Leonard Bernstein, cond.

- COLUMBIA ML 5703. LP. \$4.98.
- • COLUMBIA MS 6303. SD. \$5.98.

To revive a symphony after two hundred years is easy; to revive one after twenty years may be embarrassing. This proves to be true of Bernstein's *Jeremiah*, especially in its labored and obvious scherzo. But the first movement still has some prophetic grandeur and the Biblical lament of the finale still has power, especially when it is sung as beautifully as it is here, by Jennie Tourel, in Hebrew.

The Harris work on the other side is not a revival; it has never been out of the repertoire since Koussevitzky introduced it in 1939. As I observed in these columns not long ago, the premiere of Harris' Third was the break-through for all American symphonies; at one stroke the American symphony won the respect of the world audience and one no longer had to fight to get it a hearing. This broad, tawny, grandiose, energetic, tightly built work sounds just as powerful, original, and challenging today as it did then, although Bernstein's excited interpretation lacks the classic poise which Koussevitzky brought to it. But the Koussevitzky is no longer available. Bernstein is warm and communicative as always, and his wonderful recording captures some things in the score which the old electronic ear couldn't hear. A.F.

## BLOCH: *Quartet for Strings, No. 5* —See Hindemith: *Quartet for Strings, No. 3, Op. 22.*

## BOITO: *Mefistofele*

Rosetta Noli (s), Margherita; Simone dall'Argine (s), Elena; Ebe Ticozzi (c), Martha and Pantalìs; Gianni Poggi (t), Faust; Gino del Signore (t), Wagner and Nereo; Giulio Neri (bs), Mefistofele. Chorus and Orchestra of the Opera di Milano, Franco Capuana, cond.

- URANIA UR 230. Three LP. \$14.94.
- • URANIA US 5230. Three SD. \$17.94.

Urania's re-release of this recording is well worth noting, for the performance is a solid one, preferable at some points to London's more recent presentation. To be specific: the Faust of Gianni Poggi (in far fresher, more attractive form than he has been for the past seven or eight years) is assuredly an improvement over Del Monaco's muscle-bound rendition, and Simone dall'Argine is a more secure, dramatic Elena than Floriana Cavalli. Rosetta Noli is fragile and sensitive as Margherita, and some

listeners (though I am not among them) might prefer her work to Tebaldi's lush, more mature-sounding portrayal. For that matter, the basic timbre of Giulio Neri's tough bass voice is much better suited to the title role than Siepi's silky *basso cantante*; too much of Neri's singing, though, is stiff and effortful. Capuana's conducting is quite alive, and the orchestra and chorus do well.

London, of course, has a tremendous edge in the sound, and anyone seriously considering the Urania performance should be cautioned away from the wretched "duophonic" edition (here boldly labeled "stereo"), which is as badly processed a recording as one could reasonably expect to encounter. The mono version is adequate for its age (roughly eight or nine years), which means that it's somewhat muddy and distant, but listenable. C.L.O.

## BRAHMS: *Concerto for Piano and Orchestra, No. 1, in D minor, Op. 15*

Claudio Arrau, piano; Philharmonia Orchestra, Carlo Maria Giulini, cond.

- ANGEL 35892. LP. \$4.98.
- • ANGEL S 35892. SD. \$5.98.

Rudolf Serkin, piano; Philadelphia Orchestra, Eugene Ormandy, cond.

- COLUMBIA ML 5704. LP. \$4.98.
- • COLUMBIA MS 6304. SD. \$5.98.

Although we are not at a loss for excellent stereo recordings of this demanding music—Epic's fine entry by Leon Fleisher with George Szell and the Cleveland Orchestra, for example, and, at a lower voltage, London's discerning and well-reproduced Katchen-Montoux disc—both the Angel and Columbia re-recordings by Brahms authorities offer triumphant accounts of the score.

Serkin descends on the music like an eagle. There is something majestic, even imperial, about his approach here. Not a note nor an accent is misplaced, and his tone, while not particularly colorful, is magnificently solid. As in his recent remake of the Brahms Second Concerto, the pianist's tempos are slower than they used to be; but unlike that performance, in this one the leonine Serkin intensity is ever present. It turns on the writing like a steady flame, uniting phrase with phrase, paragraph with paragraph, movement with movement. Ormandy sees the work from the same point of view as Serkin, perhaps too much so: whereas Szell, on Serkin's earlier recording of this work, offset the pianist's austerity by bringing warmth and tonal hue to the orchestral part, Ormandy's clean-cut, rather objective statement tends to give a monochromatic cast to the performance. Otherwise, the conductor's finely disciplined, dramatic support is all that can be desired.

Sunlight rather than menacing skies is characteristic of the Arrau-Giulini performance. Arrau favors very deliberate tempos, although they are really not so much slower than Serkin's as they might seem at first. The reason for this illusion is due to the fact that Arrau's interpretation is basically loose, relaxed, and romantic, while Serkin's approach is sharp, classical, and organizational. In the third movement, for example, the former changes gear for the second subject, while Serkin keeps the tempo going rigidly throughout. Arrau's approach is

*Continued on page 68*

*“This is the finest Brahms Second in stereo... The Best Classical Orchestral Album of 1961”* THE NEW YORK HERALD TRIBUNE



# Command 35/MM CLASSICS

A MAJOR BREAKTHROUGH IN RECORDED CLASSICAL MUSIC

Just a few short months ago, COMMAND Records (acknowledged leader in popular stereo albums) entered the highly selective field of classical music with a series of five releases . . . all master-recorded on 35 millimeter magnetic film. The impact this initial set of classical albums created among music critics and connoisseurs alike, was nothing short of sensational. Even though released late in the year, William Steinberg's delicate reading of Brahms' Symphony No. 2 was selected as the No. 1 classical orchestral album of 1961, in the New York Herald Tribune's annual record review.

In this newspaper's same selection of the year's best records, another of COMMAND'S CLASSICS, Pierre Dervaux's version of Ravel's Daphnis et Chloe, Suite No. 2, was also singled out for top classical honors.

These new COMMAND CLASSICS (including the Rachmaninoff Symphony No. 2; the Mussorgsky-Ravel Pictures at an Exhibition, and the two capriccios; Tchaikovsky's Capriccio Italien and Rimsky-Korsakov's Capriccio Espagnol)

revealed to the critics the tremendous potential of the new 35 mm recording technique.

In fact, COMMAND'S total success in faithfully reproducing the sound of large orchestras through the use of 35 mm magnetic film, was neatly epitomized in this statement by The American Record Guide, an independent journal of opinion: "These first five classical issues from COMMAND constitute a technological breakthrough of major proportions. They are the product of multiple microphone pickup of sound recorded on 35 mm magnetic film traveling at 18 inches per second. The results are, beyond question, the most life-like sound any of us has ever heard . . . Enoch Light, producer of the records, deserves our thanks." And, American Record Guide was sufficiently impressed with the COMMAND 35 mm recording technique to terminate their review with the observation that "to all record companies, the message by now should be loud and clear enough: the word is convert —to 35 mm film."

## NEW 35/MM CLASSICS FROM COMMAND



**BRAHMS** Symphony No. 1 in C minor, Op. 68. **WILLIAM STEINBERG** and the Pittsburgh Symphony Orchestra.



**DEBUSSY** La Mer/Fetes/Ibéria — **PIERRE Dervaux**. L'Orchestre des Concerts Colonne.



**BERLIOZ** Symphony Fantastique, Op. 14—**ANDRE VANDERNOOT**/l'Orchestre National.



**LEONID HAMBRO & JASCHA ZAYDE**, world renowned duo-pianists, now play **MOZART/MENDELSSOHN/SCHUBERT**.

The four albums pictured on the left represent COMMAND'S latest contribution to the crusade for true sonic realism in the recording of classical repertoire. Again featuring some of the world's finest classical musicians, these albums reflect the latest advance in the realization of greater range in dynamics, frequency and dimension, now made possible through the use of 35 mm magnetic film as a recording medium.

If your classical library doesn't yet contain the COMMAND CLASSICS . . . it's lacking the most exciting advance in recording history since the advent of high fidelity. And you're missing an adventure in musical listening that will positively exceed your fondest expectations. COMMAND CLASSICS are available in stereo, monaural and 4 track tape versions. See your COMMAND record dealer now!

Send for free descriptive brochure of all COMMAND releases

**Command RECORDS**

Manufactured by Grand Award Record Co., Inc.  
1501 BROADWAY, New York 36, N. Y.

CIRCLE 28 ON READER-SERVICE CARD

by far the more difficult to bring off, and in the past I have heard him fail utterly to do so. Here, however, he is entirely convincing, and I feel that he owes a great deal to Giulini whose own authority helps greatly to consolidate the pianist's reading. As a team, the two work together magnificently, with the fervent, expressive orchestral playing crowning Arrau's wonderfully spacious phrasing. Like Serkin, this pianist has a notable tonal weight on this disc, and if Serkin is more the philosopher, Arrau excels him as an introspective poet.

I have yet to hear a recorded version of this Concerto which does justice to the string-brass dialogue around the solo piano in the first movement or the final brass fanfare at the very end of the finale, but, as recordings go, both of the new discs are splendid. Columbia has captured Serkin's piano with full-blooded sonority, although the engineers seem to have cut back the volume in the proclamative double-octave cascade leading into the first-movement development, and that passage, as a result, sounds a mite small-scaled. I could also wish for a more prominent balance of the brass section (possibly Ormandy's responsibility here rather than that of the recording technicians). Angel's sound is warm and glowing, with more brass proportionately, but with a smaller, more intimate orchestral pickup in general. There is also less separation and clarity than Columbia's edition provides.

In summation, this is a true battle of titans. Serkin's interpretation has an inevitable quality, which neither Arrau nor

Fleisher quite matches. But although the latter's bracing, kinetic performance might sound a trifle unpolished alongside Serkin's supremely accomplished pianism, it has, to my mind, more spontaneity and enthusiasm, not to say more poetic infusion. For these very personal reasons I continue to prefer it, if only very slightly. Arrau's reading will also have many adherents, and deservedly so. H.G.

**BRAHMS: *Symphony No. 1, in C minor, Op. 68***

Pittsburgh Symphony, William Steinberg, cond.

- COMMAND CC 3311011. LP. \$4.98.
- • COMMAND CC 11011. SD. \$5.98.

Steinberg's Brahms Second for Command created quite a stir among the *cognoscenti* when it appeared last autumn, and this recording is likely to do the same. The sound, if anything, is even more spectacular, which means that there is now little real competition among the two-channel versions of this popular score. As before, the largest sound masses are handled without a trace of hedging, and the quality of the reproduction is splendidly clear and clean. One feels the presence of the orchestra without an electronic barrier, and the ear is able to pick out details which even in most stereo versions are covered by a sort of wash of extraneous tone.

Steinberg's performance, particularly in the two outer movements, begins by giving the impression of a fairly strict ap-

proach. As it goes along, it loosens up and, as the coda draws near, tempo and accent have become considerably more flexible than might have been anticipated. At least I assume Steinberg loosened up as he went along; it is also possible that the variations are due to combining material from more than one recording session. In any case, the conductor's tendency to liberate himself from a rigid metrical pattern does no great harm, and, indeed, many will probably feel that the climactic sections of the work benefit from Steinberg's eagerness to make the most of their possibilities.

The slow movement and scherzo are reserved without being restrained. Both have been recorded with greater expression, but Steinberg does them justice and—more important—avoids all the pitfalls which lie in these seemingly innocent pages. The solo violin of the *Andante sostenuto* can easily get out of hand, and the transitions of the third movement must be handled with care if, in fact, they are to be *grazioso*.

This is not going to be every man's Brahms First. As total performances the Toscanini and Klemperer surpass it in their unity of approach and consistent integration of the material within a single point of view. Achievements of this level are rare, however, and neither of the examples cited is on a par with the Steinberg in matters of engineering. If your primary interest is sound, this is unquestionably the version to have. And if you will settle for a sensitive, authoritative, and effective performance, lying somewhat short of the finest we have ever known, Steinberg delivers it in this recording. R.C.M.

**CHOPIN: *Les Sylphides* (trans. Roy Douglas)**

†Delibes: *Coppélia: Ballet Suite*

Berlin Philharmonic Orchestra, Herbert von Karajan, cond.

- DEUTSCHE GRAMMOPHON LPM 19257. LP. \$5.98.
- • DEUTSCHE GRAMMOPHON SLPM 136257. SD. \$6.98.

Von Karajan brings a certain style and distinction to this oft-recorded ballet music. Dancers may not feel altogether at home with the conductor's tempos—the opening of the Czardas in *Coppélia* is inordinately slow—but his interpretations make good listening, and he certainly gives stature to two scores that are so often tossed off casually by recording conductors. The sound is good in mono, superior in stereo. P.A.

**CORELLI: *Concerto grosso in G minor, Op. 6, No. 8 ("Christmas")***  
—See Tartini: *Concerto for Cello and Orchestra, in D.*

**DEBUSSY: *Images pour orchestre***  
†Stravinsky: *Symphonies for Wind Instruments*

†Ravel: *Pavane pour une infante défunte*

Orchestre de la Suisse Romande, Ernest Ansermet, cond.

- LONDON CM 9293. LP. \$4.98.
- • LONDON CS 6225. SD. \$5.98.

Nice in detail and nice in recording, but, as is so often the case with Ansermet, rather listless in spirit. A.F.

*Continued on page 70*

**NEXT MONTH IN**

**high fidelity**

**The Czech Philharmonic**

Some of the world's finest orchestral playing can be heard in the ancient city of Prague.

by Paul Moor

**Memories of Fritz Kreisler**

by Joseph Szigeti

**The Kreisler Legacy on Records**

by Harris Goldsmith

**AND**

**Spotlight on FM**

Programming: An Incredible Diversity

by Robert Silverberg

Stereo Multiplex: A Progress Report

by Norman Eisenberg

Antennas for FM

by Charles Tepfer



“When the cannonade was at its height, a Confederate band of music began to play polkas and waltzes which sounded very curious, accompanied by the hissing and bursting of the shells.”

COLONEL ARTHUR J. L. FREMANTLE, British military diarist with Lee at the time of the Battle of Gettysburg



# THE CIVIL WAR

## ★ ITS MUSIC AND ITS SOUNDS ★

THIS UNIQUE ALBUM tells the story of the Civil War through its music and the men who made it—bandsmen, buglers, fifers and drummers. The Union and Confederate songs recorded here are taken from actual Civil War band books and played on authentic Civil War instruments. Included are such favorites as Hail to the Chief, Listen to the Mockingbird, Dixie and Bonnie Blue Flag; Camp, Garrison and Field Calls for Fife and Drum; and Cavalry Bugle signals.

For this deluxe LIVING PRESENCE SOUND SERIES presentation, Mercury has combined over 1500 shots from authentic Civil War weapons in 93 separate battle sound tracks to re-create the Battle of Gettysburg's awesome sounds of conflict. Martin Gabel narrates this spectacular dramatic sequence.

## FREDERICK FENNEL EASTMAN WIND ENSEMBLE

THERE HAS NEVER BEEN A RECORD ALBUM LIKE THIS ONE—IT IS A LASTING AND INSPIRING RECORDED

LPS 2-901 DOCUMENT FOR THE ENTIRE FAMILY. LPS 2-501

**LIVING PRESENCE SOUND SERIES 35 M**

**AN ORIGINAL 35MM MAGNETIC FILM RECORDING**

CIRCLE 61 ON READER-SERVICE CARD

OTHER SPECTACULAR SOUND PRESENTATIONS IN MERCURY'S SERIES OF BATTLE-MUSIC RECORDINGS:

1812 OVERTURE (with cannon and bells) by Tchaikovsky. Minneapolis Symphony, Dorati. SR90054/MG50054

WELLINGTON'S VICTORY (with cannon and muskets) by Beethoven. London Symphony, Dorati. LPS9000/LPS5000

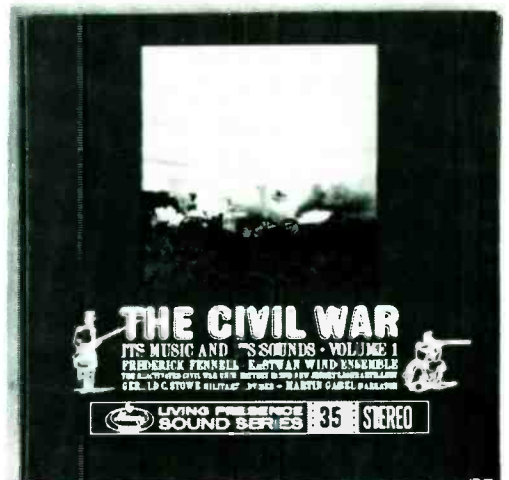

## DEBUSSY: *Songs*

*Beau soir; Mandoline; Les Cloches; Green; Chevaux de bois; Le Jet d'eau; La Mer; Le son du cor s'afflige vers le bois; L'échelonnement des haies; De soir; Le temps a laissé son manteau; Pour ce que plaisance est morte. Fêtes galantes I: En sourdine; Fautoches; Clair de lune. Fêtes galantes II: Les Ingénus; Le Faune; Colloque sentimental. Le Promenoir des deux amants: Auprès de cette grotte sombre; Crois mon conseil, chère Climène; Je tremble en voyant ton visage.*

Gerard Souzay, baritone; Dalton Baldwin, piano.  
• DEUTSCHE GRAMMOPHON LPM 18758. LP. \$5.98.  
• • DEUTSCHE GRAMMOPHON SLPM 138758. SD. \$6.98.

This release offers a fine cross section of the composer's song writing, the second side (the two d'Orléans songs, both sets of *Fêtes galantes*, and *Le Promenoir des deux amants*) being particularly rich from a musical standpoint.

And when I say that Souzay's renditions do not much satisfy me, it may be that I am simply confessing a resistance to impressionistic songs. The singer is creating just the effect called for in most instances—now you see it, now you don't. Just as we often find ourselves asking of these songs, "How did that phrase go again?" so we frequently wonder of the singing, "Is there a tone there, or isn't there?" Still, I am not *conscious* of any dislike of these settings, and I cannot help feeling that if only the singer would forego a few of his flights into wispy mezza-voce, the effect would be no less Debussyian, and perhaps a bit more musical. His constant resort to this virtual non-tone forces one to suspect that he may be unable to hit the middle ground between no volume and full volume; the suspicion is strengthened by the limited resources of color and the peculiar formation of his *forte* high tones.

Yet Souzay's familiar sensitivity to text (more important, even, in Debussy than in other French composers), his sure concepts of phrasing, and the flexibility of his pleasant baritone place him in the front rank of interpreters of these *mélodies*, and records devoted to Debussy's songs are not released every month. Baldwin's collaborations are exemplary, and the sound clear as a bell. However, DGG still refuses to supply English translations. C.L.O.

DELIBES: *Coppélia: Ballet Suite*—  
See Chopin: *Les Sylphides*.

DVORAK: *Concerto for Violin and Orchestra, in A minor, Op. 53; Romance for Violin and Orchestra, in F minor, Op. 11*

Josef Suk, violin; Czech Philharmonic Orchestra. Karel Ancerl, cond.  
• ARTIA ALP 193. LP. \$4.98.  
• • ARTIA ALP S 193. SD. \$5.98.

The Dvořák Violin Concerto has received some notable interpretations on records, outstanding among which have been those by Johanna Martzy and Nathan Milstein. Now their leadership is challenged by the immensely gifted young Czech violinist Josef Suk, grandson of the noted Czech composer of the same name and great-grandson of Dvořák him-

self. It is not surprising, then, that he should be stylistically attuned to this music. His performance of the Concerto and the Romance, the latter transcribed by Dvořák from a discarded string quartet, is incisive, admirably proportioned, beautifully expressive, and rich in firm, glowing tone. More than that one cannot ask. Ancerl's orchestral accompaniments are completely *en rapport* with the soloist, while the fairly high level stereo sound is true, spacious, and rather resonant. P.A.

## FOSS: *Time Cycle*

Adele Addison, soprano; Improvisation Chamber Ensemble; Columbia Symphony Orchestra, Leonard Bernstein, cond.  
• COLUMBIA ML 5680. LP. \$4.98.  
• • COLUMBIA MS 6280. SD. \$5.98.

The Ford Foundation has made grants to a number of distinguished American singers and instrumentalists so that they, in turn, may commission new works to add to their repertoires. This is the first of such works to be recorded, and it provides singularly rich and lively entertainment.

*Time Cycle* is, in essence, a cycle of four songs for soprano and orchestra on texts by W. H. Auden, A. E. Housman, Franz Kafka, and Friedrich Nietzsche, the first two sung in English, the last two in German. The songs are largely atonal, employing various serial devices and exploiting the wide leaps and jagged rhythms in the vocal line characteristic of serial composition. In the last song, however, tonal and atonal are unified in a most extraordinary fashion: there are three simultaneous levels of sound, one diatonic and tonal, one chromatic and atonal, and one atonal in terms of a complex serialism derived from the text in a manner I cannot attempt to describe here. The whole thing comes off; you can really *hear* those three levels of sound and the difference between them.

Between the movements of the cycle, the composer and his Improvisation Chamber Ensemble (piano, clarinet, cello, percussion) improvise a series of interludes, all of them grandly aloof from the songs in substance and spirit, although they too are atonal. These are marvelously brilliant and spirited affairs, but they are matched by the spirit and drama of the songs. The whole thing is incredibly ingenious, exhilarating, and thought-provoking. Lukas Foss was long counted among the more conservative of American composers; turning to atonality and serialism seems to have released some extra energy and creativeness inside him, and he is now doing the best work of his career. Performance and recording leave nothing to be desired. A.F.

FRANCK: *Grande pièce symphonique, Op. 17; Choral No. 2, in B minor; Prélude, fugue, et variation. Op. 18; Prière, Op. 20; Pastorale; Pièce héroïque, in B minor*

Jeanne Demessieux, organ.  
• LONDON CM 9302/03. Two LP. \$4.98 each.  
• • LONDON CS 6220/21. Two SD. \$5.98 each.

Several years ago, Jeanne Demessieux gave exceptionally perceptive accounts of the three Franck *Chorals* in a London monophonic recording. Consequently, my expectations for the present discs

(CM 9302 or CS 6220 containing the *Grand pièce symphonique* and Choral No. 2, CM 9303 or CS 6221 the other works listed above) ran high. Unfortunately, they are quite disappointing. Here the organist plays everything in a perfunctory fashion, often with tempos that are too fast and interpretations that barely scratch the surface. London's sound encompasses the complete range of the organ with excellent fidelity and gives it realistic spacing, with different stops emanating from the two speakers without being unnaturally isolated. But the overly spacious acoustics of the Church of the Madeleine, with a reverberate overhang of about six seconds, cause some unfortunate muddying of many passages. P.A.

GERSHWIN: *Concerto for Piano and Orchestra, in F; Variations on "I Got Rhythm"; Cuban Overture*

Earl Wild, piano (in the Concerto and Variations); Boston Pops Orchestra, Arthur Fiedler, cond.  
• RCA VICTOR LM 2586. LP. \$4.98.  
• • RCA VICTOR LSC 2586. SD. \$5.98.

George Gershwin achieved a remarkably effective union between jazz and symphonic music in his Concerto in F. The spontaneity and melodic invention combine with rhythmic verve to make this a truly irresistible modern American masterpiece. The *Variations on "I Got Rhythm,"* though less inventive and interesting, still are worth hearing now and then, while the spirited *Cuban Overture* is always refreshing. But the important work here is the Concerto, and it is treated importantly by Wild and Fiedler. There is commanding style, warm lyricism, and a proper amount of nervous energy in the pianist's interpretation, at once penetrating and brilliant. An old and respected hand at Gershwin, Fiedler provides ideal orchestral collaboration in the two solo works and gives a rousing account of the Overture. The sound could hardly be better. The ring of the piano tone is unusually true, and it is surrounded by the spacious deployment of the orchestral instruments, which emerge with bright fidelity. This is definitely one of the outstanding Gershwin discs of recent years. P.A.

GLINKA: *Songs: Traveler's Song; The Scythe; The Wind Is Blowing at the Gate; A Prayer; Oh, Nightingale, Be Silent; What Is the Matter, Pretty Girl; The Wind Howls*  
†Tchaikovsky: *Romeo and Juliet: Balcony Scene Duet*

Ivan Kozlovsky, tenor (in *A Prayer*); Tatiana Lavrova, soprano, and Sergei Lemeshev, tenor (in the Tchaikovsky); other soloists; Radio Ensemble of Songs; Chorus and Orchestra of the Bolshoi Theatre; Moscow Philharmonic Orchestra; Samuel Samosud, Vassili Tselikovskiy, Serafina Popova, conds.  
• MONITOR MC 2055. LP. \$4.98.

All this music, with the exception of the Tchaikovsky, has a folksy, semipopular flavor about it. The Glinka songs are atmospheric, never profound, but listenable and frequently touching. However, *A Prayer*, which is a setting for tenor and chorus of a poem by Lermontov and

*Continued on page 72*





1



2

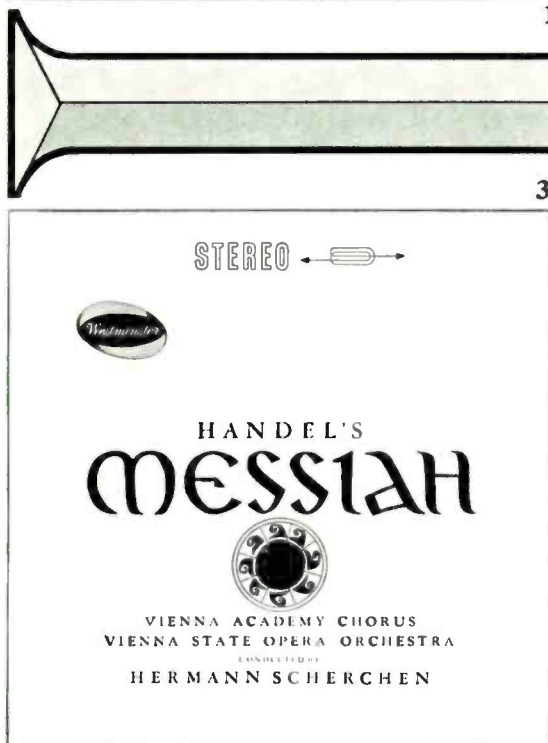

3

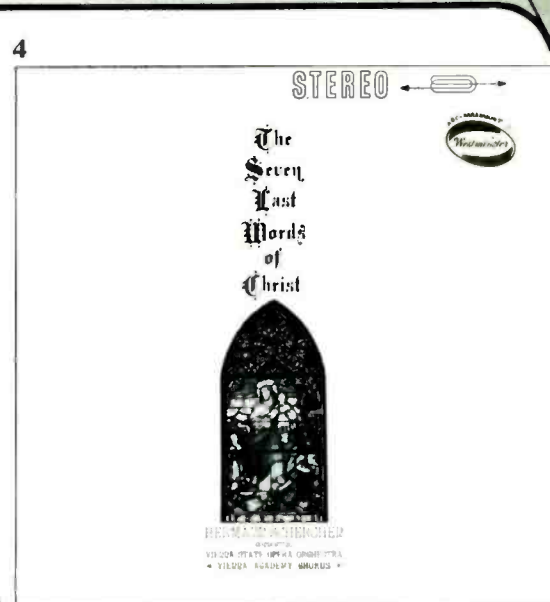

4

## WESTMINSTER PRESENTS AN EASTER OFFERING FOR THE SELECTIVE LISTENER

Your Westminster dealer is featuring a number of superb albums this month especially appropriate for the spirit of the Easter Season. Highlighting the list are three masterpieces of sacred music: Handel's *Messiah*, the Bach *St. John Passion* and Haydn's *Seven Last Words of Christ*, in definitive interpretations by Hermann Scherchen. You will also

1) **BACH:** *St. John Passion*. Phyllis Curtin. Soloists. Vienna State Opera Orchestra and Vienna Academy Chorus conducted by Hermann Scherchen. (3-record set) WST-319 (Stereo), \$17.94; XWN-3319 (Monaural), \$14.94.

2) **BEETHOVEN:** *Fidelio*. Sena Jurinac. Jan Peerce. Soloists. Bavarian State Opera Orchestra and Chorus conducted by Hans Knappertsbusch. (3-record set) WST-318, \$17.94; (Stereo), XWN-3318 (Monaural), \$14.94.

**BACH:** *Mass in B Minor*. Vienna State Opera Orchestra and Vienna Academy Chorus conducted by Hermann Scherchen. (3-record set) WST-304 (Stereo), \$17.98; XWN-3305 (Monaural), \$14.98.

**BACH:** *St. Matthew Passion*. Vienna State Opera Orchestra. Hermann Scherchen, conducting. XWN-4402 (Mono). Fritz Werner, conducting, WST-402 (Stereo).

**BERLIOZ:** *Requiem*. Soloists, orchestra and chorus conducted by Hermann Scherchen. (2-record set) WST-201 (Stereo), \$11.98; XWN-2227 (Monaural), \$9.98.

want to hear — and own — Westminster's new recording of *Fidelio* with its message of hope and deliveration, in a widely-acclaimed new recording featuring Sena Jurinac and Jan Peerce, with Hans Knappertsbusch conducting. This is music for the Selective Listener who demands — and gets — the very best in recorded music on Westminster.

3) **HANDEL:** *The Messiah* (original Dublin version). Vienna State Opera Orchestra and Vienna Academy Chorus conducted by Hermann Scherchen. (4-record set) WST-306 (Stereo), \$19.98; (3-record set) XWN-3306 (Monaural), \$16.98.

4) **HAYDN:** *Seven Last Words of Christ*. Soloists, Vienna State Opera Orchestra and Vienna Academy Chorus conducted by Hermann Scherchen. WST-17006 (Stereo), XWN-19006 (Monaural).

### FROM THE WESTMINSTER CATALOG OF MUSIC FOR THE SELECTIVE LISTENER:

**CAMPRA:** *Requiem*. Soloists, orchestra and chorus conducted by Louis Frémaux. WST-17007 (Stereo), XWN-19007 (Monaural).

**HANDEL:** *Highlights from the Messiah* — Scherchen. WST-14095 (Stereo), XWN-18676 (Monaural).

**The Westminster Listener is the Selective Listener** Free . . . for the Westminster Listener . . . complete new catalog. Write Dept. HF-6, Westminster Recording Co., Inc. A subsidiary of ABC-Paramount Records, Inc. 1501 Broadway, New York 36, New York. Stereo: \$5.98 — Monaural: \$4.98.



CIRCLE 95 ON READER-SERVICE CARD

# LEARN

electronics theory this easy way.  
No previous technical knowledge required.

# BUILD

the finest professional quality TV Set  
on a practical "pay-as-you-wire" plan.

# SAVE

up to 1/2 on cost of equivalent  
educational course plus TV set.

Build the Transvision "Professional" TV Kit  
described below and get this complete course  
of study for \$7.95 (available only to  
Transvision Kit builders.)

Requires no previous technical knowledge.  
Prepared by experts in teaching novices  
about electronics.

**YOU LEARN:** About block diagrams... How to read and follow electronic circuits... How to use basic measuring instruments... Theory and operation of basic electronic circuits... How to service TV, Radio, and other types of electronic equipment.



Prices range  
from \$119 to \$199.

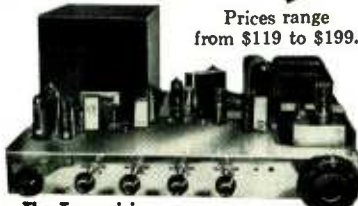

The Transvision

"Professional" TV Kit  
Choice of 19", 23", or 27"  
Picture Tube... Easy "Pay as  
You Wire" Terms... Only \$15  
for the Starting Package.



A few of the Professional Quality Features  
of Transvision TV Kits:

Choice of push-pull 10-watt audio or output to  
your Hi-Fi System... D.C. restoration... Ultra-  
linear sweep circuits... Standard Coil Model  
PKO Automatic Tuner... Super-sensitivity for  
fringe areas... Complete line of Accessories for  
Custom Installations.

U.S. Armed Services and over 4000 schools and  
colleges have selected Transvision Receivers for  
educational television.

**ASSEMBLY MANUAL—\$2.00**

See how easy it is to assemble the Transvision  
Kit. Cost of Manual refunded on purchase of Kit.

**TRANSVISION** New Rochelle, N.Y.  
NE 6-6000

**START NOW — MAIL THIS COUPON —**  
TRANSVISION Electronics, Inc., New Rochelle, N.Y. Dept. HIY-4  
 Send FREE 12-page Catalog...  I enclose \$2 for Assembly  
Manual, refundable on purchase of Kit.  
 I enclose \$15 for Starting Pkg. on pay-as-you-wire plan.  
(Complete Kits range from \$119 to \$199.)

Name \_\_\_\_\_  
Address \_\_\_\_\_  
City \_\_\_\_\_ Zone \_\_\_\_\_ State \_\_\_\_\_

CIRCLE 88 ON READER-SERVICE CARD

the longest of the Glinka pieces, strikes me as being banal and syrupy in its inspirational effort—the sort of thing that used to become theme music for radio programs about the American heritage.

The Tchaikovsky scene uses themes familiar from the *Romeo and Juliet* Overture. It was completed and orchestrated by Sergei Taneiev, having been intended as a part of the composer's projected opera on the subject. It is effective, even haunting, and would be even more so had not its principal material been pounded into one's head in so many watery, sleazy versions. (Where would Muzak be without Peter Ilich?) The soloists are equal to their assignments, which means that Kozlovsky displays a wide range and considerable ease in the vicinity of high C; that Lemeshov and Lavrova produce well-focused, full-bodied lyric tone (rather remarkable for the veteran tenor, if this was recorded at all recently); and that the others can negotiate a few easy lines without disaster. The sound is a trifle distant, a trifle muddy, but not enough to ruin the disc for those interested in the music. C.L.O.

**GOEB:** *Concertino for Trombone and Strings*—See Martin: *Ballade for Trombone and Piano*.

**HARRIS:** *Symphony No. 3*—See Bernstein: *Jeremiah Symphony*.

**HAYDN:** *Sonata for Piano, No. 40, In G*—See Scarlatti, Domenico: *Sonatas for Piano*.

**HAYDN:** *Sonata for Piano, No. 52, in E flat*

†Bach: *Concerto for Two Pianos and Orchestra, in C, S. 1061*

Sviatoslav Richter, piano; Anatol Vedernikov, piano (in the Bach); Moscow Chamber Orchestra, Rudolf Barshai, cond. (in the Bach).  
• ARTIA-MK 1569. LP. \$5.98.

Richter's performance of Haydn's last, and possibly finest, piano sonata is a *tour de force* of controlled virtuosity. Taking the last movement at a breakneck speed desperately beyond the reach of all but a few pianists, the great Soviet artist still succeeds in obtaining the utmost transparency and most loving tonal caress. Furthermore, Richter highlights the drama in the writing by judiciously adjusting the tempo to the needs of the music without really altering it. An example of this sort comes at the beginning



Richter: Haydn lovingly caressed.

of the first movement development where the closing subject dramatically recurs. The virtuoso's fingerwork in the treacherous finale is so impeccable that I was rather surprised by the enthusiastic burst of applause at the end, which told me that the disc had been made under the uncontrolled conditions of an actual concert. (A look at the record label revealed that this took place in Bucharest, and was recorded by Electrecord. No date is given.)

The Bach is also played with very fast tempos, but here the approach is excessively romantic and articulation degenerates into mere clatter. Since the sound tends to be rather overresonant with distant pickup of the solo keyboard instruments, perhaps I am prejudiced against the performance for sonic reasons. H.G.

**HINDEMITH:** *Quartet for Strings, No. 3, Op. 22*

†Bloch: *Quartet for Strings, No. 5*

Fine Arts Quartet.

• CONCERTDISC M 225. LP. \$4.98.  
• • CONCERTDISC CS 225. SD. \$4.98.

Gentlemen, Hindemith, not César Franck. Bloch, not Ravel. A.F.

**HINDEMITH:** *Sonata for Trombone and Piano*—See Martin: *Ballade for Trombone and Piano*.

**IVES:** *Sonata for Piano, No. 2 ("Concord")*

George Pappa, piano; Bonnie Lichter, flute.  
• COMPOSERS RECORDINGS CRI 150. LP. \$5.95.

For a feature review of this recording, see page 62.

**JOSQUIN DES PREZ:** *Missa Hercules dux Ferrariae; Four Motets*

Wiener Kammerchor; Musica Antiqua Wien, Hans Gillesberger, cond.  
• VANGUARD BG 620. LP. \$4.98.  
• • VANGUARD BGS 5042. SD. \$5.95.

Gillesberger uses instruments as well as voices in the Mass—not only organ, bassoon, trumpet, and trombone, but also modern reproductions of krummhorn, sordun, pommer, and alto trombone. These add rich and unfamiliar hues to the music. Less convincing is his treatment of the Kyrie: "Kyrie I" and "Christe" are first played by the instruments and then repeated with the voices; "Kyrie II" is first performed by voices and instruments, then repeated by the latter alone. The performance is sometimes, as in the elevated and lovely Sanctus, eloquent; at other times, as in the Credo, it is rather metronomic. With some fifteen Masses by Josquin still unrecorded, it seems a pity that Gillesberger chose one of which two versions were already available in the domestic catalogues.

The other works on the present disc comprise the fine "Et incarnatus est" from the *Missa Da pacem* (here performed by instruments alone); the six-part *Veni Sancte Spiritus*, with its interesting double canon (one canon between top and third voices, another between fourth voice and bass); and the beautiful four-part *De profundis*, with its grand opening sweep upward "out of the depths." Excellent sound. N.B.

KURKA: *Symphony No. 2, Op. 24*—  
See Whitney: *Concertino*.

LISZT: *Dante Symphony*

Margit László, soprano; Budapest Radio Choir; Budapest Philharmonic Orchestra, György Lehel, cond.

• WESTMINSTER XWN 18971. LP. \$4.98.  
• • WESTMINSTER WST 14152. SD. \$5.98.

LISZT: *Les Préludes; Orpheus; Mephisto Waltz; Spanish Rhapsody* (trans. Gabor Darvas)

Hungarian State Orchestra, György Lehel, cond. (in *Les Préludes* and *Spanish Rhapsody*); Janos Ferencsik, cond. (in *Orpheus* and *Mephisto Waltz*).

• WESTMINSTER XWN 18970. LP. \$4.98.  
• • WESTMINSTER WST 14151. SD. \$5.98.

LISZT: *Tasso: Lament and Triumph. Hungaria*

Hungarian State Orchestra, Janos Ferencsik, cond.

• WESTMINSTER XWN 18969. LP. \$4.98.  
• • WESTMINSTER WST 14150. SD. \$5.98.

These three discs, part of Westminster's observance of the 150th anniversary of the birth of Franz Liszt, are of variable interest. One can't help wondering, for example, just how important it is that we hear *Tasso* and *Hungaria*. Although the former reveals Liszt's ability to transform and develop several themes and to combine the elements of a four-movement symphony into a single movement, both it and *Hungaria* are too often full of turgid, bombastic writing. On the other hand, *Les Préludes*, *Orpheus*, and the *Mephisto Waltz* remain beautiful and inspired. The same disc also contains the *Spanish Rhapsody*, Gabor Darvas' orchestral transcription of Liszt's *Rapsodie espagnole* for piano, a deft fantasy on two popular Spanish dance tunes, the *Folia d'españa* (also used by Corelli in his *La Folia*), and the *Jota Aragonesa* (employed by Glinka). Darvas' arrangement is tasteful and within Lisztian orchestral bounds, though I personally prefer Busoni's transcription for piano and orchestra. By far the most arresting of these records, however, is that given over to the *Dante Symphony*, a sort of spiritual brother to Liszt's finer, more extensive *Faust Symphony*. The work is in two parts, the first a fairly stormy picture of *Inferno*, the second an amazingly placid one of *Purgatorio*, leading to a final celestial Magnificat, the latter set for soprano solo and women's chorus.

In the performances too, it is the *Dante Symphony* which comes off best. I might have liked a bit more storm and stress in the *Inferno* section, but there is refinement in the contrapuntal *Purgatorio* and beautiful blending of voices and orchestra in the inspired Magnificat. Considering the altogether competent job he does in the *Dante Symphony*, it is surprising to find Lehel so vapid—almost perfunctory—in his readings of *Les Préludes* and the *Spanish Rhapsody*. Ferencsik's conducting of the other works carries more conviction.

The monophonic reproduction in all three discs is good without being startling, though in the record containing *Les Préludes*, etc., the general volume level appears to be lower. In the *Dante Symphony*, the celestial effect of the final

the incredible

# BIRGIT NILSSON



## in *Salome*

Mono A-4247  
Stereo OSA-1218

One of the greatest records of all time

conducted by

# GEORG SOLTI

with

Eberhard Wächter, Gerhard Stolze & Grace Hoffman

and

The Vienna Philharmonic Orchestra

**LONDON**  
RECORDS

CIRCLE 59 ON READER-SERVICE CARD

section is heightened apparently by placing the solo soprano back with the chorus. Westminster could have spared itself the trouble of printing the seating diagrams on the jackets of the stereo versions, since the addition of a second channel adds little to the sonic effect except perhaps a bit of resonance and spatial depth. There is practically no illusion of direction or horizontal spread to the sound. P.A.

**MARTIN: Ballade for Trombone and Piano**

†Hindemith: *Sonata for Trombone and Piano*

†Goeb: *Concertino for Trombone and Strings*

Davis Shuman, trombone; Leonid Hambro, piano; WQXR Strings.  
• GOLDEN CREST RE 7011. LP. \$4.98.

Davis Shuman is a remarkable man. I have heard him play the horn part of the Brahms trio on the trombone with all the mellowness and discretion of the instrument for which that part was written, but he can also blast out like ten trombones if he wants to. Here he neither blasts nor pretends to be a horn; he sets forth the noble-Roman tone of his instrument in superlative style, and in the Hindemith sonata he has a first-class work to match his playing. I am not so sure about the quality of the other pieces, though. A.F.

**MAYAZUMI: Nirvana Symphonie**

Tokyo Choraliers; Nippon University Chorus Group; NHK Symphony Orchestra, Wilhelm Schüchter, cond.  
• • TIME S 8004. SD. \$5.98.

Toshiro Mayazumi is one of that considerable group of Japanese composers, trained in Western techniques, who have risen to prominence since World War II. This is the first sizable work produced by any member of the group to reach American discs.

As the composer himself informs us in his notes, the composition is based essentially on two things—the sound of the Japanese temple bell and the sound produced by Buddhist priests chanting sutras together. The music calls for a symphony orchestra plus many bells and gongs of different sizes and pitches, and the bell effect is further enhanced by the use of woodwind and brass instruments playing bell-like harmonies. Each of the three movements is called a “cannonology,” and each is full of huge, dense, clangorous, bronze-colored, tremulous sonorities; at times the effect is as if one were sitting inside a bell tower during Buddhist services, or even inside a bell. These percussive sounds mingle with the sounds of the male chorus in a marvelously effective way (and a way, I suspect, which is the product of imaginative recording and is not capable of being reproduced in the concert hall), but there is also much independent chanting, at times a bit monotonous.

Since Mayazumi describes his piece as a “sort of Buddhist cantata” and emphasizes its religious as well as its purely sonorous motivation, the texts of the sutras should therefore have been given or at least indicated and not merely named. (One of them is named—deep breath—*Mahaprajnaparamita*.)

The composer has obviously fallen under several Western influences over the years, and in some ways his score is an

anthology of undigested impressions of the musical Occident, especially of Varèse, Stravinsky, Webern, and Boulez. Still and all, the piece has character; for all its faults, it comes to grips with a whole new world of experience (new, that is, for Western music) and it increases one's understanding to know it. Furthermore the climax at the end of the second movement is a real spine tingler. The recording is magnificent. A.F.

**MENDELSSOHN: A Midsummer Night's Dream: Overture, Op. 21; Incidental Music, Op. 61**

Heather Harper, soprano; Janet Baker, contralto; Philharmonia Chorus and Orchestra, Otto Klemperer, cond.  
• ANGEL 35881. LP. \$4.98.  
• • ANGEL S 35881. SD. \$5.98.

**MENDELSSOHN: The Hebrides, Overture, Op. 26; Symphony No. 3, in A minor, Op. 56 (“Scotch”)**

Philharmonia Orchestra, Otto Klemperer, cond.  
• ANGEL 35880. LP. \$4.98.  
• • ANGEL S 35880. SD. \$5.98.

**MENDELSSOHN: Symphony No. 4, in A, Op. 90 (“Italian”)**

R-†Schumann: *Symphony No. 4, in D minor, Op. 120*

Philharmonia Orchestra, Otto Klemperer, cond.  
• ANGEL 35629. LP. \$4.98.  
• • ANGEL S 35629. SD. \$5.98.

Presenting Mendelssohn's most popular orchestral works in integrated recordings by a single orchestra and conductor should have been a fruitful enterprise, but Klemperer seems to have been the wrong choice for the assignment. Mendelssohn must be elegant, crisp, light, flowing. Klemperer gives us plenty of elegance but almost always at the expense of everything else. His tempos are consistently on the slow side, with the result that one often hears too many rhythmic “trees” and not enough basic pulsating “forest.” For example, the *Midsummer Night's Dream* Scherzo emerges with a stiff three beats to the measure instead of a light, basic one beat. The incidental music to Shakespeare's play, by the way, is not offered in its entirety, but it is about as complete a recording as can be found in the catalogue. The one big vocal excerpt, *Ye spotted snakes*, is delightfully sung here by the soloists and a women's chorus.

If I cavil at Klemperer's slow-paced readings and occasionally heavy-handed approach, I must still admire him for the nobility with which he invests the normally slower sections of the *Scotch* Symphony. Then, too, he seems more at home in the Schumann Fourth, which shares the third record with the *Italian* Symphony. His reading of this work couples the aforementioned nobility with considerable vigor.

The recorded sound is natural and spacious, without being too reverberant. The only unnatural moment occurs in the *Midsummer Night's Dream* Wedding March, where the cymbals have a small, stifled quality. There is somewhat more separation in the stereo edition of all three discs than I am accustomed to hearing from Angel. It is a natural separation, however, and is particularly effective in the first movement of the

*Italian* Symphony, where there is a great deal of interplay between the first violins on the left and the second violins on the right. P.A.

**MENDELSSOHN: Quartet for Strings, No. 2, in E minor, Op. 44**  
—See Schumann: *Quartet for Strings, No. 1, in A minor, Op. 41.*

**MOZART: Concerto for Piano and Orchestra, No. 22, in E flat, K. 482; Sonata for Piano, in E flat, K. 282**

Philippe Entremont, piano; Philadelphia Orchestra, Eugene Ormandy, cond.  
• COLUMBIA ML 5678. LP. \$4.98.  
• • COLUMBIA MS 6278. SD. \$5.98.

This French pianist, now twenty-seven, has toured widely and successfully in the United States in the last few years. The present disc reveals him as a mature artist, with most of the qualities of a first-rate pianist and with few faults (and these of the kind that a little more polishing could easily erase). His tone is attractive, though some single *forte* notes sound a little hard, he phrases nicely, he has a good legato, and his command of dynamic nuance is considerable. All these qualities are especially evident in the Sonata, which is particularly well done. It is in the Concerto that an occasional hardness of tone creeps in. The whole conception here is laudably remote from the prettified Mozart that used to be all too common, but sometimes there is a tendency to lean too far in the other direction, resulting in one or two tuttis that seem rather heavy and incisive for Mozart. On the other hand, there is much fine playing by both soloist and orchestra, Ormandy's men providing, for example, an unusually eloquent introduction in the Andante.

The dynamic range could have been wider—there is not a true *pianissimo* to be heard—and there is a spot in the first movement of the Concerto where important material in the bassoons is buried, but in all other respects balances and sound are very good. N.B.

**MOZART: Quartets for Strings: No. 20, in D, K. 499; No. 22, in B flat, K. 589**

Vienna Philharmonic Quartet.  
• LONDON CM 9298. LP. \$4.98.  
• • LONDON CS 6231. SD. \$5.98.

This is the first appearance of stereo versions of these quartets, but it is welcome on other counts too. The performers are clearly first-rate artists, playing with a unanimity that comes from long association and common aims. Mozart is obviously close to their hearts. The general conception is virile, yet the tone is never permitted to grow coarse; and when delicacy or songfulness is required it is forthcoming. The frequent dynamic nuances, which are unusually plentiful in K. 499, are carefully observed most of the time. The finale of the same work is taken at a spanking pace, but it is not breathless, nor does it impair the cellist's articulation of the staccato triplets. The sound is spacious and realistic. N.B.

**MOZART: Sonata for Piano, No. 12, in F, K. 332—See Scarlatti, Domenico: Sonatas for Piano.**

Continued on page 76



## THE IMPORTS

**P**IER Francesco Cavalli rates no less than four pages in Grove's *Dictionary* as Monteverdi's disciple and the composer of forty-two full-blown Venetian operas. Yet despite this eminence in the history of dramatic music, Cavalli is totally absent from the domestic record catalogues, and his first complete work to be released in Europe is a choral one, the *Messa Concertata* (Schwann/Dusseldorf AMS 14/15).

The recording was made three years ago in the Church of St. Angelo in Milan under conditions faithful to Cavalli—and perfect for stereo. Choruses are split on either side, and the soloists and brasses are placed opposite the string body. There are striking contrasts in the music too, with the rhythm taking surprising turns, the chorus alternately chantlike and melodious, and the strings and brass cast first in the role of obbligato against the voices and then blending in full sonority. Fortunately, the church echo permits the subtle detail of the choral singing to be heard and gives just the right arching sound to the three soloists. The total effect is impressive in the same detached, powerful manner as Berlioz's *Requiem*, written two hundred years later, especially the big opening of the *Kyrie*. Umberto Cattini handles the *Angelicum Orchestra* of Milan well, and the stereo, called "compatible," is finely balanced. The records are compatible to the extent that a monophonic stylus seems to do no damage at all; the monophonic sound is a trifle pinched. The only reservation I have against the whole venture is that the music could easily have been pressed more economically on three sides instead of four.

Another German firm, Bärenreiter Musicaphon, has released a major portion of Bach chamber music: the six unaccompanied cello suites; the six solo violin sonatas and partitas; and the six sonatas for violin and harpsichord. It is convenient to compare the cello suites, played by August Wenzinger (BM 30 L 1507/09), with the complete set of the same work performed by Henri Honegger on the French Valois label (MB 422/24). Before Pablo Casals gave this music its proper weight half a century ago, much of it written for the lowest string was considered a series of passing notes, to be used as a basis for accompaniment. No one would handle it in that way today. Honegger (no relative of the composer), playing with a small but sweet and full tone, manages to project a continuous melodic line with many rises and falls, but his accenting is questionable, and his tempos are frequently slow. Wenzinger, with a deeper sound

and a more resonant recording, utilizes all the notes to give an impression of continuous harmonic overtones. His cello, however, is out of tune, varying from a half to a whole tone off, and he does not accent properly. Neither of these performers brings out the polyphony inherent in this music for a single instrument nor its varied rhythms, as Casals does in his set of six now available as a reissue on the domestic Angel label. For an equivalent in present-day sonics we shall evidently have to wait for Janos Starker, who has already recorded Nos. 2 and 5 for English HMV.

**I**T is baffling why the music of Carl Nielsen (1865–1931), the greatest Danish composer since Buxtehude, is so neglected in this country. Only a few of his works are available on records, whereas in Europe all the symphonies and concertos and most of the chamber music have wide circulation; perhaps foreign discs will eventually fill in the gaps here. Danish Odeon, an EMI subsidiary, has now issued the performance of Nielsen's *Violin Concerto* (MOAK 7) which originally appeared about six years ago on the HMV label.

It's good to have this amiable concerto back in circulation. The jacket notes, in English, quite correctly state that it is less characteristic of Nielsen than any of his other major compositions and is not one of his most important works, but it is both tuneful and varied in spirit, rang-

ing from tranquil to humorous. The style of violin writing is post-Romantic, very much like that of early Bartók and the Sibelius *Concerto*. The form, however, is original, consisting of two fast movements preceded by gentle, introductory music, and the juxtaposition of violin and orchestra is clever. Both the performance—by Yehudi Menuhin and the Danish National Radio Orchestra conducted by Mogens Wøldike—and the sound on this record are excellent. Also included are three excerpts from the colorful *Aladdin Suite*.

BAM, which is the trademark of Editions de la Boîte à Musique, has produced two sets of Mozart chamber music: the four *Flute Quartets*, with Jean-Pierre Rampal as soloist (LD 055); and the two *Flute Quartets*, with Robert Veyron-Lacroix as pianist (LD 057). The string parts in both cases are played by the brothers Pasquier, whose recording history goes back to prewar domestic Victors and Columbias. The flute record is a winner, with Rampal positively Orphic in his sweet tone production and effortless phrasing, and the Pasquiers a buoyant support. The piano quartets present far more difficult music, both in technique and seriousness of approach, and the strings are not up to them. The tempos are too fast, the phrasing mechanical, and even the recorded sound itself is without the fullness needed for the passionate *Quartet in G minor*, K. 478. Mark one out of two for BAM.

**H**AVING last month pilloried Deutsche Grammophon's current crop of Italian operas sung in German, I think it is only fair to note here the reappearance of one of the best efforts of this kind. A radio performance of *Rigoletto* was recorded in Germany in 1944, with Erna Berger as Gilda, Heinrich Schlusnus in the title role, Helge Roswänge as the Duke, Josef Greindl as Sparafucile, George Hann as Monterone, and Margarete Klose as Maddalena, with Robert Heger conducting. Berger was at her best in that production, surpassing her later recording of the part for RCA Victor; Schlusnus and Hann were particularly good, and the ensembles superb, with only Roswänge overdoing his characterization and sounding beery. The performance was issued in the United States by Urania after the war and later withdrawn. It has now been remastered (well) and issued by DGG as LPEM 19222/23. The two records, with libretto in German only, will not be made available here through DGG's regular distribution channels, and can be obtained only as an import. GENE BRUCK



Carl Nielsen: why so forgotten?

**"ASTONISHING!"**  
**"EXCELLENT!"**  
**"TERRIFIC VALUE!"**



Unfinished

**CABINART**  
**SPEAKER SYSTEMS**

Acoustic damping material inside

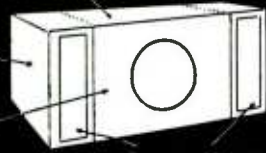

3/4" thick throughout  
 Plastic cone grill cloth  
 Tuned double ducts

mark I 8" model  
 11" H x 9 1/2" D x 23" L,  
 Shipping Wt. 27 lbs.  
 Sculptured Front Walnut  
 Veneer, Oiled Finish \$30.00  
 FOB Factory

**\$18<sup>00</sup>**  
 Unfinished

Extended range domestic speaker, new hi-efficiency magnetic circuit. Ideal for med. & low level monaural or stereo reproduction. 1" voice coil, 8 ohms impedance. Speaker resp. 45 to 13,000 cps. 3.16 oz. new type magnet. Nominal power rating 10 to 15 watts.

mark II 12" model  
 14" H x 11 1/2" D x 23 3/4" L,  
 Shipping Wt. 37 lbs.  
 Sculptured Front Walnut  
 Veneer, Oiled Finish \$43.20  
 FOB Factory

**\$27<sup>00</sup>**  
 Unfinished

12" coaxial 6.8 oz. Alnico V magnet with 1" voice coil, heavy 1-pc. cone and specially designed 3" Alnico V PM tweeter mounted coaxially with built in hi-pass filter, capacitor type. Power rating 15 watts; imp. 8 ohms. Speaker resp. 40 to 15,000 cps.

Cabinart Cabinets are made of extremely dense pressed wood, unfinished. Walnut models are genuine hardwood veneers with superlative finish. Extra heavy 3/4" thick construction, solidly glued, achieves maximum speaker response. Unique principle of acoustic resistive loading effectively improves low end response for balanced full fidelity reproduction. Each system tuned, double ducted, acoustically insulated.

"Astonishing!" says E. T. Canby in Audio, Nov. '61. Send for FREE re-print article on Cabinart speaker systems.

AVAILABLE AT YOUR DEALER OR ORDER DIRECT FOR IMMEDIATE DELIVERY

**CABINART GUARANTEES**

You must be satisfied for 10 full days or your money back.

**ONE FULL YEAR WARRANTY**

Written registration card and warranty included.

**CABINART ACOUSTICAL DEV. CORP.**

33 Geyer St., Haledon, N. J.

Please ship the following to be used in my home for 10 full days. I understand unit (s) may be returned and my money refunded within that time unless fully satisfied.

- ..... Mark I Unfinished \$18.00 each
- ..... Mark II Unfinished \$27.00 each
- ..... Mark I Oiled Walnut \$30.00 each
- ..... Mark II Oiled Walnut \$43.20 each

(Please make check or money order payable to Cabinart Acoustical.)

Name \_\_\_\_\_  
 Address \_\_\_\_\_  
 City \_\_\_\_\_ State \_\_\_\_\_

CIRCLE 22 ON READER-SERVICE CARD

**MUSSORGSKY: Pictures at an Exhibition**

†Schumann: *Carnaval, Op. 9*

Benno Moiseiwitsch, piano.

- DECCA DL 10042. L.P. \$4.98.
- DECCA DL 710042. SD. \$5.98.

For his first American-made disc Moiseiwitsch has remade the *Pictures*, which he once did for HMV 78s, and provides his first recorded *Carnaval*. Both works have figured prominently in the noted virtuoso's recital programs, and, in fact, classify as Moiseiwitsch specialties. It is therefore most disappointing to hear the drab quality of this recording—probably to be attributed to an inferior piano rather than to any inadequacy on the part of the engineers. The bleak, monochromatic scheme is especially hurtful to a pianist like Moiseiwitsch, whose art relies so greatly on nuance and atmosphere. Whatever pleasure I did derive from this release came from listening to the monophonic pressing, in which the tonal faults are at least minimized. There, some of Moiseiwitsch's grace and charm come through.

The pianist gives both works old-style performances, ones in which inner voices are stressed and much rubato permitted. For example, Moiseiwitsch underlines the syncopated figure in the *Paganini* section from *Carnaval*, and also the left-hand countermelody of *Aveu*. Another device used by this artist is the linking of one section with another. A case in point: *Chopin* and *Estrella*, who walk arm in arm on this disc. As a whole, the Schumann comes off better than the Mussorgsky, which, in addition to having competition from two Richter recordings and from an excellent Firkusny version, is heavily cut. One can appreciate many rarefied details in Moiseiwitsch's guided tour—the unhatched chicks chirp engagingly—but this music really has more stark energy and power than Moiseiwitsch's basically salon performance can achieve. The opening promenade, to cite one instance, is decidedly low-powered, even static.

It is only left for me to praise the pianist's technical fluidity, which remains unimpaired despite his seventy-odd years—and, again, to deplore the piano used. H.G.

**PUCCHINI: La Bohème**

Renata Scotto (s), Mimi; Jolanda Meneguzzi (s), Musetta; Gianni Poggi (t), Rodolfo; Enzo Guagni (t), Parpignol; Tito Gobbi (b), Marcello; Giorgio Giorgetti (b), Schaunard; Giuseppe Modesti (bs), Colline; Virgilio Carbonari (bs), Benoit and Alcindoro; Mario Frosini (bs), A Sergeant; Augusto Frati (bs), Doganiere. Chorus and Orchestra of the Maggio Musicale Fiorentino, Antonino Votto, cond.

- DEUTSCHE GRAMMOPHON LPM 18764/65. Two LP. \$11.96.
- DEUTSCHE GRAMMOPHON SLPM 138764/65. Two SD. \$13.96.

With so many *Bohèmes* to choose from (and the end nowhere in sight—Victor already has a new version on tape) the only justification for another one is the presence of a really extraordinary cast or conductor. This new DGG version simply doesn't qualify, being the preservation of a performance that is thoroughly routine in all respects.

Votto turns in a reading that is sensibly paced and relatively clear, but never exciting; his orchestra is only an ordinary one, and the total effect is tensionless and slightly choppy. His Mimi is Renata Scotto, the young soprano who has been Mercury's operatic bellwether. She produces a great deal of attractive, full-bodied sound, particularly in the upper-middle portion of her range, but she does not exude much warmth or charm. Her phrasing is unimaginative, and many little dramatic details (such as the "Ah!" when Rodolfo seizes her hand at the start of "*Che gelida manina*") are forced or in the wrong spirit altogether. Miss Scotto's voice and mannerisms seem headed in the direction of a hardness: this lends a piquancy that is welcome in eighteenth-century *opera buffa* roles, which currently represent her strongest suit. One can't help being disappointed, though, that a talent which offered so much promise for roles such as Violetta, Gilda, or Mimi, is not fulfilling that promise. Gianni Poggi sounds tired on this recording (his second Rodolfo on discs), and the bleaty quality of the voice is more pronounced than ever—an uninspired, workaday performance. Giorgio Giorgetti, possessed of a rather characterless voice, makes a perfect cartoon of Schaunard—a bag of overdone buffo tricks. There is an adequate Musetta from Miss Meneguzzi, and Modesti sings his "Coat Song" nicely, though not in such a way as to throw a scare into competitors like Siepi and Tozzi. This leaves only the very vital, rich (except for those hooty top notes) Marcello of Tito Gobbi to provide some interest.

The entire production has about it an unwelcome air of lowbrow Italian slapstick. All this is made depressingly clear by DGG's crystalline sound; the company has again made the mistake of placing soloists much too close to the microphone. All in all, the set is not in the same league with four or five available versions. C.L.O.

**RAVEL: Pavane pour une infante défunte**—See Debussy: *Images pour orchestre*.

**RESPIGHI: Feste Romane; Fontane di Roma**

Orchestra of Accademia di Santa Cecilia (Rome), Fernando Previtali, cond.

- WESTMINSTER XWN 18959. LP. \$4.98.
- WESTMINSTER WST 14140. SD. \$5.98.

Czech Philharmonic Orchestra, Antonio Pedrotti, cond.

- PARLIAMENT P.L.P 155. LP. \$1.98.
- PARLIAMENT PLPS 155. SD. \$2.98.

**RESPIGHI: Feste Romane**  
 †Sibelius: *Symphony No. 7, in C, Op. 105*

Philadelphia Orchestra, Eugene Ormandy, cond.

- COLUMBIA ML 5675. LP. \$4.98.
- COLUMBIA MS 6275. SD. \$5.98.

Ottorino Respighi's imaginative, colorful tone portraits of the sights and sounds of the Eternal City have long served as brilliant orchestral showcases, both in concert and on records. On these three discs they are exposed in the best light by three conductors who obviously know their business. Previtali's



Ormandy: his Respighi's hair-raising.

reading is of the utmost transparency, well accented in cleanly separated yet unexaggerated stereo. Listening to his interpretations, one has the impression that he is intent on evoking the spirit of the past rather than that of the present. There is a certain aura of mystery, especially in the quieter sections of *Roman Festivals*, and a great sensitivity in the *Fountains*. Pedrotti and Ormandy, on the other hand, seem to be concerned with the present. Like Previtali, Pedrotti emphasizes clarity, but also injects a bit more virtuosity. The Czech Philharmonic is a first-rate orchestra, but Pedrotti has it playing even better than usual. He has been accorded reproduction with the requisite spaciousness, brilliance, and tonal splendor—and all this at a budget price. Ormandy's performance of *Feste Romane* is a hair-and-decibel-raising *tour de force*, calculated to have you cheering at its conclusion. The over-all volume level is a little higher than that of the Westminster or Parliament recordings, and the unsurpassed orchestral brilliance shines dazzlingly in both mono and stereo.

The Philadelphia conductor takes an entirely different tack with the one-movement Sibelius symphony. Nobility and consistency are the keynotes here. Tempos are broader than usual, particularly in the Scherzo; but everything fits together with glowing logic. P.A.

**SCARLATTI, ALESSANDRO: *Messa di Santa Cecilia***

Soloists; University of Utah Chorus; Utah Symphony Orchestra, Maurice Abravanel, cond.

- VANGUARD BG 621. LP. \$4.98.
- VANGUARD BGS 5044. SD. \$5.95.

In the best residential section of Naples today the main avenue is called Via Alessandro Scarlatti. It is a busy thoroughfare, crowded with traffic and lined with good shops. There is something strangely fitting in the fact that it is named for the composer of the present Mass, for this music goes about its affairs in businesslike fashion and it too is lined with good things. The general tone is festive and ceremonial—the work was written in 1720 for a wealthy Neapolitan cardinal. There are lively fugues at the end of both Gloria and Credo, a good deal of florid solo writing, and bustling violin figures. All of this is done with the skill of a master; the counterpoint is smooth and rich, the instrumental ritornels sharply profiled à la Vivaldi. In the sections where Scarlatti turns introspective—the “*Et in terra*,” the tragic

“*Qui tollis*,” the gravely lovely “*Et incarnatus*,” and the very beautiful Agnus Dei—he produces music of moving expressivity. Outstanding among the five soloists is the soprano Jean Preston, whose voice as recorded here has power, attractive quality, and firm focus. The other soloists perform their elaborate parts ably, and Mr. Abravanel keeps things moving at a good clip. Excellent sound in both versions. N.B.

**SCARLATTI, DOMENICO: *Sonatas for Piano*** in G, L. 286; in E, L. 23; in C minor, L. 352; in A, L. 238; in F, L. 119

†Haydn: *Sonata for Piano, No. 40, in G*

†Mozart: *Sonata for Piano, No. 12, in F, K. 332*

Ivan Davis, piano.

- COLUMBIA ML 5695. LP. \$4.98.
- COLUMBIA MS 6295. SD. \$5.98.

Ivan Davis gives a far more commendable account of his abilities here than he did on his recent Liszt disc: his pianism on this record is much more controlled and interesting. The five Scarlatti gems in particular are treated with flexibility and finesse; and although Mr. Davis preserves the classicism and proportion inherent in these pieces, he furnishes plenty of fiery rhythmic thrust, accent, and scintillant color. Furthermore, the playing retains a measure of intimacy while not at all miniaturized. In Longo 23, the pianist uses a text which repeats the closing refrain, but the liner notes make no reference to this unorthodoxy (it appears four times in the course of the performance).

Mr. Davis also deviates from the original text in the second movement of the Mozart Sonata, where he follows a version printed by Artaria and Schott which is at considerable variance with Mozart's manuscript. The clear articulation and rhythmic brio constitute very fine instrumental playing, but neither the Mozart nor the Haydn are, to my mind, as successfully interpreted as are the Scarlatti pieces. For one thing, the pianist's whole conception of this music is excessively delicate, even dainty. The bouncy, tinkly account of the Haydn first movement, in particular, suggests that this artist retains some rather passé notions regarding “classical” style. And why must so many of today's musicians persist on playing appoggiaturas before rather than *on* the beat so that they sound like musical mosquito bites? Indeed, though Haydn may have marked this first movement *Allegretto innocente*, surely this innocence mustn't be allowed to extend to musicological points!

But while purists will quibble about details such as these, even they will note the lively musicality of the interpretations. The exciting virtuosity displayed here gave me genuine pleasure, as did the finely transparent reproduction of it. H.G.

**SCHUBERT: *Quartet for Strings, No. 14, in D minor*** (“*Tod und das Mädchen*”)

Fine Arts Quartet.

- CONCERTDISC M 1212. LP. \$4.98.
- CONCERTDISC CS 212. SD. \$4.98.

Although this is one of the more dramatic and intense of Schubert's quartets, drama and tension are not very prominent

*Mated to Perfection!*  
**THORENS**  
NEW STEREO TURNTABLE  
WITH INTEGRATED ARM



**THORENS TD-135**

**COMPLETE WITH INTEGRATED ARM**

For the first time, Thorens — in the new TD-135 — offers a *component-quality* arm and turntable mated with a precision that insures you perfect sound . . . always . . . with a minimum of installation effort on your part.

*There's no compromise whatever with quality such as you usually find in integrated turntable and arm units.* THORENS TD-135 is Swiss-precision crafted throughout . . . true component high fidelity all the way. You get: A precision turntable featuring 4 speeds, all adjustable, with an 8-pound non-magnetic table . . . plus a completely new, advanced tone arm that's so good we also sell it separately (see below) for use with any turntable of your choice. Exceeds NAB specs for wow, rumble and flutter. Has same belt-slidler drive as famous TD-124. Shuts off automatically at end of record. Many, many more features than we can detail.

\$110 net



**THORENS BTD-12S**

**12" PROFESSIONAL TONE ARM**

Identical arm included with TD-135, but sold as separate unit. Less than 0.5"/inch tracking error. Built-in cueing device. All adjustments: vertical height; calibrated gram-force; stylus positioning slide; balancing counter-weight. Unique vertical pivot keeps stylus vertical for any height adjustment. Resonance well below audible frequencies. Interchangeable 4-pin cartridge shells. Mounted on board for THORENS TD-124, TD-121 turntables.

\$50.00 net

See and hear the THORENS TD-135 and ALL the members of the “TD” family of fine turntables at your franchised dealer's today; there's one for every budget! For additional information, write us direct.



THORENS DIVISION

**ELPA MARKETING INDUSTRIES, Inc.**  
New Hyde Park, N. Y.

CIRCLE 99 ON READER-SERVICE CARD

# MUSIC BIG AS LIFE

## Utah's High-Fidelity CONTINENTAL SPEAKERS



C12RD 12"  
WOOFER  
2 Lb. Alnico  
V Magnet and  
2" Voice Coil

YOU GET LIFE-SIZE SOUND in every range, from 20 to 20,000 CPS, with Utah's precision-engineered stereo/high-fidelity speakers. Tweeters and mid-range speakers feature a specially engineered horn formula to enhance "presence". Each speaker has color-coded 4-way terminals.



Please mail me prices, specifications and performance details of your Continental speaker line.

NAME \_\_\_\_\_  
ADDRESS \_\_\_\_\_  
CITY \_\_\_\_\_ STATE \_\_\_\_\_

CIRCLE 92 ON READER-SERVICE CARD

in the present performance. It is clear but fairly literal, without much imagination. These shortcomings are most apparent in the slow movement, from which an air of brooding and mystery is absent. The recorded sound is full and rather close-to. For a more felicitous, more idiomatic account of this work, delivered with greater intensity, yet with more forward flow, try the recently released disc by the Juilliard String Quartet on RCA Victor. It also includes, as a bonus, the *Quartettsatz* in C minor. P.A.

### SCHUBERT: *Sonata for Piano, in D, Op. 53*

Artur Schnabel, piano.  
• ANGEL COLH 83. LP. \$5.98.

Schnabel recorded this Sonata in London on January 26 and 27, 1939, and (as RCA Victor M 888) his was for a long time the only complete recorded edition of the music. Although the current catalogue lists several competitive versions, including a very beautifully played one by Sviatoslav Richter, I am firmly convinced that Schnabel's profound musical understanding, his superior grasp of structure, and his loving attention to detail set his rendition apart.

This is not to say that this is the best playing Schnabel ever did for the phonograph. At times, his tone has a slightly harsh, driven quality indicating tenseness on the player's part. Another factor that leads me to suspect that the pianist was pushing ever so slightly is the evidence of rushed time values and occasional rhythmic exaggerations of other sorts. From the purely pianistic standpoint, then, Richter's lucid, perfectly fluent and symmetrical execution is to be preferred.

Schnabel's over-all design, however, seems to me much grander, more far-reaching, revealing, and impassioned. This Sonata, as Schnabel gives it to us, shows its composer to be a master of large-scaled utterance and a builder of propulsive rhythmic momentum comparable to Beethoven. Heard in this reading, it transcends Richter's more conventional portrait of Schubert as the genial, Viennese melodist with a sunny smile.

The first movement, with its swirling *ir.petus*, is especially compelling here, and Schnabel's intense delivery of the middle part of the slow movement (he increases the tempo here considerably) is another successful stroke of genius. And if the exaggerated reading of the scherzo does not wholly convince—Schnabel is too zealous in his attempt to divide the music into paragraphs, and he overdoes his re-creation of the accent marks which Schubert placed on the half notes throughout this section—he is back in form for a wonderfully fleet and energetic statement of the finale (though again, one might prefer Richter's more comfortable and consistent tempo for this movement).

The engineers have done a superb job with the transfer from 78s. The sound on this disc is fully competitive with that on the Richter edition. I am eagerly looking forward to the day when Angel will get around to reissuing Schnabel's lofty account of the A major posthumous Sonata—in my opinion, his greatest Schubert recording. H.G.

### SCHUMANN: *Carnaval, Op. 9*—See Mussorgsky: *Pictures at an Exhibition*.

### SCHUMANN: *Quartet for Strings, No. 1, in A minor, Op. 41* †Mendelssohn: *Quartet for Strings, No. 2, in E minor, Op. 44*

Claremont String Quartet.

- MUSIC GUILD 19. LP. \$4.12 to members; \$5.50 to nonmembers.
- MUSIC GUILD S 19. SD. \$4.87 to members; \$6.50 to nonmembers.

When Robert Schumann wrote to Clara that he was contemplating quartets because "the piano is getting too narrow for me," she was not entirely pleased: "Are you, then, thoroughly acquainted with the instruments?" she wondered. The answer, in truth, was no. There are passages in the A minor quartet that properly belong on a keyboard, and others—in fact, much of the last movement—that threaten to burst the strings asunder and might easily, as one observer has pointed out, occupy a full battery of trombones. But in the end, Schumann gets away with it. The very individualism of the work is its strength, and there are pages (the fugal opening among them) proper enough to have satisfied even Clara. The Mendelssohn is better behaved, and less distinctive. The two middle movements are charming, however, and the scherzo in particular allows the Claremont Quartet an opportunity to display some fine dexterity and rhythmic precision. The performances are understanding and spirited, though not perfect—the first violin skims the underside of the pitch more than once. But the musical essentials are there, the sound is good, and stereo spaces the four instruments very suitably. There are no competing versions of either work in the catalogue, and this Claremont edition creditably fills the gap. SHIRLEY FLEMING

### SCHUMANN: *Symphony No. 3, in E flat, Op. 97 ("Rhenish")*

New York Philharmonic, Leonard Bernstein, cond.

- COLUMBIA ML 5694. LP. \$4.98.
- • COLUMBIA MS 6294. SD. \$5.98.

"Mr. Bernstein," says an anonymous author in the jacket notes for this disc, "has faith in the rightness of Schumann's own instrumentation of the *Rhenish* Symphony. In this recording the listener is given the unique opportunity of hearing the work just as Schumann left it, unburdened with the usual revisions designed to 'correct' the composer's reputed deficiencies as an orchestrator."

Is this faith well founded?

George Szell, who has defended Schumann's gifts for instrumentation as eloquently as any of his interpreters, nonetheless admits the composer's "inability to establish proper balances. This can and must be helped with all means known to any professional conductor who professes to be a cultured and style-conscious musician."

Bernstein's sound in the *Rhenish* is thick and (in the first movement in particular) there is little variation in ensemble textures. With his fast tempo and personal exuberance, however, Bernstein makes it go. Szell (Epic LC 3774 and BC 1130), in the same pages, provides a great deal of transparency in registration, a variety of textures, and a consistent subordination of accompaniments so that the principal thematic lines stand out in relief. His superiority to Bernstein in the second and third movements is based on more than textual matters. He



chooses better tempos and avoids the fussy, sentimental mannerisms Bernstein permits himself.

On the other hand, Bernstein's flair for sonorities (plus the resonance of what I assume to be Carnegie Hall) makes the scene in Cologne Cathedral robust tone painting. If you like your Schumann with maximum heft, the Bernstein will delight you. If you're not sure, listen first. R.C.M.

**SCHUMANN:** *Symphony No. 4, in D minor, Op. 120*—See Mendelssohn: *Symphony No. 4, in A, Op. 90 ("Italian")*.

**SHOSTAKOVICH:** *Age of Gold, Op. 22: Orchestral Suite*—See Bartók: *Miraculous Mandarin: Orchestral Suite*.

**SIBELIUS:** *Symphony No. 7, in C, Op. 105*—See Respighi: *Feste Romane*.

**STRAUSS, JOHANN II:** "Treasures of Vienna"

*Indigo (1001 Nacht): Intermezzo. Polkas: Im Krappfenwald'l, Op. 336; Leichtes Blut, Op. 319. Waltzes: Tales from the Vienna Woods, Op. 325; Emperor Waltz, Op. 437.*

Vienna Philharmonic Orchestra, Rudolf Kempe, cond.  
• ANGEL 35851. LP. \$4.98.  
• • ANGEL S 35851. SD. \$5.98.

Close, but no bull's-eyes. Kempe obviously is well versed in the finest Straussian traditions; his program is imaginatively chosen and varied; he tolerates no score cuts and properly insists on a zither in *Tales from the Vienna Woods*. But he is unrelaxedly German rather than Austrian in too careful readings, alternating between overintense vigor and languid lyricism, which never quite encompass the music's essential grace and humor. Then, too, Angel's boldly crisp stereo recording reveals only too transparently that the conductor's nervous tension is reflected in his players' excessively taut tonal qualities. (The LP seems tonally duller and heavier than the SD, and my review copy has rougher surfaces as well as considerable background hum or tube-"roar," which apparently is inherent in the master recording since it is occasionally noticeable in both editions.) Yet it is only fair to note that despite such flaws these performances are never lacking in dramatic interest. The vibrantly incisive polkas (especially *Im Krappfenwald'l*, with its exceptionally impudent cuckoos) are exhilarating, and even Kempe's mannerisms cannot mask the originality and seductive charm of the bonus here—Josef Strauss's *Dynamiden Waltz*, appropriately subtitled "Magnetic Attractions." R.D.D.

**STRAUSS, RICHARD:** *Salome*

Birgit Nilsson (s), Salome; Liselotte Maikl (s), A Slave; Grace Hoffman (ms), Herodias; Josephine Veasey (c), Page of Herodias; Gerhard Stolze (t), Herod; Waldemar Kmentt (t), Narraboth; Nigel Douglas (t), Second Nazarene; Kurt Equiluz (t), Aron Gestner (t), Paul Kuen (t), Stefan Schwer (t), Jews; Eberhard Wächter (b), Jokanaan; Tom Krause (b), First Nazarene; Heinz

Holecek (bs), Second Soldier; Theodor Kirschbichler (bs), A Cappadocian; Zenon Koznowski (bs), First Soldier; Max Proebstl (bs), A Jew. Vienna Philharmonic Orchestra, Georg Solti, cond.

• LONDON A 4247. Two LP. \$9.96.  
• • LONDON OSA 1218. Two SD. \$11.96.

For a feature review of this recording, see page 61.

**STRAVINSKY:** *Symphonies for Wind Instruments*—See Debussy: *Images pour orchestre*.

**TARTINI:** *Concerto for Cello and Orchestra, in D*

†Corelli: *Concerto grosso in G minor, Op. 6, No. 8 ("Christmas")*  
†Vivaldi: *Sinfonia in G*

Vera Dénes, cello; Hungarian Chamber Orchestra, Vilmas Tátrai, cond.  
• MONITOR MC 2056. LP. \$4.98.  
• • MONITOR MCS 2056. SD. \$4.98.

The Hungarian Chamber Orchestra, organized in 1957, is another of the now numerous groups specializing in baroque and other compositions written for small orchestras. To judge by the present sample, it is a well-trained collection of able players, on a par with some of the better Italian, American, and German ensembles of this type. There are more imaginative recordings of the Corelli in the catalogues, and the Vivaldi, which I could not find in Pincherie's thematic index, sounds like an authentic but middle-grade work by that master. The chief point of interest on this disc is the Tartini, a very attractive work in that transitional, mid-eighteenth-century style which embodies some traits of the dying baroque and others of the oncoming Classic era. Its four movements are in the old slow-fast-slow-fast pattern, but the third, a Grave, a brooding poetic reverie, points far ahead. Good sound. N.B.

**TCHAIKOVSKY:** *Concerto for Violin and Orchestra, in D, Op. 35*

David Oistrakh, violin; Philadelphia Orchestra, Eugene Ormandy, cond.  
• COLUMBIA ML 5698. LP. \$4.98.  
• • COLUMBIA MS 6298. SD. \$5.98.

Of the many recordings David Oistrakh has made of the Tchaikovsky Concerto, this must surely rank as the best. His suave tone has never sounded richer, while everything is in its proper place interpretatively to produce a well-proportioned, glowing account of this lyrical masterpiece. The first movement appears to be uncut, though the usual excisions are made in the finale. Ormandy and his superlative orchestra provide ideal support, and the reproduction matches the glow of the performance. P.A.

**TCHAIKOVSKY:** *The Nutcracker, Op. 71*

Utah Symphony Orchestra, Maurice Abravanel, cond.  
• VANGUARD SRV. 123/24. Two LP. \$3.96.  
• • VANGUARD SRV 123/24 SD. Two SD. \$5.96.

Normally, after praising the gleamingly bright and clean recording here (scarcely

## Now! The identical world-acknowledged **FAIRCHILD** components are available in EASY-TO-ASSEMBLE **KITS**

The same electro-mechanical know-how that for over a quarter century has established FAIRCHILD as a leader in quality components is now available to the astute audiophile and kit builder in quality controlled ready-to-assemble kits.

### FAIRCHILD 412-1K Turntable Kit

For the astute audiophile who dreams of owning only the finest the famous FAIRCHILD 412 is now available in kit form. The

FAIRCHILD 412-1K is identical as its assembled counterpart which includes locked in synchronous 33 1/3 speed, 8 lb. turntable and

the famous exclusive FAIRCHILD Double-Belt Drive. Comes complete with mounting board.

KIT \$74.95

Assembled \$95.00

### FAIRCHILD COMPANDER® Model 510K

Dynamic Realism in kit form! Through the use of the FAIRCHILD COMPANDER you can now add Dynamic Realism to all your disc and tape recordings. Acclaimed by music and audio experts the COMPANDER restores many of the dynamic values that are necessarily controlled in recording or broadcast. Can also be used as a compressor for background music.

KIT \$59.95

Assembled \$75.00

### FAIRCHILD 440-2K Turntable Kit

This Fairchild single-belt drive, two-speed turntable, 33 1/3 and



45 rpm., has performance characteristics similar to the famous FAIRCHILD 412. This

robustly designed FAIRCHILD 440-2K kit with fast speed change, accurate speed control through use of FAIRCHILD Speed Sentinel, unusual low low rumble and practically immeasurable wow and flutter makes this a desired addition to any quality component system. Comes complete with mounting board.

KIT \$58.00

Assembled \$69.95

All these FAIRCHILD KITS are available at your audio dealer. Write for complete details.

## FAIRCHILD

RECORDING EQUIPMENT CORPORATION  
10-40 45th Ave., Long Island City 1, N.Y.  
CIRCLE 42 ON READER-SERVICE CARD

GRANT

# JOHANNESSEN

PLAYS

GABRIEL

# FAURÉ

Vol. I—CR 4030

Vol. II—CR 4046

"... the music as it should be played."  
—N. Y. Times

FRANCIS

# POULENC

CR 4042

"... this one is sheer fun to hear."  
—N. Y. Herald Tribune

Available at your dealer

or write

## GOLDEN CREST RECORDS

222 Broadway

Huntington Station, N. Y.

CIRCLE 45 ON READER-SERVICE CARD

**ROBERTS STEREO TAPE RECORDERS**



**LAWRENCE WELK:**  
"My Roberts 1040 tape recorder is the closest to recording studio equipment that I have seen."

**ONLY THE ROBERTS 1040**  
**4-TRACK STEREO PHONIC TAPE RECORDER**  
**Combines these Advanced Features:**  
Unique "listen-to-yourself" feature • Records new FM MULTIPLEX STEREO CASTS • 4-track stereo and monaural record/play • 2-track stereo and monaural play • Sound-with-sound, using either track as basic track • Dual, self contained power stereo amplifiers • Dual, built-in extended range stereo speakers • Automatic shut-off. **\$329.50**

ROBERTS ELECTRONICS, INC. Dept. HF-4-L  
5920 Bowcroft Ave., Los Angeles 16, Calif.  
Please send me:

Roberts Stereo Tape Instruction Manual containing stereo and monaural applications. I enclose 25¢ (cash, stamps) for postage and handling.

The name of my nearest dealer.

Name \_\_\_\_\_

Address \_\_\_\_\_

City \_\_\_\_\_ Zone \_\_\_\_\_ State \_\_\_\_\_

CIRCLE 72 ON READER-SERVICE CARD

less attractive in monophony than its of course even airier stereo edition), one would assign a relatively low rank to this latest entry in the complete *Nitcracker* discography. For it's impossible to claim that Abravanel's "concert" reading approaches the balletic grace of Irving's, the poetry of Rodzinski's, or the blazing virtuosity of Ansermet's; and even at its best the Utah Symphony (and University of Utah Chorus in *The Waltz of the Snowflakes*) cannot match the tonal refinement and brilliance of these rival conductors' forces. But Vanguard's shrewdness in releasing this otherwise routine album in its bargain-price "demonstration" series gives it a substantial special significance in that it is sure to tempt listeners previously unfamiliar with the complete score to discover how much more there is in this ballet than in the familiar suite or abridgments alone.

R.D.D.

**TCHAIKOVSKY: *Romeo and Juliet: Balcony Scene Duet***—See Glinka: *Songs*.

**VERDI: "Great Duets"**

*Don Carlos: Io vengo a domandar. Aida: Pur ti riveggo. Simon Boccanegra: Vieni a mirar. Un Ballo in maschera: Teco io sto; Non sai tu. Otello: Già nella notte.*

Eileen Farrell, soprano; Richard Tucker, tenor; Columbia Symphony Orchestra, Fausto Cleva, cond.

• COLUMBIA ML 5696. LP. \$4.98.

• • COLUMBIA MS 6296. SD. \$5.98.

Listeners who do not own satisfactory complete editions of most of the operas represented here may find this disc rewarding enough. The music is all top-grade Verdi, and the combination of Tucker's utterly reliable, resonant tenor with Farrell's sumptuous soprano means that the music is, in a general way, done justice. Still, much of Farrell's singing is on the passionless, static side, almost as if her attention were wandering, and Tucker's failure to do more than outline a treatment of the music means that his portion of the singing is predictable and not terribly varied.

There are opportunities missed. Neither artist really gets beneath the surface of the *Don Carlos* scene, which is one of the most subtly painted in all Verdi. For some reason, Gabriele's "*Cielo di stelle orhato*," which is supposed to be sung offstage at the beginning of the *Boccanegra* excerpt, is barreled into the microphone as if the tenor were standing on the apron of the stage. Cleva, whose accompaniments here are never more than routinely adequate, is so insistent about his steady quick beat in the *Ballo* duet that both singers tend to sound at some points like voice machines rather than artists. And surely a retake could have put Mr. Tucker more squarely on pitch for his "*Già la pleiade ardente in mar discende*" near the end of the *Otello* duet; in his effort to create an effect of immobility, he manages to sing quite distinctly below the tone throughout the phrase.

None of these things is a disaster in itself, but together they conspire to turn what should have been an exciting record into a collection of competently done, occasionally rousing scenes. The sound per se is good, though there seems little difference between the mono and stereo versions.

C.L.O.

**VIVALDI: *Psalm 126, Nisi Dominus; Magnificat, in G minor***

Emilia Cundari, Angela Vercelli, sopranos (in the *Magnificat*); Annamaria Rota, alto; Polyphonic Choir of Turin (in the *Magnificat*); Angelicum Orchestra of Milan, Carlo Felice Cillario, cond.

• MUSIC GUILD 11. LP. \$4.12 to members; \$5.50 to nonmembers.

• • MUSIC GUILD S 11. SD. \$4.87 to members; \$6.50 to nonmembers.

There are somewhere between a hundred and two hundred instrumental works by Vivaldi on discs, but only four of his sacred vocal compositions are listed in Schwann. This reflects the general attitude towards the Red Priest: his instrumental works are being published and discussed and analyzed, but not so his operas and choral works. That this imbalance has been depriving us of some fine music is shown by the present disc, a first recording of the works it contains. The *Psalm*, for alto and orchestra, has much of interest in it, such as the skillful writing for the voice, a darkly expressive *da capo* aria ("*Cum dederit*"), and an effective use of the viola d'amore as obbligato instrument in the "*Gloria Patri*." But it is the *Magnificat* that is especially impressive: it is as fine a work by this master as I have heard. As was customary in the baroque period, each sentence is set as a separate number. Some of them are made into beautiful arias for soprano, mezzo, or alto; the rest are choral movements, powerful and dramatic when the text invites such qualities ("*Fecit potentiam*," "*Deposuit potentes*"), or full of poignant harmonies ("*Et misericordia*"). There is little emphasis on counterpoint: melody, harmony, and rhythm are the chief elements of this expressive music. The soloists perform their tasks capably, the chorus is good, and the sound is quite satisfactory.

N.B.

**VIVALDI: *Sinfonia in G***—See Tartini: *Concerto for Cello and Orchestra, in D*.

**WHITNEY: *Concertino***

†Kurka: *Symphony No. 2, Op. 24*

Louisville Orchestra, Robert Whitney, cond.

• LOUISVILLE LOU 616. LP. \$5.98. (Available on special order only.)

As conductor of the Louisville Orchestra, Robert Whitney has been responsible for the commissioning, first performance, and recording of more modern music than all the other current conductors of American symphony orchestras rolled into one; this, however, is his first recording of any of his own music. The *Concertino* is a light, extremely gracious, piece in four movements, a little in the tradition of Grieg's *Holberg Suite*.

Robert Kurka, whose Second Symphony is on the other side, died prematurely in 1957. The symphony is a vivid, brilliant, hard-driving but finely shaped affair, basically in the *sec*, neoclassical style, but with genuflections to Copland and Prokofiev by the way. The piece indicates that Kurka could have gone far, but its values are by no means purely symptomatic; it is well worth hearing and treasuring for itself. The performances are presumably of the highest authority and the recordings themselves are good.

A.F.

HIGH FIDELITY MAGAZINE

## RECITALS AND MISCELLANY

### E. POWER BIGGS: "A Stereo Festival of French Organ Music"

Widor: *Organ Symphony No. 5: Toccata in F*. Saint-Saëns: *Fantasia in E flat*. Franck: *Pièce héroïque*. Gigout: *Scherzo in E*. Vierne: *Organ Symphony No. 1: Final*. Alain: *Litanies*. Dupré: *Variations on a Noël*.

E. Power Biggs, organ.  
● ● COLUMBIA MS 6307. SD. \$5.98.

This recording gives more of a left-right antiphonal effect than any other stereo organ disc I have ever heard. Whether or not this treatment is ideal is arguable, but it seems well enough suited to the music at hand, and it is sure to excite the neophyte with brand-new twin-channel equipment. The new Möller organ in St. George's Church, New York City, is actually three organs, the Positiv and Choir divisions on the left, the Great and Swell to the right, and a Bombarde with Principals and Reeds high in a gallery in the rear. The pedal stops are distributed among the three sections. The resulting possibilities for stereo exploitation are obvious, and Biggs takes full advantage of them, albeit with complete musical taste. The music, selected from the works of late nineteenth- and twentieth-century French organist-composers, is mostly of a showy nature, and Biggs gives it bright registration and fleet-fingered delivery. From both the sonic and musical standpoint, the most interesting of the pieces is Marcel Dupré's *Variations on a Noël* where, at one point, there is a canon between the left and right organ divisions. In addition to fine separation, Columbia has provided reproduction that is wide in tonal and volume range. P.A.

### APRIL CANTELO: *Eighteenth-Century Shakespearean Songs*

April Cantelo, soprano; Raymond Leppard, harpsichord; English Chamber Orchestra, Raymond Leppard, cond.  
● OISEAU-LYRE OL 50205. LP. \$4.98.  
● ● OISEAU-LYRE SOL 60036. SD. \$5.98.

The present disc comprises a well-chosen selection of fourteen songs, most of them with texts from Shakespeare's plays. All the composers are English except Haydn (*She never told her love*, from *Twelfth Night*) and John Christopher Smith, the German-born son of Handel's amanuensis (three songs). There is variety in style and mood, and a rather high level of quality. Some songs are accompanied by a string orchestra (sometimes with flute), the rest by a harpsichord, although two of these—the Haydn and William Linley's *Now the hungry lion roars*—might have been done on a piano instead. Miss Cantelo reveals a wide range of skills. She colors her tones nicely in accordance with the texts, singing with vigor in John Weldon's *Take, o take those lips away*, with delicacy and fancy in Smith's *You spotted snakes*, with lovely, flowing lyricism in T. A. Arne's *Thou soft-flowing Avon* (to a text by Garrick), and with mock sadness in Smith's *Sigh no more, ladies*. In Arne's *Come away Death*, one of the best of

these pieces, she is particularly expressive, and produces exemplary legato scale passages as well as a strong, round high note. Long, florid phrases are smoothly negotiated. Altogether an interesting and rewarding disc, well recorded. N.B.

### VICTORIA DE LOS ANGELES and DIETRICH FISCHER-DIESKAU: *Vocal Duets*

Purcell: *Let us wander; Lost is my quiet*. Haydn: *Schlaf in deiner engen Kammer*. J. S. Bach: *Ah, lamenta oh bella Irene*. Beethoven: *Oh! Would I Were but That Sweet Linnet; He Promised Me at Parting; They Bid Me Slight My Dermot Dear; The Dream*. Schubert: *Nur wer die Sehnsucht kennt*. Berlioz: *Le Trébuchet*. Dvořák: *Möglichkeit; Der Apfel*. Tchaikovsky: *Schottische Ballade*. Saint-Saëns: *Pastorale*. Fauré: *Pleurs d'or*.

Victoria de los Angeles, soprano; Dietrich Fischer-Dieskau, baritone; Gerald Moore, piano; Eduard Drolc, violin, and Irmgard Poppen, cello (in the Haydn and Beethoven).

● ANGEL 35963. LP. \$4.98.  
● ● ANGEL S 35963. SD. \$5.98.

This is a very beautiful record, if one will sit back and let its total effect take hold. There are certain problems inherent in the De los Angeles/Fischer-Dieskau partnership. The timbre and quality of each voice is quite distinct; the two singers' approaches to interpretation differ, sometimes rather startlingly; and, in languages where neither of them sings as a native, their accents are not similar. All these things stand in the way of what we might call "perfect" duet singing. Yet, because each artist places the music ahead of everything else, and because each of them is expert in the techniques of scaling and coloring the voice, such problems are minimized.

What we are left with are two of the richest, best-controlled voices in the world today, applied to strong expressive purpose in music which we do not often hear, at least in duet form. The high point, for me, is the Bach "*Ah, lamenta oh bella Irene*"—purely focused, flowing *bel canto* singing of the finest sort. But no one will want to miss the quasi-operatic drama of Tchaikovsky's setting of the *Ballad of Edward* either, or the murmuring of the lovely Saint-Saëns *Pastorale*. The music, in fact, is all quite lovely, except for a cute little horror by Berlioz called *Le Trébuchet*: let us hope that these two artists will now turn their attention to some of the Mendelssohn two-part songs or to other neglected cornerstones of the literature for two voices. The instrumentalists' contributions are thoroughly praiseworthy.

Precisely because the stereo version does such an excellent job of distinguishing among timbres—of separating the elements, and not quite putting them back together—I find that the mono edition makes pleasanter listening. C.L.O.

### DOM JOSEPH GAJARD: *Gregorian Chant*

Choir of the Monks of L'Abbaye Saint Pierre de Solesmes, Dom Joseph Gajard, O. S. B., cond.  
● LONDON 5632/33. Two LP. \$4.98 each.

These discs are devoted mainly to the Ordinary of the Mass for various occasions. No. 5632 offers Masses I, IX, XI, XVII, and XVIII. Appended to



A PRECISION  
4 SPEED



PLAYBACK UNIT,  
SECOND TO NONE

for only \$99<sup>50</sup> complete

For the ultimate in record playing togetherness, ask your dealer for the ESL Concert Series playback unit—the unique, high performance Gyro/Spension turntable, the famed Super Gyro/Balance arm and the Triumphant new Redhead stereo cartridge—all factory assembled for your instantaneous pleasure. This harmoniously engineered combination assures you the finest reproduction obtainable... just plug it in.

ESL-61 Concert Series  
playback unit, complete,  
\$99.50



FOR LISTENING AT ITS BEST

Electro-Sonic  
Laboratories, Inc.

Dept H - 627 Broadway - New York 12, NY



CIRCLE 39 ON READER-SERVICE CARD



## be an angel

write to us in London for a free back issue of RECORDS & RECORDING or MUSIC & MUSICIANS—the illustrated English monthly magazines which are absolutely devoted to classical records and music.

HANSOM BOOKS

7 & 8 HOBART PLACE  
LONDON SW1, ENGLAND

CIRCLE 48 ON READER-SERVICE CARD

# Musica Antiqua Bohemica



A unique collection of recorded masterpieces

from 18th century Bohemia

GRAND PRIX DU DISQUE

de l'Académie Charles Cros, Paris

"The recordings...were made well, with constant adaptability to the special characteristics of the pieces in hand. Altogether, these six records represent an admirable idea handsomely carried out." Saturday Review

Beautifully packaged in a linen jacket with a booklet of extensive musical annotations and handsome full color art reproductions.

Suggested list price \$6.98 per record

Exclusive Distribution by  
ARTIA-PARLIAMENT INDUSTRIES, INC.  
38 West 48th Street, N. Y. C. 36, N. Y.

CIRCLE 8 ON READER-SERVICE CARD

82

Mass I is the antiphon *Vidi aquam*. The listing of the contents on the sleeve of this record is incomplete: it omits the Sanctus in Masses I and XI and the Agnus in Mass IX, but these chants are included on the disc (and listed on the labels). Especially striking is the Kyrie of Mass XI, with its sinuous curve and uncommon leaps. One is accustomed to thinking of these ancient melodies as purely modal, yet several of them—the Sanctus and Agnus of XVII, the Sanctus and Agnus of IX—are squarely in a major key. No. 5633 continues with Masses XII and XV and the Requiem Mass. The last is rounded off by the antiphon *In paradisum*. It seems to me that Dom Gajard's finely trained choir sings here with even more fervor and rhythmic and dynamic nuance than usual. N.B.

### BENIAMINO GIGLI: *Operatic Recital*

Leoncavallo: *I Pagliacci: Vesti la giubba*. Verdi: *Rigoletto: La donna è mobile*. Aida: *Celeste Aida*. Puccini: *Tosca: E lucevan le stelle*. La Bohème: *Che gelida manina*. Donizetti: *L'Elisir d'amore: Una furtiva lagrima*. Massenet: *Manon: O dolce incanto*. Bizet: *Carmen: Il fior che avevi a me tu dato*. I Pescatori di perle: *Mi par d'udir ancora*. Agnus Dei. Handel: *Serse: Ombra mai fu*. Gounod: *Faust: Salve, dimora*.

Beniamino Gigli, tenor; various orchestras and conductors.

• ANGEL COLH 118. LP. \$5.98.

This is an excellent representation of the Gigli of the 1930s—that is, Gigli at vocal flood tide (though for some purely lyrical roles he was probably in his best estate during the first fifteen years of his lengthy career). No tenor has been more generously gifted, at least in terms of voice; certainly our century has known no more beautiful sound. On the other hand, few singers are such infuriatingly sloppy musicians, such annoyingly tasteless interpreters.

Both the good and the bad are demonstrated on this disc. On the credit side are the magnificent legato of this "*E lucevan le stelle*"; the incredible sustained mezza voce of this "*Mi par d'udir ancora*"; the sheer liquid luster of tone throughout the recital. On the other hand, there is a "*Che gelida manina*" spiked with aspirate h's, unnecessary breaks in the line, and notes slid over so carelessly as to be almost unvoiced. The same absurdities mar the "Flower Song" (though to a lesser extent), and several of the other renditions, effective as they are, would be still better with closer attention to the composer's instructions and to ordinary good taste. In some ways, I prefer the Victor collection (LM 2337), which represents the Gigli of a few years earlier—somewhat fresher-voiced, somewhat less effusive—and which includes the magnificent Gigli/De Luca duets.

Angel's record includes the handsome informative booklet, complete with texts and translations, that is usual with releases in this series. C.L.O.

### WILLIAM KAPELL: "*The Unforgettable Kapell*"

Khachaturian: *Concerto for Piano and Orchestra, in D flat*. Albéniz: *Evocación*. Liszt: *Mephisto Waltz*. Rachmaninoff: *Rhapsody on a Theme by Paganini: Variation 18*.

William Kapell, piano; Boston Symphony Orchestra, Serge Koussevitzky, cond. (in the Khachaturian); Robin Hood Dell Orchestra, Fritz Reiner, cond. (in the Rachmaninoff).

• RCA VICTOR LM 2588. LP. \$4.98.

It seems to me that the repertoire chosen for this Kapell memorial pays dubious homage to the late pianist. Kapell's magnificent recording of the Rachmaninoff Rhapsody has been crying out for re-issue, and why can't RCA re-release it in its entirety? Eighteenth Variation, indeed! And in regard to the Khachaturian Concerto, I submit that Victor should have entitled the release "The Art of Serge Koussevitzky," for that conductor's absurd posturings and interpretative pretentiousness are certainly the dominant features of the performance. In an attempt to endow this intentionally flashy concerto with "significance," the late conductor draws from his orchestra weighty, Parsifal-like declamations, and poor Kapell, brilliantly though he plays, is all but crushed under the lugubrious tonnage of the B.S.O.

The *Mephisto* and Albéniz performances were recorded at an early stage in Kapell's tragically short career, but both are excitingly rendered. The sound of the solo selections is adequate, that of the Khachaturian, wheezy on top, boomy below. Let us hope RCA will issue a happier sequel to this ill-judged disc. H.G.

### LOUIS LANE: "*Music for Young America*"

Cleveland Pops Orchestra, Louis Lane, cond.

• EPIC LC 3819. LP. \$4.98.

• EPIC BC 1154. SD. \$5.98.

The main thing here is the suite from Herbert Elwell's *The Happy Hypocrite*. This was written for the dancer, Charles Weidman, and anyone who ever saw his dance composition of that title, based on a story by Max Beerbohm, will never forget it; it was one of the masterpieces of modern dance. One good reason for its success was Elwell's delightful score, which is as clever a piece of satirical and lyric music, in a light, transparent vein, as the American repertoire affords.

The disc also includes Copland's well-known *Outdoor Overture*, a suite from Menotti's *Amahl and the Night Visitors*, Wallingford Riegger's *Dance Rhythms*, and Arthur Shepherd's *The Old Chisholm Trail*. All in all, a singularly bright, entertaining, and instructive set, beautifully performed and recorded. A.F.

### JAMES PELLERITE: *Flute Recital*

Poulenc: *Sonata for Flute and Piano*. Mozart: *Sonata for Violin and Piano, in F, K. 13*. Hüe: *Fantaisie*. Bournonville: *Danse pour Katia*. Paganini: *Caprice No. 23, in E flat*. Debussy: *Children's Corner Suite: Le petit berger*. Popp: *Nachtigallen Serenade*.

James Pellerite, flute; Ashley Miller, piano.

• GOLDEN CREST RE 7010. LP. \$4.98.

This disc is one of a series of recital records featuring various wind instruments and designed with the student in mind. It makes for good listening by anyone. Especially is this true of the charming little Poulenc Sonata, which is closely related to the composer's earlier Sextet for Piano and Winds. The amaz-

HIGH FIDELITY MAGAZINE

ingly chromatic Mozart Sonata, written when the composer was eight, and Hübner's *Fantaisie*, a typical flutist's showpiece, are also noteworthy.

Pellerite, who served for a season as first flutist of the Philadelphia Orchestra, is a master of his instrument. His tone is full and appealing in all registers, his technique secure, and his interpretations clear and straightforward. He sounds particularly effective in the Poulenc Sonata and the unaccompanied Paganini Caprice, the latter requiring some rapid octave shifts. Miller is an excellent sonata partner and accompanist. There is exceptional realism and equitable balance in the full-range, close-up recording. P.A.

**STEWART ROBB: Music for Harpsichord and Virginal**

Stewart Robb, harpsichord and virginal.  
 • FOLKWAYS FM 3320. LP. \$5.95.

On one side of the present disc Mr. Robb, at the harpsichord, plays *La Capricciosa*, a theme with thirty-one variations. This work was first published in 1942 and its authorship is ascribed to Dietrich Buxtehude. Some of the variations are imaginative and of differing moods, others are rather monotonous, but on the whole it is a very interesting set, a kind of predecessor of the *Goldberg Variations*, though there is no evidence that Bach knew it. Side 2 contains pieces by Byrd, Bull, Gibbons, Frescobaldi, and Purcell and two anonymous dances, all played on a modern virginal. Especially attractive among these are the songlike Pavana by Byrd, and the charming anonymous Coranto. Except for Purcell's "Sicilienne," where the rhythm is curiously halting, all the pieces are nicely played, and the sound is excellent. N.B.

**SIR MALCOLM SARGENT: "English Ballets of the Twentieth Century"**

Royal Philharmonic Orchestra, Sir Malcolm Sargent, cond.  
 • ANGEL 35889. LP. \$4.98.  
 • • ANGEL S 35889. SD. \$5.98.

Two of the three works recorded here are not ballets at all, but concert pieces to which choreography has been composed. They are Sir William Walton's *Façade*, in its orchestral version, and Benjamin Britten's *Simple Symphony*. The third piece, Gustav Holst's *The Perfect Fool*, is (or was) an opera that contained a ballet: the three dances presented here are pleasant but unimpressive.

This release as a whole is a devastating comment on the use of British music in the British dance theatre. The English don't commission their best composers to write ballet scores but take over their concert works for the stage, and such ballet music as they do commission is not very good. There are some exceptions to these generalizations, but on the whole they are true.

*Façade* has, of course, been recorded many times. Sir Malcolm underlines its insouciant qualities very deftly, but the best thing on the disc is the delightful *Symphony* by Britten. This work was written when its composer was nineteen years old, although some of its material goes back to his early childhood. It is for string orchestra, and it reminds one a little of Schubert in the purity of its tunefulness and the frank simplicity of its appeal. A.F.

Historic collaboration presents

**A TREASURY OF EARLY FRENCH ORGAN MUSIC**

■ *Andreas Silbermann*, one of the great organ builders of all time; completed the Organ for the Abbey Church of Marmoutier, Alsace in 1709. His suave and gentle bourdons, varied and incisive reeds, colorful mutations, exciting Fourniture, Cymbale and splendid Cornet join and swirl about you in a 13th C. nave to offer a new listening experience — The French Baroque Organ, and its Music.

■ *Melville Smith*, awarded the 1961 Grand Prix du Disque for his recording of the complete works of De Grigny (Disques Valois, Paris) is, in the words of an outstanding French critic, "a scholar completely aware of the traditions of the French organ school, whose playing recreates the nobility, the ardent zeal, and the intense vitality and inner life of this music."

■ *Peter Bartók*, Master recording engineer, takes you on a journey in time for an experience of tonal beauty and historic integrity. He is your link to the serious side of this great period so often dismissed as a comedy of perfumed ladies and gentlemen, namely, the music of the divine service, presented at its best, in a beautiful and resonant building on a superb instrument of the period.

**A TREASURY OF EARLY FRENCH ORGAN MUSIC**  
 Vol. I (CRS-506) Pieces from the Livre d'Orgue of Nicolas de Grigny and the Suites of J. F. Dandrieu.

Vol. II (CRS-507) The Hymn "Exsultet Coelum" of Jean Titelouze, Offertoire in C of François Couperin, bell pieces of Louis Couperin and Nicolas Lebègue, the Benedictus of Couperin, the Basse de Trompette of Clérambault, and the Dialogue du Troisième Livre of Louis Marchand.

FROM YOUR DEALER, or \$4.98 each record post-paid (mono only).

**CAMBRIDGE RECORDS, INC.**  
 473 Washington Street, Wellesley 81, Mass.  
 CIRCLE 23 ON READER-SERVICE CARD

VANGUARD RECORDS

**ERICH KUNZ**

"A rousing, ribald and thoroughly splendid songfest."

*Playboy*, on Vol. 1

"An unqualified triumph of the recording art."

*High Fidelity*, on Vol. 2

"No happier events have occurred for lovers of Viennese ebullience."

*Washington Star*, on Vol. 3

"Wonderful y human songs... consummate artistry."

*Musical Courier*, on Vol. 4

and now —

**GERMAN UNIVERSITY SONGS**

Vol. 5

Mono and Stereo



Songs of Revelry, Riba dry and Romance with chorus and orchestra of the Vienna State Opera, Anton Paulik conductor.

Send for free catalog. Vanguard 154 W. 14 St., N.Y.  
 CIRCLE 93 ON READER-SERVICE CARD

take any size  
 THE CYBERNETICALLY ENGINEERED STEREO TAPE RECORDERS



reel... even 10 1/2"

- MIXING CONTROLS
- 2 INPUTS EACH CHANNEL
- MONITOR WHILE RECORDING
- POINTER-TO-POINTER RECORDING LEVEL METERS
- 4-DIGIT COUNTER

**NEWCOMB**

They're the easiest to operate tape recorders made because they are cybernetically engineered — tailored to intuitive operation. The natural thing to do is the right thing to do. Furthermore, they are most gentle with tape. Tape transport has been granted a U.S. patent. There are two models — SM-310, half-track; SM-310-4, quarter-track. Write for free catalog.

**NEWCOMB AUDIO PRODUCTS CO., Dept. W-4 6824 Lexington Ave., Hollywood 38, Calif.**  
 CIRCLE 102 ON READER-SERVICE CARD

# SOUND EFFECTS!



**NEW PERSPECTIVES IN  
PIANO SOUNDS...  
DAVID SWIFT B/BS 1441**







**INGENUITY  
IN SOUND  
...BUDDY COLE  
B/BS 1442**



**THE FOURTH DIMENSION  
IN SOUND...  
SHORTY ROGERS  
B/BS 1443**



**DYNAMIC ADVENTURES  
IN SOUND  
...MEL HENKE  
B/BS 1447**

There are all kinds of sound effects. And all kinds of sound *affects!* Here at Warner Bros., where recorded sound was born, we take a rather special interest in the discovery of new directions.  Six months ago Warner Bros. Records assigned a task force of fine composers and arrangers and top recording engineers to produce The Stereo Workshop Series.  This creative team, while recognizing that the purpose of sound recording is never to distort the music itself, maintained that audio recording techniques *can* enhance music presentation.  Experimenting with both theory and practical application, the Workshop group crystallized an exciting new concept that not only extends the frontiers of sound recording, but adds a dramatic new perspective to music itself.  Through the use of as many as six separate Ampex recording decks, overdubbing, re-recording, and absolute audio separation (sometimes by simultaneous use of two or more recording studios) composers and arrangers are given a new means of musical expression. Added to tonal, rhythmic and harmonic dimensions is a fourth—*space!* Result: audio adventures that explore uncharted patterns of music and *sound*. Listen!

the first name in sound  
**WARNER BROS. RECORDS**

4000 Warner Boulevard  
BURBANK, CALIFORNIA

CIRCLE 103 ON READER-SERVICE CARD



# The Lighter Side



POPULAR • THEATRE • FOLK

## For Each Song, Some Slight Personal Way

✓  
“Broadway’s Fair Julie.” Julie Andrews; Henri Rene and His Orchestra. Columbia CL 1712, \$3.98 (LP); CS 8512, \$4.98 (SD).



Oh rare Miss Andrews.

THE “Made in America” career of England’s Julie Andrews is one of those old-time *Cinderella* stories in the annals of the theatre. When Miss Andrews arrived in this country in the summer of 1954 as a member of the cast of the American production of *The Boy Friend*, she was completely unknown to American audiences. For that matter, she was almost equally unknown to London theatre-goers, although some may have remembered her appearance in *Starlight Roof*, a London revue of 1948. In this extravaganza she had been given, at the tender age of thirteen, a solo spot during which she sang “*Je suis Titania*” from Thomas’s opera *Mignon*. It is unlikely that her performance was compared to Tetrzini’s, but it evidently made enough impres-

sion to be recorded by English Columbia. (I have yet to meet anyone, though, who ever heard the recording.) Three pantomimes and six years later she came to New York.

On the night of September 30, 1954, she stepped on stage as the blond-wigged heroine of Sandy Wilson’s delightful spoof of the musical comedies of the Twenties, giving one of the most enchanting performances seen in the New York theatre in years. The show received unanimous praise, and on October 1, Julie Andrews awoke to find herself a star. If Sandy Wilson and his director, Vida Hope, were responsible for discovering her potentials, it was Lerner and Loewe, however, and the late Moss Hart who developed and fully exploited them, first in *My Fair*

*Lady* and later in *Camelot*. Yet, although her career has been shaped by American directors and methods, she remains, *au fond*, a very English performer, with a style and manner that seems to have strayed out of one of the better Edwardian musical comedies. Today she has become that rarity in the musical comedy theatre—a beautiful woman with stunning stage presence, a good actress, a resourceful comedienne, and a leading lady who can really sing.

Apart from her work on the original cast recordings of her three starring vehicles, Miss Andrews has not made many recordings. Two still remain in the catalogue, a collection of children's songs and stories (with Martyn Green) on Angel, and RCA's *Rose Marie*, in which I felt she was sadly miscast. Her most charming recorded program, a fine collection of songs by Kern, Coward, Gershwin, and Arlen (RCA Victor LPM 1681), has been deleted. But wonderful as that was, it is now superseded in every way by Columbia's new recording of outstanding show tunes, which, with one exception, might all have been written expressly for this singer. The exception—*A Fellow Needs a Girl*, from *Allegro*—Miss Andrews sings beautifully, but it simply isn't right for her or for any female vocalist. The remainder? I can only single out what seem to me the finest performances in a wonderful program.

In an absolutely fascinating performance of

*I Feel Pretty*, her phrasing of certain words is so expressive that the portrait of a young girl in love is literally created in front of the listener's eyes. Arlen's *A Sleepin' Bee*, one of his most delicate and inspired songs, has long been a personal favorite of mine. I have never heard it more beautifully sung, or its lyrics more beautifully handled. It is a joy. And *How Are Things in Glocca Morra?*—the appeal of which has eluded me all these years—becomes a revelation. Miss Andrews brings to the questioning phrases in the lyrics a sort of youthful eagerness which finally makes the whole song fall into place. From Kurt Weill's score for *Lady in the Dark* she has chosen *This Is New*, a song I have always regarded as the personal property of the great Gertrude Lawrence. Miss Andrews sings it almost exactly as Miss Lawrence did—the same tempo, the same wonder in the voice; and since Miss Andrews has a more musical voice, I must, rather reluctantly, give her the palm. And so it goes with the remainder of the program, each song illuminated by some slight personal way with both lyrics and melody, nothing out of place, everything perfection.

This sweet, lyrical voice is beautifully presented in Columbia's excellent stereo sound, which also does full justice to the fine arrangements (by whom?) which the Henri Rene Orchestra plays so handsomely in accompaniment. J.F.I.

## **Eighteen Virtuosos Who Play Accordions**

**"Accordiorama." Hohner Accordion Symphony Orchestra, Rudolf Würthner, cond. Vanguard VRS 9098, \$4.98 (LP); VSD 2105, \$5.95 (SD).**



*Conductor Rudolf Würthner.*

**T**HERE WAS A TIME when I shared the common supercilious inability to recognize the accordion's potentials as a serious musical instrument. Indeed, I probably would have contemptuously dismissed an accordion-orchestra program unheard. That time, I am glad to say, is no more.

Enlightenment came with hearing Larry Adler and John Sebastian demonstrate the unsuspected resources of another long-disdained instrument, the harmonica. Then I discovered that the accordion too not only could be played with genuine distinction in pop and jazz styles (by Jo Basile, Art Van

Damme, and others) but that a few exceptional soloists could endow it with true artistry in more substantial repertoires. The recorded transcription recitals by Mogens Ellegaard for Vox and Charles Magnante for Award Artists, plus the older but still extraordinary Angel LP of Yuri Kazakov's performances on the *bayan*—a Russian variety of button-key accordion or concertina—come at once to mind. Probably there are others, but these alone at least prepared me for what is to be heard in the present release. Here some eighteen virtuoso instrumentalists (genuine musicians, who just happen



to play accordions), plus a highly professional percussionist, are led by an electrifyingly vital conductor in transcriptions of familiar light symphonic favorites.

What the redoubtable young Rudolf Würthner and his obviously well-drilled players can do—and how well they meet the highest standards of precision, phrasing, tonal nuance, richness of sonority, and dynamic variety—must be heard to be believed. There is no suggestion here of the wheeziness, throbs, or sonic coarseness so often characteristic of café accordionists. Often one is scarcely aware that normal orchestral instruments are not being used; when one is, the clues are only the novel growly timbres in the low register or a velvety organlike quality elsewhere.

The selections themselves, while hardly daring, are certainly varied and testing enough: the Johann Strauss *Perpetuum mobile*, Liszt *Hungarian Rhapsody No. 2*, Weber *Invitation to the Dance*, Brahms *Hungarian Dances Nos. 5 and 6*, Ponchielli's *Dance of the Hours*, and—perhaps most dazzlingly effective of all—Rossini's *William Tell Overture*. Quite apart from the aurally attractive and always musi-

cally expressive sonics themselves (caught to perfection in extremely pure and rich recording, but most expansively and authentically so in stereo), the readings are not only in admirable taste but are characterized throughout by rhythmic zest and controlled strength.

There are also, to be sure, a couple of *tour-de-force* show pieces: Würthner's own *Concert Etude* on Paganini's *Campanella*, starring Karl Perenthaler's incredibly fleet and florid solo accordion, and Wolfgang Vogt's rearrangement of the Dinicu-Heifetz *Hora Staccato* for solo "chromonica" (i.e., harmonica), played by Günther Wertz, with accordion-ensemble accompaniment. But flashily brilliant as these are, they remain exhibitionist displays, far less impressive in retrospect than the more straightforwardly dynamic, lyrical, and dramatic standard works. It is the latter that best reveal the accordion's true capacities—and, incidentally, enable the Hohner Orchestra to honor the name of this instrument's (and the harmonica's) best-known manufacturer: the firm established by Matthias Hohner over a century ago in Trossingen, Germany, and still carried on by his descendants. R.D.D.

["Carnival Time on the Rhine." RIAS Chorus, Hans Georg Arlt, cond. RIAS Kammerorchester, Günter Arndt, cond. Kapp KS 3269, \$4.98 (SD).

German songs boast a convivial appeal unequaled in the Western world. When the oompahs start and the singers weave their malty *Gemütlichkeit*, only the tone deaf can resist raising both stein and voice. Herr Arlt emphasizes this catchy charm as he leads his RIAS Chorus through thirty-seven favorites. Here are all the schmaltzy old standbys that never seem to age—*Du, du, liegst mir im Herzen*; *Ach du lieber Augustin*; *Muss i denn*; *Bier her, Bier her*—handsomely sung by Germans who know them, love them, and are proselytizing for them. Excellent sound wraps up a winner. O.B.B.

"The Liberty Square Dance Club." Vol. 1, with calls (Homer Garrett); Vol. 2, without calls. Liberty LRP 3218/19, \$3.98 each (Two I.P).

No square (or other) dancer myself, these are the first records of their kind to convince me that I've been missing immense fun as well as strenuous exercise. The verve of the present little ensemble led by fiddler Gordon Terry is infectious indeed when it is heard alone in a dozen favorite dance pieces, so brightly and cleanly recorded that every detail of the vibrant performances is perfectly differentiated; but when the same pieces are repeated, this time with Homer Garrett's rhythmically lilting calls, they are wholly irresistible. I can't imagine better incentives to home or club dancing, yet they are almost as stimulating for sheer listening. One regrets every time the band winds up with a flourish to Garrett's cadential "That's it—that's all!" R.D.D.



Ferrante and Teicher.

"Tonight." Ferrante and Teicher; Orchestra, Nick Perito, cond. United Artists UAI 3171, \$3.98 (LP); UAS 6171, \$4.98 (SD).

These duo-pianists here perform another of their minor miracles in bringing freshness and sparkle to a collection of film and show tunes. Particularly impressive is their ability to reilluminate the older numbers—*I'll Be Seeing You*, *The Way You Look Tonight*, and *Lili Marlene*—or to take a song such as *Tonight*, which I have never regarded as one of Leonard Bernstein's major inspirations, and turn it into something of musical stature. Even *Moon River*, which has been done to death recently, glistens brightly in their hands, and they provide a particularly lovely, lyrical performance of *Shalom*, one of the better songs from *Milk and Honey*. The orchestral arrangements, also by the pianists, are exciting, although the performances of them are inclined to be hectic; the choral group, used occasionally, I could have dispensed with; the sound is stunning in both mono and stereo versions. J.F.I.

"The Classic Della." Della Reese; Orchestra, Glenn Osser, cond. RCA Victor LPM 2419, \$3.98 (LP); LSP 2419, \$4.98 (SD).

Nobody raises an eyebrow nowadays at finding the classical music of Chopin, Debussy, or Tchaikovsky used as material for popular songs. As long as the melodies are not grossly mutilated and the arrangements not devoid of musical taste, these creations offer a pleasant and melodic change from most of the pops songs being written today. Twelve such numbers are presented by Della Reese, but in performances that can only be called extremely affected. Miss Reese goes in very heavily for "style"—which here seems to mean a curiously explosive enunciation, some garbling of vowels, supercharged emotionalism, and a veneer of sophistication. Her most successful number is Musetta's Waltz from *La Bohème*, which turns up on this disc, as it recently did on the hit parade, as *Don't You Know*. The remainder seem merely indifferent. It's a pity the singer's performances considerably vitiate the Glenn Osser arrangements, which are both stimulating and musically interesting. J.F.I.

"Lisboa Antiga." Fernanda Maria; Jaime Santos; Pais Da Silva. Monitor MFS 363, \$4.98 (SD).

For the visitor, present-day Portugal wears a mantle of wistful tragedy. The lowest per capita income in Europe stifles its economy, a ponderous dictatorship smotheres its liberty, and the last remnants of its great empire—Goa, Angola, Mozambique—slip away one by one. Even the supper clubs of Lisbon reflect the national sense of tragedy as night after night a handful of locally celebrated singers weave the darkling

spell of Portugal's traditional and unique song form, the *fado*. Dealing with melancholy and irresistible forces of fate, *fados* mourn lost loves, lost days, lost ways. *Lisboa Antiga* (Old Lisbon), the title song of this release, is typical: "Old city of Lisbon/Filled with charm and beauty/In other times there were royal bullfights/Fiestas, processions, cries of street vendors/That will never be again." Fernanda Maria, in the forefront of today's *fadistas*, is all somber fire in this outstandingly engineered collection. She is, in fact, the only *fadista* I have heard who needs concede nothing to Amalia Rodrigues, the long-time queen of the genre. Listen to Maria's deeply moving *Estante Vellina* and *Lamento Fadista* for perhaps the best *fado* available on records. O.B.B.

"The Many Voices of Miriam Makeba." Miriam Makeba; Hugh Masekela, trumpet; Ensemble. Ralph Hunter, cond. Kapp KS 3274, \$4.98 (SD). It's good to hear again from the gifted Miss Makeba, especially since this program includes more ethnically authentic and significant materials than did her first release. The selections here are primarily from the singer's native Africa, of course, but also include a West Indian ballad and calypso song, the Brazilian Carnival song from the film *Black Orpheus*, and a moving version of the American *Night Must Fall*. Almost all the pieces here are interesting, but I liked particularly the poignant *Ntjilo Ntjilo* (lullaby) and *Thanayi*, the catchy children's game song *Umqokozo*, the odd *Ngola Kuvita* with passages for Zanza

or African "thumb-piano," the unaccompanied multi-dubbed Witch Doctor's Song *Nagula*, and the naïve West Indian *Love Tastes Like Strawberries*. In many of these Miss Makeba shares honors with the distinctively original trumpet playing of Hugh Masekela; a little ensemble of two guitars, bass, and five percussion players provides vibrant accompaniments; and the stereo recording is superbly atmospheric. R.D.D.

"Linger Awhile." Vic Damone; Jack Marshall's Music. Capitol T 1646, \$3.98 (LP); ST 1646, \$4.98 (SD).

About a year ago the Damone-Marshall combination made a recording presenting the singer as a swinger. That disc I found only moderately successful, but their second effort along the same lines (this time for Capitol) is completely satisfying. In fact, it may well be the finest disc Vic Damone has made. Sounding more relaxed and assured than on any of his previous records and singing with unusual verve and freedom, he swings lightly through a batch of superior songs of the Thirties and early Forties. His performances have unusual jauntiness, yet they do not completely obscure the romantic side of these ballads. Almost every performance is a gem, although I am particularly struck by *In the Still of the Night* and the three Irving Berlin songs—*Change Partners*, *Let's Face the Music and Dance*, and *Soft Lights and Sweet Music*.

Jack Marshall has provided not only superior orchestrations, featuring a light beat, but also extremely solid musical accompaniment for the vocalist. The stereo sound is comfortably spread, with a sturdy middle of strings, Damone and rhythm section in left, brass and reeds in right, the whole very nicely meshed. The mono version is, in its way, equally good, though naturally lacking in such a broad musical span. J.F.I.

"Bud and Travis in Concert, Vol. Two." Liberty LRP 3222, \$3.98 (LP); LST 7222, \$4.98 (SD).

The appearance of this sequel to the excellent two-disc *Bud and Travis in Concert* (Liberty LDM 11001, LP; LDS 12001, SD) makes one regret more keenly the recent dissolution of this gifted team. Bud Dashiell and Travis Edmonson not only boasted vocal and linguistic equipment generally superior to other groups riding the crest of the folk song wave, but they brought genuine sensitivity to their interpretations. In addition, alone among those who bracket their songs with comic patter, they were unfailingly original, unfailingly witty.

This release lacks the luster of its predecessor culled from the same live recital at the Santa Monica Civic Auditorium in March 1960: lack of coordination rears its head once or twice and a few of the selections are of only secondary interest. But there are high points—*Angelico*, *Amor de la calle*, *My Mary*—that compare with the best numbers this duo has recorded. As between the LP and SD, the stereo neatly separates the singers insofar as repartee and solos are concerned but melds their voices nicely in the duets. To my ear, it is the version of choice. O.B.B.

"The Sound of the Sjolund Singers." Supreme SS 2008, \$4.98 (SD). Again Paul Mickelson's Supreme Recordings, Inc., distinguishes itself among

**JOURNEY TO INFINITY**

**Now . . . For the first time!**

Audio Master presents an amazing record which takes you on man's first trip to the moon! Authentic sounds from Cape Canaveral make listening experiences so realistic that you are virtually carried away by your emotions . . . An introduction by Dr. Wehner Von Braun leads you into a story . . . a story so constructed that you the listener will be a passenger on the first rocket flight to the moon.

Your flight is conducted by means of a narrator who describes each new experience encountered during launch and flight through space. In spite of the hazards you land safely on the moon . . . leaving the moon we travel further into space . . . A JOURNEY TO INFINITY.

Spectacular production in the adventures of an emotional play. Vivid sound effects, and colorful music providing the listener with exciting . . . breathtaking . . . entertainment. A record that will be a must to every high fidelity enthusiast . . . a real test of quality sound reproducing equipment. Reproduced for the listener are the powerful low frequencies of the rocket captured during blast off. Eight pages of photographs . . . 53 pictures bring most people for the first time inside Cape Canaveral . . . to see their rocket and many more breathtaking sights. Hundreds of voices and a full symphony orchestra were used to capture with music a spectacular background for this exciting story.

**Audio Master Recording Company**

**AUDIO**  **MASTER**

306 Lakeview Avenue, Orlando, Florida

CIRCLE 14 ON READER-SERVICE CARD

the numerous specialists in sacred music, this time by the rich sonorities of Paul Sjolund's thirteen-man West Coast male chorus (frequently starring the impressively robust bass solos of Paul Bergen) and by the warmth and naturalness with which, despite extremely close miking, these sonorities are captured in the most broadspread and air-borne stereoism. The music itself is of less aesthetic distinction: mostly familiar spirituals and Victorian hymns, plus a more spirited anthem, *All Ye Saints Be Joyful*, by Katherine Davis. They are sung, however, with great fervency (with one exception unaccompanied) as well as with sonic qualities rare in this or indeed any other repertory. If not available from your dealer, the record may be obtained from Box 352, Glendale, California. R.D.D.

**"The Musical World of Jerome Kern."** Starlight Symphony, Cyril Ornadel, cond. M-G-M E 3906, \$3.98 (LP). The admiration the English have always had for the theatre music of Jerome Kern is admirably reflected in this excellent recording of sixteen of the composer's most delightful songs, played by the London-based Starlight Orchestra under Cyril Ornadel (currently conductor of the London production of *My Fair Lady*). The splendidly scored arrangements by Brian Fahey, though larger than any Kern envisioned for this music, are in excellent taste and show unusual respect for Kern's melodic line; and the positively gleaming orchestral performances are presented in lustrous sound. Now that this group have given us such a superb account of the more popular Kern songs, perhaps they will turn their attention to some less familiar Kern numbers. J.F.I.

**"Paul Taubman's Big Brass Band."** Epic BN 612, \$4.98 (SD). Here we have a blazing hoedown of marches with all the accents, as the title proclaims, on bigness and brassiness. Sometime TV conductor Paul Taubman has obviously recruited top musicians for this effort, and both he and they seem to be enjoying every loud but eminently musical moment of it. Tradition and invention mix boldly. For example, *Stars and Stripes Forever* is all blare and bluster, but Taubman cutely counterpoints its heroic decibel count with a gay flute solo. *Entry of the Gladiators* wraps up every grand parade in every circus tent that has ever been, *St. Louis Blues March* is a scintillating romp. Yet, all is not just for fun; the concluding *Star-Spangled Banner* gleams with burnished majesty. Epic's brilliant stereo reproduction spreads the band out to full room size. O.B.B.

**"Soft Guitars."** "Mr. Guitar"; "Mr. Y." Time S 2052, \$5.98 (SD). Like Al Viola's "Guitar Lament" (World Pacific), this is an almost ideal program of mood music. The playing here (by two obviously skilled artists, using true rather than electronic guitars) is less languorous, more lilting than Viola's; it is sensitively accompanied by an uncommonly discreet harpsichord and string bass; and the duo soloists make tasteful use both of stereo antiphonal potentialities and of atmospheric spacing between lead and accompaniment roles. Yet the resources of the full-blooded, apparently quite closely miked record-

ing are exploited only for plasticity and delicate nuances of tonal coloring; there are no mood-shattering dynamic contrasts, although the prevailing romanticism (of *Clair de lune*, *I Can't Get Started*, *Stella by Starlight*, *Poinsettia*, etc.) is varied briefly in a bouncer *'S Nice*. It is a pity not to be able to identify the pseudonymous creators of so delectable a half-hour of light music making. R.D.D.

**"Living Strings Plus Two Pianos Play the Most Beautiful Music in the World."** Orchestra, Mario Ruiz Ar-mengol, cond. RCA Camden CAS 687, \$2.98 (SD). Two pianos and what sounds like an unusually large aggregation of strings provide a particularly fine program of

music ranging from Debussy's *Clair de lune* and Chopin's Nocturne No. 2, in E flat to *Nola* and *Among My Souvenirs*. It is something of an understatement to call the arrangements lush, but this should not suggest that the performances themselves lack good taste or musical value. They abound in both. The stereo version, the only one to which I have listened, offers a rich, velvety sound which is both well balanced and nicely dispersed. The final selections on each side of the record showed evidence of inner groove distortion, however. J.F.I.

**"Ballads of the King."** Johnny Mann Singers. Liberty LRP 3217, \$3.98 (LP); IST 7217, \$4.98 (SD). The king whom the Johnny Mann Sing-

# Compare...

## DAYSTROM

### STEREO/HI-FI KITS



### for value

Compare the features of this deluxe Daystrom AM-FM Tuner: 12-tube circuit, FM automatic frequency control, flywheel tuning, separate tuning "eyes," FM multiplex adapter output jack. Compare this low price!

Kit DA-286  
\$84<sup>95</sup>



Listen to the solid power and fine fidelity of this stereo amplifier-pre-amp . . . 36 watts (18 per channel) at IHFM standards . . . with four stereo inputs, clutched volume controls, separate ganged tone controls, styled in the sparkling Daystrom motif of beige vinyl-clad steel and brushed anodized aluminum. Look at this low price!

Kit DA-282  
\$79<sup>95</sup>



Enjoy FM in Stereo with this Daystrom Multiplex Adapter kit . . . easy to build circuit complete with cabinet and cables. Check this low price!

Kit DA-330  
\$34<sup>95</sup>



West Coast prices slightly higher

Bring the wonders of high-fidelity FM radio to your home easily and economically with this Daystrom FM Tuner kit. Wide-band circuit features factory-built "front-end," multiplex adapter output, automatic frequency control, flywheel tuning, and cabinet. Extra value at this low price!

Kit DA-287  
\$49<sup>95</sup>



### for easy assembly

Compare the ease of Daystrom kit methods with any! Multi-color manuals tell what and how! Parts packed in order of use; factory-installed hardware.



### for performance

Compare the thrilling Daystrom Stereo/Hi-Fi performance . . . clear, quiet, and dynamic. See and hear these quality components . . .



at your nearest  
Daystrom dealer

**DAYSTROM PRODUCTS CORPORATION**  
BOX 167 / ST. JOSEPH, MICHIGAN  
CIRCLE 30 ON READER-SERVICE CARD

ers affectionately salute in this very handsomely sung concert of romantic ballads is none other than Frank Sinatra. From Sinatra's huge repertoire of misty-eyed numbers, the group has selected a dozen of his more memorable successes of the past twenty years. While the program relies heavily on fairly recent hits, Sinatra's paternal paean to the charms of his daughter, *Nancy* (the young lady is now a recording star in her own right), and *Put Your Dreams Away* (which used to wind up Sinatra's stint on the Lucky Strike program during the war years) are also included. Both retain much of their original appeal. The nice, easygoing performances are so completely satisfying that many listeners will probably be scarcely aware of the program's lack of pace and variety. J.F.I.

**"Calypso Exposed."** Lord Melody, Mighty Cypher, Mighty Skipper, King Sparrow, Herbert Howard; Brute Force Steel Band. Cook 1189, \$4.98 (LP). This disc gives us an off-beat—and sometimes faintly off-color—exploration of calypso as it really is. Emory Cook taped all of these entries in the West Indies some years ago, but the prudish atmosphere of the times regarding record contents delayed their release. (It is difficult to believe that a mere ten years ago even such innocent ballads as *The Foggy Dew* were invariably bowdlerized for vinylite.) In any case, Cook's performers—particularly the incomparable Lord Melody—are all first-rate calypsonians, and the selections provide a true and earthy segment of their idiom. The sound occasionally shows its age, but no calypso admirer will cavil. O.B.B.

**"Subways Are for Sleeping."** Percy Faith and His Orchestra. Columbia CS 8533, \$4.98 (SD). Faith's elaborate scorings and well-nigh symphonic performances benefit by the exhilaratingly big and open recording here as well as by the vibrant pulse and lift of Julie Styne's fine tunes from the current Broadway show. Perhaps especially effective are *Ride through the Night*, *Getting Married*, *Comes Once in a Lifetime*, and *What Is This Feeling in the Air*, although the romantic *Now I Have Someone* is also extremely well, if more lushly, done. Occasional over-fanciness in the arrangements and a few moments when the high modulation level is pushed a bit too far are more than compensated by the gusto of this high-spirited program. R.D.D.

**"Sounds Sensational!"** Chorus and Percussion of Keith Textor. RCA Victor LSA 2425, \$5.98 (SD). Actually the sensationalism here is relatively mild for the "stereo-action" series, but both the moving sound sources and varied percussion effects are exploited with a refreshing sense of humor and to far more musical point than usual. Particularly engaging are the self-importantly chuffing little train in *Down by the Station*, the leader's own tenor voice drifting across stage in *It's a Lonesome Old Town*, Tad Tadlock Vosburgh's deft tap dancing in *Tea for Two*, an eerily circling carousel in *Hi-Lili Hi-Lo*, and the prancing snares and pipes in *When Johnny Comes Marching Home*. Best of all, the often wordless chorus is used (and sings) with genuine skill and the instrumentalists (a bass clarinet player especially) have an apt feeling for rhythmic lilt and attractively nuanced tonal coloring. If there's nothing really memorable here, it's seldom that a stereo *divertissement* leaves one with such a sense of having been wittily, and always musically, entertained. R.D.D.

**"Sail Away."** Noel Coward; Orchestra, Peter Matz, cond. Capitol W 1667, \$4.98 (LP); SW 1667, \$5.98 (SD). There are one or two rather barren spots in Noel Coward's recording of a dozen songs from the score of his current Broadway musical, but otherwise the record is one of the best he has given us in years. Whether the engineers are responsible or the singer himself, Coward's voice has a decidedly more robust quality than was formerly the case. Unfortunately, even this does not help him surmount some of the obstacles presented by the ballads, and I found my interest sagging when he was struggling through *Later Than Spring* and *Where Shall I Find Her?* However, these were merely temporary lulls, quickly forgotten when Mr. Coward got back into high gear by way of his brightly written satirical numbers. It is in these songs that the phenomenal Coward expertise is at its peak, with Coward the vocalist delivering, with obvious relish, every line and rhyme that Coward the lyricist has written. In the original cast recording there was some senseless blue penciling of the lyrics of *The Customer's Always Right* and *Why Do the Wrong People Travel?* which robbed the former of some of its point and ruined a good laugh in the latter. Fortunately, no such excisions have been made here.

The arrangements by Peter Matz are not only imaginative but perfectly attuned to Mr. Coward's performances, and the sound is excellent. J.F.I.



an astounding  
new sound . . .  
an incredible  
new cartridge

SHURE M33

*Stereo Dynamic*®

An extraordinary achievement in superior re-creation:

**RESPONSE:** 20 to 20,000 (conservatively). Singularly clean and smooth. Goes right through the top limits of audibility without a hint of "break-up" prevalent in most other stereo cartridges.

**COLORATION:** virtually non-existent. Imparts no false sound to the music. It is transparent, clear, hum-free (special Mu-metal shielding rejects electrically induced hum). Peak-free.

**COMPLIANCE:** over  $20 \times 10^{-6}$  cm/dyne! Tracks as low as 1 gram . . . virtually eliminates record and stylus wear. Separation over 22.5 db. at 1000 cps.

**THE STYLUS:** Choice of .0005" or .0007" diamond tips. Exceptionally rugged. Special plastic grip makes stylus changing easy as plugging in an electric cord.

**PRICES:** M33-5 (with .0005" diamond) or M33-7 (with .0007" diamond). Tracks at 1 to 3 grams . . . \$36.50 net.

Model M77 (for tracking at 4 to 7 grams) only \$27.50.



SHURE

*Stereo Dynamic*®

hi fi phono cartridge

Shure Brothers, Inc., 222 Hartrey Avenue, Evanston, Illinois  
CIRCLE 77 ON READER-SERVICE CARD

**"Eddie Heywood Plays the Greatest."**

Eddie Heywood, piano; Orchestra, Bedford Hendricks, cond. Liberty LRP 3210, \$3.98 (LP); LST 7210, \$4.98 (SD).

If, as I suppose, the album title's superlative is used to describe the music, then it is rather wide of the mark—certainly some of these songs, as *Love Letters*, *An Affair To Remember*, and *This Is My Beloved*, hardly measure up. The adjective is much more applicable to Heywood's performances, a series of delicate piano portraits touched with humor and in some cases invested with a subdued jazz feeling. The latter is particularly evident in a deft performance of Harry Revel's *Jet*. I also liked the perky performance of *Ruby* and a rhythmic account of *Love Is a Many-Splendored Thing*, the latter far more intriguing than the overblown presentations usually reserved for this number. The warmth of the sound on the monophonic versions is more attractive than the stridency characteristic of the stereo pressing. J.F.I.

**"Interurban Memories."** Mobile Fidelity MF 7, \$3.98 ("Stereomonic").

**"Steam Railroading Under Thundering Skies."** Mobile Fidelity MF 8, \$3.98 ("Stereomonic").

One of the most technologically enterprising of specialist recording companies, a pioneer in the adoption of the static-free "Polymax" disc materials, now advances a solution of the compatibility problem via the use of the sum-and-difference (rather than normal 45/45) disc-cutting technique. My guess is that the method used here is that suggested by Columbia before the standardization of 45/45 methodology some years ago, but at any rate it results in genuine stereoism (if perhaps somewhat more closely blended channels than usual), while the disc also can be effectively reproduced with a monophonic pickup (although of course I can't yet judge whether disc wear is greater in this mode).

There is a great deal more than novel technical interest in these programs, however. MF 8, starring the Baldwin locomotives of the Bonhomie and Hattiesburg Southern Railroad Company, is particularly dramatic in its "A"-side documentation of freight making-up and runs during the heavy storms of February 1961. The clatter of the train itself and the banshee whistling virtuosity of Engineer A. J. Lee are enhanced by some of the most startlingly realistic rain, thunder, and lightning ever captured on discs. MF 7, starring on one side the big red "blimps" of Pacific Electric's Long Beach line and on the other the electroliners and steeple-cab freight locomotives of the Chicago, North Shore, and Milwaukee Skokie Valley line, is one of—if not *the*—first sonic tributes to the onetime great interurban electric railroads. The highlights here are the long bands devoted to complete runs (recorded from the trains themselves) between Los Angeles and Watts, and between Skokie and Edison Court, Waukegan. The latter, at speeds exceeding 75 mph and with only one stop (in contrast with the many stops on the Watts Local run), is exceptionally exciting.

R.D.D.

**"Sing Out."** The Limelitters. RCA Victor LPM 2445, \$3.98 (LP); LSP 2445, \$4.98 (SD).

Apparently loath to discard a program

formula which has made them one of the most successful singing groups on records. The Limelitters present here another hodgepodge of folk songs, pseudo-folk songs, and numbers aimed at delighting fraternity folk. Some of the latter, particularly *Jehosephat* and *Pretty Far Out*, come perilously close to Frank Crumit's old vaudeville songs, while *Marvin*, the humorous tale of a man living on his collection of credit cards, sounds like a good night club number. The boys have quite a flair for these songs, though I must say I prefer them in more folklike material, where they are often very appealing. I have in mind their gentle version of *Everywhere I Look This Morning*, and a poignant performance of *The Little Land*. This is the trio's first studio recording for RCA Victor, and I think it represents a higher

level of artistry than those made before a live audience. J.F.I.

**"Music of the Toreador."** Banda Taurina, Ricardo Vidal, cond. United Artists UAS 6172, \$4.98 (SD).

This is an uninhibited program of Spanish bull ring music, featuring the conductor's own rather melodramatic *Perfumes Clavelinos* and—more effectively—several spirited genre compositions by Luis Avaque: notably the tuneful *Sangre Hispana*, proclamative *Crisol Gitano*, and slambang *Tauromaquia*. High level, wide dynamic range, markedly stereoisic, but extremely sharp and closely miked recording makes the most of the band's crisp vehemence, but at the same time spares one none of its frequent raucousness. R.D.D.

# HEAR IT NOW

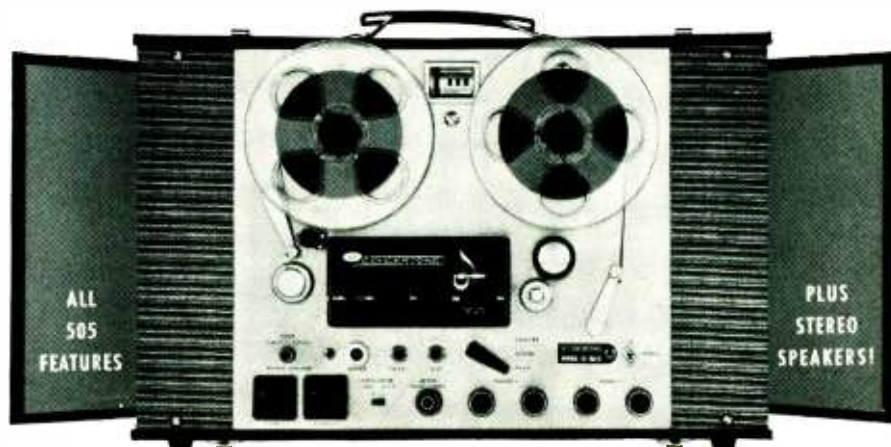

## CONCERTONE 510

the famous S505 REVERSE-O-MATIC®

with built-in stereo speakers

What more could you want than Concertone's S505? Here's what—the new Concertone 510! It's the S505 with integrated stereo speakers. Concertone engineers equipped the famous S505 stereo recorder with a pair of built-in matched amplifiers and speakers with sound-directing panels. Unlimited flexibility of stereo recording and playback in one self-contained stereo system—permits immediate monitoring of the recorded signal. Luxurious simulated leather portable case. That's the new Concertone 510.

Now—stereo sound plus all these famous S505 features!

- Exclusive Reverse-O-Matic feature plays 4-tracks from end-to-end and back again without interruption
- Professional quality, with brushed stainless faceplate
- 3 Hysteresis Motors, including hysteresis synchronous drive
- 4 individual heads, no compromise
- 2 calibrated Reference Meters
- Flutter filter, usually found only on \$1000 tape-recorders
- Automatic Tape-lifters.



AMERICAN CONCERTONE, INC.  
A DIVISION OF ASTRO-SCIENCE CORPORATION  
9449 WEST JEFFERSON BOULEVARD • CULVER CITY, CALIFORNIA  
CIRCLE 5 ON READER-SERVICE CARD

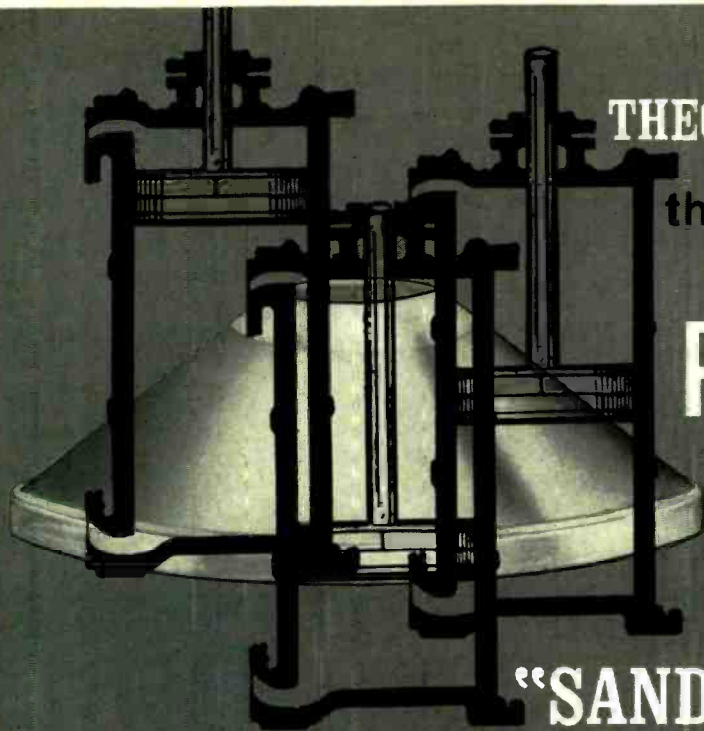

**THEORY BECOMES REALITY**

**the first loudspeaker ever  
with true**

**PISTON-ACTION**

**the new, dynamic**

**LEAK**

**"SANDWICH SPEAKER"®**

Ever since the invention of the moving-coil loudspeaker in 1925, the achievement of TRUE PISTON-ACTION has been the long sought-after goal of loudspeaker designers. But due to the limitations of available materials for cone construction, even the finest speakers, to this day, have fallen short of this goal. Flexible paper, composition or cloth cones are inefficient pistons at best. Because of this unfortunate flexibility ordinary speaker cones buckle—creating "breakup" distortion. Various areas of flexible cones move with different intensities—often in opposite directions, resulting in distortion peaks and troughs. (Diag. A.)

Now, from the renowned laboratories of H. J. Leak & Co. Ltd. comes the most revolutionary invention since the moving-coil loudspeaker—the LEAK Piston-Action "Sandwich" Speaker—only in the new Leak sandwich speaker does the speaker cone give true piston-action—each point on the cone surface moving in the same direction—at the same time—giving excellence of transient response—no peaks, no troughs, no "breakup" distortion! (Diag. B.)

The Leak Piston-Action "Sandwich" Speaker is a totally new, advanced invention! Aerodynamic sandwich structure principles gives its cone **3,000 times** the stiffness of a paper cone of the same mass! This results in remarkably smooth, uncolored, natural reproduction of sound . . . incomparable quality never before heard! A Leak Piston-Action "Sandwich" Speaker will be available soon for demonstration at select Audio Specialists . . . you may have a short wait before you can own one!

**The British Experts Say—**

"This design must be regarded as a breakthrough of fundamental and far-reaching importance. If you seek unspectacular sound of natural quality, in mono or stereo combination, you will be hard put to beat the LEAK system."

—AUDIO & RECORD REVIEW (Gt. Brit.)

"One of the best loudspeakers one could buy. And can be fully recommended."

—GRAMOPHONE (Gt. Brit.)

"The (LEAK) speaker undoubtedly sets a very high standard and will make many friends."

—H.F.I. NEWS (Gt. Brit.)

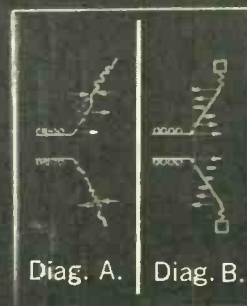

Exclusive U.S. Representatives:

**ERCONA CORPORATION — 16 West 46th Street, New York 17, N. Y.**

In Canada: ELDON INDUSTRIES, SCARBOROUGH, ONTARIO

CIRCLE 101 ON READER SERVICE CARD



**Shorty Baker and Doc Cheatham:** "Shorty and Doc." Prestige/Swingville 2021, \$4.98 (LP).

Baker and Cheatham are two of an unfortunately large group of middle-aged jazzmen of unusual talent who are being allowed to waste some of their best years with no adequate outlet for their playing. Both are trumpeters—Baker an old Ellington hand, Cheatham an alumnus of McKinney's Cotton Pickers, Chick Webb, Benny Carter, and other bands of the '30s and '40s. Both have an immaculate, warmly glowing style. Backed by a strong rhythm section (Walter Bishop, Jr., piano; Wendell Marshall, bass; J. C. Heard, drums), they blow skillfully through six loosely organized, pleasantly casual unpretentious pieces. The one drawback here is the lack of indication as to which trumpeter is doing what; since they are stylistically very similar, it is frequently difficult to distinguish between them.

**Brun Campbell-Dink Johnson:** "The Professors." Euphonic 1201, \$5.00 (LP). Campbell and Johnson (both now dead) are almost completely undocumented pianists, although Campbell was known somewhat for his writing on ragtime. He was a friend and student of Scott Joplin in Joplin's Sedalia days, and his performance of Joplin's *Maple Leaf Rag* on this disc is, one assumes, as definitive as anything one may hear. Campbell followed the advice of ragtime composers in playing their pieces at moderate tempos, and in his hands this deliberately paced *Maple Leaf* builds into a forcefully moving performance. The remaining ten tracks by Campbell, some very brief, are all his own compositions, most of them melodic and lilting, some airy and gay.

Johnson was a pianist and singer with much of Fats Waller's ebullience, and a distinct tinge of Jelly Roll Morton's piano style (he was Morton's brother-in-law). He hums, sings, and shouts along with his piano solos at times, generating a tremendous amount of zest. One can only be amazed that he lived out his career in obscurity. The recording is not high-fidelity—Campbell's selections were cut on acetate discs in the middle Forties, and Johnson's on early tape at about the same time. Yet this is a fascinating recording, with both intrinsic interest and historical value.

**Candido:** "Conga Soul." Roulette 52078, \$3.98 (LP); S 52078, \$4.98 (SD).

The prospect of an album by a conga drummer may well stir some listeners to anticipatory ennui. But this set owes more to the brilliant Brazilian composer-pianist, Lalo Shifrin, than to Candido's conga drumming. The congas are

strongly present, but Shifrin has contrived some fascinating uses for them as a driving rhythmic undercarriage—with bass, and with bass and piccolo. He has shown ingenuity, too, in his adaptation of *Big Noise from Winnetka* (once a bass and drum novelty in Bob Crosby's band), and in his ensemble use of trombone, tenor and baritone saxophones, and flute. This collection mixes imagination and propulsion in equal proportions, and is full of rousing excitement. Two superb bassists—Milt Hinton and George Duvivier—serve extremely well. Jimmy Cleveland suggests that he may be retrieving some of the fluid brilliance he once had, and an unbilled reed man, tripling on tenor saxophone, flute, and piccolo, plays with enormous verve.

**Paul Desmond:** "Desmond Blue." RCA Victor LPM 2438, \$3.98 (LP); LSP 2438, \$4.98 (SD).

Coming right on the heels of Stan Getz's adventurous work with strings (*Focus*, Verve 8412), Paul Desmond's initial effort for Victor, with somewhat similar backing, seems relatively uninspired. Bob Prince has written some pleasant backgrounds, using strings, woodwinds, harp, and rhythm section—but this is, roughly, the customary soloist-and-strings arrangement already used time and again. But Desmond is not, of course, the customary jazz soloist. His airily swirling alto saxophone lines have been a saving grace of the Dave Brubeck Quartet since its inception. He is not lacking in style here, but his individual tone blends fuzzily with the strings. There is a hint of what Desmond might have done on *I've Got You Under My Skin*, in which he is happily free from the obtrusive strings most of the time. But his saxophone is miked so closely on some numbers that what should emerge as a smooth, silken tone is turned to rasping breathiness. Jim Hall pops up for occasional brief guitar solos, very welcome and all too infrequent.

**Dizzy Gillespie Quintet:** "An Electrifying Evening." Verve 8401, \$4.98 (LP); 68401, \$5.98 (SD).

The electricity on the evening under consideration, at a concert at the Museum of Modern Art in New York, was supplied not by Gillespie alone (although his incandescence has rarely glowed more luminously) but by his entire group. Only four of the selections played at the Museum—*Kush*, *Salt Peanuts*, *Night in Tunisia*, and *The Mooche*—have been fitted into this LP, but they constitute one of the most consistently stimulating jazz programs yet committed to a single disc. All the participants play with that blend of easy relaxation and roaring intensity which is the essence of success-

ful jazz. The ensembles and solos are remarkably clean-lined, and bristling with vitality. Gillespie, who is at the very peak of his form, makes a fascinating remold of Ellington's highly individual *The Mooche*, creating a valid projection of his own musical personality.

**Franz Jackson Original Jass All Stars:**

"No Saints." Pinnacle 102, \$4.98 (LP). This high-spirited traditional jazz is more consistently exuberant than Franz Jackson's previous Pinnacle release (*Night at Red Arrow*, Pinnacle 103). This collection actually preceded *Night at Red Arrow*; it was originally released on the Replica label, then repackaged by Pinnacle. This is the first time it has come my way. The foundation of Jackson's group is a rhythm section which gains power from a tuba and a banjo without seeming ponderous. Above it are the crisply biting trumpet of Bob Shoffner and the broad-toned trombone of Al Wynn, and both men steam into their solos with tremendous enthusiasm. Jackson is a bubbling, decorative clarinetist who is not prepossessing as a soloist, although he fills in the ensembles capably. The players are a closely knit group, and their knowledge of each other enables the ensembles to drive ahead with sure-footed, unruffled confidence. These are extremely knowledgeable jazz musicians playing in their natural idiom, a circumstance that distinguishes their work from the performances of those stolid revivalists who have tried with so little success to recapture this delightfully lighthearted form of jazz.

**Quincy Jones and His Orchestra:** "At Newport '61." Mercury 20653, \$3.98 (LP); 60653, \$4.98 (SD).

A potentially good showcasing of Quincy Jones's exciting band is destroyed by the muffled, thin recorded sound of these performances at last year's Newport jazz festival. Despite this, occasional suggestions of the merit of this band force their way through the dismal murk that hovers over everything—notably Joe Newman's magnificent shouting, growling trumpet work over the band's rocking riffs on *Boy in the Tree* (a performance by soloist and ensemble worthy of the Ellington band in its halcyon days), and the gorgeous saxophone ensemble rising out of Jones's dashing attack on *Air Mail Special*. But the recording is so bad, sonically, as to be scarcely worth the agony of trying to sit through it.

**Tommy Ladnier:** "Blues and Stomps." Riverside 154, \$4.98 (LP).

Although Ladnier was almost the only cornetist who could challenge Louis Armstrong in the '20s, he slipped through

YOU ALWAYS GET THE  
**BEST for LISTENING**



**TONIGHT** plus other Motion Picture & Broadway Hits—as played by Ferrante & Teicher.  
 UAL 3171 UAS 6171 (Stereo)



**STANDING ROOM ONLY** — The Highwaymen present their authentic folk songs.  
 UAL 3168 UAS 6168 (Stereo)

**WE REMEMBER TOMMY DORSEY, TOO**—Great Dorsey songs sung by the Modernaires.  
 WWR 3524 WWS 8524 (Stereo)



THE PROUDEST NAME  
 IN ENTERTAINMENT

CIRCLE 89 ON READER-SERVICE CARD

the meshes of jazz history without gaining much attention. He died at the age of thirty-nine in 1939 after a decade of relative inactivity. Aside from a few records made for Bluebird just before his death, almost all that we know of him comes from recordings made in the '20s; this present collection was made between 1923 and 1926. With one exception the pieces were all recorded by small groups led by the South Side Chicago pianist, Lovie Austin. Half of them are by a trio: Miss Austin, Ladnier on cornet, and clarinetist Jimmy O'Bryant (with the occasional addition of an unknown drummer). The acoustical recording tends to dim the piano, but Ladnier and O'Bryant come through clearly and cleanly and their playing is consistently brilliant. In such a small group, there is no laying out while somebody else solos. Ladnier and O'Bryant are working almost all the time, playing as an ensemble, taking breaks, or providing support for each other. O'Bryant is another musician who has rarely received much notice, but he plays with soaring excitement. He is absent from two selections, but is replaced by nothing but the best—Jimmie Noone and Johnny Dodds. In addition, there are four blues sung by Edmondia Henderson, an adequate singer, with accompaniment by the trio. But the real meat—and fine meat at that—is the eight instrumental selections, all of them refreshing and exhilarating examples of unstereotyped small group performances.

**Henry Mancini and His Orchestra:**

"Combo!" RCA Victor LPM 2258, \$3.98 (LP); LSP 2258, \$4.98 (SD). Recorded in June 1960, between Mancini's *Peter Gunn* period and his more recent success with *Moon River*, this is a carefully manufactured set of pieces played by eleven good studio men who are only mildly effective as jazz soloists. The sole exceptions are Art Pepper, playing clarinet, and occasionally Larry Bunker, on vibes. There is, moreover, something perverse in Mancini's attempt to make an eleven-piece group sound like a small combo: eleven pieces once constituted a big band—and sounded like one.

**Gerry Mulligan and The Concert Jazz Band: "On Tour." Verve 8438, \$4.98 (LP); 68438, \$5.98 (SD).**

The two special merits of this set, recorded at concerts in Milan, Berlin, and Santa Monica, are the presence of Zoot Sims as guest soloist on all seven tracks, and the superbly relaxed quality of the Mulligan band. Sims's pliant, swinging strength surges throughout, stimulating Mulligan to some fine solo spots of his own. The material is standard matter from the Mulligan repertory—*Come Rain or Come Shine*, *The Red Door*, *Apple Core*, and two pieces from *I Want To Live*—plus Ben Webster's *Go Home*, heard in two different treatments. Unfortunately, the three selections taped in Milan are heavily laden with tape hiss and consequent distortion. But *Go Home* and Sims's dazzling *Apple Core* are so good that a willing listener can adjust his ears to the sonic shortcomings.

**Red Norvo: "Mainstream Jazz." Continental 16005, \$4.98 (LP).**

Recorded in the middle '40s, this set catches Norvo at one of the brightest periods of his career. His group includes the Basie- and Waller-influenced piano



There are  
**headphones...**  
 and then there are  
**Superex**  
**Stereo/Phones.**

**ONLY SUPEREX STEREO/PHONES HAVE BOTH A WOOFER AND A TWEETER IN EACH EARPIECE.**

Now you can enjoy a new level of perfection in stereo high fidelity listening. Superex Stereo/Phones provide matchless sound by utilizing a high quality, precisely engineered, ceramic tweeter and dynamic woofer in each earpiece. Frequency response is 20 to 20,000 cps; reproduction exceeds anything you have ever heard before. No wonder that this new development has been editorially acclaimed as one of the most important advances in high fidelity technology and listening pleasure.

With these phones, distracting room noises can't bother you. The problems of room muddle and bounce are gone. You listen, with volume as high as you want, in complete privacy.

Superex Stereo/Phones are lightweight, padded, and shaped for complete comfort. They are manufactured in the U.S.A. of finest materials for long listening pleasure.

Your dealer will let you test these amazing new headphones. Try them. 3 minutes of listening will prove that these phones offer a differently beautiful music experience.

Two models. ST-M, 8-16 ohms... \$29.95; ST-MH, 15,000 ohms... \$34.95. Complete with crossover networks, built-in overload protection, monaural adapter, connecting cables, and simple instructions.

**SEND FOR TECHNICAL DATA AND THE NAME OF YOUR NEAREST DEALER**

**Superex Stereo/Phones**

SUPEREX ELECTRONICS CORPORATION • 4-6 RADFORD PLACE, YONKERS, N. Y.

CIRCLE 83 ON READER-SERVICE CARD



of Johnny Guarneri, Slam Stewart's potent bass (and his bowing-humming duets with himself which, unfortunately, turn up on almost every selection). Morey Feld on drums, and either Bill de Arango or Chuck Wayne on guitar. The group swings along with a lighthearted attitude all but lost to jazz since the war. These pieces are delightful reminders of a central area of jazz that is neither too old-fashioned nor too modern, but remains warm, spirited, and sparkling no matter what the changes in superficial tastes.

**Anita O'Day:** "All the Sad Young Men." Verve 8442, \$4.98 (LP); 68442, \$5.98 (SD).

The notice served by Gary McFarland (in his *Jazz Version of "How To Succeed in Business Without Really Trying"*) that a young man had finally arrived to blast away the stodginess afflicting big-band arranging for too, too many years, is reiterated in remarkable fashion here. This time, in contrast to the all-instrumental *How To Succeed* set, he is writing for a vocalist—another field where big-band arrangers have been sadly remiss, with orchestrations which either ignored the singer or drowned him (her), or both. And always there were the clichés to follow.

McFarland's lively imagination and his guiding good taste keep the purpose of these arrangements in focus and infuse them with stimulating ideas. But possibly the most amazing aspect of this record is what he has done for Anita O'Day. When she was only a sprite, Miss O'Day was a wonderfully natural jazz singer. After a period of personal tribulations, she made a comeback in which she has sung with occasional suggestions of that early ease, along with mannerisms often exasperatingly coy or grotesque. Much of this was quite obviously due to the fact that she could rarely count on any help from her accompaniment.

After all these trials, she settles into McFarland's arrangements with comfort, and once again is the vibrant, sensitive singer one always hoped for. The program is adventurous: new approaches to familiar pieces such as *Boogie Blues* and *You Came a Long Way from St. Louis*, and several attractive new songs (three by McFarland). My only quibble is the tempo taken on Willard Robison's lovely *A Woman Alone with the Blues*. Otherwise—viva O'Day and the solos by Phil Woods, Bob Brookmeyer, Willie Dennis, and Zoot Sims. And especially, viva McFarland!

**Dick Ruedebusch and The Underprivileged Five:** "Meet Mr. Trumpet." Jubilee JGM 5008, \$4.98 (LP); JGS 5008, \$5.98 (SD).

Ruedebusch is a trumpeter from Milwaukee whose facility is sometimes alarming. His group plays such pieces as *Panama*, *Limehouse Blues*, and *Tiger Rag* at a furious rate and yet without any signs of desperation. Far from being a showoff, Ruedebusch is inclined to stay in the middle range on these rapid excursions, letting go with fireworks only as a climax. At more moderate tempos, he finds a dark, lustrous depth in his horn reminiscent of Bunny Berigan. The individual musicians, aside from trombonist Sunny Sievert, do not stand out, but they manage to keep up with Ruedebusch's ideas. These performances were recorded in the Tunnel Inn, Ruedebusch's home base. Apparently he has succeeded

in blasting the foundation loose—the tape has a tendency to tremble, particularly during piano solos.

**Doc Souchon and His Milenburg Boys.** Southland 231, \$4.98 (LP).

Dr. Edmond Souchon, a New Orleans surgeon by trade and a jazz guitarist at heart, leads two slightly different New Orleans groups through warmly swinging treatments of staples from latter-day traditional jazz (*Smiles, Angry, How Come You Do Me Like You Do*). Although both groups play with relish and gusto, that on Side One has a slight edge in these respects, along with a warmth and polish that mark it as at least the equal of any group playing in this vein today. The front line men are Mike Lala, a clean, driving lead trumpeter; Jack Delaney, who has absorbed both the trombone and vocal styles of Jack Teagarden; and the highly individualistic clarinetist, Raymond Burke. With Armand Hug's piano leading the accompaniment, these men can even make originals like *You Cooked Your Goose with Me* and *That's Why I Like New Orleans* sound interesting. This meeting of the New Orleans and swing styles retains the best of both.

**Roosevelt (The Honeydrinker) Sykes:** "Blues." Folkways FS 3827, \$5.95 (LP).

Sykes is a delightfully extroverted singer and pianist who charges through this blues-based program in a spirit of exhilarated gaiety. He favors boogie-woogie figures on the piano at rollicking tempos and also for slow blues, and this adds to the enlivening party spirit. The sociological branch of jazz musicology would be hard-pressed to find anything of great significance in Sykes's songs, but no matter how trivial their content he throws himself into them with vigor. He has a very natural, person-to-person manner of performing; it may well be that the presence of Memphis Slim, another pianist-blues singer as a & r man on the date may have contributed to the easy atmosphere of this album.

**Lester Young and The Kansas City Five.** Commodore 30014, \$4.98 (LP).

Lester Young's two Kansas City Five sessions for Commodore in 1938 and 1944 produced a group of classic performances which have not dimmed in the slightest since then. If anything, one appreciates them more than ever, now that this type of airily swinging ensemble has virtually disappeared from jazz. Eight of these twelve selections were made at the earlier date by five Basie men still in the first flush of their success—Buck Clayton, Eddie Durham, Walter Page, Jo Jones, and Young. Besides lyrically graceful tenor saxophone work by Young and rare examples of the clean, silvery tone of his clarinet playing, there are a number of Clayton's most poignant solos, both muted and open, and several electric guitar solos by Eddie Durham that reveal how much he was already implying the direction Charlie Christian was to take with this instrument. The 1944 selections, on which Young is joined by Bill Coleman, Dicky Wells, Joe Bushkin, John Simmons, and Jo Jones, are rather thinly recorded, but they include beautiful passages by Young (on tenor only), Coleman, and Wells. This collection belongs on that small shelf reserved for really essential jazz LPs.

JOHN S. WILSON

**the  
Concord  
880  
is for  
connoisseurs\***

If you're going after top results in stereo tape you'll want to meet the Concord 880. There isn't a unit 4-track stereo recorder that can match the 880's important professional features. 3 heads, 3 speeds, 2 separate speakers, sound-on-sound, computerized tracking, dual VU meters and many other big advantages in achieving professional standards in stereo recording and playback. Enjoy the luxury of listening to the Concord 880 soon. Certainly before you invest in any tape recorder. And write for your copy of the specific catalog brochure "All The Facts." Price as shown \$400.

*\*naturally it's Bill Felzer*

**CONCORD 880**  
CONCORD ELECTRONICS CORPORATION

8098 N. Cahuenga Blvd., Los Angeles 38, Calif.  
CIRCLE 98 ON READER-SERVICE CARD



## The new Fine Line Ampex 1200

### The 4-track recorder that bids cross-talk good-bye.

Now, for those who insist upon the very finest in 4-track recording: the new Fine Line Ampex 1200. This precision recorder completely eliminates cross-talk common among ordinary 4-track machines. And gives you studio quality performance in your home. The reason: the Ampex 1200 is built to professional standards—with over 170 engineering advances. □ The first three advances: three new heads to permit precise narrow track recording, playback and erasing. (They're made like those in Ampex professional and scientific recorders.) □ Fourth advance: a new tape guidance system to keep the tape in precision alignment from supply reel to take-up reel. We call this: fine line alignment. It prevents cross-talk and gives you full frequency response. (It can't be jarred away, either. Both system and heads are mounted on a micro-milled die cast frame to insure stability for the long life of the machine.) □ Advancement five: low signal-to-noise ratio. Comparable to broadcast recorders. □ These—and other advances—are the many reasons why the Fine Line Ampex 1200 is your best buy among 4-track recorders today. See and hear it at your local Ampex dealer. Prices start at \$499.50. Ampex Corporation, 934 Charter St., Redwood City, Calif.

CONSERVATIVE SPECIFICATIONS: Records 4-track stereophonic 4-track monophonic. Plays 4-track stereophonic, 2-track stereophonic (optional), 4-track monophonic. Speeds: records and plays at  $3\frac{3}{4}$  and  $7\frac{1}{2}$  ips with up to 8 hrs. 32 mins. of monophonic recording or playing. Recording inputs: high impedance inputs (radio-phono-TV-auxiliary) approx. 0.25 volts rms for maximum normal recording level; high impedance microphone inputs. Playback outputs: approx. 0.75 volts rms from cathode follower

**AMPEX**

with tapes recorded to maximum normal recording level. Frequency response: 50-15,000 cps  $\pm$  2 db at  $7\frac{1}{2}$  ips; 50-8,000 cps  $\pm$  2 db at  $3\frac{3}{4}$  ips. Signal-to-noise ratio: better than 55 db at  $7\frac{1}{2}$  ips; better than 50 db at  $3\frac{3}{4}$  ips. Flutter and wow: under 0.2% rms at  $7\frac{1}{2}$  ips; under 0.3% rms at  $3\frac{3}{4}$  ips. (Measured according to American Standards Assoc.) Timing accuracy: perfection of pitch to within  $\frac{1}{3}$  of a half-tone. Models: 1250—without case, 1260—portable, 1270—portable, built-in amplifier-speakers.

CIRCLE 6 ON READER-SERVICE CARD



# the **Tape Deck**

Reviewed by R. D. DARRELL

The following reviews are of 4-track 7.5-ips stereo tapes in normal reel form.

**BEETHOVEN: Concerto for Piano and Orchestra, No. 5, in E flat, Op. 73 ("Emperor")**

Leon Fleisher, piano; Cleveland Orchestra. George Szell, cond.  
● ● EPIC EC 817. 38 min. \$7.95.

**CHOPIN: Concerto for Piano and Orchestra, No. 1, in E minor, Op. 11**

Artur Schnabel, piano; New Symphony Orchestra of London. Stanislaw Skrowaczewski, cond.  
● ● RCA VICTOR FTC 2088. 40 min. \$8.95.

It's a rare month that brings us two such outstanding concerto releases as these: the first fully satisfactory *Emperor* on tape, and a Chopin First that comes as close to the definitive as any individual approach to a masterwork can come. Both are nearly as notable, too, for their recording as for their performance qualities, and except for slight initial preëchos they are excellently processed. The stereo itself is extremely full-blooded and broadspread in each, yet the somewhat closer miking in the *Emperor* appropriately sharpens its sinewy, heroic impact, while in the Chopin, the rich, even more floating sonics enhance that work's romantic lyricism no less appropriately.

There are many attractions in the earlier 4-track *Emperors* by Backhaus and Cliburn, but the new Fleisher-Szell reading has more gusto and bite than the former, more dramatic point and personal conviction than the latter. Except for a slight stiffness in the rhythmic articulation in the finale, this is one of the most impressive modern performances of the work, not only for the pianism but for the superbly controlled orchestral accompaniment. At least one orchestral detail—the somberly eloquent timpani passage just before the end—has never been brought out so effectively in previous recordings. Rubinstein's Chopin simply begs description. One can only acknowledge that it represents him at the height of his powers and poetic eloquence.

**CANTELOUBE: Chants d'Auvergne (15)**

Netania Davrath, soprano; Orchestra, Pierre de la Roche, cond.  
● ● VANGUARD VTC 1636. 45 min. \$7.95.

The happiest discovery I ever stumbled on, back in 1931-33, was a trio of foreign

language Columbia 78s featuring the then obscure names of Madeleine Grey and Jean Canteloube. The later metamorphoses of those *Songs of the Auvergne* went on to make discographic history, and even now continue to win new devotees in their latest Electrola-Odeon LP reissue. No one has ever succeeded in matching Miss Grey's peculiar and quite unique magic, and Miss Davrath wisely makes no imitative attempt to do so. Yet her sweeter and more delicately controlled voice, her less lusty but scarcely less poignant readings, provide new illuminations on ten of the eleven songs recorded by Grey (including the heart-wrenching *Brezairola*, *Bailero*, and *Passo del Prat*). In addition, Miss Davrath introduces us to five more of the still incompletely represented Canteloube series. Best of all, of course, the exquisite transparency of modern stereo lends atmospheric enhancements to the music, and enables us to hear in far better detail (and with more authentic timbre nuance) the piquant effects of the small orchestra scoring. This reel cannot supersede the well-worn Grey discs; but it should win a worthy place beside those incomparable jewels.

**MUSSORGSKY: Boris Godunov (excerpts)**

*Prologue and Coronation Scene: "I Have Attained the Highest Power"; Boris-Shuisky Dialogue and Clock Scene; Farewell and Death.*

Mildred Allen (s), Feodor; Stanley Kolk (t), Boyar; Howard Fried (t), Shuisky; George London (b), Boris Godunov. Columbia Symphony Orchestra and Chorus. Thomas Schippers, cond.  
● ● COLUMBIA MQ 418. 39 min. \$7.95.

The first tape representation of *Boris*, while regrettably incomplete, does include the great scenes dominated by its protagonist. It has the distinctive merit of being sung in Russian, and the more dubious one of employing the familiar Rimsky-Korsakov scoring rather than the original. And while London is not the most dramatic of Borises, he does sing magnificently, albeit with more care and refinement than can lend complete verisimilitude to a portrayal of the crazed Czar. Apart from a perhaps slightly too small chorus and an occasional ragged entrance, the supporting forces sing and play well under Schipper's somewhat overcareful direction. The stereo recording is broadspread and powerful, with its very wide dynamic range captured in the tape processing without preëcho or spill-over (although there is some slight ripply tape noise which I've never encountered before and which may well be an idiosyncrasy of the individual reel I received). Perhaps it is also a personal idiosyncrasy that I

cannot respond with more enthusiasm to so generally admirable a performance of music which normally holds me spellbound; but something essential for complete dramatic conviction seems lacking here.

**MUSSORGSKY: Pictures at an Exhibition (orch. Ravel)**

Orchestre de la Société des Concerts du Conservatoire de Paris, André Vandernoot, cond.  
● ● COMMAND CC 4T 11003. 30 min. \$7.95.

**RAVEL: Daphnis et Chloë: Suite No. 2. Miroirs: No. 4, Alborado del gracioso; La Valse**

Chorus (in the Suite), Orchestre des Concerts Colonne, Pierre Dervaux, cond.  
● ● COMMAND CC 4T 11005. 38 min. \$7.95.

**RIMSKY-KORSAKOV: Capriccio espagnol, Op. 34**

†Tchaikovsky: *Capriccio italien*, Op. 45

Orchestre de la Société des Concerts du Conservatoire de Paris, André Vandernoot, cond. (in the Rimsky-Korsakov); Orchestre des Concerts Colonne, Pierre Dervaux, cond. (in the Tchaikovsky).  
● ● COMMAND CC 4T 11004. 31 min. \$7.95.

Command's 35-mm recordings made in the Salle Wagram in Paris are technologically the peers of those originating in the Pittsburgh Soldiers and Sailors Auditorium (reviewed in March), but unfortunately neither Vandernoot nor Dervaux can match Steinberg in interpretative or executant excellence. Except for a notably snappy and zestful *Limoges* section, Vandernoot's *Pictures* are quite routinely and often coarsely played, and his *Capriccio espagnol* not only is slapdash, but reveals the multi-miking technology too explicitly in the tendency of some featured solo instruments to jump out of the orchestral textures. Dervaux's *Capriccio italien* also is coarse-grained and heavy-handed, but while his Ravel performances are somewhat erratic (with occasional overspotlighted solo passages), they are generally more effective and, at their best, electrifyingly exciting—due in part to the ultrabright engineering. At any rate, from the standpoint of sound this is a truly sensational recording, and on tape it sounds less sharp-edged than in its disc edition, though no less glittering.

Continued on next page

Hard to get...you bet!..but

**WORTH  
WAITING FOR!**

## the Viking 86 STEREO-COMPACT

It's selling so fast dealers are constantly out of stock. We're sorry for the delay in getting delivery on enough 86 Stereo-Compacts, but that's how good this new all-in-one component recorder is.

The 86 Stereo-Compact will likely continue to be in short supply through the next few months. We hope you will be willing to wait the necessary two to three weeks for delivery of this year's hottest stereo product.

We promise you the ultimate in performance; a carefully-built, quality-built stereo recorder, unmatched in the current market.



Check these quality and performance features of the 86 Stereo-Compact.

• 25-18,000 cps  $\pm$  3 db • two track, four track and combination models • Auto-Equalized Recording/Playback • Built-in Playback Equalization • Recording Interlock • Multiplex-Ability for FM Stereo Recording.

**AUDIOPHILE NET \$297.50**

See your Viking Dealer or send today for FREE detailed technical catalog.



OF MINNEAPOLIS, INC.

Viking of Minneapolis **HF-3**  
9600 Aldrich Ave. So., Minneapolis 20, Minn.  
Please send technical catalog on  
 86 Stereo-Compact  76 Stereo-Compact  
NAME \_\_\_\_\_  
ADDRESS \_\_\_\_\_  
CITY \_\_\_\_\_  
STATE \_\_\_\_\_

CIRCLE 94 ON READER-SERVICE CARD

## THE TAPE DECK

Continued from preceding page

**STRAVINSKY: *Jeu de cartes***  
†Poulenc: *Concerto for Organ, Strings, and Timpani*

Berj Zamkochian, organ; Everett Firth, timpani (in the Poulenc); Boston Symphony Orchestra, Charles Munch, cond.  
• • RCA VICTOR FTC 2077. 44 min. \$8.95.

Munch's lucid, unexpectedly humorous reading of *Card Game* reminds us how unjustified is the neglect of this ballet. Surely Stravinsky has never been more gleeful and infectiously sparkling, and his bubbling, small orchestra score is a delight throughout, in this spicily piquant Bostonian performance.

The Poulenc Concerto (anticipated by Capitol last December as a reel "first," coupled with his *Gloria*) is particularly valuable for its proof that Zamkochian's fine organ playing in the Saint-Saëns Symphony No. 3 was no flash in the pan. His is a more incisively forceful reading than that by the expansive Duruflé, but one feels no necessity here to judge one performance superior to the other. There is fascination enough in comparing the distinctive tonal qualities of the instruments of Symphony Hall and St. Etienne du Mont, and in noting the difference in the acoustical ambiances of the Boston concert hall and the Paris church—markedly unlike, but each ideal of its kind. I give an edge of superiority in recording and processing to the Victor reel, but a choice between the performances must depend on individual taste.

**TCHAIKOVSKY: *Concerto for Violin and Orchestra, in D, Op. 35***  
†Dvořák: *Concerto for Violin and Orchestra, in A minor, Op. 53*

Ruggiero Ricci, violin; London Symphony Orchestra, Sir Malcolm Sargent, cond.

• • LONDON LCL 80080. 65 min. \$7.95.

From the first bars, Ricci's astonishingly assured combination of virtuosity and poetic sensibility erased my forebodings in regard to "another" Tchaikovsky Violin Concerto, and held me in a state of admiration throughout a score which seems, here, so fresh and vivacious that it might have just been composed—and specifically for Ricci himself. His uncanny technical security has never been more electrifyingly demonstrated. (The performance as a whole is in marked contrast to the only other 4-track taping of the work—the almost chamber-scaled, gypsily romantic Morini-Rodzinski version for Westminster.) Ricci is sure-handed, too, in the less familiar Dvořák Concerto (in its first appearance on tape), but here, alas, he is interpretatively far less persuasive. In both sides, the uncommonly transparent, delicately differentiated stereoism (and immaculate processing, free even from pre-echoes) makes the most of the soloist's silken, varicolored tonal qualities; it also reveals unmistakably that Sargent and the London Symphony players themselves are much more at home in the Tchaikovsky than in the Dvořák—they are a bit stiff and heavy-handed in the latter, in contrast to their lyrical grace in the Tchaikovsky.

## WAGNER: *Tristan und Isolde*

Birgit Nilsson (s), Isolde; Regina Resnik (ms), Brangäne; Fritz Uhl (t), Tristan; Ernst Kozub (t), Melot; Waldemar Kmentt (t), Young sailor; Peter Klein (t), Shepherd; Thomas Krause (b), Kurwenal; Arnold van Mill (bs), King Marke; Theodor Kirschbichler (bs), Steersman. Singverein der Gesellschaft der Musikfreunde; Vienna Philharmonic Orchestra, Georg Solti, cond.  
• • LONDON LOY 90034. Three reels: approx. 82, 79, 79 min. \$33.95.

The rapidly expanding repertoire of large-scale works on tape is crowned here by the most substantial release to date—one fortunately no less impressive for its musical and technical merits than for its sheer size and cost. Few if any multi-reel 4-track releases have been as consistently well processed with minimal surface noise (especially important here where the ultrawiderange recording embraces the softest of pianissimos as well as the most robust fortissimos) and complete freedom from pre-echo and spill-over. This is the only *Tristan* on tape, and is likely to remain without competition for some time to come.

The recording here has been unanimously praised. Not every opera fan, of course, will agree with London's choice of balance, in which the soloists seem located slightly above and well back of the orchestra rather than spotlighted in front of it. Even Nilsson's clarion fortissimos are integrated with, rather than projected over, those of the orchestra, yet the effect not only is closer than that of older operatic recordings to the sound in the opera house itself, but it vitally enhances the over-all impression of the work as a protean tone poem for orchestra with voices, rather than a stage piece for voices with orchestral accompaniment.

Listeners may vary considerably in their judgment of individual performances, but few of them can deny the magnificence of Nilsson's *Isolde*, whether or not it is compared with Flagstad's (in the old monophonic disc version). The rest of the cast strikes me as only routinely competent, except for Uhl's *Tristan*, which, while it lacks the impact of a true *Heldentenor*, achieves genuine dramatic conviction in the fevered soliloquies of Act III.

In any case, the whole here is markedly greater than the sum of its parts: the concentrated magic of Solti's symphonic-poem reading, perhaps even more than Nilsson's outstanding performance or the superbly evocative recording itself, gives this *Tristan und Isolde* a spellbinding power throughout its inordinate length, and makes it an experience unique in home listening.

## ERNEST ANSERMET: *French Overtures*

Lalo: *Le Roi d'Ys*. Auber: *Le Domino noir*; *Fra Diavolo*. Hérold: *Zampa*. Offenbach: *La belle Hélène* (arr. Haensch); *Orphée aux Enfers* (arr. Karl Binder).

Orchestre de la Suisse Romande, Ernest Ansermet, cond.

• • LONDON LCL 80064. 42 min. \$7.95.

Ansermet seems almost sulkily disinterested here, as he goes through the

motions of leading his deft orchestra through these familiar scores. The men themselves play expertly, as always, and are well recorded in smoothly spread stereoism, but the music's lilt and verve are scarcely even suggested. No great loss in the serious Lalo overture, this leaves the Auber, Hérold, and especially the Offenbach works mere empty shells.

**ANTONIO JANIGRO:** "The Virtuoso Trumpet"

Helmut Wobisch, Adolph Holler, Josef Hell, Gerald Conrath, trumpets; Anton Heiler, harpsichord and organ; I Solisti di Zagreb, Antonio Janigro, cond.

• • VANGUARD VTC 1637. 46 min. \$7.95.

Having recently reviewed the stereo disc edition of this program, there is no need to repeat my encomiums of its extraordinary musical and executant attractions. It is sufficient to note that while the two arrangements (the Clarke voluntary and Stanley tune) sound impressively ceremonial, the original baroque concertos and sonatas for one, two, and four trumpets (by Vivaldi, Torelli, Corelli, Gabrieli, Purcell, and the hitherto unrecorded Giacomo Perti) sound even more exhilarating.

Technically, the recording again strikes me as superlative, and comparisons prove the ultrabright high frequency and transient responses of the two media to be indistinguishable (at least to my ears). I must give the disc a fractional margin of superiority, however, since the tape is processed at a considerably lower modulation level, and when it is reproduced at the same concert hall loudness level as the disc it then betrays a few whispers of spill-over between some selections, as well as a shade more surface noise and preëcho. These are relatively small points, however; most listeners are sure to be delighted by this program in either medium.

**"Banjos Back in Town."** The Banjo Barons, Jimmy Carroll, cond. Columbia CQ 405. 30 min., \$6.95.

It's good to find that the rattling gusto of these *divertissements*—dominated by banjo, xylophone, tuba, and trumpet—sound here, if cornier than ever, still just as much fun as they did in the original SD release of nearly a year ago. To be sure, the electronic organ seems even more prominent and anachronistic, but all timbres are better differentiated, and the bold stereoistic recording demonstrates even more dramatically on tape its mastery of the most explosive of transients.

**"Bing and Satchmo."** Bing Crosby and Louis Armstrong; Orchestra, Billy May, cond. M-G-M STC 3882, 35 min., \$7.95.

This old-timers' reunion is not entirely free from synthetic camaraderie, but it is redeemed by the casual zest of the soloists, especially in *Sugar*, *Muskrat Ramble*, *Way Down Yonder in New Orleans*, and other apt materials. Bing is in surprisingly good voice, and if Louis is hoarser than ever (and his trumpet solos only caricatures of their onetime virtuosity), his unique power of per-

**THE WORLD'S FIRST  
(AND STILL THE FINEST)  
AUTOMATIC / MANUAL  
TURNTABLE / TURNTABLE**



**& RECORD CHANGER!**



**THE DUAL-1006 CUSTOM**

We consider the Dual-1006 CUSTOM to compare more than favorably with any other record player now on the market. So much so that we submitted it for testing to a completely impartial authority. A copy of this report is now available upon request. It contains the facts to be familiar with before considering any purchase of record playing equipment. For your copy write: Dept. A-4,

**united  Audio**

WIGO • PRODUCTS OF DISTINCTION • DUAL  
12-14 W. 18th Street, New York 11, N. Y.

CIRCLE 35 ON READER-SERVICE CARD

**M**agnecord  
for

## UNFORGETTABLE PERFORMANCES

The King of Swing Chose  
Magnecord for the World's  
First Stereo Tape Recording  
of Popular Jazz

(Chicago's Blue Note—1951)

It takes a real pro to stand the test of time . . . a musician like Benny Goodman . . . a tape recorder like Magnecord, the choice of professionals, the one most widely used in the sound and broadcast industry. Don't settle for less . . . your home deserves the best! For incomparable Stereo, you'll want the Magnecord Olympian . . . it's perfect! Has everything you've wanted including full fidelity 4-track play and record.

write for additional information and name of your nearest Magnecord dealer



In his New York apartment, Benny Goodman listens to his Magnecord Professional with Martin Bettan, factory sales representative.

**M**agnecord SALES DEPARTMENT

MIDWESTERN INSTRUMENTS, INC.

manufacturers of electronic data acquisition instruments

P. O. BOX 7509

TULSA 35, OKLAHOMA

CIRCLE 104 ON READER-SERVICE CARD

### An Important Announcement to High Fidelity Readers who want to BUY, SELL or SWAP

So many of you are in the market to buy, sell or swap used equipment and records that we've been swamped with listings for Trader's Marketplace. This section can't begin to accommodate the many classified ads we receive from readers each month. It was therefore discontinued with the March issue.

To give everybody a chance to reach HIGH FIDELITY'S interested readers, we're starting publication immediately of a monthly Buy, Sell or Swap Newsletter. Subscriptions will be accepted at a nominal charge of \$1.00 per year to cover part of our printing and mailing costs.

Classified listings of used equipment and/or records will be available at \$1.00 per advertisement. Messages will be limited to 30 words, including name and address. No dealer ads can be accepted. Publishers cannot guarantee the accuracy of statements or condition of merchandise advertised.

So, if you're looking for bargains in used equipment or recordings, fill in and mail the coupon below with your check or money-order for \$1.00. We'll start your Newsletter subscription with the first issue. If you're looking for a buyer for your used equipment or records, send an additional dollar for a 30-word listing. There's space on the coupon to type or print your message.

HIGH FIDELITY, Dept. CE  
Great Barrington, Mass.

Start my subscription to your Buy, Sell or Swap Newsletter with the first issue. (\$1)

Name \_\_\_\_\_

Address \_\_\_\_\_

City \_\_\_\_\_ State \_\_\_\_\_

Enclosed is my payment for \$

Insert the following 30-word advertisement (including name and address) in the first issue of the Newsletter. (Type or print plainly.) (\$1)

## THE TAPE DECK

Continued from preceding page

sonality is unimpaired. May's appropriately unfancy and buoyant accompaniments contribute to the fun of the whole.

"Dream Dancing in Stereo." Ray Anthony and His Orchestra. Capitol TZ 723, 34 min., \$6.98.

The recording here sounds much too broad and rich to date back to 1958 or 1957 when this program (or a predecessor, "Dream Dancing") first appeared on LP. At any rate, new or old, the sonics are fine and the usually colorless Anthony band contributes lushly attractive performances of the title tune "original" and such other terpsichorean hypnotics as *This Love of Mine*, *Embraceable You*, *Stars Fell on Alabama*, etc.

"Folk Songs." Tony Mottola, guitar, and His Ensemble. Command RS 4T 823, 32 min., \$7.95.

Mottola's deft arrangements and performances seem every bit as imaginative and effective as they struck me when I first encountered the disc edition. Indeed, I relish more than ever the piquancies of the lively pieces (*Skip to My Lou*, *Oh Susanna*) and the poignant lyricism of the slower ones (*He's Gone Away*, *Swing Low*). Stanley Webb's versatile contributions (on recorders, flutes, piccolo, and bass clarinet) prove to be genuine *tours de force*.

"How To Succeed in Business Without Really Trying." Original Cast Recording. Elliot Lawrence, cond. RCA Victor FTO 5011, 49 min., \$8.95.

"Milk and Honey." Original Cast Recording. Max Goberman, cond. RCA Victor FTO 4010, 42 min., \$8.95.

These two show programs have more in common than Broadway success: different as they may be in many respects, they both have the rare power of delighting home listeners almost as much as theatre audiences. This is more surprising in the case of *How To Succeed*, which has been most praised for its clever book and its antic acting, but the Loesser music stands up nobly on its own; and if star Robert Morse has even less singing voice than Rex Harrison or Robert Preston, he is in their class as an entertainer. I relished every minute of it (above all, the incomparable ode to self-faith, *I Believe in You*), and so has everyone else I've played it to.

Jerry Herman's *Milk and Honey* score is less excitingly novel, except for the occasional mild Israeli spicings; its effectiveness in recording rests on the fine voices of Weede, Benzell, and Rall, and especially on Max Goberman's spirited handling of the fine chorus and orchestra. But it is not without humor, either: witness Molly Picon's show-stealing *Chin Up*, *Ladies* and *Hymn to Hymie*. Both reels are technically first-rate, but the rich and live recording of *Milk and Honey*, with its vivid close-up miking of the soloists and its ingenious exploitations of stereo potentialities, calls for special praise.

"In a Latin Bag." Carl Tjader and His Sextet. Verve VSTC 261, 33 min., \$7.95.

My first hearing of Tjader's distinctive blend of cool jazz and Latin idioms confirms what I've read in praise of his

varied skills as a composer (exemplified in *Triste* and *Pauneto's Point*) and as vibraharpist. Yet what impresses me most is his ability as a small group leader and his ear for consistently delicate and bewitching percussion timbres. The highly imaginative treatments of *Green Dolphin Street*, *Speak Low*, and *Half and Half* have the intimate charm and intricacy of chamber music, beautifully captured with all their antiphonal interplays, in pellucid stereo.

**"I Remember Tommy."** Frank Sinatra with Orchestra, Sy Oliver, cond. Reprise RSL 1707, 38 min., \$7.95. Frankie's tribute to the late great Tommy Dorsey has a few sticky moments, but he brings characteristic bounce to *Polka Dots and Moonbeams*, *The One I Love*, and *Without a Song*, as well as persuasive fervency to *There Are Such Things*, and *It Started All Over Again*. Fine recording centers the soloist in front of a widespread orchestra, and although the latter is occasionally a bit raucous, its accompaniments are generally more suavely suitable than those of other recent Sinatra releases.

**"Kenton's West Side Story."** Stan Kenton and His Orchestra. Capitol ZT 1609, 39 min., \$6.98. Kenton's twenty-five-man band, with its currently featured mellophonium quartet, has its best materials in Johnny Richards' evocative arrangements of the familiar Bernstein score. There are the usual outbursts of brassy raucousness, of course, but much of the music is surprisingly warm and expressive—not excluding that contributed by Kenton's own lyrical piano soliloquies. And while the recording is exaggeratedly stereoistic, it does full justice to the richness and sheer power of these well-varied and controlled performances.

**"Phase 4: 'Exotic Percussion' and 'Percussive Moods.'"** Stanley Black and His Orchestra; Johnny Keating's Kombo. London LPL 74004/05, 37 and 32 min., \$7.95 each. I'm afraid these can be graded only as "also-rans" in the Phase-4 sweepstakes. The Keating program is as synthetic and ugly as the name of Kombo would suggest; and while Black can always be relied upon to do well with quasi-exotic materials, his present examples (*Jungle Drums*, *By the Waters of Minnetonka*, *Hymn to the Sun*, etc.) are so overlaid with "angelic" wordless voices and the excessive clatter of meaningless percussion that the fine straight orchestral qualities are never given a fair chance to be heard. The recording itself, of course, is as ultrabright and the stereoistic effects as melodramatically vivid as ever, but the acoustical ambience is unnaturally dry—except at times in the Black program when there are arbitrary injections of what sounds like highly artificial reverberation.

**"Popular Piano Concertos of Famous Film Themes."** George Greeley, piano; Warner Brothers Orchestra. Felix Slatkin, cond. Warner Brothers WSTC 1427, 39 min., \$7.95. Ordinarily no admirer of Greeley's "concerto" inflations of a basically cocktail hour pianism, I have to concede that the present program has considerably more lyrical attractiveness than most of his long series; and surely none of the earlier releases has been more trans-

parently and authentically recorded. What gives this tape distinction, however, is the ten-minute *divertissement* on the main theme from *Exodus*, with its scherzo-fugal (indeed quite Bachian!) contrasting passages, which are ingeniously combined with the theme in an elaborate working up to the final apotheosis. Both Greeley and Slatkin's orchestra play it very impressively.

**"Romantic Europe."** Frank Chacksfield and His Orchestra. Richmond RPE 45028, 34 min., \$4.95.  
**"Theme Music from 'King of Kings' and Other Film Spectaculars."** Frank Chacksfield and His Orchestra. London LPM 70050, 38 min., \$6.95. Again Chacksfield's skilled and rich-

toned orchestra proves to be one of the most aurally attractive of its kind, and its varicolored sonorities are entrancingly recorded. Curiously, though, the lush film theme program, while headed surely for best-seller-dom, is much less immediately pleasing than the lighter and more zestful treatments of varied European hits on the bargain-priced Richmond reel: a buoyant pops version of the *Swedish Rhapsody*, a catchy *Wonderful Copenhagen*, an atmospheric *Wonderland by Night*, among others. Mandolins, accordion, oboe, and cellos all get a chance to co-star with the singing strings, but it's the unnamed horn player who bewitches my ears most often.

Continued on next page



**THIS SYMBOL IDENTIFIES TRUE MASTER TAPE SOUND**

**on 12" L.P. STEREO RECORDS**

It has never before been possible for you to hear the thrilling sound of a master tape — the special tape from which records are reproduced.

Now you can enjoy this exciting sound on Quarante-Cinq Records.

**HOW HAS THIS BEEN MADE POSSIBLE ?**

The increased rotational speed used on Quarante-Cinq Records means that wave-lengths corresponding to even the highest frequencies will be traced by the playback stylus separately and distinctly. This cannot be done at recording speeds which cause these wave-lengths to become less than the radius of the stylus. These losses, normally most pronounced in the inner grooves, are greatly reduced at our higher speed. Eliminating these conditions gives rise to cleaner highs and superior transient response. The latter is especially important because the sounds which are of a sudden transient character give us much of our awareness of three-dimensional sound. Quarante-Cinq clean sound reproduction resulting from these factors maintains the dynamic range and frequency response found on the master tapes. Electronic Engineers have long been aware of the theory involved in producing records of this caliber. But it was necessary to conduct extensive research and tests to make this dream become a realistic fact.

PLAYING TIME OF QUARANTE-CINQ 45 RPM RECORDS IS AS LONG OR LONGER THAN MOST STEREO DISCS.

**FIRST RELEASES AVAILABLE AT INTRODUCTORY PRICE**

**CHABRIER:** (45001 stereo)  
 Fete Polonoise, Espana, March Joyeuse  
 Weber—Invitation to the Dance  
 Adam—Si j'etais Roi  
 Pierre Dervaux, Orchestre des Concerts Colonne

**BRAVO! TORO** . . . (45002 stereo) Exciting bullfight music  
 Estaban Valdez, Banda de Corrida de Cadiz

*Quarante-Cinq Records (Audio Reproductions, Inc.) Records available only direct. Fill in coupon and mail.*

**QUARANTE-CINQ RECORDS**  
 333 Sixth Avenue • New York 14, N. Y.

Please send me:  
 . . . . . Chabrier—\$3.00 each (plus 30¢ postage)  
 . . . . . Bravo! Toro—\$3.00 each (plus 30¢ postage)

I am enclosing \$ . . . . (Records available in stereo only)

Name . . . . .  
 Address . . . . .  
 City . . . . . State . . . . .

New York City Residents add 3% Sales Tax

CIRCLE 97 ON READER-SERVICE CARD

## THE TAPE DECK

Continued from preceding page

"Sing to Me, Mr. C." Perry Como with Mitchell Ayres and His Orchestra, RCA Victor FTP 1090, 44 min., \$7.95. If this ingratiating program is as characteristic of Como's TV appearances as it purports to be, with the Ray Charles Chorus "theme" introductions, Tony Mottola's deft guitar doodlings and catchy beat, Ayres' warmly expressive accompaniments, and above all with Mr. C's genial vocalizations of pop standards, I've been missing a good deal of extremely attractive and unpretentious music making. The present well-recorded stereo tape, which brings the never overlifesize soloist right into one's

living room, can hardly please the devotees of his television programs more than those who have never fully realized before the solid grounds for the immense popularity which this singer has achieved.

"Songs of Praise." Mantovani and His Orchestra, Chorus, and Organ. London LPM 70048, 47 min., \$6.95.

As I suspected, in my January review of this symphonic-hymn program in its LP version, even the most broadspread of stereoism can add relatively little further opulence to the extravagant lushness of these ultra-Mantovanian performances. Although the tape is modulated at a considerably lower level than the disc, it is processed so well that the latter's background noise and hum are greatly mini-

mized (the remaining traces are obviously inherent in the recording itself) and there are no preëchoes or spill-overs. No processing, however, can temper the fanciness of the scorings here or the emotionalism of the playing throughout.

"Sound 35/MM." Enoch Light and His Orchestra. Command RS 4T 826, 38 min., \$7.95.

I don't envy the processors who had to transfer this sensationally acclaimed technological showpiece to tape: only the elusive preëcho problem seems to have baffled them. The extremely marked channel differentiations are, if anything, even more cleanly preserved here than in the disc edition, yet the separation effect never seems as extreme as it did in earlier Command spectaculars, thanks to the natural big reverberance of Carnegie Hall. Light's arrangements, too, are less often overfancy, yet no less ingenious—especially those of *You Do Something to Me*, *Love for Sale*, and *Someone*. High on the disc best-seller lists for several months now, this program can hardly miss a similar popular success on tape.

"Spanish Songs and Dances in Motion." José Greco and His Dance Company; Orquesta de Conciertos de Madrid. Roger Machado, cond. Columbia MQ 416, 50 min., \$7.95.

One of the best introductions to the "typical" music of Spain, this festive program displays the varied facets of the art of flamenco, not only in solo and ensemble guitar playing and in dancing (italicized with heel stamping, hand slapping, and the incisive clatter of castanets), but also in vocalism ranging from wild gypsy rhapsodies to Moorish ballads. In some pieces Greco's own group is augmented by an intensely energetic orchestra. Extremely vivid and stereoisitic recording enhances the fascinating timbre contrasts, wide stage spread, antiphonies, and interplays. Particularly memorable are the haunting melodiousness of *Romance Andaluz*, the sombre impressiveness of *La Petenera*, and the seemingly inexhaustible rhythmic inventiveness of *La Molinera Caprichosa*.

"TV Sing-Along with Mitch and the Gang." Columbia CQ 384, 32 min., \$6.95.

As long as the available supply of parlor and back-porch song favorites holds out (the present sixteen run from *California Here I Come* to *Auf Wiedersehen My Dear*), this best-selling series should go on forever. What's perhaps most remarkable about it is that neither Miller himself nor his lusty choristers seem to lose any of their zest, and that the current full-blooded recordings of their performances are still just as much fun to listen to as they are to participate in.

"The Vamp of the Roaring Twenties." Dorothy "Pinky" Provine, with Trio, Chorus, and Playboys, Sandy Courage, cond. Warner Brothers WSTC 1419, 33 min., \$7.95.

Like most sequels, the second installment of TV-resuscitated songs and styles of the now fabulous era isn't quite as electrifying as Volume 1. Yet it, too, should beguile old-timers into chortling and weeping into their (no longer near) beer; while youngsters surely will relish the unflagging gusto of Miss Provine and her collaborators, quite unaware that they

## Preserve the Genius of the Masters



### with the Natural Sound of RE Tandberg



•498.

#### MODEL 6 3 SPEED 4 TRACK STEREO RECORD/PLAYBACK TAPE DECK

The remarkable features of this superb unit speak for themselves—records 4 track; plays back 2 and 4 track stereo and mono; records/plays back FM Multiplex Stereocast with magnificent clarity, even at 3¼ ips. Permits sound-on-sound, track adding, direct monitor from source or tape; has push button controls, three separate Tandberg engineered precision laminated heads, hysteresis synchronous motor; installs into HI-FI system. Price \$498. Remote control "F" model also available.



•199.50

#### MODEL 65 3 SPEED 4 TRACK STEREO PLAYBACK TAPE DECK

Another Tandberg triumph—for pure playback of 2 and 4 track stereo and mono tapes with finest frequency response. Extremely versatile; facilities for adding erase and record heads. Price \$199.50.

*Tandberg remains unchallenged for clear, crisp, natural sound!*

**Tandberg** OF AMERICA, INC., 8 THIRD AVENUE, PELHAM, NEW YORK

CIRCLE 85 ON READER-SERVICE CARD



TAPE

never can fully appreciate how brilliantly these performances echo—and transcend—their original models. The eight long medleys include some thirty period pieces, and fine as "Pinky" is in such solos as *California Here I Come*, *The Man I Love*, *Somebody Loves Me*, etc., it's when the tough-baby gals of the chorus line strut their stuff (in such *Meisterwerke* as *Mama Goes Where Papa Goes*, *Ain't We Got Fun*, *Freddy the Freshman*, and many others) that the whole period, so often sentimentalized, speaks with its authentically vulgar, incomparably salty voice.

**"Victory at Sea," Vol. 3.** Orchestra, Robert Russell Bennett, cond. RCA Victor FIC 2079, 46 min., \$8.95. This reel, well processed at a more moderate modulation level than its recent disc predecessor, does even better justice to the kaleidoscopic glitter and bold stereoisim of the original recording, although no way has been found to

eliminate its prevalent preëchoes. The terrifyingly realistic sea and battle sound effects, together with Bennett's inspired orchestral scorings, not only help to conceal the relative paucity of the best Rodgers tunes (although the hits of Volumes 1 and 2 are briefly reprised here in the closing "Symphonic Scenario"), but they do provide potent materials for what is essentially a sonic spectacular—one of the most vivid and breath-taking in the current repertory.

**"La Voce d'Italia."** Giuseppe Di Stefano with Orchestra. Dino Olivieri, cond. London LOL 90037, 42 min., \$7.95. If you're susceptible to Neapolitan songs and uninhibited Italianate singing, you'll find this program one of the finest of its kind ever made. Di Stefano is in magnificent voice (not excluding a remarkable command of pure and accurate falsetto) and he sings his heart out here, most effectively of all in *Addio Sogni di Gloria*, *Come è bello far l'amore*, and

De Curtis' *'A Canzone 'e Napule* and *Ti voglio tanto ben*. He is well accompanied, too, by a small but warm ensemble, and both soloist and orchestra are richly recorded.

**"Zungo! Afro-Percussion."** Olatunji and His Ensemble and Chorus. Columbia CQ 392, 41 min., \$6.95.

Although normally my threshold of tolerance for primitive chanting is low, the passionate fervor of Olatunji and his thirteen-voice choir impressed me strongly in the original disc release of this well-diversified program, and it does so again here. Yet, apart from the infectious singing in *Jolly Mensah*, the most arresting feature of the program remains its fantastic variety and intricacy of now vibrantly catchy, now thunderous drumming—the full impact and detail of which are of course far better captured in stereo than in the mono disc edition. There is breadth and power in this admirably processed tape.

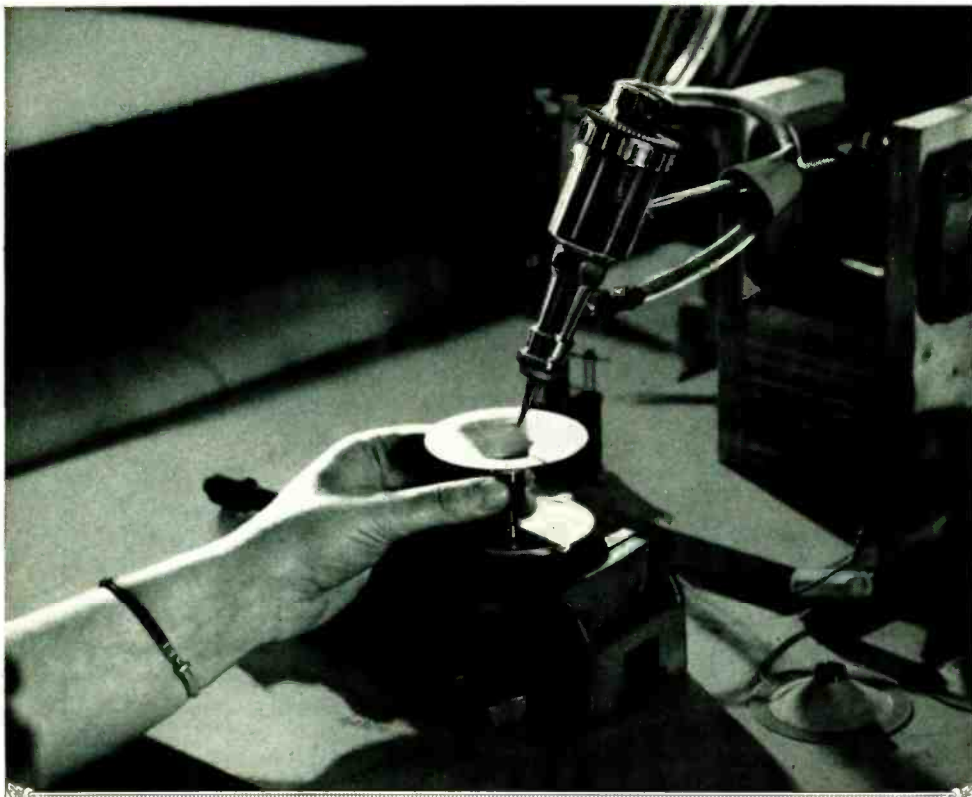

## Hand Made Speaker-circa 1962

*The speaker system you buy, no matter how well it was designed, is only as good as the hands which produce it.*

*These two hands are attaching the coil of a Model Ten tweeter to its cone.*

*The metal hand was invented at KLH — steadier and more precise than any human hand.*

*The human hand provides craftsmanship.*

*They work together to make every Model Ten match every other Model Ten, octave by octave and note by note, within ±1½ db.*

KLH MODEL TEN —  
23 5/32H x 11 25/32W x 8 3/4D.  
Operates with  
12 watt amplifier (up to 60 watts).  
In five finishes from \$86 to \$94.  
Available in matched stereo pairs.



KLH RESEARCH AND DEVELOPMENT CORPORATION  
30 CROSS STREET, CAMBRIDGE 39, MASSACHUSETTS

*Descriptive literature, with the name of your nearest franchised KLH dealer, is available on request.*

CIRCLE 53 ON READER-SERVICE CARD



# 9 New Features Now In The New 1962 EICO RP100 Transistorized Stereo/Mono 4-Track Tape Deck

### A great tape recorder made greater:

1. New professional studio recording hysteresis-synchronous capstan motor: 24 stator slots for ultra-smooth drive, ultra-quiet and vibrationless professional bearing system.
2. Two new take-up and rewind reel motors, both extra-powered for effortless operation.
3. New cored-out steel capstan flywheel with all the mass concentrated at the rim for improved flutter filtering.
4. New optimally designed capstan drive belt brings wow down to negligibility.
5. New relay provides instantaneous extra power to the take-up reel motor at start to minimize tape bounce. Provides near-perfect stop-and-go operation and eliminates any risk of tape spillage when starting with a nearly full take-up reel.
6. New automatic end-of-tape stop switch cuts off take-up reel motor power. Also permits professional editing techniques, whereby tape being edited out runs off the machine while you are listening to it.
7. Playback preamps remain "on" during stop-standby mode to permit cueing.
8. Recording level adjustment during stop-standby.
9. Shock-absorbent helical spring tape lifters practically eliminate tape bounce at start of fast winding.

### And All These Well-known RP-100 Features:

Separate stereo 1/4 track record and playback heads permitting off-the-tape monitor and true sound-on-sound recording; separate transistor stereo record and stereo playback amplifiers meeting true high fidelity standards; monaural recording on 4 tracks; digital turns counter; electrodynamic braking (no mechanical brakes to wear out or loosen); all-electric push-button transport control (separate solenoids actuate pinch-roller and tape lifters); unequalled electronic control facilities such as mixing mic and line controls, two recording level meters, sound-on-sound recording selected on panel, playback mode selector, etc. Modular plug-in construction.

**Wow and flutter:** under 0.15% RMS at 7 1/2 IPS; under 0.2% RMS at 3 3/4 IPS. **Timing Accuracy:** ± 0.15% (±3 seconds in 30 minutes). **Frequency Response:** ± 2db 30-15,000 cps at 7 1/2 IPS, 55db signal-to-noise ratio ±; 2db 30-10,000 cps at 3 3/4 IPS, 50db signal-to-noise ratio. **Line Inputs Sensitivity:** 100mv. **Mike Inputs Sensitivity:** 0.5mv.

**Semikit: Tape transport assembled and tested; electronics in kit form \$299.95**  
**Factory-assembled: Handwired throughout by skilled American craftsmen \$399.95**

**An original, exclusive EICO product designed and manufactured in the U.S.A. (Patents Pending)**

**Carrying Case \$29.95**  
**Rack Mount \$9.95**



**FM-AM Stereo Tuner ST96**  
Kit \$89.95 Wired \$129.95  
Includes Metal Cover and FET



**70-Watt Integrated Stereo Amplifier ST70**  
Kit \$84.95 Wired \$149.95  
Includes Metal Cover

**40-Watt Integrated Stereo Amplifier ST40**  
Kit \$79.95 Wired \$129.95  
Includes Metal Cover



**FM MULTIPLEX AUTODAPTOR MX99 (Patent Pending)**  
Kit \$39.95 Wired \$64.95 Cover Optional \$2.95

An original EICO contribution to the art of FM-Multiplex reception

The MX-99 employs the EICO-originated method of zero phase-shift filterless detection of FM Stereo signals (patent pending) described in the January 1962 issue of AUDIO Magazine (reprints available). This method prevents loss of channel separation due to phase shift of the L-R sub-channel before detection and matrixing with the L+R channel signal. In addition, the oscillator synchronizing circuit is phase-locked at all amplitudes of incoming 19kc pilot carrier, as well as extremely sensitive for fringe-area reception. This circuit also operates a neon lamp indicator, whenever pilot carrier is present, to indicate that a stereo program is in progress. The type of detection employed inherently prevents SCA background music interference or any significant amount of 38kc carrier from appearing in the output. However, very sharp L-C low pass filters are provided in the cathode-follower audio output circuit to reduce to practical extinction any 19kc pilot carrier, any slight amounts of 38kc sub-carrier or harmonics thereof, and any undesired detection products. This can prove very important when tape recording stereo broadcasts. The MX-99 is self-powered and is completely factory pre-aligned. A very high quality printed board is provided to assure laboratory performance from every kit. The MX-99 is designed for all EICO FM equipment (ST96, HFT90, HFT92) and component quality, wide-band FM equipment.

©1962 EICO Electronic Instrument Co. Inc.  
3300 Northern Boulevard, L. I. C., I. N. Y.

**EICO, 3300-N. Blvd., L.I.C. 1, N.Y. HF-4**

Send free 32-page catalog & dealer's name

Send new 36-page Guidebook to HI-FI for which I enclose 25¢ for postage & handling.

Name \_\_\_\_\_

Address \_\_\_\_\_

City \_\_\_\_\_ Zone \_\_\_\_\_ State \_\_\_\_\_

Over 2 MILLION EICO instruments in use.  
Most EICO Dealers offer budget terms.  
Add 5% in West.

Listen to the EICO Hour, WABC-FM, N. Y. 95.5 MC. Mon.-Fri., 7:15-8 P.M. Export Dept., Roburn Agencies Inc., 431 Greenwich St., New York 13

CIRCLE 37 ON READER-SERVICE CARD

# High Fidelity Newsfronts



**Return of the 45.** Professional recordist Ted Ratnoff—a man who manages to look neat while lugging around 150-watt amplifiers, outsize turntables, and pockets full of cartridges—has come up with an idea for commercial records that, at the very least, will provide new fare for the connoisseur and may conceivably shake things more than just a bit in the recording field. Reasoning that the faster a record spins the greater is the fidelity of reproduction, but aware also that any decrease in playing time from the standard set by the 33 $\frac{1}{3}$ -rpm disc would represent something less than real progress, Ratnoff and his associates have developed a 12-inch, 45-rpm record that provides the same playing time as a regular LP.

The new venture is appropriately called "Quarante-Cinq" and is set up as a branch of its parent recording company, Audio Reproductions, Inc., of New York. Music by Chabrier, a stereo *Carmen*, and *Bravo! Toro* are the first announced releases. More will follow. Ratnoff explains that the "first of our 45ers were an experiment, produced solely to demonstrate equipment at the last New York High Fidelity Show. People liked them so well, we decided to launch 'Quarante-Cinq' as a new label."

The faster speed, says Ratnoff, means better transient response from a record as well as consistently smoother high frequency response "right down to the record label." What's more, Quarante-Cinq is using a cutting technique "which would improve even 33s, and therefore makes our 45s better than they normally would be. The cutter, developed in Europe, has literally nonmeasurable distortion, and its resonances are inaudible, being well above the audio range."

"How," we wanted to know, "do you manage to get 45s to have the same playing time as 33s?"

"Playing time," says Ratnoff, "is regulated by guiding the pitch and depth of the cutter, according to a 'preview signal' fed to the cutting lathe. It's actually a kind of servo system which makes the cutter self-regulating so that the groove at any point along the record is as wide as it should be for the signal. We call it an advanced form of variable groove spacing in which both the lateral and vertical dimensions of the groove are automatically controlled. With this technique, it is possible to cut up to 25 minutes of playing time, at 45 rpm, on a 12-inch record—and with superior fidelity."

For its records, which it claims have the frequency response and dynamic range of 15-ips master tapes, Quarante-Cinq anticipates a market among "quality-minded music lovers." What about those who don't own a player with the 45-rpm speed? "We judge," says Ratnoff, "that most record collectors do own a turntable which plays at that speed. However, the single-speed 33 $\frac{1}{3}$ -rpm player can be modified to handle 45 rpm very simply, by the addition of a new puck in the drive system. This is something many can do themselves, or have done at a service shop. Actually, we don't consider it a serious problem."

Nor does Quarante-Cinq anticipate anything like the "war of speeds" which confused record buyers and threatened the industry in the early days of micro-groove records. "It's not a matter of speed, as such," Ratnoff points out, "but rather of playing time and of compatibility for use on existing equipment. Our record is, in fact, a long-playing record and not a 'doughnut.' It fits on a standard turntable and can be played with standard pickups. Actually, we expect other record companies to issue their own 45-rpm 12-inchers as a prestige line, and we also expect that many of them will come to us to do their mastering. At least, we hope so."

Whether or not any lines form to the right remains to be seen. We have, in the meantime, been playing a few advance pressings of the new releases. They are characterized by full, brilliant tone, with a high degree of definition and "air" about the instruments which is held from the deepest bass to the highest treble. Channel separation is excellent, and the dynamic range is quite impressive. With records such as these, it may come to pass that when a fidelitarian is asked to demonstrate his sound system he will simply reach for his 45.

**Maytime, 1962.** The radio broadcasting industry will take a long look at itself next month when it observes National Radio Month, a time set aside by the National Association of Broadcasters to examine the contributions made by individual stations in terms of programming and civic responsibilities. Coincidental with this observance, the FCC is planning a series of informal hearings on the program sources used by broadcasters, and on existing standards for licensee qualifications. For our part, this journal next month will examine that area of broadcasting most important

to high-fidelity-minded listeners, FM—and particularly stereo FM—with articles covering both its cultural and technical aspects.

**Project Beep.** In the meantime, one reason to pre-celebrate National Radio Month is the demise of a new bug threatening home tape recordists which reared its head in Texas recently only to fall flat on its tail. We first learned of this menace from several letters sent with news clippings by readers who were aroused over reports that station KTOD in Corpus Christi was injecting a super-sonic signal into its broadcasts. A press wire service had the story which also found its way into our own local paper in these Northern hills. It told of a tone, inaudible when listening to programs with a receiver, but which would intrude into any off-the-air recording and thus spoil the tape. Thus alerted, we made inquiries, and started a file named "Project Beep" (for "Bad Effort to End Playback" or "Beastly Effort to Exceed Preëmphasis"). As might be expected, tape enthusiasts were up in arms. The general attitude was: they can't do this; besides, if they do, we'll fight back. Superscope president Joe Tushinsky, for instance, told us that it is possible to build a network into a tape recorder, or else provide instructions for recorder owners to build their own, which could easily frustrate this attempt at "adulteration of a broadcast signal." Tushinsky, by the way, recalls that a similar attempt about twenty-five years ago to put AM radio on a subscription basis (nonsubscribers would have been subjected to a "pig whistle" tone) never got off the ground.

Apparently, neither will Project Beep. According to an FCC official, the use of such a signal by a station simply is not permitted. The latest word, from trade sources, has it that the story released to the wire service was solely the work of the device's inventor and further, that the Texas station involved never had any intention of using it and actually has been the "innocent victim" of ill-advised publicity. The whole thing now seems like a tempest in a teapot, but a tempest that could have fractured the teapot if allowed to go unchecked. The alertness of tape enthusiasts, the firm stand by the industry and the FCC, and the forthright disavowal by station KTOD all are very creditable. And so, let's see—the Boston Symphony is on stereo this Saturday night. . . .

# PURCHASING A HI-FI SYSTEM?

TIME PAYMENTS AVAILABLE  
Up to 2 years to pay!

Send Us  
Your List of  
Components  
For A  
Package  
Quotation

**AIREX WON'T  
BE UNDERSOLD**

All merchandise  
is brand new,  
factory fresh &  
guaranteed.

FREE Hi-Fi  
Catalog Avail-  
able on Request

## AIREX RADIO

CORPORATION

85-HF Cortland St., N. Y. 7, WO 4-1820

CIRCLE 2 ON READER-SERVICE CARD

Jim Lansing\*  
Altec Lansing  
Electrovoice  
Jensen-Hallcrafter  
Hartley\* • Gonsel  
USL Citizen Band  
Texas Crystals  
Internat'l Crystals  
University  
Acoustic Research  
Janszen • Viking  
Wharfedale  
Concertone  
Bell • G.E.  
Weathers  
Harman-Kardon  
Eico • Pilot  
Sherwood\*  
Tandberg\*  
ESL • Frazier  
Superscope  
Dual Changer\*  
Bogen • RCA  
Dyna-kit • Fisher  
H. N. Scott  
Thorens\*  
TEC • Roberts  
De Wald • National  
Sony • Challenger  
Wollensak  
Garrard  
Miracord  
Glaser-Steers  
Rek-O-Kut  
Polytronics  
Norelco • Conrac  
Fairchild  
Pickering • Sonar  
Audio Tape  
Magnecord\*  
Rockford Cabinets  
\* Fair Traded

## THE MET

Continued from page 41

orchestra after a Reiner or a Szell said he wasn't—but there was no Reiner or Szell or simulacrum on the Met's side of the argument. One cannot wholly blame the musicians in the orchestra for feeling that their judgment of a man's competence was as good as that of a top management team which did not command the continuing services of a single professional musician.

**E**XCEPT for the question of why Bing and Anthony Bliss (president of the Metropolitan Opera Association) thought they could get away with it, most of the mystery has now cleared away from the attempted cancellation of the current season. In 1958-59—after picking up payments from Knabe for the right to advertise itself as the Met's piano, from Texaco for broadcasts, from Sherry's for the restaurant, from the hat-check department, from the fund raisers, from the tour guarantors, from Sol Hurok for rental of the auditorium and assorted retailers for rental of store fronts, from recording royalties, etc.—the Met wound up about \$3,000 ahead on its year's work. In 1959-60, ticket sales plus all the subsidiary income left a loss of \$40,547. In 1960-61, despite a \$300,000 increase in revenue from ticket sales, the deficit was up to \$72,140 after total contributions of some \$800,000 from charitable individuals, institutions, and the public.

Looking forward to 1961-62, with singers' fees rising and raises due to all the unions that work in the house, Bing and Bliss foresaw a deficit of at least a quarter of a million dollars, and perhaps more than half a million dollars. They could not face it. Most people in a position to know believe that in March 1961, before the musicians' union had submitted its demands, Bing and Bliss had decided that there was to be no 1961-62 season, assuming that the shock of cancellation would produce a flood of donations and perhaps federal aid to assure the reopening of the house the next year. The musicians' union unwittingly played along with the game by making demands which Bing accurately described as "fantastic."

By May it was widely known around town that the Met was not planning a season. Farcical negotiations with the union dragged on (the Met offered before July 12 not a penny of wage increase for the first season under the new contract, and the union insisted on about \$100 a week, plus fringes, atop the existing base salary of \$170). No work was done toward the new season, and dismissal notices were sent to employees. Singers' contracts automatically lapsed on July 30, and on August 7 the Metropolitan Board announced cancellation. Bing went abroad to make a grand tour of Europe and see what might be around for a 1962-63 season.

People still refused to believe the evidence of their senses. The *New York Times* placed the story in its second

section with a headline reminding readers that seasons had been cancelled and reinstated before. Mayor Wagner, who had enough trouble already with a schools scandal in the middle of a primary campaign, brought the parties together again, though Bing kept proclaiming that a season was now impossible because so many artists had made other arrangements. Here and there, artists who had not in fact made other arrangements did the Met management a favor by announcing that they had. Most artists screamed that the management was lying. On August 17, the Metropolitan Board broke off all negotiations on the grounds that the loss of singers and valuable preparation time had made a 1961-62 season "no longer a possibility."

Led by the *New York Herald Tribune's* editorialist and Irving Kolodin of the *Saturday Review*, whose column carried the headline "Bing Fires the Public," the press furiously attacked the Metropolitan management for its irresponsibility. President Kennedy asked Secretary of Labor Goldberg to intervene. Bing said Goldberg's intervention would not help "a bit." Bliss knew better, and flew to Denver on August 20 to confer with Goldberg.

By August 21 the Metropolitan Board was in full retreat. Chairman Lauder Greenway said of Goldberg's intervention, "This is a splendid thing. I am wholeheartedly behind it—and so are many members of the board who have been told of it." (The others presumably would continue unenlightened unless the butler read them the newspapers.) From the Italian Alps, still blithely unconscious of the knife in his back, Bing reported to the press that the whole foofaraw was meaningless, it was "too late." Two days later, without the participation of Mr. Bing, who was still abroad, the parties had agreed to let Goldberg arbitrate the issues, and to proceed as scheduled with the Met season. The very minimal award Goldberg later handed down—\$10 a week for the current season, plus a better per diem expense allowance on tour—has led some to speculate that Bliss and Goldberg decided on more than procedure at their Denver meeting.

Yet Goldberg could not have given the union more, for the Met's financial condition is truly desperate. Even with the minimal award, the deficit from 1961-62 may run considerably over \$250,000, and the ten per cent increase in ticket prices announced for next season (to an \$11 top) will probably not bring a balanced budget.

Lincoln Center exacerbates the prob-



HERE'S **PROOF** YOU ALWAYS GET  
**Rock-Bottom Prices**  
WITH CONVENIENT TIME PAYMENTS AT

**Rabsons**  
SINCE 1905

- Unless you're a multi-millionaire get our quote, like these shrewd buyers did!
- These excerpts from letters in our files are proof positive that **RABSONS PRICES ARE ROCK BOTTOM!** Your purchase backed by our reputation for 56 years of **RELIABILITY!** PLUS our 90 (6) months guarantee, instead of the usual 90 days. **STANDARD NAME BRAND LINES.**
- **From "B.M." North Carolina—**  
"I was pleased with your quotation on my proposed Hi-Fi set, as it was \$30.00 less than the next lowest bid of over ten."
- **From "W.W.B." California—**  
"Your package quote was best I received."
- **From "J.K.B." New York State—**  
"Yours was the lowest of six quotations."
- **From "G.E.M." Ohio—**  
"Your quotation was prompt and I was influenced by the six months warranty offer."

**FREE—** With our quote on the equipment or system of your choice we will include a \$1 genuine Miracle Record Cleaning Cloth.

**Rabsons-57 ST., Inc. Dept. 24**  
119 West 57 St., New York 19, N. Y.

••••• (Diagonally opposite Carnegie Hall)

CIRCLE 96 ON READER-SERVICE CARD

# New society for kit enthusiasts passes 6,000 membership mark

*R·A·E Society now ready with first issue of quarterly Journal*

lem. Met musicians who make less than \$10,000 a year are inevitably infuriated by the fact that New Yorkers are willing to spend more than \$140,000,000 for buildings to house the performing arts at the same time that they plead absolute poverty before the performers themselves. At least one more contract will have to be negotiated with orchestra, chorus, and weekly-fee singers in the old house. The opening of the new Met at Lincoln Center is now officially postponed until the fall of 1965, and is not really likely to occur before the fall of 1967. Meanwhile, the money to build the house is still not pledged—at the most liberal estimate of funds in hand and the most conservative estimate of cost of construction, there is still \$19,000,000 to go, and many competent observers would put the actual gap closer to \$30,000,000—especially considering the extra costs which may be involved in doing something about the underground river which has recently been discovered at the site.

Nor is a new house guaranteed to bring economies of operation. Greater storage space, more efficient stage machinery and the like (assuming no objection from the stagehands, who have not yet been consulted) could save several hundred thousand dollars a year. The trucking bill alone ran \$158,000 in the 1960-61 season, and would be virtually eliminated by the below-stage storage facilities planned for the new house. But the Met, as a part of Lincoln Center, would have to pick up certain new housekeeping bills, which might eat up as much as half the savings. (These bills cover the costs of air conditioning, however, offering the Met the possibility of revenue from rental of the house over the summer.) There will be no greater income from the sale of tickets, unless prices are boosted substantially.

Everything considered, past and future, one must admire Bing's courage in planning a 1962-63 season with twenty-six weeks in New York, the longest run the Met has ever attempted, and with five new productions (all of them already sponsored as to basic costs, however, by various charitable individuals and institutions). All five are ambitious operas—Tebaldi's *Adriana Lecouvreur*, and Sutherland's *Sonnambula*, in addition to *Otello*, *Meistersinger*, and *Ariadne auf Naxos*, the last never done at the house before, though the Met in recent years has put its superbest into Strauss. The conductor problem will be tackled head-on, with Ansermet making his debut at the house for *Pelléas et Mélisande*, Solti returning for *Otello* and *Tristan*, and Varviso (who came with Sutherland this year and made a good impression) tackling *Adriana* as well as his sponsor's opera. Orchestral rehearsal time will have to rise considerably from this year's 230 hours, and choral expenses will be up considerably.

This is a fighting season for a man who might have been expected to pull

*Continued on next page*

Announcements of the R·A·E Society have brought an overwhelming response from kit enthusiasts all over the Country. Membership has passed 6,000 and applications are pouring in daily from hobbyists interested in assembling radio, audio, and electronic kits.

## KIT ENTHUSIASTS PRAISE R·A·E SOCIETY PURPOSES

Letters accompanying membership applications make it quite clear that this Society fills a long-felt need for a national organization to represent and advance the interests of kit-builders. Applicants are outspoken about the advantages they will have from membership. One letter summed it all up with: "This looks like the best \$1 investment I ever made."

Most often mentioned as reasons for seeking membership:

- The R·A·E Quarterly Journal available to Society members only—the first and only publication devoted to kits and kit building. (No music articles, no record reviews)
- The R·A·E Advance-Test Panels comprised of members who will pre-test newly designed R·A·E Kits before they are marketed, and who will then keep the finished kits as their own equipment—without any cost.
- The "Members' Roundtable" and other features of the Quarterly Journal where members offer their ideas and experiences, views and opinions, hints and recommendations in an exchange of helpful information about kits and complete systems.

## R·A·E JOURNAL NOW READY

Members of the R·A·E Society are now receiving their copies of the eagerly-awaited first issue of the Society's unique Quarterly Journal. A limited number of extra copies has been set aside to take care of new-member requirements. By acting now, you can be sure to receive this "first-edition" issue as part of your regular membership privileges.

This issue previews the first kits ever designed by kit-builders. Among the equipment articles are:

- NEW: Modular Stereo FM Tuner
- NEW: Electronic Crossover Network
- NEW: Mono Preamp can be Converted to Stereo
- NEW: 36 Plans for High-Quality Installations
- PLUS: New concepts of kit design.

## YOU CAN'T BUY COPIES OF THE JOURNAL

Copies of R·A·E Journal are available ONLY to members of the R·A·E Society. The \$1 annual membership dues entitle you to four issues as one of the benefits of membership—free of charge. No copies can be bought anywhere.

## MORE ABOUT THE QUARTERLY JOURNAL

Milton B. Sleeper, noted figure in electronics and Chairman of the R·A·E Society, heads the editorial staff of the Society's Journal. The Journal is devoted exclusively to subjects of interest to kit builders—newly developed R·A·E kit designs, Advance-Test Panel reports; high-quality mono and stereo installations from the simplest to the most complete; recording techniques; testing and maintenance

CIRCLE 68 ON READER-SERVICE CARD

methods; and how-to articles on improving performance from records, tape, multiplex FM, and TV sound.

The Journal includes a regular "I Think" department where members air their opinions about what they like or don't like in available kit designs, circuits, and assembly methods. News and critical views of subjects related to radio, audio and electronics are covered by "Notes and Comments". A "Buy, Sell and Swap" section is available to members without charge. In short, the Journal contains a wealth of informative, authoritative, and reliable information not available from any other single source. Its contents are refreshing, stimulating, and provocative.

## R·A·E MEMBERS TO SERVE ON ADVANCE-TEST PANELS

This is one of the most original ideas ever adopted for pre-testing new products. Designs intended for kit builders will now reflect the kit builders' point of view, and will be based on actual kit-building experience.

Before any new R·A·E kit is released, 10 prototypes will be tested by an Advance-Test Panel comprising 10 Society members. Each will receive a kit to assemble, and will report his findings to the Society. The completed kit will then become his property at no cost to him. A new Panel will be chosen for each new kit; no member will serve twice. Any Society member may qualify to serve on the Advance-Test Panels.

## RUSH YOUR MEMBERSHIP APPLICATION TODAY!

Just \$1 pays for your first year's dues in the R·A·E Society, and entitles you to all benefits of membership, including four issues of the quarterly Journal. It qualifies you to be chosen to serve on an Advance-Test Panel, and to participate in many other activities to be announced in the Journal from time to time. By acting now, you can still receive a copy of the first issue of the Journal, and you will be eligible to serve on the first Advance-Test Panels.

Use Coupon Below or Your Own Stationery. Read the UNCONDITIONAL MONEY-BACK GUARANTEE in the Coupon. Act today!



R·A·E SOCIETY  
(sponsored by R·A·E  
Equipment, Inc.)  
Savings Bank Building  
Great Barrington, Mass.

Yes, I want to participate in the R·A·E Society's activities. I enclose \$1 as my membership dues for one year. I understand that I will receive a Membership Card, the Quarterly Journal issues for one year, and will qualify to serve on the Advance-Test Panel.

Name .....

Street .....

City & Zone ..... State.....

I understand that I am not required to purchase any R·A·E kits to enjoy membership privileges. I am a  Beginner  Experienced kit-builder  Professional

UNCONDITIONAL MONEY-BACK GUARANTEE  
If I am not completely satisfied after I receive and examine my first issue of the Quarterly Journal, my money will be refunded promptly on request. No extra charge outside the USA.

## Now... build your own TOP QUALITY TELEVISION SET

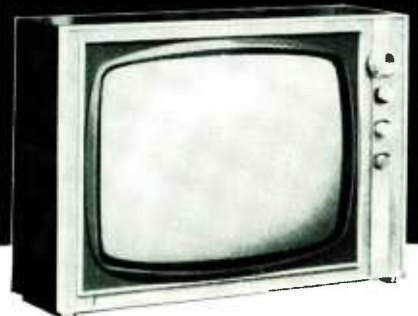

Save money as you enjoy constructing your own fine table-model TV set. Anyone can build it—no technical knowledge or skill needed. The "Custom 70" is Performance Guaranteed by NRI—the top name in Electronic training for nearly 50 years. Picture tube has 206 sq. in. of viewing area. All-American parts. Quality "slim-line" cabinet. Everything included at one low price. Package payment plan. Tear out this ad, write your name and address in margin and mail. Conar will rush pictures and facts on the "Custom 70." A Division of National Radio Institute.

**CONAR instruments**

DG 2C

3939 Wisconsin Ave., Washington 16, D.C.  
CIRCLE 100 ON READER-SERVICE CARD

**TOP ALLOWANCE  
FOR YOUR USED COMPONENTS  
AT**

**audio exchange**

**WHEN YOU PURCHASE**

**The SHERWOOD S-3000 IV  
FM/MX STEREO TUNER**

with "Acro-Beam" Tuning

Features 7" expanded slide-rule tuning scale, Automatic Frequency Scale, special inter-channel hush system which eliminates noisy "hash" between FM channels.

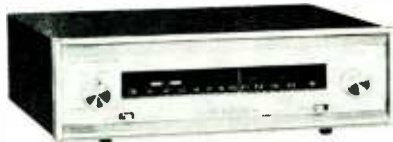

**TRADE 4 WAYS**

- TRADE Hi-fi for hi-fi
- TRADE Amateur radio\* for hi-fi
- TRADE Hi-fi for amateur radio
- TRADE Amateur radio\* for amateur radio\*

\*Includes HAM; SWL; Citizen's Band; Test Equipment

**AUDIO EXCHANGE EXCLUSIVES:**

Trade-Back Plan • New Equipment from over 100 manufacturers • Used Equipment sold on 10-day unconditional money-back guarantee... plus 90-day service warranty • Special GE credit plan • Custom Installation for stereo and monaural equipment. • Hi Fi service laboratory.

Get more! Pay less when you trade at

**audio exchange**

For Trading info., write dept. HA  
PLEASE MAIL ALL ORDERS AND INQUIRIES TO JAMAICA  
153-21 Hillside Ave., Jamaica 32, N. Y. • AXtel 7-7577  
WHITE PLAINS, N. Y. BROOKLYN, N. Y. MANHASSET, N. Y.  
203 Mamaroneck Ave. 1065 Flatbush Ave. 451 Plandome Rd.

CIRCLE 12 ON READER-SERVICE CARD

## THE MET

Continued from preceding page

in his horns. Though only one member of the Met's board—Mrs. August Belmont, who was an actress before her marriage and is the only artist present—voted against canceling the season, there is no question that many members were queasy about the matter and are more than a little annoyed with Bing for the embarrassment he caused them. Last fall, Bliss looked very much like The Vicar of Bray, and Bing's resignation was rumored on odd Tuesdays throughout the first months of the season. Nobody expected Bing to risk the largest number of new productions he has ever attempted. In the past, Bing has had a bad name for arrogance (people say that singers know how to handle him, rather than that he knows how to handle singers) and for petulance (it has been absolutely impossible to keep him from shooting violent letters off to the press the moment anything at the Met is criticized). His willingness now to fight for his job, and his admission that perhaps he made a mistake in his handling of the cancellation question, make him a far more attractive figure. For all his reliance on star sopranos, his inability to get along with strong conductors, his infatuation with Broadway, and his tolerance for certain musical barbarities (the butchered reorganization of Verdi's *Forza*, the cloddish reorchestration of Offenbach's *Périchole*), he has made the Met a functioning theatre, which most people would have regarded as impossible under New York conditions before he came. And great opera, after all, is only a functioning theatre in a state of grace.



**NO FUNERAL TAPS  
FOR DELIUS**

Continued from page 48

of *Sea Drift* is one of the greatest uses of modulation in all music.

Although Delius was cosmopolitan, there was something about him that reflected his boyhood in Yorkshire and that was distinctively English. Compare Shakespeare with Racine: the Frenchman is formal, ordered, measured, objective; the Englishman "simple, sensuous, and passionate"—formless, subjective, passionately concerned with passion and the human person. So also is Delius. Delius may well be compared with Keats, who was himself in the direct line of Shakespeare. One thing more reflecting Delius' Englishry: there is a certain kind of free variation form found in early English music and nowhere else, except in the music of Delius and Arnold Bax. It is the form of *Brigg Fair*, the first *Dance Rhapsody*, *Appalachia*, and other Delius works.

These are, of course, the works Sir

Thomas performed with a kind of perfection, and it is necessary to restore the balance at this point by saying so. He brought to them a saturated pantheism not untouched by deep human compassion that the overripeness of his last years dulled but could not destroy. They meet with precision Sir Thomas' own epicurean Englishness. But there are other aspects of Delius' work that either transcend, or are strangely different from this one, and in order to see him whole we must take them into account. Some of them have been discussed above. Then there is a massive grandeur, of a kind Beecham could not always bring off (in his odd readings of Beethoven, for instance), as in the opening of *A Mass of Life*, music which one has actually heard better done by far inferior conductors; disquieting bitterness, as in *An Arabesque* (Delius the man could be very bitter sometimes); and something akin to mystic vision (how he would have hated the description!) seen in *A Song of the High Hills* and in the wonderful last act of *A Village Romeo*.

Exquisite though many of Sir Thomas' performances of Delius were, he had not such a monopoly of the composer that we may say the works will die with their greatest interpreter. There were even aspects of Delius that may come into their own in the hands of other, even lesser, men. Some Delians even now prefer the readings, on very old records, of Francis Toye, and even if we do not share this view (I do not) it proves that there have always been other interpreters of this music.

Delius was a whole man. He was not a simple hedonistic dreamer at the sunset of romanticism, but a composer of majestic strength, compassion, strange and sometimes eerie insight. He was a poet of the human heart as well as the moods of nature, and he interpreted the one in the light of the other. Above all, he was the ecstatic singer, not of the unattainable past, but of the marvelous moment. In Delius we have a complete man, and a complete music—a great music that will outlive fashion and will triumph over misconception. This is not the work of a weak dreamer but of a man who saw the world whole, saw it clearly and loved what he saw, and died, after a long and painful illness, having summed it up by saying: "I have had a wonderful life."

Sir Thomas deserves our affectionate thanks for all he did for Delius, but he would be the first to say that the creator is greater than the performer. Although perhaps there were things in Delius' music that even Sir Thomas never quite brought out fully, he often remarked on its wide emotional range and scope. Actually there are many reasons, including economic ones, why it is precisely the greatest works, the rugged imaginative things far removed from the lotus-eating legend, that are the most seldom performed. The music of Delius is not the last monument of romanticism, but an eternal mirror of the whole richness of human experience, the glory of the dear earth, not remembered in regret, but experienced anew with rapture, poignance, and an immediate impact of glory.

## IMPROVEMENTS IN ARMS

Continued from page 45

nism that takes the arm off its resting post, moves it over the record, and sets the stylus down in the lead-in groove, all in one easy motion. Rek-O-Kut has introduced a motor-driven device called "Auto-Poise," which automatically sets the arm over the record and lifts it off at the end of the record. The latest Empire arm has a tiny magnetic catch that lifts the arm off the record at the end of play. In the new AR turntable and arm combination viscous damping is used to offer some amount of friction as long as the arm is off the record; once the stylus touches the groove, the friction is removed. In somewhat like manner, the new Neumann integrated turntable and arm boasts an air-compression system which lowers the pickup when actuated by a remote lever. The mechanism disengages itself from the arm when the stylus is in the record groove.

IF it remains a tossup as to whether the best performance can be achieved with an integrated arm and pickup or with a "universal" arm designed to accept any number of pickups, it seems equally open to question as to whether the tone arm should be integrated in another direction—that is to say, with the turntable. There are strong arguments in favor of such integration, regardless of what happens at the pickup end of the chain. For one thing, as pointed out earlier, the resonance of the arm should be adapted to the rumble frequency of the turntable so that it helps to cancel, rather than to reinforce, it. There are other important factors to be considered in the relation of arm and turntable if rumble, as well as instability, are to be minimized. Although arm manufacturers strive for an arm design which will work well with most turntables, it is obviously easier to build one which works best with a given turntable. The growing tendency towards such integration is fairly apparent, with the same manufacturer offering both an arm and a turntable for use together.

In the record changer, of course, the arm must of necessity be integrated with the turntable. At one time, the arms of most automatic players were primitive and crude as compared with the best separate tone arms. They had to operate at higher pressures, loaded the stylus more heavily, had fairly large tracking errors, and generally failed to deliver the performance possible with a good tone arm and turntable combination. More recently, however, some changer designers have corrected this disparity with conspicuous success. The Garrard "Type A" and the new Studio series from Miracord, for example, use arms which look, and behave, like good independent tone arms. They employ many of the principles discussed here, making possible the use of high compliance pickups and fairly low tracking pressures. Improved motors, more sophisticated mechanical designs, and lower rumble levels also characterize the new changers.

The improvement in sound quality made by the new arms depends on circumstances. Installation of a new arm in an existing system may yield no significant performance improvement unless the present tone arm does not provide optimum tracking and adjustments or unless you have a pickup permitting a low needle pressure of 2 grams or less. Most of the older pickups require more than 2 grams of pressure and thus work quite adequately with the older type of tone arm. While a new arm might coax a little more performance from an older pickup, it is rather doubtful that the improvement would justify the cost. Replacing both arm and pickup offers a far better possibility of improvement. Assuming one of the new pickups with compliances of  $6 \times 10^{-6}$  or better, the new arm should provide good tracking at pressures between 1 and 2 grams and allow the use of a 0.5-mil stylus. Record wear may be minimized since with pressures of 2 grams or less the stylus loses its tendency to deform the record. Wear caused by rubbing should become insignificant, not only because the rubbing force is reduced, but also because the needle itself will not develop "flats"—a great cause of record deterioration. And while audible improvement may not be very dramatic, there may be some reduction of distortion in peak passages, highs may be smoother, and transient response significantly better.

The new tone arms, along with the new high compliance pickups which they complement (and current refinements in turntables), today afford records the best ride they have ever enjoyed in the history of sound reproduction.



### THE BIG BANDS

Continued from page 51

stituting a reed section using written parts instead of the single improvising clarinet of his earlier music. The sound of the older style could be retained by having the sax players frequently double on clarinets and take clarinet solos. Oliver profited by Redman's example (and he used an arranger named Billy Paige, for whom Redman had worked in Pittsburgh) but only as a guide to expanding what he already had. To hear the most interesting evidence of the evolution of this style, compare Oliver's 1923 *Riverside Blues* with the 1936 Crosby band's *Dixieland Shuffle*, obviously inspired by *Riverside*.

Duke Ellington learned from Redman and Henderson too (indeed some of his early recordings are virtually imitations) but he abandoned the dance band idea and started all over again for himself—and his conception proved to be the

Continued on next page

# SAVE OVER 40% ON HI-FI

USE OUR EASY-PAY-PLAN Up to 24 months to pay

2418/Bell 30 Watt Stereo Amp.....\$109.95  
RC88/11 Garrard 4/Speed Stereo changer 59.50  
108-Audio Empire Diam. Stereo Cart.. 35.00  
2-Famous make 3-way speakers mounted in walnut bookshelf cabinets..... 119.90  
All Interconn. Cables & Inst..... 4.50

Send for FREE Quotations on Your Package or Single Components

Catalog Price..\$328.85  
YOUR COST.... 195.00

You Save Over 40%.... 133.85

BEFORE YOU BUY HI-FI write for no obligation quotation on your Hi-Fi requirements. We guarantee. "We Will Not Be Undersold." FREE WHOLESALE CATALOG.

### ELECTRONIC WORLD HI-FI RECORDING TAPE

7" Spools - Splice Free - Freq. Resp. 30 15KC

		3-11	12-23	24-100
12A	1200' Acetate	\$1.29	\$1.17	\$ .99
18A	1800' Acetate	1.79	1.59	1.45
18M	1800' Mylar	2.09	1.99	1.85
24M	2400' Mylar	2.69	2.59	2.49

Any assortment permitted for quantity discount. Add 15c per spool postage. 10c 24 or more.

ALL MDSE. SOLD ON 15-DAY MONEY-BACK GUARANTEE.

## HI-FIDELITY

CENTER  
"The House Of Low Low Prices"

220-A East 23rd St., New York 10, N. Y.

CIRCLE 51 ON READER-SERVICE CARD

## NEW STEREO SPEAKER SELECTOR SWITCH

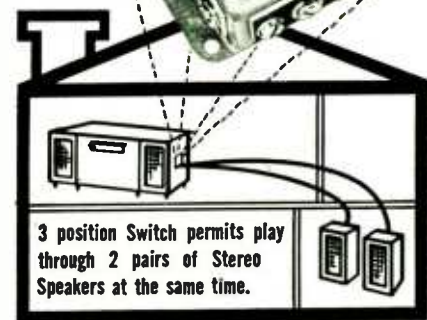

3 position Switch permits play through 2 pairs of Stereo Speakers at the same time.

Now you can listen to Stereo in any room in your home. Quality tap switch permits selection of main speakers, remote speakers or both sets at the same time.

Simple installation. Mounts on wall or cabinet. Screw terminals.

Part No. 670. U.S.A. List Price \$6.25  
Contact your dealer or write for name of dealer nearest you.

## SWITCHCRAFT

5539 N. Elston Ave., Chicago 30, Ill.

CIRCLE 84 ON READER-SERVICE CARD

THE BIG BANDS

Continued from preceding page

most brilliant and durable of all.

Ellington has been a major jazzman for over thirty years, and his achievements are large enough to cut across any considerations of period or style. But it was precisely at the height of the swing craze that he was doing some of his greatest work, and his was one of the few groups of this period that had a really original approach to big-band jazz.

In 1927, Ellington's orchestra was hired by the Cotton Club to provide music for elaborately staged and lurid floor shows. Acts by talented singers and dancers would be separated by wildly absurd production numbers in which sheiks abducted innocent American heiresses, or "white goddesses" ruled native African tribes with bullwhips. Here Ellington's talent was released, and he soon found himself with a new sort of band. In effect, he converted a pit or show orchestra into a jazz group. The emphasis fell on refinement in orchestration, on the integration of solo and group, and on creating varied sounds and textures.

Ellington led the band, but everyone contributed. As he later commented: "The music's mostly written down, because it saves time. It's written down if it's only a basis for a change. There's no set system. Most times I write it and arrange it. Sometimes I write it, and the band and I collaborate on the arrangement. Sometimes Billy Strayhorn, my staff arranger, does the arrangement. When we're all working together, a guy may have an idea and he plays it on his horn. Another guy may add to it and make something out of it."

Ellington's whole career is full of excellences, but between 1938-40 he produced one exceptional record after another. *Rumpus in Richmond*, *Ko Ko*, *Harlem Air Shaft*, *Sepia Panorama*, *Banjangles*, *Concerto for Cootie*, *Across-the-Track Blues*, *In a Mellotone*, *Jack the Bear*—these are surely the jazz masterpieces of their time, and in them the composer, the solo improviser, and the group form an emotional and musical whole which surpasses the sum of its parts. Ellington has influenced everyone (including such acknowledged followers as Charlie Barnet, to whom he once even loaned his library of arrangements), but he has had very few successful imitators.

One other band that was inspiring musicians in 1939 was Count Basie's, and it gave the Goodman orchestra such pieces as *One O'Clock Jump*, *Sent for You Yesterday*, and *Jumpin' at The Woodside*. But in Basie's orchestra—with its special kind of light swing and the nearly revolutionary ideas of some of its soloists, particularly the brilliant tenor saxophonist Lester Young—we hear the beginning of a new kind of music which a few years later was to become "modern jazz."

The innovations in the Basie band were the handwriting on the wall for the big swing bands, it seems to me. Their demise has often been attributed to economics, but I think the real reason is

ARIZONA

**WESTERN HI FI FANS**  
ARE YOU INTERESTED IN PRICES?  
**WRITE FOR QUOTATION**  
AUTHORIZED DISTRIBUTORS  
SCOTT-JENSEN and OTHERS MAJOR LINES  
**Hi-Fi Sales Company**  
735 West Main Street  
Phone 969-3191 Mesa, Arizona

CIRCLE 52 ON READER-SERVICE CARD

that the work of all but the very best big bands was done. By the late Thirties, the swing style had made a musical summary and synthesis of fifteen years of jazz. Great numbers of bands had spread the news and popularized the music. Artistically, it was time for something new, and that something new eventually came from individual improvisers working in small groups. Only the most truly creative bands of the Forties could endure both the artistic impact of "modern" jazz and the spiraling expense of keeping so many men together.

Today, Henderson is dead, but Goodman periodically gets out the old book and forms a new band to play it again. Don Redman's chief occupation is writing arrangements for Pearl Bailey. And Ellington? Well, of course, he still leads the best big band in jazz.

SOME of the performances mentioned in this article have been reissued on microgroove recordings, as follows:

Columbia's Henderson anthology "Fletcher Henderson: A Study in Frustration" (C4L19)—beginning with *Dicty Blues* and including two versions of *Sugarfoot Stomp* (one with Armstrong), the remarkable *Stampede* by the Henderson trumpeters, *Henderson Stomp*, early and late versions of *King Porter Stomp*, *Honeysuckle Rose*, *Blue Lou*, *Christopher Columbus*, *Stealin' Apples*—presents sixty-four titles from all periods. Other early Henderson (and early Ellington) is on Riverside 12129.

Goodman versions of *Sometimes I'm Happy* are on both RCA Victor LPM 1239 and Columbia CL 818. Also on LPM 1239 are *Big John Special*, *Sugarfoot Stomp*, and *Wrappin' It Up*; and RCA Victor LPM 1099 has *Down South Camp Meeting*, *King Porter Stomp*, and *Sing, Sing, Sing*. Alternate "concert" versions of most of the same pieces appear on Columbia CL 818 and 820. A collection of Henderson arrangements, played by the Goodman band on Columbia CL 524, includes *Honeysuckle Rose*, *Stealin' Apples*, *Henderson Stomp*, etc.

The Crosby band is on Coral 57005, which includes *Dixieland Shuffle*. This disc and Decca 8061 cover the Crosby repertory very well. The Oliver *Riverside Blues* (with Louis Armstrong in the band) is on Riverside 122.

The Ellington pieces mentioned in this article can be heard on RCA Victor CPM 1364 and LPM 1715. The former has *In a Mellotone*, *Rumpus in Richmond*, *Sepia Panorama*, and *Cotton Tail*; the latter, *Jack the Bear*, *Concerto for Cootie*, *Harlem Air Shaft*, *Across-the-Track Blues*, and *Ko Ko*.

CALIFORNIA

**QUICK-SEE ALBUM FILE**



Eliminates bottom jacket wear. Rolls forward for front-view, flip-through selection. 9 models fit any cabinet, closet or shelf. \$7.95 up. Also available with cabinet shown. Dealers, inquire.

**KERSTING MANUFACTURING COMPANY**  
504 S. Date Street, Alhambra, California

CIRCLE 55 ON READER-SERVICE CARD

**RENT**  
stereo tapes

- Over 2000 different albums All Labels
- 2-track and 4-track
- No deposit on tapes rented
- Postpaid to and from your home

FREE BROCHURE  
**stereo-parti** 

811-A CENTINELA AVE., INGLEWOOD, CALIF.

CIRCLE 82 ON READER-SERVICE CARD

DISTRICT OF COLUMBIA

Save 30%, 4-Track  
Stereo Music on Tape  
Empty 3" Plastic Reels, 7c ea.



Bargain Prices! Send for our Recorder, blank / pre-recorded tape catalog H-1.

**NORELCO SPEAKER**  
Famous AD3800M, twin cone 8" (75-19,000 cycles) discontinued model, former list 16.00, usual net 9.90 going at 4.99 plus postage (2 for 9.00). Other Norelco speaker sizes at bargain prices—SEND FOR SPEAKER SPECIFICATION SHEET.

**SAXITONE TAPE SALES**  
(Div. of Commissioned Electronics, Inc.)  
1776 Columbia Rd., Wash., D. C.

CIRCLE 29 ON READER-SERVICE CARD

IN WASHINGTON, D. C.  
Nearly Everyone Buys At...  
**Myer's EMCO**

MAIN STORE:  
509 11TH ST., N.W., WASH., D.C.



CIRCLE 64 ON READER-SERVICE CARD

ILLINOIS

**record index**

recocards

Designed for collections of 150 up.  
Send for brochure, sample record index cards, sample index guides by composer.

Recocards  
(H 2) 503 Hyde Park Bank Building  
1525 East 53rd St., Chicago 15, Illinois

CIRCLE 69 ON READER-SERVICE CARD

MARYLAND

**DIXIE**  
HIGH FIDELITY WHOLESALERS

Largest discount High Fidelity component distributors in the South. Wholesale prices on package or individual components. Latest models in factory sealed cartons.

**Are prices too high?—Write:**  
**DIXIE HI-FI**  
12402 Connecticut Ave., Silver Spring, Md.

CIRCLE 32 ON READER-SERVICE CARD



MARYLAND



**HARPSICORDS  
CLAVICHORDS**  
by  
**SPERRHAKE**

write for  
Illustrated brochure

**Robert S. Taylor**  
8710 Garfield St.  
Bethesda, Maryland

CIRCLE 86 ON READER-SERVICE CARD

NEW JERSEY

**WRITE FOR QUOTATION  
ON HI-FI COMPONENTS**

**SOUND  
REPRODUCTION, INC.**

34 New Street, Newark 2, N. J.  
Mitchell 2-6816

CIRCLE 80 ON READER-SERVICE CARD



**Universal Record Club**  
ONLY RECORD CLUB OF ITS KIND  
offers you **EVERYTHING!**  
**ALL Hi-Fi and Stereo Records**  
**Buy 2-Get 1 FREE**  
**50% DIVIDEND**  
This offer good every time you buy  
Write for full details and new 250-page catalog—  
35c coin, deductible from first order. Records guaranteed  
factory-fresh. Shipped immediately at regular  
catalog prices. Small handling & mailing charge.  
**Universal Record Club**  
Box 1111C, Mountainside, N. J.

CIRCLE 90 ON READER-SERVICE CARD

NEW YORK

**FOR THE TOPS IN VALUE  
AND THE BEST TRADE-IN ON  
HIGH FIDELITY EQUIPMENT**  
*Check with Arrow!*

**ARROW ELECTRONICS, INC.**

65 Cortlandt St., New York 7, N. Y.  
Digby 9-4730  
525 Jericho Turnpike, Mineola, N. Y.  
Pioneer 6-8686

CIRCLE 7 ON READER-SERVICE CARD



**AUDIO unlimited**  
Specializes in **SAVING YOU MONEY**  
✓ **FACTORY FRESH COMPONENTS**  
✓ **LOWEST POSSIBLE QUOTATIONS**  
✓ **FAST DELIVERY**  
We are **FRANCHISED DEALERS** for most Hi-Fi  
lines. Most orders **SHIPPED PROMPTLY** from  
stock. **RECORDING TAPE AT LOWEST PRICES.**  
**FREE-95-PAGE STEREO CATALOG.**  
190-F Lex. Ave., Cor. 32  
St., New York 16, N. Y. **Visit Our Showroom**

CIRCLE 15 ON READER-SERVICE CARD

**OUT OF SPACE?**  
You bet we'd be...  
If we were to tell you  
All about AUDION's  
"Out of this World"  
Hi-Fi Values.  
Write for free catalog.  
**audion**  
25-HF Oxford Road  
Massapequa, New York

CIRCLE 16 ON READER-SERVICE CARD

NEW YORK

**PROMPT  
DELIVERIES**  
**LOWER PRICES**

**AMPLIFIERS, TAPE  
RECORDERS, TUNERS, ETC.**

**NO CATALOG. INDIVIDUAL QUOTES. COMPARE**  
**L. M. BROWN SALES CORP.**  
Dept. F-239, East 24 St., New York 10, N. Y.  
CIRCLE 21 ON READER-SERVICE CARD

**MAIL ORDER HI-FI**

Recorders Components Tapes  
at wholesale prices  
Reliable, Prompt Delivery  
(Free Catalogue)  
We'll Air-Mail

**CARSTON Studios**

125-D, E. 88 St. New York 28, N. Y.

CIRCLE 25 ON READER-SERVICE CARD

**RECORDS AT COST...**

Through Our Special Membership Plan  
Regular High Fidelity and Stereo  
Classical—Popular—Jazz—Show Hits—Folk etc.  
A unique kind of record club — no "agree to purchase"  
obligations — no "selected" record list to choose from —  
no "list price" purchases — no "division" requirements.  
Simply, Citadel club members can purchase virtually any  
record or album, by any artist, on any label for cost price.  
Yearly membership \$3.00. Write for free details...

**CITADEL RECORD CLUB**

545 Fifth Ave. Dept. H. New York 17, N. Y.

CIRCLE 26 ON READER-SERVICE CARD

**USED HI-FI BOUGHT—SOLD  
TOP CASH PRICES PAID**  
**All Equipment Guaranteed**  
**EXPERT REPAIR SERVICE,  
KITS WIRED.**

"Always A Bargain" At  
**DOUGLAS RADIO BARGAIN BASEMENT**  
128 Greenwich St., New York 6, N.Y.  
WOrth 4-0470 4-0471

CIRCLE 33 ON READER-SERVICE CARD

**TAPE RECORDERS**  
**HI-FI Components**  
**SLEEP LEARN KITS**  
**Unusual Values**  
**FREE**  
1962 Catalog  
**DRESSNER** 1523 FA Jericho Turnpike,  
New Hyde Park, New York  
CIRCLE 34 ON READER-SERVICE CARD



**MERITAPE**  
Low cost, high quality recording tape in boxes or cans.

**SAVE UP TO 40% on  
HI-FI COMPONENTS**

- 15-Day Money-Back Guarantee
- EASY PAY PLAN—24 MOS. TO PAY
- WE GUARANTEE WE WILL NOT BE UNDERSOLD

Please write for FREE return mail quotation, and wholesale catalog. Also pre-recorded tape catalog on request.



220-HP East 23rd St.  
New York 10, N. Y.

CIRCLE 51 ON READER-SERVICE CARD

NEW YORK

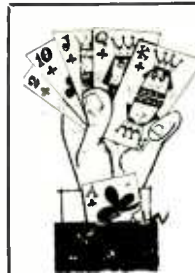

**WINNERS  
ALL\***

Be a winner too! Write for our big discount prices on your hi-fi needs—and send for our unusual money-saving audio catalog A-15. It's free!

\*71,592  
**SATISFIED CUSTOMERS**  
**Key Electronics Co.**  
120 Liberty St.,  
N. Y. 6, N. Y.

CIRCLE 56 ON READER-SERVICE CARD

**NATIONWIDE DELIVERY...**  
on all your Stereo needs. **Recorders, Tuners, Amplifiers, Turntables, etc.**  
**LET US PROVE** that we can supply your requirements **PROMPTLY AT LOWEST COST. FREE CATALOG.**  
**STEREO COMPONENT Supply Co., Dept. F**  
148-25 — 12th AVE., FLUSHING 57, N. Y.



CIRCLE 81 ON READER-SERVICE CARD

**TRADE-INS ACCEPTED**  
**SAVE MONEY**  
on **High Fidelity Equipment**  
Check our prices first on all Hi-Fi and Stereo Equipment. **New, fully guaranteed. Prompt service on all inquiries.**  
Write to **Arthur Knight**  
**TERMINAL-HUDSON ELECTRONICS, Inc.**  
236 West 17th St., N. Y. 11, N. Y. Dep't HF

CIRCLE 87 ON READER-SERVICE CARD

PENNSYLVANIA

**"FRED MILES PRESENTS"**  
Records For Jazz Fans



CIRCLE 62 ON READER-SERVICE CARD

WASHINGTON

**LEARN WHILE YOU SLEEP**

**Headquarters**  
Experiment in this fascinating, educational new field. Use your phonograph, recorder or amazing new "Electronic Educator" endless tape recorder. We carry a full line of endless tapes for standard recorders, plus timers, pillow speakers and complete outfits. Also 200 unusual educational and self-help courses on tape and record for sleep-learning and self-hypnosis experimenters. Write for free 300-item catalog and full details.  
**Sleep-Learning Research Association**  
P. D. Box 24-F, Olympia, Washington

CIRCLE 78 ON READER-SERVICE CARD

ENGLAND

**TAKE THE TIME...**  
to write to us and we will show you how to keep your **HI-FI COSTS LOW!**  
**BRITISH EQUIPMENT**  
Amplifiers, Tuners, Speakers, Motors, Pick-Ups from the United Kingdom. **Hi-Fi Mail Order Specialists.** carefully packed, insured and shipped promptly at minimum cost.  
**C. C. Goodwin (Sales) Ltd.**  
(Dept. H)  
7, The Broadway, Wood Green London N. 22, England



CIRCLE 46 ON READER-SERVICE CARD

# ADVERTISING INDEX

## THE NEW LAFAYETTE



### LT-200 UNIVERSAL MULTIPLEX ADAPTER

achieves the finest stereo performance from your tuner.

**54<sup>50</sup>**

**NO MONEY DOWN**  
Made In U.S.A.

- 35 db Stereo Separation (at 400 cps)
- Matches With Virtually All Recent Model Wide-Band Tuners Equipped With MPX Output Jacks
- Less Than 1% Harmonic Distortion From 50 to 15,000 CPS
- Hum Level Better Than 60 db At 60 cps For 1 Volt Signal Input
- Self Powered
- As Easy To Connect As Were Your Original Components
- Features Include: Notch Filter For 38KC; Low Impedance Plate Follower Output; Matched Diodes For Optimum Separation
- Complete With Enclosure & All Necessary Connecting Cables



Keep Your Components Operating AT Peak Performance with the LAFAYETTE

### TE-15 TUBE TESTER

**19.95**

COMPLETELY WIRED — NOT A KIT

- Accurately Checks Over 1000 Different Tubes
- Tests for Cathode Emission, Leakage and Shorts plus Filament Continuity
- Completely Portable—Weighs Only 6 lbs. and Measures 3¼Wx8½Dx2¾"H

**NEW!**  FREE 340-page 1962 Catalog 620

### LAFAYETTE RADIO ELECTRONICS

Dept. WD2-2, P. O. Box 10  
Syosset, L. I., N. Y.

LT-200 Multiplex Adapter  TE-15 Tube Tester

\$ ..... enclosed

NAME .....

ADDRESS .....

CITY ..... ZONE ..... STATE .....

CIRCLE 58 ON READER-SERVICE CARD

Key No.	Page	Key No.	Page		
1	Acoustic Research, Inc.	9	53	KLH Research & Development Corp.	103
2	Airex Radio Corp.	106	55	Kersting Mfg. Co.	110
3	Allied Radio	32	56	Key Electronics	111
4	Altec Lansing Corp.	29	57	Koss, Inc.	14
5	American Concertone	91	58	Lafayette Radio	4, 112
6	Ampex Corporation	96	101	Leak, H. J. & Co., Ltd.	92
7	Arrow Electronics	111	59	London Records	73
8	Artia Records	82	104	Magnecord	100
9	Audax	17	60	McIntosh Laboratory, Inc.	27
11	Audio Devices	5	61	Mercury Records	69
10	Audio Dynamics	18, 19	62	Miles, Fred	111
12	Audio Exchange	108	63	Minnesota Mining & Mfg. Co.	26
13	Audio Fidelity	60	64	Myer's Emco	110
14	Audio Master Recording	88	102	Newcomb Audio	83
15	Audio Unlimited	111	65	PACO	8
16	Audion	111	66	Pickering & Co.	2
17	Bell Sound	21	67	Pilot Radio	Inside Front Cover
18	Benjamin Electronic Sound Corp.	33		Professional Directory	110, 111
19	Bozak, R. T., Co.	24	97	Quarante-Cinq	101
20	British Industries Corp.	36	68	RAE Society	107
21	Brown, L. M., Sales Corp.	111	96	Rabson's—57 St., Inc.	106
22	Cabinart Acoustical Dev. Corp.	76	69	Recocards	110
23	Cambridge Records	83	70	Reeves Soundcraft	25
25	Carston Studios	111	71	Rek-O-Kut	23
26	Citadel Record Club	111	72	Roberts Electronics	80
27	Columbia Records	58	73	Sarkes-Tarzian, Inc.	34
28	Command Records	67	29	Saxitone	110
29	Commissioned Electronics	110	74	Schober Organ	28
100	Conar Instruments	108	75	Scott, H. H., Inc.	6, 7
98	Concord Electronics	95	76	Sherwood Electronics	Back Cover
30	Daystrom	89	77	Shure Bros.	90
31	Deutsche Grammophon Gesellschaft	65	78	Sleep Learning Research Association	111
32	Dixie Hi-Fi	110	79	Sony Corporation	30
33	Douglas Radio Supply	111	80	Sound Reproduction	111
34	Dressner	111	81	Stereo Component Supply Co.	111
35	Dual	99	82	Stereo-Parti	110
37	EICO	104	83	Superex	94
38	Electro-Acoustic Products	16	84	Switchcraft	109
39	Electro-Sonic Labs., Inc.	81	85	Tandberg	102
40	Electro-Voice, Inc.	22	86	Taylor, Robert S.	111
41	EMPIRE	1	87	Terminal-Hudson	111
101	Ercona Corp.	92	99	Thorens	77
42	Fairchild Recording Equip.	79	88	Transvision	72
43	Fisher Radio Corp.	11-13, 15	89	United Artists	94
20	Garrard Sales	36	35	United Audio	99
44	General Electric Co.	20	90	Universal Record Club	111
45	Golden Crest Records	80	91	University Loudspeakers, Inc.	Inside Back Cover
46	Goodwin, C. C.	111	92	Utah Electronics	78
47	Grado Labs., Inc.	10	93	Vanguard Recording	83
48	Hansom Books	82	94	Viking of Minneapolis	98
49	Harman-Kardon, Inc.	31	103	Warner Bros.	84
50	Heath Co.	35	95	Westminster	71
52	Hi-Fi Sales	110			
51	Hi-Fidelity Center	109, 111			



**JULIAN D. HIRSCH**  
of Hirsch-Houck  
Laboratories

Summing up his report  
for HI-FI STEREO  
REVIEW, Julian  
D. Hirsch wrote:

*"In my opinion,  
the UNIVERSITY  
CLASSIC MARK II  
... is one of a  
limited group of  
speakers to which I  
would give an  
unqualified topnotch  
rating."*

"Despite the popularity of bookshelf-size speaker systems, the big speaker system is far from extinct. There is still a great deal to be said for the sound quality of a really good large speaker system, one of which is University's new Classic Mark II.

In operation, the Classic Mark II handles low frequencies up to 150 cps through a 15-inch high-compliance woofer that is installed in a ducted-port cabinet. The bulk of musical program content, however, is handled by an 8-inch mid-range speaker, which covers from 150 to 3,000 cps. Above 3,000 cps, a Sphericon super tweeter takes over.

The measured indoor frequency response of the Classic Mark II was remarkably uniform. As a rule, such response curves are so far from flat that I do not attempt to correct them for the slight irregularities of the microphone's response. However, the measurements for the Classic Mark II prompted me to plot the microphone response also. This further emphasizes the uniformity of the system's frequency response. A 5-db increase in the setting of the tweeter-level control would probably have brought the range above 3,000 cps into nearly exact conformity with the microphone-calibration curve.

The low-frequency distortion of the woofer, even at a 10-watt input level, was very low, and it actually decreased at 20 cps, where the output was beginning to rise... Any good amplifier of 10 watts rating or better should be able to drive it satisfactorily.

In listening tests, the Classic Mark II sounded very clean... there was an undercurrent of bass, more often felt than heard, that was completely lacking in some other quite good speaker systems that I compared to the Classic Mark II. The speaker sounded at its best (to my ears) at moderate listening levels. At high levels the bass tended to be overpowering. A different listening room, of course, could easily alter this situation completely. Over-all, the sound was beautifully balanced, with wide dispersion and a feeling of exceptional ease. There was never a hint that three separate speakers were operating; the sound seemed to emanate from a large, unified source.

In my opinion the University Classic Mark II justifies the substantial claims that its manufacturer has made for it. It is one of a limited group of speakers to which I would give an unqualified topnotch rating. Anyone who is in a position to consider a system of its size and price would be well advised to hear it. The price of the system is \$295.00."

**WRITE TODAY FOR THE COMPLETE HIRSCH-HOUCK/HI-FI STEREO REVIEW REPORT** on the new CLASSIC, as well as the documented CLASSIC brochure and "Informal Guide to Component Stereo High Fidelity." Simply write: Desk P-4, University Loudspeakers, 80 S. Kensico Ave., White Plains, New York.



A Division of Ling-Temco-Vought, Inc.

another flawless  
combination of  
form & function

# THE CLASSIC MARK II

by UNIVERSITY

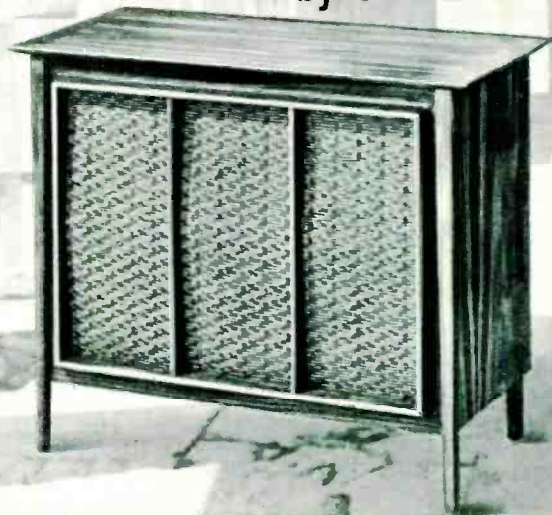

CIRCLE 91 ON READER-SERVICE CARD

**DO YOU LIVE NEAR  
ONE OF THESE  
STEREO-FM CITIES?**

Ariz., Phoenix: KEPI, KNIX  
 Calif., Fresno: KCIB, KXQR  
 Los Angeles: KFMU, KMLA  
 Oceanside: KUDE  
 Sacramento: KSFM  
 Santa Barbara: KMUZ  
 San Diego: KGB, KLRO, KPRI  
 San Francisco: KPEN, KBAY  
 San Jose: KSJO  
 Visalia: KONG  
 Woodland: KATT  
 Conn., Newton: WGMF  
 Dela., Wilmington: WJBR\*  
 Fla., Miami Beach: WAEZ, WVCG  
 Orlando: WHOO  
 Sarasota: WYAK  
 Ga., Columbus: WRBL  
 Ill., Chicago: WEFM, WFMT, WKFM\*  
 Rock Island: WHBF  
 Ind., Evansville: WIKY  
 Indianapolis: WFMS, WISH  
 Iowa, Des Moines: KDMI  
 Kans., Lawrence: KANU  
 Wichita: KCMB  
 Md., Towson: WAQE  
 Mass., Boston (Waltham): WCRB  
 Lynn: WUPY  
 Mich., Detroit: WDTM, WGPR, WLDM  
 East Lansing: WSWM  
 Grand Rapids: WJEF, WOOD  
 Minn., Minneapolis: WAYL, KWFM  
 Mo., Kansas City: KCMO  
 St. Louis: KCFM, KSHE, KWIX  
 Nebr., Omaha: KQAL  
 Nev., Las Vegas: KORK  
 N.J., Dover: WDHA  
 Long Branch: WRLB  
 N.Y., Garden City: WLIR  
 New York: WQXR, WTFM  
 Schenectady: WGFM  
 Syracuse: WSYR  
 Westbury: WGFM  
 N.C., Burlington: WBBB  
 Ohio, Akron: WDBN  
 Cleveland: WNOB  
 Columbus: WBNS  
 Middletown: WPFB  
 Ore., Eugene: KPFM  
 Portland: KPFM  
 Penn., Johnstown: WJAC  
 Norristown: WFI  
 Philadelphia: WFLN, WHAT, WQAL  
 Pittsburgh: WKJF  
 Wilkes-Barre: WYZZ  
 R.I., Providence: WPFM  
 S.C., Spartanburg: WSPA  
 Texas, Dallas: KIXL, KSFM  
 Houston: KODA, KFMK\*, KGHM  
 Wichita Falls: KNTO  
 Va., Richmond: WFMV  
 Wash., Seattle: KISW, KLSN  
 Wisc., Milwaukee: WFMR, WMKE, WTMJ  
 Canada, Oshawa: CKLB  
 Toronto: CFRB, CHFI

\*Sterecasts use Sherwood-built FM-MX equipment.

If so, see your Sherwood dealer right away! The FM stations listed above are now—or soon will be—broadcasting in Stereo. To enjoy fully this thrilling new experience, you need the incomparable Sherwood S-8000 FM-Stereo Receiver and a pair of Sherwood SR3 "Ravinia" Loudspeakers. See and hear these superb stereo starters at your Sherwood dealer. Sherwood Electronic Laboratories, Inc., 4300 N. California Ave., Chicago 18, Illinois. For details, write Dept. H4

**SHERWOOD**

only for those who want the ultimate



S-8000 FM/MX 64 Watt Stereo Receiver  
 16 1/2" x 4" x 14" deep. \$299.50

Ravinia Model SR3 3-way Speaker System  
 26" x 15" x 13 1/2" deep. \$139.50 (Hand rubbed walnut.)



CIRCLE 76 ON READER-SERVICE CARD