

RUDOLF SERKIN *by Joseph Roddy*

high fidelity

JULY

THE MAGAZINE FOR MUSIC LISTENERS

60 CENTS

How To Get Your Equipment Serviced

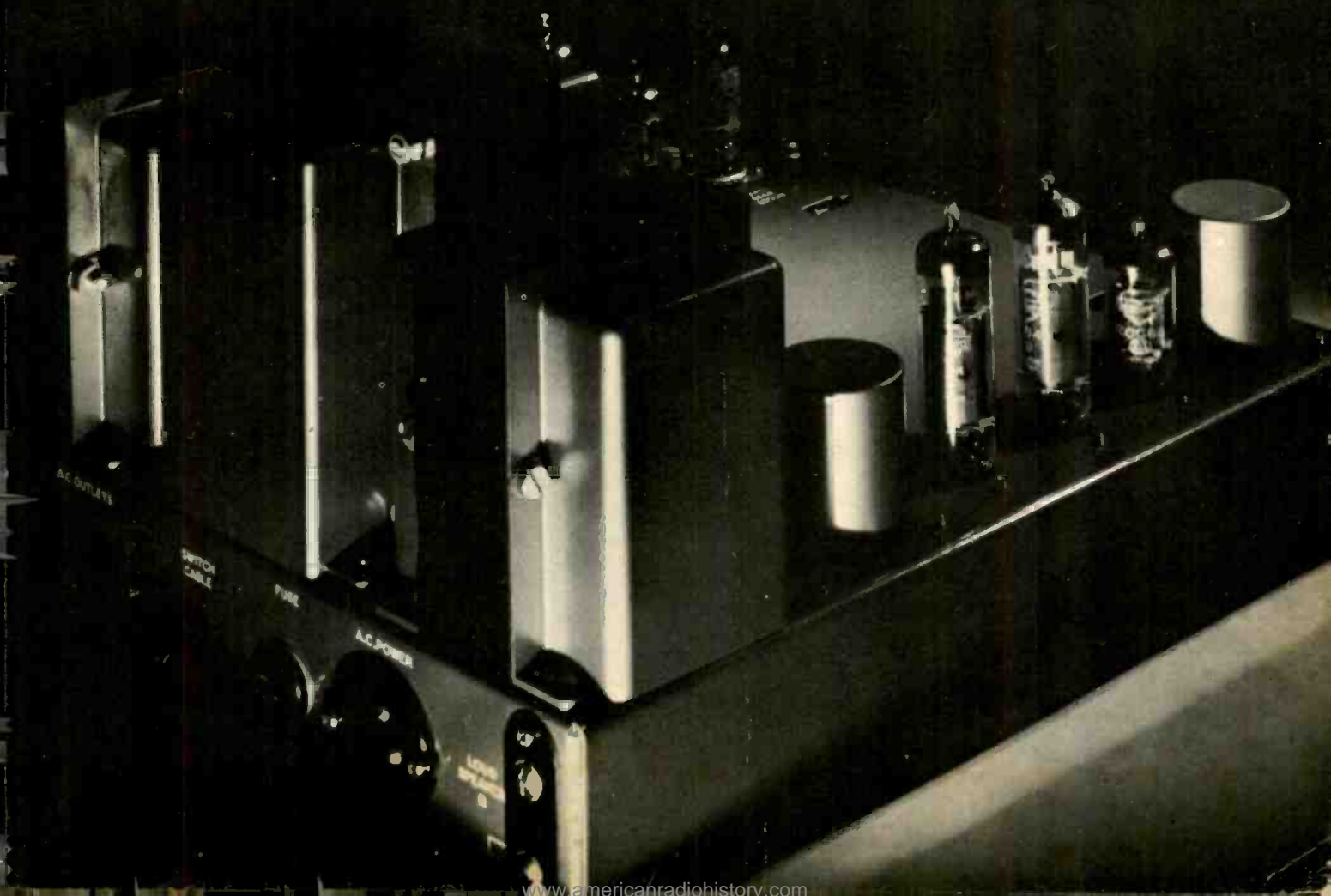

**RED SEAL
RARITIES
ON RCA VICTOR**

In Living Stereo
and Monaural Hi-Fi



Now for the first time at regular prices, four outstanding recordings by Herbert Von Karajan and the Vienna Philharmonic. Formerly available only in the de luxe Soria Series. Beethoven "Symphony No. 7"; Brahms "Symphony No. 1"; "The Vienna of Johann Strauss"; and Mozart "Symphony No. 40" with Haydn "Symphony No. 104." Salzburg-born Karajan is an ideal conductor of the Viennese "classics." These recordings are models of clear, bright, enchanting sound, wonderful ensemble playing, and infallible musicianship.

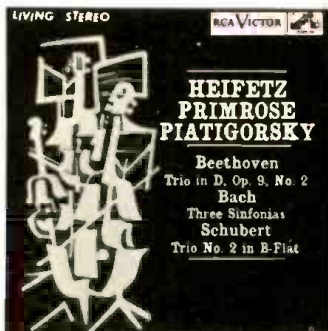

Heifetz, Primrose, Piatigorsky in three remarkable stereo premières! Also, as recorded here, a "first" for these Bach "Sinfonias" which are derived from the "Three-Part Inventions." Original texts were used by our virtuosi, with the three parts given to violin, viola, cello. Pure, rare trio masterpieces.

Morton Gould hand-picked the "best of the best"—songs by Richard Rodgers, Hoagy Carmichael, Harold Arlen, other greats—and cast them in his own smart, polished stylings. Result: Irresistible! Enjoy "Stormy Weather," "Speak Low," "Body and Soul," "Where or When," "Stardust," other delights.



Music for the adventurous by modern masters in superb Juilliard Quartet readings. Berg, whose rich, romantic "Lyric Suite" is heard here, made headlines recently when his ultra-modern opera, "Wozzeck," was a surprise popular hit at the Met. The Webern works are brief, delicate "poems."

Here is music melodious and passionate, with flashing rhythms and much of the true gypsy flavor Brahms portrayed in his "Hungarian Dances." The world-renowned Festival Quartet—Szymon Goldberg, William Primrose, Nikolai Graudan, Victor Babin—fashions a marvelously blended performance.



A very special plum for Mario Lanza fans! It's the first and only "live" concert performance of Lanza ever recorded. You'll especially enjoy his spontaneous remarks to a delighted audience, and laugh with them as he essays a bit of daring in a witty English music-hall ditty, "Bonjour, Ma Belle."

the world's greatest artists are on... **RCA VICTOR**

this is the empire[™] troubador

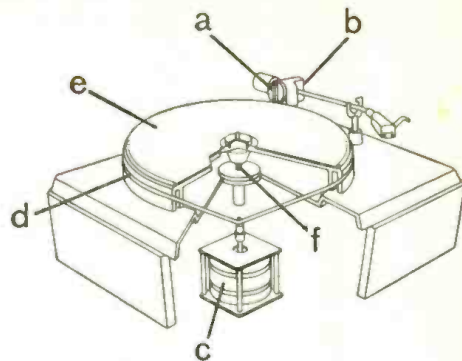

the playback unit that enables you to enjoy all the quality of today's records

With the tremendous advances achieved in record quality, and in amplifier and speaker components, the playback unit assumes a role of unprecedented importance. It is the vital link between the record's promise of performance and its ultimate realization. For, if all the quality in the modern record were extracted from its grooves, and delivered—unaltered—to the amplifier, the result would be almost indistinguishable from the original live performance.

No one playback component can fulfill this requirement. It takes all three. And that is why you can depend upon the Troubador—combining the finest cartridge, arm and turntable—to deliver all the quality in your records to the rest of your music system.

empire 108 mono-stereo cartridge

Low mass and high compliance. Stylus tracks with force as low as 1 gram. Flat from 10 to 20,000 cycles on both channels, balance to $\pm 1/4$ db. Full channel separation over entire spectrum. \$34.50

empire 98 playback arm

Dynamic balance, low inertia and high compliance make the 98 the most stable yet freely responsive arm available. Tracks 108 cartridge at 1 gram. \$37.50

ARM NOTES: (a) Calibrated knob—accurate to ± 0.1 gram—adjusts torque of clock spring for desired stylus force without disturbing arm balance—does not shift center-of-mass. (b) Vertical and lateral pivot bearings suspended in ball races.

empire 208 3-speed turntable

Only two moving parts—motor and turntable—coupled by seamless belt for lowest rumble content. Vertical and horizontal rumble amplitude, less than 1 millionth of an inch. No wow or flutter. \$92.50

TURNTABLE NOTES: (c) Hysteresis motor has dynamically balanced rotor and stepped, 3-speed pulley. (d) Neoprene-impregnated seamless belt is ground to uniform thickness $\pm .0005$ ". (e) Turntable platter individually adjusted to dynamic balance. Weighs 6 lbs., and has dual rim for optimum flywheel effectiveness. (f) Lapped mainshaft rotates in micro-honed bearing-well. Tolerance is less than .0001".

See and hear the Troubador at your high fidelity dealer today and discover the wonderful difference it will make in the performance of your music system. Price is \$180, including cartridge, arm, turntable and walnut base. Price, less cartridge, is \$145.50. For descriptive literature, write to:

empire
DYNA-EMPIRE INC. 1175 STEWART AVE.
GARDEN CITY, N.Y.

CIRCLE 30 ON READER-SERVICE CARD

Exclusive Assurance of Quality

Only the Stanton Fluxvalve can provide the exclusive and patented features which make it the finest pickup available.

The significance of a document . . . a LETTERS PATENT conferring *exclusive* rights and privileges on an individual to manufacture and vend an invention both *new* and *useful* . . . further signifies a most important responsibility upon that individual.

Endowed with this responsibility, PICKERING & COMPANY pioneered—through their outstanding participation in stereophonic development—the STANTON STEREO FLUXVALVE, the very first (and only) stereo cartridge incorporating the revolutionary T-GUARD stylus.

But this was only the beginning—through continued development—major advances in stereo pickup design were brought about by the use of PICKERING & COMPANY'S long experience . . . special skills and exclusive techniques.

Thus; less than one year after the introduction of the stereo record, PICKERING & COMPANY introduced the MODEL 380 STANTON STEREO FLUXVALVE. And, in a few short months, the 380 earned its reputation from the experts as—
"The finest stereo pickup ever tested".

Isn't it time you found the true answer to stereo as it was meant to be?

WE urge you to go to your dealer for a 380 FLUXVALVE DEMONSTRATION—we know you will find its quality of performance almost beyond belief.

FOR THOSE WHO CAN HEAR THE DIFFERENCE



for more than a decade—the world's most experienced manufacturer of high fidelity pickups . . . supplier to the recording industry.
PICKERING & CO., INC., PLAINVIEW, NEW YORK

The Stanton Fluxvalve and Stereo Fluxvalve are patented (and patents are pending) in the United States, Great Britain, Canada, Japan and other countries throughout the world.

CIRCLE 56 ON READER-SERVICE CARD



high fidelity

JULY 1961
volume 11 number 7

MUSIC

Roland Gelatt
Editor

Joan Griffiths
Executive Editor

Norman Eisenberg
Audio Editor

Conrad L. Osborne
Managing Editor

Shirley Fleming
Assistant Editor

Roy Lindstrom
Art Director

H. C. Robbins Landon
European Editor

Ralph Freas
Audio Coordinator

Editorial Board

John M. Conly
Chairman

E. Power Biggs

Nathan Broder

R. D. Darrell

Alfred Frankenstein

Howard Hanson

Robert C. Marsh

Francis Robinson

Joseph Szigeti

Warren B. Syer
General Manager

Claire N. Eddings
Advertising Sales Manager

Walter F. Gruening
Circulation Director

Publication Policy

Charles Fowler

Lawrence Gatto

W. D. Littleford

Warren B. Syer

ADVERTISING

Main Office
Claire N. Eddings, The Publishing House
Great Barrington, Mass. Telephone 1300

New York
1564 Broadway, New York 36
Telephone: Plaza 7-2800
Seymour Resnick, Andrew Spanberger

Chicago
10 East Huron St., Chicago 11
Telephone: Michigan 2-4245
Peter Dempers, Thomas Berry,
Allen Campbell

Los Angeles
1520 North Cower, Hollywood 28
Telephone: Hollywood 9-6239
George Kelley

Rudolf Serkin—Seraphic and Serious 24 Joseph Roddy
A portrait of the mild but dynamic pianist who puts the art of music before his own virtuosity.

Summer Music in the Berkshires 32
A picture essay, with text by Jay Rosenfeld, photos by Clemens Kalischer.

Segovia 10 Shirley Fleming
The classical guitar's veteran champion looks to the future.

Notes from Abroad 18
Musical notes from Oslo and Paris.

EQUIPMENT

High Fidelity Servicing 29 Charles Tepfer
Some counsel on the vexing subject of component repair.

FM Portables 36 Norman Eisenberg
Thanks to transistors, you can have music wherever you go.

Audio Doctor in the House? 23
An editorial.

Equipment Reports 39
University TMS-2 Stereo Speaker System
Sherwood S-7000 Stereo Receiver
Transis-Tronics TEC S-15 Stereo Amplifier
Sonotone 9TSDV Stereo Cartridge

Audio News from Europe 45 The Gramophone

High Fidelity Newsfronts 79

REVIEWS

Feature Record Reviews 47
Mahler: Symphony No. 4 (Mengelberg, Solti)
Brahms: Intermezzos (Gould)

Other Classical Record Reviews 50

The Lighter Side 63

Jazz Record Reviews 71

The Tape Deck 75

Cover photo by Hans Wild

LAFAYETTE RADIO

"Let Your Ears Be The Judge" — Satisfaction

Guaranteed or Money Refunded with Lafayette's 15-Day Free Home Trial.



LAFAYETTE LA-250A
50-WATT STEREO AMPLIFIER



GARRARD
RC210



PICKERING 380C
CARTRIDGE
WITH
DIAMOND STYLUS



LAFAYETTE
SK-58
FREE EDGE
12" COAXIAL
SPEAKERS



(OPTIONAL)
LAFAYETTE
ELIPTOFLEX SERIES
BOOKSHELF ENCLOSURES

The dynamic brilliance of stereo, featuring Lafayette's remarkable LA-250A, 50-watt stereo amplifier.

OUR BEST STEREO SYSTEM BUY

LAFAYETTE 50-WATT STEREO PHONO SYSTEM

MATCHED COMPONENTS

LAFAYETTE LA-250A 50-WATT STEREO AMPLIFIER	99.50
GARRARD RC210 4-SPEED RECORD CHANGER	44.50
PICKERING 380C DIAMOND STEREO CARTRIDGE	29.85
LAFAYETTE WOOD CHANGER BASE	3.95
2 LAFAYETTE SK-58 FAMOUS FREE EDGE 12" COAXIAL SPEAKERS @ 29.50 EACH	59.00
Regular Catalog Price	236.80

HI-FI STEREO SYSTEM with mahogany, walnut or blonde changer base (specify finish).	
HS-103WX	5.00 Down 194.50
Same as HS-103WX, plus 2 Lafayette Eliploflex Series Bookshelf Enclosures in mahogany, walnut, blonde or oiled walnut finish (specify finish).	
HS-104WX	10.00 Down 257.50

LAFAYETTE SPECIAL PRICE **194.50** YOU SAVE **42.30**

LAFAYETTE'S CRITERION LINE

Pacesetter of the High-Fidelity industry . . . renowned for its performance. The ultimate for those who demand the finest.

NEW! KT-550 100-WATT BASIC STEREO AMPLIFIER KIT

KT-550 In Kit Form **134.50**

LA-550 Completely Wired **184.50**

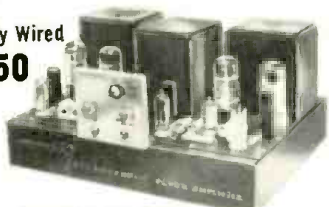

5.00 Down

- Rated at 50-Watts per Channel
- Response from 2-100,000 cps, 0, -1db at 1-Watt
- Grain Oriented, Silicon Steel Transformers
- Multiple Feedback Loop Design
- Easy-To-Assemble Kit Form

Made in U.S.A.

A new "Laboratory Standard" dual 50-watt amplifier guaranteed to outperform any basic stereo amplifier on the market. Advanced engineering techniques plus the finest components ensure flawless performance. Distortion levels so low they are unmeasurable. Hum and noise better than 90 db below 50-watts. Complete with metal enclosure. 9 1/4 x 12 1/2" D. Shpg. wt., 60 lbs.

KT-600A PROFESSIONAL STEREO CONTROL CENTER

KT-600A In Kit Form **79.50**

LA-600A Completely Wired **134.50**

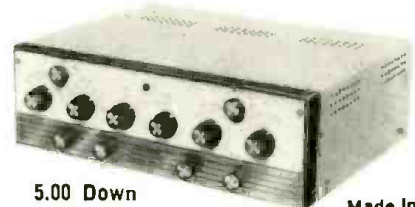

5.00 Down

Made in U.S.A.

- Response 5-40,000 cps ± 1 db.
- Precise "Null" Balancing System
- Unique Stereo and Monaural Control Features
- Concentric Input Level Controls
- Easy-To-Assemble Kit Form.

Sensitivity 2.2 mv for 1 volt out. Dual low impedance "plate follower" outputs 1500 ohms. Less than .03% IM distortion; less than .1% harmonic distortion. Hum and noise 80 db below 2 volts. 14x10 1/2 x 4 1/2". Shpg. wt., 16 lbs.

Lafayette Radio, Dept. wg 1-1 P.O. Box 190 Jamaica 31, New York

Name _____
Address _____
City _____ Zone _____ State _____

FREE!!
1961
CATALOG

LAFAYETTE RADIO	NEW YORK 13, N.Y.	BRONX 58, N.Y.	NEWARK 2, N.J.
LOCATIONS ▶ JAMAICA 33, NEW YORK	PLAINFIELD, N.J.	PARAMUS, N.J.	BOSTON 10, MASS

CIRCLE 46 ON READER-SERVICE CARD

AUTHORitatively Speaking

In writing about Joseph Roddy in this column some time ago, we said that he was not exactly a virtuoso pianist. Mr. Roddy, we're afraid, took umbrage; he informed us that our statement was no more nor less true than the fact that he is not exactly a trapeze artist. To set the record straight, we hereby announce that Mr. Roddy plays "the intractable instrument" (his term) for his own entertainment. Interviewing pianist Rudolf Serkin for HIGH FIDELITY gave him particular satisfaction, he says, since he had the pleasure of hearing his personal prejudices reinforced. Mr. Serkin likes the cello ("Ah . . . at once, beautiful tone"); Mr. Roddy is presently engaged in trying to get "beautiful tone" out of a cello; ergo, kindred spirits. In all seriousness, we think Mr. Roddy's sympathy with his subject has provided us with one of his most perceptive pieces: see p. 24.

Charles Tepfer, whose "High Fidelity Servicing" appears on p. 29, is a physicist by education, a music lover by avocation, and a free-lance writer on audio subjects by profession. Mr. Tepfer was the first editor of *Electronics Illustrated*, has designed and built electronic measurement instruments for cosmic ray research, and still does some design work and a great deal of kit building. In spite of the ingenuity which the above would seem at the very least to imply, Mr. Tepfer has not yet discovered how he can solve the difficulties of living in New York exurbia and maintaining his status as a sailboat fancier. We're sure he will, but meanwhile said exurban dwelling (it's a converted red barn) provides a 17- by 33-foot living room with a ceiling fourteen feet high—ideal for stereo, he claims.

As is meet and fitting, our feature on "Summer Music in the Berkshires," p. 32, is the work of two Berkshire residents, music critic Jay Rosenfeld and photographer Clemens Kalischer. Mr. Rosenfeld, onetime student in Brussels and at the Institute of Musical Art, found himself covering the musical events of Berkshire County for the *Berkshire Eagle* almost before he got out of uniform after the First World War. He has been continuing in this role ever since. His activities have not been confined solely to Massachusetts, however: he was representative for the *New York Times* at the first Casals festival in Prades and accompanied the Boston Symphony to Europe in 1952. Mr. Kalischer was born in Bavaria and grew up in France, serving in the French army in World War II until his imprisonment in a concentration camp. He came to this country in 1942, and has lived in Stockbridge, just a few miles from Tanglewood, for the last ten years. Both Mr. Rosenfeld and Mr. Kalischer are, of course, friends and neighbors of HIGH FIDELITY's Great Barrington staff.

Change of Address notices and undelivered copies (Form 3579) should be addressed to High Fidelity, Subscription Fulfillment Department, 2160 Patterson Street, Cincinnati 22, Ohio.

COLUMBIA RECORD CLUB offers with pride the greatest musical achievement since the introduction of stereo records

The first complete recordings of the
9 SYMPHONIES
of
BEETHOVEN

conducted by
BRUNO WALTER
with the Columbia Symphony Orchestra

reproduced in glorious

STEREO

in a deluxe package of
seven 12-inch long-playing records

ALL
FOR ONLY **\$5.98**

REGULAR RETAIL
VALUE, \$41.98

if you join the Club now and agree to purchase
as few as six selections from the more than 150
to be made available during the coming 12 months



UNANIMOUS CRITICAL ACCLAIM!

"... a noble exposition of Beethoven as seen by one of the greatest of his prophets" —High Fidelity Magazine

"A collection which stands as near the pinnacle of perfection as any human product ever can" —San Francisco Chronicle

"One of the triumphs of a memorable career... the result is a 7-disc set of remarkable clarity" —Time Magazine

"One of the summits of modern recorded music" —New York Herald-Tribune

DELUXE PACKAGE

Seven 12" Columbia stereo records in a luxurious box, covered with white leather-like Fabrikoid and lustrous black-and-gold cloth. Also includes 48-page booklet with previously unpublished photographs, program notes, anecdotes and reviews by Beethoven's contemporaries and present day critics.



NOTE: Stereo records must be played only on a stereo phonograph

THE CORNERSTONE OF ANY STEREO LIBRARY...

If you now own a stereo phonograph, or plan to purchase one soon, here is a unique opportunity to obtain — for only \$5.98 — this magnificent Columbia 7-Record Set containing all nine Beethoven Symphonies... in glowing performances by one of his greatest interpreters, Dr. Bruno Walter... and reproduced with amazingly realistic "concert hall" fidelity through the miracle of stereophonic sound!

TO RECEIVE YOUR BEETHOVEN SET FOR ONLY \$5.98 — simply fill in and mail the coupon now. Be sure to indicate which one of the Club's four Divisions you wish to join: Classical; Listening and Dancing; Broadway, Movies, Television and Musical Comedies; Jazz.

HOW THE CLUB OPERATES: Each month the Club's staff of music experts selects outstanding recordings from every field of music. These selections are described in the Club Magazine, which you receive free each month.

You may accept the monthly selection for your Division... or take any of the other records offered in the Magazine, from all Divisions... or take NO record in any particular month.

Your only membership obligation is to purchase six selections from the more than 200 records to be offered in the coming 12 months.

Thereafter, you have no obligation to purchase any additional records... and you may discontinue your membership at any time.

FREE BONUS RECORDS GIVEN REGULARLY: If you wish to continue as a member after purchasing six records, you will receive a stereo Bonus record of your choice free for every two selections you buy — a 50% dividend.

The records you want are mailed and billed to you at the regular list price of \$4.98 (Classical \$5.98; occasional Original Cast recordings somewhat higher), plus a small mailing and handling charge.

MAIL THE COUPON TODAY! Since the number of Beethoven Sets we can distribute on this special offer is limited — we sincerely urge you to mail the coupon at once.

**ALSO AVAILABLE IN
REGULAR HIGH FIDELITY!**

If you have a standard phonograph, you may receive the regular high-fidelity version of this Deluxe Beethoven Set for only \$5.98. The plan is exactly the same as outlined above — except that you pay the usual list price of \$3.98 (Classical \$4.98; occasional Original Cast recordings somewhat higher), for the regular high-fidelity records you accept. Check appropriate box in coupon.

**MORE THAN 1,250,000 FAMILIES NOW ENJOY THE MUSIC PROGRAM OF
COLUMBIA RECORD CLUB TERRE HAUTE, IND.**

**SEND NO MONEY — Mail this coupon now to receive
the 9 Beethoven Symphonies for only \$5.98**

**COLUMBIA RECORD CLUB, Dept. 261-2
Terre Haute, Indiana**

Please send me, at once, the Deluxe 7-Record Set of Beethoven Symphonies, for which I am to be billed only \$5.98, plus a small mailing and handling charge.

Send my Beethoven Set and all future selections in (check one) **REGULAR** **STEREO**

... and enroll me in the following Division of the Club:
(check one Division only)

Classical **Listening & Dancing** **Jazz**
 Broadway, Movies, Television & Musical Comedies

I understand that I may take selections from any Division. I agree to purchase six selections from the more than 200 records to be offered during the coming 12 months, at usual list price plus small mailing and handling charge. Thereafter, if I decide to continue my membership, I am to receive a Bonus record of my choice FREE for every two additional selections I accept.

Name.....
(Please Print)

Address.....

City..... ZONE..... State.....

APO, FPO addressees: write for special offer

CANADA: address 1111 Leslie St., Don Mills, Ontario

If you want this membership credited to an established Columbia or Epic record dealer, authorized to accept subscriptions, fill in below:

Dealer's Name.....

Dealer's Address..... 57

85-DA (STER) **85-DG (REG)**

© "Columbia," "Epic," "Marcas Reg." © Columbia Record Club, Inc., 1961

CIRCLE 21 ON READER-SERVICE CARD

McIntosh is the best

McIntosh music reproduction instruments are **the best**. McIntosh alone guarantees the advertised performance capabilities of McIntosh instruments to further assure you that you are buying **the best**.

Conservative claims and specifications are traditional at McIntosh. *"Rated with honesty and conservatism" . . . are the words used by independent experts when writing of McIntosh. Every advertised claim is individually analysed and verified by engineers using the most sensitive test equipment and internationally recognized test procedures. Every McIntosh instrument manufactured is tested to meet the same rigid standards.

Careful, diligent research, meaningful design considerations and meticulous manufacturing produces the highest quality equipment. When you buy McIntosh—you know you are buying **the best**. Only McIntosh is **the best**.

McIntosh LABORATORY, INC.

2 CHAMBERS STREET, BINGHAMTON, N. Y.

Phone—Area Code 607-723-5491

*High Fidelity Magazine, April 1961

CIRCLE 52 ON READER-SERVICE CARD



747. CALLAS PORTRAITS PUC-
CINI HEROINES. Favorite
arias from operas Manon
Lescaut, Butterfly, Bohème,
Turandot, others. \$4.98.



5731. Sibelius. SYMPHONY
NO. 2. Powerfully played by
the Philharmonia Orchestra.
Paul Kletzki conducting. \$4.98; Stereo \$5.98.



749. VERDI OPERA CHORUS.
The Regimental Band and
Massed Pipes in pulse-
quickening marches, reels,
strathspeys. \$4.98.



702. THE SCOTS GUARDS.
The Regimental Band and
Massed Pipes in pulse-
quickening marches, reels,
strathspeys. \$4.98.



759. PIAF. 12 ballads in the
postwar style of France's
greatest torch singer, with
Robert Chauviagny's orchestra.
\$3.98.



5738. Beethoven. PIANO
CONCERTO NO. 4. Russia's
famed Emil Gilels is soloist
with the Philharmonia Orch.
\$4.98; Stereo \$5.98.



752. EILEEN FARRELL IN
SONGS AND BALLADS. 15
pieces, best-loved and little-
known, with George Throld
on piano. \$4.98.



5700. SOVIET ARMY CHORUS
& BAND. 200 thundering
male voices sing Russian
folk ballads and army songs.
\$4.98; Stereo \$5.98.



730. BRAHMS. SYMPHONY
NO. 4. His final symphony,
played by the Philharmonia
Orchestra, conducted by
Herbert Von Karajan. \$4.98.



5754. THREE RHAPSODIES.
The Vienna Philharmonic
under Silvestri plays rhapso-
dies by Liszt, Ravel, Enesco.
\$4.98; Stereo \$5.98.



5762. RUSSKAYA! The Holly-
wood Bowl Symphony in
rousing Russian music by
Glinka, Rimsky-Korsakov,
others. \$4.98; Stereo \$5.98.



5740. Tchaikovsky. VIOLIN
CONCERTO; Mendelssohn:
VIOLIN CONCERTO. Christian
Ferras with the Philharmonia
Orch. \$4.98; Stereo \$5.98.



736. Mozart. 4 HORN CON-
CERTOS. Virtuoso pieces
flawlessly performed by Den-
tis Brail with the Philhar-
monia Orchestra. \$4.98.



750. VIENNA ON PARADE.
Julius Hermann conducts the
Deutschermeister Band, with
soloists and choir. In gay
waltzes, folk songs, opera
favorites. \$4.98.

"In masterful use of reproductions, Angel holds the lead." —NEWSWEEK

Choose FOUR ANGEL ALBUMS Pay only 99¢

Plus a small
charge for
postage, packing
and mailing

WHEN YOU BECOME A TRIAL MEMBER OF THE ANGEL RECORD CLUB AND AGREE
TO BUY AS FEW AS SIX FUTURE SELECTIONS DURING THE NEXT 12 MONTHS



As a member of the Angel Record Club, you
will be offered selections from Angel Records'
magnificent international repertoire, including
Columbia Gramophone (of England), Pathé
Marconi (of France), E. M. I.'s historic "HMV"
label, and the world famous Capitol catalog.



743. Stravinsky. PETROUCH-
KA. The complete score of
the famous ballet. Erem
Nurtz conducts the Philhar-
monia Orchestra. \$4.98.



736. MUSIC ON THE DESERT
ROAD. The haunting sounds
and music of the East—14
pieces recorded on a journey
from Turkey to India. \$4.98.



745. Chopin. 8 MAZURKAS;
3 POLONAISES. Witold Mal-
Cuzynski at the piano in
flery renditions of 11 nota-
ble works. \$4.98.



760. TWO IN A GONDOLA.
Dino Oliveri Conducts
Venetian music with
romantic violins and man-
dolins. \$3.98.



737. Rhatenaturali. VIOLIN
CONCERTO. David Distrah
plays, in a dazzling, unfor-
gettable performance. \$4.98.



5755. APÉRITIFS. The Phil-
harmonia Orchestra in 7 vi-
cious French concert pieces
by Berlioz, Chabrier. \$4.98; Stereo \$5.98.



5727. FIRE-BIRD; CIEL.
DREN'S GAMES; MOTHER
GOOSE SUITE. 3 exciting
works by Stravinsky. Blek.
Ravel. \$4.98; Stereo \$5.98.

HOW TO BUILD AN OUTSTANDING RECORD COLLECTION OF THE WORLD'S FINEST MUSIC AT TREMENDOUS SAVINGS!

YOU GET FOUR ALBUMS—when you enroll as a Trial Member of the Angel Record Club, and pay only 99¢. As a member, you will be offered over 100 albums during the next 12 months... great classical masterworks... favorites in concert music... operas... chamber music... and the world's most enchanting folk music.

You need buy as few as six future selections at the rate of at least one every other month. Then you may resign, or retain membership by buying only 3 albums annually with full bonus credit. For the records you buy, you pay the Club retail price (\$3.98 or \$4.98) plus a small charge for postage, packing and mailing.

BONUS ALBUMS! Each time you buy two more records after your agreed-upon six future selections, you may choose a 12" long-play BONUS ALBUM from a list of current Angel best-sellers.

TAKE YOUR CHOICE! Each month you receive—FREE—the illustrated Angel Record Club Review (The Stylus), describing the month's selection and alternate selections. If you want the month's selection, do nothing; it will come automatically. If you wish any of the other selections—or no record that month—simply notify the Club on the form always provided.

SEND NO MONEY—RISK NOTHING! If not delighted, return the four albums within 7 days and your membership and all charges will be cancelled without further obligation. See for yourself why the Saturday Review says of Angel Records: "It is hard to say which is the greater miracle, the performance or the recording." Mail coupon to: Angel Record Club, Dept. 2048, Scranton 5, Pennsylvania.

Mail to ANGEL RECORD CLUB, Dept. 2048, Scranton 5, Pa.

Please accept my application for membership. These are the 4 records I choose.

WRITE ALBUM NUMBERS IN BOXES:

I agree to buy 6 records during the next 12 months (at a rate of at least one every other month) at the Club retail price plus a small charge for postage, packing and mailing. After these purchases I may cancel my membership. **NO-RISK GUARANTEE:** If not delighted, I will return these four albums within seven days and my membership will be cancelled without further obligation.

STEREO: Check here if you own a STEREO record player and agree to buy your six future selections in stereo which the Club sells for \$1.00 more than monaural. Then the 4 records you have chosen marked "S" will be sent to you in STEREO with a bill for \$1.00 more (total: \$1.99). **BONUS ALBUMS** and future selections will also be in stereo. **NOTE:** Stereo records can be played only on stereo equipment.

PRINT NAME.....
ADDRESS.....
CITY.....
ZONE..... STATE..... HF-7

SEND NO MONEY. We will bill you. (Membership limited to one per household.) Slightly higher in Canada: Angel Record Club of Canada, 1184 Castlefield Ave., Toronto 19, Ont. If you wish to join through an ANGEL record dealer authorized to solicit club subscriptions, write his name and address in margin.

The new T300X
Award Tuner
does not need
a multiplex
adapter

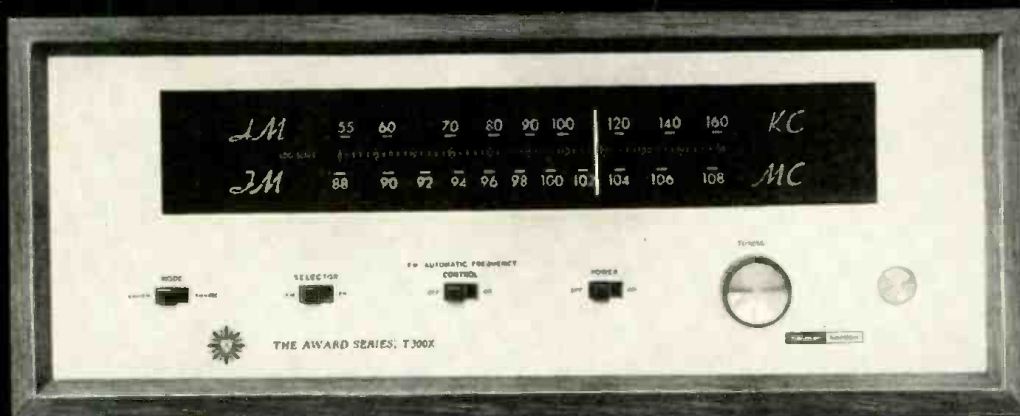

The T300X, AM/FM tuner, does not need a multiplex adapter. It has one. Right where it belongs—built-in. On the chassis and out of sight. The T300X is completely ready to receive multiplex (FM Stereo) broadcasts now.

What is the significance of multiplex? It represents a major technological advance in the technique of broadcasting. Now, for the first time, you can enjoy all of the color and genuine excitement of stereo with the fidelity that only FM can provide. And what a wonderful opportunity it presents for taping stereo selections right off the air.

The T300X is a striking example of Harman-Kardon's engineering leadership in the development of instruments for multiplex reception. It is designed with a wide-band Foster-Seeley discriminator and a 6BN6 limiter to insure freedom from distortion and noise. A total of 4 IF stages guarantee greater sensitivity. Automatic Frequency Control (AFC) with regulated voltage supply maintains oscillator stability regardless of line voltage variations. The T300X boasts superior impulse noise rejection plus uniform limiting and output at all signals. Here is a solid performer, rock stable and ideal for multiplex reception.

The T300X takes its place in the Award Series alongside the classic F500 tuner shown below. The F500 is a completely professional FM tuner designed with every provision for multiplex now or in the future. It has space on its chassis to accommodate the excellent MX500 wide-band, plug-in multiplex adapter. No spe-

cial controls are needed; no special adjustments. Just one simple connection converts the F500 into a completely integrated multiplex tuner.

Either tuner will provide outstanding performance with the Award amplifiers shown on the opposite page. Both are beautifully finished in brushed gold.

The T300X, AM/FM stereo multiplex tuner, is \$149.95; the F500, FM/multiplex tuner—\$129.95. The MX500 multiplex adapter for use with the F500—\$39.95. Optional enclosures, which fit both, include the CX50 (metal)—\$12.95 and the WW50 (walnut)—\$29.95. Prices are slightly higher in the West.

For complete information on the Award Series and other fine Harman-Kardon products write to Dept. HF-7, Harman-Kardon, Plainview, N. Y.



harman kardon

CIRCLE 37 ON READER-SERVICE CARD

The new A300
Award Amplifier
makes stereo
attractive and
inexpensive

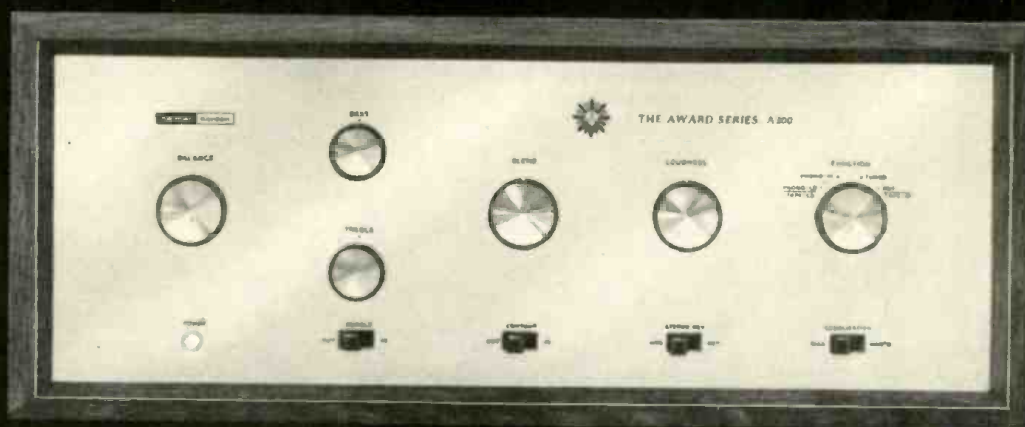

The A300, 30 watt stereo amplifier, is a sparkling new addition to the widely acclaimed Award Series. Its strikingly handsome styling, professional features, solid performance and moderate price (\$99.95) make it clearly the best buy in a stereo amplifier.

It is designed with the same skill and precision reflected in the 50 watt A500—first of the great Award amplifiers. When the A500, shown below, was introduced it quickly established new performance standards for integrated stereo amplifiers. In its own power category, the A300 is certain to establish similar standards of excellence.

The A300 delivers 15 watts (Music Power) per channel with less than 1% distortion. Special grain-oriented cores in the output transformers provide wide-band response. At normal listening levels the frequency response is ± 1 db at 15 to 70,000 cps.

Its many features, unique for an amplifier in this price class, include: A zero to infinity balance control which permits balancing of speakers for virtually any listening position in the room; a variable blend control to eliminate undesirable "hole-in-the-middle" effect; ganged treble and bass tone controls provide 12 db boost and cut at 50 cycles and 10 db boost and cut at 10,000 cycles; dynamic loudness contour control; silicon diode power supply for excellent B+ regulation; RIAA phono and NARTB tape equalization controls; two tape outputs (after tone and loudness

controls) for recording; illuminated push-button on/off switch which permits unit to be turned on and off without upsetting carefully pre-set controls; stereo reverse/normal switch and rumble filter.

The A300 and A500 will perform superbly with either of the Award tuners shown on the opposite page. Both instruments are handsomely finished in brushed gold.

The A300 is \$99.95; the A500—\$159.95. Optional enclosures, which fit both, include the CX50 (metal)—\$12.95 and the WW50 (walnut)—\$29.95. Prices are slightly higher in the West.

For complete information on the Award Series and other fine Harman-Kardon products write to Dept. HF-7, Harman-Kardon, Plainview, N. Y.

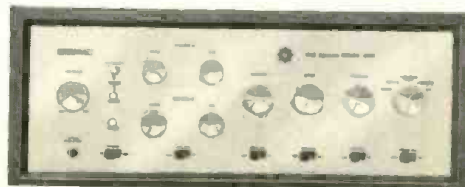

harman kardon

CIRCLE 37 ON READER-SERVICE CARD



Above: Model RRL-8
from \$95.50
Below: Model RRL-12
from \$114.95

GOT GOOD EARS?
GOT A SHELF?
GOT A BENCH?
GOT A BUILT-IN?
GOT AN EYE FOR VALUE?
UNIVERSITY'S
GOT THE SPEAKER
SYSTEM FOR YOU!

Such as the justly popular high compliance RRL's . . . chosen over all others by over 70% of the experts who listened to several compact models in demonstrations conducted first from behind a curtain and then right out in the open! Listen to the RRL's at your dealer's and you too will be thoroughly impressed with their smoothness and range of performance, without the restricted sound of other bookshelf systems. Write for University's unique "Informal guide to component high fidelity." Desk P-7. University Loudspeakers, Inc., White Plains, N. Y.



A Division of Ling-Temco Electronics, Inc.

CIRCLE 74 ON READER-SERVICE CARD

Segovia



The maestro who's worked for fifty years at restoring the guitar to serious music says its day has just begun.

ANYONE who has watched Andrés Segovia pace to the center of a concert stage with the bearlike gravity suited to his massive physique and his massive reputation might possibly expect to encounter off stage a man of comparably bearlike disposition. But as soon as the maestro of the guitar tells you (amusement twinkling through the thick lenses of his horn-rimmed glasses) that he practices five or six hours a day "because the guitar is like a woman—it sometimes grows hysterical and is very difficult to handle," you realize that his innate dignity, at sixty-eight, is leavened by a rather broad humor. And if you have the opportunity of seeing him at work with other musicians—as he was recently, while recording a Boccherini concerto with the Symphony of the Air—you will realize further that he is a sympathetic though usually laconic collaborator. Through all the multiple details of experimenting with balances and adjusting tempos, he remains patient, becoming annoyed only at his own rare mistakes, when he will slap his knee in exasperation and, in French, beg "*pardon, pardon.*" ("I would rather give ten concerts than make one record," he said in carefully selected English, "and I would rather make ten records than be once on television. But the microphone is—what is the word?—inhibiting. When you record and are thinking that you play a piece for eternity, it is hard to play it well in the present.")

It was several days after taping the Boccherini that Segovia stopped by the offices of Decca Records and began to talk about guitars. He was asked if he had ever suggested any changes or modifications in the guitar's traditional structure in order to improve it for concert use. "Changes? Heavens no. The guitar is a perfect instrument. It was made so by Antonio Torres in the nineteenth century, just as the violin was made perfect by Stradivarius. But in

one respect," he went on, "the guitar is like the dog: both of them, to stay close to man, have had to grow in all different sizes. There are little dogs you hold in your lap and big ones that guard the sheep, and there are little ukuleles and also enormous guitars. I remember once in Russia, after a concert one night, someone brought in a huge guitar for me to see. It was a monster, and had at least sixteen strings. I told this man to play it . . . I thought it would sound like an orchestra. And do you know—he played a simple, stupid little tune, ping-ping-ping, plunk, plunk. It was ridiculous.

"But the guitar, even of normal size, is not an intimate instrument. Stravinsky was right when he said that it does not play loud, but far."

The story of Segovia's own introduction, one day in Madrid, to the Ramírez guitar with which he was to launch his concert career (he was eighteen) has been told by the artist in his autobiography-in-progress, *The Guitar and Myself*, some early and vivid chapters of which have already appeared in the *Guitar Review*. (Segovia hopes, incidentally, to finish volume one for his publishers next year.) That guitar was his companion for many years. What instruments had he used since then? He told me that in Munich in 1923, while he was still performing on the Ramírez, he examined some violins made by a craftsman named Hermann Hauser and was so much impressed by their workmanship that he requested Hauser to undertake a guitar. The maker came directly to his hotel, Segovia recalls, and studied the Ramírez for three hours; one year later he completed a guitar identical to it in every respect, except one: "It had no soul." Hauser kept trying for almost ten years and finally, in the mid-1930s, finished the guitar Segovia had been waiting for. "I played it until last year," the Maestro said, "and now I have left it in

Continued on page 12

Multiplex Is A PLEASURE, Not A Problem

WITH THE FABULOUS

FISHER MPX-100

AND THE REASON IS

*Stereo
Beacon*

FINDS MULTIPLEX PROGRAMS
AUTOMATICALLY!



\$89⁵⁰

THE MPX-100 MULTIPLEX ADAPTOR

with *Stereo Beacon* makes Multiplex a *pleasure*, not a problem—because *Stereo Beacon* *automatically* lights a signal on the control panel if the station selected is broadcasting in Multiplex. You do not have to guess, as you do with other brands! Because there are more Fisher tuners and receivers in use than any other brand, the demand has been enormous. The result—large quantity production and the important savings this represents. We originally felt it would be necessary to price this all-out Adaptor at \$129.50. The demand has now made it possible to price it at only \$89.50. And at this price we unconditionally guarantee it will *outperform* any adaptor you can buy—*regardless of price*. Place your order with your favorite Fisher dealer—today.

THE FISHER MPX-100 CAN BE USED
WITH ALL RATIO DETECTOR TUNERS

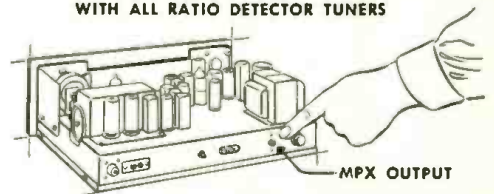

USE THIS COUPON

FISHER RADIO CORPORATION
21-21 14th Drive, Long Island City 1, N. Y.

Please send MPX-100 details. I now own:

(Brand) _____

(Model) _____

Send complete literature on Fisher Stereo Components and Installation Guide.

Name _____

Address _____

City _____

State _____

HF-6

EXPORT: Telesco International Corp., 171 Madison Ave., N. Y. 16, N. Y.

Continued from page 10

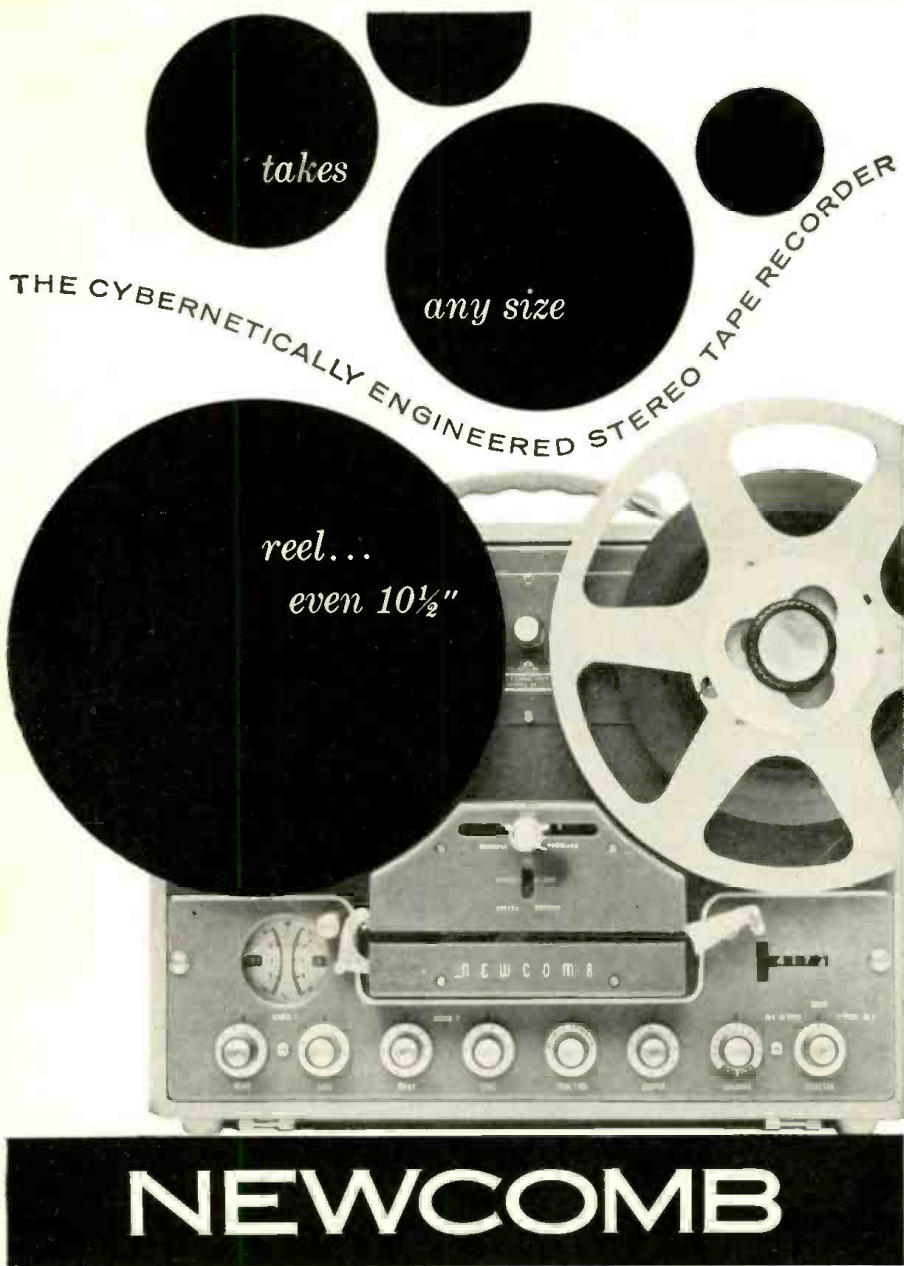

THE CYBERNETICALLY ENGINEERED STEREO TAPE RECORDER

takes

any size

reel...
even 10 1/2"

NEWCOMB

- MIXING CONTROLS
- 2 INPUTS EACH CHANNEL
- CANNON SOCKETS
- AUTOMATIC SHUT-OFF
- TWO SPEEDS—7½ or 3¼
- NAB HUB EQUIPPED
- DUAL-ACTING TENSIONER
- PLUG-IN TRANSFORMERS
- MONITOR WHILE RECORDING
- POINTER-TO-POINTER LEVEL METERS
- 4-DIGIT COUNTER
- INTERLOCKED FUNCTION SWITCH
- POWERFUL, COOL-RUNNING, FULLY-SYNCHRONOUS MOTOR

Why is Newcomb's Model SM-310 *the most wanted* stereo tape recorder? Many reasons. One of the first attractions is the fact it takes any size reel including 10½". Then, as acquaintance grows, you become increasingly impressed with its natural ease of operation. Controls are logically arranged. The natural thing to do is the right thing to do. Tape transport is governed by a central joystick. There is now a pause-edit position between "stop" and "play." And this is just one of the features planned with *you*, the operator, in mind. Lighted volume level meters are arranged pointer-to-pointer. The counter displays *four* digits. Tape is loaded easily—in a straight line without looping or threading. And it's so easy on tape...no stretching...no jerking even though the machine reaches playing speed instantaneously. You can operate the Newcomb recorder in any position—vertical or horizontal. All necessary preamplification is built in along with a balance control and ganged volume control. Available in either half-track (SM-310) or quarter-track (SM-310-4) models. The latter records quarter-track and plays back either quarter- or half-track. Matching power amplifier and reproducers are also offered. Learn all the details in your free copy of Bulletin SM-3. Write for yours today.

NEWCOMB AUDIO PRODUCTS COMPANY
Dept. W-7, 6824 Lexington Avenue, Hollywood 38, California
CIRCLE 55 ON READER-SERVICE CARD

Madrid to rest. The one I have here is made by Hermann Hauser's son."

Segovia, as transcriber, composer, and commissioner of guitar works, has been responsible for adding, by his own count, over three hundred pieces to his instrument's repertory. Of all these, probably the most famous is the transcription of the Bach Chaconne from the Partita No. 2 for violin alone. Before he began work on it he spent two years studying arrangements (for piano and other instruments) of Brahms, Busoni, Raff, Hubay, and others who had tried their hand. He emerged from his own labor of transcription convinced that Bach originally intended the work not for violin, on which it is notoriously difficult to render the polyphonic texture cleanly and musically, but for the guitar or for the instrument very much like it, the lute.

"The Chaconne and the Sarabande were Spanish dances; the Chaconne, in fact, was a lewd dance which young ladies were not permitted to watch. Then composers took over the form and made it something noble. Still, it is Spanish, and in Bach's work even the harmonic progressions move down by step in a manner typical of Andalusian folk music. Could he not have conceived this piece for a Spanish instrument? The key, D minor, lies perfectly on the guitar. It is one of the best keys. Only one variation is not good—though I play it, I do not suppress anything. But the simple melody is ruined on the violin. . . ." Here followed a devastating vocal approximation of the fiddler's attempts to encompass the four-part harmony. "Even violinists—when they have an attack of sincerity—admit that the Chaconne sounds best on guitar."

As for the works of other composers, Segovia pointed out that their adaptability to the guitar varies according to how closely they have been shaped to the original instrument. "Nineteenth-century music has more the physiognomy of the instrument," as he put it. "Chopin and Schumann, for example, write for the piano in such a way that they do not transcribe well. But a piece which has less of the character of the instrument can be very good for guitar."

A list of contemporaries who have written for Segovia includes, of course, many of the finest non-Spanish composers as well as practically every well-known name among his compatriots. In every instance but one, the peculiar problem has arisen: these composers do not know how to play the guitar. How, then, can they write for it? "Composers will always have to compose *through* the player," said Segovia. "This was true even of Villa Lobos. He himself played the guitar—very badly. He was my great friend for many years, but he was—how shall I put it?—childish-proud. He would not admit that he played badly.

Continued on page 14

Most Powerful of All!

THE FISHER 110-Watt Master Control-Amplifier

STUDIO STANDARD MODEL X-1000



Here it is—the world's most powerful Stereo Master Control-Amplifier, 110 watts of crystal-clean power on *one* compact chassis. The FISHER STUDIO STANDARD Model X-1000 was designed specifically for the no-compromise audio enthusiast who wants maximum flexibility, maximum reserve power, maximum quality—*without* going to the expense and greater size of a separate control and audio power chassis. In the FISHER X-1000 everything you want, everything you could possibly need now and in unnumbered years ahead, has been combined without compromise on *one magnificent chassis*.

OUTSTANDING FEATURES OF THE FISHER X-1000

- Power Output, 110 watts with less than 0.5% distortion.
- Exclusive FISHER internal switching system, makes it possible, *for the first time*, to use the entire range of controls during tape playback while recording! ■ Complete facilities for center channel operation—Center Channel Speaker Output eliminates need for third channel power amplifier; front panel control turns off center speaker without affecting other channels. ■ STEREO DIMENSION Control. ■ SPACEEXPANDER Control. ■ Earphone Jack. ■ 16-15/16" wide, 5-13/16" high, 13 3/4" deep. Weight: Approximately 50 pounds.

EXPORT: Telesca International Corp., 171 Madison Ave., N. Y. 16, N. Y.

THE FISHER X-1000 STUDIO STANDARD
110 -WATT MASTER CONTROL-AMPLIFIER

\$329⁵⁰

USE THIS COUPON

FISHER RADIO CORPORATION

21-25 44th Drive, Long Island City 1, N. Y.

Please send complete details on the Fisher X-1000 Master Control-Amplifier and Complete Component Catalogues.

NAME _____

ADDRESS _____

CITY _____

STATE _____

FOR magnificent sound



TARZIAN TAPE

engineered for highest fidelity

- **High Output**—can accept signals with dynamic range to realize the full potential of even the finest professional equipment.
- **Wide-Range Response**—virtually flat response for all recording frequencies.
- **Low Distortion**—distortion is less than 2½% at maximum record level as measured by Navy Specification W-T-0061.
- **High Uniformity**—uniformity within a 1200-foot reel is within plus or minus ¼ db. A new oxide formula and special selectivity of oxides protect recording heads from wear and prevent abrasion.
- **Humidity and Temperature Protection**—special coating, priming, and binding techniques help keep Tarzian tape in new condition longer in ordinary good tape storage conditions.

Given great sound in the first place, Tarzian Tape will keep it for you, and give it back undiminished and undistorted. It is a tape of truly professional fidelity, worthy of your most valued recordings, at a price that lets you use it for all your work (or play).

The proof is in the listening... of course. But you can see the smooth, tightly bonded oxide surface that doesn't flake, that does run smoothly without abrasion and without contributing to wow or flutter. Hold a reel to the light. You can see that Tarzian Tape is wound on the reel at perfect tension. You'll find a written replacement guarantee in every box. The box is well made, with ample identification space. You'll see that the tape is factory sealed in a plastic bag, with labels and a tape-end clip included.

Try Tarzian Tape. Summon the keenest and most discriminating ears you know. Tarzian Tape has what they, and you, will appreciate—highest fidelity! Available on standard 3-, 5-, and 7-inch reels and in professional lengths on reels or hubs, 1½ or 1 mil acetate. Ask your dealer. If he cannot supply you, send us his name and we will see that your needs are promptly supplied.

Helpful new booklet free on request: "The Care and Feeding of Tape Recorders."

Note: Tarzian Tape on Du Pont Mylar base will be available shortly. Your inquiry is invited.



SARKES TARZIAN, INC.

World's Leading Manufacturers of TV and FM Tuners • Closed Circuit TV Systems • Broadcast Equipment • Air Trimmers • FM Radios • Magnetic Recording Tape • Semiconductor Devices

MAGNETIC TAPE DIVISION • BLOOMINGTON, INDIANA

Export: Ad Aurisma, Inc., N.Y. • In Canada, Cross Canada Electronics, Waterloo, Ont.

CIRCLE 63 ON READER-SERVICE CARD

SEGOVIA

Continued from page 12

He would write a chord in one position, which was possible; and the next chord in another position, which was also possible; but to get from one to the other—impossible! I had to transpose notes and rework the harmony.

"Castelnuovo-Tedesco does not play, but he writes most easily for the guitar and he is very prolific. I am working now on a new composition of his, a set of twenty-eight pieces based on Juan Ramón Jiménez's *Platero and I*, for guitar, orchestra, and narrator. Twenty-eight pieces! I have learned four of them. I will record this, next year perhaps, and speak the narration myself, in Spanish."

These reflections upon his performing and nonperforming colleagues reminded me of an admirer of Segovia's who enjoys some renown as a guitarist himself. I mentioned Carl Sandburg. "Ah, he is a great poet. As a guitarist, he is . . . all right. We first met in Paris at the house of mutual friends, and he sang and accompanied himself. But he played all the time only two chords, tonic and dominant in the same key, while he was singing through many different keys. I said to him, 'My dear friend, that is very good, but I am going to send you some more chords!' Later he wrote an article somewhere and said that every-day he looked in his mailbox for the chords Segovia promised, but he never found them. I read this, and sent him some chords right away. But I wrote him not to play them anywhere until I could hear them."

Having devoted more than fifty years to establishing the guitar as a concert instrument, Segovia is not overlooking one important factor in ensuring the permanence of this achievement. Through his efforts, many of the major European conservatories now conduct classes in guitar, most of them taught by Segovia pupils. The master-teacher spoke with particular pleasure of the fact that one of his most gifted protégés, a twenty-year-old Englishman named John Williams, has recently been installed as instructor of guitar at the Royal Academy of Music in London.

"For the guitar," said Segovia, "this is just the beginning." SHIRLEY FLEMING

High Fidelity, July, 1961. Vol. 11, No. 7. Published monthly by The Billboard Publishing Co., publishers of Billboard Music Week, Vend. Amusement Business, and Billboard Music Week Overseas Edition. Telephone: Great Barrington 1300. Member Audit Bureau of Circulations.

Editorial Correspondence should be addressed to The Editor, High Fidelity, Great Barrington, Mass. Editorial contributions will be welcomed. Payment for articles accepted will be arranged prior to publication. Unsolicited manuscripts should be accompanied by return postage.

Subscriptions: Subscriptions should be addressed to High Fidelity, Great Barrington, Mass. Subscription rates: United States, Possessions, and Canada, 1 year, \$6; 2 years, \$11; 3 years, \$15; 5 years, \$20. Elsewhere \$1 per year extra. Single copies 60 cents.



Decorate With Music THE FISHER WAY!

■ Fisher stereo components are beautifully designed for simple and perfect installation in existing bookshelves, furniture, closets or specially built cabinets. Our twenty-four years of experience in this field is so vast and varied as to be truly without equal. You can draw on this experience for guidance, assuring perfect results in advance. Send today for the **AUTHORITATIVE GUIDE** to custom stereo installations, packed with illustrations and helpful data.



Use This Coupon

FISHER RADIO CORPORATION
21-25 44th Drive, Long Island City 1, N. Y.

Please send the Authoritative Guide, Owners Roster and complete Stereo Catalogues.

Name _____

Address _____

City _____ State _____

EXPORT: Telesco International Corp., 171 Madison Ave., N. Y. 16, N. Y.

CIRCLE 31 ON READER-SERVICE CARD

ONLY HEATHKIT OFFERS TOP QUALITY

AND LOWER PRICES AND . . .

NOW . . . *We Guarantee*

You Can Build Any Heathkit®!

You Get Guaranteed Success With Heathkit!

Never before has a manufacturer of do-it-yourself kits guaranteed your success in completing a project. Heath does so and backs it up with an iron-clad, money-back guarantee! By making this guarantee, we hope to banish any doubt you may have about your ability to build a kit. How is such a guarantee possible? The careful planning that goes into the design of Heathkit equipment revolves around this paramount thought—anyone, regardless of background or experience, must be able to build any Heathkit. This same thought guides the writing of the detailed Heathkit assembly instructions with the world-famous "check-by-step" system. These attributes plus the experience of a million customers attests to the fact that anyone can build a Heathkit. Order your favorite Heathkit today. Enjoy top quality equipment with savings of up to 50% and the satisfaction of doing it yourself. Get guaranteed success with Heathkit!



"LEGATO-COMPACT" . . . finest in the Heathkit line

- All Altec Lansing Speakers • Covers 30-22,000 cps • Pre-assembled, prefinished cabinets • Measures just 32" L x 19" D x 32 3/4" H.

Smaller in size, yet acoustically as fine as its namesake, "Legato-Compact" is a singular achievement in design. Two 12" high compliance woofers cover 30-800 cps; a special exponential horn and high-frequency driver cover 800-22,000 cps. 800 cps network is factory assembled. Rates 30 watts program. Drives with 3 watts. 16 ohm Z. Modified infinite baffle design. 132 lbs.

- Kit AS-21U, unfinished . . . \$22.50 dn., \$20 mo. **\$224.95**
- Kit AS-21W, walnut fin. . . . \$23 dn., \$20 mo. **\$229.95**
- Kit AS-21M, mahogany, fin. . . . \$23 dn., \$20 mo. **\$229.95**

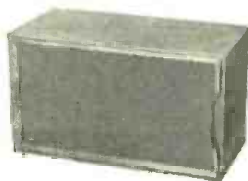

**NEW
LOW-COST
ACOUSTIC
SUSPENSION
SPEAKER**

- 10" Acoustic Suspension Woofer • 2-3/4" Cross-Fired Tweeters • Covers 30-15,000 cps • Drives With 10-40 Watts • Hi-Freq. Control • L-C 2250 cps Crossover Network • Assembled Cabinets

Enjoy the extended bass response and brilliant highs of an acoustic suspension speaker at never-before savings! Cabinet is finished on four sides; 24" L x 11 1/2" D x 13 1/2" H. 16 ohm Z. 41 lbs.

- Kit AS-10U, unfinished . . . \$6 dn., \$6 mo. **\$59.95**
- Kit AS-10W, walnut fin. . . . \$6.50 dn., \$6 mo. **\$64.95**
- Kit AS-10M, mahog. fin. . . . \$6.50 dn., \$6 mo. **\$64.95**



MONEY BACK GUARANTEE
The Heath Company *unconditionally guarantees* that you can build any Heathkit product and that it will perform in accordance with our published specifications, by simply following and completing our check-by-step instructions, or your purchase price will be cheerfully refunded.

HEATH COMPANY, Benton Harbor, Michigan

CIRCLE 38 ON READER-SERVICE CARD

**Introducing A New Styling Concept
In Two Popular Heathkit Stereo Units**



Heathkit AJ-11 AM/FM Tuner

Successor to the popular AJ-10, this new version features flywheel tuning, two "magic-eye" tuning indicators, adjustable FM automatic frequency control, AM "fidelity" switch for max. selectivity or fidelity, dependable 12 tube circuit, built-in power supply. 21 lbs.

Kit AJ-11... \$7 dn., \$7 mo... **\$69.95**

Assembled AJW-11...
\$13 dn., \$11 mo... **\$129.95**



**Heathkit AA-151
28-Watt Stereo Amplifier**

Here's the popular SA-2 model all dressed up in brand-new styling. Delivers 28 hi-fi rated watts (14 per channel) for plenty of power. Has clutched volume controls, ganged tone controls, 4 dual inputs. 28 lbs.

Kit AA-151...
\$6 dn., \$6 mo... **\$59.95**

Assembled AAW-151...
\$12 dn., \$11 mo... **\$119.95**

Here's a handsome matching pair for your new Heathkit stereo system! Both have new louvered wrap-arounds of luggage-tan vinyl-clad steel with contrasting charcoal-grey front panels framed with polished aluminum bezels... a regal new look to Heath's medium-price stereo line.



**New Stereo/Mono Record Changer...
As Low as \$37.95**

With Cartridge and Diamond Stylus

- Oversize 11" turntable • Anti-skate • Plug-in head • 4 speeds • Hum-shielded • Automatic or manual • Automatic shut-off • Brown & beige color • Easily assembled

Available in your choice of stereo cartridges. 15 lbs.

Kit AD-80C, Sonotone 8TA4-SD ceramic,
diamond & sapphire... **\$37.95**

Kit AD-80A, GE VR-227 mag., diamond... **\$41.95**

Kit AD-80B, Shure M8D mag., diamond... **\$42.95**

ADA-80-1, 45 rpm adapter spindle, 1 lb... **\$2.95**



Big-Buy Portable 4-Track Stereo Tape Recorder

- 2 speeds—3 1/4" and 7 1/2" • 2 Tape control levers • All amplifiers & speakers included • Listen while recording • 2 "Eye" recording indicators • Assembled cabinet & mechanism

Value sensation of the year! Nothing more versatile, nothing at this quality level even close to this price! The AD-40 is a 3-way recorder: a self-contained unit for monophonic and 4-track stereo tape recording and playback, a hi-fi stereo center to amplify and control record players, tuners, etc., and a tape music source for separate hi-fi systems. Complete controls for tape functions, tone balance and level, monitoring while recording, and "pause" control for tape editing. All parts included for building electronic section. Turquoise and white styling. Less mic. 49 lbs.

Kit AD-40... \$18 dn., \$16 mo... **\$179.95**

Assembled ADW-40... \$30 dn., \$25 mo... **\$299.95**



Finest Tuner In The Kit Industry!

- 16 Tubes • Separate AM & FM circuits • AM & FM tuning meters • Flywheel tuning • Selectable AFC • Delayed, amplified AVC • AM fidelity switch • Built-in AM & FM antennas • Terminals for external antennas • FM sensitivity 2 uv for 20 db quieting

Kit AJ-30... 25 lbs... \$10 dn., \$9 mo... **\$99.95**

Assembled AJW-30... \$16 dn., \$14 mo... **\$159.95**



50 Watt Stereo Amplifier

- Hi-Fi rated at 25 watts per channel • Includes stereo preamps & power amps • 5 stereo inputs • Tape head input • Complete controls • Stereo speaker outputs • Mixed-channel center speaker output • Lighted panel • Luggage-tan vinyl clad louvered cabinet

Kit AA-100... 31 lbs... \$8.50 dn., \$8 mo... **\$84.95**

Assembled Model AAW-100...
\$14.50 dn., \$13 mo... **\$144.95**



FREE CATALOG

Contains complete descriptions and specifications on all of the above new models plus more than 200 other Heathkit items.

SAVE UP TO
50% WITH
HEATHKIT!

See how you can enjoy the top quality, big savings and satisfaction of doing-it-yourself with Heathkit equipment. There's a Heathkit for your special interest... send for your free catalog today!



ORDERING INSTRUCTIONS: Fill out the order blank. Include charges for parcel post according to weights shown. Express orders shipped delivery charges collect. All prices F.O.B. Benton Harbor, Mich. A 20% deposit is required on all C.O.O. orders. Prices subject to change without notice. Dealer and export prices slightly higher.

Item	No.	Price

Ship Parcel Post Express C.O.D. Best Way



HEATH COMPANY
Benton Harbor 8, Michigan

Please send My Free Heathkit Catalog

Name _____

Address _____

City _____ Zone _____ State _____

ORDER DIRECT BY MAIL OR SEE YOUR HEATHKIT DEALER

CIRCLE 38 ON READER-SERVICE CARD

Schober...



a superlative
electronic organ
you assemble yourself
to save half
usual cost



Here is magnificent Pipe Organ tone; two complete 61-note keyboards; lustrous hand-rubbed cabinetry in the finish of your choice.

Yet, when you assemble the Schober model of your choice, you save more than half its value and create a superb instrument to bring the delightful gift of music to your family.

Matched kits and the miracle of printed circuitry make it possible.

Work requiring knowledge and experience is eliminated. All that remains is the pride and pleasure of watching a superb musical instrument take shape under your own hands. The magnificent organ you assemble will surpass any factory-built organ for quality, reliability and circuitry.

Simply mail the coupon for details. No salesman will call.

THE SCHOBER ORGAN CORPORATION
Dept. HF-7 43 West 61st St., N. Y. 23, N. Y.

Mail this coupon today

The Schober Organ Corp., Dept. HF-7
43 West 61st Street, New York 23, N. Y.

- Please send me FREE full-color booklet and other literature on the Schober organ.
- Please send me the Hi-Fi demonstration record. I enclose \$2 which is refundable when I order my first kit.

NAME _____

ADDRESS _____

CITY _____ ZONE _____ STATE _____

CIRCLE 64 ON READER-SERVICE CARD

NOTES FROM ABROAD

Oslo

By far the youngest of the major Scandinavian symphony orchestras, the Philharmonic Orchestra of Oslo has the distinction of being the most often recorded. Although its history can be traced back to 1871 when Edvard Grieg was one of the founders and conductors of a Norwegian symphony, it was not until 1919 that the present organization was established. Today seventy musicians make up its permanent roster, and the orchestra gives annually about fifty public concerts, sixty radio broadcasts, and ten performances for school children. In the past few years it has also toured all over Norway, and plans are under way for a United States tour in the near future. Artistic director and conductor since 1945 is Odd Gr uner-Hegge, who began his career as a concert pianist and later studied under Felix Weingartner. For several years, Gr uner-Hegge was conductor of the Norwegian National Theatre where, under his baton, Kirsten Flagstad made her first entrance as Isolde. He is also a noted composer and has appeared as guest conductor in most capitals of Europe.

Scandinavian Specialties. A few years ago, partly through the mediation of the musically minded manager of the Norwegian Information Service of New York, Camden began making with the Oslo Philharmonic a series of recordings ranging from Haydn and Mozart to Tchaikovsky and Grof . Grieg's two *Peer Gynt* suites were particularly well received (this journal's reviewer commented that the orchestra was "exhibiting an obvious affection for an immersion in this music"). There is, therefore, much anticipation of the forthcoming Camden release of the Grieg piano concerto, with Kjell B ekkelund as soloist. The orchestra has also been featured in recordings of contemporary music issued by Composers Recordings. This year they will tape for this company four more works: Goodenough's *Elegy*; Bezanon's *Rondo Prelude*; Brunswich's *Lysistrata*; and Goeb's *Concertant No. 4*.

Although some Norwegian works have been recorded for Mercury, a more ambitious project for recording native com-

posers is now materializing. In collaboration with the Norwegian Foreign Office, the Norwegian Composers' Association, and Philips (Epic Records in the States) the orchestra will make a number of albums—sessions started this summer—of Norwegian music. Among others, Johan Svendsen (1840–1911), one of the more prominent names in Norway's musical history, will for the first time be amply represented on discs. Apart from his popular *Carnival in Paris*, available on a Capitol release, his Symphony No. 1, Romance for Violin, and *Festive Polonaise* will be taped, as will also Halvorsen's Rhapsody No. 3, Klaus Egge's Second Symphony, and six or seven other works by contemporary Norwegian composers.

FRANK HEDMAN

Paris

If you are thinking about making a record-buying expedition to France some day, you should get acquainted with the magazine *Disques* and with the huge annual catalogue of the same name. These handsome publications will give you a properly scholarly feel for the situation over here. Then, when you arrive, you should listen to a Sunday afternoon FM broadcast called *La Tribune des critiques de disques*, a free-swinging session in which four or five well-known critics compare recorded versions of the same work. This program will make a proper connoisseur and iconoclast of you.

Panigel—Phonographic Potentate. If you follow this procedure, you will be in contact with Armand Panigel, a ruffled, rather melancholy man who has long merited a note in this space. Panigel is the editor of *Disques*, the publisher of the catalogue, and the quietly ruthless master of ceremonies for *La Tribune des critiques*. As such he is perhaps the most powerful individual in the French record industry, at least in classical music. When he puts on his three hats, he can make the sun shine or the rains fall.

Panigel's career is reassuring for people who like to play the phonograph. He was born in Turkey forty-odd years ago, brought up in Cairo, and educated at the Sorbonne, where he took degrees in both law and mathematics. He started

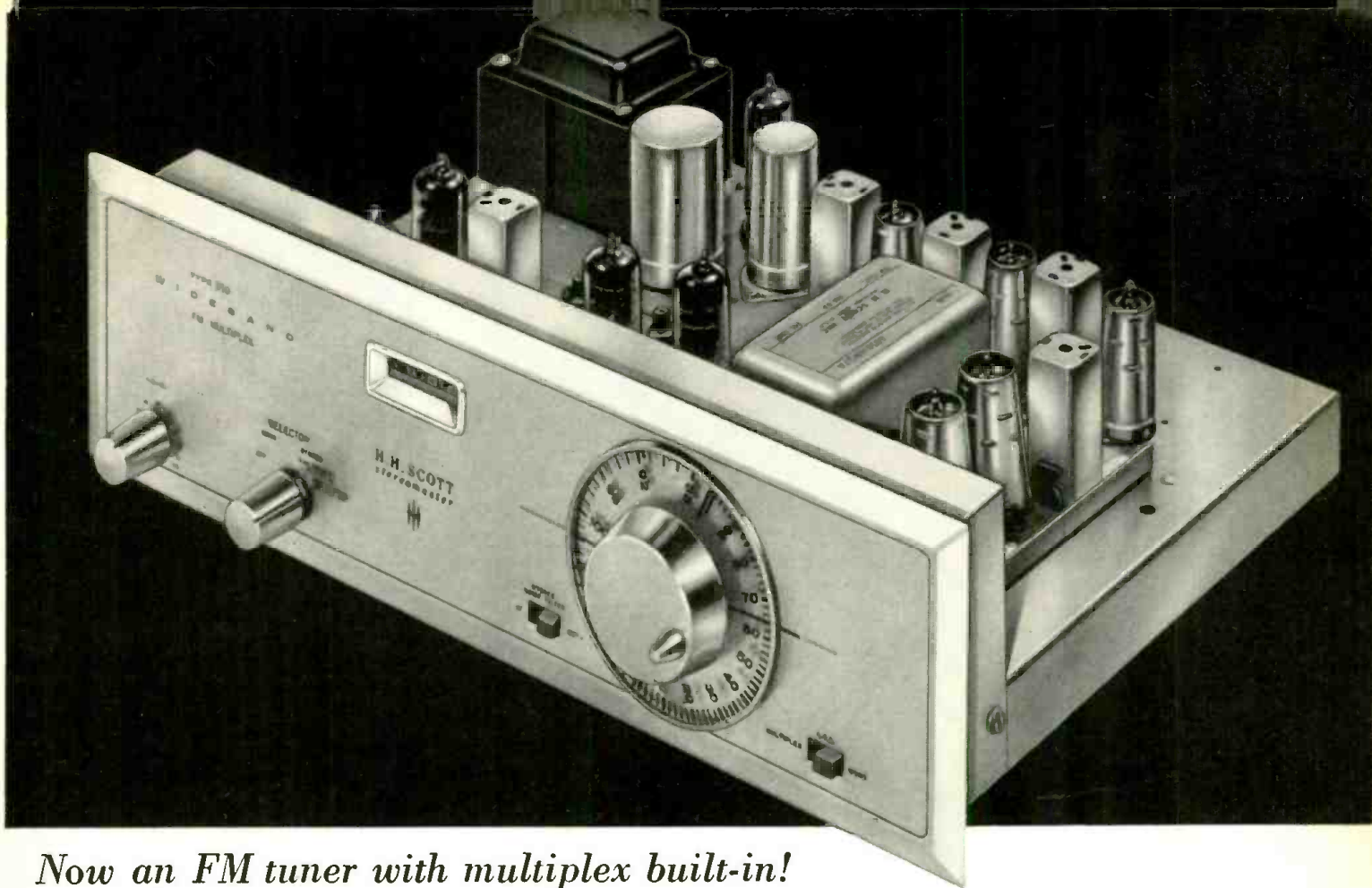

Now an FM tuner with multiplex built-in!

New H. H. Scott FM Stereo Multiplex Tuner uses Wide-Band design for top performance

Here it is! No adaptor needed! The world's first Wide-Band tuner designed specifically for multiplex! H. H. Scott's new Model 350 FM Multiplex Stereo Tuner heralds a new era in FM reception.

The FCC, in its recent acceptance of FM stereo multiplex, said that the approved system "... like any multiplex transmission system, will increase energy transmission at the edges of the channel involved. Accordingly, for optimum stereophonic reception, the (tuner's) bandwidth ... must be considerably greater than that of monophonic (tuners). . . ."

From our very first design ... the revolutionary 310A ... H. H. Scott incorporated substantially wider IF bandwidth than conventional tuners. This gave better selectivity and usable sensitivity. The new 350 FM Multiplex Stereo Tuner incorporates this same exceptional circuitry allowing reception of even weak multiplex stations with amazing clarity. You get other benefits, too—the 2 MC Wide-Band detector provides superior rejection of interference and complete freedom from drift. The Wide-Band design of the

IF's and detector give the new 350 a remarkable *usable* sensitivity of 2.5 μ v measured by stringent IHFM standards ... one of the best measurements of a tuner's ability to effectively receive weak multiplex signals.

If you are considering a new tuner, or addition of an adaptor to a conventional narrow-band tuner, you owe it to yourself to first listen to the new H. H. Scott Model 350 Wide-Band FM Multiplex Stereo Tuner. Its superiority in sound quality ... its ability to receive weak multiplex signals ... its complete freedom from drift ... are so dramatically different that you will not want to settle for less.

Important Technical Information

Usable (IHFM) Sensitivity: 2.5 μ v. 10 tubes, 11 diodes. Famous H. H. Scott silver plated front end. Tuning meter. Performance matches FCC transmission specifications. Can receive either monophonic or stereo multiplex programs. Special circuitry for perfect stereo tape recording. Dimensions in handsome accessory case 15½"W x 5¼"H x 13¼"D. Matches styling of all H. H. Scott amplifiers. \$199.95, East of the Rockies.

*see paragraph 36, FCC Report and Order, Docket no. 13506, 4/19/61. Emphasis ours.

Wide-Band Multiplex Adaptor



Important News for H. H. Scott Tuner Owners

H. H. Scott has once again protected your investment against obsolescence. Your tuner, regardless of age or model, can be quickly converted to multiplex with the new Model 335 Wide-Band Multiplex Adaptor. Because of H. H. Scott's unique no-compromise Wide-Band design, we can guarantee superior multiplex reception only when the 335 and an H. H. Scott tuner are used together. 5 tubes, 8 diodes. \$99.95, case extra.

H. H. SCOTT

H. H. Scott, Inc. Dept. 226-07
111 Powdermill Rd., Maynard, Mass.

Please rush me full details on your Wide-Band Multiplex Tuner and Adaptor. Include new 1961 catalog.

Name _____

Address _____

City _____ Zone _____ State _____

Export: Morhan Exporting Corp., 458 Broadway, N.Y.C.

CIRCLE 65 ON READER-SERVICE CARD

SHERWOOD

THE FIRST FM STEREO MULTIPLEX RECEIVER



the S-8000
64 watts \$299⁵⁰

only for those who want the ultimate . . .



At last, Stereo Multiplex is here . . . and, once again, *Sherwood is first* . . . ready immediately with a brilliant combination of Sherwood's "high rated" FM tuner design plus all circuitry necessary to receive the new FCC-approved FM multiplex stereo . . . two 32-watt amplifiers, two phono/tape pre-amplifiers and all controls necessary for playing records, tape or TV. The S-8000 Receiver needs only the addition of speakers to complete a basic system for FM stereo listening enjoyment. Overall size, just 16 x 4 x 14 inches deep.

Sherwood's dramatic Correlaire Furniture Modules are the perfect setting for your Sherwood hi fi components. Choose from sixteen interchangeable modules, styled with a contemporary flair in hand-rubbed Walnut and Pecan woods. Have truly flexible room arrangements. A beautiful four-color brochure is yours for the asking. Sherwood Electronic Laboratories, Inc., 4300 N. California Ave., Chicago 18, Illinois. FOR COMPLETE TECHNICAL DETAILS WRITE DEPT. MF-7

CIRCLE 66 ON READER-SERVICE CARD

acquiring records as a boy, and by World War II his collection in Egypt had grown to some twenty thousand discs. He joined the Free French and soon found himself engaged in a very pleasant sort of propaganda: playing his own records and talking about them on the radio from Cairo, Beirut, and Tunis. After the liberation of France he tried teaching mathematics for a time, but could not stay away from his phonograph. He started *La Tribune des critiques* on the French radio network in 1946 and his magazine in 1947, and is still surprised to find himself making money out of his hobby. *Disques* now has a stable circulation of about 70,000, which is very good for a French luxury magazine.

Panigel has had, of course, the troubles one finds everywhere when art and business come together. His unrelenting campaign for cheaper discs has made him something of a hero to record buyers and something considerably less to record manufacturers, who are apt to refer to him as *Panigel la baisse* (Cut-price Panigel). Musicians whose performances are adversely criticized on his radio program have a distressing way of turning out to be friends of a cabinet minister. And there was one terrible Sunday afternoon when an argument about Tchaikovsky led to the resounding use of a four-letter word (five in French), since which time the program has been taped and edited. Still, it is nice work.

Forthcoming for Angel. On her way from the Mediterranean to London, Maria Callas stopped off in Paris for a couple of weeks to see *West Side Story* several times and to record for Angel selections from *Samson et Dalila*, *Le Cid*, *Mignon*, *Louise*, *Carmen*, *Roméo et Juliette*, and *Alceste*. Georges Prêtre conducts the Orchestre National. Also for the Angel label in the States, Pathé Marconi has done a complete *Pecheurs de perles*, with Nicolai Gedda, Janine Micheau, Ernest Blanc, and the Opéra-Comique orchestra under Pierre Dervaux.

Golden Orpheuses. For centuries the French have been either reticent or defensive about the quality of their language when sung, and it must be admitted that *je t'aime*, as rendered by the usual Paris tenor, is not darkly lovely. But now an offensive is under way. Last year an Académie du Disque Lyrique ("academy" in this usage means simply a prize jury) was founded, and this year its oscars, called *Orphées d'or*, have gone to some fine records and unusual voices. Deutsche Grammophon won one of the top prizes for its *L'Enfant et les sorcières* (mentioned by Kurt Blaukopf in a note in our March issue), in which the role of the Enfant is sung by Françoise Ogeas, a recent discovery at the Opéra. Joan Sutherland was singled out for her *Art of the Prima Donna* (London). I haven't space to list all the prizes, but another went to Guy Chauvet for his role in Massenet's *Hérodiade*, recorded by Véga. This strapping young tenor, who has been singing at the Opéra for only two years, is coming along very fast indeed. ROY McMULLEN

NO TOOLS . . . NO CONTROLS . . . NO SWITCHES . . . NO PROBLEMS . . .

FM MULTIPLEX RECEPTION AUTOMATICALLY WITH AMAZING PILOT-200



THE AUTOMATIC ANSWER TO FM MULTIPLEX RECEPTION—THE PILOT-200-MULTIPLEXER!

The great beauty of stereophonic music till now has been confined to records or tape. NOW, with the Federal Communications Commission ruling on April 19th, 1961, all this great music can be broadcast over the air-waves. The Pilot 200 automatic Multiplexer is the easiest way to enjoy the new stereo Multiplex broadcasts. All connections are external, made with jack cords that simply plug in place. No controls. All switching is done automatically—when the tuned-to station is broadcasting stereo, the Indicator Light goes on and the Multiplexer automatically switches to stereo reception. And, it will not affect reception of monaural FM. Completely self powered. Measures 5" high x 7½" wide x 10¾" deep. Contains four tubes and one rectifier. Housed in an attractive black and brass enclosure designed to match Pilot components. Complete with enclosure **\$79.50**



The Pilot 200 Multiplexer shown with the Pilot 654 Stereo Receiver

PILOT-100-SEMI-AUTOMATIC FM MULTIPLEXER!

Completely self powered with only one operational control—a simple slide switch to put the Multiplexer into or out of the circuit. All connections can be made externally. Contains two tubes and one rectifier. In handsome black and brass styling. Complete with enclosure **\$49.50**



FOR COMPLETE TECHNICAL INFORMATION ON THE PILOT-200-AUTOMATIC FM MULTIPLEXER OR THE PILOT-100 SEMI-AUTOMATIC FM MULTIPLEXER, PLEASE FILL OUT AND MAIL COUPON.

Pilot RADIO CORPORATION, 37-12 36th Street, Long Island City 1, N. Y.

Please send me complete information on both Pilot FM Multiplexers. I presently own a (make & model) _____

_____ Tuner or Receiver.

Name _____

Address _____

City _____ State _____

CIRCLE 57 ON READER-SERVICE CARD

Audio Doctor in the House?

OUR USUAL REVELING in the progress of high fidelity notwithstanding, we have the impression that one aspect of the art has somehow not kept pace with the increasing excellence of audio equipment or its ever widening use. What we have in mind is, simply, facilities for servicing components—for repairing defective equipment as well as for maintaining one's system in top performing condition. Despite manufacturers' service departments and authorized service centers (and the liberal warranties usually offered), many owners of high-fidelity equipment have had to put up with inconveniently located service shops, long delays, additional expense, or less than the best handling of the problem itself.

This situation is due partly to the fact that in its early days high fidelity was a hobby confined largely to the technically informed, who generally could perform their own servicing, following the instructions provided in manufacturers' service manuals. Plainly, however, today's existing (and potential) audience for high quality music reproduction extends far beyond that early handful of enthusiasts; and while equipment is now far more complicated than it was some years ago, its owner may understand its workings (not to speak of its repair) as little as he does the mechanism of an expensive watch or camera. Knowing how to troubleshoot an amplifier no longer is a concomitant of owning one, any more than, say, having an ear for the technique of an Oistrakh implies that the listener himself can play the violin, or even be able to identify its four strings.

Up to a point, naturally, *some* maintenance can be performed by *some* high-fidelity owners—but what happens when the trouble seems to be more serious than a worn stylus or a loose signal cable? Indeed, the new fidelitarian might well be found asking: "Am I expected to know whether it *is* merely a worn stylus that is causing the distortion?"

Not only is this latter-day owner reluctant to diagnose his system's ills, but—aside from the servicing facilities maintained by components manufacturers—it is not always easy for him to find someone else who can. Actually, there is little in the way of an "audio servicing industry." Often, the business of servicing has had to be grafted onto selected audio dealers, or has fallen, by default, into the area normally covered by the general radio-TV service shop.

That neither of these approaches quite fills the bill is pointed out in the article by Charles Tepfer elsewhere in this issue.

One novel attempt to take up the slack in this area is the servicing offered by a new group of specialized audio technicians, or "high-fidelity doctors." Some operate independently or free-lance style; others team up and form small companies. Some charge a fixed fee, around \$40, which includes new tubes and small parts as needed; others charge an hourly rate plus cost of parts. A recent notice in a city newspaper, for instance, listed these charges: in the customer's home, \$5.95 for the first half-hour, and \$5.00 for each additional half-hour; at the service shop, \$4.00 flat, per half-hour. These would seem to be reasonable rates, assuming that the work performed is reliable.

The prospective client must of course realize that, since setting up a complete testing laboratory in the living room is obviously out of the question, work done in the home is necessarily limited. Tubes and possibly certain small parts readily discovered to be defective can be replaced; interconnections between components can be checked; some kinds of local interference (from appliances and such) may be cleared up, as well as many cases of hum and noise; and help may be given in solving general installation problems. Insofar as home servicing is technically feasible, its practical convenience is certainly very much to be welcomed.

Major repairs, alignment of tuners, and the kind of trouble that calls for lab-type testing are, however, best carried out in the service shop—the thoroughly professional kind of audio shop described by Mr. Tepfer. Perhaps seeing to it that there are many more such shops—on an organized, accredited, nationwide basis—is something for high-fidelity manufacturers to consider as their next contribution in a long series of noteworthy achievements. Certainly, it would reassure the thousands who now own high-fidelity equipment, as well as encourage countless more to take the plunge with components (rather than with poorer-sounding but more easily serviced package sets). In this sense, solving the servicing problem might easily prove to be the most effective and enduring kind of public relations the high-fidelity industry has yet embarked on. NORMAN EISENBERG

AS high fidelity SEES IT



Portrait of a pianist who prefers making chamber music in the

by Joseph Roddy

Rudolf Serkin

MMUSICAL PERFORMANCES, whether on the recital stage or before the recording microphones, are, in essence, lecture hall demonstrations at which artists teach the literature of music. The artists range from the transparently mountebank to the wholly incorruptible. Their audiences vary from the innocent or infatuated to the discriminating or even erudite. Some lecturers play down to their audiences because that seems to be the surest way to lure in the largest numbers. Others simply pour out the ideas that consume their own interest at the time—an ancient didactic method based on the assumption that the teacher has a body of knowledge to teach and that his students have come in to learn all about it. Teachers who use that approach are serious. Their students are serious too.

Rudolf Serkin is an artist who is serious about music. He is serious about it in the way William Faulkner is a writer who is serious about the novel and Bertrand Russell is a philosopher who is serious about civilization's survival. In some, seriousness comes and goes, and it exists in degrees in others. Walter Lippman is a political critic who is serious, but he is addressed to a subject which is often hard to take seriously. Other types fall in place neatly. Pablo Picasso is a painter who is serious some of the time. Sir Laurence Olivier is an actor whose seriousness declines. And Ernest Hemingway is a writer who cannot be taken seriously ever again.

Seriousness in a musician is partly a matter of intention, and the rest a matter of attainment. Rudolf Serkin's intentions are primevally simple. He works for music. This is an altogether different activity from working music for a living. It means

that the art of music matters more to him than the earnings he wrests from it. From that state of mind, or moral stance, others follow. Serkin will not submit to the seeming truth of the proposition that to be a concert performer is to be a marketable commodity of Show Business. He will not feign the airs and graces a performing artist in search of listeners should by all self-serving means display, and he is far too purposeful about his work to pause and ply interviewers with accounts of how purposeful he is. In the judgment of veteran Serkin watchers, he has never played the piano in such a way as to draw attention to the pianist and away from the music, but then, he has always played recital programs of such formidable musical substance that a tawdry showpiece on a Serkin program would be as improbable as a self-display of virtuosity. As intentions go, Serkin's should have fitted him nicely for a career in musicology along the academic trail. But there he is on the concert stage instead, a testament that excellence can profit a man even in this Dark Age.

By estimating the sales in box offices and over record counters, observing the character and behavior of audiences, and poring over the pronouncements of critics, it can be deduced that Rudolf Serkin is among the surest investments a concert manager can book into his premises. This is made all the more remarkable by the fact that Serkin is among the best of the concert pianists. No block of serious opinion holds the opposite view. The precise way in which, *Pathétique* for *Pathétique* and *Emperor* for *Emperor*, he is better than, or not better than, Sviatoslav Richter will stand un-

Green Mountains to making money in Show Business

Seraphic and Serious



SERKIN



resolved until the precise strengths and weaknesses of Richter's performances are fixed. But with the Russian temporarily by-passed, and the whole splendid contingent of young pianists spared comparison because Serkin's age and erudition give him such a lead, then his peers in the sum of all the imperfect indices that measure reputation remain only Artur Schnabel and Vladimir Horowitz.

Rubinstein, ever on stage, is far more illustrious than Horowitz or Serkin for a series of reasons which are not primarily audible and may even be extramusical. Pink-fleshed and cherubic-mannered at seventy-two, he is indeed so pleasing to behold that there are Rubinstein devotees who would be no less enthralled if he did not play the piano at all but simply came on stage to enable them to look at him a little. Horowitz, whose sabbatical from the concert stage continues, is more facile than Rubinstein or Serkin at the gymnastics of getting around the keyboard. For him the instrument itself appears the central fact of life. About it music seems to arrange itself as a processed material which is useful to his Steinway in about the same sense that high octane gasoline is to a Mercedes.

Serkin, unlike Rubinstein, cannot be conceived of in any context other than music. And unlike Horowitz, he does not regard the piano per se as giving his life its purpose. To Serkin, music is an enveloping ethic that he is to observe to the limit of his capacities. The piano has meaningfulness for him only as an instrument he must use to reveal his studies to others—which is quite different from revealing himself through music. Until electronic instruments take over altogether, all performing musicians will to some extent impress their own personalities on the music they play. Even a record listener, with a gain control and a pair of bass and treble filters at his fingertips, does something of the sort. But the ethic Rudolf Serkin lives by has transformed him into a medium through which music passes to emerge with few, if any, traces of the Serkin personality adorning it but with much evidence of the Serkin brain giving it coherence. This does not leave the music correct and characterless but correct and comprehensible, for it comes out with all the notes in place and with all of the character Beethoven or Mozart wrote into it.

The presence of such an uncompromising man in the main ring of music has had a somewhat Socratic effect on a scene which is far from Athenian. In recent years Serkin has become the gadfly to a loose formation of serious young performers (probably more of them string players than pianists) who regard themselves as music's latter-day Greeks and who try not to regard the rest of the profession's professionals as barbarians. A six-week summer music school at Marlboro, Vermont, has become the academy where Serkin's class of regulars convenes with each new year's converts to play chamber music magnificently and exchange ideas on how to play it better. Year after year the encampment is a money-losing venture largely supported by Serkin's fall and winter recital fees and the patronage of a few wealthy local residents. And year after year, as a result of this association, a few more virtuoso-size performers go back to the concert circuits more interested than ever before in the meaningfulness of music and less willing than ever before to see themselves merely as Show Business attractions.

By having this missionary effect on the musicians he mingles with, Serkin has at the age of fifty-eight reached a patriarchal status. Every performance he now gives in Marlboro or New York is an event which serious musicians regard as a lecture they cannot easily afford to miss. Every recording he makes serves as a textbook or reference work no pianist can be without. Whenever he plays, what emerges is a thoroughly reasoned and clearly stated exposition of some section of the piano literature. His reading can be disputed over, or assented to, but never dismissed. It is, like a Faulkner novel, or an *aperçu* of Lord Russell's, a hard position at which equally serious musicians can direct their disagreements. Since Artur Schnabel, no pianist has been as integral a link in the preservation of a tradition of musical performance.

Between record sessions and recital dates, Serkin is constantly sought out by young musicians who wish to perform for him. Of all the concert artists who are at the crest of their careers, Serkin is almost the only one who has made himself available in this way. His relationship to those who regard him as their teacher, either in fact or through his influence, has never been dogmatic in the way Schnabel's tutorial approach was. Serkin exercises a light and subtle authority which does not crush anyone who spends the summer with him—but then he takes great care in choosing crush-proof spirits when assembling his student body. Serkin has learned that with the moderately gifted the teacher should be a stern methodologist showing the student what to do every bar of the way, but that in dealing with a large talent, a didactic approach is limiting and causes the student to throw off the teacher quickly. The teacher endures at Marlboro because those who return there year after year are the larger talents. The talents do not regard themselves as large (which is why they probably are), and Serkin does not

regard himself as their teacher (which is probably why he is). "Rudi wants it to be as if a lot of his friends came to his house to play music," one Marlboro hand explained. "Only he wants them to play it better here than anywhere else. You will notice that he gets what he wants."

Rudolf Serkin is a somewhat gangly man who wears a shy smile when he is not at the piano, and an expression of considerable pain much of the time when he is. He does not feel comfortable seated before the instrument. He has, he claims, never found it easy to play, whether he is practicing at home or performing on stage. He is not even physically well equipped for the piano. His hands are neither large nor ideally shaped for it, and a half-century of hard use has left them honorably battered until they now look more like the hands of a bruiser who hefts concert grands for a living than a musician who plays them with a missionary sense of involvement.

Though he has spent more time at the piano than probably any man alive, Serkin is still given to day-long stretches of practicing that would inflict muscle cramp on pianists half his age and twice his strength. There is something oddly mystical or almost Zen-like about this work. When he has beaten down all the technical difficulties in a piece, he is likely to invent satanically difficult fingerings so that his practicing of it will not become routine to him. Music that he does not believe in, he

practices for the same self-disciplining reasons. "I've played Liszt," Serkin said, "and I don't like Liszt much. But in playing it I learned things I needed for playing Mozart. I will tell you what Rachmaninoff used to say about this. 'Anyone can play the *Hammerklavier* or the *Emperor*,' he said, 'because they are such magnificent music. But to play Liszt—ah, there is almost nothing there and it takes a master to make something of what there is. If I don't bring something to it, there is nothing.'"

Serkin modulated then from Rachmaninoff on Beethoven and Liszt to Serkin on Mozart and Rachmaninoff. "In a Mozart sonata," he maintained, "there is nothing for the pianist to hide behind. It is not like Rachmaninoff, if you know what I mean. In Mozart the pianist must try to get up to the music. It is hard, very hard, to do. But it is so beautiful when you get there."

Serkin gleaned Rachmaninoff's views on the auxiliary uses of Liszt-sized composers when he was living in Berlin years ago. He would turn up at Rachmaninoff's studio then to play four-hand Schubert piano pieces with him. After every few bars Rachmaninoff would stop, turn to his young partner, and say, "Let us play that over again, Serkin, it is so beautiful." Serkin is quick to add that what Rachmaninoff had in mind was the music of Schubert and not the handiwork of the junior pianist on the scene.

Rachmaninoff was heard at times to work up considerable enthusiasm for his own performances



Photos by Kalischer

At Marlboro, in the company of musicians who share his seriousness, Serkin finds both spiritual refreshment and relaxation.

at the piano, but Serkin is not at all given to self-congratulation. He is not even able to get up much of a case for the piano as an instrument suitable for the performance of music. He regards it as a machine from which it is supremely difficult to extract music. "It takes so long to get anything lovely from it," he laments. "Take a cello, a bow—ah. At once, beautiful tone." As an instrument for children beginning the study of music, he thinks the piano has a whole complex of disadvantages, which can be best overcome if the child learns to sing, or to play a wind or string instrument at the same time that he is tussling with the keyboard. "Phrasing is breathing, and so many pianists do not get to learn about phrasing," he said. "In Philadelphia a while ago I recorded the Schumann Concerto and I learned a beautiful phrasing of one passage just from hearing the oboist Marcel Tabuteau play it before me. All that I had to do was think like the oboe."

A seraphic expression came over Serkin's face as he thought about that phrase again. Matching his piano to the oboe was a chamber music experience for him, even with the Philadelphia Orchestra at full strength wafting great torrents of tone all around him. In Serkin's set of values, playing chamber music is about the finest thing in life, a mystical union of the performers with each other, and all of them with the composer. Serkin is so convinced of its restorative effect on professionals that he feels obligated to provide the setting in which they can come to feel the way he does about it. At Marlboro orchestra men wearied of submersion in the psyches of their conductors get to play uncondemned Beethoven quartets with recitalists wearied of playing flashy encores for easily impressed audiences.

Reputations are left outside the Marlboro gate, for once inside the settlement only musicianship counts. The refugees from Show Business like to regard Serkin as the only celebrated figure present, but Serkin makes this hard for them by immersing himself even further than they do in the Marlboro idea. Once when pressed to account for his skill at being influential there from a concealed position, Serkin first doubted that he was, then came up with a possible explanation in which he compared himself to a string quartet's second violinist. "Sascha Schneider of the Budapest Quartet comes here in summer, and he gave me my greatest compliment one time," Serkin said, suddenly looking a little pained as he realized he had fallen into the trap of talking about himself. "Sascha said that I like to be inside the music and that I would have made the world's second-greatest second violinist. That's from the man who says he is the world's greatest second violinist, and I suppose he is, so I must respect what he says, yes?" Serkin looked relieved that his little story seemed funny rather than fatuous, but he quickly skirted back to less treacher-

ous conversational grounds. "You see," he said, "this is not really a school at Marlboro, for there are no teachers. We are all students. Or we are all teachers. I talked to Issac Stern about another name for this place and he thought it should be called the Institute for Advanced Studies in Music. I do not know if that is right for it either."

There are some indications that the Marlboro retreat might be called the Institute for the Replenishment of Rudolf Serkin. The man of austere mien who makes world-wide concert tours most of the year dissolves into almost small-town affability once he settles in for his months in the country. The company of serious musicians pleases him completely, and Serkin's relaxation when he is with them is sometimes hard to believe. In Carnegie Hall, as in the concert halls of Kansas, Serkin's shy bow at the end of a performance looks like the compromise gesture of a man whose real wish is to disappear up the sleeves of his tail-coat. At Marlboro, all that reserve is shaken off. Before and after concerts there he is likely to greet visitors outside the little auditorium with the cheeriness of a minister chatting with his flock after Sunday service. And at times Serkin is even seen about with a baby girl in his arms. The last-born of the pianist's half-dozen children is a year-and-a-half-old daughter named Marguerite, referred to by Marlboro wags as Serkin's Opus 6. She turns up because there are often no Serkins at home to keep her company. Serkin lives on a 300-acre farm twenty miles away; but it seems even closer, for most of his family joins in the music making at Marlboro. Though his oldest daughters, Ursula, a flutist, and Elizabeth, a clarinetist, are married and unavailable, and his eighteen-year-old son John, a horn player, has taken a teen-ager's sabbatical from the scene, there are still lots of Serkins to be heard from. His daughter Judy, eleven, and his son Peter, thirteen, teamed with their father last summer in playing the three-piano Mozart concerto (K. 242), while his wife Irene Busch Serkin played the viola in the orchestra.

Serkin was born in Eger, Bohemia, but his parents were both Russians. He was the fifth of eight children, all of them addicted to making music on one instrument or another. After a year with the violin, Serkin turned to the piano when he was four and progressed dazzlingly. To accommodate the family to its prodigy, the Serkins moved in 1911 to Vienna, where there were teachers who could cope with his talent. Professor Richard Robert directed his piano studies. Arnold Schoenberg taught him composition, and George Szell was a fellow student. Schoenberg told Serkin to compose a tonal work in the style of Mozart, but the pianist never managed it. He did learn to play a lot of Schoenberg tone-row works, however, though he plays few of them any more and has recorded none. He has recorded much of the clavier repertoire of Mozart instead, including *Continued on page 82*



High Fidelity Servicing

A survey of the facilities available—with some pointed advice on what to seek and what to avoid when your components need professional care.

BY CHARLES TEPFER

IN A UTOPIAN world, nothing would ever break down, nothing ever need to be repaired. But in our imperfect world everything we cherish is susceptible to time and accident. High-fidelity equipment is no exception, despite its intrinsic excellence and the loving care with which it is normally treated. Sooner or later its owner must concern himself with the availability and reliability of servicing facilities, and he may discover that these can be far from ideal.

Genuinely "high-fidelity" equipment will not, of course, "break down" soon after its purchase, but occasionally defects are apparent even in newly bought components. If the unit has been purchased and taken home by the buyer himself, he will naturally report the trouble to the dealer with whom he traded. If, however, the unit was purchased by mail or ordered to be sent by a delivery service, there are complications. Most equipment carries

a notice stating that damages caused en route should be handled by "a claim against the carrier." Question: how is the purchaser to decide whether a bent amplifier cage or a chipped finish on a speaker enclosure was caused by someone's carelessness at the factory or by the package's being dropped on the floor of a loading platform? And, assuming it can be determined that the damage was caused in transit, the purchaser can make a "claim against the carrier." Usually, such a claim involves some filling out of forms, a visit by an inspector to assess the damages, and finally a check in settlement. Some dealers may replace the damaged unit with a new one and will then take over the damage claim themselves, with the buyer signing the appropriate papers for this transaction.

With regard to defective parts in new equipment, the high-fidelity purchaser is relatively blessed, since

warranties for high-fidelity components generally are among the most liberal of all those provided for consumer products. Some components manufacturers offer a ninety-day guarantee (except for vacuum tubes), but many more issue a one-year warranty and some go as high as two years. In fact, one speaker manufacturer will replace an open voice coil at no charge up to three years from the date of sale. Some admit to a flexible warranty period despite the limits set on the guarantee card given the customer. Under a typical warranty, all defective parts (other than tubes) are replaced free with no charge for labor (assuming of course that the factory is at fault and the customer did not misuse the instrument). Sometimes the tubes are guaranteed for ninety days and the rest of the component or system is guaranteed for one year.

In the matter of who does the servicing, guarantees differ. Some manufacturers insist that it be done by the dealer and a very few insist on making all repairs in the factory, but most components manufacturers cover themselves for in-warranty servicing by naming authorized service stations. These stations are, in reality, independent businesses which perform in-warranty service for a number of high-fidelity manufacturers. Some components companies employ roving instructors who visit these stations, as well as selected dealers: their job is to train technicians in the repair of the company's products. Other companies offer free instruction courses in their factories to designated technicians from the authorized stations or dealers.

The drawback to this system of special service stations is that often they are too few and far between. For example, one components manufacturer offers his customers authorized service stations in only nineteen states. There are nine stations in New York City, but just one, in Newburgh—and that only sixty-five miles up the Hudson—to serve all the rest of the state. According to the warranty, the man who lives even in the heavily populated Mohawk Valley has just two alternatives: he may send the component to the nearest authorized service station (Newburgh, presumably) or he may return it to the factory (Railway Express at his expense). Both courses involve inconvenience (especially if the original packing case is not kept by the customer), some expense, and considerable time—possibly up to four weeks before the repaired component is returned. The farther a man lives from a really large metropolitan center, the more difficult his situation.

To be fair, it should be mentioned that the manufacturer cited above and many others authorize their dealers to return in-warranty equipment to the factory or authorized service station at no expense for their customers. In this connection, as in others, it behooves the buyer to read the guarantee carefully before he buys the product; he should make it at least as important a consideration of purchase as the finish of the case or cabinet.

Now, what happens after the first ninety days or one year, when the warranty and ostensibly the responsibility of the manufacturer towards his customer ends? Where does the high-fidelity owner then go for his servicing? First, let us remark the comforting fact that if we rule out the troubles caused by mishandling in shipment and the early tube and pilot light failures, all covered by the warranty, the average well-designed component does not require as much service as the average TV set. But, with the emphasis in recent years on high-power amplifiers, the need for servicing of these components has gone up. (It's not the power alone that does it as much as the closeness of the design tolerances; if capacitors and output tubes are made to carry voltages and wattages right up to their maximum ratings, things will pop after a while and take other parts along with them.) And with many components, the heat generated may play havoc with the parts and change their values after a period of use. Tape recorders certainly need looking after: tape heads probably will need alignment after two or three years of steady use, and they certainly should be cleaned and demagnetized before that; capstan and idler rollers may need replacement. Speakers probably need the least attention; they are not fragile, but rough handling (especially by children) can strain the most rugged construction. In short, servicing will be required.

It should not be necessary to point out to the sophisticated high-fidelity owner that such servicing cannot, as a rule, be provided by the one-man TV-and-radio repair shop. Such establishments usually do not have a reference high-fidelity system with which to make listening-test comparisons for distortion. Often there is no FM antenna on hand to hook up to an FM tuner. And while the proprietor probably owns an oscilloscope, he frequently doesn't bother to use it for audio equipment—even though this instrument, in trained hands, is probably the most effective means of detecting, analyzing, and solving distortion, hum, degenerated frequency response, and a host of other tuner and amplifier problems. Merely "getting the set to play"—a workable goal in TV and ordinary radio servicing—just isn't enough for high-fidelity servicing, which entails becoming involved with areas of acoustic response unique to high-fidelity equipment. These "ultra" performance features are of primary concern in the design and manufacture of high-fidelity components and are, indeed, a chief reason for buying components in the first place.

For reliable servicing, the high-fidelity owner must then either return the equipment to the manufacturer or find a "specialist" serviceman. While some manufacturers will allow you to send a component to the factory for repairs after its warranty period (if you do so, prepare for delay since in-warranty repairs are granted priority), most feel that there is an adequate number of trained high-fidelity servicemen throughout the country and that

service is the dealer's responsibility. Unfortunately for the owner, fees are often high—many manufacturers claim to monitor the service fees charged by their dealers but in fact the dealer generally is free to charge whatever he chooses—and the servicing competency of some dealers may very well be open to question.

Recently my tuner, a well-known make with separate AM and FM circuits for stereo programs, was in need of repair. The 12AZ7 tube in the oscillator stage of the FM section sometimes would work as it should, but sometimes the tube did not heat up properly and the signal to the amplifier was low and distorted. To make the tuner a real test case of servicing efficiency, I gave the core in the primary coil of the transformer at the output of the third limiter stage five turns counterclockwise, detuning the transformer enough to introduce an obvious distortion on every station. I then put

some red sealing wax over the opening at the top of this transformer "can"; the wax would have to be removed by a serviceman to readjust the transformer. (The manufacturer's service data clearly stated that this transformer should be adjusted for minimum distortion.)

These troubles were designed purposely to separate the servicing men from the boys. Any competent "tube puller" would find the defective tube easily enough and replace it, but it would take real servicing knowledge and competence in the use of test instruments to find the cause of the distortion. If a serviceman used an oscilloscope and signal generator on the tuner, he would find the mistuned transformer in a matter of minutes. If he had enough high-fidelity servicing experience, he might guess the trouble. In addition, the distortion would test the serviceman's ear and his test speaker.

Continued on page 84

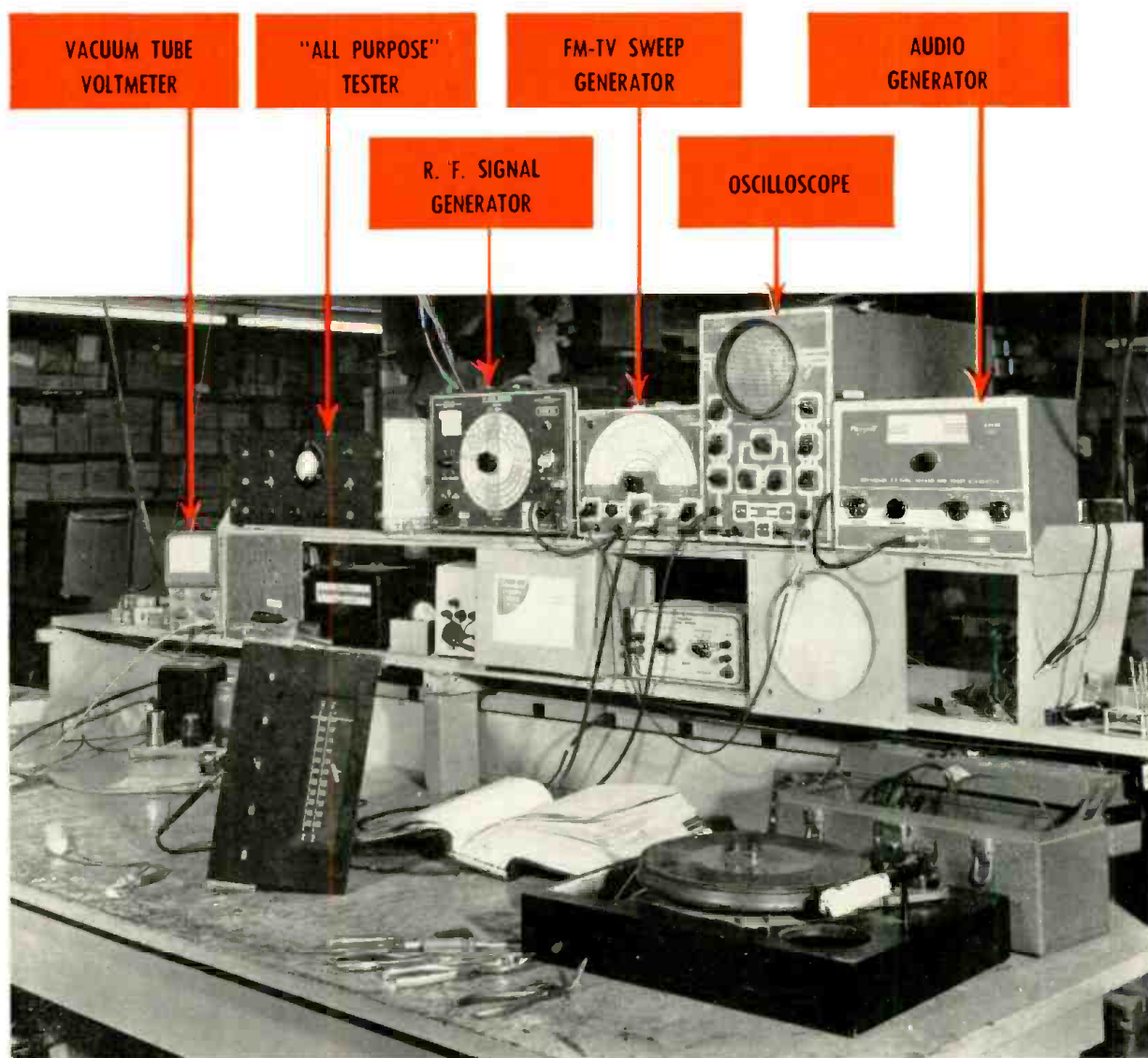

A service bench for high-fidelity testing should include at least a voltmeter, oscilloscope, and signal generator.

Summer Music in the

BERKSHIRES



STARTING ABOUT A CENTURY AGO wealthy families from the large cities of the Eastern seaboard were drawn to the Berkshire Hills, the Massachusetts county which stretches from Vermont to Connecticut flush along the New York State line, by its summer climate and constantly seductive scenery. With a cosmopolitan class of "summer people" and a native tradition of culture, it would seem natural that the arts

Text by

Jay Rosenfeld

Photos by

Clemens Kalischer

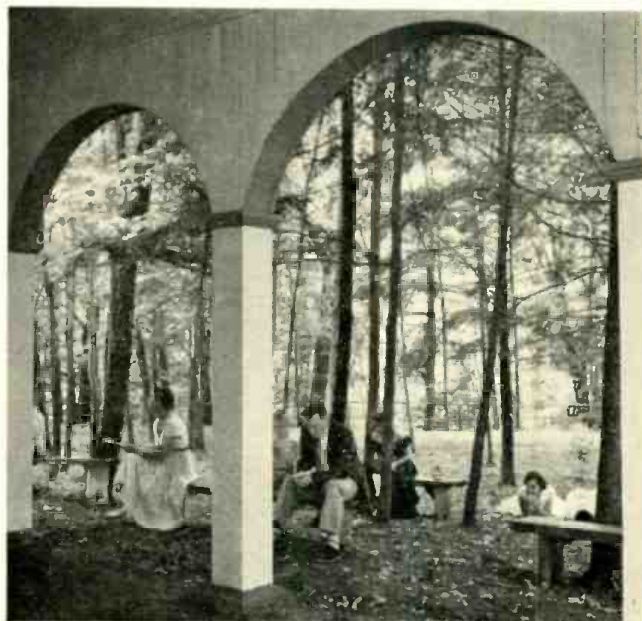

South Mountain provides a sylvan Temple of Music.

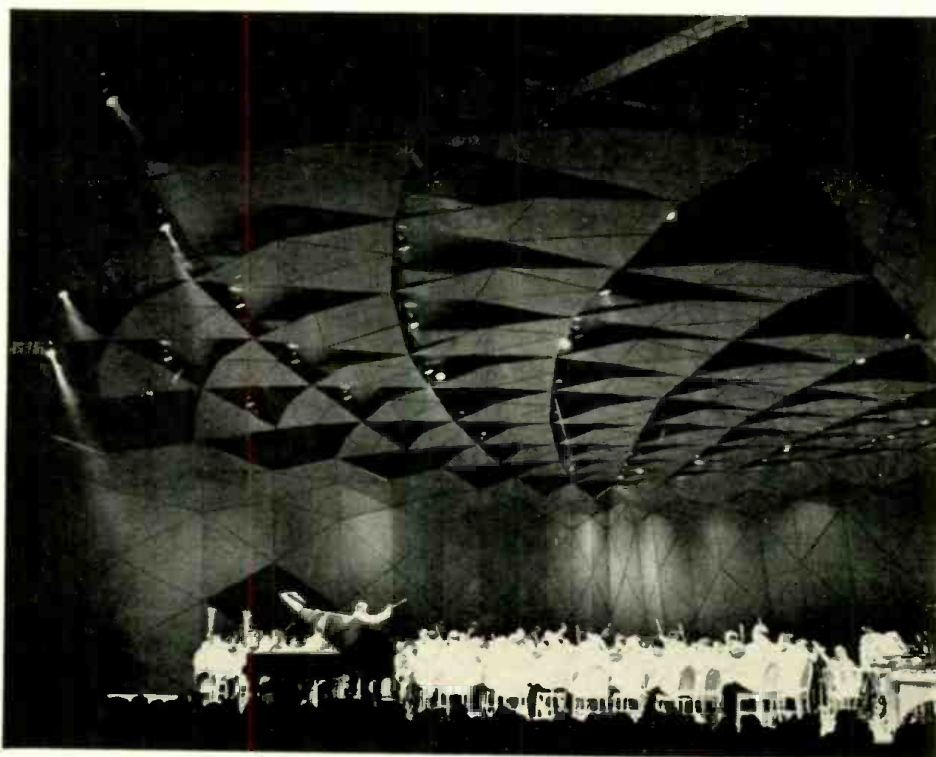

The Shed at Tanglewood: the Boston Symphony assembles here in full force.

should take root and flourish in this soil. There was even a music "festival" in Pittsfield, the county seat, in 1891, which, yellowed records show, included the appearance of "the world's greatest cellist," a young Irishman named Victor Herbert. But in fact it was not until after World War I that the area emerged as a music center of more than local importance—and this largely through the enterprise and determination of



At top, Ted Shawn's dance theatre at Jacob's Pillow; above, its students in class.

Summer Music

two dedicated individuals: Mrs. Elizabeth Sprague Coolidge and Serge Koussevitzky.

Mrs. Coolidge was the daughter of a well-known Chicago family, who as a young girl had seen Wagner conduct at Bayreuth and who had heard Brahms at the piano in Vienna. Once installed in Pittsfield, where her husband had decided to settle for reasons of health, she invited four former Chicago Symphony orchestra members to form a quartet and to come play for her guests at the palatial Coolidge estate on the edge of the city.

From this private pursuit soon developed the project which was to become unique in the field of chamber music. Acquiring "South Mountain," she built a 600-seat Temple of Music on the ridge and on the nearby slope cottages for resident artists. The Berkshire Festivals of Chamber Music, starting in 1918, were conspicuous for the eminence of the performers and the renown of the composers whose works were played. Many scores were specifically commissioned, and competitions—whose prizes were as valued for prestige as for their money value—were sponsored.

When the scope of the festivals required year-round implementation, the United States Congress accepted Mrs. Coolidge's offer to construct an auditorium in a courtyard of the Library of Congress in Washington. Through the Foundation established before she died in 1953, the Washington concerts have continued with vigor; those on South Mountain continue with less concentrated aim. *Continued on page 84*



Tenor Richard Dyer-Bennet, one of many artists who live in the Berkshires.



Music Mountain, in nearby Connecticut: chamber music every Sunday.



A local inn shelters the School of Jazz: here, John Mehegan and lecturer Al Mins.



by Norman Eisenberg

FM Portables

Transistors have made it possible to enjoy FM programming in the great outdoors

NOT TOO MANY Julys ago, a not uncommon sight in the remote seats at a baseball park was the fan watching the game “with both hands”—that is to say, with one hand shielding his eyes against the sun and the other pressing a portable radio against an ear. The radio, of course, was tuned to the station broadcasting a play-by-play account of the game. Why would anyone have to supplement his admission ticket with a radio? “Well, I came down here,” went the explanation, “I may as well know what’s going on.”

In addition to compensating for long-distance viewing as well as the random acoustics of outdoor stadiums (including those with public-address systems), the portable set served other uses. It alerted its owner, for instance, to coming changes in the weather. While there was nothing he could do about it, at least he wouldn’t be taken completely unawares when summer showers came down between the final play and the hike to subway, bus, or parked car. The portable also served as a private ear on the world, offering subjects for discussion on the way home somewhat less tedious than the inevitable debates over whether Di Maggio should have belted that long one in the third inning. Finally, the portable of those days (non-high fidelity, non-FM) could be tuned to what passed for the sound of music—mainly current jukebox hits (without even the bass response provided by “jukebox boom”). The occasional strains of opera, symphony, or chamber music, picked out from the crowded station dial, were a real find indeed. The music lover who for one reason or another had to depend on such a portable set for serious listening could do little more than twirl the knob and hope, like Micawber, to “be ready, in case of anything turning up.”

Such recollections made for certain reservations on my part when I recently came to renew my acquaintance with portable radios. Circum-

“A jug of wine, a loaf of bread, and . . .” a bevy of FM portables for turning any summer afternoon into a musical one. Upper left is the Westrex, with phonotape attachment; at its right is the Zenith. The Norelco occupies the center, while the Columbia (lower left) and the Sony complete the electronics display pictured in this rustic setting.

Basket courtesy Jennifer House

stances, however, called for a reëxamination: professionally, I was interested in an apparent new design trend—the use of transistors and other forms of “semi-conductors” that replace tubes, facilitate tuner circuitry, and operate on the tiny power drains that can be furnished by flashlight batteries; personally, I was temporarily denied the pleasures of an elaborate stereo component system while moving my family from a New York suburb to new quarters in the Berkshire Hills of Massachusetts. This move also provided an opportunity to test a few portables under the ideal signal conditions that prevail in the metropolitan area and then again with the reception available in an unfamiliar “fringe” area.

The net result of this experience amounted to a rediscovery of the “portable principle.” With the better models I sampled, I found that it is possible now to enjoy *most* of what is available as program fare on FM as well as a good measure of that medium’s superior sound—all from an attractive set that weighs a few pounds, can be carried around more easily than an attaché case, needs no plugging in, and may soon become a more commonplace sight in the warm weather than the straw hat. Indoors, of course, the FM portable serves as a “second set” in study, bedroom, or kitchen. About the only intricacy involved in successfully using these portables is learning just how far and at what angle to set the built-in telescoping antenna. When this antenna is properly oriented, signal-to-noise ratio is improved, pull-in power strengthened, and distortion reduced. Some portables have provision for external antennas, presumably for use in a “non-portable” situation where maximum sensitivity can be achieved.

By no stretch of the aural imagination can the sound of any portable truly be called “high fidelity.” It simply lacks the wide-range response and dynamics, as well as the low distortion, of high-fidelity sound and, except perhaps on the strongest of local signals, it is hardly ever completely free of some background hiss. Nonetheless, the sound is much cleaner than what is heard on the average AM radio, portable or table model. What’s more, the FM portable does

provide FM programming, and there is something quite thrilling about being able to tune in on Beethoven or Bartók or Brubeek on a summer outing under circumstances that hitherto could produce only ball games, soap operas, and overworked pop tunes.

The most dependable portables with which I lived for some weeks turned out to be a Norelco, a Westrex, a Zenith, and a Columbia. In addition to their ability to furnish FM broadcasts, each has certain unique features. The Norelco has the highest rated output (750 milliwatts) as well as a “long-wave beacon band” (for those who care to eavesdrop on weather messages) and a phono jack for playing records with a high output-level cartridge. The Westrex has a short-wave band which, with a little luck, gets an assortment of marine, weather, and other relatively remote signals; it also can be connected to operate from a car battery.

Most intriguing of all, the Westrex can be ordered with the new “phonotape” cartridge and player attachment, which makes it virtually a complete sound system in miniature. The Westrex “phonotape” actually is a cross between a tape and a disc recording. It consists of a $\frac{5}{8}$ -inch-wide plastic tape on which a modulated groove is tracked by a stylus and cartridge. The pickup engages the groove at right angles as the tape spirals past it on an endless loop. The sound is amplified and heard through the Westrex portable, switched to PHONO operation. This device extends the carry-it-yourself musical horizon a step beyond the scope of radio-only portables; with the “phonotape” you always can play music of your own choice whenever the airwaves fail to satisfy you.

The sturdy and attractive Zenith model has—for my ears—the kind of sound that typifies portability at its best, plus such special features as a switch that permits its use as tuner only (to be connected to an external amplifier and speaker) or as a phono amplifier. The Zenith also employs the largest of the built-in telescoping antennas, the biggest speaker of any FM portable we’ve seen (a 7-inch by 5-inch oval type), as well as the huskiest power pack, a nest of eight size-D batteries that provide 12 volts to power its eleven tuned circuits.

The Columbia is the most compact of the group, and is provided with only a single-section telescoping mast antenna—yet its apparent sensitivity and sound come close to rivaling those of its larger cousins.

In New York, the fact that these sets pulled in most of the stations we had been accustomed to hearing on high-fidelity tuners did not particularly surprise us. After all, we argued, the air here is full of strong signals; it would be a poor set indeed that didn’t pick up a fair share of them. On moving day as we traveled along the parkway, the portables proved less dependable: even with antennas extended precariously out of the car window, most of what we got was drowned out by the rotund staccato of the car’s engine. The farther north we drove, the lower went our opinion of portables, transistors, battery operation, and

Continued on page 82

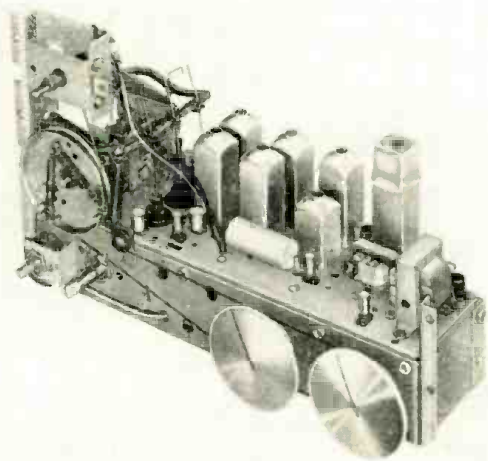

Pea-size transistors replace tubes in Zenith.

*The consumer's guide
to new and important
high-fidelity equipment*

high fidelity

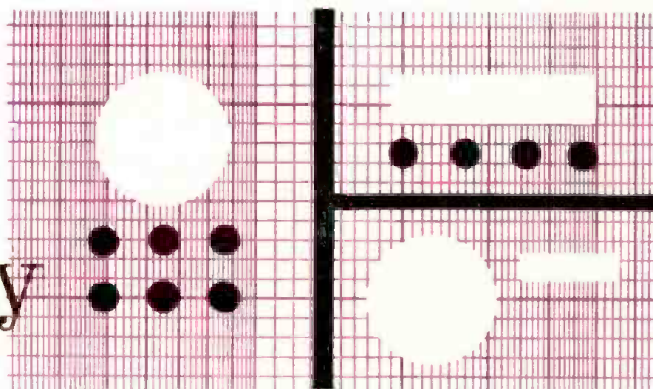

EQUIPMENT REPORTS

AT A GLANCE: The University TMS-2 is a stereo speaker system housed in a single cabinet. It consists of a double voice-coil woofer which reproduces bass from both channels, plus two separate sets of midrange cone and horn tweeter, one set for each channel. The total system is, in effect, a pair of full-range three-way speaker systems but housed in one enclosure. The bass radiates from the rear of the cabinet; treble, from the sides with swing-out doors acting as sound deflectors. On stereo, each system handles its own channel; on mono, both systems are paralleled.

Measurements and listening tests indicate that, in either mode of use, the TMS-2 is a fine reproducer. Prices and dimensions vary slightly with type and finish of cabinet. Contemporary models are 30 in. wide, 25 in. high, 12½ in. deep: in mahogany, \$258; blond, \$263; walnut, \$263; oiled walnut, \$269. An Early American model is 30 in. wide, 24¾ in. high, 13½ in. deep: in fruitwood, \$279.95. All models contain the same reproducers.

IN DETAIL: Although the dimensions for the TMS-2, or "Tridimensional" speaker system, as it is called, indicate a relatively compact cabinet (especially so in view of its housing two reproducer systems), it is by no means a "book-shelf" system. It is designed specifically to stand on its legs so that the bass can radiate from behind it, while the midrange and highs are spread out from its sides.

The TMS-2 is based on two familiar concepts in sound reproduction. One is the approach that bass notes (in this case, 150 cps and lower) are not directional, or directionally perceived, and thus can be reproduced—even on stereo—from a source that need not be geographically identified by the listener. Needless to say, this approach, like so many others in audio, is a debatable one despite the fact that it is used in many speaker systems. The other concept involves the diffusion of midrange and high frequencies: "spreading" them by some means or other is held to produce a more natural quality of musical sound than merely projecting them directly into the room. This latter concept is more generally agreed on, and finds expression in a very large variety of designs for speakers and enclosures. In fact, it has even led some listeners to "aim" their speakers at a wall, since—at some angle and at some distance from the wall—the sound often takes on a smoother, "airier" quality.

In the case of the TMS-2, everything—including the bass—is "aimed" and spread, with some interesting effects noted as the spread is varied.

The system comprises a sturdy 12-inch woofer with a dual voice-coil. The twin voice-coil enables bass notes from two separate channels to be fed directly into the one speaker without the need for a mixing network. These notes are supplied from a pair of conventional crossover networks, each of which channels midrange and highs to respective 8-inch cone speakers and horn tweeters, operating independently on the two channels. These units are furnished with their own level controls for adjusting response to individual tastes.

The woofer faces to the rear of the cabinet so that bass notes radiate effectively from all four sides (assuming of course the cabinet is not jammed flush against the wall!). The midrange cones and horn tweeters look out from each side of the cabinet, left and right channels respectively. A pair of swing-out doors may be opened from their fully closed position over the front of the cabinet to any position where they serve as deflectors for the sound radiat-

University TMS-2 Stereo Speaker System

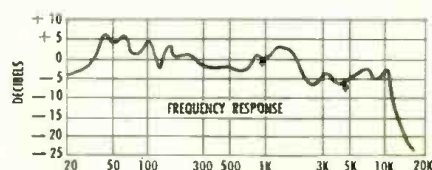

ing from the two sides. Obviously, the exact position of the doors is a matter of personal preference—on stereo or mono—although the more they are opened, the greater is the sense of “spread” in the sound.

This is an unusual system, and unusual pains were taken in our laboratory measurements of it. Nine different sets of response readings were taken by Hirsch-Houck personnel, varying the position of the microphone as well as that of the speaker system. All nine sets of data then were averaged for each frequency and plotted as the response curve, shown in the accompanying graph. Reports the lab: “The frequency response proved to be unusually smooth and wide. The woofer, a long-excursion high-compliance type, produced useful response to well below 30 cycles with little distortion. The waveform appeared to be clean at the lowest frequencies. For flattest response, it seems that the ‘Brilliance’ control should be set higher than midway; if this is done, the response curve would be within plus or minus 4 db from 30 to 12,000 cps.”

One interesting thing became apparent during tests of the TMS-2: the bass response seemed to depend directly on the distance from the rear of the cabinet to the wall. Placing the speaker six inches from the wall, for instance, caused a sizable rise in lows from 50 to 150 cps. On the other hand, moving the cabinet out from the wall by several feet lowered the bass peak and actually extended the lower limit of response somewhat. To what extent this change was due to room effects could not be estimated. Obviously, some experimentation by the user in placing the system in a given room would seem to be indicated. Tone burst response, observed on an oscilloscope and indicated here in the photos, was judged to be “fairly good.” Efficiency is about average; the TMS-2 is recommended for use with quality amplifiers of 15 watts or higher power output.

The net impression of listening to the TMS-2 can be summed up as one of a pleasing spread of sound, with no “hole in the middle” and with a fair degree of depth that is perceptible from most parts of an average-size living room. There was some disagreement over the setting of the tweeter control (“Brilliance” control), with some listeners urging that it be turned up, and others satisfied with it at midway position.

Whether the method employed in the TMS-2 of reproducing two channels by the common woofer and the separate midrange and tweeter units is a more successful one than that of using two completely independent speaker systems separately housed is a matter best decided by the listener, in terms of personal tastes in acoustics as well as in décor. It is apparent, in any case, that the high quality of the elements used in the “unitized” TMS-2 can make for better sound—stereo or mono—than a pair of speaker systems that employ elements of lower quality, or that are incorrectly baffled, or poorly placed in the room, even though the latter be physically separated as two distinct systems. N.E.

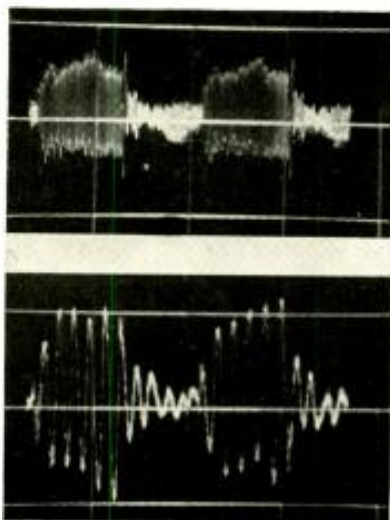

Sherwood S-7000 Stereo Receiver



AT A GLANCE: The Sherwood S-7000 stereo receiver is a recent addition to the growing roster of the “all-in-one.” A single chassis contains stereo AM/FM tuners plus twin-channel preamplifiers and power amplifiers. The unit measures 16¼ by 14 by 4½ inches. Not only is the S-7000 attractive in appearance but it incorporates many ingenious and effective operating features.

The convenience of having all the electronic elements for a mono or stereo system in a single package that can deliver high quality performance makes the S-7000 a very worthwhile buy. Price: \$299.50 (with brown leatherette case, \$307).

IN DETAIL: One major concern of those who plan to purchase a combination component such as the S-7000 in which dual tuners and amplifiers all are built on one chassis is its ability to dissipate heat. Heat, of course, is one of the worst enemies of a high-fidelity system, and one might suspect that it would be a problem on a chassis that contained as much as this one does. In this regard, however, the design of the S-7000 is outstanding. The output tubes are located at the rear of the chassis and are shielded from the other components. These tubes run exceptionally cool, as the result of a “chimney effect” with air coming up through the bottom of the chassis, and passing over the tubes on its way out the back. As a further aid in ventilation, Sherwood recommends leaving at least four inches of space at the rear of the unit when install-

REPORT POLICY

Equipment reports are based on measurements and listening tests. The choice of equipment to be tested rests with High Fidelity's editorial department. Many equipment reports are prepared for us by Hirsch-Houck Laboratories, an independent organization whose staff was responsible for the original Audio League reports. Some reports are prepared by the High Fidelity staff using data supplied by Hirsch-Houck Laboratories or by other similar independent testing organizations. No report or any portion thereof may be reproduced without written permission of the publisher.

ing. This space also provides room for the interconnecting cables and wires to and from other components, such as phono, tape deck, and speakers.

Sherwood makes some fancy claims for the S-7000, which are verified in large measure by our laboratory measurements and listening tests. The accompanying graphs testify to the high quality of this unit. As shown, the frequency response could almost be plotted with a ruler from 10 cps to far out on the high end. Actually, response doesn't vary by more than tenths of a db over the entire range. RIAA phono equalization is seen to be very good and the NARTB tape equalization is excellent down to 30 cps.

This accurate equalization characteristic, plus the tape input and output facilities provided on the S-7000, should prove of special interest to tape owners. The excellent equalization eliminates the need for separate playback pre-amplification in the tape deck and suggests that this unit would be a logical mate for a playback-only deck or "tape phono." Of course, should the owner care to use the electronics in his tape deck, he can still do so since the S-7000 has connections for tape preamps as well.

Recordings may be made through the amplifier from any of its own built-in program sources (FM and AM) or from any external program source, such as a record player, feeding into it. Jacks are provided for connecting to a tape recorder. A tape monitor function also is included.

The distortion curves, measured at Hirsch-Houck Laboratories, give a clue to the clean sound of the S-7000. Both intermodulation and harmonic distortion are very low when the amplifier is driven at normal listening levels. At extreme levels of 24 watts per channel, the unit produced only 1½ per cent intermodulation distortion. This, it should be noted, was measured with both channels driven simultaneously, which indicates well-balanced channels. Pushing the amplifiers to various power levels resulted in more than 1 per cent harmonic distortion at 20 cps. The laboratory feels that this is a normal level in units of this type. Only in considerably more expensive units with very large transformers would an improvement at 20 cps be realized. The amplifiers were very stable and should be capable of driving electrostatic speakers without difficulty. The hum level was low on PHONO, but not quite as low at the AUX input. To judge from the otherwise excellent performance of the unit, the lab feels that one side of the AUX input was "evidently defective"—at least on the sample tested. At that, they were able to reduce the hum to an acceptable level.

Sherwood rates the FM sensitivity of the tuner section at 1.8 microvolts (IHFM usable sensitivity). Our laboratory approached this figure (2.5 microvolts) while pointing out that "the distortion measured in this test includes the distortion of the audio system since it was measured, at 100 milliwatts output, at the speaker terminals." The laboratory added that "this is, by any standards, as sensitive a receiver as one could wish, except for reception in extreme fringe areas."

Without AFC, the tuner checked out as "quite stable"; with AFC it was five times as good. Line voltage variations, deliberately introduced as part of the test, had no effect on the unit; it was virtually insensitive to them.

The AM section includes a ferrite rod antenna. Additionally, terminals are provided for a wire antenna and ground to improve AM reception in rural areas. The AM sound, as might be expected, was only fair in comparison to the FM sound. As an aid here, the S-7000 incorporates an "AM selectivity switch" as part of its high frequency filter. This filter, when used to select the narrow AM bandwidths, cuts audio response above 5 kc. As a consequence, it cuts most of the noise and interstation whistle, leaving the major part of the AM signal intact. A side benefit of this effective filter is better reception of AM/FM stereo simulcasts. This filter also serves as a scratch filter to reduce noise from old or worn records. The rumble filter, incidentally, is equally very effective in the low frequency region and can indeed eliminate much of the noise associated with turntable rumble without, at the same time, causing excessive loss of bass response.

The tone controls also are worthy of mention. Bass controls for both channels are ganged on the same shaft. To facilitate simultaneous or separate use, one channel is controlled by a conventional knob while the other channel is controlled by a lever or bar extending outside of the knob. A similar arrangement is used for the treble controls. This sensible ganging gives the user independent control of both channels without adding an appearance of complexity. Both bass and treble controls are, incidentally, highly effective. Their action, as well as that of the filters, is shown on the accompanying graph.

The S-7000 features a pair of "acro-beam" tuning eyes of the maximum closure type, a distinct aid when tuning in stations. Balanced flywheels give the tuning dials a smooth and easy feel. The power off/on switch is found on the loudness control for both channels. Slide switches control the loudness compensation, high and low filters, AM-AFC, AM bandwidth, phase reversal, and tape monitor. A front-panel control is provided for adjusting the phono level independently of the loudness control. It is ganged to an outer bar which serves as a channel balance control. All controls were found to work smoothly and effectively.

In sum, the Sherwood S-7000 is as attractive and as compact a stereo receiver as we have seen and one that certainly represents fine value. Its good sound and smooth operation as well as the very convenience of all the functions found on the single chassis undoubtedly will swing many purchasers to it. R.F.

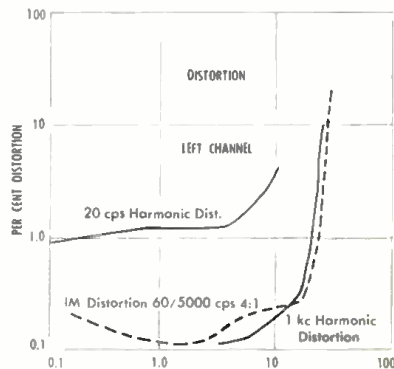
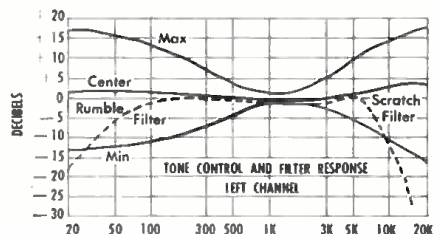
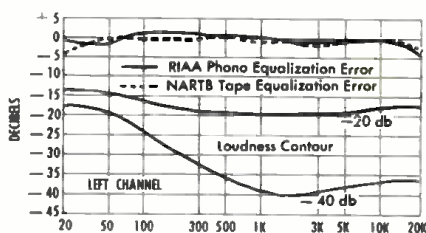
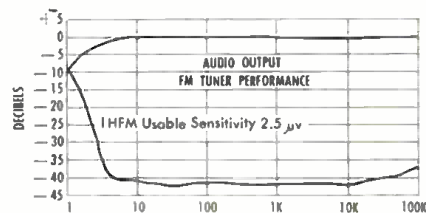

Transis-Tronics TEC S-15 Amplifier

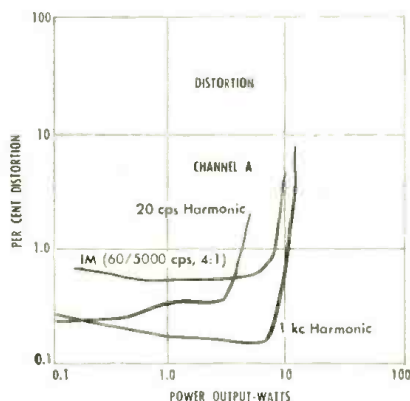
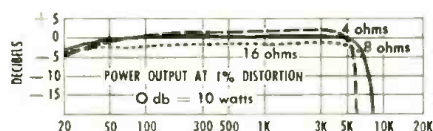

AT A GLANCE: The Transis-Tronics TEC S-15 is a fully transistorized (no tubes) stereo integrated amplifier. It has a power transformer but no output transformers. All normal control functions are provided as well as twin power output channels, yet the unit is very compact, weighs eight pounds in all, runs absolutely cold and needs no ventilation, may be operated from batteries as well as regular AC line voltage, and has virtually unmeasurable hum and noise. It compares very favorably with conventionally built amplifiers in its price class, but is outclassed by the better conventional amplifiers since its distortion does rise—especially in the high frequencies—when the unit is driven to its maximum power capabilities. Price: \$129.50.

IN DETAIL: An amplifier of this type was, until recently, a matter of speculation not only over whether it could (or would) be designed and produced, but also—being made—how it would perform, and how it would compare with conventionally built amplifiers. The former area of doubt at least has been resolved. What may have been once a gleam in an engineer's eye now is the reality of a neat, compact black (and gray) box that looks and works like, and is in fact, an amplifier. In place of tubes, the circuit stages are built around 14 low-level transistors, 4 power transistors, 2 germanium rectifiers, 2 germanium diodes, and 3 silicon diodes. These are all pea-size "semiconductors" that can be so arranged as to provide the normal complement of preamplifier-control facilities as well as power output stages for two channels and still be contained within a unit that measures only 3 in. high, 10 $\frac{1}{8}$ in. wide, and 8 $\frac{1}{2}$ in. deep. No output transformers are used; the circuit terminations of the final stages are designed to work directly into the load represented by a conventional loudspeaker. The amplifier performs best on normal AC line voltage, although the low power demands of transistors enable this unit to be operated from batteries of 12 to 28 volts—with a considerable reduction, however, in available audio output power.

Despite its compact size, the TEC S-15's front panel has man-size controls neatly and logically arranged. Knobs include: a concentric volume/balance control, with the power off/on switch on the volume control; concentric bass tone controls (operating independently on each channel); similar treble tone controls; and an input selector switch. Slide-switches, arranged vertically, provide for stereo/mono operation (on mono, either channel input may be fed to both power amplifier sections); loudness compensation (a fixed characteristic not related to the volume control setting); a scratch filter; and a rumble filter.

Signal connections are made in the usual way, with standard input jacks on the rear. Since there is no output transformer, the speaker terminals are not marked with the usual 4-, 8-, or 16-ohm impedance ratings; there are in fact only two terminals for each speaker connection. The unit, of course, will drive speakers of any impedance, although our laboratory noted that it provides less available power output as the impedance is increased. The TEC S-15 also has twin-channel tape recorder outputs which by-pass all its controls, as well as an "A plus B" output signal for mono recording. The amplifier comes on instantly, without warm-up time, and runs absolutely cold, requiring no ventilation.

Internal construction, reports our lab, "is good, with printed circuits and very neat cabled wiring. Quality components are evident. Much use is made of encapsulated capacitors. The power transistors are temperature-compensated." Functional features, such as frequency response, tone control effects, phono (RIAA) equalization, loudness contour effect, were found to be conventional in design and adequate in function. The loudness contour, by the way, has a fixed boost effect which can severely overload the amplifier when it is played at high volume settings. Thus, when the volume control is turned up high, the loudness contour should be turned off, as indeed the instructions supplied with the equipment urge you to do. The rumble and scratch filters were found to be "mild in their action, but with well-chosen cutoff points. Tracking of the two sections of the volume control is good. As advertised (and expected), hum is virtually unmeasurable and noise is very low. Gain is adequate for any stereo cartridge or other program source.

In the view of Hirsch-Houck Laboratories, this amplifier is best used with a "compatible" speaker system, which is to say, a high efficiency, conventional reproducer. With a full-range electrostatic used at H. H. Labs., the TEC S-15 showed signs of instability, with a tendency to oscillate or "motorboat." Sudden shifts of the controls sometimes caused the amplifier to "block" or momentarily cut off. The action of the controls, by the way, is slightly noisy due to the fact that the arms of the potentiometers carry current (as is normal in a transistor circuit).

With a speaker system in which only the tweeters were electrostatic units, the TEC S-15 performed much better though there was a tendency to high frequency peaking. These limitations are, of course, common to many low-priced amplifiers, including conventionally built units. Similarly, the TEC S-15's modest power reserves raise some doubt about its ability to drive a truly low efficiency speaker. The power response holds up, without exceeding the 1 per cent distortion point used in normal IHFM measurements, to just below 6 kc; above this frequency, power response drops for the 1 per cent distortion level. Higher power, up to 20 kc, is of course available but with an appreciable rise in distortion. Actually, the power out-

put, according to the lab, is dependent on speaker impedance and "thus will vary widely in different installations. At best, with a 4-ohm resistive load, we got 13.5 watts output from each channel at 1 per cent distortion." The lab goes on to state that "the distortion below clipping level is indeed low, much less than 1 per cent, but this limits the user to 7 or 8 watts, at most, per channel."

When operated from a DC supply, simulating battery conditions, power output was greatly reduced. At 12 volts, the amplifier developed 1 watt output per channel. This increased to more usable audio levels as the DC voltage was increased to 18 volts and higher. Power drain was low enough to enable the use of ordinary dry cells as a power source.

Aside from its performance with electrostatics, the TEC S-15—when operated on regular AC line voltage, and driving speaker systems of moderate to high efficiency—produced very clean sound. Distortion was lower than with some other conventional amplifiers in its price class. It seemed especially good on bass; with one speaker—which had sounded boomy with most other amplifiers—it actually improved the sound, lending it a clean, crisp tone. Thus, reproduction was very acceptable, though not the kind of sound that would fill a large room. When driven closer to its maximum limits—as when handling sudden orchestral crescendos and the like, or with the volume control turned up full, or both—distortion, particularly of the high frequencies, becomes fairly obvious, as indeed it well might do with many low-priced, low-powered amplifiers. To conclude, then, that more expensive amplifiers clear these sonic hurdles with less strain (particularly when driving medium-to-low efficiency speakers), is only to state the obvious. Within its limitations, the TEC S-15 stands as an example of what can be accomplished with transistors. While this accomplishment, to date, may represent acoustically no more than what has been done with tubes and transformers, it certainly represents, for a given power and performance class, no less. And from the standpoint of convenience, to say nothing of its technological implications for future audio equipment, it may well represent something more. N.E.

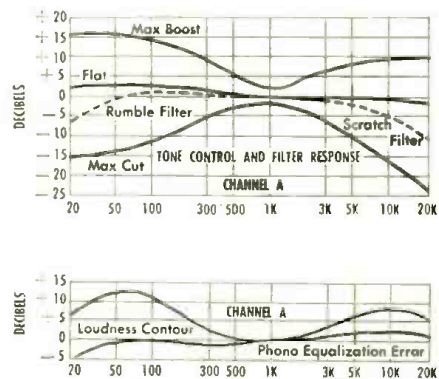

AT A GLANCE: The 9TSDV "Velocitone" is one of a new series of ceramic pickups from Sonotone, differing from earlier models in that it is furnished with plug-in equalizers. These devices convert the signal to a response suited for RIAA equalization and thus for connecting to magnetic phono inputs.

The unit is a turnover cartridge with interchangeable styli. It has fairly high compliance and very acceptable sound. The unit tested was furnished with a 0.7-mil diamond stylus for microgroove records (stereo and mono), and a 3-mil sapphire stylus for 78-rpm records. Price: \$23.50. Model 9TD77V, with two diamond styli, \$26.50. Model 9T5V, with one 0.7-mil sapphire and a 3-mil sapphire stylus, \$20.50. All prices include the "Velocitone" equalizers and installation accessories.

IN DETAIL: Many high-fidelity enthusiasts have long felt that a gap in acoustic performance separated piezo-type cartridges (crystal or ceramic models) from magnetic types. The present 9T series from Sonotone should lessen that gap considerably since it is evident, from measurements and extensive listening tests on a wide variety of program material (and with different systems), that it is possible to produce a ceramic cartridge that boasts high compliance, low moving mass, fine tracking ability, good stereo separation, and very listenable sound on both stereo and mono. This has been achieved in a unit that additionally features a high degree of adaptability as well as reasonably low cost.

To begin with, the term "Velocitone" refers to the pair of plug-in adapters. Each of these is a slim tube with standard phono input and output connections. In use, the signal cables from the tone arm are plugged into one end of the adapter while its other end connects into the phono input jack of the pre-amplifier (or combination amplifier, as the case may be). The adapter houses a tiny printed circuit consisting of a resistor-capacitor network which tailors the response, both in amplitude and frequency characteristic, so that it is suited for RIAA equalization and the voltage gain normally available in "magnetic phono" input circuits.

The output of the 9TSDV was measured at 12 millivolts, higher than most magnetic cartridges, but still within the range suited for magnetic phono inputs without danger of overloading the preamplifier stages and with the possible benefit in improved signal-to-noise ratio as a result of being able to run those stages at lower gain settings.

The cartridge itself is very slim and its mounting bracket will fit most tone arms with standard mounting centers. It also is rather light in weight, which means that on some arms the small weight furnished by the arm manufacturer will have to be used in the arm's cartridge shell to get sufficient downward thrust for tracking. The 9T is a turnover type, with accommodations for two styli. The model tested, the 9TSDV, is equipped with a 0.7-mil diamond stylus for all microgroove discs, stereo and mono, while the opposite side

Sonotone 9TSDV Stereo Cartridge

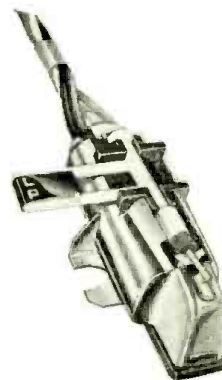

is furnished with a 3-mil sapphire stylus for playing 78-rpm discs. The stylus in either case is replaceable by the user. What's more, it is interchangeable with its counterpart, so that the buyer—if he chooses—can order the 9T with two 0.7-mil diamond tips and have, in effect, two stereo pickups in one. No model incorporating two 3-mil styli has been announced, but conceivably the basic 9T cartridge body also could be rigged in this way as well to provide a note of versatility of possible interest to the owner of a large collection of 78-rpm discs.

The cartridge appears to be sturdily made, with attention to such details as a mid-detent "needle guard" position for the stylus turnover lever, which may be used to safeguard both styluses when the unit is not being used; a considerable reduction (over former Sonotone cartridges) in the housing area near the stylus as well as in the size of the stylus holder, which makes the stylus more resistant to dust collection; and a plated metal outer cover with an electrostatic shield. The cartridge is fitted with a molded plug to which four color-coded wires are permanently connected. These wires are long enough to run through most tone arms; in most cases they will have to be cut and the ends near the cartridge then soldered to the existing leads in the arm. If this installation is a bit novel, it does eliminate the need for pesky sleeve fittings.

In tests run at Hirsch-Houck Laboratories, stylus compliance was found to be "evidently high, since arm resonance (in a test arm) occurred at about 1.5 cycles." The lab report goes on to state: "We found it would handle most records very well at 2 grams (stylus pressure)." Although the high amplitudes of the demanding Cook 60 test record would not be tracked at any force up to 5 grams (above which the lab did not go), the high velocity signals of the 1,000-cycle band on the Fairchild test record "were tracked remarkably well at 2 grams." Since some improvement in tracking was noted at 4 grams, this last figure was used as the stylus force in the lab tests, and in some listening tests. In other listening tests, lower stylus forces, on the order of 3 to 3½ grams, were also used with no apparent difficulty. Needle talk was moderate to low.

The lab reports that the 9T's frequency response "is smooth from below 20 cycles to over 10,000 cycles, with only a slight rise of 2 db at 8,000 cycles. It dips some 5 db at 13,000 cycles, and begins to rise above this point, presumably due to the armature resonance with the record compliance." This variation is shown on the accompanying graph.

Channel separation below 1,000 cycles was generally good. Between 1,000 cycles and 5,000 cycles, reports the lab, it was extremely good, better than 20 db, and on one channel reaching 35 db at 2,000 cycles. "However, above 5,000 cycles, the separation fell off gradually, reaching zero at 12 or 13 kc." Actually, comments the lab, "the channel separation curve is reminiscent of some of the earlier magnetic types."

In listening tests, using current stereo and mono discs, the 9T produced sound that was characterized variously as "unstrained," "pleasing," and "very smooth." Its lows were notably solid and clean. Most listeners agreed that the 9T did not have the "over-brightness" or "hard sound" of many previous ceramic pickups. Yet many felt it still was somewhat "brighter" than the best of today's magnetics.

In general, one could sum up by suggesting that it is very close in quality to a good magnetic cartridge, though not the equal of the top-performing magnetics of most recent vintage—specifically in terms of an almost elusive quality of "crispness" or "transparency" at the extreme high end, a quality which, by the way, would be perceived on only the finest reproducing equipment. In the long run, of course, this suggests that all types of cartridges—magnetic as well as ceramic—have been upgraded of late. In the short run, it also would suggest that, in view of its price and other features, the 9T certainly merits a careful audition by the cost-conscious buyer. N.E.

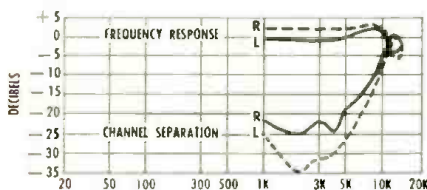

NEXT MONTH'S REPORTS

McIntosh MC-240 power amplifier

A new giant size power amplifier that may be used for stereo or mono operation.

KLH Model M-8 preamplifier

A miniaturized and transistorized preamp-control for use with the KLH-8 receiving system.

From Europe

AUDIO NEWS

PREPARED FOR HIGH FIDELITY BY

THE GRAMOPHONE

EDITOR'S NOTE: *This is another in a series of reports on audio developments abroad prepared for us by our counterpart in Britain. The Gramophone, and appearing here at regular intervals. This month, The Gramophone and HIGH FIDELITY both make grateful acknowledgment to the Wireless World, also of Great Britain, and to M. Jacques Dewèvre, of Brussels, for information supplied.*

THE FM broadcast band in Europe extends from 87.5 megacycles to 100 megacycles, which means of course that FM programs in Britain and on the Continent can be tuned in with American-made FM receivers when used within a reasonable radius of the broadcasting stations. This bit of news may tip the scales in favor of toting along one's FM portable or plug-in set on a trip abroad, or may at least spur the traveler to seek out an FM set as refreshment from the usual tourist program of restaurants, museums, and markets of the "flea" and "straw" variety.

If the mechanics of FM reception abroad are not very different from those in the States, the pattern of broadcasting, as well as its apparent objectives, does, however, differ. While FM in America has been largely a matter of fluctuating fortunes, FM in Europe has simply expanded, steadily and continuously, "sponsored" as a quasi-official activity of individual governments and nurtured generally by the European Broadcasting Union, an international body which allocates frequencies and periodically examines the over-all broadcasting situation. Under the aegis of this body, FM broadcast frequencies currently are designated as "Band II" of the VHF (for "very high frequencies") spectrum. Since the entire VHF spectrum corresponds to wavelength designations from 1 to 10 meters, this region also is known as the "metric waveband."

Britain. Designations and definitions aside, just what is available on European FM? The BBC, to begin with, operates twenty VHF/FM transmitters, which

cover most of Britain. This FM service does not replace the BBC's AM services (with its famous "three-program" schedules); these, in fact, the BBC continues to improve. Other than local area news bulletins and weather reports, the FM stations broadcast the same programs as the AM stations do. In addition, however, the BBC transmits experimental stereo programs on alternate Saturday mornings. These hour-long programs use commercial stereo recordings or specially prepared material, and are transmitted by what Britishers call their "Network 3," a group of stations that regularly cater to more sophisticated tastes. On stereo, incidentally, the left channel goes out on a broadcast frequency, while the right channel is handled by BBC's television sound facilities.

Although FM is received well in most



districts with the use of the internal antennas supplied in most radio sets, BBC counsels that a better antenna can overcome distortion caused by ignition noise interference as well as by multi-path reflections of the FM signal. Sales promotional literature for FM receivers emphasizes, of course, the vastly improved sound quality of FM. Cautious engineers, on the other hand, point out that while FM can indeed improve the dynamic range and frequency response of broadcast music, this improvement—if it is to be enjoyed by the listener—must be bolstered with improvements in studio acoustics, original recording techniques, transmission land-lines, station repeaters, and finally in the audio response of the receivers themselves.

The BBC first broadcast FM in 1955 at Wrotham (pronounced Rootam). This station serves southeast England, including the London area, and still is con-

sidered to be the best for fidelity of transmission. Its land-lines to the studio centers are comparatively short, with few repeaters offering a flat frequency response up to 12,000 cps. Some of the more remote stations in the BBC network must use, of course, longer land-lines, but even so the broadcast quality remains highly acceptable.

France. In 1959, new VHF/FM transmitters went into operation in metropolitan France. Since then, the RTF (Radio-diffusion—Télévision Française) has assigned these transmitters to the network broadcasting FM programs, known as "France IV," as well as for use on France I, II, and III (AM programs). The opening of the new Paris Broadcasting House and the establishment of high-quality transmission circuits have made possible the broadcasting of high quality programs, including stereo, to the whole country.

Elsewhere. Pioneer work and rapid success have characterized FM in Western Germany, where the problem of introducing FM transmission—before there was any question of introducing TV service—was rather acute. In Italy, the RAI (Radio-televisione Italiana) has set up a comprehensive network, with some 490 transmitters in service. Many of these are low-powered, yet the broadcasts cover virtually the entire country.

The Netherlands has its share of FM transmitters, although for stereo's twin channels transmissions are made over the medium-wave AM Hilversum transmitters, operating on 298 and 402 meters. Norway, Finland, Switzerland, and the Vatican State all have FM transmitters of their own. Belgium's new FM network is expected to come on the air by September 1961.

Finally, it appears that some form of multiplex stereo is being planned by all of Europe's broadcasting stations. In fact, a published recommendation for a proposed standard system is expected from the European Broadcasting Union before the year is out.

AF AUDIO FIDELITY

DOCTORED FOR
Super-Stereo
 AND
Super-Sound
 RECORDINGS
 THE ULTIMATE IN
DIRECTIONALITY
 AND DYNAMIC
PRESENCE !!

■ UNSURPASSED SOUND REPRODUCTION! ■ BRILLIANT ARRANGEMENTS AND PERFORMANCES!
 ■ FINEST ENGINEERING SKILLS!

NEW! ZANY! ORIGINAL!

AUDIO FIDELITY DFS 7008
 STEREO

BOB PRESCOTT presents

CARTOONS IN STEREO

with
 Cy
 Harrice

A new adventure in sound comedy. Hilarious sketches with an "O. Henry" twist accented by Bob Prescott's superb, professional, sound effects genius and the many voices of Cy Harrice. Humor plus high fidelity excellence. DFM 3008/DFS 7008

AUDIO FIDELITY DFS 7006
 STEREO

SOUND EFFECTS
 Volume 1

Doctored for Super Stereo

TRACK 1	TRACK 2
1. BEACH WAVE (MIMICRY) 01	1. TYPICAL BARK (10)
2. AT SEA (10)	2. CAR ENGINE (10)
3. AIR TRAFFIC (10)	3. CLAY (10)
4. AIR TRAFFIC (10)	4. CUP (10)
5. AIR TRAFFIC (10)	5. CUP (10)
6. AIR TRAFFIC (10)	6. CUP (10)
7. AIR TRAFFIC (10)	7. CUP (10)
8. AIR TRAFFIC (10)	8. CUP (10)
9. AIR TRAFFIC (10)	9. CUP (10)
10. AIR TRAFFIC (10)	10. CUP (10)
11. AIR TRAFFIC (10)	11. CUP (10)
12. AIR TRAFFIC (10)	12. CUP (10)
13. AIR TRAFFIC (10)	13. CUP (10)
14. AIR TRAFFIC (10)	14. CUP (10)
15. AIR TRAFFIC (10)	15. CUP (10)
16. AIR TRAFFIC (10)	16. CUP (10)
17. AIR TRAFFIC (10)	17. CUP (10)
18. AIR TRAFFIC (10)	18. CUP (10)
19. AIR TRAFFIC (10)	19. CUP (10)
20. AIR TRAFFIC (10)	20. CUP (10)

Unique! Entertaining! A wide variety of 50 sounds especially recorded. Not simulated, but perfect realism taken from life! Roaring lions to beach surf. DFM 3006/DFS 7006

AUDIO FIDELITY DFS 7007
 STEREO

VOL. 2 PER-CUS-SIVE JAZZ

** Moanin', Fever and other Swingin' Hip Tunes*

Doctored for Super-Stereo

Moanin'
 Fever
 Tender Trap
 Just in Time
 Everything's Coming Up Roses
 and others

A swinging, modern jazz recording unequalled for dynamic engineering and brilliant sound reproduction! Sid Cooper's sparkling arrangements in a thrilling performance. DFM 3007/DFS 7007

AUDIO FIDELITY DFS 7002
 STEREO

per-cus-sive JAZZ

The Man With The Golden Arm
 Mack The Knife
 Peter Gunn
 Dragnet
 Harlem Nocturne
 Mambo Inn
 Witchcraft
 and others

DOCTORED for Super-Stereo

Ricochet sound on stereo, dynamic presence on mono in the modern jazz idiom. A throat-lumping beat paced by Pete Appleby, 6 percussionists. DFM 3002/DFS 7002

AUDIO FIDELITY DFS 7003
 STEREO

per-cus-sive Latin

Cha
 Cha
 Cha

doctored for SUPER STEREO

Torrid Latin rhythms pulsating with a crisp directionality of sound. Nicolaesa, El Bodeguero, Cero, Sambia, Mambo Inn included. DFM 3003/DFS 7003

AUDIO FIDELITY DFS 7001
 STEREO

per-cus-sive BIG BAND JAZZ

Doctored for Super-Stereo

On the Street Where You Live
 Willow Weep For Me
 Reach Me
 Did I Remember
 Pretty Baby
 and others

Bright, new interpretations by Bobby Christian with a spine-tling, big band sound. High Fidelity at its swinging greatest! DFM 3005/DFS 7005

AUDIO FIDELITY DFS 7001
 STEREO

per-cus-sive VAUDEVILLE

the BIG theatrical sound

DOCTORED for Super-Stereo

Fantastic sound capturing the exciting vaudeville atmosphere including tap dancers, wood blocks, soft shoe... the works! DFM 3001/DFS 7001

AUDIO FIDELITY DFS 7004
 STEREO

Baldwin ORGAN AND BONGOS BONGOS

DOCTORED for Super Stereo

Most unusual effect in sound treatment with Eddie Osborn playing Washington Post, El Cumbachero, Buttons & Bows, Frenesi, others. DFM 3004/DFS 7004

DFM Series (Mono)—\$4.98/DFS Series (Stereo)—\$5.95
 Write for FREE Mono and Stereo album catalogs: Dept. HF 7, AUDIO FIDELITY INC., 770 11th Ave., New York 19, N. Y.

CIRCLE 12 ON READER-SERVICE CARD

reviewed by

PAUL AFFELDER
NATHAN BRODER
O. B. BRUMMELL
R. D. DARRELL
ALFRED FRANKENSTEIN
HARRIS GOLDSMITH
JOHN F. INDCOX
ROBERT C. MARSH
CONRAD L. OSBORNE
JOHN S. WILSON

Records in Review



by Robert C. Marsh



Today's Solti; yesterday's Mengelberg.

Mahler's Fourth Symphony— By the Concertgebouw Then and Now

IN October 1904, Gustav Mahler went to Holland for the first Amsterdam performances of his three-year-old Fourth Symphony. His friend and host Willem Mengelberg had arranged a premiere such as few new works have enjoyed. Mahler himself conducted the symphony at the opening of the concert, whereupon the audience retired for intermission, only to return to hear the music again with Mengelberg on the podium and Mahler seated in ease on the main floor, listening to a likeness of himself. Frau Mahler later reported that on her husband's return to Vienna he told her that Mengelberg had grasped his meaning so perfectly that it was just as if he had been conducting himself.

In his letters home Mahler had written, "The orchestra plays . . . so cleanly that I'm enchanted." He found the performance "magnificent" and the audience response impressive. "At first they were a little puzzled, but with each movement they grew warmer. . . . When the last note died away the tumult of applause was almost daunting. Everyone said nothing like it could be remembered. I have beaten [Richard] Strauss, who is all the rage here, by yards."

Mahler left the city after two more triumphs, thinking that he might "find in Amsterdam the musical home for which [he had] hoped in that stupid Cologne." In fact, in the years remaining to him he was to have only limited

contact with the Dutch capital. His music was always popular in Holland, however, and in 1920 Mengelberg chose to mark his twenty-fifth season as director of the Concertgebouw by offering one of the first major festivals of Mahler's works.

The recordings considered here grow directly from this tradition. The first, taken during a performance of the 1939-40 season, gives us the Fourth as Mengelberg played it in his later years. The second presents the Concertgebouw of today in a splendid re-creation of the score under Georg Solti. From the point of view of sonics, there is no comparison at all between the two editions. Issued on L.P. as part of the Philips *Documenta*

Musicae series, the Mengelberg must be taken, with its faults in balance and limitations of frequency response and dynamics, as source material for history. It is actually no better or worse than average for its day, but when contrasted with the Solti its limitations are exaggerated by the fact that the new set is one of the finest representations of orchestral sound in the present catalogue.

Mengelberg was conductor of the Concertgebouw for fifty years, and even today, with more than fifteen seasons past since he left the orchestra, he remains the greatest single artistic influence in its history. Naturally, in the course of half a century, his interests changed, becoming concentrated more and more on orchestral color and nuance at the expense of rhythmic continuity and a unified presentation of the musical content. The statement of the Fourth preserved here is not, I think, very similar to that of thirty-five years earlier which Mahler admired so greatly. I am sure that the performance of 1904 must have had a firmer and more regular pulse and better-scaled climaxes. The Mengelberg version now given us will obviously arouse discussion and a strong difference of opinion between those who find it insufferably mannered and those who insist that it is unsurpassed in capturing the poetry of the score. For myself, in spite of all the lovely shadings and phrasings this performance presents, it is just plain too slow-moving and fussy. I start out being sympathetic and end by being irritated. Still, the recording is a unique document, preserving an interpretative approach that has virtually disappeared. Now available from some import shops, its expected release on the Epic label is much to be welcomed.

With each rehearing, I am more and more delighted by the new Concertgebouw version. Solti too is sensitive to coloring and phrasing, but he is also aware of the need for preserving the plastic integrity of a phrase and the forward thrust of a rhythmic pattern. This is a performance that moves, builds, soars, and yet retains the chuckle of rustic humor and the ability to beguile. Indeed if its principal asset over the excellent Reiner version were given in a word, that word would have to be *gemütlich*. And a special note should be made of the use of Sylvia Stahlman's voice in the finale, a clear high soprano ideally suited to the childlike simplicity of the text.

Since I have recently heard the Concertgebouw on tour, I shall not say that its performance here sounds just like the orchestra. It sounds better, as if produced under ideal conditions.

MAHLER: *Symphony No. 4, in G*

Jo Vincent, soprano; Amsterdam Concertgebouw Orchestra, Willem Mengelberg, cond.

• PHILIPS W 09911 L. LP.

Sylvia Stahlman, soprano; Amsterdam Concertgebouw Orchestra, Georg Solti, cond.

• LONDON CM 9286. LP. \$4.98.

• LONDON CS 62.7. SD. \$5.98.



Glenn Gould: "Primarily a contrapuntalist. . . ."

Brahms Intermezzos, Strictly Chosen

by Harris Goldsmith

A NEW RECORDING by the redoubtable Glenn Gould is bound to be, at the very least, stimulating. Perhaps the most controversial performer of his generation, this brilliantly gifted artist has always demonstrated musical independence as well as digital independence: a Gould rendition is always clearly articulated and, clearly, articulate. The pianist is, and probably always will be, a student—in the sense that he has a seemingly inexhaustible bent for research and discovery: he always sheds light on the music he plays, even though he is apt to disregard the cumulative light shed on the music by generations of past performers.

The release of ten intermezzos from the literature of Brahms affords one the opportunity of hearing the Gould operation in a realm he has hitherto ignored. As one might expect from a severely patrician musical personality, Gould has chosen these pieces scrupulously, with a determined avoidance of the more bombastic ones. It is clear that Gould has little use for the conventional Brahmsian rhetoric (a point of view with which I have great sympathy), but that he finds much to admire in the composer's more intimate, later writing. Primarily a contrapuntalist who favors line rather than mass, economy more than luxury, Gould never uses color for general effect, but only to clarify and separate the musical weave of lines. Then, he orchestrates—not in the usual sense of mimicking specific instrumental timbres on the piano but, rather, in the interests of musical verity.

The Op. 117 trilogy (the only opus given in its entirety here) receives a most impressive performance, with a highly dramatic account of the opening E flat major Intermezzo. Perhaps Gould misses some of the work's genial repose, but I suppose it is hard for this pianist to subdue his sharp-edged, probing intellectual curiosity. The popular B flat minor, however, is a complete success. How poignant and mobile it sounds under his undulant ministrations. As for the C sharp minor, perhaps it is sufficient to say that it is faster, more impetuous, and less detached than in the celebrated Gieseeking interpretation.

I am less happy with the performance of the E major Intermezzo, Op. 116, No. 4. It seems to me that Gould has here set for himself a tempo that doesn't quite work. True, the indication is Adagio, but I feel that this beautifully moving piece (my own favorite of the whole set) needs to flow with greater simplicity than it does in this rendition. The triplet figurations sound rushed and overintense, as Gould plays them; indeed, he seems to be at odds with himself, failing to convey the impression of a unified pulse throughout the whole Intermezzo. Another miscalculation, it seems to me, is the avoidance of repeats in the very brief Op. 118, No. 1. Without them, the result is flimsy and insubstantial. Perhaps Gould was striving for the kind of fleeting effect Beethoven achieves in the scherzo of his Op. 130 string quartet, but if so, I feel that he has not succeeded.

The highlights of this recording are,

to my mind, the shimmering nostalgia Gould conveys in the Op. 119, No. 1 (which, as David Johnson points out in his notes, bears striking resemblance to the Adagio of the great B minor Clarinet Quintet written the year before) and the two examples from Op. 76. Gould has reversed the order of these, placing No. 6 after No. 7, presumably so that the former's cheerful exuberance may contrast with the quiet sadness of the A minor (that piece being a fond remembrance of Chopin's F minor Nocturne). Gould's sparkle in the No. 6 and his

grave simplicity in the No. 7 really touch the heart.

Throughout the collection, there is an emphasis on the cantabile, vocal-duet quality of Brahms's writing. These performances, to be sure, savor the harmonic fundamentals of German romantic music, but the basic framework is much more elastic than is usually the case. Certainly, this is a recording one will want to return to again and again.

The album cover shows Mr. Gould, looking very serene and handsome, seated in an elegant library. He is not

as one might have anticipated, smoking a fat Brahmsian cigar! The recorded sound is very vivid and atmospheric.

BRAHMS: *Intermezzos* (10)

Op. 76: No. 6, in A; No. 7, in A minor, Op. 116: No. 4, in E, Op. 117: No. 1, in E flat; No. 2, in B flat minor; No. 3, in C sharp minor, Op. 118: No. 1, in A minor; No. 2, in A; No. 6, in E flat minor, Op. 119: No. 1, in B minor.

Glenn Gould, piano.

- COLUMBIA ML 5637, LP, \$4.98.
- • COLUMBIA MS 6237, SD, \$5.98.

CLASSICAL

BACH: *Chromatic Fantasy and Fugue, in D, S. 903; Italian Concerto, in F, S. 971; Toccata in D, S. 912; French Suite No. 5, in G, S. 816*

George Malcolm, harpsichord.

- LONDON CM 9266, LP, \$4.98.
- • LONDON CS 6197, SD, \$5.98.

The Suite seems to me the high spot of this little Bach recital. Malcolm conveys the lyrical quality of the Allemande, he intimates in the flowing Sarabande that it was once a dance, and he makes the Gigue skip gaily along. There are good things in the other pieces too, along with one or two procedures that seem questionable. Thus, the first movement of the *Italian Concerto* has an orchestral breadth, and the finale is jolly, but why does Malcolm change registration in the middle of the Andante? If this were a violin piece, as it could easily be, Bach would not suddenly demand a mute in the course of it. The Chromatic Fantasy too has changes of registration that I do not find motivated or justified by the music. The Toccata is first-rate for its last two thirds, but the Allegro seems rather mechanical rhythmically. The sound is excellent. N.B.

BACH: *Italian Concerto, in F, S. 971; Partita in B minor, S. 831*

Ralph Kirkpatrick, harpsichord.

- ARCHIVE ARC 3155, LP, \$5.98.
- • ARCHIVE ARC 73155, SD, \$6.98.

In 1735 Bach published the Second Part of his *Clavier-Uebung*, "consisting of a Concerto in the Italian taste and an Overture in a French style," for a harpsichord with two manuals. The *Italian Concerto* and the *French Overture* (also known as the B minor Partita) are presented here in splendid performances. I have never heard the slow movement of the former more persuasively done: the long melody is sung out on one manual, with a quasi-pizzicato accompaniment on the other. Only the rather noisy finish raises a question in this work. In the Overture of the Partita, Kirkpatrick provides an object lesson in the double dotting of a highly ornamented slow section, while the Allegro has a grace not often

heard in Bach playing. Each of the other movements is made into a genre piece. In all of them one must admire the ease and naturalness of the embellishments, the plausibility of the tempo, and the vitality of the rhythm. Excellent sound in both versions. N.B.

BARBER: *Second Essay for Orchestra; Music for a Scene from Shelley; A Stop Watch and an Ordinance Map; A Hand of Bridge; Serenade for Strings*

Patricia Neway, soprano; Eunice Alberts, mezzo; William Lewis, tenor; Philip Maero, baritone; Robert de Cormier Chorale; Symphony of the Air, Vladimir Golschmann, cond.

- VANGUARD VRS 1065, LP, \$4.98.
- • VANGUARD VSD 2083, SD, \$5.98.

By far the best thing here is *Music for a Scene from Shelley*, a short orchestral piece of great intensity and fineness, beautifully played and nicely recorded. The famous *Second Essay* is also a first-class work and its performance is not bad, but the recording is poor. The choral piece entitled *A Stop Watch and an Ordinance Map* and the *Serenade for Strings* (Barber's Opus 1) are not of sufficient stature or importance to arouse much interest or comment, one way or another. *A Hand of Bridge* is a short chamber opera with text by Gian-Carlo Menotti. The music, too, sounds as if Menotti had written it—which in my opinion means sleazy and slovenly. A.F.

BARTOK: *Concerto for Orchestra; Dance Suite*

Amsterdam Concertgebouw Orchestra, Bernard Haitink, cond.

- EPIC LC 3772, LP, \$4.98.
- • EPIC BC 1129, SD, \$5.98.

The twelfth recorded version of the Concerto for Orchestra and the sixth Dance Suite to be listed in current catalogues—and one of the very finest of both. Haitink makes an excellent case for himself here, and the recording in both cases is first-class. A.F.

BEETHOVEN: *Sonatas for Piano: No. 12, in A flat, Op. 26; No. 23, in F minor, Op. 57 ("Appassionata")*

Sviatoslav Richter, piano.

- RCA VICTOR LM 2545, LP, \$4.98.
- • RCA VICTOR LSC 2445, SD, \$5.98.

BEETHOVEN: *Sonatas for Piano: No. 8, in C minor, Op. 13 ("Pathétique"); No. 14, in C sharp minor, Op. 27, No. 2 ("Moonlight"); No. 23, in F minor, Op. 57 ("Appassionata")*

Wilhelm Kempff, piano.

- DEUTSCHE GRAMMOPHON LPM 19227, LP, \$5.98.
- • DEUTSCHE GRAMMOPHON SLPM 136227, SD, \$6.98.

None of these four records seems likely to win any prizes for engineering. The margin between the stereo and the monophonic versions is slight, and the sound, though not unpleasant, is characteristic of several years ago.

Richter's recording of the *Appassionata* is a rather pale copy of the impression this pianist gives in the concert room, and the exaggerations in the final movement become more pronounced when you are not distracted by the sheer presence of the performer. On purely musical terms my verdict after a couple of comparative hearings goes to Kempff, who is quite exciting enough and a good deal closer to my idea of Beethoven's intentions. There is more justification in buying the Richter disc for the Op. 26 sonata, which he projects with much greater serenity and impact than the Op. 57, once you adjust yourself to his tendency to play all Beethoven in the style normally associated with the composer's middle period.

Richter apparently is a very difficult artist to record. His tone, in particular, seems to alter when reproduced by the microphone. (Columbia's *Pictures at an Exhibition* is among the few Richter productions to ring true.) The Kempff collection is premium-priced, but it provides mature and disciplined performances by a distinguished representative of the German school. R.C.M.

BEETHOVEN: *Symphonies: No. 1, in C, Op. 21; No. 8, in F, Op. 93*

Vienna Philharmonic Orchestra, Pierre Monteux, cond.

- RCA VICTOR LM 2491, LP, \$4.98.
- • RCA VICTOR LSC 2491, SD, \$5.98.

You would never guess from this performance that the conductor has eighty-

six birthdays behind him. Quite the contrary, what pours forth from the record is youth triumphant, and radiant in its joy.

The engineering here is extremely good and gives us the full zest of a Viennese orchestra respecting French standards of ensemble coloring. The weight of tone we associate with the German tradition is here, but also Parisian elegance. Montoux is unfailingly skillful, although it is in the middle movements that he rises to the greatest heights. For me, this is the preferred version of both these scores, particularly in stereo where there is no longer any really competitive edition.

R.C.M.

BEETHOVEN: *Trio for Piano and Strings, No. 7, in B flat, Op. 97 ("Archduke")*

†Haydn: *Trio for Piano and Strings, No. 4, in E*

Trio di Trieste.

• DEUTSCHE GRAMMOPHON LPM 19220. LP. \$5.98.
• • DEUTSCHE GRAMMOPHON SLPM. 136220. SD. \$6.98.

You cannot object to any lack of polish here, but you may protest a lack of ginger. Both these performances are intelligently conceived and have been rehearsed to the point of ultimate genteel refinement. I admire the result for its impeccable surface, but a good deal of the communicative impact of the music seems to have disappeared along with the rough bowings. This disc provides a better buy than our only other stereo *Archduke*, however, and if you want the work in two-channel form, the choice is made.

DGG's engineering is, as always, marked by discreet aesthetic distance, and here, both in mono and stereo, the high gloss is retained.

R.C.M.

BIZET: *Jeux d'enfants*—Sec Ibert: *Divertissement*.

BRAHMS: *Intermezzos (10)*

Op. 76: No. 6, in A; No. 7, in A minor. Op. 116: No. 4, in E. Op. 117: No. 1, in E flat; No. 2, in B flat minor; No. 3, in C sharp minor. Op. 118: No. 1, in A minor; No. 2, in A; No. 6, in E flat minor. Op. 119: No. 1, in B minor.

Glenn Gould, piano.

• COLUMBIA ML 5637. LP. \$4.98.
• • COLUMBIA MS 6237. SD. \$5.98.

For a feature review of this recording, see page 48.

CHOPIN: *Les Sylphides* (trans. Jacob)

†Ponchielli: *La Gioconda: Dance of the Hours*

†Meyerbeer: *Les Patineurs: Ballet Suite* (arr. Lambert)

Philharmonia Orchestra, Charles Mackerras, cond.

• ANGEL 35833. LP. \$4.98.
• • ANGEL S 35833. SD. \$5.98.

The best portions of this disc devoted to light, popular ballet music are *Les Sylphides* and the *Dance of the Hours*,

both accorded sensitive, idiomatic readings by Mackerras. Somewhat less satisfactory is *Les Patineurs*, only five movements of which are included, and these often in a slow, heavy-handed fashion. The recorded sound is good in mono, but takes on greater spaciousness and depth in stereo.

P.A.

CHOPIN: *Waltzes (complete)*

Alexander Brailowsky, piano.

• COLUMBIA ML 5628. LP. \$4.98.
• • COLUMBIA MS 6228. SD. \$5.98.

This is one of Brailowsky's best recordings and should please admirers of his pianism. I am afraid, however, that I cannot number myself in their camp. The pianist has, it seems to me, little or no sense of continuity beyond that of a single measure. Even when the music plainly indicates a continuous filigree linking several bars together, he fragments the line, and disrupts the forward flow of the pieces with awkward stop-go rubato mannerisms. And while Brailowsky's interpretations are metronomical, they are not at all accurate rhythmically. Rests are not counted out with any sort of detail, many measures are foreshortened, and the total effect is one of basic unsteadiness, even choppiness.

Let it be said for the artist that he does observe Chopin's tempo markings at all times: the posthumous D flat Waltz is *moderato*, and No. 3 is played at the indicated *lento*, for example. It should also be noted that Brailowsky's tone quality in the quieter pieces is much improved over that displayed in his recent set of the Preludes. But the interpretative

perversities in his playing on this disc forbid my accepting it without forsaking my loyalty to Chopin's music.

H.G.

COUPERIN: *Concerts royaux: No. 3; No. 4*

New York Chamber Soloists.

• DECCA DL 10035. LP. \$4.98.
• • DECCA DL 710035. SD. \$5.98.

The *Concerts royaux* are chamber suites written for the entertainment of the aged Louis XIV at Versailles. Each begins with a prelude and continues with various types of dances. Some of the movements—the Sarabande of No. 3, the Prelude of No. 4—have considerable expressive power. Others, like the Chaconne of No. 3 and the Rigaudon of No. 4, are delightful character pieces. All are highly embellished but strongly constructed music of noble mien and, in this performance, rich investiture.

Couperin published them in a form playable by a single harpsichord or by other instruments, and he says that he and four others performed them for the King. Albert Fuller, the harpsichordist and editor of the version used here, has taken advantage of the freedom implied by the composer's remarks to vary the instrumentation considerably. In the two-part dances, each part may be played first by the harpsichord alone, or a flute or oboe with continuo, and on its repetition by a larger group. This constant change of color, coupled with rhythmic vivacity and expert playing by each performer, adds up to a highly enjoyable performance. The sound is a little close up but not disturbingly so, and the balance is good.

N.B.

D'ALAYRAC: *Quartets for Strings: in D, Op. 7, No. 3; in E flat, Op. 1, No. 5*—See Vachon: *Quartets for Strings, Op. 11: No. 1, in A; No. 5, in F minor*.

DVORAK: *Serenades: for Strings, in E, Op. 22; for Winds, in D minor, Op. 44*

Prague Soloists' Orchestra, Václav Talich, cond. (in Serenade for Strings); Chamber Ensemble of the Prague Conservatoire (in Serenade for Winds).

• SUPRAPHON LPV 410. LP. \$5.98.

Some of Dvořák's most infectious music, the two Serenades, are not done complete justice here. Although the Serenade for Strings is exceptionally sunny, Talich (who can usually be relied upon for authoritative, communicative Dvořák interpretations) treats it rather darkly, and the string playing is not always as highly polished as the music requires. The more dramatic Serenade for Winds fares somewhat better in the careful hands and lips of the Chamber Ensemble of the Prague Conservatoire. The recorded sound, while satisfactory, could have been somewhat brighter than the engineers have given us here.

A better version of the Serenade for Strings is that by Kubelik and the Israel Philharmonic, available on London in both mono and stereo. The Wind Serenade is also to be had in good mono and stereo editions by Eric Simon and the Boston Woodwind Ensemble (Boston).

P.A.

NEXT MONTH IN

high fidelity

The Bach Renaissance

Today, the work of the Leipzig cantor is at last receiving its due.

by Paul Henry Lang

Inside the Tube

The key to your system's performance is contained in a small glass envelope.

by Ralph Freas

A Hot Time in San Remo

A new brand of aria is heard in the land of opera.

by Elisé Radant

and

A Special Preview of Fall Recordings

FAURE: *Piano Works*

Barcarolles: in G flat, Op. 42, No. 3; in D flat, Op. 97, No. 9. Impromptus (complete). Nocturne, in A flat, Op. 33, No. 3. Neuf Préludes, Op. 103. Huit Pièces brèves, Op. 84. Valse-Caprice, in A, Op. 30, No. 1.

Grant Johannesen, piano.

• GOLDEN CREST CR 4030. Two LP. \$9.96.

At one time there were several discs of Fauré's music around (none of them wholly satisfactory), but in recent years the American catalogue has been devoid of even a single example of his piano solo output. The omission has always struck me as being totally incomprehensible, since this lovely literature is completely romantic and accessible.

The present two-record album is Vol. 1 in a projected recording of Fauré's complete piano music. Johannesen is an ideal artist for the task: he has always shown a marked affinity for the French romantic idiom, and the present pair of discs show him in top form. An excellent technician and a splendidly forthright musical thinker, he gives the pieces an impassioned utterance, without any superficiality or mannerisms. He captures to perfection the poignancy of the impressionistic Preludes, written in 1910, and his broad virtuosity is just what the early *Valse-Caprice* needs. (Its *burlesca* rhetoric is splendidly realized). Furthermore, there is real nuance in Johannesen's tone: filigree or repeated notes always sing forth melodiously and never sound brittle. The exciting delivery of the *Impromptus*, especially No. 2 with its swirling tarantella figurations, exceeds my previous experiences with the music.

The resonant recorded sound is a further merit of what amounts to a definitive edition of this much needed music. In fact, the only quibble I have concerns the distribution of the material. Wouldn't it have been preferable to issue the *Barcarolles*, *Nocturnes*, and *Valse-Caprices* in integral sequence instead of scattering them throughout this volume and the next one? But this is just a small point, and I eagerly await the next album. H.G.

HANDEL: *Concertos: for Lute, Harp, and Orchestra, in B flat, Op. 4, No. 6; for Harp and Orchestra, in F, Op. 4, No. 5. Concerto grosso in C ("Alexander's Feast")*

Desmond Dupré, lute; Osian Ellis, harp; Philomusica of London, Granville Jones, cond.

• OISEAU-LYRE OL 50181. LP. \$4.98.
• OISEAU-LYRE SOL 60013. SD. \$5.98.

The six concertos of Op. 4 were published in London in Handel's time as for either organ or harpsichord and orchestra, with the exception of No. 6, for which the harp was also named as solo instrument. Now the British musicologist Thurston Dart claims that No. 6 was written for harp and lute with orchestra, and that the lute part has been lost. He also says that No. 5 "seems to have been designed for the harp." The present version of No. 6 includes a lute part reconstructed by Mr. Dart. This is a delicate and airy performance, and has the advantage of recorders instead of flutes in the orchestra, but it seems to me that



Grant Johannesen.

the version for harp only and orchestra (also available on records) sounds more effective. On the other hand, the harp as solo instrument for No. 5 seems to suit the music less well than an organ or a harpsichord. The *Concerto grosso* is performed with vivacity, and the sound throughout is fine. N.B.

HARRIS: *Folk Song Symphony*

American Festival Chorus and Orchestra, Vladimir Golschmann, cond.

• VANGUARD VRS 1064. LP. \$4.98.
• VANGUARD VSD 2082. SD. \$5.98.

Of all the symphonies of Harris, this is probably the least effective. It sounds as if it had been written to confirm Constant Lambert's famous crack: "All you can really do with a folk tune, once you have played it, is play it over again louder." In other words, the composer relies far too much on the charm of his raw material and really does very little with it. Furthermore, the performance here is stodgy, the sound only fair. A.F.

HAYDN: *Trio for Piano and Strings, No. 4, in E—See Beethoven: *Trio for Piano and Strings, No. 7, in B flat.**

HINDEMITH: *Three Sonatas for Organ*

E. Power Biggs.

• COLUMBIA ML 5634. LP. \$4.98.
• COLUMBIA MS 6234. SD. \$5.98.

According to Biggs's notes, these three sonatas and one concerto, the whole filling fewer than eighty pages, constitute Hindemith's entire output for the organ. Small as it may be, this composer's contribution to organ literature is of the first importance, and it is superbly represented on this disc. The sonatas are all, in their way, tributes to the memory of Bach, and the third of them makes use of folk tunes of a religious kind much as Bach himself used chorales. But this is not music about other music; Hindemith is too direct and original a composer for that. The recording brings the baroque organ of the Busch-Reisinger Museum at Harvard right into your living room. Columbia claims that Biggs has made more records than any other organist in the world, and each one is better than the last. A.F.

IBERT: *Divertissement*

†Saint-Saëns: *Danse macabre, Op. 40;*

Re Rouet d'Omphale, Op. 31

†Bizet: *Jeux d'enfants*

Orchestre de la Société des Concerts du Conservatoire de Paris, Jean Martinon, cond.

• LONDON CM 9269. LP. \$4.98.
• LONDON CS 6200. SD. \$5.98.

Here is French music of fun and fantasy. Of particular interest is the satirical Ibert *Divertissement*, a suite of incidental music that pokes fun at Mendelssohn's *Wedding March*, Strauss's *Blue Danube Waltz*, and the Offenbachian galop. As far as I can recall, all previous recordings of this work utilized a large orchestra; this one employs the orchestra of chamber proportions for which the music was originally intended. Without overdoing matters, Martinon and the musicians perform it with a real sense of humor. Bizet's little suite of *Children's Games* is also delivered with appropriate lightness of touch, while the two Saint-Saëns symphonic poems are colorfully and convincingly set forth. The stereo reproduction has a gratifying amount of liveness and instrumental distribution. P.A.

JANACEK: *Cunning Little Vixen*

Hana Bohmova (s), Bystroushka; Libuse Domaninska (ms), The Fox; Ludmila Hanzalikova (ms), Lapak; Antonin Votava (t), The School Master; Jiri Joran (b), Harashta; Rudolf Asmus (bs), The Forester; Vaclav Halir (bs), The Parson and The Badger; et al. Chorus and Orchestra of the Prague National Theatre, Vaclav Neumann, conductor.

• ARTIA ALPO 88 B/L. Two LP. \$9.96.

While I find myself still untouched emotionally by the power so many listeners find in Janáček's *Jenufa* and *Katya Kabanova*, I have to capitulate when it comes to *Cunning Little Vixen*. Few operas put a complete mastery of musical materials to such use in the simplest, most direct kind of utterance. All of the composer's immense skill in orchestration and thematic variation goes to the creation of an idiom at once economical and rich.

The libretto for *Cunning Little Vixen* is an adaptation of episodes from a series of stories by Rudolf Tesnohlidek which ran in a Czech newspaper—it is almost as if an American composer were to set selected *Pogo* strips. The opera recounts the life history of the little vixen, Bystroushka. As a baby fox, she is caught and taken home by the Forester. But she proves intractable, fomenting revolt among the hens, then killing them off; in the chaos, she bites through her rope and escapes to the forest. Here, she cheats the Badger out of his den, creates disturbances to embarrass human interlopers, eludes the Forester, finds a mate and raises a large family, but finally pushes her luck too far and is killed by Harashta. The Forester, out tramping one day as he had been when he caught the vixen, finds himself overwhelmed by love of the forest and nostalgia for his younger days; as he dozes, all the animals appear before him. He realizes that Bystroushka is missing, but he joyfully recognizes her image in the face of another little vixen—her daughter.

It is clear that Janáček intended his forest and village as a microcosm of the world and its cycles of life. The opera is a description of the way things are (or were, anyway), and a plea to leave them untampered-with (Harashta, who inter-

feres, is a poacher). The score glows with the sounds of the forest and its inhabitants, all presented with the greatest affection and precision. Even the human characters who are satirically drawn—the Parson and the School Master—are treated with a gentle warmth. The only miscalculation, it seems to me, is in the chorus of wedding celebration for Bystroushka and the Fox that is used to provide a finale for Act II—it is overblown, trite, and unnecessary. Otherwise, not a false note.

The performance can for all practical purposes be regarded as definitive. The Prague orchestra does not have the plush horns or the velvety strings of the great Western ensembles, but this is simply a matter of taste in orchestral texture; it is a first-rate organization, and Neumann

has fitted everything into place with wonderful naturalness. Rudolf Asmus uses his fine light bass to create a lasting impression of the Forester's character, and Hana Bohmova paints her vixen with strokes that are delicate but firm. The remaining cast members are perfectly suited to their parts, with particularly important contributions coming from Antonin Votava as the School Master, Vaclav Halir as the Parson (and the Badger, who bears a "strange resemblance" to the Parson), Libuse Domaninska as the Fox, and Jiri Joran as Harashta. The monophonic sound (no stereo version) is excellent, and the complete Czech libretto is given a clear translation by Marie Winn. All in all, there is little to complain of, much to delight in. C.L.O.

LOCATELLI: *Concertos for Violin and Orchestra, Op. 3* ("L'Arte del violino"): No. 1, in D; No. 4, in E

Susanne Lautenbacher, violin; Mainz Chamber Orchestra, Günter Kehr, cond.
 • Vox DL 500. LP. \$4.98.
 • • Vox STDL 500500. SD. \$4.98.

When credits are handed out for the development of violin technique and the solo violin concerto, the name of the Italian violinist and composer Pietro Locatelli (1695–1764) is often overlooked. Yet his *Art of the Violin*, published in Amsterdam in 1733, is a most important technical and artistic legacy, comprising twelve concertos for violin and strings, together with twenty-four caprices for solo violin. A caprice is inserted into the end movements of each concerto, serving as a very extended cadenza, as well as a practical exposition of the instrument's technical capabilities—runs, leaps, double-stops, arpeggios, and so on. After listening to a few of these caprices, one is not at all surprised to learn that they influenced directly the two dozen works in this form by Paganini.

The two concertos recorded here have tremendous vitality, imagination, and invention, with cadenza-caprices that bristle with difficulties. Susanne Lautenbacher, however, proves more than equal to the challenge. She plays both works in commanding style and with flawless technique and a big, firm, yet rather sweet tone. Vox's stereo reproduction is crystal-clear, setting the soloist nicely off against the expert string orchestra and cembalo and imparting direction and spaciousness to the sound. P.A.

MAHLER: *Symphony No. 4, in G*

Jo Vincent, soprano; Amsterdam Concertgebouw Orchestra, Willem Mengelberg, cond.
 • PHILIPS W 0991 L. LP.

Sylvia Stahlman, soprano; Amsterdam Concertgebouw Orchestra, Georg Solti, cond.
 • LONDON CM 9286. LP. \$4.98.
 • • LONDON CS 6217. SD. \$5.98.

For a feature review of these recordings, see page 47.

MENDELSSOHN: *Symphony No. 3, in A minor, Op. 56* ("Scotch"); *Scherzo, in G minor, Op. 20*

Boston Symphony Orchestra, Charles Munch, cond.
 • RCA VICTOR LM 2520. LP. \$4.98.
 • • RCA VICTOR LSC 2520. SD. \$5.98.

Highly polished orchestral performance fails to save Munch's strange interpretation of the *Scotch* Symphony. His treatment of the introduction to the first movement is most expressive, and he handles the Scherzo and the scherzo-like opening of the finale with appropriate lightness; but his tempos in the main section of the first movement and in the closing portion of the finale waver erratically from too slow to too fast. Mendelssohn's own orchestration of the Scherzo from his Octet in E flat is delivered with delicacy and precision, however.

The resonant acoustics of Boston's Symphony Hall afford spacious sonics in

GRADO "Truly the world's finest..."

AN IMPORTANT MESSAGE

We take extreme pride in introducing a new series of electro-dynamic, moving coil stereophonic phonograph cartridges which are destined to completely revolutionize stereo record reproduction.

From these cartridges you the audiophile will realize the softest, smoothest, most effortless sound you have ever heard.

The disastrous distortions due to overcut records, the harsh, strident, plastic resonant type stereo sounds are now a thing of the past.

These cartridges designated "THE CLASSIC SERIES" will track the most violently complex recorded passages put on records, whether they be on the inner or outer grooves.

Your records will assume a clarity of sound and lack of distortion beyond your wildest expectations. The complete lack of surface noise is almost eerie, the tremendous dynamic range and bass response will leave you breathless. The highs have an infinite quality that makes you suspect a somewhat lack of highs until they blossom forth with a smoothness that completely defies comparison. The superb transient separation is such that a dimensional quality is achieved even with solo recordings.

For a most rewarding experience, listen to the truest of all sound the . . .

GRADO CLASSIC SERIES STEREO CARTRIDGE audiophile net \$37.50

CLASSIC LABORATORY SERIES CARTRIDGE audiophile net \$49.50

LABORATORY SERIES TONE ARM \$39.50

For further information write: **GRADO LABORATORIES, INC.**
 4614 Seventh Ave., Brooklyn 20, N. Y. • Export—Simonrice, 25 Warren St., N. Y. C.

CIRCLE 34 ON READER-SERVICE CARD

both mono and stereo, with the latter offering a wider lateral spread and a moderate amount of separation. The best extant version of the *Scotch* Symphony remains that by Peter Maag on London. P.A.

MEYERBEER: *Les Patineurs: Ballet Suite* (arr. Lambert)—See Chopin: *Les Sylphides* (trans. Jacob).

MOZART: *Concerto for Clarinet and Orchestra, in A, K. 622; Quintet for Clarinet and Strings, in A, K. 581*

Jost Michaels, clarinet; Endres Quartet; Westphalian Symphony Orchestra, Hubert Reichert, cond.
 • Vox PL 11110. LP. \$4.98.
 • • Vox STPL 51110. SD. \$4.98.

Mr. Michaels, an artist not further identified by Vox, is, to judge by these performances, a master of his instrument. He phrases musically, his runs are smooth as velvet, and his tone in the upper register does not become fluty, as with some players, but stays reedy. The wonderful Quintet is beautifully performed here. Especially effective, to mention only one of the felicities of this reading, is the true *piano* achieved by all the players when the main section of the slow movement returns. This, it seems to me, is the best of the three stereo versions of the Quintet. Two thirds of the Concerto is excellent, too, but the finale is a little too *gemütlich* for my taste and the orchestra is not the most precise or the most polished imaginable. The recent recording of this work by Gervase de Peyer with the London Symphony Orchestra (London CS 6178) seems to me superior. N.B.

MOZART: *Concerto for Piano and Orchestra, No. 13, in C, K. 415; Sonata for Piano, in F, K. 280; Variations on "Ab vous dirai-je, Maman," K. 265*

Clara Haskil, piano; Festival Strings Lucerne, Rudolf Baumgartner, cond.
 • DEUTSCHE GRAMMOPHON LPM 18670. LP. \$5.98.
 • • DEUTSCHE GRAMMOPHON SLPM 138670. SD. \$6.98.

The Concerto performance is another endearing memento of the gentle and poetic artistry of the late Clara Haskil. This is one of the smaller concertos, in every way, and neither soloist nor conductor tries to inflate it. The former sings away in all three movements, giving full value to the moment of pathos in the first Allegro and to the plaintive Adagio interpolations in the finale. As for the conductor, he chooses an option offered by Mozart and uses only strings; the work sounds none the worse for it. This is a more musical and more attention-holding performance than its only rival now in the domestic catalogues, a Vox disc with Ingrid Haebler as pianist.

In the solo works Miss Haskil again does many admirable things. The sixth variation of K. 265, for instance, is a marvelous display of perfect evenness in rapid runs in either hand, and throughout both works there are numerous felicities of phrasing and differentiation in tone weight. The only criticism I have here,

aside from the common error of beginning all trills on the main note, is a tendency on the part of the pianist to ignore dynamic contrasts and certain special effects, such as the arpeggiation of chords, indicated by Mozart. The sound is excellent in both versions. N.B.

MOZART: *Don Giovanni* (excerpts)

Sena Jurinac (s), Donna Anna; Maria Stader (s), Donna Elvira; Irmgard Seefried (s), Zerlina; Ernst Häfliger (t), Don Ottavio; Dietrich Fischer-Dieskau (b), Don Giovanni; Karl Kohn (bs), Leporello; Walter Kreppel (bs), Commendatore. Radio Symphony Orchestra of Berlin. Ferenc Fricsay, cond.

• DEUTSCHE GRAMMOPHON LPM 19224. LP. \$5.98.

• • DEUTSCHE GRAMMOPHON SLPM 136224. SD. \$6.98.

The complete performance, reviewed here in January 1960, is one of the two or three best available on records, despite a few weaknesses. This sampling offers the overture, some of the arias and duets, the quartet from Act I, and excerpts from the two finales. Each member of the cast is represented except Masetto, and the numbers chosen show the singers at their best in this recording—with one exception: Miss Jurinac's "*Or sai ch' l'onore*" (given here) is not as well done as her "*Non mi dir*" (absent). But the

LISTEN...



there's more
to the
Amperex 12AX7/ECC83

than meets the eye!

- Contact potential 0.8v Max. for lower distortion in input stage
- Tongue-mica clamp on cathode for major reduction in microphonics
- Double helical tungsten filament for less hum and greater reliability
- Cleaner cathode to eliminate spurious noise
- Production virtually 100% automated for unrivalled tube uniformity

Introduced by Amperex in 1955, the 12AX7/ECC83 easily outperformed all competing tubes of its type. Amperex continued development, made further improvements and refinements. The result is good news for the designer. For, in its present Amperex version, the 12AX7/ECC83 is a rugged, super-uniform twin-triode, purged, for all practical purposes of hum and microphonics and available at fully competitive prices.

Applications engineering assistance and detailed data are always available to equipment manufacturers. Write: Amperex Electronic Corporation, Special Purpose Tube Division, 230 Duffy Avenue, Hicksville, Long Island, New York.

Other Amperex Tubes for Quality High-Fidelity Audio Applications:

POWER AMPLIFIERS

- 6CA7/EL34: 60 w. distr. load
- 7189: 20 w., push-pull
- 6BQ5/EL84: 17 w., push-pull
- 6CW5/EL86: 25 w., high current, low voltage
- 6BM8/ECL82: Triode-pentode, 8 w., push-pull

VOLTAGE AMPLIFIERS

- 6267/EF86: Pentode for pre-amps
- 12AT7/ECC81 } Twin Triodes, low
- 12AU7/ECC82 } hum, noise and
- 12AX7/ECC83 } microphonics
- 6BL8/ECF80: High gain, triode-pentode, low hum, noise and microphonics

RECTIFIERS

- 6V4/EZ80: Indirectly heated, 90 mA
- 6CA4/EZ81: Indirectly heated, 150 mA
- 5AR4/GZ34: Indirectly heated, 250 mA



ask Amperex

about hi-fi tubes
for hi-fi circuitry

CIRCLE 4 ON READER-SERVICE CARD

big question the disc raises is how anyone could be satisfied with merely one third of *Don Giovanni*. N.B.

MOZART: *Mass No. 19, in D minor, K. 626 ("Requiem")*

Werner Pech, soprano; Hans Breitschopf, contralto; Walther Ludwig, tenor; Harald Pröglhöf, bass; Vienna Hofmusik-kapelle, Josef Krips, cond.

• RICHMOND B 19077. LP. \$1.98.

This recording, originally released sometime in 1950, employs boy sopranos and altos as soloists and in the chorus. It is a perfectly decent performance on the part of all concerned, if you don't mind unchanged male voices in this music. There is occasionally some surface noise,

and the violin tone is streaked, but the choral balance is good and instrumental balances seem even a little better than in the original. Not one of the shining, glamorous productions, but good value for the money. N.B.

PONCHIELLI: *La Gioconda: Dance of the Hours*—See Chopin: *Les Sylphides* (trans. Jacob)

PUCCHINI: *Madama Butterfly* (highlights in English)

Marie Collier (s), *Butterfly*; Ann Robson (ms), Suzuki; Charles Craig (t), Pinkerton; Gwyn Griffiths (b), Sharpless. Sadler's Wells Orchestra, Bryan Balkwill, cond.

• ANGEL 35902. LP. \$4.98.
• ANGEL S 35902. SD. \$5.98.

Each listener will have to decide for himself whether or not the English language is well suited to Puccini's music. The translation used here is the one copyrighted by Ricordi in 1907. While it makes stilted reading and certainly has its ridiculous moments in performance, it is a great deal more appropriate and singable than the majority of the colloquialized, vulgarized texts that have recently passed for "modern" translations or adaptations.

Considered simply as a version of *Butterfly* highlights, in competition with, say, the De los Angeles/Bjoerling disc, this record doesn't stand a chance. Marie Collier's voice is bright and attractive, but very limited in color and frequently bothered by a not-fast-enough vibrato. Craig has good equipment and sings smoothly, but his method of production is of the covered sort so common among English singers, and the result is a lack of the open Italian richness which should inform this music. Griffiths has an ordinary baritone voice with a strained top; he can, however, be understood most of the time, which puts him one up on his fellow cast members. Balkwill obtains some lovely effects in the quieter moments, but his conducting lacks urgency at the climaxes—he chastely foregoes the accelerandos which might lend the music some dramatic vibrancy. All in all, for a disc that is supposedly demonstrating the dramatic virtues of opera in the language of the audience, this is a strangely limp, passionless affair. The sound is good, and an accompanying booklet provides the English texts.

C.L.O.

PURCELL: *The Indian Queen*

Soloists; London Chamber Singers; London Chamber Orchestra, Anthony Bernard, cond.

• MUSIC GUILD M1. LP. \$4.12 to members; \$5.50 to nonmembers.

This "semi-opera," which seems to have been written in the last year of Purcell's life, contains some wonderful music. The play it was written for concerns Montezuma and the Indians of Peru, but Purcell made no attempt to achieve local color: the songs and choruses and instrumental pieces are as English as their composer. All of the music except for some purely instrumental pieces and sections is presented here. It includes a delightful duet between a soprano and a countertenor at the end of the Prologue; the song for bass "What flattering noise is this," with its original and effective touch when two other singers join the bass on the word "hiss"; a fine Trumpet Overture; another impressive number for bass, "Ye twice ten hundred deities"; a lovely song for soprano, "Seek not to know"; the celebrated and very beautiful "I attempt from Love's sickness to fly"; and a darkly expressive chorus, "All dismal sounds."

Bernard keeps things going at a lively pace, he deploys his instrumental forces imaginatively, and on one or two occasions applies unwritten dotted rhythms to good effect. All of the vocal soloists are satisfactory (since there are eight of them and their roles are not given, it is often difficult to know who sings what): the orchestra is first-rate—a special word

Now... assemble the finest:
A Professional Quality

CUSTOMIZED

TV KIT

ON EASY

"PAY AS YOU WIRE" TERMS*

- ☆ Designed for the perfectionist seeking maximum performance.
- ☆ Easy to assemble; no technical knowledge required.
- ☆ An ideal "Learning" Kit with a complete Course of Study is available.

Professional Quality Features

The Transvision "Professional" Model TV Kit (or Assembled Chassis) is designed to satisfy those video-and-audiophiles who seek the best possible performance of which the art is capable. Nevertheless, the kit builder can assemble this chassis for less than the cost of an ordinary receiver.

Note these unique features:

- Hi-Fi Audio (with 2 EL-84 output tubes, oversize audio output transformer, Woofer-Tweeter Speaker System with heavy magnets and crossover; Extended Range Tone Control).
- Ultra-linear sweep circuits; D.C. restoration; Standard Coil Guided Grid Turret Tuner with provisions for UHF and special low noise tubes; 4 megacycle picture bandwidth; 10 microvolt sensitivity.
- Heavy-duty power supply (power transformer, two low voltage rectifier tubes — no silicon rectifiers).

The TRANSVISION
"Professional"

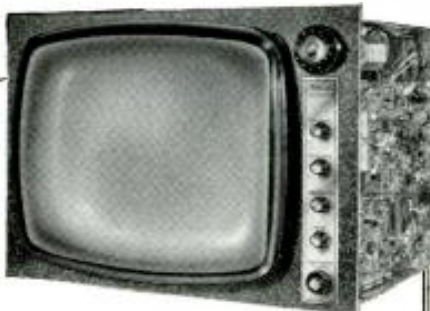

* Only \$15 for the Starting Package!

ALSO AVAILABLE AS AN
ASSEMBLED CHASSIS
for custom installations

- Heavy-duty ruggedized construction, no printed circuits; built to give trouble-free performance for many years.
- Includes newest reflection-free 23" tube with bonded face, or the 24" or 27" CRT.
- Selected because of superior performance for use in Educational TV by over 3000 schools and colleges and U.S. Armed Services.

Interested in Electronics?

Learn the basic principles of electronics from the Complete Course of Study which is available with the Kit.



As a preliminary, order the Assembly Instructions for only \$2.00; to be refunded if you purchase kit.

TRANSVISION

Pioneers in Television Kits

NEW ROCHELLE, N. Y.

• NEW ROCHELLE 6-6000

----- START NOW — MAIL THIS COUPON —-----

TRANSVISION, New Rochelle, N. Y.

Dept. HIY

- Send Free 8-page Catalog Enclosed is \$2. for Assembly Instructions so that I might see how easy it is to assemble the Transvision Kit. I understand that this will be refunded if I purchase a kit.
- Enclosed is \$15 for the Starting Package. I understand that I can buy packages one at a time as I wire. (Models range from \$119 to \$199.)

Name..... Address.....

City..... Zone..... State.....

CIRCLE 72 ON READER-SERVICE CARD

of praise is due the person responsible for the continuo realizations on the harpsichord; and the sound is excellent. N.B.

RACHMANINOFF: Concerto for Piano and Orchestra, No. 2, in C minor, Op. 18

Leonard Pennario, piano; Los Angeles Philharmonic, Erich Leinsdorf, cond.
 • CAPITOL P 8549. LP. \$4.98.
 • • CAPITOL SP 8549. SD. \$5.98.

While it is hard to define why this good, conventional reading fails to catch fire—it is expertly presented technically and accomplished musically—I would venture to guess that the weakness lies in the slight tendency, on both the soloist's and the conductor's part, to sectionalize the work. Basically, the present disc is a kinetic, fast-paced performance, but the "expressive" easing up for such sections as the third movement's second subject causes the edifice to go slack, fragmenting the reading as an entity. The Richter-Wislocki performance on Deutsche Grammophon (temporarily unavailable in this country, but due to return in imported pressings) is, to my mind, much the best of the modern versions, although Rachmaninoff's own ancient documentation is still unsurpassed interpretatively.

The monophonic recording gives a far crisper, more incisive and compact sound than does the stereo, to which some artificial reverberation seems to have been added. While the piano tone is sleek and rounded on that disc, the orchestral attacks are a bit coarse and muffled.

H.G.

RAVEL: Piano Music (complete)

Vlado Perlemuter, piano.
 • Vox VBX 410. Three LP. \$7.95.

Of the three available "complete" editions of Ravel's piano music, each contains slightly different material: Casadesus's Columbia set offers, in addition to the staple items, the works for Piano Duet, in which the pianist is partnered by his wife, Gaby. The present discs omit these but include the two concertos (excellently accompanied by Jascha Horenstein and the Orchestre de l'Association des Concerts Colonne). Gieseking's five-sided album offers the early *à la manière de Borodin* which is omitted from the Perlemuter discs.

All three collections are, as a whole, very fine indeed. Casadesus, who probably has the most technique of the three pianists, strives for a sharp definition of sonority, rhythmic precision, and classical phrase contours. Gieseking, on the other hand, plays with his customary impressionistic "tonal wash." By a skillful use of the half-raised pedal, that artist produces some of the most exquisitely kaleidoscopic coloristic effects that I have ever heard in this music. In some of the smaller pieces, however, Gieseking tends to be slightly finicky and sentimental, while the pyrotechnical demands of *Gaspard*, say, seem to present a challenge to this artist. Fine as his performances are, I feel that Gieseking's particular kind of pianistic gifts were better suited to Debussy than to Ravel.

Perlemuter's performances were issued some time ago in Vox's regular-priced series. (The disc containing the Pavane, the Minuet Antique, and the two Con-

certos is still available.) When they first appeared, Alfred Frankenstein gave the set a generally unfavorable review, citing a prevailing lack of humor throughout. I would agree with him, to a point, but in general I am more impressed with Perlemuter's readings than my colleague was. The pianist seems to view this music in warmer terms than is customary. He eschews the cool, reserved "brittleness" that one so often encounters, and instead makes every effort to humanize the writing. He shows a fine structural comprehension, and engages in very little rubato. This, of course, is a mixed blessing: many of the works benefit from Perlemuter's lack of ostentation and sentimentality, his rhythmic

tempos, and his firmly ample tonal weight; the *Valses noires et semi-métronomiques*, however, sound stolid and metronomic, although this may be partly the fault of the constricted recorded sound in this number. The concertos lack some of the brio and finish evident in the Michelangeli, Bernstein, and François editions, but they should afford one a lot of solid enjoyment. The Sonatine and Pavane receive really lovely performances, and the player's technique is adequate for the *Gaspard* and Toccata. (The repeated notes in the former do, however, give Perlemuter a little trouble.)

Although there is some congestion throughout and surfaces are occasionally

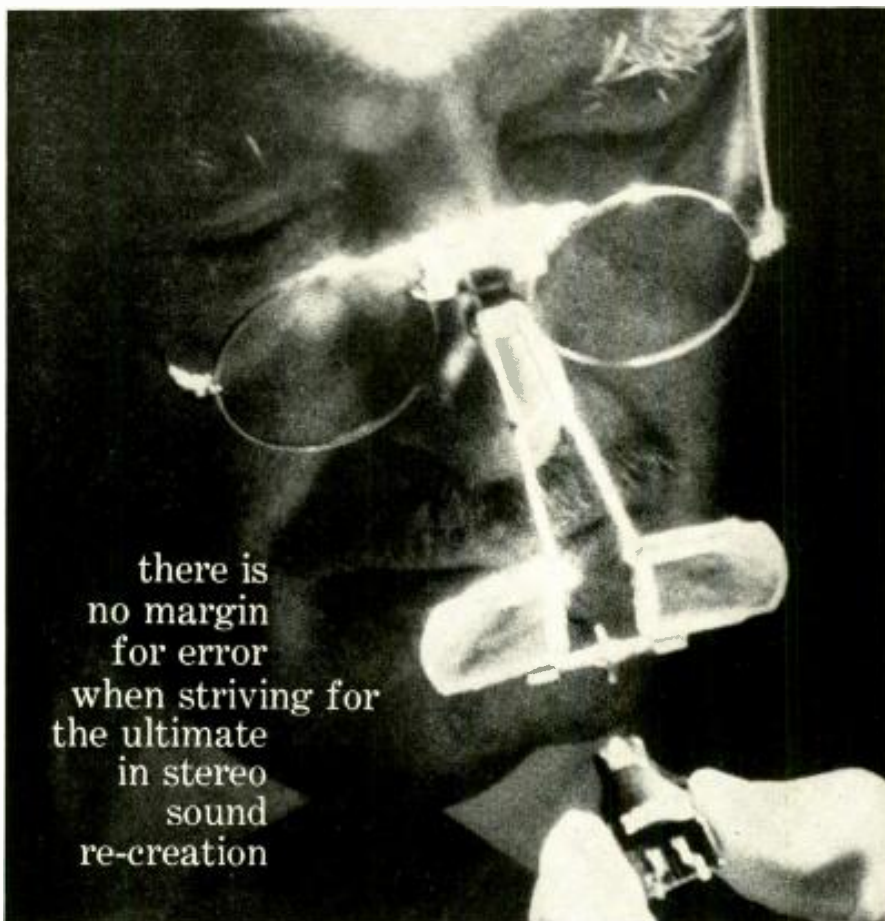

there is
no margin
for error
when striving for
the ultimate
in stereo
sound
re-creation

SHURE

Stereo Dynamic

HI-FI PHONO CARTRIDGES

Tiny though it is, the cartridge can make or break a stereo system. For this breathtakingly precise miniaturized electric generator (that's really what it is) carries the full burden of translating the miles-long undulating stereo record groove into usable

electrical impulses... without adding or subtracting a whit from what the recording engineer created. Knowing this keeps Shure quality standards inflexible. Shure Brothers, Inc., 222 Hartrey Avenue, Evanston, Illinois.

CARTRIDGES

- Standard M8D. A superb blend of quality and economy... \$16.50
- Custom M7D with N21D stylus. Widely acclaimed... \$36.75
- Professional M3D with N21D stylus. Choice of critics... \$47.25
- Laboratory Standard Model M3LS. Individually calibrated, limited quantity... \$75.00

TO NE ARMS

- Studio Dynamic. Integrated arm and cartridge. Cannot scratch records... \$89.50
- Professional Independent Tone Arm. For any quality cartridge... stereo or mono... \$29.95



CIRCLE 67 ON READER-SERVICE CARD

the 4 pleasures of DYNACO HI-FI



MUSICAL

Sheer listening pleasure for you and your family. The delights of the original performance are recreated in accurate detail and perspective. Every nuance of tonal shading and phrasing is clearly delineated without hum, noise, or distortion.



MANUAL

To assemble your own DYNAKIT is a uniquely rewarding experience. Easy . . . fun . . . educational . . . satisfying your creative interests.

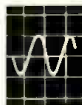

TECHNICAL

The superiority of premium components and the functional simplicity which typify the advanced engineering and design of DYNACO high fidelity equipment add a special satisfaction for you who appreciate excellence. Building your own makes you intimately aware of the quality of DYNACO equipment.



FINANCIAL

The unexpected bonus—substantial savings on high fidelity components of unquestioned technological superiority and unparalleled listening satisfaction.

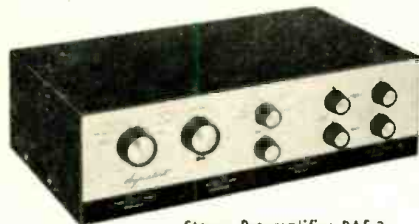

Stereo Preamp PMS-2
\$59.95 kit — \$99.95 assembled

Ask your HIGH FIDELITY SPECIALIST
or send for literature below.

Dynaco INC.

3912 Powelton Ave., Phila. 4, Pa.

Please send me complete information on
DYNACO products.

Name _____
Address _____
City _____ Zone _____ State _____

CIRCLE 27 ON READER-SERVICE CARD

noisy, the general level of reproduction is satisfactory. In my opinion, the considerable saving in the price of this set tilts the balance in its favor and more than outweighs its defects. The album is on the whole a fine, musically accomplishment worthy of a place in any record library. H.G.

REGER: Concerto for Piano and Orchestra, in F minor, Op. 114

Rudolf Serkin, piano; Philadelphia Orchestra. Eugene Ormandy, cond.

- COLUMBIA ML 5635. LP. \$4.98.
- COLUMBIA MS 6235. SD. \$5.98.

Max Reger's Concerto has always reminded me of the poor centipede who was unable to walk because a malicious grasshopper had asked him which foot went first. This innately genial and expressive music is inhibited by the composer's excessive concern with the "whys" and "hows" of composition. Reger's ground plan is grandiloquent and pretentious; the Concerto as a whole is turgid and aimless, with so much chromaticism and modulation that one cannot orient to a definite key-center. Nevertheless, the slow movement has a lovely mood, and there are enough fine details throughout the work to make it worth an occasional hearing.

Serkin really puts his best foot forward in this magnificent performance. The pianist has been caught here in one of his moments of calm exaltation, and Ormandy's orchestra is pure cream. All of this interpretative brilliance wedded to some of Columbia's finest engineering virtually adds up to a definitive recorded edition. The poetic, but far less electric Then-Berg-Roshaud version on German Electrola is altogether eclipsed by the new one. H.G.

ROSSINI: Overtures

Guillaume Tell; Le Siège de Corinthe; Il Barbiere di Siviglia; La Cenerentola; L'Inganno felice; La Gazza ladra; La Scala di seta; L'Italiana in Algeri; Semiramide; Il Signor Bruschino; Tancredi.

Orchestra dell'Accademia di Santa Cecilia, Fernando Previtali, cond.

- WESTMINSTER XWN 18944/45. Two LP. \$4.98 each.
- WESTMINSTER WST 14128/29. Two SD. \$5.98 each.

The idea behind this collection is a sensible one—a pair of records, available individually, presenting eleven Rossini overtures, including all the most popular, plus several not encountered quite so often. This means just about all the Rossini overtures most of us would care to listen to, played by a single orchestra and conductor. (The first five listed above are in Vol. 1, the remaining six in Vol. 2.)

Amid the welter of Rossini records dedicated to demonstration of this or that orchestra's virtuosity, or this or that conductor's penchant for frenzy, it is a pleasure to hear the unfaulingly musical approach of Previtali. He concentrates on the scores, rather than on effect, and these delicious pieces emerge with unusual clarity and balance. He does full justice to the grander pieces, such as *Le Siège de Corinthe* or the somewhat less familiar *Tancredi*—a most

exciting performance—but maintains lightness and grace in the others. I am especially happy about the inclusion of the delicious little overture to *L'Inganno felice*, though a number of the others are performed so well as fully to merit yet another recording. The only performance here I do not care for is the overly slow *Signor Bruschino* overture; it is impossible for me to forget the singing sparkle and crispness of the Toscanini version, though perhaps I shall come to like Previtali's more gradual, almost dancelike treatment. Previtali's orchestra is not a great one, but it is thoroughly competent, and right in the spirit of things.

The sound has, to my ears, a somewhat hoxy quality, though it is clear enough. The surfaces on Vol. 1 of the review set were fine, but those on Vol. 2 of the stereo version poor—this is a point to check. C.L.O.

SAINT-SAENS: Danse macabre, Op. 40; Le Rouet d'Omphale, Op. 31—
See Ibert: *Divertissement*.

SCHUMANN: Symphony No. 1, in B flat, Op. 38 ("Spring"); Manfred Overture, Op. 115

Boston Symphony Orchestra, Charles Munch, cond.

- RCA VICTOR LM 2474. LP. \$4.98.
- RCA VICTOR LSC 2474. SD. \$5.98.

Munch gives a fairly straightforward account of the *Spring* Symphony, though he does not overlook its romantic qualities. He seems more conscious of these, however, in the *Manfred* Overture, which he invests with greater interpretative fire. The spacious acoustics of Symphony Hall occasionally intrude upon the clarity of sound in the LP; in stereo, the space appears to be better filled by the lateral sense of direction. P.A.

STRAUSS, RICHARD: Don Juan, Op. 20

†Tchaikovsky: *Romeo and Juliet, Fantasy-Overture*

Vienna Philharmonic Orchestra, Herbert von Karajan, cond.

- LONDON CM 9278. LP. \$2.98 (for a limited time).
- LONDON CS 6209. SD. \$2.98 (for a limited time).

STRAUSS, RICHARD: Interludes from Die Frau ohne Schatten; Salomes Tanz; Till Eulenspiegels lustige Streiche, Op. 28

Philharmonia Orchestra, Erich Leinsdorf, cond.

- CAPITOL P 8548. LP. \$4.98.
- CAPITOL SP 8548. SD. \$5.98.

STRAUSS, RICHARD: Don Juan, Op. 20; Till Eulenspiegels lustige Streiche, Op. 28; Two Waltz Sequences from Der Rosenkavalier

Amsterdam Concertgebouw Orchestra, Eugen Jochum, cond.

- EPIC LC 3769. LP. \$4.98.
- EPIC BC 1127. SD. \$5.98.

The listing above gives the order of merit. Both *Don Juan* and *Romeo and*

Juliet are musical summations of dramatic narratives which must be built, scene by scene, towards an appropriate climax and resolution. If they are treated as virtuoso pieces for orchestra, their emotional force is lost. Yet, if they are presented as a series of dramatic episodes, their cumulative effect is lost. Every so often we get performances that unite true romantic exuberance with the architectural and dramatic sense required to keep the line of the music soaring. Karajan's versions are of this type. His orchestra's playing and the way its sound has been captured provide an exceptional release.

Leinsdorf receives nearly as fine engineering—heard at its best in *Till's* tricks, which makes this the best of the stereo treatments of this popular score. The rest of the collection is equally spectacular in its sonics but musically less interesting. This *Salome* is a square, quite lacking in voluptuous appeal. The suite from *Die Frau ohne Schatten* is Leinsdorf's own (rather than that the composer issued) and interesting for about two hearings. After you have been introduced to these marvelous orchestral effects, you begin to expect the music to go somewhere; unfortunately, it never stops rambling.

Epic's sound for this Strauss collection is too resonant to give us the force of registration one hears in the Karajan and Leinsdorf sets, while Jochum's pacing of the works seems loose and lacking in dramatic focus. You hope for better in the waltzes, but they turn out to be rather wooden and graceless in execution. R.C.M.

TCHAIKOVSKY: Concerto for Piano and Orchestra, No. 1, in B flat minor, Op. 23

Emil Gilels, piano; U.S.S.R. State Symphony Orchestra, Konstantin Ivanov, cond.

• MK-ARTIA 1532. LP. \$5.98.

Artia, which recently issued two recordings of this work by Sviatoslav Richter (one of them on the company's economy-priced Parliament label), now brings forth a new Gilels edition. There are now over forty discs of this concerto on the market, and so many are distinguished performances that one need not accept anything less than the superb.

Unfortunately, the new Gilels disc, while extremely well reproduced, does not measure up to the best of the competing versions. The pianist does not attempt the subjective niceties featured in the Richter and Cherkassky renditions, and instead concentrates on momentum and bravura brilliance. But his playing here lacks the finish and temperament of, say, Horowitz, who plays the concerto in similar fashion. Gilels uses too much pedal in octave passages, and his tonal range lacks coloristic hue. (There is loud playing and soft playing to be sure, but *all* the playing tends to sound gray and neutral.) And as in the artist's earlier RCA disc with Reiner, he misreads the rhythmic values of the first movement's principal subject: Tchaikovsky wrote triplets (two notes-one rest) here, and not a main beat preceded by a grace note. Other pianists have been lax about this particular point, but Gilels is especially remiss. Furthermore, I do not recall Gilels' previous performances of the piece as being as cautious as the

present version: he sounds a bit tired.

This last fault may be attributable to Ivanov's sluggish tempos. Nor do I like the wide vibrato that characterizes the Russian school of wind and brass playing. The solo oboe, in particular, produces a wheezy, nasal quality, and the opening brass fanfare, as given here, has a disturbing wobble. Otherwise, the orchestral work is sturdy and sympathetic.

The piano sound is superior to that on the Gilels-Reiner disc, but all told the Tchaikovsky B flat minor seems to be Gilels' *bête noire*. H.G.

TCHAIKOVSKY: Romeo and Juliet. Fantasy-Overture—See Strauss, Richard: Don Juan, Op. 20.

TCHAIKOVSKY: Symphony No. 5, in E minor, Op. 64

Czech Philharmonic Orchestra, Lovro von Matacic, cond.

• PARLIAMENT PLP 149. LP. \$1.98.
• • PARLIAMENT PLPS 149. SD. \$2.98.

The easiest way to interpret a Tchaikovsky symphony is to be as sentimental and drippy as possible. It is far less simple to eschew the sentimentality and play the work strictly as absolute music. Von Matacic takes the latter course. His performance is all crispness and animation, yet he allows time for the superb horn soloist to sing most beautifully in the second movement, and he builds an impressively broad climax in the finale. In his hands, the symphony takes on freshness and musical stature. Parliament's stereo sound is well distributed, though some of the highs could have been cleaner. Put this down as one of the better Fifties on discs—and at a bargain price too. P.A.

TELEMANN: Concertos: for Oboe and Orchestra, in F minor; for Three Trumpets, Two Oboes, and Orchestra, in D. Suite for Recorder and Orchestra, in A minor

Theodora Schulze, oboe and recorder; Arthur Statter, Harry Peers, Maurice Peress, trumpets; Telemann Society, Richard Schulze, cond.

• Vox DL 590. LP. \$4.98.
• • Vox STDL 500590. SD. \$4.98.

The Concerto for Trumpets is the sort of thing Telemann and many of his contemporaries turned out by the yard, and it is not helped by a performance in which the trumpets sound harsh and shrill and often slightly off-pitch. The other two works have more substance (the Oboe Concerto) and charm (the Suite). Here too the music is somewhat handicapped by rather heavy-handed orchestral playing. There is no indication of where the Telemann Society hails from, but it is clearly no match, in finesse or in precision, for the expert baroque ensembles we are accustomed to on records. Theodora Schulze's performance on the oboe is acceptable; on the recorder it is not impeccable, and in the Polonaise of the Suite the orchestra begins at too fast a pace for her and has to slow up. The basses sound heavier than necessary, and in several movements the harpsichord is faint or not audible at all. N.B.



tick, tick.

Maybe you don't remember the magic tick-tick of Dad's alarm clock . . . or the excitement you felt at the tiny sound of his key turning in the lock.

But don't despair. Grownups, too, can experience exciting moments in sound. Try Audiotape and see.

The unique quality of this tape gives you more clarity and range, less distortion and background noise. It's your silent (but knowledgeable) partner in capturing fresh, clear, memorable sound—whether it's Saturday night merriment . . . or a Sunday afternoon concert.

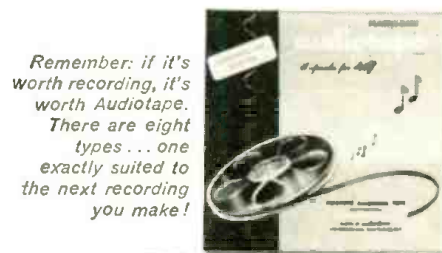

audiotape
"it speaks for itself" TRADE MARK

AUDIO DEVICES INC., 444 Madison Ave., N.Y. 22, N.Y.
Hollywood: 840 N. Fairfax Ave., Chicago: 5428 N. Milwaukee Ave.
CIRCLE 9 ON READER-SERVICE CARD

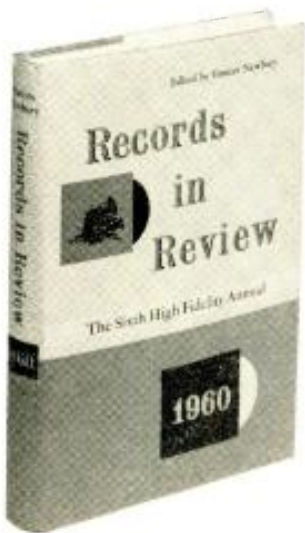

Helps You Build a Record Collection YOU Enjoy!

Records in Review—1960 brings you in one convenient volume hundreds of reviews of stereo and mono records and stereo tapes which appeared in HIGH FIDELITY Magazine over the eighteen months from July 1959 through December 1960—classical and semiclassical music exclusively.

This hardcover book of more than 450 pages, edited by Frances Newbury, is the most complete and authoritative book of its kind—the standard reference work that gains in value as the years roll by.

The reviews discuss the composition, performance, and sonic fidelity. And they compare the new recordings with earlier ones. They are organized alphabetically by composer for quick, easy reference—and in the case of composers frequently recorded, further subdivided by such categories as Chamber Music, Vocal Music, etc. You'll find, too, a section on recordings of Recitals and Miscellany, a special section on Tape, and an Index of Performers.

Records in Review—1960, the Sixth High Fidelity Annual, sells for \$6.95. Payment with order, please—but satisfaction guaranteed or your money back!

The Wyeth Press, a Division of High Fidelity The Publishing House, Great Barrington, Mass.

Send me RECORDS IN REVIEW—1960. I enclose payment in full, \$6.95, on a satisfaction guaranteed or money-back basis.

Name _____
 Address _____
 City _____
 Zone _____
 State _____

Foreign orders sent at buyer's risk. Add 25¢ for postage on foreign orders except Canadian.

VACHON: Quartets for Strings, Op. 11: No. 1, in A; No. 5, in F minor
†D'Alayrac: Quartets for Strings: in D, Op. 7. No. 3; in E flat, Op. 1, No. 5

Loewenguth Quartet.

- ARCHIVE ARC 3149. LP. \$5.98.
- • ARCHIVE ARC 73149. SD. \$6.98.

Pierre Vachon (1731–1802), a French violinist and composer who was active in Germany in the last sixteen years of his life, is revealed here as a skilled composer in the classic style. The material is melodious, the workmanship smooth and elegant, the writing for the instruments expert. Although there is activity in the inner parts, the layout is essentially melody and accompaniment. Sometimes counterpoint threatens—the first theme of the F minor Quartet sounds like the subject of a fugue—but Vachon's *galant* upbringing wards it off. He is no Haydn, nor yet a Boccherini, but he is a cut or two above, say, Pleyel. Of D'Alayrac (1753–1809), who wrote little instrumental music but many operas, very much the same may be said. His textures are a bit thinner than Vachon's, but he is an inventive melodist, his rhythms are lively, and occasionally he has some interesting harmonic ideas. I found all four works very agreeable listening in this excellent performance and recording. N.B.

WAGNER: *Orchestral Excerpts*

Rienzi Overture: Der fliegende Holländer Overture. Die Walküre: Magic Fire Music. Die Meistersinger: Prelude to Act III; Dance of the Apprentices; Entry of the Mastersingers.

Detroit Symphony Orchestra, Paul Paray, cond.

- MERCURY MG 50232. LP. \$4.98.
- • MERCURY SR 90232. SD. \$5.98.

Paray's earlier Wagner recordings showed him to be one of the few French conductors who can challenge those of Mitteleuropa in this repertory. Unfortunately, French gallantry is here confronted with heavy guns. Both Reiner and Klemperer offer recent and memorable versions of the *Meistersinger* selections (although Klemperer omits the third-act prelude), and the Klemperer versions of the two overtures have an authority in style and solidity in registration that excels even performances as fine as these. The rival sets add up to three records, however; and if you find this combination of excerpts particularly attractive, you should not pass it by. Mercury's sound here, both in mono and stereo, is bright but somewhat coarse-grained. R.C.M.

YARDUMIAN: *Passacaglia, Recitative, and Fugue; Cantus Animae et Cordis: Chorale Prelude*

John Penninck, piano; Philadelphia Orchestra, Eugene Ormandy, cond.

- COLUMBIA ML 5629. LP. \$4.98.
- • COLUMBIA MS 6229. SD. \$5.98.

Richard Yardumian of Philadelphia is a conservative with something to say, although his emphasis upon the rich, picturesque effect of modal counterpoint eventually grows a bit tiresome here.

The best of the three pieces is the *Passacaglia*. Recitative, and Fugue, which, to all intents and purposes, is a concerto for piano and orchestra. The *passacaglia* is strongly indebted to the famous one by Bach, although the use of the piano solo for some of the variations gives it a very special color of its own. The recitative and fugue are very dramatic movements, and the whole has great color and character, especially when it is so beautifully played and recorded as it is here.

The *Cantus Animae et Cordis* and the *Chorale Prelude* are short, meditative, essentially religious works, each of which, one suspects, would be quite beautiful by itself, but together they add up to a muchness. The record label, for some odd reason, accounts for them in reverse order. A.F.

RECITALS AND MISCELLANY

TERESA BERGANZA: "Arias of the Eighteenth Century"

Gluck: *Orfeo: Che farò; Che puro ciel. Alceste: Divinités du Styx. Paride ed Elena: O del mio dolce ardor. Cherubini: Medea: Medea, O Medea . . . sono un pianto. Pergolesi: La serva padrona: Stizzoso mio, stizzoso. Handel: Giulio Cesare: Piangerò la sorte mia. Paisiello: Nina, pazza per amore: Il mio ben quando verrà.*

Teresa Berganza, mezzo; Orchestra of the Royal Opera House, Covent Garden, Alexander Gibson, cond.

- LONDON 5591. LP. \$4.98.
- • LONDON OS 25225. SD. \$5.98.

At this juncture, little comment need be made on the Berganza voice, which is surely one of the loveliest and most flexible to come along since the war. Here she gives evidence of a very firm grip on classical style. Her "O del mio dolce ardor," a bit slower than we are accustomed to hearing it, is spun forth with great tranquility—the vocal texture, the relaxed but never slack attack, are exactly right. "Piangerò la sorte mia" is extremely impressive, both in the sustained phrases of the "A" section and in the agitated coloratura of "Ma poi morta." The Cherubini and Paisiello scenes—the latter is in a complete form, with recitative, not often heard—are equally well done, and her "Stizzoso mio" is light and tart.

The *Orfeo* excerpts are less satisfactory, especially the "Che farò," which sounds unsettled and a bit precipitous, and loses the sense of classical repose that ought to underline its emotional outpouring. "Che puro ciel" is somewhat better, though open to the same sort of criticism. There is certainly no reason why Miss Berganza should not be one of this role's greatest exponents, given a little more time, some deepening of her vocal timbre, and a good conductor. The "Divinités du Styx" is just too "big" for her, both vocally and stylistically, at the moment. The orchestral accompaniments are decent enough, the sound ditto. C.L.O.

MISCHA ELMAN: "Caprice viennois and Other Kreisler Favorites"

Kreisler: *Liebesfreud; Schön Rosmarin; La Gitana; Rondino on a Theme of Beethoven; Caprice viennois; Preghiera in the Style of Martini; Allegretto in the Style of Boccherini; Sicilienne and Rigaudon in the Style of Françoise; Præliudium and Allegro in the Style of Pugnani.* Dvořák: *Slavonic Dances: No. 1, in G minor: No. 2, in E minor* (trans. Kreisler). Tartini: *Variations on a Theme of Corelli* (arr. Kreisler).

Mischa Elman, violin; Joseph Seiger, piano.

- VANGUARD VRS 1066. LP. \$4.98.
- VANGUARD VSD 2084. SD. \$5.98.

Miniatures such as these are decidedly Elman's forte. He delivers them with his famous big tone and broad and fairly free interpretative style, providing artistic playing of the old school, such as one seldom hears today. Of the noted violinist's recent sets of recordings, this is surely one of the best. From the standpoint of sonics, however, there seems little need for stereo—practically no difference could be noted when the two versions were played through two channels—and there is a bit too much room resonance on the first side of both editions. P.A.

MAURICE GENDRON: Cello Recital

Schumann: *Träumerei.* Saint-Saëns: *Le Cygne.* Paganini: *Introduction and Variations on One String on a Theme by Rossini.* Bach: *Chorale, "Ich ruf' zu Dir, Herr Jesu Christ."* Handel: *Largo from "Xerxes."* Falla: *Spanish Dance No. 1 from "La Vida breve."* Granados: *Andaluza.* Fitzenhagen: *Moto Perpetuo.* Popper: *Serenade.* Kreisler: *Liebesleid.*

Maurice Gendron, cello.

- EPIC LC 3753. LP. \$4.98.
- EPIC BC 1115. SD. \$5.98.

Gendron is a virtuoso instrumentalist with elegance and supreme tonal beauty; he is also a musician of taste. Never, on this disc, does he distort the organic growth of a phrase by portamento, excessive vibrato, or audible scoops of intonation, and all of these performances have an exquisite purity of intention that I, for one, find most moving. The cellist's pearly, symmetrical account of Schumann's *Träumerei* shows him to be a master of a subtle, almost classical rubato, and in his hands, even so hackneyed a *morceau* as Kreisler's *Liebesleid* sounds fresh as a daisy. Bach, Handel, and Saint-Saëns further establish Gendron as a master of the cello's finely drawn *cantabile*, while the works of Paganini, Popper, and Fitzenhagen receive here the crisp technical precision and tonal chiaroscuro which they demand.

Another indication of Gendron's musical integrity is his respect for the pianist. Peter Gallion, obviously an expert collaborator, is allowed prominence when the music demands.

Gorgeous sound on both versions rounds out an altogether delectable encore record. H.G.

JOHN GILLESPIE: Music for Harpsichord

John Gillespie, harpsichord.

- EDUCO 4005, 4007, 4009, 4010. Four LP. \$5.95 each.

Mr. Gillespie, who has given a number of recitals here and abroad and now teaches at the University of California in Santa Barbara, has put together four "programs" nicely varied in mood and style. The Spanish group (4007) consists almost entirely of unfamiliar works, including a charming and characteristically Iberian anonymous *Favorita*, a flavorful Sonata by Mateo Albéniz (1760-1831), a pleasant Andante and a lively *Pieza de clave* by one Felix Lopez (born about 1742), and three attractive Sonatas by Antonio Soler. Outstanding in the Italian group (4010) are the highly imaginative *Toccata sul canto del cuculo* by Bernardo Pasquini (1637-1710), a brilliant *Toccata in G minor* by Alessandro Scarlatti and two Sonatas by Domenico, a plaintive Fugue in G minor by Porpora, a fanciful and substantial *Studio* by Durante, and a playful Gavotte by Padre Martini. The French collection (4009) includes, besides those favorite fowls Rameau's *La Poule* and Daquin's *Le Concert*, a nice Rondeau by Chambonnières, a Courante of character by Lully, a dark and imposing Sarabande by D'Anglebert, and other works. The album entitled "Keyboard Favorites" (4009) comprises the C minor Prelude and Fugue from Book I of the *Well-Tempered Clavier*, Handel's *Harmonious Blacksmith* variations, two of the most familiar Sonatas (in D minor and C major) by Scarlatti, two pieces by Couperin and two by Rameau, including the latter's *Tambourin*, Haydn's Sonata in D, and Mozart's variations on *Ah! vous dirai-je maman*, K. 265, and *Rondo alla turca*.

Most of these pieces are played with impressive technical proficiency. One or two split tones may be heard, but they are not bothersome. Especially in the disc of "Favorites," Mr. Gillespie exhibits a nice sense of the different approaches required by different types of pieces. Elsewhere, however, his playing does not always escape a certain monotony, induced by a rigid, unyielding rhythm. It is not enough, after all, merely to change registers when repeating sections and to slow up at final cadences. The liner notes are not as good as they should be and sometimes violate the first requirement of such things, which is to identify the music. The Scarlatti Sonatas are given neither Longo nor Kirkpatrick numbers, and for the Haydn Sonata we are furnished only the key. Good sound. N.B.

WALTER HAUTZIG: "Great Waltzes for Piano"

Brahms: *Waltzes, Op. 39 (16).* Chopin: *Waltzes: Op. 64: No. 1, No. 2; Op. 70: No. 1; No. 2; Schubert: Waltzes: Op. 9, No. 1; No. 2; Op. 18: Nos. 1, 2, 6, 12; Op. 50: No. 13; Op. 77: Nos. 9, 10, and 12.* J. Strauss-Gruenfeld-Hautzig: *Soirée de Vienne.*

Walter Hautzig, piano.

- UNITED ARTISTS UAS 7008. LP. \$4.98.
- UNITED ARTISTS UAS 8008. SD. \$5.98.

Hautzig continues to impress as an excellent exponent of the German classical and romantic keyboard literature. His per-

Listen with
discriminating
pleasure

TO YOUR



A startling achievement—an ultra-compact 2-speaker system capable of sound you'd expect from a much larger unit. Volume control on front. Perfect for FM Multiplex, very low cost stereo, other-room extensions.

X-10 2-speaker 2-way system for use with amplifier having 4, 8, or 16 ohm output. Power rating—6 watts. Adequate room sound with 1 watt to speaker. 7¼" H, 13" W, 4½" D.
In oiled Walnut\$29.95

TO YOUR



A popularly priced full-sized 3-speaker bookshelf system—perfect for inexpensive stereo. Recent "blindfold" tests by audio experts proved a preference for the TF-2 over "rated" systems costing much more.

TF-2 3-speaker 2-way system. Full size Flexair* woofer for distortion-free bass response, plus two special direct radiator tweeters giving smooth, extended highs. 13½" H, 23¾" W, 11½" D.
In oiled Walnut\$79.50
Unfinished Hardwood...\$64.50



6601 S. Laramie Ave., Chicago 38, Ill.

In Canada: Renfrew Electric Co., Ltd., Toronto
In Mexico: Universal De Mexico, S.A., Mexico, D.F.
CIRCLE 41 ON READER-SERVICE CARD

VANGUARD VOICES



"The voice so sweet, the words so fair
As some soft chime had stroked the air."

Ben Jonson
NETANIA DAYRATH sings SONGS
OF THE AUVERGNE (arr. Canteloube)
with orchestra.
VRS-9085/ *VSD-2090

"The songs of the Auvergne find a lovely exponent
... her voice has a burnished gleam." *New York Times*

"Puts us once more in Vanguard's debt." *Saturday Review*

"So smooth, so sweet, so silvery is thy voice"

Herrick
JOAN BAEZ — Silver Dagger.
East Virginia, House of the
Rising Sun, Donna Donna, Rake
and Rambling Boy, Henry Martin,
and other folk songs
VRS-9078/ *VSD-2077

"An achingly pure soprano voice
... a profound emotional involvement that
seems to envelop the listener." *High Fidelity*



"A great voice, as of a trumpet" *Relation*

ODETTA at CARNEGIE HALL —
If I Had a Hammer, Red Clay
Country, God's A Gonna Cut You
Down, John Henry, Jericho,
Prettiest Train, Motherless
Child, and other songs
VRS-9076/ *VSD-2072

"Once you hear her, you
are never quite the same."
San Francisco Chronicle

*Stereo



VANGUARD
recordings for the connoisseur

Vanguard Recording Society, Inc., 154 West 14 Street, New York 11, N. Y.
CIRCLE 75 ON READER-SERVICE CARD

formance of the Brahms Waltzes here is impeccable from a technical standpoint, and supplies just the right mixture of warmth, brilliance, and intimacy. This is a less sedate and square-cut rendition than Carl Seeman's for Decca, and it has more charm, if not so much fire, as Leon Fleisher's for Epic. (Hautzig's piano, incidentally, has a far more incisive treble than the dull-sounding one that Fleisher uses.) The Schubert series goes equally well, and it is a pleasure to hear these delightful miniatures sans the Liszt fancywork.

The remaining items must, I'm afraid, be classified as failures. Hautzig's Chopin is of the stolid, Teutonic variety—with a rubato that goes limp and with tempos that may be justified by the printed indications but that do not work aesthetically. As for the patchy *Fledermaus* mélange, the pianist is altogether too serious about it all. Unless this kind of salon pyrotechnics comes to an artist as naturally as breathing, the music will sound simply trashy.

The sound is full-bodied, ringing, and extremely lifelike. H.G.

JOSEF LHEVINNE: "The Art of Josef Lhevinne"

Chopin: *Etudes: Op. 10, No. 11; Op. 25: Nos. 6, 10, and 11. Polonaise, in A flat, Op. 53. Preludes: Op. 28: Nos. 16 and 17.* Debussy-Ravel: *Fêtes.* Schumann: *Toccata, Op. 7.* Schumann-Liszt: *Frühlingsnacht.* Johann Strauss, II-Evler: *Blue Danube Waltz.*

Josef Lhevinne, piano.
● JULLIARD LIMITED EDITION. LP. \$4.00.

A reissue of a recording deleted from the RCA Victor catalogue, this disc is being sold by the Juilliard School for the benefit of the Josef Lhevinne Scholarship Fund (the minimum contribution is the amount stated above). Since it is one of the truly indispensable piano recordings, I urge you to acquire it. Lhevinne was a mighty player, fully the equal in pyrotechnics of his more celebrated contemporaries, Rachmaninoff and Hofmann, and his interpretations display a consistency and conservatism—good taste, if you will—not always conspicuous in those artist's renditions. Yet at the same time Lhevinne's artistry is never in the least lacking imaginative insight.

The Polonaise and Schumann Toccata were specialties of the pianist and both are performed with astonishing breadth and fervor. With all his amazing keyboard facility, Lhevinne was not a speed demon, and the Schumann piece, as given here, is broadly conceived and impeccably planned. The phrases sound all the more impressive because of the "air" around them. Even so notable a reading as Richter's recent one for Deutsche Grammophon cannot, in my opinion, match the nobility of the present reading. The Chopin Polonaise reaches the same high level. The series of Etudes and the two Preludes are of a comparable interpretative stature. These Lhevinne editions are, in fact, the definitive versions.

The Debussy Nocturne (arranged for two pianos by Ravel) provides a recorded specimen of the marvelously integrated teamwork of Lhevinne and his wife, who is, of course, a fine pianist too. It is interesting to note that these artists take the processional middle section of the piece *in tempo* as Toscanini did, and as Cantelli does on his Angel disc. Most conductors, upon arriving at this point, pause, and then resume the tread of the music at a slightly slower tempo. I offer this piece of information as a compliment to the musical sensibilities of the Lhevinnes, for I feel that their way of playing this section is, by far, the better way!

The Strauss transcription is somewhat cut, but it is really tremendous. You will have a hard time convincing your friends that only one piano is being played with two hands. I cannot think of any pianist before the public today, who is capable of giving such a full-bodied, yet musical, *tour de force*. The sound of the dubbed 78s is a little constricted, and there is some surface scratch, but all told, it is sturdy and acceptable. H.G.

CHARLES MILGRIM: "The Romantic Music of Spain"

Albéniz: *Seguidillas, Op. 232, No. 5; El Albaicin; El Puerto; Malaguena.* Albéniz-Severac: *Navarra.* Falla: *Andaluz.* Granados: *Maja y el Ruiseñor; El Fandango de Candil; Playera, Op. 5, No. 5.* Turina: *Sacro-Monte.*

Charles Milgrim, piano.
● KAPP KCL 9058. LP. \$4.98.
● ● KAPP KCS 9058. SD. \$5.98.

On first hearing, one might feel that the pieces comprising this recital are too similar in their use of the Spanish idiom to provide enough contrast for an interesting program. Subsequent playings, however, will reveal the subtle contrasts

AN IMPORTANT ANNOUNCEMENT ABOUT FM STEREO MULTIPLEX!

Will You Be Ready When FM Stereo Multiplex Starts ?

FM Multiplex is no longer experimental — the FCC has approved and authorized full-time, regularly scheduled FM Stereo Multiplex Broadcasts beginning June 1, 1961.

Will you be ready . . . to receive . . . to record . . . music in its fullest dimension — music that is "live", that is truly reproduced with the highest fidelity.

You can be ready — by simply flipping a single dial — using your present stereo components . . . and we can tell you how!

The AUDIO EXCHANGE SERVICE LABORATORY has been in constant touch with the multiplex situation from its beginnings . . . to the present...and we are up to date on all of the technological data.

FREE CONSULTATION! We know just what you will need . . . and just what it will cost for you to receive FM Stereo Multiplex Broadcasts using your present FM or AM/FM tuner and stereo components . . . regardless of make or model! Some conversions cost as low as \$39.

IS YOUR FM OR AM/FM TUNER LISTED? FOR FREE CONSULTATION REGARDING CONVERSION TO STEREO MULTIPLEX COMPLETE FORM BELOW AND MAIL . . .

Alec	Fisher	Leak	REL
Ampex	Grammes	McIntosh	Sargent-
Aray	Harman-Kardon	Pilot	Raymont
Bell	Heathkit	Radio-	HH Scott
Bogen	Karg	Craftsman	Shawood
Browning	Knight	Rauland	Stromberg
De Wale	Lafayette	Realistic	Carlson
Eico			

LIST MAKE AND MODEL OF COMPONENTS: _____ TUNER HF-7
 _____ PREAMPLIFIER _____ AMPLIFIER
 _____ SPEAKERS
 NAME _____
 ADDRESS _____
 CITY _____ ZONE _____ STATE _____



THE HI-FI TRADING ORGANIZATION

audio exchange

153-21 Hillside Ave., Jamaica 32, N. Y. 1065 Flatbush Ave., Brooklyn, N. Y.
 203 Mamaroneck Ave., White Plains, N. Y. 451 Plandome Road, Manhasset, L. I.

CIRCLE 11 ON READER-SERVICE CARD

between the various composers. Falla's piece is quite the most dynamic and intense, Albéniz's group, especially *El Albaicin*, is brighter in texture, occasionally with impressionistic qualities. But it is the two excerpts from Granados' *Goyescas* that furnish the highlights here.

Milgrim does all of the music to a turn. He gives a most sensitive account of the beautiful "Maiden and the Nightingale," with just the right amount of rubato expression—the more extrovert compositions are delivered crisply, with gaiety and gusto. There is the further advantage of clean, light-textured reproduction of the piano in what sounds like a small concert hall rather than a studio. H.G.

ANNA MOFFO: Operatic Arias

Gounod: *Faust: Air des bijoux*. Puccini: *La Bohème: Mi chiamano Mimì*. *Turandot: Signore, ascolta; Tu che di gel sei cinta*. Meyerbeer: *Dinorah: Ombre légère*. Bizet: *Carmen: Air de Micaëla*. Delibes: *Lakmé: Bell Song*.

Anna Moffo, soprano; Rome Opera House Orchestra, Tullio Serafin, cond.
 • RCA VICTOR LM 2504. LP. \$4.98.
 • • RCA VICTOR LSC 2504. SD. \$5.98.

All my admiration for Miss Moffo's sensitivity and lovely vocal quality cannot bring me to enthusiasm about her work in standard coloratura arias. Her renditions of the three Puccini selections on this disc are as appealing as any now in the catalogue. Her *Carmen* air, too, is exquisitely sung—one wishes here for more of a pickup in the center section of the aria "*Je vais voir de près cette femme*," etc.; ordinarily, one would ascribe the limpness here to Serafin, who has been known to drag a tempo now and then—except that the singer seems to have an inordinate predilection for slow speeds, as demonstrated on her previous coloratura display recital for Angel.

This brings us to the real trouble—a lack of *elan*, most specifically evident in a rhythmic slackness, in the arias that most demand some dash and a strong rhythmic accent. The first occurrence of this difficulty on the present disc is in the very first selection—the "Jewel Song." Miss Moffo gives us a very nice sound on the trilled "*Ah!*" at the beginning of the aria proper, but then insists on taking a perceptible hold before her very careful-sounding upward scale. Thus the music is robbed of spontaneity at the very outset, and when she goes into "*Je ris*," we do not quite believe her—"Je souris," perhaps, but no more. The tendency to drag the rhythm at the very point where it should pick up—presumably to get the voice "set" and secure for the challenges to follow—crops up throughout the coloratura showcase numbers, along with a propensity for substituting legato for staccato execution when the latter becomes too uncomfortable a prospect. There is simply no point at all in singing "*Ombre légère*" or "*Bel raggio*"—or the "Bell Song," for that matter—unless the artist can launch them with genuine, I-don't-give-a-damn insouciance. All the pretty tone, all the wistful inflection in the world won't make up for a lack of *brío*. And the worst of it is that, to judge by most of her singing, there is no real reason for Miss Moffo's hesitancy.

Of course, her singing is always pleasant enough, except for a couple of pinched tones up above C. My total impression is that the singer's true *métier* is the lyric, not coloratura, repertoire.

The sound is quite warm and clear in the monophonic edition, and pleasingly spread in the stereo. C.L.O.

ROBERT SHAW CHORALE: Operatic Choruses

Bizet: *Carmen: Les voici!* Offenbach: *Les Contes d'Hoffmann: Presentation of Olympia*. Gounod: *Faust: Soldiers' Chorus*. Verdi: *Nabucco: Va, pensiero*. *Otello: Dove guardi splendono raggi*. *Il Trovatore: Anvil Chorus*. *Rigoletto: Zitti, zitti*. Wagner: *Lohengrin: Bridal Chorus*. *Die Meistersinger: Wach' auf!* Thomas: *Mignon: Au soufflé léger du vent*. Mascagni: *Cavalleria rusticana: Gli aranci olezzano*. J. Strauss, II: *Die Fledermans: Brüderlein und Schwesterlein*.

Robert Shaw Chorale, RCA Victor Orchestra, Robert Shaw, cond.

• RCA VICTOR LM 2416. LP. \$4.98.
 • • RCA VICTOR LSC 2416. SD. \$5.98.

These performances are simply perfect, and to hear these often maltreated pieces given such vigorous, precise, caring renditions is refreshing, to say the least. It's enough to restore one's faith in Gounod. I question only the inclusion of the very brief fragment from *Hoffmann*; the choristers are quite sprightly, but the section doesn't really stand by itself. Victor's sound is excellent, its cover photo a triumph of improbability. C.L.O.



THE NEW KLH MODEL TEN SPEAKER SYSTEM

*Is smaller than our other models,
 Costs less than our other models,
 Operates with a 12 watt amplifier,
 And - has the KLH sound.*



KLH RESEARCH AND DEVELOPMENT CORPORATION
 30 CROSS STREET, CAMBRIDGE 39, MASSACHUSETTS
 CIRCLE 42 ON READER-SERVICE CARD

the original cast album!



Monaural KDL-8500 Stereo KD-8500-S

Broadway's Newest Hit

KAPP RECORDS

CIRCLE 43 ON READER-SERVICE CARD

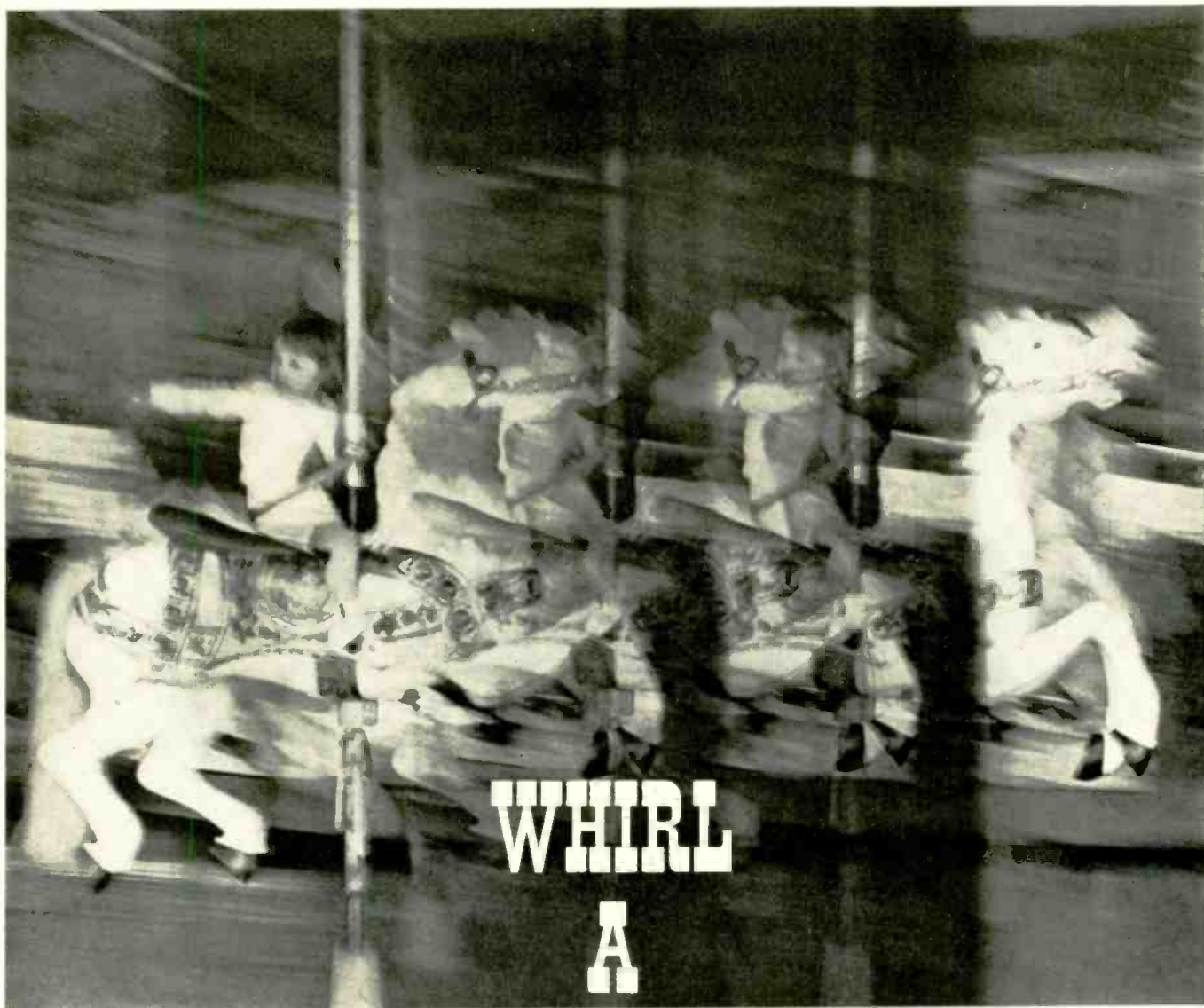

WHIRL A GIG

The music goes round and round oho hoho, and if you're set up for stereo you can actually follow it with your eyes as it spins around the room from speaker to speaker. Waltzes from *Carousel* and *Masquerade*, *La Ronde*, *Dance of the Comedians*, and other fetching tunes of carnival and fun make up this new Capitol Musical Merry-Go-Round. Waltz down to your friendly neighborhood record store, give it a whirl.

And while you're there, catch these other new Capitol Classics: BORODIN: *Polovtsian Dances*, *Symphony No. 2 in B Minor* (S)G7249; *Exotique* (selections by RAVEL, DEBUSSY, etc.) (S)P8550; BEETHOVEN: "Kreutzer" and "Spring" Sonatas (S)G7246; SCHUMANN: *Scenes From Childhood* and *Carnaval* (S)P8555; *Starlight Fantasie* (S)P8553.

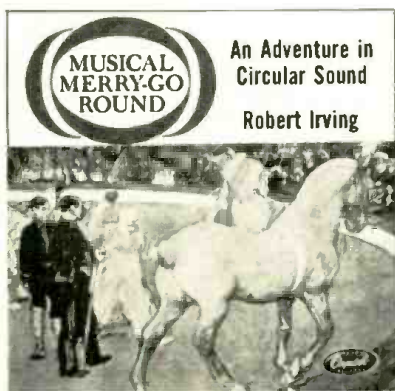

(S)G7244

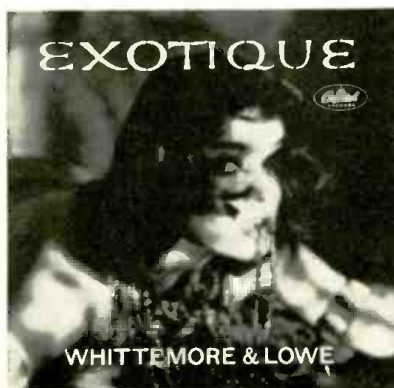

(S)P8550

CIRCLE 19 ON READER-SERVICE CARD

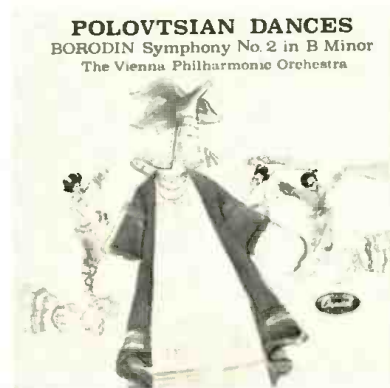

(S)G7249

The Lighter Side

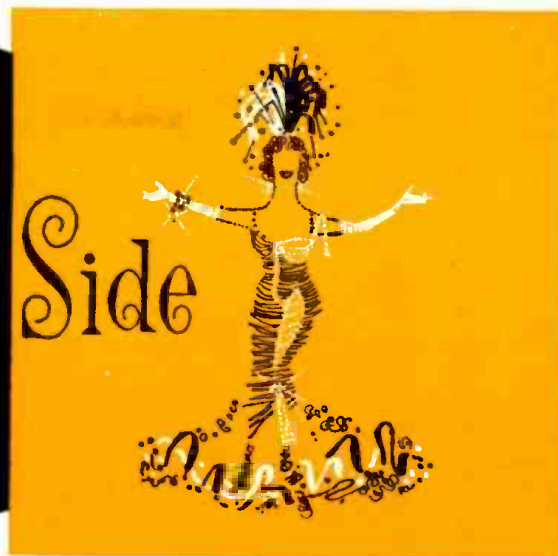

POPULAR • THEATRE • FOLK

Seductive—and Sometimes Sad

"Tahiti Dream Island." *Capitol TAO 10281*,
\$4.98 (LP); *STAO 10281*, \$5.98 (SD).



... a soft and sultry singing

THE STORY—and it is a true one—goes that in July 1767, *H.M.S. Dolphin*, Captain Samuel Wallis commanding, climaxed a long, weary voyage around the Horn by making an unexpected landfall in mid-Pacific. To the delight of the crew, the lissome island maids proved eager to alleviate their lengthy continence. The price: a single nail per alleviation. With the holds crowded with keg upon keg, the happy sailors felt that they had indeed stumbled upon Paradise. But both sailor and *vahines* proved less exhaustible than the kegs: Captain Wallis hastily put to sea when he found frantic crewmen pulling nails out of the ship's timbers.

This episode is a *preëcho*—mildly caricatured, to be sure—of the pattern that European-Tahitian

relations have followed ever since. Westerner after Westerner has discovered with ecstasy the uninhibited Polynesian *joie de vivre* and the fantastic beauty of the islands themselves. But there is almost always the sad *denouement*, the painful leave-taking.

With him, however, today's voyager can carry away at least one imperishable memento—the rich, varied, infatigably rhythmic music of Polynesia. Tahiti, now a French possession, is the "cultural center," in the musical sense, of all the South Sea Islands; the discerning listener can hear Tahitian melodies sung all the way from New Zealand—whose Polynesians are called Maoris—to lonely, isolated Easter Island, the farthest eastern outpost of the Vikings of the Pacific.

While the catalogue bulges with Hawaiian records, the far richer vein of Tahitian melody remains virtually untapped. Happily, with this release recorded in Papeete by Gaston Guilbert, Capitol has now gone far towards redressing the balance. One side of the disc offers purely traditional chants and dances. Of these, the narrative ballad *Marara* (Flying Fish), the frenetic dance *Kiore* (Persistent Suitor), and the poignant *Maruru a Vau* (Goodbye to You) will haunt your ear long after the last note fades from your speakers.

The overside correctly takes cognizance of the enormous French influence exerted on present-day Tahitian music. This wedding of Paris and Polynesia, incidentally, is musically more propitious than most such miscegenation (I think specifically of what Tin Pan Alley has begot upon a dazed Hawaii). As an example, *Marcelle Vahine* could pass as either French or Tahitian. Yet it is faintly exotic to either context and actually represents much more than the sum of its two elements. In another Gallicized

ballad, *Oruitui Tau Mafatu* (The Beat of My Heart), a Tahitian girl named Loma sings with a soft sultriness that will make clear to you why Gauguin elected to live out his days on her island. The languid hula *Manuia* (Good Luck) sways like a banana leaf in the trade winds, and the record ends with the melting *Tiare Taina* (Beautiful Gardenia).

This intelligent, engaging program of Tahitian song is, I think, one of the finest available. The sole sin is one of omission: M. Guilbert has not included an example of the unique, unforgettable, wildly beautiful *himenes* sung at Catholic Church services on the islands. An approximation of these can be heard, however, in a two-disc album, *Tahiti Fête* (TT 1800), taped by Tiare Tahiti Records in Papeete and marketed in the United States by Criterion Records of Hollywood. Nonetheless, Capitol's noble effort stands as a resounding success. If your equipment permits, buy the big, broad, subtly separated stereo version; if not, buy the full-range, transparent mono. But, above all, buy it. O.B.B.



Inia Wiata

American Musicals

Done to the Queen's Taste



Helena Scott

ROMBERG: *The Desert Song*. Angel 35905, \$4.98 (LP); S 35905, \$5.98 (SD). **GRIEG:** *Song of Norway*. Angel 35904, \$4.98 (LP); S 35904, \$5.98 (SD). **LOESSER:** *The Most Happy Fella*. Angel 35887, \$4.98 (LP); S 35887, \$5.98 (SD). **RODGERS:** *Flower Drum Song*. Angel 35886, \$4.98 (LP); S 35886, \$5.98 (SD).

A YEAR AGO, Angel gave us excellent English recordings of four European light operas which were later produced successfully in this country. This year's gift from the same company offers equally fine British presentations of four American musicals which repeated their Broadway success in London. Oldest of these is *The Desert Song*, Romberg's popular musical of love and intrigue in French Morocco, which achieved a run of 432 performances at Drury Lane's Theatre Royal back in 1927. The Frank Mandel-Otto Harbach book was nonsensical, but

Romberg had written for it one of his finest scores, and people were soon whistling many of its still popular songs. The new recording provides the most extensive presentation of the score on discs. Two numbers—the somber injunction *Let Love Go*, magnificently sung by the Maorian bass Inia Wiata, and a topical number called *IT* (the quality Elinor Glyn ascribed to Clara Bow, the sex symbol of the Twenties)—have never been recorded previously. Vocally, the new edition is superior to current competitive versions, with splendid work from Edmund

Hockridge, a fine manly baritone, and on the distaff side from soprano June Bronhill.

Song of Norway arrived in the British capital in 1946, two years after its Broadway opening, and ran for over a year. A romanticized musical biography of Grieg, it followed the formula originated by *Blossom Time* (Schubert) and such later productions as *White Violets* and *Polonaise* (Chopin) and *Music in My Heart* (Tchaikovsky). The book is more satisfactory than most of its kind, but Robert Wright/George Forrest lyrics get a bit sticky. The strength of the show was the skillful adaptation of excerpts from Grieg's musical output. Of the available versions, the American original cast recording on Decca DL 9019, a transfer from a 78 recording, is showing its age badly where sonics are concerned, although the actual performance is quite strong vocally; the version on Columbia CL 1328, with good sound and a striking performance by Brenda Lewis, has little else to recommend it. The new Angel version wins hands down, with its trio of fine singers—Victoria Elliott, Norma Hughes, and John Lawrenson—really doing justice to Grieg's music. The two ladies sing quite ravishingly, with top honors going to Miss Elliott's brilliant work in *Now*. Lawrenson is consistently satisfying as Grieg, with a most enjoyable version of *Strange Music* (with Norma Hughes) as his major contribution. Only the work of Thomas Round, usually excellent, is disappointing. The performance of the Piano Concerto, neither better nor worse than in the competitive versions, does not alter my opinion of the fundamental inappropriateness of its appearance in this musical.

An unexpected hit of the English stage in 1960 was Frank Loesser's musical *The Most Happy Fella*, which opened in April and ran through the end of the year. Londoners found Loesser's ambitious score, a shrewdly contrived collection of semioperatic arias, typical Broadway production numbers, and pseudo-

Italian folk songs, as much to their taste as it had been to that of New Yorkers in 1956. Angel's original cast recording of the London production is evidence of what a splendid presentation Londoners heard. With the exception of Inia Wiata, singing the part of Tony, all the leading singers are American. Helena Scott makes a convincing and vocally charming Rosabella; Libi Staiger is a delightfully energetic and brash Cleo; and Art Lund repeats his New York performance of Joey. Mr. Wiata uses his sonorous bass voice with genuine musical distinction. His is a genuinely touching portrait of Tony, although it fails to capture the almost childlike naiveté which Robert Weede suggested in his remarkable New York performance. Angel's excerpts from the complete score parallel those found on Columbia OL 5118, but the latter is available only monophonically.

Angel's other original cast recording is of the London production of *Flower Drum Song*, a minor Rodgers and Hammerstein effort which managed to have a good run both at home and abroad. The polyglot cast (Chinese, American, French, Australian) assembled for the London presentation offers a pleasant but by no means distinguished performance of Rodgers' music. While everyone is competent and the teamwork notably fine, the performance sadly needs someone with Pat Suzuki's sparkling personality or Myoshi Umeki's winsome charm to really bring it to life. For this reason, I prefer the Columbia original cast recording.

All four albums are available in mono and stereo editions, and unless you simply must have stereo, I think you will be more than happy with the mono versions. These all have the usual warm, round Angel sound, which never becomes edgy as it occasionally does on the stereo counterparts. In any case, Angel has kept stereoistic effects to a minimum, except in *Flower Drum Song*, where there is some effort to suggest stage action. J.F.I.

"Piano Forte." Peter Nero; Orchestra, Marty Gold, cond. RCA Victor LPM 2334, \$3.98 (LP); LSP 2334, \$4.98 (SD).

The combination of Marty Gold's excellent string orchestra and Peter Nero's assured and brilliant pianism produces one of the most delightfully intimate concerts of pop standards to which I have listened in some time. Nero swings most of these numbers in a completely airy and agreeable manner, in stylings that might be called a cross between the work of Teddy Wilson and Alec Templeton. Particularly effective are his Rachmaninoff-colored version of *My Funny Valentine*, a moody *Night and Day* (into which he weaves the first movement of the Beethoven *Moonlight Sonata*), and a joyous performance of his own composi-

tion, rather tastelessly entitled *Scratch My Bach*. The arrangements, presumably by Marty Gold, are consistently ingenious without being eccentric, and they admirably complement the soloist's assured performance. Altogether this is a delightful set of miniatures. J.F.I.

"Over the Waves." Capitol Symphony Orchestra, Carmen Dragon, cond. Capitol P 8547, \$4.98 (LP); SP 8547, \$5.98 (SD).

Dragon's current London activities have yet to be heard from, but before he left the West Coast, Capitol must have accumulated a rich backlog of recordings. The present salty program includes some topnotch examples of his neo-Straussian elaborations on familiar tunes—notably a long and varied *divertissement* on *Rule*

Britannia, a deft *Blow the Man Down*, and a poignantly yet unsentimentalized setting of perhaps the grandest of all chantey-tunes, *Across the Wide Missouri*. His rescoring of the title piece is rather too elaborate and the "straight" performances (except for a beautifully dark and calm Debussy *En Bateau*) reveal that the Capitol Symphony lacks a sufficiently large string choir to balance its winds and percussion adequately in such display pieces as Glière's *Russian Sailors' Dance* and an abbreviated last movement of *Scheherazade*. However, the recording throughout matches, if indeed it does not surpass, the ultrabrilliance and vivid presence of Dragon's earlier successes, in a remarkable effective LP edition as well as the more expansive stereo version.

R.D.D.

"Cisco Houston Sings the Songs of Woody Guthrie." Cisco Houston; Eric Weisberg, banjo, mandolin, and fiddle. Vanguard VRS 9089, \$4.98 (LP).

An era of American history—the turbulent 30s of bread lines and Okies and folk-hero criminals—is fast slipping away from us. Woody Guthrie, the authentic American minstrel who transliterated the stresses of the period into ballads like *Talking Union*, *Deportees*, and *Curly-Headed Baby*, lies under the shadow of incapacitating illness; his old sidekick Cisco Houston met an untimely death a few months ago. This lends an extra dimension of pathos to the collection of Guthrie ballads here sung by Houston. Cisco made few records in recent years—our loss, and now irreparable—but in my opinion his true, mellow baritone rang with all the vigor of American life. Listen, on this recording, to the relaxed yet exhilarating treatment he accords *Grand Coulee Dam*. In sum, Vanguard here presents, in superb reproduction, the ballads of a great folk poet sung by an outstanding folk singer. O.B.B.

"Mavis." Mavis Rivers; Orchestra, Marty Paich, cond. Reprise R 2002, \$4.98 (LP).

Here is a great vocal talent—a girl who can melt your senses with her warm, sweet way with a ballad, or raise your pulse rate with her jazz-tinged version of a good up-tempo number. Whether Reprise can succeed with her, where Capitol failed, remains to be seen, but it would be a pity if she doesn't make it this time round. Backed by Marty Paich's small jazz group, an ideal supporting dectet for her stylings, she posi-

tively caresses songs like *Candy* and Harold Arlen's little gem *A Sleepin' Bee*. At the other end of the scale there is her brightly turned version of *It Don't Mean a Thing*, in which she sings the verse (all too seldom heard) and a couple of bop interludes with a sort of restrained fervor far more appropriate than the vocal mugging indulged in by too many vocalists. Then there's her . . . but why go on. . . . This is one of the prettiest vocal discs in ages. J.F.I.

"World War I Fighter Planes in Action." Riverside 95508, \$5.98 (SD).

A poignant documentation of the first war-in-the-air era and a valuable reminder to the youngsters of today that there were heroes in the skies long before Commander Shepard was even born. Such famous old crate-types as the Sopwith "Camel," Standard J-1, Curtis "Jenny," Nieuport 28, and even the Pfalz D-12 (the nemesis of German as well as Allied fliers) have been miraculously preserved in, or restored to, operational condition. We not only see them pictured and described but also actually hear them starting (with great difficulty), revving up, taking off, flying by, and landing. There is also the powerful voice of the old reliable Liberty engine (here ground-bound in a wingless fuselage) and, via dubbing, at least the suggestion of an aerial chase and an over-the-trenches reconnaissance. Perhaps not many individuals (apart from graying graduates of the Lafayette Escadrille) are in the market for a disc like this, but it should be a unique treasure for every archive of sonic history. R.D.D.

"Italia Mia." Mantovani and His Orchestra. London LL 3239, \$3.98 (LP); PS 232, \$4.98 (SD).

Out of a curious hodgepodge of Italian music—including Puccini arias, folk music, and even a smidgen of Italian-inspired Tchaikovsky—Mantovani has evolved a colorful musical portrait of his homeland. The canvas has a few dull spots, but these are compensated for by the highlights in the picture. Among the latter are a brief episode from *Capriccio italiani* (which may not be good Tchaikovsky but is excellent Mantovani), a tastefully restrained orchestral arrangement of "*Vissi d'arte*," and a good version of Di Capua's *E Bersaglieri*, which might have been more exciting had more brass been used for the martial music. I find the folk songs a little overdressed orchestrally, and those strings have a habit of becoming intrusive. Yet on the whole this is an appealing portrait, and one that should certainly please the conductor's large public. London has given him truly gorgeous sound. J.F.I.

"A Moiseyev Spectacular." Orchestra of the Moiseyev Dance Ensemble, Nikolai Nekrasov and Samson Galperin, conds. Artia 189, \$4.98 (LP).

Of all the Soviet gems that have come our way thanks to the Cultural Exchange Program, none has smote American audiences with the dazzling impact of the Moiseyev Dance Ensemble. Choreographer Igor Moiseyev—himself a classically trained dancer—has managed to synthesize the polish of the professional and the raw vitality of the peasant in his presentations. In the Moiseyev metamorphosis, traditional dances maintain

INTRODUCING THE AMERIPAK[®]

NOW! AMERICAN, the world's finest recording tape is available in a permanent plastic container **AT NO EXTRA CHARGE.**

- No more worn and torn boxes. Unlike cardboard containers, the "Ameripak" is crushproof and scuff resistant.
- The beautiful "Ameripak" is decorator designed in fashionable tan and ivory.
- "Ameripak" containers interconnect forming a handsome expanding tape library.
- Merely press a button and your tape selection is at your fingertips.

GREENTREE ELECTRONICS
1122 SOUTH LA CIENEGA BOULEVARD
LOS ANGELES 35, CALIFORNIA

For the dealer nearest you write

CIRCLE 36 ON READER-SERVICE CARD

their basic integrity but are enriched by the suppleness, skill, and insight of his dancers. The intricate interweaving patterns that characterize the troupe—along with the incredible acrobatics of the male dancers—defy the re-creative capacities of a recording; but here, for those who have seen and marveled, is the authentic musical backdrop of the performances, including the unforgettable *Venzelya*, *Snow Storm*, and *Hopak*. Clean, open sound plus unusually informative album notes completes the attractive package. O.B.B.

"Vienna Night." Boston Pops Orchestra, Arthur Fiedler, cond. RCA Victor LM 2548, \$4.98 (LP); LSC 2548, \$5.98 (SD).

These are certainly the finest performances of light Viennese music that Fiedler and his Bostonians have ever presented on records. Throughout the whole program the orchestral work is sheer delight—brilliant and crisp in the four short polkas by the Strauss Brothers, warm and soothing in the waltzes of Lehár, Waldteufel, and Vollstedt. The Lehár waltzes are virtually potpourris of music from *The Merry Widow* and *The Count of Luxemburg*, the latter one of the composer's most melodious scores; Waldteufel is represented by *The Skater's Waltz*; and Fiedler rounds out his quartet with a superb performance, complete with whistling chorus, of Vollstedt's *Jolly Fellows Waltz*, long a Boston favorite. The stereo edition eclipses the mono at all points, but nowhere more effectively than in the reverberant rumblings of *Thunder and Lightning Polka*, a real sonic dazzler. J.F.I.

"Charanga (Pachanga)." Tito Rodriguez and His Orchestra. United Artists UAS 6140, \$4.98 (SD).

Unless you're a habitu  of a local Rose-land or hip to the latest dance vogues, you probably are unaware of the sensational rise to popularity of a successor to the mambo and cha-cha—a Latin-American step called alternatively the *Charanga* and *Pachanga*, although the latter term is properly applied only to the performing nucleus-trio of flute, violin, and percussion. The flood of recordings is apparently just beginning. Certainly this example is highly attractive in Rodriguez's bouncing performances of such catchy tunes as *La Brisa e Yo*, *Manteca de Coco*, *La Comparza*, etc., and the more suavely songful *Oiganto*. A small vocal ensemble sings along in Spanish with immense gusto, the strongly stereoisitic recording is gleamingly transparent, and for good measure the disc jacket is illustrated with diagrammatic instructions for performing the proper sequence of *Charanga* steps. R.D.D.

"The International Pop Orchestra . . . 110 Men." Cameo C 2001, \$3.98 (LP); SC 2001, \$4.98 (SD).

A small company previously specializing in rock and roll records, Cameo has produced with this recording a most desirable program of light popular music. It is not only beautifully played by the 110 musicians of the International Pop Orchestra (fifty-eight of whom are string players), but it has been stunningly recorded by Michael Addey in the London studios of EMI. Although there are a couple of dreary moments—for in-

stance the sleepy, heavily cut version of *Rhapsody in Blue*, as well as the insipid performance of the *Habanera* from *Carmen*, with its la-la-la-ing female chorus—the rest of the program is completely satisfying (which makes it seem very odd that the conductor is left anonymous). I particularly liked a flaming *Ritual Fire Dance*, a very light and jaunty *Lisbon Antigua*, and the rhapsodic version of *Misirlou*. The mono sound is good, the stereo stunning—magnificent in range, directionality, and spaciousness. J.F.I.

"Percussion on Parade." Various Artists.

United Artists WWS 8515, \$5.98 (SD). An extensive and shrewdly selected sampling of the latest (and most successful) releases in the "ultra-audio" series, starring prime examples of the current Sauter-Finegan and Tito Rodriguez programs, but also notable for Ferrante & Teicher's antiphonal *Begin the Beguine*, Terry Snyder's chiming *If I Were a Bell*, Al Caiola's twangy *Jeepers Creepers*, etc. The truly ultrawide-range and markedly channel-separated recording is characteristic of the entire series, but here it is not only exploited at its best but exceptionally careful processing makes it seem at times even better than the original releases. R.D.D.

"Wiederschen mit Marlene." Marlene Dietrich; Orchestra of Burt Bacharach. Capitol 7 10282, \$3.98 (LP).

Anyone who believes that Marlene Dietrich possesses a fine singing voice should forthwith consider a hearing aid. But—and *what* a but—when Dietrich



THOROUGHbred PERFORMANCE

The Wharfedale 70 Achromatic three speaker system reproduces a pure musical image, non-colored by extraneous modulation. Wharfedale's exclusive inert sand filled panel eliminates false cabinet resonances, vibrations are damped and the three speakers perform with the enclosure as a single unit. The full range of sound, is exceptionally smooth, never strident; transient response, in bass and treble is exceptionally clean. Decorator-designed in true wood veneers. Oiled Walnut, Polished Walnut, Mahogany and Limed Oak. W70, \$164.50; W60, \$116.50; W50, \$99.50

Mail coupon, Dept. WG-21 British Industries Corp., Port Washington, N. Y.
Please send Wharfedale Achromatic Series literature.

Name _____

Address _____

City _____

State _____



Wharfedale, a division of British Industries Corp., Port Washington, N.Y.

CIRCLE 17 ON READER-SERVICE CARD

Head and Shoulders

above any other wall baffle or enclosure made today!



THE NEW
Wald inc.
DECORATOR LINE

SPEAKER BAFFLES and ENCLOSURES

The ROYALTY BAFFLE...

with its Decorator Frame, and sparkling grille cloth, has a rich "custom" appearance. 6", 7", 8" and 5x7" speakers fit without modification. Decorator Frames are available in white, beige, ivory or gray, and metallic finishes in brass, copper and chrome. All will accept any latex base paint. Exclusive Low-Frequency Ports for full range sound.



The NOBLEMAN BAFFLE

beautifully styled in ivory, beige, gray and white. Ideal for installations requiring a more functional design. Accepts 6", 7", 8" and 5x7" speakers. Exclusive Low-Frequency Port design.

EASIEST TO INSTALL... in new or existing construction

One-piece Wald plaster ring fastens to wall studs, or fits in hole cut in plaster. Baffle is attached (Royalty decorator frame snaps in place), and it's done. Fast, simple, and secure. No other parts to buy!



Write for Illustrated Catalog

Wald inc.
119 PROSPECT AVENUE, BURBANK, CALIF.

CIRCLE 24 ON READER-SERVICE CARD

launches forth in her hoarse, restricted fashion, something happens—something inexplicably magnetic or electric or empathetic or, perhaps, just emotional. Her voice conveys an undertone of irony—the cachet of our century?—an overtone of sensuality and a sense of deep intimacy. Her songs here, ranging from *Lili Marlene* to a brace of melodies from *The Blue Angel*, run the full gamut of her artistry. Taped live in Germany, the recording captures the dynamism and tension of Dietrich's return to the city that, one suspects, her heart had never left—Berlin. O.B.B.

"Hey! Look Me Over." Pete King Chorale and Orchestra. Kapp KS 3240, \$4.98 (SD).

The Pete King Chorale, one of the least pretentious of the choral groups now singing popular music, is also one of the best. Their records are great fun to listen to, and even greater fun to sing along with. (Kapp has not plastered this disc with that sort of invitation, but it is certainly implied in the zestful performances.) Variety being the spice of any program, the songs range from the sprightly title song and the gay *Give a Little Whistle*, both from *Wildcat*, to the dreamy *Misty* and the altogether charming *Scarlet Ribbons*. And you don't need to be a Caruso or Pons to have quite a ball. J.F.I.

"Motion Picture Themes Cha Cha Cha." Tito Rodriguez and His Orchestra.

United Artists WWS 8507, \$5.98 (SD). Just to prove that there's life in the old dances yet, Rodriguez's eighteen-man band turns back from the new *Charanga* to demonstrate how effectively the best-known current film hits (themes from *Exodus*, *Never on Sunday*, *The Apartment*, *Gigi*, *Dark at the Top of the Stairs*, etc.) can be adapted to deft cha-cha treatments. The clean—if exaggeratedly stereoisitic—recording and an elastic beat that never degenerates into monotony make this one of the most listenable, as well as danceable, cha-cha programs I've yet encountered. R.D.D.

"Shake It and Break It." Various Artists. Capitol TBO 1572, \$7.96 (LP).

These twenty-four great songs from the Roaring Twenties will provide a heady dose of nostalgia for men who wore baggy pants, raccoon coats, Harold Teen hats, and danced the Black Bottom, as it will for women who once sported boyish hobs, short skirts, and rolled stockings, and preferred the Shimmy. It will also probably prove irresistible to the younger generation, who over the past few years have shown an increasing interest in the musical mores of the jazz-crazy decade that Capitol inexplicably labels "Turbulent." Indestructible is the word for most of these old songs; if *All Aboard for Dixieland* and *Good-Bye Blues* hardly belong in that category, all of the remainder are still going strong. In two cases so are the artists who originally introduced them, with Paul Whiteman leading a performance of *Sun* and Nick Lucas turning in a fine *Tip-toe through the Tulips*.

Some of these recordings were issued as singles some years ago, others have been extracted from Capitol albums of a more recent vintage. The sound is consistently good (there is obviously no stereo version), and the performances capture the basic style of the period

extremely well. An exception would have to be taken to Billy May's brassy 1950 version of Irving Berlin's doleful ballad *Always*, which is completely out of place here. J.F.I.

"The Virtuoso Band." Royal Artillery Band, Major Sidney V. Hays, Jr., cond. Vanguard VRS 8087, \$4.98 (LP); VSD 2093, \$5.95 (SD).

It's virtuoso, all right, both as an ensemble heavily driving medleys of favorite marches by Alford, Sousa, and various German and French bandmasters, and in the individual and group solos featured in the novelty pieces. Of the latter, most notable are the variations on *My Old Kentucky Home* starring Walter Appleton's elephantinely gamboling euphonium, *Four in Hand* with Edward Whittall's boldly ringing coach-horn fanfares, and *Helter Skelter* with Douglas James's glittering xylophone clatter. These are frankly corny bandstand *divertissements*, but the disc must rank high for the breadth and strength of its impressively realistic recording, particularly in the stereo edition which seems freer from occasional tonal hardness than the more constricted if scarcely less brilliant LP. R.D.D.

"Here's Jonathan." Jonathan Winters. Verve V 15025, \$4.98 (LP).

As a comic, Jonathan Winters cannot be easily categorized. His humor depends less upon patter and topical gags than upon the incisively characterized—and delightfully satirized—personalities he draws from life. Senators, test pilots, TV cowboys all feel the flick of the Winters lash and all provide a deep belly-laugh. But the comedian is at his unique best in *The Thoughts of a Turtle* while crossing the Pennsylvania Turnpike. Here is brilliant humor that portrays the comic-savage world of man as seen from ground level. True, Winters is uneven—his *Child Psychiatrist* misses by a far-out kilometer and his *Portuguese Pirates* is a laugh soufflé that never rises—but when he hits he is hilarious. Good recorded sound neatly preserves the atmosphere of the original live performances. O.B.B.

"Wine, Women, and Waltzes." Medallion Strings and Percussion, Eric Vaughn, cond. Medallion MS 7519, \$5.98 (SD).

It was inevitable, of course, that the percussionists would get around to Johann Strauss and his fellow waltz kings; but luckily the present arrangers, Emanuel Vardi and Jack Elliott, have mercifully held their bongos, vibes, and other kitchenware in firm check, as well as remembered the essential role of strings in this repertory. Although some of these rescorings verge on excessive cuteness, they almost all are surprisingly bright and vivacious, with much ingenious exploitation of the antiphonal potentialities of the highly stereoisitic (and dazzlingly brilliant) recording. R.D.D.

"Golden Piano Hits." Ferrante and Teicher and Their Orchestra, Nick Perito, cond. Ultra Audio WWS 8505, \$5.98 (SD).

Although not completely devoid of gimmickry, this is reasonably straight Ferrante and Teicher, a fact that may appeal to the musical-minded more than to those who listen, with both ears, for spectacular sonic surprises. With full orchestral support, the keyboard artists

here give their personal impress to relatively familiar material. The result is fine in the haunting, eerie-sounding *Quiet Village*, in a gentle and completely musical Chopin Nocturne in E flat, and in the somber autumnal mood achieved in *Les Feuilles mortes*. In more explosive music—the theme from *Exodus* and the two concertos of Tchaikovsky (well cut, naturally) and Addinsell—the performances are equally meritorious, but how weary one becomes of hearing all three so frequently. The stereo sound tends to be overbrilliant, but is otherwise very good. J.F.I.

"The Happiest Girl in the World." Original Cast Recording. Columbia KOL 5650, \$5.98 (LP); KOS 2050, \$6.98 (SD).

Listening to the lyrics and music of *The Happiest Girl in the World*, I am baffled to discover why a New York critic called it "an Olympian hit"—unless he was utterly beguiled by the visual allure of the stage production. To me it sounds like a big, pretentious bore.

The Harburg lyrics, though they try desperately to be bright, witty, and sophisticated, merely sound empty and forced. It is, of course, virtually impossible to ruin the Offenbach music, out every effort has been made to do so by apportioning it to people who, on the evidence of this album, don't seem able to sing. Janice Rule's voice is tiny, thin, and colorless, and here she is sometimes not on pitch. Dran Seitz is a little better, but I can hardly imagine her playing a secondary role in a provincial French operetta. Some slight improvement is to be noted where the men are concerned. Bruce Yarnell has a voice, though he does not yet know how to use it well and is completely devoid of style. The situation is reversed when we come to Cyril Ritchard, who has the requisite style but no voice. Even so, Ritchard's performance, full of dry wit and some obvious tricks, is the one redeeming feature in a dull show. Stereoscopic effects are held to a minimum in the SD; and since the LP is sonically very acceptable, it is my choice. J.F.I.

"A Song at Twilight." Roger Wagner Chorale. Capitol P 8543, \$4.98 (LP); SP 8543, \$5.98 (SD).

Those with a fondness for such indestructible ballads as *Home, Sweet Home*, *Benedicite's Stream*, *In the Glomming*, and *Aloha Oe*, to mention only four of the eleven nostalgic melodies in this program, will find these well-sung performances very much to their taste. Roger Wagner's arrangements are for unaccompanied voices, with an occasional discreet use of either harp or accordion, and seldom can these beautiful old melodies have been given such complimentary settings. The Chorale, a group richly endowed with fine vocalists who sing with dazzling choral virtuosity, is reproduced in wonderfully well-spread but clearly defined sound. J.F.I.

"The Highwaymen." United Artists UAL 3125, \$3.98 (LP); UAS 6125, \$4.98 (SD).

Newest group to join the rapidly burgeoning ranks of college men turned folk singers are The Highwaymen, a quintet of students from Connecticut. In a well-diversified program, part staple



Tchaikovsky: THE SLEEPING BEAUTY—Complete. The Paris Cons. Orch. Anatole Fistoulari. BA 42001 2-12" \$3.96 complete



Bach: BRANDENBURG CONCERTOS—Complete. Stuttgart Chamber Orch. Karl Münchinger. BA 42002 2-12" \$3.96 complete

Definitive Recordings At Low Cost

\$1.98 MONO

RICHMOND A PRODUCT OF **LONDON RECORDS**

140 West 22nd St. New York, N. Y.



Tchaikovsky: THE SWAN LAKE—Complete. London Sym. Orchestra. Anatole Fistoulari. BA 42003 2-12" \$3.96 complete



Bach: ST. MATTHEW PASSION—Complete. Ferrier, Suddaby, Greene, Cummings, Bach Choir. Jacques Orchestra. BA 43001 3-12" \$5.94 complete

CIRCLE 49 ON READER-SERVICE CARD



THE NEW KLH MODEL TEN SPEAKER SYSTEM

Is smaller than our other models, Costs less than our other models, Operates with a 12 watt amplifier, And - has the KLH sound.



KLH RESEARCH AND DEVELOPMENT CORPORATION
30 CROSS STREET, CAMBRIDGE 39, MASSACHUSETTS
CIRCLE 42 ON READER-SERVICE CARD

THE GRAMOPHONE

"THE GRAMOPHONE" IS TO BRITAIN AS "High Fidelity" IS TO AMERICA.

- ★ Authoritative Record Reviews
- ★ Interesting and Informative Articles
- ★ Technical Reports

"The Gramophone" is available by Annual Subscription \$4 which can be remitted by International Money Order or Personal Dollar Cheque to:

"The Gramophone" Subscription Department (2), 49 Ebrington Road, Kenton, Harrow, Middlesex, England.



"THE GRAMOPHONE" also publish quarterly the LP CLASSICAL and POPULAR RECORD CATALOGUES—Annual Subscriptions \$3 and \$1.50 respectively

CIRCLE 35 ON READER-SERVICE CARD

Amazing, Ultra-Powerful

T-30

FM/AM

Provides Fantastic Reception



The only radios in the world
with "Panasonic Transistors"

There's a good reason why the T-30 is absolutely the finest FM-AM transistor radio in the world: "panasonic transistors", an exclusive development of Matsushita. No other radio in the world has these unique, ultra-powerful transistors, engineered for advanced FM circuitry.

That's why only the T-30 can provide such superb sensitivity with very sharp selectivity. You will find it hard to believe that such tremendous sound, such clear and satisfying music can be produced by so compact a set. Its remarkably efficient 3½" PM dynamic speaker provides sound of marvelous range and wonderful smoothness.

Remarkably inexpensive to play, the T-30 works for months on just 4 ordinary C-size flashlight batteries. Actually costs you far less than electricity.



MATSUSHITA

Electric Corporation of America
41 EAST 42ND ST., NEW YORK 17

CIRCLE 51 ON READER-SERVICE CARD

folk fare and part less familiar material from France, Canada, Bolivia, and the domestic repertoire, they show themselves to be an excellent singing group with a fine feeling for the folk idiom. They may not yet be authentic folk singers, but their work is certainly much closer to the real thing than that of many of their better-known rivals and they seldom resort to the commercial gimmickry and artifice that is such a distressing feature of many so-called folk singers. The vocal work throughout is on a very high level indeed, and I was particularly attracted by their delightful handling of the French song *A si mon moine*, their moving version of *Michael*, and above all by *Irish Work Song*, a fine American folk song with a pleasant dash of Hibernian humor. J.F.I.

"Bonneville 1960: Sounds on the Salt Flats." Riverside RLP 5506, \$4.98 (LP).

"Grand Prix of the United States, 1960." Riverside RLP 95021, \$5.98 (SD).

Last fall's Grand Prix race (won by Sterling Moss) is well reported in authentic sound, informative commentary, and a few pit-stranded driver interviews, but in general this documentary is too uneventful to attract attention of listeners other than *aficionados*. RLP 5506, however, is packed full of vivid sonic and motor interest in over thirty snapshot recordings of the varied hot-rodders, motorcycleists, and both amateur and pro racers essaying official speed trials on the famous Bonneville flats. There are snarling starts and buzzing pass-bys representing everything from a 93.45-mph one-cylinder kart-sized Schapel-Orndorf to Mickey Thompson's record-smashing four-engined 406.60-mph *Challenger 1*, all identified in detail in the jacket annotations and many (but particularly the first turbojet racer, Dr. Nathan Ostich's *Flying Caduceus*) producing impressive aural evidence—even in monophony—of awesome power and speed. R.D.D.

"Far Away Places." Enoch Light and His Orchestra and Vocal Ensemble. Command RS 822, \$5.98 (SD).

The latest program from the pioneer in percussion discs sports a distinctive new timbre in Billy Rowland's closely miked, incisively clashing harpsichord, but that advantage (and the more familiar ones of the channel-jumping Kraus & Rosen-garden bongos, Phil Bodner's flute, etc.) is considerably negated by the omnipresence of a four-man and one-woman vocal group whose insipid la-la-lah-ing and do-de-doh-ing contribute little to *Waltzing Matilda*, *Sunrise over Sumatra*, the theme from *Sundowners*, and nine other mildly exotic pieces. The ultrabright, ultrastereoistic recording is as spectacular as ever, however, and the starred harpsichord provides a plenitude of steep wave-fronted transients. R.D.D.

"Play, Emery, Play." Emery and His Violin of Love; Orchestra and Chorus, Sid Feller, cond. ABC 354, \$3.98 (LP).

With or without his Violin of Love, Emery Deutsch has been purveying this sort of fiddling schmaltz for many years. Although it now seems a bit old-fashioned, it still effectively conjures up the romantic overtones of these sentimental ditties. It is fortunate that he is in such good form, for he gets little assistance from the spasmodic vocal ef-

forts of the mixed chorus or from Sid Feller's consistently plodding orchestral arrangements. The orchestral sound is overpowering and almost ruins the soft-lights-and-sweet-music atmosphere. J.F.I.

"More Music for Relaxation." Melachrino Strings and Orchestra. RCA Victor LPM 2278, \$3.98 (LP); LSP 22/8, \$4.98 (SD).

Melachrino seems perfectly content to continue as one of the most reliable purveyors of the form of musical therapy that induces calm and serenity of mind. The prescription, as in the past, calls for several soothing pop standards and a leavening of light classics (this time Schubert and Chopin), all enveloped in silky, smooth arrangements and presented in luscious sound (in the SD version achieved, incidentally, by cutting the highs considerably). Once again, the treatment is undeniably very effective, particularly in a lovely lilting performance of *The Champagne Waltz*, a wonderfully restful version of *Drifting and Dreaming*, and an almost hypnotic version of *Softly, Softly*. J.F.I.

"Military Marches." Al Melgard, organ. Audio Fidelity AFSD 5908, \$5.95 (SD).

Melgard's labored, when not slapdash, performances come close to outright travesties of the familiar (and a few unfamiliar) marches here, but the monstrous Chicago Stadium organ never has boomed and blared more formidably, nor its pedal tones threatened more dangerously to shake the strongest woofer cones right out of their anchorage, than in these relatively distantly miked, incredibly powerful and broadspread recordings. Thick as the sonics may be, they are incomparably *big*, and if for nothing else spectacularly unique for the longest reverberation period any audio engineer has yet dared to cope with. R.D.D.

"This Is Norman Luboff." Norman Luboff and His Choir. RCA Victor LPM 2342, \$3.98 (LP); LSP 2342, \$4.98 (SD).

If the Norman Luboff Choir is "The Greatest Choir Ever," as RCA Victor proudly claims in block capitals, what a dispiritingly lightweight assortment of music this is on which to waste its talents. I certainly don't quarrel with the performances, which have the elegance, suavity, and richness of tone for which the group is famous, and RCA Victor's sound is faultless, particularly in the stereo version: but *Beer Barrel Polka* and *Get Happy* should be left to other hands. J.F.I.

"Mad Drums." Rolley Polley and His Ensemble. Capitol ST 1454, \$4.98 (SD).

The title is a complete misnomer, for although Bobby Black's originals and arrangements feature a wide variety of mostly Latin-American percussion instruments, these are deftly integrated into imaginative and far-from-frantic ensemble *divertissements*. Several of these (*Bongo Bash*, *Blue Rumba*, *Bangkok Beat*, and *Swingin' the Samba*) are wholly charming. Unfortunately, however, Black calls elsewhere for an electronic organ whose ugly qualities are also only too candidly captured in the markedly stereoistic recording. R.D.D.

JAZZ



Red Allen: "Plays King Oliver." Verve 1025, \$4.95 (LP); 61025, \$5.95 (SD). Red Allen seems bent on making up for all the slapdash excesses he has indulged in for the past twenty-five years. His recent recordings with Kid Ory gave encouraging evidence that Allen could still be a meaningful, disciplined trumpeter; this set, with a group of his own, adds to that evidence. The basic lustiness in Allen's best playing is present here, but it is controlled and directed, in both his open horn and muted work, creating a crackling edginess and electricity in his playing. Sammy Price adds strong piano solos on a couple of pieces, and clarinetist Buster Bailey's presence is also helpful. The only real lapse is a "Dixie Medley" in Allen's worst tourist trade vein.

Bunny Berigan and His Orchestra: "Bunny." RCA Camden 550, \$1.98 (LP).

These dozen reissued selections cover Berigan's big swing band from its start in 1937 to mid-1939. It was a steadily improving group, as the difference between the first session (*Carelessly*) and the last two (*Deed I Do* and *Sobbin' Blues; There'll Be Some Changes Made, Little Gates Special, and Jazz Me Blues*) testifies. By the time these later titles were cut, it had become a solidly swinging band with such authoritative soloists as Don Lodice, Georgie Auld, and Joe Bushkin, in addition to Berigan. Berigan was a sloppy soloist—there are lapses in almost all of his appearances—but once past these slips he created such compellingly warm, aptly phrased solos that his failings are readily overlooked. Both as a sampling of the work of a major jazz trumpeter and as examples of good Swing Era playing, this collection is well worth while.

"The Bix Beiderbecke Legend." RCA Victor LPM 2323, \$3.98 (LP).

Of these twelve selections (by the orchestras of Jean Goldkette, Paul Whiteman, Hoagy Carmichael, and Beiderbecke), seven have previously been reissued on LPs that lingered only briefly in Victor's active catalogue. Of the new material on this re-issue, the main point of interest is the discovery of a short, previously unknown Bix solo on Goldkette's 1924 recording of *I Didn't Know*. The record itself is a period piece, and it is interesting to find that the only part of it which has not dated is Beiderbecke's cleaned half chorus. But, except for devoted Bixites, this brief solo scarcely justifies acquiring the disc if one already has the

earlier LP reissues. Bing Crosby and the Rhythm Boys are heard on some of the Whiteman sides, and an awkward female trio on Goldkette's *Sunday*.

John Coltrane: "My Favorite Things." Atlantic 1361, \$4.98 (LP); S 1361, \$5.98 (SD).

On two of these four long performances, Coltrane is heard on soprano saxophone. He plays it in much the same way he plays tenor—with a lean but warm tone, varying between suspended, wailing lines and rolling runs. His mannerisms are most effective in the rocking waltz tempo of Richard Rodgers' *My Favorite Things*, since the accompaniment sketched in by pianist McCoy Tyner provides a contrasting accent to Coltrane's steady outpour. Coltrane has reached a point of synthesization now, and apparently no longer finds it necessary to run through an entire scale every time he wants to find a note—a move toward economy that gives his playing much more interesting form than it had before. There is, however, a constant sameness in the texture of these pieces, and one's attention is apt to wander. Tyner breaks the spell with an occasional piano solo, but when there are only two soloists involved it scarcely seems necessary for pieces to go on so long.

Johnny Dankworth and His Orchestra: "Collaboration." Roulette 52059, \$3.98 (LP); S 52059, \$4.98 (SD).

Dankworth's English band, slightly supplemented, plays Stravinsky's *Ebony Concerto* and, with the London Philharmonic, two works commissioned by that orchestra: *Improvisations for Jazz Band and Symphony Orchestra*, and *Rendezvous*. For various reasons, the disc amounts to an elaborate trip to nowhere. Stravinsky's *Concerto*, written in 1945 for the Woody Herman band, is a hovering, crouching piece that never springs. Just why he should write this soft, subdued work for the powerhouse Herman band is puzzling. Its main drawback as a work for a jazz band is not that it has no overt jazz qualities but that it lacks something essential for anything related to jazz—the possibility of swinging. The two works with the London Philharmonic point up the essential incongruity of attempting to ally jazz horns and symphonic strings.

The Bobby Donaldson Group. Jazz Unlimited 1003, \$4.98 (LP); \$5.98 (SD).

Although this is a shallow, sloppily pro-

duced set, one track deserves the attention of anyone who treasures the Ellington band in its prime. It is called *Yah, Yah, Yah*, and it features two remarkable trombone choruses by Elmer Crumbley which completely capture the phrasing and intonation of Ellington's master trombone growler, Tricky Sam Nanton. Crumbley, a onetime Jimmie Lunceford trombonist, hasn't been heard from in years, and he appears here only on this track. There are a few other good spots by Seldon Powell, on tenor saxophone, and Irv Stokes, trumpet, but for the most part this is trivial stuff.

Don Ellis: "How Time Passes." Candid 8004, \$4.98 (LP); 9004, \$5.98 (SD).

Ellis, a trumpeter, is a member of the avant-garde, and though one may detect an occasional reflection of Ornette Coleman in the work of his quartet (Jaki Byard, piano and alto saxophone; Ron Carter, bass; Charlie Persip, drums) it is much better organized and directed than Coleman's. Furthermore, Ellis and Byard show a more positive command of their instruments. Ellis' *Improvisational Suite No. 1* occupies one disc side, a piece described as free association on twelve-tone rows. It moves between free time and strict time, between lyrical passages and staccato scratches. Some portions are outright jazz, others have an oblique relationship to jazz, and still others defy classification. It lasts twenty-two minutes, seven seconds and requires considerable patience from the listener. Ellis is much less demanding in the shorter pieces. One of them, *Sallie*, is a relaxed and lyrical ballad on which he achieves admirable dynamics with a mute. He and Byard rollick through *A Simplex One*, which maintains a swinging stance within Ellis' own musical terms. There is nothing obvious in his work, but he has the musicianship and the imagination to hold one's attention even when he is shifting tempos and breaking lines down to stabs and squeaks.

Bob Havens: "In New Orleans." Southland 226, \$4.98 (LP).

Havens is a trombonist who became so attached to the jazz of New Orleans when he played there several years ago as a member of Ralph Flanagan's band that he decided to stay on for awhile. Although he has recently joined Lawrence Welk (following in the footsteps of another New Orleansian, Pete Fountain) he made some worthy contributions to current New Orleans jazz while he was there. He is an admiring follower of Jack



**TAKE
THE
GUESS
WORK
OUT OF
STEREO**

To achieve the utmost in realism through stereophonic sound reproduction it is mandatory that the audio signals of all recording and playback channels be maintained in phase. Out-of-phase stereo reproduction results in confused directionality, diffuse sound, loss of bass response and reduction in center instrument presence.

The **STEREOSONICS PHASE COORDINATOR** provides a simple and effective way to determine the phase of any audio signals or stereo high fidelity components. It may be used to measure the phase and stereo effectiveness of discs, tapes, multiplex broadcasts and microphone setups, and to distinguish honest two channel stereophonic material from pseudo or doctored stereo.



FEATURES: High impedance transformer inputs to permit use with all studio 600, 300, 150; or 75 ohm grounded or ungrounded line systems, as well as with any high fidelity component.

Individual input level controls, adjust meter sensitivity for a wide range of input signal levels.

Function switch converts the **PHASE COORDINATOR** to a dual channel balance meter.

May be removed from oil finished wood cabinet for easy rack or panel mounting.

Cabinet Dimensions: 9 1/2" wide, 4 1/2" high, 3" deep.

Price: \$27.50 Audiophile net at your high fidelity dealer.

For further information
write to DEPT. P

**STEREOSONICS INC.
BOX 4205**

Long Island City 4, New York

CIRCLE 69 ON READER-SERVICE CARD

Teagarden, using some of Teagarden's involuted phrasing, and achieving a big tone. But he can also produce a rough and ragged attack that is closer to George Brunis than to Teagarden. He plays well here in a generally good company which is at its best charging through ride-out choruses. The group frequently uses a muted brass trio (two trumpets and trombone) with a perky, driving style descended from the staccato brass attack associated with Red Nichols in the Twenties. To offset the disc's good points, there are two unfortunate vocals by trumpeter Tommy Gonsoulin.

Freddie Hubbard: "Goin' Up." Blue Note 4056, \$4.98 (LP).

Hubbard's high-spirited, electrifying trumpet excursions flash fleetingly through these pieces, occasionally catching fire but just as often fizzling damply. He has challenging company, however, in a newly vitalized Hank Mobley, a tenor saxophonist who has been grinding along in desultory fashion for many years but shows in some of these selections a well-directed, surging, authoritative attack that suggests he may be on the verge of finding himself. And there's also McCoy Tyner, a pianist who can dig in with a strong projection when he is not hypnotizing himself with long, weaving lines of unshaded notes. It's very much an in-and-out affair, several cuts above a routine blowing session but scarcely an essential part of any jazz collection.

Quincy Jones and Band: "I Dig Dancers." Mercury 20612, \$3.98 (LP); 60612, \$4.98 (SD).

Two earlier LPs by the Quincy Jones band were actually studio products made before the complete band was assembled. This disc contains the first numbers recorded by the group which made its bow last year in Europe and toured there for eight months. (These eight selections were made in Paris; four others were cut in New York by a more recent version of the band—but the uninformative liner notes by the well-known jazz authority Dorothy Kilgallen fail to say which are which.) In view of the remarkable personnel that Jones assembled for both versions of his band, this is a disappointingly lightweight set. Even with a year's experience behind it, the group has no positive personality, and the arrangements that are offered in this set are largely cut and dried. There are occasional solos so characteristic as to be readily recognizable (Clark Terry, Phil Woods, Julius Watkins—again, the notes let the listener guess) which brighten some of the pieces. But most of this is faceless, professionally competent, commercial music that might have come from one of the Elgart brothers' bands; in fact, they do this sort of thing better.

Gerry Mulligan and the Concert Jazz Band: "At the Village Vanguard." Verve 8396, \$4.98 (LP); 68396, \$5.98 (SD).

The promising record debut of Mulligan's band (Verve 8388) is fulfilled and expanded on this second disc. It opens with an old favorite of Mulligan's quartet days. *Blueport*, translated into one of the most surgingly swinging big-band performances to find its way onto records—a succession of roaring ensemble explosions that lead to drivingly urgent

solos by Mulligan and Bob Brookmeyer, and a brilliant climactic exchange between Mulligan and Clark Terry. Only slightly less provocative is a nudging, edgy swinger called *Let My People Be* on which Terry opens up his whole bag of trumpet tricks in a wildly exhilarating solo. Balancing these are a pair of slow ballads, beautifully evolved, showing the high lyrical level to which Mulligan has brought the somewhat recalcitrant baritone saxophone. Mulligan's band, in less than a year's time, has achieved a loose, easy propulsion—a hallmark of really good big-band jazz all but nonexistent in recent years.

New Orleans, the Living Legends. Riverside 356/357, \$9.98 (Two LP); 9356/9357, \$11.98 (Two SD).

The Negro jazz musicians of New Orleans have been shamefully neglected for the past thirty-five years. Occasionally, itinerant researchers have sought them out, but the only record company that specializes in current New Orleans jazz, Southland, records a select group of white musicians over and over while the local Negro talent is ignored. That the Negro talent exists, and in relative plenty, is shown on this two-disc set made by Riverside with its mobile recording studio. For the first time, we are able to hear some neglected and now aging jazz performers who play with the basic fire that gave jazz its original incentive in New Orleans—and to hear them in technically adequate recordings. There are magnificent trumpet performances by Dede Pierce—beautifully constructed solos and pungent, cutting accompaniments to the blues singing of his wife, Billie. There are the joyous, exultant clarinet of Albert Burbank, and the soft mellow tones of another fine clarinetist, Louis Cottrell. (Cottrell has not been recorded since the early Thirties because he is president of the Negro local of the musicians' union and, since the few sessions involving New Orleans Negroes have usually been nonunion or cut-rate affairs, it did not seem judicious to invite the union president to take part.) There is a brilliantly propulsive banjoist-guitarist, Emmanuel Sayles; a richly lyrical trombonist, Louis Nelson; the Humphrey brothers (Percy, trumpet, and Willie, clarinet); and Jim Robinson playing rugged, traditional trombone. Eight different groups are represented, all achieving at least some measure of compelling interest. Many tend to get off to a ragged start, but once they get rolling these men can pour it on with great ensemble discipline. Riverside has done a real service by presenting these musicians while they are still capable of such creditable performances.

Bill Russo and His Orchestra: "Seven Deadly Sins." Roulette 52063, \$3.98 (LP); S 52063, \$4.98 (SD).

Russo's rundown of the seven deadly sins is an amusing and inventive bit of composing. Greed is a hip-swinging theme; lechery, a sonorous trombone over whining cellos; gluttony, heavy but busy; and so on. Russo has done much more than simply depict the sins musically, however, for his orchestrations are lively and adventurous, and his orchestra (a semi-permanent group rather than the custom-

Continued on page 74

TELL 'EM YOU
HEARD IT ON

ARGO

THE BEST OF ARGO JAZZ

Eleven outstanding selections from that many Argo LPs, all swinging, all important, all recorded in the glistening sound that is Argo's hallmark.

The price?

An unbelievable \$1.98.

The same for stereo.

ALPS 1

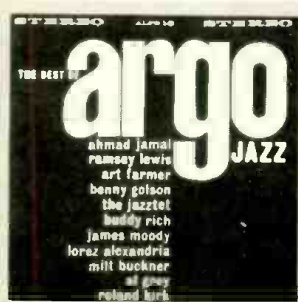

BENNY GOLSON

Benny starts with an unaccompanied solo, then adds a man on each cut until this LP culminates in a surging 10-piece orchestra. A backbreaking challenge that Golson meets in superb fashion.

ARGO LP 681

LOREZ ALEXANDRIA

A sumptuous singer, backed warmly here by the strings of Riley Hampton. Lorez makes a moving excursion through some of the fine ballads of our time, coming up with her best recording to date.

ARGO LP 682



PROFESSOR PARADIDDLE

Drums, Drollery, and Drive! brings into sharp focus one of the funniest gentlemen you are likely to ever meet. The Professor rarely allows his drumming talent (?) to get in the way of his flow of wit.

ARGO LP 4008

**JOHNNY HAMLIN
/MARCI MILLER**

A slick, robustly swinging, quintet that gains added sheen from the presence of Miss Miller on five tracks, she being the former Ray Anthony singer. Good jazz sounds and an unusual blending of instruments.

ARGO LP 4001

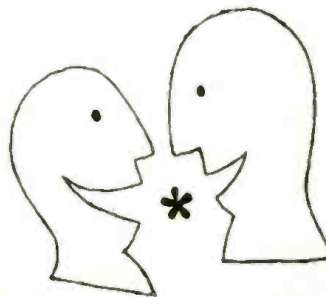

* AVAILABLE IN STEREO. OF COURSE. AT NO EXTRA CHARGE

ARGO RECORDS 2120 S. MICHIGAN AVENUE, CHICAGO 16, ILLINOIS

CIRCLE 6 ON READER-SERVICE CARD

MORE NEW SOUNDS AND GREAT NAMES

FROM THE
FABULOUS



FERRANTE and TEICHER • Golden Piano Hits
WWS 8505 (Stereo) WW 7505 (Mono.)

TERRY SNYDER • Footlight Percussion With a Bongo Beat
WWS 8508 (Stereo) WW 7508 (Mono.)

EYDIE Gorme & STEVE Lawrence • COZY
WWS 8509 (Stereo) WW 7509 (Mono.)

TITO RODRIGUEZ • Motion Picture Themes Cha Cha Cha WWS 8507 (Stereo) WW 7507 (Mono.)

SAUTER-FINEGAM • The Return of the Doodletown Fifers
WWS 8511 (Stereo) WW 7511 (Mono.)

RALPH MARTERIE • 88 Strings
WWS 8506 (Stereo) WW 7506 (Mono.)

OTHER ULTRA AUDIO RELEASES

TERRY SNYDER & the All Stars • Unique Percussion
WWS 8500 (Stereo) WW 7500 (Mono.)

DON COSTA • Echoing Voices & Trombones
WWS 8501 (Stereo) WW 7501 (Mono.)

NICK PERITO • Blazing Latin Brass
WWS 8502 (Stereo) WW 7502 (Mono.)

AL CAIOLA • Guitars, Woodwinds & Bongos WWS 8503 (Stereo) WW 7503 (Mono.)

FERRANTE & TEICHER • Dynamic Twin Pianos WWS 8504 (Stereo) WW 7504 (Mono.)

Also Available in the New Deluxe 3500 Series Package
(Monaural Only) at \$3.98



AND WALL TO WALL SOUND... MONAURAL
ULTRA AUDIO A product of UNITED ARTISTS RECORDS • 729 7th Avenue • New York 19, N. Y.

CIRCLE 73 ON READER-SERVICE CARD

Listening Post to the world of Opera

Britain's only magazine devoted entirely to Grand Opera — "OPERA" — is your listening post to world performances. Vivid reports by British and Continental authorities, with graphic photographs. OPERA, founded by the Earl of Harewood, is essential reading for opera lovers.

Edited by Harold Rosenthal with regular contributions from John Warrack, Philip Hope-Wallace, William Mann, Andrew Porter and Desmond Shawe-Taylor.

So that you may enjoy and judge this magazine for yourself, mail the coupon below with \$1 bill or check, and three different specimen copies will be sent to you by return of post. Then you will want to have it sent to you regularly.

Send \$1 for three specimen copies of OPERA

CLIP COUPON AND MAIL WITH \$1 BILL OR CHECK

To: OPERA, Rolls House Publishing Co. Ltd., Rolls House, Breams Buildings, London, E.C. 4, England
I enclose \$1. Please send me three different specimen copies of OPERA.

NAME

ADDRESS

HF 61

CIRCLE 76 ON READER-SERVICE CARD

ary studio pickup outfit) is well rehearsed. Unlike most efforts at extended composition for jazz groups, which usually get bogged down in pretentiousness, Russo's work maintains an atmosphere of sprightly entertainment.

Doc Severinsen and His Orchestra: "Tempestuous Trumpet." Command 33819, \$4.98 (LP); 33819 SD, \$5.98 (SD).

Doc Severinsen, who was one of the major points of excitement in the Charlie Barnet and Tommy Dorsey orchestras a dozen years ago, has been swallowed up in studio work since then. This album, his first, is based on the rather tired idea of using tunes associated with other trumpeters, but Severinsen rises above it by consistently being himself. "Himself" is a virtuoso instrumentalist with great range, a beautifully full, brassily clear tone, and a temperament that goes from serene lyricism on *Star Dust* to a fierily tempestuous display on *After You've Gone*. Severinsen engenders excitement no matter what he is playing (in this case, he wanders back and forth across the borderlines of jazz), and the soundly conceived big-band arrangements (written by Bobby Byrne) are given added sparkle by typically intense Enoch Light recording.

The Soul of Jazz Percussion. Warwick 5003, \$4.98 (LP); 5003 ST, \$5.98 (SD).

Three slightly different groups (involving such performers as Bill Evans and Mal Waldron, piano, Don Ellis, Donald Byrd, Booker Little, and Marcus Belgrave, trumpet, Curtis Fuller, trombone, Ed Shaughnessy and Philly Joe Jones, drums, and others) work their diverse ways through selections of varying quality which, in the stereo version, have been gimmicked up so that the instruments wander from channel to channel. Such nonsense aside, there's some reasonably good jazz to be found here, particularly in a serene bit of mood setting written by Mal Waldron, *Quiet Temple*, in a crisp and amusing little vignette, *Construction Crew* (also by Waldron), and in Alonzo Levister's ominous *Prophecy*. Shaughnessy's drumming helps his pieces to breathe easily, and both Evans and Waldron keep the piano passages on a high level. The net result might have been better, however, if the entire disc had been given over to a single good group instead of the set's being pulled together in bits and pieces.

Fats Waller: "In London." Capitol 10258, \$3.98 (LP).

These sides, recorded in London in 1938, are pretty thin Waller. Six of the tunes are spirituals and spiritual-type tunes (*Lonesome Road*, for instance) played as pipe organ solos, performances that may be of more interest to pipe organ enthusiasts than to jazz fans. On the remaining six selections, Waller is accompanied by a small English band which serves only to point up the excellence of the swinging little group with which he worked in the States. Waller, singing and playing the piano, is relatively unquenchable (less so when he is playing the pipe organ), but that organ and the English band, between them, somehow manage to burden this set with a tired and plodding air.

JOHN S. WILSON

HIGH FIDELITY MAGAZINE

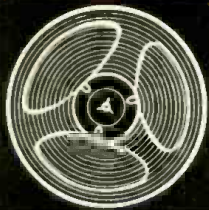

the **Tape Deck**

Reviewed by R. D. DARRELL

The following reviews are of 4-track 7.5-ips stereo tapes in normal reel form.

BEETHOVEN: *Symphony No. 9, in D minor, Op. 125 ("Choral"); Overture: Leonore No. 3*

Jennifer Vyvyan, soprano; Shirley Carter, mezzo; Rudolf Petrak, tenor; Donald Bell, baritone; BBC Chorus; London Symphony Orchestra. Josef Krips, cond. • • EVEREST TT 43-006 (twin-pack). 79 min. \$11.95.

Announced last fall, this first tape representation of the highly praised Krips series of all nine symphonies and several overtures has been unavailable until now for review. It is especially welcome, and I hope that other tapings in the series (and also several other important reels promised but not yet delivered by Everest) are actually on their way. The only 4-track Ninth we have had previously is Ansermet's lucid, but sonically somewhat lightweight, version for London—a fact which heightens the appeal of Krips's larger-scaled, more heroic, and sonically more monumental performance. Interpretatively this is perhaps the closest present-day approach to the restrained strength and lyrical nobility of the famous Weingartner reading (Krips was, of course, a Weingartner apprentice in his youth). It is slightly handicapped by a merely routine vocal quartet, but this is more than compensated for by the excellence of the chorus and by really magnificent orchestral playing—the power of which is impressively captured in the bold, broadspread stereoism, which boasts a dramatically wide range of dynamics.

The best known of the *Leonore* overtures is admirably played too, and perhaps slightly more reverberantly recorded. It is somewhat surprising that the labels credit the London Symphony here also, since an Everest official has publicly noted that "as a matter of expediency" the overtures in this series were recorded in this country by a "different" orchestra (possibly the Symphony of the Air?).

BERLIOZ: *Overtures*

Le Carnaval romain, Op. 9; Béatrice et Bénédicte; Le Corsaire, Op. 21; Benvenuto Cellini, Op. 23; Les Troyens à Carthage: Royal Hunt and Storm.

Boston Symphony Orchestra, Charles Munch, cond. • • RCA VICTOR FTC 2059. 44 min. \$8.95.

However one evaluates Munch in other repertoires, it's generally agreed that his preeminence as a Berlioz interpreter has

been challenged only by Beecham—and the latter's recordings of some of the present works date well back into the pre-stereo era. With the exception of the popular *Roman Carnival*, these selections are all tape firsts and in their idiomatic authenticity (to say nothing of their orchestral virtuosity, particularly in the breathtakingly fleet *Corsaire* and whimsically resilient *Béatrice et Bénédicte*) they are not likely to be soon surpassed. The smooth stereo spread and transparency are extremely effective at their best here, although there may be some lack of the ultrabrilliance of the latest technology. (Released only a few months ago in disc form, the recordings apparently were made several years



Munch: preëminent in Berlioz.

earlier.) And while the tape also discloses the differences in quality between the A and B sides which Paul Affelder noted in his disc review, the slightly less sharp tonal focusing in the second side is not as obvious in the tape processing.

BRAHMS: *Concerto for Piano and Orchestra, No. 2, in B flat, Op. 83*

Rudolf Serkin, piano; Philadelphia Orchestra. Eugene Ormandy, cond. • • COLUMBIA MQ 347. 48 min. \$7.95.

Serkin's latest recording of the Brahms Second, gravely passionate and nobly expansive, has been deservedly ranked as first of all the available disc editions in Harris Goldsmith's discography of the Romantic Piano Concerto—which alone would justify hosannas for its prompt release in reel form. In addition it sup-

plies an alternative to the rather ambiguously meritorious Richter-Leinsdorf version, one extraordinarily thrilling in some respects but quite uneven, especially in soloist-orchestra integration. Serkin's approach is more heroic, yet he is romantically lyrical too, and if his tonal colorings are never as sensuously rich and as subtly varied as Richter's best, they are blended more satisfactorily with the orchestral sonorities, which in turn are more precisely controlled and contoured by Ormandy than by Leinsdorf. Particularly effective here is the poetic eloquence of the solo cellist in the slow movement and of the first horn player throughout. The recording, bold in breadth, auditorium authenticity, and dynamic range, is more uniformly impressive. So, while the fascinations of Richter still remain well worth investigating, it is the better-rounded and more substantial satisfactions of Serkin and Ormandy that are surest to prove the most rewarding investment.

BRAHMS: *Hungarian Dances (8): Nos. 1, 5, 6, 7, 12, 13, 19, 21*
†Dvořák: *Slavonic Dances (5): Nos. 1, 3, 8, (Op. 46); 9, 10 (Op. 72, Nos. 1, 2)*

Vienna Philharmonic Orchestra. Fritz Reiner, cond. • • LONDON LCL 80069. 44 min. \$7.95.

Some of the reasons why Reiner is respected so highly by musicians are made evident in this recording, where he achieves a harmonious blending of American (or Chicagoan) precision and bravura with the riper sonic warmth unique to the Vienna Philharmonic. His performances are romantically and tonally richer than is usual in these familiar, but inexhaustibly delectable dances, but even for those who theoretically prefer a lighter, more "folkish" treatment, Reiner's carry their own seductive conviction—one powerfully enhanced here by notably full-blooded and spacious stereo recording. My only complaint is that the selections (especially of the *Slavonic Dances*) are all too few: conductor and orchestra are obviously enjoying themselves so much that it's a shame they couldn't complete both series.

CHOPIN: *Concerto for Piano and Orchestra, No. 1, in E minor, Op. 11*

†Mendelssohn: *Capriccio brillant, in B minor, Op. 22*

Gary Graffman, piano; Boston Symphony Orchestra, Charles Munch, cond. • • RCA VICTOR FTC 2050. 48 min. \$8.95.

The prodigiously talented Graffman

MASS HIGH FIDELITY

OR

MODERN HIGH FIDELITY

There is an inevitable time lag between laboratory developments in high fidelity and the time when they come into popular use.

Writers on high fidelity, unfortunately, often praise products that are, technically speaking, obsolescent.

LECTRONICS, engaged in basic research, and in conjunction with research labs all over the world, has decided to offer its data to a wide audience through the LECTRONICS NEWSLETTER. Do you want to know of the pending, revolutionary changes in dynamic speakers? Do you want the latest, most accurate knowledge on mono and stereo record playback?

If so, you will want to write for Copy One of the LECTRONICS NEWSLETTER. It's free.

LECTRONICS

OF CITY LINE CENTER, INC.

7644 CITY LINE AVENUE
PHILADELPHIA 51, PA.

CIRCLE 47 ON READER-SERVICE CARD

EXPLOSIVE!

4 TRACK STEREO TAPE



ST-90054



Biggest "SOUND" of the Century
— with real Cannon & Bells!

Write for free catalog 77 of
over 200 Bel Canto releases.

Manufactured and Nationally Distributed by:

h Bel Canto Stereophonic Recordings
a subsidiary of Thompson Ramo Wooldridge Inc. 
1977-1985 McAllister Ave. COLUMBUS, OHIO

CIRCLE 16 ON READER-SERVICE CARD

seems miscast here, even more than in his earlier tapings of the Brahms First and Beethoven Third Concertos. In his meticulous articulation only the physique of the work is delineated: its poetic spirit never comes to life. Neither the overbig orchestra playing (lovely though it is in the slow movement) nor the solid, strongly stereoisitic recording enhances the music's essential grace and delicacy. The shallow but glittering little Mendelssohnian showpiece, however, is a far more suitable vehicle for Graffman at the present stage of his career, when his technical prowess remains so far in advance of his capacity for emotional projection. Except for a few overponderous orchestral tuttis, it comes off with dazzling éclat, and here the solidity and brilliance of the recording technology is just right for so virtuosic performance.

ROSSINI: Quartets for Woodwinds:
No. 1, in F; No. 4, in B flat; No. 5, in D; No. 6, in F

Samuel Baron, flute; David Glazer, clarinet; Bernard Garfield, bassoon; John Barrows, horn.

•• FERRODYNAMICS CS 1204. 45 min. \$7.95.

SCHUBERT: Quartet for Flute, Guitar, Viola, and Cello, in G, D. 96; Quintet for Piano and Strings, in A, Op. 114, D. 667 ("Trout")

Karl F. Mess, flute; Arthur Faiss, guitar; Heinz Kirchner, viola; Siegfried Barchet, cello (in the Quartet). Istvan Nádás, piano; Felix Galimor, violin; Karen Tuttle, viola; Laszlo Varga, cello; Julius Levine, bass (in the Quintet).

•• FERRODYNAMICS CS 1201. 53 min. \$7.95.

Here are some diverting discoveries for the innumerable listeners who failed to make their acquaintance in the original Period disc versions of 1958 or earlier. Three of the Rossini tidbits originated as schoolboy sonatas for strings (recorded on discs by I Solisti di Zagreb) which were later transcribed for woodwinds, but No. 6 is supposed to have been composed specifically for the latter medium—a supposition given some validity by the obviously idiomatic character of its long Variations movement. Whether one relishes these miniatures for their clear foreshadowings of Rossini's later operatic writing or simply for their own innocent tunefulness, they are often quite moving and always great fun. Skilled members of the New York Woodwind Quintet play them delightfully. The markedly stereoisitic recording still sounds bright, but the miking is so close that many of the more intense passages are unnaturally shrill. There is a good deal of background noise, and the first minute or two of side B is marred by tape speed uncertainty. I hope the latter fault is confined to my review copy only; the other technical flaws are hardly serious enough to spoil one's pleasure in such charming music.

Schubert's *Trout*, colorlessly performed here, has been superseded by a more vital version by Glazer, Sorkin, et al., on Concertapes 4T 4004. But the singularly scored Quartet, hitherto untaped, boasts unique appeals. Schubert added a second trio to the minuet movement and a part for cello to a *Notturmo*,

Op. 21, written by Wenzel Mategka, a Czech composer now remembered, if at all, by the fact that Schubert chose to embellish upon his composition. One has only to listen for a moment here to discover what enchanted Schubert. The present players obviously relish it too: their performance is a gem of piquancy and touching expressiveness. The recording, while a bit drier and less closely integrated than present-day stereo technology favors, still provides clean and translucent sound.

"Exodus." Original Sound Track. Sinfonia of London. Ernest Gold, cond. RCA Victor FTO 5007. 35 min., \$8.95.

"Music from Exodus." Hollywood Studio Orchestra, Mitchell Power, cond. United Artists UATC 2224, 45 min., \$7.95.

Ernest Gold's powerfully dramatic music for the film success is so pervasively somber, for all its excitements, that anyone who denigrates the discrimination of mass public tastes would never have expected its sound track disc versions to rise and cling to a near-top spot in the best-seller lists. The welcome taping of this composer's performance demonstrates how compelling it is, even to listeners who have never seen the film itself or read the Uris novel. And if Power's rival reading is less authoritatively played, it is recorded with almost as much dark breadth, and includes, curiously, a few additional sections of the score which Gold himself omits from the Victor recording.

"Genius Hits the Road." Ray Charles, vocals and piano, with Ralph Burns and His Orchestra. ABC-Paramount ATC 820, 34 min., \$7.95.

My sole previous encounter with the proteanly versatile Charles (on Atlantic) left me unimpressed, but while there is more of the same often overaucous orchestral playing here (and some of the same superfluous choral bits), the soloist himself reveals both his vocal and personality-projection powers to much better advantage in a geographically—and stereoisitically—panoramic program. The list is topped by jaunty versions of *Alabama Bound*, *Mississippi Mud*, *Chattanooga Choo Choo*, *New York's My Home*, etc., plus an effectively contrasted, if highly sentimental, *Carry Me Back to Old Virginia* (in blues style) and *Georgia on My Mind*.

"Jealousy." Percy Faith and His Orchestra. Columbia CQ 341, 46 min., \$6.95.

Unlike a large segment of the general public, I've found little to admire in Faith's recent performances, most of which have struck me as too fancily arranged and overbrashly played and recorded. But the reformation here is astonishing: both his talent for ingenious scoring and the skills of his orchestra are exploited with consistently good taste and a high degree of imagination. *Tia Juana*, *Temptation*, *Most Beautiful Girl in the World*, *Begin the Beguine* are outstanding, but the whole program is notable for its romantic effectiveness and for rich, quite distantly miked, yet always vivid stereo.

"The Greatest Horn in the World." Al Hirt, trumpet; Henry René and His Orchestra. RCA Victor FTP 1082, 33 min., \$7.95.

Hirt is indeed a remarkable trumpet virtuoso; if he is, at the same time, limited to cliché figurations in his improvisations and incapable of producing other than pinched and strained tones, these deficiencies were no great handicap in his indefatigably driving contributions to the Dixieland ensembles in which he has been featured in earlier recordings. But here he is starred as a soloist, and the unaccustomed prominence stimulates him to uninhibited displays in the worst possible musical and sonic taste. Unfortunately, too, the ultraclear stereo recording spares us none of his ugly screaming and meaningless floridities, nor the crude raucousness of René's heavy-handed accompaniments.

"Happy Go Lucky: Honky Tonk Piano."

Lucky Roberts and His Trio. Ferrodynamics CS 1210, 39 min., \$7.95. Hardly my idea of a honky tonk specialist, Roberts is an almost legendary representative of the early Harlem pianists who bridged the ragtime and jazz eras, and as such his genuinely happy-go-lucky playing has notable old-time charm and authenticity. *Sweet Georgia Brown, Bullin' the Jack, and Runnin' Wild* are irresistibly bouncing. I'd like to hear much more of his solo work, however; he shares honors here rather too generously with Garvin Bushell's zestful but less distinctive clarinet and alto sax. The well-spread stereo gives little indication that it actually dates back to 1958.

"My Very Good Friends the Bandleaders." Ted Heath and His Music. London LPM 70009, 36 min., \$6.95.

This anthology of British tributes to outstanding swing-era leaders and hits (*Sing Sing Sing, Tuxedo Junction, One O'Clock Jump*, etc.) commands some respect for its own virtuosity, its effective stereo, and the big studio acoustics. But it is primarily interesting for comparison with the memorable original versions by Goodman, Miller, Basie, Ellington, *et al.*—and as new proof that even the ablest of imitations and modern technology can never efface the memories of the real McCoy.

"Never on Sunday." Original Sound Track, Manos Hadjidakis, cond. United Artists UATC 2225, 35 min., \$7.95.

Not the least of the piquant attractions of Jules Dassin's Greek film success is the vibrantly strumming musical score by Hadjidakis, with its exuberantly improvisatory playing of native musicians on the *houzoukia* and other, mostly guitarlike, instruments. Fresh from seeing the film, I am perhaps unduly delighted with the opportunity of rehearing the music by itself; even if those who encounter it for the first time here find a few of the episodes a bit wispy, they surely will relish the more substantial ones—especially the various appearances of the Oscar-winning title tune, heard at least once in star Melina Mercouri's haunting vocalization. And in contrast to the usual movie theatre sound reproduction to which one may be unhappily accustomed, the technical qualities of this taping are lucid, crisp, and gleamingly colored.

For those who love *live* music!



This AM/FM stereo tuner, the STROMBERG-CARLSON® SR-445A, is one of the finest available. It is designed for music lovers who are determined to carry the orchestra—harp, horn and bassoon—out of the concert hall into their own homes. Here is a superb AM circuit that closely matches the sensitive wideband FM circuit for truly smooth and superb stereo realism. And here, in addition to unequalled performance, is STROMBERG-CARLSON decorator-styled beauty. Suggested list price \$139.95.

For the sheer joy of listening . . . THERE IS NOTHING FINER THAN A STROMBERG-CARLSON®

GENERAL DYNAMICS | ELECTRONICS

For component catalog write: Commercial Products Division, Box AJ, 1407 N. Goodman St., Rochester, N. Y.
CIRCLE 33 ON READER-SERVICE CARD

*dedicated
to
perfection*



TRANSISTORIZED
4-TRACK STEREO TAPE DECK
MODEL RP-100W
Completely assembled, wired and tested.
\$395.00

MODEL RP-100K
Semi-kit. Includes a completely assembled and tested transport, electronics in kit form.
\$289.95

Perfected 4-track stereo/mono recording, 4 & 2 track playback. True high fidelity transistor electronics, individual for record & playback, plus separate record & playback heads permitting off-the-tape monitor. 2 recording level meters, mixing, mic & level controls, switched sound-on-sound recording. Electro-dynamically braked supply & take-up reel motors; hysteresis synchronous capstan motor. Individual solenoids for pinch-roller & tape lifters. All-electric, interlocked push-button transport control & interlocked safety "record" pushbutton. Precision tape guidance & sweep loading — no pressure pads. No slurring or tape bounce problems. Digital turns counter. Vertical or horizontal mounting. Modular plug-in construction. An original, exclusive EICO product designed & manufactured in U. S. A. (patents pending).

NEW MEDALIST LINE



FM-AM STEREO TUNER ST96

Kit \$89.95 Includes Metal Cover and FET Wired \$129.95

FM and AM stereo tuners on one compact chassis. Easy-to-assemble: prewired, prealigned RF and IF stages for AM and FM. Exclusive precision prewired EYE-TRONIC® tuning on both AM and FM.

FM TUNER

Switched AFC (Automatic Frequency Control). Sensitivity: 1.5uv for 20db quieting. Frequency Response: 20-15,000 cps ±1db

AM TUNER

Switched "wide" and "narrow" bandpass. High Q filter eliminates 10 kc whistle. Sensitivity: 3uv for 1.0V output at 20db S/N ratio. Frequency Response: 20-9,000 cps ("wide"); 20-4,500 cps ("narrow").

OF EICO STEREO



70-WATT INTEGRATED STEREO AMPLIFIER ST70

Kit \$94.95 Includes Metal Cover Wired \$149.95

40-WATT INTEGRATED STEREO AMPLIFIER ST40

Kit \$79.95 Includes Metal Cover Wired \$129.95

BOTH AMPLIFIERS: Complete stereo centers plus two excellent power amplifiers. Accept, control, and amplify signals from any stereo or mono source.

ST70: Cathode-coupled phase inverter circuitry preceded by a direct-coupled voltage amplifier. Harmonic Distortion: less than 1% from 25-20,000 cps within 1db of 70 watts. Frequency Response: ±½ db 10-50,000 cps.

ST40: Highly stable Williamson-type power amplifiers. Harmonic Distortion: less than 1% from 40-20,000 cps within 1 db of 40 watts. Frequency Response: ±½ db 12-25,000 cps.

Over 2 MILLION EICO instruments in use. Most EICO Dealers offer budget terms.

There's an EICO for your every stereo/mono need. Send for FREE catalog.

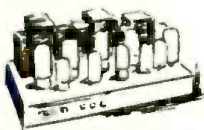

Listen to the EICO Hour, WABC-FM, N. Y. 95.5 MC, Mon.-Fri., 7:15-8 P.M. © 1961 by EICO, 33-00 N. Blvd., L. I. C. 1, N. Y.



EICO, 3300 N. Blvd., L.I.C. 1, N. Y. HF-7
 Send free 32-page catalog & dealer's name
 Send new 36-page Guidebook to Hi-Fi for which I enclose 25¢ for postage & handling.
 Name
 Address
 City Zone State

Add 5% in West.

Export Dept., Roburn Agencies, Inc., 431 Greenwich St., New York 13, N. Y.

CIRCLE 28 ON READER-SERVICE CARD

High Fidelity Newsfronts



Audio Avoirdupois. Most of us associate deep voices with large bodies (a string bass, Salvatore Baccaloni, a full-range speaker's enclosure). Well, the size and contour of a string bass are unlikely to change. The Falstaffian proportions of Mr. Baccaloni are altogether appropriate to the famous basso-buffo and we'd be the last to suggest that *he* change. Speaker systems? They get slimmer by the minute.

The Audax speaker division of Rek-O-Kut has a new, complete, full-range (40 to 18,000 cps, according to the firm) speaker system called "The Sonoteer." The cabinet is only 4 in. deep and quite handsome in the bargain. The other dimensions: 21 in. by 25 in. The speaker complement of The Sonoteer includes two woofers, two midrange, and a super-tweeter. Its price is \$79.95.

Jensen also has a new thin speaker that measures only 3 $\frac{3}{8}$ in. front-to-back. The slim profile, according to Jensen's Ralph Glover, results from the use of a flat-plane diaphragm in the woofer and a ceramic magnet which allows a $\frac{3}{4}$ -in. excursion of the woofer. Additionally, this three-way system has a midrange speaker, two tweeters, and an ultra-tweeter. Designated the 3P2, the slim system is priced at \$159.50. Other new systems from Jensen include the 3P1 at \$119.50 which boasts of being "half a bookshelf" in depth (5 $\frac{1}{2}$ in.), and the 3P3 furniture group which maintains



Audax: slim profile, big voice.

the customary hefty size but employs the firm's new speakers. Of the 3P1 and the 3P2, Jensen says that Baccaloni sounds like Baccaloni in spite of the speakers' thinness.

Four-Track Tape Player. Another in the growing roster of playback decks or "tape phonos" is Tandberg's Model 65. This unit is a three-speed deck which features

a playback head for two- and four-track stereo and mono prerecorded tapes. Facilities also are provided for adding record and erase heads, when and if the buyer chooses to do so. Frequency re-

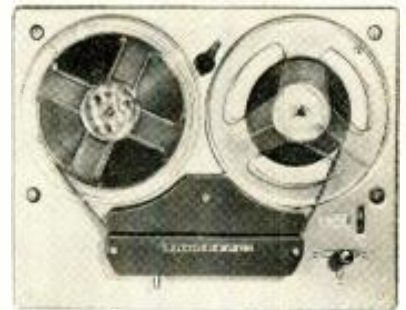

Tandberg: play now, record later.

Revised Capture Ratio Figure. The following letter, a copy of which was received here, is self-explanatory.

Mr. Fred Mergner
Chief Engineer
Fisher Radio Corp.
21-21 44th Drive
Long Island City 1, N.Y.

Dear Mr. Mergner:

I have carefully rechecked the capture ratio of the 202-R tuner which we tested for HIGH FIDELITY magazine. I am happy to say that it proved to be considerably better than the original figure. I made several observations, at different signal levels, and came up with a figure of 2.0 db quite consistently.

I suspect that there were some hand capacity effects in the original observations which caused the higher reading. In any event, I am satisfied that the 2.0 db figure represents a reasonably accurate figure for the unit we have tested. This was taken at 100% modulation, incidentally.

I am sending a copy of this letter to . . . HIGH FIDELITY, and so far as Hirsch-Houck Laboratories is concerned, we would be quite willing to have you use the revised figure in any reprints you use. Of course, HIGH FIDELITY will have to grant you the permission to reprint the report. I don't know how you will handle the revision of the capture ratio figure: perhaps as a footnote to explain the difference from the published report, or some other procedure acceptable to HIGH FIDELITY.

Very truly yours,
HIRSCH-HOUCK LABORATORIES
Julian D. Hirsch

The report referred to ran in our May issue. We are delighted to learn of the improved capture ratio figure; it indicates even finer FM performance than we attributed originally to the 202-R tuner.

—Ed.

sponse at 7 $\frac{1}{2}$ ips is claimed to be 30 to 20,000 cps, plus or minus 2 db. The Model 65 runs on a hysteresis-synchronous motor and features a 4-digit revolving counter. It measures 16 by 12 by 6 inches and weighs 16 pounds. Tandberg of America, Inc., Pelham, N.Y., urges those seeking more details to check with their local Tandberg dealer.

Shakespeare and Electronics. The immortal words of William Shakespeare were given a non-mortal reading at a recent session of the Acoustical Society of America when scientists from Bell Telephone Laboratories demonstrated how an electronic computer could recite the "To Be or Not To Be" soliloquy from *Hamlet*. Of course, as far as the computer was concerned, to be or not to be (alive) was not the question. It merely had synthesized the speech from "instructions" fed to it on punched cards by Bell scientists Doctors John L. Kelly, Jr., and Louis J. Gerstman.

For an encore, the computer simulated a deep baritone voice and sang a verse of *Bicycle Built for Two*—on pitch. The serious side of this recital had to do with the use of a computer in research at Bell Laboratories for gaining a better understanding of the nature of speech. Bell advises, however, that actors and entertainers need not fear being superseded by the talents of the computer. Computers cost more by the hour than live talent, and it takes up to twenty-five minutes of computer time to produce one minute of "speech."

"Outboard" Stereo Preamplifier. Shure Brothers, Inc., has announced its M65 stereo preamplifier said to provide the voltage boost and equalization needed to operate a magnetic phono pickup through an amplifier originally designed only for a ceramic cartridge. According to the manufacturer, it also can be used "without circuit modification as a micro-

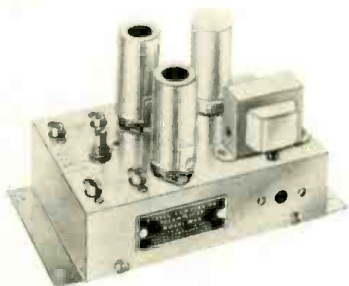

M65 preamp for stereo conversion.

phone or tape head preamplifier." The unit is self-powered and has twin sets of "in" and "out" signal jacks as well as a function selector switch. Price is \$24. For details, write to the manufacturer at 222 Hartrey Ave., Evanston, Ill.

Cybernetics, Canto II. Another manufacturer laying claim to effective "human design engineering" is Bell Sound of Columbus, Ohio. Says Bell: "We not only make components *appear* easy to operate—they *are* easy to operate." The most-often-used controls have large white knobs. The less-frequently-used, or "pro-

fessional" controls, are subordinated in color, shape, and size (small and black against a dark green background). In prose that throbs a bit more than that of the ordinary press release, Bell frowns upon the stereo components "designed to represent an engineer's dream" but which are "actually nightmares to the average music lover and his family." How easily does a Bell unit work? Simply pull the volume control (a combination push-pull on-off switch preset to a comfortable level) and the music plays.

Literature, Free and Otherwise. Shure and Bell, by the way, show signs of furthering the trend by many manufacturers in issuing attractive booklets as well as attractive products. The latest item from Shure is its new product catalogue, which is sent free on request. And for twenty-five cents, Shure will send a copy of the company's "The Art of Selecting, Playing, and Preserving Records."

"Not long ago," writes John Conly in "All About Stereo" (published by Bell Sound Systems), "I received a song recital record—contralto and piano. It was a good recital, but my comment to my wife . . . was: 'Sounds like Town Hall in New York.' She looked at the jacket notes and said: 'It is Town Hall.' That is a true story, and that is what I mean by the reproduction of space. It makes for easy, easy listening. It's stereo—for real!"

Bell Sound reports that the booklet by Conly is a runaway best seller (at thirty-five cents, by the way). Write Bell at 555 Marion Road, Columbus 7, Ohio.

The Grommes Division of Precision Electronics, Inc., 9101 King St., Franklin Park, Ill., goes with the trend toward showing amplifiers and tuners in "decorator settings." Included in the new Grommes full-color catalogue are décor ideas originating from such houses as Herman Miller and Paul McCobb which the purchaser of component high fidelity can put to work.

A rather elegant brochure, which shows an equally elegant component high-fidelity line in various settings, issues now from Sherwood. The purpose of the brochure is to convey information about Sherwood's "Correlaire" furniture, holding Sherwood components. The furniture is modular; it lends itself to a number of different arrangements, depending on specific room requirements. If you want to plan, or maybe just dream, write to Sherwood Electronics Laboratories, Inc., 4300 N. California Ave., Chicago 18, Ill.

Radio Shack Corporation, the Boston mail order firm, has published a 24-page record and tape catalogue (No. 105) that is free for the asking. Just write to the firm at 730 Commonwealth Ave., Boston 17, Mass.

Compatible Discs. Five independent record manufacturers reportedly will soon produce "compatible" records which are intended for rendering monophonic sound when played on single-channel equipment, as well as stereo when played on stereo equipment. The five labels are

Stereo Sound

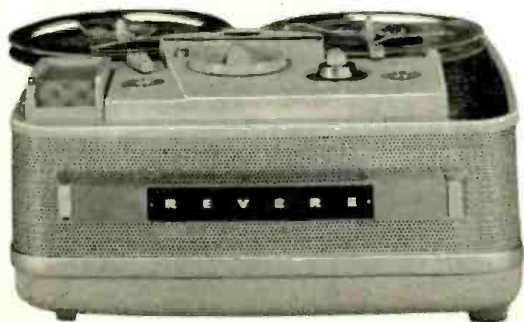

This NEW REVERE T-2200 Stereo Tape Player Recorder and matching Stereo Companion Unit combine beauty and simplicity with the full-dimensional brilliance of famous Revere "Balanced-Tone" stereo sound. Companion Unit, with space for tape storage, self-contained amplifier, controls, and microphone, facilitates stereo recording and second channel playback. Revere Recorders are backed by the research and experience of 3M, makers of "Scotch" Brand Magnetic Tapes. The T-2200 Player-Recorder is priced under \$240, matching Companion Unit under \$70, both for under \$310. At fine music and photo stores everywhere.



Sounds of Our Times, Golden Crest, Tops, Stereodiddies, and Project Records. Until recently only Design Records had been actively promoting compatibility, although a report from the Audio Engineering Society's recent convention in Los Angeles tells of a demonstration by International Sound, Inc. of a stereo/mono disc called "Stereo-O-Matic."

Cy Leslie, president of Pickwick Sales, merchandising arm for Design, holds that the compatible disc can "stimulate buying on the part of people who were contemplating converting from mono to stereo and had stopped buying records." Leslie further points out that compatible discs can "save dealers the trouble and expense of stocking mono and stereo versions of the same record."

Disagreement in audio circles over the quality of compatible discs centers largely on whether such a record can provide as full a response, particularly on the bass end, as a record that is made to be either mono or stereo. With the former type, of course, there is "compatibility"—in the sense that it can be played on both mono and stereo equipment. The latter type, however, may be damaged when played with a mono pickup. What about the new compatibles? We'll wait and see—or rather hear.

Kits Abroad. Pacotronics, Inc., of Glendale, N.Y., has extended its PACO kit line of high-fidelity components and test instruments to include a European firm on a royalty basis. Kits, which have enjoyed an increasing share of the U.S.

market for some time, are, in the words of PACO, "in the infancy of what is expected to be a substantial growth in Europe. It is generally felt by U.S. high-fidelity manufacturers that Western European countries are historically 'about ten years behind' the U.S. in the use and understanding of component high fidelity." The company's present plans include PACO licensing arrangements in six European nations.

Kits at Home. Do-it-yourself components and accessories, including novel tools for kit builders, continue to pour forth here. One particularly engaging kit is a huge speaker system announced by Polycoustic Co., 958 Arguello Drive, San Leandro, Calif. Dubbed the "PC-28K," this 29 $\frac{7}{8}$ -by 41 $\frac{3}{4}$ -by 9 $\frac{1}{2}$ -inch system is described as a "vented infinite baffle" that houses no less than twenty-eight separate speakers. True, the speakers themselves are not large ones, but they do add up. According to Polycoustic, the group that handles low frequencies has a piston area "equal to four 15-inch speakers." Details are available from the manufacturer; a kit report on the unit is planned as soon as we find shelf space for those 28 speakers during the building of the kit.

Among the new tools available is a handy "Tuck-Away" soldering iron listed at \$2.95 by Sampson Co., Electronics Division, 2244 South Western Ave., Chicago 8, Ill. The unique thing about this iron is its handle which actually is a hollow bakelite sleeve that can be fitted

to either end of the iron. Thus, when the iron is not being used, it can be covered and tucked away. The tip furnished is round, and comes to a fine point, which is nicely suited for most kit-building chores, including working on printed circuits. The iron is rated at 30 watts and heats up sufficiently for most under-chassis work. We found it an efficient and practical little tool.

Not exactly in the kit department, but more of a do-it-yourself maintenance gadget is the "Stereo Stylusmaster" announced by Prestige Products, 13647 Burbank Blvd., Van Nuys, Calif. This \$5.25 device is intended to simplify and assure correct alignment of stereo car-

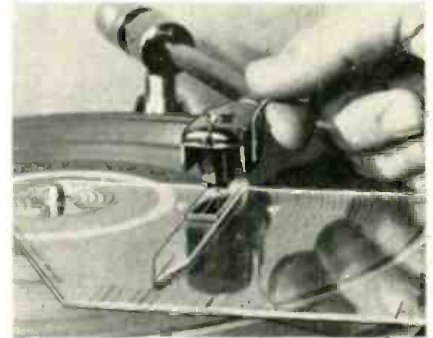

Reflection shows stylus alignment.

tridges, and provides checkups on tracking angle and stylus overhang. Two plastic, calibrated sections, one with a mirror,



pure and sim

SPECIFICATIONS: Plays and records 2 and 4 track stereo tapes at 7 $\frac{1}{2}$ and 3 $\frac{3}{4}$ IPS • Up to 8 hours monaural playing time on double length tapes • Patented braking system eliminates tape tearing • High frequency erase • Automatic head demagnetization • Rapid-forward and rewind • Two-level recording indicator • P. A. system, appliance power outlet • Frequency response: (both channels) 40-18,000 \pm 3 db at 7 $\frac{1}{2}$ IPS; 40-13,000 CPS \pm 3 db at 3 $\frac{3}{4}$ IPS • Powerful 8-watt maximum output on upper channel • Signal from lower channel pre-amp output: $\frac{1}{2}$ to 1 $\frac{1}{2}$ volts; cross talk —50 db; extension speaker output impedance: 8 ohms • Size 7 $\frac{1}{2}$ " x 14" x 14" each unit • Complete with microphone (each unit), hi-fi cables, radio-TV cords, audio cables, 7" reel with tape, take-up reel.

Revere

CAMERA COMPANY

A Subsidiary of

MINNESOTA MINING AND MANUFACTURING COMPANY

...WHERE RESEARCH IS THE KEY TO TOMORROW

Chicago 16, Illinois





now hear this!

You are looking at the new ADC-1 stereo cartridge. It is the most effortless cartridge available today. You'll hear subtleties of timbre and tone you never suspected were in your discs. Hear it at your favorite dealer.

AUDIO DYNAMICS CORPORATION
1677 CODY AVENUE
RIDGEWOOD 27, N. Y.

ADC

CIRCLE 10 ON READER-SERVICE CARD

RUDOLF SERKIN

Continued from page 28

two concertos (K. 453 and K. 503) with his old schoolmate Szell and the Cleveland Symphony Orchestra and six others with Schneider leading the Marlboro student body. "Love and understanding for Mozart came rather late in my life as a musician," Serkin once said. "His music didn't mean much to me until I was thirteen or fourteen."

He showed all the signs of becoming an accomplished Mozartean when he was seventeen. That was when he met violinist Adolf Busch, also a man of complete seriousness about music, in Vienna in 1920. Serkin was invited to join him for an evening at a friend's home. After the night's playing Busch said to Serkin, "We will tour in the spring. You must live at my house in Berlin and work until then." When Serkin was moving in as he was told to, the first person he met was Busch's four-year-old daughter who sized him up and informed him that she would marry him when she was eighteen, and did. Serkin made his Berlin debut playing the Bach *Brandenburg* No. 5 Concerto with Busch's group in a performance so well received that an encore for the pianist alone was indicated. Serkin thought quickly about what he knew best by memory, then swung into the *Goldberg Variations*, which he ended fifty-five minutes later. A year later the Busch group settled down to recording the *Brandenburgs* on 78-rpm discs in London. Serkin recalls that it required seventy-three rehearsals to get the pieces fit for performance, but very little time to record them. The preparation shows. Dubbed on to LP, the series is still considered by many discriminating listeners the best existing recording.

Serkin came to the United States in 1933 to play with Busch at the Coolidge Festival in Washington, D.C. He returned in 1936 to play the Beethoven Fourth Concerto with Toscanini leading the New York Philharmonic-Symphony Orchestra in Carnegie Hall. "It is very rarely that the performance of a soloist can match an orchestral interpretation directed by Arturo Toscanini," the late Olin Downes wrote of that debut in the *New York Times*. Serkin's did. was Downes's judgment, and he added that the pianist's playing "had only the qualities of mastery, and none of the qualities of sensationalism about it." Before and after these trips to this country Serkin lived in Basel, Switzerland, with his bride, their small home connected to his father-in-law's larger one by a library the two families shared. Months before World War II broke out in Europe, the Busch-Serkin ménage moved to the United States, eventually to Vermont, where assorted Busches settled first, the Serkins later, and chamber music ever since.

AWAY from the Green Mountains, Serkin earns the costs of keeping his family and Marlboro afloat by giving concerts and recitals for which his fee is in the top (or \$2,500) vicinity and by serving on the faculty of the Curtis In-

stitute in Philadelphia. Last year he granted himself a year's leave from concert work and Curtis so that he could have time to restudy a number of Bach cantatas and Haydn quartets which he will never perform. Inquiries about why he should spend time studying music that has no role for a pianist got the answer which performers interested mainly in their earnings find so unsettling. "They are such beautiful music," is all Serkin says.

He finds recordings particularly painful to make. His *Moonlight* Sonata, which has sold more than 100,000 copies since it was made in 1951 for Columbia, is regarded by that company as the longest siege ever waged to get 23 minutes and 18 seconds of music played to the artist's satisfaction. Columbia would like to get Serkin to record all thirty-two Beethoven sonatas, but at the *Moonlight* rate this would run into about three Serkin lifetimes. "I'm not very good for recordings," Serkin says. "Or maybe recordings are not very good for me." He would much sooner be a fifth for Brahms's Opus 34 or a duet partner of Pablo Casals in the Bach Sonatas.

Serkin has been a regular at all the cellist's annual levees at Prades, Perpignan, and Puerto Rico, and Casals turned up at Marlboro last summer to repay the courtesy. Serkin was proud that the old Spaniard was impressed by the seriousness of the scene, and as he said as much he stopped short and remembered to correct an error in an earlier conversation about second-fiddling. "I had that wrong," he apologized. "What Sascha must have said is that Casals is the world's second-greatest second violinist. So that makes me perhaps the third. That's what he told me I was . . . the world's third-greatest second violinist. It's a very good thing to be, yes?" Serkin looked like a man worried about whether he had said something vain. He had not.

FM PORTABLES

Continued from page 38

telescoping dipoles. It was with a perverse kind of satisfaction that we finally drew in our metal masts and switched on the car radio (Motorola, vintage 1955).

When we arrived, at night, at our new home (some hundred and twenty-five miles from our former suburb) we felt somewhat disoriented. Technological progress doesn't seem to have done much to alleviate the ancient miseries of Moving Day. We contemplated blankets, clothes, and the instant coffee packed in the back seat for the next morning's brave start. We wished it were the morning, when the moving van would arrive. In the meantime we did, of course, have our armful of FM portables.

Feeling as if we were expecting too much, we brought the sets in from the car, and shortly afterwards found ourselves settled, with our belongings scattered around us, on the floor before the fireplace. Extending antennas and pushing buttons wildly, we at once got the well-known rushing noise between sta-

tions (none of these sets has anything like a muting control), and then—a Brahms quartet. When it was over and the announcer told us we were listening to a branch station of the QXR network, we felt we were back among the living. We sat up with the network that night.

The absence of nearby neighbors (nearby in the city or suburban sense, which means close enough to be annoyed at a few decibels in the night) meant we could turn up the volume as far as it would go. Even in a 30-foot room, the sound from these little instruments is quite loud, albeit with some distortion. Since then, other sounds from other equipment—more glorious, more faithful to the original—have filled that room and continue to reaffirm the promise of real high fidelity. But that night, with the sound of music picked from the air on a set that weighs less than my regular system's preamp, or even one of its tweeters, is one I will not forget.

IN its ability to deliver and perform sans wires, sans outside antenna, sans complications, the transistorized FM portable makes its unique claim to attention. Of course, the quartet of sets I have mentioned are not the only available models: a good many other sets in this class are being produced and sold, at varying prices and of varying performance capabilities. As portables go, none of the FM units can be called exactly low-priced. The Westrex III, for instance, with its unique "phonotape" attachment, lists for \$189.95; FM units without the player cartridge device sell for less, as does the cartridge player alone. The smooth-sounding Zenith goes for \$149.95. A model by Matsushita is priced at \$79.95, one by Toshiba at \$89.95, an entry by Lafayette at \$69.95. The Columbia portable costs \$99.95, as does a new model from Sony. Both of these last-named are stylish and compact: the Sony comes with an earphone for really private listening, as well as provision for using an external antenna; the Columbia unit includes short-wave band. Norelco's dependable L-498, with its long slide-rule tuning scale and push-button operation, sells for \$99.95.

The apparent burgeoning of FM portables can be traced to two prime developments. One has to do with the general increase of interest in FM broadcasting and programming. The other relates to the increasing importance of transistors, their availability for consumer use, their lowered cost, and the widening knowledge of their application, particularly (at this stage in the art) in tuners and low-powered audio circuits. Knowledge of transistors is not yet as certain and advanced as with vacuum tubes. One thing, however, is certain—and quite comforting, thanks to the FM portable: whatever the reason one may leave home ground temporarily—business trip, vacation, journey abroad, or just a day at the beach or picnic ground—the need to put up with third-rate program fare and low-grade sound no longer is a concomitant condition. The FM portable can add the sound of music to all journeyings, making the pleasant more so, the tedious less so.



Model 7 Stereo Console

Performance Specifications that are Unequaled Anywhere!

The full meaning of Marantz Quality becomes clear when you compare competitive performance with those inherent in the Marantz design. Here is how much more you get for your investment in Marantz.

- **LOWEST DISTORTION** ... by at least 2½ times!
- **LOWEST HUM & NOISE** ... by at least 3 times!
- **HIGHEST SENSITIVITY** ... by at least 50%!
- **GREATEST ACCURACY** ... for better reproduction!
- **FINEST CONSTRUCTION** ... better quality, inside and out!
- **MOST RELIABLE** ... backed by new TWO YEAR warranty!

Write for folder 41F

marantz

25-14 Broadway, Long Island City 6, N. Y.

CIRCLE 50 ON READER-SERVICE CARD

EICD new Transistor Stereo/Mono 4-track Tape Deck

Model RP 100W
Completely assembled, wired and tested with 3 heads; and stereo record and stereo playback preamplifiers.

Model RP 100K
Semi-kit includes transport completely assembled and tested with 3 heads; and control electronics, stereo record, and stereo playback pre-amplifiers in easy-to-assemble kit form.

Write for full specifications

TAPE STORAGE OR CARRYING CASE

reg. 9.95, now 5.95

(Heavy wood construction, waterproof vinyl covering. Holds up to 24 tapes.)

reg. 2.45, now 1.49

(Pressed cardboard, holds 10 tapes or 60 45 rpm records.)

SAXITONE RECORDING TAPE

*Oxide guaranteed not to rub off or slip—our money back. Compare ours with other "Bargain" tape. You'll find it's more than just "cheap" when you deal with us. We are original purveyors in the tape recorder business and our reputation means everything to us.

600' acetate (plastic), 5"	75
600' MYLAR 5" reel	95
600' MYLAR (Polyester) 5"	99
1200' MYLAR 1/2 mil, 5" reel	1.18
1200' Acetate (plastic), 7"	1.19
1200' MYLAR 1/2 mil, 5" stereo	1.68
1800' acetate (plastic), 7"	1.79
1800' MYLAR 1 mil, thick 7"	1.99
2400' MYLAR, unoxidized, 7"	2.89
2400' MYLAR, oxidized, 7"	2.99

Studios, Large Users Even Lower. Plus Postage

TAPE STORAGE CAN

Unique twist-lock insures dust-free moisture-proof, non-breakable. High impact styrene. Ideal shipping container. reg. 89c now 59c



FERRO-DYNAMICS
"Bookshelf" open end case reg. 1.25, now 89c

30% off Entire Stock Pre-recorded Music Tape 30% off

NORELCO SPEAKERS

DISCONTINUED MODELS: Famous 9777—successor to 9710M (with coil)—original list \$29.95, (40-20,000 cycles) usual NET 23.97, **NOW 11.98!** also 3800M—list \$9.00, usual NET 0.00, now 4.95 while they last. **PLUS POSTAGE.** Other sensational speaker reductions on a first come, first served basis. **SEND FOR SPEAKER SPECIFICATION SHEET.**

SAXITONE TAPE SALES

(DIV. OF COMMISSIONED ELECTRONICS, INC.)
1776 Columbia Rd., NW, Washington, D.C.



CIRCLE 23 ON READER-SERVICE CARD

BUILD-YOUR-OWN ELECTRONIC ORGAN

STEP UP TO AN

Artisan

GREATEST NAME IN ORGAN KITS

20TH CENTURY SUCCESSOR TO THE PIPE ORGAN



PIPE-LIKE TONE AND APPEARANCE

DIRECT FACTORY TO OWNER SAVES 50%

Dept. HF-7

WORLD'S LARGEST SELECTION OF ORGAN KITS, ACCESSORIES AND CUSTOM-BUILT ORGANS

Send for FREE literature.

ELECTRONIC ORGAN ARTS, INC.
4949-H YORK BLVD., LOS ANGELES 42, CALIF.

CIRCLE 29 ON READER-SERVICE CARD

PURCHASING A HI-FI SYSTEM?

TIME PAYMENTS AVAILABLE
Up to 2 years to pay!

Send Us Your List of Components For A Package Quotation

YOU CAN BUY WITH CONFIDENCE AT AIREX

All merchandise is brand new, factory fresh & guaranteed.

FREE Hi-Fi Catalog Available on Request

AIREX RADIO

CORPORATION

85-HF Cortlandt St., N. Y. 7, WO 4-1820

- Jim Lansing*
- Altec Lansing
- Electrovoice
- Jensen • Harlicrafter
- Hartley* • Gonset
- USL Citizen Band
- Texas Crystals
- University
- Acoustic Research
- Janszen • Viking
- Whartedale
- Concertone
- Bell • G.E.
- Weather's
- Harman-Kardon
- Eico • Pilot
- Sherwood*
- Tandberg*
- ESL • Frazier
- Superscope
- Dual Changer*
- Bogen • Leak
- Dynakit • Fisher
- H. H. Scott
- Thorens*
- TEC • Roberts
- De Wald
- Sony • Challenger
- Wollensak
- Garrard
- Miracord
- Glaser's-Steers
- Rek-O-Kut
- Components
- Norelco • Conrac
- Fairchild
- Pickering • Gray
- Audio Tape
- Maenecord*
- Rockford Cabinets
- Arizan Cabinets
- * Fair Traded

CIRCLE 2 ON READER-SERVICE CARD

Music Mountain
Falls Village, Connecticut

Berkshire Quartet

and distinguished
guest musicians

Sundays at 4:00

July 2 through September 3

Admission—\$2.50

Write for folder
listing programs
for the season

CIRCLE 53 ON READER-SERVICE CARD

now

big savings on
stereo hi-fi



send for this

ALLIED
BARGAIN
SALE BOOK

free!

SAVE MOST on terrific closeouts of quality Stereo hi-fi systems and components! Top values in Allied's own KNIGHT® products and exciting build-your-own KNIGHT-KITS®. See hundreds of bargains in famous name amplifiers, tuners, changers, speakers. Extra big savings on recorders, phonos, records and tape. Also specials in radios, cameras, TV accessories, Citizens Band radio, test instruments and tools. Dozens of new products, too. Send coupon today!

Easy Terms,
No Money
Down.

ALLIED RADIO

FREE
Sale Book

ALLIED RADIO, Dep't 74-C1
100 N. Western Ave., Chicago 80, Ill.

Send FREE Allied Sale Book No. 205

Name _____

PRINT

Address _____

City _____ Zone _____ State _____

CIRCLE 3 ON READER-SERVICE CARD

BERKSHIRE MUSIC

Continued from page 34

No patron of music, even Esterházy or Rasumovsky, ever devoted more intelligent zeal, unrelenting energy, acute vision (and, incidentally, more financial resources) towards his goal than the woman whom her British counterpart, W. W. Cobbett, called "the lady bountiful of chamber music."

In 1934 the availability of the New York Philharmonic-Symphony at the conclusion of its Stadium concerts and also of the American composer and conductor Henry Hadley came to the action-minded attention of Miss Gertrude Robinson Smith, descendant of a long line of Berkshire "cottagers." Quick as a trill, a shell for the orchestra and 2,000 seats under the skies were set out on the Stockbridge estate of Dan Hanna, son of the Ohio senator. Two seasons later the Boston Symphony orchestra and its famed conductor, Serge Koussevitzky, took over. Two more seasons—now under a huge tent, but with harassments which included a thunderstorm during the Ride of the Valkyries—brought this phase to a close, with a stern ultimatum of a permanent shelter or nothing. At this point the donation of the Tappan estate, Tanglewood, in Lenox, decided the question.

Koussevitzky's acceptance of the original invitation was considerably influenced by the prospect of fulfilling a long-held dream of founding an "academy" for particularly gifted students. With the establishment of the Berkshire Music Center on the same grounds and in conjunction with the public concerts, this vision was realized. Koussevitzky devoted himself to this project with tremendous enthusiasm and with all his prodigious talents. No other musician, certainly no conductor, has left such a legacy. The Center still flourishes, numbering among its alumni Leonard Bernstein, Lukas Foss, Lorin Maazel, Eleazar Carvalho, Seymour Lipkin, and many other distinguished young artists.

Inevitably, South Mountain and Tanglewood created a cultural atmosphere which induced others to take advantage of the presence in the area of an increasingly large and sophisticated audience. First came the great American dancer Ted Shawn to Jacob's Pillow in Lee, to establish a dance enterprise on the Koussevitzky pattern of performance *cum* instruction. It soon gained world recognition. Later, at Music Inn in Lenox, Philip and Stefanie Barber opened a folk song theatre (with Alan Lomax as prime mover) which evolved into one of the most serious schools of jazz in America. Just over the Massachusetts border four members of the music faculty of the University of Indiana took up summer residence as the Berkshire Quartet, giving weekly concerts at Music Mountain, near Falls Village, Connecticut. The Yale School of Music expanded its summer session in adjacent Norfolk; a school of the arts sprouted

in Cummington (a small village east of Pittsfield) next to the birthplace of William Cullen Bryant. Schools of painting, sculpture, and drama followed; resort inns added instruction in the arts to their scheduled activities, and children's camps did the same.

This cross-pollination of so many endeavors has created an audience which is near incredible in both size and enthusiasm. Dominating all, of course, is the Berkshire Festival, which adheres to a policy, unique among summer orchestral institutions, of employing the entire roster of the famous orchestra (including all the first-chair men and the conductor, now Charles Munch) in programs of the same content and importance as those offered at their home hall in Boston. Some of its concerts have drawn audiences of up to fourteen thousand, which means some eight thousand sitting outside the huge Shed on the spacious lawns which are a particular glory of Tanglewood.

As for Berkshire County, it finds itself with a thriving new industry. There are some long-time residents who complain a bit that their pleasant way of life is disturbed by the week-end influx of hordes of visitors seeking "culture." Others decry the departure from the spirit of the sanctuary and workshop which characterized the initial ventures and its replacement by what they feel is a musical supermarket. These reactions are perhaps understandable; but whether or not the end is precisely what Mrs. Coolidge, Koussevitzky, and all the others envisaged, their initial inspirations have made the Berkshire Hills one of the outstanding summer music centers of the world.

HIGH FIDELITY SERVICING

Continued from page 31

I first took the tuner to a radio-TV-hi-fi dealer who sold this particular make in a suburban town and whose service department claimed to perform high-fidelity component and console servicing on all makes. There was one oscilloscope in the shop, a TV and FM signal generator, and a variety of other test instruments such as are found in most TV service shops. There were no specific audio test instruments and no outdoor FM antenna, although there was a small dipole over the test bench. No well-enclosed test speaker was in evidence, but the high-fidelity demonstration room was nearby and a speaker system from there presumably could be used to test the equipment under repair.

Although properly trained servicemen are taught to question a customer in detail about what he feels is wrong with his equipment and the way it operates and then to verify the symptoms by their own ears—thus saving the customer valuable and costly servicing time—the man who took my tuner merely asked

Continued on page 87

HIGH FIDELITY'S Berkshire Directory

Services of Interest in the MUSIC FESTIVAL AREA

The Music Box

Offers Discriminating Audiophiles
Throughout the World

A Mail Order Service on all
Long Playing Records and Stereo Tapes
that is unrivaled anywhere

Write for details of our Unique Personal Service.

THE MUSIC BOX Main Street
Great Barrington, Mass.

OLD STAGE GRILL AND PATIO

Enjoy our dinner specialties
Sunday night buffet
Terrace dining
Cocktail Lounge
Enjoy our heated pool

CURTIS HOTEL

GEO. TURAIN
Mgr.-Owner

LENOX
Tel. 510

What is so rare as a

MUSIC INN

with **THE BERKS' I'E
MUSIC BARN**

basie/ellington/sarah/biubeck/
louie/shearing/dizzy/m...

and a **POTTING SHED**

classic n. Italian menu/pasticcio di
lasagne verde alla bolognese 20 oz.
sirloin rum cake/top folk entertain-
ment 6-1 am closed monday.

LENOX, MASS.

TEL. 930

THE FINEST IN HIGH FIDELITY SOUND

Carrying a complete supply of
component parts

Call or write Dept. HF

SAMMY VINCENT, Inc.

Everything Musical

33 NORTH ST. PITTSFIELD, MASS.
Hillcrest 5-5223

Dale Barn

FINE FOOD AND GROG

Dinner Served Every Night

Weekdays 5 to 10 P.M.

Sundays 12 to 8:30 P.M.

Luncheon 12 to 2:30

On Route 44, CANAAN, CONN.
Taylor 4-7495

Most Modern Hostelry
in the Berkshires

BARRINGTON HOUSE

GREAT BARRINGTON, MASS.

Hotel • Restaurants • Bar

Air Conditioning and Television
in Every Room

WRITE FOR COLOR BROCHURE BH
AND RATES

FLY FOR BUSINESS OR PLEASURE

Passenger and Cargo Service
to all Points

Flight Instruction—Private and C.I.

Authorized Piper Dealers
and Piper Factory Service Center

BERKSHIRE

AVIATION ENTERPRISES, Inc.

Gt. Barrington, Mass. Tel. 1010



The RED LION INN

and

RED LION MOTOR LODGE Stockbridge, Mass.

IN THE HEART OF THE BERKSHIRES

SEND FOR COLOR FOLDER H
AND RATES

BERKSHIRE TROUT CLUB and MOTOR LODGE

Overnight Accommodations

Dinner 5 P.M. to Midnight

Fine Steaks and Brook Trout
Our Specialties

ROUTE 41, SHEFFIELD, MASS.
Closed Mondays

See Your
Professional-Experienced Travel Agent

For All

TRAVEL ARRANGEMENTS

You Pay Only Advertised Rates

HERBITS TRAVEL SERVICE, INC.

10 Bank Row
Pittsfield
Hi 3-9188

Barrington House
Great Barrington
Tel. 1917

Jug End

1,600 Acre Resort in the Berkshires

Where friendliness and gayety com-
bined with sophisticated informality
and scrumptious food provide an ideal
vacation. All sports and activities.

Write for Color Booklet F

Box 84, Great Barrington, Mass. Tel. 434
N.Y.C.—Bryant 9-4845

For Berkshire Directory

OF

WHAT TO DO

WHERE TO STAY—EAT

Write

BERKSHIRE HILLS CONFERENCE

P. O. Box 1141 Pittsfield, Massachusetts

CALIFORNIA



QUICK-SEE ALBUM FILE

Eliminates bottom jacket wear. Rolls forward for front-view, flip-through selection. 9 models fit any cabinet, closet or shelf. \$7.95 up. Also available with cabinet shown. Dealers, inquire.

KERSTING MANUFACTURING COMPANY
504 S. Date Street, Alhambra, California
CIRCLE 44 ON READER-SERVICE CARD

RENT stereo tapes

- Over 2000 different albums All Labels
- 2-track and 4-track
- No deposit on tapes rented
- Postpaid to and from your home

FREE BROCHURE **stereo-parti**

811-A CENTINELA AVE., INGLEWOOD, CALIF.
CIRCLE 68 ON READER-SERVICE CARD

DISTRICT OF COLUMBIA

NORELCO SPEAKERS

Famous 9777M—successor to the 9710M, twin-cone 8" speaker, original list \$39.95, usual NET \$23.97. NOW, while they last 1/2 off net... \$11.98 plus postage. (Discontinued model.) Frequency 40-20,000 cv.

Other SENSATIONAL Speaker reductions on a first come, first served basis. Send for Speaker Specification Sheet.

COMMISSIONED ELECTRONICS CO.
1776 Columbia Road Washington, D. C.

CIRCLE 23 ON READER-SERVICE CARD

IN WASHINGTON, D. C.
Nearly Everyone Buys At...

Myer's EMCO

MAIN STORE:
509 11TH ST. N.W., WASH., D.C.

CIRCLE 54 ON READER-SERVICE CARD

ILLINOIS

record index

recocards

Accommodates 150 to 500 Albums.

Send for brochure, sample record index card.

Recocards
(H 16) 503 Hyde Park Bank Building
1525 East 53rd St., Chicago 15, Illinois

CIRCLE 59 ON READER-SERVICE CARD

MARYLAND

DIXIE HIGH FIDELITY WHOLESALE

Largest discount High Fidelity component distributors in the South. Wholesale prices on package or individual components. Latest models in factory sealed cartons.

Are prices too high?—Write:
DIXIE HI-FI
12402 Connecticut Ave., Silver Spring, Md.

CIRCLE 25 ON READER-SERVICE CARD

NEW JERSEY

WRITE FOR QUOTATION ON HI-FI COMPONENTS

SOUND REPRODUCTION, INC.

34 New Street, Newark 2, N. J.
Mitchell 2-6816

CIRCLE 70 ON READER-SERVICE CARD

NEW YORK

FOR THE TOPS IN VALUE AND THE BEST TRADE-IN ON HIGH FIDELITY EQUIPMENT

Check with Arrow!

ARROW ELECTRONICS, INC.

65 Cortlandt St., New York 7, N. Y. Digby 9-4730
525 Jericho Turnpike, Mineola, N. Y. Pioneer 6-8686

CIRCLE 7 ON READER-SERVICE CARD

THE HI-FI SERVICE!

90 Day Warranty

JAMAICA—JA 3-8850
MANHASSET—MA 7-5737
BROOKLYN—BU 2-5300
WHITE PLAINS—WH 8-3380

The Original Hi-Fi Trading Organization

audio exchange

JAMAICA 153-21 Hillside Ave.

CIRCLE 11 ON READER-SERVICE CARD

a Note to the Hi-Fi buyer

AIR MAIL us your requirements for an IMMEDIATE WHOLESALE QUOTATION Components, Tapes and Recorders SHIPPED PROMPTLY AT LOWEST PRICES

AUDIO unlimited 190-F Lex. Ave., N.Y. 22, N.Y.

FREE CATALOG

CIRCLE 13 ON READER-SERVICE CARD

SOUNDTASTIC!

That's what our customers are saying upon receiving our prices! Write for special low prices on hi-fi components, tape recorders, etc. INDIVIDUAL QUOTATIONS ONLY! No catalogs.

AUDIO WORLD

2057 Coney Island Ave., Brooklyn 23, N. Y.

CIRCLE 14 ON READER-SERVICE CARD

OUT OF SPACE?

You bet we'd be... If we were to tell you All about AUDION's "Out of this World" Hi Fi Values.

Write for free catalog.

audion
25-HF Oxford Road
Massapequa, New York

CIRCLE 15 ON READER-SERVICE CARD

NEW YORK

PROMPT DELIVERIES

WE WILL NOT BE UNDERSOLD AMPLIFIERS, TAPE RECORDERS, TUNERS, ETC.

CATALOG. AIR MAIL QUOTES. COMPARE

L. M. BROWN SALES CORP.
Dept. F-239, East 24 St., New York 10, N. Y.
CIRCLE 18 ON READER-SERVICE CARD

HI-FI RECORDING TAPE

Splice Free (except 2400')
15 day money-back guarantee

	3+	12+	24+
1200' 7" Acetate	\$1.29	\$1.17	\$1.09
1800' 7" acetate	1.79	1.59	1.45
1800' 7" mylar	2.09	1.99	1.85
2400' 7" mylar	3.29	2.99	2.75
2400' 7" tensilized mylar	4.25	3.95	3.75

Can Be Assorted. Add 15¢ Postage Per Reel.
10¢ For 24+ Lot Orders.

HI-FI COMPONENTS TAPE RECORDERS available from wide variety of stock and shipped within 24 hours. Write for free wholesale catalogue "WE WILL NOT BE UNDERSOLD." Write us and see why.

CARSTON
125-D East 88 St.
New York 28, N. Y.

CIRCLE 20 ON READER-SERVICE CARD

TAPE RECORDERS

HI-FI Components SLEEP LEARN KITS Unusual Values FREE 1961 Catalog

MERITAPE
Low cost, high quality recording tape. In boxes or cans.

DRESSNER 1523 FA Jericho Turnpike, New Hyde Park, New York

CIRCLE 26 ON READER-SERVICE CARD

Professional Quality **F & B RECORDING TAPE**

Unconditional 25 Year Money-back Guar.!

Top-Quality Freq. Resp. 30-15,000 cycles. **GUARANTEED FOR 25 YEARS**

1200 ft., 7" reel	3 for \$3.89
1800 ft., 7" reel	3 for \$5.22
1800 ft. MYLAR, 7" reel	3 for \$6.59
2400 ft. MYLAR, 7" reel	3 for \$9.93

add 15¢ per reel for postage & handling

FLOMAN & BABB, Inc.
68 West 45th St. New York 36, N.Y.

CIRCLE 32 ON READER-SERVICE CARD

WINNERS ALL*

Be a winner too! Write for our big discount prices on your hi-fi needs—and send for our unusual money-saving audio catalog A-12. It's free!

*\$71,592 SATISFIED CUSTOMERS

Key Electronics Co.
120 Liberty St., N. Y. 6, N. Y.

CIRCLE 45 ON READER-SERVICE CARD

TRADE-INS ACCEPTED

SAVE MONEY on High Fidelity Equipment

Check our prices first on all Hi-Fi and Stereo Equipment. New, fully guaranteed. Prompt service on all inquiries. Write to Arthur Knight

TERMINAL-HUDSON ELECTRONICS, Inc.
236 West 17th St., N. Y. 11, N. Y. Dep't HF

CIRCLE 71 ON READER-SERVICE CARD

HIGH FIDELITY SERVICING

Continued from page 84

rather perfunctorily what was wrong. He was told that the volume was variable, blasting and then low in turn, and that there was distortion, the sound less clear than it had been a short time before. In answer to a query as to how I knew the tuner, rather than some other part of the system, was at fault, I assured the serviceman that I could play records through the system satisfactorily.

Four days later the tuner was ready and I called for it. The dealer presented me with an \$8.25 bill (\$4.75 for tubes, \$3.50 for labor), which stated that two tubes had been changed, the 12AZ7 and a 6BA6 in the AM section, and that the tuner had been "peaked up." I reinstalled the tuner in the rest of my system and turned it on. The FM distortion was still there. I rechecked the 6BA6 that had been replaced (the dealer had returned the "defective" tubes) and found that it was good and should not have been replaced! The spot of red sealing wax over the misadjusted transformer was still intact; obviously the transformer had not been touched. In effect, the tuner had not received adequate service. In such situations, the customer becomes a victim of fraud and the manufacturer who depends upon such a dealer to satisfy the needs of his customers after the warranty period is being short-changed.

The plain fact is that there are not enough good high-fidelity service shops, certainly not enough for the manufacturers of high-fidelity components to divorce themselves from the responsibility of insuring adequate service to their customers. What the high-fidelity owner has every right to expect from a dealer service department can be illustrated by the next episode in the saga of my tuner. I took it to a store selling both high-fidelity components and consoles in a small-to-medium-size city in upstate New York. Here I was questioned closely on the tuner's symptoms. I was asked about the tuner's history of service. After two days, the tuner was ready. It operated perfectly. The 12AZ7 tube had been replaced (no others!) and the tuner had been realigned. The red sealing wax on the misadjusted transformer was punctured. The repair bill came to \$12.75, which covered time and labor charges for testing and alignment and the list price of the tube. I returned and asked to speak with the serviceman who had done the repairs. This man had been servicing high-fidelity equipment for eight years, he had a good high-fidelity component system of his own at home, and he flatly stated that he could not perform satisfactory work without an oscilloscope and audio signal generator. Besides these test instruments, he uses an audio analyzer, a signal tracer, FM signal and sweep generator, and a special three-way speaker system in a bass reflex enclosure. His final listening test is performed in the dealer

demonstration room with a pair of other high quality speakers.

This particular shop, by the way, would like to do more component servicing, but the kind of servicing they offer takes time and exacting skills, reflected in relatively high servicing charges which the customer isn't always prepared to pay. What is the solution? One suggestion has been to get help from the components manufacturer in the form of a concerted campaign to inform high-fidelity owners of the need for good servicing and of places to get it. At the same time, manufacturers might foster new service shops and dealer service departments in truly significant numbers and in strategic locations. Many observers feel that when this is done, servicing will become a positive factor in increasing sales—just as the widespread availability of service stations has helped to make the Volkswagen the best-selling foreign car in the United States.

In the meantime, how does one find a good service shop when one needs it?

Let our experiences with the tuner be a guide. Look for a dealer that sells a wide range of components. Ask to see his service department. If he is proud of it and knows his business, he will be glad to display it. Look for an audio signal generator and/or a square wave generator; they will be plainly identified on the front. Notice whether there is an oscilloscope (and if it's covered with a thick layer of dust and has no test leads coming from the front, beware). Ask the serviceman whether he is familiar with your component and whether he has the service data for it (all manufacturers send service data to service shops and customers on request). Does he have a good system himself? Is there an FM antenna on the roof and a test speaker in the shop?

If you cannot find a satisfactory service shop in your area, then your best bet is to send your piece of equipment to the nearest authorized service station. If you do not have the name of one, the manufacturer will send you a list on request. Be sure to use prepaid Railway Express, and most important, pack securely, using the original packing case if you still have it. One manufacturer recommends a case within a case, with cut-up newspapers, excelsior, or similar packing material inside to serve as a buffer. In an accompanying letter describe the problem clearly and in full detail. And before you send your unit to the factory itself, write to inquire whether or not your unit will be accepted.

Check the guarantee before you buy. Determine for just how long you will be covered for defective parts and service. If you buy a kit, you cannot expect the manufacturer to guarantee your labor, but the service policies of some kit manufacturers are very liberal: they have a flat fee for rewiring or otherwise repairing a defective kit-built unit when it is returned to their plant. New parts, needed after the warranty period, will of course cost extra for kits, as they do for factory-built equipment.

TRADER'S MARKETPLACE

This classified space is available only to those who wish to buy, swap, rent, or sell used equipment, records, or what-have-you. Rates are only 45¢ a word, including name and address. Renittance must accompany copy and insertion instructions. Copy must be received by the 5th of the 2nd month preceding publication and is subject to approval of publishers.

"HARD TO GET" records—all speeds. Record Exchange, 812 Seventh Ave., New York 19, N.Y.

RARE AND SCARCE BOOKS on Musical Literature and Musical Instruments—located with skill and luck. Catalogs issued. B. Mlynarski, Box 367, Beverly Hills, Calif.

SALE: 78 R.P.M. RECORDINGS, 1902-1950. Many types. Free lists. Collections bought. Mr. Ellie Hirschmann, P. O. Box 155(HF), Verona, N.J.

RENT STEREO TAPES—over 2,000 different—all major labels—free catalog. Stereo-Parti, 811-D Centinela Ave., Inglewood 3, Calif.

CASH FOR your unwanted LP's. Leonard Reder, c/o Restaurant on the Mountain, Suffern, N.Y.

RARE 78's. Write Record-Lists, P.O. Box 2122, Riverside, California.

WILL BUY McIntosh MC30, Wharfedale 15", Tape Deck S100-S200. Robert L. Mangus, R. R. 6, LaFayette, Indiana.

HI-FI SPEAKERS repaired. Used speakers for sale. Amprite, 168 West 23d Street, New York 11, N. Y. CHelsea 3-4812.

AMPEX STEREO SYSTEM components (unmounted). All stereo—=954 recorder, \$399.95; =503 tuner, \$169.50; =403 preamp and audio control center, \$109.50; two =302 amp/speaker systems (15 watt amp, 12-inch woofer, 3-inch tweeter), \$105.50 each. Original cost \$1353—complete system as above \$889.95 or best offer. A. W. Webster, P. O. Box 652, Santa Barbara, California.

SELL: AR-2 mahogany speaker system, \$48.00. Chester Ogogzalek, 115 Bonneville Ave., Chicopee, Mass.

BELL T 203 stereo deck; with pre-amps; perfect. \$135.00. Benjamin Edelstein, Box 495, Asbury Park, N. J.

SELL: Weathers MM-10 pickup system; two Stephens 80FR's; Electrostat-3; 700 cps Crossover; Dyna PS-1. R. C. Keathley, 760 Adams, Apt. 109, Memphis 5, Tenn.

FOR SALE: University speaker system, folded horn enclosure with HF206 tweeter, Cobraflex mid-range horn, C15W woofer, \$100. Toff, 8 Cambridge, Great Neck, New York.

PROFESSIONAL DIRECTORY

PENNSYLVANIA

LOOKING for LOW LOW QUOTES?
Send us YOUR list. Free bargain sheet & tape cat. Brochure best & newest
HiFi
BUILT 1950 ESTB. 1932
1373 EASTON ROAD, ROSLYN, PENNA.
The brand name stereo specialist.

CIRCLE 39 ON READER-SERVICE CARD

LAFAYETTE 9-TRANSISTOR FM-AM PORTABLE RADIO



69⁹⁵
5.00
Down

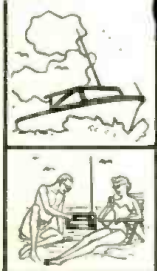

HI-FI
*Wherever
You Go!*

- Full FM and AM Broadcast Bands
- 2 Antennas
- 2 Antenna Extension Jacks
- 3 Outputs—Speaker, Earphone and Tuner
- Operates on 4 Inexpensive Flash-light Batteries
- 9-Transistor Superheterodyne Circuit

Now you can have all the advantages of a portable radio with all the power of a console. A wonderful combination of advanced technique and design in an extremely efficient 9-transistor AM and FM portable radio. Features a tuner output that converts this portable to a transistorized AM/FM tuner. Other highlights include speaker output, earphone output for private listening, separate AM and FM antenna extension jacks, built-in AM antenna, and 7 section telescopic FM antenna. Convenient carrying handle; on/off switch on volume control; vernier tuning knob. 2-position band selector—FM band 86.5-108 MC, AM band 535-1605 KC. Economical to operate, uses only 4 "C" type flashlight batteries (included). Overall 10x2 $\frac{1}{4}$ x6 $\frac{3}{4}$ " high.

FS-92 5.00 Down Net 69.95
BA-156 Extra "C" Type Battery
(4 required) ea. Net .13

LAFAYETTE RADIO ELECTRONICS

Dept. W61-2 P.O. Box 190, Jamaica 31, N. Y.

- FS-92 Lafayette AM/FM Portable Radio
- BA-156 Extra "C" Type Battery (4 required)

\$..... Enclosed.

Name.....

Address.....

City..... Zone..... State.....

CIRCLE 46 ON READER-SERVICE CARD

ADVERTISING INDEX

Key No.		Page
1	Acoustic Research, Inc.	21
2	Airex Radio Corp.	83
3	Allied Radio	84
4	Amperex	53
5	Angel Record Club	7
6	Argo Records	73
7	Arrow Electronics	86
8	Aspen Music	88
9	Audio Devices	57
10	Audio Dynamics	82
11	Audio Exchange	60, 86
12	Audio Fidelity	46
13	Audio Unlimited	86
14	Audio World	86
15	Audion	86
16	Bel Canto	76
	Berkshire Directory	85
17	British Industries Corp.	67
18	Brown, L. M., Sales Corp.	86
19	Capitol Records	62
20	Carston Studios	86
21	Columbia Record Club	5
22	Columbia Records	Inside Back Cover
23	Commissioned Electronics	83, 86
25	Dixie Hi-Fi	86
26	Dressner	86
27	Dynaco, Inc.	56
28	FICO	78
29	Electronic Organ Arts	83
30	EMPIRE	1
31	Fisher Radio Corp.	11, 13, 15
32	Florman & Babb	86
33	General Dynamics/Electronics	77
34	Grado Laboratories, Inc.	52
35	Gramophone	69
36	Greentree Electronics Corp.	66
37	Harman-Kardon, Inc.	8, 9
38	Heath Co.	16, 17
39	HiFi	87
40	Hi-Fidelity Center	82
41	Jensen Mfg. Co.	59
42	KLH Research & Development Corp.	61, 69
43	Kapp Records	61
44	Kersting Mfg. Co.	86
45	Key Electronics	86
46	Lafayette Radio	4, 88
47	Electronics	76
49	London Records	69
50	Marantz Co.	83
51	Matsushita Electronics	70
52	McIntosh Laboratory, Inc.	6
53	Music Mountain	84
54	Myer's Emco	86
55	Newcomb Audio Products	12
76	Opera Magazine	74
56	Pickering & Co.	2
57	Pilot Radio	22
	Professional Directory	85, 87
58	RCA Victor Division	Inside Front Cover
59	Recocards	85
	Records in Review	58
61	Revere Camera Co.	80, 81
62	Sargent-Raymont Co.	Back Cover
63	Sarkes Tarzian, Inc.	14
64	Schober Organ Corp.	18
65	Scott, H. H., Inc.	19
66	Sherwood Electronic Labs	20
67	Shure Bros.	55
70	Sound Reproduction	86
68	Stereo-Parti	86
69	Stereosonics	72
71	Terminal-Hudson	86
	Trader's Marketplace	87
72	Transvision	54
73	United Artists	74
74	University Loudspeaker, Inc.	10
75	Vanguard Recording Society, Inc.	60
24	Wald, Inc.	68
17	Wharfedale	67

ASPEN MUSIC FESTIVAL



- CONCERTS
- LECTURE RECITALS
- SPECIAL EVENTS
- CONFERENCE ON AMERICAN MUSIC

Summer 1961 ASPEN MUSIC SCHOOL

- DISTINGUISHED ARTIST - FACULTY
- DEPTS.: piano, voice, opera, diction, strings, chamber music, winds, percussion, conducting, composition
- PRIVATE INSTRUCTION
- FESTIVAL EVENTS



For Information Write:

Music Associates of Aspen, Inc.
Dept. F—P. O. Box AA
Aspen, Colorado
CIRCLE 8 ON READER-SERVICE CARD
HIGH FIDELITY MAGAZINE

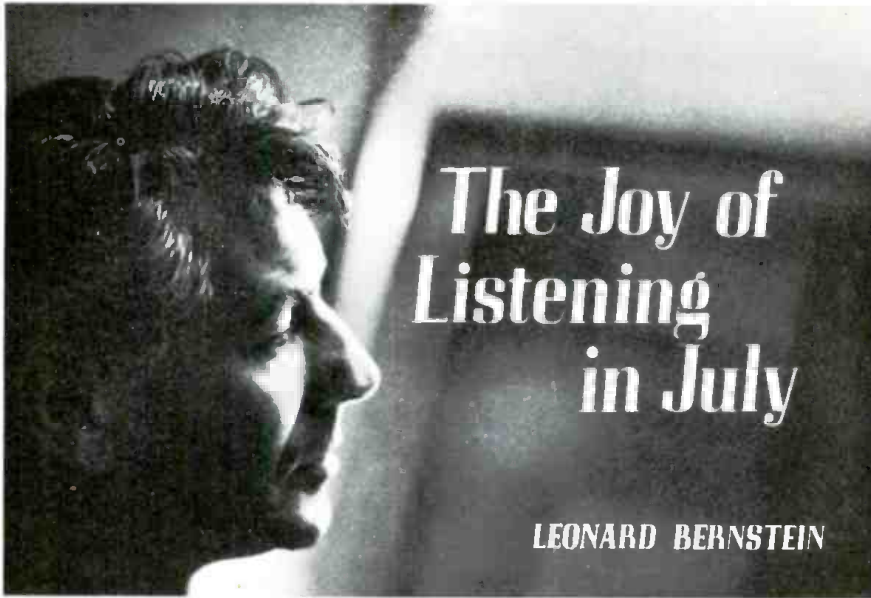

William Schuman: Symphony No.3
Leonard Bernstein / New York Philharmonic

BERNSTEIN CONDUCTS SCHUMAN
Leonard Bernstein, ardent advocate of 20th century American music, conducts William Schuman's clean-lined Third Symphony. HERALD TRIBUNE Critic Paul Henry Lang hailed its N.Y. Philharmonic concert performance as "wonderfully alive." ML 5645/MS 6245*



DANCES AND CAPRICES
Rachmaninoff's fiery Symphonic Dances are recorded by his favored ensemble, Eugene Ormandy and The Philadelphia Orchestra. Companion piece is Casella's setting of Paganini solo violin Caprices, stunningly played by The Philadelphia Strings.
ML 5605/MS 6205*



THE ART OF RUDOLF SERKIN
Columbia Masterworks presents a far-ranging collection of his profoundly perceptive recordings... Reger, Mozart, Brahms and Mendelssohn... concert and chamber works.
ML 5635/MS 6235*
BRAHMS: TRIO IN E-FLAT MAJOR FOR PIANO, VIOLIN, HORN; SCHUBERT: AUF DEM STROM
Rudolf Serkin, piano; Michael Tree, violin; Myron Bloom, French horn. ML 5643/MS 6243*



ANIARA—OPERA IN OUTER SPACE
Aniara, Swedish composer Blomdahl's widely praised operatic excursion into outer space, is now recorded by its world premiere cast—the Stockholm Opera company soloists, and conductor Werner Janssen. Complete with eerie electronic sounds.
M2L 405/M2S 902*

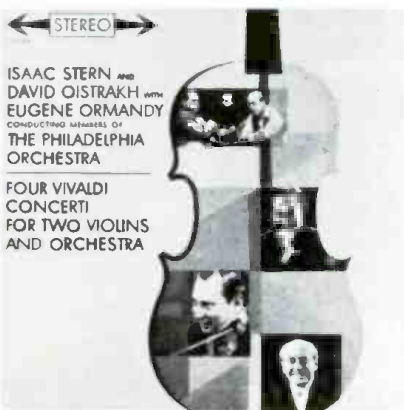

VIVALDI, STERN AND OISTRAKH
Musical Summit conference: master violinists Isaac Stern, David Oistrakh join in Vivaldi Double Concertos. "It is doubtful whether Vivaldi ever heard these four concertos played in a manner quite as virtuosic as in this recording" says HIFI/STEREO REVIEW.
ML 5604/MS 6204*



SACRED SERVICE
First stereo recording of this noble work, it's praised by Alfred Frankenstein in HIGH FIDELITY for "Bernstein's typical warmth, eloquence and flair."
ML 5621/MS 6221*



**On
Columbia
Records** 

*Available in Stereo and Regular High Fidelity

© Columbia. ® Marks Reg. Printed in U. S. A.



**This Symbol is your
new Standard of Reference**

Our finest achievements in over 33 years of electronic manufacturing are identified by this trademark. It signifies our pledge to you that SR — more than ever before — represents an investment in better engineering, superior reproduction, and matchless reliability.

Get the full story by sending for SR's free High-Fidelity Planning Folder. It contains a helpful layout chart and cost guide for planning your home music system, together with information on what to look for when you buy.

To: SARGENT-RAYMENT CO.

- 462 Hester Street, San Leandro 2, California
- 30 Rockefeller Plaza, Suite 2, New York 20, N.Y.

Please send free High-Fidelity Planning Folder to:

NAME _____

ADDRESS _____

CITY & ZONE _____

STATE _____