

high fidelity

60 CENTS

THE MAGAZINE FOR MUSIC LISTENERS

NOVEMBER

®



Vienna

... its music

... its orchestra

... its landmarks



...foolproof...

"... the Speedminder feature makes it virtually impossible to play a record at the wrong speed or with the wrong stylus. It is hard to imagine a more foolproof system of record playing."

...unique...

"Another unique feature of the GS-77 is the fact that the turntable stops rotating during the change cycle... This eliminates the possibility of damage to a record by scraping against a rotating record..."

...ingenious design...

"All of this ingenious design would be to no avail if the changer failed to meet the performance requirements of a high fidelity stereo system. Happily, it does meet them with room to spare."

...flexible...

"It appears that Glaser-Steers has tried to make the GS-77 as nearly fool-proof and flexible as possible. They have succeeded admirably."

...perfection...

"The GS-77 comes about as close to perfection in a changer design as anything we have seen. Its mechanical performance is comparable to that of many other turntables and it has nearly removed the possibility of human error from its operation."





TWO TINY SATELLITES . . . ONE SMALL CABINET . . .

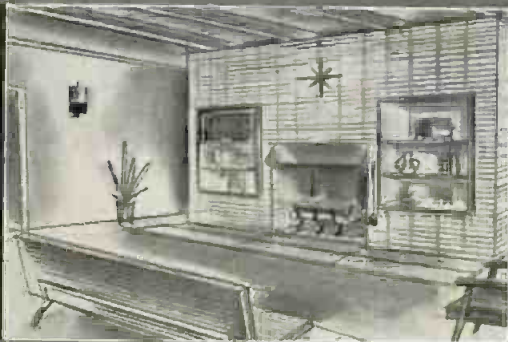
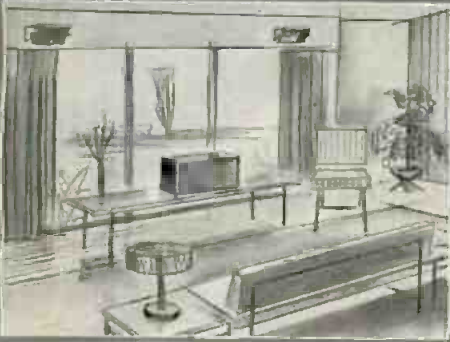

IT'S YOUR DECOR-DESIGNED STEREO SPEAKER SYSTEM!

the exciting new **GALAXY*II**

by
Jensen

The stereo speaker system designed with your home in mind.

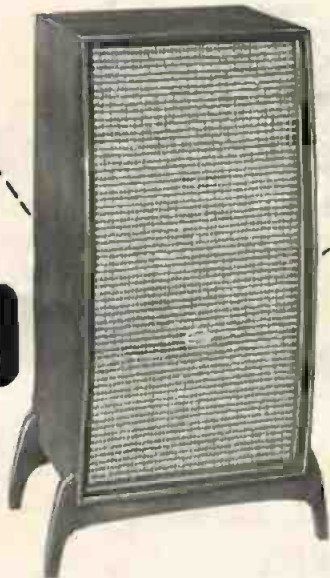

WITH NEW "FLEXAIR" WOOFER

You've never seen a stereo speaker system like this . . . an inspired merging of function with decor . . . that takes less than a square foot of floor space (or can be off-the-floor entirely) . . . yet gives you big speaker dual 3-way system performance with wide panoramic stereo sound for an entirely new listening thrill! For living room, or any room in your home . . . Jensen Galaxy II is the most livable stereo speaker system ever.

WRITE FOR BROCHURE BY

\$169⁵⁰ complete in choice of Walnut, Mahogany or Tawny Ash



GALAXY II is the equivalent of two complete 3-way speaker systems with the added feature of a "derived third channel" for center-fill. Bookshelf-size Bass-Center Unit in handsome fine hardwood cabinet, contains the new dual channel 8" FLEXAIR* woofer (which handles all bass and center-fill middle frequencies from both stereo channels), dividing networks for both channels and terminal-receptacle panel. Two Satellite Units each with yokes and wall-mounting hardware, plus 20-foot cord, plug into terminal-receptacle panel on Bass-Center Unit. Satellites may be mounted high or low on end, side or adjacent walls or placed on horizontal surfaces up to 20 or more feet apart for wide panoramic stereo sound.

Jensen

MANUFACTURING COMPANY

6601 South Laramie Avenue • Chicago 38, Illinois

In Canada: Renfrew Electric Co., Ltd., Toronto

In Mexico: Radios Y Television, S.A., Mexico D.F.

DIVISION OF THE WALTER CO.

*T.M.

an extra measure of quality

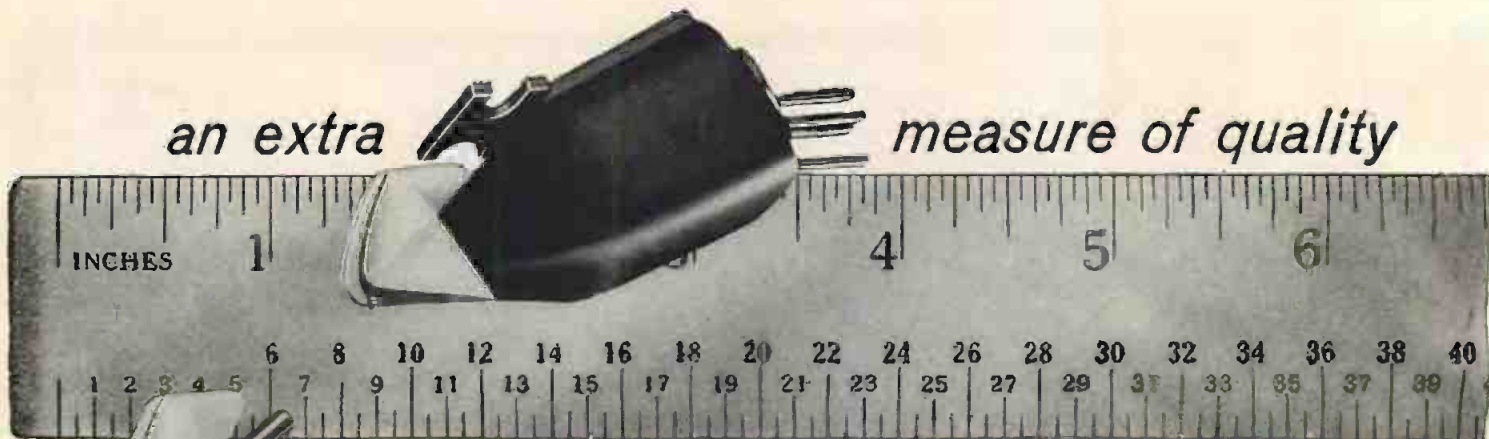

Shown is PICKERING's Collectors' Ensemble, Model 380E with 3 styli for stereo+microgroove-78's

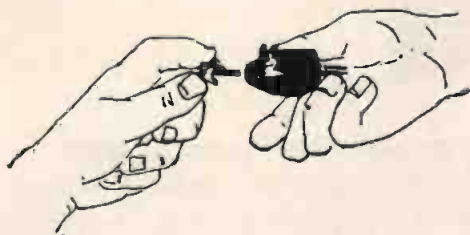

Only the Stanton Stereo FLUXVALVE features the safe, comfortable, easily replaceable stylus-assembly.

The extra measure of quality in every PICKERING product adds extra value... extra convenience... to any high fidelity system! The beautifully simple sculptured lines... the low, sleek profile... the new look in quality stereophonic pickups—this is the shape of good things to come—this is the PICKERING Collectors' Series.

Without question, the 380 is the finest—with more features and more flexibility than any other stereo pickup in the world. For example—the 380 is fully encapsulated in precious mu-metal for absolutely hum-free performance.

Visit your dealer for a demonstration today, you will love the live, eager response to every nuance in the record groove... you will find yourself listening to a bright, delightful quality... second only to the original live performance. The only true way to judge a high fidelity component is to compare it with another... measure its performance with the most vital instrument of all... the ear. Those who can hear the difference... choose PICKERING*.

COLLECTORS' SERIES

Totally new and unique to high fidelity is the "Collectors' Ensemble"... a complete quality "pickup-package" for reproduction of all records—stereo—microgroove—78's.

Model 380E—Collectors' Ensemble, includes the Stanton Stereo FLUXVALVE with 3 "V-GUARD" styli for stereo, microgroove and 78 rpm records \$60.00

Model 380A—Includes Stanton Stereo FLUXVALVE with D3807A "V-GUARD" stylus for transcription arms\$34.50

Model 380C—Includes Stanton Stereo FLUXVALVE with D3807C "V-GUARD" stylus for auto-changer arms\$29.85

PRO-STANDARD SERIES

It may interest you to know that in one short year, PICKERING'S Pro-Standard Series has become an industry standard... the universal choice of professionals. Now, the new and revolutionary PAC² technique developed by PICKERING has effected economies in manufacture which permit a reduction in the price of the Pro-Standard Series.

Model 371A Mk II Stanton Stereo FLUXVALVE Pickup now \$26.40

Model 371C Mk II Stanton Stereo FLUXVALVE Pickup now \$24.00

Model 196 Mk II UNIPOISE Arm with integrated Stanton Stereo FLUXVALVE Pickup now \$49.50

*PICKERING AUTOMATED CRAFTSMANSHIP

FLUXVALVE, "V-GUARD", "T-GUARD", UNIPOISE, PAC²

**PICKERING — for more than a decade — the world's most experienced manufacturer of high fidelity pickups... supplier to the recording industry.*

FOR THOSE WHO CAN HEAR THE DIFFERENCE

Pickering

PICKERING & CO., INC., PLAINVIEW, NEW YORK

high fidelity

including **AUDIOCRAFT** and **HI-FI MUSIC AT HOME**

NOVEMBER 1959

volume 9 number 11

ARTICLES

Roland Gelatt
Editor
Miriam D. Manning
Managing Editor
Jean Griffiths
Victor Rangel-Ribeira
Associate Editors
Roy Lindstrom
Art Director
Frances A. Newbury
Manager, Book Division

Editorial Board

John M. Conly
Chairman
E. Power Biggs
Nathan Broder
R. D. Darrell
Alfred Frankenstein
Howard Hanson
Julian Hirsch
Robert Charles Marsh
Francis Robinson
Joseph Szilgeti

Charles Fowler
Publisher
Warren B. Syer
General Manager
Claire N. Eddings
Advertising Sales Manager
Walter F. Grueninger
Circulation Director
Andrew J. Csida
Marketing and
Merchandising Manager
Joseph W. Pace
Circulation Fulfillment
Manager

ADVERTISING

Main Office

Claire N. Eddings, The Publishing House
Great Barrington, Mass. Telephone 1300

New York

1564 Broadway, New York 36
Telephone: Plaza 7-2800
Bert Covit, Sy Resnick

Chicago

188 W. Randolph St., Chicago 1
Telephone: Central 6-9818
Andy Spanberger

Los Angeles

1520 North Gower, Hollywood 28
Telephone: Hollywood 9-6239
George Kelley

The Ancient and Honorable Philharmonic 54 John M. Conly

Long known to record collectors, the Vienna Philharmonic comes to American concert stages this fall. Here's a personal letter of introduction.

Wurst and Beethoven 58 H. C. Robbins London

In Vienna, the places where the great composers lived and worked still stand. An evocation in pictures, by Erich Lessing, and text. . . .

Flittermice and Merry Widows 64 Joseph Wechsberg

Viennese operetta is an art unique and—its beginning to seem—immortal.

Night Lights in the Konzerthaus 67 Hans Herzog

For some years, Austria's capital has been a paradise for recording companies.

How To Buy a Stereo Tuner 70 Charles Fowler

REPORTS

Notes from Abroad 30 Charles Reid

Books in Review 41 R. D. Darrell

Music Makers 73 Roland Gelatt

Records in Review 77

Tape Deck 123

AUDIOCRAFT

From the High-Fidelity Newsfronts 137

HF Equipment Reports 138

Radio Shack Electrostat 3 Electrostatic Tweeter
Marantz Stereo Preamp and Amplifier
Z-400 Speaker System with Woofer and JansZen
Electrostatic Tweeters
Lafayette KT-315 Stereo Adapter
Regency MFT-1 Preamp/ifier

The Gray HSK-33 Turntable 142

A Kit Report

Audionews 145

AUTHORitatively Speaking 4 Letters 9 As the Editors See It 53

Trader's Marketplace 162 Professional Directory 169 Advertising Index 170

Published monthly by Audicom, Inc., Great Barrington, Mass. Copyright © 1959 by Audicom, Inc. The design and contents of High Fidelity Magazine are fully protected by copyrights and must not be reproduced in any manner. Second-class postage paid at Great Barrington and at additional mailing offices. One-year subscription in U. S., Possessions, and Canada \$6.00. Elsewhere \$7.00.

Lafayette Superior Quality Hi-Fi Kits

OUTSTANDING DESIGN — INCOMPARABLE PERFORMANCE



NEW!

KT-250 50 WATT INTEGRATED STEREO AMPLIFIER

KT-250 IN KIT FORM **64.50**
LA-250 COMPLETELY WIRED **89.50**

- 50 WATTS MONAURALLY — 25 WATTS EACH STEREO CHANNEL ● RESPONSE 17-21,000 CPS ±1 DB (at normal listening level)
- UNIQUE "BLEND" CONTROL
- PREMIUM EL86 OUTPUT TUBES ● SEPARATE BASS AND TREBLE CONTROLS
- CLUTCH-OPERATED VOLUME CONTROL
- 3rd CHANNEL OUT

A completely new stereo high fidelity amplifier with a high quality of reproduction, versatility of operation, and distinctive styling. A full range of controls enables you to enjoy the utmost in listening pleasure in any situation. Deluxe features include: unique "Blend" control for continuously variable channel separation—from full monaural to full stereo, 4-position Selector, Mode, Loudness and Phase switches. Also provided are outputs for 4, 8 and 16 ohm speakers. Hum-free operation is insured by the use of DC on all preamp and tone control tubes. Harmonic distortion, less than 0.25%. IM distortion, less than 1%. Hum and noise, 74 db below full output. Designed with the kit builder in mind, assembly is simple—no special skills or tools required. Complete with deluxe cabinet and legs, all parts, tubes and detailed instruction manual. Shpg. Wt., 26 lbs.

KT-250 Stereo Amplifier Kit.....64.50 Down
 Net 64.50
 LA-250 Stereo Amplifier, wired.....8.95 Down
 Net 89.50

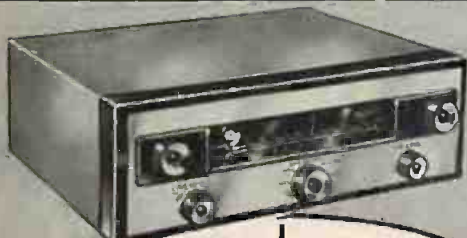

KT-500 IN KIT FORM **74.50**
LT-500 COMPLETELY WIRED **124.50**

- Multiplex Output for New Stereo FM
- 11 Tubes (Including 4 dual-purpose) + Tuning Eye + Selenium rectifier Provide 17 Tube Performance ● Pre-aligned IF's
- Tuned Cascade FM ● Dual Cathode Follower Output

KT-500 FM-AM STEREO TUNER KIT

More than a year of research, planning and engineering went into the making of the Lafayette Stereo Tuner. FM specifications include grounded-grid triode low noise front end with triode mixer, double-tuned dual limiters with Foster-Seeley discriminator, less than 1% harmonic distortion, full 200 kc bandwidth and sensitivity of 2 microvolts for 30 db quieting with full limiting at one microvolt.

The AM and FM sections have separate 3-gang tuning condenser, separate flywheel tuning and separate volume control. Automatic frequency control "locks in" FM signal permanently. Two separate printed circuit boards make construction and wiring simple. Complete kit includes all parts and metal cover, a step-by-step instruction manual, schematic and pictorial diagrams. Size is 13 1/2" W x 10 1/2" D x 4 1/2" H. Shpg. wt., 22 lbs.

KT-500.....7.45 Down.....Net 74.50
 LT-500. Same as above, completely factory wired and tested.....12.45 Down.....Net 124.50



KT-600 IN KIT FORM **79.50**
LA-600 COMPLETELY WIRED **134.50**

A REVOLUTIONARY DEVELOPMENT IN STEREO HIGH FIDELITY.

- UNIQUE STEREO & MONAURAL CONTROL FEATURES ● AMAZING NEW BRIDGE CIRCUITRY FOR VARIABLE 3d CHANNEL OUTPUT & CROSS-CHANNEL FEED ● PRECISE "NULL" BALANCING SYSTEM ● RESPONSE 5-40,000 CPS ± 1 DB

KT-600 PROFESSIONAL STEREO CONTROL CENTER

Solves Every Stereo/Monaural Control Problem!

Provides such unusual features as a Bridge Control, for variable cross-channel signal feed for elimination of "ping-pong" (exaggerated separation) effects. Also has full input mixing of monaural program sources, special "null" stereo balancing and calibrating system. Also has 24 equalization positions, all-concentric controls, rumble and scratch filters, loudness switch. Clutch type volume controls for balancing or as 1 Master Volume Control. Has channel reverse, electronic phasing, input level controls. Sensitivity 2.2 millivolts for 1 volt out. Dual low-impedance outputs (plate followers), 1500 ohms. Response 5-40,000 cps ± 1 db. Less than .03% IM distortion. Uses 7 new 7025 low-noise dual triodes. Size 14" x 4 1/2" x 10 1/2". Shpg. wt., 16 lbs. Complete with printed circuit board, case, profusely illustrated instructions, all necessary parts.

LAFAYETTE KT-600—Stereo Preamp/Amplifier kit—7.95 Down.....Net 79.50
 LAFAYETTE LA-600—Stereo Preamp/Amplifier, Wired—13.45 Down.....Net 134.50

AUTHORitatively Speaking

Last winter someone gave John M. Conly (formerly Editor of this publication, now Chairman of its Editorial Board) an especially dashing Tyrolean hat. First thing we knew, he was off to Austria—but spending more time in Vienna's Hofburg and environs than on the ski slopes. One result: the article on the Vienna Philharmonic which leads off this issue (p. 54). Among other results: while still dutifully performing his regular stints as music critic for the *Atlantic Monthly*, writer on music and audio topics for various other journals, and member of the Selection Panel of the RCA Victor Society of Great Music, he's taken to substituting white wines for lunch-time Martinis. We wouldn't be surprised if he were found strolling in the Prater again any day now.

H. C. Robbins Landon really does have employ other than happily wandering around landmarks of the musical past, even though readers of his account of Esterháza (August) and of the present guide (p. 58) to musical Vienna might imagine otherwise. He is perhaps the authority on Haydn and a specialist on Mozart, too. In any case, we knew of no one better able to describe the scenes photographed by Erich Lessing.

Joseph Wechsberg, whose history of Viennese operetta we present herewith, is undoubtedly familiar to HIGH FIDELITY readers through his contributions to *Holiday*, *Esquire*, and *The New Yorker*. They might not know, however, that he has been a dedicated amateur of chamber music and opera since he first took up the fiddle at the age of eight. For reasons unclear to us, Mr. Wechsberg doesn't care to publicize his professional appearances, but the dossier does reveal that he played with ship's orchestras on certain vessels of the French Line. It seems possible that our author's experience of "Flittermice and Merry Widows" (see p. 64) may not have been solely from the audience.

As Assistant Editor of *Welt am Montag* (Vienna's largest weekly newspaper), record reviewer, and press manager for Vienna's biggest record shop, Hans Herzog has excellent qualifications for the piece of detective work you'll find on p. 67. See why there are "Night Lights in the Konzerthaus."

High Fidelity, November, 1959: Vol. 9, No. 11. Published monthly by Audiocon, Inc., Great Barrington, Mass., a subsidiary of The Billboard Publishing Co., publishers of The Billboard, Vend. Funspot and The Billboard International. Telephone: Great Barrington 1300. Member Audit Bureau of Circulations.

Editorial Correspondence should be addressed to The Editor, Great Barrington, Mass. Editorial contributions will be welcomed. Payment for articles accepted will be arranged prior to publication. Unsolicited manuscripts should be accompanied by return postage.

Subscriptions, change of address notices, undeliverable copies, orders for subscriptions should be addressed to High Fidelity Magazine, 2160 Patterson Street, Cincinnati 22, Ohio.

Subscription rates: United States, Possessions and Canada, 1 year, \$6; 2 years, \$11; 3 years, \$15. Elsewhere \$1.00 per year extra. Single copies 60 cents.

Lafayette Radio

P.O. BOX 222
 JAMAICA 31, N. Y.

DEPT. WK-91

Send FREE LAFAYETTE Catalog 600

Name

Address

City..... Zone... State.....

CUT OUT
 AND
 PASTE ON
 POSTCARD



IN A TRIAL SUBSCRIPTION... to start you on the systematic collection of a well-balanced library of classical records...



Symphonies



*1. BEETHOVEN
Eroica
Symphony
Boston Symphony
Munch

*4. BEETHOVEN
Symphony
No. 7 AND
Fidelio
Overture
Chi. Sym., Reiner

3. BEETHOVEN
Pastoral
Symphony
Boston Symphony
Munch

5. BERLIOZ
Symphonie
Fantastique
Boston Symphony
Munch

6. BRAHMS
Symphony
No. 1
Boston Symphony
Munch

2. BEETHOVEN
Symphony
No. 5
SCHUBERT
Unfinished
Symphony
Boston Symphony
Munch

7. BRAHMS
Symphony
No. 3 AND
Tragic
Overture
Chi. Sym., Reiner

*8. FRANCK
Symphony
in D minor
Boston Symphony
Munch

*9. MENDELSSOHN
Italian and
Reformation
Symphonies
Boston Symphony
Munch

10. MOZART
Jupiter
Symphony
AND Symphony
No. 40
Chicago Sym.,
Reiner

11. PROKOFIEFF
Classical
Symphony AND
Concerto No. 3
Craffman, pianist
SAN FRAN. SYM.,
Jorda

*12. TCHAIKOVSKY
Symphony
No. 5
Boston Symphony
Monteux

*13. TCHAIKOVSKY
Pathétique
Symphony
Chicago Sym.,
Reiner

Concertos

21. RACHMANINOFF
Concerto 2
Chi. Sym., Reiner

*17. BRAHMS
Concerto No. 2
Gilels, pianist
Chi. Sym., Reiner



*15. BEETHOVEN
Emperor
Concerto
Rubinstein,
pianist
SYM. OF THE AIR
Krips

Concerto 1
RCA VICTOR SYM.,
Wallenstein
Rubinstein, pianist

*18. BRAHMS
Concerto in D
Heifetz, violinist
Chi. Sym., Reiner

*23. TCHAIKOVSKY
Concerto No. 1
Cliburn, pianist
Kondrashin
conductor

*16. BEETHOVEN
Concerto in D
Heifetz, violinist
Boston Symphony
Munch

*14. BEETHOVEN
Concerto No. 3
Rubinstein,
pianist
SYMPHONY OF THE
AIR, Krips

19. CHOPIN
Concerto 2
SAINT-SAENS
Concerto No. 4
Bralowsky, pianist
Boston Symphony
Munch

20. GRIEG AND
MENDELSSOHN
Concertos
No. 1
Dorfmann,
ROBIN HOOD BELL
ORCH., Leinsdorf

22. RACHMANINOFF
Concerto 1
R. STRAUSS
Burleske
Janis, pianist
Chicago Sym.,
Reiner

*24. TCHAIKOVSKY
Concerto in D
Heifetz, violinist
Chicago Sym.,
Reiner

Other Orchestral Works



*25. BARTOK
Concerto for
Orchestra
Chicago Sym.,
Reiner

*26. BERLIOZ
Harold in Italy
Primrose, violist
Boston Sym.,
Munch

*33. OFFENBACH
Gaite
Parisienne
KHACHATURIAN
Gayne Ballet
Suite
(Excerpts)
BOSTON POPS
Fiedler

*28. DEBUSSY
La Mer • IBERT
Ports of Call
Boston Symphony
Munch



29. GERSHWIN
An American in
Paris • Porgy
and Bess Suite
Morton Gould
AND HIS ORCH.

30. GLIERE
The Red Poppy
IPPOLITOV-
IVANOV
Caucasian
Sketches
LONDON PHILHAR.
Fiatouari



31. GRIEG
Peer Gynt and
Lyric Suites
BOSTON POPS
Fiedler

*32. MOUSSORG-
SKY-RAVEL
Pictures at
an Exhibition
Chi. Sym., Reiner

*27. COPLAND
Billy the Kid
AND Rodeo
Morton Gould
AND HIS ORCH.

*34. RAVEL
Bolero; Raps.
Espagnole;
La Valse
DEBUSSY
Afternoon of
a Faun
Boston Symphony
Munch

*35. RIMSKY-
KORSAKOFF
Scheherazade
LONDON SYM.,
Monteux

37. STRAVINSKY
Petrouchka
AND The Fire-
bird Suite
PARIS CONSERVA.
ORCH., Monteux

*38. STRAVINSKY
The Rite of
Spring
PARIS CONSERVA.
ORCH., Monteux



*36. R. STRAUSS
Till Eulenspiegel AND
Death and
Transfiguration
VIENNA PHIL.
Reiner

41. WAGNER
Tannhäuser
Over; Venus-
berg Music;
Sieg. Rhine
Journey; Magic
Fire
Music
Boston Symphony
Munch

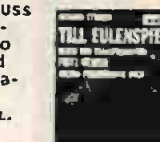

39. TCHAIKOVSKY
Romeo and
Juliet AND
Francesca
da Rimini
Boston Sym., Munch

*40. TCHAIKOVSKY
The Sleeping
Beauty
(Excerpts)
LONDON SYMPHONY
Monteux

Solo and Chamber Music

42. BACH
Brandenburg
Concertos
Nos. 1, 2 and 3
Boston Sym. Munch

43. BACH
Brandenburg
Concertos
Nos. 4, 5 and 6
Boston Sym. Munch

44. BEETHOVEN
Pathétique and
Appassionata
Sonatas
Rubinstein

45. BEETHOVEN
Trios Opus 9,
Nos. 1 and 3
Heifetz, Prim-
rose, Piatigorsky

46. HAYDN
Quartets
Op. 74, No. 1
and Op. 77,
No. 1
JULLIARD
STRING QUARTET

47. MOZART
Clarinet
Quintet and
Concerto
(Gardman
Boston Sym.,
Sir. Quartet
Boston Sym.,
Munch

48. MOZART
Quartets in G
K.387 and in
C, K.465
JULLIARD
STRING QUARTET

49. MOZART
Sonatas
Nos. 4 and 9
and Country
Dances, K.606
Landowska, pianist

50. SCHUBERT
Trout Quintet
THE FESTIVAL
QUARTET with
Sankey
double bass

MOST MUSIC-LOVERS certainly intend to build a representative record library of the World's Great Music. Unfortunately, almost always they are haphazard about this. Because of more systematic collection, operating costs can be reduced and marked savings can be passed on to record collectors. The Introductory Offer above is a dramatic demonstration. In the first year it represents a saving of AS MUCH AS 40% over the manufacturer's nationally advertised price. After purchasing the six records called for in this trial membership, members who continue will be building their record libraries at almost a ONE-THIRD SAVING, since for every two records purchased (from a group of at least 100 made available annually by the Society) members will receive a third RCA VICTOR Red Seal record FREE. A cardinal feature of the plan is GUIDANCE. The Society has a Selection Panel whose sole function is to recommend "must-have" works for members. The panel includes DEEMS TAYLOR, composer and commentator, Chairman; SAMUEL CHOTZINOFF, General Music Director, NBC; JACQUES BARZUN, author and music critic; JOHN

M. CONLY, music editor, *The Atlantic*; AARON COPLAND, composer; ALFRED FRANKENSTEIN, music editor, *San Francisco Chronicle*; DOUGLAS MOORE, composer and Professor of Music, Columbia; WILLIAM SCHUMAN, composer and president of Juilliard School of Music; CARLETON SPRAGUE SMITH, former Chief of Music Division, N. Y. Public Library; G. WALLACE WOODWORTH, Professor of Music, Harvard.

HOW THE SOCIETY OPERATES

EACH month, three or more 12-inch 33 1/2 R.P.M. RCA VICTOR Red Seal records are announced to members. One is singled out as the record-of-the-month and, unless the Society is otherwise instructed (on a simple form always provided), this record is sent. If the member does not want it he may specify an alternate, or instruct the Society to send nothing. For every record purchased, members pay only the nationally advertised prices: \$4.98 for regular L.P.s; \$5.98 for Stereo versions. (For every shipment a small charge for postage and handling is added.)

The RCA Victor Society of Great Music

OFFERS YOU

Any Six

REGULAR LONG-PLAYING \$1.00
OR STEREOPHONIC RECORDS: 1 EACH

... if you agree to buy six selections within the next year from at least 100 that will be made available

THE RECORDS STARRED (*) ARE AVAILABLE IN STEREO AS WELL AS REGULAR L. P.

RCA VICTOR Society of Great Music V12-11
345 Hudson Street, New York 14, N. Y.
c/o Book-of-the-Month Club, Inc.

Please register me as a member of *The RCA Victor Society of Great Music* and send me immediately the six RCA Victor albums indicated below, billing me \$1.00 for each record (plus a small charge for postage and handling). I agree to buy six additional records within twelve months from those made available by the Society, for each of which I will be billed the manufacturer's nationally advertised price —\$4.98 for monaural recordings, \$5.98 for stereophonic recordings, depending on which box I have checked below. A small charge for postage, handling, and sales tax is added. Thereafter, I need buy only four such records in any twelve-month period to maintain membership. I may cancel my membership any time after buying six records from the Society (in addition to those included in this introductory offer). After my sixth purchase, for every two records I buy from the Society I will receive a third RCA Victor Red Seal record free.

Write Below the Numbers of the Six Albums You Want

Check the version you want: STEREO MONAURAL

MR. }
MRS. }
MISS } (Please print plainly)

ADDRESS

CITY ZONE STATE

NOTE: If you wish your membership credited to an authorized RCA VICTOR dealer, please fill in here:

DEALER'S NAME

ADDRESS
PLEASE PRINT plainly and include only to residents of the U. S. and its territories, and Canada. Records for Canadian members are made in Canada and shipped duty free from Ontario.



Collaro
 stereo 
 record players
 with typical
 British precision
 steadfastly
 guard your
 records and
 stylus from
 wear and
 accidental
 damage



The Constellation, Model TC-99—\$59.50



The Continental II, Model TSC-840—\$49.50



The Coronation II, Model TSC-740—\$42.50
 *The Conquest II, Model TSC-640—\$38.50



Transcription Turntable, Model 4TR-200—\$49.50



Manual Player, Model TP-59—\$29.95

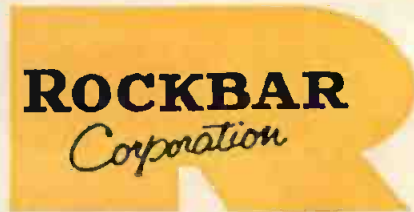

Every Collaro stereo record player is built with typical British attention to every detail. They are precision engineered and rigidly tested to give truly professional performance and the ultimate in operating convenience. Here are some of the important features that make Collaro the logical choice for stereo or monophonic records. • Performance specifications exceed NARTB standards for wow, flutter and rumble—with actual performance test reports accompanying each model TC-99. • Extra-heavy, die-cast, non-magnetic turntables (weighing up to 8½ lbs.). Extra-heavy weight is carefully distributed for flywheel effect and smooth, constant rotation. • Shielded four-pole motors are precision balanced, screened with triple interleaved shields to provide extra 25 db reduction in magnetic hum pick-up. • Detachable five-terminal plug-in head shells (on TC-99, TSC-840, TSC-740, TP-59) provide two completely independent circuits, guaranteeing ultimate in noise reduction circuitry. • Transcription-type stereo tonearms are spring-damped and dynamically counterbalanced to permit the last record on a stack to be played with virtually the same low stylus pressure as the first. • All units are handsomely styled, available with optional walnut, blond and mahogany finished bases or unfinished utility base. There's a 4-speed Collaro stereo record player for every need and budget! Prices slightly higher in the West. For free catalog on the Collaro line, write to: Rockbar Corporation, Dept. HF-11, Mamaroneck, N. Y. (*Not shown. Similar in appearance to The Coronation).

To introduce you to THE RCA VICTOR POPULAR ALBUM CLUB

ANY FIVE for **\$3.98** only
(NATIONALLY ADVERTISED PRICES TOTAL UP TO \$29.90)

EITHER STEREO or REGULAR L.P.

... if you agree to buy six albums from the Club during the next year from more than 150 to be made available

THIS EXCITING NEW PLAN offers you the finest stereo or hi-fi music being recorded today for far less money than you would pay otherwise. Now you may join either the Stereophonic Division or the Regular L.P. Division of The RCA Victor Popular Album Club in a short trial membership—and receive five albums of your choice for the single low price of only \$3.98! The plan also helps you build your record library carefully, confidently, completely.

You save up to 40% with this introductory offer alone. Thereafter, if you continue membership, through the Club's Record-Dividend Plan you will save about one-third of the manufacturer's nationally advertised prices of RCA Victor regular L.P.

and stereo albums. You may choose a free twelve-inch 33 1/3 R.P.M. regular L.P. or stereo album (depending on which division you enroll in) with every two you buy.

Every month you are offered a wide variety of albums. One will be singled out as the album-of-the-month. If you want it, you do nothing; it will come to you automatically. If you prefer an alternate—or nothing at all—simply state your wishes on a form always provided. For regular L.P. albums you will pay the nationally advertised price—usually \$3.98, at times \$4.98. For stereo albums you will pay the nationally advertised price of \$4.98, at times \$5.98 (plus—in all cases—a small charge for postage and handling).



14. Fresh versions of 12 harmony hits. Paper Doll, To Each His Own, Cool Water.



15. Liting versions of The Blue Danube, Arius' Life, Emperor Waltz, 9 others.



16. Key highlights from Tchaikovsky's enchanting masterpiece for ballet.



17. On-the-spot recording. Yes, includes Day In—Day Out plus 14 others.



19. Lush, rhythmic, exotic instrumentals. Valencia, Granada, Delicado.



20. His 12 biggest hits, newly remade. Green Eyes, Linda Mujer, Adios, etc.



21. Composite of Latin rhythms, cha cha, jazz. Lullaby of Birdland, 10 more.



22. Now Broadway star, top tunes from top musicals, Flower Drum Song, etc.



24. 12 pop favorites and light classics. September Song, Warsaw Concerto, Diane.



26. La MacKenzie sings 12 ballads. Hey There, Ebb Tide, Too Young, Moonglow.



27. 12 dance-mood favorites by trio plus strings. I'll Get By, Dream, etc.



30. Pipes, drums. Black Watch Band in a sock sonic treat! Marches, folk songs.



33. Rich baritone of the Graham Crusade sings some most-requested songs.



34. Fantastic sound, realistic atmosphere, familiar songs, virile singing. Different!



35. My Man, Young and Foolish, They Say It's Wonderful, Yesterdays, 8 more.



36. 12 meaningful songs. Whither Thou Goest, Scarlet Ribbons, Only One.



37. Pianist's trio plays Summertime, The Man I Love, All of You, Cherry, etc.

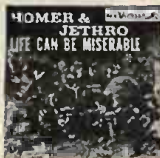

40. Wacky, banjo-pickin' country comics raise havoc with hits and specials.



42. Modern big-band jazz; top West Coast stars. Chances Are, other hits.



48. Riotous musical satire, slapstick; wry commentary by TV's Henry Morgan.



50. Tony Martin, Gogi Grant entice the Academy Award winning film score.

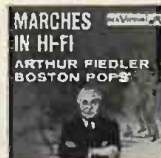

54. 25 varied strutters. 76 Trombones, Semper Fidelis, Colonel Bogey, others.



56. 16 magnificent spirituals: Swing Low, Sweet Chariot; Dry Bones, others.



58. Mood guitar with strings. Estrellita, The Three Bells, Greenleaves, 12 in all.



74. 12 shimmering waltzes. Charmaine, Ramona, Always, Would You, etc.



89. Exciting, exotic African rhythms and themes, sometimes blended with jazz.



97. Gershwin plays his own Rhapsody in Blue in hi-fi! Other vintage piano rolls.

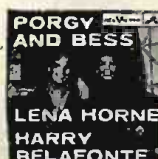

100. 12 Gershwin treasures in fresh, modern manner. The best-selling Porgy.

IMPORTANT—PLEASE NOTE

Regular (monaural) long-playing records can be played on stereophonic phonographs; in fact, they will sound better than ever. However, stereophonic records are designed to be played ONLY ON STEREOGRAPHIC EQUIPMENT.



1. Melachrino plays Autumn Leaves, Star Dust, While We're Young, Estrellita.



2. Hottest album of year! All-star modern "mood" jazz from NBC-TV series.



3. Blues types, rhythm backing. Hallelujah I Love Her So, 11 others.



4. Original soundtrack recording from Rodgers and Hammerstein film hit.



5. All-time classical best-seller by most-talked-about pianist of the generation.



7. Breath-taking new recording of best-selling suite from dramatic TV score.



8. New recording of Kern-Hammerstein classic. Gogi Grant, Howard Keel.



9. Operetta film stars remake their 12 biggest hits. Indian Love Call, etc.



10. Lanza sings 12 Italian classics. Funiculi Funicula, Santa Lucia, more.



11. Miller-styled modern repertoire. Ray McKinley, Birdland, 11 others.



12. New remakes of their biggest hits. Jealousy, Skaters Waltz, Liebestraum.



13. His latest and most danceable act yet. Ballads, lindy, waltzes, Latin, etc.



19. Lush, rhythmic, exotic instrumentals. Valencia, Granada, Delicado.



20. His 12 biggest hits, newly remade. Green Eyes, Linda Mujer, Adios, etc.



21. Composite of Latin rhythms, cha cha, jazz. Lullaby of Birdland, 10 more.



22. Now Broadway star, top tunes from top musicals, Flower Drum Song, etc.



33. Rich baritone of the Graham Crusade sings some most-requested songs.



34. Fantastic sound, realistic atmosphere, familiar songs, virile singing. Different!



35. My Man, Young and Foolish, They Say It's Wonderful, Yesterdays, 8 more.



36. 12 meaningful songs. Whither Thou Goest, Scarlet Ribbons, Only One.



50. Tony Martin, Gogi Grant entice the Academy Award winning film score.

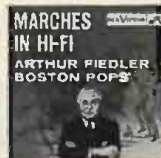

54. 25 varied strutters. 76 Trombones, Semper Fidelis, Colonel Bogey, others.



56. 16 magnificent spirituals: Swing Low, Sweet Chariot; Dry Bones, others.



58. Mood guitar with strings. Estrellita, The Three Bells, Greenleaves, 12 in all.

ALL ALBUMS ARE 12-INCH 33 1/3 R.P.M.

THE RCA VICTOR POPULAR ALBUM CLUB, P. O. Box 80, Village Station, New York 14, N. Y. P12-11

Please register me as a member of The RCA Victor Popular Album Club and send me the five albums whose numbers I have circled below, for which I will pay \$3.98 (plus a small postage and handling charge). I agree to buy six other albums offered by the Club within the next year, for each of which I will be billed at the manufacturer's nationally advertised price: regular L.P.s usually \$3.98, at times \$4.98;

stereo versions \$4.98, at times \$5.98. (A small postage and handling charge is added to all prices.) Thereafter, I need buy only four such albums in any twelve-month period to maintain membership. I may cancel any time after buying six albums from the Club (in addition to those included in this introductory offer), but if I continue after my sixth purchase, for every two albums I buy I may choose a third album free.

Check which Division you wish to join: REGULAR L. P. STEREOGRAPHIC

Name _____ 1 2 3 4 5 7 8
 Address _____ 9 10 11 12 13 14 15
 City _____ Zone _____ State _____ 16 17 19 20 21 22 24
 NOTE: If you wish your membership credited to an authorized RCA VICTOR dealer, please fill in below: 26 27 30 33 34 35 36
 Dealer _____ 37 40 42 48 50 54 56
 D Send no money. A bill will be sent. Albums can be shipped only to residents of the U. S., its territories and Canada. Albums for Canadian members are made in Canada, and shipped duty free from Ontario. 58 74 89 97 100

Without touching a finger to it...

**PLAYS CONTINUOUSLY
OR TURNS OFF
AUTOMATICALLY**

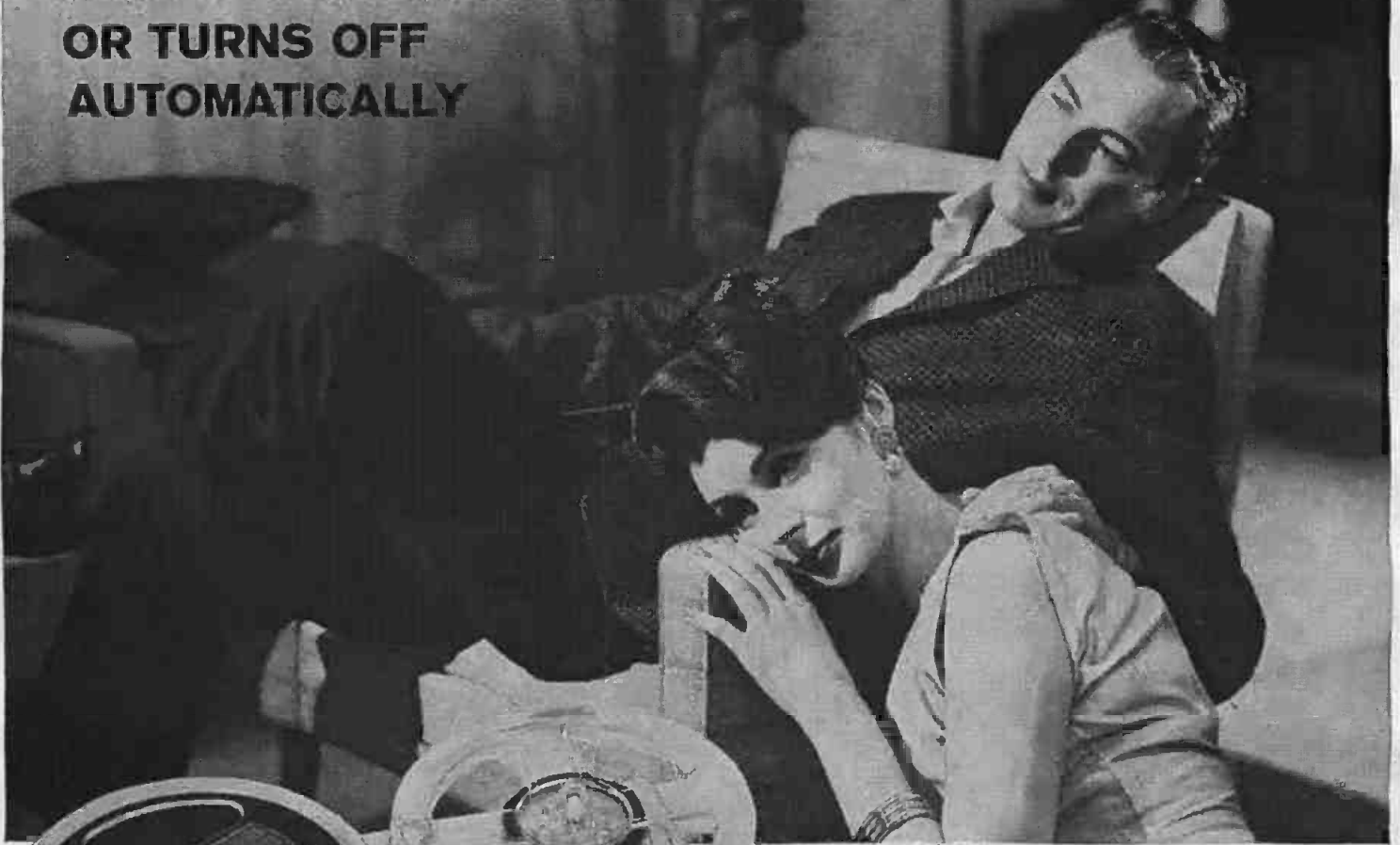

SETTING BY PAUL MCCOBB

Plays continuous music.
Repeats any passage. Rewinds or turns
off automatically! Back spaces!

Incomparable listening luxury! Hours and hours of
musical enjoyment, without any attention whatso-
ever! Or, if you desire, the reel rewinds and recorder
shuts itself off automatically. It's another "first"
from Wollensak!

You'll find equal pleasure in recording. Just a feather
touch of a key electronically changes function of the
recorder, instantly and effortlessly. A "Back Space
Bar" plays back a word or a sentence—an invaluable
aid for correction and teaching.

Exclusive "Balanced-Tone" emphasizes treble and
bass, giving exquisite depth, more realistic high-
fidelity quality. Full range of 40-16,000 cps., simpli-
fied drop-in loading; dual speeds of 3¾ and 7½ ips.;
2-level record indicators; index counter; accepts 7"
reels which play for four hours, using long play tape.

Model T-1600 with remote control, ceramic-type
microphone; two reels; tape and cords, \$299.50.

IN STEREO, TOO... Model T-1616 with built-in
pre-amp. Plugs directly into hi-fi system, radio, phono-
graph or TV which serves as a second speaker for
magnificent, third-dimensional stereo sound. \$329.50.

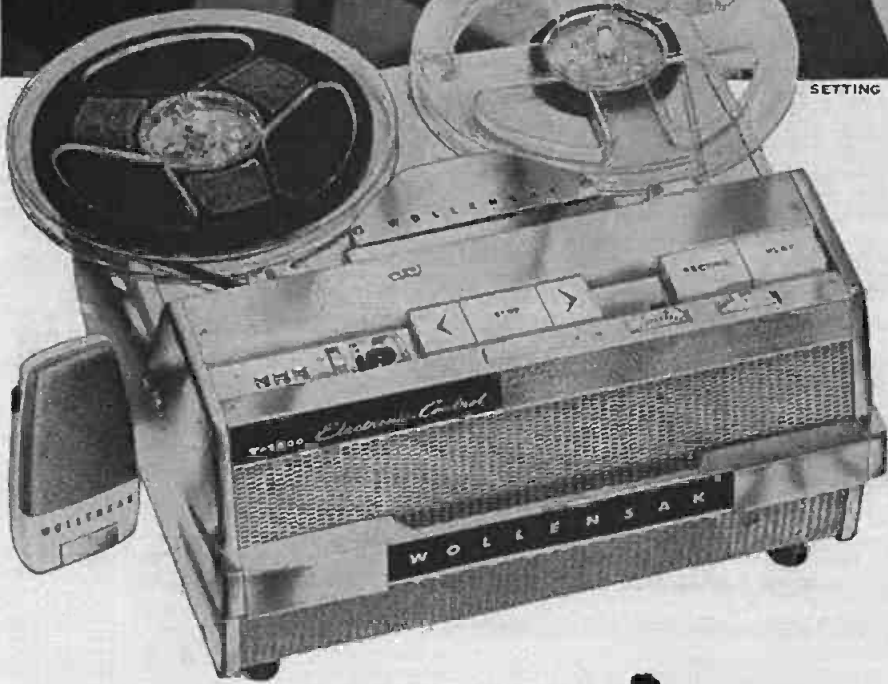

Ultra-lightweight and portable
... carry it anywhere!
Letterhead-size, with full
10-watts of power—enough
to fill an auditorium.



Push-To-Talk
switch on micro-
phone permits
precise remote
control of recorder.



Back Space Bar
provides instant
replay of a word,
phrase, or musical
passage as desired.



Illuminated
"record" and
"play" keys on
panel light up
when pressed.

WOLLENSAK "1600"

Electronic Control

HI-FIDELITY TAPE RECORDER

Ask your Wollensak dealer to demonstrate these exciting new features!

WOLLENSAK OPTICAL COMPANY · CHICAGO 16, ILLINOIS



Debt to the Past

Sir:
Your article on Thomas Edison [September] was most entertaining. Though it was quite lengthy, it still was not long enough. The variety of information and the method with which the author presented it made me slip back into the time when I was a visitor at Menlo Park, a bystander in Washington, etc. When I finished the article I didn't feel quite satisfied. I wanted a few lines telling about Edison's other inventions; Berliner and his phonograph and how it concerned Edison; but even so I still feel there is something about Mr. Josephson's story that must capture the whole-hearted interest of all people who genuinely appreciate what has come to be high fidelity.

Yale Brevda
Tampa, Fla.

Stereo Sanity

Sir:
Maybe "every regular reader of HIGH FIDELITY knows what true stereo is" but here's one who didn't—until Charles Fowler's article came along in your September issue. Congratulations on bringing sanity to bear on sound and fury. I'm still among the monophonic incorrigibles, but conversion (in more than one sense) may be on its way.

William A. Ditters
Seattle, Wash.

A Yawn for the Id

Sir:
Isn't it a bit late in the day for you people to be playing the tired old game of the analyst's couch? Matthew Arnold's been dead a long time, and who in this year of enlightenment doubts that "Beethoven Had an Id, Too" [September]? In fact, who cares? Mr. Lockspeiser's article plays to the gallery—even housewives like myself get pretty bored by this stuff. And I said bored, not outraged.

Mary P. Grant
New Haven, Conn.

Continued on next page

The Very Best Now Costs You Less



KNIGHT STEREO HI-FI

A PRODUCT OF ALLIED RADIO

... challenges comparison with the costliest components ...
prove it for yourself on our 15-day free home trial ... doubly guaranteed:
specifications meet or exceed published figures or we refund your
money ... unconditionally guaranteed for one full year ...



deluxe 60-watt complete stereo amplifier

Fifteen stereophonic and monophonic controls • 60 watts rated stereo output ... 76 watts usable ... 152 watts peak-to-peak • ± 0.5 db, 25-20,000 cps • Third channel speaker output with new additive full-range circuit • 5 pairs of stereo inputs ... including auxiliary for new cartridge tape playback • Long-life silicon diode heat-free power supply with oversize transformer • Humless DC on all preamp tubes • Vinyl-clad metal case included in price • Anodized front panel in brushed gold and charcoal brown • Shpg. wt., 35 lbs. ... only \$149.95. \$5.00 down.



deluxe stereo FM-AM tuner

Separate FM and AM sections for stereo reception • Adjustable DSR corrective feedback for lowest distortion of FM • Front panel audio and a.c. switching for multiplex • Dual limiters on FM • Tuned RF stage on both FM and AM • 2.5 microvolt sensitivity on FM • ± 0.5 db, 20-20,000 cps • Cathode follower multiplex and tape output jacks • Dual "Microbeam" tuning indicators • Illuminated $9\frac{1}{2}$ " tuning scale • Low-noise 50-ohm extra antenna terminals • Solid aluminum front panel, gold anodized, with vinyl-clad case. Shpg. wt., 21 lbs. ... only \$139.95. \$5.00 down.

New Easy Terms:
Only \$5 down (or less)
on orders up to \$200.
Up to 24 months to pay.



FREE 1960 ALLIED CATALOG

Send for your complete, money-saving guide to the world's largest selection of hi-fi components and systems. See everything in stereo; all the new KNIGHT components; all leading make lines. For everything in hi-fi, for everything in Electronics, get the 1960 ALLIED Catalog. FREE—write for it today.

order from

ALLIED RADIO

ALLIED RADIO, Dept. 49-L9
100 N. Western Ave., Chicago 80, Ill.

Ship the following Knight components:

KN-760. \$_____ enclosed (I understand your 15-day trial and money-back guarantee applies to this purchase.)
 KN-125. \$_____ enclosed

Send FREE 1960 ALLIED Catalog

Name _____
Address _____
City _____ Zone _____ State _____

Now... from Sonotone—

4 Big Improvements

in the quality stereo cartridge



Sonotone 8TA cartridge ...
higher than ever quality

The new Sonotone 8TA cartridge gives greater than ever stereo performance... has 4 big extras:

- fuller, smoother frequency response
- higher compliance than ever before
- lighter tracking pressure
- practically eliminates dust pile-up

ONLY
\$1450*

New 10T cartridge at lowest price ever
—easiest to install

The 10T sells at record low price of \$6.45.* And it covers the complete high fidelity range. 10T's unitized construction makes it easiest to install, even for the person with ten thumbs. Snaps right in or out. Cuts stereo conversion costs, too.



SPECIFICATIONS

	BTA	10T
Frequency Response	Smooth 20 to 20,000 cycles. Flat to 15,000 with gradual rolloff beyond.	Flat from 20 to 15,000 cycles \pm 2.5 db.
Channel Isolation	20 decibels	18 decibels
Compliance	3.0×10^{-6} cm/dyne	1.5×10^{-6} cm/dyne
Tracking Pressure	3-5 grams in professional arms 4-6 grams in changers	5-7 grams
Output Voltage	0.3 volt	0.5 volt
Cartridge Weight	7.5 grams	2.8 grams
Recommended Load	1-5 megohms	1-5 megohms
Stylus	Dual jewel tips, sapphire or diamond.	Dual jewel tips, sapphire or diamond.

*including mounting brackets

Sonotone ceramic cartridges have more than impressive specifications... always give brilliant performance. You'll hear the difference with Sonotone. For highest stereo fidelity, use genuine Sonotone needles.

Sonotone

CORP.

Electronic Applications Division, Dept. CH-119
ELMSFORD, NEW YORK



Leading makers of fine ceramic cartridges, speakers, microphones, electronic tubes.

LETTERS

Continued from preceding page

Threni Welcomed

Sir:

As one who has long deplored the indifference (if not contumely) with which contemporary music is treated in much of the press, may I thank you, and Alfred Frankenstein, for the review of Stravinsky's *Threni* in your September issue? In general it is good to see the catholicity of taste exemplified in your record reviews, and the humility with which your critics temper their wisdom.

C. Randall Adams
Tucson, Ariz.

Request Seconded

Sir:

On page 12 of the September issue of HIGH FIDELITY is a short letter of D. L. Weeks of Los Angeles. I most emphatically want to second his request for a *Siegfried* recording. I cherish an old *Siegfried* by RCA Victor (M 83-78RM) which is totally inadequate by recording standards of today.

Notwithstanding the shabby omissions of Wagner operas by Messrs. Rudolf Bing & Co. there is a definite need for more Wagner. Wagnerian singers are available all over Europe, and performances are plentiful there. Granted that the great length of these operas presents problems here in overtime pay for musicians and stage hands, and the financiers and benefactors of former days are impoverished by exorbitant taxes, still a way should be found to produce these operas. Perhaps the new and larger opera houses will be able to meet this problem. Europe is impoverished too, but Wagner is a necessity there. In the meantime our only hope in this country is new recordings. . . . Please, oh, please, let us have a complete recording of *Siegfried*. How about you Wagnerians: will you write letters, and more letters? Only in this way will we ever get what we want.

Walter F. Kirsten
San Antonio, Tex.

Help Fight TB



Use Christmas Seals

Announcing the Magnificent

FISHER 202-T

STEREO FM-AM TUNER and MASTER AUDIO CONTROL



■ The quality, the scope, the sheer capability of the FISHER 202-T will strike you the instant you see it. Behind its beautifully brushed brass control panel are the three finest components ever conceived for the knowledgeable high fidelity enthusiast *who is no longer content with 'second-best.'* He has learned that it pays to buy the best *first.* That is why he is ready for FISHER . . . and particularly for the FISHER 202-T Stereo FM-AM Tuner and Master Audio Control.

THE FM TUNER offers better than one microvolt sensitivity, *four* IF stages, automatic interstation noise suppression, MicroRAY tuning, and space and controls for the FISHER MPX-20 Multiplex Adaptor.

THE AM TUNER has been equipped with a tuned RF stage, temperature-compensated converter stage, 10-Kc sharp cut-off filter, a *rotatable* antenna and a MicroRAY Tuning Indicator.

THE MASTER AUDIO CONTROL provides the user with *twenty-eight* controls for every conceivable program source and application, including—MULTIPLEX, CENTER CHANNEL and REMOTE CONTROL operation! Naturally, hum, noise and distortion are *inaudible.* Frequency response 20 to 20,000 cps ± 1 db. **\$349.50**

WRITE TODAY FOR COMPLETE FISHER STEREO LITERATURE

FISHER RADIO CORPORATION • 21-25 44th DRIVE • LONG ISLAND CITY I, N. Y.

FOR DISTORTION-FREE POWER, add



THE FISHER SA-300
60-Watt Stereo Power Amplifier
— world's only stereo amplifier
whose performance
specifications are guaranteed!
\$169.50

FOR FLAWLESS REPRODUCTION, add



THE FISHER XP-1
Free-Piston Three-Way
Speaker System
— first high-compliance
plus high-efficiency system!
\$129.50

Prices Slightly Higher In The Far West

General Electric's all-new VR-22 Stereo Cartridge

try it in your own home

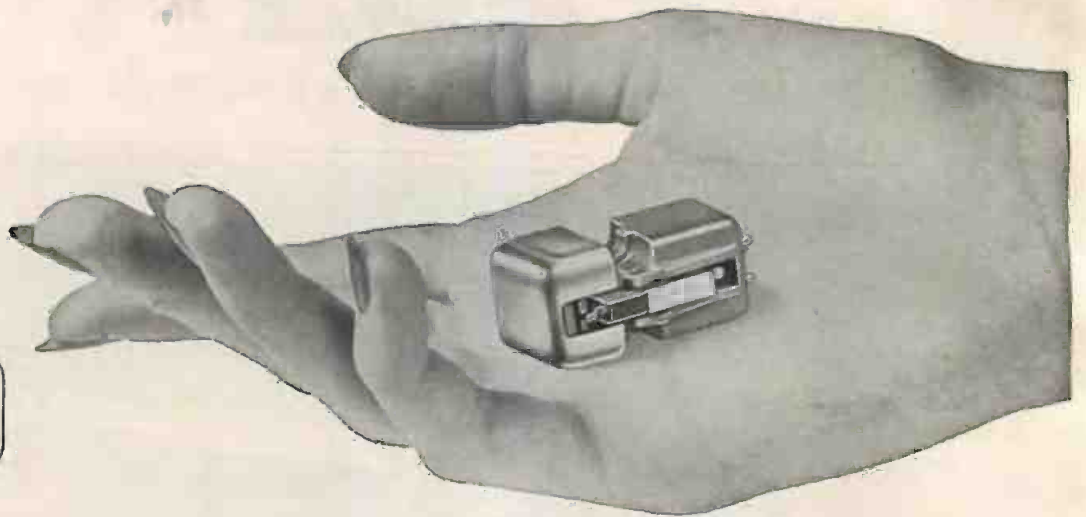

money-back guarantee!

We believe that once you hear General Electric's all-new VR-22 in the privacy of your own home, on your own equipment, you'll want to have this superb stereo cartridge for your very own.

We're so sure of it, in fact, that we are making you an offer virtually without precedent in the Hi-Fi field: Try the VR-22 at home for 10 days. If you don't agree that this is *the* stereo cartridge for you, bring it back and the full purchase price will be cheerfully refunded. You have nothing to lose and a whole new world of enjoyment to gain! See your participating General Electric Hi-Fi dealer.

The VR-22 is outstanding in all four critical areas of stereo cartridge performance: *Channel separation—Response—Freedom from hum—Compliance.*

VR-22-5 with .5 mil diamond stylus for professional quality tone arms, \$27.95*. VR-22-7 with .7 mil diamond stylus for professional arms and record changers, \$24.95*. TM-2G Tone Arm—designed for use with General Electric stereo cartridges as an integrated pickup system, \$29.95*. General Electric Co., Audio Components Products Section, Auburn, N. Y.

*Manufacturer's suggested resale prices.

Acclaimed
by the
experts!



Oliver P. Ferrell
Editor
Hi-Fi Review
as quoted
in issue
of Aug. 1959

"... the VR-227 is a top performer. The frequency response is as flat as any cartridge tested to date. Channel-to-channel separation in the vital area between 700 cycles and 8000 cycles was equal to the very best stereo cartridges now offered the public."



Wm. A. Stocklin
Editor
Electronics World
as quoted
in issue
of Sept. 1959

"... listening tests did not show up any flaws. Frequency response from 30 to 15,000 cps (limits of our test) was within 2.25 db of flat. Provides about the best channel separation available of any checked with the exception of [cartridge selling for \$65.00] in the frequency range from about 5000 to 9000 cps."



C. G. McProud
Editor
Audio
as quoted
in issue
of Sept. 1959

"... is even better than its predecessor with respect to output, channel separation and extended frequency response and the two channels balance within ± 2 db to 15,000 cycles. The shielding has been improved and the grounding of the shield and the method of shorting the two 'ground' terminals are well thought out."

GENERAL ELECTRIC

"The Aristocrat of stereo power amplifiers!"

— HI FI REVIEW

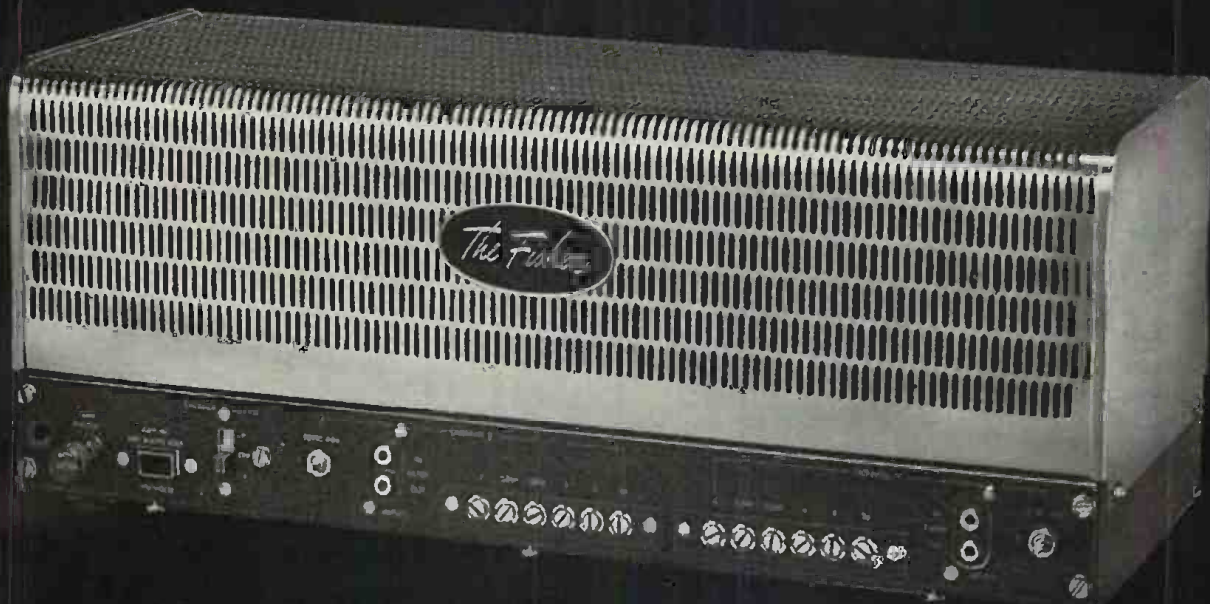

THE **SA-300** 60-Watt Stereo Power Amplifier \$169.50
Music Power: 90 Watts at 0.8% Harmonic Distortion!

THE FISHER

Specifications Guaranteed!

- Hum and noise less than 0.00001 part of full rated output—100 db down!
- Distortion-free power at all listening levels!
- Optimum results with all speakers! Wrote *HiFi Review*: "Results equalled manufacturer's highly exacting specifications."

Prices Slightly Higher In The Far West

■ In their October 1959 stereo amplifier report, the editors of *HiFi Review* said the following of the FISHER SA-300: "This is undoubtedly the most 'sophisticated' stereo power amplifier available to the public at this writing. The advertised claims of low hum and noise levels appear to be readily available in production models now on your dealers' shelves. This is certainly the *quietest* amplifier likely to be found outside of a professional recording studio. The built-in 'controlled-frequency-response-filter' is a quantum jump in thoughtful engineering design. It was especially developed to permit this amplifier to operate with electrostatic speakers, and may also prove immensely valuable where subsonic woofer and supersonic tweeter problems are to be encountered. All in all, the SA-300 is the Aristocrat of stereo power amplifiers, and is a wise investment for superlative stereophonic hi-fi."



WRITE TODAY FOR THE COMPLETE SA-300 STORY!

FISHER RADIO CORPORATION · 21-25 44TH DRIVE · L. I. CITY 1, N. Y.

Export: Morhan Exporting Corp., 458 Broadway, New York 13, N. Y.

NEW PYRAMID[®] POINT

by Fidelitone

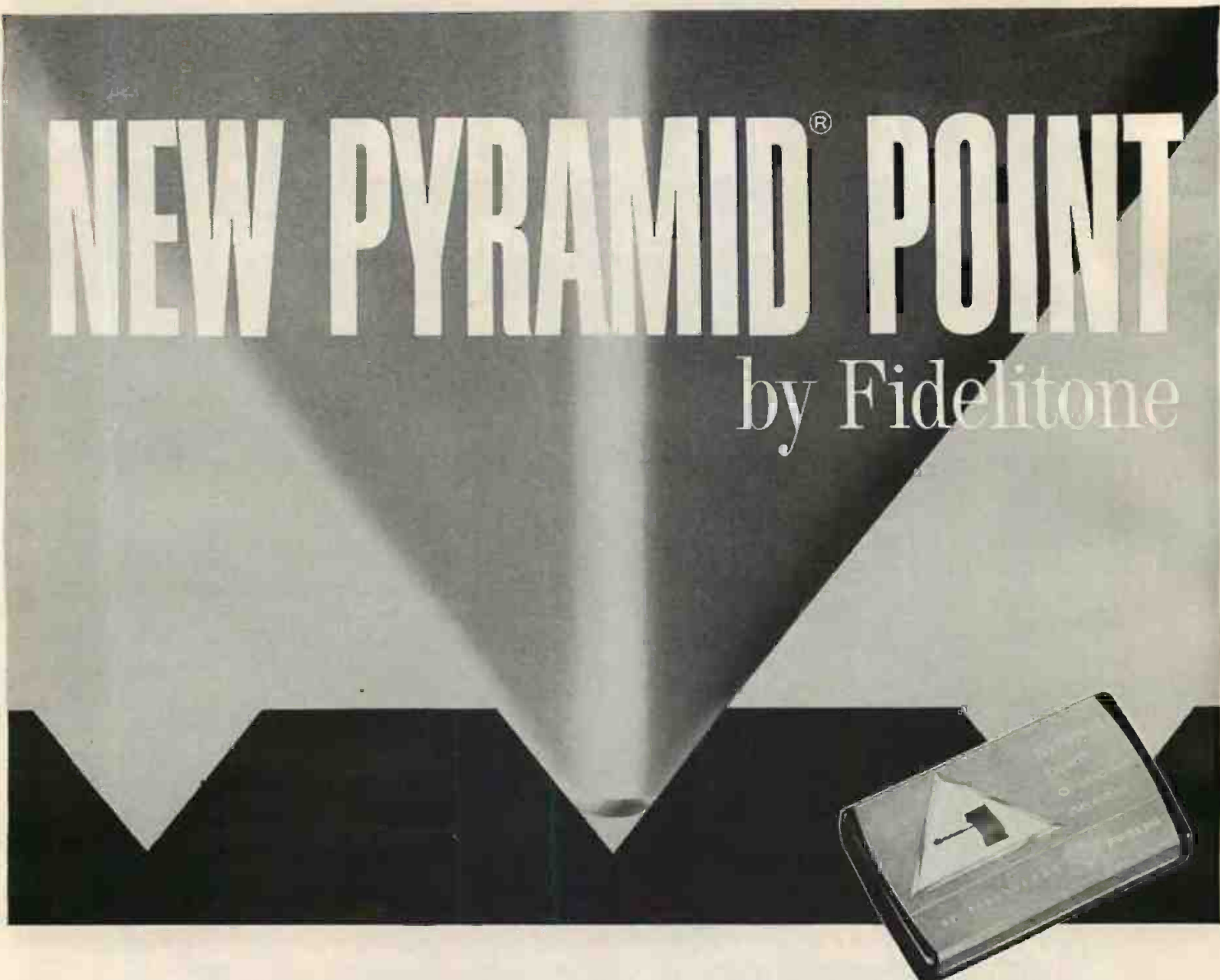

for the first time.. a needle shaped to follow record grooves exactly.. pick up all the sound

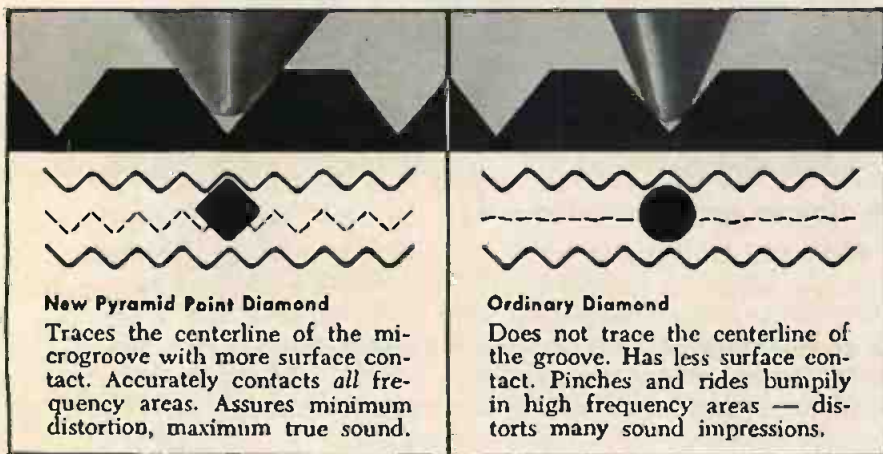

New Pyramid Point Diamond

Traces the centerline of the microgroove with more surface contact. Accurately contacts *all* frequency areas. Assures minimum distortion, maximum true sound.

Ordinary Diamond

Does not trace the centerline of the groove. Has less surface contact. Pinches and rides bumpily in high frequency areas — distorts many sound impressions.

It's here! The new Pyramid Point Diamond by Fidelitone — the only needle tip scientifically shaped to simulate the original recording stylus. It's designed to pick up *all* sound information — cleanly reproduces the highest highs — the lowest lows. The exclusive new pyramid shape minimizes pinch effect in the high frequency passages, lowers background noise — and reduces distortions as much as 85%! Now for the first time the full pure tones of the original recorded sound are faithfully reproduced. And the greater surface contact between needle and record prolongs your needle and record life. So hear the amazing difference yourself in sound quality — stereophonic or monophonic with the new Pyramid Point Diamond by Fidelitone.

Over 30 years of quality needles

Fidelitone

"Best buy on records"
Chicago 26, Illinois



Write today for free booklet of the complete Pyramid Point Diamond story.

BEST
IN EVERY
STEREO
HIGH FIDELITY
CATEGORY

THE FISHER

RECEIVERS • TUNERS
MASTER AUDIO CONTROLS
CONTROL AMPLIFIERS
POWER AMPLIFIERS



THE FISHER 600 Stereo FM-AM Receiver is the world's first and *finest* complete stereo receiver. It contains everything you need on one magnificent chassis: a Stereo FM-AM Tuner, Stereo Master Audio Control, and a 40-Watt Stereo Power Amplifier. Because of its ample power reserve, it is also the *only* receiver suitable for *both* high and low-efficiency speakers! FM sensitivity under one microvolt. Cascade RF stage on FM. Rotatable AM antenna. Nineteen operating controls, including separate, dual-channel Bass and Treble, plus facilities for center channel operation! Add two speakers (we recommend the FISHER XP-1) and a turntable, and you will have a stereo installation *second to none*. Ask your dealer for a demonstration — *today!* **\$349.50**



THE FISHER 101-R
Stereo FM-AM Tuner

World's most sensitive Stereo FM-AM Tuner — 0.75 microvolt FM sensitivity for 20 db quieting! Four IF stages. Independent tuners for stereo or mono reception. Two Micro-Ray Tuning Indicators. Automatic FM inter-station noise suppression. **\$229.50**



THE FISHER 400-CA
Stereo Master Audio Control

World's finest, most versatile stereo control center. Sixteen inputs for any combination of stereo or mono applications — including remote control with the FISHER RK-1! Uniform frequency response 20 to 25,000 cps. Hum and noise inaudible. **\$174.50**



THE FISHER X-101A
Stereo Master Audio Control
and 40-Watt Stereo Amplifier

Peak power, 75 watts. Twelve inputs for all stereo or mono program sources. Uniform frequency response from 20 to 20,000 cps. Separate dual-channel Bass and Treble controls. Record-Monitor facilities. **\$194.50**

Prices Slightly Higher In The Far West

WRITE TODAY FOR COMPLETE FISHER STEREO LITERATURE

FISHER RADIO CORPORATION • 21-25 44th DRIVE • LONG ISLAND CITY, NEW YORK

Get this stereo tape bonus...

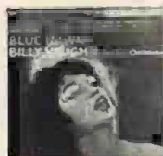

when you buy a **BELL** stereo tape transport

Four new 4-track, 7½ ips Bel Canto Stereo Tapes **free**—to start your library with a 4-track Bell Tape Transport

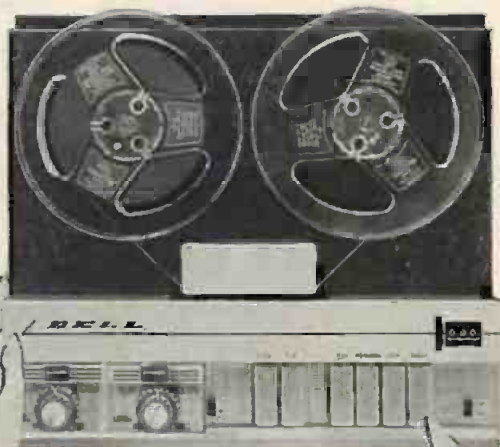

Stereo Tape Bonus applies to Models T-223, T-228, T-238.

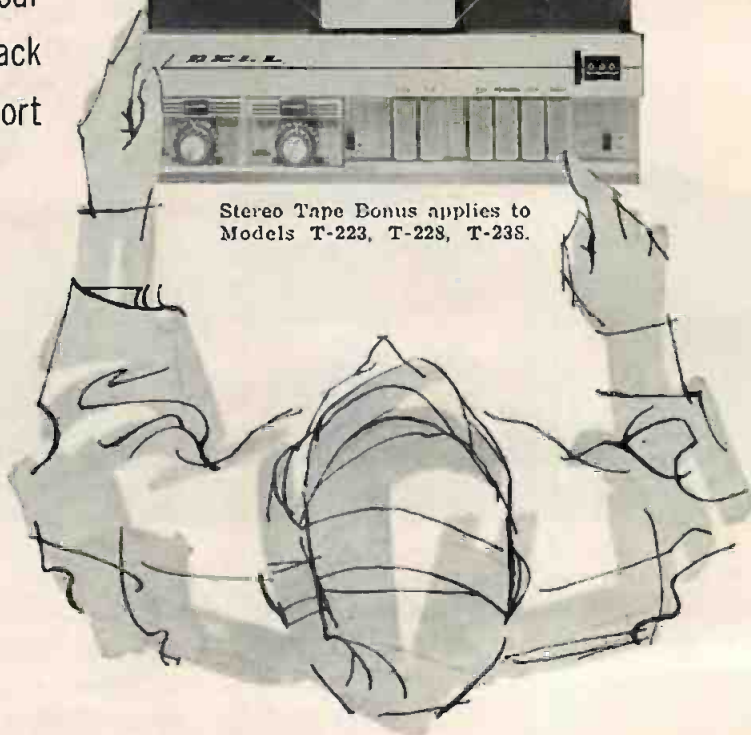

With scores of brand new 4-track stereo tapes already available, now's the time to buy the tape transport you've wanted for your stereo system. Make sure it's a Bell . . . because only Bell gives you a **STEREO BONUS** of four new 4-track stereo tapes to help you start your tape library with a Bell Tape Transport.

These stereo bonus tapes have been carefully selected from the complete Bel Canto library. Wonderful music. More than 2 hours of enjoyable listening. Worth nearly \$32.00 to you!

But it's all yours, absolutely free, from your Bell dealer when you buy a Bell 4-track Stereo Tape Transport. Rated best for stereo recording, Bell gives you the best in performance and features

. . . three motors for positive tape control . . . automatic stop mechanism . . . add-on pre-amps for stereo recording . . . many more.

If you already own a Bell Tape Transport, ask your Bell dealer about easy-to-install 4-track-head conversion kits for as little as \$25.00.

See and hear the Bell Stereo Tape Transport—and get the bonus tapes shown on this page when you buy. Do it today at your Bell dealer's.

Bell dealers offer this stereo record bonus, too!

*Four Mercury Stereo Records, worth nearly \$24.00, as a bonus when you buy a model 3030 Bell Stereo Amplifier—now priced at only \$149.95**

**slightly higher west of the Rockies*

BELL Sound Division • Thompson Ramo Wooldridge Inc. - Columbus 7, Ohio
In Canada: THOMPSON PRODUCTS, Ltd., Toronto

by H. H. SCOTT

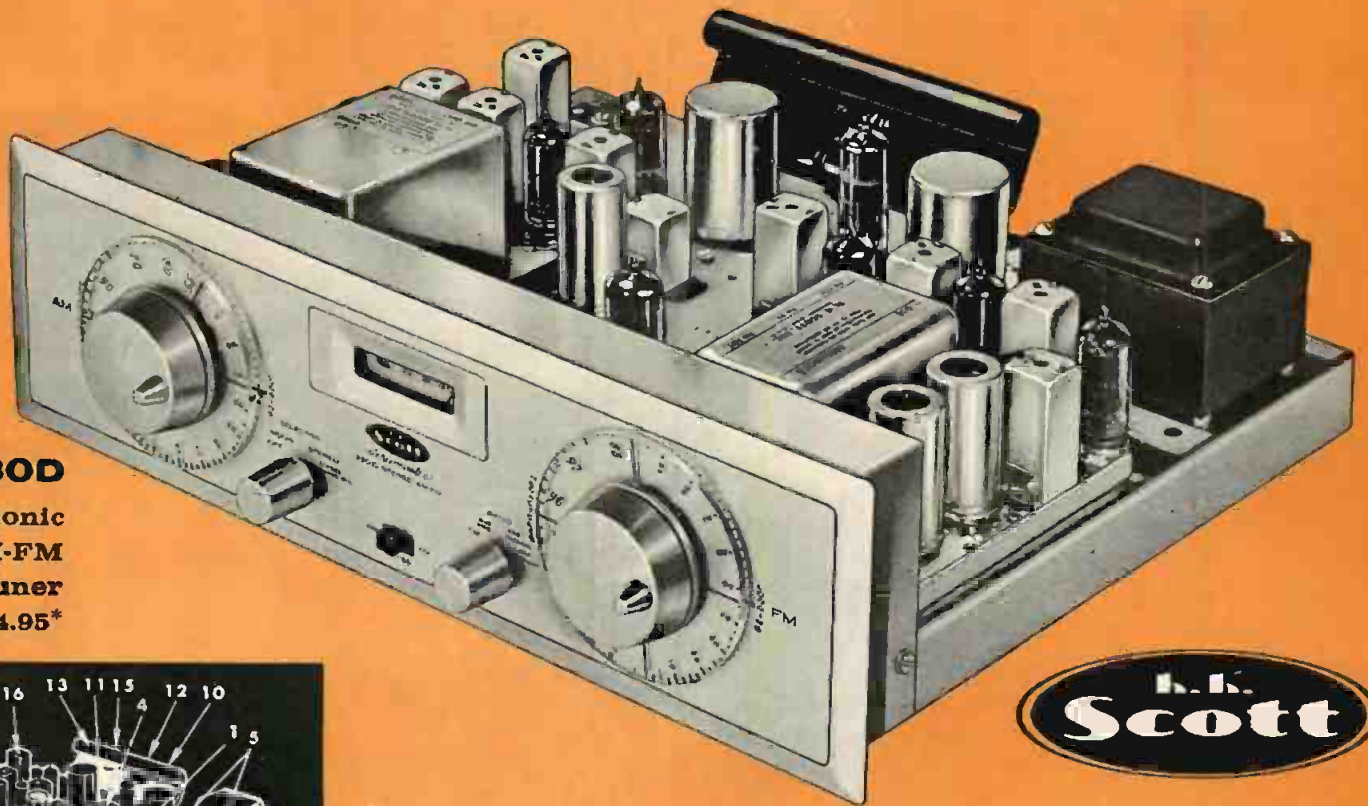

330D
Stereophonic
AM-FM
Tuner
\$224.95*

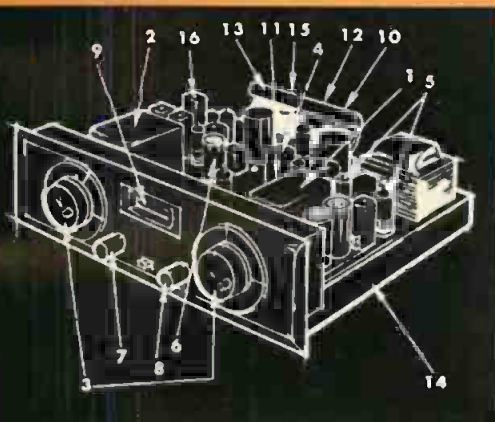

All H. H. Scott FM Tuners Feature Wide Band Design

Wide-Band FM tuner design is recognized as one of the most significant of H. H. Scott's many contributions to audio science. It assures you of absolutely drift-free and interference-free reception in even the weakest signal areas. It also results in ability to separate stations so close together on the dial that ordinary tuners would pass them by. In AM circuitry the unique H. H. Scott Wide-Range detector is equally important. For the first time you can receive full-frequency AM broadcasts with fidelity and frequency response comparable to FM.

Important Features 330D AM-FM Stereo Tuner

1. Separate Silver-Sensitive FM Front End, heavily silver plated for maximum sensitivity and reliability. Meets all FCC radiation specifications.
2. Highly sensitive, separate AM front-end.
3. Separate AM and FM professional tuning controls for precise station selection.
4. Wide-Band FM detector for distortion-free reception on all signals.
5. Highly selective FM IF stages permit separation of stations close together on dial.
6. New wide-range AM detector for high fidelity performance on AM stations.
7. Selector switch with these positions: Off, Mono, Stereo, Stereo Phase Reverse.
8. Band switch with these positions: FM, AM Wide, AM Normal, AM Distant.
9. Illuminated professional signal strength and tuning meter.
10. Stereo output jacks.
11. Special jack for instant connection of accessory multiplex adaptor.
12. Separate stereo tape recorder output jacks.
13. Highly sensitive AM Ferrite Loop Antenna.
14. Chassis specially constructed of heavy copper bonded to aluminum to insure reliability and high sensitivity over many years of use.
15. Separate level controls on AM and FM output channels.
16. 10 KC whistle filter eliminates heterodyne whistle on wide range AM reception.

Specifications: FM sensitivity 2 microvolts for 20 db of quieting on 300 ohm antenna terminals (IHFM rating 2.5 μ v.); FM detector bandwidth 2 megacycles; Automatic Gain control; 85 db cross-modulation rejection.

320 AM-FM Tuner

The many fine features built into this superb AM-FM tuner have never before been available for less than \$200. This tuner is equipped with Wide-Band FM and Wide-Range AM. It has complete facilities for simple addition of a multiplex adaptor when available. This sensitive tuner meets the discriminating



listener's requirements where AM-FM Stereo reception is not available. Sensitivity 2.5 μ v. for 20 db quieting; IHFM sensitivity rating 3 μ v. \$139.95*

310C FM Tuner

This professional tuner is the most sensitive and selective available. Its high standards of performance, including sensitivity of 1.5 microvolts for 20 db of quieting (IHFM rating 2 μ v.), have made it the choice of broadcast stations, universities and government laboratories throughout the world. It is instantly adaptable to multiplex.

\$174.95*



For stronger signal areas where the ultimate sensitivity of the 310C is not required, the 311D rated at 2.5 microvolts is recommended. \$124.95*

high fidelity

and what's in it for you



The Editors of *High Fidelity* have one-track minds. Their main concern is pleasing their readers . . . giving you the most practical, entertaining and informative magazine possible.

- The articles, features, reviews will greatly enhance your enjoyment and appreciation of all music — live and recorded . . . classical, popular and jazz.
- The commentary on records — by the nation's leading reviewers — will help you build a truly outstanding library . . . one that will continue giving you and your family pleasure through the years. Each *High Fidelity* reviewer (and there are more than a dozen!) is an expert in his particular field. Nathan Broder, for example, reviews the Classical composers, Harold C. Schoenberg and Robert Charles Marsh the Romantics . . . John S. Wilson covers jazz, etc. Thanks to this kind of authoritative reviewing, you'll save money on records, too — you need never be disappointed in a record purchase again!
- The information and ideas you will get on building, adding to, maintaining your sound system will pay for your subscription many times over. *High Fidelity's* technical experts test-in-depth, at home and in the laboratories, new sound equipment you may be thinking of buying. Their objective reports insure your owning a high fidelity system that represents the best value available for your particular budget.

So read High Fidelity . . . use High Fidelity . . . buy from High Fidelity's advertisers. You can't make a sounder investment of your time and money!

high fidelity

NOW 4 MAGAZINES-IN-ONE,

INCORPORATING

high fidelity

audiocraft

hi-fi music
AT HOME

Audio League Reports

press
comment *on the*

AR-3

The American
**RECORD
GUIDE**

(Larry Zide)

"Given a good stereo source, a pair of AR-3's comes as close to musical realism in the home, I believe, as the present state of the art permits . . . In sum, until someone comes out with something better that doesn't take up the entire house, the AR-3 is for me the reference standard."

high fidelity *(TITH report)*

"A major problem of tweeter design has been the beaming effect of very high frequencies . . . The "fried egg" [nickname for the AR-3 tweeters] appears to be a major step forward in the smooth dispersion of sound at extreme high frequencies."

HI-FI
SYSTEMS

"In terms of bass response, these two speakers [the acoustic suspension AR-1 and AR-2] represent a phenomenal improvement in the state of the art.

"The complete AR-3 speaker system, in addition to containing a superb acoustic suspension woofer, which has enjoyed wide acceptance by professionals as well as audiophiles, constitutes, in our opinion, a mid and high frequency system which is in every way complementary to the bass quality. The new AR-3 rivals in overall quality the very best woofers and combinations."

The AR-3 is priced from \$203 to \$231, depending on cabinet finish (\$216 in mahogany or birch). Literature is available for the asking.

ACOUSTIC RESEARCH, INC.

24 Thorndike St., Cambridge 41, Mass.

HOW TO BUILD A STEREO CONSOLE THAT REPRODUCES MUSIC AS FAITHFULLY AS SEPARATELY MOUNTED COMPONENTS

For many years, serious music lovers have searched for a way to enclose high quality high-fidelity equipment in a cabinet that would match their finest furniture.

Until now, there was no practical solution. You had to compromise. You had to sacrifice the best possible music reproduction if you wanted a good looking cabinet. If you insisted on high quality reproduction, you chose components, some of which may not have been quite so appealing to the eye.

If you dislike compromise, Stromberg-Carlson's new kind of console will interest you. We call them Integrity Series Component Ensembles—and to an uncompromising music lover each word in that name will be significant.

At the start, we faced the same problem that every console manufacturer has tried to overcome: when full-range speakers were rigidly mounted in the same console as high quality components, there was a serious loss of sound quality.

This loss—most often recognized as muddy or boomy noise—is caused by "feedback." It occurs because sensitive components can detect the speaker vibrations which are fed back through the body of the cabinet. These vibrations are amplified with the music and reproduced as noise.

If you own a console now, but do not hear these noises, it is not because your ears are insensitive.

You do not hear them because we and every other console manufacturer had to eliminate them by compromising the musical reproduction of your console. You do not hear them because the sound you hear is not complete.

HOW TO BUILD A CONSOLE THAT ELIMINATES FEEDBACK NOISES

As we analyzed the problem, we realized there were seven projects that we had to accomplish before

we could bring you this new kind of console.

PROJECT #1 The first consideration was given to our components. They had to have high quality reproduction. The standards we set for them can be most simply described by the phrase "Integrity in Music Reproduction." If you are familiar with Stromberg-Carlson stereo tuners, amplifiers, turntables and speakers, we believe you will agree they earn this description.

PROJECT #2 Speaker systems were the next important project. For our new kind of stereo console we needed two speaker systems of unquestionable quality. We were fortunate here, because we



had already developed a system that met the quality requirements, the well-regarded Acoustical Labyrinth® Speaker System. Its quarter

wavelength duct enclosure, properly coupled to a low-frequency radiator, achieved a system resonance lower than the un baffled free air cone resonance of the radiator itself. This is the kind of quality we knew you wanted.

PROJECT #3 To reduce the size of high quality speaker systems so that they would fit into a stereo console of reasonable dimensions. We were certain that component-quality sound in a console could only be achieved with speaker systems that

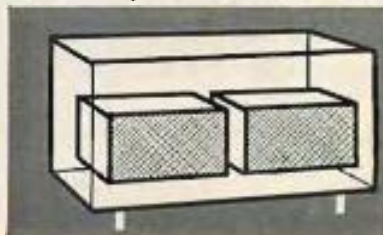

did not depend on the console cabinet for their enclosure. This meant that we had to reduce the size of the Acoustical Labyrinth enclosure.

sure so that we could fit two separate speaker enclosures within a cabinet that had reasonable dimensions. It was not easy, but we did it. After many, many trials and tests we achieved the correct size without sacrificing one iota of the extremely linear and extended response of the system.

NOW THE MOST DIFFICULT PROBLEM HAD TO BE FACED

PROJECT #4 To effectively eliminate feedback by effectively eliminating the mechanical coupling that allows it to occur. Instead of treating the symptoms, we treated the cause. We developed a method of effectively isolating the speaker systems from the sensitive components. (As a result, Stromberg-Carlson Integrity Series Ensembles are the first successful uncompromised ensembles.)

The key development is what we call ISO-COUSTIC SPEAKER SYSTEM MOUNTING. This mounting, in which the resistance and compliance to vertical and horizontal pressures have been carefully engineered, has solved the problem. It allows Stromberg-Carlson to create a cabinet-within-cabinet suspension system which prevents transmission of speaker vibrations to the sensitive components.

If you component owners could put your equipment into a cabinet whose speaker systems have our ISO-COUSTIC Mounting, the quality of the sound you'd hear would be as good as your component system is now. In fact, the components we use are the same ones you would choose for your separately mounted component system. They are interchangeable.



INTEGRITY SERIES WILL NEVER BECOME OBSOLETE

PROJECT #5 To assure the purchaser of an Integrity Ensemble that his choice would never be obsolete, we designed the units in accordance with a modular concept. All of the components are completely interchangeable. You can replace any component in the ensemble to keep pace with new developments—without ever replacing your fine cabinetry.



CABINETRY HAD TO BE EXCEPTIONAL, TOO

PROJECT #6 To design cabinets with the permanent beauty of fine furniture. Federico responded to the challenge by creating cabinetry in Traditional, Contemporary, Early American, Italian Provincial, French Provincial and Oriental

styling. You choose from 16 basic models in these styles, in a choice of finishes. These cabinets, like a fine painting, best describe themselves. They must be seen.

PROJECT #7 To give you maximum flexibility in your enjoyment of an Integrity Series Ensemble. Every ensemble provides for your listening tastes and room acoustics by including the Stereo Choice Switch for precise regulation of stereo separation, with or without separate matching speaker systems. All ensembles provide space for adding a tape deck.

You may select your own Stromberg-Carlson stereo components or choose a recommended component complement—in any case Stromberg-Carlson components are always interchangeable.

If you now own a console or components, we invite you to exercise your critical judgment by listening to an Integrity Series Ensemble. (You will find that the better component shops—as well as the better department and music stores—have chosen to feature this new kind of stereo console.) Listen carefully. Look closely. Ask questions. Then accept not our judgment, but your own.



INTEGRITY SERIES COMPONENT ENSEMBLES

—three hundred and fifty dollars to about six thousand dollars. You may choose from 16 models in Traditional, Contemporary and Period stylings, each tastefully designed by Federico. You may select your own Stromberg-Carlson components or choose a recommended Stromberg-Carlson component complement—in any case Stromberg-Carlson components are always interchangeable.

For a complete color catalog of Integrity Series Component Ensembles and components write STROMBERG-CARLSON, Special Products Division, 1419 N. Goodman St., Rochester 3, New York.

"There is nothing finer than a Stromberg-Carlson"

STROMBERG-CARLSON
A DIVISION OF **GENERAL DYNAMICS**

For integrity in music...

A NEW STROMBERG-CARLSON SINGLE-SPEED TURNTABLE

...in component systems

...in Integrity Series Ensembles



PR-500

PR-500 SINGLE SPEED Here is a revolutionary concept in turntable design: a dual-drive system consisting of two hysteresis-synchronous motors operating one belt drive.

The motors are spaced exactly 180° apart. Any variation of speed is automatically corrected by the interaction of the motors and the impregnated belt. Rumble and noise are virtually eliminated by the belt drive and a unique suspension system in which the tone arm and table, as a unit, are isolated from the mounting board.

Single, 33 $\frac{1}{3}$ speed. Includes tone arm. PR-500, black and brushed chrome \$69.95*

PR-499 "PERFECTEMPO" ALL SPEEDS The "Perfectempo" incorporates every valid, time-proven design principle: belt drive; continuously variable cone drive (14 to 80 rpm); stroboscopic speed indicator; dynamically balanced, weighted table; precision motor; plus Stromberg-Carlson's original double-acting motor and table suspension system that effectively eliminates unwanted noise. Performance proves it: Wow 0.14% rms; Flutter 0.09% rms; Rumble -55 db re 20 cm/sec at 1 kc. PR-499, morocco red with aluminum trim \$99.95*

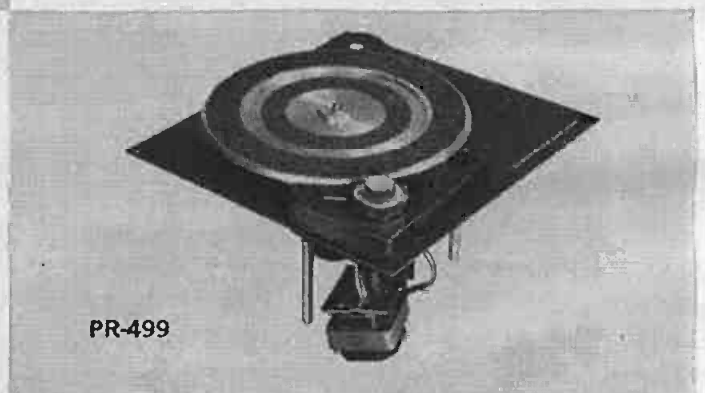

PR-499

RA-498 TONE ARM The Stromberg-Carlson Tone Arm uses the most valid engineering concepts of tone arm design. Single pivot point suspension, true viscous damping and high moment of inertia result in extremely low resonance and consequently yield flat response below the limits of audibility. A calibrated counterweight is adjustable to provide any needle point force. For stereo operation, complete with mounting base, viscous fluid, rest, and cartridge clip. Fits all standard turntables. RA-498 \$24.95*



RA-498

*Prices audiophile net, turntables less bases.

"THERE IS NOTHING FINER THAN A STROMBERG-CARLSON"



For integrity in music...

THREE NEW STROMBERG-CARLSON TUNERS

...in component systems

...in Integrity Series Ensembles

SR-455 AM-FM STEREO TUNER The SR-445 is actually two separate and complete units which have been placed together for convenience of mounting and use. They have individual circuitry in which no duplicate use of tubes or circuits is involved. Operate as an AM tuner, an FM tuner or together as an AM-FM stereo tuner. The SR-455 combines the separate AM and FM tuners described below. The specifications are exactly the same as listed for these two units. SR-455 . . . \$129.95*

All three tuners are available in gold and white or black and brushed chrome. Top cover in white, black, tan or red available at extra cost.



SR-445



FM-443

FM-443 FM TUNER Exceptionally sensitive, low noise reception due to the wide peak-to-peak separation (475 kc) and long, linear slope (350 kc) of the balanced ratio detector, and the grounded grid cascode front end. Sensitivity is 2 uv for 20 db quieting, 4 uv for 30 db quieting (300 ohm). Local-Distant Switch results in 2 uv for 40 db quieting on local stations. Dial station selector and "hair-trigger" tuning eye. Temperature controlled circuits eliminate drift. Includes switched AFC circuit. Tuning Range: 88-108 mc. Bandwidth: 200 kc. Frequency Response: 20-20,000 cps. Self-powered with auxiliary power for AM-441 tuner. Provision for multiplex adapter. FM-443 . . . \$79.95*



AM-442/AM-441

AM-442 AM TUNER For exceptional AM reception, this tuner has a frequency response of 20-7,000 cps, down 7 db at 7,000 cps. It features a tuned RF stage and 3-gang variable tuning condenser. Its tuning range is 540 to 1,600 kc; Bandwidth is 9 kc. Local-Distant Switch adds 20 db quieting on local stations. Adjustable ferrite loop and external antenna. AM-442 . . . \$59.95*

AM-441 AM TUNER Same as above, but without its own power supply . . . \$49.95*

**Prices audiophile net, zone 1, less cover*

STROMBERG-CARLSON

A DIVISION OF **GENERAL DYNAMICS**

For integrity in music...

STROMBERG-CARLSON STEREO CONTROL AMPLIFIERS

...for component systems

...for Integrity Series Ensembles

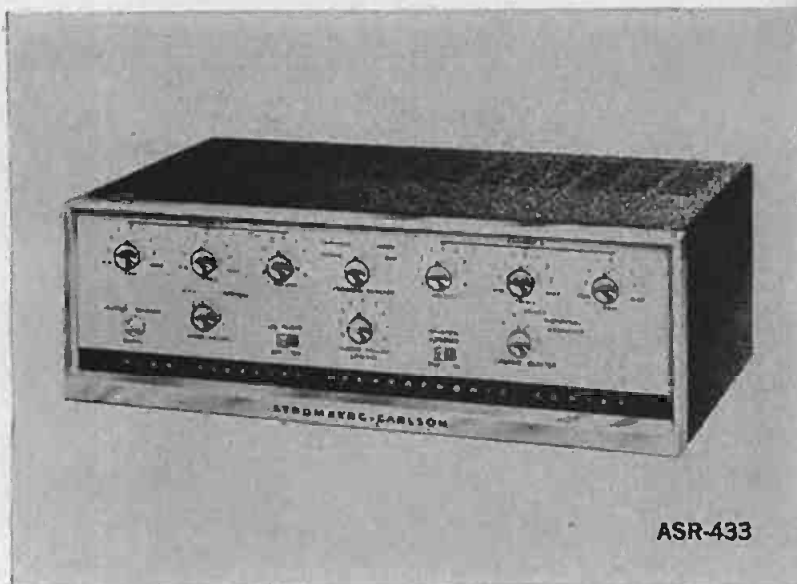

ASR-433

ASR-433 STEREO "24" CONTROL AMPLIFIER A dual channel amplifier with excellent performance and control features. Each channel provides 12 watts of exceptionally clean, balanced power. The exclusive "Stereo Tone Balance" signal permits you to adjust the two channels by a single tone.

The deliberately conservative specifications include: frequency response 20-20,000 cps; harmonic distortion less than 1% at full output; IM distortion less than 1% at program level; hum and noise 63 db down. Inputs: magnetic and ceramic phono; tuner; tapehead; auxiliary/tape. Available in gold and white or black and brushed chrome. ASR-433 .. \$129.95*

ASR-444 STEREO "60" CONTROL AMPLIFIER offers all desirable controls, plus high power. Each channel provides 30 watts of balanced power. It features separate bass, treble and volume controls for each channel, a master gain and loudness control, and the "Stereo Tone Balance" signal. Specifications: frequency response 20-20,000 cps; harmonic distortion less than 0.7% at full output, IM distortion less than 1% at program level. Same inputs as ASR-433. In gold and white or black and brushed chrome. ASR-444 \$169.95*



ASR-444

ASR-333 STEREO CONTROL AMPLIFIER, and a fine ceramic cartridge, give you quality performance at a low price. This amplifier—with 12 watts per channel—was designed for optimum reproduction with ceramic cartridges. It features tone and volume controls for each channel, plus a loudness control. Frequency response, noise level, distortion, same as ASR-433. Inputs: ceramic phono, tuner, tape/auxiliary. In black and brushed chrome. ASR-333 \$99.95*



ASR-333

*Prices Audiophile net, Zone 1, less top covers, which are available in white, black, tan or red.

"THERE IS NOTHING FINER THAN A STROMBERG-CARLSON"



For integrity in music...

STROMBERG-CARLSON SPEAKERS AND SYSTEMS

...for component systems

...for Integrity Series Ensembles

Stromberg-Carlson manufactures a full line of speakers and the famous Acoustical Labyrinth® Speaker System. This system enclosure achieves a system resonance that is lower than the un-baffled free air cone resonance of the low frequency radiator. It utilizes mass loading and frictional damping as acoustical devices to extend the low frequency range of the system with extreme flatness of response. Five new complete speaker systems with a variety of decorator housings are now available. We suggest that you compare the quality of their performance with similar equipment. You be the judge.

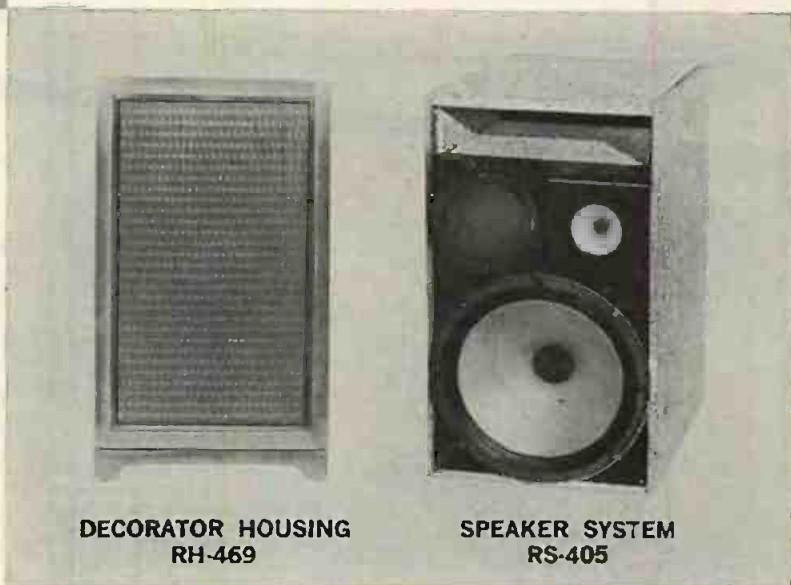

DECORATOR HOUSING
RH-469

SPEAKER SYSTEM
RS-405

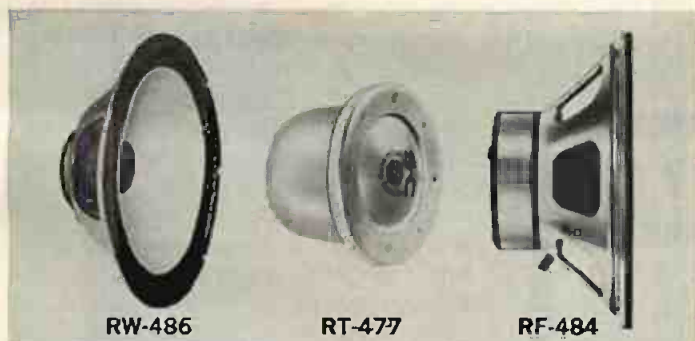

RW-486

RT-477

RF-484

SPEAKERS Stromberg-Carlson loudspeakers include tweeters, woofers, coaxials and mid-range transducers. They are available in all popular sizes and price ranges.

The unusual Stromberg-Carlson "Slimline" feature allows maximum versatility in installation, and is made possible by another feature: the new "Barite" ceramic magnet, which is used to insure excellent transient response over the full effective frequency range.

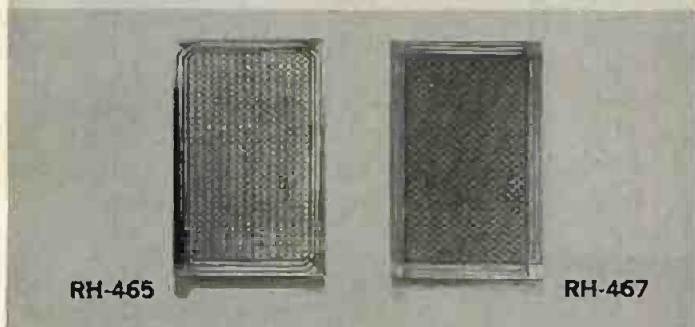

RH-465

RH-467

ENCLOSURE KITS Acoustical Labyrinth enclosures are now available as unassembled kits. All pieces are precision-cut to size, ready to assemble. Nails, glue, complete instructions—everything you need is included. Enclosures are available for 8", 12" and 15" systems. The same decorator housings available for factory assembled systems may be used. Write for full details on speakers and housings available.

For full details on Stromberg-Carlson components, write Stromberg-Carlson, a Division of General Dynamics, 1419 N. Goodman St., Rochester 3, N. Y.

STROMBERG-CARLSON

A DIVISION OF **GENERAL DYNAMICS**

Traditional
OLD WORLD
Craftsmanship



Serving a
NEW WORLD
of Sound!

Connoisseur TURNTABLE

for the discriminating who demand the ultimate in
stereo reproduction

NEW
MODEL
B



Newly
Developed!

Automatic control arm and diamond stereo pickup must be seen and heard to be appreciated. Just one touch lifts or lowers arm with perfect precision. Superb stereo! Only \$59.50 net.

MADE IN ENGLAND

Created by skilled hands of English craftsmen working to tolerances of .0001", the Connoisseur turntable is constructed to assure you of remarkable silent operation. The hysteresis synchronous motor-driven turntable is non-magnetic and equipped with an illuminated strobe disc to insure speed perfection. Wow is less than .15% and Rumble is 50 db down (7 cm/sec. at 500 cps). Mounting size: 15 1/4" x 13 1/2". Only \$119.50 net.



Reslo STUDIO MICROPHONES

England's most honored line of microphones to assure the highest broadcasting quality standards.

Of rugged, compact design, each features a dual ribbon cartridge weighing 1.2 mg (1/960 oz.) and triple screen protected. Impedances available for professional or home recording equipment. Three models: Symphony, Celeste (with switch) or Avon supercardioid. From \$59.50 net.

Impedances available for professional or home recording equipment. Three models: Symphony, Celeste (with switch) or Avon supercardioid. From \$59.50 net.



time for
listening

VITAVOX

MADE IN ENGLAND

When superlatives pall . . . and specifications no longer impress . . . it's time to listen—long and carefully. In this most exacting of audio tests, the Vitavox DU120 Duplex Coaxial Speaker emerges triumphant! Here's full range reproduction free of distortion and peaks. For proof, ask for a demonstration of the new Vitavox Hallmark System which employs the DU120. You'll hear the difference and want either the DU120 or Hallmark as part of your own system. \$89.50 net.

High priced speakers a "must"?

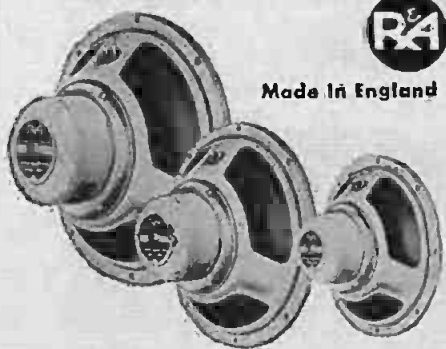

Made in England

700 SERIES—MARK III

"Big" speakers don't have to have big price tags. Not with the famous R & A! Here are speakers that bring true high fidelity and luxury listening—yet at a price unbelievably lower than expected for such excellent performance. Your stereo speaker investment can be minimized without sacrificing quality if you add an R & A to your present speaker system. Coaxial construction in 8", 10" and 12" models. Aleomax III Anisotropic Magnetic systems of 12,000 Gauss Flux density. From as low as \$13.95 net.

at selected Hi-Fi Dealers

Specific literature on request

ERCONA CORPORATION

(Electronic Division)

Dept. 51, 16 West 46th Street, New York 36, New York

Notes



Abroad

LONDON—In fifteen sessions, at Walthamstow Town Hall on London's outer rim, Sir Thomas Beecham, the Royal Philharmonic Orchestra and Chorus, Jennifer Vyvyan, Monica Sinclair, Jon Vickers, and Giorgio Tozzi completed for RCA a full, 250-minute recording of Handel's *Messiah*. Owing to a wealth of unprecedented orchestral effect, this production is sure to send the purists into a huff as soon as it hits the Christmas market. The eight sides are divided into two sections, one big, one small. The big section comprises a self-contained concert edition of the oratorio which Beecham conducted publicly for the first time in the Kunsthaus at Lucerne's autumn music festival. The small section is an appendix comprising all choral and other numbers left out of the concert edition. Beecham's orchestra took part in the recording at the height of their Glyndebourne Opera Festival commitments, a circumstance involving them in hectic cross-country shuttling and many early mornings following late nights.

The new orchestration is not Beecham's handiwork but was, as he jocosely puts it, "instigated" by him. One day he said to Sir Eugene Goossens, the conductor-composer, "Would you like to write the *Messiah* accompaniments as Handel would have scored them if he had been living today?" Goossens accepted the commission and spent five months on it. Handel's string parts remain untouched, except that in this version they are allocated to a full symphony complement with eight string basses. For the rest the specification includes triple woodwind (with a fourth oboe), contrabassoon, bass clarinet, four horns, two trumpets, three trombones, bass tuba, one harp (or more) and, in the "kitchen," triangle, cymbals, bass drum and tenor drum.

Some of the details—e.g., the bumpety-thump of the tenor drum in the "Glory to God" chorus and the triangle trills that underline the "Wonderful Counsellor!" outbursts—make an odd

Continued on page 32

Discover for yourself why Sherwood is the most honored line of high fidelity components in the field. Sherwood Tuners (the first ever to achieve sensitivity under 0.95 microvolts) feature: Inter-Channel Hush, a noise muting system which makes FM tuning easier than ever • FM Multiplex Output • "Feather-Ray" Tuning Eye • Automatic Frequency Control • Flywheel Tuning. Combine these tuners with either of Sherwood's "mated" stereo amplifier choices; 20+20 watts or 36+36 watts. And only Sherwood offers all these features: Single/Dual Bass & Treble Controls • Mid-Range Presence Rise • Stereo-Mono Function Indicator Lights • Phase-Reverse Switch • Damping Factor selection. Sherwood also offers either 36 or 60 watt monaural amplifiers, FM Multiplex Adapters and a complete decorator-styled line of cabinetry and 3-way speaker systems —The Finest in High Fidelity, Sherwood Electronic Laboratories, Inc., 4300 N. California Avenue, Chicago 18, Illinois.

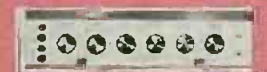
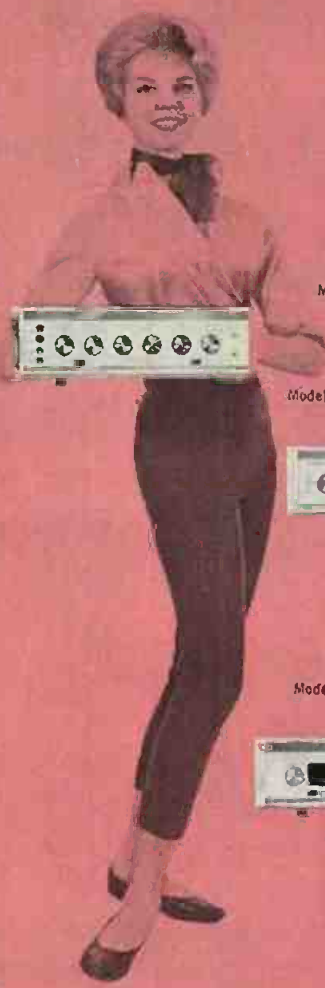

Model S-4400, Stereo Preamp, +36W Amp —\$159.50



Model S-5000, 20 + 20W Stereo Dual Amplifier —\$189.50



Model S-3000 II, FM Tuner —\$105.99



Model S-1000 II, 36W Monaural Amplifier —\$109.50



Model S-2000 II, FM/AM Tuner —\$145.50

only for those who want the ultimate

SHERWOOD HIGH FIDELITY

For complete technical details write Dept. H-11.

All prices fair trade.

© 1959 Sherwood Electronic Laboratories, Inc.

Mullard TUBES CIRCUITS

engineered for high fidelity

stereo
am / fm
television

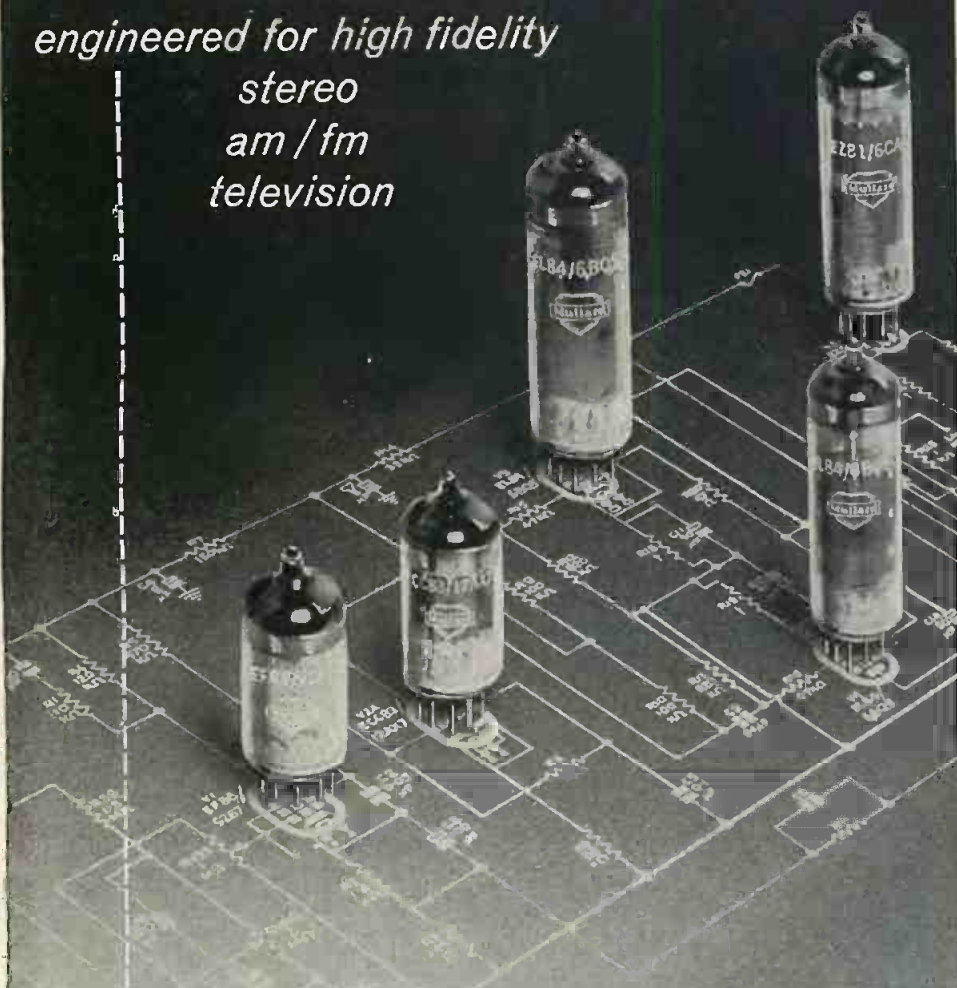

MULLARD electron tubes, universally recognized for their advanced designs and reliability, offer a selected range* of tubes for High Fidelity, AM/FM, Television, and Industrial Applications.

This selected range*, which uses frame grids, special glass, coiled heaters, bifilar windings, special mica construction, low hum and microphony, rugged construction, longer life are features found in more expensive premium tubes.

At MULLARD these extras are standard

in the regular commercial production —

AT NO EXTRA COST.

Discover the advantages of MULLARD tubes in your equipment — now!

Detailed data and application engineering assistance available upon request.



Trade Mark
Mullard Ltd.



"Circuits for Audio Amplifiers" is a new MULLARD publication in which the wide range of MULLARD high quality audio circuits is presented conveniently in one book. Four introductory chapters are devoted to theoretical and practical considerations of high quality sound reproduction with monophonic equipment or with stereophonic systems. The rest of the book comprises circuit descriptions, constructional details, and some performance figures of 12 MULLARD circuits. These circuits include well-known MULLARD designs, some modifications and improvements to these circuits, and a number of completely new ones. Only \$2.50 from your dealer or by mail from our Technical Services Division.

INTERNATIONAL ELECTRONICS CORP.
81 SPRING ST., NEW YORK 12, N.Y.

NOTES FROM ABROAD

Continued from page 30

initial impact. At an early Walthamstow run-through the contralto looked over her shoulder with a startled expression, as though the roof were caving in, when the cymbalist came in with a crescendo roll under her upward triplets on the repeated phrase "is risen." Perhaps the tenor was similarly disturbed by the plucked string basses doubled by soft bass-drum strokes which dog his steps in "Thou shalt break them." I must say, however, that on a second hearing I found this particular "realization" hair-raisingly dramatic. Goossens has here been creative; he actually adds something to Handel.

There is much doubling and reinforcing of choral strands by instrumental groups; much juxtaposing of solid blocks of woodwind, string, and brass tone one against the other. I am not certain that this is how Handel would have written for the oratorio if living today. It is certainly how he would have written for it if he had lived in the age of Berlioz, Wagner, and Elgar or under their influence.

During the Lucerne rehearsals I thought of the meager *Messiah* specifications that have come down to us from Handel's time (thirty-three players at the outside, plus organ) and of how scrupulously these vestiges are prized by the purists.

"What are the purists going to say about your version?" I asked Sir Thomas.

"I never think about the purists," he replied. "If Handel and many other composers were left to the purists, you would never hear them at all. The thing to remember is that no man knows how the oratorios were performed. I have thought about it for sixty years, much longer than the gentlemen who write strange books and monographs on the subject. They leave out of account that Handel, who played the organ or clavichord or harpsichord in these performances, was the greatest *improvisatore* of his day."

"Would you care to discuss any 'purist' *Messiahs* you have heard recently?"

"My dear boy, I have done 'purist' *Messiahs* myself. I have done them all over the world. Invariably the public walk out. And for a simple reason.

... Until people heard Wagner and Tchaikovsky they had no notion of the modern orchestra. Once they heard the modern orchestra they refused to listen to the old orchestra. They won't tolerate two and a half hours of singing with archaic orchestral sounds."

CHARLES REID

the "fourmost reasons" why Audax Paraflex[®] is not "just another speaker system."

George Silber, as President of Rek-O-Kut and its new Audax Division has been a pioneer in the manufacture of the highest quality components. In Audax Speaker Systems, you will find the same uncompromising standards that have made Rek-O-Kut Stereo Tables the most respected brand in high fidelity.

Saul White, well known design engineer and writer on transducers and inventor of the patented Paraflex foam compound suspension, the greatest step towards the reproduction of natural sound.

Tom Mulligan, representing the great Union Carbide Company who researched and developed the Dynel fabric adapted by Audax for its "Acoustiscreen."

George Nelson, one of America's greatest industrial designers, brilliantly styled the enclosures and developed the Dynel three-dimensional "Acoustiscreen" grille.

TWO MODELS now at your dealer's — CA-80 System, 12" x 12" x 24", \$99.95. CA-100 System, 15" x 12" x 25", \$139.95.
*PAT. APP. FOR

PARAFLEX

Write for free catalog and specifications, to:
AUDAX Division of the Rek-O-Kut Co., Inc.
Dept. HF-11A
38-19 108th St., Corona 68, N. Y.

Name _____

Address _____

City _____ State _____

**SPEAKERS
BY AUDAX**



Export: Morhan Exporting Corp., 458 Broadway, New York 13, N. Y. Canada: Atlas Radio, 50 Wingold Avenue, Toronto 19, Ontario RA 8

AUDIO EMPIRE

ANNOUNCES
TWO NEW STEREOHONIC
HIGH FIDELITY COMPONENTS —
THE FIRST TO ACHIEVE

STEREO/BALANCE

MOST ESSENTIAL REQUIREMENT
TO FULL-DIMENSIONAL STEREO PERFORMANCE

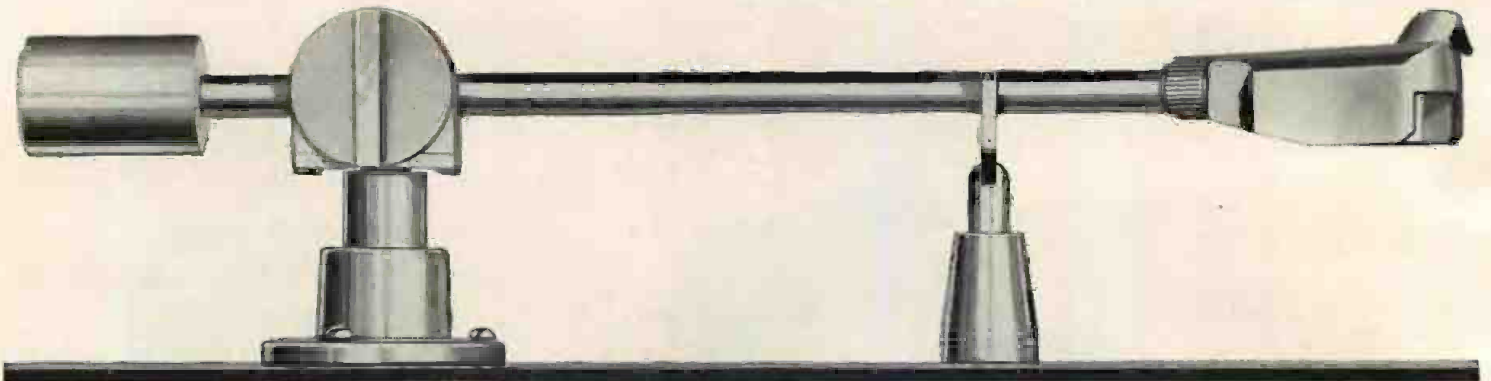

NEW empire 98 STEREO/BALANCE TRANSCRIPTION ARM

Stereo/balance through dynamic balance—the outstanding achievement of the new Empire 98 Transcription Arm. The geometry of the arm's design aligns the center of mass at the pivot point, so that the arm is in balance in all planes. The stylus exerts no greater pressure on either wall of the groove if the table is tilted at any angle—even upside down.

Further, this balance is not disturbed with any required change in stylus pressure, because changing stylus pressure with the Empire 98 does not shift the center of mass as it does in arms where stylus pressure depends upon the position of the counterweight.

The counterweight is only used to 'zero-out' the cartridge. Stylus pressure is actually dialed with a calibrated knob. This knob adjusts the tension of a temperature compensated linear torsion spring which applies a torque force as close to the theoretical center of mass as is mechanically possible. This knob is calibrated in grams with an accuracy of 0.1 grams.

The natural resonance of the Empire 98 is below the threshold of audibility (approximately 10 to 13 cycles). Precision ball-bearing races provide friction-free compliance in both vertical and lateral movements. The cartridge shell accepts all standard cartridges, is interchangeable, and is fitted with gold-plated, non-oxidizing electrical contacts. Every detail of the Empire 98 substantiates the careful planning that went into its design, and gives ample evidence of its quality in action.

EMPIRE 98 12" transcription arm \$34.50; EMPIRE 98P 16" transcription arm \$38.50

NEW empire 88 STEREO/BALANCE CARTRIDGE

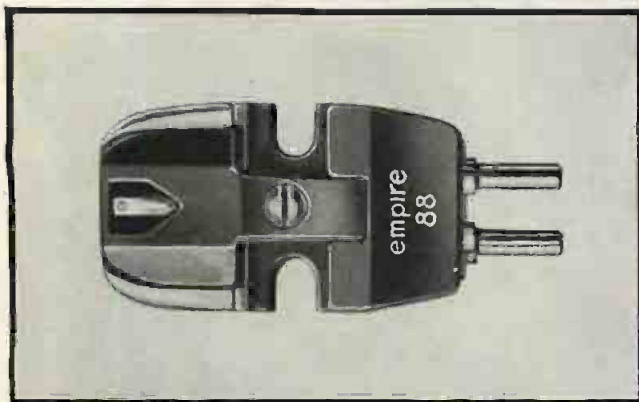

The most impressive—the most dramatic feature of the new Empire 88 is the quality of its performance. It is difficult to equate and describe smoothness of response, clean, articulate reproduction, dimensional fullness and balance—yet, these are the sensations immediately evident with the first demonstration of this remarkable cartridge.

The Empire 88 employs the much-acclaimed moving magnet principle, incorporated in a new, improved design. Frequency response extends from 20 to 20,000 cycles, ± 2 db. The outputs of the two channels are perfectly balanced within ± 1 db. Yet, interchannel isolation over the entire stereo frequency range is better than 20 db. Hum-free operation is assured by the use of modern precautionary techniques: 4-pole balanced 'hum-bucking' construction, mu-metal magnetic shielding and 4-terminal output.

Aside from the noticeably superior performance of the Empire 88 over other cartridges playing the same monophonic or stereo records, there is virtually no groove wear. This is a result of the exclusive Empire 88 stylus lever design which achieves high compliance (5×10^{-9} cm/dyne vertically and laterally) and dynamic mass (less than 0.7×10^{-4} grams) diminishing to zero at high frequencies.

EMPIRE 88 with diamond stylus \$24.50; EMPIRE 88S with sapphire stylus \$18.50

See and hear these quality stereophonic components at your high fidelity dealer today, or write for details:

Audio Empire—precision products of Dyna-Empire, Inc., 1075 Stewart Avenue, Garden City, N. Y.
Dept. HF-11

In Canada: Active Radio & TV Ltd., Toronto 2, Ont.

audio/empire

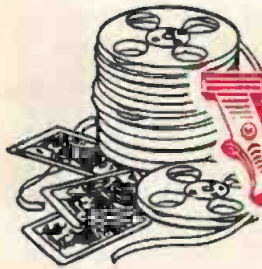

When

the chips are down... tape is still king

SONY Sterecorder

the finest complete **STEREOPHONIC RECORDING
and PLAYBACK SYSTEM*** *in one low cost unit.*

* All STERECORDER models are also available with an extra stereo play-back head with a frequency response of 30-12,000 CPS to reproduce the new pre-recorded 4-track stereo-
phonic tapes (Model 555-A4).

*...and the SONY
STERECORDER
is your best bet!*

- Built-in stereo pre-amplifiers and power amplifiers (can be used for other components)
- Separate head for 4-track tapes
- Two V. U. meters for professional level indication
- Stereo outputs for loud speakers and external amplifiers

NATIONALLY
ADVERTISED PRICE NOW **\$ 395⁰⁰**

- Individual stereo tone and volume controls plus master volume
- Inputs for live stereo and "off the air" stereo recording
- Automatic tape lifters (eliminates head wear in fast forward and rewind)



DK 555-A
Ideal for "built-in" installations

Tape Speeds
Instantaneous selection —
7½ IPS or 3¾ IPS

Frequency Response (per Channel)
30-18000 CPS at 7½ IPS
± 2 DB 50-15000 CPS at 7½ IPS
30-12000 CPS at 3¾ IPS

Signal to Noise Ratio (per Channel)
50 DB or more across line output
(measured by proposed NARTB standards)

Flutter and Wow
Less than 0.2% at 7½ IPS
Less than 0.3% at 3¾ IPS

Harmonic Distortion
Less than 2% at 3 DB below
rated output

Tube Complement
2-EF86, 4-12AZ7, 3-6AQ5
1-5V4-G

SONY
SUPERSCOPE
Sterecorder

*Finest components and construction
assures years of trouble-free operation*

• For Free Descriptive Literature and Name of Nearest Franchised Dealer write
SUPERSCOPE, INC., Audio Electronics Division / Sun Valley, California

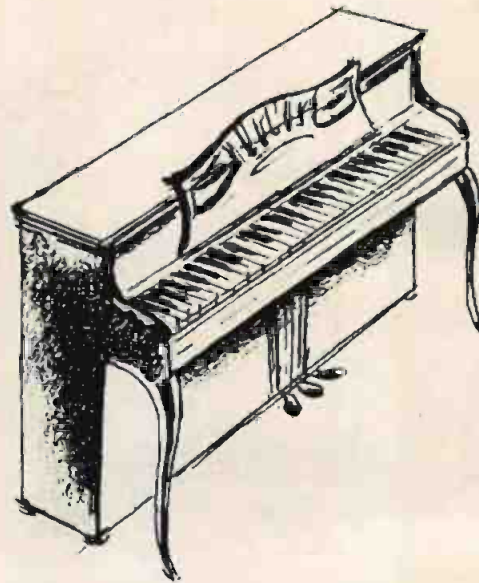
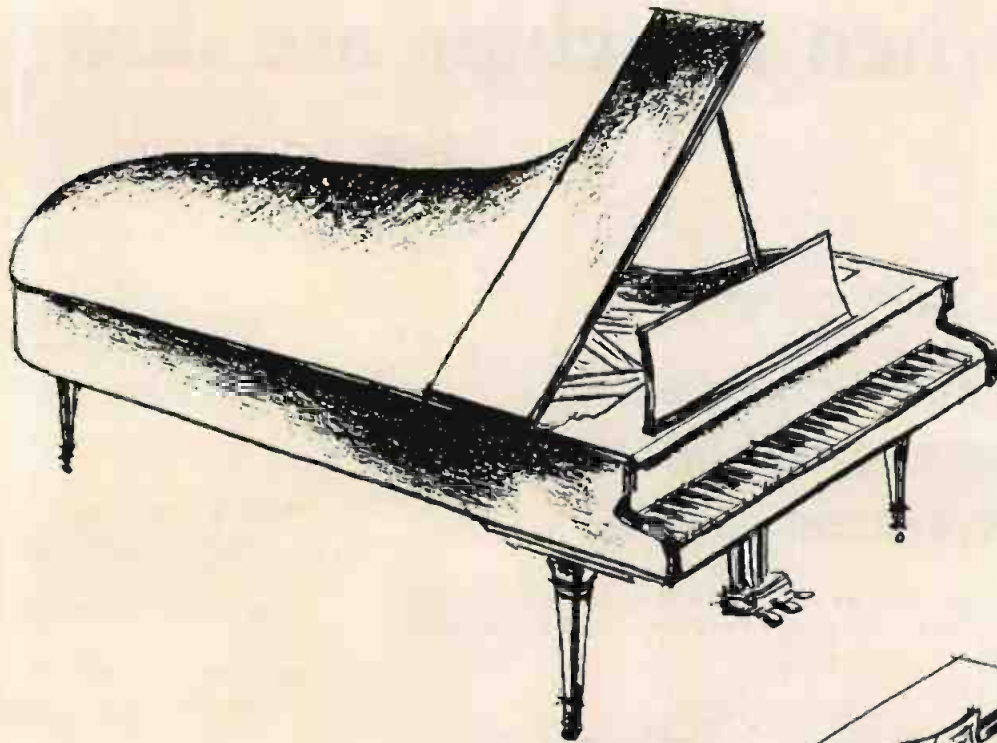

SPINET to CONCERT GRAND

Every musician knows that a Spinet can never equal a Concert Grand, yet he recognizes that each has its place. For the finest quality and performance in his chosen size of instrument, he turns to a maker known for his integrity in design and craftsmanship.

B O Z A K • D A R I E N • C O N N E C T I C U T

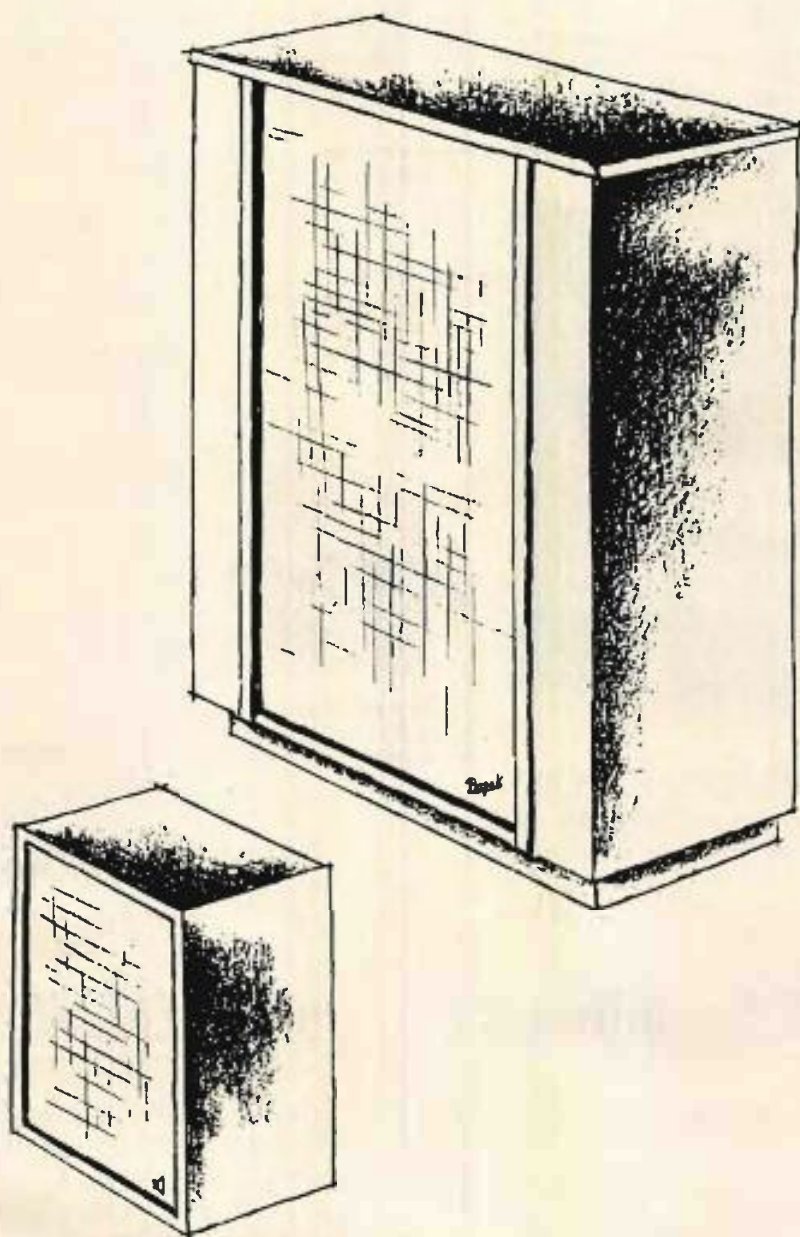

BOZAK is the Symbol of Quality

In loudspeakers, too, no experienced listener expects any miniature to equal the performance of which larger units are capable. For assurance of the finest craftsmanship and musical quality in the size of instrument suited to his needs, he turns to Bozak.

T H E V E R Y B E S T I N S O U N D

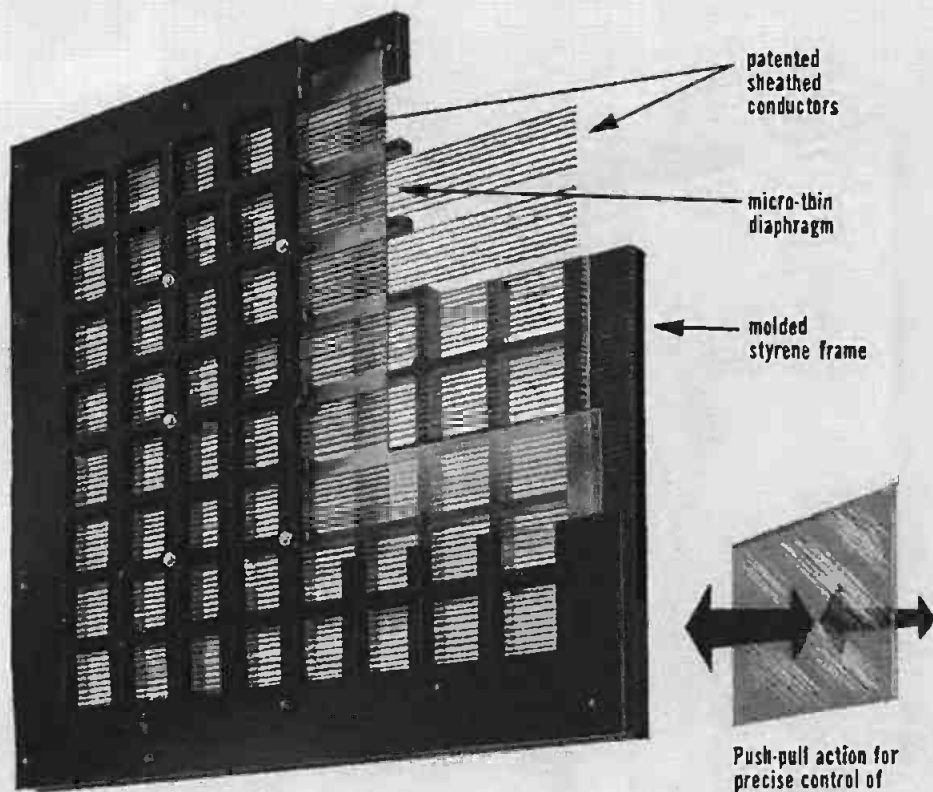

JansZen Electrostatic for the mids and highs

Wide-range transparent treble brilliantly recreated by each JansZen Electrostatic element. The 176 push-pull sheathed conductors give precise control over diaphragm movement.

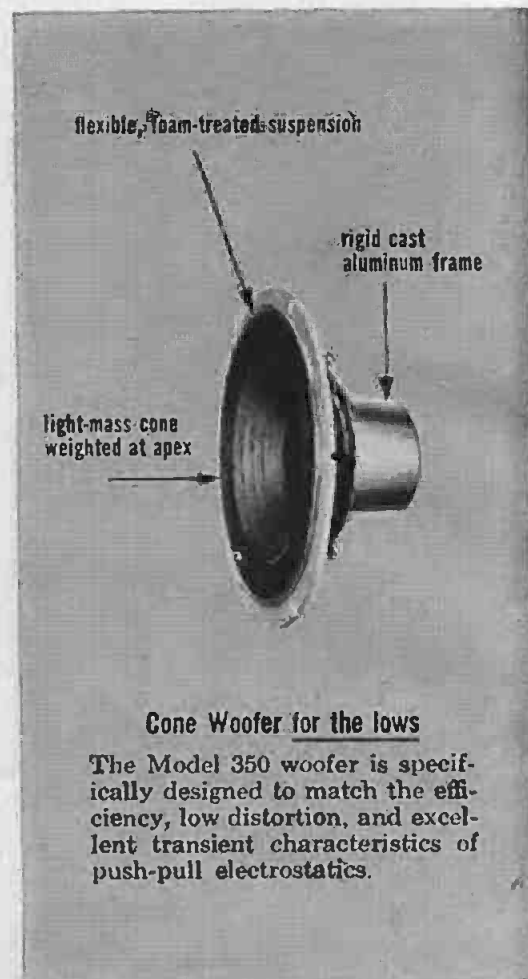

worth KNOWING the difference... worth HEARING the difference

The Z-300 console and the new Z-400 shelf speaker systems are definitely not for those who've been listening to shrilling trebles and booming basses for so long they've forgotten what "live" music is really like.

For whatever the program—velvety strings, the human voice, percussion, full organ—the Z-300 and Z-400 reproduce with measurable precision the full audio spectrum from 30 to 30,000 cycles. Nothing escapes them... nothing is added by them to mar

the clarity of the original recording or broadcast.

The secret is the sonic mating of the remarkable JansZen Electrostatic mid-high range speaker with the Model 350 cone woofer—the low frequency speaker designed *specifically* to match the efficiency, low distortion, and excellent transient characteristics of an electrostatic.

Listen to these compact integrated speaker systems... singly, or in pairs for stereo... at leading high fidelity dealers.



Model 65 Electrostatic Two-element Mid/High Range Tweeter gives absolutely clean response to 30,000 cycles.



Model 130 Electrostatic Four-element Mid/High Range Tweeter for those who demand the ultimate in widely-dispersed sound... ideal for multiwoofer systems... response to 30,000 cycles at less than 0.5% harmonic distortion.



Model 350 Cone Woofer designed specifically for small enclosures... undistorted bass to 30 cycles.

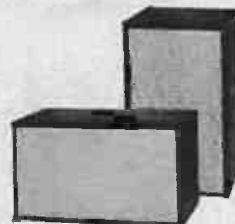

Model Z-400 Shelf Speaker System combines Model 65 electrostatic with Model 350 woofer... Ideal for stereo... vertical or horizontal placement on shelf or floor.



Model Z-300 Console Speaker System combines Model 65 electrostatic with Model 350 woofer... exceptionally compact... uniform response from 30 to 30,000 cycles.

Write for descriptive literature and prices.

JansZen

* incorporating designs by Arthur A. Janszen made exclusively by

NESHAMINY ELECTRONIC CORP.

Neshaminy, Penna.

AMPEX 960

STEREOPHONIC

RECORDER/REPRODUCER

Plays Both 2- & 4-Track Tape



RECORDS STEREO
OR MONOPHONIC

Stereo Portable PLUS!

Guiding the Ampex engineers who created the 960 was a dual objective—that of building a machine which was not only a superb example of engineering skill, but one which would also offer its user a range of capabilities far exceeding that of any other recorder made today. The result was not merely an improved stereo recorder, but *an entirely new concept* in home entertainment.

The STEREO 960 fits into family life in literally dozens of ways, contributing many tangible benefits in musical, educational and recreational fun. You'll use it to keep up the family correspondence by sending "letters in sound", to tape stereo programs off the air, to preserve your best monaural and stereo discs on tape, and to acquire new musical and language skills. You'll have endless fun exploring the 960's many fascinating recording capabilities, including sound-on-sound, echo chamber effects, and other advanced techniques.

ABOVE--960 PORTABLE STEREO
RECORDER/REPRODUCER

BELOW--MODEL 2560 PORTABLE
STEREO SYSTEM CONSISTING OF
960 AND PAIR OF 2010
AMPLIFIER/SPEAKERS

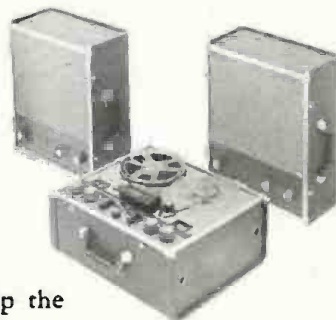

AMPEX STEREO

SIGNATURE OF PERFECTION IN SOUND

RECORDER/REPRODUCER SPECIFICATIONS

The true values of a recorder are best assessed through careful evaluation of its performance specifications and operating features. It is worthwhile noting here that these specifications are based not on theoretical design parameters but on actual performance tests. They are specifications which the recorder not only meets or exceeds today, but which years from now will still hold true.

The Ampex Model 960 Stereophonic Recorder/Reproducer is capable of essentially distortionless frequency response from 30 to 20,000 cycles per second at the operating speed of 7½ inches per second, and from 30 to 15,000 cycles per second at 3¾ inches per second. Its precision-engineered timing accuracy is such that it offers perfection of pitch held to tolerances of less than one-third of a half-tone. Playing times, using standard (.002"), long play (.0015"), and extra-long play (.001") tapes are as follows:

	(a) 4-Track Stereo Tapes	(b) 2-Track Stereo Tapes	(c) Monaural Tapes, half-track
1200 foot reel	3¾ ips - 2 hrs. 8 min. 7½ ips - 1 hr. 4 min.	3¾ ips - 1 hr. 4 min. 7½ ips - 32 minutes	3¾ ips - 2 hrs. 8 min. 7½ ips - 1 hr. 4 min.
1800 foot reel	3¾ ips - 3 hrs. 12 min. 7½ ips - 1 hr. 36 min.	3¾ ips - 1 hr. 36 min. 7½ ips - 48 minutes	3¾ ips - 3 hrs. 12 min. 7½ ips - 1 hr. 36 min.
2400 foot reel	3¾ ips - 4 hrs. 16 min. 7½ ips - 2 hrs. 8 min.	3¾ ips - 2 hrs. 8 min. 7½ ips - 1 hr. 4 min.	3¾ ips - 4 hrs. 16 min. 7½ ips - 2 hrs. 8 min.

RECORD INPUTS: High impedance line inputs (radio/TV/phone/auxiliary) 0.3V rms for program level; high impedance microphone inputs

PLAYBACK OUTPUTS: Approximately 0.5V rms from cathode follower when playing program level tapes

PLAYBACK FREQUENCY RESPONSE: 30-20,000 cps at 7½ ips; 30-15,000 cps at 3¾ ips

Within ±2 db 50-15,000 cps at 7½ ips, 55 db dynamic range
Within ±2 db 50-10,000 cps at 3¾ ips, 50 db dynamic range

FLUTTER AND WOW: Under 0.2% rms at 7½ ips; under 0.25% rms at 3¾ ips

HEADS: Manufactured to the same standards of precision that exist in Ampex broadcast and recording studio equipment. Surfaces are lapped to an optical flatness so precise that they reflect specified wavelengths of light, resulting in uniform performance characteristics and greatly minimizing the effects of head wear. Azimuth alignment of stereo head gaps in the same stack is held within 20 seconds of arc, equivalent to less than 10 millionths of an inch — a degree of precision achieved through use of a unique process involving micro-accurate optical measurements within a controlled environment. Head gap width is 90 millionths of an inch ±5 millionths of an inch.

KEY TO THE EXCITING FUN FEATURES OF THE 960 —

THE AMPEX STEREO-GRAPH

Here's the simplest, quickest answer to almost every question about how to perform the operations illustrated at right and numerous other recording functions. The Ampex Stereo-Graph shows you, quickly and clearly, the proper dial settings to make for more than a dozen of the most popular uses for the 960 . . . including sound-on-sound, language and music instruction,



and other special effects. A convenient tape forage/playing time indicator is included on the reverse side.

MODEL 2010 MATCHING AMPLIFIER-SPEAKER

The Ampex Model 2010's ten-watt (20 watts peak) amplifier section provides operating characteristics (unequalized) flat within ±0.1 db, with total harmonic distortion less than 0.5 of 1%, throughout the maximum range of human hearing ability, at rated output. Noise and hum are 80 db below rated output, and input sensitivity is 0.18V to develop rated power.

The specially designed 8" speaker provides smooth, peak-free response throughout a remarkably wide audio range. Such superior design features as its massive die-cast frame and edgewise-wound ribbon coil contribute effectively to higher levels of performance than ever before achieved with a speaker this size.



MODEL 960 DIMENSIONS: Portable cases 9" x 15" x 17½". Unmounted recorder 13" x 15" x 6½" depth below top plate, 1¾" above. Recorder weight 36 lbs., speaker amplifier 31 lbs.



Relax and enjoy the show—let your Ampex do the narration! With the commentary on tape, your color slide shows are more professional, more complete and more fun!

Your favorite LP's and Stereo Discs are at their exciting best while they're new and unscratched. That's when to gape them on your Ampex, and preserve their original quality for keeps!



When you tape it "off the air" your only cost is for blank tape. Yet your musical repertoire can soon equal that of all the stations you hear!

There's a real future in family fun like this—with your Ampex you can live such happy moments over and over again, with a quality so lifelike you're almost literally carried back.



In the Ampex "Speech Test Game", you pit your wits against the trigger-quick memory of the Ampex recorder/reproducer. You can't win, but it's fun trying!

Letter-writing is no longer a problem, with an Ampex in the house . . . now it's a family project. And even more fun than sending letters in sound is receiving them!



For "letters in sound", the 3" tape reel holds as much as a 10-page letter, mails first class anywhere in the United States for 8c.

A command performance exclusively for you! Whether you prefer jazz, pops, or classical, the privacy of headphone listening is a unique pleasure. You don't disturb the rest of the family, and they don't disturb you!



The Ampex, in private rehearsal, can be a wonderful confidence-builder for people who normally develop rubber knees when faced with the prospect of speaking before a group.

Learning to speak a new language is made immeasurably easier on the Ampex: you can record your own phrases side-by-side with those of the instructor, and play them back for comparison at any time.



When you strike up the band in stereo, you don't need professional musicians to make a professional recording. Advanced techniques are amazingly easy on the Ampex.



Books in Review

The *Sense of Music*. Although Victor Zuckerkandl explicitly renounces the orthodox methods of music appreciation books, his general purpose is much the same: to enhance the musical understanding of novice listeners. His approach, however, is distinctively new in that it is based solely on direct aural experiences, gradually progressing from single tones, melodies, and chords to complete compositions. These are analyzed and explained in terms of *dynamic* tonal qualities and relationships rather than expressive intentions or emotional reactions, and their technical terminology is provided only *after* what actually happens in sound and perception has been both perceived and comprehended. Nothing could be more sensible or lead more directly to a grasp of basic psychoacoustical principles, as well as those of melodic structures, polyphonic and harmonic textures, and so-called musical theory in general. This, of course, provided that the reader follows the text line-by-line with the musical illustrations actually sounding in his ears. In Zuckerkandl's own classes (at St. John's College, Annapolis), his analyses and elucidations must be exciting and immediately rewarding, but in book form they make heavy demands on attention as well as require constant access to recordings of the examples (mostly available on LPs, but also in a special tape which can be obtained from the book's publisher).

The listener with some ability to read the notated examples or to play them himself will, however, find these pages less laborious. For him there will be a wealth of new insights into familiar experiences and techniques—most particularly perhaps the “dynamic” qualities of individual tones and chords, the ancient ambiguities of consonance/dissonance, and the complexities of tonality. Readers of Zuckerkandl's controversial *Sound and Symbol: Music and the External World* (1957) should also find the present work—much clarified in theory, less polemical, and far less turgidly written than the earlier volume—of very special interest. In at least breaking the way for more meaningful introductions to familiar music, the *Sense of Music* is an outstanding achievement indeed. (Princeton University Press, \$6.00).

Mozart and His Music, by John N. Burk, is a book of substantial merit,

Continued on next page

Is Your Stereo Thinking Upside Down?

Stereo Fidelity & Somerset are manufactured by Miller International Co., Swarthmore, Pa., U.S.A.

Also available on Somerset
monaural 12" long play

298

Over 100 stereo albums
from Bach to Dixieland

This is music of a unique and spicy flavor. This is the lure and the spell of Exotic Island including "Quiet Village", "Orchid Lagoon", "Fire Goddess", etc.

The Surmen
SF-10500



A full symphony orchestra plus the greatest driving big band ever recorded. A fascinating sound experiment played by hand picked, award-winning side men and soloists.

Skip Martin conducting
Video All Star Orchestra
SF-9700



For that lush, wonderful mood to chase the troubles of the day including "All Through the Night", "Berceuse", "Greensleeves", "Serenade", "Drigo and others.

"101 Strings" Orchestra
SF-10200



The London Philharmonic Orchestra
Highlights from Richard Rodgers
"Victory at Sea" arranged by Robert Russell Bennett. Music from the thrilling, dynamic TV series depicting VICTORY AT SEA in World War II.

VICTORY AT SEA
SF-10900

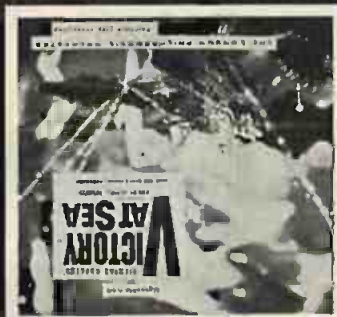

Available at better record stores everywhere

HEARING IS BELIEVING
proves it is NOT necessary to pay exorbitant
prices for stereo records regardless of your
program preference or audio discernment



WEATHERS

TrioPhonic

STEREO

THE SOUND THAT OUTMODES
CONVENTIONAL STEREO!



It took the engineering know-how of Weathers to discover this revolutionary electronic advancement in sound and size! TrioPhonic Stereo introduces the listener for the first time to "Equalized Sound." Now you can sit anywhere in the room and experience the same magnificent tonal realism and fidelity of full-range stereo. "Equalized Sound" is produced by two book-size full range stereo speakers and a unique, non-directional hideaway bass.

Ask your dealer today for a demonstration of Weathers startling new audio dimension—TRIOPHONIC STEREO with "Equalized Sound." You must see it, hear it, compare it, to believe it!

For the ultimate in TrioPhonic stereo listening, select the matched Weathers synchronous turntable with StereoRamic pickup system.

For more information of TrioPhonic Stereo write for FREE booklet, Dept. H-F.

WEATHERS INDUSTRIES, 66 E. Gloucester Pike, Barrington, N.J.
Division of Advance Industries, Inc.

Export: Joseph Plascencia, Inc., 401 Broadway, New York 13, N. Y.

BOOKS IN REVIEW

Continued from preceding page

but one more likely to appeal to admirers of the well-known Beethoven biographer and Boston Symphony program annotator than to Mozarteans—simply because it is overshadowed by several earlier, more penetrating and subtle studies. It is to Burk's credit that he steadfastly eschews any touches of sensationalism or honey-eyed popularization. His "life" is soberly organized and sympathetically recounted, yet never romanticized; his analytical and descriptive notes for the works are notably inclusive and informative. There is little with which even the most finicky scholar can take exception and much to satisfy and stimulate the lay concertgoer and record collector—but unfortunately this book can be recommended only as supplementary to the richer masterpieces of the Mozartean literature by Turner, Einstein, Dent, *et al.*, to say nothing of the composer's own letters (Random House, \$4.75).

Encyclopedia of Concert Music is the latest in the interminable series of "family guides" which David Ewen has been producing since the early Thirties. The materials (mostly "appreciative" program notes) and the style (pedestrian) remain doggedly unchanged. The present example, which specifically complements an *Encyclopedia of the Opera* of 1955 and like it is cast in dictionary form, runs to some 550 pages of brief entries (plus a 12-page bibliography) covering music-term definitions as well as program notes for well-known instrumental compositions and biographical sketches of their composers and interpreters. Apart from the most topical entries there is little here that cannot be found, usually in less sketchy form, in standard musical dictionaries and encyclopedias (Hill & Wang, \$7.50; boxed with the *Encyclopedia of the Opera*, \$13.50).

Jean Sibelius, by Harold E. Johnson, is at once the long-needed more objective successor to Karl Ekman's quasi-authorized biography of 1935-6 (now out-of-print in this country); a sober deflation, rather than debunking, of the fantastic and often self-fostered Sibelian legends; and the first really convincing attempt I've ever encountered to explain and mediate between the violently contradictory evaluations of Sibelius' music by his overenthusiastic partisans and his overprejudiced detractors. Few other

Continued on page 44



PRECISION INSTRUMENT: NATURAL HABITAT



A precision instrument performs flawlessly. It blends naturally into its proper setting and imparts a special distinction to that setting. A sports car on the open road; a fine camera in the hands of a skilled photographer; a **high fidelity instrument in the home.** The new Harman-Kardon Stereo Festival is just such an instrument. It is simple and precise in its operation. It is straightforward and logical in its design. Its reproduction of music is incomparable. The Stereo Festival, timeless in its styling, free of frills or faddishness—adds distinction and beauty to any home.

THE STEREO FESTIVAL

Species: STEREO FESTIVAL — member of a family of precision-built stereo high fidelity instruments. A 30 watt stereo power amplifier, dual preamplifiers and stereo AM/FM tuner all on one handsome chassis.

Genus: HARMAN-KARDON — manufacturer of the finest quality stereo high fidelity instruments for your home.

Natural Habitat: YOUR HOME.

Distinguishing Characteristics: Brushed copper, satin chrome or brass sculptured escutcheon. Optional walnut,

fruitwood or copper and black enclosure. Especially noted for ease of operation, functional design, unsurpassed reproduction of music.

Additional Features: HARMAN-KARDON FRICTION CLUTCH TONE CONTROLS: permit adjustment of bass and treble tone controls separately for each channel. Once adjusted, controls lock automatically to provide convenience of ganged operation. ILLUMINATED PUSH-BUTTON ON/OFF SWITCH: Permits Stereo Festival to be turned on and off without upsetting careful prior setting of controls. Separate ELECTRONIC TUNING BARS for AM and FM; AUTOMATIC FREQUENCY CONTROL to insure accurate FM tuning every time; RUMBLE AND SCRATCH FILTERS to eliminate annoying phonograph rumble and record hiss; CONTOUR SELECTOR, MODE SWITCH, BALANCE CONTROL, RECORD-TAPE EQUALIZATION SWITCH and two high gain magnetic inputs for each channel.

The Stereo Festival, Model TA230....\$259.95, Copper and Black Enclosure, Model AC30....\$12.95, Walnut or Fruitwood Enclosure....\$29.95. All prices slightly higher in the West. For free catalog of all H-K high fidelity instruments write: Dept. HF-41, Harman-Kardon, Inc., Westbury, N. Y.

harman kardon

Outperforms Costliest Speaker Systems

ENJOY THE BEST AT GREATEST SAVINGS

EXCLUSIVE

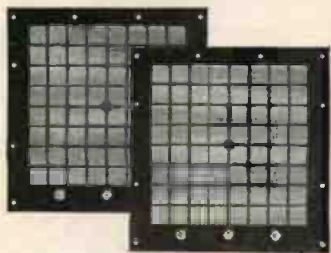

ARTHUR JANSZEN DESIGN patented dual electrostatic radiators... rated the best again and again. Built-in power supply; velvet-smooth response to beyond 25,000 cps.

EXCLUSIVE



HIGH-COMPLIANCE 12" woofer featuring weighted cone in solid cast-aluminum alloy frame... with heavy-duty sintered ceramic magnet for extremely dense flux.

EXCLUSIVE: Acoustically correct enclosure of choice hardwoods, finished on 4 sides...



High-Compliance Electrostatic Speaker System

ONLY **\$129⁵⁰** Comparable to speaker systems selling at 50% more! Here's an Allied exclusive—**\$5 Down** the hi-fi speaker sensation of the year—combining patented Arthur Janszen design dual electrostatic tweeters with a new and revolutionary high-compliance woofer. The results are amazing: Distortion is held to a mere 0.5% at full 50 watts input. Response is clean and level, 30-25,000 cps. You have to hear it to believe it—transparent high frequencies to beyond audible limits—smooth, honest bass. The KN-3000 enclosure, of ¾" wood throughout, is finished on 4 sides; 14 x 26½ x 13"; available in mahogany, limed oak or walnut. Impedance, 8 ohms. U. L. Approved. Shpg. wt., 50 lbs.

KN-3000. Only \$5.00 Down. NET \$129.50



15-Day Trial & Moneyback Guarantee. Try the KN-3000 Speaker System in your home for 15 days; if you are not completely satisfied, your purchase price will be refunded by Allied upon return of the equipment.



SEE YOUR ALLIED 1960 CATALOG for a detailed description of the remarkable new KN-600 HC high-compliance 2-

way speaker, with the sensational 4.6 lb. ceramic magnet and ½" thick polystyrene cone. See hundreds of other top buys on everything in Hi-Fi in the 1960 Allied Catalog. Write for your FREE copy today.

New Easy Terms: Only \$5 down (or less) on orders up to \$200. Up to 24 months to pay.

order from

ALLIED RADIO



ALLIED RADIO, Dept. 180-L9
100 N. Western Ave., Chicago 80, Ill.
 Ship me _____ KN-3000 Speaker System(s). Mahog. Oak. Wal.
\$_____encl. (Shipped F.O.B. Chicago)

I am interested in saving money on everything in Hi-Fi. Send me your FREE 1960 Catalog.

Name _____

Address _____

City _____ Zone _____ State _____

BOOKS IN REVIEW

Continued from page 42

composers have ever aroused such critical dichotomy. For that matter, perhaps César Franck is the only other "great" composer who wrote so many potboilers and as few major works; and probably only Rossini offers a comparable example of abdication from creative activity at the very peak of a career. Johnson's task in making understandable both the personal and artistic contradictions here well may have been one of the most formidable tackled by any musical biographer. Yet any impartial reader who studies his pages carefully will find it hard to decide which is the more admirable: the author's painstaking Finnish researches in uncovering long-lost or deliberately obscured facts and influences, or his rigorous refusal to succumb to the temptations of special pleading, either pro or con. Yet for all this sobriety, his book has the hypnotic fascination of a psychological thriller. And still more important than its power to command one's rapt attention is the superb illumination it throws not only on Sibelius, but on one's own previously mixed reactions to the music itself. Johnson surely would be the last to claim that he has solved the Sibelian enigma, but he unquestionably has uncovered the vital clues to many of the long-baffling problems posed by a composer who became a national monument in his own lifetime, while then and now presenting a Janus-like duality to the rest of the world (Knopf, \$5.00).

The New Yearbook of Jazz. After taking a year out to produce his *Book of Jazz: A Guide to the Entire Field* (Horizon Press, 1957), the indefatigable Leonard Feather has returned to his documentary series begun with the monumental *Encyclopedia of Jazz* in 1955 and its supplementary *Encyclopedia Yearbook* of 1956. Like the latter work, the present one is primarily a specialist's miscellany combining reports on the latest developments in this country and overseas with extensive additions to the biographical and discographical sketch entries, listings (with addresses) of various types of jazz organizations, recording companies, etc. Again there is an excellent pictorial section of some fifty well-chosen photographs, but probably the liveliest appeal lies in two brand-new features: a six-page "Meet the Critics" section of biographical sketches of the leading writers and reviewers, and Charles Graham's ten-page historical survey of "Jazz and the Phonograph" (Horizon Press, \$4.95).

R. D. DARRELL



must I remove this stack to play the other side?



not if you own a **STEREO-TABLE...**
the best way to play modern records!

Facts about the modern record prove this so. **Fact 1**—Today's "lp's" offer up to 30 minutes of music per side! **Fact 2**—Most albums are recorded on 2 sides! **Fact 3**—You must flip the record over to play the second side! Therefore, the record changer now has virtually nothing to change—its one special feature is no longer essential! Why then choose this way to play both sides of your records? If you have stereo in mind, you can only obtain genuine high fidelity with a **STEREO-TABLE**

made only by Rek-O-Kut. Only Rek-O-Kut **STEREO-TABLES** give you: silent, accurate rotation, hysteresis synchronous motors, exclusive engineering and over 51 lab tests to insure trouble-free operation. Choose your **STEREO-TABLE** from the world's largest selection... the world's largest manufacturer of high fidelity turntables... **Rek-O-Kut!** **STEREO-TABLES** from \$39.95, **STEREO TONEARMS** from \$28.95, **Bases** from \$8.95. Write us for the complete **STEREO-TABLE** story.



REK-O-KUT COMPANY, INC.

Dept. HF-11, 38-19 108th Street, Corona 68, New York



Export: Morhan Exporting Corp., 458 Broadway, N. Y. 13 • Canada: Allas Radio, 50 Wingold Ave., Toronto 19



A recording challenge!

the magnetic tape engineered to help you meet it best is

The low, round, billowing notes of the tuba as a band swings out on "El Capitan." Try to capture them on tape without the rhythm going muddy! At the same time catch the shrill staccato of the piccolo!

It's a challenge to your recording skill, your equipment and most of all to the tape you use. It takes tapes that are engineered for professional requirements—"SCOTCH" BRAND Magnetic Tapes available on acetate or polyester backings. These tapes protect you from dropouts and response variations. They have: 1) *precision oxide dispersion for*

flawless fidelity; 2) controlled uniformity for perfect response on every inch of every reel; plus 3) dry silicone lubrication to reduce recorder head wear.

"SCOTCH" BRAND Magnetic Tapes are products of 3M Research, the only pioneer of magnetic tape in all its applications: audio, video and instrumentation. So whatever your recording challenge, look to "SCOTCH" BRAND Magnetic Tapes for the engineered fidelity that can help you capture the "living" sound. And remember—*stereo music sounds best on tape!*



*"SCOTCH" BRAND Magnetic Tape
—the memory of tomorrow*

"SCOTCH" and the Plaid Design are Registered Trademarks of 3M Co., St. Paul 6, Minn. Export: 99 Park Ave., New York. Canada: London, Ontario. © 1959 3M Co.

MINNESOTA MINING AND MANUFACTURING COMPANY
... WHERE RESEARCH IS THE KEY TO TOMORROW



NEW SOUND EXCITEMENT FOR THE HI-FI STEREO AGE!

Kingdom **LORENZ** AN IT&T ASSOCIATE

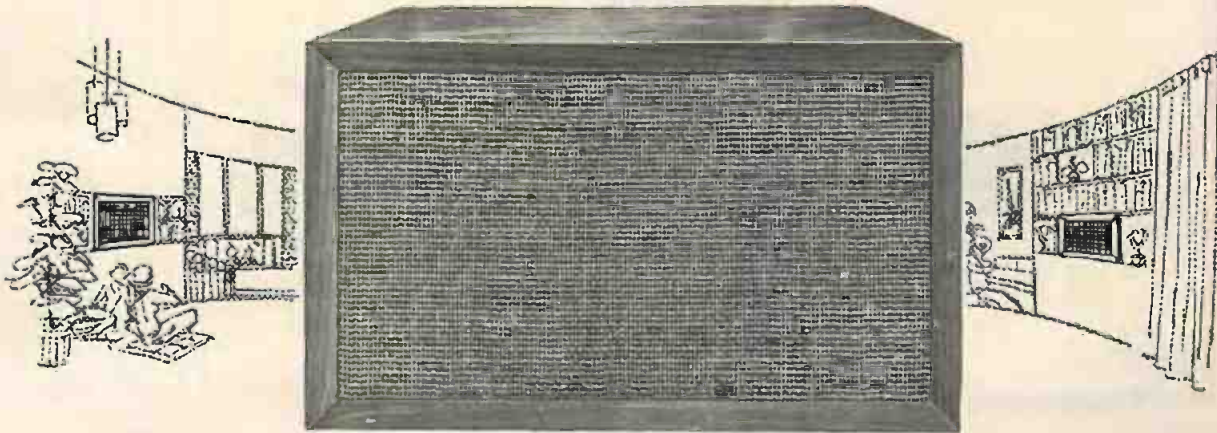

All-New and Incomparable OMEGA I



NEW! KAL Audette

Compact for bookshelf or table, this cabinet of high impedance port construction becomes a console

table simply by attaching matching brass legs. Houses a superb Lorenz 8" woofer, tweeter and crossover. Frequency response: 35-18,000 cps. Impedance: 8 ohms. Power rating: 18 watts peak. Size: 11" x 23 3/4" x 10". Gross weight: 16 lbs. Brown or Blond Leatherette \$49.50
Matching Brass Legs 5.95



NEW! Audette III

Big performance in small space! Use singly or pair for stereo. Completely finished on 4 sides for use horizontally or vertically. Features Lorenz 8" woofer with matched quality tweeter and high pass crossover. Frequency response: 30-18,000 cps. Impedance: 8 ohms. Power rating: 18 watts peak. Size: 11" x 23 3/4" x 10". Gross weight: 20 lbs.

Unfinished Birch (sanded, ready for finishing) \$57.50
Oiled Walnut, Mahogany, Walnut, Blond or Ebony 64.50
Matching Brass Legs 5.95



NEW! Audette SENIOR

A superior system of advanced audio engineering and decorator beauty. Infinite baffle construction for "big

system" performance. Complete with elegantly proportioned 4" legs. Contains famous Lorenz 8" woofer and tweeter with high pass crossover. Frequency response: 30-18,000 cps. Impedance: 8 ohms. Power rating: 20 watts peak. Size: 22 1/4" x 22 1/4" x 10 1/2". Gross weight: 37 lbs. Satin Mahogany \$69.50
Blond or Walnut 74.50

For the connoisseur with an ear for true fidelity—and an eye for true value! The Kingdom Lorenz all-new OMEGA I is a masterpiece of engineering skill and rare decorator beauty—specially designed to be used in pairs for stereo, or singly for brilliant monaural.

Modern slimline cabinet completely finished on four sides for use horizontally or vertically—ideal for bookshelf, table top or floor. Constructed of 1 1/2" solid lumber core with selected face veneers of genuine African ribbon mahogany, American black walnut and other choice woods. Joints meticulously crafted for air-tight stability.

Inside the OMEGA I is a brilliantly matched combination of advanced Lorenz speakers: a full-spectrum 12" woofer with two quality tweeters and high pass crossover. The "infinite baffle" principle provides a thrilling realism found only in the largest most expensive systems.

• 18 to 18,000 cps • 16 ohms
• 40 watts peak • 27" x 14 1/4" x 11 1/2" • 46 lbs. • At any price, you simply can't buy better!

Unfinished Birch (sanded, ready for finishing) \$109.50

Oiled Walnut, Mahogany, Walnut, Blond or Ebony 119.50

Never before, so many quality features in loudspeakers—yet priced for the modest budget! Dual cones for breathtaking wide range performance! Twin voice coils in 12" loudspeakers, with flexible impedances of 4, 8 or 16 ohms, enabling you to select the impedance you require! Non-resonant cast aluminum girder constructed frames! Fully tropicalized for finest operation in any climate. For stereo or monaural—singly or in matched pairs.

NEW! Lorenz S-1288
Value-packed basic 12" loudspeaker of advanced design, with dual cones and twin voice coils. Choice of impedances of 4, 8 or 16 ohms on one speaker! • 18 to 15,000 cps. • Magnet assembly weight: 61.5 oz. • 30 watts peak. \$44.50



NEW! Lorenz S-1288 II
A complete system—consists of Lorenz S-1288 with twin tweeters on rigid metal bracket and high pass crossover. Dual cones and voice coils with 4, 8 or 16 ohm impedances. • 18 to 18,000 cps. • 35 watts peak. A "system" in itself! \$67.50

NEW! Lorenz S-888
Spacious sound with real economy! Outstanding 8" speaker with dual cones and high efficiency 8 ohm voice coil. • 30 to 14,500 cps. • 18 watts peak. • Magnet assembly weight, 28.5 oz. \$21.50



NEW! Lorenz S-388
Armored horn-type 2 1/4" tweeter with plastic cone for 120-degree high frequency sound dispersion. New ferrite magnet hermetically sealed. \$8.50
• 2,000 to 18,000 cps. • 5.5 ohms. • 2 watts peak. The perfect mate for Lorenz 12" or 8" speakers. \$8.50

HP-1 High Pass Crossover
Crosses over at 2,000 cps. at rate of 3 db per octave—feeds highs to tweeters, lows to woofer. Extends speaker system range to limit of audibility. For use with 2 or 3 way systems. \$4.95



At High Fidelity Dealers Everywhere. FREE Catalog. Write Dept. HF-11
Kingdom PRODUCTS, Ltd. 514 Broadway, New York 12, N. Y. • WOrth 6-0800
Exclusive U. S. Distributors for Lorenz High Fidelity Loudspeakers

The verdict is in!



CONSUMER PUBLICATIONS *Hi-Fi Systems*

"... best unit in its class, regardless of price ... must be seen to be believed ... one of the gentlest record drops we have ever seen ... electrical tests indicate rumble characteristics as good or better than those specified for broadcast-type turntables."

Modern Hi-Fi

"... the DUAL is an outstanding machine ... it shows a uniformly high level of performance in every respect ... standards were exceptionally high in each critical testing area, especially in such vital aspects as wow, rumble, flutter and hum."

QUALITY CARTRIDGE MANUFACTURERS

Fairchild

"... we put your machine through an extensive laboratory check ... we congratulate you on (its) excellence ... tracking was perfect ... automatic operation consistent and reliable ... truly does justice to and amply meets the requirements of top quality stereo cartridges."

Pickering

"... tests included all customary measurements ... including 'torture tests' designed to show up any malfunctioning ... it came through with flying colors ... tracking is all we could ask for ... trip mechanism functioned smoothly ... our unqualified approval ... you have a beautifully simple and efficient product."

TECHNICAL PUBLICATIONS

Edward Tatnall Canby in Audio

"... the first time I saw it, I couldn't believe my eyes ... the DUAL is absolutely silent in use; the motor is so quiet you must put your ear to the table to hear it ... rumble and pitch steadiness are absent and excellent respectively ... real manual automation ... it will do more things that please me ... than any changer so far."

Electronics World

"... one of the best stereo record changers we have seen to date ... the wow and flutter is as low as in some professional-type turntables ... we suggest that anyone who is interested in a changer for stereo hi-fi operation make sure that the dealer demonstrates this one for you."

MUSIC PROFESSION PUBLICATIONS

Downbeat

"... brand new sleeper ... very high quality ... excellent facilities for manual operation ... arm adjustment easier than on any other machine ... well worked-out arrangement for off-on manual playing ... they seem to have thought of everything."

Billboard

"... I have been giving the player a real workout ... and I must say that it passes every test. It's as good as I thought it was and as good as you claim. In short, it is tops."

DUAL-1006
combination stereo
turntable/changer
**TESTED
AND
ACCLAIMED
THROUGHOUT
THE
HIGH
FIDELITY
AND MUSIC
INDUSTRY**

Full reprints of current and forthcoming evaluation reports will be sent upon request.

united  Audio
PRODUCTS OF DISTINCTION
202-4 East 19th St., N.Y. 3, N.Y.

You will find the DUAL-1006 only at selected authorized United Audio dealers.



TWO SENSITIVE SPEAKERS

EXCLUSIVELY **ALTEC** FOR THE TRUE REPRODUCTION OF SOUND

*ALTEC BIFLEX AND DUPLEX SPEAKERS
ARE PRECISION BUILT FOR DURABILITY*

ALTEC BIFLEX SPEAKERS are the leading high fidelity single voice-coil speakers. They have a frequency response far greater than any other type of single voice-coil speaker and equal to or exceeding the majority of two or three-way units. Biflex speakers are selected as the bass speaker in many extended range systems. Alone or in conjunction with other speaker components, an Altec Biflex is the greatest value in high fidelity loudspeakers.

412B BIFLEX—True high fidelity at moderate cost

The Altec 412B is an extraordinary combination of true high fidelity reproduction, compact size and low price. This 12¼ inch speaker has a guaranteed frequency response of 40 to 15,000 cycles achieved through Altec's Biflex principle of a viscous-damped mid-cone compliance that permits the entire cone to propagate low frequencies while the inner section operates independently to reproduce the audible high frequency tones. Listen to the superior frequency response and efficiency of the 412B. Compare its quality and price with other speakers. We think you'll agree that the 412B is a great value in high fidelity speakers. Priced at \$51.00. Other Biflex speakers: 408A 8"—60-16,000 cps \$31 • 415A 15"—30-14,000 cps \$67.

ALTEC DUPLEX® SPEAKERS are the world's finest single-frame high fidelity reproducers, and are in wider use in professional recording and broadcast studios than any other type. Their superiority is achieved by mounting two mechanically and electrically independent loudspeakers on a single frame for compactness, point-source relation, phasing and installation simplicity. A special high compliance suspension system, precision assembled, is used to achieve lowest possible resonance and distortion. This construction technique in combination with high quality materials maintains the superior properties of the Duplex indefinitely. Listen and you will know why Altec Duplex speakers are chosen over all others by the discerning audiophile and as the listening standard in most professional studios.

605A DUPLEX—An improvement on perfection

Unchallenged for 14 years as the finest high fidelity speaker in the world, the Altec 604D now steps aside for the new 605A Duplex speaker—a precision instrument that has no peer in the faithful reproduction of sound. The 605A, with Altec's exclusive *controlled linear excursion* principle, provides unequalled purity from 20 to 22,000 cycles: unusually smooth response in the highs, extremely high linearity and clean transient response in the lows. Priced at \$177.00. Other Duplex speakers: 601B 12"—40-22,000 cps \$120 • 602B 15"—30-22,000 cps \$143.

A SUBSIDIARY OF LING-ALTEC ELECTRONICS, INC.



ALTEC LANSING CORPORATION Dept. 11H
1515 South Manchester Avenue, Anaheim, California
161 Sixth Avenue, New York City 13, New York

THE BIGGEST NEWS

IN STEREO IN YEARS!

THE **NEW...**

CONCERTONE 505

STEREO RECORDER

for the first time... a modestly priced stereo recorder with all the professional features found only in the finest instruments.

Check these outstanding quality features in such a low cost unit:

FEATHER TOUCH PUSH-BUTTON OPERATION

4 HEADS, INCLUDING SEPARATE 2-TRACK & 4-TRACK PLAYBACK HEADS

3 MOTORS, INCLUDING HYSTERESIS DRIVE

MECHANICAL FLUTTER FILTER PLUS DYNAMIC BALANCED FLYWHEEL

INSTANT SOURCE/TAPE MONITORING

SEPARATE RECORD/PLAYBACK PRE-AMPLIFIERS

INSTANT START/STOP

AUTOMATIC CUT-OFF SWITCH

3 3/4-7 1/2 IPS SPEEDS

AUTOMATIC TAPE LIFTERS

TAPE LOCATION INDICATOR

SEPARATE MICROPHONE/LINE INPUTS, EACH CHANNEL

These are only a few of the many features of the Concertone 505. See it and hear it demonstrated at your dealer.

CONCERTONE

... THROUGH THE YEARS, THE UNMATCHED STANDARD OF EXCELLENCE IN TAPE RECORDERS.



• STEREO RECORDER

• MONAURAL RECORDER

• SOUND ON SOUND RECORDER

• PLAYS MONAURAL AND STEREO 2-TRACK AND 4-TRACK TAPES



AMERICAN ELECTRONICS, INC.

AMERICAN CONCERTONE DIVISION

9449 WEST JEFFERSON BOULEVARD, CULVER CITY, CALIFORNIA

Don't fall victim to the myth that some of your stereo components can be weak links without loss in performance. A boy sent to do a man's job is still a boy no matter how many men surround him. Pilot stereo components are all "men." Each is a strong link in any system... each is as responsive an instrument as you could demand.



- Pilot 232
Basic 40-Watt Stereophonic
Amplifier \$89.50
- Pilot 260
Basic 80-Watt Stereophonic
Amplifier \$139.50
- Pilot 580
Stereophonic EM-AM Tuner \$179.50
- Pilot 240
30-Watt Stereophonic
Preamplifier-Amplifier \$129.50
- Pilot 590
Stereophonic FM-AM Tuner-
Dual Preamplifier \$239.50
- Pilot 216-A
Professional Stereophonic
Preamplifier \$199.50
- Pilot 210
Stereophonic Preamplifier \$89.50
- Pilot 680
Deluxe Stereophonic
FM-AM Tuner \$219.50
- Pilot 245-A
40-Watt Stereophonic
Preamplifier-Amplifier \$199.50
- Pilot 690-A
Deluxe Stereophonic FM-AM Tuner-
Dual Preamplifier \$289.50
- Pilot 660
Basic FM Tuner \$149.50
- Pilot PSV-1
5-Speaker, 3-Way Bookshelf
System \$139.50

The components shown are available as you see them, or in seven magnificent stereophonic consoles. Write for our 40th Anniversary Brochures, indicating whether you wish information on Pilot components, consoles, or both.
**PILOT RADIO CORPORATION,
 37-02 36th St., Long Island City 1, N. Y.**

PILOT
 FOUNDED 1919



"Our tests prove that Garrard Changers deliver the peak stereo performance built into the new **FAIRCHILD SM-1 Cartridge,**"

says Mr. George G. Cohen, Marketing Manager, Fairchild Recording Equipment Corporation.

"We pioneered in the development of stereo cartridges. From the very beginning we have used Garrard Changers in our testing laboratories. We are pleased to report that, thanks to the complete absence of any disturbing or distorting factors such as rumble or wow, the Garrard has met every requirement of our highly sensitive and compliant rotating magnet and moving coil type cartridges."

We are grateful for Mr. Cohen's and Mr. O'Shaughnessy's comments which reflect the actual experience of the discriminating owners of Garrard Changers with Fairchild Stereo Cartridges. This kind of superior performance is the reason why more Garrard Changers are sold as components for the finest stereo systems than all other changers and turntables combined.



"Our service records show that the Garrard Changer and Fairchild Cartridge make a perfect team for stereo"

says Mr. George O'Shaughnessy, Service Manager, Fairchild Recording Equipment Corporation.

"With us Garrard has an outstanding record of performance. We are gratified at how few complaints there are from owners of Garrard Changers with Fairchild Stereo Cartridges. That is due to Garrard's non-resonant aluminum tone arm and its precise tracking characteristics."

Here are the reasons why Garrard Changers are endorsed for stereo not only by Fairchild, but by all other manufacturers of fine stereo cartridges such as Pickering, Electro-Voice, Shure, General Electric, etc.

- Vertical and lateral rumble completely inaudible. Wow and flutter far below exacting "broadcast tolerance" standards.
- Exclusive aluminum tone arm, precision-mounted at engineering works for optimum tracking angle, perfect sound reproduction.
- Unrestricted choice of stereo cartridges—any of them will track at the manufacturer's lightest specified weight.
- Record handling gentler than the surest human hand.
- The important convenience of manual play plus completely automatic operation without compromise in performance.

These are the **FACTS**, no one can deny them with authority—and they are backed by the 36 years of experience that have created Garrard's unique reputation for unsurpassed quality.

For the best in Stereo...
Insist on a
Garrard
CHANGER
The World's Finest!

Send for free Garrard Comparator Guide

Your Name: _____

Address: _____

City: _____ State: _____

Mail to Dept. GS-29 at address below.

There's a Garrard for every high fidelity system...all engineered and wired for Stereo and Monaural records.



GARRARD-SALES CORPORATION, Division of British Industries Corporation, PORT WASHINGTON, N. Y.

Canadian inquiries to Chas. W. Pointon, Ltd., 66 Racine Road, Rexdale, Ontario
Territories other than U.S.A. and Canada to Garrard Engineering & Mfg. Co., Ltd., Swindon, Wilts., England

VIENNA



In Praise of a City

It has been said that every civilized man has two homes: his own and Paris. The civilized musical man, however, may rightfully beg leave to differ. For him it is Vienna that asserts strongest claim to being his spiritual "other home." No rival capital can come close to equaling the multitude of musical associations established within Vienna's confines.

In the course of forty-seven brilliant years—from 1781, when Mozart took up residence in Vienna, to 1828, when Schubert died there—the city witnessed an almost unbelievable eruption of musical masterpieces: Mozart's Figaro and Magic Flute, the quartets and oratorios of Haydn's maturity, Beethoven's symphonies and concertos, the songs and sonatas of Schubert . . . you could continue the compilation indefinitely. Never again was there to be quite such a dazzling flare-up of creative accomplishment in Vienna; but the afterglow produced by Brahms, Johann Strauss, Bruckner, Mahler, and Berg was nevertheless far from negligible.

All of this happened, historically speaking, only yesterday. The Athens of Phidias, the Florence of Michelangelo, the London of Shakespeare are remote places, way off in the yonder of long, long ago. The Vienna of Beethoven seems much more accessible. You can still find people in Vienna who remember seeing Brahms on his daily walks in the Prater; and in Brahms's day there were plenty of people who could remember seeing Beethoven on his walks round the city's ramparts. Amidst the streets and buildings frequented by Brahms and Beethoven, it requires no great effort of the imagination to call back yesterday.

This is an issue in salute to Vienna. Any month of any year would have sufficed as an occasion to bring it out. Vienna is perennially ripe for the devotion of musical enthusiasts. But November 1959, when the Vienna Philharmonic is visiting us on the American lap of its round-the-world tour, seems a particularly fitting moment to do her honor.

If Vienna is the city of your dreams, read on. R. G.

The Ancient and



by JOHN M. CONLY

The Vienna Philharmonic, probably the world's most independent orchestra, has been described by one of its leading members as a family with 124 heads. It's a family you'd enjoy meeting.

VIENNA is a city in league with time. It is both old and young, wearing its age with a bright dignity and its youth with dash; on amiable terms with history, and with progress. Its folk have a cordial conversance with yesterday and an easy expectancy of tomorrow, springing mainly from a lively enjoyment of today. They are famous for this, of course. It is, however, something sometimes ill-described, as if it were a sort of shiftlessness. It is not. As instance, Vienna is a good deal cleaner than New York, London, or Paris. There is nothing contradictory about this. A New Yorker is always a little too busy and hustled to put his personal rubbish in a trash container; a Viennese isn't, and he is also more conscious of his surroundings. New York and London are good-hearted cities, helpful to strangers. A New Yorker or a Londoner will take the time to be pleasant. The Viennese needn't take it; he has it. It's a gift.

This quality, this atmosphere, is certainly not new, and it is one of the reasons—not the only one—why this uniquely independent city on the Danube has been the

western world's capital of music for most of the centuries we remember. Art must have a ready environment for its creation, especially art which is realized in performance. For four hundred years London has been the world's best theatre town; there is plainly some connection there with the phenomena of Shakespeare and Shaw. In Vienna there is *time for music*; perhaps it is significant that, historically, Viennese concerts—important ones—often were played in the early morning, because music was important and because it was a good thing to start a day with.

It belongs to everyone, too. A bartender in the Bristol Hotel will mention that his son-in-law is a concert pianist who has toured America and made recordings; the dining-car steward on the Austrian State Railways' Rome Express informs you that his daughter has a violin scholarship at the Academy. Vienna newspapers sometimes relegate the latest acrimonies exchanged by Eisenhower and Khrushchev to page three, but if a new guest conductor for the Staatsoper or the Philharmonic comes

Honorable Philharmonic

to town, *that* you discover on page one—along with any possible scandal going on in musical circles. (Vienna's star reporters concentrate on such affairs, describing them in the most vivid and colorful terms, which the Viennese love.)

This kind of attitude may be different from that of people in westward nations, but it isn't provincial. It couldn't be, or it would not so thoroughly have infected the rest of the musical world. Be it remembered that very many of the musical names associated with Vienna are those of men who weren't born in Vienna. They went there. (Include among these one you wouldn't have thought of: the founder of the Boston Symphony, Henry Lee Higginson, who surely had his inspiration from the Philharmonic concerts while he was studying piano as a youth in Vienna.)

The second reason for Vienna's musical progenitiveness is its geographical position. It sits athwart the main southerly thoroughfare from East to West, along which have wandered through centuries Czechs, Turks, Slovenes, Magyars, Gypsies, Bulgars, and west-Eurasian peoples with no name at all. All had their music, and all of it came up the Danube, where on the Vienna wharfsides the waltz was born, and many another musical folk-form captured. The flow of tunes and tempos was endless and resistless. Its infinite variety we hear now in the minuets of Haydn, the Schubert trios, the dancing finales of Brahms. The essence began in villages and firelit encampments far away; the last refinements took their indestructible shape in Vienna, the mint and treasury. Naturally this became the place to which born music makers made their way if they could.

The city's acquisitive instinct for music seems to have begun with the tenth-century Babenberg dukes, who collected minnesingers. It flowered highest in the days of the later imperial Hapsburgs, whose courts collected princes, who in turn collected Mozarts and Haydns.

Then princely music ended, even before the great Mozart and the great Haydn died. There was a chance that all large-scale instrumental music would die. The French Revolution, though technically a failure, had wrought a drastic change in the roles of monarchs and the nobility. They felt themselves now answerable to the

people whose money they lived on. Private orchestras were promiscuous luxury; therefore they were assembled no more. It is an ironic thing that Beethoven's revolutionary *Eroica*, performed at the Lobkowitz palace, had one of the last truly great premieres given as an invitation event.

In Vienna, for orchestral players, the jobs that held out were those at the Royal Chapel, the Court Opera, and the Kärntnertor Theater, and the last was dubious: it depended on promotion, an art not well understood in the early 1800s. Beethoven's later life was wracked with endeavors to assemble audiences and orchestras at the same time. Neither existed in any dependable shape, at least in Vienna, and there wasn't anybody who knew how to get them together. London might have been able to do a better job. Beethoven himself thought so, apparently, but still, for some reason, he couldn't leave Vienna. Vienna was, for musicians, and for better or worse, home.

This is all an essential prelude to the story of the Philharmonic, which becomes afterward mostly a tale of success, and compressible. At first, however, it is a tale of initiative, and of a change in the attitude of the artist toward his society which has a Beethovenian complexion, or perhaps even a Jeffersonian one, since it is a declaration of independence.

Between the need and the fulfillment came both boon and something sad enough to weep about. With the vanishment of good princely orchestras, Beethoven wrote his last sonatas and quartets, perhaps as noble personal testaments as we have. But also, in this darkened interim, Franz Peter Schubert put forth one of the three tallest and most radiant symphonies of the nineteenth century, and he never heard it himself at all, because there was nobody to play it. "I think of this," said a member of the Philharmonic, "whenever we play the C Major."

The Philharmonic organized itself fourteen years too late to do the living Schubert any good, though it has done him splendid service since. Its focal personalities, leaders in the assembly, were Karl Otto Nicolai, then only thirty-two, later to make his name by writing *The Merry Wives of Windsor*, and Nikolaus Lenau, a poet

destined for the madhouse, meanwhile obsessed with the work of Beethoven. There was considerable overlap in the personnel of the three working Viennese orchestras. The organizers seized upon that of the Kärntneror Theater as the most promising.

There is some dispute as to which is the oldest permanent professional orchestra in the world (third place is firmly held by the New York Philharmonic), revolving around the questions of permanency and professionalism. It doesn't matter. The Viennese musicians who met to make themselves the Philharmonic early in 1842 had no precedent. They simply voted for an executive committee and asked it to secure the Redoutensaal (the Imperial Formal Hall) for their first concert. They got it, and their music making has not really stopped since, though it was interrupted by the revolution of 1848. Parenthetically, it is possible that they were the first cooperative in history. The Rochdale Society (of weavers and grocers) in England, commonly tendered this distinction, did not start until 1844.

Certainly they are a cooperative now, and they have behaved like a cooperative since the beginning. That is to say, they began at once to squabble vigorously among themselves, while retaining outward unity. Nicolai fought unstintingly and impartially with everyone, until he took sick and died in 1849. Karl Eckert succeeded him, bringing with him a fine new bone of contention, Wagner, whose cause he had been fighting for also at the Opera. Eckert and Wagner won out. Then came Otto Dessoff, promoting Brahms. Brahms played

his First Concerto with the orchestra, but for some reason the membership raised objections to the D Major Serenade. Dessoff, who had been hired after winning a large majority vote, quelled the dispute. Next came Hans Richter, the first alumnus (he'd been first horn) of the orchestra to serve as its conductor; others to follow him were Artur Nikisch and the composer-conductor Franz Schmidt. Richter's main campaign was on behalf of Bruckner. Oddly, he was displaced finally, at both the Opera and the Philharmonic, by the man whose name is most commonly coupled with Bruckner's, Gustav Mahler.

Mahler had the appeal of what is called today a "controversial" figure. Fascinated with sound—as his own works attest—he was forever experimenting with tonal balances and orchestral placement. He even tried reorchestrating, not drastically, some of the Beethoven symphonies, on the ground that Beethoven had written for older, smaller halls. This was undoubtedly a worthwhile experimentation (later Weingartner, Tovey, and Toscanini all ventured into the same effort, without proclaiming it so loudly), but the Viennese didn't care for the way it was carried out. The ticket sales were very good, but a lot of people came to boo. Mahler stayed four years, which, at that, is longer than he lasted in New York.

Thereafter the Philharmonic began taking on conductors for one concert apiece. Their playing schedule had settled into its present shape of eight subscription concerts a year, which afforded plenty of time between performances to negotiate. Among others, Richard Strauss, Karl Muck, Nikisch, Felix Mottl, young Bruno Walter, and Felix Weingartner helped see them through the turn of the century and into the first quarter of the next, the time of the First World War. Then, perhaps inconsistently, but respondent to circumstances, they once more tried a permanent conductor, Weingartner. He worked for them and led them nearly twenty years. He was called by Viennese their most elegant conductor; he took the Philharmonic on its first tours out of Austria (to great acclaim); and he made the orchestra famous, too, in places it never had been seen, by virtue of his epochal cycles of symphonic recordings. For English Columbia, he put on discs the entire symphonies of Beethoven and Brahms, in versions still treasured and deemed definitive by many a studious listener—and certainly studied by every wise aspirant conductor—down to the present day. At last he quit, nobody seems to know exactly why. Incidents don't explain it. It seems likeliest that the extreme vivacity of the orchestra, expressed partly in internal politics, finally wound him down in his advancing age, so he went away to Switzerland. Many people think that the Philharmonic reached its highest and most durable style working with him.

It is hard to describe this style, or say what constitutes it. It can be heard and sensed, though, in many current recorded works. Take the nuptial march in *The Marriage*



Its unique style, "effortlessly unified spontaneity."

of *Figaro*, in either the Kleiber (London) or Leinsdorf (Victor) versions. Probably no other orchestra can play this just the way the Vienna Philharmonic does, straightly joyous, and yet sublimely but surely conveying Mozart's implication of whimsies still to come. Or take the last movement of the Beethoven Fourth Concerto, recorded with Clifford Curzon (London LL 1045). It is almost false in this to identify the pianist as *the* soloist; it's rather as if he were playing duets with the sundry orchestral instruments, in musical repartee almost incredibly articulate. A listener can (hearing something like the Beethoven concerto) think of the Philharmonic as a huge chamber group, there is such effortlessly unified spontaneity. This springs from something as simple as it is uncommon: understanding of the music, and love for it. Kindred is the orchestra's virtue in its other role, as an opera orchestra. Nearly from the beginning, and continuously since 1869, when the Opera House was built, the Philharmonic has doubled as the Opera orchestra—the Court Opera until 1918, the State Opera since then. More than one new conductor, essaying *Don Giovanni* at the Staatsoper, has had his life saved by the fact that the Orchestra players knew the music better than he did.

It is a matter of justice, thus, that the Orchestra should have had its life saved by a conductor. When Hitler's Germany absorbed Austria, the Philharmonic was in trouble: the Berlin cultural ministry viewed it jealously and, in fact, set up a rival orchestra to lure its players away. No VPO man succumbed. Further, the players responded to purge orders by hiding their Jewish colleagues and helping them out of the country. There are no Jews now in the Orchestra, incidentally, but this is not the Orchestra's fault; it is because Jews have not cared to return to a scene of past dread. The Orchestra dealt in Austrian style with other Nazi nonsense. When orders came to burn the non-Aryan scores of Mahler and Mendelssohn, the archivist Franz Schreiner managed to get lost looking for the incinerator, and turned up instead at the house of the concertmaster, who had a cellar suitable for hiding manuscripts. The Philharmonic would have been dissolved, had it not been for Wilhelm Furtwängler, who became a one-man lobby on their behalf in Berlin, and won. Every year now the VPO gives two memorial concerts, one for Nicolai, one for Furtwängler.

It has nine other concerts, the eight subscription evenings all played in the Musikvereinsaal, behind the Imperial Hotel, and the New Year's Eve all-Strauss waltz concert which takes place in the Sofiensäle, the ballroom where the Waltz King himself used to preside. Willy Boskovsky, senior concertmaster, conducts this now as Strauss used to, standing and playing his violin. One can either dance or sit, if one is fortunate enough to get in at all, which is pretty hard to do.

It's hard to get in to any Philharmonic concert, or to any of the eight public rehearsals. Eighty per cent of

all tickets are bought by subscribers, called "associate members." The rest are put on sale, as a *series*, and are always all gone within three hours. The Philharmonic would love to play more concerts, but can't. As Boskovsky points out, what with nightly performances at the Staatsoper over a ten months' season, the summer Salzburg festival, and the heaviest recording schedule of any major orchestra in the world, everyone is doing too much work. "We keep it up because we are idealists. The Staatsoper is our livelihood. The Philharmonic is our renown, and it is where, as an association, we do our musical duty. Some kinds of music we think we know better than anyone else. Furtwängler said once: 'Everywhere in the world there are good musicians, but the Viennese don't believe it.'" Boskovsky disavows this immodesty, but only in part: "Our dominion, with our sound, is Beethoven, Brahms, Bruckner, and the classics; at this we are good. Perhaps American orchestras can play some of the newer music better."

"However," he adds thoughtfully, "our style has grown for a hundred years, and is not yet static."

The Philharmonic lives in symbiosis with the Staatsoper. Perhaps, indeed, if it didn't, it wouldn't live at all. The New York Philharmonic also began as a cooperative and worked as one for a half century, whereafter it couldn't afford to continue. For one thing, it had the perpetual problem of aging members, whom it couldn't support in retirement, and thus kept on too long. The VPO's survival owes to its unwritten contract with the State Opera. The Opera actually hires its instrumentalists individually, and its active rolls contain about 150 musicians. Of these, 124 are members of the Philharmonic and the rest hope to be, after they have played out their probationary years to the satisfaction of the Philharmonic's admissions committee. In other words, the Philharmonic selects, trains, and maintains in readiness an orchestra for the Opera. *Continued on page 154*



Von Karajan, conductor for the current world tonv.

by H. C. Robbins Landon

Wurst and Beethoven

An un-Baedeker-like guide



REMEMBER, when I received the commission for this article, getting out a map of Vienna and marking the places I thought HIGH FIDELITY readers might like to know of; when I finished, I had a list impressively long—and as dull as a page out of Baedeker. The Gluck houses; the Schubert houses; the lovely villa in Hietzing where Wagner began to write the text of *Die Meistersinger*; the café in Hietzing where Johann Strauss used to play, and where I often drink a cup of morning coffee, looking over the Hietzing square; the house where Salomon came to fetch Haydn, and where, a few years later, Beethoven came to study counterpoint and composition; the enchanted garden in Perchtoldsdorf where Hugo Wolf, treading the narrow path between genius and sanity, wrote some of his most beautiful songs; the stately Webern villa in Mödling; the Schoenberg and Berg houses; the café where Strauss, Hofmannsthal, and Clemens Krauss used to discuss a new operatic production; the Redoutensaal, where Haydn, Mozart, and Beethoven performed some of their best dance music; the archives of the Gesellschaft der Musikfreunde, where you can see the autographs of Mozart's G minor Symphony, Schubert's *Unfinished*, or the dedication copy of the *Eroica* with Napoleon's name scratched out in terse, angry lines; the Theater an der Wien, where Beethoven's *Eroica* and *Fidelio* were first publicly performed; the stately Lobkowitz Palais, where the *Eroica* was first privately played before a small, invited audience; the Prunksaal of the Austrian National Library, that splendid wash of baroque color where Van Swieten held his Sunday morning concerts, and where Mozart arranged and conducted Handel and Bach; the Augarten, formal gardens of measured elegance situated across the Danube Canal, where extravagant concerts were held, sometimes with fireworks, and where,

In Vienna the boundaries of time dissolve:



Seen through the Imperial Castle Gate, above, is the house on the Michaelerplatz where Haydn lived as a young boy, after being expelled from the Choir of St. Stephen's. The open window, shown also in the close-up at right, identifies the garret room he occupied.

even the wallpaper radiates musical memories

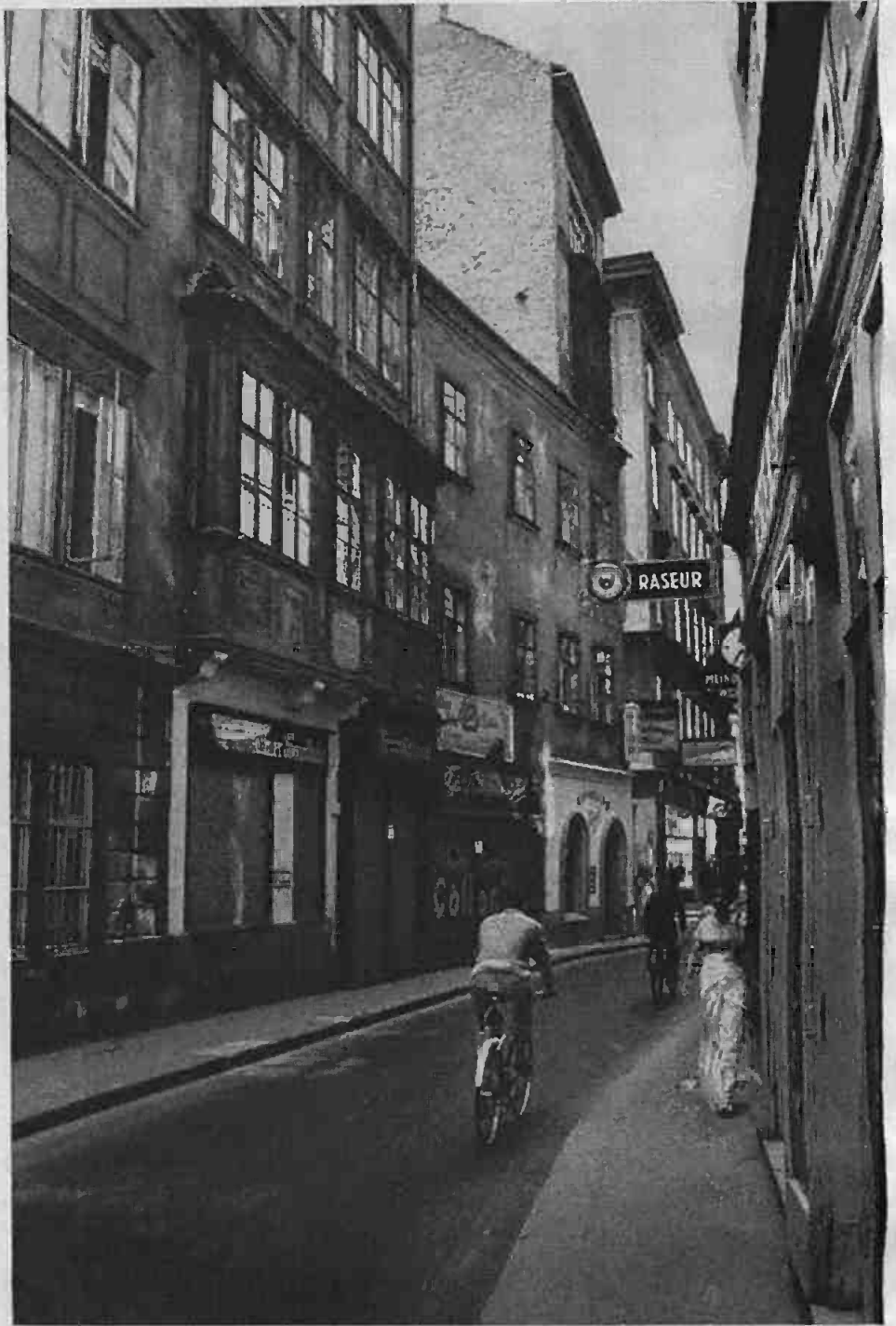

Musical museums can be dead things, but in Vienna they are full of living presences. Above, at left, is the house on Haydngasse (in the eighteenth century, Kleine Steingasse and in the suburb of Gumpendorf) which Haydn bought in 1793 at his wife's request. Beyond its courtyard is a garden where the composer used to take his morning walks. At lower left is the house where Schubert was born, and above right is the handsome Baroque house on Schulerstrasse which Mozart rented for 460 Gulden a year and where he spent perhaps his happiest days, from September 1784 to April 1787. Here his father Leopold and Herr Haydn and the young Beethoven all visited him and made music. Another Mozart house, on Domgasse, appears opposite.



Seen through the Imperial Castle Gate, above, is the house on the Michaelerplatz where Haydn lived as a young boy, after being expelled from the Choir of St. Stephen's. The open window, shown also in the close-up at right, identifies the garret room he occupied.

even the wallpaper radiates musical memories

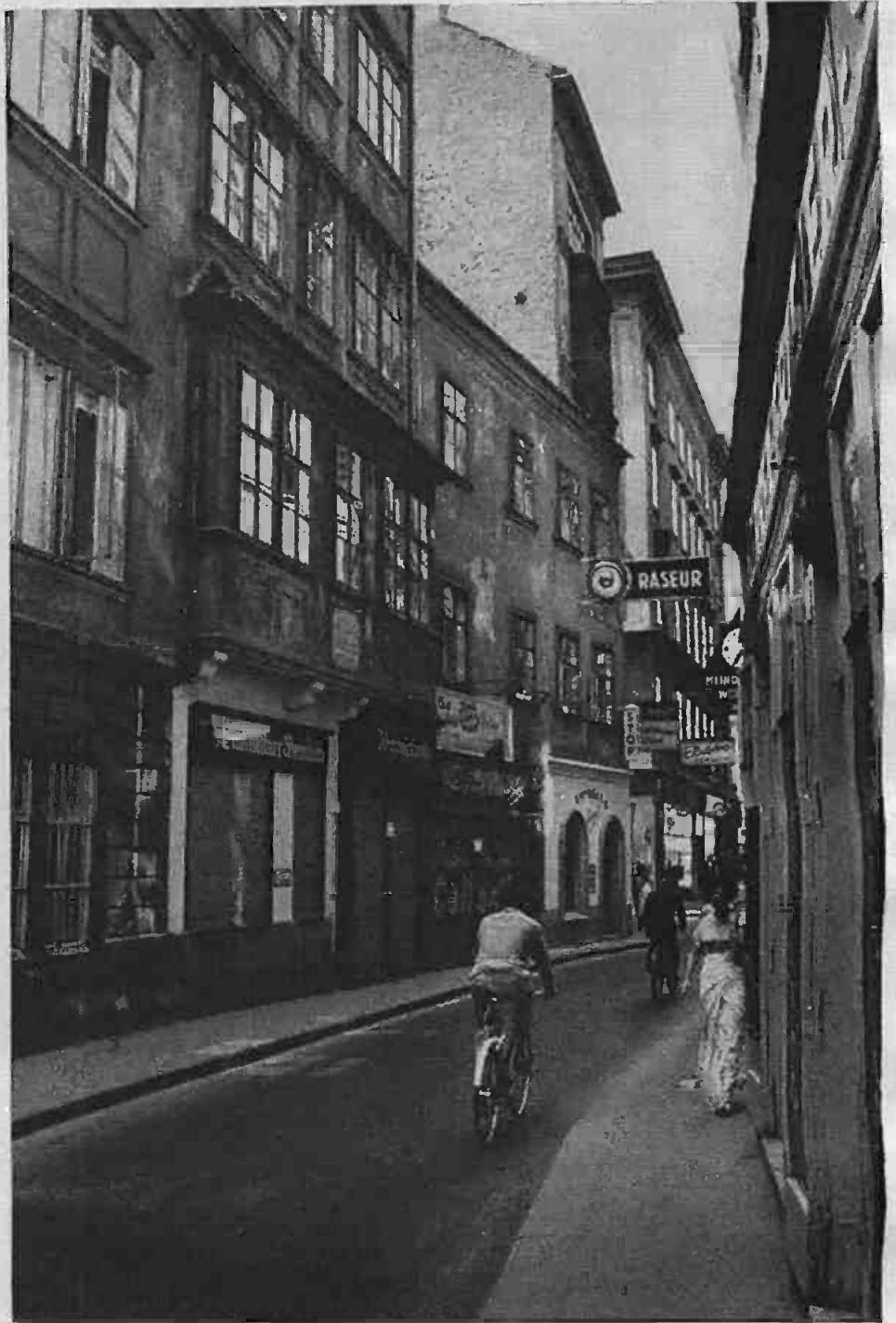

Musical museums can be dead things, but in Vienna they are full of living presences. Above, at left, is the house on Haydngasse (in the eighteenth century, Kleine Steingasse and in the suburb of Gumpendorf) which Haydn bought in 1793 at his wife's request. Beyond its courtyard is a garden where the composer used to take his morning walks. At lower left is the house where Schubert was born, and above right is the handsome Baroque house on Schulerstrasse which Mozart rented for 460 Gulden a year and where he spent perhaps his happiest days, from September 1784 to April 1787. Here his father Leopold and Herr Haydn and the young Beethoven all visited him and made music. Another Mozart house, on Domgasse, appears opposite.

Photographs by Erich Lessing



in the 1780s, you could hear Mozart symphonies early on a Sunday morning; Brahms's favorite restaurant on the Fleishmarkt, where you can still get some of Vienna's best food; the exotic orange gallery in Schönbrunn Castle, where Mozart's *Schauspieldirektor* was first given; the Musikverein, that famous concert hall with an acoustical warmth which no other European hall quite approaches (here, the aging Bruckner witnessed a triumphal performance of one of his symphonies, and at the same concert the young Richard Strauss was introduced to Vienna's elite via his *Till Eulenspiegel*). My list suggested a bewildering array of famous works, famous composers, famous performers, all involved one with another—Brahms with Mozart, Gluck with Wagner, Haydn with Schoenberg, Beethoven with Webern. Yet, as one saw this vast parade of musical genius stretching back over the centuries, nothing appeared incongruous, nothing seemed impossible. It was one great and mighty river, flowing from one source: the city of Vienna.

Never has any one city nourished so many great musicians, and never has any one city provided inspiration for so many widely differing musical geniuses, whether performers or composers. Vienna is not an outwardly fascinating city: it lacks the eternal grandeur of Rome, the warmth of Paris, the cosmopolitan brilliance of London or Berlin. But it was Vienna to which, inevitably, musicians flocked for the past three centuries. Faced with a roll call of the mightiest names in musical history—only a very few, such as Bach and Handel (who never visited Austria) are physically absent—there seemed only one choice. I decided to concentrate on the three composers who formed and perfected the Viennese classical style and who thus shaped the face of Western music for nearly a hundred years: Haydn, Mozart, and Beethoven.

Museums devoted to musicians are generally very boring. The case of a musician is radically different from that, say, of a painter. In a painter's birthplace you can hang one of his masterpieces. In a musician's home, the best you can offer is a portrait or two on the wall, the first page of an autograph, or the title of a first edition; compared to the sound of his music, this is a very poor substitute indeed. And yet there is a great deal of atmosphere in these Viennese museums and composers' houses, if you combine all the various circumstances, past and present. I have tried to take a very short tour in a very un-Baedeker-like manner through Haydn's, Mozart's, Beethoven's, and—in passing—our own, present-day Vienna. The dividing line between eighteenth- and twentieth-century Vienna is not, as any Austrian knows, that clear and definite anyway; on a warm summer night, over a glass of new wine, the line grows wavy and soon disappears entirely. . . .

On a wet November evening in 1955, the Vienna State Opera opened its doors again, after almost total destruction during the last days of the war (only the

outer walls remained more or less intact). As it happened, I was in London when this historic event occurred, and attended the new production of *Fidelio*, conducted by Karl Böhm, via radio broadcast, sitting comfortably before an open fire with friends in a cozy London house. One could somehow sense the joyous excitement, the glittering audience, the electrical atmosphere; but of course it wasn't the same thing as being there.

A fortnight later, I returned to Vienna on the Orient Express, arriving at the newly built Westbahnhof. As my taxi drove past Schönbrunn Castle, I asked the driver about the newly opened opera house.

"I drove two parties there the first evening," he said. "It was crazy, I tell you, simply crazy. Policemen all over the Ring, mobs of people fouling up traffic and making it almost impossible to drive up to the foyer. And the clothes! The jewels! Mautner-Markhof's wife. . . ." And he launched into a reverent description of one of Austria's richest beer-brewing families.

The conversation continued, and it turned out that the cab driver was an ardent opera fan.

"*Fidelio* was all right," he went on. "I heard it a week later with my wife, way up in the gallery. Of course it was all so exciting that you didn't really mind about Mödl—she's not really a first-class Leonore," he added thoughtfully, skirting a fat blue Mercedes.

I asked him what else he had seen. Apparently he had already gone to four performances.

"*Wozzeck*," he said, meditatively, as we turned up the Hietzinger-Hauptstrasse, in the quiet western part of the city where I live. "Now that's a difficult piece for us conservative Viennese. But my wife and I thought it was a wonderful production. I don't understand all that . . . all that new business . . . that. . . ."

"Atonality?" I put in.

"Is that what it's called? Well, whatever it is, it's difficult. But my wife and I are going back to see *Wozzeck* again," he added, as we pulled up in front of my apartment house.

"You have to hear music like that many times before you can understand it properly," he concluded. I thought to myself: this is the kind of thing that's always happening to other people—Viennese taxi drivers talking about *Wozzeck*.

Improbable events and improbable conversations are, however, typical of Vienna's musical life. After twelve years in Austria, nothing—either past or present—surprises me. Recently the Viennese papers were full of just such an unlikely story. The other day, it seemed, a dashing young Viennese with a curious past (including a prison sentence for rather "gray dealings" just after the war) went up to a tall, *Continued on page 160*

At Perchtoldsdorf, not far from Vienna, the garden where Hugo Wolf wrote some of his most beautiful songs still flourishes. And in the suburb of Heiligenstadt the courtyard of Beethoven's house is not a museum at all: the Viennese go there on long summer evenings to sit under the tall trees, to drink the new wine and sing soft, sentimental songs . . . and to dream.





At left, the so-called Pasqualati House (named for the Emperor's private physician), where Beethoven had a flat on the top floor—shown in the photograph above—for some ten years, from 1804 to 1815. Below, the Beethoven House in Heiligenstadt, showing the big double doors that open to the courtyard we picture on the facing page.



Flittermice and Merry Widows

by JOSEPH WECHSBERG

Austria's liveliest export, for a century, has been operetta, inimitably flavored by the gay city on the Danube.

WHEN A SPECIAL BRAND of entertainment has produced world-wide smash hits for over a hundred years, it's time to take notice. Ever since the night in 1860 when an eighteen-year-old composer named Karl Millöcker made his Vienna debut with *Das Pensionat*, millions of theatregoers have continued to be enchanted by the musical shows that go under the generic title of Viennese operetta.

All these people can't be wrong. The best Viennese operettas have been impervious to the finicky changes of popular taste. Today they are appreciated by fastidious connoisseurs and they have not lost their popular appeal. Longevity, if nothing else, creates respectability.

Das Pensionat itself is forgotten—as are most of the seven hundred Viennese operettas written since—but at least a dozen have proved indestructible: Johann Strauss's *Fledermaus* and *Gypsy Baron*, Millöcker's *Beggar Student* and *Gasparone*, Suppé's *Boccaccio*, Richard Heuberger's *The Opera Ball*, Lehár's *Merry Widow* and *Land of Smiles*, Oscar Straus's *Waltz Dream* and *Chocolate Soldier*, Leo Fall's *Dollar Princess*, Emmerich Kalman's *Countess Maritza*.

Viennese operetta did not spring full-grown. It evolved—slowly and tortuously. It was a mixture of various elements which baffled the critics who didn't know where

to file it. Comic opera? Singspiel? Musical comedy? The Viennese critic Eduard Hanslick took a dim view of it, but then he didn't like *Meistersinger* either. Many operettas failed because they were too highbrow for Vienna's *petit bourgeois* audiences and too lowbrow for the small group of musical snobs. The greatest Viennese operetta, *Die Fledermaus*, even baffled the local income tax collectors. In Vienna, where operettas are taxed more highly than operas on the debatable theory that operettas are "luxury" and opera "culture," the authorities ruled in the Twenties that *Fledermaus* was an operetta. This decidedly missed the Staatsoper management, where *Fledermaus* had been conducted by Mahler, Weingartner, Walter, and other accredited opera specialists who called it a "comic opera." Happily, everybody agreed that it was a masterpiece.

Viennese operetta never pretended to be Art, though the greatest operettas have outlived a good many "serious" works; and it never tried to compete with grand opera, comedy, drama, or the revue. Its aim was simple and straight: all good operettas from Millöcker to Robert Stolz were written to entertain. Kalman, who thought a lot about his medium, wrote, "With an opera or symphony you can pretend to create an 'important' work. But a simple operetta melody must have a genuine spark



or it will not catch on. Maybe one page of a Liszt score is worth more than all my operettas but, after all, there are so many people who want a little escape and fun at the theatre. . . ."

In Vienna an evening's perfect entertainment had to include laughter and tears, melody and dance, heartbreak and hoopla. Operetta offered all that, and a lot more. Its libretto was a mixture of romantic nonsense and preposterous intrigue, a well-conceived hoax that, by unspoken agreement between authors and public, no one took seriously. Plausibility was neither expected nor provided. Around nine-thirty, at the end of the second act, the love affair between Hero and Heroine was on the rocks, and ladies of the audience were crying. On first nights librettists and composers would anxiously watch the audience from their boxes. They knew that if tears weren't shed at certain climaxes, the operetta was a flop. But there were nuances in weeping, as in everything else in Vienna. Obvious methods of tearjerking were taboo and might backfire. There had to be just the right air of sentimentality, as light and fluffly as a well-beaten crown of *Schlagobers* topping your afternoon coffee. In the end the *Schlagobers* melted into the coffee—and the tears dissolved into happiness.

The finest operettas were written by men who had the Austrian genius for ignoring life's minor troubles by escaping into a pleasant haze of melody and song, women and romance. For two hours the little shopkeeper's wife was able to escape into a never-never world of dashing hussars and lovely princesses. Since it was a foregone conclusion that He would get Her in the end, it was a pleasure to cry.

And there had to be comedy, too, to please the male animal in the audience. The humor was the responsibility of the buffo and the soubrette and it was not oversubtle; but in the classic Viennese operetta it was also never off-color and never gauche. A Berlin critic wrote, "What people want is lots of Paris dresses, beautiful women, frivolity, and legs, legs, legs!" Maybe the Berliners were satisfied with that but the Viennese wanted more; they wanted sentiment and laughter at the same time. The humor might be created by a character or a situation or by both, as in the third act of *Fledermaus*. The immortal antics of Frosch, the prison warden, have delighted generations of operetta fans. (From Frosch's time, it has

been an unwritten law to put the great scene of comic relief early in the last act, when it's getting late and the audience might begin to get tired.)

The most important element, however, was the music itself—the sort of music that goes from heart to heart and makes you happy or sad or both at the same time (which is the best), genuine melody, singable tunes that are hummed as people walk out of the theatre, Music That Does Something to You. The perfect Viennese operetta makes people happy, moves them to tears, wraps them up in tuneful melody, exciting dances, colorful costumes, and pleasant concern about the fate of Him and Her. That is a complicated recipe and few have been able to follow it. A good many composers have tried and failed—perhaps because they didn't know the shortcut to people's basic emotions.

This mixture-as-before is not exactly a Viennese invention. It was first created to near-perfection in Paris by Jacques Offenbach, the son of a Jewish cantor in Cologne. Offenbach, a brilliant amalgam of Rhenish exuberance and French *esprit*, took over a small theatre in Paris, the "Bonbonnière," and in 1858 produced with sensational success his *Orphée aux Enfers* and later *La belle Hélène*. His operettas were masterpieces of musical parody and topical persiflage, full of wit and insinuation. A charming but merciless critic of the Second Empire, he had respect neither for the gods on Olympus nor the Emperor in the Tuileries Palace. No one ever admitted that Menelaus was a caricature of Napoleon III and that *La belle Hélène* was the Empress Eugenie—but everybody sensed it.

Offenbach had great success in Vienna, where audiences loved his music and didn't understand his innuendo. The Viennese have always been more susceptible to charm and schmalz than to wit and irony. In Paris, Offenbach's public were the sophisticated upper-middle classes and the aristocrats, who smiled slyly at his topical innuendo. In Vienna the *Spießbürger* like their operettas filled with make-believe.

Orphée aux Enfers was performed at the Theater an der Wien in 1860, the year of Millöcker's first local success. At that time Franz von Suppé—who came from a Belgian family, was born in Italy, and considered himself an Austrian—had begun to work on *Die schöne Galathée*.



Viennese Operetta on Discs

- Emmerich Kalman: *Countess Maritza*. Pallesche, Richter, Ritzman, Westmayer, Zorn; Radio Leipzig Symphony Orchestra, Kegel, cond. (Urania B 238, Two LP).
- Franz Lehár: *Count of Luxembourg* (excerpts). Zurich Tonhalle Orchestra, Reinshagen, cond. (London 5352, LP).
- Franz Lehár: *Giuditta*. Dickie, Gueden, Loose, Kmentt; Vienna State Opera Chorus and Orchestra, Moralt, cond. (London A 4333, Three LP; OSA 1301, Three SD).
- Franz Lehár: *Land of Smiles*. Gedda, Kmentt, Kraus, Kunz, Loose, Nattonk, Schwarzkopf; Philharmonia Orchestra and Chorus, Ackermann, cond. (Angel 3507 B/L, Two LP).
- Franz Lehár: *The Merry Widow*. Dönch, Grunden, Gueden, Kmentt, Loose; Vienna State Opera Chorus and Orchestra, Stolz, cond. (London A 4233, Two LP; OSA 1205, Two SD). Gedda, Kraus, Kunz, Loose, Niessner, Schmidinger, Schwarzkopf; Philharmonia Orchestra and Chorus, Ackermann, cond. (Angel 3501 B/L, Two LP).
- Franz Lehár: *Paganini* (excerpts). Vienna Light Opera Company, Sandlauer, cond. (Epic LC 3130, LP).
- Karl Millöcker: *The Beggar Student*. Anday, Bierbach, Christ, Dönch, Jaresch, Kaufmann, Lipp, Preger, Rethy, Sallaba, Wächter; Vienna Volksooper Chorus and Orchestra, Paulik, cond. (Vanguard 474/75, Two LP).
- Oscar Straus: *The Chocolate Soldier*. Merrill, Palmer, Stevens; Orchestra (RCA Victor LOP 6005, Two LP; LSO 6005, Two SD).
- Oscar Straus: *A Waltz Dream*. Vienna Light Opera Co., Straus, cond. (Period 1903, LP).
- Johann Strauss: *Die Fledermaus*. Dermota, Gueden, Jaresch, Lipp, Patzak, Preger, Proell, Wagner; Vienna Philharmonic Orchestra and Chorus, Krauss, cond. (London A-4207, Two LP). Boheim, Christ, Dönch, Gedda, Krebs, Kunz, Majkut, Martini, Schwarzkopf, Streich; Philharmonia Orchestra and Chorus, Von Karajan, cond. (Angel 3539 B/L, Two LP). Kullman, Pons, Tucker, Welitch; Metropolitan Opera Orchestra and Chorus, Ormandy, cond. (Columbia 3SL 108, Two LP).
- Johann Strauss: *The Gypsy Baron*. Gedda, Köth, Kunz, Schwarzkopf; Philharmonia Orchestra and Chorus, Ackermann, cond. (Angel 3566-B/L, Two LP). Anday, Bierbach, Dönch, Jaresch, Leuerenz, Loose, Patzak, Preger, Proell, Zatek; Vienna Philharmonic Orchestra and Chorus, Krauss, cond. (London A 4208, Two LP). Fez, Kmentt, Kunz, Loose, Preger, Rössl-Majdan, Schreyer, Spani, Wächter; Chorus and Orchestra of the Vienna State Opera, Paulik, cond. (Vanguard 486/7, Two LP).
- Johann Strauss: *One Night in Venice*. Gedda, Kunz, Loose, Schwarzkopf; Philharmonic Orchestra and Chorus, Ackermann, cond. (Angel 3530 B/L, Two LP).
- Johann Strauss: *Thousand and One Nights*. Groh, Seegers; Radio Berlin Symphony Orchestra and Chorus, Dobrindt, cond. (Urania 203, Two LP).
- Johann Strauss: *Wiener Blut*. Gedda, Kunz, Schwarzkopf; Philharmonia Orchestra and Chorus, Ackermann, cond. (Angel 3519 3S/L, Two LP).
- Franz von Suppé: *Die schöne Galathée*. Kmentt, Roon; Vienna State Opera Orchestra and Chorus, Paulik, cond. (Urania 7167, LP).

Suppé, Millöcker, and Johann Strauss the younger became the heroes of the Golden Epoch of Viennese operetta. Strauss was the last of the three to take to writing operettas. The "waltz king" of Vienna, the celebrated *kaiserlich-königliche Hofball-Musikdirektor*, had another domain: the ballroom. He knew nothing about the stage, had no idea of plot and libretto—and perhaps he was afraid of the sustained effort of writing a lengthy score: it wasn't like jotting down the *Blue Danube* waltz, which he'd finished in a few hours.

The notion that he too might compose operetta was in part the result of a fortunate meeting with Offenbach when both of them were writing special waltzes for the press ball of the Concordia. (Strauss's contribution was *Morgenblätter—Morning News*—which has survived Offenbach's *Abendblätter—Evening News*.) One day

during lunch at the Goldenes Lamm, Offenbach insisted, "My dear Strauss, you've got to write an operetta!" But it was really his first wife, the singer Jenny Treffz, who convinced him he could do it. She made him sit down one afternoon in the dark, empty auditorium of the Theater an der Wien, and asked the orchestra to play a couple of her husband's waltzes so that he could hear "how they sounded in a theatre."

They sounded so good that Strauss wrote his first operetta, *Indigo and the Forty Robbers*. It was a flop. It seems that there were more writers involved in its libretto than in a Hollywood extravaganza. People said "Indigo" was by Strauss and the "forty robbers" were the librettists who had stolen from the whole of world literature. But the music was beautiful, and the operetta became a posthumous success *Continued on page 151*

by Hans Herzog

Night Lights in the Konzerthaus



Ever since tape made it possible for the recording studio to go to the artist, reversing old procedures, Vienna has been the happy hunting ground of independent record companies,

MY FIRST CONTACT with the recording world in Vienna was a rather curious one. Late one evening in the Spring of 1950, when I was a cub reporter for the American-sponsored *Wiener Kurier*, I had been sent on some dreary assignment in the British district above the Schwarzenbergplatz (it was then called Stalinplatz), and was walking home along the Stadtpark and up past the Konzerthaus, that monstrously ugly pile of stone that constitutes one of Vienna's three principal musical establishments. It was about two in the morning, and I noticed with some surprise that the lights in the building were still on. Just as I went past, the sleepy porter was opening the main doors, and out of the cavernous depths poured a line of exhausted-looking men, their eyes bleary with fatigue. Some of them had swollen lips; almost all carried musical instruments. They said good-by to each other and went off in various directions. The last two men out shook hands with the porter, crossed his palm with silver (or rather aluminum, since this was in the days when the Austrian schilling was still rather shaky), and went off to an automobile, talking English. I caught the words "next session" and "knock off the finale." As the porter was locking the door after them, I pushed my nose through the gap and asked him what it was all about.

"Recordings," he said. "It's the only time when they can get that many wind players together."

"When who can get that many players together for what?" I asked him, not much wiser.

"American recording company. Mozart wind-band music," he said rather curtly, and closed the door.

In the Autumn of 1949 and all through 1950 and 1951, it was nothing out of the ordinary in Vienna for Mozart serenades to be recorded at two o'clock in the morning, or Strauss waltzes before breakfast. The city was witnessing one of the most interesting phases of its many-sided musical history: the invasion of the independent recording company from America. Unlike most invasions, however, this one was most welcome to the Viennese; at a time when the economic situation was still precarious, it brought work to every musician in Vienna who could fiddle his way professionally through a classical score. An official at the Austrian National Bank estimates that the total sum of money brought into Austria by recording companies from 1949 to 1952 was well over ten million schillings, which is a lot of money in anybody's currency. (The official rate of exchange is twenty-five schillings to one American dollar; in those days, however, the black market rate made the dollar worth considerably more.)

The sudden emergence of the name "Vienna" on the disc labels of the smaller American recording companies was by no means accidental. Several factors contributed to make Vienna a mecca for the "Independents," among which one of the most important was the use of tape. During the war, the Germans perfected magnetic tape



Musicians in winter coats gather in an unheated ball for one of Vienna's first postwar recording sessions for an American company. Conditions have changed somewhat since then, and today Paul Badura-Skoda and Joerg Demus record in comfort in lightweight suits, while conductor Kurt Redl sports a sweater. Recording costs are still lower than in the U.S.A.



to an extent where it was superior to any previous recording medium (e.g., wax masters, and so forth) in fidelity of sound and in technical range. By means of tape, small companies could, for the first time in history, easily record a whole symphony in three hours. The possibility of correcting a bad spot in an otherwise flawless take was patently revolutionary. Furthermore, recording costs in Vienna were ridiculously low. Small companies could afford to record chamber music in America (or in England), but the cost of recording a full orchestra at home was beyond their means. Symphonic music was, of course, Vienna's principal commodity, and it was one sold cheap.

Vienna was, and is, blessed with a number of orchestras, most of which played a part in the activities of American recording companies.

Perhaps best known was the Vienna Philharmonic, which had done so much to spread the capital's musical fame throughout the world. Before the war, the name "Vienna" meant those delicious Bruno Walter recordings of Haydn and Mozart for HMV (Victor); it meant the Weingartner Beethoven Symphonies; it also came to mean Furtwängler and Herbert von Karajan. In a way, the small American companies were trading on this reputation when they came to Vienna to make their first records. The Vienna Philharmonic Orchestra was then under exclusive contract to EMI (the records appeared on the Columbia label), and only the Haydn Society managed to get permission to use it, for recordings of *The Creation* and *The Seasons*. Subsequently, the Vienna Philharmonic went to Decca — and by extension to RCA Victor — under whose exclusive patronage it has remained ever since.

The Vienna State Opera Orchestra is a body of nearly 150 members, of whom over a hundred are also members of the Vienna Philharmonic. In the first years after the war, it was possible to get round EMI's exclusive contract by hiring individual members of the Vienna Philharmonic and attaching to this pickup group the name "Vienna State Opera." Many United States record buyers are under the misapprehension that *all* records issued under the name of the Vienna State Opera Orchestra are really made by the Vienna Philharmonic. (Actually, more of them—at least in the past few years—have been made by the Volksoper Orchestra, which, though it is part of the Vienna State Opera, has no connection with the Philharmonic.) There are, in fact, comparatively few "Vienna State Opera Orchestra" records which are the work of the *bona fide* Vienna Philharmonic; offhand, the only ones I know are some Telefunken records (Tchaikovsky Serenade, etc.) which have since been withdrawn, one or two early Westminsters, and a few Haydn Society discs (Symphony No. 85 with Baltzer and the *Posthorn* Serenade with Sternberg).

The "Orchestra in the Volksoper" ("People's Opera") is a body of about eighty men. It is an orchestra

that can be made into a first-rate symphonic team if given a conductor who knows his business. Almost all Vanguard (Bach Guild) records use this group. The Volksoper has also made many releases for American record clubs, though the name is often changed so as to make it unrecognizable.

The Vienna Symphony Orchestra, with some 125 permanent members, was the impetus for the first recordings made by American companies in 1949. This group not only played the music, but owned a recording studio and a staff of technicians, and was thus able to provide a customer with a package job if he so desired. It also advised on vocal soloists and choirs and would engage such soloists if requested.

The "Tonkünstler" Orchestra, almost never using its legitimate name, has made innumerable records for firms such as Remington, and for clubs. It's a second-rate outfit on the whole, but provided with a conductor of the late Fritz Busch's caliber, it can turn out quite a respectable Haydn or Mozart Symphony or provide decent accompaniments for operatic arias, and the like.

The Vienna Chamber Orchestra, with the backbreaking name of "Kammerorchester der Wiener Konzertgesellschaft," is (or was) mostly made up of women. It was formerly conducted by Franz Litschauer, and the advantage of using it was that, for the same recording fee as that charged by the Vienna Symphony, the ladies would arrive fully rehearsed. The orchestra consists of strings only, and such wind players as were required for a given session were borrowed from the Vienna Symphony or State Opera Orchestras.

In the spring of 1950, the Vienna Symphony signed an exclusive contract with Philips. This meant that the name "Vienna Symphony" could no longer be used by other companies, though United States makers were free to record with the orchestra if they invented a fictitious name for it. The fertile imagination of many firms got them into trouble; SPA thought up the delightful "Vienna State Philharmonia Orch.," which the Vienna Philharmonic made them change. Vox's "Pro Musica Orchestra, Vienna" is composed entirely of Vienna Symphony Orchestra members. This juggling with names had a rather demoralizing effect on some companies. Certain United States record clubs deliberately mixed up Dutch, German, Austrian, and Italian orchestras with five or six conductors. I remember, for instance, being played one American record-club disc listed as by a Dutch orchestra and a German conductor; in fact it was made by Hans Swarowsky and the Volksoper Orchestra. In the long run, it does not matter very much by whom the inferior records were made; but the historian will have quite a time sorting out all the spurious names.

In any case, the prolific recording of Viennese orchestras—under whatever names—was too great an economic advantage to be given up by reason of such small difficulties as what to call the performing group. In compiling the following data I am much indebted to Herr Josef

Duron of the Vienna Symphony, who placed at my disposal the bills for a number of recording sessions made from the Fall of 1949 through the next few years. When the Haydn Society arrived in Vienna about ten years ago, they were alone on the scene except for Telefunken and, of course, EMI. In those days the Vienna Symphony charged 38 schillings per man per hour (about \$1.50), and the Tonkünstler the rock-bottom fee of \$1.00 per man per hour. The accounts of the Vienna Symphony show that the *Mariazellermesse*, recorded in June 1949, cost the Haydn Society 8,608 schillings (\$344) for the total orchestral fee; per soloist they paid an almost incredibly low 500 schillings (\$20)—and that included Walter Berry, who has since become a State Opera star; the chorus (the Akademie Kammerchor) cost them about \$250 and the conductor (Hans Gillesberger) \$80. Other expenses amounted to some \$180. Thus, the Haydn Society was able to produce a recording of a Haydn Mass for less than \$1,000; an early Haydn Symphony, in those days, could be recorded for an average of \$200. George London, Lisa Della Casa, Elisabeth Höngen, and Horst Taubmann got what was then considered the staggeringly large fee of 4,000 schillings each for singing the Haydn *Nelson* Mass; but with three full sessions, the orchestra cost only 13,210 schillings (just over \$500). The economics of being able to do large-scale choral works, symphonies, and operas at these low prices made it possible for Westminster, the Haydn Society, Vox, the Bach Guild (Vanguard), Concert Hall, the American Recording *Continued on page 157*

Hermann Scherchen, conductor, discusses a score with harpsichordist George Malcolm and a member of the Vienna State Opera Orchestra. Over a hundred members of this group also belong to the Vienna Philharmonic, which has led many music lovers to believe that all State Opera recordings are made by the Philharmonic. In fact, several have been made by the Volksoper (or People's Opera) Orchestra, a group of some eighty men that forms part of the State Opera but has no connection with the Philharmonic. Many of its recordings go to U. S. record clubs under a fictitious name.



HOW TO BUY

A STEREO TUNER

by CHARLES FOWLER

SOMEONE SENT US a clipping recently in which credit for the invention of stereophonic high fidelity was given to a man who got the idea after listening to his wife on one side and his mother-in-law on the other, both telling him the same thing at the same time. With but slight modification, this will serve as a definition of what we mean by a stereo tuner: it is one which can receive FM on one side and AM on the other, simultaneously.

The last word is important. There are plenty of tuners available that are FM-AM units but which can receive only one at a time. A stereo unit must be, in effect, two separate tuners, separately tunable by means of two tuning knobs. That is the easiest identification characteristic: two separate tuning knobs. There will also be two separate dial pointers. Two tuning scales, however, are not an identification characteristic; two are needed for any FM-AM tuner.

Actually, stereo broadcasting takes several forms these days. Most common is the arrangement utilizing an FM transmitting facility for one channel and an AM transmitter for the second. These may be two halves of the same station, as is the case in New York with broadcasts from WQXR or in Boston from WCRB. Or two independent stations may form a cooperative arrangement for the broadcast. The tuners discussed in this article are intended for the reception of such broadcasts.

(Incidentally, a stereo FM-AM tuner may be used to receive two entirely different programs. For example, one channel of the stereo setup might be tuned, for family listening, to a local good-music station. The other channel could tune rock 'n' roll for the kids and be piped, through the separate amplifier, to the rumpus room or some other part of the house—preferably as far away from civilized society as possible.)

On the other hand, there are other combinations of transmitting facilities which are occasionally used for stereo broadcasts. For example, two FM stations may work together or, rarely, a TV transmitter may be used in conjunction with either an AM or FM station. An

FM-AM stereo tuner cannot be used for both halves of an FM-FM transmission though it can, of course, pick up one of the FM stations. Nor will it work for TV, except that some FM tuners can get down to the sound part of the Channel 6 signal.

Although FM multiplexing is still officially in an experimental stage, several stations are transmitting stereo material regularly by this means. Since the Federal Communications Commission has not yet decided which one of twenty-odd multiplexing techniques will be adopted as final, manufacturers are moving slowly. There are multiplex adapters on the market, and some tuner manufacturers have left space on the tuner chassis for such an adapter. Most manufacturers have provided some method for adding a multiplex adapter, and a few have made it possible to switch into the multiplex mode of operation by means of a control on the front panel.

There is no significant technical reason why a stereo tuner, on one chassis, should be any better than two

NOTES

- A Local/distance switch on AM
- B Local/distance switch on FM
- C Local/distance switch affects both AM and FM
- D AM sensitivity continuously variable
- E Has adjustable Dynamic Sideband Regulation
- F Hush or squelch circuit can be defeated
- G Hush or squelch circuit continuously variable
- H Low-impedance antenna connection for coaxial cable
- I Has tuning indicator or eye
- J Has volume or level controls on front panel
- K Price as kit
- L Space provided on chassis for multiplex adapter
- M Has tuning meter
- N AFC is continuously variable
- O Omits AFC
- P Phase reverse provided
- Q AM bandwidth adjustable for broad/narrow
- R AM bandwidth adjustable for broad/medium/narrow
- V Has log scale
- W Price wired at factory

A typical stereo tuner. Two distinguishing characteristics are: separate tuning knobs and separate dial pointers, for FM and AM.



Some of the many features found on modern stereo tuners include—reading in the usual order—variable AM bandwidth, variable squelch or hush circuitry, and provision for operation as a multiplex receiver. The next three buttons select AM, FM, or off; the slide switch to the right is the AFC control.

MAKE	MODEL	PRICE	CASE	SENSI- TIVITY	TUNE	LOG	NOTES
Ampex	503	249.50	+	3.0	I		Q
Arkay	ST11	K 49.95	+	4.0		V	N; Q; W \$74.50
Bell	3070	139.95		6.0	I	V	
	6070	189.95		1.1	M	V	Q
	2222	109.95		6.0		V	
Bogen	TC322	109.50	+	3.0			
	ST442	149.50	+	2.0	M	V	H
	ST662	189.50	+	1.5	I	V	H
DeWald	N1000B	99.95		3.0		V	
Fisher	101R	229.50	+	0.75	I	V	O; Q
Grommes	103GT	189.95	+	1.0	M		Q
Harman-Kardon	T230	119.95		3.5		V	
	ST360	199.95	+	0.95	I	V	L; Q
Heath	PT1	K 89.50		2.0	M		Q
Knight (Allied)	KN135	79.50		4.0		V	H
	KN125	139.50		2.5	I	V	E; H; R
	83YX731	K 87.50		2.5	I		E; Q
Lafayette	LT77	74.50		1.5	M	V	J
	KT500	K 74.50		1.0	I		J; W \$124.50
Madison Fielding	380	160.00	+	2.0	I		J
Pilot	580	179.50		1.5	I	V	H
	680	219.50		1.0	M	V	F; H; Q
Sargent-Rayment	SR1000	184.50		0.85	I		Q
Scott	330D	224.95	+	2.0	M	V	O; P; R
Sherwood	S2200	179.50	+	0.95	I		G; L; Q
Stromberg-Carlson	SR445	129.95	+	2.0	J		A; B

separate tuners. A stereo unit will be more convenient to install; its controls will be centralized and designed specifically for stereo operation. Problems of hum, which might be encountered when two separate units are interconnected, will not exist. The cost to you will be lower; only one power supply is necessary, instead of two, and certain production economies can be effected.

In this review, only stereo tuners are included. Monophonic FM-AM tuners, and mono or stereo tuners combined on one chassis with preamp-control or power amplifier functions, are not covered. Stereo "combos" will be checked out next month.

The table presents basic features of stereo tuners, such as make, model number, and price. Some makers charge extra for a case; this is indicated with a + sign.

Sensitivity of the FM section is the only technical specification listed, and we have included it more or less from force of habit. Sensitivity is important, and it is a significant measure. But it used to have more significance when variation from one model to another was so much greater than it now is. The narrowing of the range today is a tribute to engineering progress.

The sensitivity figure states the amount of FM signal, in microvolts, needed to effect a 20-db reduction in noise. Imagine, if you will, that you have adjusted an FM tuner so that it is precisely on the frequency of a transmitter that is about to come on the air. If the volume control is turned up, you will hear a certain amount of noise—from cars, lights, one thing and another. When the transmitter is turned on, and before the announcer speaks, the level of this background noise will drop substantially—probably to complete silence. This is FM quieting. The amount of quieting is dependent on the strength of the signal reaching the receiver. A typical graph will show that a signal of, for instance, 2.0 microvolts will lower the noise by 20 db. A signal of 3.0 microvolts would then quiet by 30 db; beyond a certain point, the line on the graph reaches a plateau at which no more quieting can be achieved (or is necessary). A signal of 20 microvolts would, in our example, put the line on the plateau with 40 db or more of quieting.

It is obvious that signal strength will decrease as the distance between transmitter and receiver increases. Hence a highly sensitive tuner is advisable in remote or fringe locations. Elsewhere, any modern, well-engineered stereo tuner will have more than adequate sensitivity.

The next column in the table shows whether or not the tuner incorporates a tuning indicator or meter. A meter, or an eye or indicator device of some sort, is not a necessity, but precise tuning always helps the fidelity of a tuner, and a meter or indicator makes precision easier

to achieve. There is less need for such precision if the tuner incorporates . . .

Automatic Frequency Control, which is an electronic circuit designed to compensate for sloppy tuning! It will also compensate for a slight shifting in tuning components while the set warms up—drift.

The AFC circuit simply centers, electronically, the tuning over a strong signal. It almost guarantees correct tuning, and is a feature on almost every tuner in the list. Also, manufacturers' specifications indicate that in every case it can be defeated when desired, by a front-panel control. Why defeat AFC? Because it automatically selects a strong station. If you want to tune in a weak station right next to a strong station, AFC may make it impossible; the AFC circuit will pull the tuner over to the stronger station. Therefore it should be defeatable, particularly in areas where weak stations are very close to strong ones.

The desirability of a logging scale is a matter of receiver location and dial design. Some FM dials have a fairly finely divided megacycle scale. Others simply put a figure at 96 mc, another at 98, and so on. In a metropolitan area where perhaps half a dozen strong signals are all that will be tuned to regularly, such a marking arrangement will be adequate. But in medium fringe areas along the East coast it may be possible to tune in forty to sixty stations. Under crowded conditions of this nature, it is next to impossible to go back to a station without a finely divided logging scale for guidance.

Beyond this . . . there is a column of "Notes," and here are indicated some of the many features which may be included on tuners. Let's take them alphabetically: A: Local/distance switch—this is a good idea for people who live near powerful AM or FM transmitters. Many tuners incorporate automatic volume control devices (such as AGC, Automatic Gain Control), but there is some danger that an overly strong signal may produce distortion or create spurious images. The latter is an occasional problem for oversensitive FM tuners; the same strong station may appear in two or three spots on the dial.

B and C: See above.

D: Same as a switch, except continuously variable. The effect is much like that of a volume control.

E: DSR is described by the manufacturer as a method of adjusting the modulation of an FM carrier to compensate for errors in this adjustment at the transmitter.

F and G: There are two basic types of FM circuits, the ratio detector and the so-called Armstrong circuit. Thousands of words have been

Continued on page 165



by Roland Gelatt

Music Makers

EN ROUTE HOME from a late-summer holiday in France, we tarried for a few days in Holland to attend a recording session by the Concertgebouw Orchestra and renew acquaintances with our friends at Philips Phonographic Industries.

The Concertgebouw Orchestra is passing through some difficult days just now. Since its founding in the 1880s it has had only three permanent conductors: Willem Kes, Willem Mengelberg, and Eduard van Beinum. The latter's sudden death last spring cast the orchestra somewhat adrift, for no official heir apparent was waiting ready in the wings to take over. Piet Heuwekemeyer, erstwhile violinist in the Concertgebouw Orchestra and now its manager, told us that Van Beinum's successor would not be named until October or November 1960. Until then, a number of guest conductors will preside. Heuwekemeyer strongly intimated that the orchestra's artistic direction would henceforth devolve upon two regular coconductors. The Concertgebouw's wide-ranging repertoire and arduous schedule (at least 150 concerts per year) are more, it is felt, than any one conductor can comfortably handle.

Although no official announcement will be forthcoming for almost a year, it would seem reasonable to suspect that the choice of coconductors may ultimately fall on the two musicians who have already been engaged for the Concertgebouw's nine-week American tour in the spring of 1961: German-born Eugen Jochum, 57, and Dutch-born Bernard Haitink, 31. Jochum has a solid reputation in Europe as an interpreter of the Bach-to-Bruckner repertoire and is familiar in countries he has never visited by virtue of many recordings. Haitink,

by contrast, is almost unknown outside the Netherlands; yet he is nevertheless the leading contender for the Concertgebouw post. The orchestra has always been directed by a native son, and Haitink seems everywhere considered Holland's most talented young conductor.

Unfortunately, we had no chance to hear Bernard Haitink in action, though we did have a pleasant talk with him at his home in Laren, a suburb of Amsterdam much favored by painters, writers, and musicians. Despite his current guest engagements and his future prospects with the Concertgebouw Orchestra, Haitink's chief present devotion is his own orchestra, the Radio Philharmonic, of which he has been permanent conductor for the past two years. This ensemble works for Holland's four broadcasting companies, gives its own public concert series, and regularly tours various European countries. Sometimes the Radio Philharmonic Orchestra plays as many as three different concerts a week. Needless to say, Bernard Haitink does not conduct every program, but the over-all musical direction of the orchestra is his sole responsibility.



Recording session in preparation.

Haitink got his start, in the classic manner, by substituting for an ailing colleague. In 1956 the Italian conductor Carlo Maria Giulini fell ill shortly before a scheduled performance in Amsterdam of the Cherubini Requiem. Haitink, who had previously conducted the work in Utrecht, was asked to take over. During one of the rehearsals, Eduard van Beinum wandered into the auditorium of the Concertgebouw and watched young Haitink at work. A close relationship soon sprang up between the two musicians. Van Beinum gave him no formal lessons in conducting, but he was—says Haitink—“extremely helpful.” Last year, when a bout of ill health caused Van Beinum to curtail his appearances in Los Angeles, it was Haitink whom he sent for to fill out the engagement.

In one respect Bernard Haitink feels himself less fortunately situated than either Mengelberg or Van Beinum. “A conductor,” he told us, “should lead the fight for new music. He must be a spokesman for contemporary composers in whom he passionately believes. Mengelberg fought for Strauss and Mahler, Van Beinum for Bartók. These campaigns provided a focus for their careers. I spend hours of every week going through new music, looking for someone whom I can fight for. I’m afraid I haven’t found him yet. I keep up with all the latest developments in serial music. It is interesting, to be sure, but I’m not at all convinced I want to fight for Mr. Stockhausen or Mr. Henze. Still, am I to spend my life playing what every other conductor in the world plays?”

San Franciscans will be able to hear

Continued on page 55

THE NEW TURNTABLE THAT CHANGES RECORDS!

*The
Push-Button
Miracle
for stereophonic and
monophonic
high fidelity sound!*



MIRACORD XS-200

The pushbutton miracle of high fidelity sound—with *every* practical and proven feature for the perfect reproduction of stereophonic or monophonic records.

- it's a heavyweight, professional-type turntable—and a fully-automatic changer!
- a special switch adapts Miracord to stereophonic or monophonic reproduction, with finest quality output on either system!
- vibration eliminated by special mounts!
- 5 push-buttons permit you to start, stop, pause, repeat or filter, without touching tone arm!
- Magic Wand spindles eliminate pusher platforms and stabilizing arms!
- Intermixes 10" and 12" in any sequence: plays all 4 speeds, has a 4-pole motor. Plug-in head!
- shuts off automatically, returns tone arm to rest position!
- and many other outstanding features, not found in any other record changer or record player!

—yet it costs only \$67⁵⁰



STEREOTWIN 210/D a thrilling new standard in a stereo cartridge!

Acclaimed by engineers and audiophiles, STEREOTWIN 210/D is the finest cartridge for the stereo age. "Moving-magnet" principle gives new high in quality performance. Hum is eliminated by Mu-Metal casing. Stylus replacement is instant. Phenomenal separation: 22 db at 1000 cps. EXCLUSIVE ADJUSTMENT puts stylus in proper position both vertically and horizontally for record changers or manual tone arms. Truly an audio engineer's cartridge at an audiophile's price!

Now \$34⁵⁰

FAR AHEAD > THE FINEST BY FAR Available at selected dealers.

For Free catalogue, please write Dept. II



AUDIOGERSH CORP.

514 Broadway, New York 12, N. Y.

WORTH 6-0800



Bernard Haitink this coming spring, when he guest-conducts their orchestra. Meanwhile, the rest of us can sample his work with the Concertgebouw Orchestra on Epic (i.e., Philips) records. First release will probably be the Dvořák Second Symphony, recorded this September.



ANOTHER DVORAK SYMPHONY was being taped in the Concertgebouw when we paid our visit to Amsterdam—the *New World Symphony*, under Antal Dorati's direction. The occasion provided us with our first glimpse of the Concertgebouw, a square, spacious auditorium ornately decorated, and our first opportunity to watch Philips' chief recording director, Jaap van Ginneken, at work. Van Ginneken (pronounce the "G" as if it were an "H") is an awesomely ambidextrous man. Combining the talents of professional sound engineer and professional musician, he sets up microphones himself, handles all controls at the master console, monitors every "take" for musical imbalances and imprecisions, confers directly with the conductor during sessions and postsession playbacks, and finally edits the master tapes. These tasks are customarily divided between two men: an engineer responsible for electronics and a recording director responsible for music. Van Ginneken does it all himself—not because Philips is short of competent personnel but because he feels this is the only way in which he can work at full efficiency.



A dreamlike office at Baarn, Holland.

"When I came to Philips as their first recording director," he told us, "it was on condition that I could operate in this way. I had been trained as a musician at the conservatory and for six years worked as a conductor with the Dutch radio system and composed music in my spare time. Then I became a producer of radio programs, and for another six years I handled the knobs in the control room. During the war, when it was impossible for me to work, I wrote a book on the future of music in an age of electronics. I do not believe that electronics and music should be divorced. As a musician, I have an intuitive feeling for microphone placement and balancing which I could never communicate fully to another person. The minute you turn the controls over to a technical man, you lose something."

At Concertgebouw sessions, Van Ginneken works in the checkroom and communicates with the conductor by telephone. Standing behind the control console, he uses his left hand to turn knobs and his right hand to turn and

annotate the pages of an orchestral score. Often he would break into the middle of a passage with a request for the conductor to begin again. "Most conductors," he explained, "are so used to hearing music from the podium that they don't understand what is needed for proper reproduction in the living room. My job is not to tamper with a musician's style but to tell him within that style what he should do." Dorati seemed to take none of this amiss: indeed, at lunch afterwards, he went out of his way to praise the meticulous care for detail and apparent unconcern for costs that prevail at Philips recording sessions.



PHILIPS Phonographic Industries has its headquarters in Baarn, a town 23 miles east of Amsterdam and as dreamlike a place to work as we have ever seen. We drove along its quiet streets, paved with red bricks and lined with old trees, and saw no houses—only villas, palatial and sturdy, with beautifully tended lawns and gardens. Philips' offices occupy one such villa, the "Hoog Wolde," to which a modern wing has been added. The setting is so spacious, the offices so light and airy, that the place has been nicknamed "The Sanatorium." Elsewhere in Baarn is the pressing plant, whence records are shipped throughout the world. We found it almost incredibly neat and clean and soothing. If you envisage factories as *ipso facto* dank, dirty, and noisy, come to Baarn and forever hold your peace.



Scenes at the Philips plant. At left: minute faults found in positive "mother" matrix can be corrected with aid of engraving tool under the microscope. At right: press operator trims edges of record, inspects it visually (and sometimes aurally) and slips it into inner sleeve.



Presents

The Complete Works of Chopin

Performed by

Laureate Winners of the

Chopin International Competition

in Warsaw



HESSE-BUKOWSKA



BAKST



KEDRA

Here are the first releases in Westminster's 150th Anniversary Edition of the complete piano works of Chopin.

SONATA NO. 1 in C MINOR, OP. 4; SONATA NO. 2 in B FLAT MINOR, OP. 35; SONATA NO. 3 in B MINOR, OP. 58—Wladyslaw Kedra, piano. (Monophonic XWN 18882)

SONATA NO. 2 in B FLAT MINOR, OP. 35; SONATA NO. 3 in B MINOR, OP. 58—Wladyslaw Kedra, piano. (Stereo WST 14072)

14 WALTZES—Barbara Hesse-Bukowska, pianp. (Monophonic XWN 18883—Stereo WST 14071)

24 PRELUDES, OP. 28—Ryszard Bakst, piano. (Monophonic XWN 18881—Stereo WST 14073)

51 MAZURKAS—Ryszard Bakst, piano. (Monophonic XWN 3313; also available singly XWN 18876/7/8)

19 NOCTURNES—Barbara Hesse-Bukowska, piano. (Monophonic XWN 2231; also available singly XWN 18879/80)

PIANO CONCERTO #1 in E MINOR, OP. 11—Barbara Hesse-Bukowska, piano; Vienna State Opera Orchestra; Sir Adrian Boult, cond. (Stereo WST 14048)

PIANO CONCERTO #2 in F MINOR, OP. 21—Barbara Hesse-Bukowska, piano; Vienna State Opera Orchestra; Sir Adrian Boult, cond. (Stereo WST 14089)

A VIVALDI MILESTONE

VIVALDI: THE FOUR SEASONS—Julian Olevsky, Violin; Vienna State Opera Orchestra; Hermann Scherchen, cond. Stereophonic WST 14087—Monophonic XWN 18913.

VIVALDI: IL CIMENTO DELL' ARMONIA E DELL' INVENZIONE (COMPLETE)

(CONCERTI GROSSI, OP. 8, NOS. 1-12)—Julian Olevsky, Violin; Vienna State Opera Orchestra; Hermann Scherchen, cond. Monophonic Album XWN 3315; also available singly XWN 18914 (Nos. 5-8), and XWN 18915 (Nos. 9-12).

For complete catalog, write Westminster, Dept. HF 11, 275 7th Ave., N. Y.



reviewed by

PAUL AFFELDER
NATHAN BRODER
O. B. BRUMMELL
R. D. DARRELL
RAY ERICSON
ALFRED FRANKENSTEIN
JOHN F. INDCOX
ROBERT CHARLES MARSH
CONRAD L. OSBORNE
JOHN S. WILSON

Records in Review



by CONRAD L. OSBORNE

For Angel's Newest *Lucia* . . .

La Callas Controlled and Calculating

In a Reading Invincibly Right

IF THE UBIQUITOUS REPORT of Maria Callas' own request for another crack at recording *Lucia* is true, it substantiates a small theory of mine regarding La Callas, a theory lent further weight by her work on the present Angel recording. The theory runs something like this: Maria Callas, the soprano who exists in the scribbles of publicists, program annotators, and magazine feature writers, is a very different singer from Maria Callas, the soprano who appears on some opera and concert stages and who can be heard on many recordings. The fictional image is of a fiery, abandoned actress, gifted with a voice remarkable for its size and range, if not for its beauty; the woman I have observed is a controlled, conscious actress, who by the most ingenious calculations elicits astounding results from a voice only moderate in size and practical range.

Mine. Callas provides many thrilling moments, but close listening reveals that these moments do not generally occur at the tradi-

tional high points of a work, and are not usually produced by either the range or the power of her voice. In fact, she frequently falls short at precisely those places where we expect to be swept off our feet. She is not, for example, very exciting in the climactic passages of a Puccini opera, because her voice simply is not large enough or warm enough to dominate the orchestra. In *Lucia*, she misses some of the juiciest opportunities because she cannot hit a high D natural with the steadiness and clarity that should be among the coloratura's basic assets. In short, the Callas instrument, whether classified as dramatic, spinto, or coloratura, suffers from one or two elementary failings, causing her to disappoint us just when we are prepared to fall completely under her spell.

On the other hand, she surprises us by executing beautifully countless bars we had given up for lost, by lending point and meaning to passages we had learned to dis-

regard—in other words, by doing exactly those things we have come *not* to expect of a prima donna. And all of this is achieved, not through fire or abandonment, but by the most painstaking attention to note values, vowel shadings, dynamic markings, ornamentation, etc. It is this devilish precision—emotional as well as musical—that accounts, I think, for the unique atmosphere of a Callas performance. It may also explain, in part, the incredible critical and popular attention devoted to miniscule details of her singing and acting—the interesting fetishism concerning her use of the hands, for example.

So far as the new *Lucia* is concerned, there is no point at all in comparing Callas' work with that of Pons or Peters; it would be like comparing Dr. Kinsey's work with that of D. H. Lawrence—same subject, but different approaches towards different ends. There may be a purpose served, though, in noting the features of the present Callas interpreta-

tion as opposed to her own earlier one. There is an important vocal difference: the peculiar "hooded" quality of the voice is much more in evidence on the new recording, and with it comes a more thoroughly "covered" approach. Consequently, the voice is a bit less open, a bit less powerful, and the very high tones are less rousing than formerly. Much of the harshness has been eliminated, however, and the strong throb that afflicts her upper register is less obtrusive. The line of "*Regnava nel silenzio*" is even more carefully and subtly embroidered than before, and the runs, trills, and diminuendos throughout the score are even more perfectly executed. Except for an excruciating wobble on B flat in the Mad Scene, which I take is intended as a trill, and a couple of thin notes at the conclusion of the two sections of this scene, that entire number simply could not be better. And there are so many long stretches that are musically and psychologically right that it is impossible to begrudge her the high, hard one.

Next to the singing of Mme. Callas, the conducting of Tullio Serafin is the most interesting aspect of this performance. The Donizetti and early Verdi operas are generally assigned to hacks who drive their way metronomically through the scores; and when they are assigned to first-line conductors, these gentlemen often overlook the necessity of giving a clear beat. Maestro

Serafin combines a firm beat with enough elasticity to allow his singers elbowroom. The choruses in particular (and the Philharmonia Chorus is a fine one) bounce along with a wonderful zest and lightness.

As for the rest of the cast, Ferruccio Tagliavini's appearance on a new recording calls for comment, inasmuch as this tenor—who was once rated along with Caruso, Gigli, and other luminaries—has been toiling in relatively unimportant houses lately. On the whole, I am surprised to find him singing this well. Not that there is nothing wrong with his performance: he treats us to a fair dose of the sterile pianissimo with which he used to slip through large hunks of the lyric repertoire; the higher tones, as of yore, are rather steely and tight; and he still cannot encounter words like "*sangue*," "*guerra*," or simply "*no!*" without resorting to barking. Nonetheless, his voice sounds pleasant much of the time. Piero Cappuccilli is a warm, smooth baritone, very like our old friend Enzo Sordello (*amathema sit!*), he of the long-held high note. He does not quite have the poise to blend well with Callas in the second-act duet, but he does a straightforward unobjectionable job—and sad as it is to say, his is the best Ashton on discs. Bernard Ladysz, the Raimondo, has a black bass of good quality, and must be excellent as, say, Baron Ochs; but the combination of his pronounced Slavic accent and somewhat

unwieldy production make his Raimondo into a sort of beneficent Fafner. The two supporting tenors are barely adequate; moreover, Normanno's opening solo is drowned by the orchestra. This may be part of new stereo opera house perspective, but since I regard a recording as the only time I shall ever get to hear poor Normanno, I feel a bit cheated at the effect. Margreta Elkins, the mezzo who sings Alisa, has a round, firm tone, and it is a pleasure to hear her few lines given respectable treatment.

The sound is extremely clear and well-balanced. Some "moving about" of the principals is done during the Wedding Scene and Raimondo's narrative, but the real advantage of stereo here is in placing the chorus in three-dimensional alignment.

There is room enough for reservation concerning this performance, but I think that in sum it is the best *Lucia* on records. Mme. Callas has done everyone, herself included, a favor in re-recording it.

DONIZETTI: *Lucia di Lammermoor*

Maria Callas (s), Lucia; Margreta Elkins (ms), Alisa; Ferruccio Tagliavini (t), Edgardo; Lenard del Ferro (t), Arturo; Renzo Casellato (t), Normanno; Piero Cappuccilli (b), Lord Enrico; Bernard Ladysz (bs), Raimondo. Philharmonia Chorus and Orchestra, Tullio Serafin, cond.

◆ ANGEL 3601 B/L. Two LP. \$10.96.

◆◆ ANGEL 3601 B/L. Two SD. \$12.96.

by ALFRED FRANKENSTEIN

Everest Presents Carlos Chávez: The Composer Conducts Three Symphonies In Their First Stereo Recordings

A MASTERPIECE can breed other masterpieces when the time is ripe, and no man can tell what strange and distant echoes a work of genius may arouse. At least one of Carlos Chávez's compositions on this new disc from Everest may be a case in point. In 1913 Igor Stravinsky unlocked the world of the primitive in his *Sacre du Printemps*; twenty years later the music of Latin America came into its own. In Mexico the *Sacre* struck new fire just as the intellectual renaissance fanned by the revolution of the 1920s reached its height. The most enduring

monument to its influence in Latin America is Chávez's *Sinfonía India*, which has become the musical symbol of Mexico as the murals of Diego Rivera have become the symbols of Mexico in the plastic arts. The *Sinfonía India* joined the world repertoire almost immediately after its first performance, in 1936; it has been played everywhere, and, what is more important, has been repeated everywhere; now it comes out in its first stereophonic recording under the composer's own direction.

It does not diminish the stature of Rivera

to point out that he was indebted to Picasso, and it only intensifies the significance of the *Sinfonía India* to point out that it could not have existed if Stravinsky's great ballet had not previously been composed.

The work is based on five Mexican Indian melodies, four of them employing gapped scales of one kind or another and one using a gamut of only three notes. These five tunes are deployed in a single-movement symphony of extraordinary rhythmic complexity, blazing color, and monumental sinew. It handles the normal orchestral forces with



proper heroic accent, but its timbre is suffused throughout with the pounding of drums, the crackling of raps and clappers, the shrilling of whistles, and the thin, edgy piping of flutes and clarinets transformed for the moment into Indian reeds. It is a symphony from which sentimentality and condescension alike are banished. Although it is derived from folk themes of the present day, it also evokes ancient Mexico in the tragic, fanatical intensity of its rhythms and in its adornment of a grandly simple outline with an infinitely complex surface tracery. This rich surface texture is particularly well caught in stereo; no previous recording has been able to come to grips with it.

Along with the *Sinfonía India*, Chávez provides here his *Sinfonía de Antígona* and his *Sinfonía Romántica*.

The *Antígona* was written in 1932 and is listed as the first symphony of Chávez. It was originally composed as incidental music to the *Antígona* of Sophocles as "contracted" for modern performance by Jean Cocteau. It is also a symphony in one movement, but it is totally different in character from the *Sinfonía India*. Everything is spare, reserved, and large in gesture. The orchestra as a whole has the resonance of a gong. The themes are modal, and, as the composer informs us, the harmonic and rhythmic practices employed here are derived from ancient Greek musical theory. The piece has a wonderfully archaic feeling about it; it compresses the sense of the Greek tragedy into ten immensely eloquent minutes, but its stature is less than that of the *Sinfonía India*, for the *Sinfonía India* is one of the key works of our century.

Everybody on this side of the Atlantic wrote one-movement symphonies in the 1930s. Today Chávez can write a three-movement symphony that fills an entire record side and even be paid for doing so. The *Sinfonía Romántica* was commissioned by the Louisville Orchestra in 1952. Unlike the *India* and the *Antígona*, it has no dramatic or evocative target, and its title is an afterthought. Except for a suggestion of a Spanish-Mexican march tune in its finale, it is devoid of folk color, but the treatment of its materials, the construction of its climaxes, and its entire communication of masculine verve and life is in the same tradition as the other works.

The recording is superb in both versions, thanks to excellent engineering and to the magnificent response of the Stadium Symphony Orchestra of New York to the composer's direction, but, for reasons indicated above, the stereophonic edition is preferable. Chávez, of course, has had vast experience as a conductor and is the final authority on the interpretation of his own works.

CHAVEZ: *Sinfonía India; Sinfonía de Antígona; Sinfonía Romántica*

Stadium Symphony Orchestra of New York, Carlos Chávez, cond.

• EVEREST LPBR 6029. LP. \$4.98.

• • EVEREST SDBR 3029. SD. \$5.98.



by NATHAN BRODER

Haydn's *Seasons* . . .

Sir Thomas and All

In Very Top Form

HAYDN'S *The Seasons*, his "other" oratorio, has never been as popular as *The Creation*. Its neglect is probably due in part to reports about Haydn's own indifference to it: he is said not to have relished writing music imitating frogs, and other such "Frenchified trash." And in part it may be due to a disinclination on the part of conductors to undertake the labor involved in preparing a long secular work on a subject that has been out of style since the eighteenth century. But whatever the reasons, they dwindle into insignificance when one hears the music, particularly in so warm and loving a performance as this new Capitol disc provides.

For this is the work of a great master, dealing, to be sure, with everyday things, but lavishing upon them inventive powers and an imaginative craftsmanship sharpened and mellowed by a lifetime of successful creativity. Some of the choruses are very beautiful, others impress by their power. The hunting chorus in *Autumn* is the culmination of all the music written about the chase in the eighteenth century; and the spinning song and chorus in *Winter* left its mark on many similar musical scenes composed in the nineteenth century. The solo vocal numbers vary from operatic, Italianate arias to songs of a folklike cast but of elevated feeling, like some of the music in *The Magic Flute*. That opera, in fact, composed ten years earlier, sets the tone for much of the nonrepresentational music in this oratorio, and the duet "You beauties of the town" in *Autumn* sounds as though it might have been patterned after Papageno's "*Ein Mädchen oder Weibchen*." The commentators frequently speak of Haydn's simplicity and naïveté in this music. Let us not be deceived. The sixty-eight-year-old composer, admired throughout Europe and with two successful trips to England under his belt, was no artless provincial. He deploys his folklike material with enormous skill. Even the instrumental tone painting—of a thunderstorm, of splashing fishes, swarming bees, fluttering birds, even the croaking frogs that were supposed to have so much pained him—is finely

integrated into the musical context. Haydn's "frisking lambkins" are a delight each time we encounter them, whereas Strauss's far more realistic bleating sheep are no longer very interesting after the second time. And the country folk in the drinking chorus here, making merry and dancing to their bucolic instruments, are, musically speaking, a very sophisticated peasantry indeed.

Beecham seems to me to be at the top of his form in this presentation. Aside from a cut in the overture to *Spring* and another in the aforementioned duet, there is no tampering with the printed score. Here are reunited the qualities that won Sir Thomas his large and faithful following: penetration to the spirit of the music, sensitive line, superb balance, and constant vitality, in tranquil as well as in animated passages. He is aided by an excellent chorus, rather large-sounding but flexible and possessed of lovely tone. Of the soloists Michael Langdon, the bass, has a well-focused voice of pleasing quality and spins out long phrases in a single breath. The same is true of Alexander Young, the tenor, whose air "Here stands the wand'rer now," in *Winter*, is especially nicely done. Elsie Morison is the least satisfactory of the three. Although she sings her cavatina "Light and life," in *Winter*, beautifully, elsewhere she is sometimes not very secure technically, her diction is not as clear as that of the others, and she lacks the bravura required in the air "So reviving to the senses," in *Summer*.

The sound in general is clean, full, and spacious, though usually without obvious separation. In the handsomely illustrated booklet is the English text, by Dennis Arundell, sung here, a version considerably closer to the German text set by Haydn than is the English translation that is usually printed.

HAYDN: *The Seasons*

Elsie Morison, soprano; Alexander Young, tenor; Michael Langdon, bass; Beecham Choral Society; Royal Philharmonic Orchestra, Sir Thomas Beecham, cond.

• • CAPITOL SCCR 7184. Three SD. \$17.94.



In a Commemorative Album

Capitol Pays Tribute to Thirty Years

Of the Art of Nathan Milstein

TWO DAYS after Christmas in 1947, I had an appointment with Nathan Milstein to supervise his recording of the Beethoven *Spring Sonata*. As irony would have it, that was the day when New York was just beginning to shovel itself out from under one of the worst blizzards in its history. The only means of transportation was by foot or subway, yet the violinist and his sonata partner, Artur Balsam, arrived in good time. As they thawed their icy hands before attempting to play, Milstein told us of his adventures the previous afternoon.

During the height of the storm, he had taken a bow to a violin maker on 57th Street to have it repaired. To pass the time until the bow was ready, he had walked up the street and dropped into Carnegie Hall to catch part of the regular Friday afternoon concert by the New York Philharmonic, at which one of his colleagues was playing the Beethoven Violin Concerto. It was this performance that Milstein wanted to talk about. Everyone else in New York was busy relating his experiences in the Great Snow, but Milstein was completely engrossed in his account of the concert, one of the greatest performances of the Beethoven Concerto he had ever heard. We listened to the shower of praise—and after that got down to the business of recording the sonata.

This incident of nearly twelve years back came to mind as I listened to his new recording of the selfsame sonata, this time with Rudolf Firkusny as the collaborating pianist. Milstein's unstinted praise of another artist was an example of his great humility. And his ultimate refusal to permit the release of the earlier sonata recording—which had seemed to me an excellent performance—because it failed to come up to his uncompromisingly high standards was an example of the ultimate artistic integrity that has made him a leader among the world's violinists and has kept him at the top for years.

The *pièce de résistance* of this new Capitol album entitled "*The Art of Milstein*"—issued to commemorate the thirtieth anni-

versary of the violinist's American debut, in 1929, with Stokowski and the Philadelphia Orchestra—is, of course, the Tchaikovsky Concerto. This is the third time the violinist has essayed this work on records, and it is by far the best. He displays brilliant technique throughout, yet technique is never exploited for its own sake but always subjugated to the demands of the music. The violin tone is exquisite, and has been just as exquisitely reproduced.

With the Tchaikovsky Concerto, there is always the problem of cuts. On records, only Grumiaux has played it complete. If memory serves me correctly, both in concert and on his earlier discs Milstein made more cuts than he does here. He offers the first two movements in their entirety, and the third movement has only the brief excisions made by most violinists and, I believe, first sanctioned by Milstein's teacher, Leopold Auer.

For me, the high point of this performance is the Canzonetta. Unlike almost every other violinist, Milstein follows the composer's instructions and keeps his mute on throughout the movement. The effect is most beguiling. Besides, he gives it an exceptionally expressive interpretation, precisely phrased and played with great intensity of feeling, coupled with considerable restraint. This is a difficult feat, carried off here with tremendous effectiveness.

As in nearly all of Milstein's concerto recordings for Capitol, he is supported by William Steinberg and the Pittsburgh Symphony Orchestra. The support is a trifle pedestrian in the first movement, but the conductor catches the spirit of the soloist's interpretation in the remaining two sections. The orchestral articulation is excellent all the way through. Furthermore, the concerto has been treated to some very clear, well-defined sound. The stereo separation is good if not outstanding, and the soloist is well set off from the orchestra at the center of the stage.

Both Milstein and Firkusny give a careful, serious account of the Beethoven Sonata. This is the first time these two artists have

appeared together on records, yet they form a first-rate sonata team. In the stereo version the piano is well reproduced, but the violin is a bit too close to the microphones, resulting in some overmodulation and imbalance. In the shorter pieces in the set—music which, though not all written after 1900, is by composers who lived in the twentieth century—Milstein's tone comes through with warmth and smoothness, while Leon Pommers' piano is well focused. Here, too, the performances are all marked by that impeccable taste and finesse with which Milstein invests all works of this sort.

Thirty years of public acclaim and artistic growth is a long time. It took several years for Milstein really to establish his reputation in this country, but once he became generally known, his fame grew by leaps and bounds. His artistry, high in the beginning, has never stopped growing. Capitol has seen to it that he has committed to microgroove nearly all the standard nineteenth-century concertos, several Beethoven and Mozart sonatas, and—possibly his greatest achievement on discs—all of the Bach Sonatas and Partitas for Unaccompanied Violin. With this new album we experience again sounds that are always rich in texture, warm in intensity, and perfectly balanced in musicianship. Nathan Milstein and Capitol deserve our gratitude.

NATHAN MILSTEIN: "*The Art of Milstein*"

Tchaikovsky: *Concerto for Violin and Orchestra, in D, Op. 35*. Beethoven: *Sonata for Violin and Piano, No. 5, in F, Op. 24 ("Spring")*. Szymanowski: *La Fontaine d'Arethuse*. Debussy: *Minsirels*. Fauré: *Après un rêve*. Pizzetti: *Canto No. 3*. Sarasate: *Introduction and Tarantella*.

Nathan Milstein, violin; Rudolf Firkusny, piano (in the Beethoven); Leon Pommers, piano (in the short pieces); Pittsburgh Symphony Orchestra, William Steinberg, cond. (in the Tchaikovsky).

● CAPITOL PBR 8502. Two I.P. \$9.98.
● ● CAPITOL SPBR 8502. Two SD. \$11.98.



Rysanek and Warren (tieless) talk it over.

Verdi's *Macbeth*: An Early Masterpiece Impressively Revived in RCA Victor's Stereo Recording of the Metropolitan Production

by CONRAD L. OSBORNE

I DARE SAY that at any time during the 1940s, a suggestion for a Met production of any of Verdi's pre-*Rigoletto* works would scarcely have been taken seriously. But within the last three years, we have had both *Ernani* and *Macbeth*, the latter now chosen by RCA Victor for one of its "Selected by the Metropolitan Opera" packages. It is fitting that *Macbeth* should be the first of the young Verdi's operas to be accorded a major modern recording effort, since it was a production of this work, in Germany back in the Twenties, that started the early-Verdi revival movement.

In a sense, *Macbeth* is not early Verdi at all, which perhaps explains why it triumphed (it is back in the Met repertory this season) where *Ernani* failed. The first version dates from 1847; chronologically, it was preceded by *Attila* and followed by *I Masnadieri*. The revision, written for the Théâtre Lyrique of Paris, was completed in 1865, which places it between the first scorings of *La Forza del destino* and *Don Carlos*. One does not have to be thoroughly familiar with the early version to realize how extensive Verdi's changes must have been. True, Verdi was inspired by the subject from the outset, and his melodic gift found freer expression here than in any other opera before *Rigoletto*; but *Attila*, written only a year earlier, is a genuinely miserable opera. Those familiar with the later works, *Forza* and *Don Carlos*, will notice the subtle, dark shadings in orchestration and the wonderful variety in the accompaniments, in common with nearly all of Verdi's post-*Traviata* work. They will also feel at home with the exciting Battle Fugue, new in the second version. Where they will mark a foreign element is in the nature of

the melodies themselves, and in the form taken by their development.

It is here that *Macbeth* runs into some difficulty, best demonstrated by the unsolved problem of the Witches' treatment. In each of the scenes of prophecy, the instrumental introductions and interludes are magnificently to the point, thanks largely to the Verdi of 1865. But (to take a closer look at the first scene) the mood is utterly wrecked when the hags launch into their first set number, "*M'e frullata nel pensier*." It is slowly restored by the actual prophecy and the carefully set recitative which follows, and is maintained throughout the messengers' chorus and the fine duet for Macbeth and Banquo, "*Due vaticini compiuti or sono*," only to be violated in the stretta, another concerted number for the Witches. It is not that these are bad choruses. They are good choruses, but they belong in the salon of Flora Bervoix, not in the antechamber of the nether regions. Similarly, the final hymn of victory creates a feeling of banality and bombast, and this is entirely due to the puerile nature of the theme itself.

Having registered these complaints, I must allow that my impression is still that *Macbeth* is an opera of true greatness. The characters of Macbeth and his Lady are tellingly rendered. A few bars of introduction to the second scene tell us that Verdi knows his heroine intimately, and his mastery of characterization shows in a dozen ways—the perturbed little figure which underlines the first section of "*La luce langue*," the ostentatious glitter of the *Brindisi*, and finally the whole Sleepwalking Scene, as penetrating and mournful as any in Italian opera. Of course, even the Verdi

of the revised *Macbeth* was not quite the Verdi of *Otello*, as a comparison of the Dagger Soliloquy ("*Mi si affaccia un pugnale?*") with the Moor's "*Dio! Mi potevi scagliar*" will show; nevertheless, Macbeth's guilt, as well as his dependence on Lady Macbeth, is beautifully illustrated in the whispered duets of the Murder Scene and the terrified outbursts and demented wanderings of the Banquet Scene. His music at the end has the noble, virile line required to give him tragic stature (which is fortunate, since "Fling out the banners on the castle walls," etc. becomes "*Prodi all'armi*" in Pieve's libretto, and only a Verdi could compensate for that). Banquo and Macduff have just one aria apiece, but each is an effective number, sufficient to establish the character's place in the drama.

The recording is the Met production down to the smallest detail, with every stage movement mirrored by the stereo directional effect. Leonard Warren's interpretation of the title role is, I think, more impressive on records than it is in the opera house. He is not a visually convincing Macbeth; more importantly, much of his best work is done at a level lower than *mezzo-forte*, and was at least in part wasted in the huge Met auditorium—it was often unclear just what effect he was trying to achieve. The recording brings us every nuance of his characterization, and a knowing, brilliantly executed job it is. In recent seasons I have heard an increasing shakiness in Warren's voice, particularly in declamatory passages, and a certain "locked" effect which has robbed the upper-middle register of some of its old volume and ring, but the first problem is minimized and the second

eliminated completely on this recording. His voice retains its plump sound and remarkable capacity for tonal shading, and I very much doubt that any other baritone now singing could hold a candle to him in this role.

Mme. Rysanek, on the other hand, was somewhat more magnetic at the Metropolitan than on these discs. The fact that her voice can soar out above full chorus and orchestra counts for relatively little on a recording, even in stereo, and the rather undeveloped state of her low voice is not disguised by the engineers. In the main, though, her work is extremely impressive. Her dark, dramatic voice is commanding yet flexible enough for the runs and flour-

ishes of this high-lying role, and she modulates her tone in sensitive fashion for the Sleepwalking Scene. Hines is a rich-sounding Banquo, and Bergonzi brings a fine flow to "Ah, la paterna mano."

Leinsdorf gives the music good impetus and considerable expansion, and the Met orchestra has seldom sounded this good. The chorus is incisive in attack and well balanced, but those Witches are needlessly offensive, being forced to sing with a nasal, infantile sound and to cackle embarrassingly. This is supposed to be a drama, not a Hallowe'en pageant. The sound, as I have indicated, is outstanding for directionality, and is also reasonably clear and tonally faithful. The treble highs, however, bring with them

a slight, but annoying, bleat. The package is another of Victor's Conspicuous Consumption items, handsome and impractical.

VERDI: *Macbeth*

Leonie Rysanek (s), Lady Macbeth; Emilia Cundari (s), A Bloody Child; Mildred Allen (s), A Crowned Child; Carlotta Ordassy (s), Lady-in-Attendance; Carlo Bergonzi (t), Macduff; William Olvis (t), Malcolm; Leonard Warren (b), Macbeth; Calvin Marsh (b), A Warrior; Osie Hawkins (b), A Murderer; Jerome Hines (bs), Banquo; Gerhard Pechner (bs), A Physician; Harold Sternberg (bs), A Manservant. Metropolitan Opera Chorus and Orchestra, Erich Leinsdorf, cond.

• • RCA VICTOR LSC 6147. Three SD. \$17.94.

CLASSICAL

ALBENIZ: "Spanish Dances"

Orquesta Lirica Audio Museum (Madrid), José Ohnedo, cond.

• TELEFUNKEN TC 8027. LP. \$1.98.

Unfailingly lyric and pleasing, these works fall in the middle ground between light music and more serious fare. As realized in the agreeably idiomatic manner of this Spanish orchestra, they can be recommended for those moments when music is desired as a tranquilizer rather than a stimulant. R.C.M.

BACH: *Arias*

Bach Aria Group, William H. Scheide, cond.

• DECCA DL 9405. LP. \$4.98.

• • DECCA DL 79405. SD. \$5.98.

The reappearance of the Bach Aria Group on records after a long absence is an occasion for cheers. Seldom do artists of this caliber, instrumental as well as vocal, address themselves to the performance of Bach cantatas. Equally rare on records, and especially striking, is the dedication apparent in these performances. The power and skill of Eileen Farrell, the rich tones of Jan Peerce, the mellow voices of Carol Smith and Norman Farrow are all wholly engaged in the transmission of Bach's musical message.

As usual with Mr. Scheide's programs, this one is carefully chosen to provide variety of color and mood. There are two arias for soprano (the exulting "Mein gläubiges Herz" from Cantata 68 and the beautiful "Gott versorget alles Leben" from Cantata 187), one for alto (the lovely melodic curve of "Wenn kommt der Tag" from Cantata 70), two for tenor (the considerably embellished "Ich traue seiner Gnaden" from Cantata 97 and the lighthearted "Jesus nimmt die Sünder an" from Cantata 113), one for bass ("Ja, ja, ich halte Jesus feste" from Cantata 157, a little operatic scene, in which the repetition of the aria is three times

interrupted by recitative), and two duets ("Zweig' und Aeste" for alto and tenor, from Cantata 205 and "Gott, du hast es wohl gefügt" for soprano and bass, from Cantata 63). Mr. Scheide's defense of the piano as continuo instrument is not very convincing, but it would be hard, I think, to find the spirit of Bach's music more faithfully conveyed on records than it is here. N.B.

BACH: *Brandenburg Concertos: No. 3, in G, S. 1048; No. 4, in G, S. 1049. Suite No. 2, in B minor, S. 1067*

David Oistrakh, violin; Alexander Korneyev, Naum Zeidel, flutes; Moscow Chamber Orchestra, Rudolf Barshai, cond.

• MONITOR MC 2037. LP. \$4.98.

These, the first Soviet Russian performances of any of Bach's purely orchestral works to come our way on records, are far superior to most of the previous Bach recordings from the same source. In style, in technique, and in recording they are first-rate. In the *Brandenburg* No. 4 the opening movement is taken at a rather lively pace, which makes the thirty-second-note figures in the solo violin very fast indeed, but they roll out effortlessly from under Oistrakh's bow. He is not especially favored by conductor or recording engineer; he is simply one voice in a trio, but the tone of this voice has a beauty rare in recorded performances of the work. The performance of No. 3 is almost as good, though Barshai plays only the two slow chords instead of a cadenza and takes the finale a shade too speedily. If Korneyev usually plays as he does here, he would be an adornment to any major orchestra. His tone is round, his phrasing musically, his technique more than adequate, and his breathing inaudible. N.B.

BACH: *Concerto for Violin and Strings, in E, S. 1042; Partita for Unaccompanied Violin, No. 3, in E, S. 1006*

Alan Loveday, violin; Royal Danish Orchestra, George Hurst, cond.

• FORUM F 70009. LP. \$1.98.

Alan Loveday is a young New Zealander who studied and lives in England. To judge by this disc, he is an excellent violinist, with an attractive tone, generally good intonation, and a serviceable technique. The Concerto is well performed, although there is no continuo instrument, and the Partita, aside from a bit of sentimentalizing towards the end of the Gavotte, proceeds in smooth and lively fashion. The sound here is live and free from distortion. N.B.

BEETHOVEN: *Mass in D, Op. 123 ("Missa Solemnis")*

Elisabeth Schwarzkopf, soprano; Christa Ludwig, mezzo; Nicolai Gedda, tenor; Nicola Zaccaria, bass. Chorus of the Society of Friends of Music (Vienna); Philharmonia Orchestra, Herbert von Karajan, cond.

• • ANGEL S 3595 B/L. Two SD. \$12.96.

The present Angel recording of Beethoven's *Missa Solemnis*, under the direction of Herbert von Karajan, is the tenth edition of this work to be available in the United States or Western Europe in the three decades of electrical recording, the fifth version in current American catalogue listings, and the second appearance of the work in stereo.

One might say of it, in brief, that it is a moving, interesting, and effectively realized performance, unfortunately none too well recorded. But this description really leaves us nowhere, since every edition of the *Missa Solemnis* has been seriously flawed in one way or another. We will continue to listen to this music anyhow, trusting that—especially with stereo—someone, sooner or later, is going to do justice to the score both interpretatively and sonically. Until then we must decide which failings are least incompatible with a continuing realization that this is probably the greatest of all settings of the Mass, providing a succession of those unique musical achievements which rank Beethoven above all

Continued on page 84

HIGH FIDELITY MAGAZINE

If you're a
prima donna
about sound,
you'll insist on

Mercury

Living
Presence Stereo



- MEDEA HIGHLIGHTS. Callas, La Scala, Serafin. SR90233
- MUSIC FOR QUIET LISTENING. Eastman-Rochester Orchestra, Hanson. SR90053
- BARTÓK Second Suite. Minneapolis Symphony, Dorati. SR90098
- BOUQUET DE PARAY. William Tell Overture; Danse Macabre: Invitation to the Dance; Mephisto Waltz. Detroit Symphony, Paray. SR90203
- IVES Third Symphony; Three Places in New England. Eastman-Rochester Orchestra, Hanson. SR90149
- BARBER Medea; Capricorn Concerto. Eastman-Rochester Orchestra, Hanson. SR90224
- PERCY GRAINGER FAVORITES. Eastman-Rochester Pops, Fennell. SR90219
- BRITISH BAND CLASSICS. William Byrd Suite; Hammersmith Prelude & Scherzo; Crown Imperial March. Eastman Wind Ensemble, Fennell. SR90197
- MOUSSORGSKY Pictures at an Exhibition; Excerpts from Khovanshchina. Minneapolis Symphony, Dorati. SR90217
- RESPIGHI Brazilian Impressions; The Birds. London Symphony, Dorati. SR90153
- HERBERT Cello Concerto; PETER Sinfonia. Miquelle, Eastman-Rochester Orchestra, Hanson. SR90163



SR90233



SR90203



SR90217



SR90224



SR90197



SR90219



The Living Presence Monaural
Recording of Each of These Albums
is Available Now, Too.

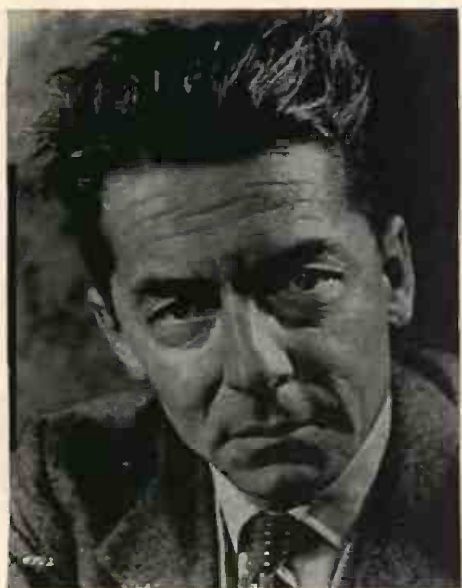

Karajan: a *Missa* dramatically intense.

other composers of the nineteenth—and possibly every other—century.

To date, the two great recorded performances of the *Missa Solemnis* were those of Klemperer and Toscanini. As distinct from each other musically as their conductors were distinct in temperament, heritage, and point of view, these editions nonetheless captured great achievements in musicianship. In both cases the recording was confined in sound and otherwise flawed, but to the imaginative listener it could, under optimum conditions, present a vivid impression of the original.

The initial stereo set, originally issued as a Concert Hall tape and then successfully revamped for its current disc appearance on Urania, offered the first approximate likeness of the score as it is heard in concert. It had its oddities—such as the placement of the soloists—but the sonic picture was closer to reality than any we had known before. Unfortunately the performance under Walter Goehr's direction was not a great one.

Karajan is reported to have waited some years before committing the *Missa Solemnis* to records. His performance reflects careful preparation not only of himself but his forces, and is surely worthy of "the General Musical Director of Europe." His own strongest characteristics as a musician, already well established in our experience of his earlier work, are dominant here, and they serve to add dramatic intensity to the spiritual intensity of Beethoven's writing. In those sections in which the recording seems best to serve the music, the *Agnus Dei* for example, this is a performance of exceptional beauty, distinguished for the strength of its architecture and the miraculous sonorities Karajan secures by the blending of organ, instrumental, and vocal lines. (Karajan's solo quartet is one of the best ever heard in this work.) Were it all of this quality, one could gladly hail this version as the *Missa Solemnis* we have all been waiting to hear.

Unfortunately, the quality is not at all even. Recorded in what I should judge to be the European equivalent of Madison

Square Garden, the master tapes apparently provide a mixture of sound from two sets of microphones, one set placed near the stage for solo voices and the solo violin of the *Benedictus*, and another placed up near the roof for the big choral and orchestral passages. The effect is rather like having a good balcony seat from which you can swoop down over the stage for a more intimate account of the proceedings. Yet, ironically, once you become accustomed to the fact that your perspective is that of someone flapping around the hall on batlike wings, you become irritated only when the approach of a really loud passage drives you up under the roof.

Close to the stage, you receive relatively precise stereo information, conveying a good likeness of the orchestra and solo sources, but the chorus always remains distant and, except in its quiet passages, blurred with hall resonances. In the distant position, you are mainly conscious of the size and very long reverberation period of the hall, and some of the climactic passages are (for me, anyway) ruined by the echo and blast which distort the sound before it ever reaches the microphones. The extremes of the frequency range, essential to any true high-fidelity sound, are, of course, the most perishable part of such a scrambled passage.

Under these circumstances the obvious thing to say is that Karajan should ask for an opportunity to re-record this work under more favorable circumstances. He and his musical colleagues have provided the quality the public has a right to demand, but the engineers have failed to do their part. There are many things here that make these records worth having in spite of sonic deficiencies, but the consumer should be aware that his highest expectations will not be met. He has a right to his disappointment. After all, more difficult works than the *Missa Solemnis* have been recorded—and with brilliant effect. R.C.M.

BEETHOVEN: *Symphony No. 3, in E flat, Op. 55 ("Eroica")*

Hamburg State Philharmonic Orchestra, Joseph Keilberth, cond.

• • TELEFUNKEN TCS 18003. SD. \$2.98.

Keilberth's approach to this score and the recent Scherchen edition can be taken as the practical limits of alternative interpretative approaches to this music. The Scherchen is very fast, very intense, sharply accented in line, creating its heroic drama through action and vitality. To Keilberth a long line, sustained in the gradual unfolding of big, powerful phrases and unflinching melodic in character, provides the key to the heroism Beethoven wished to represent.

Scherchen gets all the first movement (including the repeat) and the whole of the funeral march on one side. Keilberth omits the repeat and only completes the introductory section of the second movement before the record must be turned over.

The measure of a performance lies not merely in the interpretative point of view and the consistency with which it is

realized in details as well as larger outlines; it depends also on the power of the conception to seize the listener's attention and sustain it. My own reaction was that, although completely different in orientation, this *Eroica* was quite as interesting as Scherchen's, and that both were more interesting than the majority of the safely orthodox readings which defend a middle ground long acknowledged as the common property of all who wish to claim its sanctuary.

In this Keilberth reading one finds many things recalling the great experience the *Eroica* could be under the baton of Wilhelm Furtwängler; and although Keilberth is too good a musician to need to go in for conscious borrowing, the association indicates the impact this performance can have on those who see the work in this light.

The recording is spacious and pleasingly directional. R.C.M.

BEETHOVEN: *Symphonies: No. 8, in F, Op. 93; No. 1, in C, Op. 21*

Hamburg State Philharmonic Orchestra, Joseph Keilberth, cond.

• • TELEFUNKEN TCS 18004. SD. \$2.98.

BEETHOVEN: *Symphony No. 8, in F, Op. 93*

†Schubert: *Symphony No. 8, in B minor ("Unfinished")*

Hamburg State Philharmonic Orchestra (in the Beethoven); Bamberg Symphony Orchestra (in the Schubert); Joseph Keilberth, cond.

• • TELEFUNKEN TCS 8010. LP. \$1.98.

All three performances are convincing examples of fine German musicianship and well-trained ensembles. The First is the best of the lot, indeed, one of the most effective statements of that work we have, with particularly good stereo recording to add to its appeal. The Eighth is about a step behind, chiefly due to its less refined sonics, but Keilberth observes the important repeat in the first movement and is bested only by Klemperer and Walter in the stereo field. In the monophonic coupling with the *Unfinished* we have, however, a disc that is undoubtedly a best buy in its price range. R.C.M.

BOCCHERINI: *Concerto for Cello and Orchestra, in B flat*

†Haydn: *Concerto for Cello and Orchestra, in D, Op. 101*

Janos Starker, cello; Philharmonia Orchestra, Carlo Maria Giulini, cond.

• • ANGEL S 35725. SD. \$5.98.

Although the authenticity of these two concertos has always been in doubt, the question of authorship is of small importance. They remain the finest classical concertos in the all-too-limited repertoire for the instrument. Starker employs the usual Griitzmacher edition of the Boccherini, but it is impossible to ascertain what version he uses of the Haydn. The album notes mention Gevaert, but the extended version of the first movement is

Continued on page 86

THE INCOMPARABLE

BRUNO WALTER BEETHOVEN

CONDUCTS THE FIRST COMPLETE RECORDINGS
OF THE NINE SYMPHONIES OF
IN STEREOPHONIC SOUND . . .

An event of unique importance, representing the cumulative experience of Dr. Walter's 66 years of conducting, and one of Columbia's proudest achievements in sound reproduction.

Seven 12" LP records, handsomely packaged with an elaborate 48-page booklet, containing analytical notes and thematic index to each symphony, previously unpublished photographs and drawings, reviews and anecdotes by Beethoven's contemporaries and present day critics. D7S 610 \$41.98.

Also available in regular high fidelity. D7L 265 \$34.98.

THE SOUND OF GENIUS IS ON

COLUMBIA  **MASTERWORKS**

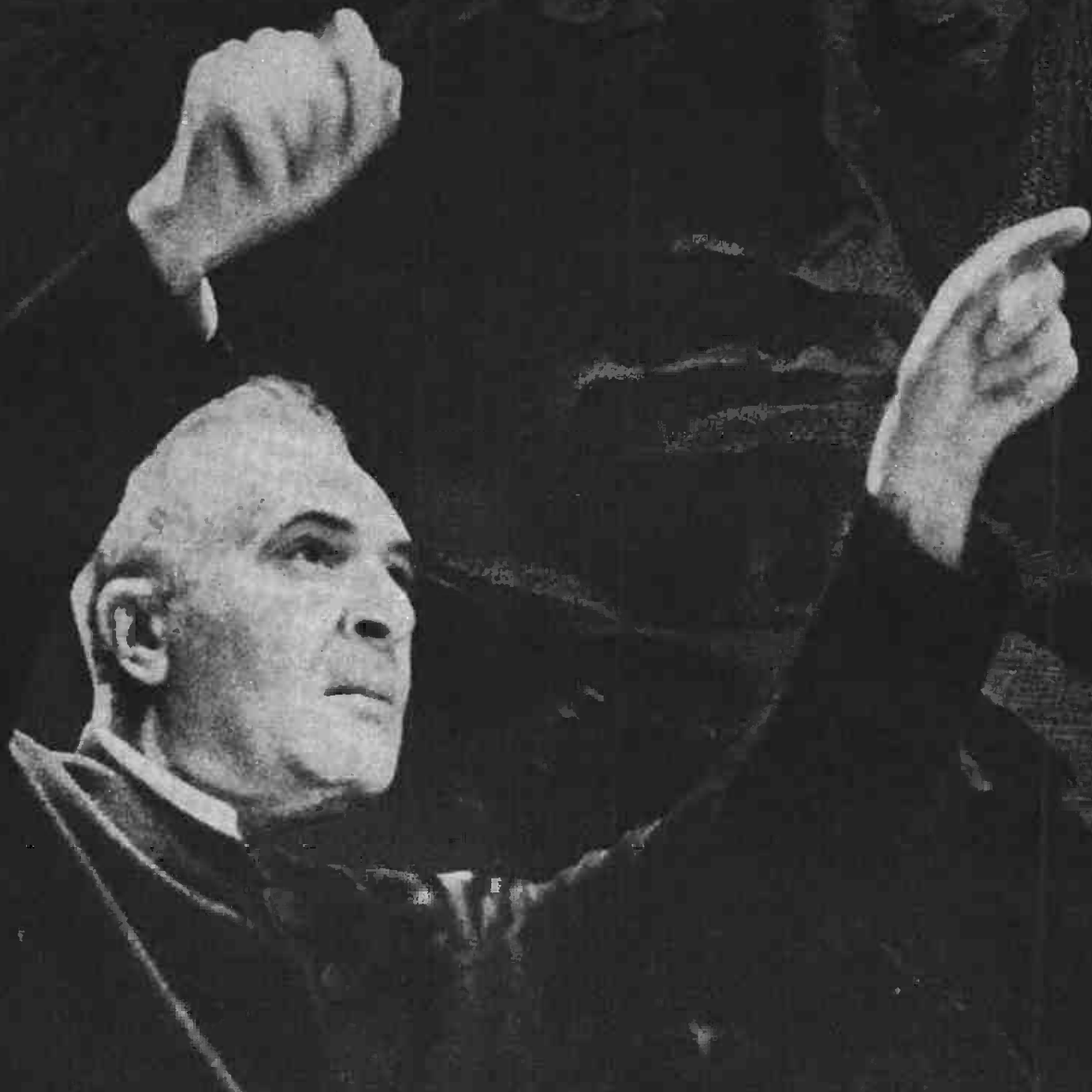

The nine symphonies of Beethoven have been in existence for one hundred and thirty-two years. For half of that time, Bruno Walter has been conducting them with the world's greatest orchestras.

© "Columbia" "Masterworks" ® & ™ Marks Reg. A division of Columbia Broadcasting System, Inc. Prices are suggested list.



The late Eduard van Beinum.

closer to the original edition used by Feuermann in his old and still admirable recording for Columbia. In both concertos Starker has, unquestionably, inserted some changes of his own, including all the cadenzas. In any case, he performs both works in masterful fashion, while Giulini and the orchestra support him with precision and finesse. The stereo sound is well dispersed, though the cello tone is not quite as bright as it has been on some other Starker releases. P.A.

BRAHMS: Concerto for Piano and Orchestra, No. 2, in B flat, Op. 83

Artur Schnabel, piano; RCA Victor Symphony Orchestra, Josef Krips, cond.
 • RCA VICTOR LM 2296. LP. \$4.98.
 • • RCA VICTOR LSC 2296. SD. \$5.98.

What a satisfactory recording this is! With his technical command, his ever-shining tone, his unforced yet elegant phrasing, Schnabel reduces this grandiose, complex concerto to a work of sweet reasonableness. There may be nothing special in this approach—not the demonic energy of a Serkin, the febrile intensity of a Horowitz, the massive simplicity of a Backhaus; but its serene beauty in sound and shape provides—and I can only repeat—the most satisfactory of recordings, if not the one with the greatest excitement or impact.

The recording surpasses in every way the one previously made by Mr. Schnabel, with Charles Munch and the Boston Symphony: the piano and orchestra are heard more distinctly, so that subtleties in both cases are more apparent; the soloist gives a more rangy, flexible performance, more deliberate in the slow passages, more vigorous in the fast; and Josef Krips has a more vital conception of the orchestral score than did Munch. Some listeners may find in the new monophonic release too much prominence given to the piano at some slight expense to the orchestra when both are going full tilt, but this criticism does not hold for the stereo version, where every sound is transcendently clear in Victor's best new engineering style. R.E.

BRAHMS: Overtures: Academic Festival, Op. 80; Tragic, Op. 81. Variations on a Theme by Haydn, Op. 56a

Amsterdam Concertgebouw Orchestra, Eduard van Beinum, cond.
 • ERIC LC 3586. LP. \$4.98.

One of the most notable qualities of the late Eduard van Beinum's conducting was the sanity of his interpretations. These Brahms performances are more or less typical of his work. This is especially true of the *Haydn Variations*, beautifully proportioned and set forth. Much the same characteristics imbue the *Academic Festival Overture*, though it is delivered in a more rousing fashion. Only the *Tragic Overture* seems a little too deliberate, with an over-all tempo just slow enough to cause the music to drag from time to time. As might be expected from the Concertgebouw, the orchestral execution is superb, while the reproduction is clear and well rounded. P.A.

BRAHMS: Symphony No. 4, in E minor, Op. 98

Royal Danish Orchestra, John Frandsen, cond.

• FORUM F 70002. LP. \$1.98.

Philharmonia Orchestra, Otto Klemperer, cond.

• • ANGEL S 35546. SD. \$5.98.

The Forum recording sounds as if it had been made several years ago. The tonal range is quite limited, especially in the highs. The middle register strongly predominates, with a resulting imbalance that often pushes the middle voices—particularly the horns—into an undeserved limelight. This is a pity, for Frandsen's interpretation is marked throughout by fine sense of proportion and good taste.

Stereo really fulfills its function by adding depth, spaciousness, and perspective to Klemperer's noble and eminently alive reading. Moderately distant microphone placement creates the illusion that the listener is seated halfway back in a large concert hall, yet there is no sacrifice of instrumental presence. P.A.

CARISSIMI: Oratorios: Judicium extremum; Suscitavit Dominus; Militia est vita hominis

Nino Adami, tenor; Giuliano Ferrein, bass; Polyphonic Chorus of Turin; Angelicum Orchestra (Milan), Aladar Janes, cond.

• WESTMINSTER XWN 18835. LP. \$4.98.

Only the first of these works corresponds, in its text, to any commonly accepted description of an oratorio. The others, though they alternate between solos and choruses, lack the narrative and dramatic qualities characteristic of the genre. Musically, however, all three works are similar in style. The recitative is like that of some of the earliest operas: slow-moving in harmony and generally rather static. Perhaps seventeenth-century players provided more interesting accompaniments than our continuo players can. But in the concerted numbers and choruses the mu-

sic springs into life. Here Giacomo Carissimi displays power (as in the triple choruses of *The Last Judgment*), invention, and feeling, and makes it quite clear why he was regarded by his contemporaries as one of their greatest masters.

The soloists here do not transcend mere acceptability, but the chorus does well on the whole. Latin text and English translation are provided (the text given for *Militia* is incomplete). Some twenty-four measures are cut off from the end of *Judicium extremum*, and there is some distortion towards the end of *Militia*. N.B.

CHAVEZ: Sinfonia India; Sinfonia de Antigua; Sinfonia Romantica

Stadium Symphony Orchestra of New York, Carlos Chávez, cond.

• EVEREST LPBR 6029. LP. \$4.98.

• • EVEREST SDBR 3029. SD. \$5.98.

For review of this recording, see p. 78.

CHOPIN: Ballades: No. 1, in G minor, Op. 23; No. 2, in F, Op. 38; No. 3, in A flat, Op. 47; No. 4, in F minor, Op. 52; Andante Spianato and Grande Polonaise brillante, in E flat, Op. 22

Gary Graffman, piano.

• RCA VICTOR LM 2304. LP. \$4.98.

• • RCA VICTOR LSC 2304. SD. \$5.98.

Since Mr. Graffman is such a gifted, intelligent, and musically conscientious pianist, it becomes a regrettable task to put this recording down as largely a failure. (It does not help to point out that no one on LP discs has had equal success with all four Ballades.) He is at his best here when his outstanding virtuosity is brought into play, and there are stunning moments in the second and fourth Ballades. But the careful phrasing, clean texture, even the proper stressing of inner voices, suggest an efficiency at odds with the poetic nature of the music. Because it depends more than the others on a superior technique, the fourth Ballade comes off best. The Polonaise gets the finest performance of all, with a delightfully crisp rhythm and some lovely handling of the florid lines above it. The piano tone is a pure one, never hard but having a certain coldness. The monophonic release conveys this sound naturally, but the stereo version gives it an unwarranted penetrating quality. R.E.

DEBUSSY: Prélude à l'après-midi d'un faune; La Mer

† Ravel: *Daphnis et Chloë: Symphonie Suite No. 2*

Philadelphia Orchestra, Eugene Ormandy, cond.

• COLUMBIA ML 5397. LP. \$4.98.

• • COLUMBIA MS 6077. SD. \$5.98.

The Debussy *Prélude* and Ravel *Suite* are the latest remakes of two longtime Ormandy favorites (most recently coupled in a 1956 LP, ML 5112, with the Debussy *Nocturnes*), here played more

Continued on page 88

VIENNA PHILHARMONIC FESTIVAL, Herbert von Karajan conducting. A magnificent four-record commemorative album specially recorded by the celebrated orchestra and conductor to mark their triumphant 1959 world tour.
 Record I: Mozart *Symphony in g, K550*; Haydn *Symphony in D, No. 104*.
 Record II: Beethoven *Symphony No. 7*.
 Record III: Brahms *Symphony No. 1*.
 Record IV: The Vienna of Johann Strauss.

The gift-type album includes a 28-page book, gravure-printed in Italy, containing full-color plates of famous paintings, 70 photographs, the history of orchestra and conductor, and six delightful essays by Joseph Wechsberg.

The complete album is \$21.98 on regular LP, \$25.98 in Living Stereo. The four records are also sold individually: \$4.98 on regular LP, \$5.98 in Living Stereo. (Manufacturer's nationally advertised prices.)



RCA VICTOR presents its distinguished new SORIA SERIES  featuring definitive performances in De Luxe cloth-bound library editions, with special texts and Art Book illustrations.



sumptuously and recorded more thrillingly than ever before. *La Mer*, apparently an Ormandy discographic first, also reveals the Philadelphians and the Columbia engineers at the top of their form; pure and powerful in monophony, luminous and overwhelming in stereo. Yet, except perhaps in the sure-fire *Daphnis et Chloë* Suite (which lacks only the electrifying excitement unique to Koussevitzky), I'm sure that these performances can never fully satisfy listeners familiar with more idiomatic Gallic and authentically impressionistic interpretations. This species of concert hall realism captures everything except the music's essential magic, and in *La Mer* in particular Ormandy's vehemence rudely rips the seamless fabric into jagged tatters. But what glorious sound to intoxicate those who do not insist on stylistic sense as well!

R.D.D.

DONIZETTI: Lucia di Lammermoor

Maria Callas (s), Lucia; Margreta Elkins (ms), Alisa; Ferruccio Tagliavini (t), Edgardo; Lenard del Ferro (t), Arturo; Renzo Casellato (t), Normanno; Piero Cappuccelli (b), Lord Enrico; Bernard Ladysz (bs), Raimondo. Philharmonia Chorus and Orchestra, Tullio Serafin, cond.

- ANGEL 3601 B/L. Two LP. \$10.96.
- • ANGEL S 3601 B/L. Two SD. \$12.96.

For review of this album, see p. 77.

FRANCK: Symphony in D minor

New York Philharmonic, Leonard Bernstein, cond.

- COLUMBIA ML 5391. LP. \$4.98.
- • COLUMBIA MS 6072. SD. \$5.98.

Bernstein's treatment is not the traditional Franck Symphony reading, but at many points his interpretation contributes to what is a very alive and dramatic account of this noble work. The Philharmonic plays here in top form, and Columbia's reproduction, both in monophonic and nicely pinpointed stereo, is bright and clearly defined.

P.A.

FRANCK: Variations symphoniques—
See D'Indy: *Symphonie sur un chant montagnard français*, Op. 25.

GERSHWIN: An American in Paris; Rhapsody in Blue

Joyce Hatto, piano (in the Rhapsody); Hamburg Pro Musica, George Byrd, cond.

- FORUM F 70008. LP. \$1.98.

The young American conductor George Byrd has some very musicianly ideas about *An American in Paris*, which he puts across rather convincingly. There may be a few retards and alterations of phrases here and there, but the essential Americanism of the score remains intact. The same applies to Byrd's joint efforts with Joyce Hatto in the *Rhapsody in Blue*, though this work could profit by a little more jazzlike freedom. Forum's surfaces are beautifully silent, but its reproduction is not up to present high-

fidelity standards; many of the upper frequencies and all the heavier passages are marred by considerable distortion.

P.A.

GILBERT and SULLIVAN: H.M.S. Pinafore (or The Lass That Loved a Sailor)

Elsie Morison (s), Josephine; Marjorie Thomas (c), Hebe; Monica Sinclair (c), Little Buttercup; Richard Lewis (t), Ralph Rackstraw; George Baker (b), The Rt. Hon. Sir Joseph Porter, K. C. B.; John Cameron (b), Captain Corcoran; Owen Brannigan (bs), Dick Deadeye. Glyndebourne Festival Chorus, Peter Gellhorn, chorus master; Pro Arte Orchestra, Sir Malcolm Sargent, cond.

- • ANGEL 3589 B/L. Two SD. \$12.96.

After two well-sung, but otherwise undistinguished, performances of *The Mikado* and *The Gondoliers*, Angel's resident Gilbert and Sullivan Opera Company now come up with a zestful and stylish performance of Sullivan's breezy nautical opera, *H. M. S. Pinafore*. Where the earlier recordings tended to sound almost oratorical, this new venture really begins to sound like a D'Oyly Carte performance. Some of the credit, at least, must go to the appearance in this cast of that veteran singer George Baker. Though never a member of the D'Oyly Carte Company, Baker is an illustrious Savoyard, at least by association. His very phonic voice graced all the early recordings of the Savoy operas, issued by H. M. V., from the 1917 version of *The Mikado* on. It could well be that he has transmitted to the present group some of his own considerable knowledge of how these operas are most effectively performed. Certainly his own performance here, in the role of Sir Joseph Porter, is outstanding—full of wry humor, crisp and biting, with an undercurrent of kindness always evident. And for a man of seventy-four, it is remarkably well sung.

But the singing throughout this per-



Sargent conducts a buoyant Pinafore.

formance is pure joy, so much so that it seems invidious to single out any particular member of the cast. Yet the Ralph Rackstraw of Richard Lewis and the Josephine of Elsie Morison are both so good that they deserve special commendation. Monica Sinclair's voice sounds a trifle young and light for Little Buttercup, and I confess I found her "I'm Called Little Buttercup" rather dull;

but as the opera progresses there is noticeable improvement, and in the end she won me over. Sargent leads a very buoyant performance, and one played with considerable grace by the Pro Arte Orchestra. And although the warm and brilliantly dispersed stereo sound fails to suggest much illusion of stage movement, I didn't find that lack much of a drawback.

J.F.I.

HAYDN: Concerto for Cello and Orchestra, in D, Op. 101—See Boccherini: Concerto for Cello and Orchestra, in B flat.

HAYDN: Concerto for Trumpet and Orchestra, in E flat

†Mozart: *Concerto for Flute and Orchestra, No. 2, in D, K. 314*

†Schumann: *Adagio and Allegro for Horn, in A flat, Op. 70* (orch. Ansermet)

Paolo Longinotti, trumpet; André Pepin, flute; Edmond Leloir, horn; Orchestre de la Suisse Romande, Ernest Ansermet, cond.

- • LONDON CS 6091. SD. \$4.98.

The idea of coupling three concertos for instruments that are rarely heard in these roles proves to be an attractive one, making a delightfully unbackneyed addition to the stereo catalogue.

The best-known score of the three is probably the Haydn, written for the classical E flat trumpet's home key, and sounding here very much as if it were being played on that instrument rather than the familiar B flat trumpet of today. The performance is one of burnished elegance, providing fine contrast to the distinctive romantic flavor of the lovely—and too nearly unknown—Schumann, which Ansermet has orchestrated with a real flair for the style. The Mozart is up against heavier competition, but this remains an appealing performance.

The soloists, whom I take to be principals from the orchestra, and the conductor seem in every case to collaborate on the best of terms, and the engineering is first-class.

R.C.M.

HAYDN: The Seasons

Elsie Morison, soprano; Alexander Young, tenor; Michael Langdon, bass; Beecham Choral Society; Royal Philharmonic Orchestra, Sir Thomas Beecham, cond.

- • CAPITOL SGCR 7184. Three SD. \$17.94.

For review of this album, see p. 79.

D'INDY: Symphonie sur un chant montagnard français, Op. 25

†Franck: *Variations symphoniques*

Robert Casadesus, piano; Philadelphia Orchestra, Eugene Ormandy, cond.

- COLUMBIA ML 5388. LP. \$4.98.
- • COLUMBIA MS 6070. SD. \$5.98.

Precipitous in the interpretation of this literature, Robert Casadesus does not disappoint here. Between his limpid, aristo-

Continued on page 91

The surest sign
of the
finest sound

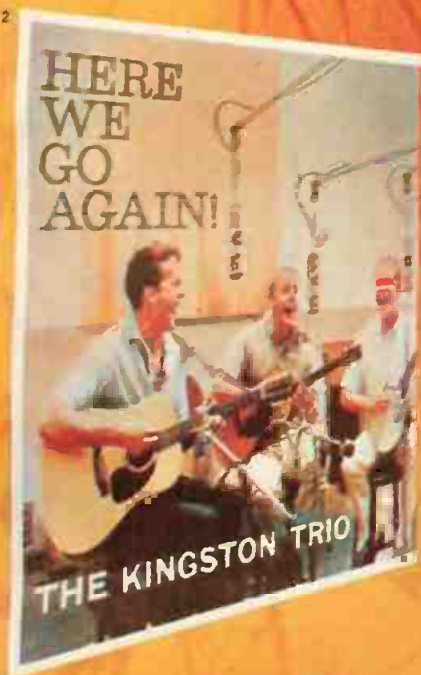
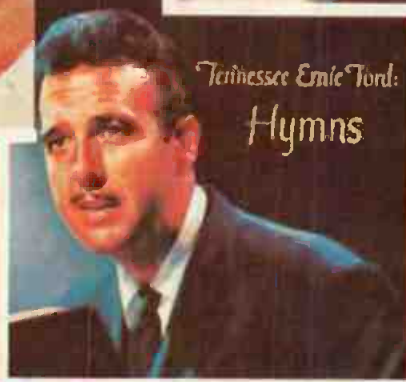
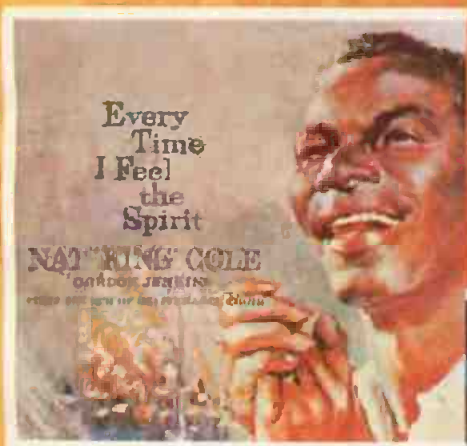

BEST SELLERS? BIGGEST STARS? THIS MUST BE THE PLACE!

1 **KAY STARR** The brightest Starr of all shines again for Capitol in a blazing new album of standards styled to her driving style. *Night Train, Indiana, Lazy River* and nine more. ST 1254

4 **NAT 'KING' COLE** Glorious, moving music as Nat joins Chicago's First Church of Deliverance Choir in *Nobody Knows the Trouble I've Seen, Go Down, Moses*, other stirring spirituals. ST 1249

2 **KINGSTON TRIO** *Tom Dooley* sold a million. They made *Life's* cover. Their sparkling albums of ballads lead all sales in the nation. They love to sing, and **HERE THEY GO AGAIN!** ST 1258

5 **TENNESSEE ERNIE FORD** Ernie Ford's warm and deeply honest singing of beloved hymns like *Rock of Ages, In the Garden and The Old Rugged Cross* in an all-time favorite best-seller. ST 756

3 **FRANK SINATRA** Revealing... affecting... masterful. *A Cottage for Sale, I'll Never Smile Again, Ghost of a Chance, I Can't Get Started, Stormy Weather* and six more sad ones. SW 1221

6 **GEORGE SHEARING** A brilliant live concert recording. Quintet favorites like *East of the Sun and Roses of Picardy*; new arrangements like *Caravan* and *On the Street Where You Live*. ST 1187

Stereo album numbers are shown; for monophonic versions, omit S. **FREE:** Latest catalog, "Capitol's 400." See next page.

TAKE ME TO YOUR DEALER. Use this checklist as a shopping guide.



The surest sign
of the
finest sound

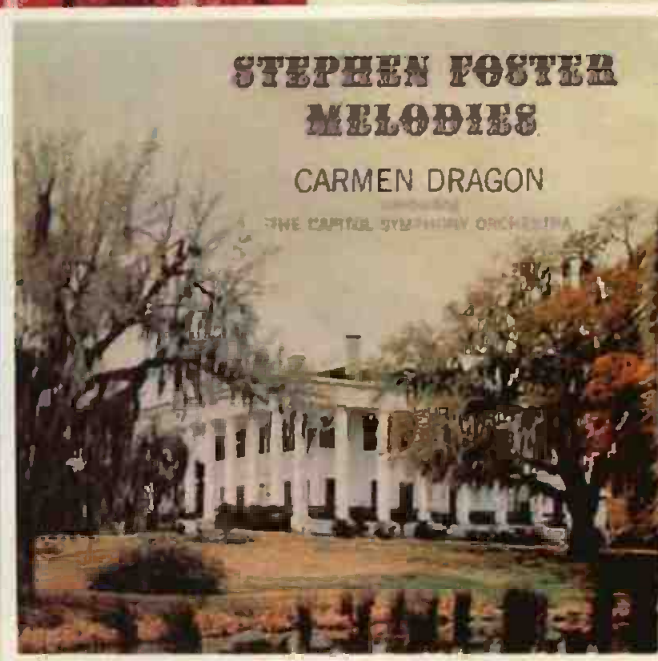
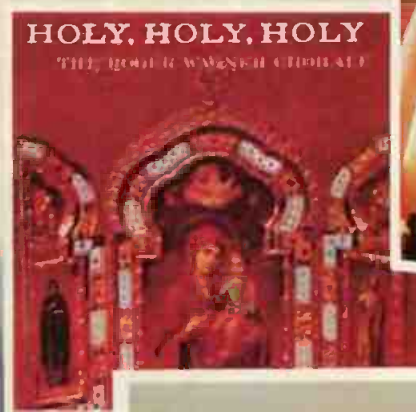
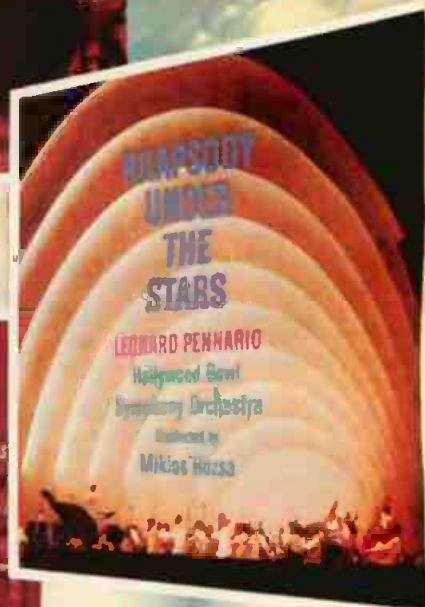
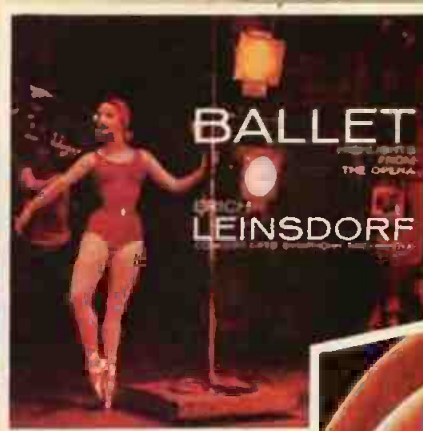

Collections to enrich your collection

□ 1 CARMEN DRAGON

Keeping traditional flavor, adding imaginative new instrumentation, this eminent arranger-conductor reveals fresh charm in nine best-loved Foster songs. SP 8501

□ 3 WHITTEMORE & LOWE

Colorful Spain from inside (de Falla, Albéniz, Granados) and out (Ravel, Lecuona, Kreisler). A stimulating program, superbly played by top-ranking duo-pianists. SP 8500

□ 5. ROGER WAGNER CHORALE

Songs of Christian faith from many backgrounds, including the grandeur of Bach's *Passion of St. John* and the simplicity of two beloved Negro spirituals. SP 8498

□ 2 NATHAN MILSTEIN

Crowning achievement (to date) of a distinguished career. Beethoven "*Spring*" Sonata, Tchaikovsky concerto (Steinberg conducting), 5 short works. Two records. SPBR 8502

□ 4 PENNARIO/HOLLYWOOD BOWL

Rachmaninoff, Liszt, Beethoven, and Mozart favorites; *Dream of Olwen*; *Rustle of Spring*; and Rozsa's *Spellbound Concerto*, dedicated to the brilliant young Pennario. SP 8494

□ 6 ERICH LEINSDORF

Six engaging scenes, from the tuneful *Dance of the Hours (La Gioconda)* to the wild and exotic *Bacchanale (Samson and Delilah)* and *Venusberg Music (Tannhäuser)*. SP 8488

FREE: "CAPITOL'S 400," 48-page brilliant color catalog of newest and greatest Capitol albums: classics and pops, stereo and monophonic. Write: Dept. A2, Capitol Tower, Hollywood 28, Calif.



Stereo album numbers are shown. For monophonic versions, omit S.

cratic fingerwork and the gorgeous sound of the Philadelphia Orchestra, both works are as well performed as they are likely to be on records. With a style characterized by a certain detachment, this pianist also invests his playing with a vigor and momentum that keeps the music from lapsing into cloying sentiment. The D'Indy symphony is particularly rewarding for two reasons: the piano is properly placed among the orchestral forces, not obtruding like a solo instrument but precisely blended in the tonal fabric as a supplemental color; and Ormandy is at his best in giving a highly nuanced, glowingly colored reading of the score. Both monophonic and stereo releases are praiseworthy, but the concert-hall, three-dimensional sound Columbia now gives its stereo discs makes the latter version outstanding. R.E.

LASSUS: Sacred and Secular Works

Dessoff Choirs, Paul Boepple, cond.
 • FANTASY 5006. LP. \$4.98.
 • • FANTASY 8015. SD. \$5.98.

Mr. Boepple has brought together here a magnificent program, which shows Lassus' mastery in various styles of Renaissance composition—the Latin motet, the German Lied, sacred and secular, the French chanson, and the Italian madrigal. Here are the powerful *Timor et tremor* and the grand *De profundis*—the sixth of the seven great *Penitential Psalms*; here the lovely *Bon jour mon coeur*, the exquisite *La Nuit froide et sombre*, with its sad first strophe and lively second. But there is no space to itemize; each of the sixteen pieces on the disc displays in worthy fashion some aspect of Lassus' protean genius.

The Dessoff Choirs seem rather large for this type of music, and the sound—particularly of the sopranos—is not as round or as warm as in some other choruses, but the balances are good and the singers' enthusiasm infectious. Sung by many voices, the secular pieces lose their intimacy and become rather impersonal. This danger was foreseen by Mr. Boepple, who writes disarmingly that he could not resist including such pieces "because we felt we could communicate our strong feeling for their beauty to our audience." On the first side of the stereo version there is some distortion; it is not present on the other side or in any part of the monophonic recording. N.B.

LECOCQ: La Fille de Mme. Angot (arr. Jacob)—See Walton: *Façade: Orchestral Suites*.

LISZT: Concertos for Piano and Orchestra: No. 1, in E flat; No. 2, in A

Philippe Entremont, piano; Philadelphia Orchestra, Eugene Ormandy, cond.
 • COLUMBIA ML 5389. LP. \$4.98.
 • • COLUMBIA MS 6071. SD. \$5.98.

Mr. Entremont has a brilliant, lithe style that gives a lot of dash and sparkle to these two war horses. Not that he cannot turn a pretty melody with loving care, but he seems happiest when he can un-

leash his swiftly flying fingers in glittering passagework. The contribution of Ormandy and his Philadelphians is so good as almost to dominate the proceedings; I do not know any other orchestral accompaniments in these concertos that have so much verve and flair, and the engineering is faultless, in respective ways, in both versions. Taking everything into consideration, this is the best available pressing of this concerto coupling. R.E.

LISZT: Etudes d'exécution transcendante: No. 5, Feux follets; No. 11, Harmonies du Soir. Valses oubliées: No. 1, in F sharp; No. 2, in A flat
 †Schubert: *Moments musicaux, Op. 94: No. 1, in C. Impromptus, Op. 90: No. 2, in E flat; No. 4, in A flat*

Sviatoslav Richter, piano.
 • COLUMBIA ML 5396. LP. \$4.98.

The stylistic gap between Schubert and Liszt is wide, so that it is astonishing when a pianist plays both as well as Richter does here. There are superior Schubert interpreters, it is true, but none plays Liszt this well.

The hauntingly beautiful tone, the singing melodies, the chords melting almost imperceptibly into each other, the uninterrupted single rise and fall of sound that characterize *Harmonies du Soir* make this a truly memorable performance. *Feux follets* is a miracle of gossamer tracery and deftness, so controlled that the pace can be slackened effortlessly for a tiny rubato. The two *Valses oubliées*, among Liszt's most at-



Richter: "None plays Liszt this well."

tractive works, are played with great refinement, emphasizing most discerningly the nostalgic element.

In playing Schubert, Richter avoids subtleties and depth probings; he states the music plainly, with simplicity and again with delicacy and refinement. For the *Moment musical* and the *Impromptu No. 4* he works precisely within a small dynamic range. Only in the *Impromptu No. 2* does he let loose on a scale too big for the music.

This recording was made during a re-

recital in Sofia, Bulgaria, on February 25, 1958, and it has the expected virtues and faults. The former include the unique tension in a public performance where an artist of this stature is concerned; the faults comprise the uneven balance of tone, considerable audience coughing and rustling, a piano tone that grows tinny when it gets loud, and some surface noise. But the Soviet artist's playing can always be heard clearly, and that is all that matters. R.E.

MASSENET: Manon (excerpts)

Je suis encore tout étourdie; Voyons, Manon, plus de chimères; Duo de la lettre; Adieu, notre petite table; Le rêve; Suis-je gentille ainsi?; Obéissons quand leur voix appelle; Duo de Saint-Sulpice; A nous les amours et les roses.

Ninon Vallin, soprano; Miguel Villabella, tenor; Orchestra.
 • PATHE PCX 5002. LP. \$5.95.

Those who do not care to buy the only complete *Manon* now on the market (with Monteux and De los Angeles), or who wish to supplement that version with some characteristic excerpts, will do well to investigate this collection, rendered by an exemplary *Manon* and a worthy Des Grieux. Vallin has a few bad moments (in coloratura and staccato work), but by and large she sings with appealing tone and unusual comprehension of the character; "*Voyons, Manon*" and "*Adieu, notre petite table*" are particularly outstanding. Miguel Villabella's contributions are excellent, and it's too bad that "*Fuyez, douce image*" and the final duet could not have been included. The orchestral sound is faded, and there are one or two frightful, if momentary, slips in speed in the transfers. C.L.O.

MOZART: Concerto for Flute and Orchestra, No. 2, in D, K. 314—See Haydn: Concerto for Trumpet and Orchestra, in E flat.

MUSSORGSKY: Pictures from an Exhibition
 †Rimsky-Korsakov: *Capriccio espagnol, Op. 34*

New York Philharmonic, Leonard Bernstein, cond.
 • COLUMBIA ML 5401. LP. \$4.98.
 • • COLUMBIA MS 6080. SD. \$5.98.

While Bernstein misses no opportunities to make the Mussorgsky-Ravel *Pictures* as vivid as possible, his reading is most notable for the cohesion he gives to a many-segmented work and the supple beauty he brings to the phrasing, particularly where the melodies are extended. He cannot be outdone here, but where the *Capriccio espagnol* is concerned, he has a master in Kiril Kondrashin, whose recent recording for Victor has more flamboyance without losing shape.

Columbia's stereo sound for both works is not as hair-raisingly larger than life as Victor's is for the Reiner version of *Pictures* and for the above-mentioned Kondrashin recording, but it is still superbly clear and considerably more nat-

ural. The orchestra seems more of a totality, as it is in a concert hall, with the instrumental sounds decently spaced rather than strikingly separated. Still, when Mr. Bernstein got to the *Great Gate of Kiev* it would have been nice if Columbia had let go with the decibels for a more rousing climax, after the Victor fashion. Columbia's excellent monophonic disc unfortunately sounds tame after the stereo version. R.E.

RACHMANINOFF: *Concerto for Piano and Orchestra, No. 2, in C minor, Op. 18*

†Tchaikovsky: *Concerto for Piano and Orchestra, No. 1, in B flat minor, Op. 23*

Felicja Blumental, piano; Orchestra of the Musikgesellschaft of Vienna, Michael Gielen, cond.

• Vox PL 11500. LP. \$1.98.
• • Vox STPL 511500. Two SD. \$2.98 each.

Felicja Blumental here gives a passionate headlong performance that is not unattractive, but the playing otherwise is no more than competent. In the monophonic edition, the piano has a highly resonant sound characteristic of Vox, but the orchestra sounds beautifully transparent and homogenous. Over an hour's playing time is available on this disc at an extremely low price. A casual listener could do a lot worse for more money.

In the stereo version, which gives an entire disc to each concerto, the piano sound comes from the far right at concert stage distance. The orchestra is spaced out to the extreme and seemingly at a lesser distance from the auditor, so that one is startled by woodwinds barking right beside one while the piano echoes resoundingly far off. If the orchestral sound ever jelled, the stereo effect would be remarkable—but it never does. R.E.

RAVEL: *Daphnis et Chloë: Symphonic Suite No. 2*—See Debussy: *Prélude à l'après-midi d'un faune; La Mer*.

RIMSKY-KORSAKOV: *Capriccio espagnol, Op. 34*—See Mussorgsky: *Pictures from an Exhibition*.

SCHUBERT: *Moments musicaux, Op. 94: No. 1, in C. Impromptus, Op. 90:*



Monteux makes Sibelius debut on discs,

No. 2, in E flat; No. 4, in A flat—See Liszt: *Etudes d'exécution transcendante*.

SCHUBERT: *Symphony No. 8, in B minor ("Unfinished")*—See Beethoven: *Symphony No. 8, in F, Op. 93*.

SCHUBERT: *Symphony No. 9, in C*

Boston Symphony Orchestra, Charles Munch, cond.

• RCA Victor LM 2344. LP. \$4.98.
• • RCA Victor LSC 2344. SD. \$5.98.

There are times, particularly in the opening and closing movements of this symphony, when Munch treats Schubert with the fire and brimstone that should be reserved for Tchaikovsky, and his reading in general is almost completely devoid of lyricism. Still and all, this music does call for a certain amount of forcefulness in its presentation, and the Bostonians play with lots of bite and spirit. All this has been stunningly reproduced in truly top-quality monophonic and stereo versions, the latter being among the most realistic orchestral recordings to come from RCA Victor thus far. P.A.

SCHUMANN: *Adagio and Allegro for Horn, in A flat, Op. 70 (orch. Ansermet)*—See Haydn: *Concerto for Trumpet and Orchestra, in E flat*.

SCHUMANN: *Carnaval, Op. 9; Concerto for Piano and Orchestra, in A minor, Op. 54*

Sergio Fiorentino, piano; Hamburg Pro Musica, Erich Riede, cond. (in the Concerto).

• Forum F 70007. LP. \$1.98.

Sergio Fiorentino is a highly interesting newcomer to American records, who would make more of an impression if he were not represented by two works already recorded many times—and more beautifully. His tone is a little hard, his style occasionally brittle, but he has his own intelligent ideas about using rhythm, accent, and phrasing to point up the musical characterizations in the *Carnaval*. His playing is less individual in the Concerto, but it still maintains a personal sensitivity, and the tone, cushioned by the orchestra, sounds more mellow. The orchestra, able enough, sometimes makes inelegant sounds and the instruments are not in tune all of the time. The engineering is satisfactory. R.E.

SIBELIUS: *Symphony No. 2, in D, Op. 43*

London Symphony Orchestra, Pierre Monteux, cond.

• RCA Victor LM 2342. LP. \$4.98.
• • RCA Victor LSC 2342. SD. \$5.98.

As far as I can ascertain, this is the very first Sibelius recording ever made by Pierre Monteux. Eighty-four may be a trifle late in life for most conductors to attack the Finnish master's music for the first time, but not for the perennially

young Frenchman. Though this may be his Sibelius debut on discs, he must surely have presented some Sibelius music in the concert hall. His account of this dramatic and often majestic score is meaty and most satisfying. If you like your Sibelius broad and spacious, warm and songful, Monteux is your man. He has the London Symphony performing at its very best, too. Furthermore, the engineers have turned in a top-flight job in both versions; in stereo, the reproduction has depth, direction, and transparency. P.A.

TCHAIKOVSKY: *Concerto for Piano and Orchestra, No. 1, in B flat minor, Op. 23*

Eugene Istomin, piano; Philadelphia Orchestra, Eugene Ormandy, cond.

• Columbia ML 5399. LP. \$4.98.
• • Columbia MS 6079. SD. \$5.98.

Temperamentally, Istomin is not the ideal interpreter for this concerto, but he is such a fine pianist that it is fascinating to see what he does with it. In the first movement his big, solid tone, his deliberate, thoughtful manner, and the placement of the piano well to the fore in this recording create a massive effect. The slow movement begins neither *andantino* nor *semplice*, as marked, but for most of the way the exactitude of Istomin's treatment of the double notes, the staccatos, the off-beat chords is refreshing. So is the unforced swiftness of the scherzo section, with a delicious waltz rhythm in the middle. Musical precision is also the hallmark of the last movement, where so many pianists scramble notes for the sake of speed and effect. Brio, momentum, and dynamic contrast in greater quantities are needed to make this performance equal to the best, but a reading of this integrity is welcome among the surfeit of superficial ones. Conductor, orchestra, and engineers cannot be faulted in any way for their part in the production. R.E.

TCHAIKOVSKY: *Concerto for Piano and Orchestra, No. 1, in B flat minor, Op. 23*—See Rachmaninoff: *Concerto for Piano and Orchestra, No. 2, in C minor, Op. 18*.

TELEMANN: *Concertos: for Four Violins, in D; for Flute, Oboe d'Amore, Viola d'Amore, and Strings, in E; for Three Oboes, Three Violins, and Continuo, in B flat; for Recorder, Flute, and Strings, in E minor*

Soloists; Kammermusikreis Emil Seiler.
• Archive ARC 3109. LP. \$5.98.

TELEMANN: *Concertos: for Trumpet and Strings, in D; for Trumpet, Two Oboes, and Continuo, in D. Quartets: for Flute, Oboe, Violin, and Continuo, in G; for Recorder, Oboe, Violin, and Continuo, in G*

Adolf Scherbaum, trumpet; Heinz Nordbruch, Heinz Schwesinger, oboes; Bach-Orchester Hamburg, Robert Stehli, cond.

Continued on page 94

**ONLY ON
KAPP
RECORDS**

ROGER WILLIAMS

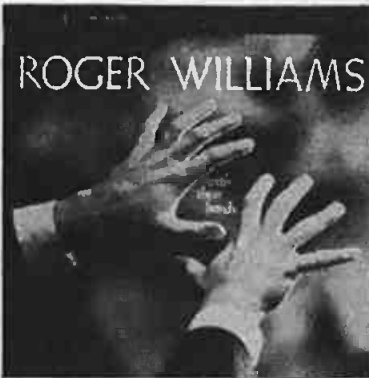

WITH THESE HANDS—Roger Williams • With These Hands • Two Different Worlds • Gigi • Greensleeves • The Very Thought of You • Bess You Is My Woman • Forgotten Dreams • Oh, My Beloved Daddy • and others.
Regular KL-1147
Stereo KS-3030

KAPP STEREPHONIC SOUND

JANE IN SPAIN



JANE IN SPAIN—Jane Morgan • The Moon Was Yellow • Adios • Perhaps, Perhaps, Perhaps • Perfidia • You Belong To My Heart • Baia • Granada • I Got Ideas • Be Mine Tonight • What A Difference A Day Made • Let Me Love You To-Night • Magic Is The Moonlight.
Regular KL-1129
Stereo KS-3014

**F
R
E
D
A
S
T
A
I
R
E**

**F
R
O
G
G
E
R
W
I
L
L
I
A
M
S**

**E
A
R
T
H
A
K
I
T
T**

**J
A
N
E
M
O
R
G
A
N**

NOW



NOW FRED ASTAIRE • Change Partners • Isn't This A Lovely Day • A Foggy Day • I Love To Quarrel With You • They Can't Take That Away From Me • They All Laughed • I'll Walk Alone • One For My Baby • Oh, Lady Be Good • Puttin' On The Ritz • Top Hat • Lady Of The Evening • Something's Gotta Give • and others.
Regular KL-1165
Stereo KS-3049

The Fabulous Eartha Kitt



THE FABULOUS EARTHA KITT • Mack The Knife • Shango • Tierra Va Tembla • Sholem • Yellow Bird • Love Is A Gamble • Jambo Hippopotami • Kl-Mizion • Lamplight • I'd Rather Be Burned As A Witch • In The Evening (When The Sun Goes Down) • Independent.
Regular KL-1162
Stereo KS-3046



FREE: Send for latest catalog

**KAPP
RECORDS**

136 East 57th St., New York 22, N. Y.

VIOLIN . . . Treble instrument of viol class. Fundamental frequency: 200 to 9,000 cps. Overtones extend to 16,000 cps.



HOW often have you wanted to study and fully enjoy the realism of a favorite violin passage and found it dulled by recording technique, a worn record, room acoustics or perhaps, the characteristics of your own equipment? In such instances, what a blessing a Blonder-Tongue Audio Baton, for, just by a turn of a few selected knobs you control the fundamentals and overtones of the violin, and the instrument suddenly emerges in all its original beauty.

The Audio Baton does this by dividing the audible spectrum into 9 separately controllable octaves. Each octave can be independently boosted or attenuated as much as 14 db. By boosting the overtone frequencies of a specific instrument you can enhance its character and timbre. By boosting its fundamentals as well, you can bring the instrument forward in relation to the rest of the orchestra or ensemble. To make even the finest high fidelity system sound better add an Audio Baton. In modern enclosure \$119.95 at high fidelity dealers, or write for details: Blonder-Tongue Laboratories, Inc., 9 Alling Street, Newark 2, New Jersey.

Dept. HF-11

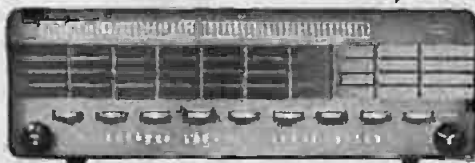

fingertip control of the full orchestral range... octave by octave... new Blonder-Tongue audio baton

(in the concertos). Camerata Instrumentale Hamburg (in the quartets).
• ARCHIVE ARC 3119. LP. \$5.98.

Georg Philipp Telemann, who was born four years before Bach and outlived him by seventeen, turned out a vast amount of music, including, it is said, some three thousand cantatas. Only a tiny proportion of it ever achieved publication, but the list of Telemann works on records is growing nicely. The eight compositions in the present group reveal some characteristic traits—a lightness of touch that aligns him with the more progressive spirits of his time, a delight in all sorts of instrumental combinations, a mastery of counterpoint when he feels like featuring that technique, and a fondness for the rhythms and accents of peasant dances.

The E minor Concerto is an especially attractive work, with a deeper undercurrent of feeling than the others. Its opening Largo has some harmonic progressions of an almost Bachian intensity; it is followed by a gay Allegro of transparent contrapuntal texture, another Largo, which begins like Handel's "Where'er you walk" and continues in that lyric vein, and a final Presto whose drone-bass passages evoke a country festival. Most of the other works have their special points of interest, like the highly spiced Polish dance rhythms in the finale of the E major Concerto, or the brilliant writing, especially for the oboe, in the Flute Quartet; only the trumpet concertos seem routine. Performance and recording are first-class. N.B.

VERDI: *Macbeth*

Leonie Rysanek (s), Lady Macbeth; Emilia Cundari (s), A Bloody Child; Mildred Allen (s), A Crowned Child; Carlotta Ordassy (s), Lady-in-Attendance; Carlo Bergonzi (t), Macduff; William Olvis (t), Malcolm; Leonard Warren (b), Macbeth; Calvin Marsh (b), A Warrior; Osie Hawkins (b), A Murderer; Jerome Hines (bs), Banquo; Gerhard Pechner (bs), A Physician; Harold Sternberg (bs), A Manservant. Metropolitan Chorus and Orchestra, Erich Leinsdorf, cond.

• • RCA Victor LSC 6147. Three SD. \$17.94.

For review of this album, see p. 81.

VIVALDI: *Concertos*

Concertos: in G, for Strings and Continuo, P. 143; in B flat, for Violin, Cello, Strings, and Continuo, P. 388; in C minor for Strings and Continuo, P. 427; in C minor, for Cello, Strings, and Continuo, P. 434; in A minor, for Two Violins, Strings, and Continuo, Op. 3, No. 8.

I Musici.

• Epic LC 3565. LP. \$4.98.

The only work new to microgroove on this disc is P. 427. It is a fine orchestral concerto: the first movement has a singing pathos and a delicate ending; the Largo is based on the same thematic material; and the finale is a fugue, not

as common a type of writing in Vivaldi's works as might be supposed. This and the other concertos are all performed with the Musici's customary vivacity, and the sound is first-rate. Also customary with this group is the timidity of the harpsichord, which often cannot be heard at all here. N.B.

WAGNER: *Parsifal: Good Friday Spell; Symphonic Synthesis of Act III* (arr. Stokowski)

Houston Symphony Orchestra, Leopold Stokowski, cond.

• EVEREST LPBR 6031. LP. \$4.98.
• • EVEREST SDBR 3031. SD. \$5.98.

In his sensuous unfolding of the music from this "consecrational festival stage drama," as Wagner called it, Stokowski leans toward the profane rather than the sacred. As he revels in the sounds, he often draws out phrases to inordinate lengths; but if your taste is for warm, sonorous Wagner, these rich-toned performances may please you. The only thing unlikely to please is the sound of the electronic chimes; their artificiality spoils the entire grand effect in the transformation music of the synthesis (in his earlier recording, made many years ago for RCA Victor, Stokowski used standard tubular chimes). This synthesis, by the way, is compounded of important passages from the end of the first scene of Act III, the transformation music to the second scene, and excerpts from the final moments of the music-drama.

Aside from a small amount of distortion in heavy climaxes, the monophonic recording is very good, but stereo is better able to transmit the big sonorities called for by the conductor. The advantages of the two-channel medium are emphasized at the very outset of the synthesis by the entrance of the brasses, which seem to emanate from the rear of the stage. And if Stokowski had only used real chimes, they, too, could have provided some big sonic moments. P.A.

WALTON: *Façade: Orchestral Suites* (Lecocq: *La Fille de Mme. Angot* (arr. Jacob)

Royal Opera House Orchestra, Covent Garden, Anatole Fistoulari, cond.

• RCA VICTOR LM 2285. LP. \$4.98.
• • RCA VICTOR LSC 2285. SD. \$5.98.

In its original version, a set of poems by Edith Sitwell recited to the accompaniment of music for a handful of instruments, *Façade* is a major achievement and one of the key works in modern British music. (London and Columbia both have editions in the catalogue.) Walton later made a transcription of some of the *Façade* pieces for symphony orchestra; that version, also available in several recordings, is amusing but far less good. Finally, Frederick Ashton selected some of the pieces, in their symphonic dress, to provide the score for a ballet. It is this which is recorded here. There are ten pieces all told, arranged in

Continued on page 96

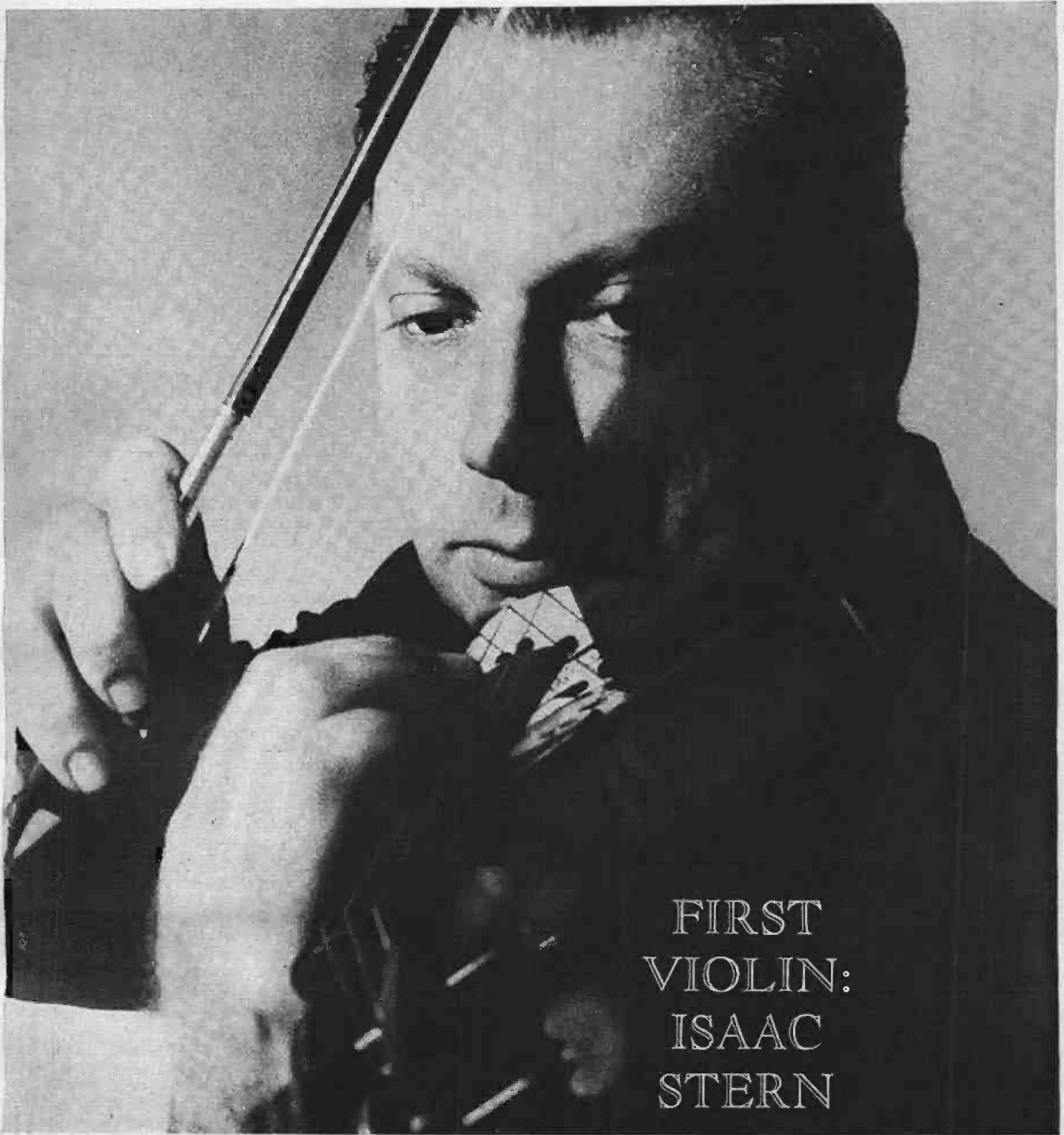

FIRST
VIOLIN:
ISAAC
STERN

THE ONLY MAJOR VIOLINIST ENTIRELY TRAINED IN THIS COUNTRY, ISAAC STERN HAS FEW PEERS AMONG MUSIC MAKERS, VIOLINISTS OR OTHERWISE. HE HAS BEEN APPLAUDED ON FIVE CONTINENTS FOR HIS BIG SUMPTUOUS TONE, HIS FIERY TECHNIQUE, HIS COMPLETE GRASP OF THE ENTIRE VIOLIN REPERTOIRE—BAROQUE, CLASSICAL, ROMANTIC AND MODERN. HE HAS CHOSEN TO RECORD HIS ART EXCLUSIVELY FOR COLUMBIA RECORDS.

A SELECTED ISAAC STERN DISCOGRAPHY

TCHAIKOVSKY: Concerto in D Major for Violin and Orchestra, Op. 35 • **MENDELSSOHN:** Concerto in E Minor for Violin and Orchestra, Op. 64—with the Philadelphia Orchestra, Eugene Ormandy, conductor. ML 5397 MS 6062*

BARTÓK: Concerto for Violin—with Leonard Bernstein conducting the New York Philharmonic. ML 5283 MS 6002*

*Stereo

MOZART: Concerto No. 3 in G Major for Violin and Orchestra, K. 216 • **HAYDN:** Concerto No. 1 in C Major for Violin and String Orchestra—with the Columbia String Orchestra, Alexander Zakin, cembalist. ML 5248

PROKOFIEV: Violin Concertos Nos. 1 in D Major and 2 in G Minor—with the New York Philharmonic,

Dimitri Mitropoulos and Leonard Bernstein, conductors. ML 5243

SAINT-SAËNS: Introduction and Rondo Capriccioso • **RAVEL:** Tzigane • **WIENIAWSKI:** Concerto No. 2 in D Minor for Violin and Orchestra—with the Philadelphia Orchestra, Eugene Ormandy, conductor. ML 5208

COLUMBIA  **MASTERWORKS**

© Columbia "Masterworks" ® & ™ Marks Reg. A division of Columbia Broadcasting System, Inc.



luxurious
additions
to your
record
library...

... AT RCA CAMDEN'S LOW, LOW PRICES!

REGULAR L. P., ONLY \$1.98 EACH... LIVING STEREO, \$2.98 EACH

PORGY AND BESS — Songs from Gershwin's celebrated folk opera, featuring two outstanding soloists, Lawrence Tibbett and Helen Jepson. CAL-500

ARTIE SHAW SWINGS SHOW TUNES — *Zigeuner, Bill, Can't Help Lovin' Dat Man, They Didn't Believe Me, Yesterdays* and other show stoppers. CAL-515

THE ART OF GRACE MOORE — Favorite operatic arias, concert pieces and show songs, performed by the late beloved American soprano. CAL-519

TCHAIKOVSKY: SYMPHONY NO. 6 ("Pathétique") — Superb performance of a Russian masterpiece of tragic beauty. Brilliant sound! Also in *Living Stereo*. CAL/CAS-503

EZIO PINZA SINGS ITALIAN SONGS — One of the truly accomplished bassos, in concert selections from his homeland. Music of Scarlatti, Monteverdi, others. CAL-539

SELECTIONS FROM "GYPSY" & "FLOWER DRUM SONG"—Florence Henderson, bright new Broadway talent, in songs from two big musicals. Also in *Living Stereo*. CAL/CAS-560



Manufacturer's Nationally Advertised Prices Shown—Optional With Dealer

sequence for balletic purposes—which is not necessarily the best for musical purposes, and they are played as ballet music, which is to say with swoopier upbeats and heavier downbeats than are absolutely necessary. The recording is nice and the whole thing passes, but is not very important.

Mamzelle Angot, the ballet suite arranged by Gordon Jacob from the score of Charles Lecocq's comic opera, is a masterly example of nineteenth-century French light music—fluffy, chic, tuneful, cynical, bright, ending with a vertiginous caucan. Its performance and recording here are as perfect as the delicious score itself. A.F.

RECITALS AND MISCELLANY

AMBROSIAN CHANTS

Choir of the Polifonica Ambrosiana, Mons. Giuseppe Biella, cond.

• Vox DL 343: Three LP. \$25.

In the early centuries of Western Christendom local churches often established their own rites, including collections of liturgical music. Of these only the Ambrosian music of the Church of Milan has held its own against the Gregorian music that Rome decreed should be universally used. Fragments of other collections exist, while the known music of the Mozarabic rites in Spain indicates a third "musical dialect" together with those of Rome and Milan.

By its name, Ambrosian music honors the great Church Father who was Bishop of Milan from 374 till his death in 397. Among other things, St. Ambrose introduced into liturgical music of the Western Church the use of hymnody and antiphonal psalmody in public worship. These involve extended singing by the congregation, and, so it is said, the momentous innovations came as a result of his seeking ways to interest attendant crowds when he was in a state of siege in a basilica in 386.

Ambrosian and Gregorian styles interacted, apparently, in succeeding centuries, and they are basically similar. Certainly, the nonspecialist will find little that is unique in listening to these records. Students of plain song, however, will find fascinating the freer Ambrosian use of modes, cadences, melismas, intervallic leaps. This freedom has given Ambrosian chant a lower status than the more stylistically contained Gregorian music, in the view of many musicians. In any case, there are many brief touches that stand out in the excerpts on these records—the curving descent of an Amen, the "gentle" preparation of a chant ending as the final note is approached deviously in a winding phrase, the Oriental effect—eloquent and mesmeric—of elaborately filigreed Alleluias.

The sampling of the chants in this set is comprehensive, the performance by a choir of men and women wholly satis-

Continued on page 98

HIGH FIDELITY MAGAZINE



HONOR THY NEIGHBOR

If the sound of your hi-fi or stereo rig infiltrates his (or her) apartment, make certain it's from a Vanguard record. If a gift is in prospect, "do unto others," give the finest in recordings for the connoisseur the record industry can offer, a Vanguard or Bach Guild disc. Featured are artists who, whether celebrities to the multitude or specialists for the cognoscenti, are chosen masters of their select repertory. For the music lover interested in the Elizabethan or the space ship age, the enchantment of the past or the lusty voice of the present, the fascinating discovery or the fresh view of the familiar, Vanguard-Bach Guild finds the right artist to bring his favorite music to life. And each disc, from the first to the last production step, is a labor of love.



MISCHA ELMAN

with Vienna State Opera Orch., Golschmann cond. KHACHATURIAN: VIOLIN CONCERTO. SAINT-SAENS: INTRODUCTION AND RONDO CAPRICIOSO. VRS-1049 (Stereolab VSD-2037)
MENDELSSOHN: VIOLIN CONCERTO. LALO: SYMPHONIE ESPAGNOLE. VRS-1050 (Stereolab VSD-2047)

MOGENS WOLDIKE

conducting. BACH: THE ST. MATTHEW PASSION — Stich-Randall, Rossi-Majdan, Braun, Kmentt, Berry, Ebrelius, Choirs, Orchestra. 4-12" boxed, with illustrated booklet. A Bach Guild Anniversary Special. BG-594/7 \$11.90 (Stereolab BGS-5022/5 \$17.85)

I SOLISTI DI ZAGREB

Antonio Janigro, conductor. AN 18th CENTURY CHRISTMAS (Works of Corelli, Torelli, Bach and Haydn's Toy Symphony). BG-569 (Stereolab BGS-5006)

VIVALDI: THE FOUR SEASONS. BG-564 (Stereolab BGS-5001)

VLADIMIR GOLSCHMANN

conducting the Vienna State Opera Orch. TCHAIKOVSKY: SYMPHONY NO. 6, "PATHETIQUE." Vanguard Demonstration Special. SRV-112 \$1.98 (Stereolab SRV-112 SD \$2.98)

ALFRED DELLER

and The Deller Consort. THE HOLLY AND THE IVY (English Carols). VRS-499. PURCELL: WELCOME TO ALL THE PLEASURES. BLOW! ODE ON THE DEATH OF HENRY PURCELL. BG-590 (Stereolab BGS-5015)

MONTEVERDI: MADRIGALI AMOROSI. BG-579 (Stereolab BGS-5007)

"One of the most important recordings of the year . . . a recording to gladden the heart, the soul, the spirit, and the mind, as well as the ear." American Record Guide

ODETTA

MY EYES HAVE SEEN. VRS-9059 (Stereolab VSD-2046)

"One of America's most exciting young folk singers." Saturday Review

"Odetta is a noble artist." N. Y. Herald-Tribune

PAUL ROBESON

ROBESON. VRS-9037 (Stereolab VSD-2015)

ROBESON AT CARNEGIE HALL. VRS-9051 (Stereolab VSD-2035)

"One of the supreme, communicative artists of our time. . . . A great recording." Musical America

THE WEAVERS

AT CARNEGIE HALL. VRS-9010 AT HOME. VRS-9024 (Stereolab VSD-2030)
ON TOUR. VRS-9013 TRAVELING ON. VRS-9043 (Stereolab VSD-2022)

"A key force in transforming folk music from a coterie cult to a popular pastime . . . grateful discovery at the riches of world folk music." New York Times

ERICH KUNZ

GERMAN UNIVERSITY SONGS. Four volumes of enchanting student and folk songs, with chorus and orchestra. Vol. I: VRS-477. Vol. II: VRS-1010 (Stereolab VSD-2009) Vol. III: VRS-1035 (Stereolab VSD-2020) Vol. IV: VRS-1045 (Stereolab VSD-2040)

"An unqualified triumph of the recording art . . . Kunz is in superb form." High Fidelity Magazine

CAROL CHANNING

Recorded on location. VRS-9056 (Stereolab VSD-2041)

"The funnest, funniest fifty-five minutes in show business." Variety

CHARLTON HESTON

Reads the Holy Bible. FROM THE FIVE BOOKS OF MOSES. Vol. I. In The Beginning. Vol. 2. Out of Egypt (with the Robert Corman Chorale). 2-12" VRS-9060/1 (Stereolab VSD-2049/50) Also available singly.

SIOBHAN MCKENNA

(with All-Star Cast). DICKENS: A CHRISTMAS CAROL. VRS-9040

Prices (except special priced items above) Monaural \$4.98, Stereolab \$5.95



VANGUARD

recordings for the connoisseur

Send for Catalogue to: Vanguard Recording Society, Inc., 154 West 14 Street, New York 11, N. Y.

LONDON IS PROUD
to present a great recording by

HERBERT VON KARAJAN

conducting

THE VIENNA PHILHARMONIC ORCHESTRA

STRAUSS

Also Sprach Zarathustra

Stereo: CS 6129

Mono: LL 3130



Other fabulous recordings by this great orchestra

BOSKOVSKY

VIENNESE BONDONS
Stereo: CS6008 Mono: LL3026

VIENNA CARNIVAL
Stereo: CS6149

KNAPPERTSBUSCH

THIS IS VIENNA
Stereo: CS6014 Mono: LL3011

Brahms: HAYDN VARIATIONS, etc.
Stereo: CS6030 Mono: LL1752

Wagner: DIE WALKURE (Act I)
Stereo: OSA1204 Mono: A4229

SOLTI

Wagner: DIE WALKURE (Act III)
Stereo: OSA1203 Mono: A4225

DAS RHEINGOLD (Complete)
Stereo: OSA1309 Mono: A4340

MUNCHINGER

BEETHOVEN OVERTURES
Stereo: CS6053

Haydn: SYMPHONIES 96 and 104
Stereo: CS6083 Mono: LL1756

KRIPS

THE BLUE DANUBE
Stereo: CS6007 Mono: LL3023

Haydn: SYMPHONIES 94 and 99
Stereo: CS6027 Mono: LL3009

DON GIOVANNI (Complete Opera)
Stereo: OSA1401 Mono: A4406

Brahms: SYMPHONY No. 1
Stereo: CS6110 Mono: LL1608

KLEIBER

MARRIAGE OF FIGARO
Stereo: OSA 1402 Mono: A4407

LONDON LEADS THE WORLD



Write for free catalog.
Dept. TD 539 W. 25th St., N. Y. 1

factory, barring an occasional engagingly human variation in attack. The style is more straightforward, less subtle and exquisite, than that of the famous Solesmes Abbey monks in their recording of Gregorian chant.

This first recording of Ambrosian chants has been issued by Vox with appropriate splendor in a limited edition of five hundred. The three discs come in a beautiful white album accompanied by a lengthy booklet prepared by Monsig. Ernesto Moneta Caglio. Included in it are a description of the chants' origins and an analysis of each excerpt—both sections given in English, French, and Italian; the Latin texts; and some reproduction in color and black and white of the illuminated manuscripts of the music. Published in Italy, the English text has some oddities, and the references to excerpts by disc and band number are confusing and at least on one occasion, wrong. But these are minor matters in an unusually handsome presentation. R.E.

ALCEO GALLIERA: "Italian Opera Intermezzos"

Catalani: *Loreley*; *Danza delle ondine*; *La Wally*; *Preludes, Acts III & IV*. Zandonai: *Giulietta e Romeo*; *Intermezzo*. Wolf-Ferrari: *I Gioielli della Madonna*; *Serenata*. Pich-Mangiagalli: *Notturno Romantico*; *Waltz*. Mascagni: *Guglielmo Ratcliff*; *Sogno*; *Le Maschere*; *Overture*.

Philharmonic Orchestra, Alceo Galliera, cond.

• • ANGEL S 35483. SD. \$5.98.

The Catalani compositions are of the most interest here, especially the selections from *La Wally*—both are hauntingly sad, and the second surges to a fine climax. Catalani, spurned by his contemporaries and all but ignored by posterity, probably deserves a lengthier hearing. The familiar *Gioielli della Madonna* intermezzo is always enjoyable, and Pich-Mangiagalli's waltz is exhilarating. Mascagni's contributions are inoffensive but undistinguished, and Zandonai's piece is an exercise in sustained pounding—long, loud, and futile, but will be cherished by anyone who regards his stereo system as an instrument of retaliation.

Everything is played in fittingly splashy fashion by the Philharmonia under Galliera, and the orchestra's plush sound is well served by rich, well-balanced stereo. The review copy had a slight surface hiss, disturbing only in very subdued moments, of which there are precious few. C.L.O.

JAIME LAREDO: *Recital*

Vivaldi: *Sonata for Violin and Piano, No. 2, in A, Op. 2, No. 2*. Falla: *Suite Populaire Espagnole: Nana; Jota*. Paradies-Dushkin: *Sicilienne*. Wieniawski: *Scherzo-Tarantelle, Op. 16*. Bach-Wilhelmj: *Air for the G String*. Paganini: *Caprice for Unaccompanied Violin, No. 13, in B flat*. Debussy: *La fille aux cheveux de*

Continued on page 100



the big
PLUS FOUR
in tubes
for hi-fi!

RCA-7025... "low noise and low hum" characterize the performance of this high-mu twin triode—ideal for your pre-amplifier designs.

RCA-7199... "versatility" keynotes the applications for this tube—a sharp-cutoff pentode and a medium-mu triode in one envelope—for low-level stages.

RCA-6973... "compact, but powerful" can describe monophonic and stereophonic power amplifiers designed around this 9-pin miniature—a pair in Class AB1 can deliver up to 20 watts output.

RCA-7027-A "power deluxe"—up to 76 watts with only 2% distortion from a pair in Class AB1 audio service—new structure design provides exceptional electrical stability and reliability.

ANOTHER WAY RCA SERVES YOU THROUGH ELECTRONICS



RADIO CORPORATION OF AMERICA
Electron Tube Division
Harrison, N. J.

From pre-amplifier to power amplifier, mono or stereo, you can design a comprehensive line of high-fidelity products around these 4 RCA tube types. And your designs with RCA tubes add up to recognition . . . for quality, performance, prestige. Contact your RCA Field Representative for details. For technical data, write RCA Commercial Engineering, Section K-74-DE Harrison, N. J.

EAST:
744 Broad St., Newark 2, New Jersey,
HUMboldt 5-3900

MIDWEST:
Suite 1154, Merchandise Mart Plaza,
Chicago 54, Ill., WHItchall 4-2900

WEST:
6355 East Washington Boulevard, Los
Angeles 22, Calif., RAYmond 3-8361

RCA TUBES FOR HI-FI ALSO AVAILABLE AT YOUR RCA TUBE DISTRIBUTOR

lin. Sarasate-Zimbalist: *Carmen Fantaisie*.

Jaime Laredo, violin; Vladimir Sokoloff, piano.

• RCA VICTOR LM 2373. LP. \$4.98.
• • RCA VICTOR LSC 2373. SD. \$5.98.

At eighteen, Jaime Laredo is the youngest artist ever to win the Queen Elisabeth of Belgium competition. Shortly after this young Bolivian violinist's victory last May, RCA Victor signed him to a recording contract. If one is to judge from his debut disc, here is a real find, an important new artist. His technique is absolutely flawless, and he has an unusually big, fully rounded, pleasing tone. Even more unusual in one so young, he has a fine sense of interpretative style, a style adaptable to Vivaldi or Falla. Per-

haps all his admirable qualities are summed up in the dazzling but always musicianly performance of the *Carmen Fantaisie*. Vladimir Sokoloff provides steady, tasteful accompaniments, and the recording is clear and well balanced. There is, however, no reason for issuing a stereo edition of music for violin and piano only. The difference between the stereo and mono versions is just about nil. Laredo, however, is an up-and-coming fiddler worth hearing. P.A.

NATHAN MILSTEIN: "*The Art of Milstein*"

Nathan Milstein, violin; Rudolf Firkusny, piano (in the Beethoven sonata); Leon Pommers, piano (in the short pieces); Pittsburgh Symphony Orchestra, William

Steinberg, cond. (in the Tchaikovsky concerto).

• CAPITOL PBR 8502. Two LP. \$9.98.
• • CAPITOL SPBR 8502. Two SD. \$11.98.

For review of this album, see page 80.

NEW YORK PRO MUSICA: *Elizabethan and Jacobean Ayres, Madrigals, and Dances*

New York Pro Musica, Noah Greenberg, cond.

• DECCA DL 9406. LP. \$4.98.
• • DECCA DL 79406. SD. \$5.98.

An attractive collection, which combines well-known pieces, such as Dowland's great *Flow my teares*, with relatively unfamiliar ones like Captain Tobias Hume's song in praise of tobacco, Gibbons' *London Street Cries*, and three charming dances by Coperario. Mr. Greenberg has ordered them with a keen ear for contrast and variety, and he has been bold enough to employ instrumental accompaniment for most of the "balletts" and other polyphonic vocal pieces, which are usually performed *a cappella* nowadays. His procedure not only is historically justifiable but renders some of the pieces even more enjoyable than they would be without the instruments. These last comprise recorders, viols, and harpsichord, but no lute—a puzzling omission in a collection that includes three pieces by Dowland, one of the greatest lutanists of his time.

Other composers represented here are Morley, Byrd, Robert Jones, John Farmer, and Campian (or Campion); there are also the anonymous *Woodycock*, played here by a bass viol, and three pieces from the *Mulliner Book*. All are satisfactorily performed and well recorded, the monophonic version being perhaps as pleasing as the stereo, except in Morley's *Phillis, I faine would die now*, where the two-channel version effectively juxtaposes the two "quiers" of performers. N.B.

MADO ROBIN: "*Airs de Coloratur*"

Thomas: *Mignon: Je suis Titania*. Massé: *Les Noces de Jeannette: Au bord du chemin*. Gounod: *Roméo et Juliette: Ah! Je veux vivre dans le rêve*. Offenbach: *Les Contes d'Hoffmann: Les oiseaux dans la charmille*. Massenet: *Manon: Suisje gentille ainsi?* Rossini: *La Danza*. Benedict: *La Gitane et l'oiseau: Charmant oiseau, ta cage est d'or*. David: *La perle du Brésil: Charmant oiseau qui sous l'ombrage*. Pestalozza: *Ciribiribin*. Delibes: *Les filles de Cadix: Trois garçons, trois fillettes*. Ponce: *Estrellita*.

Mado Robin, soprano; Orchestre du Théâtre National de l'Opéra de Paris, Pierre Dervaux, cond.

• PATHE DTX 276. LP. \$5.95.

This is a disc that has you scurrying to the pitchpipe in disbelief, then setting the needle back a few grooves to make sure you heard aright. Of course, Mlle.

LEON FLEISHER—*The virtuoso called "The pianistic find of the century," by Pierre Monteux, records exclusively for Epic Records.*

BEETHOVEN: Concerto No. 4 in G Major for Piano and Orchestra, Op. 58 • **MOZART:** Concerto No. 25 in C Major for Piano and Orchestra, K. 503—with the Cleveland Orchestra, George Szell, Cond. LC 3574 BC 1025 (Stereorama)

BRAHMS: Variations and Fugue on a Theme of Handel, Op. 24; Waltzes, Op. 39 LC 3331

BRAHMS: Concerto No. 1 in D Minor for Piano and Orchestra, Op. 15—with the

Cleveland Orchestra, George Szell, Cond. LC 3484 BC 1003 (Stereorama)

DEBUSSY: Suite Bergamasque • **RAVEL:** Sonatine; Valses Nobles et Sentimentales; Alborada del Gracioso LC 3554

RACHMANINOFF: Rhapsody on a Theme of Paganini, Op. 43 • **FRANCK:** Symphonic Variations • **DELIUS:** In the Forest—Prelude—with the Cleveland Orchestra, George Szell, Conductor LC 3330

THE WORLD OF WONDERFUL MUSIC IS YOURS ON



RECORDS



A PRODUCT OF CBS © "Epic" Marca Reg. "CBS" T.M.

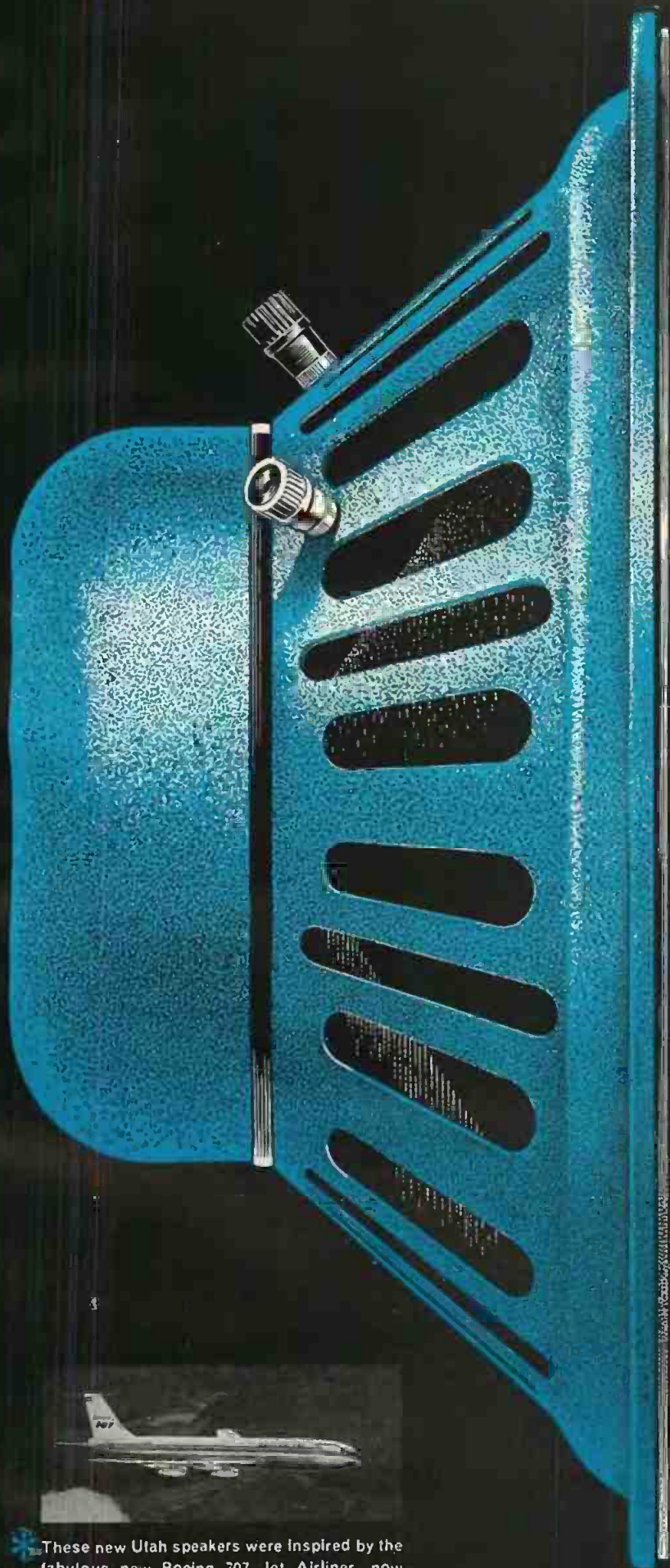

MORE POWER PER POUND

in the
ALL-NEW

UTAH*

**dual-diameter
speakers**

... Never before such *concentrated power!* The secret is in Utah's brand new dual-diameter magnetic circuitry and dynamic Uni-coils. By ingeniously combining two magnetic material structures into one, Utah has produced the greatest power per pound in a loud-speaker since the advent of Alnico V. See the all new Utah speakers now — 8" full range model D8LA and 12" full range model D12LA — they're as "hot" as a Jet Airliner!

*These new Utah speakers were inspired by the fabulous new Boeing 707 Jet Airliner, now streaking coast to coast in just 4¼ hours! Utah speakers, too, pack more power per pound, feature Jet Airliner slim-line design to meet modern demands for more compact Stereo and High Fidelity applications.

Utah
SPEAKERS 

Utah Radio & Electronic Corp., Huntington, Ind.

Robin is not precisely a stranger to LP collectors, but it is this record that establishes the authenticity of her talent. Although it is probably ungracious to take even the smallest exception to such a virtuoso display, I must admit that a certain excitement is missing from her singing: after all, what terror can even the most exacting vehicle hold for a soprano who trafficks in G sharps above high C, and who chooses to practice her *messa di voce* on high D?

But if the delicious apprehension which usually accompanies a coloratura recital is absent, what a pleasure it is to hear a voice that can soar into the highest regions without thinning and becoming wiry and that can make the turns in the upper-middle range sound like music, and not like a gargling session. Robin's tone is beautiful and strong from top to bottom. She can expand, diminish, and trill at least as high as the E flat in *al-tis-si-mo*—a sure sign of real vocal freedom. The high G sharps and, in one case, A natural, are clear and attractive, firmly connected to the rest of the voice, and in no way freakish. Unless Pathé has evolved a new and highly deceptive recording technique, one is hearing here a magnificent, perfectly controlled instrument, of the sort one imagines the legendary nineteenth-century divas to have possessed.

As for the music, the standard showpieces certainly require no comment. The operetta selections are all engaging *oiseau*-numbers, one indistinguishable from another. Such music, combined with such faultless singing, makes for unalloyed pleasure. The orchestral accompaniments are adequate, the sound top-notch.

C.L.O.

RICHARD TAUBER: "Richard Tauber Chante . . ."

Lehár: *Frasquita: Serenade; Friederike: O Mädchen, mein Mädchen; Paganini: Girls Were Made to Love and Kiss; Die Lustige Witwe: Waltz Song; You Are My Heart's Delight; Röslein auf der Heiden; The Czarevitch: Wolgalied.* Lockton: *Vienna. City of My Dreams.* Schubert: *Ständchen.*

Richard Tauber, tenor; Orchestra.

• ODEON OD 1022. 10-inch. LP. \$2.98.

This is typical Tauber material, largely *kitsch*, replete with tremulous violins, balalaikas, and the great tenor's usual blend of rich lyric tone, unparalleled rhythmic flair, ravishing pianissimos, and constricted high tones here and there. It is no wonder that two full generations placed him immediately beneath God. Several of the numbers are trotted forth shamelessly in outrageous English (including *Vienna, City of My Dreams* and *You Are My Heart's Delight*: these are not Tauber's best recordings of these songs). The music has a definite charm, and Tauber's way with it is irresistible. With the exception of the unspeakable version of Schubert's *Ständchen*, any one of these selections is well worth the price of this little ten-incher. The sound is listenable, with some scratch in spots, and the transfers are accurate.

C.L.O.

FOLK MUSIC

THE YEAR'S FINEST single recording of folk music to date is, in my opinion, Warner Brothers' *Sun's Gonna Shine* (B 1251, LP; BS 1251, SD). In a well-chosen collection of ballads, Elmerlee Thomas, of San Francisco's Gateway Singers, displays a burnished contralto of deep emotional power that can, however, turn light and gay whenever her material demands. Stylistically, she follows a pure melodic line, scorning all mannerisms, all affectations. This simplicity—combined with her ability to project a mood—shapes lovely, moving renditions of *Turtle Dove, Ribbon Bow, and All the Pretty Little Horses*. Miss Thomas' insight and trained voice unlock new beauties in the songs she has chosen. As far as sound goes, I myself prefer the monophonic version.

A great American poet and folk song collector, Carl Sandburg, returns to the record scene with Columbia's *Flat Rock*



Elmerlee Thomas and Gateway Singers.

Ballads (ML5339, LP), taped at his North Carolina home. At eighty-one, Sandburg has a voice still soft, intense, flexible, and—magically—fresh, particularly in *Wanderin'* and *Careless Love*.

Another noted collector, Alan Lomax, appears to advantage as a singer on Tradition's *Texas Folk Songs* (TLP 1029, LP). Lomax's somewhat tentative, Texas-accented voice adapts well to these unvarnished cowboy ballads. His singing of *Doney Gal*, to an inspired harmonica accompaniment by John Cole, is, for example, a haunting echo of loneliness. Lomax also teams with Peggy Seeger and Guy Carawan on Kapp's *Folk Song Saturday Night* (KL 1110, LP). In solos, duets, and trios, the three singers present an earthy cross section of the American folk heritage in performances that are short on polish but long on authenticity.

After a period of shifting personnel and descents into—save the mark—comic patter, the famous Weavers have at last returned to their specialty, singing folk songs better than any other quartet in the country. In addition to a wide range of home-grown ballads infused with their

usual personalized twist, the ensemble offers on Vanguard's *Travelling on with the Weavers* (VRS 9043, LP; VSD 2022, SD) songs from Chile, Yugoslavia, Africa, and Spain. The mono edition is cleaner and crisper than its stereo counterpart.

Countertenor Alfred Deller has a soaring voice that is perfectly secure in a startlingly high register. Since much pre-eighteenth-century traditional material was first sung by countertenors, Deller's appeal is particularly in the older songs. His Anglo-American program on *Western Wind* (Vanguard VRS 1031, LP; VSD 2014, SD) spans the centuries as well as the seas, showing the singer at his plangent best. Avoid the noisy stereo edition in favor of the monophonic.

While sonically not among the cleanest Westminster discs, *Folk Songs from Erin* (WF 12025, LP) gives us a superb recital of ballads in English and Gaelic by Deirdre O'Callaghan, who accompanies herself on the harp. Miss O'Callaghan's voice, light and rather delicate, captures all the shifting moods and emotional nuances of her enchanting songs. I particularly admired her *Shiu! Aroon* and *The Spinning Wheel*.

Monitor's *Songs of Old Russia* (MP 560, LP) are sung, by a dazzling array of Soviet vocalists, with the florid orchestration and operatic approach favored in the U.S.S.R. The songs seem to thrive on such treatment, and the translucent tenor of the famous Sergei Lemeshev—who sings five of them—is a joy to the ear. Technically, the recording compares favorably with the Western mean.

On the ethnic front, Indian folklorist Deben Bhattacharya has recorded for Westminster—under UNESCO auspices—*A Gypsy Festival* (WF 12030, LP), a documentary of the annual gypsy gathering at Les Saintes Maries de la Mer in France. In addition to flamencolike *cantes* and guitar improvisations as impassioned as they are unpolished, Bhattacharya has caught key parts of the accompanying religious ceremonies and the gypsies' *entre-eux* entertainments. A stunning record of its kind, with annotation that throws a good deal of light on gypsy origins.

Finally, on the farthest edge of respectability looms "country music." Folklorists generally decry these hillbilly songs because they are composed in cold blood, exploited to a fare-thee-well, and are painfully contemporary. But, like it or not, the barbarisms of *Educated Mama* and *Your Cheatin' Heart* do express a valid aspect of present-day American folk culture—or lack of it. Veteran "Grand Ol' Opry" star Ernest Tubbs' Decca pressing, *The Importance of Being Ernest* (DL 8834, LP)—Stop spinning in that grave, Oscar!—is a palatable—even enjoyable—excursion through the world of honky-tonks, neon-bubbled jukeboxes, and whining sorrow. For implacable *aficionados*, RCA Victor has released *Train Whistle Blues* (LPM 1640, LP), a creditable repressing of the songs of Jimmie Rodgers, twenty-six years dead, who fathered the genre.

EDWARD L. RANDAL

Reviews continued on page 105

EVEREST'S exclusive recording technique brings you THE FINEST SOUND ON RECORDS



Direct From 35mm Magnetic Film to Disc

Only on Everest . . . brilliant performances by the world's finest musicians are recorded on 35 mm magnetic film . . . then transferred to the discs you hear. The result: great music in the most accurate monaural and stereo high fidelity yet achieved. For you—a revelation in sound.

EVEREST MAGNETIC FILM COMPARED WITH CONVENTIONAL TAPES

Everest sprocket-driven magnetic film is much wider and five times thicker than conventional tapes. With it, Everest achieves:

- the widest dynamic range ever recorded
- recording without "wow" or "flutter"
- elimination of print-through distortion and tape-stretch
- the lowest possible noise factor

Everest's 35 mm magnetic film actual size

1/2" stereo tape actual size

1/4" tape actual size

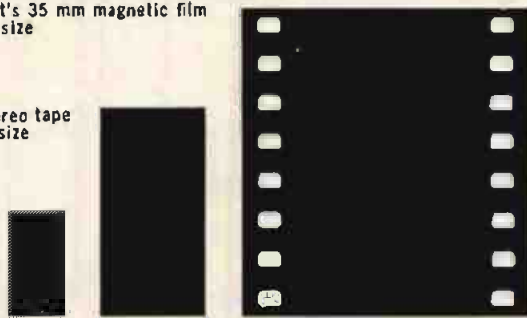

Hear this exciting new sound yourself. Hear it in these and other selections in the growing Everest library of great monaural and stereo recordings.

All Everest recordings are high fidelity . . . available in monaural long-play, stereo discs and tape. For a complete Catalogue, in full color, write: Everest Records, Dept. F 11, 360 Lexington Avenue, New York 17, New York.

EVEREST RECORDS

Division of Belock Instrument Corp.



Music in the Morgan Manner. Russ Morgan, his Orchestra. "Flower of Dawn," and other favorites. LPBR 5054 SDBR 1054*



Tchaikovsky: Symphony No. 5 in E minor, Op. 64. Sir Malcolm Sargent, the London Symphony Orchestra. LPBR 6039 SDBR 3039*

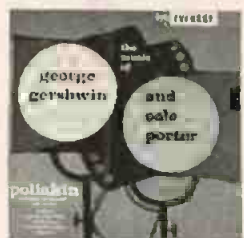

The Music of Gershwin and Cole Porter. "Night and Day," "Man I Love," etc. Poliakin, Chorale & Orchestra. LPBR 5051 SDBR 1051*



Berlioz: Symphonie Fantastique, Op. 14. Sir Eugene Goossens conducting the London Symphony Orchestra. LPBR 6037 SDBR 3037*



Front Row Center. Charles K. L. Davis; songs from recent hits, "West Side Story," "My Fair Lady." Others. LPBR 5050 SDBR 1050*



Honky Tonk Goes To College (with Good Time Charley). College songs—happy songs. instrumentalists and singers. LPBR 5058 SDBR 1058*

*Stereo number

Say Merry Christmas in Hi Fi

For music lovers and sound enthusiasts who demand the BEST in sound reproduction!



R410 CHRISTMAS FROM HAWAII—A fresh South Sea slant on the Yuletide season. Recorded in Kaiser's Aluminum Dome, Honolulu. A unique Xmas L.P.

STEREOPHONIC
HIFIRECORDS
HIFTAPES

The best Stereo Sound by far!

Available at record shops and HIFI equipment dealers everywhere.



R706 MERRY CHRISTMAS—George Wright plays the Mighty Wurlitzer Pipe Organ. For a festive mood in this the most festive season.



R705 MUSIC FOR CHRISTMAS—Recorded in San Francisco's Grace Cathedral. Hear sound recorded in its purest form.



R417 TAHITI—Exciting, exotic and rhythmic harmonies by The Surfers from their Tahitian show at the Stardust Hotel, Las Vegas.

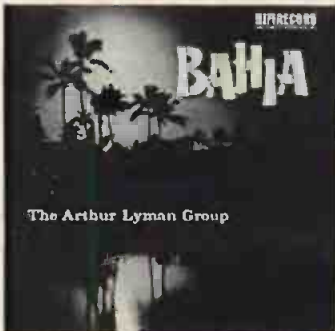

R815 BAHIA—New, exciting exotic sounds from the fantastic creativeness of Hawaii wonder boy, Arthur Lyman recorded in Kaiser's Aluminum Dome with big gorgeous sound.



R721 HAVE ORGAN, WILL TRAVEL—George Wright clowns thru tunes of 14 countries in his own inimitable style—it's the big beautiful sound of the mighty Wurlitzer Organ.



R806 TABOO—The fabulous sounds of Arthur Lyman's Hawaiian Village Group recorded in Henry J. Kaiser's Aluminum Dome, Honolulu.



R811 FLAMENCO ESPANA—Sixteen exciting flamenco tracks with Bernabe DeMoron, guitarist; three other guitars and six castanet dancers.



R608 BIG DIXIE—Harry Zimmerman's big band plays the biggest, wildest, Dixie and Blues you've ever heard. Sensational sounding brass!



R910 A FAREWELL TO STEAM—Recorded especially for Railroad and HIFI enthusiasts. The story of the last Steam Locomotive in the Los Angeles Division.

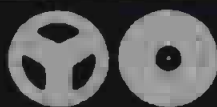

"The sound that named a company"
HIGH FIDELITY RECORDINGS, INC.

7803 Sunset Boulevard, Hollywood 46, California
In Canada — Sparton Records • P. O. Box 5035, London, Ontario



Here at Home

"Once Around the Clock with Patricia Scot." Patricia Scot; Creed Taylor Orchestra. ABC-Paramount ABC 301, \$3.98 (LP).

I can't decide whether to categorize Patricia Scot as club, pop, or jazz singer—there are traces of all three here—but I can tell you that she is an exciting artist, with an individuality of style quite unusual these days. Occasionally one detects a very slight similarity to Lena Horne, but otherwise this is pure Scot. She is a singer of remarkable versatility, and her program has been carefully chosen to exploit every facet of her talent. She can make a jump version of Romberg's usually sedate *Just Once Around the Clock* positively tingle with excitement, yet just as easily wring the last moan from Coward's *Mad About the Boy*. She can summon up a sexy, come-hither voice for *Do It Again*, yet be equally at home (oh, so very much at home) in her own song *Let's Sit Down and Talk It Over*. Maybe there's some song she couldn't handle—after all there are only twelve here—but I can't imagine what it might be. With the small Creed Taylor group, in unusual Bob Kenyon arrangements, providing quality support, this is something of a triumph for a new artist.

"The Great Sound of Les Elgart." Les Elgart and His Orchestra. Columbia CL 1350, \$3.98 (LP).

Familiar as most of the numbers may be in this Elgart program, they seem to take on new freshness when decked out in the provocative arrangements that the leader has concocted. Here once more are the unusual instrumental voicings that are Elgart's specialty, here too the fat growling brass, the sweet smooth-toned reeds, carefully blended into a homogeneous musical whole. Here also is that big, solid beat that helps make this such an excellent dance program. The sound is, as the title says, "Great," and Columbia's engineers, who always seem to be in top form at Elgart sessions, have captured the full-blown orchestral image to absolute perfection.

"A Night in Venice." Original cast recording of the Michael Todd 1952 Production. Everest SDBR 3028, \$5.95 (SD). With nature, and Robert Moses, obligingly contributing half of the necessary

Venetian atmosphere, in the form of a huge lagoon, Mike Todd's choice of *A Night in Venice* to open the Marine Theatre at Jones Beach in 1952 was almost inevitable. Producers are seldom offered such cooperation, and Todd was certainly too astute a showman to pass it up. Although hardly in the same league with *Die Fledermaus* or *Der Zigeunerbaron*, this merry operetta has a goodly share of ear-catching tunes, most in the best Viennese tradition but some liberally splashed with an Italian coloration. If the entire score lacks the cohesion of its companion works, put this down to the fact that it is a composite score from a number of sources, and one rather hastily thrown together.

This performance, by the original 1952 cast specially reassembled for the recording, offers a bluff, good-natured account of the music. The gentlemen sound virile—and occasionally bemused (not particularly surprising in view of the numerous involvements of the libretto). The ladies, thank heaven, do not sound overarch (a distressing aspect of so many versions), nor do they overdo the high spirits. The singing is generally agreeable, although only Laurel Hurley



Les Elgart of the big, solid beat.

and Thomas Hayward turn in outstanding performances. Though I think some of the orchestral work sounds rough, Thomas Martin keeps the work moving at a most sensible pace; and even if Everest's stereo doesn't manage to convey much of the animated stage action, the sound is extremely good.

"Till the End of Time." Florian Zabaich, violin; Orchestra. Mercury SR 60084, \$4.98 (SD).

Even though most of the arrangements appear to have come straight out of Mantovani's book, you would have to go back to the great days of Joe Venuti or Eddie South to recall such a fiddler in the pop field. Like his famous predecessors, Zabaich can literally make his instrument talk, whether he's suggesting the oldster singing *When Your Hair Has Turned to Silver* or a French chanteuse singing *I Married an Angel*. His classical background comes to the fore in a concertolike arrangement of the title number, and a polite jazz touch is introduced into both *Ain't Misbehavin'* and *I Can't Give You Anything but Love*. There is, thank goodness, a minimum of trickery in his performances, and what little is introduced is invariably in good taste. The stereo sound suffers from overwide separation, with soloist and rhythm section in right speaker, the main string orchestra in left, and little sound emerging from center.

"The Gershwin Years." Richard Hayes; Paula Stewart; Lynn Roberts; Chorus and Orchestra, George Bassman, cond. Decca DXZ 160, \$13.98 (Three LP); Decca DNXZ 7160, \$16.98 (Three SD).

Decca's tribute to the genius that was Gershwin is the most comprehensive survey of his show and film scores ever committed to records. In quantity of material it completely overshadows both the old RCA Victor album (reissued on RCA Camden CAL 177) and the fine two-record set released by Walden (Walden 302/3). But in quality, in the fine art of presenting Gershwin songs as they should be sung, it is decidedly inferior to both the earlier issues. Where Camden and Walden made use of vocalists with attractive voices and sound theatrical know-how, Decca has relied on two ladies who appear to be lost in a medium completely unfamiliar to them. Nor are their voices attractive enough to make up for the deficiency of style. Richard Hayes is much better, but there are times when he too sounds a little uneasy in the songs assigned him. I found the orchestral arrangements rather puzzling. They start off quite promisingly, particularly in the 1916 rag *Rialto Ripples*, but quickly take on too modern a style, and certainly do nothing to suggest the zippy rhythms of Gershwin's music in the mid-Twenties.

Decca offers a fine example of well-balanced, broad-range sound in the stereo version, which is considerably superior to its monophonic counterpart. The three records are housed in a box-type album,

GRADO

... takes pride in announcing a new Custom Series Stereo Cartridge. The Grado "Custom" was designed for the selective audiophile who desires excellent reproduction at a moderate cost. With its excellent tracking ability and extremely low distortion, the new Custom Stereo Cartridge becomes a perfect companion to the widely acclaimed Grado "Master" Stereo Cartridge. Because of small moving masses and low tracking forces, stylus wear is virtually nonexistent. Grado Laboratories now guarantees all of the stereo diamond styli for a period of 5 years from date of manufacture.

A greatly improved Grado Tone Arm is now available. It is dynamically balanced and features a new micrometer tracking force adjustment. Stylus force accuracy of tenths of grams may now be achieved with complete simplicity. Also new is a stainless steel arm rest lock. All present Grado Tone Arms can be modified.

Master Stereo Cartridge . . . \$49.50
Custom Stereo Cartridge . . . \$32.50
Micrometer Stereo Tone Arm \$29.95

For further details write to:

GRADO LABORATORIES, INC.

4614 7th Avenue Brooklyn 20, New York
Export-Simontrice, 25 Warren St., N.Y.C.

containing not only a reproduction of Gershwin's celebrated *Self-Portrait in a Checkered Sweater* but the best booklet of its kind I have ever encountered. In addition to Edward Jablonski's extremely informative article on Gershwin, profusely illustrated with pictures from Jablonski's recent book *The Gershwin Years*, it includes a complete guide to all the shows and films for which Gershwin wrote music—individual songs, members of the cast, theatre played and length of run. There is also further comment on the numbers recorded in this set, plus a glowing tribute to Gershwin from Louis Untermeyer. What a pity that all aspects of this production were not equally fine.

"The Flirty Thirties." Lew Raymond and His Orchestra. Mayfair 9654S, \$2.98 (SD).

As many listeners will have discovered, a number of small companies are now issuing a stereo product that compares favorably with that of the higher-priced labels. Among the former is Mayfair, which appears to be an affiliate of Tops Records. Here ten old favorites from the Thirties make up an attractive program of dance music. You may feel that the *Three Little Fishes* or *The Music Goes 'Round and 'Round* are hardly worth re-visiting, but this still leaves you with eight solid hits, neatly arranged and played with a good deal of bounce. The stereo sound is clean and realistic, of excellent depth and good directionality. In addition, Mayfair is using pure vinylite, with resultant very quiet surfaces. All told, this is quite a bargain.

"Como Swings." Perry Como; Ray Charles Singers; Mitchell Ayres's Orchestra. RCA Victor LPM 2010, \$3.98 (LP); RCA Victor LSP 2010, \$4.98 (SD).

By ordinary standards this record would be considered a rather mildly swinging affair, but coming from the usually unruffled Como it could be called "Wild, man, wild." Actually, listening closely, I found the Como style was still pretty relaxed and that most of the excitement was generated by Mitchell Ayres's arrangements. One thing in its favor, apart from Como's subdued animation, is the complete absence of the usual saccharine numbers Como thrives on. It will be up to his many admirers to give their approval to the switch. A good mono recording is hopelessly outclassed by the spectacular stereo version.

"Imported Carr, American Gas." Carole Carr; Orchestra, Warren Barker and Pete King, conds. Warner Bros. WS 1316, \$4.98 (SD).

This newly arrived English singer has already been dubbed, by some bright Hollywood lad, as the girl with "The Pure Cashmere Voice." I'll concede that the voice is pleasantly warm, but it definitely isn't woolly. Furthermore, it is vibrant and expressive, and Miss Carr is obviously a singer who knows just what she wants to do with a song and how best to do it. Unfortunately, I don't think this program is designed to display

her at her best. The special material numbers are well enough handled, but they are a little too "special," and it strikes me that the boy chorus in *Come Runnin'* is definitely not in her line. She has, however, the benefit of excellent arrangements by the two conductors, plus fine Warner Brothers stereo sound. Her next record should be worth waiting for.

"Romance à la Mood." Pierre Chaille and The Grande Orchestre. ABC-Paramount ABC 280, \$3.98 (LP).

What distinguishes this disc from so many similarly styled recordings is the inclusion of some once-popular, now almost forgotten items such as *The Love Nest*, *Dancing Tambourine*, *I've Got Rings on My Fingers*, and *A Shine on Your Shoes*. Chaille goes in for extremely lush arrangements, and for optimum effect uses an orchestra of more than fifty musicians. The Continental touch is applied to good purpose, and most of these American numbers sound surprisingly fresh and attractive. The sound is powerful, but on the whole not unpleasantly so.

"All the King's Songs." Teddi King; Orchestra, Lew Douglas and Johnny Richards, conds. Coral 57278, \$3.98 (LP); Coral 757278, \$4.98 (SD).

Teddi King, who came out of Boston with an enviable reputation as a jazz singer, now appears on her fourth—and decidedly her best—record as a pops singer. In striking contrast to current singers who try to impress the listener by practically deafening him, Miss King uses her small, sweet voice with discretion and makes her effects by understatement. There is still strong evidence of her feeling for jazz in several of these songs. And this feeling is accentuated when she is backed by Charlie Shavers' trumpet, Jimmy Cleveland's trombone, and Phil Bodner's clarinet. Elsewhere the string backgrounds by Johnny Richards gracefully complement Miss King's warm singing. Although all these songs are closely associated with male singers, there is nothing at all incongruous in Miss King appropriating them, pro tem, and making them her own.

"Way Out Far." The Lewis Sisters. Liberty LST 7128, \$4.98 (SD).

None of your old-fashioned two-part harmony for the Lewis Sisters, a pair of vocalists who have set out to exploit every known and unknown vocal combination. They run the scale from outright dissonance to harmony so close that it is barely distinguishable from the sound produced by a single voice. It's all extremely complicated, puzzling—and dare one say it—odd-ball. It is also completely fascinating. To appreciate entirely the subtle interweaving of vocal sounds calls for a good deal of concentration. If you can manage that, I think you will be well rewarded. The imagination displayed by the singers is well matched

Continued on page 108

This Christmas
give **high fidelity**
to your
Very Special Friends

Much as we enjoy welcoming new subscribers, we don't suggest you choose HIGH FIDELITY for everyone on your gift list.

Reserve HIGH FIDELITY for special friends and relatives of all ages who share with you the exaltation that comes from hearing memorable music peerlessly performed, recorded and reproduced at home.

And, if they are adventurous souls eager to broaden their musical horizons, so much the better.

They, most of all, will appreciate your gift of HIGH FIDELITY... they, most of all, will thank you not only on December 25, but every month of 1960.

Use the handy envelope bound in this issue to order Christmas gifts of HIGH FIDELITY. The first subscription costs \$6.—the second \$5.—and each additional gift only \$4. Your own subscription—new or renewal—may be included at these special rates.

Act now to enable us to give your order the careful attention it deserves. If you wish, we'll send handsome gift announcement cards to your friends.

give **high fidelity**
for a Merry Christmas
and a Hi-Fi New Year

THE PUBLISHING HOUSE, GREAT BARRINGTON, MASS.

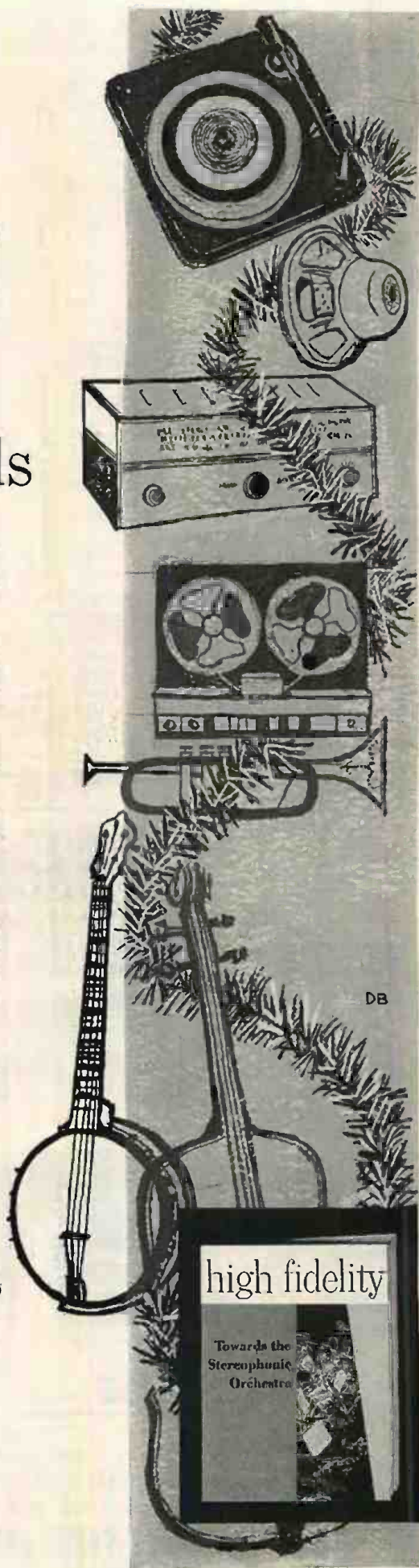

THE EAR
THAT HAS
HEARD
EVERYTHING,
HAS HEARD
NOTHING
UNTIL
IT HEARS

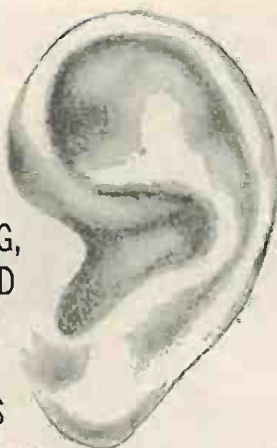

THE SWINGING LENY EVERSONG

Said to be "The Most Extraordinary Voice of Our Time," she is one of the highest paid performers in South America and Europe. A unique talent that must be heard to be described, Leny sings in her native Portuguese as well as in English, French and Spanish.

HI-FIDELITY



STEREOPHONIC RECORDS



CELP 435

SEECO RECORDS, 39 W. 60 ST., N.Y.C.

by that of the admirable small group of supporting musicians.

"My Heart Sings." Paul Anka; Orchestra, Don Costa, cond. ABC-Paramount ABC 296, \$3.98 (LP).

There are about three numbers on Paul Anka's program that are sung with all the dramatic fervor that has endeared this young Canadian singer to the hearts of American teen-agers. So far, so good. When he attempts to tackle more sophisticated Parisian songs, however, he comes a cropper. There is neither subtlety nor shading in his delivery of these numbers; and if the lyrics mean anything at all to him, you would never know what. Surrounding him with a choir and adding one or two orchestral gimmicks hasn't helped much.

"Melis at Midnight." José Melis, His Piano and Strings. Seeco CELP 4140, \$4.98 (SD).

Backed by a group of string players, José Melis—musical director and pianist for Jack Paar—runs through a fine program of selections that range from the delicate *Lilacs in the Rain* to the exciting *Cuban Concerto*. Between these two extremes are some deft performances of pleasant background-music standards. The only trouble is that Mr. Melis' playing is too good to be comfortably ignored as unobtrusive background. I suggest that you don't wait until midnight to put this on your machine. Stereo sound, as such, is perfectly satisfactory, but there is an occasional unpleasant edge to the strings.

JOHN F. INDOX

Foreign Flavor

"Solo Flamenco . . . The Fabulous Sabicas." Sabicas, guitar. ABC-Paramount ABC 304, \$3.98 (LP).

The gypsy genius for flamenco flickers through Sabicas' recital of ten of his own compositions in classical flamenco molds: stately *soleáres*, heartbroken *siguiriyas*, a bouncy *zambra*. Sabicas' technique defies description. His sure fingers shape and reshape chords with incredible swiftness: what emerges is a kind of breath-taking chromatic cascade always controlled but always emotionally supple. A blazing performance by a great guitarist. ABC's sound is as pure as Sabicas' art.

"Piaf." Edith Piaf; Robert Chauvigny and His Orchestra. Capitol T 10210, \$3.98 (LP).

It is now twelve years since Edith Piaf, tiny and unbeautiful, burst upon the American scene with songs such as *Les Trois Cloches* and *La Vie en Rose*. Her voice is an extraordinary combination of sweetness and toughness. No one can limn the lovelorn whore more effectively than she; no one can capture the heart-break of everyday life more movingly. And her versatility continues to surprise: you will not soon forget her hair-raising treatment of the marchlike *Les Grognards* on this release, or her bittersweet *La Foule*. Piaf, a torcher who generates light as well as heat, reputedly receives \$1,000 a performance. By this measure, as well as any other, Capitol's brilliantly engineered disc is a rare bargain.

"Gigi." Original French Version. Maurice Chevalier, Sacha Distel, Marie-France, Jane Marken. Orchestra, Paul Baron, cond. Columbia WL 158, \$4.98 (LP). Even in French—or, perhaps, even better in French—Alan Jay Lerner and Frederick Loewe's songs for *Gigi* impress one as superlative musical comedy. Chevalier is the whole show here, with his insouciant decadence delicately enhanced by the droll overtones of the French idiom. Sacha Distel is a properly baffled nephew, Marie-France a charming *Gigi*, and Paul Baron's work bubbles like champagne—and not the California variety.

"Blood Wedding Suite." Vicente Gomez, guitar. Decca DL 8918, \$3.98 (LP); DL 78918, \$5.98 (SD).

Vicente Gomez, a *madrileño* who plays a lithic-fingered, golden-toned guitar, has composed the music for several Hollywood films. Here, in an obvious labor of love, he has written a suite based upon Federico García Lorca's darkling play *Blood Wedding*. In this death-shadowed drama, centered upon a rural blood feud, Lorca probes the Spanish obsessions with fecundity and honor. Gomez's somber, intensely Spanish score echoes the brooding lyricism of Lorca's tragedy, and the composer plays it with skill and economy. The lone guitar, with its hints of *cante*

Continued on page 110

WHERE
THERE'S
A FINE
TAPE
RECORDER...

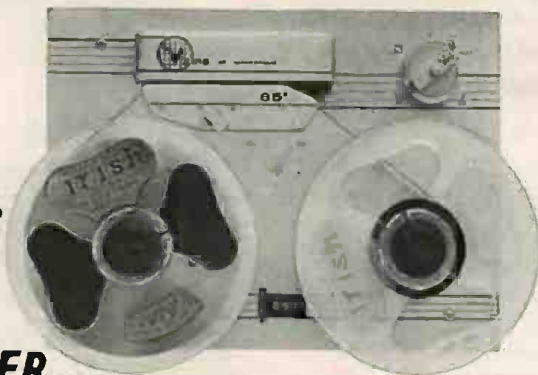

ferro-sheen tape

note to **VIKING** owners

To insure optimum recording quality with your machine, the recommended tape is **irish** Long Play #601. Send for technical bulletin.

ORR INDUSTRIES INC.
Opelika, Alabama

maybe
you've
seen such
quality
before
but never
at these
low
prices



SONIC

STEREO COMPONENTS

Engineered by one of the nation's foremost independent phonograph manufacturers, a company that pioneered the first line of stereo phonographs — these new high fidelity stereo components represent this firm's vast engineering and production experience.

SONIC CUSTOM-CRAFT S-400 The happy twosome above are admiring this quality 40 watt stereo amplifier/transistorized preamplifier. It achieves maximum performance, ease of operation. Advantages of transistorized preamplifiers are: minimum hum, no thermal noise and no microphonism. 20 watts-per-channel delivers 80 watts peak power. Frequency response, flat from 20 to 20,000 cps ± 0.5 db. Harmonic distortion, less than 1% at full rated output. Internal audible stereo test signal for adjusting channel and speaker balance, as well as speaker phasing. Sonic Stereo Monitor, a precision meter, tells at a glance when both channels, properly balanced. Better than 40 db separation between channels from 50 to 20,000 cps. 8 inputs, 9 front panel controls including channel reverse switch handle any program source as well as magnetic stereo phono cartridges. 4, 8 and 16 ohm outputs for single, double or triple channel operation.

audiophile net with enclosure **\$9995**



SONIC CUSTOM-CRAFT S-100 Popular, low-priced high fidelity 10 watt stereo, master control center, and dual amplifiers. 5 watts-per-channel develops 20 watts of peak power. 50 to 15,000 cps response with less than 5% of total harmonic distortion at full rated power. Hum and noise, 45 db below maximum rated power. Channel separation, better than 40 db between 50 and 10,000 cps. 4 inputs for stereo or monophonic programs, for ceramic or crystal phono cartridges and for AM or FM tuners. 8-ohm outputs for single or double operation.

audiophile net with enclosure **\$3495**



SONIC CUSTOM-CRAFT S-200 High fidelity 12 watt stereo, master control center and dual amplifiers, provides full dimension stereo reproduction. 6 watts-per-channel develops 24 watts of peak power. Frequency response, flat within 1.5 db from 50 to 15,000 cps. Total harmonic distortion, less than 2% at full rated output. Minimum separation between channels, 37 db from 10 to 15,000 cps. Stereo or monophonic inputs for ceramic or crystal phono cartridges, tuner, and tape recorder. Internal audible stereo test signal, for adjusting channel and speaker balance, as well as speaker phasing. 9 separate controls — balance, loudness-contour, tandem bass, tandem treble, tandem volume, program, system selector, power, channel reverse. 4, 8 and 16 ohm outputs for single, double, or triple-channel operation.

audiophile net with enclosure **\$4995**



SONIC CUSTOM-CRAFT 19 FM-AM TUNER Supersensitive tuner features drift-free automatic frequency control performance and 3-gang tuning capacitor for optimum selectivity. Sensitivity — FM 5 μ v for 30 db quieting, AM 200 μ v per meter for 20 db S/N ratio. Distortion — FM 1.5% total harmonic at rated output. Selectivity bandwidth at 6 db point — FM 200 kc, AM 9 kc. Noise level — FM less than 55 db below 100% modulation at 1 volt output, AM less than 45 db below 30% modulation. Audio frequency response — FM ± 2 db of standard de-emphasis curve, AM 20 to 9,000 cps. Function switch AM, FM or FM-AFC. Standard FM 300 ohm balanced-input antenna terminals. Built-in ferrite rod AM antenna.

audiophile net less cabinet **\$7995**

MODEL 19C with handsome genuine mahogany cabinet, audiophile net \$99.95

Hear Sonic stereo components at your local hi-fi dealer today, or write
SONIC INDUSTRIES, INC., 19 WILBUR STREET, LYNBROOK, NEW YORK

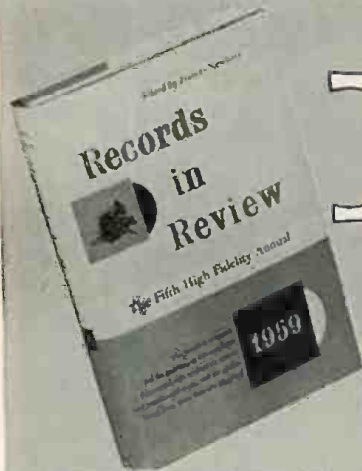

INew

5TH

HIGH FIDELITY ANNUAL

RECORDS IN REVIEW 1959

Save a full dollar by taking advantage of this special prepublication offer to HIGH FIDELITY readers.

Here is the most important and practical book a record and tape collector can own. It will save you money... save you time... save you frustration—insure your building an outstanding library of recorded music that will bring you and your family maximum listening enjoyment for years and years.

It's the fifth *High Fidelity Annual—Records in Review 1959*—containing reviews of classical and semiclassical music, and the spoken word, that appeared in *High Fidelity* from July 1958 through June 1959.

Records in Review 1959 is the most complete and authoritative book of its kind published.

1. Brings you lively, informative reviews of approximately 1,000 releases—disc and tape, mono and stereo.
2. Reviews are by *High Fidelity's* staff of eminent critics—each an expert in his particular field.
3. Reviews cover the merits of performance, the quality of recording... and make comparative evaluations with releases of previous years.

Records in Review 1959 is convenient to use, too. Reviews are organized for quick, easy reference—alphabetically by composer. And there's a special performer index included.

Records in Review will be published November 15th and sell in book stores for \$5.95. But you can order copies now—for delivery the minute books come off the press—at the special prepublication price of only \$4.95 each. At this low price, you'll want to order extra copies, too—*Records in Review* is an ideal Christmas gift for every disc and tape collector on your list!

Satisfaction Guaranteed... or Your Money Back!

THE WYETH PRESS • The Publishing House • Great Barrington, Mass.

I enclose \$_____ for which please send me _____ copies of the new RECORDS IN REVIEW 1959 at the special prepublication price of only \$4.95 each. (No C.O.D.'s or charge orders please.)

NAME _____

ADDRESS _____

CITY _____

ZONE _____

STATE _____

Foreign orders sent at buyer's risk. Add 25¢ per book for postage on foreign orders except Canadian. This offer is good only until November 15th, 1959.

jondo, conveys perfectly the play's aura of doom, vengeance, and ultimate futility. Gomez fills out the overture with several short compositions of his own as well as works of Sor, Tarrega, and his West Coast colleague, Victor Young. Lustrous sound.

"The Swinging Leny Eversong." Leny Eversong; Pierre Dorsey and His Orchestra. Seeco CELP 435, \$3.98 (LP). Big sound, big songs, and a big woman with a big voice make—you guessed it—a big record. Brazilian Leny Eversong, a 280-pound bleached blonde, sings here in four languages. Her voice—deep, rich, powerful—swings in a subtle approximation of jazz that imparts new colors and new depths to international hits like *Granada*, *Fascination*, and *In My Solitude*. While superficially the two have little in common, I think that admirers of Mahalia Jackson would readily appreciate the Eversong style. Lucid, well-balanced engineering. Audition this one: you won't regret it.

"Continental Visa Renewed." Raoul Meynard and His Orchestra. Warner Bros. WS 1320, \$4.98 (SD).

Once again Meynard displays his ability to impart a new flavor to seasoned international staples. Although his arrangements are as ornate as the genre seems to demand, Meynard focuses attention upon both the melody and spirit of a song. He offers nothing profound, but his music is eminently listenable, particularly in the full, three-dimensional sweep of Warner Brothers' stereo.

"Latin Love." Bob Bain, guitar. Capitol T 1201, \$3.98 (LP).

A *tour de force* for Bob Bain who, by the process of multiple recording, strums two-guitar versions of standard Latin favorites—*Bésame Mucho*, *Perfidia*, *Brazil*, etc. Refreshingly enough, Bain concentrates upon melody and subtle harmony; while he by no means ignores rhythm, he does not subordinate every other musical value to it. In these days when every Mudcat Band north of Yucatan whips these songs into a cha-cha-cha frenzy, Bain's lyrical approach is doubly enjoyable. Clear, close sound.

"Songs of the British Isles." Norman Luboff Choir. Columbia CL 1348, \$3.98 (LP).

Norman Luboff's talented vocal ensemble is Columbia's answer to RCA's Robert Shaw and Capitol's Roger Wagner. Luboff's latest essay—in the realm of English, Scottish, and Welsh ballads—is suave, shimmering, and sumptuously recorded. As with many of this conductor's finest arrangements, several on this release (among them, surprisingly but effectively, *The Girl I Left Behind Me*) are redolent of a fugitive melancholy that deepens their appeal. The performances are uniformly superior.

"Cavallaro with That Latin Beat." Carmen Cavallaro, piano; instrumental ac-

Continued on page 112

Early American Model,
in fruitwood,
30" wide, 21 1/4" high, 13 1/2" deep,
\$279.95 user net.



Furniture courtesy of Loxipero Inc.



Containing two complete multi-speaker systems in one compact enclosure, the 'Trimensional' TMS-2 projects frequencies of both channels to the rear and side walls of the room. Thus, one large wall area becomes channel A; another channel B... exactly as if you had a series of widely distributed speakers for each channel.

TMS-2... most sensational advance in stereo reproduction

When you listen to the TMS-2, you will experience stereophonic reproduction that no conventional system can ever achieve. Its entirely new principle of operation permits every listener *throughout* the room to enjoy fully balanced sound with such extraordinary breadth and three-dimensional depth that it seems to originate beyond the confines of the room itself. Full controls and adjustable doors allow the 'Trimensional' TMS-2 to be placed *anywhere* — along wall or corner — without affecting its performance capabilities. The full TMS-2 story is a fascinating one. Write for it today.



Furniture courtesy of Jens Risom Design Inc.

Contemporary Model,
30" wide, 25" high, 12 1/2" deep.
In mahogany — \$258.00,
in blond or walnut — \$263.00 user net.

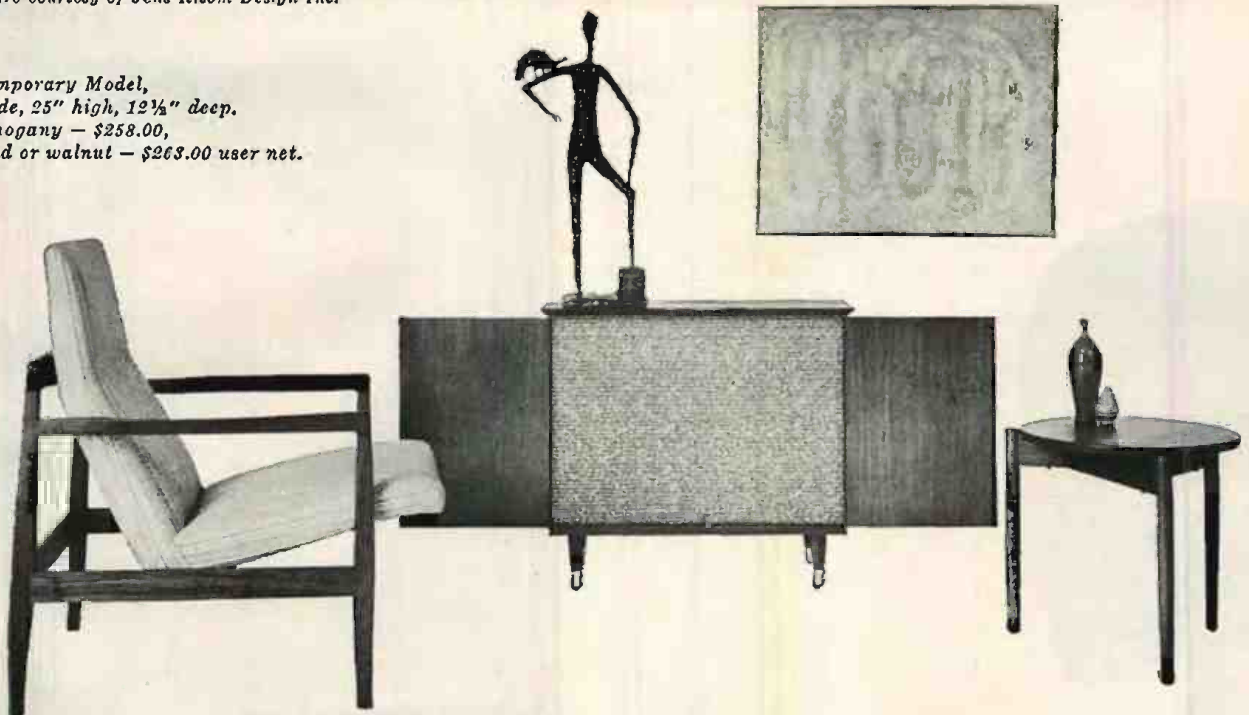

WRITE DESK P-6, UNIVERSITY LOUDSPEAKERS, INC., WHITE PLAINS, N. Y.

companiment. Decca DL 8864, \$3.98 (LP).

Backed by a solid-sounding quartet, Carmen Cavallaro caresses the ivories with his habitual good taste. The emphasis here is on variegated Latin rhythms—nothing new, God knows—but Cavallaro takes on the assignment with zest, romping through *La Cumparsa*, *Frenesi*, and *Green Eyes* as though they were as fresh as this morning. A sophisticated pianist, he provides a full measure of entertainment, and Decca's engineers have miked him with crisp clarity.

"Russian Songs and Dances." Chorus of the Volga and Ensemble of Folk Instruments, P. Miloslavov, cond. Monitor MF 319, \$4.98 (LP).

Still another Russian assemblage displays the power and vitality of their Moisheyev and Beryozka cousins. All of the Volga group's choral works have as their subject the great river and its hinterland; all are as deep and rolling as the stream itself. Notably, *The Broad Steppe* is at once lovely and vigorous, while the chorus' *a cappella Song of the Volga Boatmen* transforms that chestnut into a magnificent listening experience. The sound is perfectly acceptable, but somewhat brassier than Monitor has heretofore derived from Soviet tapes. Russian and English texts provided.

"Captivation." The Outriggers. Warner Bros. WS 1314, \$4.98 (SD).

"The 50th State." Charles Bud Dant, His Chorus and Orchestra. Coral CRL 57270, \$3.98 (LP); CRL 757270, \$4.98 (SD).

"R.S.V.P." The Invitations; Russ Garcia and His Orchestra. Liberty LST 7117, \$4.98 (SD).

"My Hawaii." Ed Kenney; Luther Henderson and His Orchestra. Columbia CL 1333, \$3.98 (LP).

If Hawaiian statehood has served no other purpose, it has at least given every islander who can carry a tune, sound an A, or scrape a gourd the opportunity to cut a disc for a mainland label. Leading off this month's batch of musical *poi* are Warner Brothers' Outriggers, a rather conventional, but extremely capable, rhythm and steel guitar combo. Their well-rounded repertory includes *Blue Hawaii*, *The Hukilau Song*, and *Lovely Hula Hands*. Superior sound save for small-scale shattering in the high frequencies.

Also in stereo (as well as monophonic), and more cleanly engineered, is Coral's *The 50th State*. Maestro Dant's choristers do a bouncy job on both *Pagan Love Song* and *Hawaiian War Chant*, but their accents are of Ohio rather than Oahu. Unfortunately, the program features several potboilers—*Hawaii Is the 50th Star*, etc.—that must have been knocked out in the first twenty minutes of statehood.

Another robust-sounding two-channel disc, Liberty's *R.S.V.P.*, introduces *The Invitations*, a Hawaiian vocal quintet that, in general, sings with the naïveté of

a college group. Occasionally, however—as in the introduction to *Ka Makani Kaili Aloha*—they evince a genuine potential.

Perhaps the gem of the lot is Columbia's *My Hawaii*, featuring Ed Kenney, star of Broadway's *Flower Drum Song*. A native of Hawaii, Kenney intersperses his songs with authentic chants. In true island songs, such as *Liliu E* and *Kalalea*, Kenney's flexible baritone and command of the idiom merit a *lei*, but he becomes downright saccharine in the likes of *Sweet Leilani* and the ubiquitous *Blue Hawaii*. Fine, full-bodied sound throughout.

"Folk Songs from the Philippines." Bernabe Roxas Solis and group, featuring Corbelita Astraquillo and A. Caviles, Jr., soloists. Ultra 334-1, \$4.98 (LP).

One defect prevents this record from being outstanding. The songs themselves are little known and stunningly melodic. The Solis Group performs with sure skill, and the soloists—particularly Miss Astraquillo in the haunting *Ang Dalagang Bukid*—are excellent. An accompanying booklet contains full texts and translations of the songs. All in all, a rare combination of diligence and artistry. However—and this is a king-sized however—the engineer has betrayed the entire proceeding: the reproduction is lamentable, with distortion throughout its entire range. Barely tolerable on good equipment, the disc gains acceptability on medium- and low-fi systems, which tend to blur its shortcomings.



LANIN

A CHRISTMAS DANCE PARTY
—Lester Lanin LN 3617 BN 547*

NEW POPULAR RECORDINGS*
HYMN SING WITH THE MARINERS
LN 3615 BN 545*

BAVARIAN POLKA PARTY—Theo Fersil and
his Orchestra LN 3618 BN 548*

GYPSY FIRE—Veres Lajos and
his Orchestra LN 3616

MONSIEUR GEORGES BRASSENS SINGS
—with his Guitar LN 3619

JAMAL

THE PIANO SCENE
—Ahmad Jamal LN 3631

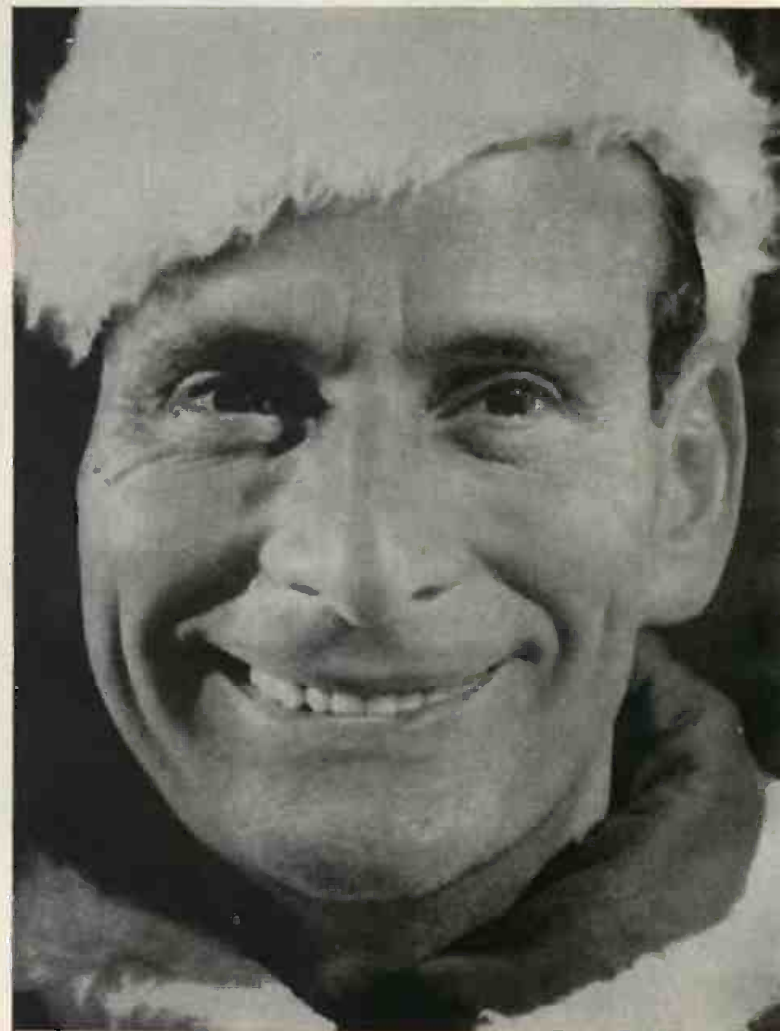

"Not Too Seriously." Mira, accompanying herself on the guitar. Ultra 334-2, \$4.98 (LP).

Mira precedes each of her seventeen ballads (sung in twelve-count them—reasonably fluent languages) with a spoken précis of the content. It's a good idea, although the singer tends to overdramatize the import of her material. Unfortunately, Mira's vocal gifts equal neither her linguistic accomplishments nor her diligence as a collector of songs. Her soprano wobbles—sometimes rather badly. Still, her enthusiasm and sincerity along with the outstanding songs she has gathered on this disc—e.g., the Spanish *El Vito*, the Hebrew *Lo Va Yom*, the Russian *Och Ti Sertze*—merit attention. The sound is harsh and lacks definition.

"Reveillon No Estoril." Line Renaud; Orchestra. Pathé ATX 130, \$5.95 (LP). This release, taped during actual performance in Portugal, documents Line Renaud's appearances in Estoril. The French thrush is her usual vivacious self, although her songs—all French, incidentally, despite the album's Portuguese title—are second-rank. There is applause *ad nauseam*, and Mlle. Renaud engages in some odd antics with her audience. Pathé's engineering is excellent, but this disc is limited in appeal (as well as content—a skimpy nine songs). Few beside the vocalist's most ardent *aficionados* would play it more than once.

O. B. BRUNMELL

hi-fi music

"March Steps in Stereo." Warner Brothers Band, Henry Mancini, cond. Warner Bros. WS 1312, \$4.98 (SD).

That the versatile Mr. Mancini has not been beguiled by his "Peter Gunn" successes into abandoning his first love, the military band, was indicated just a year ago in his "Sousa in Hi-Fi" program and confirmed now in the present miscellany of favorite American (*National Emblem*, *American Patrol*, *On the Mall*, *Marines' Hymn*, etc.) and European (*Colonel Bogey*, *Under the Double Eagle*, and *Entry of the Gladiators*) marches. These too are all played with indefatigable vigor, zip, and drive in ultrabright, widespread, and rambunctious stereoism.

"Operatic Highlights for Orchestra, Vol. 5." London Symphony Orchestra, Pierino Gamba, cond. London CS 6087, \$4.98 (SD).

I lost touch with this series soon after its debut nearly a decade ago, but the latest example gives impressive testimony that its high technical standards are still rigorously maintained in stereo notable for its wide dynamic range, beautifully blended channels, and warm, natural acoustics. The present program also is interesting

for its frankly Italianate readings, more fervently emotional than we usually hear, of such war horses as the *Traviata* Preludes, *Cavalleria rusticana* Intermezzo, *Vespro Siciliani* Overture, and *Gioconda* Dance of the Hours—and for the one-time child-prodigy conductor Pierino Gamba's inclusion of the less familiar melodramatic *Cleopatra* Overture by Mancinelli and the old-fashioned romantic *Notturmo* by Martucci (although the last-named work is scarcely "operatic" except in its rich songfulness).

"Persuasive Percussion." Terry Snyder and the All Stars. Command RS 800 SD, \$5.98 (SD).

This new label's debut in the audiophile-showpiece stakes certainly lives up to its name with its arresting black-and-white dotted cover and the bold claims of its album notes for the dynamic channel-balancing and transient-response-checking virtues of its contents. And the fancy Lew Davies novelty arrangements not only effectively exploit the extraordinarily (even in these days) wide dynamic frequency range and marked channel differentiations of the recording, but also—with the help of dramatic channel switching—do indeed provide useful and rigorous playback system tests.

The performances themselves are mostly overheard and glassily brilliant, but the driving versions of *I Surrender Dear*, *I Love Paris*, *Tabu*, and *Japanese Sandman* in particular do have considerable zest as

THE WORLD OF WONDERFUL MUSIC IS YOURS ON EPIC RECORDS



© "Epic" Marca Reg. "CBS" T.M. A PRODUCT OF CBS

NEW CLASSICAL RECORDINGS

- SCHUMANN: Symphony No. 1 in B-Flat Major, Op. 38 ("Spring") • Manfred Overture, Op. 115—The Cleveland Orchestra; George Szell, Conductor LC 3612 BC 1039*
- CHOPIN—Concerto No. 2 in F Minor for Piano and Orchestra, Op. 21 • Polonaise—Fantasia in A-Flat Major, Op. 61—Uninsky, Piano; Hogue Philharmonic Orchestra; Van Otterloo, Cond. LC 3610 BC 1037*
- SCHUBERT—Sonatina in D Major for Violin and Piano, Op. 137, No. 1 Sonatina in A Minor for Violin and Piano, Op. 137, No. 2 Sonatina in G Minor for Violin and Piano, Op. 137, No. 3 Sonata in A Major for Violin and Piano, Op. 162 ("Duo") —Grumiaux, Violin; Castagnone, Piano LC 3609
- The Romance of the Piano—Hans Richter-Haaser, Piano LC 3620
- HANDEL—Dettingen Te Deum—Netherlands Bach Society LC 3640 BC 1042*

BRANDENBURGS

BACH—Brandenburg Concertos (Complete) —Netherlands Chamber Orchestra; Goldberg SC 6032 BSC 105*

Also available as singles:
Volume I (Concertos 1, 2, 3) LC 3604 BC 1043*

Volume II (Concertos 4, 5, 6) LC 3605 BC 1044*

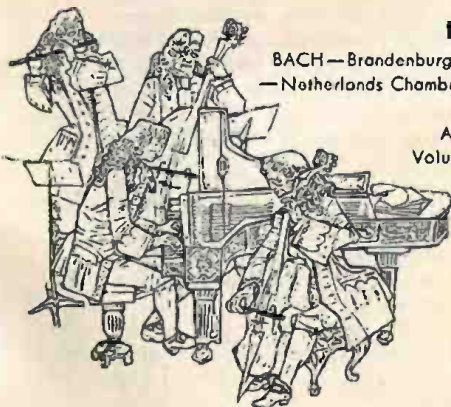

FLEISHER

- BEETHOVEN—Piano Con. No. 4 in G Major / MOZART—Piano Con. No. 25 in C Major—Fleisher; CLO; Szell LC 3574 BC 1025*
- MOZART—Sonata in C Major (K. 330) Sonata in E-Flat Major (K. 282) Rondo in D Major (K. 485) Leon Fleisher, Piano LC 3584
- DEBUSSY—Suite Bergamasque / RAVEL—Sonatine; Valses Nobles et Sentimentales; Alborada del Gracioso—Fleisher LC 3554

*Stereorama

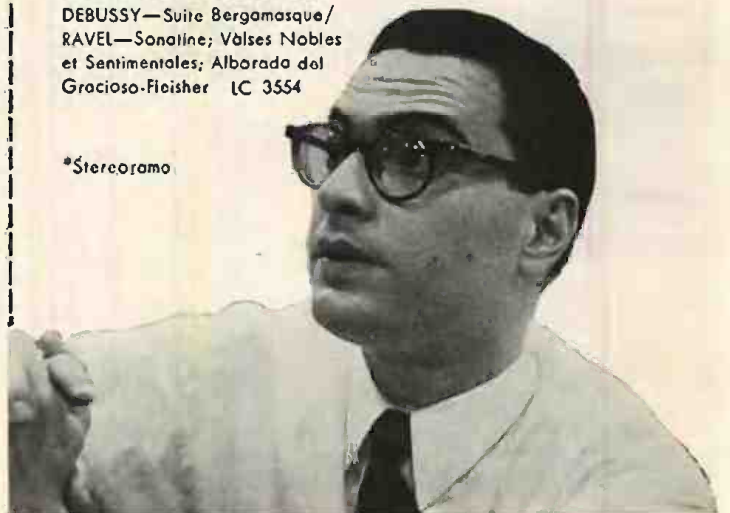



8 Wonderful Gift Suggestions for Record and Tape Recorder Owners

ROBINS

RECORD AND TAPE KARE KITS

When you're out gift shopping for yourself or for someone else, if love of good music on either tapes or records is a consideration, these Robins Record Kare Kits and Tape Kare Kits are the ideal gift solution.

ROBINS ENGINEERED SOUND RECORD KARE KITS

The finest record reproducing system — stereo or hi-fi — will sound even better if you pay attention to the little details — for example — dirt on the record or dirt on the stylus causes both record and stylus wear; an uneven turntable causes the stylus to favor one side of the groove wearing out the groove and the stylus; too much stylus pressure causes record wear, too little distorted performance. These Robins Engineered Sound Kits are dedicated to taking care of the little things that spell hours of additional enjoyment of your treasured records.

DELUXE ENGINEERED SOUND RECORD KARE KIT ESK-3 only \$5.00 LIST

Contains Stylus Pressure Gauge, Stylus Microscope, Turntable Level, Jockey Cloth, Klee-Needle Needle Brush, Record Brush, Tone Arm Lift.

PROFESSIONAL ENGINEERED SOUND RECORD KARE KIT ESK-2 only \$3.00 LIST

Contains Stylus Pressure Gauge, Stylus Microscope, Turntable Level.

HOBBYIST ENGINEERED SOUND RECORD KARE KIT ESK-1 only \$2.00 LIST

Contains Stylus Pressure Gauge, Turntable Level.

ENGINEERED SOUND TURNTABLE LEVELING KIT ESK-4 only \$3.50 LIST

Contains four adjustable rubber feet and mounts for use under base of turntable. The circular 4-way spirit level can be mounted permanently on top of the base or cabinet housing the turntable. Tells you at a glance when your turntable is not level.

ROBINS GIBSON GIRL * TAPE KARE KITS

Every tape recorder owner will welcome these attractive, practical tape care kits that are a must for distortion-free stereo and monophonic tape recording reproduction. They contain all the necessary accessories for increased tape recording enjoyment and longer life of your treasured tapes and equipment. The nominal cost of these kits — there's one for every pocket-book — will be repaid many times by the recording pleasure and protection it affords your equipment and tapes.

ROBINS GIBSON GIRL * TAPE KARE KIT TK4-STD

Contains: Gibson Girl Standard Splicer for quick precise professional splicing and editing. Splicing Tape for long lasting splices. Tape Threader for quick easy handling of tape. Head Cleaner protects both tapes and equipment by removing dirt and grime accumulated oxides from head. Tape Cleaning Cloth cleans, lubricates and protects with microscopic film of Silicone on tapes. Tape Clips keep tapes from unwinding. Reel Labels perfect way to identify and catalog your tape library. Tape Editing Book tips on editing and splicing help you obtain optimum performance. Only \$12.00 list.

ROBINS GIBSON GIRL TAPE KARE KIT TK4-JR

Contains: Gibson Girl Junior Splicer, Splicing Tape, Tape Threader, Head Cleaner, Tape Cleaning Cloth, Tape Clips, Reel Labels, Tape Editing Book. List only \$10.00.

ROBINS GIBSON GIRL TAPE KARE KIT TK-4H

Contains: Gibson Girl Hobbyist Splicer, Tape Cleaning Cloth, Splicing Tape, Tape Clips, Tape Editing Book. List only \$3.50

ROBINS TAPE KARE KIT TK-2

Contains: Head Cleaner, Tape Cleaning Cloth. List \$2.00.

* Tm. reg. patent No. 2778420, pats. pending.

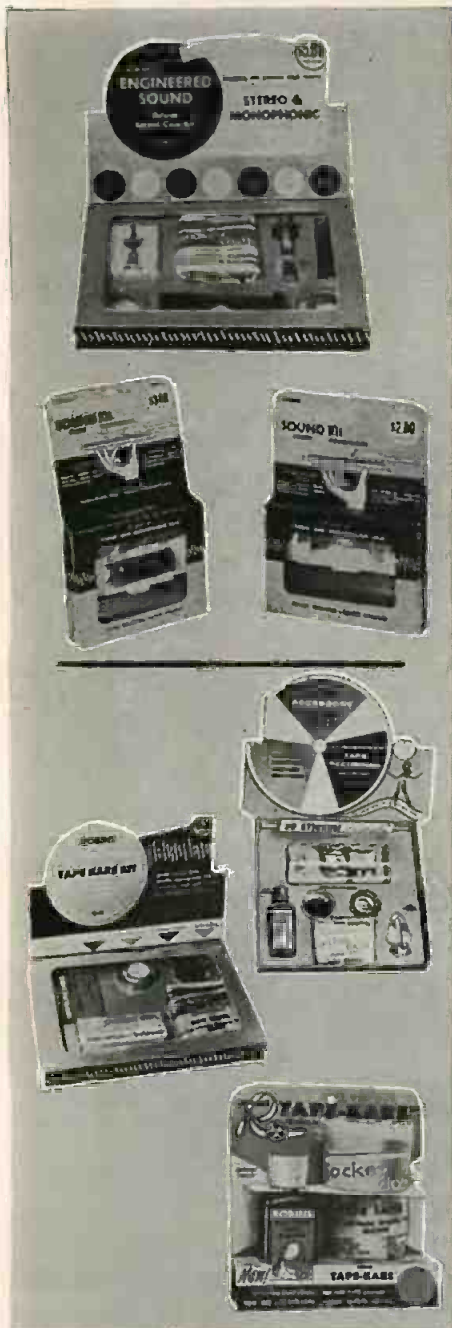

Available at dealers everywhere. Write for FREE new catalog.

ROBINS INDUSTRIES CORP.

36-27 Prince Street, Flushing 54, N. Y.

3219

well as ultrarealistic and transient-rich scratcher, cowbell, drum, marimba, and especially Chinese bell-tree sonics (along with those of a far less attractive accordion, electronic organ, and electronic guitar). Among these infinite varieties of jingle-jangle, the omnivorous sound fancier will certainly find a few new sonic titillations.

"Bahia." Arthur Lyman Ensemble. HIFI Record R 815, \$4.95 (LP); SR 815, \$5.95 (SD).

The fifth in Lyman's best-selling series proves that his particular mine of Hawaiian exoticism is far from exhausted and that his engineers are still discovering new ways to exploit the superb acoustics of the Kaiser Aluminum-Dome auditorium and the transient-rich sonorities of vibes, marimba, bongo drums, etc. Of the dozen present examples, the most captivating are the jangly *Jungle Jalopy*, glittering *Mau Chimes*, catchy *Tropical*, and clattering *Busy Port*, but the eight others all have considerable sonic—if minimal musical—interest, especially in the atmospheric and antiphonal stereo version.

Scots Guards Regimental Band and Massed Pipers: "Hi-Fi in the Highlands"; "Marches for Pipes and Drums." Angel S 35464 (SD); S 35774 (SD); \$5.98 each.

I'm afraid I have to take even the best examples of unleavened bagpiping (and the present one, S 35774, surely tops them all in pipe-and-drum-timbre authenticity and expansive out-of-doors stereoism) in mercifully limited doses. I can assure non-Sassenach connoisseurs, however, that this disc is the closest home-reproduction yet of the unique Gaelic march music. S 35464, with only four short bands of piping, is more suitable for general recommendation, for although the Regimental Band's present marches are musically less interesting than those in previous Scots Guards releases, there is the irresistible attraction of a splendid Fantasy on Kennedy-Fraser's *Songs of the Hebrides*, as well as the delight of ringing sonorities captured in stereo even more impressively than in the LP.

"The Golden Touch of Frank Cammarata at the Organ." ABC-Paramount ABC 302, \$3.98 (LP).

For all some seemingly inescapable throb and thud, the tonal qualities of the Conn "Classic" instrument are far less synthetic-sounding than most others of their kind, and Cammarata displays a tasteful choice of registrations, exceptionally light touch, virtuosic éclat, and imaginative programming. In addition to the expected pops standards (topped by a frisky *Nola* and infectious *Miserlou*), he brings genuine verve to his ingenious arrangements of the Brahms Fifth *Hungarian Dance*, Sarasate *Zigeunerweisen*, and (most effectively of all) a sparkling transcription of the Scherzo from Kabalevsky's *Comedians*—all of which are cleanly and attractively, if somewhat dryly, recorded.

Buying a Tape Recorder?

If so, you'll want a copy of the 1959-60 Tape Recorder Directory — just off the press. Its 28 pages list virtually every tape recorder sold in the U.S.—a total of 324 models from 64 manufacturers. Data on each model includes list price, frequency response, speeds, wow and flutter, signal-to-noise ratio and many more mechanical and electronic specifications.

The Tape Recorder Directory is published by Audio Devices—makers of Audiotape, the world's finest magnetic recording tape—to help you select the tape recorder best suited to your needs. To get your copy, send only 10¢ (to cover the cost of mailing and handling) to Audio Devices, Inc., Box AR, 444 Madison Avenue, New York 22, N. Y.

audiotape

Manufactured by **AUDIO DEVICES, INC.**
444 Madison Ave., New York 22, New York
Offices in Hollywood & Chicago



"Exotica, Vol. 3." Martin Denny Ensemble. Liberty LST 7116, \$4.98 (SD). There is still a good deal of cocktail-hour sentimentality in the latest installment of Denny's "Exotica" series, as well as insensate plugging of jungle effects, but there also is far richer atmospherism in the present *Harbor Lights*, a glassily piquant *Limehouse Blues*, racing *Congo Train*, and the glittering cross-channel antiphonal *Caravan*. And the markedly stereoeistic recording itself is more dazzling and smoothly spread than ever.

"Highland Pageantry." Pipes and Drums and Regimental Band of the Black Watch. RCA Victor LSP 1525, \$4.98 (SD).

Here there is certainly no indication of the brass "veiling" or "ragged edge to the wailing pipes" mentioned in the February 1958 review of the LP of this program. In the comparatively few and brief selections for pipes and drums only, the marked channel separation gives them far better, and more dramatic, tonal authenticity; while the big-band works, and especially the long and well-varied medley of Harry Lauder songs, have a fine ringing sonority in extremely broadspread stereoisim. The rollicking *Wee MacGregor* patrol piece, however, is considerably less impressive than in its memorable Scots Guards performance for Angel.

"The Singing Trumpet." Rafael Mendez; Orchestra, Russ Garcia, cond. Decca DL 8869, \$3.98 (LP); DL 78869, \$5.98 (SD).

Devotees of the virtuoso trumpet will delight in a full-length program in which one of its outstanding masters, Rafael Mendez, hogs the spotlight throughout. But neither the pops tunes (*Sleepy Lagoon*, *Body and Soul*, etc.) he embellishes here, nor his transcriptions ("*Un bel di*" from *Madama Butterfly*, *Les Filles de Cadiz*, and the Waltz from Tchaikovsky's *Serenade for Strings*) are really suitable materials for such unabashed floridity; and his own three pieces in Spanish style are only blandly sentimental when they are not pretentiously showy. But at least the closely miked, strongly stereoeistic recording realistically captures the solo instrument's plangent brilliance and (here) limited coloristic variety. The LP version is also clean and brilliant, but considerably more constricted sonically.

"German Overtures." Orchestra of the German Municipal Opera, Artur Rother, cond. Telefunken TC 8020, \$1.98 (LP); TCS 18020, \$2.98 (SD).

There is excellent musical value here, especially in the first stereo version of Gluck's *Iphigénie en Aulide* Overture (Wagner concert edition), which is played with noble dramatic breadth and power, and in the well-controlled and animated performances of Weber's *Oberon* and Nicolai's *Merry Wives of Windsor* (the Humperdinck *Hänsel und Gretel* is rather too stolid for my taste). But the technology is less satisfactory, for in the rather exaggerated and separated stereoisim, occasional woodwind soloist spotlighting, and overdry acoustics, the or-

Own a Tape Recorder?

If so, you'll want "Blood-and-Thunder Classics," a 7" reel of musical excitement that belongs in every tape library. The program includes seven great passages of fine classical music—selected for their emotional impact—totaling a half-hour of rich stereo or a full hour of dual-track mono sound, both at 7½ ips.

This exciting recording is available in a special bonus package that contains one 1200-foot reel of Audiotape (Type 1251, on 1½-mil acetate base) and the valuable "Blood and Thunder Classics" program (professionally recorded on standard Audiotape). For the entire package, you pay only the price of two boxes of Type 1251 Audiotape, plus \$1. See your Audiotape dealer right away. Or write to Audio Devices, Inc., Box AR, 444 Madison Ave., N. Y. 22, N. Y.

audiotape

Manufactured by **AUDIO DEVICES, INC.**
444 Madison Ave., New York 22, New York
Offices in Hollywood & Chicago



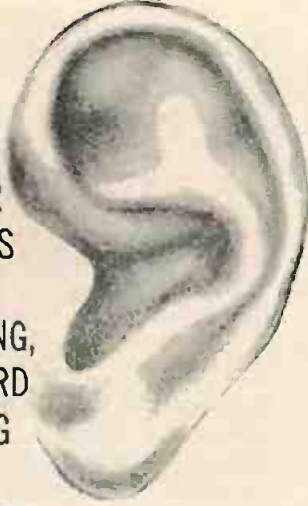

THE EAR
THAT HAS
HEARD
EVERYTHING,
HAS HEARD
NOTHING
UNTIL
IT HEARS

SHOSHANA DAMARI

Israel's greatest singing star brings you two unusual albums filled with romance and mysticism. Shoshana Damari who represented Israel at the Brussels World Fair has just completed a starring role in "Hatikvah," Israel's first technicolor film.



SEECO RECORDS, 39 W. 60 ST., N.Y.C.

a New World of Sound...

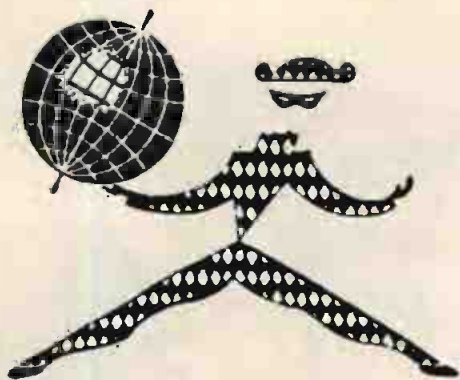

DECCA

Records

chestral sonics seem thinned out and lacking in depth and warmth; while in monophony the *ff* high strings are stridently sharp-edged.

"Subliminal Sounds." Leo Diamond and his Orchestra. ABC-Paramount ABC 303, \$3.98 (LP).

The title is apparently metaphorical—or if there is any concealed message here, it's just too subliminal for me to catch. And "orchestra" too is stretching things a bit since, besides a rhythm section, the ensemble consists mainly of harmonicas and what the notes describe only as "kinstruments" (how many players are actually concerned beyond the multi-dubbed Mr. Diamond himself is not clear). But at any rate the potentialities of harmonica timbres are exploited and transformed beyond belief—and perhaps need. The tunes are mostly pops standards, but in their present traumogrifications they—and Diamond's own four originals—become true sonic curios.

"Pops Caviar." Boston Pops Orchestra, Arthur Fiedler, cond. RCA Victor LSC 2202, \$5.98 (SD).

Although quite obviously not of the latest vintage, the recording here was considered outstanding when it first appeared monophonically a year and a half ago, and it now benefits considerably, especially in its reverberant big-hall acoustics, from the present unexaggerated stereoism. The performances, however, which alternate violently between overexpressivity and slambang vehemence, do better justice to the Pops Orchestra's bravura than to Rimsky-Korsakov's *Russian Easter Overture*, and Borodin's *In the Steppes of Central Asia*, *Prince Igor Overture* and *Polovtsian Dances*.

"You Ain't Heard Nothin' Yet!" Warner Bros. XS 1307, \$1.98 (SD).

As befits its Hollywood origins, Warner Brothers' demo-sampler is the brassiest yet. Its introductory "Cavalcade of Sound" enlists no less than four film and TV stars as cross-channel narrators (Efrem Zimbalist, Jr., Roger Smith, James Gardner, and Edd "Kookie" Byrnes) and recounts the history of sound recording from the first "talkie," *The Jazz Singer* (produced by guess who), to the stereo of today; following which the latter is illustrated without commentary, by some dozen examples of current WB pops releases, all of them recorded with extreme brilliance and channel separation.

"Bouquet." Percy Faith Strings. Columbia CL 1322, \$3.98 (LP).

Even in LP, Faith's forty-eight strings (plus harp, piano, guitar, and vibraphone) are Mantovanian-lush in elaborate arrangements of the title piece and eleven other pieces of the same emotional kind. But the whistling high-string fortissimos are often almost too intense for the ultrarich and high-level recording's capacities. I suspect that the simultaneously released stereo version, which I haven't yet heard, probably handles them with less obvious strain.

R. D. DARRELL

JAZZ

"The Birth of Jazz." Folkways FA 2464, \$5.95 (LP).

The fourth volume in Samuel B. Charters' valuable "Music of New Orleans" series is colorful and has its merits but, because it contains relatively little music, it is not quite up to the level of the first three volumes. This time Charters has attempted to portray the setting in which the earliest forms of jazz were created. Louis Keppard (brother of Freddie) tries to re-create with his voice the way a 1910 New Orleans hand would play *Bucket's Got a Hole in It*; Charlie Love and Harrison Barnes recall Buddy Bolden and the Bolden band; H. J. Boiusseau describes the early days of Storyville. The only music included is Boiusseau's few rather stumbling piano solos and a rugged, intensely deliberate performance of *Maple Leaf Rag* by a group which includes Love on trumpet and Emile Barnes on clarinet. A picture emerges from this disc, but it could come as well, or possibly better (barring *Maple Leaf Rag* and Keppard's ingratiating reminiscence), from a written report of these interviews.

Count Basie and His Orchestra: "Breakfast Dance and Barbecue." Roulette 52028, \$3.98 (LP); S 52028, \$4.98 (SD).

The Basie band, playing at a dance for a convention of disc jockeys, holds to medium, easygoing tempos, skips any effort to bring forward soloists, and concentrates on the present band's superb saxophone section. The result is one of the best discs the band has turned out—relaxed, and full of some of the most stimulating saxophone ensembles recorded in recent years. Even blues shouter Joe Williams sings with some signs of sensitivity.

Buck Clayton and His All-Stars: "Songs for Swingers." Columbia CL 1320, \$3.98 (LP); CS 8123, \$4.98 (SD).

Swing, in its best sense, will apparently be with us at least as long as the Basie Alumni Association lasts. For this generally productive session, Clayton has splendid company: Buddy Tate playing tenor saxophone in a consistently strong, supple, and lifting fashion; Earl Warren, less consistent on alto but, when he is not playing too broadly, showing a hard-toned, driving style that rides with a grace suggestive of Benny Carter; Emmett Berry providing a sharp, edgy trumpet contrast to Clayton's muted delicacy; and the lusty trombone of Dickie Wells. Backed by a spirited rhythm section (Al Williams, Gene Ramey, Herbie Lovelle), the group comes out swinging brilliantly on the opening selection, *Swinging at the Copper Bar*, and maintains a good swinging pace through both sides of the disc.

Eddie Condon and His Chicagoans: "That Toddlin' Town." Warner Bros. W 1315, \$3.98 (LP); WS 1315, \$4.98 (SD).

There are a couple of subtitles on this one—"Chicago Revisited" and "In Celebration of the 20th Anniversary of the First Jazz Album Ever Recorded." It is, in effect, a re-creation of a re-creation. In 1939 George Avakian produced for Decca an album by Condon's gang, recalling the records by that group made in the late Twenties and later identified as "Chicago jazz." Now Avakian has produced another album by Condon's gang recalling both events. It boils down to performances of some sturdy tunes notable for Pee Wee Russell's breathy adventurousness in the low, quiet reaches of the clarinet, forthright, slashing tenor saxophone work by Bud Freeman, and Max Kaminsky's clean and insistent trumpet.

Miles Davis: "Kind of Blue." Columbia CL 1355, \$3.98 (LP); CS 8163, \$4.98 (SD).

The effect of Davis' association with Gil Evans shows strongly in this set. Although Davis plays here with his own sextet and without Evans' arrangements, what we hear is the pure-toned, singing Davis first defined within the guidelines of Evans' arrangements. And while these are Davis' most consistent performances yet put on a single disc, they emphasize the limitations of his present group. Davis has sketched out five attractive pieces which provide good ensemble material leading to appealing solos by himself. Bill Evans occasionally adds further solo interest on piano, but the potential effectiveness of the pieces is invariably dissipated in the course of protracted solos by John Coltrane and Julian Adderley, who move as if by instinct away from the lyricism and strong sense of form that Davis bequeaths to them in his solos.

Duke Ellington's Orchestra: "Anatomy of a Murder." Columbia CL 1360, \$3.98 (LP); CS 8166, \$4.98 (SD).

Ellington's first film score is also one of the more disciplined of his large-scale efforts. The padding frequently characteristic of his longer works is largely absent here—possibly because of the functional nature of the writing (though the functional nature sometimes makes the performances annoyingly fragmentary). There is more strong, dark, singing Ellington here than the Duke has produced in a long time, passages which can stand up with the work of the Ellington band's finest days (the Ellington band must always be considered as one of the essential elements of an Ellington composition). The band rises to the occasion, finding that blend of polish, elegance, and earthiness peculiar to the Duke or playing with a heel-kicking, joyful abandon that no other band has approached. Soloists weave in and out of the proceedings (Johnny Hodges is particularly brilliant in a strong, gutty blues), but here the Duke is not depending on his soloists to carry him. This time he is in complete control.

Duke Ellington and Johnny Hodges: "Back to Back." Verve 8317, \$4.98 (LP).

behind
every
Bogen
component
stands a
guarantee of
satisfaction



HE'S ADMIRING TWO INVEST-
ments well-made; investments
which guarantee him—and you—a world
of unending listening pleasure. The
ST442 Stereo FM-AM Tuner gives you
sensitivity and freedom from distortion
that are unequaled at its remarkable
price. It also includes a tuning meter,
provision for multiplex adapter and au-
tomatic volume control on each channel,
features usually found only in units cost-
ing much more.

Combine the ST442 with the DB212
Stereo Control Center/Dual 12-Watt

Amplifier and you have versatility and
engineering excellence that assure the
ultimate in faithful sound reproduction.
Bogen's B61 Turntable can add even
further to your complete musical enjoy-
ment. It's wonderful, too, that Bogen
components look just as handsome as they
sound. Hear them at your favorite hi-fi
dealer now.

Write for information to: Dept. HF-119,
BOGEN-PRESTO, Paramus, N. J.

A Division of The Siegler Corporation.



BOGEN

the sound way to better stereo

ST442. Sensitivity: FM: 1.5 μ V —30 db quieting at 75 ohm input. AM: 3 μ V meter, 20 db S/N. Frequency Response: FM: 20 to 13,000 cps \pm 0.5 db; AM: 20 to 4,500 cps \pm 1.5 db. Antennas: FM: built-in line antenna; AM: built-in ferrite loopstick. Tubes: 9 (plus 3 diodes). Controls: Selector, AFC out, AM, FM Tuning, Power. Price: \$149.50. Enclosure and legs: \$7.50. **DB212.** Power: 24 watts (two 12-watt channels). Response: 20 to 20,000 cps \pm 1 db. Distortion: less than 1%. Controls: Selector, Function, Speaker Inversion, Volume, Balance, Bass, Treble, HI Filter, Lo Filter, Speaker Phasing, Power. Price: \$119.95. Enclosure and legs: \$7.50. All prices slightly higher in the west.



JANUS

NEW STEREO* RELEASES!

- FST-2901—CONCERT IN STEREO
Garden Suite, William Tell, etc.
- FST-2902—BEETHOVEN
Symphony No. 1, Leonore III
- FST-2903—STRAUSS IN STEREO
Fleierhaus, Rosenkavalier, etc.
- FST-2904—MUSIC IN MOTION, Vol. 1
Lenny Herman and his band
- FST-2905—MUSIC IN MOTION, Vol. II
- FST-2906—BRAHMS
Symphony No. 1 in C Minor
- FST-2907—TCHAIKOVSKY—Symphony No. 4
- FST-2908—MUSIC IN MOTION, Vol. III
Lenny Herman and his band
- FST-2909—CONCERT IN STEREO, Vol. II
Dukas, Borodin, Moussorgsky, etc.
- FST-2910—MOON MUSIC—Lush popular tunes
- FST-2911—STEREO SAMPLER
Full tracks from FST-2901 thru 2910
- FST-2912—PICK A RALE OF COTTON
Brownie McTee—Sonny Terry Folk concert
- FST-2913—LEMONS ON THE ROCKS
Disleland Jazz ala Madelon Avenue

* also available monaurally

JANUS 1159 Broad St.
Newark 2, N.J.

RECORD AUTHORITIES AGREE... STYLUS AND RECORD LIFE DOUBLED

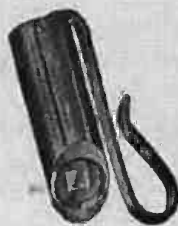

BY USE OF THE DIS- CHARGER

No More Brushing,
Spraying or Wiping
Records

LEAVES NO RESIDUE

IMITATED, BUT NOT DUPLICATED

The Discharger controls static electricity generated by your records, a static-free record stays clean, quiet, and lasts far longer. Discharger element never needs replacing.

- Clips on any arm
- Lasts indefinitely
- Weight 1/2 gram

SEE YOUR LOCAL DISTRIBUTOR OR
SHIPPED POSTPAID IN U.S.A..... \$4.50
MERCURY SCIENTIFIC PRODS. CORP.
1725 West 7th Street, Los Angeles 17, California

Two past masters of the blues, joined by trumpeter Harry Edison and a rhythm section, put an enticingly fresh look on several of the best-known commercial blues—*Wabash, Basin Street, Beale Street, Weary, St. Louis*, and *Royal Garden* plus *Loveless Love*. Hodges plays with a lean virility that he does not often have a chance to show with the Ellington band, while the Duke is continually fascinating, poking around among odd chords, drifting down sassy arpeggios, and pulling together the compelling ideas—sometimes stark in their simplicity and then again rich and steaming—so uniquely his own. Edison resorts to banal bleats from time to time but manages to play some pungent passages, too.

Gil Evans Orchestra: "Great Jazz Standards." World Pacific WP 1270, \$4.98 (LP).

Although the big-band settings that Evans has been writing for Miles Davis' Columbia recordings have become rather repetitious, his arrangements for his own orchestra on World Pacific continue to be adventurous. As he did on his first World Pacific disc, Evans has chosen a program of selections well known in jazz, both traditional and modern. But this time, instead of building around a single soloist (Julian Adderley) as he did previously, he wisely uses several featured soloists. One of the remarkable things about Evans' writing is that he gets equally good results from traditional material (*Davenport Blues* and *Chant of the Weed* on this disc) and modern (*Diango* and *Straight No Chaser*). John Coles, a trumpeter in the Davis vein, is featured on *Davenport Blues* over a lazy-daisy background that is soft but not as logy as some that Evans has written for Davis. Don Redman's old theme, *Chant of the Weed*, is ideal material for Evans, who has turned it into a clarinet showcase for Budd Johnson, normally a saxophonist, playing here with great warmth and assurance. Steve Lacey's soprano saxophone, the trombones of Curtis Fuller and Jimmy Cleveland (playing in an unexpectedly broad, smooth manner), and Evans himself on piano have other solo spots, but one's attention is always concentrated on Evans as arranger. He is quoted in the liner notes as objecting to comparisons with Duke Ellington; actually he is the only orchestrator in jazz who has approached Ellington's imaginative mixtures of tonal colors.

The Gilbert and Sullivan Jazz Workshop: "The Coolest Mikado." Anxex 26101, \$3.98 (LP); 27101, \$4.98 (SD).

As one who has objected strenuously to two recent jazz versions of Gilbert and Sullivan, I take particular pleasure in finding here some suggestion of the lightness, merriment, and melodiousness essential for such projects. Furthermore, this performance swings. Arranger Jack Fascinato obviously has some understanding of the point of the music, and his musicians—who include Milt Bernhart, John Graas, Cappy Lewis, Frank Lynn, and Bobby Gibbons—have caught and projected an apposite spirit. A Savoy-

all-new record fun

The "Conniff" shuffle beat and that Billy Butterfield trumpet. These 12 all-time favorites sound better than ever when...

CONNIFF MEETS BUTTERFIELD

Ray Conniff and his Orchestra, Billy Butterfield, trumpet. CL 1346 CS 8155 (stereo)



THE NORMAN LUBOFF CHOIR, SONGS OF THE CARIBBEAN

Norman Luboff trips to the Caribbean to bring back tantalizing island rhythms and tropical chants. It's almost like vacationing in the Caribbees. CL 1357

FABULOUS HOLLYWOOD!

The Hollywood Sounds of FRANK DeVOL and his Orchestra
Here are a dozen top Hollywood melodies (two Academy Award winners included) played by Frank DeVol (who has two Oscars to his credit) and his orchestra. CL 1371 CS 6172 (stereo)



FRANK SINATRA COME BACK TO SORRENTO

Smooth and swinging all at one time! It's Frank Sinatra singing some of the best ballads ever! CL 1359

COLUMBIA RECORDS

© "Columbia" ® Mercaz Reg. A division of Columbia Broadcasting System, Inc.

ard can listen to this disc with equanimity and even pleasure.

Wynton Kelly: "Kelly Blue." Riverside 12298, \$4.98 (LP).

Kelly plays piano both as part of a trio and with a sextet on this disc. Because he has a strongly rhythmic attack and an approach that ranges from a wide orchestral use of the keyboard to a Jamal-like suggestiveness, his trio selections have both variety and content in greater degrees than those of most of his contemporaries. He emerges equally well from the sextet surroundings, which include strong solos by Nat Adderley on cornet and Benny Golson on tenor saxophone.

Merle Koch: "Shades of Jelly Roll." Carnival 102, \$4.98 (LP).

Koch is a pianist from the West Coast who was taken to New Orleans by clarinetist Pete Fountain when the latter left Lawrence Welk to return to his home town. Although Jelly Roll Morton is the focal point of this set of solos, there is not much of Morton's style in Koch's playing. He seems to come from that midwestern line of pianists exemplified by Jess Stacy. This style he plays well on its own terms, but in a Morton context it seems pronouncedly uninflected and raggy in contrast to Jelly's more flexible, blues-touched manner. There are suggestions in some of these selections that, given a situation where he does not have to battle as formidable a shadow as Morton's, Koch can be a convincing traditionalist pianist. As it is, he comes a lot closer to the meat of Morton than does Dr. Edmond Souchon, the indefatigable New Orleans jazz buff, who tries to sing four selections.

Humphrey Lyttelton and His Band "Humph Dedicates." London LL 3132, \$3.98 (LP).

Once the leading figure in the traditional jazz revival in England, trumpeter Humphrey Lyttelton now leads an eight-piece band which is swing-based and rooted in the musical individualities of its own personnel. This disc is not a completely satisfactory representation of present-day Lyttelton, however, because its programming is derivative (it consists of tunes associated with well-known jazz groups—*Sleepy Time Down South*, *For Dancers Only*, *Marie*, etc.) even though the performances are not, and because more than half the selections are performed by expanded versions of Lyttelton's regular band. Lyttelton himself appears to have been strongly influenced by the Ellington trumpets (Cootie Williams and Rex Stewart) since he left his Louis Armstrong days behind and he is extremely effective when he is biting and slashing through a mute. However, he has sidemen who are more than a match for him—tenor saxophonist Jimmy Skidmore, who roars exhilaratingly through *Marie*; Tony Coe, an alto saxophonist who has achieved some suggestion of the floating ease of Johnny Hodges; and a brilliantly fluent baritone saxophonist, Joe Temberley. Lyttelton's octet is con-

STRAND

A DISCRIMINATING COLLECTION OF STEREO AND MONAURAL RECORDS

HANS CONRIED PETER MEETS THE WOLF IN DIXIELAND Dixieland All Stars featuring Pee Wee Erwin

Hans Conried, that learned tragedian of the TV after dark set and a success in every show business medium, takes you on a "swingin'" journey through two-beat country.... Peter, Grandpa and the Wolf become somethin' else when they knock heads with Pee Wee Erwin and the Dixieland All Stars.

SL 1001
SLS 1001 (Stereo)



LEAVE IT TO JANE ORIGINAL OFF-BROADWAY CAST

Composer Jerome Kern's early creative genius is captured with authentic period charm, in this refreshing "off-Broadway" original cast recording.... Banjos, campus cuties, and the "old college try" on songs like "LEAVE IT TO JANE," "CLEOPATTERER" and "THE SIREN'S SONG" lend a nostalgic enchantment.

SL 1002
SLS 1002 (Stereo)

STRINGS AND ALL THAT JAZZ Marv Meredith and His Orchestra

Thelonious Monk, Matt Dennis, Erroll Garner, John Lewis and other working composers are notable contributors to America's fast rising and only native art form. In a unique setting of lush strings, the truly great jazz ballads of this decade are dramatically and artfully showcased by the Marv Meredith Orchestra. ...Mood jazz for discerning moderns.

SLS 1003
SLS 1003 (Stereo)

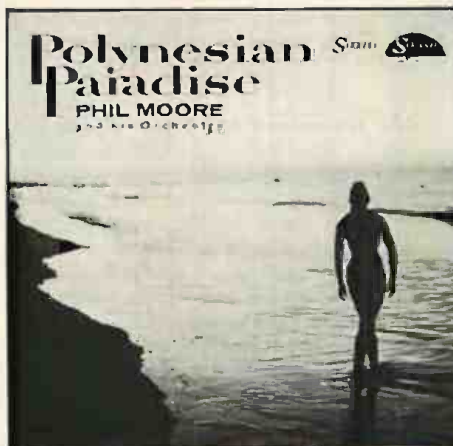

POLYNESIAN PARADISE PHIL MOORE and His Orchestra

Strand Records takes you away on an escape to a tropical holiday.... The roar of the surf and the sounds of Polynesia enhance the natural charm of island inspired music.... Phil Moore conducts a musico-geographical tour through Bali Ha'i; Polynesia and Manakoura in a setting of sensuous emotion and primitive beauty.

SL 1004
SLS 1004 (Stereo)

STRAND
RECORDS
680 5th Ave., N.Y.C.



MUSIC FROM THE WELSH MINES

"deeply felt performances by these men from the Welsh Mines who bring to their music a quality as distinctive and individual as it is well known and rightly admired" The Gramophone Record Review. WR 416

The Band and State Trumpeters of The Royal Horse Guards WR 415

Songs From Ireland, The Gunns, The Singing Family of Dublin WR 417

at better record stores or write
WASHINGTON RECORDS

\$4.98 postage paid. 1340 Connecticut Ave., N.W., Washington 6, D. C.

sistently stimulating and it is unfortunate that it has to share space on this disc with the far less satisfying larger groups.

Billy Maxted and His Manhattan Jazz Band: "Bourbon Street, Billy and the Blues." Seeeco 4380, \$4.98 (SD).

Maxted heads a septet that depends for its material on many of the standbys of traditional jazz, but his group approaches them in a smoother, less ragging fashion than one is accustomed to. He has an engaging trumpeter in Chuck Forsyth and an erratic but interesting clarinetist, Dan Tracey. But I must confess to a built-in prejudice against any record that devotes almost nine minutes to another weary march with *The Saints*.

Turk Murphy and His Band: "At the Round Table." Roulette R 25076, \$3.98 (LP); S 25076, \$4.98 (SD).

Murphy's rhythm section may be heavy, but when it gets rolling you really know there's something pushing the band. This disc is made up of the now standard assortment for Murphy of jazz tunes from the Twenties and originals. Bob Helm's clarinet enlivens most of the selections, and a girl vocalist, Pat Yankee, tackles a couple of Bessie Smith numbers with commendable energy and seemingly with an equally commendable lack of illusion that she can hope to copy the Empress of the Blues.

George Russell and His Orchestra: "New York, N. Y." Decca DL 9216, \$4.98 (LP); 79216, \$5.98 (SD).

The musical portrait of New York—which almost always emerges as a chromium, sound-track sound with generous helpings of *Manhattan Tower* and *The Sidewalks of New York*—is tackled from a new angle by composer-arranger George Russell. He uses three familiar tunes (*Manhattan*, *Autumn in New York*, *How About You*) along with three of his own compositions as the basis for a tour of the city presented in modern jazz terms, a tour guided by a commentary couched in hip terms and briskly delivered by Jon Hendricks. Russell's music is fresh and often diverting, and he gets some excellent solo performances from Bill Evans, Bob Brookmeyer, and John Coltrane. But Russell tends to linger too long over each section, to milk it for more than it is worth. And even though Hendricks gives the commentary needed vitality, it has a narrow and self-conscious outlook.

Teddy Wilson and His Trio: "Gypsy in Jazz." Columbia CL 1352, \$3.98 (LP); CS 8160, \$4.98 (SD).

The life-giving qualities of Teddy Wilson's piano have rarely been better shown off than on this disc where he coaxes some spirit and vitality from the score of *Gypsy*, a score which seems to be one of Jule Styne's more arid efforts. In a signed liner statement, Styne graciously expresses appreciation for what Wilson has done with his tunes—and well he might.

JOHN S. WILSON

TWO JEWELS

to enhance your listening pleasure

STATIC master

and your DIAMOND NEEDLE



ONLY
\$14.95

The Polonium Strip does the trick

The amazing **STATICMASTER** Record Brush operates on a simple nuclear principle. When the record is brushed, a shower of alpha particles neutralizes the static charge. Soft jaguar hair bristles provide the exact degree of stiffness to remove the static free dust and lint from the record grooves. A few circular sweeps of a rotary brush record make dust and lint vanish like magic. **STEREO AND MONORIAL RECORDS SOUND BETTER AND LAST LONGER.**

Buy **STATICMASTERS** from your local audio dealer or order direct—sent postpaid—cash with order.

NUCLEAR PRODUCTS CO.
10173 E. RUSH STREET, EL MONTE 1, CALIF

Now Available

1958

high fidelity

RECORD REVIEW

INDEX

A complete index to all classical, semiclassical, jazz, and spoken word record reviews which appeared in *HIGH FIDELITY Magazine* in 1958.

Arranged alphabetically by composer or by collection-title, with the issue and page on which you will find the review you wish.

ONLY 65¢ EACH

1954, 1955, 1956 and 1957 Indexes also available at 50¢ per copy.

HIGH FIDELITY Magazine
Great Barrington, Mass.

Enclosed find..... Please send me
..... copies of the 1954 Index
..... copies of the 1955 Index
..... copies of the 1956 Index
..... copies of the 1957 Index
..... copies of the 1958 Index

Name.....
Address.....

No C.O.D.s or charge orders please

HIGH FIDELITY MAGAZINE

Introduce
YOUNG Listeners
to the **Old Masters!**



"Music Masters" SERIES

Educational, entertaining, exciting! The life stories and the music of the great composers...only \$4.98 for each 12" VOX Ultra High Fidelity monophonic recording!

BACH	MM 3500
BEETHOVEN	MM 3600
BERLIOZ	MM 3640
BRAHMS	MM 3580
CHOPIN	MM 3520
STEPHEN FOSTER & SOUSA	MM 3620
GRIEG & SCHUMANN	MM 3550
HANDEL	MM 3560
HAYDN	MM 3610
LISZT & PAGANINI	MM 3630
MENDELSSOHN	MM 3530
MOZART	MM 3510
SCHUBERT	MM 3540
JOHANN STRAUSS	MM 3590
TCHAIKOVSKY	MM 3570

Narrated by Arthur Hannos

Write to Dept. H for complete catalog.

VOX PRODUCTIONS, INC.

226 West 53th Street, New York 19, N. Y.

COMPLETE



REALISTIC



STEREO SYSTEM

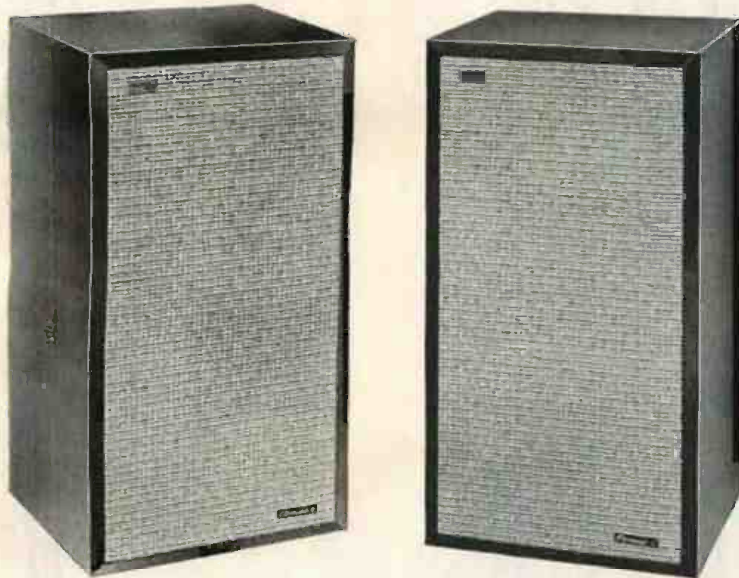

\$399⁵⁰

ONLY \$10 DOWN

REALISTIC, the name consumers and testing organizations know for "best values" in high fidelity, proudly presents the stereo summit.

Its components: Realistic's 1960 40-watt stereo amplifier hysteresis turntable and arm Electrostat-4 full-range speaker systems (two, with cabinets) and a diamond stereo cartridge, by Shure.

Here's superb equipment, so economically priced (a Realistic sine qua non) that you save fully \$300 when compared to systems offering such sonic supremacy.

- NEW REALISTIC 40-WATT AMPLIFIER actually delivers the clean watts claimed by many higher-priced unit! 40 watts monaurally (two 20-watt stereo channels) with 3200 features! Nine tubes (5 duals) plus rectifier for 14-tube performance. 20-20,000 cps \pm 1 db, 0.9% R.M.S. distortion at 400 cps. Ship. wt. 22 lbs. 12" x 4 1/8" x 9-11/16" deep, overall. \$79.50, separately. \$5 down.
- NEW REALISTIC HYSTERESIS TURNTABLE AND ARM has 4 speeds, special stereo viscous damping, simplified cartridge mounting, adjustments for arm height, position, pressure, plus "both-plane" cartridge levelling. Turntable is factory pre-mounted on 17" x 22" black mirror-finish 3/4" wood base. All fittings 14-karat gold-plated! Ship. wt. 20 lbs. \$69.50 separately. \$5 down.
- SHURE DIAMOND STEREO CARTRIDGE — famous Custom "Stereo Dynetic" .0007" diamond cartridge. Ship. wt. 1 lb. \$24, separately.
- NEW ELECTROSTAT-4 FULL-RANGE SPEAKER SYSTEMS — first and only speaker systems incorporating — and especially designed for — built-in Electrostat-3's (world's most honored tweeter!), Magnificent 3-way systems including Electrostat-3, new mid-range zone speaker, high compliance woofer, plus 3-way Crossover. Completely sealed, enclosed, fine furniture-finish cabinets (included!) 24 1/4" x 13 1/2" x 11" deep, 8 ohms. Ship. wt. 31 lbs. Separately (mahogany), \$119.50. \$5 down.

- Send FREE Bargain Bulletins, 12-month subscription FREE. . . . give you first crack at famous Radio Shack hi-fi, "ham", optical scoops!
 - Send giant 1960 ELECTRONIC GUIDE. Over 40,000 items, plus articles, illustrations, etc. 312 book-size 8 1/2 x 11 pages. Our biggest, most costly handbook ever! Only 35¢.
 - Send complete REALISTIC Stereo System @ \$399.50. Order No. 90LX118. Ship. wt. 105 lbs. Express only.
 - Send REALISTIC 40-watt stereo amplifier, 90LX023 @ \$79.50.
 - REALISTIC turntable-arm combination 90LX156Y @ \$69.50.
 - REALISTIC Electrostat-4 speaker system (including cabinet), No. 90LX243 (mahogany) @ \$119.50 each.
 - Shure diamond stereo cartridge, No. 15C215 @ \$24.00.

RADIO SHACK CORPORATION, Dept. 11-G
730 Commonwealth Avenue, Boston 17, Mass.

Name _____

Address _____

City _____ Zone _____ State _____

Check Money Order C.O.D.

RADIO SHACK CORPORATION



730 COMMONWEALTH AVENUE,
BOSTON 17, MASS.

It's
all there
on

SOUNDCRAFT TAPE

because
Soundcraft
is the
world's best
recording
tape!

Always buy
Soundcraft Tapes
...they cost no more!



REEVES SOUNDCRAFT CORP., GREAT PASTURE RD., DANBURY, CONN., CHICAGO: 28 EAST JACKSON BLVD., LOS ANGELES: 342 N. LaBREA, TORONTO: 700 WESTON RD.



the Tape Deck

Reviewed by R. D. DARRELL

The following reviews are of 4-track 7.5-ips stereo tapes in normal reel form.

COPLAND: *Billy the Kid: Ballet Suite; Statements*

London Symphony Orchestra, Aaron Copland, cond.
• • EVEREST STBR 3015. 37 min. \$7.95.

These performances—first released six months ago in LP and SD pressings—represent Aaron Copland's debut as recording conductor, a debut he wisely delayed until he had acquired enough concert experience to join the thin ranks of composers capable of truly definitive editions of their own works. Casual listeners may miss some of the more overt drama of a Bernstein or Gould in the present ballet music, but for real *aficionados* Copland's reading reveals a piquancy, point, and wealth of inner detail almost exactly comparable to those which make Stravinsky's readings of his works unique and invaluable.

Like Stravinsky, Copland demands recording qualities a bit drier and tauter than usual, less notable for their sheerly sensuous appeal than for their accuracy to every nuance of phrasing and coloration in the score. The recording here, perhaps even more than the stereo disc, meets the composer's demands completely and convinces attentive listeners that they are hearing exactly what Copland himself heard from the London Symphony players in the recording auditorium. In many other hands or in different sonics, the concise *Statements* of 1933-35 would surely seem far less individual and more abstract than they do here, where they reveal many little-known aspects of the composer's personality—particularly the brash humor of "Jingo" and somewhat sinister mysticism of "Prophetic."

(A two-track taping of these same performances is available at \$10.95, and sounds almost identical.)

GERSHWIN: *An American in Paris; Rhapsody in Blue*

Bert Shefter, piano (in the Rhapsody); Warner Brothers Symphony Orchestra, Ray Heindorf, cond.
• • WARNER BROS. BST 1243. 32 min. \$7.95.

GERSHWIN: *Rhapsody in Blue; Song Transcriptions: Someone to Watch Over Me, Liza, Love Walked In, Bid-in' My Time, Maybe, I Got Rhythm*

Roger Williams, piano; Symphony of the

Air, Willis Page, cond. (in the Rhapsody); Orchestra, Marty Gold, cond. (in the Song Transcriptions).

• • KAPP KST 41008. 36 min. \$7.95.

Heindorf's *American in Paris* is a bit slapdash and overexpressive, but his *Rhapsody* is romantically lush and mannered, with an almost complete lack of individuality in Shefter's highly competent pianism. The prime appeal here lies in the rightly brilliant, strongly stereoscopic, and quite closely miked sonics.

The Williams tape, however, is a wholly delightful sleeper—the first recorded performance of the *Rhapsody* by a popular pianist (other than Gershwin himself) which is entirely free from mannerisms, sentimentality, and overinflation. Williams himself plays with admirable straightforwardness and vivacity, while Willis Page provides a no-less straightforward and sympathetic accompaniment. The recording too, with the soloist well to the right, is notably broad-spread, rich, and completely faithful to the beautifully colored tonal qualities of both the soloist and the Symphony of the Air. The smaller orchestra in the song transcriptions is much less distinctive, and Williams (here apparently more nearly centered) chooses far too slow a tempo for my taste in *Someone To Watch Over Me*. But his *Liza*, both catchy and dazzlingly virtuosic, his highly original treatment of *I Got Rhythm*, his unaccompanied nocturnelike *Love Walked In*, the lilt of *Bidin' My Time*, and the dreamy atmosphere of *Maybe* make this a tape that no Gershwinian can resist.



Shostakovich: a Fifth flawlessly captured.

SHOSTAKOVICH: *Symphony No. 5, in D, Op. 47*

Stadium Symphony Orchestra of New York, Leopold Stokowski, cond.
• • EVEREST STBR 3010. 43 min. \$7.95.

For all Stokowski's reputation for interpretative eccentricities, he always has played certain scores with scarcely a trace of idiosyncratic quirks, as well as a plenitude of his most characteristic dramatic eloquence. The Shostakovich Fifth is one of these; and although the conductor has had finer orchestras in the past, he gets more out of the Stadium Symphony than anyone else has so far on records (or perhaps off!), in the closest possible duplication of his famous Philadelphian reading which first introduced the Russian composer's finest achievement to American listeners. In the present taping, his performance now is technically as completely satisfying and exciting as it always has been interpretatively. I have seen some criticism of the disc version, but whatever justification that may have, it certainly is not applicable here, where the tape's moderate modulation level, wide dynamic and frequency ranges, well-marked yet unexaggerated stereoism, and natural hall reverberance capture flawlessly the dark yet piquant colors, the brilliancy, tremendous low-spectrum power and solidity of this symphonic masterpiece.

TCHAIKOVSKY: *Francesca da Rimini, Op. 32; Hamlet, Overture-Fantasia, Op. 67*

Stadium Symphony Orchestra of New York, Leopold Stokowski, cond.
• • EVEREST STBR 3011. 42 min. \$7.95.

These performances, reviewed last July in their two-track taping, sound well-nigh identical in four-track form, and I repeat my praise for both the remarkably restrained yet powerfully evocative readings and the superbly big and authentic sound of the stereo recordings.

"The Broadway Bit." Marty Paich and His Orchestra. Warner Bros. WST 1296, 35 min., \$7.95.

Since the notes provide no personnel information I can only assume that the soloists here are the stars they sound like. Pianist-arranger-leader Paich has

Continued on next page

TAPE DECK

Continued from preceding page

mustered a topnotch ensemble that plays with immense gusto. Particularly imaginative are his arrangements of *I've Grown Accustomed to Her Face*, *I Love Paris*, *Lazy Afternoon*, and *The Surrey with the Fringe on Top*. Though all the pieces are pops standards, the treatments are true—and very buoyant—jazz. The recording, extremely brilliant, has channel separation that would surely seem excessive for most types of music, but is surprisingly effective here.

Maurice Chevalier: "Sings Broadway" and "Yesterday and Today." Orchestra, Glenn Osser, cond. M-G-M ST 3738, 26 min., \$7.95, and ST 3702-03 (twin-pack), 48 min., \$11.95.

The ageless boulevardier, who can still talk certain songs better than other stars can sing them, followed up his comeback on records with these programs on LP earlier this year. In stereo they bring him even more realistically into one's living room, and it would be quibbling to criticize the excessive channel separation here, with the soloist closely miked on the right in what sounds like an acoustical environment dissimilar to that of Osser's modest but competent accompanying orchestra. And what matter if not all of the dozen Broadway tunes in the shorter reel, and the no less than twenty-four old and new favorites in the "twin-pack," are best suited to the Chevalier style, or that he sings only occasionally in French? He is his incomparable self, especially in *C'est Magnifique* and *Do It Again* (in ST 3738), *Living in the Sunlight*, *Valentine*, *Hello Beautiful*, *The Yankee Doodle Boy*, *Rainbow Round My Shoulder*, *You Made Me Love You*, and many others (in ST 3702-03). That should be more than enough for his innumerable old and many new admirers.

Ella Fitzgerald: "Sings the Irving Berlin Songbook." Paul Weston and His Orchestra. Verve GST4 203 (twin-pack), 89 min., \$11.95.

Another tape bargain, with the longest running time I've yet encountered on any single tape reel, and a wealth of Ella's finest nonjazz performances—which often put to shame those of more celebrated pops balladeers by their vocal appeal, clarity of enunciation, rhythmic lilt, and of course the captivating Fitzgerald personality. The thirty-one songs here are somewhat less absorbing to me than those in the Rodgers & Hart Songbook, but I could listen to Ella singing anything. For good measure, she is discreetly yet warmly accompanied and recorded throughout, and although her mike seems fairly close, voice and orchestra are beautifully balanced and integrated.

"Flamenco Fury." José Greco and Company. M-G-M ST 3741, 46 min., \$7.95. The "fury" in the title is slightly misleading, since, for all their verve and excitement, these performances lack the

abandoned frenzy of less sophisticated flamenco interpreters, and moreover are most effective in the quieter pieces (like *Cana de los Cabales* and *Filigranes*). What we have here is one of the most persuasive and varied recorded introductions to the gypsy arts of dancing, singing, and guitar playing, a model of stereo effectiveness both in its clean-cut tonal differentiations and in the exceedingly ingenious exploitation of cross-channel antiphonies.

"Gigi." Recording from the sound track of the film. André Previn, cond. M-G-M ST 3641, 30 min., \$7.95.

The blustery overture and hit tunes from the Lerner & Loewe film score have become so familiar since the first LP appearance of this sound-track recording a year and a half ago, and they are moreover so stylistically reminiscent of the authors' *My Fair Lady*, that it is a pleasant surprise to find how much freshness and charm they acquire in the present taping—a vivid example of big and brilliant, widespread stereoism and of theatrical immediacy and presence.

"Let's Dance." David Carroll and His Orchestra. Mercury STA 60001, 27 min., \$6.95.

A Mercury two-track pops tape success of nearly two years ago, this still commands admiration for its bright and open, though rather light, recording. It also remains a sure best seller by virtue of its toe-tickling vivacity, especially in the title piece,



Ella Fitzgerald, captivating as ever.

Dancing Tambourine, *A Gliss to Remember*, and the extremely diverting *Dixie Dawn Patrol*.

"Paris in Stereo." Raymond Lefèvre and His "Grande" Orchestra. Kapp KT 41009, 30 min., \$7.95.

The orchestra unfortunately just isn't "grande" enough, especially in its string section, to cope successfully with dance versions of Offenbach's *Gaité Parisienne*, *La belle Hélène*, *La Vie Parisienne*, and *Apache Dance*, but its obvious zest (and the playing of the oboe and accordion soloists) are revealed to much better ef-

fect in such straight Gallic pops as *A Paris*, *Valentine*, and *Song from the Moulin Rouge*—all captured in clean, bright recording notable for its smooth blend of markedly differentiated stereo channels.

"Porgy and Bess" Excerpts. Louis Armstrong; Ella Fitzgerald; Orchestra, Russ Garcia, cond. Verve VST4 206 (twin-pack), 65 min., \$11.95.

What Ella and Louis do here may not be exactly what Gershwin intended—and it's a bit startling to find the former taking a chorus of *I've Got Plenty of Nuttin'* as well as the entire *Buzzard Song*—but the composer himself certainly would agree that the letter of the score is inconsequential without the proper spirit, and that is prodigiously evident in this performance. The long program has a few downs (getting off to a particularly poor start with Garcia's now pretentious, now sentimental Overture) as well as many ups, but at its frequent best it is incomparable and rises to its peak in the superbly lilting final *Oh Lawd, I'm on My Way*. Not the least of the delights here is the presence (only too rare in tape releases) of the handsome illustrated booklet of notes accompanying the original disc albums, which (for those who still think tape too costly) are priced at \$9.96 (LP) and \$11.90 (stereo).

"77 Sunset Strip." Orchestra and Chorus, Warren Barker, cond. Warner Bros. WST 1289, 32 min., \$7.95.

A couple of the originals here (especially *Late at Bailey's Pad* and *The Stu Bailey Blues*) come off effectively, as do the catchy arrangements of *You Took Advantage of Me* and *Lover Come Back to Me*. Still, having heard the "Peter Gunn" and "More Peter Gunn" recordings, I miss the greater gusto and drive of Mancini's scores and performances. The stereo recording here, however, is brilliant and strong, and many of the settings make clever use of cross-channel-response potentialities.

"The Trombones, Inc." Warner Bros. WST 1272, 45 min., \$7.95.

I had no qualms about agreeing with John S. Wilson on the West Coast men's victory in this contest and the imaginative excellence of Warren Barker's arrangements (*Lassus Trombone* and *Old Devil Moon* in particular), but I still got considerable pleasure from the less spectacular, but to my ears far from "listless," East-Coast ("A"-side) trombonists. This decidedly ingenious program should appeal to many more listeners than trombone specialists alone, although perhaps only the latter can best appreciate the virtues of the strongly stereoistic, big-sound recording in differentiating so lucidly among the various soloists' tonal qualities. Players are identified in the accompanying notes, but to experienced ears these must be nearly superfluous.

"Waltz Masterpieces." Stadium Symphony Orchestra of New York, Raoul

Continued on page 128

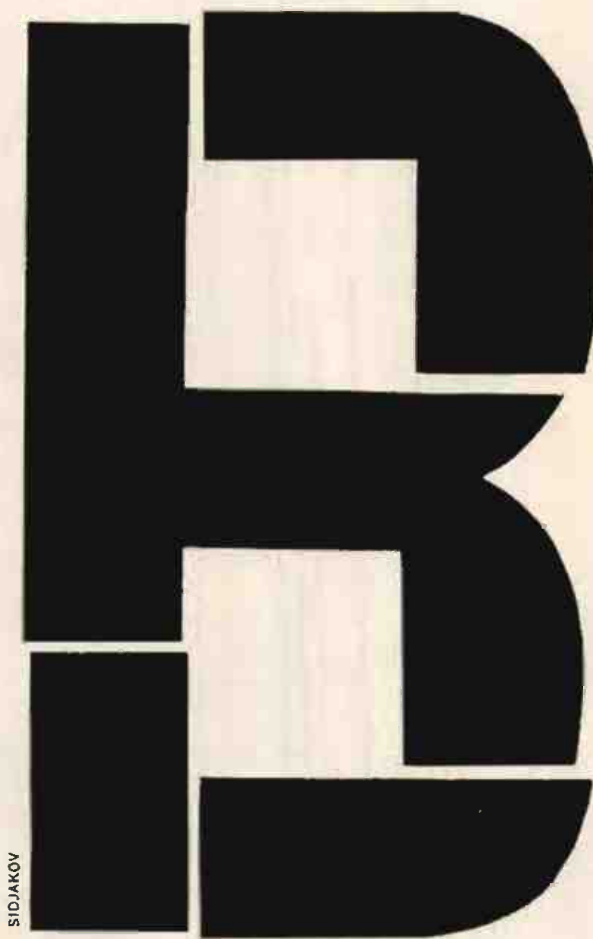

SID JAKOV

Beethoven in stereo now on 4-track tape for less than the identical recordings on stereo discs a complete Beethoven concert: Symphony No. 3 (Eroica), Symphony No. 5, plus the Egmont and Coriolan Overtures, with Sir Adrian Boult conducting the Philharmonic Promenade Orchestra of London on one reel of 4-track, 7½ ips stereo tape offering permanent master recording fidelity. . . . just one example of what is in store for you among the more than 300 4-track tapes now available from 19 leading recording companies. For complete list of tapes and dealers in your area, write 1028 Kifer Road, Sunnyvale, California. **UNITED STEREO TAPES** 

- AUDIO FIDELITY
- BEL CANTO
- CONCERTAPES
- DOT
- ELEKTRA
- EVEREST
- HIFITAPES
- KAPP
- M-G-M
- MERCURY
- OMEGATAPE
- ROULETTE
- S-M-S
- VANGUARD
- VERVE
- VOX
- WARNER BROS
- WESTMINSTER
- WORLD PACIFIC



FUN TIMES LAST

on tough, durable tapes

What a great time of the year to have a party . . . and a tape recorder! Everything's in full swing—Thanksgiving, Christmas, New Year's, after-the-game celebrations. And these fun times will stay with you forever . . . when you record them on tapes of "Mylar"* polyester film.

Tapes of "Mylar" are age-resistant . . . can never dry out or get brittle. They're extra-tough . . . with

built-in muscle that gives you a 300% safety margin against stretching.

You don't have to pamper these rugged tapes with fussy storing, either . . . because heat and moisture just can't affect them. And because they're thin, you get up to 50% more playing time per reel.

If you are not now one of the thousands of recording fans who have discovered the unmatched advan-



A LIFETIME of MYLAR[®]

tapes of these top tapes . . . then ask your dealer for a reel of your favorite brand of tape made of "Mylar". Once you've tried them, you'll be convinced that for fun-times recording or for any other recording situation tough, durable tapes of "Mylar" polyester film are the best tapes that you've ever used.

Be sure of superior performance . . . look for the name "Mylar" on the box



REG. U.S. PAT. OFF.
BETTER THINGS FOR BETTER LIVING
... THROUGH CHEMISTRY



"Mylar" is Du Pont's registered trademark for its brand of polyester film. Du Pont manufactures "Mylar", not finished magnetic recording tape. Tapes of "Mylar" are made by all manufacturers.

Even those who can afford more, buy

Grommes

STEREO

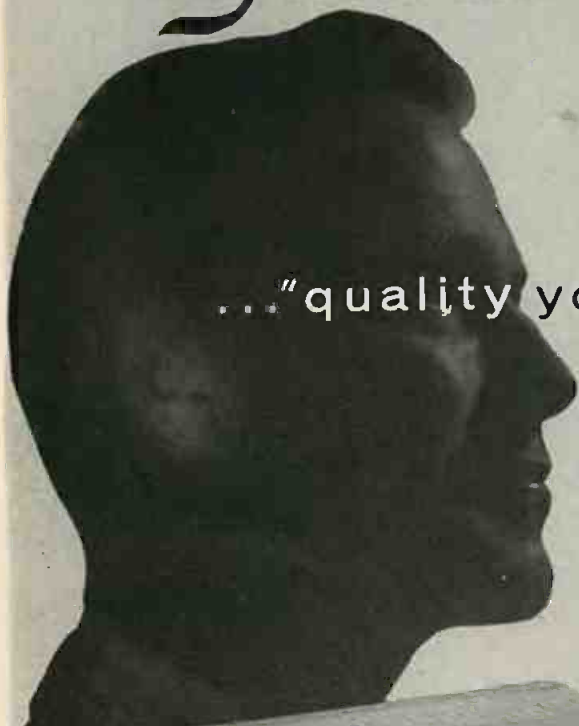

... "quality you can hear"

Even where price is no object, Grommes is the popular choice of many a connoisseur. That's because Grommes has quality you can hear . . . performance far beyond its little price. Why pay more?



GROMMES CUSTOM 101GT
FM TUNER

Outstanding performance. Electronic tuning eye and AFC simplify tuning. Foster Seeley discriminator and matched crystal diodes detector. Audiophile net, \$79.95.*

*Handsome saddle tan simulated leather enclosure \$10.00 extra.

Ask your HI-Fidelity Dealer to demonstrate GROMMES—the best buy in Stereo HI-FI

GROMMES 20LJ STEREOHONIC AMPLIFIER

The "Little Jewel," a high quality 20 watt stereo pre-amplifier and power amplifier. Two 10 watt channels convert to 20 watts monophonic, 40 watts peak. Controls are ganged for simplified stereo operation • Frequency response $\pm 0.5\text{DB}$. 20-20,000 CPS • Hum and Noise 80DB below rated output • Selector for Aux, Tuner, NARTB Tape, RIAA Phono, Crystal Phono • Treble, Bass, Loudness Controls • Inputs for records, tape or tuner • Outputs 4, 8 and 16 ohms • Two AC outlets for associated components • Size only 14" x 4½" x 9". Gold and oyster-white face plate. Audiophile net, only \$69.95.*

Please send me FREE full color catalog of the 1960 Grommes line along with detailed specifications.



GROMMES DIVISION OF PRECISION ELECTRONICS, INC.
9101-A King Street, Franklin Park, Illinois

Name _____

Street _____

City _____ State _____

TAPE DECK

Continued from page 124

Poliakin, cond. Everest STBR 3025, 38 min., \$7.95.

The recording sounds even better here than in the recently reviewed stereo disc edition—which unfortunately merely exposes more candidly the deficiencies of performance and interpretation: orchestral and acoustical coarseness, as well as the overintensity and heavy-handedness of Poliakin's readings.

Roger Williams: "Near You." Piano; Orchestra and Chorus, Hal Kanner, cond. Kapp KT 41002, 33 min., \$7.95.

Roger Williams: "Songs of the Fabulous Forties"; "Songs of the Fabulous Century." Piano; Orchestra, Marty Gold and Hal Kanner, conds. Kapp KT 45003 (twin-pack), 69 min.; KT 45006 (twin-pack), 74 min.; \$11.95 each.

If I was ever inclined to brush off Roger Williams as just another of innumerable competent but scarcely distinguished cocktail-hour pianists, his recent Gershwin tape and the present batch of standard song and ballad evocations showed me how much I've been missing and misjudging. Although he is by no means another George Feyer, he has a hardly less winning way both with a good tune and florid pianistic embellishments. Less unerring in his taste and tempos than Feyer, his prime virtue seems to me to be his powers of consistently maintaining whatever mood he first sets for a song transcription, and he usually picks one that persuasively justifies itself. He restrains his obvious virtuosity from meaningless displays of dexterity, while still bringing notable *éclat* to his best performances. His small-orchestra accompaniments are generally less imaginative than his own playing, but they too are restrained. And although the frequent deliberate shifts of the solo instrument (from one number to another) between a well-to-the-right and more nearly centered location can be a bit disconcerting, the recording throughout is clean and natural. For the most part Williams provides first-rate musical entertainment, and not infrequently commands the genuine magic of nostalgic sentiment. Even though there are no less than sixty-one transcriptions here (12 in KT 1002, 24 and 25 in the two "twin-packs"), my appetite is only whetted for more.

The following reviews are of 4-track 3.75-ips stereo tapes in "cartridge" form.

"Around the World." Frankie Carle and His Orchestra. RCA Victor KPS 3002, 31 min., \$5.95.

Except in the contrastingly slow and lyrical *Irish Lullaby*, Carle's piano playing bounces emphatically through a lively international program (*Hindustan, South American Way, Loch Lomond*, etc.), to which a rhythm section contributes a heavy, plugging beat and a small ensemble discreetly decorative backgrounds.

Continued on page 130

Viking builds the **PERFECT MEMORY**

for your music system

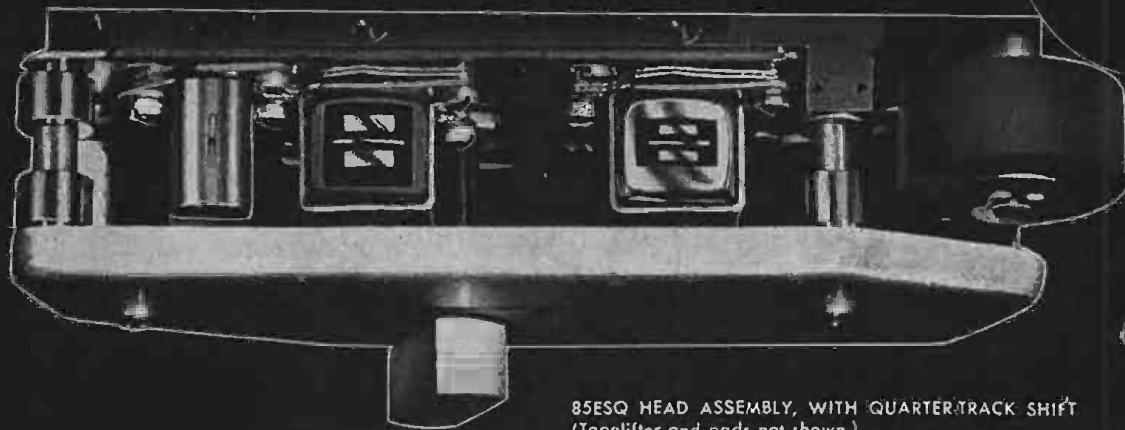

85ESQ HEAD ASSEMBLY, WITH QUARTER-TRACK SHIFT
(Topelifter and pads not shown.)

The Viking 85 Series deck and Viking recording amplifiers provide the perfect memory for your high fidelity music system. Record monaural or stereo programs at the flick of a switch. Record with the full performance provided by laminated heads. Record quarter track if you prefer, but better still, use the brilliant, ultra short-gap quarter-track head for simultaneous monitoring from the recorded track.

All Viking 85 Series decks now feature laminated (not single laminar) half-track and quarter-track record and playback heads; the same heads used on the professional 95 Series. A laminated head permits a substantially higher recording level without saturation, requires less equalization for brilliant high-end performance and provides much longer head life.

All Viking "Q" model decks may be used equally well for playing the new $7\frac{1}{2}$ i.p.s. four-track tapes and the $3\frac{3}{4}$ i.p.s. tapes featured in cartridges. Cartridge tapes may be removed from the cartridge and played reel-to-reel on the Viking 85.

Viking tape components are sold through high fidelity dealers, exclusively. Further technical information may be obtained by writing directly to Viking's Customer Service Department.



Viking OF MINNEAPOLIS, INC.

9600 Aldrich Avenue South, Minneapolis 20, Minnesota

EXPORT DIVISION: 23 Warren Street, New York City 7, New York
Cable: SIMONTRICE, NEW YORK (All Codes)

TAPE DECK

Continued from page 128

What surprises me is how well the marked stereoism and authentic tonal qualities stand up in a recording which first appeared two full years ago; it even sounds better here than in its original 1957 two-track taping.

Band of the Coldstream Guards, Major Douglas A. Pope, cond. RCA Victor KPS 3003, 31 min., \$5.95.

I commented favorably on the premature release of this 3.75-ips tape last March when I could play it only in a reel transfer; now that I can hear it in cartridge playback, I find that more accurate equalization adds a notably brilliant high end to the stereo spaciousness admired earlier. As a consequence, the sizzling cymbals and plangent brass sonorities of the British Band impressively augment the glitter and bite of Major Pope's rousing performances of *A Frangese*, *El Abanico*, *Père de la Victoire*, and the *Copenhaver* marches in particular. One of the best of the cartridge releases so far both for sonic-demonstration effectiveness and unrestricted musical appeal.

"Dancing with the Smart Set." Meyer Davis and His Orchestra. RCA Victor KPS 3032, 39 min., \$5.95.

Conventional dance materials, but hardly in the suave society vein one expects from Davis, since the arrangements (of *The Carioca*, *Waltz at Maxim's*, medleys from *Gigi*, *Oklahoma*, *Can-Can*, etc.) are surprisingly slapdash and both the doggedly brisk performances and strongly stereoisitic recording lack any real distinction.

"Georges Feyer Takes You to Rodgers & Hammerstein's 'Oklahoma' and 'South Pacific.'" RCA Victor KPS 3016, 33 min., \$5.95.

The same coupling of familiar hit tunes, with Feyer's pianistic embellishments and rhythm-section accompaniments, was considerably less attractive sonically in last year's stereo disc version than in the separate release on 7.5-ips tapes (APS 145 and BPS 146), but happily the new taping recaptures all the warmth and ringing piano tone of the earlier one, as well as—of course—Feyer's own inimitable vivacity and grace.

"The Desert Song." Giorgio Tozzi, Kathy Barr, et al.; Chorus and Orchestra, Lehman Engel, cond. RCA Victor KPS 4000, 46 min., \$5.95.

The most faded of operettas is odd material indeed for sumptuous stereo recording. It may well delight whatever admirers *Romberg's* score still commands, but more sophisticated listeners are scarcely likely to be won over by the inflation to wide-screen grandiloquence of the stylistic incongruities between super masculine robustness (of Tozzi and Galjour in particular) and ingénish warbling (in which Kathy Barr's pleasant small voice is forced into tremulous screams in the climaxes).

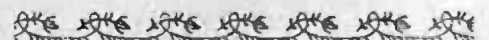

4-19

why
ruin
your
valuable
records?



dextrafix®

TONARM CONTROL

lowers the
tonearm
into the
lead-in
groove...
lifts it
after play!

If the tonearm slips out of your fingers and bounces over the record—the record is ruined! If you're unlucky, you will also need a new stylus and possibly a new cartridge.

Why take a chance? DEXTRAFIX® TONEARM CONTROL prevents such accidents! It places the stylus in the lead-in groove—gently and accurately. Then, at the end of play or at any point on the record, it lifts the stylus from the record. And the stylus cannot touch the record until the lift bar is again lowered for the next play. The DEXTRAFIX® TONEARM CONTROL also facilitates "cueing" at any point on the record.

A must for turntables—and record changers with manual operation!

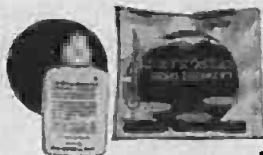

\$4.95

Another quality product
by the manufacturers of

LEKROSTAT®
Record Cleaning Kit

dexter chemical corp. • consumer products div. • 845 Edgewater Rd., N.Y. 59

Easy-to-build



- style
- performance
- quality

costs you less!



PROFESSIONAL STEREO-MONAUROAL AM-FM TUNER KIT

MODEL PT-1 \$89⁹⁵

The 10-tube FM circuit features AFC as well as AGC. An accurate tuning meter operates on both AM and FM while a 3-position switch selects meter functions without disturbing stereo or monaural listening. The 3-tube front end is wired and prealigned, and the entire AM circuit is on one printed circuit board for ease of construction. Shpg. Wt. 20 lbs.

MODEL SP-2 (stereo)
\$56⁹⁵ Shpg. Wt. 15 lbs.

MODEL SP-1 (monaural)
\$37⁹⁵ Shpg. Wt. 13 lbs.

MODEL C-SP-1 (converts SP-1 to SP-2)
\$21⁹⁵ Shpg. Wt. 5 lbs.



STEREO EQUIPMENT CABINET KIT

MODEL SE-1 (center unit) \$149⁹⁵

Shpg. Wt. 162 lbs. (specify wood desired)

MODEL SC-1 (speaker enclosure) \$39⁹⁵ each

Shpg. Wt. 42 lbs. (specify R. or L. also wood desired)

Superbly designed cabinetry to house your complete stereo system. Delivered with pre-cut panels to fit Heathkit AM-FM tuner (PT-1), stereo preamplifier (SP-1 & 2) and record changer (RP-3). Blank panels also supplied to cut out for any other equipment you may now own. Adequate space is also provided for tape deck, speakers, record storage and amplifiers. Speaker wings will hold Heathkit SS-2 or other speaker units of similar size. Available in 3/4" solid core Philippine mahogany or select birch plywood suitable for finish of your choice. Entire top features a shaped edge. Hardware and trim are of brushed brass and gold finish. Rich tone grille cloth is flecked in gold and black. Maximum overall dimensions (all three pieces): 82 3/4" W. x 36 1/2" H. x 20" D.

World's largest manufacturer of electronic instruments in kit form

HEATH COMPANY

Benton Harbor, 8, Michigan

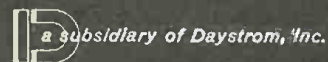

MONAUROAL-STEREO PREAMPLIFIER KIT (TWO CHANNEL MIXER)

Complete control of your entire stereo system in one compact package. Special "building block" design allows you to purchase instrument in monaural version and add stereo or second channel later if desired. The SP-1 monaural preamplifier features six separate inputs with four input level controls. A function selector switch on the SP-2 provides two channel mixing as well as single or dual channel monaural and dual channel stereo. A 20' remote balance control is provided.

HIGH FIDELITY RECORD CHANGER KIT

MODEL RP-3 **\$64⁹⁵**

Every outstanding feature you could ask for in a record changer is provided in the Heathkit RP-3, the most advanced changer on the market today. A unique turntable pause during the change cycle saves wear and tear on your records by eliminating grinding action caused by records dropping on a moving turntable or disc. Record groove and stylus wear are also practically eliminated through proper weight distribution and low pivot point friction of the tone arm, which minimizes arm resonance and tracking error. Clean mechanical simplicity and precision parts give you turntable performance with the automatic convenience of a record changer. Flutter and wow, a major problem with automatic changers, is held to less than 0.18% RMS. An automatic speed selector position allows intermixing 33 1/3 and 45 RPM records regardless of their sequence. Four speeds provided: 16, 33 1/3, 45 and 78 RPM. Other features include RC filter across the power switch preventing pop when turned off and muting switch to prevent noise on automatic or manual change cycle. Changer is supplied complete with GE-VR-II cartridge with diamond LP and sapphire 78 stylus, changer base, stylus pressure gauge and 45 RPM spindle. Extremely easy to assemble. You simply mount a few mechanical components and connect the motor, switches and pickup leads. Shpg. Wt. 19 lbs.

Model RP-3-LP with MF-1 Pickup Cartridge **\$74.95**

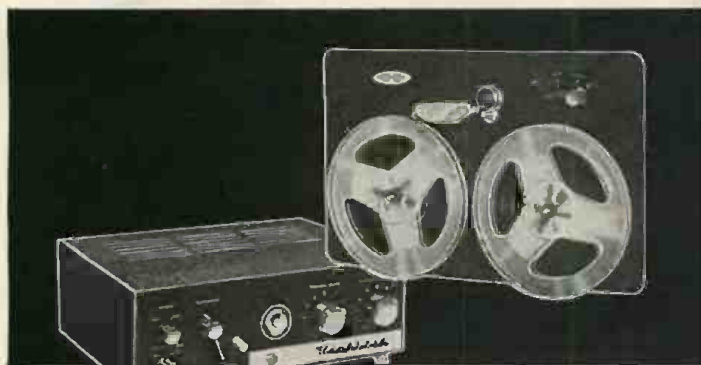

NOW! TWO NEW STEREO-MONO TAPE RECORDERS IN THE TR-1A SERIES

Offering complete versatility, the model TR-1A series tape recorders enable you to plan your hi-fi system to include the functions you want. Buy the new half-track (TR-1AH) or quarter-track (TR-1AQ) versions which record and playback stereo and monophonic programming, or the half-track monophonic record-playback version (TR-1A).

Precision parts hold flutter and wow to less than 0.35%. Four-pole, fan cooled motor. One control lever selects all tape handling functions. Each tape preamplifier features NARTB playback equalization, separate record and playback gain controls, cathode follower output, mike or line input, and two circuit boards for easy construction and high stability. Complete instructions guide assembly.

MODEL TR-1A: Monophonic half-track record/playback with fast forward and rewind functions. Shpg. Wt. 24 lbs. **\$99⁹⁵**

TR-1A SPECIFICATIONS—Frequency response: 7.5 IPS ± 3 db 50-12,000 cps. 3.75 IPS ± 3 db 50-7,000 cps. Signal-to-noise ratio: Better than 45 db below full output of 1.25 volts/channel. Harmonic distortion: Less than 2% at full output. Bias erase frequency: 60 kc (push-pull oscillator).

MODEL TR-1AH: Half-track monophonic and stereo record/playback with fast forward and rewind functions. **\$149⁹⁵**
Shpg. Wt. 35 lbs.

TR-1AH SPECIFICATIONS—Frequency response: 7.5 IPS ± 3 db 40-15,000 cps. 3.75 IPS ± 3 db 40-10,000 cps. Signal-to-noise ratio: 45 db below full output of 1 volt/channel. Harmonic distortion: Less than 2% at full output. Bias erase frequency: 60 kc (push-pull oscillator).

MODEL TR-1AQ: Quarter-track monophonic and stereo with record/playback fast forward and rewind functions. **\$149⁹⁵**
Shpg. Wt. 35 lbs.

TR-1AQ SPECIFICATIONS—Frequency response: 7.5 IPS ± 3 db 40-15,000 cps. 3.75 IPS ± 3 db 40-10,000 cps. Signal-to-noise ratio: 40 db below full output of .75 volts/channel. Harmonic distortion: Less than 2% at full output. Bias erase frequency: 60 kc (push-pull oscillator).



HIGH FIDELITY AM TUNER KIT

MODEL BC-1A **\$26⁹⁵**

Designed especially for high fidelity applications this AM tuner will give you reception close to FM. A special detector is incorporated and the IF circuits are "broadbanded" for low signal distortion. Sensitivity and selectivity are excellent and quiet performance is assured by high signal-to-noise ratio. All tunable components are prealigned. Your "best buy" in an AM tuner. Shpg. Wt. 9 lbs.



HIGH FIDELITY FM TUNER KIT

MODEL FM-3A **\$26⁹⁵**

For noise and static-free sound reception, this FM tuner is your least expensive source of high fidelity material. Efficient circuit design features stabilized oscillator circuit to eliminate drift after warm-up and broadband IF circuits for full fidelity with high sensitivity. All tunable components are prealigned and front end is preassembled. Edge-illuminated slide rule dial is clearly marked and covers complete FM band from 88 to 108 mc. Shpg. Wt. 8 lbs.

Top performance at budget cost!

NEW



MODEL EA-3
\$29⁹⁵

NOTE THESE OUTSTANDING SPECIFICATIONS: Power Output: 14 watts, HI-FI; 12 watts, Professional; 16 watts, Utility. Power Response: ± 1 db from 20 cps to 20 kc at 14 watts output. Total Harmonic Distortion: less than 2%, 30 cps to 15 kc at 14 watts output. Intermodulation Distortion: less than 1% at 16 watts output using 60 cps and 6 kc signal mixed 4:1. Hum and Noise: max. phono input, 47 db below 14 watts; tuner and crystal phono, 63 db below 14 watts.

World's largest manufacturer of electronic instruments in kit form

HEATH COMPANY
Benton Harbor, 40, Michigan

 Subsidiary of Daystrom, Inc.



"UNIVERSAL" HI-FI 12 WATT AMPLIFIER KIT

MODEL UA-1 \$21⁹⁵

Ideal for stereo or monaural applications. Teamed with the Heathkit WA-P2 preamplifier, the UA-1 provides an economical starting point for a hi-fi system. In stereo applications two UA-1's may be used along with the Heathkit SP-2, or your present system may be converted to stereo by adding the UA-1. Harmonic distortion is less than 2% from 20 to 20,000 CPS at full 12 watt output. "On-off" switch located on chassis and an octal plug is also provided to connect pre-amplifier for remote control operation. Shpg. Wt. 13 lbs.



14-WATT HI-FI ECONOMY AMPLIFIER (EA-3)

From HEATHKIT audio labs comes an exciting new kit . . . New Styling, New Features, Brilliant Performance! Designed to function as the "heart" of your hi-fi system, the EA-3 combines the preamplifier and amplifier into one compact package. Providing a full 14 watts of high fidelity power, more than adequate for operating the average system, the EA-3 provides all the controls necessary for precise blending of musical reproduction to your individual taste. Clearly marked controls give you finger-tip command of bass and treble "boost" and "cut" action, switch selection of three separate inputs, "on-off" and volume control. A hum balance control is also provided. The convenient neon pilot light on the front panel shows when instrument is on. Styled to blend harmoniously into any room surroundings, the handsome cover is of black vinyl coated steel with gold design and features the new "eyebrow" effect over the front panel to match the other new Heathkit hi-fi instruments. The panel is satin black with brush-gold trim strip, while the control knobs are black with gold inserts. Shpg. Wt. 15 lbs.

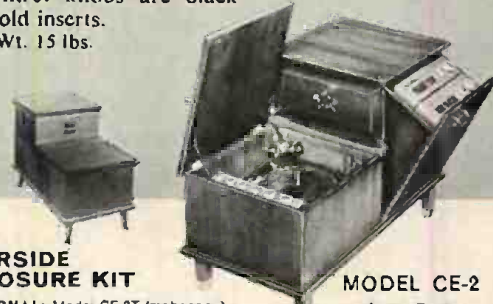

CHAIRSIDE ENCLOSURE KIT

TRADITIONAL: Model CE-2T (mahogany)
CONTEMPORARY: Model CE-2B (birch)
Model CE-2M (mahogany)

MODEL CE-2
\$43⁹⁵
each

Space saving and attractive, the CE-2 puts control of your entire hi-fi system right at your chairside. Designed to house the Heathkit AM and FM tuners (BC-1A, FM-3A, FM-4), WA-P2 preamplifier, RP-3 record changer, and any of the Heathkit power amplifiers. Supplied in beautiful furniture-grade, veneer-surfaced plywood suitable for the finish of your choice. Shpg. Wt. 46 lbs.



"EXTRA PERFORMANCE" 55 WATT HI-FI AMPLIFIER KIT

MODEL W7-M \$54⁹⁵

This hi-fi amplifier represents a remarkable value at less than a dollar a watt. Full audio output and maximum damping is a true 55 watts from 20 to 20,000 CPS with less than 2% total harmonic distortion throughout the entire audio range. Features include level control and "on-off" switch right on the chassis, plus provision for remote control. Pilot light on chassis. Modern, functional design. Shpg. Wt. 28 lbs.

"MASTER CONTROL" PREAMPLIFIER KIT

MODEL WA-P2 \$19⁷⁵

All the controls you need to master a complete high fidelity home music system are incorporated in this versatile instrument. Featuring five switch-selected inputs, each with level control. Provides tape recorder and cathode-follower outputs. Full frequency response is obtained within $\pm 1\frac{1}{2}$ db from 15 to 35,000 CPS and will do full justice to the finest available program sources. Equalization is provided for LP, RIAA, AES and early 78 records. Dimensions are 12 $\frac{3}{4}$ " L. x 3 $\frac{3}{8}$ " H. x 5 $\frac{1}{2}$ " D. Shpg. Wt. 7 lbs.





"HEAVY DUTY" 70 WATT HI-FI AMPLIFIER KIT
MODEL W6-M \$109⁹⁵

For real rugged duty called for by advance hi-fi systems or P.A. networks, this high powered amplifier more than fills the bill. Silicon-diode rectifiers are used to assure long life and a heavy duty transformer gives you extremely good power supply regulation. Variable damping control provides optimum performance with any speaker system. Quick change plug selects 4, 8 and 16 ohm or 70 volt output and the correct feedback resistance. Frequency response at 1 watt is ± 1 db from 5 CPS to 80 kc with controlled HF rolloff above 100 kc. At 70 watts output harmonic distortion is below 2%, 20 to 20,000 CPS and IM distortion below 1% 60 and 6,000 CPS. Hum and noise 88 db below full output. Shpg. Wt. 52 lbs.

"ADVANCE DESIGN" 25 WATT HI-FI AMPLIFIER KIT

MODEL W5-M \$59⁷⁵

Enjoy the distortion-free high fidelity sound reproduction from this outstanding hi-fi amplifier. The W5-M incorporates advanced design features for the super critical listener. Features include specially designed Peerless output transformer and KT66 tubes. The circuit is rated at 25 watts and will follow instantaneous power peaks of a full orchestra up to 42 watts. A "tweeter saver" suppresses high frequency oscillation and a unique balancing circuit facilitates adjustment of output tubes. Frequency response is ± 1 db from 5 to 160,000 CPS at 1 watt and within ± 2 db 20 to 20,000 CPS at full 25 watts output. Harmonic distortion is less than 1% at 25 watts and IM distortion is 1% at 20 watts (60 and 3,000 CPS, 4:1). Hum and noise are 99 db below 25 watts for truly quiet performance. Shpg. Wt. 31 lbs.



YOU'RE NEVER OUT OF DATE WITH HEATHKITS



Heathkit hi-fi systems are designed for maximum flexibility. Simple conversion from basic to complex systems or from monaural to stereo is easily accomplished by adding to already existing units. Heathkit engineering skill is your guarantee against obsolescence. Expand your hi-fi as your budget permits . . . and, if you like, spread the payments over easy monthly installments with the Heath Time Payment Plan.

20 WATT HI-FI AMPLIFIER KIT

MODEL W4-AM \$39⁷⁵

This top quality amplifier offers you full fidelity at minimum cost. Features extended frequency response, low distortion and low hum level. Harmonic distortion is less than 1.5% and IM distortion is below 2.7% at full 20 watt output. Frequency response extends from 10 CPS to 100,000 CPS within ± 1 db at 1 watt. Output transformer tapped at 4, 8 and 16 ohms. Easy to build and a pleasure to use. Shpg. Wt. 28 lbs.



GENERAL-PURPOSE 20 WATT AMPLIFIER KIT

MODEL A9-C \$35⁵⁰

The model A9-C combines a preamplifier, main amplifier and power supply all on one chassis, providing a compact unit to fill the need for a good amplifier with a moderate cash investment. Features four separate switch-selected inputs. Separate bass and treble tone controls offer 15 db boost and cut. Covers 20 to 20,000 CPS within ± 1 db. A fine unit with which to start your own hi-fi system. Shpg. Wt. 23 lbs.

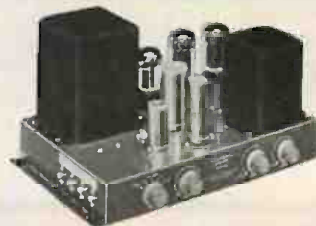

ELECTRONIC CROSSOVER KIT

MODEL XO-1 \$18⁹⁵

This unique instrument separates high and low frequencies and feeds them through two amplifiers to separate speakers. It is located ahead of the main amplifiers, thus, virtually eliminating IM distortion and matching problems. Crossover frequencies for each channel are at 100, 200, 400, 700, 1200, 2,000 and 3,500 CPS. This unit eliminates the need for conventional crossover circuits and provides amazing versatility at low cost. A unique answer to frequency division problems. Shpg. Wt. 6 lbs.



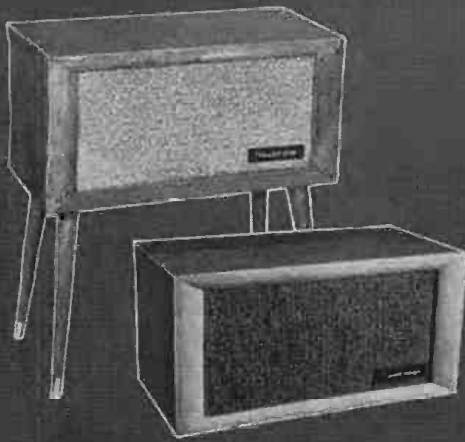

"BASIC RANGE" HI-FI SPEAKER SYSTEM KIT

MODEL SS-2 **\$39⁹⁵**

Legs optional extra. \$4.95

Outstanding performance at modest cost make this speaker system a spectacular buy for any hi-fi enthusiast. The specially designed enclosure and high quality 8" mid-range woofer and compression-type tweeter cover the frequency range of 50 to 12,000 CPS. Crossover circuit is built in with balance control. Impedance is 16 ohms, power rating 25 watts. Cabinet is constructed of veneer-surfaced furniture-grade 1/2" plywood suitable for light or dark finish. Shpg. Wt. 26 lbs.



"LEGATO" HI-FI SPEAKER SYSTEM KIT

MODEL HH-1 **\$299⁹⁵**

Words cannot describe the true magnificence of the "Legato" speaker system . . . it's simply the nearest thing to perfection in reproduced sound yet developed. Perfect balance, precise phasing, and adequate driver design all combine to produce startling realism long sought after by the hi-fi perfectionist. Two 15" Altec Lansing low frequency drivers and a specially designed exponential horn with high frequency driver cover 25 to 20,000 CPS. A unique crossover network is built in. Impedance is 16 ohms, power rating 50 watts. Cabinet is constructed of 3/4" veneer-surfaced plywood in either African mahogany or imported white birch suitable for the finish of your choice. All parts are precut and predrilled for easy assembly. Shpg. Wt. 195 lbs.

"RANGE EXTENDING" HI-FI SPEAKER SYSTEM KIT

MODEL SS-1B **\$99⁹⁵**

Not a complete speaker system in itself, the SS-1B is designed to extend the range of the basic SS-2 (or SS-1) speaker system. Employs a 15" woofer and a super tweeter to extend overall response from 35 to 16,000 CPS ± 5 db. Crossover circuit is built-in with balance control. Impedance is 16 ohms, power rating 35 watts. Constructed of 3/4" veneer-surfaced plywood suitable for light or dark finish. All parts precut and predrilled for easy assembly. Shpg. Wt. 80 lbs.

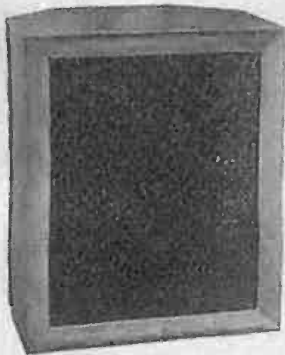

DIAMOND STYLUS HI-FI PICKUP CARTRIDGE

MODEL MF-1

\$26⁹⁵

Replace your present pickup with the MF-1 and enjoy the fullest fidelity your library of LP's has to offer. Designed to Heath specifications to offer you one of the finest cartridges available today. Nominally flat response from 20 to 20,000 CPS. Shpg. Wt. 1 lb.

SPEEDWINDER KIT

MODEL SW-1 **\$24⁹⁵**

Rewind tape and film at the rate of 1200' in 40 seconds. Saves wear on tape and recorder. Handles up to 10 1/2" tape reels and 800' reels of 8 or 16 millimeter film. Incorporates automatic shutoff and braking device. Shpg. Wt. 12 lbs.



NEW! "DOWN-TO-EARTH" High-Fidelity Book

The "HOW AND WHY OF HIGH FIDELITY", by Milton Sleeper explains what high fidelity is, and how you can select and plan your own system. This liberally-illustrated 48-page book tells you the hi-fi story without fancy technical jargon or high-sounding terminology. 25c.

SEND FOR FREE CATALOG

Write today for free catalog describing over 100 easy-to-build kits in hi-fi—marine and amateur radio fields. Complete specifications, schematics, and detailed information to help you in your selection.



HEATH

pioneer in "do-it-yourself" electronics

COMPANY • BENTON HARBOR 8, MICH.

a subsidiary of Daystrom, Inc.

- Please send the Free Heathkit catalog.
- Enclosed is 25c for the Hi-Fi book.

Enclosed find \$..... Please enclose postage for parcel post—express orders are shipped delivery charges collect. All prices F.O.B. Benton Harbor, Mich. A 20% deposit is required on all C.O.D. orders. Prices subject to change without notice.

name _____

address _____

city & state _____

QUANTITY	ITEM	MODEL NO.	PRICE

In
STEREO

and Mono Hi-Fi... the experts say
your best buy is

EICO

"The overall design of the HF-81 is conservative, honest and functional. It is a good value considered purely on its own merits, and a better one when its price is considered as well."
— Hirsch-Houck Labs (HIGH FIDELITY Magazine)

- Advanced engineering • Finest quality components
- "Beginner-Tested," easy step-by-step instructions
- LIFETIME service & calibration guarantee at nominal cost
- IN STOCK — compare, then take home any EICO equipment — right "off the shelf" — from 1500+ neighborhood EICO dealers.



Stereo Amplifier-Preamplifier HF81

HF81 Stereo Amplifier-Preamplifier selects, amplifies, controls any stereo source & feeds it thru self-contained dual 14W amplifiers to a pair of speakers. Provides 28W monophonically. Ganged level controls, separate balance control, independent bass & treble controls for each channel. Identical Williamson-type, push-pull EL84 power amplifiers. "Excellent" — SATURDAY REVIEW; HI-FI MUSIC AT HOME. "Outstanding quality... extremely versatile." — ELECTRONICS WORLD LAB-TESTED. Kit \$69.95. Wired \$109.95. Includes cover.

HF85 Stereo Preamplifier is a complete, master stereo preamplifier-control unit, self-powered for flexibility & to avoid power-supply problems. Distortion borders on unmeasurable even at high output levels. Level, bass, & treble controls independent for each channel or ganged for both channels. Inputs for phono, tape head, mike, AM, FM, & FM-multiplex. One each auxiliary A & B input in each channel. Switched-in loudness compensator. "Extreme flexibility... a bargain." — HI-FI REVIEW. Kit \$39.95. Wired \$64.95. Includes cover.

New HF87 70-Watt Stereo Power Amplifier: Dual 35W power amplifiers of the highest quality. Uses top-quality output transformers for undistorted response across the entire audio range at full power to provide utmost clarity on full orchestra & organ, IM. Total distortion 1% at 70W, harmonic distortion less than 1% from 20 to 20,000 cps within 1 db of 70W. Ultra-linear connected EL34 output stages & surge-protected silicon diode rectifier power supply. Selector switch chooses mono or stereo service; 4, 8, 16, and 32 ohm speaker taps, input level controls; basic sensitivity 0.38 volts. Without exaggeration, one of the very finest stereo amplifiers available regardless of price. Use with self-powered stereo preamplifier-control unit (HF85 recommended). Kit \$74.95. Wired \$114.95.

HF86 28W Stereo Power Amplifier Kit \$43.95. Wired \$74.95.

FM Tuner HFT90: Prewired, prealigned, temperature-compensated "front end" is drift-free. Prewired exclusive precision eye-tronic® traveling tuning indicator. Sensitivity: 1.5 uv for 20 db quieting; 2.5 uv for 30 db quieting, full limiting

from 25 uv. IF bandwidth 260 kc at 6 db points. Both cathode follower & FM-multiplex stereo outputs, prevent obsolescence. Very low distortion. "One of the best buys in high fidelity kits." — AUDIOCRAFT. Kit \$39.95*. Wired \$65.95*. Cover \$3.95. *Less cover, F.E.T. incl.

New AM Tuner HFT94. Matches HFT90. Selects "hi-fi" wide (20c — 9kc @ —3 db) or weak-station narrow (20c — 5kc @ —3 db) bandpass. Tuned RF stage for high selectivity & sensitivity; precision eye-tronic® tuning. Built-in ferrite loop, prealigned RF & IF coils. Sensitivity 3 uv @ 30% mod. for 1.0 V out, 20 db S/N. Very low noise & distortion. High-Q 10 kc whistle filter. Kit \$39.95. Wired \$65.95. Incl. Cover & F.E.T.

New AF-4 Stereo Amplifier provides clean 4W per channel or 8W total output. Inputs for ceramic/crystal stereo pick-ups. AM-FM stereo, FM-multl stereo, 6-position stereo/mono selector. Clutch-concentric level & tone controls. Use with a pair of HFS-5 Speaker Systems for good quality, low-cost stereo. Kit \$38.95. Wired \$64.95.

HF12 Mono Integrated Amplifier provides complete "front-end" facilities and true high fidelity performance. Inputs for phono, tape head, TV, tuner and crystal/ceramic cartridge. Preferred variable crossover, feedback type tone control circuit. Highly stable Williamson-type power amplifier circuit. Power output: 12W continuous, 25W peak. Kit \$34.95. Wired \$57.95. Includes cover.

New HFS3 3-Way Speaker System Semi-Kit complete with factory-built ¾" veneered plywood (4 sides) cabinet. Bellows-suspension, full-inch excursion 12" woofer (22 cps res.), 8" mid-range speaker with high internal damping cone for smooth response, 3½" cone tweeter. 2¼ cu. ft. ducted-port enclosure. System Q of ½ for smoothest frequency & best transient response. 32-14,000 cps clean, useful response. 16 ohms impedance. HWD: 26¼", 13¾", 14¾". Unfinished birch \$72.50. Walnut, mahogany or teak \$87.50.

New HFS5 2-Way Speaker System Semi-Kit complete with factory-built ¾" veneered plywood (4 sides) cabinet. Bellows-suspension, ¾" excu-



Stereo Preamplifier HF85



**70W Stereo Power Amplifier HF87
28W Stereo Power Amplifier HF86**



**FM Tuner HFT90
AM Tuner HFT94**



Stereo Integrated Amplifier AF4



**12W Mono Integrated Amplifier HF12
Other Mono Integrated Amplifiers:
50, 30, & 20W (use 2 for stereo)**



**2-Way Bookshelf
Speaker System HFS1
3-Way Speaker System HFS3
2-Way Speaker System HFS5**

tion, 8" woofer (45 cps res.) & 3½" cone tweeter, 1½ cu. ft. ducted-port enclosure. System Q of ½ for smoothest frequency & best transient response. 45-14,000 cps clean, useful response. HWD: 24", 12½", 10½". Unfinished birch \$47.50. Walnut, mahogany or teak \$59.50. **HFS1 Bookshelf Speaker System** complete with factory-built cabinet. Jensen 8" woofer, matching Jensen compression-driver exponential horn tweeter. Smooth clean bass; crisp extended highs. 70-12,000 cps range. 8 ohms. HWD: 23" x 11" x 9". Price \$39.95.

LGS-1 Brass Tip Matching 14" Legs — \$3.95.

HFS2 Omni-Directional Speaker System (not illus.) HWD: 36", 15¼", 11½". "Eminently musical" — HIGH FIDELITY. "Fine for stereo" — MODERN HI-FI. Completely factory-built. Mahogany or walnut \$139.95. Blond \$144.95.

EICO, 33-00 Northern Blvd., L.I.C. 1, N. Y.

SHOW ME HOW TO SAVE 50% on 65 models of top quality:

- HI-FI Test Instruments
 "Ham" Gear Free STEREO HI-FI Guide
Send FREE catalog & name of neighborhood EICO dealer.

NAME
ADDRESS
CITY.....ZONE.....STATE.....

HF-11

Copyright, 1959 by Electronic Instr. Co., Inc. 33-00 N. Blvd., L. I. C. 1, N. Y. Add 5¢ in the West

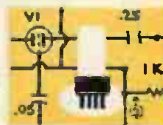

From the High-Fidelity Newsfronts

STANDARDS of measurement of the performance of high-fidelity equipment are gradually being accepted and could become common. Progress is slow; even though the Institute of High Fidelity Manufacturers announced standards for FM tuners many months ago, only a few of the manufacturers who submitted data for our roundup elsewhere in this issue of HIGH FIDELITY used the new sensitivity rating scale. This is to be expected. It takes time to convert. Equipment has to be carefully rechecked. Sales and advertising literature has to be reissued. The large mail-order houses, whose catalogues are so important to many major manufacturers, have to be notified months in advance. Finally, the public has to be educated. It may well be a year before a full-scale conversion can take place.

In the meantime, some salient points to remember are, first, that there are two (or more) methods of measuring performance. Second, that the IHFM has said nothing about performance itself. It has not said that this is good performance, and that, bad. It has simply drawn up methods of measuring distortion and/or performance, and its members have agreed to use those methods. Third, the important thing is—at the moment—to be sure the measurements are comparable. That's why we did not use IHFM sensitivity ratings, even when available, for the stereo tuner article.

Fourth, it should be clear at all times what everyone is talking about. Amplifier power ratings can be confusing because of stereo watts, monophonic watts, and peak watts. Just bear in mind that a stereo power amplifier which delivers, for instance, 12 watts per channel may also be rated as a 24-watt mono amplifier, by combining the two channels. And either the per-channel or combined figure may be doubled to give a reading in peak watts. All this is quite correct; no one is being sneaky about anything. They may be a bit conservative. There is considerable listening evidence to prove that

two 12-watt channels—in mono and even more so in stereo—sound like more loudness than a single speaker hitched to a 24-watt amplifier.

Finally, attention should be drawn to the fact that the Heath Company has gone so far as to promulgate not only standards of measurement but standards of performance. As readers of advertisements are aware, it has set up three amplifier power ratings: professional, high fidelity, and utility. In each category, five measurements are applied. Three are of harmonic distortion at different frequencies; the fourth is frequency response at specified powers; and the fifth is intermodulation distortion.

It is well worth while to make a careful study of the standards established by Heath, because they emphasize the very important fact that what matters is not how much power an amplifier can deliver, but how clean or distortion-free that power may be. For example, Heath says 3% IM distortion ranks an amplifier in the utility class; 2% is high fidelity (this, by the way, is a commonly accepted level) and 1% is professional. Some typical examples tabulated by Heath reveal that these levels of distortion are reached, by one amplifier, at 19.5, 18.9, and 18.0 watts, respectively, whereas in another amplifier they are reached at 11.6, 5.9, and 3.9 watts.

We would like to commend Heath for its decision. There will be plenty of discussion about the validity of the measurements and standards, and of their relationship to listening pleasure. But the least that can be said is that this company has taken a move in a direction worth following, and that it has publicized a good cause.

Meanderings . . . RCA Victor has been imbibing 317X, an ingredient that will be used in its discs to reduce static electricity. . . . A well-known department store in Chicago sells "hi fi under-gravel filters." For bird baths! . . . More complete info on power amps, described in September: EICO preamps are supplied self-powered only; no need for external power as implied in our comment. Fisher 300 has feature E, which is convenience outlets. . . . Morley Kahn, of H. H. Scott, says separate tone controls are wise in stereo systems, even though identical speakers are used, because room acoustics may unbalance speaker tonality. "For instance," he says, "if one speaker is located near drapes, the other near a fireplace, the speaker near the fireplace will sound shriller." True, too true. But let's not make things so simple. Let's build another fireplace. Stereo, see? CHARLES FOWLER

prepared by
Hirsch-Houck Laboratories
and the technical staff
of High Fidelity

HF reports

REPORT POLICY

Most equipment reports appearing in this section are prepared for us by Hirsch-Houck Laboratories, a completely independent organization whose staff was responsible for the original Audio League Reports. Their reports are signed: H. H. Labs. Reports are published exactly as they are received. Neither we nor the manufacturers of the equipment tested are permitted to delete information from or add to the reports, to amend them in any way, or to withhold them from publication. Manufacturers may add a short comment if they wish to do so.

On equipment that demands more subjective appraisals (such as loudspeakers), the reports may be prepared by members of our own staff. Such reports do not carry a signature. The policy concerning report publication and amendment by the manufacturer is the same as that for H. H. Reports.

Radio Shack Electrostat 3 Electrostatic Tweeter

SPECIFICATIONS (furnished by manufacturer): a three-element, single-ended electrostatic tweeter. Frequency range: 5,000 cps to 20,000 cps. Output impedance: 8 or 16 ohms, adjustable. Dispersion: 120 degrees. Polarizing voltage: built-in, AC supply. Current consumption: negligible. Size: 6 in. high by 12 wide by 4½ deep. Finish: blond or mahogany. Price: \$27.50. DISTRIBUTOR: Radio Shack Corporation, 730 Commonwealth Ave., Boston 17, Mass.

At a glance: Radio Shack's Electrostat 3 will give additional high-end luster to systems with cone tweeters and to single-cone, extended-range loudspeakers.

In detail: The Electrostat 3 is designed as an "add on" speaker for systems that lack crispness and sheen at the very top of the audible spectrum. A relatively small unit, it can be placed on top of a speaker system already installed; and as it comes in a variety of finishes, there is no problem of décor.

It is a three-element tweeter; that is, it has three sound-generating surfaces angled slightly away from each other in something like a semicircle around the front of the unit. Electrostatics often tend to concentrate their sound in a rather narrow beam, but the Radio Shack design helps spread the sound around more evenly in front of the speaker.

The Electrostat 3 has a built-in high-pass filter which reduces frequencies below about 5,000 cycles. The use of a regular dividing network (available wired from Radio Shack, for 8- or 16-ohm systems, at \$6.95) provides more flexibility in balancing tweeter and woofer.

This speaker is wired into the system just as any other tweeter would be. It has an input strip very much like the output taps of a power amplifier. A common wire is connected from the dividing network to the common lug, and the other wire to the 8- or 16-ohm tap, depending upon the impedance of the dividing network. One further step is necessary before the speaker will function. To polarize the electrostatic plates, simply plug into the wall the ordinary household AC plug provided and flip on a switch.

The Electrostat 3 is a fairly crisp-

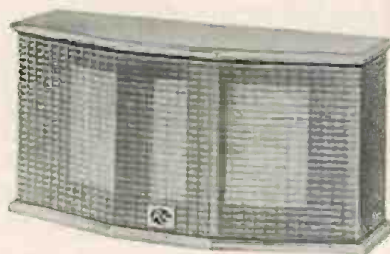

Radio Shack's 3-element tweeter.

sounding speaker. The level control on the dividing network permits adjust-

ing the level of the woofer (or your present system) to match the output of the tweeter, which is fairly low in efficiency. With the level control full up, the speaker seemed to match my AR-2; with other systems, I had to turn the control back a bit.

The several models that I listened to appeared to have more distortion and to be less smooth than more expensive electrostatic tweeters now on the market. But the Electrostat 3 is only a fraction of the cost of some of these units. For its budget price of \$27.50, it might well be a desirable first step towards improvement.

MANUFACTURER'S COMMENT: Referring to your remarks on the efficiency of the Electrostat 3, it is essential to know that the input circuit to the electrostatic elements is so designed that the load as presented to the amplifier output terminals is mainly resistive rather than capacitive, even at the highest frequencies. Consequently, the tendency towards disturbing the feedback loop and instability of the amplifier is minimized. Several imitations of the Electrostat 3, although they showed higher efficiency at the crossover frequency, will overload and upset the feedback loop of even the best amplifiers to the point where the output at the higher frequencies is reduced to a much greater extent than the difference in efficiency at the crossover frequency. Some of the competitive units tested at 20 kc showed an input impedance of $\frac{1}{10}$ of that at nominal or crossover frequency. Same, although the manufacturers claimed they would not require a crossover, showed $\frac{1}{10}$ of the nominal impedance at 50 cps. The impedance of the Electrostat 3 at any frequency is never lowered by any more than 25% of the nominal or input impedance as marked on its terminal board.

Marantz Stereo Preamp and Amplifier

SPECIFICATIONS (furnished by manufacturer): The Model 7 preamplifier is a self-powered stereo unit providing complete versatility, with selector positions for microphone as well as two separate magnetic phono cartridges and tape head. The mode switch permits paralleling the two halves of a stereo cartridge for monophonic records. **Frequency response:** ± 0.5 db 20 to 20,000 cycles. **Noise:** 80 db below 10 mv phono input in audible range. **Price:** \$249.; cabinet \$24.

The Model 5 power amplifier is conservatively rated at 30 watts ultra-linear operation; 60 watts peak. **Sensitivity:** 1.3 volts for 30 watts output. **Frequency response:** of 30 watts, ± 0.1 db 20 to 20,000 cycles. **IM distortion:** of a typical amplifier, 0.28% at 30 watts. **Feedback:** 20 db over-all. **Hum:** 90 db below 30 watts. **Price:** \$147.; grille, \$7.50. **MANUFACTURER:** Marantz Co., 25-14 Broadway, Long Island City 6, N. Y.

At a glance: The Marantz Model 7 Stereo Console, like the original Marantz monophonic control unit, is noteworthy for its extremely low distortion and noise level, and its superior construction.

The Model 5 Power Amplifier, like the well-known 40-watt Marantz power amplifier, has almost unmeasurably low distortion and noise levels, very conservative power ratings, and a caliber of construction which suggests that it can operate almost indefinitely without needing replacement or major service.

In detail: The Marantz Model 7 Stereo Console, although it has practically every operating feature which might be desired in a stereo control unit, is straightforward and easy to operate.

On the left side of the panel are the four basic controls: input selector, mode selector, volume, and balance. On the right side of the panel are the four tone controls, which are eleven-position switches instead of the usual continuously variable type. In the center are four lever type switches for rumble and hiss filters, record equalization, and tape playback monitor. A heavy-duty slide switch, rated at 15 amperes, controls power to the Model 7 (which has a built-in power supply), and to five of the six AC convenience outlets on the rear of the unit. The sixth outlet is permanently energized to connect to a turntable—which should, of course, be turned off with its own switch.

The selector switch has eight positions, for microphone, two magnetic phono cartridges, tape head, FM-AM tuner, FM multiplex input, TV sound, and AUXILIARY. Full stereo operation is possible on all inputs. Two parallel-connected amplifier outputs can be mixed to drive a third amplifier for center-fill. A third pair of outputs is taken off ahead of volume and tone controls to make tape recordings.

In addition to Stereo and Stereo Reverse, the mode switch offers three monophonic modes of operation. Either channel A or channel B may be fed to both amplifiers, or their signals may be added in the A+B position, to eliminate vertical rumble when playing mono records.

The balance control allows either channel to be completely cut off, at which time the level of the other channel is raised by 2.5 db. As a result, when the balance control is used there is no change of level to be heard, merely a shift of apparent sound source from left to right or vice versa.

The two sections of the ganged volume control are individually tested by Marantz for tracking, so that the balance does not change by more than 2 db down to 65 db attenuation.

The rumble filter provides an off position and two positions of cutoff, at 50 and 100 cps. The hiss filter has an off position and two cutoff frequencies, 5 kc and 9 kc. The phono equalization is inherently RIAA, but one of the front-panel lever switches allows this to be changed to the old Columbia LP characteristic, or to one having little high-frequency rolloff, for early 78-rpm discs. In the tape head position of the input selector, NARTB tape playback equalization is used. Each channel has an adjustment on the rear of the unit to vary the tape playback equalization around the ideal NARTB curve for tape machines requiring such corrections.

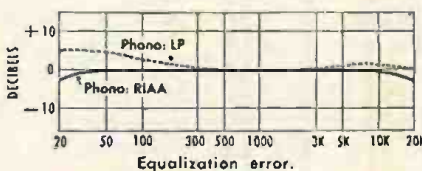
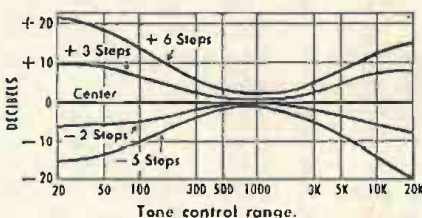
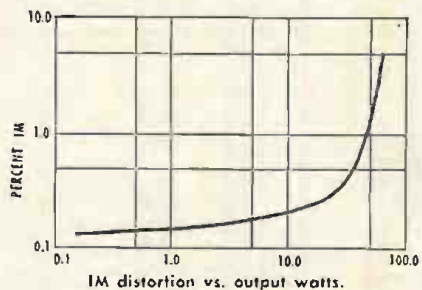

Each channel also has an output level adjustment on the rear of the preamplifier, to compensate for speaker systems of widely different efficiencies, or when very high-gain power ampli-



Marantz quality—still outstanding.

fiers are used. These controls also reduce the noise level of the signal supplied to the power amplifiers, though this seems to be a rather academic consideration in view of the performance of the Model 7.

Finally, a binding post terminal is provided on the rear of the Model 7 for making all system ground connections. This is a vital consideration in stereo systems to reduce hum, yet so far as we know only Marantz has made it a simple matter to ground the turntable chassis, tone arm, etc. without additional soldering operations.

Test Results

The tone control characteristics are of the sliding inflection point type, which have relatively little effect on mid-frequencies when used in moderation. Marantz recommends the use of the tone controls for loudness compensation, and no ordinary loudness control is provided. The switch-type tone controls offer the advantage of complete re-settability, and the curves in the instruction booklet show the response for all positions of the controls. These curves agree perfectly with our measured data.

RIAA and NARTB equalization characteristics agree exactly, within the limits of measurement error, with the theoretical curves. The Columbia LP characteristic appeared to have slightly more response at very low frequencies than it should have. We were most impressed to find that all equalization characteristics were matched on the two channels to within 0.2 db at all frequencies.

The IM distortion was about 0.1% up to 3 volts output, which is close to the residual distortion in our measuring equipment. It rose gradually above this output level, becoming 0.2% at 10 volts. For all practical purposes, the Model 7 is distortionless.

We checked the volume control tracking down to -40 db, and the gains of the two channels never differed by more than 0.2 db. Here again, as has so often happened when we test Marantz equipment, we are limited by the normal errors inherent in test instruments.

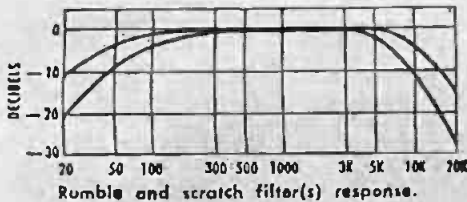

The gain of the Model 7 is extremely high, and only 50 millivolts are needed to develop 1 volt output from the AUX or other high-level inputs. On the phono input a 0.4 millivolt input develops 1 volt output. At full gain (which could not be used even with the lowest output magnetic cartridges), the hum and noise level on PHONO was about 50 db below 1 volt. This would be a respectably low hum level on almost any other preamplifier, but when the gain is reduced to a more practical level the hum falls to -78 db—which is totally inaudible under any listening conditions. On the high level inputs the hum is better than -80 db at any gain setting.

Model 5 Power Amplifier

The Model 5 is a basic power amplifier, with no controls other than screw-driver adjustments for bias on the output tubes (a pair of EL-34s). Two inputs are provided: one going directly to the grid of the input stage and the other through a filter which rolls off response below 20 cps to prevent speaker damage due to subsonic signals such as switching transients.

The outputs are for 4-, 8-, and 16-ohm loads, with a damping factor of

20. Instructions are given for making a simple change in the internal wiring to obtain damping factors of $\frac{1}{2}$, 1, or 2 if this is desired.

As with the original Marantz 40-watt amplifier, a meter is built in so that the output tubes can be balanced as required. As with the older unit, one must be careful to avoid getting burned on the very hot output tubes, due to the location of the adjustments adjacent to the EL-34s. Fortunately this adjustment is not likely to be required very often. The oil-filled input filter capacitor and telephone-quality electrolytic filter capacitor which characterized the 40-watt amplifier are also in evidence on the Model 5, and they as well as the tubes are operated well below ratings. Their life should be practically indefinite.

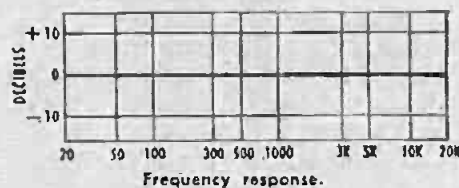

The frequency response of the Model 5, between 20 and 20,000 cps, is flat enough to be drawn with a straight edge. Less than 1 db of loss is introduced at 20 cps when going through the filtered input.

The power response is practically as flat as the frequency response. This means that the full steady stated power output of about 32 watts with no clipping of the waveform can be

obtained down to below 20 cps and that the 30-watt rating is met at 20,000 cps as well. The power output of the Model 5 into a 3-mfd capacitive load (simulating a wide-range electrostatic speaker) was 20 watts at 10 kc. The fact that two-thirds of its rated power was available under these conditions is noteworthy, since few if any amplifiers we have tested will develop as much as one-half rated power under this admittedly stringent test.

Measuring distortion in a Marantz amplifier has always been a challenge and the Model 5 is no exception. At 1 kc the harmonic distortion is below the residual of our test equipment (0.06%) up to 30 watts, after which it rises sharply, reaching 0.3% at 40 watts. At 20 cps, our residual distortion was 0.1%, which was not exceeded until 7 watts output was reached. This, too, rose to 0.3% at 40 watts output. The IM distortion was measurable, but very low throughout the range of outputs up to 30 watts, where it reached 0.3%. At 50 watts output the IM was only 1%. Since many amplifiers are power-rated at 2% IM, one appreciates the conservatism of the Model 5's 30-watt rating.

The hum level was 88 db below 10 watts output with open circuited input, and better than 90 db below 10 watts with a low-impedance source driving the amplifier. The damping factor measured at 19. The amplifier was rock-stable under all conditions of capacitive loading. —H. H. Labs.

Z-400 Speaker System With Woofer and JansZen Electrostatic Tweeters

SPECIFICATIONS (furnished by manufacturer): a full-range bookshelf speaker system consisting of the JansZen two-radiator electrostatic tweeter and the Model 350 cone woofer, in a totally sealed enclosure. **Frequency range:** 30 cps to beyond 30,000 cps. **Cross-over frequency:** 1,000 to 2,000 cps. **Type of network:** LRC high-pass filter for tweeter; mechanical rolloff on woofer. **High frequency dispersion:** 60 degrees. **Power consumption** (tweeter power supply): 2 watts. **Impedance:** 8 ohms. **Power capability:** 50 watts program. **Finish:** birch, mahogany, oil walnut, walnut, unfinished. **Price:** \$134.50 to \$149.50. **MANUFACTURER:** Neshaminy Electronic Corp., Neshaminy, Pa.

At a glance: The Z-400 provides the same wide-range, low-distortion output as JansZen's well-known Z-300, but is a more compact and versatile system. The Z-400 can be placed on a shelf or on the floor—either along a wall or in a corner. Two units, paired for stereo, provide fine quality at a reasonable price.

In detail: The Z-400 is a version of

the Z-300 scaled down only in the physical sense; it has been reshaped to satisfy the current demand for bookshelf speakers. The acoustic aspects of the speaker's design remain the same. The interior is the same 2.2 cubic feet as the JansZen Z-300. The woofer is the same Model 350 long-excursion unit as in the Z-300. And the tweeter, for which Neshaminy and JansZen are perhaps best known, uses two of the square electrostatic elements.

On the low end, the Z-400, like its predecessor, is superb. The middle-range response is smooth and evenly blended. From 2,000 cycles up the sound of the Z-400 is crisp and sharply defined. On some records, where the upper ranges have been exaggerated for an enhanced high-fidelity effect, the JansZen is a bit too bright, even with the tweeter control set at minimum. But this is certainly not a fault of the speaker, and is a condition which usually can be corrected with tone controls.

On the most dependable of all source material—first generation tapes—the Z-400 sounds open, transparent,

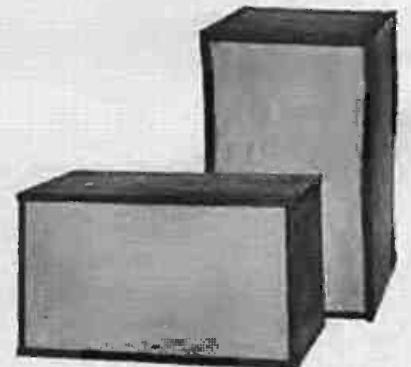

A well-balanced speaker system.

and crystalline throughout its range.

Considered as a whole, the Z-400, when fed properly equalized source material, is excellently balanced, and sounds full and natural.

MANUFACTURER'S COMMENT: Since the introduction of the first Model 130 tweeter in 1955, the JansZen Electrostatic has been designed and produced to deliver the full musical spectrum acoustically flat from 1,000 cycles to above 20,000 cycles with no attenuation and less than $\frac{1}{2}$ % distortion. In the Z-400, the same unusually wide, smooth range is obtained in a complete loudspeaker system selling for less than the original tweeter alone.

Lafayette KT-315 Stereo Adapter

SPECIFICATIONS (furnished by manufacturer): The KT-315 is a self-powered remote control adapter which permits utilization of two monophonic systems for stereo. It may be used up to 50 feet from power amplifiers. A null circuit is incorporated, to permit precise electronic balancing of the two channels. Individual volume controls may be ganged through a clutch action. **Gain:** 6 db. **Distortion:** less than 0.2% IM at 2 volts output. **Crosstalk:** better than 55 db separation. **Price:** \$27.50. **MANUFACTURER:** Lafayette Radio, 165-08 Liberty Ave., Jamaica 33, N. Y.

At a glance: The Lafayette KT-315 provides complete stereo control functions for two monophonic amplifiers. It offers greater flexibility of operation than any other stereo adapter we know of. It has no measurable effect on the distortion and frequency response characteristics of the system.

In detail: Most stereo adapters are passive devices. That is, they contain neither tubes nor power supply, but perform all their stereo control functions with potentiometers and switches. Such adapters can introduce no distortion, and are simple to install, but are somewhat limited in operating flexibility and can cause an insertion loss.

The Lafayette KT-315 incorporates active networks, with two tubes and a self-contained power supply. It is essentially the output portion of the Lafayette KT-600 stereo preamplifier. A gain of 2 is provided, instead of the loss incurred by many passive adapters. The output is from low-impedance amplifiers capable of delivering several volts output with negligible distortion. Concentrically mounted volume controls provide for balance adjustment. Once balanced, the two controls may be clutched together and operated as a single volume control.

The function switch selects either of the two inputs and feeds the selected signal to both outputs. In the stereo position it feeds each channel

to its own output. An A+B position combines the two channels and feeds the mixed signal to both outputs. A second function switch, mounted concentrically with the first one, has position for normal and reversed stereo operation. In the latter case the left signal is fed to the right channel and vice versa. A unique and very desirable feature, made possible by the tube circuitry of the KT-315, allows the phase of one channel to be reversed. This is much more convenient than the usual procedure of reversing speaker leads on one channel.



Lafayette KT-315 adapter.

An interesting means is provided for equalizing exactly the output levels of the two channels. A CAL position on both function switches adds the two channels, with a phase reversal on one channel. When the signal levels are adjusted for a null, or minimum signal in the output, the channel gains are matched. This matching applies only to the electrical output of the control unit, and does not take into account differences in the two amplifiers or speaker systems.

Another unusual feature of the KT-315 is the third channel or mixed output. A bridge control supplies a combined channel A and channel B output, equally mixed, to an output jack in the rear of the unit. This may be used to drive a third amplifier and speaker midway between the two stereo speakers, to fill in the center

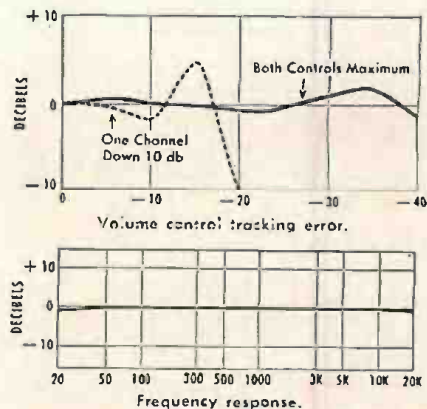

area. With a normal two-speaker stereo installation, excessive channel separation may be corrected with the bridging control by setting the function switch to A+B. With the bridging control counterclockwise, this gives a 14-db channel separation. As it is rotated clockwise, the channel separation is reduced, until in the clockwise position the two channels are completely mixed.

In our tests of the KT-315, the frequency response proved to be as flat as our measuring equipment, or within about 0.1 db from 20 to 20,000 cps. The intermodulation distortion also was almost unmeasurable, since it approached the inherent distortion of the test equipment. The IM is not more than 0.1% for output voltages up to 4 volts, which is more than sufficient to drive any amplifier. The volume control tracking error was less than plus or minus 2 db down to -40 db (relative to maximum setting), which is quite satisfactory. When the gain settings of the two volume controls are initially displaced by 10 db, the tracking error increases considerably. This points out the desirability of equalizing the gains at the external mono amplifiers with the KT-315 controls set to the same point. Minor adjustments may be made at the KT-315 without trouble from tracking error.

H. H. Labs.

Regency HFT-1 Preamplifier

SPECIFICATIONS (furnished by manufacturer): This is a transistorized preamplifier-control in kit form. Provides phono equalization, separate tone control facilities, and input selection. **Tone control range:** bass, +15 db at 20 cycles; treble, +8 and -20 db at 20,000 cycles. **Frequency response:** ±0.5 db 20 to 20,000 cycles. **Noise:** 70 db below 1 volt output. **Battery operation.** **Price:** \$34.95 less batteries. **MANUFACTURER:** Regency Division I.D.E.A., Inc., 7900 Pendleton Pike, Indianapolis 26, Ind.

At a glance: The Regency HFT-1 is a fully transistorized, extremely compact, and completely self-contained

preamplifier. It has its own batteries, and operates with an extremely low noise level. On the other hand, its gain is relatively low and its output voltage capability is similarly low with the final result that speaker volume may be insufficient.

In detail: The Regency HFT-1 is available in kit form or ready-wired. The three transistors and most of the components are mounted on a printed wiring board. The over-all dimensions in its cabinet are 7½ by 2½ by 3½ inches. It weighs only 29 ounces including batteries. Either one or two



Regency's new preamplifier.

9-volt batteries may be used, but distortion is substantially lower with 18 volts and this voltage is strongly recommended. Some 500 hours of battery life should be obtained.

This is a basic preamplifier and has

Continued on page 158

A high fidelity **KIT REPORT**



The **GRAY HSK-33** *Turntable*

In about 25 minutes, you can put together a unit that looks beautiful, works well, has little vibration, almost no noise, keeps constant speed

The Gray HSK-33 is a single-speed, $33\frac{1}{3}$ -rpm turntable, available in kit form at the excellent price of \$49.50. It employs a hysteresis-synchronous motor, is belt-driven, and has an aluminum (nonmagnetic) turntable platter. Construction time is claimed to be 25 minutes, and this is within reason, though we dawdled and took nearly an hour and a half. A special belt is used, to provide optimum decoupling from motor shaft to turntable proper. The motor shaft may be adjusted in three planes. A base is available from Gray, though it seems likely that the home craftsman, intrigued with the idea of constructing a turntable from a kit, will be sufficiently intrigued to build his own base. Also available is a matching tone arm kit, costing \$23.95; an outstanding feature is the viscous damping principle, used by Gray for many years.

Assembly of the turntable kit involves mounting the motor to a support bracket and then to the mounting plate; attaching the turntable well, the starting capacitor, a line-cord clamp and a terminal strip to the mounting plate; clamping nine wires to the terminal strip, two

to a toggle switch, and one to the motor (which in turn is grounded to the frame); and making seven soldered connections. The rest of the project is adjustment of the motor to the correct distance from the mounting plate to keep the belt in its right place. This step would probably be needed even if you bought the turntable already assembled.

From this point on you are involved in woodworking if you build your own base from scratch, or in a minor bit of hole drilling if you mount the turntable in one of Gray's ready-built bases. Most of the hole drilling has to do with mounting an arm, however, and has nothing to do with the HSK-33 kit. The only hole necessary for the turntable is a half-inch in size, to mount the toggle switch. This hole can be dispensed with, if you run a jumper across the terminal strip where the switch wires are connected and plug the line-cord into the switched AC outlet on the back of your control amplifier or preamp. If, however, you operate your system with, say, a tuner or tape recorder, you'll probably want some way to turn off the turntable while the other equipment is still operating, and the switch will be necessary.

My personal feeling is that the toggle switch supplied is not esthetically a fitting companion to such a beautiful piece of equipment. The turntable, in flat black and aluminum, and the base, in lustrous wood-grained formica, are much too elegant for a common, garden-variety on-off switch. I'd prefer the type of switch that turns on clockwise and that takes a knob, like the kind found on volume controls. (You can, of course, add your own switch, which is just what I plan to do.)

How well does the HSK-33 perform? Very satisfactorily, indeed. It requires a bit of breaking in; the manual recommends ten hours. This is adequate, but my experience was that the longer it ran, the quieter (mechanically) it became. The motor makes only a slight swish. There is very little vibration to it, and four quite large and very resilient damping spheres (they are hollow) keep virtually all vibration away from the turntable itself.

The noise which must be worked out comes primarily from the turntable well. Tolerances between well and turntable shaft are so slight that, until the two are broken in to fit each other, the sound of metal rubbing on metal is noticeable. But this gradually dies down until the mechanism makes almost no noise at all.

Rumble appears to be very low, though not as low as on some expensive turntables of professional quality I have used. Here again, it will probably get lower as the unit continues to operate.

Speed constancy, as expected, is excellent. The turntable maintains its speed even when you try to slow it down by rubbing your finger against the edge of the platter. You *can* stop it completely, if you try hard enough, but for normal loads, it stays on speed without deviation.

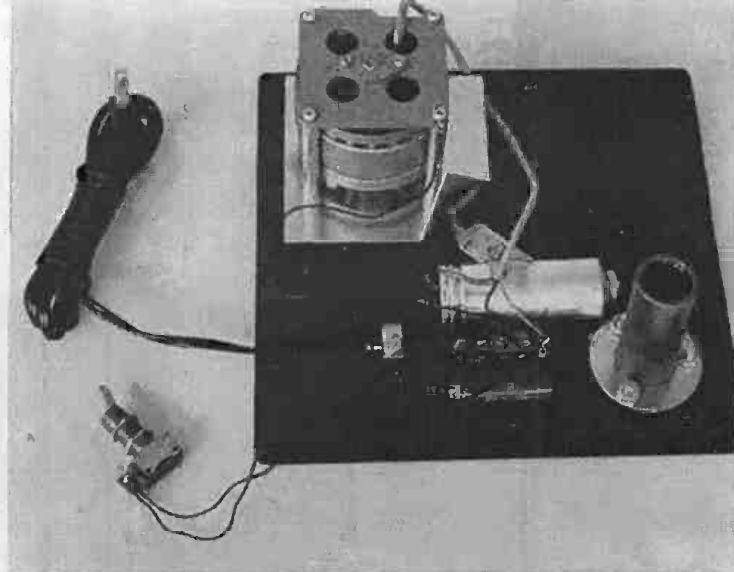

Motor is attached first to its support bracket, then to mounting plate.

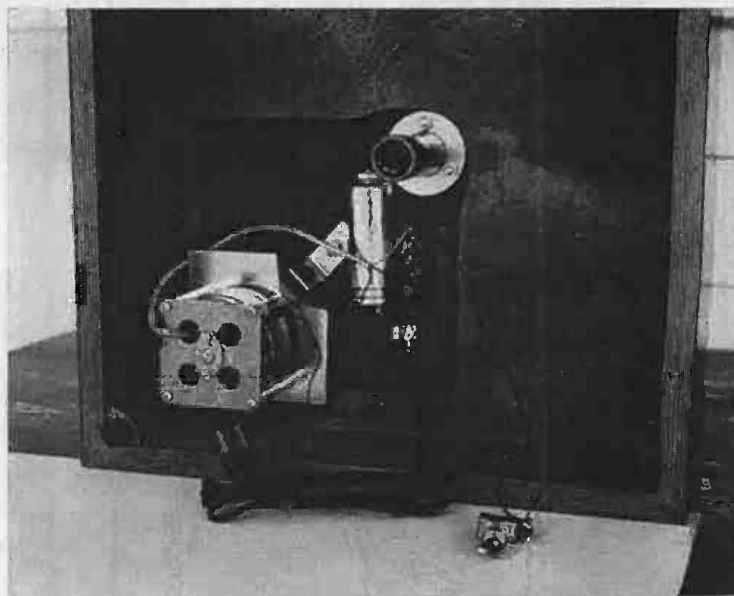

Lower view of completed unit. The longer it works, the quieter it runs.

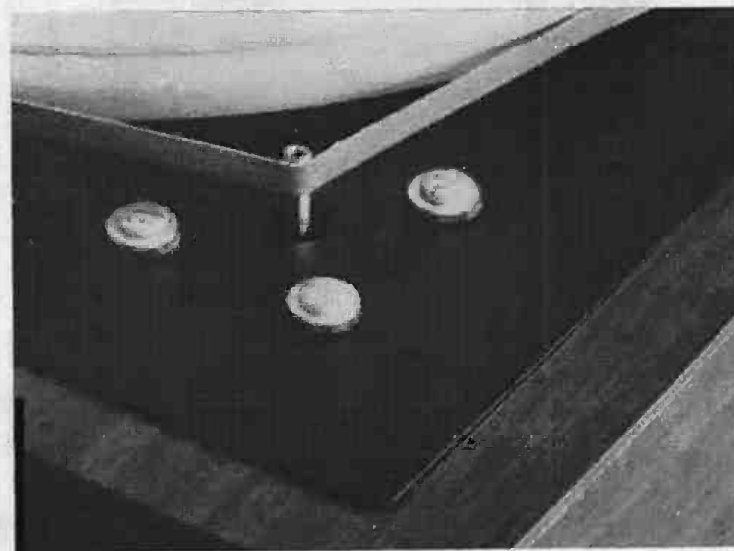

Belt-driven turntable keeps constant speed even when you try to slow it.

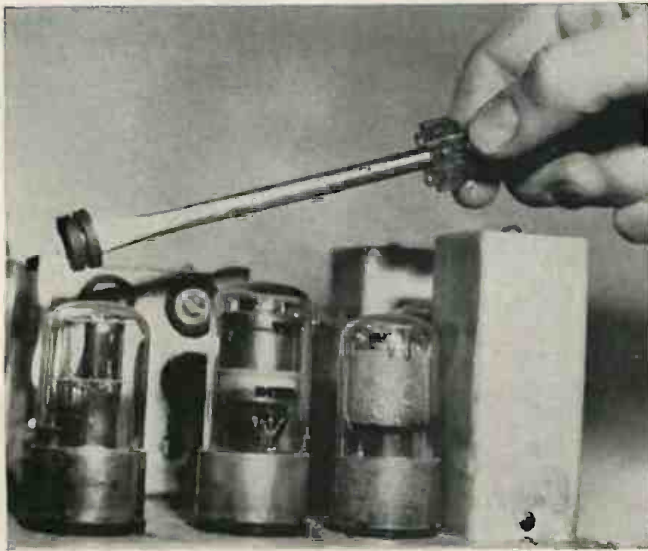

HELPFUL HINTS

by *John A. Comstock*

- When you suspect that the trouble with your system is a microphonic tube (one having loose elements), proceed gently. Don't pick up just any tool from the bench to use as a tube tapper. A good soft hammer for the job is simply a rubber wire feedthrough grommet, slipped over the tip of a screw driver's blade.

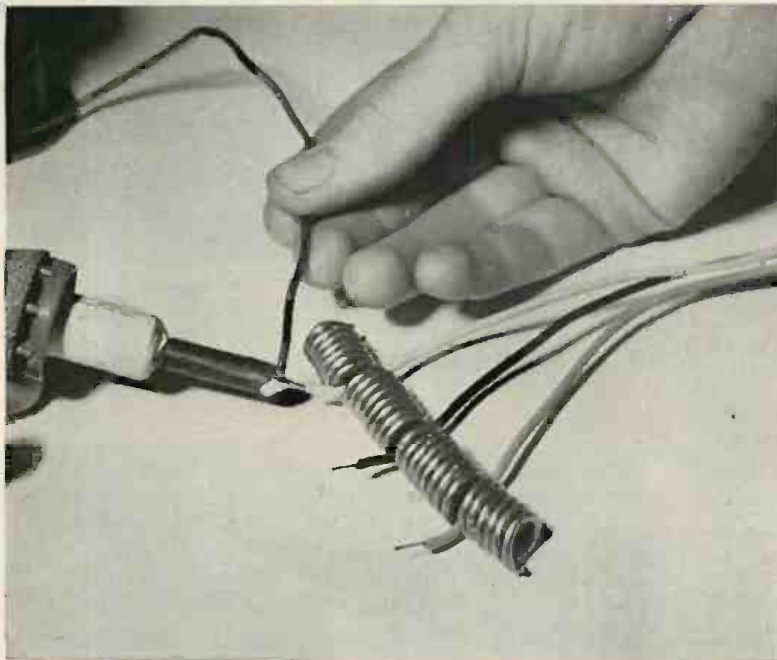

- When you have several wire leads to tin, a spring made of coiled-up wire solder can be used to hold the leads as shown, while you tin their tips. After the job is done, you will find the spring of solder more convenient to use than a spool of solder. Make the spring by wrapping the solder around a pen or similar object.

- To keep the AC line-plug of a high-fidelity system from slipping out of the socket of an extension cord when the other cords are pulled, tie a simple overhand knot in it. Just entwine the cords and insert the plug into the socket. This way the plug can't possibly slip out and disconnect the circuit.

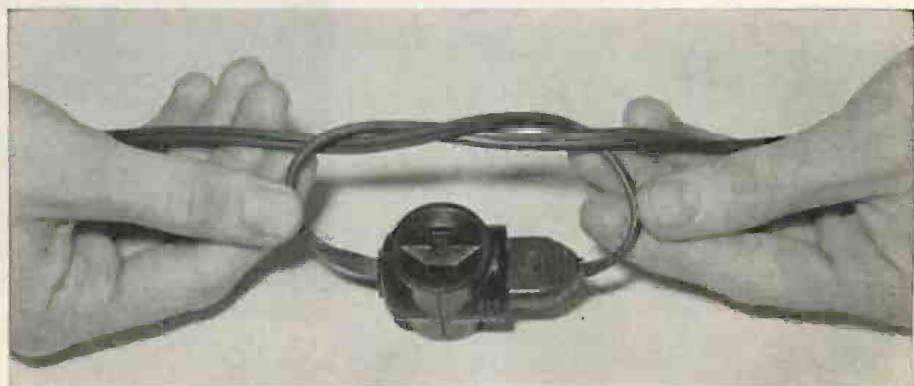



Audionews

Acro

The Acrosound stereo preamplifier is available either as a kit or completely factory-wired. Two magnetic cartridges may be connected to this preamplifier at the same time and selected by the front-panel selector switch. Thus a changer and a turntable may be used in the system. Other features



include tape head equalization as well as input for microphone connections. This may be faded into one channel for announcing. A third-channel output is provided, as well as an output to tape recorder. Phase of speakers may be reversed from the front panel. Scratch, rumble, and loudness controls are included as well as separate bass and treble for each channel. Price: as a kit, \$79.50; laboratory-assembled \$129.50.

Concertone 505

This new American-Concertone tape recorder will record and play back in 2-track as well as play back in 4-track methods. For 4-track stereo a second head designed for slow speed ¼-track tapes is used. Separate record and playback heads, in 2-channel operation, permit instant monitoring. Speeds are 3¼ and 7½ ips. Operation is by push-button relay; 3 motors, including a hysteresis drive unit, are incorporated. Each channel has separate microphone and line inputs. Output is low impedance. Level indicators and tape revolution counters are included. Price: \$495.

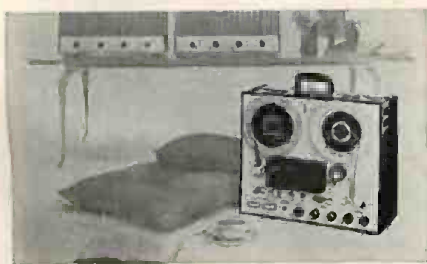

Roberts

An adapter is now available which permits playing of tape cartridges on Roberts reel-to-reel recorders. The adapter is mounted directly over the feed-reel and take-up spindles and is driven by a belt from the recorder capstan to a flywheel beneath the adapter. A separate head is provided for playback. Tentative price for the entire unit is \$75.

Knight-Kit Amplifier

The Knight-Kit 83YX774 is a stereo control amplifier kit delivering 40 watts. It is rated at 0.5% distortion at 20 watts per channel; frequency response is ± 1 db 15 to 35,000 cycles at 10 watts. A special feature is the center channel output. Other features include single-knob balance control; du-

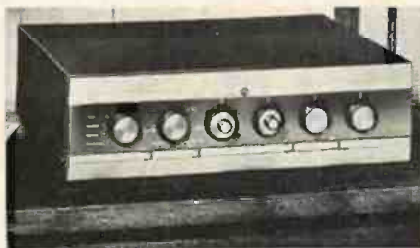

al concentric, clutch type tone controls; rumble and scratch filters. The price is \$79.50.

Heath AS-2

The Heath Company has been licensed by Acoustic Research to offer the AR Acoustic Suspension principle in kit form speaker system. The AS-2 incorporates a 10" acoustic suspension woofer and two tweeters. Response is stated to be ± 5 db from 42 to 14,000 cps at 10 watts. Impedance: 8 ohms. The prefabricated cabinet makes it necessary only to mount the speakers, construct the crossover network, and line the cabinet with fiberglass. Dimensions: 24 by 13½ by 11½".

Robins Turntable-Leveling Kit

A new turntable-leveling kit has just been announced by Robins. It consists of four adjustable rubber feet and a spirit level that can be mounted on top of the base.

Recorder

The Recorder is an ingenious device consisting essentially of two side pieces and two rods . . . one of the side pieces sliding on the rods so that



the record holder is expandable. The rods supplied with the unit are 10" long, so the unit can hold 50 LPs. Extensions are available; each pair increases capacity by 25 records. The Recorder may be put anywhere; it has felt feet. Price: \$6.95.

Grommes 240A

This power amplifier has two separate 20-watt channels with separate level controls and a meter to check channel balance. Can be used as a 40-watt monaural amplifier. This is a power amplifier only.

Bogen-Presto TC-322

The "Challenger" stereo tuner features automatic volume control as well as automatic frequency control and an illuminated dial scale. It will receive stereo AM-FM broadcasts as

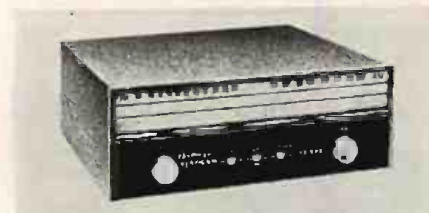

well as regular ones. Multiplex may be obtained by the addition of an adapter. Sensitivity on FM is specified as 5 microvolts for 30 db quieting. Price, including cabinet, is \$109.50.

Altec 353A

This control amplifier's stereo program peak power rating is 100 watts, with

50 watts continuous or 25 watts nominal per channel. Frequency response at 1 watt is specified as within ½ db from 10 to 30,000 cycles. There are seven inputs for each channel and six stereo or monophonic outputs. In addition to the customary bass, treble, and volume controls, the unit features a loudness contour switch and a rumble filter. Price: \$195.

Norelco Model 400

This self-contained tape recorder will record or play back in stereo or monaural, either 4-track or 2-track. It features three speeds, 7½, 3¾, and 1½ ips.



Inputs are provided for microphone, tuners and phonograph with facilities for mixing microphone with tuners or phono. An output jack for monitoring with stereo headphones is incorporated. The microphones are enclosed in one case, using the cross-fire technique. A single speaker is incorporated in the carrying case. Frequency response at 7½ ips is specified as 50 to 18,000 cycles. There are ganged input volume controls on microphone and on radio-phonograph channels, as well as separate playback volume controls, and individual concentric but friction-ganged tone controls. Output connections from each channel may be made direct to stereo loudspeakers or to power amplifiers. Also included is a recording-level indicator (magic eye) and a four-digit reel revolution counter. Price: \$399.50.

Fisher SA-100

This power amplifier's two stereo channels together deliver 50 watts. Output impedances are 4, 8, and 16 ohms. A center channel jack permits addition of a third amplifier and speaker system. Harmonic distortion is rated at

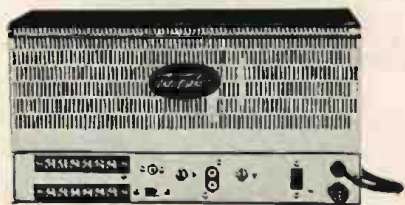

0.8% at 25 watts of music per channel; 1M distortion is 0.1% by CCIF standards. Each channel has bias controls. Three external test point terminals are included. Price: \$119.50.



Bogen-Presto AC-220

This stereo control amplifier provides 10 watts per channel. Separate bass and treble tone controls are ganged for operation on each channel simultaneously. Each channel has a separate volume control. Inputs are for magnetic phono, radio, and auxiliary. A loudness control switch is included. Price: \$79.95.

GE Control Amplifiers

Rated at 28 watts (IHF) per channel, this stereo control amplifier accommodates five input channels: tape, monophonic cartridge, stereo cartridge, tuner, and 1 auxiliary. Flexibility is also the keynote of the speaker mode selector which permits parallel as well as stereo operation. The parallel mode is for stereo cartridges used on monophonic discs. Other controls include loudness, contour, balance, separate bass and treble controls, scratch and rumble filters.

The Model G-7600 is the same except that output rating is 20 watts and scratch filter and phasing switch are omitted.

Connoisseur Pickup and Arm

Ercona has announced importation of a new 10¾" arm equipped with a 0.6-



mil diamond stereo ceramic pickup. The arm is lifted by means of a knob located above the pivot point of the arm. Frequency response of the cartridge is stated as ± 2 db from 20 to 20,000 cycles; channel separation is from 20 to 25 db. Prices: arm, \$59.50; turntable, \$119.90.

Heath SA-1

This stereo control amplifier provides 14 watts per channel and complete preamplifier-control facilities. An important feature is two switch-selected phono inputs, one for monophonic cartridges and the other for stereo cartridges. In addition there is a tape head input and three high-level in-

puts. Ganged volume controls as well as a separate balance control and individual power amplifier level controls are incorporated. Bass and treble controls are separate for each channel. Finally, there is a dimension control.

Heath SA-2

This stereo control amplifier is available as a kit and provides 14 watts per channel. The four-position input selector provides a choice of magnetic phono, crystal phono, tuner, or high-level auxiliary input. Tone controls are dual and ganged; the volume control is dual concentric.

EICO HF-87

This stereo amplifier is rated at 35 watts per channel with 1M distortion

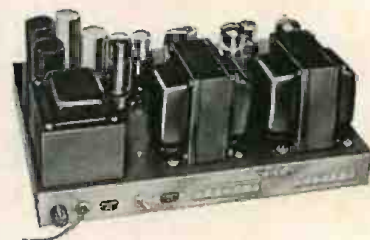

at 1% at 70 watts and frequency response at this power within 1 db from 20 to 20,000 cycles. Available in kit form at \$74.95; prewired at the factory, \$114.95.

Bogen Catalogue

The complete line of Bogen high-fidelity equipment is described and illustrated in *Catalogue 510*, now available. All new items introduced during the current season are included.

Catalogue 510 is available free of charge at Bogen dealers or directly from the company upon request.

Ferrograph 808

Ercona has announced importation of the Ferrograph 808 series which provides complete stereo recording and playback facilities for either 2-track or 4-track systems. Each pair of tracks is served by dual inputs for low- and high-level sources such as micro-

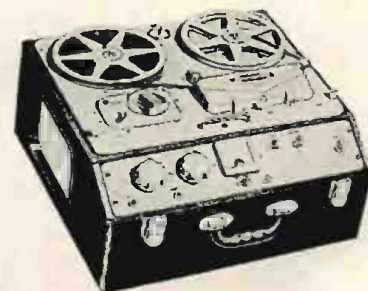

phones and tuners. Outputs are low-level, to feed amplifier-speaker systems. Price: \$595.

"The new Citation Kits represent for me the successful culmination of years of research and experimentation to achieve the ultimate in high fidelity design."

Stewart Hegeman, Director of Engineering, Citation Kit Division, Harman-Kardon, Inc.



THESE ARE STRONG WORDS from a conservative audio engineer. But the proof is overwhelming. All that's necessary is a look at the technical specifications of the new Citation I Stereophonic Preamplifier Control Center and Citation II 120 Watt Stereophonic Power Amplifier. (We'll gladly send them to you.)

Hegeman is recognized as one of the world's great audio engineers. His original designs for the famous Brociner amplifier and preamplifier, and the Hegeman-Loewer speakers, are still regarded as classics by audio engineers and audiophiles. In his capacity as head of the kit engineering group at Harman-Kardon, he has again created new classics.

Easily Assembled— Professional Performance

THERE ARE MANY exciting new concepts built into the Citation Kits. The engineering is so wonderfully precise that the instrument constructed by the kit builder will duplicate the precision of the finest factory-assembled products. Here are some of the remarkable new assembly features that distinguish the Citation Kits:

Military Type Construction: For ease of assembly and durability, rigid phenolic boards are used. **Special Cable Harness:** Unique harness template enables builder to make a professional cable harness to facilitate wiring and insure accuracy. **Special Aids:** Resistors and condensers are filed individually on special component cards so that they can be quickly identified. Wire strippers are supplied free with each kit to produce clean wire junctions.

The Citation I Stereophonic Preamplifier Control Center

HERE IS THE FIRST brilliant expression of the advanced design concepts which

sparked the new Citation Kit Line: the incomparable Citation I, Stereophonic Preamplifier Control Center.

The Citation I consists essentially of a group of circuit blocks termed active and passive networks. Active networks incorporate the vacuum tubes and furnish amplification; passive networks consist of resistors and condensers and provide precise equalization. The active networks are treated as one- or two-stage amplification units, flat over an extremely wide frequency range, and each one of these networks is surrounded by a feedback loop. *This results in levels of distortion so low as to prove unmeasurable.* The passive networks are constructed of precision components and are designed for minimum phase shift.

PROFESSIONAL STEP-TYPE tone controls are used on the new Citation I. They overcome the limitations of continuously variable potentiometers; each position on a step control can be engineered to perform a specific function which is absolutely repeatable when necessary. The flat position of the controls by-passes all tone control circuitry, thereby eliminating transient distortion and phase shift.

Other features include: The new Citation Blend Control which introduces a continuously variable amount of cross-feed between the two channels to eliminate the "hole-in-the-middle" effect of many stereo records; DC heated preamplifier filaments; six silicon diode rectifiers to provide unexcelled B+ and filament regulation; separate turnover and rolloff controls to provide precise equalization.

The Citation I is available with an optional walnut hardwood enclosure which sets off its magnificent sculptured satin-gold escutcheon. The Citation I... \$139.95, Factory Wired... \$239.95; Walnut Enclosure, WW-1... \$29.95.

The Citation II 120 Watt Stereophonic Power Amplifier

HERE IS ALL the power required from a stereophonic amplifier. Two 60 Watt Channels—with a combined peak power output of 260 Watts!

The Citation II reflects a dramatic new approach to amplifier design. Audio engineers have discovered that the characteristics of an amplifier in the non-audible range strongly influence sound quality in the audible range. This can be determined in critical listening tests where the pro-

gram material for each amplifier is laboratory controlled.

Because of this vital consideration the Citation II is engineered to produce frequencies as low as 5 cycles virtually without phase shift. At the high end—the amplifier has a frequency response beyond 100,000 cycles without any evidence of ringing or instability.

AUDIO ENGINEERS have also found that the higher the degree of feedback—and the consequent lower distortion—the more apparent the improvement in sound quality and the greater the reduction in listener fatigue. In order to increase the degree of feedback in the Citation II, a "multiple loop" technique is used in contrast to conventional "single loop" techniques. This results in a 20/1 to 30/1 reduction in distortion compared with the 10/1 to 20/1 reduction in conventional amplifiers.

Other important Citation II features include: video output pentodes in all low level stages for exceptional wide frequency response and low distortion; power supply consisting of four silicon diode rectifiers, choke and heavy duty electrolytics with potted power transformer for superb regulation and long life; bias meter to adjust individually the plate current of each KT88 for balance and lowest distortion.

The Citation II is a handsomely styled brown and gold instrument with an optional Charcoal Brown protective cover. The Citation II... \$159.95; Factory Wired... \$219.95; Charcoal Brown Enclosure, AC-2... \$7.95.

All prices slightly higher in the West.

For a complete report on the new kits write to Harman-Kardon, Inc., Citation Kit Division, Dept HF-11, Westbury, N. Y.



Citation I



Citation II

Build the Very Best

CITATION KITS

by **harman kardon**



Who are all these people
... and what do they want?



Photos by Kevork K. Fags

These are the folks who work in the farmhouse, and feed Peter, the cat, and write and edit and illustrate and produce your magazine.

Issue by issue, as you read these special messages from us to you, you're going to get to know each of these men and women (and others) a whole lot better. You'll know who they are and what they do . . . their education, background, special talents . . . how warmly they live with their work. Whether you know it or not, it takes a lot of living, and a lot of loving to get out your special kind of a magazine each month, and just for you.

You'll learn how they go about discovering what you want to read most, and how they spare no effort to find the one right authority to write it for you. And how genuinely pleased these men are to do a story for the readers of High Fidelity. You'll learn more about our 9-man editorial advisory board, and their zealous interest in keeping this the finest publication of its kind. You'll learn how these pages are actually put together, how we work with our printer,

The Rumford Press, outstanding craftsmen. You'll learn . . .

And before we're through, we'll be telling you how our general manager lost his Thanksgiving turkey in the East Boston tunnel . . . we'll introduce you to our lady advertising manager who's never been known to wear her hat in the office . . . show you our business manager in action as America's champion fly-swatter.

But more than anything else, we want you to come away feeling that we enjoy making this magazine every bit as much as we hope you enjoy reading it. And that, in turn, when you are so benefited, it works out perfectly peachy for your favorite record and equipment dealer's business . . . and that conscientious manufacturers, in their turn, make lots more sales, and go on to develop new and improved products.

In short, there are an awful lot of people who care about satisfying your special wants . . . and especially the folks at . . .

high fidelity

THE MAGAZINE FOR MUSIC LISTENERS

Superior Stereo... from

SARGENT RAYMENT



Dr. Kenneth Eldredge, noted Electronic Consultant and Research Director, puts SARGENT-RAYMENT equipment through an intensive series of performance tests in one of the West Coast's most advanced electronic laboratories.

**From antenna to output terminals...
SARGENT-RAYMENT has the
LOWEST COMBINED DISTORTION
of any stereo system available today,
at any price!**

It is easy to claim superiority—difficult to prove it. But there is one proof that passes every test—the proof of *performance*. This

is what SARGENT-RAYMENT has to offer, and is why SARGENT-RAYMENT components are fast becoming the stereo standard of comparison. To engineer and music lover alike, SARGENT-RAYMENT Stereo offers performance all out of proportion to its price. Judge it yourself, with the one test that's undisputable—your own ears. Hear it at your Component HI-FI Dealer's today.

**SARGENT
RAYMENT CO.**
4926 East 12th Street,
Oakland 1, California



HI-FI's BEST GUARANTEE
S-R Stereo Reproducers are backed
by the Industry's best Guarantee...
15 MONTHS

Please send FREE 12-page technical brochure
describing S-R Stereo Reproducers.

Name

Address

City & State

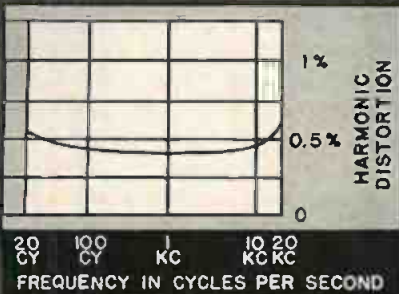

FM distortion through entire audio band at full modulation

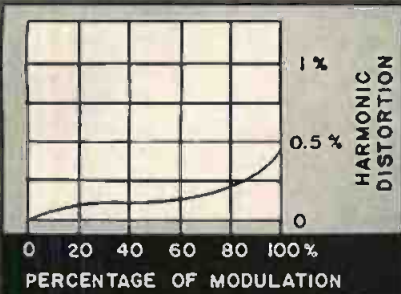

AM distortion of special S-R two-tube detector

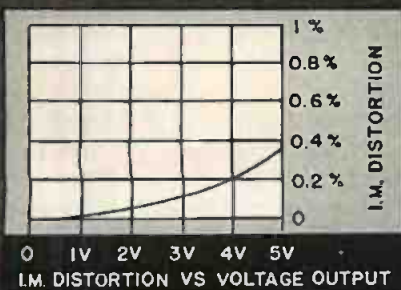

Tone control, high voltage—low-distortion cathode follower output

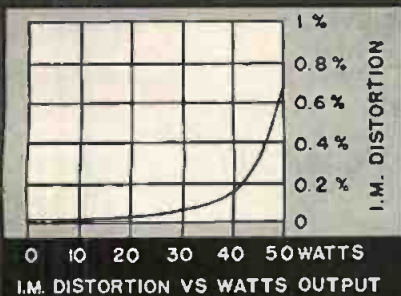

Amplifier output with all tubes being driven within recommended operating voltages

Photos at left and curves above refer to SARGENT-RAYMENT SR-1000 AM-FM Stereo Tuner (\$184.50), SR-2000 Master Stereo Preamplifier (\$163.50), and SR-5100 dual 50-watt Stereo Power Amplifier (\$183.60). These and other S-R stereo equipment fully described in free 12-page brochure available through coupon at left.

MERRY WIDOWS

Continued from page 66

in 1907 when it was renamed *1001 Nights*.

Strauss had better luck on his next try, when he was offered the adaptation of a book by Henri Meilhac and Ludovic Halévy, Offenbach's librettists. Their comedy *Réveillon* eventually became *Die Fledermaus*, written in forty-two nights and given its first performance on April 5, 1874. It was presented only sixteen times in its first season, but since then it has been performed thousands of times all over the world—the perfect operetta, witty and sentimental, with beautiful music and great songs, exquisite taste and genuine humor. Johannes Brahms compared it to *The Marriage of Figaro* and never missed a performance. Together with Mozart's *opera buffa*, Wagner's *Meistersinger*, Verdi's *Falstaff*, and Richard Strauss's *Rosenkavalier*, it belongs to the small group of genuine comic masterpieces in music.

Strauss never recouped his happy inspiration. *The Gypsy Baron*, based on the novel *Saffi* by the Hungarian poet Maurus Jokai, has beautiful music (the income tax collectors might be more justified in calling it a comic opera), but it doesn't have the certain spark that makes people do the sort of things they regret the next morning. But this opera for the first time brought off the successful marriage between Viennese waltz and Hungarian melody which later became a phenomenon of many Viennese operettas. Another phenomenon is that the action of Viennese operetta almost never takes place in Vienna. Romantic complications occur at Maxim's, on the Italian Riviera, in the Hungarian *puszta*, in the Alps, on anonymous lakes, and in unspecified night clubs but never in Vienna.

It must have been a great time, that Golden Epoch of the Vienna operetta. Suppé and Millöcker used polkas and galops in their works, Strauss introduced the waltz. Suppé scored with *Boccaccio* (the libretto had been offered to Strauss and rejected), and Millöcker wrote *The Beggar Student*. There were fine performers available, among them Mme. Maria Geisteringer and the celebrated comedian Alexander Girardi, for whom many parts were especially written. But nothing lasts forever. The Golden Epoch ended on the last day of 1899 with the death of Millöcker. Strauss had died earlier, in June, and Suppé had been dead since 1895. The critics buried the Viennese operetta. It was all over, they said.

Continued on next page

NEW! sensation of TWO hi fi shows

If you're a stereo connoisseur with a limited budget, you deserve the sensation of the New York and Chicago high fidelity shows: the superb new ESL C-99 Micro/flex stereo cartridge.

Years of advanced transducer technology have culminated in a cartridge which equals the astonishing performance specifications of the international stereo standard, the ESL C-100 Gyro/jewel.

Like the world-famed C-100, the new C-99 utilizes two patented D'Arsonval generating assemblies—the most linear transducer elements known. Instead of the C-100's jeweled separating elements, the C-99 pioneers the exclusive new Micro/flex frictionless molded coupling system.

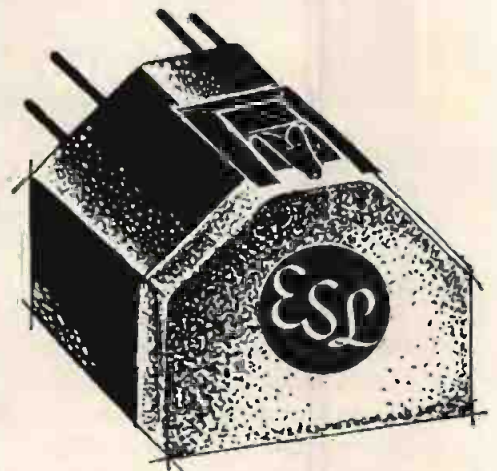

The resulting cartridge is distinctly superior to everything except the ESL C-100 and P-100, yet costs only half the price.* At a mere \$49.50, the new C-99 is the lowest price ever for authentic ESL stereo superiority.



FOR LISTENING AT ITS BEST

Electro-Sonic Laboratories, Inc.

Dept H • 35-54 36th Street
Long Island City 6, NY

*Net price for the C-100 is now \$100, and the P-100 is \$110, including transformers.

THORENS TD-124 lets you concentrate on music... not on mechanics



Finest Swiss-precision craftsmanship, famous for generations, is embodied in the Thorens TD-124. It's the *one* turntable that lets you forget technical problems—rumble, wow, flutter, incorrect speed and consequent "off-pitch" reproduction... all the rest of them, as if they never existed. Relax. Concentrate solely on music as it was *meant* to be heard. See, hear this world-renowned transcription turntable at your Thorens franchised dealer's today. 9-17



\$99.75 net.

Thorens TD-124. Finer craftsmanship, more features, than any other turntable anywhere. Acclaimed by critics throughout the world.

AND THESE OUTSTANDING VALUES COMPLETE THE "TD" FAMILY OF FINE TURNTABLES:

Thorens TD-184, \$75.00 net. A "TD" transcription table with integral arm, "Dial-o-matic" operation. Arm wired for any standard stereo pickup.	Thorens TD-134, \$60.00 net. A manually-operated transcription table with stereo-wired arm gives you superlative quality with minimum expense.	Thorens TDK-101, \$47.50 net. "TD" precision in kit form. Simple to assemble with no special tools for superlative record reproduction.
--	--	---

Sold only through carefully selected franchised dealers



THORENS

SWISS MADE PRODUCTS
HI-FI COMPONENTS • LIGHTERS
SPRING-POWERED SHAVERS
MUSIC BOXES
NEW HYDE PARK, NEW YORK

MERRY WIDOWS

Continued from preceding page

And almost exactly six years later, on December 29, 1905, a young man named Franz Lehár, from Komorn, Hungary, made his Viennese debut with *The Merry Widow*. At the end of the performance everybody was cheering; the next morning people everywhere sang the "Maxim's" song and the critics celebrated the resurrection of the Viennese operetta. True, it was only a Silver Epoch, but there was plenty of 24-carat gold, too. Lehár wrote a score of operettas, among them *The Count of Luxembourg* and *Land of Smiles*; a gifted young man named Oscar Straus (no relation, one "s") contributed *A Waltz Dream* and *The Chocolate Soldier*; Leo Fall did *Dollar Princess* and *Madame Pompadour*, Kalman wrote *The Gypsy Princess* and *Countess Maritza*; and there were Zeller's *Birdseller*, Eysler's *Brother Straubinger*, Abraham's *Victoria and Her Hussar*, to name only the biggest successes. (In America, *The Merry Widow* and *The Chocolate Soldier* are the most frequently performed Viennese operettas, followed by *Fledermaus* and *Gypsy Baron*.)

By the time the Habsburg Monarchy had broken up into the succession states, Viennese operetta was one of the very few things that everybody everywhere liked about Vienna. Operetta became an industry—and quantity of output didn't improve quality. An army of librettists, gagmen, composers, orchestrators, singers, hangers-on, and promoters promenaded between the Café Museum (headquarters of the various operetta cliques), the Hotel Sacher (home of those who had arrived), and the lovely old Theater an der Wien, where Beethoven's *Fidelio* had first been performed in 1805 and where most of the classic Viennese operettas have had their premieres. The theatre is now closed because no one wants to pay for its restoration—a sad letdown for the house with the greatest tradition of all theatres in Vienna.

The decline and fall of Viennese operetta began in the early Twenties. Plots became strictly a matter of formula. Typical is *Countess Maritza* (1926), written by the master librettists of the time, Julius Brammer and Alfred Grünwald. (Librettists always seem to come in pairs, *vide* Meilhac and Halévy, Leon and Stein.) *Countess Maritza*, a rich lady about town whom every man wants to marry "after a ten minutes' acquaintance," gets tired of life in the big city and goes back to her estates in Hungary. (There is a chance for folklore dances

and harvest songs and colorful native costumes.) Naturally she falls in love with the one man who doesn't want to marry her after ten minutes; in fact, he's her penniless administrator, and she couldn't marry him because he's a commoner (she thinks). There are some side-plots involving a fictitious fiancée. Great climax towards the end of the second act when the lady and her employee split off. Great finale half an hour later when they find out that they are made for each other. Incidentally, it isn't a *mésalliance* after all, because he turns out to be a count himself and he's got plenty of money. Curtain.

Obviously, there's no social awareness in this type of operetta. The hero, a bankrupt prince, may briefly fall in love with a peasant, but he marries only in his own circle. It's mostly a case of mistaken identity, and everybody is deadly serious about the whole thing: unlike the Parisian operetta, its Viennese sister has never laughed about itself. There are a few solo arias for the stars, and there are far too many dances in moments when they have no business being there. Oscar Straus and Kalman worried a lot about getting too many dance numbers in the wrong places, but they were not always successful. The clichés began to deteriorate.

These were the days when at the Café Museum you met characters who had struck it rich with a little inspiration in waltz and lyrics. Every month there was another premiere. The press was corrupt and the critics indulgent. There were speeches and encores and banquets, but they couldn't change the fact that operetta was dying even in its native habitat. And it has never traveled very well. Non-Viennese orchestras don't know about its subtleties, such as the ever-so-slight accent on the second beat of its waltz themes. Somehow in being transported the bubbles go out of the champagne.

The advent of Nazism signed off the end officially. The Café Museum became the hangout of brownshirts and blackshirts. People who create operettas and want to make other people happy have never worn such shirts. Hitler is said to have loved *The Merry Widow* but he was no inspiration to the operetta composers of his time. The Silver Epoch of Viennese operetta, too, is ended. But we have the musical legacy—and who knows when a new Golden Age may be around the corner?



new madison fielding series 440

it'll do everything but fly

And if you're one to be transported on wings of song, then this is truly hi-fi to fly by. All puns aside, though, Madison Fielding's new Series 440 is a triumph of stereophonic component design. A powerful AM tuner and a high sensitivity FM tuner are combined on the same chassis with a dual channel 40-watt stereo preamp-amplifier. The result? Amazing flexibility! And the knowledge that there is nothing in high fidelity reproduction that will stymie this fabulous piece of equipment.

Item: Automatic third channel stereo. A true mixing of both channels. Perfect for a three channel system or for stereo in one room and a monaural source in other rooms.

Item: Output for stereo headset. Just plug in and listen in complete privacy.

Item: Push buttons and lights. Mix from six program sources on each channel with push button selectors. Jewelled indicator lights eliminate any possible ambiguity.

Item: Aural Zero Null (AZN) Circuit. Push a button and tune for silence. When the sound disappears both channels are in perfect electronic stereo balance.

Item: Separate bass, treble and volume controls for each channel. Nulling, phasing, noise, rumble, tape monitor and loudness switches. Other controls include FM tuning, AM tuning, master volume, stereo/monaural switch and stereo reverse. Power switch is push/push button. Permits all dial settings to remain untouched while set is not in use.

Item: The Series 440 is fully described in a specifications brochure we have prepared. Write for it or see your Madison Fielding dealer for a comprehensive demonstration.

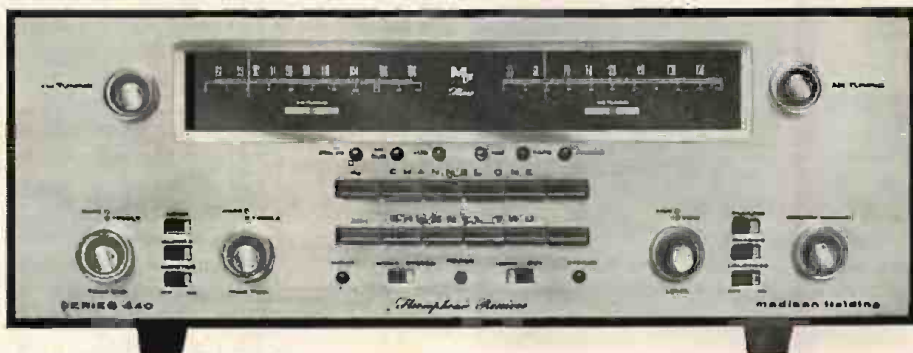

Series 440 \$325.00
Matching cabinet \$30.00
PRICES SLIGHTLY HIGHER IN THE WEST.

madison fielding stereo

by Crosby Electronics, Inc.

mw BRAND PRODUCTS, INC.

Dept. HF119, 39 West 55th St., N. Y. 19, N. Y.
Marketing organization for Madison Fielding

BEYOND COMPARE



marantz Stereo console

Consumer Net \$249

Cabinet 24

Slightly higher in West

In pre-amplifiers and power amplifiers, Marantz has set today's highest standard of quality.

Consider the Marantz Stereo Console. Here is the essence of uncomplicated, beautiful styling. So simple to use, even the most non-technical person can easily achieve matchless reproduction quality. Yet, this fine instrument offers an order of versatility that pleases the most discriminating professional users. Carefully planned circuitry and wiring layout result in unsurpassed freedom from distortion, hum and noise.

Dedication to quality in every detail is the reason why the Marantz 30-watt power amplifier, too, is in a class by itself. The Marantz circuit permits this superb amplifier to recover instantaneously from sharp, musical transients — to effortlessly drive loudspeakers of all types — to consistently outperform amplifiers of considerably higher ratings.

For both stereophonic and monophonic programs, Marantz is your assurance of long, carefree operation and unprecedented performance.

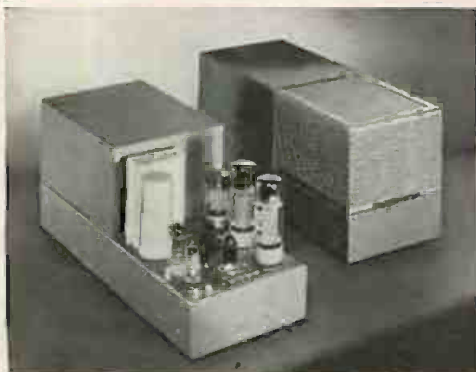

30-WATT AMPLIFIER

Net \$147

Grill 7.50

Slightly higher in West

★ Selected for demonstration at the American Natl. Exhibition in Moscow

marantz

C O M P A N Y

2574 BROADWAY, LONG ISLAND CITY 6, N.Y.

PHILHARMONIC

Continued from page 57

The bulk of each man's earnings comes from work at the Opera, and so does the bulk of his retirement pension (remember that the Opera is a governmental institution). From the Opera and the Philharmonic together, an alumnus receives a pension of more than seventy per cent of his active salary. The active salary (of the average member) is, according to Helmut Wobisch, trumpeter and business manager, about 80,000 schillings a year. Translated at the official exchange rate, this comes to something like \$3,200, and might seem small pay. The official exchange rate, however, has small observable connection with the way Austrians live. Pictured as practical purchasing power, the wage figure probably should be multiplied by two.

Leading members also do considerable chamber music work. The Vienna Octet, the Barylli Quartet, the Konzerthaus Quartet, and the Vienna Woodwind Ensemble all consist of VPO members, and will be names familiar to American record buyers. And, of course, the senior instrumentalists do a great deal of teaching. Nearly all the first-desk men teach at the famous Academy, preparing the next generation of Philharmonic members. Incidentally, the title of Professor, borne by fifty-two members of the Orchestra, does not necessarily imply a doctorate or a teaching job. It is given out annually by the President of the Republic to distinguished artists and scholars. Furthermore, it's used. Helmut Wobisch will accept "Herr Wobisch" from an ignorant foreigner, but woe to the Austrian who doesn't say *Professor Wobisch*. Or better yet, Herr Professor.

Professor Wobisch calls the Philharmonic the world's most democratic musical organization, in tones of mixed pride and irritation. "This is a family," he says, "with 124 heads." Everything is voted on, by secret ballot when necessary. The Philharmonic's earnings from concerts, tours, and recordings are divided equitably no matter who plays when. This spring, for example, in successive weeks the Orchestra recorded *Also Sprach Zarathustra*, for London, and Haydn's 104th Symphony, for RCA Victor. Naturally the latter required fewer players than the former, but the trombonists and percussionists shared in the fee just the same. Before World War I the Orchestra banked its savings; hence it lost them in the postwar inflation. Now it buys apartment buildings (it owns two), which would seem a good investment in housing-short Vienna.

The Orchestra is, in point of fact, a fairly good living proof that artists can be businessmen. "Everyone you see around here," said Wobisch between phone calls in his very busy office in the Musikverein building, "is a musician in the orchestra. Dr. Otto Strasser, the president, is a violinist, as are the librarian, Professor Franz Slavicek, and the treasurer, Professor Walter Weller, and I am a trumpeter. Everyone plays an instrument except the accountant. We are elected for three-year terms. Usually there are more jobs than people who want them, but the work gets done." The work was getting done as he talked, since arrangements were being made for the Vienna Philharmonic to undertake the first around-the-world tour ever made by a major symphony orchestra. (They will be crossing North America as you read this.) The route was to be southerly: New Delhi, Bombay, Hongkong, Manila, San Francisco, Provo (Utah), Chicago, Cleveland, New York, Boston, Atlanta, Montreal, and back to Europe. "Much detail," he explained apologetically, as the telephone rang for the third time in eight minutes. "Wobisch *hier*," he said, into the instrument, then, waiting said: "All go by airplane, 118 men with instruments. We could not include Russia, they wanted us three weeks, too long. Perhaps we will go there another time. While we are gone we must pay salaries for substitutes at the Staatsoper, so we cannot be away too long."

Should the business offices on the second floor of the Musikverein building seem inordinately businesslike (though they are dark and carpeted and altogether charming), one can always go upstairs to the realm of Dr. Slavicek, which is purely antic and scholarly. Every square foot of the walls is taken up with autographed photographs and sketches, except those occupied by bound volumes of concert programs, going back a century, and collections of letters signed, in ink now fading, with such names as Johannes Brahms, Richard Wagner, Gustav Mahler, and Richard Strauss. More than that, one can hold and handle (not twirl) a light, strong walking stick that once belonged to a confirmed Viennese stroller named Ludwig van Beethoven. In an ordinary museum this sort of thing would be bolted down in a glass case, but not in the Library of the Vienna Philharmonic Orchestra. Perhaps, in fact, not anywhere in Vienna, which is part of the town's timeless quality. The room in the Heiligenstadt inn where the *Pastoral* Symphony was con-

*Management for the American tour: National Artists Corporation, 711 Fifth Avenue, New York.

ceived is not a museum. The tavern is still in business. You may drink new white wine there now, under trellised vines thick and gnarled enough to date from Beethoven's day, in the courtyard. The main difference is, probably, that you will pay a little more for the wine than he did. And that what was countryside for him is countryside no longer; down the street are coöperative apartment houses. But some of them do have mosaics on the streetside walls. Vienna.

Being a self-governing coöperative, the Philharmonic has no musical director; it still engages conductors for individual events. It has to be diplomatic in its dealings with the musical director of the Opera, of course, since he is the members' boss when they function as Staatsoper Orkester, but the dealings are carried on as between equals. Currently the musical chief at the Opera is Herbert von Karajan, whom the Orchestra happens to get along with very well. (He is conducting on the world tour.) In fact, they'd like him as concert conductor more often, but he has so many other jobs—notably those at Berlin and La Scala—that he limits himself to two subscription concerts. With other conductors, admits Professor Boskovsky, the orchestra sometimes has had to be "a little cross." Dr. Fritz Metzlik, director of the Austrian Federal Press Service, recalls once receiving an anxious letter from an arriving conductor, asking if he might borrow photographs of the principal players in the Orchestra, so that he could memorize their names and faces before his first rehearsal and thus make a good impression on them.

The Philharmonic makes recording contracts in its own corporate capacity. All its recording is done, these days, in the Sofiensäle, which is quiet and acoustically kind to microphones. Since World War II the VPO has recorded exclusively for London-Decca, until recently when London and RCA Victor worked out a sort of subcontracting exchange agreement. Its Victor records thus far, accordingly, have been made by the regular London location crew. This consists of recording director John Culshaw, his assistant Ray Minshull, and three engineers, Gordon Parry, Jim Brown, and Karl Brugger. Actually these comprise two crews, at least when they are working for Decca-London, since stereo and monophonic tapings are made separately.

Culshaw says that recording with the Philharmonic is not like working with any other group in the world. They are very fast: sometimes he has

Continued on next page

In the British Tradition!

In these days of factory mechanisation on the grand scale—where success so often is measured only in terms of ever-expanding output—people tell us that it is refreshing to meet a manufacturer imbued with the quaint idea of refusing to grow big.

But it is quite true. The success of the Ferrograph during the past ten years has been due entirely to our deliberate decision to make *quality* rather than quantity our sole objective. Not for us models to suit all pockets or Tape Recorders built down to a price to compete in world markets. Instead, to maintain our high standards without compromise we have chosen to restrict our output.

We believe that a Tape Recorder, being an instrument of high mechanical precision, needs a great deal of critical and unhurried supervision at every stage of its manufacture which it would be difficult to carry out in a factory geared to large scale production.

This then is the Ferrograph tradition. It is based upon a policy of utilising to the full the wealth of technical knowledge and craftsmanship that is still part of Britain's heritage.

Today all who are seriously interested in tape recording—and this includes



those who use the Ferrograph professionally in scientific and industrial research, in the teaching of music, drama and languages, in the manufacture of gramophone records, in the exploration of far-away places, in radio and home entertainment—know that Ferrograph equipment is the best that money can buy.

Ferrograph Series 4A

Fitted with three independent motors, including synchronous main drive to capstan, with recording level meter and interchangeable plug-in heads. Two speeds ($3\frac{1}{2}/7\frac{1}{2}$ or $7\frac{1}{2}/15$ i.p.s.) with automatic changeover to correct compensation network. Fitted with Brief Stop, gear-driven Turns Counter and with provision for additional stacked Head for stereo playback conversion. $2\frac{1}{2}$ watts of undistorted output through high quality elliptical speaker. Auto Stop instantly stops motor drive when spool is empty or tape breaks.

\$399.50

Ferrograph Stereo 808

An all-purpose instrument permitting full stereophonic recording and playback together with conventional half track monophonic recording and playback. The output of all channels (stereo and mono) ends at low level so that owner can conveniently make use of his existing hi-fi amplifiers and loud speaker systems.

General specification and mechanical features similar to Ferrograph Series 4A. **\$595**

Ferrograph Stereo 808/4

Model 808/4 records two-track stereo and monophonic tapes and plays four-track stereo, two-track stereo and monophonic tapes. As with Model 808 the output of all channels ends at low level thus permitting existing high fidelity amplifiers and loud speaker systems to be used.

General specification and mechanical features as Ferrograph Series 4A above. **\$595**

The Incomparable
Ferrograph

Manufactured in England by

BRITISH FERROGRAPH RECORDER CO. LTD

131 SLOANE STREET, LONDON, S.W.1 and SOUTH SHIELDS, ENGLAND

U.S. DISTRIBUTORS: Ercona Corporation, 16 West 46th Street, New York 36, N.Y.

CANADIAN DISTRIBUTORS: Astral Electric Co. Ltd. 44 Denforth Road, Toronto 13

One important facet of magnetic tape is its permanence... this applies not only to the tape

itself but the package you keep it in.

Here's the best answer —

sonaromic

wide latitude magnetic tape

a product of ferrodynamics corp.

lodi, n. j.

PHILHARMONIC

Continued from preceding page

been able to record an entire work played without halt, with only a few retakes for safety's sake. However, the members would rather be caught dead than looking efficient. Only a few go to listen to the playbacks at break time; the rest fish newspapers from their pockets and turn to the scandal columns or racing results. (Of course, newspaper reading is the great Viennese recreation; when you go into a café, the waiter brings you a choice of newspapers along with the menu.)

There is commonly also some small and endearing show of either independence or temperament, it is hard to say which. One day last April, when *Zarathustra* was being recorded, the old ballroom's curtains had to be parted, since on the stage had been mounted an enormous 2,400-pound bronze church bell, rented from a foundry by Culshaw's tireless fi-men for a climactic effect towards the end of the tone poem. There were also photographers present, preparing publicity for the world tour. Into the control room came one player, in a stout wool sweater. The hall was too cold, he said, there was a draft from the stage. As he left, in came another, in shirt sleeves, wiping his brow. He was bothered by the heat, he said, from the floodlights. "They sit about five feet apart," said Culshaw later, "but now they've had their say, and they can play." Indeed, they were already tuning up.

They were not, may it be said here, tuning to an A-note of 447 cycles, as they have been charged with doing in the press. This is a canard, says Dr. Strasser. It may have been started by singers who bobbled high notes and wanted to lay the blame elsewhere. The orchestra varies its pitch upward somewhat from the 440-cps of the International A, according to where it's playing, but seldom above 444. In recording it holds rigidly to 443.

In any case, the secret of the famous Vienna tone is not pure brilliance. It is a sort of transparent depth, which comes simply from long knowledge among the players of the sounds each other make. Rarely does a player leave the Philharmonic, and it is not unusual for a member to be training his son to succeed him; this is happening now in the horn and flute sections. Hence the extraordinary empathic give-and-take that informs their work, and hence the high unlikelihood that anyone will imitate their formula successfully. It would take 117 years.



NOT FOR EVERYONE
... perhaps for you

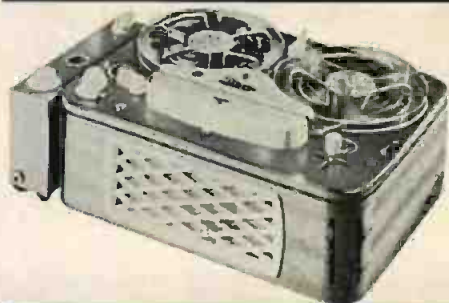

Tandberg 5

**3-SPEED, 4-TRACK
STEREO | RECORDER
PLAYBACK**

The Tandberg 5 is not everyman's tape recorder. It is an instrument built to incredibly rigid standards of perfection, designed to provide the discriminating listener with a lifetime of listening pleasure. To the educated ear, the difference between Tandberg reproduction and conventional recorder playback is immediately apparent.

Yet, the difference is subtle. It is reflected in shadings and nuances that most recorders ignore. If your ear is finely attuned to musical perfection... if you relish the certainty that you own the finest... then the Tandberg 5 will give you more pleasure-per-dollar than any other tape recorder, anywhere.

See and hear the Tandberg 5 at your high fidelity dealer. The instrument illustrated here is the Tandberg Model 5-2. Complete with two TM-2 microphones for home stereophonic recordings, input-output cords, reels and handsome Transport luggage case. \$513.95. Other Tandberg models from \$249.50.

For full information, write Dept. H11

Tandberg of America, Inc.
8 Third Avenue • Pelham, New York

HIGH FIDELITY MAGAZINE

When you
convert to
STEREO



Specify the
new low cost
STEREO
cartridge

The newest thing in exciting stereophonic sound reproduction is Erie's STEREO cartridge. It can be the inexpensive first step to achieving full dimensional sound from your present hi fi set.

You get these important stereophonic benefits for only \$8.95:

BALANCED CHANNEL OUTPUTS . . . inherent in STEREO because of a single ceramic element

EFFECTIVE CHANNEL SEPARATION . . . 20 db—because of the unique conductor-insulator element design

FULL FREQUENCY RESPONSE . . . 20 to 16,000 cps

LOW RECORD WEAR . . . tracking force of only 5-6 grams

SIMPLE TO INSTALL . . . merely plug it into any standard tone arm—adapter included

COMPATIBLE WITH MONAURAL . . . excellent reproduction from regular microgroove records as well as stereophonic

Available with dual stylus—sapphire/sapphire or diamond/sapphire (at slightly higher cost)—from your local Erie distributor.

For his name or for complete literature write to:

ERIE Electronics Distributor Division
ERIE RESISTOR CORPORATION
Erie, Pennsylvania

NIGHT LIGHTS

Continued from page 69

Society, SPA, and a number of others to enter the recording field on a hitherto undreamt-of scale. Nor were artists' fees the only bargain. The famous Musikverein, where the Vienna Philharmonic always recorded, rented for 1,800 schillings per session in 1950 (it now costs just double); the Konzerthaus charged 900 schillings a session for the beautiful Mozartsaal and 1,500 schillings for a session in the large hall. The Konzerthaus studio cost \$3.20 an hour in 1949, and it was here that the *Nelson Mass*, the *Vox St. John Passion*, and the first Bach Guild records were made. The Vienna Symphony's technical outfit, called "Symphonia," charged \$9.00 an hour for their technicians in 1949. Telefunken Studios, which was under the supervision of a brilliant engineer named Otto Leitner, had delightful facilities in the suburb of Dornbach; there, amidst green trees, you could record for the same price as in town, and there was the additional advantage that the Dornbach studios were right round the corner from a *Heuriger*, who did a brisk business sending up frosty glasses of white wine to thirsty technicians. Herr Leitner says he made his best records after the third or fourth glass.

Prices in Vienna are not so fabulously low nowadays: the Vienna Symphony has gone up double its price since 1949, but even at \$3.00 per man per session, it is still an attractive proposition to come and record in Vienna. Herr Duron, at least, isn't worried.

"It's not like 1950, of course," he said. "But it was too much then. We couldn't have kept it up all these years. And look at our orders for this fall. . . ." He showed me the huge tally sheet on which recording sessions were charted.

"Now that they've gone through most of the Haydn symphonies and Bach cantatas, what do you expect to do next?" I asked.

Duron leaned back and laughed.

"We'll do them all over again in stereo," he said, pointing through the window. On the other side two technicians were busily setting up the equipment.



TRADE IN
YOUR PRESENT HI-FI
EQUIPMENT for
the new

SHERWOOD

**S-3000 II
FM TUNER**

with interchannel hush

0.95 μ V FM Sensitivity
FM Multiplex Output
"Feather-Ray" Tuning Eye
Cascade Balanced Input
Automatic Frequency Control
"Local-Distant" Switch



BUY SHERWOOD
AT AUDIO EXCHANGE AND
TAKE ADVANTAGE OF
AUDIO EXCHANGE'S UNIQUE
SERVICES SUCH AS:

- NEW COMPONENTS
lowest competitive prices
- USED COMPONENTS—for 8 years largest
supplier of fully guaranteed components
- TRADING OUR SPECIALTY
Highest prices. Trade up to Stereo
- COMPLETE STOCK—all major manufacturers
- KNOW HOW—Hi Fi is our only business.
Our people are experts in sales and service
- MAIL ORDER SPECIALISTS—We boast of
satisfied customers in 49 states and abroad
- REPAIR AND CUSTOM INSTALLATIONS
by Hi Fi Experts—90 day warranty

Write Dept. HFS for our unique trade-back plan and trading information.

audio
exchange

Registered Component Dealers



The Hi Fi Trading Organization
153-21 Hillside Ave., Jamaica 32, N.Y.
Closed Mondays • Parking at all stores

Branches:

Brooklyn 836 Flatbush Avenue.
White Plains . . 367 Mamaroneck Ave.
Manhasset . . . 451 Plandome Road

New
PROFESSIONAL 55
the Ultimate
STEREO CARTRIDGE



COLUMBIA 

Professional 55 . . .
Cost \$28.95

This new transparent cartridge is the professional's version of the popular Columbia CD. A high-compliance model with excellent transient response, it uses a .5-mil diamond stylus and is designed for transcription turntables. Comes complete with 4 miniaturized plug-in equalizing networks for low- and high-level inputs.

CURVES, FACTS AND FIGURES PROVE IT

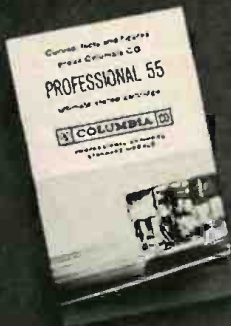

Ask for Bulletin E-331. Check the Professional 55's superiority in: linearity . . . separation . . . needle point impedance . . . low mass . . . freedom from hum and distortion . . . output level . . . and ruggedness.

YOUR OWN EARS PROVE IT

Better still. Your own ears will convince you the Professional 55 is your best investment. Ask to see and hear it at your distributor's today!

CBS ELECTRONICS
A Division of
Columbia Broadcasting System, Inc.
Danvers, Massachusetts
Distributed in Canada by
CANADIAN GENERAL ELECTRIC CO., LTD., TORONTO

HF REPORTS

Continued from page 141

a minimum of controls and operating flexibility. Nevertheless, its flexibility should be quite adequate for most home installations. An input selector offers a choice of magnetic phono, microphone, tuner, and crystal phono inputs. Separate bass and treble tone controls supply the usual boost or cut characteristics. The level control is combined with the on-off switch.

The phono equalization (RIAA) is designed for the GE RPX series of monophonic cartridges, and makes use of the inductance of the cartridge coil to roll off the high frequencies. Satisfactory results should also be obtained with the Pickering 350S Flux-valve pickup. Instructions are provided for the simple modifications needed when the preamplifier is used with the Audiogersh MST-1S and Fairchild 225 series cartridges.

We measured the equalization error both from a low impedance (600-ohm) source and through a GE GC-5 stereo cartridge. In the latter case the equalization was within 3 db of the RIAA curve from 20 to 10,000 cps, while there was pronounced rise in high-frequency response when a low-impedance source was used. Fortunately, the tone control characteristics are such that this rise can be compensated for easily by the use of treble cut. The NARTB tape playback characteristic can be approximated fairly well using the phono input and some treble cut.

The response through the microphone input was very flat from 300 to 15,000 cps, but fell sharply below 300 cps. Here too, the bass boost characteristics of the HFT-1 would make possible a reasonably flat response curve. Through the tuner input the frequency response was flat within 1 db from 20 to 20,000 cps, and the tone controls were fairly conventional in their action.

As one would expect with a battery-operated transistor preamplifier, there is absolutely no hum in the output of the HFT-1. The noise (hiss) is also very low, being from 60 to 70 db below 1 volt output on all inputs and at any gain setting. This is inaudible even when one's ear is placed against the speaker.

In our tests, the intermodulation distortion proved to be considerably higher than the Regency specifications would indicate. The usual upper limit of tolerable IM (2%) was reached at 0.6 volts indicated output, which corresponds to about 0.75 volts with a sine wave test signal. This would be acceptable when a relatively high-gain or high-powered pow-

Acknowledged
EXCELLENCE
BASED ON RESEARCH



LEAKPROOF
CHROME PROTECTED
SEALED-in-STEEL
GUARANTEED!



Radar-Lights
CORROSION-PROOF
PORTABLE LIGHTS

BURGESS BATTERY COMPANY

FREEPORT, ILL. • NIAGARA FALLS, CANADA

"BUCK
STRETCHER"
HI-FI
VALUES!



Expand the buying power of your Hi-Fi dollar at Sun Radio with substantial savings on new and fully guaranteed name brand Hi-Fi components!

Send for our special price quotations and our Hi-Fi package specials!

Dept. 29

Sun Radio 
& ELECTRONICS CO. INC.

650 Sixth Avenue, New York 11, N. Y.
Phone: ORegon 5-8600

BUY IT! . . . I can't even pronounce it!

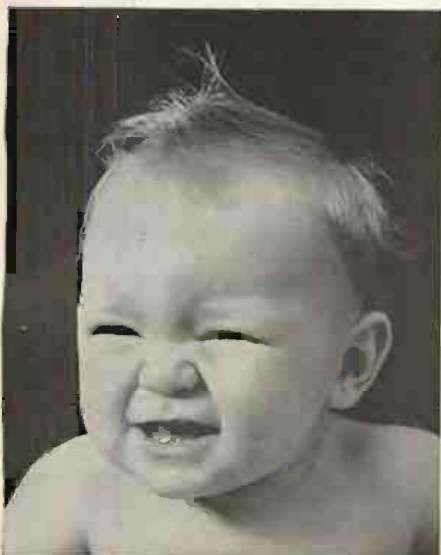

"ah!"

ELECTROSTATIC TRANSDUCER...

the 2-in-1 mid-range and super tweeter that brings out "hidden sound" your present cone or piston-type speaker cannot capture!

Make it easy on yourself. Just ask for the AH! Speaker and we promise you'll hear sounds you never believed possible with your present Hi-fi set-up. Your conventional tweeter cannot and does not give you complete high frequency response, due to its inability to recover quickly enough from abrupt frequency change. The AH! electrostatic transducer, of course, is based on a completely new electronic principle and reacts instantaneously to all frequency change—no matter how abrupt—so, areas of "Hidden Sound" are revealed with the "AH!". Just one minute of your listening time at your dealer's will convince you.

The 2-in-1 AH! is a mid-range and super tweeter to give you full response from 600 cps to past the limit of audibility. And, the AH! is complete. Nothing else to buy—R/C crossover network and AC power are built in. To prove our confidence in AH's superior quality we guarantee the elements for 5 full years.

Only
49.95



Send for **FREE** booklet "8 unusual Hi-fi and stereo arrangements with the AH!" Complete with schematic diagrams and wiring instructions.

Cosmos Industries, Inc.
31-28 Queens Blvd., Long Island City 1, N.Y.

er amplifier is used, but not with some amplifiers which might require 1.5 or 2.0 volts to drive them to 10 or 15 watts output.

Another limitation, though not a severe one, is the low gain on the magnetic phono input. A 10-millivolt signal is needed to develop 1 volt output. The gain is, of course, quite sufficient for the GE or Pickering cartridges for which this unit was designed, but when used with low-output types there is no reserve gain. Here the low noise level of the HFT-1 is advantageous, since it can be operated wide open with no ill effects. In listening tests we used a Grado stereo cartridge, which has less than 1 millivolt output, and a 50-watt power amplifier. There was no difficulty in obtaining uncomfortably loud volume levels, though the preamplifier was operated at maximum gain.

A final minor criticism is the lack of a pilot light or other indication that the unit is turned on. It would be necessary to develop a systematic procedure for turning off a system to avoid leaving the preamplifier turned on. This could be a rather expensive mistake.

All in all, the Regency HFT-1 is a moderate-performance preamplifier, having no serious faults except the limitation on output voltage. It certainly is unsurpassed when it comes to low noise and small size. Its chief application will probably be in limited-space installations or in portable equipment, where its virtues can be fully exploited.—H. H. Labs.

MANUFACTURER'S COMMENT: It is difficult to account for the results found, in the case of the discrepancy in the audio response curves using microphone input and tuner input, and in the high IM readings noted. It should be noted that the amplification circuits for microphone and tuner inputs are identical with the exception of the 470 K-ohm resistor in the tuner input, which would hardly account for the response difference found.

Further, under factory test procedure, factory-wired and tested HFT-1 preamplifiers indicating IM distortion readings over .8% at 1 volt output are rejected. Test is made with lone controls set "flat" and gain control at maximum.

The unit tested here was a kit, constructed in the field, and it is possible that incorrect assembly or component mishandling might account for the above results.

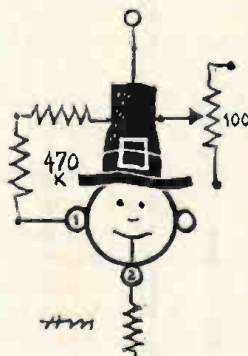

ONLY the ACRO Stereo pre-amplifier gives you these years ahead design features!

CHECK THESE EXTRAS that no other kit gives:

- | | |
|---------------------------------------|---|
| 1. Selective Rumble & Scratch Filters | 5. Input Level Controls |
| 2. 3rd Channel Output | 6. Exclusive Panel Light Matrix |
| 3. Exclusive Mike Dub Switch | 7. Lowest Hum with D.C. Filament Supply |
| 4. Phasing Switch | Plus many other features |



ACRO'S STEREO PRE-AMPLIFIER

EASY TO ASSEMBLE KIT

Unequaled Versatility: Logical planning: Pre-assembled, tested, printed circuit board makes construction simple. A PERFECT MATE FOR ACRO'S STEREO 20 AND ULTRA LINEAR II AMPLIFIERS.

SPECIFICATIONS

INPUTS each channel

- Magnetic (Turntable & Changer) Equalized 78, LP, RIAA
- Crystal/ceramic (switched in mag. input) Sensitivity for 1.5V out Low Level 5 MV. High Level 30 MV.
- Tape Head Equalized NARTB Sensitivity 2 MV
- FM ● AM ● FM Multiplex ● Tape Head
- Microphone (switched into one channel for announcing, faded in or out with balance control)

OUTPUTS 2 Ampl., 2 Tape, 3rd Channel

INPUT SELECTOR (8 position) 78, LP, RIAA1, RIAA2, Tape Head, FM-AM, FM Multiplex & Aux.

OUTPUT SELECTOR 7 MODES (Check-A, Check-B, Stereo, Stereo Reverse, Monaural A-B, Monaural A, Monaural B.) 6 panel light Matrix provides selection Mode at a glance.

CONTROLS Gauged Volume/Loudness, Balance, Individual Bass & Treble for each channel

SWITCHED EXTRAS effective each channel. Filters, scratch and rumble ● loudness ● phasing ● tape Input/monitor ● mike dub

AC OUTLETS 2 switched 2 direct

TUBES (4) Type 7199 low noise pentode/triode

DIMENSIONS 4-1/2H x 13-3/4L x 6-3/8D

PRICE: Kit \$69.50 Self powered kit \$79.50

Write today for free folder

ACRO PRODUCTS COMPANY KIT DIV.

410 SHURS LANE, Dept. HF 11
Philadelphia 28, Pa.

ACRO, THE FIRST NAME IN AUDIO!



Stuzzi
MAGNETTE
transistorized
tape recorder
with professional
broadcast quality!

Professional performance packed into a mere eight pounds! Hand-crafted in Vienna to the highest Continental standards, it's the ideal traveling companion for dictation, conference recording, interviews and recording fine music to broadcast standards. Up to two hours on each reel!

Fully transistorized, (seven transistors + 2 diodes) the STUZZI Mulette will operate up to 100 hours on 4 standard flashlight batteries. Vibration-proof, it will operate in *any* position . . . on land, sea and air. Wow and flutter to professional minimums. New feather-touch push button controls for whisper-quiet performance plus these features:

- Dual Track—Dual Speed 3 $\frac{3}{4}$ -1 $\frac{1}{2}$ ips.
- VU Level Magic-Eye Modulation.
- Separate motors for fast wind and capstan drive.
- Battery Life Indicators.
- Tapes can be replayed on *all* recorders.
- Doubles as small portable PA system.
- An engineering triumph!

Only \$269.50 net.

For complete details on how you can take efficiency and enjoyment with you, see your local dealer or write:

ERCONA CORPORATION

(Electronic Division)

Dept. 52, 16 West 46th St., New York 36, N.Y.

WURST AND BEETHOVEN

Continued from page 62

ancient building on the beautiful Michaelerplatz where, incidentally, the old Burgtheater, in which *Figaro* was first performed, used to stand. He rang the porter's doorbell, and a well-padded *Hausmeisterin* answered.

"Is Herr Haydn's room still free?" the dashing young man with the curious past asked.

The *Hausmeisterin* thought a moment, and then answered, as if Herr Haydn had just vacated the room last week, "As a matter of fact, it is. You want to rent it? I'll show it to you."

She led him up flight after flight of stairs, each landing shabbier than the one before. The last flight was practically perpendicular. She unlocked a door in the huge attic, and there, overlooking St. Michael's Church and the round, elegant square, was the very room Haydn had occupied in 1749 or 1750, when he was a penniless student, just expelled from St. Stephen's Choir for cutting off the pigtail of a fellow student during High Mass.

The dashing young man with the curious past surveyed the room. It had scarcely changed since Haydn's time: the plaster had peeled off the walls, and there was the musty, heady air of a room unused for many years. The *Hausmeisterin* threw open a window and the fresh summer air of 1959 filled the old garret.

"It's not a bad room for the price," she said, eyeing the prospective tenant warily.

The dashing young man with the curious past rented the room. He hopes—rather naively, I fear—that the city authorities will turn it into a tiny museum and appoint him the guardian.

The Viennese authorities have far too many musical museums to care for, as it is. Their director, Franz Gluck, a kindly scholarly-looking man with thick glasses and a soft-spoken, elegant manner, sighed when I asked him about the problem.

"These museums cost a fortune to maintain," he explained. "They are mostly in very old houses which have to be repaired constantly. Take the Haydn Museum," and he shook his head gloomily.

"The last time I was there, the house looked very solid to me," I put in.

"Ah, but you didn't see inside the walls," answered Director Gluck. "All the timber rotten, the whole house unsafe. We had to renovate it from attic to cellar. If you would like to see what happened, I'll show it to you."

We drove from Director Gluck's

Coming
TO YOUR CITY



High Fidelity
Music Shows

FEATURING THE LATEST
IN STEREO EQUIPMENT

See and hear the latest in
HIGH FIDELITY from
leading high-fidelity
manufacturers . . .

Don't miss these public showings of Hi-Fi Equipment . . . from the most economical units for the budget-minded to spectacular home music theatres . . . compare and enjoy them all. Components and complete systems will be displayed.

ADMISSION 75¢

ALL SHOWS OPEN

FRIDAY — SATURDAY — SUNDAY

1 P.M. TO 10 P.M.

1959

HIGH FIDELITY
MUSIC SHOW SCHEDULE

BUFFALO, N. Y. Statler Hotel.
October 30, 31; November 1, 1959.

SEATTLE, WASH. New Washington Hotel. November 6, 7, 8, 1959.

PORTLAND, ORE. New Heathman Hotel. November 13, 14, 15, 1959.

PHILADELPHIA, PA.
Benjamin Franklin Hotel
November 20, 21, 22, 1959.

RIGO ENTERPRISES, Inc.

500 North Dearborn Street

Chicago 10, Illinois

DYNAKITS

Look Best — Test Best — Sound Best

NEW STEREO 70 KIT



- ★ Dual 35 watt super-quality amplifiers—70 watt continuous monophonic rating—160 watt peak.
- ★ All critical parts on prefabricated printed circuit assembly reduces wiring time to five hours.
- ★ Premium quality parts conservatively operated permit one year guarantee.
- ★ Uncompromised design for finest performance—usable with all speakers.
- ★ Only \$99.95* net including all parts, instructions, and protective cover.

NEW STEREO PREAMP KIT



- ★ The unique "no distortion" performance initiated by the famous DYNAKIT Preamp.
- ★ 7 stereo inputs, DC heaters, built-in power supply, DYNA's exclusive "blend" control.
- ★ Highest gain, lowest noise, greatest channel separation, and the easiest to use.
- ★ The ultimate in simplicity—2 preassembled printed circuit boards cut assembly time to 8 hours.
- ★ Complete with cover \$59.95* net.

Available from leading Hi-Fi dealers everywhere.
Descriptive brochure available on request.
* Slightly higher in West

DYNACO, INC.

Dept. HF, 3916 Powelton Ave., Phila. 4, Pa.

splendid new office building on the Karlsplatz to the busy Mariahilferstrasse, Vienna's principal shopping street and one of the main arteries to the West. (Traffic in Vienna has become a terrible problem, because most of the small, winding streets in the *Stadt*, or inner city, are totally unequipped to take the present flow of automobiles, local and foreign.) In an endless stream of delivery trucks and cars, we crawled past the stately baroque church where Haydn's funeral service was held on a June afternoon in 1809. "A hot, sticky day," reports a contemporary diary. "Choking dust. Haydn's body was carried thrice round the church in a solemn procession. Not a single Viennese *Kapellmeister* was there. . . ."

"Vienna hasn't changed much," was Director Gluck's terse comment as I reminded him of the conduct of Haydn's colleagues 150 years ago.

Just before the Westbahnhof, we turned off the Mariahilferstrasse and suddenly the years rolled away as we traversed what was, in the eighteenth century, the suburb of Gumpendorf. Haydn's house used to have the address Kleine Steingasse 73, but the street was later renamed Haydngasse: it is quite an imposing house, with a lovely garden where the aged composer used to take his morning walks, leaning on the arm of his faithful servant Johann Elssler.

Director Gluck and I stood for a moment in the courtyard, looking out onto the garden. We seemed to be on an enchanted island in the middle of the great, sprawling city; the soft green of the trees along the brick wall contrasted gently with the yellow and white of the house.

In fact, it was Haydn's wife who discovered the house. She wrote to her husband, then in London, with her usual tact and charm, suggesting that he buy the house for her to live in when she became a widow. Haydn returned, fell in love with the house, and bought it straightaway. "And it's I who am living in it, as a widower," he used to tell people, with his quick irony.

He had bought the place in 1793, between his two London visits, and immediately asked the authorities if he could enlarge it. The petition Haydn submitted to the Vienna City Magistracy is still extant: "In this projected construction [wrote Haydn], good materials would be used . . . and [the house] would contribute to improving the general looks of the street. [Haydn] hopes therefore that his plan will be approved, the more so because by enlarging the building, an in-

Continued on next page

DYNACO B&O

STEREODYNE II PHONO PICKUP



New, hum free push pull magnetic stereo pickup of superb characteristics. True stereo reproduction because of wide channel separation. Smooth response and light tracking combine to give clean natural sound from both stereo and monophonic recordings. Mounts in all standard arms. With replaceable diamond stylus—\$29.95* net.

B&O TONE ARM



MODEL TA-12

Combined arm and Stereodyne II Cartridge for optimum results. Dynamically balanced, gimbal-pivoted arm permits 2 gram tracking. Simple to mount, handsome appearance, and outstanding in performance. Only \$49.95* net.

* Slightly higher in the West

Available from leading high fidelity dealers everywhere

DYNACO, INC.

3916 Powelton Ave., Phila. 4, Pa.
Cable address: Dynaco, Phila., Pa., U.S.A.

TRADER'S MARKETPLACE

Here's the place to buy, swap, or sell used equipment, records or what have you. Rates are only 45¢ a word (no charge for name and address) and your advertisement will reach more than 110,000 music listeners. Remittance must accompany copy and insertion instructions. Copy must be received by 5th of 2nd month preceding publication and is subject to approval of publishers.

JANSZEN 130 mahogany, \$95; Quad electrostatic, \$200; Quad preamp, \$50; Leak diamond with arm (new), \$25; Ortofon C diamond with arm, \$35; Sherwood AM-FM tuner, \$95; High Fidelity 1-80; Hi-Fi Music at Home 1-38; best offer. Carl Hovland, 151 Hartford Turnpike, Hamden 17, Conn.

TRADE-IN monaural for Stereo—Disc or Tape. Definitive Recordings Club, 11024 Magnolia Blvd., North Hollywood, Calif.

FOR THIN THINKING People . . . our Tumblemat . . . a professional exercise mat designed exclusively for home use . . . write The Country Shop, Route 3, Box 265, Little Rock, Arkansas.

ATTENTION: Bol Canto discs for sale, rare operatic recordings. Send for catalog. George Moran, Box 274, Lodi, Wisconsin.

SELL: Lowther TP-1 horn, PM3 driver, \$300 shipped; EV-665 mike, \$44; GE A1-501 arm, \$15. Richard Dunn, Sunspot, New Mexico.

FOR SALE: Complete collection of High Fidelity. Raymond Gerin, 770, della Ronde, Quebec City, Canada.

OLD AND RARE vocal 78s, G & T, Zenophone, etc. Hard-to-get imported LPs. Send for monthly lists. Ross, Court & Co., 2098 Yonge, Street, Toronto, Canada.

TAPE RECORDERS, components. All makes. Special quotes. Bayla Co., 1470-F Elmer Road, Wantagh, L.I., N.Y.

HIGH FIDELITY—Nos. 1 thru 56, best offer. W. W. Moyer, Creamery, Pa.

FOUR Track United Stereo tapes, \$3.95 up. Bob's Tape Service, 7909 Lazy Lane, Fort Worth 18, Texas.

PROFESSIONAL Quality recording tape (standard-type) frequency response 20-20,000 cycles, 1200 ft., \$2.25; 1800 ft., \$3.25. No. C.O.D. P.Q.R.T., Box 445, Bloomfield, N.J.

RECORD CUTTING for every occasion from your tape to unbreakable disc weddings, socials, lectures, schools. Free information. Albergo Recording Studio, 121-18 Rockaway Blvd., South Ozone Park 20, N.Y.

HI-FI, Recorders, Tapes. Send for free wholesale catalogue. Carston, 215-N East 88 Street, New York 28, N.Y.

PRECISION RECEIVER ALIGNMENT: AM-54; FM-55; AM/FM-58. Kits a specialty. Telephone ED 4-4490. I. Pollack, Westbury, L.I., N.Y.

HIGH-QUALITY STEREO—Complete sets only. Fully tested. Big discounts. George's Music House, California, Missouri.

ALL MAKES HIGH FIDELITY speakers repaired. Amprite, 70 Vesey St., New York 7, N.Y. BA 7-2580.

INDUCTORS for Crossover Networks. 118 types in stock. Send for brochure. C & M Coils, 3016 Holmes Avenue N.W., Huntsville, Ala.

RENT STEREO TAPES—over 800 different—all major labels—free catalog. Stereo-Parti, 1608-D Continella Ave., Inglewood 3, Calif.

HI-FI LOWEST quotes; write for prices. Registered IHFM dealer, R. Bruna, 162 E. Cook Avenue, Libertyville, Illinois.

WURST AND BEETHOVEN

Continued from preceding page

crease of tax money would accrue to the most exalted Magistracy. Vienna, 14th August 1793 . . ."

Needless to say, permission was granted.

Director Gluck led us up the stairs to the rooms Haydn lived in. During the renovation, workmen stripped the walls down, revealing layer after layer of wallpaper and paint. Gluck said that it was like taking a trip backwards through the nineteenth century. Finally, they got down to the last layer, and to their delight they found a delicate, exquisitely patterned late eighteenth- or early nineteenth-century paper.

"It might have been Haydn's own paper," Gluck said. "The pity is that there wasn't enough of it in a good enough state of preservation, and I had to scrap the idea of doing the whole of Haydn's apartments that way."

Improbable occurrences, improbable conversations. . . Imagine a string quartet party at Mozart's house, Haydn playing first violin, Mozart viola; Leopold Mozart, a venerable old man, is there, on a visit from Salzburg. After the quartet is finished, Haydn talks about Wolfgang to Father Mozart, and someone takes down the conversation. It all sounds like fiction—and yet the very meeting described above took place, and the house where it occurred is still standing.

You start at St. Stephen's Cathedral, the sprawling late Romanesque *cum* Gothic *cum* (on the inside) Baroque building which is so typically Viennese. It does not have the soaring mysticism of Chartres or Reims, or the Northern secrecy of Durham or Speyer;

the Stephansdom is *gemütlich* and friendly. Here the brazen trumpets of Mozart's *Coronation* Mass sound entirely appropriate, as the Cardinal, in his rich scarlet robes, celebrates Midnight Mass at Christmas before a huge congregation, most of whom have come from candlelit warmth and mulled wine.

Behind the Cathedral, on the east side, you pass the little chapel where Mozart's funeral was held before a tiny group of mourners. To the right is the heavy grandeur of the Deutsch-Ordens-Haus, where the Salzburg



Archbishop's minion, Count Arco, booted Mozart down the stairs, out of the Archbishop's service, and into immortality. You cross into the Schulerstrasse, a tiny street reminding you that Vienna was a flourishing city in the Middle Ages. A few doors down is a four-story late Baroque house, with a handsome façade. The Mozarts rented the whole first floor for the stiff price of 460 Gulden a year (the annual salary of a second violinist in an Austrian provincial town); they remained there from September 1784 to April 1787.

They were certainly Mozart's happiest years. His subscription concerts were attended by almost the entire Viennese aristocracy, including Emperor Joseph II (who really understood neither Mozart's nor Haydn's music). It was in this house that *Le Nozze di Figaro* was composed, as well as many of the greatest piano concertos (e.g., K. 466, 467, 482, 488, 491, 503), the *Prague* Symphony, and the last three of the six string Quartets dedicated to Joseph Haydn.

It was on a February evening in the year 1785 that Wolfgang held at his house in the Schulerstrasse the musical evening mentioned above. Leopold Mozart, on a lengthy visit from Salzburg, wrote back to his daughter a few days later: "Saturday evening Herr Joseph Haydn and the two Baron Tindis were here; the new Quartets were played, but only the three new ones [K. 458, 464, 465] which [Wolfgang] has added to the three we already have—they are a little easier but excellently written. Herr Haydn said to me: 'I tell you before God and as an honest man, that your son is the greatest composer I know, personally or by reputation; he has taste and apart from that, the greatest possible knowledge of composition.'"

TAPE Recorders, Hi-Fi Components, Sleep Learning Equipment, Tapes. Unusual Values. Free Catalog. Dressner, 69-02A, 174 St., Flushing 65, N.Y.

TAPE RECORDERS! Recording tape, Bell tape decks, Hi-Fi Equipment, Norelco Speakers. We will not be undersold! Send for our catalog and see why! Commissioned Electronics Company, Inc., 1776 Columbia Road, Northwest, Washington 9, D.C.

HI-FI DOCTOR—Will solve your hi-fi problems on-the-spot. Acoustic, Audio, Radio Engineer. Stereo designing. Professional visits, day, evening, New York area, weekdays. William C. Bohn, 550 Fifth Avenue, New York City, Plaza 7-8569.

"**SCOTCH** recording tape at "Profit Sharing" prices—send for catalog—you'll be glad you did!—Tapeco, Dept.-D, P. O. Box 4353, Inglewood 3, California.

SALE: 78 R.P.M. RECORDINGS, 1902-1950. Many types. Free lists. Collections bought. Mr. Ellie Hirschmann, P.O.B. 155 (HF), Verona, N. J.

FAIRCHILD 225A cartridge, Fairchild 281A tone arm. Both 10 hours use. \$35.00. W. B. Syor, Hartsville Stage, Great Barrington, Mass.

On a spring day in the year 1787, shortly before Mozart—because of financial difficulties—had to give up his beautiful flat, he had another visitor, this time from Bonn. Mozart was very busy and barely noticed the young man, who asked to be allowed to play something on the piano. When, however, the young man began to play, Mozart (so the story goes) cocked an attentive ear and said: "Pay attention to him! One day he will make the world sit up and take notice." The young man was Ludwig van Beethoven.

Vienna is full of Beethoven houses. Discovering all the houses Beethoven inhabited in Vienna and its outskirts is rather like trying to make a list of all the beds in which George Washington or Queen Elizabeth I slept. There is an old Viennese joke to the effect that every second house in Vienna has some connection with Beethoven, if you look hard enough.

One Beethoven flat, however, was his home, with occasional absences, for some ten years—from 1804 to 1815. It is on the top floor of the so-called Pasqualati House (Freiherr von Pasqualati was the Emperor's private physician) on the M \ddot{o} lker-Bastei, originally connected to the city walls (which were torn down in the nineteenth century to make the present Ringstrasse), and thus higher than the surrounding part of the district. When you stand below the Bastei, you can imagine what Vienna must have looked like in the late eighteenth century. Like Haydn's house in Gumpendorf and the "Figaro" House, the top floor of the Pasqualati Haus is also a museum, dedicated in part to Beethoven and in part to the Emperor's then-famous physician.

Personally, the Beethoven house I much prefer is out in Heiligenstadt, once a little village an hour's carriage drive from the city, and now a quiet, rather dreamy suburb. In the year 1802, when Beethoven realized that he was going deaf, he was living in this little house, now Probusgasse 6; it was here that he wrote to his brothers the searing document called the "Heiligenst \ddot{a} dter Testament," protesting his affliction and seeming almost to welcome the release of death. Round the corner, if you follow the winding street, you find the Pfarrplatz, or village square, with shady trees, old houses (hardly a fa \acute{c} ade has changed very much in the last 150 years), and a rustic village church. (Recent excavations have shown that the church was built on the foundations of an early Romanesque basilica.) Here, too, Beethoven

Continued on next page

DEWALD *more for the money*

STEREO AND MONAURAL HI-FI COMPONENTS *Double the Quality at Half the Price!*



Model 2200 "Classical" 50 Watt Stereo Control Amplifier. 25 W. each channel (100 W. peak). Separate Loudness and Tone Controls. Tape Monitoring and Direct Tape Recording jacks.

\$139.95 AUDIO-PHILE NET (CASE INCLUDED)

"You Never Heard It So Good!"

Model N-803-B
FM-AM
TUNER

\$77.95
(CASE INCLUDED)

Model N-1000-B
Stereo & Mono-
phonic AM-FM
Tuner

\$99.95
(CASE INCLUDED)

Model N-1200-B
30 watt Stereo
Control Amplifier

\$99.95
(CASE INCLUDED)

OVER 35 YEARS OF DEPENDABILITY!

EXPORT DEPT.:
25 Warren St.
New York, N. Y.
Cable Address:
SIMONTRICE

DEWALD
A DIVISION OF
UNITED SCIENTIFIC LABORATORIES, Inc.
35-19 37th Ave., Long Island City 1, N. Y.

Free!
**ILLUSTRATED
BROCHURE
ON REQUEST**

Trader's Marketplace Classified Advertising

ORDER FORM

Fill in coupon below and mail, with check or money order (no cash). Rates 45¢ per word with no charge for name and address. Print or type your ad below.

HIGH FIDELITY MAGAZINE
Great Barrington, Massachusetts

- Next issue only
- Next 3 issues
- Next 6 issues
- Next 12 issues

\$.....Payment Enclosed

NAME.....
STREET.....
CITY.....ZONE.....
STATE.....

WURST AND BEETHOVEN

Continued from preceding page

lived, at Pfarrplatz No. 2, during the year 1817.

The house is not a museum at all. If you go there on a summer evening, you will find the big double doors to the courtyard open, and rows of green benches and tables under the tall trees. There, the Viennese go to drink the new wine, "Heurige" ("this year's"), and to dream away half the night with their sweethearts or their wives. You sit under the window where Beethoven lived and worked, and the music they play is *Schrammelmusik*—soft, sentimental Viennese songs that surround and envelop you together with the warm glow of the new wine.

The first time I went there, on a summer evening which was too beautiful to be true, I thought: how incongruous, how impossible, to sing *Schrammelmusik* and drink wine and eat black bread and *Wurst* in a place like this. But after my first *Viertel* of the strong, heady wine, I suddenly realized that, like so many seemingly incongruous things in Vienna, *Heurige* and Beethoven are not so far apart after all; for in the Viennese gardens where you drink the new wine, the line between joy and sorrow, between past and present, perhaps even between life and death, is a very thin one. The house on the M \ddot{o} lker-Bastei is a museum, with a proper custodian and, under glass, some proper Beethovenian relics; but in the courtyard at Heiligenstadt, under the whispering trees, there is more: there is the *Pastoral*, there is even the *Missa Solemnis*. Here, you feel, the words at the top of the autograph score of the *Missa*, "Von Herzen, m \ddot{o} ge es wieder zu Herzen gehen," might have been conceived—"From the heart, may it speak to the heart." *Wurst* and the *Pastoral*, new wine and the *Missa*—it is all part of the secret and the mystery of Vienna.

Special Offer 25¢

Hear these authentic recordings of dramatic events from



"The Amazing World of Short Wave Listening"

narrated by Alex Dreier, Radio-TV "Ma on the Go"

- President's voice from outer space!
- Actual capture of a desperate criminal!
- Radio amateur of Little America!
- Ships at sea . . . aircraft in action!



SX-110
receiver
\$159.95

Standard broadcast plus short wave coverage from 1550 kc. to 34 mc. Cal. electrical bandspread.

MAIL COUPON TODAY!



hallicrafters

DEPT. 15, CHICAGO 11, ILL.

Gentlemen: Please rush by return mail my recording, "The Amazing World of Short Wave Listening." I enclose 25¢.

NAME _____
ADDRESS _____
CITY _____ STATE _____



A Wigo
PRONOUNCE IT WEEGO

SPEAKER FOR LOOKS!

Wigo's true beauty is on the inside, where you can't see it, but where you can sure hear it! . . . And with Wigo it's not done with mirrors! For literature, write . . .

united Audio
PRODUCTS OF DISTINCTION
202-4 East 19th St., N. Y. 3, N. Y.

expressive
stereophonic reproduction!

The margin between the original performance and good stereophonic reproduction is slight indeed, but narrowed to an imperceptible degree with a Webster Stereo-Ceramic phono cartridge. That's when your discs breathe new life, new color . . . with depth and direction you can distinctly feel. And the fidelity is superb! Much better, too, is monophonic reproduction. Stereo-Ceramic is a plug-in type cartridge — fits any standard arm.



SC-3D Stereo turn-under — with .7 mil diamond and 3 mil sapphire stylii. \$20.00



SC-2D Stereo single needle — with .7 mil diamond stylii. \$17.50



MC-2 78 RPM single needle — with 3 mil sapphire stylii. \$6.50

ELECTRONICS DIVISION
WEBSTER ELECTRIC
our **50th** year RACINE · WIS

FM/Q

ANTENNAE

THE FINEST OF ITS KIND . . .
Get more FM stations with the world's most powerful FM Yagi Antenna systems.

To be fully informed, send 25¢ for book "Theme And Variations" by L. F. B. Carini and containing FM Station Directory.



APPARATUS DEVELOPMENT CO.
WETHERSFIELD 9, CONN

STEREO TUNER

Continued from page 72

devoted to discussion of which is better. From the practical standpoint, the answer is simple: either, if well designed and carefully produced. In the early days of FM, ratio detectors acquired a bad reputation because they could be produced economically and were often coupled with poorly built and insensitive tuners. The Armstrong circuit, *per se*, was more expensive to manufacture and was therefore used only on better grades of equipment. This is simply background information, designed to clear the reputation of ratio detectors; several of the best manufacturers use them with complete success.

There is a listening difference, however; and that brings us to hush or squelch circuits. When a receiver which uses a ratio detector is tuned, there is no (violent) noise between stations. On the other hand, the area between stations in an Armstrong-circuited receiver has some of the finest waterfall-rushing and hissing sound ever heard. (Makes a wonderful loud-speaker test sound, by the way.) It can be unpleasant when tuning up and down the dial. So engineers developed hush or squelch circuits to reduce and even eliminate this sound, enabling one to tune in quiet.

Provision should be—and is—made on all tuners to defeat such circuits, because if too much hush is applied, a weak station, as well as extraneous noise, can be squelched. Some tuners are designed so that the hush or squelch circuit is either in or out; others enable the amount of squelch applied to be varied.

H: Practically all FM antenna installations use 300-ohm twin lead for the connections between antenna and tuner. And all tuners have the proper terminals for wire of this impedance. In some instances, it may be desirable to use coaxial cable, to help reduce pickup of interference along the lead-in wire. Coaxial cable of this type has a low impedance, between 50 and 70 ohms. Therefore, if coax cable is used, either the tuner must have low-impedance antenna terminals, or an impedance-matching transformer must be used. The former arrangement is better; the latter is entirely adequate.

I: Tuning indicators, and the need therefor, are discussed above. Either an eye (or indicator) or a meter can be sufficiently accurate for precise tuning.

Continued on next page

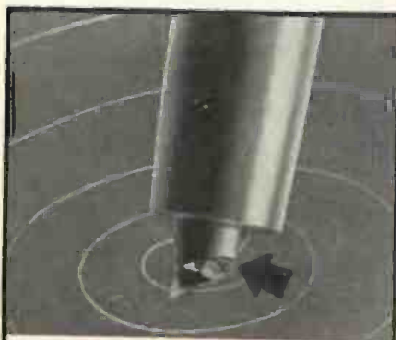

FROM ONE WHO LEARNED

This enlargement shows a diamond-chip needle sent us by a disappointed user, who learned all diamond needles are not O.K. Shows what happens if a heat bubble forms when a chip is welded on. Can't happen with a Duotone Needle that uses only the *whole* diamond set deep in the metal shank.

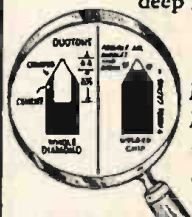

Insist on Duotone. Be sure, Duotone's whole diamond can't break off.

DUOTONE DIAMOND NEEDLE

"that remembers"
Keyport, N. J.

In Canada: Chas. W. Pointon, Ltd., Toronto

Personal

STEREO HIGH-FIDELITY WITH KOSS DYNAMIC STEREOPHONES



MODEL
SP-3

- Frequency response 30-15000 Flat, impedance 4 ohm
- Excellent response from any Stereo or Monaural system. Organs, Hi-Fi, etc.

Complete separation of the two channels gives the realism and fine tonal qualities that are unobtainable by any other method regardless of cost. Price \$24.95

Available at your Local Hi-Fi Store or Write Direct.

KOSS INCORPORATED
2227 N. 31st ST., MILW. 8, WIS.

NOW...ASTOUNDING* FM/AM RADIO IN YOUR CAR

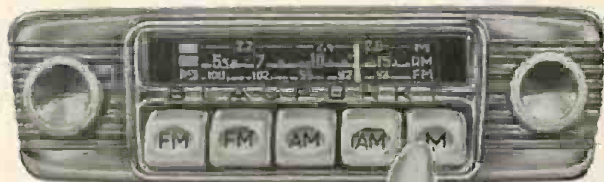

Thrill to the rich, "living-room" HI-FI performance of Blaupunkt car radios—in both FM/AM and AM models. New transistorized Blaupunkt FM/AM gives you the added advantage of uninterrupted reception even in underpasses. When you buy your new car insist on a Blaupunkt car radio, the world's finest HI-FI in Motion! Easily installed in American or imported cars.

Finest across the Atlantic...
LUFTHANSA
GERMAN AIRLINES

FREE! WIN TRIP TO EUROPE FOR TWO

Enter Blaupunkt "Wings of Sound" Sweepstakes now! Nothing to buy, nothing to think up. Just fill in the entry form at your BLAUPUNKT dealer. 20 exciting prizes, including free trip to Europe for 2, via LUFTHANSA.

* WRITE FOR REPRINT of article in Electronic Industries Magazine on the "astounding reception" of Blaupunkt FM/AM car radio.



Dept. HF, Robert Bosch Corporation, Car Radio Division,
40-25 Crescent St., Long Island City 1, N. Y. or
225 Seventh Street, San Francisco 3, Calif.

BLAUPUNKT FM-AM & AM CAR RADIOS

REG. U. S. PAT. OFF. BLAUPUNKT-WERKE GMBH HILDESHEIM-GERMANY SYMBOL OF QUALITY
A SUBSIDIARY OF ROBERT BOSCH C. O. B. H.

one
word
more
about
the

Amperex
6CA7/EL34
OUTPUT
PENTODE



**NOW ITS
RATED POWER OUTPUT
IS 60 WATTS**
(CLASS AB₁)

We are pleased to announce that as a result of the further exploration of the 6CA7's capabilities ... its power output rating has been raised to 60 watts in a distributed load circuit. This was achieved by increasing the screen grid voltage to 500V. The screen voltage rating now equals the plate voltage rating, thus greatly simplifying the design of power supplies.



ask your Amperex distributor about Amperex voltage amplifiers, rectifiers and output tubes for hi-fi circuits.

AMPEREX ELECTRONIC CORP.
230 Duffy Avenue, Hicksville, L. I., N. Y.

the only

SURE

way to continue getting

SHURE

performance from your

SHURE

high fidelity stereo
cartridge is to be

SURE

your replacement stylus
is a genuine

SHURE

precision made stereo

STYLUS

STEREO TUNER

Continued from preceding page

J: Time was when HIGH FIDELITY Magazine used to campaign to get volume controls off tuners, in the interest of simplicity. It seems sensible to adjust volume at only one point: on the preamp-control panel. It was our feeling that inclusion of a control on the tuner was a redundancy. Today, there are so few tuners with volume controls on the front panel that we make a special mention of their appearance. (Some tuners provide level controls on the rear apron, where they can be set once and for all; still others provide none, either front or back.)

K: Clear enough? See also W.

L: As pointed out at the beginning of this article, manufacturers confronted with the multiplex situations have reacted in a variety of ways. Some provide no more than an extra phono jack, wired parallel to the regular audio output connection, which can be used for anything, including multiplex (with some extra work.) Some insert this jack into the circuit so that adaptation to multiplex will be considerably easier. Some leave space on the tuner chassis, and all you have to do is to plug in the adapter. And at least one goes so far as to provide a multiplex separation control on the front of the panel.

Best advice to prospective purchasers: get the latest information about the local multiplex situation from a competent dealer, and then you can buy accordingly.

M: See I. The meter is better than an indicator (which may be an eye or a bar) for measuring signal strength, but a good indicator is better than a poor meter insofar as precision of tuning is concerned. Try both types on weak signals.

N and O: Automatic Frequency Control is included on all but two of the tuners in our compilation. In all cases, it can be defeated; the reason for doing so was discussed in our introductory paragraphs. Some tuner manufacturers make AFC variable, so that it may be adjusted to suit local conditions. The same theories apply to squelch circuits, discussed under F.

P: Phase reverse . . . um . . . when a sound strikes the diaphragms of two microphones in a recording or broadcasting studio, both diaphragms move in the same direction. When the electrical impulse representing this sound reappears at the voice coils of the

PURCHASING A HI-FI SYSTEM?

Send Us
Your
List Of
Components
For A
Package
Quotation

PARTIAL LIST
OF BRANDS
IN STOCK

Altec Lansing
Electrovoice
Jensen
Harley
University
Acoustic Research
Janzen
Wharfedale
Karlson
Viking
Concertone
Bell • G.E.
Weathers
Harman • Kardon
Eico • Pilot
Sherwood
Acrosound
Fisher
Bogen • Leak
Dynakit
H. H. Scott
Ferrograph
Tandberg
Pentron
Ampro • VM
Revere • Challenger
Wollensack
Garrard
Miracord
Glasar-Stears
Rek-O-Kut
Components
Norelco • Conrac
Fairchild
Pickering • Gray
Audio Tape
Full Line of
Wellcor Cabinets

WE WON'T BE
UNDERSOLD!

All merchandise
is brand new, factory
fresh & guaranteed.

**AIREX
RADIO**

CORPORATION

64-HF Cortlandt St., N. Y. 7, CO 7-2137

STATEMENT OF THE OWNERSHIP, MANAGEMENT, CIRCULATION, ETC., REQUIRED BY THE ACTS OF CONGRESS OF AUGUST 24, 1912, AND MARCH 3, 1933
Of High Fidelity, published monthly at
Great Barrington, Massachusetts, for
September 29, 1959

1. The names and addresses of the publisher, editor, managing editor, and business manager are: Publisher, Charles Fowler, Egremont, Mass.; Editor, Roland Gelatt, Bridgewater, Conn.; Managing Editor, Miriam D. Manning, Great Barrington, Mass.; General Manager, Warren B. Syer, New Marlboro, Mass.

2. The owner is: Audiocom, Inc., Great Barrington, Mass.; The Billboard Publishing Company, Cincinnati, Ohio.

3. The known bondholders, mortgagees, and other security holders owning or holding 1 per cent or more of total amounts of bonds, mortgages or other securities are: none.

4. The two paragraphs next above giving the names of the owners, stockholders, and security holders, if any, contain not only the list of stockholders and security holders as they appear upon the books of the company, but also, in cases where the stockholder or security holder appears upon the books of the company as trustee or in any other fiduciary relation, the name of the person or corporation for whom such trustee is acting, is given; also that the said two paragraphs contain statements embracing affiant's full knowledge and belief as to the circumstances and conditions under which stockholders and security holders who do not appear upon the books of the company as trustees, hold stock and securities in a capacity other than that of a bona fide owner; and this affiant has no reason to believe that any other person, association, or corporation has any interest direct or indirect in the said stock, bonds, or other securities than as so stated by him.

(Signed) Warren B. Syer
Sworn to and subscribed before me this
Twenty-ninth day of September 1959.
(Seal) Lillian F. Bendross, Notary Public
Commission expires June 24, 1961.



Home recording is more fun with RCA SOUND TAPE



You'll find that recording at home is more fun when you use RCA Sound Tape. And your favorite "memories on tape" will sound better, too, because RCA Sound Tape gives you incomparable high-fidelity reproduction. Available in the popular and economical 5" and 7" reel sizes, on splice-free Mylar* or acetate bases. Ask for RCA Sound Tape wherever superior quality magnetic recording products are sold.



RADIO CORPORATION OF AMERICA

Electron Tube Division - Harrison, N. J. DuPont Reg. TM.

STEREO-FAX

Provides Stereo Realism From Monaural Source



Hear new depth and brilliance from your monaural tape and record collection by installing the STEREO-FAX in your high fidelity stereo system. This network component permits you to take full advantage of your stereo system with all monaural program material by introducing phase displacement between amplifiers. The result is extraordinary realism. Get new enjoyment from ALL radio broadcasts. Written up in Hi-Fi Directory and other leading publications. Unit comprises a passive RLC circuit requiring no power source. Easily installed without disruption of existing hook-up.



Available only by mail, postpaid if cash with order, or C.O.D. plus postage. (Call. residents add 4% tax.) Shipping weight approx. 1 1/2 lbs. for either model. Complete technical data, simple installation instructions, and schematic included with each order. Satisfaction guaranteed.

AUDIOPHILE MODEL U-3A \$19.95
STANDARD MODEL U-4B \$16.95

ORDER NOW or write for full information

Gaylor Products Co. Dept. S6-119
11100 Cumpston St., No. Hollywood, Calif.

loudspeakers in your home, it must push both speaker diaphragms in the same direction. If one diaphragm sucks in while the other pushes out, they are said to be out of phase. Out of step would be a good semantic alternate. If they are out of phase, the sound tends to cancel. This is Part I of the lesson for today. Part II has to do with how you keep things in phase. In setting up a stereo system, phase is established once and for all for records, and need not be changed. Phase can be reversed by reversing the connections to one loudspeaker



(not both). In phase, the middles and lows are strong; out of phase, they are weak, and the hole-in-the-middle is more apparent. A correct phase relationship can be maintained relatively simply by the record manufacturer, so that once it is set properly, for record playback, the chances are very good that it will not have to be shifted.

This is not equally true of stereo broadcasting. Each electronic step (even in a home system) reverses the phase of the sound signal. Thus the number of steps must be kept the same throughout the process. They can be, in record producing. They can be, in a home system. And once in a while, they can be in broadcasting. They can be if the same studio, and the same equipment, are used each time. But change microphones, add one stage of amplification, or shift transmitting facilities, and the chances are fifty-fifty that phase will be reversed.

Thus it seems probable that, from time to time, stereo broadcasts will not sound quite the same. One night they will be good, the next they might be a bit weak. Reversing the phase the second night—by reversing the leads to one speaker system—would probably effect an improvement.

Hence the need for phase-reversal provisions on tuners. Some preamp-control manufacturers provide for it at this step in the process, and here is probably the best place because occasionally it may be desirable to re-

Continued on next page

HOW & WHY of HI-FI & STEREO

NEWEST AND BEST HI-FI STEREO BOOK



Has all the answers. Explains how HI-FI Stereo components work. Tells HOW and WHY to select amplifiers, preamps, record players, tuners, tape recorders, microphones, pickups, speakers and enclosures.

Tells how to read mfr's specs of HI-FI equipment. Shows how to adapt monaural systems to stereo. Contains easy way to use decibels. Also explains distortion and means of eliminating it. Explains feedback, Williamson & Ultra-Linear circuits, impedance matching, audio power needs, crossover networks, equalization, volume compression and expansion, bass and treble boost, pickups and cartridges, styli and many other subjects.

Includes latest stereo developments in record players, tuners and tape recorders.

STROBOSCOPE DISC

In each book!

Biggest Hi-Fi Stereo Dollars Worth

Guaranteed Money Back in 5 Days if not Satisfied SPECIAL INTRODUCTORY OFFER!

ABSOLUTELY FREE with each order: Your choice of Ciesin's newest book **BASIC ELECTRICITY**—Vol. for TV & RADIO TUBE SUBSTITUTION GUIDE. These sell for 50c ea. ACT NOW—get 2 books postpaid at cost of only one!

\$1 Post-paid

RUSH COUPON NOW!

H. G. CISIN, Consulting Engineer—Dept. H-1 Amagansett, N. Y.

Enclosed find \$1. Rush HI-FI & STEREO & free book marked above. (If not marked Basic Elec. will be sent.)

Send all 3. Enclosed find \$1.50.

Name

Address

City Zone State

BALANCE YOUR STEREO SYSTEM

ONCE

SO IT SOUNDS RIGHT.

CENTER THE NEEDLE OF THE NEW

kinematrix

STEREO BALANCE METER

WITH SIMPLE CONTROLS ON THE BACK

ONCE

THEN YOUR SYSTEM

ALWAYS

SOUNDS PERFECT—

IMPROVES LISTENING PLEASURE

FOR THE ROOM IT'S IN—

WHENEVER YOU CENTER

THE BRIGHT NEEDLE

SIMPLE? YES! EFFECTIVE? DECIDEDLY!



SOUND CHOICE FOR CHRISTMAS

\$14⁹⁵ At Better Hi-Fi Suppliers

kinematrix, inc.



1616 North Damen Avenue

Chicago 22, Illinois



Fairchild is progress



... progress typified by the new SM-1 Rotating Magnet Compatible Stereo/Monophonic cartridge.

The FAIRCHILD SM-1 will complement any home music system. Rugged enough to stand the abuse of any record changer, yet, will enhance the performance of the finest professional arms and turntables.

In this cartridge, the highly skilled FAIRCHILD engineers have achieved practically all the objectives of good stereo cartridge design — high output, high vertical and lateral compliance, uniform frequency response . . .

Comparison of the specifications will convince you that, for stereo cartridges, all you need say is FAIRCHILD . . . \$34.95.

FAIRCHILD RECORDING EQUIPMENT CORP.
10-40 45th Ave. Long Island City 1, N.Y., Dept. HF 119



NEW WINEGARD GOLD FM ANTENNA GETS 100-MILE RECEPTION



Unique Offset
Clamp — Mounts
Right On TV
Antenna Mast!

**Omni-Directional — Covers
88-108 MC . . . no rotor needed!**
Pulls in stations within 100-mile radius. Installs quickly on same mast as TV antenna or separately. Two antennas give 40% power increase. Weatherproof . . . bright gold anodized finish. Model FM3T. **\$1195**

**FOR LONG-DISTANCE FM
RECEPTION — UP TO 300 MILES!**
WINEGARD MODEL FMY8 — Powerful 8-element, high gain, directional yagi. Gold anodized. . . **\$2250**

New 6 and 12 element "Transcoupler" yagis also available.

Ask your TV Serviceman or write for free literature.



Winegard Co.

3014-11 Scotten, Burlington, Iowa

STEREO TUNER

Continued from preceding page

verse phase from a tape recorder and even from a phonograph record. A switch in the speaker line will do it, but this is not as neat as a switch on the preamp or on the tuner.

Eventually, of course, ways and means will be found to maintain phase regardless of the broadcasting or recording setup. Meantime, the problem should be borne in mind, and some convenient method for phase reversal provided.

At least one stereo tuner already has this feature.

Q and R: FM broadcasts carry the full range of audible frequencies, say from 20 to 20,000 cycles. Except in rare circumstances, AM transmissions are of limited frequency range. They may be as low as from 100 to 4,000 cycles; some go as high as 8,000 cycles; a few special stations go above this figure. The reason for restricting the frequency range is to minimize interference between stations, whose channels are only 10,000 cycles apart (as set by the FCC). The reverse side of this coin is that it's a lot easier to build a small kitchen radio with a restricted frequency response than it is to make it handle even 6,000 cycles. So most of the manufacturers—to reduce interstation interference and to provide sharper tuning, as well as for reasons of economy—have limited their receivers to 4,000 cycles or so. Thus the broadcasters have not had, until recently, any incentive to improve their transmitting quality.

Times change. High fidelity has become a strong influence, strong enough to encourage broadcasters to improve their signals, and manufacturers to improve their receivers and tuners. But there is a conflict. For fidelity, the wider the frequency range accepted by an AM tuner, the better. But for interference-free reception, the narrower the range, the better. So several AM tuner manufacturers provide variable AM bandwidth.

W: See K.

RECORD · DUPLICATE · PLAY · STEREO TAPES



WITH
PROFESSIONAL
QUALITY

STEREO RECORDER \$349.50

RECORDING AMPLIFIER \$149.50

THE Roberts STEREO SYSTEM

achieves the full, true potential of stereophonic sound. Roberts' superbly designed transport mechanism, with its hysteresis synchronous drive motor, provides perfection in pitch — and timing accuracy of 0.2%. This, with Roberts' exclusive Multirase Head, gives you professional recording quality.

Send 25¢ for Complete Stereo Information Kit.

Complete Stereo System \$499 — Four-Track \$509

ROBERTS ELECTRONICS Inc. 1045 N. SYCAMORE AVE., HOLLYWOOD 38, CALIF.

• CALIFORNIA •

SPECIAL
Recording Tape . . . **\$1.19**

1200 ft.; 7" guaranteed splice-free. Also, 1800 ft.; 7" for \$1.89. Enclose 10¢ for each reel to cover postage & handling



PROFESSIONAL DIRECTORY

CALIFORNIA

RENT stereo tapes

- over 800 different albums
- all major labels
- no deposits on tapes rented
- postpaid to and from your home

send for catalog...

stereo-parti 

1608-N CENTINELA AVE., INGLEWOOD, CALIF.

DISTRICT OF COLUMBIA

NEW YORK



Only a Rich Purple People Eater

Does Not...

Check with **AUDION**

before buying HI-FI components

audion

25-HF-Oxford Road
Massapequa, L.I., N.Y.

NEW YORK

PROFESSIONAL RECORDING TAPE

Finest quality of famous prime manufacturer. Full frequency response. Finest lubricated and polished tape available. Money back guarantee.

Acetate 5" Reels

600' 1 1/2 Mil 4/\$3.24

900' 1 Mil 4/\$3.96

Acetate 7" Reels

1200' 1 1/2 Mil 4/\$5.20

1800' 1 Mil 4/\$6.78

Mylar 5" Reels

900' 1 Mil 4/\$5.40

1200' 1 1/2 Mil 4/\$7.52

Mylar 7" Reels

1200' 1 1/2 Mil 4/\$7.48

1800' 1 Mil 4/\$9.00

2400' 1 1/2 Mil 4/\$13.00

Add 15¢ each 7" and 10¢ each 5" reel—P.P.

HI-SONIC

P. O. Box 86B

New York 63, N. Y.



TAPE RECORDERS

recording tape
Bell Tape Decks
Hi-Fi equipment
Norelco Speakers

WE WILL NOT BE UNDERSOLD!

Send for our catalog and see why!

COMMISSIONED ELECTRONICS CO.

1776 Columbia Rd., Washington, D. C.

MARYLAND

DIXIE

HIGH FIDELITY WHOLESALERS

Largest catalog High Fidelity distributors in the South. Guaranteed lowest prices on package quotations. Wholesale prices on individual components. All new merchandise in factory sealed cartons. Are prices too high?—Write:

DIXIE HI-FI

12402 Connecticut Ave., Silver Spring, Md.

NEW JERSEY

RECORDS from YOUR TAPES

Spectrofonc®—HIGH FIDELITY

Your tapes transferred by our skilled engineers using top professional equipment: Ampex 300's—Grampian Feed-Back Cutters—Thermo Stylus

Write for Free Folder

Recorded Publications Laboratories
1540-1568 Pierce Avenue, Camden 5, N. J.

NEW YORK

FOR THE TOPS IN VALUE
AND THE BEST TRADE-IN ON
HIGH FIDELITY EQUIPMENT
Check with Arrow!

ARROW ELECTRONICS, INC.

65 Cortlandt St., New York 7, N. Y.

Digby 9-4730

525 Jericho Turnpike, Mineola, N. Y.

Ploneer 6-8686

SOUNDTASTIC!



2057 Coney Island Ave.

Brooklyn 23, New York

WRITE FOR FREE SELECTOR & PLANNING BOOKLET LISTING SOUNDTASTIC HI-FI SYSTEMS AT SPECIAL PACKAGE QUOTATIONS



You can now purchase all your HI-FI from one reliable source and be assured of perfect delivery. Carston makes delivery from NY stock on most HI-FI Recorders and tape within 24 hours. SEND US A LIST OF YOUR HI-FI REQUIREMENTS FOR OUR WHOLESALE QUOTATION and our FREE wholesale catalogue.

CARSTON

125 MH E. 88 ST.
NEW YORK 28, N. Y.

RECORDING TAPE

Premium Quality

10-day money back guarantee

1800' Mylar 3 for \$5.95

2400' Mylar 3 for 9.60

Lots of 10, any assortment, deduct 10%. Add postage 15¢ per spool.

DON'T BUY HI-FI components, like tape recorders, until you get our low, low quotes by return mail. Wholesale Catalog Free.

ELECTRONIC WORLD INC.

1799A 1st Ave., New York 28, N. Y.

RECORDS SOUND BETTER! LAST LONGER!



New Unique EX-static® Preserves HI-FI and Stereo Discs. Anti-Static Record Cleaner gets out the superfine grit that rubs delicate microgrooves; reduces friction between stylus and groove walls, thus reducing wear; plus overcomes static attraction of dust to records for months. Simply spray and wipe with special pad included. English Import cleans and protects at least 200 sides for only \$1.85 ppd. Send check, M.O. \$1.85 to EX-static Ltd., P.O. Box 4, Kew Gardens 15, N. Y. Sole U.S.A. agent.

*Product of British electronic research

PRICE or QUALITY?

F & B MAGNETIC TAPE OFFERS BOTH!

Why pay more when F & B absolutely guarantees new, fresh, highest quality hi-fi tape—Freq. Rspn. 30-15,000 cycles—or your money refunded.

1200' 7" reel — Acetate — 3 for \$3.95

1800' 7" reel — Acetate — 3 for 5.25

1800' 7" reel — Mylar — 3 for 6.85

2400' 7" reel — Mylar — 3 for 10.60

Please add 15¢ PP & Handling—Per Reel

FLORMAN & BABB, Inc. 68 WEST 45th ST.
NEW YORK 36, N. Y.

TAPE RECORDERS



HI-FI Components SLEEP LEARN KITS

Unusual Values

FREE 1960 Catalog

DRESSNER

69-02 FA, 174 Street
Flushing 65, New York

PENNSYLVANIA



This Amazing Booklet

FREE!
A COMPLETE INTRODUCTION TO **STEREO**

Alma RADIO CO.

913 ARCH ST.

PHILA. 7, PENNA.

SORTS YOUR RECORDS

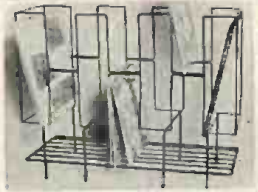

Black wrought-iron cabinet is just waiting for your collection to crow into it! "Shove-off" 200 LP albums. Ten compartments to file records by symphonies, operas, ballets, jazz, folk, chamber and show music. Sturdy 35" x 22" x 10". Fully assembled. Remit \$9.95, or ebg. Doors. Acgt. Small Exp. ebg. collected on delivery. MONEY-BACK GUARANTEE! \$9.95

© Leslie Croaltons • Dept. 2095 • Lafayette Hill, Pa.

Lafayette

PRESENTS

THE NEW ULTRA-LINEAR SPEAKER



FULL RANGE 8" DUAxIAL SPEAKER

- RESPONSE 40-16,000 CPS \pm 3 DB
- HIGH EXCURSION WOOFER WITH UNIQUE "CONICAL STIFFENER"
- HIGH EFFICIENCY
- HANDLES HEAVY BASS WITHOUT "DOUBLING"
- COMPACT INTEGRAL MOUNTING OF WOOFER & TWEETER

Eccentric Tweeter Mounting & Unique Elliptical Baffle Completely Eliminates Interaction Between Woofer & Tweeter

A compact 2-way speaker that sets new standards of performance for an 8-inch unit. Superb bass... brilliant highs... remarkable tonal clarity... all yours with the new SK-128. Exclusive design features provide smooth, even response from 40 to 16,000 cycles with no distortion or coloration to mar your listening pleasure. For stereo... for monaural... or as an extra speaker, the SK-128 is your ideal choice for true musical realism at moderate cost. Hear it... and you will want to own it! Frequency Response: 40-16,000 cps \pm 3 db. Cone Resonance: 45-65 cps. Impedance: 8 ohms. Power Rating: 20 watts integrated program material. Built-in LC crossover: 2,500 cps. Complete with brilliance control... only \$19.50

Mfd. by Matsushita Co., Ltd., Osaka, Japan

FREE — 308 GIANT SIZED PAGES — FREE

LAFAYETTE RADIO, Dept. WK92

P.O. BOX 222 JAMAICA 31, N. Y.

Send FREE LAFAYETTE Catalog 600

CUT OUT AND PASTE ON POST CARD

Name.....
Address.....
City..... Zone..... State.....

ADVERTISING INDEX

Key No.	Page	Key No.	Page
1...	Acoustic Research, Inc. 23	74...	Key Electronics 169
2...	Acro Products 159	75...	Kierulf Sound Corp. 168
3...	Airex Radio Corp. 166	76...	Kinematix 167
4...	Allied Radio 9, 44	77...	Kingdom Products, Ltd. ... 47
5...	Almo Radio 169	78...	Koss Inc. 165
6...	Altec Lansing Corp. 49	79...	Lafayette Radio 4, 170
7...	American Electronics 50	81...	Leslie Creations 169
8...	Amperex 166	82...	London Records 98
9...	Ampex Audio, Inc. 39, 40	83...	Lyon Products 169
10...	Apparatus Development 164	84...	Madison Fielding 153
11...	Arrow Electronics 169	85...	Marantz Co. 154
12...	Audax Division 33	86...	Mercury Records 83
13...	Audio Devices, Inc. 115	87...	Mercury Scientific 118
14...	Audio Empire 34	88...	Minnesota Mining and Manufacturing Co. 46
15...	Audio Exchange 157	70...	Neshaminy Electronic Corp. 38
16...	Audio World 169	89...	Nuclear Products 120
17...	Audiogersh Corp. 74	90...	Orr Industries Inc. 108
18...	Audion 169	91...	Pickering & Co. 2
19...	Bell Sound Division 16	92...	Pilot Radio Corp. 51
20...	Blaupunkt Car Radio 165	93...	Precision Electronics 128
21...	Blonder Tongue Labs. 94		Professional Directory 169
22...	Bogen, David, Inc. 117	94...	R & A Speakers 30
23...	Book-of-the-Month Club 5		RCA Components 99
24...	Book-of-the-Month Club 7		RCA Tape 167
25...	Bosch, Robert, Corp. 165	95...	RCA Victor Division 87, 96,
26...	Bozak, R. T., Co. 36, 37		Inside Back Cover
27...	British Industries Corp. 52	96...	Radio Shack 121
28...	Burgess Battery Co. 158		Record Review Index 120
29...	CBS Electronics 158	98...	Recorded Publications 169
30...	Capitol Records, Inc. ... 89, 90		Records in Review 100
31...	Carston Studios, Inc. 169	97...	Reeves Soundcraft 122
32...	Cisn, H. G. 167	99...	Rek-O-Kut Co., Inc. 45
33...	Collaro 6	100...	Reslo 30
34...	Columbia Records 85, 95, 118	101...	Rigo Enterprises 160
35...	Commissioned Electronics 169	102...	Roberts Electronics, Inc. ... 168
36...	Connoisseur 30	103...	Robins Industries 114
37...	Cosmos Industries 159	32...	Rockbar Corp. 6
38...	Decca Records 116	104...	Sargent Rayment Co. ... 105, 151
39...	DeWald Radio 163	105...	Scott, Herman Hosmer, Inc. 17-21
40...	Dexter Chemical 130	106...	Secco Records 108, 116
41...	Dixie Hi-Fi 169	107...	Sherwood Electronic Labs. ... 31
42...	Dressner 169	108...	Shure Bros. 166
43...	Dual 48	109...	Somerset 41
44...	Duotone 165	110...	Sonic Industries 109
45...	Dupont "Mylar" 126, 127	111...	Sonotone Corp. 10
46...	Dynaco, Inc. 161	109...	Stereo Fidelity 41
47...	EICO 136	112...	Stereo-Parti 169
48...	Electronic World 169	113...	Strand Records 119
49...	Electro-Sonic Laboratories 151	114...	Stromberg-Carlson 24-29
50...	Electro-Voice, Inc. Back Cover	115...	Stuzzi 160
51...	Epic Records 100, 112, 113	116...	Sun Radio and Electronics 158
52...	Ercona Corp. 30, 155, 160	117...	Superscope, Inc. 35
53...	Eric Resistor 157	118...	Tandberg 156
54...	Everest Records 163	119...	Terminal Radio 169
55...	EXstatic Ltd. 169	120...	Thorens 152
56...	Fairchild Recording Equipment 168		Trader's Marketplace 162
57...	Ferrodynamics Corp. 156		United Audio Products 48, 164
58...	Ferrograph 155	121...	United Stereo Tape 125
59...	Fidelitone 14	122...	University Loudspeakers, Inc. 111
60...	Fisher Radio Corp. 11, 13, 15	123...	Utah Radio 101
61...	Florman and Babb 169	124...	Vanguard Recording Society, Inc. 97
62...	Garrard Sales 52	125...	Viking of Minneapolis 129
63...	Gaylor Products 167	126...	Vitavox 30
64...	General Electric Co. 12	127...	Vox Productions, Inc. 120
65...	Glaser-Steers Corp. 104	128...	Washington Records 120
66...	Grado Laboratories, Inc. ... 106	129...	Weathers Industries 42
67...	Hallicrafters 164	130...	Webster Electric 164
68...	Harman-Kardon, Inc. ... 43, 147	131...	Westminster Recording Co. 76
69...	Heath Co. 131-135	132...	Wigo 164
70...	Hi-Fidelity Recordings ... 104	133...	Winegard Co. 168
71...	Hi-Sonic 169	134...	Wollensak 8
72...	Hi-Sonic 169		
73...	Hi-Sonic 169		
74...	Hi-Sonic 169		
75...	Hi-Sonic 169		
76...	Hi-Sonic 169		
77...	Hi-Sonic 169		
78...	Hi-Sonic 169		
79...	Hi-Sonic 169		
80...	Hi-Sonic 169		
81...	Hi-Sonic 169		
82...	Hi-Sonic 169		
83...	Hi-Sonic 169		
84...	Hi-Sonic 169		
85...	Hi-Sonic 169		
86...	Hi-Sonic 169		
87...	Hi-Sonic 169		
88...	Hi-Sonic 169		
89...	Hi-Sonic 169		
90...	Hi-Sonic 169		
91...	Hi-Sonic 169		
92...	Hi-Sonic 169		
93...	Hi-Sonic 169		
94...	Hi-Sonic 169		
95...	Hi-Sonic 169		
96...	Hi-Sonic 169		
97...	Hi-Sonic 169		
98...	Hi-Sonic 169		
99...	Hi-Sonic 169		
100...	Hi-Sonic 169		
101...	Hi-Sonic 169		
102...	Hi-Sonic 169		
103...	Hi-Sonic 169		
104...	Hi-Sonic 169		
105...	Hi-Sonic 169		
106...	Hi-Sonic 169		
107...	Hi-Sonic 169		
108...	Hi-Sonic 169		
109...	Hi-Sonic 169		
110...	Hi-Sonic 169		
111...	Hi-Sonic 169		
112...	Hi-Sonic 169		
113...	Hi-Sonic 169		
114...	Hi-Sonic 169		
115...	Hi-Sonic 169		
116...	Hi-Sonic 169		
117...	Hi-Sonic 169		
118...	Hi-Sonic 169		
119...	Hi-Sonic 169		
120...	Hi-Sonic 169		
121...	Hi-Sonic 169		
122...	Hi-Sonic 169		
123...	Hi-Sonic 169		
124...	Hi-Sonic 169		
125...	Hi-Sonic 169		
126...	Hi-Sonic 169		
127...	Hi-Sonic 169		
128...	Hi-Sonic 169		
129...	Hi-Sonic 169		
130...	Hi-Sonic 169		
131...	Hi-Sonic 169		
132...	Hi-Sonic 169		
133...	Hi-Sonic 169		
134...	Hi-Sonic 169		

NEW STYLES IN STEREO...

Belafonte at Carnegie Hall. An historic concert, complete on 2 L.P.'s. Features all the Belafonte favorites!

More Music from "Peter Gunn." All new, Vol. II. Exciting sequel to America's best-selling album, PETER GUNN!

An Evening with Lerner and Loewe. 30 hit songs from "Gigi," "My Fair Lady," "Brigadoon" and "Paint Your Wagon."

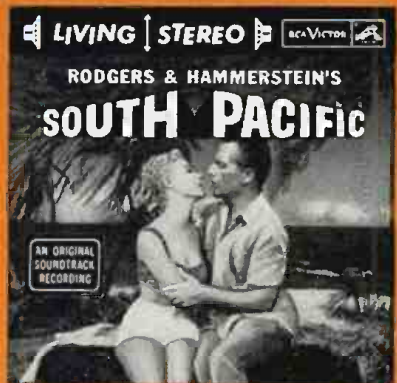
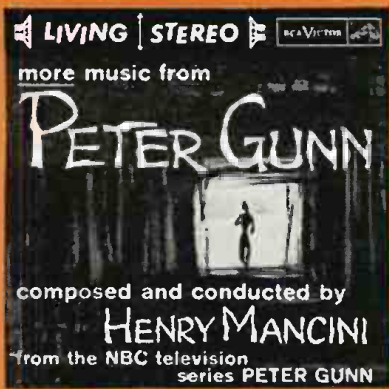

Como Swings. Perry in up tempos! "Begin the Beguine," "Route 66," "St. Louis Blues" and "Honey, Honey," others.

Porgy and Bess, Lena Horne and Harry Belafonte bring you the greatest "Porgy and Bess" of them all!

South Pacific. The Original Movie Soundtrack that won the Academy Award for achievement in sound.

ON RCA VICTOR

All of these albums are
also available on regular long play.
When ordering Stereo, say . . .



critical listeners RECORD LIKE "PROS"

WITH FINER

Electro-Voice[®]

BROADCAST-TV MICROPHONES

The right microphone makes a world of difference in sound pick-up and recording quality. That is why critical audiophiles prefer E-V high-fidelity professional microphones like those used today by radio and television stations and recording studios. (You often see E-V microphones on TV.)

These *Electro-Voice* microphones are research-engineered to pick up and reproduce the full range of voice and music with utmost fidelity for maximum realism.

Choose from two basic types: the E-V *cardioid unidirectional* microphone gives greater definition to front sounds; rejects interference from unwanted rear-background noise and room reverberation; allows precise placement for more working distance from the microphone. The E-V *omnidirectional* type picks up sound from all directions; flat response assures remarkable fidelity for individual or group pick-up without critical placement. All have the exclusive E-V non-metallic Acoustalloy diaphragm. All are extra-rugged for long-life use.



Model 666

665

655C

649A

635

Model 666 Super-Cardioid Dynamic. Variable D principle provides exceptional unidirectionality. Response 30-16,000 cps. Output -55 db. Changeable low impedance. For stand or boom use. List, \$255

Model 665 Cardioid Dynamic. Similar in function to the Model 666. Response 50-14,000 cps. Output -55 db. 50-250 ohms impedance selector. For stand or hand use. List, \$150

Model 655C Omnidirectional Dynamic. Extra-wide-range response 40-20,000 cps. Output -55 db. Changeable low impedance. Use on stand or in hand. List, \$200

Model 654 Omnidirectional Dynamic. (Not illustrated.) Similar in function to Model 655C. Response 50-16,000 cps. Output -55 db. 50-250 ohms impedance selector. List, \$100

Model 649A Miniature Lavalier Dynamic. For chest, desk or hand use. Easily concealed. Omnidirectional. Response 60-12,000 cps. Output -60 db. Matches all low impedances. List, \$105

Model 646 Lavalier Dynamic. (Not illustrated.) Omnidirectional. Response 50-10,000 cps. Output -57 db. Matches all low impedances. List, \$147.50

Model 635 Omnidirectional Dynamic. Very versatile. Response 60-13,000 cps. Output -55 db. 50-250 ohms impedance selector. For stand or hand use. List, \$82

For high-impedance applications, add E-V Model 502 matching transformer.

Wide choice of other popular-priced E-V quality microphones, in low and high impedance, in the full E-V line.



Write for Catalog 136, and Names of distributors, to Dept. 119-H
ELECTRO-VOICE, INC., BUCHANAN, MICHIGAN, U.S.A.

Microphones • Speaker Systems • Phono-Cartridges • Sound Projectors