

The Beethoven Symphonies on Microgroove Reappraised

a discography by C. G. BURKE

57

JANUARY • 60 CENTS

High Fidelity

THE MAGAZINE FOR MUSIC LISTENERS

Presto (♩ = 132)
F.O.
f
Assai meno presto (♩ = 84)
W.W.
p dolce
p dolce

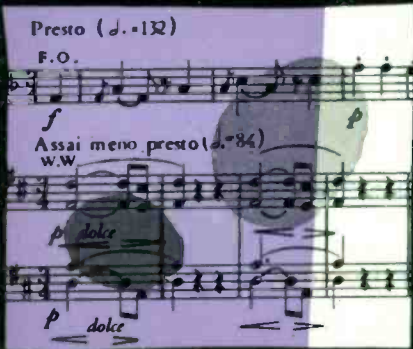

Andante moderato (♩ = 63)
Su.
espressivo cresc.

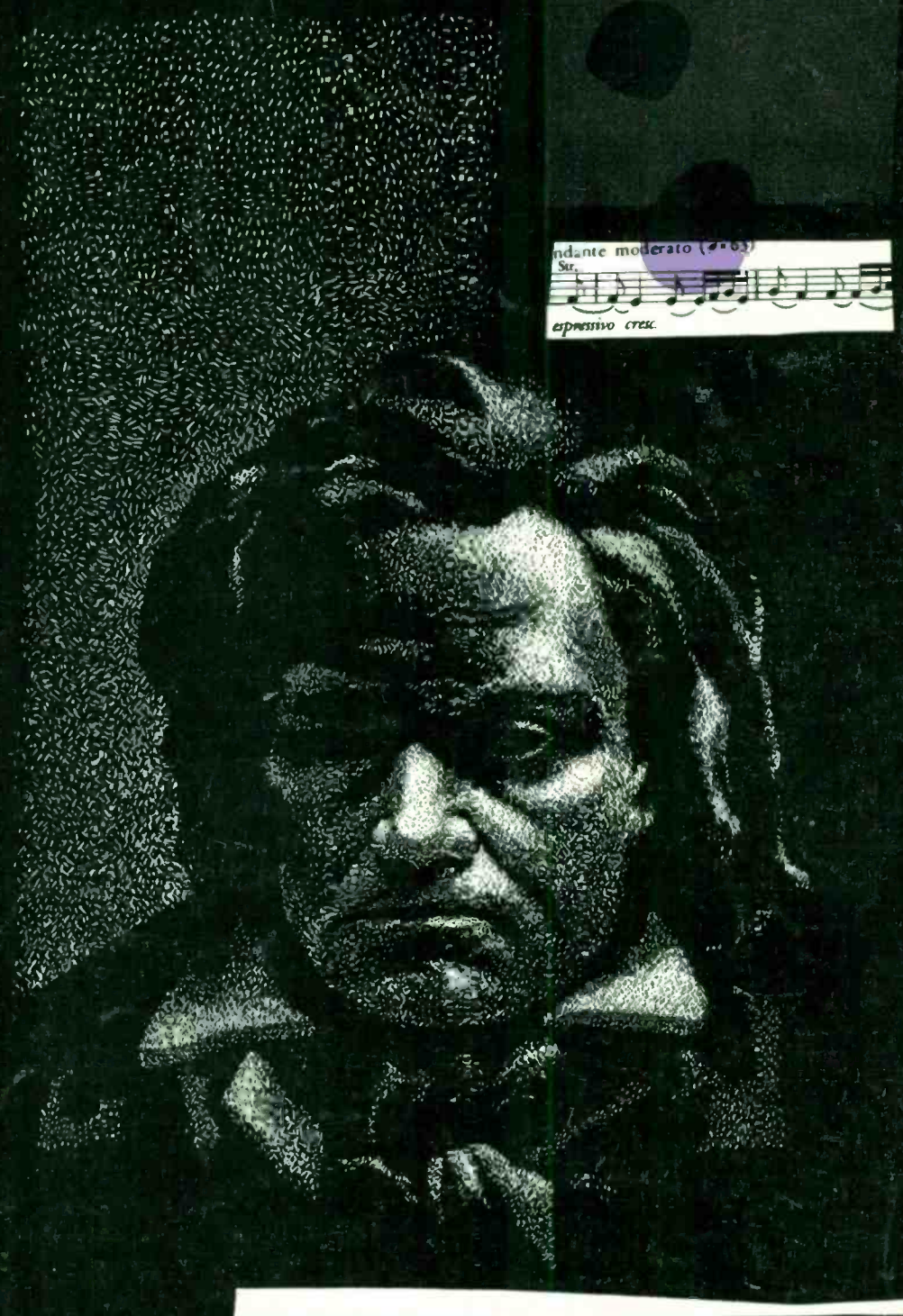
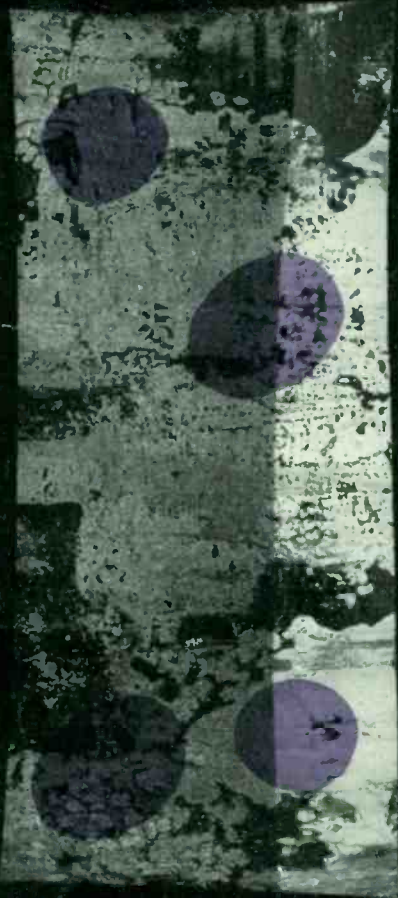
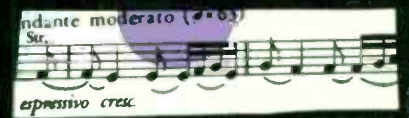

now you can meet every tape recording need

with this **COMPLETE audiotape LINE**

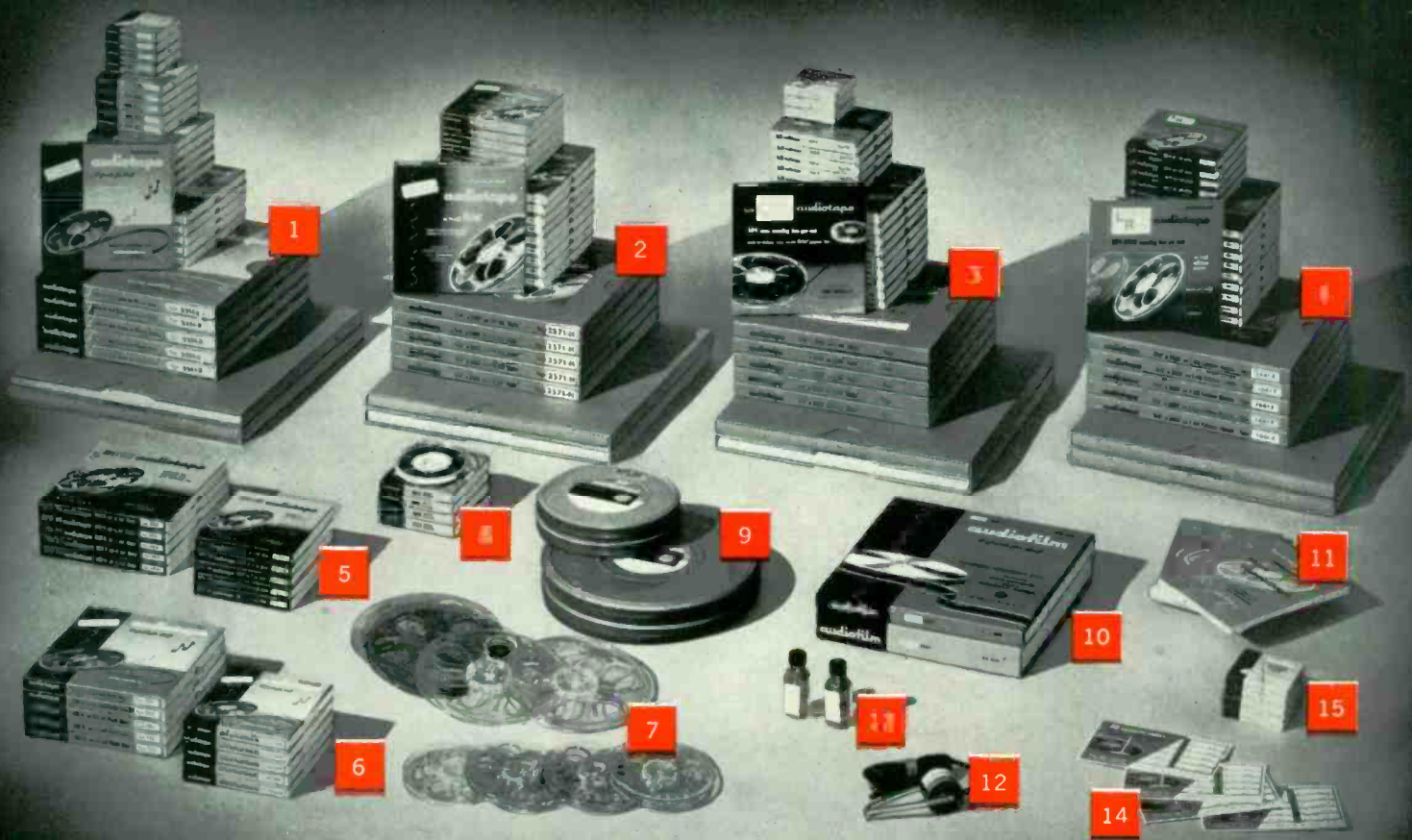

1. PLASTIC-BASE AUDIOTAPE on 1½-mil cellulose acetate meets the most exacting requirements of the professional, educational and home recordist at minimum cost. Known the world over for matchless performance and consistent uniform quality. Series 51, in the red box.

2. AUDIOTAPE ON 1½-MIL MYLAR* — a premium-quality professional tape with maximum mechanical strength and immunity to heat and humidity. Will not dry out or embrittle with age. Series 71, in the green box.

3. "LR" AUDIOTAPE ON 1-MIL "MYLAR" — 50% more recording time per reel. Strong, super-durable polyester film base assures trouble-free operation even under extreme heat and humidity. Series 61, in the black and red box.

4. PLASTIC-BASE "LR" AUDIOTAPE provides 50% more recording time on low-cost 1-mil cellulose acetate base, affording maximum economy where high strength is not required. Series 41, in the blue box.

5. SUPER-THIN AUDIOTAPE on ½-mil "Mylar" gives twice as much recording time per reel as standard plastic-base tape. For long-play applications where tape tension is not excessive. Series 31, in the yellow box.

6. COLORED AUDIOTAPE on green or blue 1½-mil plastic base provides fast, easy color cueing and color coding, at no extra cost.

7. COLORED AUDIOTAPE REELS — 7" and 5" reels in jewel-tone colors — red, yellow, green and blue — for color coding, at no extra cost.

8. HEAD ALIGNING TAPE pre-recorded with precise head alignment, giving a highly accurate reference for aligning recording heads.

9. TYPE "EP" AUDIOTAPE provides extra precision and guaranteed freedom from defects, for computers, telemetering and high-speed magnetic data recording.

10. AUDIOFILM extends Audiotape's unsurpassed sound quality to motion picture and TV film recording. Available in 35mm, 17½mm and 16mm sizes.

11. "HOW TO MAKE GOOD TAPE RECORDINGS" The complete handbook of tape recording, containing 150 pages of up-to-the-minute information of practical value to every tape recordist. \$1.50 paper bound, \$2.50 cloth bound.

12. AUDIO HEAD DEMAGNETIZER removes all permanent magnetism from recording and reproducing heads in a matter of seconds.

13. AUDIO HEAD CLEANER, especially formulated for use on magnetic recording heads — superior to carbon tetrachloride.

14. ADHESIVE REEL LABELS provide positive identification of your tapes right on the reel. Press to apply, pull off to remove.

15. AUDIO SELF-TIMING LEADER TAPE A strong, durable leader tape of white "Mylar" with spaced markings for precise timing of leader intervals.

New 5-Reel Cellophane Package



gives extra protection against dust and dirt — keeps tape and boxes factory fresh.

Ask your dealer for genuine, professional-quality Audiotape . . . it now costs no more than ordinary tape!

AUDIO DEVICES, Inc.

444 Madison Avenue, New York 22, N.Y.

Offices in Hollywood — Chicago

Export Dept., 13 E. 40th St., New York, N. Y.

*DuPont Trade Mark

BUILD YOUR OWN FINE Jensen HI-FI SPEAKER SYSTEM

COMPLETE KITS NOW AVAILABLE—EVERYTHING YOU NEED
NO SAWING . . . NO DRILLING . . . NO WOOD FINISHING . . . NO SOLDERING

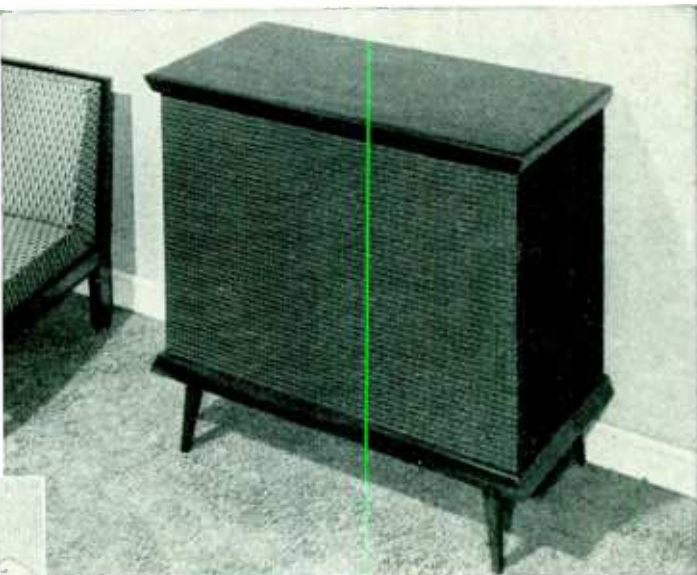
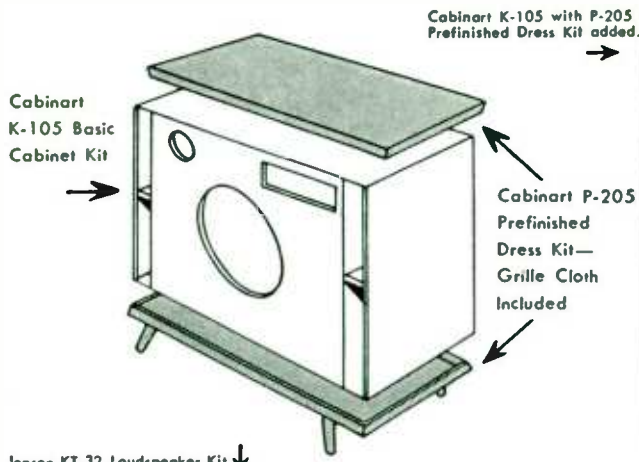

- YOU SAVE UP TO \$252.50*
 - YOU DON'T HAVE TO BE A TECHNICIAN
 - YOU DON'T NEED A WORKSHOP
 - YOU DON'T HAVE TO BE A FURNITURE FINISHER
- *Compared with factory-built Jensen Imperial reproducer

The proud owner of the Jensen 3-way hi-fi speaker system illustrated assembled the handsome low boy cabinet in a few hours in his living room with no tools except a screwdriver, pliers and a stapler. No cutting, sawing, or soldering. And the wood finishing? He just wiped off the finger prints, for the beautiful genuine selected hardwood was factory pre-finished and rubbed by professional finishers. Best of all, he saved nearly \$100 compared with cost of the equivalent factory-built speaker system.

You can have the fun and satisfaction of building your own Jensen speaker system with size and performance ranging all the way from the diminutive, economical Duette up to the big incomparable Imperial at savings which will stretch your hi-fi equipment budget. Jensen and Cabinart with their specialized skills have collaborated to make this easy and trouble-free. Everything you need is furnished.

Jensen Speaker units are matched components, carefully pretested with the smooth, balanced, wide-range performance for which Jensen factory-made reproducers are famous. Cabinart Cabinet Kits were designed by Jensen to give the best possible acoustic performance with Jensen Loudspeaker Kits; each is carefully coordinated with the recommended Jensen Loudspeaker Kit for correct loading of the low frequency channel ("woofer"). Wood pieces are accurately cut and drilled, with all cut-outs provided. Hardware, cleats and glue are included with complete instructions for easy assembly. If you like, you can start with the Basic Cabinet Kit of your choice, add the Prefinished Dress Kit later.

Here's your way to finest hi-fi speaker performance at least cost! Ask your dealer, or write now.

System Type	"Woofer" Size	Equivalent Jensen Reproducer	Jensen Speaker Kit		Type	Cabinart Cabinet Kits			
			Model	Price		Basic Cabinet Kit	Price	Dress Kit†	Price
3-Way	15"	Imperial	KT-31	\$184.50	Corner* Horn	K-101	\$89.00	P-201	\$54.00
3-Way	15"	Triplex	KT-32	169.50	Corner* Bass-Ultraflex	K-103	48.00	P-203	39.00
3-Way	15"	Triplex	KT-32	169.50	Low Boy Bass-Ultraflex	K-105	48.00	P-205	39.00
2-Way†	15"	—	KT-21	99.50	Corner* Bass-Ultraflex	K-103	48.00	P-203	39.00
2-Way†	15"	—	KT-21	99.50	Low Boy Bass-Ultraflex	K-105	48.00	P-205	39.00
2-Way†	12"	Concerto	KT-22	73.00	Corner* Bass-Ultraflex	K-107	39.00	P-207	36.00
2-Way†	12"	Concerto	KT-22	73.00	Low Boy Bass-Ultraflex	K-109	39.00	P-209	36.00
2-Way†	8"	Contemporary	KDU-10	24.75	Corner* Bass-Ultraflex	K-111	23.00	P-211	25.00
2-Way	8"	Duette Treasure Chest	KDU-10	24.75	Duette	K-113	18.00	P-213	21.00

* Gives excellent results against sidewall. Bass-Ultraflex is a Jensen trademark.
† Cabinet provides for expansion to 3-way system at any time with Jensen KTX-1 Range Extender Supertweeter Kit, price \$43.75.
‡ Available in Mahogany or Korina Blonde.

For information about Jensen Speaker Kits write:

Jensen
MANUFACTURING COMPANY
Division of The Muter Company
6601 SOUTH LARAMIE, CHICAGO 38, ILLINOIS
In Canada: Copper Wire Products Co., Ltd.

For information about Cabinart Cabinet Kits write:

CABINART

The Pioneers in High Fidelity Radio Furniture

A Division of G & H Wood Products Co., Inc.

99 North 11th Street, Brooklyn 11, N. Y.

you'll
want
to
look
for
the

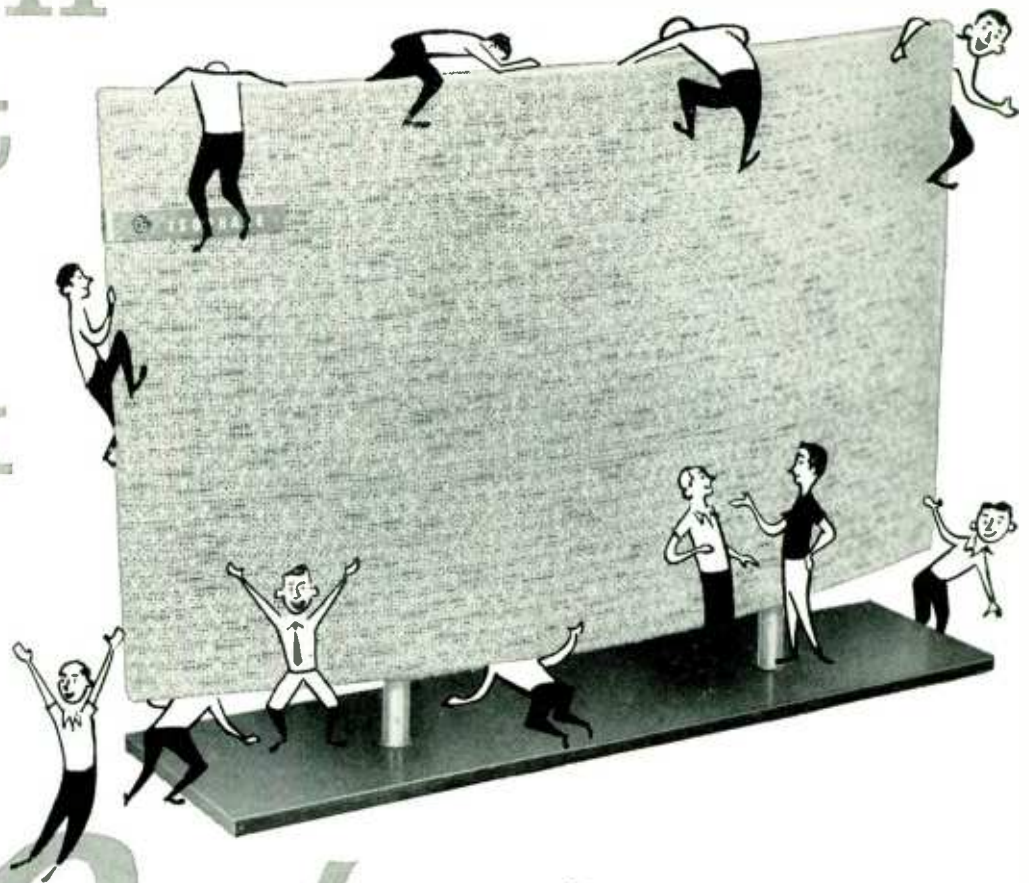

Orchestra

When your authorized Pickering Dealer is demonstrating the revolutionary new ISOPHASE SPEAKER, please, don't look behind it for the orchestra. Take our word for it—these magnificently realistic sounds are coming from the curved diaphragm itself. "Unbelievable," "extraordinary," "breathtaking," and "window-on-the-studio quality" are some of the comments we've heard from dealers and customers alike. But don't be persuaded by mere words alone. *Hear it for yourself.*

The Pickering ISOPHASE SPEAKER uses the electrostatic principle to recreate musical sounds with a degree of realism unattainable in conventional speakers.

The ISOPHASE reintroduces the original sound

into the air *at a low velocity*—instead of at a high velocity as in ordinary speakers. In addition, the ISOPHASE generates sound in phase *from the entire surface* of its large curved diaphragm—instead of from a point source as in conventional cone speakers. Thus the sound reproduced by the ISOPHASE *closely approximates the unit-area energy of the original sound* entering the microphone in the studio or concert hall.

Unlike ordinary speakers, the ISOPHASE does not "break up" at high frequencies. And because of the inherent linearity of the push-pull electrostatic design, harmonic and intermodulation distortion are virtually nonexistent—a tremendous advantage over conventional speakers. For further details, please write Department H-13.



PICKERING & CO., INC. OCEANSIDE, N. Y.

Professional Audio Components

"For those who can hear the difference"

Demonstrated and sold by Leading Radio Parts Distributors everywhere. For the one nearest you and for detailed literature: write Dept. H-13

EXPORT: AD. AURIEMA, INC., 89 BROAD ST., NEW YORK / CANADA: CHARLES W. POINTON LTD., 6 ALCINA AVE., TORONTO



High Fidelity

THE MAGAZINE FOR MUSIC LISTENERS

This Issue. According to a New York record retailer, interviewed last November in *The Billboard*, the brand new record buyer—currently called in the trade “the man behind the boom”—tends to select his disks on the basis of how lately they came out. This points up an endless task for us (us meaning, here, HIGH FIDELITY and other record reviewing publications). It develops thus: The existence of the brand new buyer provokes record producers to keep putting forth ever newer Beethoven Fifth's. But the brand new buyer does not remain brand new. Two years hence he will not want the *newest* Beethoven Third, or Seventh, he will want the *best*. How is he to settle upon a choice? In this month's discography, C. G. Burke points out that the nine Beethoven symphonies in their various versions even now add up to *more than two hundred recordings*. Not even a big metropolitan record mart will stock all of these at one time, nor could a shopper listen to them all anyway. So, more and more, the reliance of the shopper must rest upon reviewers and discographers, especially if the shopper does not happen to live in a metropolitan area. If he does, he may be able to find a record store where the staff really know their wares. These, however, are getting rarer and rarer, which is a shame but natural: these days, it is almost impossible really to know records.

CHARLES FOWLER, *Publisher*

JOHN M. CONLY, *Editor*

ROLAND GELATT, *New York Editor*

J. GORDON HOLT, *Technical Editor*

ROY LINDSTROM, *Art Director*

Assistant Editors

MIRIAM D. MANNING; JOAN GRIFFITHS

Editorial Assistant

ANNA M. FURLANI

Manager, Book Division

FRANCES A. NEWBURY

Contributing Editors

C. G. BURKE

R. D. DARRELL

JAMES HINTON, JR.

ROBERT CHARLES MARSH

WARREN B. SYER, *Business Manager*

ARTHUR J. GRIFFIN, *Circulation Manager*

Advertising

Main Office—Claire Eddings, The Publishing House, Great Barrington, Mass. Telephone: Great Barrington 1300.

New York—Fred C. Michalove, Room 600, 6 East 39th St. Telephone: MURray Hill 5-6332.

Chicago—John R. Rutherford & Associates, Inc., 230 East Ohio St. Telephone: Whitehall 4-6715.

Los Angeles—Brand & Brand, Inc., 6314 San Vicente Blvd. Telephone: Webster 8-3971.

Volume 7 Number 1

January 1957

Letters	4
Noted With Interest	18
On The Counter	30
AUTHORitatively Speaking	36
Books in Review	39
As The Editors See It	51
Halls, Hallowed and Acousticized, by Harold C. Schonberg <i>A ramble through Europe's famous opera houses and concert theaters.</i>	52
The Great Highland Bagpipe, by A. R. P. Wrathall <i>The sheepskin sack is an instrument heard round the world.</i>	55
Is There Anything Phony About Stereophony? by Norman H. Crowhurst	57
<i>It appears that we may be misconstruing the uses of two ears.</i>	
Treasurer of the Golden Age, by Philip L. Miller <i>A visit with Roberto Bauer, dean of acoustical disk collectors.</i>	60
Aroint Thee, Obtrusive Melody! by H. W. Heinsheimer	62
<i>Is there really any such thing as restful good music?</i>	
Music Makers, by Roland Gelatt	67
Record Section	71-105
<i>Records in Review; Dialing Your Disks; Building Your Record Library; Beethoven Symphonies Reconsidered, by C. G. Burke.</i>	
The Tape Deck, by R. D. Darrell	107
Tested in the Home	115
<i>Gray AM-50 amplifier; Concert Cabinetry turntable base; Robins Aud-O-File; Metzner Starlight turntable; Norelco speakers and enclosures; Pedersen Tri-Amp amplifier.</i>	
Trader's Marketplace	133
Professional Directory	134
Audio Forum	135
Advertising Index	137

High Fidelity Magazine is published monthly by Audiocom, Inc., at Great Barrington, Mass. Telephone: Great Barrington 1300. Editorial, publication, and circulation offices at: The Publishing House, Great Barrington, Mass. Subscriptions: \$6.00 per year in the United States and Canada. Single copies: 60 cents each. Editorial contributions will be welcomed by the editor. Payment for articles accepted will be arranged prior to publication. Unsolicited manuscripts should be accompanied by return postage. Entered as second-class matter April 27, 1951 at the post office at Great Barrington, Mass., under the act of March 3, 1879. Additional entry at the post office, Pittsfield, Mass. Member Audit Bureau of Circulation. Printed in the U. S. A. by the Ben Franklin Press, Pittsfield, Mass. Copyright 1956 by Audiocom, Inc. The cover design and contents of High Fidelity magazine are fully protected by copyrights and must not be reproduced in any manner.

NOW THE

improved

SHURE

UNIDYNES

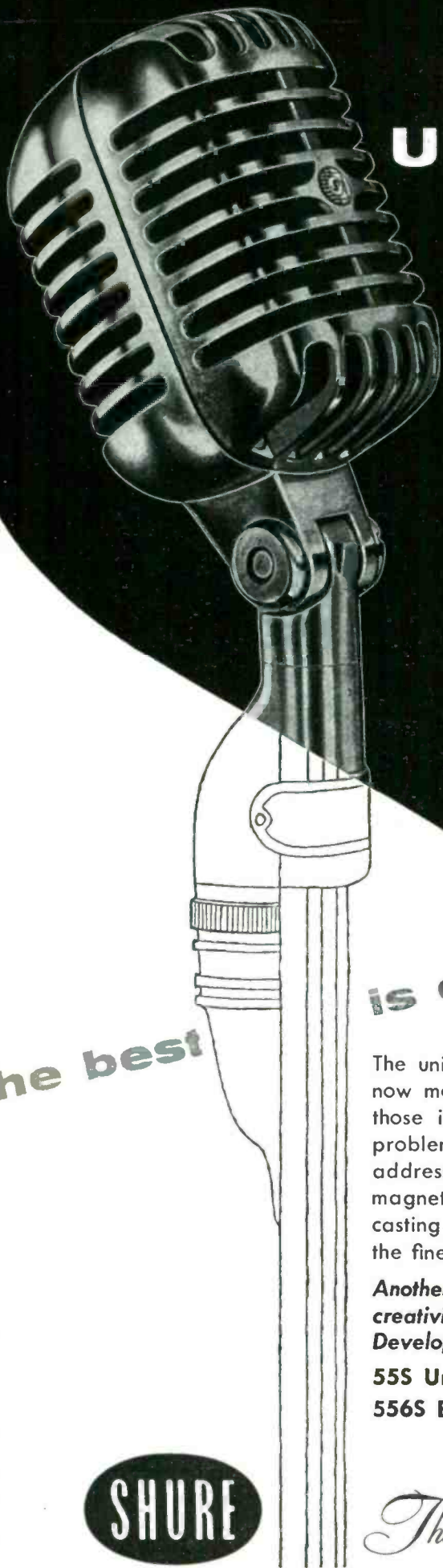

the world's most widely used fine microphones

PROVIDE

- 41% higher output!
- The perfect microphone choice for use with low-gain P. A. systems and tape recorders... in addition to their famed usage in finest quality public address systems.

The best

is even better!

The unidirectional dynamic Unidynes are now more than ever your best choice in those installations where feedback is a problem, and for all fine-quality public address, theatre-stage sound systems, magnetic recording and remote broadcasting—where critical standards call for the finest-quality microphone operation.

Another example of the continuous creativity of the Shure Research and Development Laboratories.

55S Unidyne List Price \$79⁵⁰

556S Broadcast Unidyne List Price \$120⁰⁰

IN ELECTRONICS SINCE 1925

The Mark of Quality



SHURE BROTHERS, INC.

Microphones ~ Electronic Components

220 HARTREY AVENUE • EVANSTON, ILLINOIS



SIR:

I read your editorial "Of Discordant Critics" [Oct. 1956] with interest, and felt the urge to try putting down "As the Composer Sees It," if for no other reason but to clarify my thoughts on the matter.

It is my firm belief that whenever a challenging recording, performance, or composition—new or old—is brought to the public, it would be helpful and right to have at least two critics reviewing the work, on the condition that their reviews be "informative rather than merely contradictory," as you pointed out. As long as we are not talking of advertisement or promotion, I do not see how additional and contradictory information could be confusing to the public. If anything, it would be a challenge to the reader, who would find himself raised from the position of being told what to buy, what to believe, etc. to a position of arbitrator between the distinguished and discordant critics...

As a composer, I have just begun reading critiques of my work, and have thereby discovered a new range of mixed emotions and feelings. In almost every case, critics have furnished the public with better and more truthful evaluations and analyses of the work than I could have done in the program notes if I had tried (as I did) to write them. I think most composers will agree with that; even Berlioz... Critics are, however, wont to forget that the most important facet of their art is to inform a wide audience whether a composition, a performance, or a recording is enjoyable or not. If the recording technique of a Beecham performance has flaws, if Gieseking's interpretation of a certain passage does not come off, it becomes a big item of news. But when John Smith comes out with a good and thoroughly enjoyable recording of a Beethoven sonata, it is scarcely mentioned. And yet, the majority of the listening public—in the concert hall as well as seated by the

Continued on page 6

A SENSATIONAL NEW OFFER FROM THE COLUMBIA  RECORD CLUB

Free... Any 3

OF THESE SUPERB HIGH-FIDELITY

12" COLUMBIA  RECORDS

If you join the Columbia  Record Club now—and agree to accept as few as 4 selections during the coming 12 months



THE KING OF SWING



MY FAIR LADY
Music from the Broadway Production
PERCY FAITH





MAGNIFICENT ADVENTURE IN HIGH FIDELITY SOUND
scheherazade
Rimsky-Korsakov
THE PHILADELPHIA ORCHESTRA,
EUGENE ORMANDY, CONDUCTOR



BRAHMS: DOUBLE CONCERTO
ISAAC STERN LEONARD ROSE
BRUNO WALTER





YES! You may have, FREE, ANY 3 of these best-selling 12" Columbia  records. We make this unique offer to introduce you to the money-saving program of the Columbia  Record Club... a program that selects for you each month the greatest works in every field of music—performed by the world's finest artists and brilliantly reproduced on Columbia  records.

HOW THE CLUB OPERATES

To enjoy the benefits of the Club's program and to receive your 3 records free—mail the coupon, indicating which of the four Club divisions best suits your musical taste: Classical; Jazz; Listening and Dancing; Broadway, Movies, Television and Musical Comedies.

Each month you will receive free the Club Magazine which describes the current selections in all four divisions. You may accept or reject the monthly selection for your division. You may also take records from the other Club divisions. This unique advantage assures you the widest possible choice of recorded entertainment. Or you may tell us to send you NO record in any month. Your only obligation is to accept as few as 4 selections from the almost 100 that will be offered during the next 12 months, and you may cancel membership at any time thereafter. The records you want are mailed and billed to you at only \$3.98 (original cast Broadway Shows somewhat higher) plus a small mailing charge.

FREE BONUS RECORDS GIVEN REGULARLY

The 3 records sent to you now represent an "advance" of the Club's bonus system—given to you at once. After you have fulfilled your membership obligation by purchasing four records, you will receive an additional free Bonus record of your choice for every two additional Club selections you accept. Bonus records are superb 12" Columbia  records—the very best of the world-famous Columbia  catalog—just like those shown here. Because you are given a Columbia  record free for each two records you purchase from the Club, your membership provides the best buy in records—anywhere.

Indicate on the coupon which 3 records you want free, and the division you prefer. Then mail the coupon at once. You must be delighted with membership or you may cancel without obligation by returning the free records within 10 days.

COLUMBIA  RECORD CLUB
165 West 46th Street, New York 36, N. Y.

MAIL ENTIRE COUPON NOW!

COLUMBIA  RECORD CLUB,
Dept. 694, 165 West 46th St.,
New York 36, N. Y.

Please send me as my FREE gift the 3 records indicated here: (Select the records you want by checking the 3 boxes in the list at the right) ... and enroll me in the following Division of the Club:

(check one box only)

- Classical
- Listening and Dancing
- Broadway, Movies, Television and Musical Comedies
- Jazz

Each month you will send me the Columbia  Record Club Magazine which describes the records offered in all four Club divisions. I have the privilege of accepting the monthly selection in the division checked above, or any other selection described, or none at all. My only obligation is to accept a minimum of four records in the next 12 months at the regular list price plus a small mailing charge. After accepting 4 records, I will receive a free Bonus record for every two additional records I purchase. If not delighted with membership, I may cancel within 10 days by returning all records.

Name.....
(Please Print)

Address.....

City..... Zone..... State.....

CANADA: Prices slightly higher.
Address 11-13 Soho St., Toronto 2B

If you wish to have this membership credited to an established Columbia Records dealer, authorized to accept subscriptions, please fill in the dealer's name and address also.

CHECK THE 3 RECORDS YOU WANT:

- Tchaikovsky: Nutcracker Suite; The Sleeping Beauty Ballet Philadelphia Orchestra, Ormandy, cond.
- Concert by the Sea Erroll Garner — recorded in an actual performance at Carmel, Calif.—playing 11 numbers — Red Top, Where or When, etc.
- Day Dreams Doris Day sings 12 popular songs—including Sometimes I'm Happy, You Go To My Head, etc.
- Levant Plays Gershwin 3 works—Rhapsody In Blue; Concerto in F; An American in Paris.
- King of Swing; Vol. 1 Benny Goodman and Original Orch., Trio Quartet. Ridin' High, Moon Glow—9 more.
- The Voice Frank Sinatra — 12 songs that first made him famous — Lover, Fools Rush In, etc.
- My Fair Lady Percy Faith and his Orchestra play music from this hit show.
- Rimsky-Korsakov: Scheherazade Philadelphia Orch., Ormandy, conductor. A superb performance of this exotic score.
- Brahms: Double Concerto: Variations on a Theme by Haydn; Tragic Overture Stern, violin; Rose, cello; N. Y. Philharmonic, Walter, cond.
- Music of Jerome Kern Andre Kostelanetz and his Orchestra play 20 Kern favorites.
- Songs from Walt Disney's Magic Kingdom 12 happy songs from famous Disney films.
- Jazz: Red Hot & Cool Dave Brubeck Quartet in Love Walked In, The Duke—5 more.

Dealer's Name.....

Dealer's Address..... 45-3



Quality Amplifier

Made in CAMBRIDGE, ENGLAND
 The center of scientific research
 For Those Who Will Have Nothing But The Finest
 New Wide-band amplifier, superbly crafted in the
 grand tradition for sound reproduction.

MAIN AMPLIFIER **Type HF25**
 Power output 35 watts. Output impedances 4, 7, 15 and 60 Ω . Noise and hum -90 db from full output. Harmonic Distortion less than 0.1% at 15 watts, 0.3% at 35 watts. I.M. Distortion 0.4% at 25 watts, 0.5 at 30 watts, 0.72% at 35 watts. Damping Factor adjustable from 35 to infinity. Negative feed-back 25 db round amplifier. **\$139.50**

CONTROL UNIT **Type HF25/A**
Controls: Bass, Treble, Low Pass Filter, Volume, Selector for tape, radio and microphone inputs and all standard recording characteristics. Low noise circuitry. Cathode follower output to power amplifier allows remote control up to 20 feet. **\$59.50**

Harvey Radio and Liberty Music Shops New York Distributors
 For complete equipment and local dealer information write to:

BRITISH RADIO ELECTRONICS, LTD.
 1833 Jefferson Place N.W. Washington 6, D. C.

LETTERS

Continued from page 4

record player—is concerned chiefly with the enjoyment that can be derived from a piece of music. For some, loudness does the trick; for others, it is the orchestration, the legato, percussion, the whistling potentialities, the rhythm, or the lack of it, and so on. No critic can give all the answers, and even if he could, he is still bound to a certain extent by matters of personal taste. There, definitely, two critics are better than one. As far as I am concerned, the more, the merrier. . . .

Serge de Gastyne
 Alexandria, Va.

SIR:

In reading Mr. Kerman's "The Trouble With *Tosca*" [HIGH FIDELITY, Sept. 1956], I found his cautious warnings against naturalism as the ultimate in theater, his close analysis of part of *Otello*, and his resurrection of the critical principle of the special and integral nature of opera, all, by and large, agreeable. But when he proceeded to damn *Tosca* on the basis of dogmatic . . . misstatements, we stopped agreeing.

Otello, with which Mr. K. beats *Tosca* on the head, was sixteen years in the making; upon it Verdi lavished a half-century of experience in the operatic theater, and Boito a quarter century; the lines of action had been determined by the greatest dramatist our culture has yet known. But until *Otello*, Verdi's attempt was what Mr. K. calls "trivial," just as Puccini's. Puccini wrote *Tosca* at forty, the age at which Verdi was writing *Il Trovatore*, *La Traviata*, *I Vespri Siciliani*, any one of which should be enough to convince Mr. K. of the "triviality" of Verdi's attempt. But Mr. K. does not choose to select any of these operas; he chooses to select *Otello*, not as a standard of greatness, but as a club with which he can work on Puccini, with which he can condemn *Tosca*, as he could condemn any other work of Italian *opera seria*, as trivial. . . .

[This] brings us naturally to the only point of Mr. Kerman's that space will allow us to comment on fully, that of his brusque charge that the choirboys, cardinal, etc. in *Tosca* are there for mere "extraneous . . . display of floating lyricism." Of course,

Continued on page 8



You will enjoy music far more ...
if you know what to listen for

THE SENSIBLE IDEA: You receive the complete performance of a great work of music presented on two sides of a 12-inch 33 1/2 R.P.M. long-playing record. With it (when you want it) is a 10-inch record of comment and musical illustrations which will show you *what to listen for*, in order to enhance your enjoyment of the music.

AS A DEMONSTRATION

ANY TWO of these *Music-Appreciation Records*
 for the price of one (EACH A TWO-RECORD SET—SEE ABOVE)



BEETHOVEN'S "Eroica" Symphony
 conducted by **LEONARD BERNSTEIN** with The Stadium Concerts Symphony Orchestra
 ANALYSIS RECORD BY MR. BERNSTEIN

BEETHOVEN'S Violin Concerto in D major played by **DAVID OISTRAKH**
 ANALYSIS RECORD BY G. WALLACE WOODWORTH



TCHAIKOVSKY'S Fifth Symphony
 conducted by **MAX RUDOLF** with The Stadium Concerts Symphony Orchestra • ANALYSIS RECORD BY THOMAS SCHERMAN

DVORAK'S "New World" Symphony
 conducted by **LEONARD BERNSTEIN** with The Stadium Concerts Symphony Orchestra • ANALYSIS RECORD BY MR. BERNSTEIN



MENDELSSOHN'S "Scotch" Symphony conducted by **THOMAS SCHERMAN** with the Music Appreciation Symphony Orchestra
 ANALYSIS RECORD BY DAVID RANDOLPH

MENDELSSOHN'S Piano Concerto No. 1 played by **EMIL GILELS** And the Kroll Quartet plays MENDELSSOHN'S OCTET FOR STRINGS • ANALYSIS RECORD BY THOMAS SCHERMAN



BRAHMS' Violin Concerto in D major
 conducted by **WALTER GOEHR** with the London Symphony Orchestra • ANALYSIS RECORD BY THOMAS SCHERMAN

TCHAIKOVSKY'S "Pathétique" Symphony
 conducted by **LEONARD BERNSTEIN** with The Stadium Concerts Symphony Orchestra • ANALYSIS RECORD BY MR. BERNSTEIN



STRAVINSKY'S Firebird Suite
 conducted by **GEORGE SZELL** with the Music Appreciation Symphony Orchestra • ANALYSIS RECORD BY RUSSELL SMITH

BRAHMS' Second Symphony
 conducted by **ALFRED WALLENSTEIN** with the Los Angeles Philharmonic Orchestra
 ANALYSIS RECORD BY THOMAS SCHERMAN



TRY A ONE-MONTH PROVISIONAL SUBSCRIPTION

ALL THE ABOVE are recent MUSIC-APPRECIATION recordings, and since they all demonstrate, in an exciting way, the MUSIC-APPRECIATION RECORDS idea, we will be happy to send you any two sets for the price of one.

The regular price of each of these two-disc recordings is \$3.90 (plus a small mailing charge). One disc is a 12-inch performance record, the other is a 10-inch analysis record. Should you want to receive other great works of music performed and analyzed in this way, you can allow

this one-month provisional subscription to continue for as short or as long a time as you please. If, however, the idea, after this demonstration, does not come up to your expectations, you may cancel immediately.

If you decide to continue you will not be obligated to take any specific number of records. A different work is announced in advance each month, described interestingly by Deems Taylor. As a subscriber you may take only those you are sure you want for your permanent record library.

PLEASE RETURN ONLY IF YOU HAVE A 33 1/2 R.P.M. RECORD PLAYER

MUSIC-APPRECIATION RECORDS R10-1
 c/o Book-of-the-Month Club, Inc.
 345 Hudson Street, New York 14, N. Y.

Please send me at once the two 12-inch 33 1/2 R.P.M. Demonstration Records I have indicated below, together with their 10-inch Musical Program Notes Records, billing me \$3.90, and enroll me in a one-month Trial Subscription to MUSIC-APPRECIATION RECORDS, with the privilege of canceling at any time. I understand that, as a subscriber, I am not obligated to buy any specified number of records, but may take only those I want. Also, I may cancel my subscription after hearing the Demonstration Recordings, or any time thereafter at my pleasure.

- | | |
|--|--|
| <input type="checkbox"/> Beethoven's "Eroica" | <input type="checkbox"/> Beethoven's Violin Concerto |
| <input type="checkbox"/> Tchaikovsky's Fifth Symphony | <input type="checkbox"/> Dvorak's Symphony |
| <input type="checkbox"/> Mendelssohn's "Scotch" Symphony | <input type="checkbox"/> Mendelssohn's Concerto |
| <input type="checkbox"/> Brahms' Violin Concerto | <input type="checkbox"/> Tchaikovsky's "Pathétique" |
| <input type="checkbox"/> Stravinsky's Firebird Suite | <input type="checkbox"/> Brahms' Symphony No. 2 |

Mr. }
 Mrs. }
 Miss } (Please Print Plainly)

ADDRESS

CITY Postal Zone No. STATE.....
 (If any)

Record prices are the same in Canada, and the Club ships to Canadian members without any charge for duty, through Book-of-the-Month Club (Canada), Ltd. MAR87



*Friction
free
as a
feather
in air*

In the new Rek-O-Kut Turntable Arm . . . something exciting has taken place! Here at last is lateral and vertical freedom-from-friction achieved by no other . . . distortionless tracking . . . and an exclusive micrometer-action counterweight allowing easier, more accurate stylus pressure adjustment!

A-120 for records up to 12" \$26.95

A-160 for records up to 16" \$29.95

slightly higher West of Rockies

REK-O-KUT

TURNTABLE ARM
Pat. Pending

- Friction-free lateral motion achieved by unitized sealed-in twin-bearing pivot.
- Friction-free vertical suspension between 1mm chrome-steel bearings . . . sealed in the cross-shaft!
- No need for a stylus pressure gauge! With cartridge mounted and arm in state of balance . . . turn micrometer-action counterweight to build up stylus pressure.



See your dealer. Write for Catalog and **FREE** strobe disc
REK-O-KUT COMPANY, INC.
 38-01 Queens Blvd., Long Island City 1, N. Y.
 EXPORT: Morhan Exporting Corp., 458 Broadway, N. Y. 13, N. Y.
 CANADA: Atlas Radio Corp., 50 Wingold Ave., Toronto 10, Ontario



LETTERS

Continued from page 6

neither Verdi nor Puccini indulged in such haphazard theater. Verdi's carnival chorus gives dramatic contrast to the slow dying of Violetta. Contrast is one of Puccini's ends, but he also is interested in (a) establishing the atmosphere of the surrounding city and country, and (b) in proving that things are not what they seem. *Tosca*, as no other of Puccini's operas, carries this philosophic burden: things are not what they seem. From the Magdalene who is not a Magdalene, Cavaradossi's misinterpretation of l'Attavanti's constant "prayer," Tosca's misinterpretation of the fan, to the final execution "*come Palmieri*," Puccini maintains the difference between illusion and reality. It is only after he tells us that Scarpia uses the Church to his own ends, that the priests reveal political secrets heard in confessional, that the Church is opposed to Cavaradossi both as agnostic and as revolutionary, it is only then that he presents us with a triple irony by introducing the "extraneous" Te Deum: (a) the celebration for a fake victory (also the reason for the Act II cantata), (b) the counterpoint of Scarpia and piety, (c) the realization that Scarpia and this politic piety are really on the same side. The church bells which accent Scarpia's fanning of Tosca's jealousy are suddenly reduced to the bell which he uses to summon his man Sciarrone. Hence the matin bells at the beginning of Act III not only define Rome about the Castel Sant' Angelo, but also symbolize the continuing power of authority, authority that does not die near the divan with Scarpia; Puccini uses these matin bells to crush and oppress the delicate *Tosca* themes at the opening of the act. The "extraneous" shepherd boy's song does more than "strike a mood of melancholy." Like the matin bells, it is ironic, heralding a dawn which is really not a dawning but an end. . . . Also like the matin bells, it points up the exterior world, in this case, the nearness of the valleys and the flowers of which the lovers sing but which they never reach. . . .

If space permitted, one could go on refuting Mr. K.'s blunt distortions. . . . But there is one amazing judgment in the article, over and above those mentioned. First, Mr. K. says that *Tosca* is not "gracious mu-

sically"; then he goes on to declare that the musical texture is "consistently, throughout, of café-music banality." When one has heard the music of *Tosca* . . . and then reads this article, one can only wonder what enchanted bistros Mr. Kerman frequents, in what magic coffeehouse does this our Kerman feed.

Eric Rothstein
W. Newton, Mass.

SIR:

I should like to take exception to the article "The Trouble With *Tosca*" appearing in the September issue of your magazine. . . .

In reference to the statement about the closing scenes of *Otello* and *Tosca*, in which Mr. Kerman says in effect that Puccini did not capture the quality of ominous hush that Verdi employed — isn't that presupposing too much? It is my opinion that the two scenes are poorly compared (if indeed they are as comparable as the author says), and it's quite possible that the effect of melancholy employed by Puccini which the author feels is so inappropriate is far more appropriate to the scene than an "ominous hush." In *Otello*, the composer was contemplating the destruction of the heroine by the hero — of the wife by her husband — as he made use of the "Willow Song" and similar music in this act. That in itself would seem to call for a different type of music than that written for the impending fate of Cavaradossi who was to be put to death in an impersonal way — and what could be more impersonal than a firing squad — by the direction of one (Scarpia) who was his sworn enemy.

As for the "Shepherd's Song" — when I attended a recent production of *Tosca* I felt that the introduction of this song served to offset the mounting tension of the opera, and in part, to bring home to the audience the fact that life "outside" went on quite as usual in spite of the momentous happenings to the principal characters. . . .

There are other points upon which I could touch, but there seems to be little need of defending the music which to many of us speaks so well for itself. If the author did not so plainly show his scorn for the genius of Puccini — if he had not made the unfortunate choice of such words as "simpering," "coarse," "arbitrary,"

Continued on page 11

Save on Famous knight Hi-Fi



THE VERY FINEST FOR LESS:

Knight Custom components are built to ALLIED's own special high standards to deliver outstanding musical quality with distinguished appearance at money-saving minimum cost. Each unit is unconditionally guaranteed for one full year.

**ALLIED
EXCLUSIVES**

Top Value knight Hi-Fi Components



ONLY
\$94⁵⁰

Deluxe 24-Watt Amplifier. "Space-Saver" design; response, ± 0.75 db, 20-40,000 cps; 12-position compensation; variable damping; loudness control; rumble filter; tape head input; hum balance. U.L. Approved. Shpg. wt., 30 lbs. Net . . . \$94.50



ONLY
\$99⁵⁰

Deluxe Basic FM-AM Tuner. Matches Deluxe amplifier; AFC; tuning meter; tuned RF on FM and AM; FM discriminator; 2 cathode followers; exceptional sensitivity. FCC Approved Radiation; U.L. Approved. Shpg. wt., 17 lbs. Net . . . \$99.50



ONLY
\$64⁵⁰

"Bantam" 12-Watt Amplifier. Response, ± 0.5 db, 20-20,000 cps; 3-position compensation; variable damping; loudness control; built-in preamp; tape head input; 7 inputs; "Space-Saver" design. U.L. Approved. Shpg. wt., 18 lbs. Net . . . \$64.50



ONLY
\$74⁵⁰

"Bantam" Basic FM-AM Tuner. Matches "Bantam" Amplifier; AFC; FM limiter and discriminator; output level control; RF stage; high sensitivity; temperature-compensated oscillator. FCC Approved Radiation; U.L. App. 13 lbs. Net. . . \$74.50



ONLY
\$104⁹⁵

"Uni-Fi" Tuner-Amplifier Combination. Single chassis construction; complete FM-AM Tuner, Preamplifier and Amplifier all in one; compact, $4\frac{1}{4} \times 15 \times 10\frac{1}{2}$ "; 10-watt amplifier has every advanced feature; FCC Radiation Approved. "Uni-Fi" chassis only, 17 lbs. Net. \$104.95 "Uni-Fi" complete in "Space-Saver" cabinet. 21 lbs. Net. . . . \$109.95



ONLY
\$44⁵⁰

Preamp-Equalizer. Lowest-cost self-powered preamplifier. 3-position compensation; rumble switch; loudness switch; ± 1 db, 30-30,000 cps. U.L. Approved. Shpg. wt., 8 lbs. Net . . . \$44.50

ALL PRICES NET, F.O.B. CHICAGO



**FREE
ALLIED'S 1957
356-PAGE CATALOG**

Send for this value-packed catalog featuring the world's largest selection of Hi-Fi components and systems, as well as everything in Electronics.

Write for your copy today.



LOW-COST knight PHONO SYSTEM

ONLY
\$174⁵⁰

Top value in a fine Hi-Fi music system. You save \$18.32 over cost of individual components. No cabinets required. Includes Knight "Bantam" amplifier; E-V Baronet Speaker System (specify limed oak or mahogany finish); Webcor 1632-27A Changer with G.E. RPX-050A Triple Play Cartridge (dual sapphire styli). Easy installation. Shpg. wt., 67 lbs. 94 PA 600. Complete System . . . \$174.50

ALLIED RADIO

America's Hi-Fi Center

OUR
36th
YEAR

ALLIED RADIO CORP., Dept. 49-A-7
100 N. Western Ave., Chicago 80, Ill.

Ship the following KNIGHT Hi-Fi equipment _____
\$ _____ enclosed

Send FREE 356-page ALLIED 1957 Catalog

Name _____

Address _____

City _____ Zone _____ State _____

AR-2

The AR-2 speaker system uses the same acoustic suspension principle as the AR-1. Because of this fact it is able to achieve a performance quality which, by pre-acoustic suspension standards, is associated with a price range several times higher than its 96.00.*

*in birch or mahogany; other finishes 89.00 and 102.00

SUGGESTED PRICE RANGE FOR INSTALLATIONS USING THE AR-2

COMPONENT	PRICE
AMPLIFIER (10-30 clean watts, complete with controls)	\$75 -- \$125
RECORD PLAYER (changer or manual)	\$40 -- \$60
CARTRIDGE(S) (diamond needle for LP)	\$20 -- \$45
TUNER	\$70 -- \$100
} <i>Install on shelves, or in cabinet</i>	
AR-2 SPEAKER SYSTEM (Complete with enclosure; size 13½" x 11¾" x 24")	\$89 -- \$102
	\$294 -- \$432 (phonograph only, \$224 -- \$332)

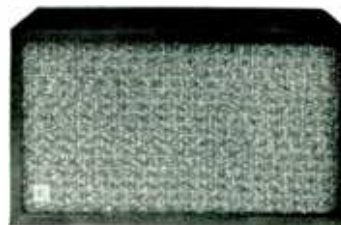

Literature on request from:

ACOUSTIC RESEARCH, INC. 24 Thorndike Street Cambridge 41, Mass.

LETTERS

Continued from page 9

"pointless," "Puccini's failure," etc., I would feel that this article had considerably more merit. It seems to me, however, that these are much too strong and harsh terms to use in describing the contribution of a man so gifted in glorious musical expression. . . .

Mrs. Frank L. Mayer
Denver, Colo.

Mr. Kerman replies to Mr. Rothstein and Mrs. Mayer:

The essential point, at the end of my article, was that *Tosca* is a cheap piece. Comparison with *Otello* as a "standard of greatness" seemed to me to make this point more graphic, that's all. That composer X also wrote junk at the age of forty is no more relevant than the fact that composer Y is still writing junk at sixty, or that composer Z wrote four operatic masterpieces before his death at thirty-six. Also beside the point, unfortunately, are my private estimates of *Traviata* (positive) and *Turandot* (negative). [Not so private: see Mr. Kerman's book, *Opera as Drama*.—Eds.] I attacked *Tosca* rather than *I Vespri Siciliani* because many people nowadays take it so seriously, thereby calling into question the "standard of greatness" that Mr. Rothstein discerns in *Otello*.

I am quite unmoved by Mr. Rothstein's ingenious analysis of *Tosca* as an essay in illusion, and would plead with him to stop using his head and listen to the piece in its own immediate terms. A philosophical burden? you might as well admire, in a grade-B Western, a subtle allegory of the heroism, brutality, gentleness, and aggression of the frontier spirit dormant in the soul of urban America. But the coarseness of presentation stultifies such an interpretation—which brings me to my central disagreement with both correspondents. I do not see anything glorious in Puccini's musical expressivity. It strikes me as tawdry, flat, faint, and corny. My standards, once again, are *Otello*, and *Figaro*, *Boris*, *Orfeo*, *Tristan*. . . .

The "Shepherd's Song," as I remarked, "might have been incorporated dramatically." But the music that Puccini wrote here is flabby; flabbiness has nothing to do with irony (Mr. Rothstein's interpretation) or impersonality (Mrs. Mayer's). The adjectives cited by Mrs. Mayer were chosen with care: The musical continuity at the end is, take it from me, "coarse and arbitrary"; *Tosca* does, in the most precise meaning of the term, "simpler" in Act I. Mrs. Mayer's letter comes from the heart rather than from the head, and I am in a way sorry to have pained her by the tone of my article. But

Continued on page 15

FAIRCHILD DESIGN

We're often asked—"How will the use of the Fairchild Arm in conjunction with the Fairchild Cartridge increase the performance of my high fidelity system?" Since the 280A Arm is the housing best designed for this famed cartridge, the results will be immediately apparent to the critical listener.

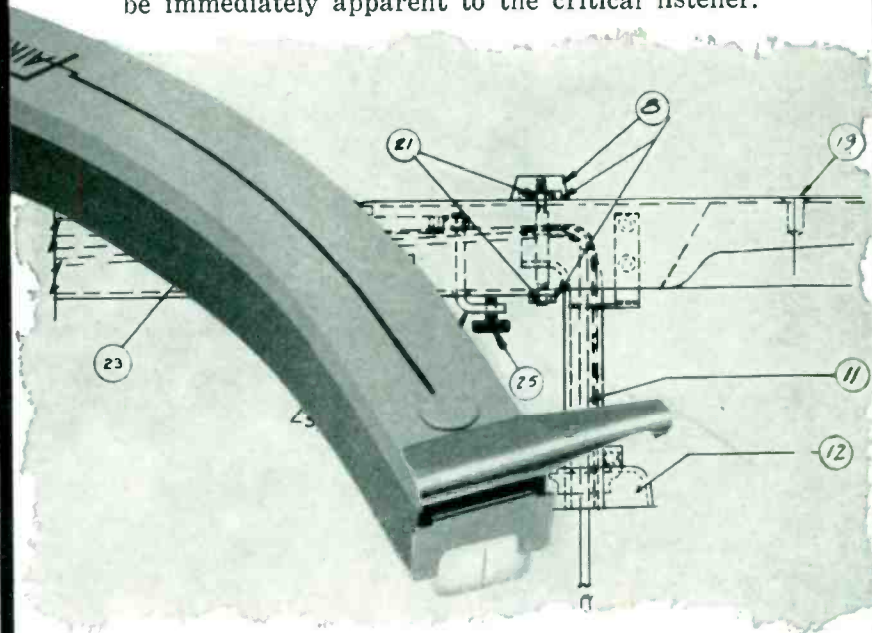

- It will reduce the fundamental resonance which is determined by the mass of the arm and the compliance of the cartridge.
- It will result in excellent tracking of the most heavily recorded passages.
- It will minimize side thrust and hence reduce distortion.
- It will allow complete freedom of motion without vibration or erratic performance.
- It will reduce tracking error to a minimum.
- It will provide unusual features of convenience and ease in handling.
- Most important, it will assure superb sound.

There is no question that a speaker housing is almost as important as the speaker itself. Similarly, the housing for the cartridge is equally important but often overlooked. The Model 280A Arm, the result of much experimentation and fundamental research* can properly be classified as professional in performance, yet is modestly priced at only \$33.95.

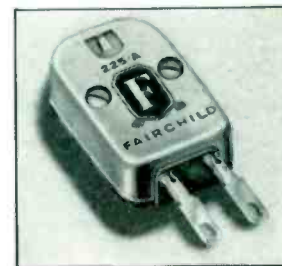

*Journal of the Audio Engineering Society,
Volume 2, Number 3, July, 1954.

Find out what to look for in a transcription arm.
Write Department "S" for free illustrated booklet
"HOW GOOD IS YOUR ARM."

FAIRCHILD
RECORDING EQUIPMENT COMPANY
10-40 45th Avenue, Long Island City 1, New York

ENJOY THE DIFFERENCE SOON!

Electro-Voice

HIGH FIDELITY EQUIPMENT IS AVAILABLE AT:

- ALABAMA**
Anniston: RADIO DIS. & SUPPLY CO. 125-27 W. 10th St.
Birmingham: TANNER COMM. CO. 94 N. 26th St.
Tuscaloosa: SCOTT RECORDING LAB. Municipal Airport
- ARKANSAS**
Little Rock: MOSES MELODY SHOP 311 Main St.
- CALIFORNIA**
Bakersfield: BAKERSFIELD AUDIO & ALARM DEVICES 2531 F St.
Barbours: VALLEY ELECTRONIC SUPPLY CO. 1302 W. Magnolia
Hollywood: HOLLYWOOD ELECTRONICS 7460 Melrose Ave.
WESTERN STATES ELECTRONICS 1509 N. Western Ave.
Inglewood: INGLEWOOD ELECTRONIC SUPPLY 836 S. LaBrea Ave.
NEWARK ELECTRIC CO. 4736 W. Century Blvd.
Lodi: GUPPILL'S HI FI 22 S. School St.
Los Angeles: CRENSHAW HI-FI CENTER 107 Santa Barbara Pl.
HENRY RADIO 11240 W. Olympic
Menlo Park: HIGH FIDELITY UNLIMITED 935 El Camino Real
Oakland: COAST ELECTRONICS 4166 Broadway
Pasadena: DOW RADIO INC. 1759 E. Colorado St.
HIGH-FIDELITY HOUSE 536 S. Fair Oaks
San Bernardino: HOLLYWOOD HI-FI SHOP 1839 E St.
San Francisco: THE LISTENING POST 2290 Fillmore St.
SAN FRANCISCO RADIO SUPPLY 1284 Market St.
TELEVISION RADIO SUPPLY 1321 Mission St.
San Rafael: CATANIA SOUND 1607 Fourth St.
Santa Ana: LOWENSTEINS 1508 S. Main St.
Santa Monica: CLEF TELEVISION 1642 Ocean Park Blvd.
Van Nuys: VALLEY ELECTRONIC SUPPLY CO. 17647 Sherman Way
- COLORADO**
Colorado Springs: DEETS BROS. 119 E. Pikes Peak
Denver: ALLEGRO MUSIC SHOP INC. 262 Fillmore St.
THE CHAS. E. WELLS MUSIC CO. 1629 California St.
C. V. A. HI FI CENTERS 1624 Broadway
C. V. A. HI FI CENTERS 434 16th St.
LYOYD'S HI-FI RECORD SHOP 6110 E. Colfax
- CONNECTICUT**
Hartford: BELMONT RECORD SHOP 163 Washington St.
MARGOLIS HIGH FIDELITY STUDIO 28 High St.
Litchfield: THE MUSIC SHED INC. Trader Lane
New Haven: DAVID DEAN SMITH 262 Elm St.
RADIO SHACK CORP. 230 Crown St.
New London: DOUGLAS AUDIOTRONICS 15 Maple Terrace
West Hartford: AUDIO WORKSHOP INC. 1 South Main St.
- DELAWARE**
Wilmington: RADIO ELECTRIC SERVICE 3rd & Taintor
WILMINGTON ELECTRIC SPECIALTY CO., INC. 403-405 Delaware Av.
- DISTRICT OF COLUMBIA**
Washington: ELECTRONIC WHOLESALEERS, INC. 2345 Sherman Avenue, N.W.
- FLORIDA**
Fort Lauderdale: CERTIFIED ELECTRONIC DISTRIBUTORS INC. 2606 S. Fed. Highway
Gainesville: GODDARD-GAINESVILLE, INC. 1031 S. Main St.
Melbourne: MCHOSE ELECTRONICS 640 New Haven Ave.
Miami: FLAGLER RADIO CO., INC. 1068 W. Flagler St.
HIGH FIDELITY ASSOCIATES 3888 Biscayne Blvd.
Orlando: GODDARD-ORLANDO 631 W. Central Ave.
Tampa: GODDARD-TAMPA INC. 601 S. Morgan St.
West Palm Beach: GODDARD DISTRIBUTORS, INC. 1309 N. Dixie
THE HOUSE OF HIGH FIDELITY 205 Datura St.
- GEORGIA**
Atlanta: HIGH FIDELITY S. S. S. 608-610 Peachtree St.
Auburn: THE SOUND CENTER 1824 Walton Way
- ILLINOIS**
Bloomington: MILLER MUSIC CO. 417 N. Main St.
MOULDER SPECIALTIES CO. 1005-1007 W. Wash.
Broadview: HI-FI UNLIMITED 1305 Roosevelt Rd.
Champaign: RADIO DOCTORS 811 W. Springfield
Chicago: ALLIED RADIO CORP. 100 N. Western Ave.
ARTHUR NAGLE INC. 913 E. 55th St.
ATRONIC CORP. 6566 Sheridan Rd.
ELECTRONIC EXPEDITORS, INC. THE HI-FI CENTER 2949 W. Devon Ave.
NEWARK ELECTRIC CO. 223 W. Madison St.
PREMIER RADIO 3239 W. North Ave.
SCHWARTZ BROS. HI-FI STUDIOS 1215 E. 63rd St.
VOICE & VISION, INC. 927 N. Rush St.
Riverdale: AUDIO DISTRIBUTORS 14218 S. Indiana Ave.
Rockford: H & H ELECTRONIC SUPPLY, INC. 506-510 Kishwaukee
- INDIANA**
Elkhart: FRICK ELECTRIC & TV, INC. 920 S. Main St.
Gary: VILLAGE HOME APPLIANCE CO., INC. 3592 Village Court
Hammond: HALL'S TELEVISION SERVICE 7430 Calumet Ave.
Indianapolis: GOLDEN EAR 15 E. 16th St.
GRAHAM ELECTRONICS SUPPLY 102 S. Pennsylvania
South Bend: FRICK ELECTRIC & TV, INC. 1001 Main St.
West Lafayette: GOLDEN EAR 108 Northwestern Av.
- IOWA**
Burlington: ELECTRONIC ENGRG. AND SUPPLY CO. F. & M. Bank Bldg.
Cedar Rapids: IOWA RADIO SUPPLY CO. 719 Center Point Rd., N.E.
Des Moines: IOWA SOUND SERVICE 1210 Grand Ave.
Iowa City: WOODBURN SOUND SERVICE 218 E. College St.
- KENTUCKY**
Louisville: GOLDEN EAR 610 S. Third St.
UNIVERSAL RADIO SUPPLY CO. 533 S. 7th St.
- LOUISIANA**
New Orleans: Hi Fi, Inc. 3303 Tulane Ave.
THE MUSIC SHOP INC. 4215 S. Claiborne Ave.
Shreveport: HIGH FIDELITY CENTER 2530 Linwood Ave.
- MAINE**
Bangor: ANDREWS MUSIC HOUSE 118 Main St.
Lewiston: DEORSEY'S RECORD SHOP 23 Libson St.
Portland: H. D. BURRAGE & CO. 92 Exchange St.
CANFIELD FLEXIPHONE CO. 57 Portland St.
- MARYLAND**
Baltimore: HI FI SHOP 2 N. Howard St.
PARK RADIO & T.V. CO. CUSTOMCRAFT SOUND STUDIOS 106 W. Fayette St.
SIRKIS MUSIC 4010 Glengyle Ave.
Salisbury: RADIO ELECTRIC SERVICE CO. OF DELAWARE
- MASSACHUSETTS**
Boston: CRAMER ELECTRONICS 811 Boylston St.
DEAMBRIO RADIO SUPPLY CO. 1095 Commonw. Ave.
LAFAYETTE RADIO 110 Federal St.
RADIO SHACK CORP. 167 Washington St.
YANKEE ELECTRONICS 257 Huntington Ave.
Cambridge: HI FI LABS 1077 Mass. Ave.
Holyoke: TEL-O-WIRE SOUND CO. INC. 37 Railroad St.
Lawrence: YOUNG & YOUNG OF LAWRENCE INC. 198 Broadway
Pittsfield: SAMMY VINCENT'S INC. 23 North St.
Springfield: SOUND CO ELECTRONICS 147 Dwight St.
Wellesley: THE MUSIC BOX 58 Central St.
Worcester: FRED G. WALTERS CO., INC. 1308 Grafton St.
- MICHIGAN**
Ann Arbor: HI FI STUDIO 1317 S. University Av.
Battle Creek: ELECTRONIC SUPPLY CORPORATION 94 Hamblin
Birmingham: MCCALLUM & DEAN 409-11 E. Maple Ave.
Detroit: AUDIO HOUSE INC. 19771 Conant
HACO DISTRIBUTING CO. 9730 Burnside St. at Grand River Ave.
Hi-Fi STUDIOS 8300 Fenkel
K. L. A. LABORATORIES 7375 Woodward Ave.
PECAR ELECTRONICS 10729 Morang
SIHLER'S RADIO SHOP INC. 15822 Grand River East Lansing
CAMPUS MUSIC SHOP 106 W. Grand River Ave.
Manistee: GARDNER ELECTRONIC SUPPLY 258 River St.
Saginaw: AUDIO COMM. CO. 1511 James St.
St. Joseph: R. A. HOWARD-CUSTOM HI FI 2938 Niles Ave.
Sault Ste. Marie: JOHN P. LEBLANC 321 E. Spruce St.
- MINNESOTA**
Minneapolis: AUDIO KING CO. 1827 E. Lake St.
- MISSISSIPPI**
Pass Christian: THE MUSIC BOX 121 Davis Ave.
- MISSOURI**
Kansas City: DAVID BEATTY CUSTOM HI FI & TV 1616 W. 43rd (Westport Rd.)
St. Louis: NAPPER RADIO CO. 3117 Washington Ave.
VAN SICKLE RADIO CO. 1113 Pine St.
- NEBRASKA**
Omaha: HOUSE OF HI FI 4628 W. Dodge
OMAHA APPLIANCE CO. 18th and St. Mary's
- NEW HAMPSHIRE**
Concord: EVANS RADIO INC. Route 3A, Bow Jct.
- NEW JERSEY**
Eatontown: HIGH FIDELITY SOUND CENTER Route No. 35
Mountainside: FEDERATED PURCHASER, INC. 1021 U.S. Highway 22
Montclair: FARDUE RADIO CO., INC. 8 S. Park St.
Newark: FEDERATED PURCHASER, INC. 114 Hudson St.
HUDSON RADIO & TV 35 Williams St.
LAFAYETTE RADIO 24 Central St.
Plainfield: LAFAYETTE RADIO 139 W. Second St.
Springfield: CREATIVE AUDIO 40 Briar Hills Circle
- NEW MEXICO**
Albuquerque: HI-FI EQUIPMENT INC. 816 San Mateo S.E.
THE HI-FI HOUSE SOUND ENGRG. & EQUIP. CO. 3011 Monte Vista Blvd. N.E.
- NEW YORK**
Albany: HI-FIDELITY CENTER, INC. 324 Central Ave.
Brooklyn: BENRAY ELECTRONICS CORP. 485 Coney Island Av.
BROOKLYN HI-FI CENTER 836 Flatbush Ave.
Buffalo: BUFFALO AUDIO CENTER 161 Genesee St.
FRONTIER ELECTRONICS, INC. 1505 Main St.
Hempstead: ISLAND AUDIO CO. INC. 414 Fulton Ave.
NEWARK & LEWIS 43 Main St.
Jamaica: AUDIO EXCHANGE 159-19 Hillside Ave.
Jamestown: WARREN RADIO INC. 31 F. Ford Ave.
Mineola, L.I.: ARROW ELECTRONICS, INC. 525 Jericho Turnpike
New York: ARROW ELECTRONICS, INC. 65 Cortlandt St.
ASCO SOUND CORP. 115 West 45th St. (3rd Floor)
CONSOLIDATED RADIO SALES 768 Amsterdam Ave.
FEDERATED PURCHASER, INC. 6 Dey St.
GRAND CENTRAL RADIO INC. 124 E. 44th St.
HARVEY RADIO CO., INC. 103 W. 43rd St.
HEINS BOLT 68 Cortlandt St.
- NORTH CAROLINA**
Charlotte: DIXIE RADIO SUPPLY CO. INDUSTRIAL ELECTRONIC DIVISION 1431 Bryant St.
SHAW DISTRIBUTING CO. 205 W. First St.
Hendersonville: BRADLEY ENTERPRISES 1470 Wood R.d. (4 miles N.W. of Hendersonville)
Rocky Mount: W. C. REID & CO. 143 S. Main St.
Winston-Salem: DIXON-HEGE RADIO SUPPLY CO., INC. 912 W. Fourth St.
- NORTH DAKOTA**
WOLTER ELECTRONIC CO. 402 N. P. Ave.
- OHIO**
Akron: OLSON RADIO WAREHOUSE, INC. 723 Mill St.
Ashtabula: MORRISON'S RADIO SUPPLY 321 Center St.
Canton: GEORGE F. EBEL CO. 1017 Cleveland Ave. N.W.
Cincinnati: CUSTOM-CRAFTERS AUDIO INC. 2259 Gilbert St.
Cleveland: AUDIO CRAFT CO. 2915 Prospect Ave.
PROGRESS RADIO SUPPLY CO. 413-415 Huron Road
Columbus: ELECTRONIC SUPPLY CORP. 134 E. Lonn St.
SHAFFER MUSIC CO. 849 N. High St.
Dayton: CUSTOM ELECTRONICS INC. 1000 S. Main St.
THE STOTTS-FRIEDMAN CO. 135 E. Second St.
Toledo: JAMESON'S HI-FIDELITY 840 W. Central
Youngstown: RADIO & TV PARTS INC. 230 E. Boardman St.
- OKLAHOMA**
Oklahoma City: RADIO & SOUND CLINIC 1239 W. Main
- OREGON**
Portland: BURKE-ARENZ MUSIC CO. (formerly L.D. Heater Co.) 1001 S.W. Morrison
Salem: CECIL FARNES CO. 440 N. Church St.
- PENNSYLVANIA**
Allentown: FEDERATED PURCHASER, INC. 1115 Hamilton St.
RADIO ELECTRIC SERVICE CO. OF PA. 1042 Hamilton St.
Chester: A.C. RADIO SUPPLY CO. ERIEON: RADIO ELECTRIC SERVICE CO. OF PA., INC. 916 Northampton St.
Erie: WARREN RADIO, INC. 1315 Peach St.
Johnstown: TELEVISION & RADIO PARTS CO. 226 Main St.
Lancaster: GEORGE D. BARBEY CO. 622 Columbia Ave.
Lebanon: GEORGE D. BARBEY CO. 821 Quentin Road
Lewistown: ALVO ELECTRONICS DISTRIBUTORS, INC. Meadville: WARREN RADIO, INC. 1057 S. Main
ELECTRONIC LABS & SUPPLY CO. 1415 Oriskany St., W.
White Plains: HIGH FIDELITY CENTER 367 Mamaroneck Ave.
Woodside, L.I.: BOYER ELECTRONICS INC. 69-18 Roosevelt Av.
Yonkers: WESTLAB 22475 Central Ave.
- TEXAS**
Austin: HIGH FIDELITY INC. 3004 Guadalupe St.
Beaumont: THOMPSON AUDIO CTR. 1090 Alma at Park
Dallas: CRABTREE'S WHOLESALE RADIO 2608 Ross Ave.
- UTAH**
Salt Lake City: DESERT BOOK CO. 44 E. So. Temple St.
- VERMONT**
Rutland: FLEETWOOD SOUND STUDIO 285 S. Main St.
OAKMAN ELECTRIC SUPPLY 12 Wales St.
- VIRGINIA**
Bristol: BRISTOL RADIO SUPPLY CORP. 31 Moore St.
Charlottesville: CHARLOTTESVILLE MUSIC CENTER 105 E. Main St.
Norfolk: ELECTRONIC ENGINEERING CO. 316 W. Olney Road
- WASHINGTON**
Seattle: OYMPIC ENGINEERING CO. 2008 Westlake Ave.
Spokane: HOUSE OF HIGH FIDELITY, 20TH CENTURY SALES INC. 1021 W. First Ave.
- WEST VIRGINIA**
Charleston: ELECTRONIC SPECIALTY CO. Virginia St. W. at Park
- WISCONSIN**
Janesville: THE AUDIO SHACK 1208 Milwaukee Ave.
Madison: THE HI-FI CORNER State at Gorham
Milwaukee: THE HI-FI CENTER, INC. 4236 W. Capitol Drive
PHOTOART VISUAL SERVICE, 840 N. Plankinton
- CANADA**
New Brunswick: St. John: THE NEW BRUNSWICK RADIO CO. 7-11 Germain St.
Nova Scotia: Halifax: CONSOLIDATED SUPPLY CO. LTD.
Ontario: Kitchener: PEPPER SOUND EQUIPMENT CO. Ottawa: CANADIAN ELECTRICAL SUPPLY CO., LTD. 836 Somerset W.
Toronto: BAY-BLOOR RADIO 1206 Bay St.
CANADIAN ELECTRICAL SUPPLY CO., LTD. 522 Yonge St.
ENGINEERED SOUND SYSTEMS LTD. 169 Kipling Ave., S.
Quebec: Montreal: CANADIAN ELECTRICAL SUPPLY CO., LTD. 275 Craig St. W.
EXCEL DISTRIBUTING INC. 690 St. James St. W.
PAYETTE RADIO LIMITED 730 James St. W.
THE RADIO CENTRE Craig at St. Urbain
Quebec: MAURICE ST.-CYR 706 Blvd. Charest East
- SONOTEC S.A., La Gran Avenida, Sabana Grande, Caracas, Venezuela.**

THERE IS A DIFFERENCE IN HIGH-FIDELITY EQUIPMENT!

HEAR IT! SEE IT! IT'S

Electro-Voice®

Hear whole octaves others miss! Look at the clean, functional lines which are the outward indication of inner quality. That's the result of "Listeneering" engineering by Electro-Voice.

All authentic high-fidelity equipment reproduces sound pleasantly. But to recreate living "presence," choose Electro-Voice as experts do. In the Aristocrat folded-horn corner enclosure and related equipment shown, you have an *integrated* three-way system which gives you amazingly wide tonal range without distortion. The enclosure with 12TRXB triaxial speaker, the Circlotron amplifier with controls and the 80 Series Ultra-Linear Ceramic cartridge in the record player of your choice combine to thrill you with concert hall realism in your home.

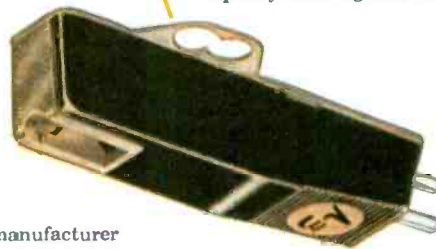
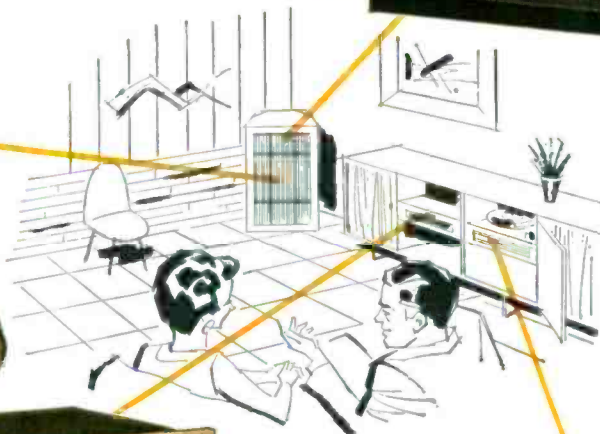
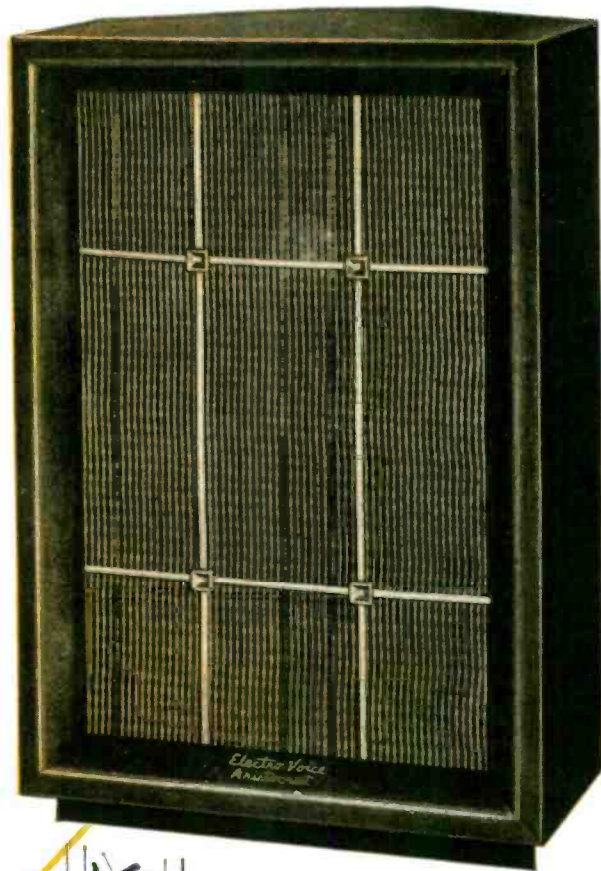

Twenty-six years of single-minded devotion to making only the finest is built into all Electro-Voice products . . . units designed to perform together as complete systems . . . units which, when added individually to *any* high fidelity system, make it sound better.

New Catalog-Guide gives quick facts on Speaker Systems for true high-fidelity music reproduction. Send 25c to cover postage and handling. Specify Catalog No. 117-F71.

Electro-Voice®

ELECTRO-VOICE, INC. • BUCHANAN MICHIGAN
Export: 13 East 40th Street, New York 16, U. S. A.
Cables: ARLAB

Electro-Voice, world's largest manufacturer of high-fidelity products, offers you the world's most complete line—speakers, speaker enclosures, systems, amplifiers, pre-amps, tuners, phono cartridges, Power-Point cartridges, Do-It-Yourself enclosure kits and microphones. Available everywhere.

*Slightly higher in the West.



THE ARISTOCRAT Folded Horn Corner Enclosure augments bass reproduction without "boom" or distortion, provides balanced bass and treble, adds to speaker power-handling capacity. You enjoy purity of extended tone never before achieved in a cabinet of this size, 29 $\frac{3}{4}$ " x 19" x 16 $\frac{1}{4}$ ". Mahogany, Net \$69. Korina Blonde, Net \$76.



LOW-BOY CIRCLOTRON AMPLIFIER WITH CONTROLS, easy to operate, designed for music lovers who want a compact, moderately-priced high quality amplifier. Five position playing selector for radio tuner, tape recorder, TV and 2 position phono. Model A15CL, \$99.50*



12-INCH TRIAXIAL REPRODUCER gives you phenomenal bass response, full-bodied mid range and silky-smooth upper octaves without distortion. Used in the Aristocrat enclosure, this integrated three-way system has a response of 35-15,000 cps. Model 12TRXB, Net \$64.00.



ULTRA-LINEAR CERAMIC PHONO CARTRIDGE, for finest reproduction of 45, 33 $\frac{1}{2}$ and 16 $\frac{1}{2}$ rpm records with true high fidelity. 1-mil sapphire tip. Model 84S, Net \$9.60.



"I'm no whiz with the wires—like you"

Wistful William is going through his usual response to an evening of Hi-Fi listening at your house.

Much as he wants good music, he tells you—he just doesn't have the know-how to line up components, select and balance, until he has a system like yours. For the hundredth time he says—

"Isn't there *any* 'ready-made Hi-Fi for guys like me?'"

Now you can give him more than a pitying smile

Here's the answer that will help him find his dream.

You can tell him Stromberg-Carlson has just introduced its renowned "Custom Four Hundred"[®] components . . . laboratory-balanced . . . in exceptionally beautiful *console instruments ready to plug in and play.*

First, of course, you'll want to hear the instruments for yourself. They are at your Stromberg-Carlson dealer's studio.

You'll get an expert's kick out of discovering the ingenious features and skilled design that achieve such performance perfection. Multiple speakers in special acoustic chambers project a flood of pure, undistorted sound to every listener in the room. Powerful amplifiers produce the finest possible tonal quality through the full range of audible sound. Four-speed changers, easy-to-reach controls—and stunning cabinet beauty are here too. And when you come to the price tags, you'll realize what a favor you can do for Friend William—these superb Stromberg-Carlson instruments start at a low \$149.95!



This electric clock sign identifies YOUR dealer for the new Stromberg-Carlson radio-phonograph series.

STROMBERG-CARLSON COMPANY

A DIVISION OF GENERAL DYNAMICS CORPORATION
1719 UNIVERSITY AVE. ROCHESTER 3, N. Y.



The new CHORAL high fidelity combination. Contemporary louvered cabinet with lift-lid over changer to prevent jar or needle scratch. 4-Speed changer—4-pole motor, free of hum or rumble; intermixes 7", 10", 12" records. Automatic shut-off; live rubber turntable cover. 10-Tube AM-FM radio with push-button control, precise fly-wheel tuning. AM band 550 to 1600 kc, FM, 88 to 108 mc. Built-in FM antenna, drift-free components. 15-Watt amplifier with Stromberg-Carlson compensated volume control, input jack and front-panel switching for easy connection of tape recorder, second changer, TV audio signals and other program material. Multiple speaker system in frequency-dividing network: 12" woofer-type bass speaker, 8" wide range, mid-range and 3" high fidelity tweeter. Walnut, \$299.95. Blonde Mahogany, \$325.00.

Complete catalog on request.

LETTERS

Continued from page 11

illusions in art, as in life, are painful in the challenging. I feel that *Tosca* is second-rate through and through, and what is worse pretentious; that makes me scornful.

Joseph Kerman
Berkeley, Calif.

SIR:

As your magazine is read so widely, I'm wondering if one of its readers might have the answer to a problem of mine.

I am keen on acquiring several organ records on the *Club Français du Disque*, *Discophiles Français*, *Erato*, and *Les Mélomanes Français* labels, manufactured in France and, as far as I know, unobtainable in Canada, England, or the United States. Having tried everything else I wonder if someone could supply the name and address of a record dealer in Paris who could furnish these disks needed to complete a comprehensive collection.

Also, I would be delighted to hear from anyone who has any data on the organs in the Reformed Church at Thalwil, Switzerland; Westminster Cathedral, London; Grosskirche des Berliner Doms (Berlin Cathedral), Berlin; and the Pauluskirche (Paul's church), Berlin.

Having indexed in detail all organ works recorded and determined in most cases the location of organs used incognito, as well as having compiled considerable data on most recorded organs, I would be most willing to pass such data along to anyone who might wish it.

The slightest help will be appreciated.

W. G. Lofft
7 Abbott Ave.
Toronto, Ont.
Canada

SIR:

I read with great interest the article by Allen Forte, "Composing With Electrons at Cologne" [Oct. 1956] and with the feeling that he is showing us *now* the work of pioneers whose fate is usually to be recognized only many years later. The article gives us an insight into the future.

However, Forte failed to mention other important pioneering work in experimental music, particularly the encouragement lent to this movement by Hermann Scherchen, and the work

Continued on next page



ON ONE COMPACT CHASSIS! FISHER FM-AM TUNER, AUDIO CONTROL AND 30-WATT AMPLIFIER!

New!

EVERYTHING YOU NEED!
ON ONE SUPERB CHASSIS!

THE FISHER

"500"

THOUSANDS have asked us for it—and here it is! An extreme-sensitivity FM-AM tuner, a powerful 30-watt amplifier, and a Master Audio Control—all built on one compact chassis. Simply add a record changer and loudspeaker to the FISHER "500" and, as easily as that, you have a complete high fidelity system. Its quality—in the finest FISHER tradition. Its appearance—the timeless beauty of classic simplicity. Here is the most economical form in which you can own FISHER equipment.

Chassis Only, **\$239.50**

Mahogany or Blonde Cabinet, **\$19.95**

Outstanding Features of THE FISHER "500"

- Extreme sensitivity on FM and AM. Meter for micro-accurate tuning. ■ Full wide-band FM detector for maximum capture ratio. ■ Powerful, 30-watt amplifier; handles 60-watt peaks. ■ Uniform response, 16 to 32,000 cycles. ■ 4 inputs, including separate tape playback preamp-equalizer. ■ 4, 8 and 16-ohm outputs match all existing speakers. ■ Recorder output ahead of volume and tone controls. ■ 7 Controls, including 9-position Channel Selector (AM, FM, AES, RIAA, LP, NAB, TAPE, AUX 1 and AUX 2), Loudness Contour (4-position), Volume, Bass, Treble, AC-Power, Station Selector. ■ Beautiful, die-cast, brushed brass escutcheon and control panel. ■ Pin-point, channel indicator lights. ■ Smooth, flywheel tuning. ■ Largest, easy-to-read, slide-rule dial, with locking scale. ■ High efficiency FM and AM antennas supplied. ■ 14 tubes plus 2 matched germanium diodes. ■ size: 13 7/16" w. x 12 3/8" d. (excluding knobs) x 6 1/4" high.

Prices Slightly Higher In The Far West

WRITE TODAY FOR COMPLETE SPECIFICATIONS

FISHER RADIO CORP., 21-25 44th DRIVE • L. I. CITY 1 • N. Y.



MODEL 80-T • MOST ADVANCED PROFESSIONAL TUNER WITH COMPLETE AUDIO CONTROLS

Outperforms Them All!

THE FISHER

MODEL 80-T • MODEL 80-R

FM-AM TUNERS

HERE ARE AMERICA'S only FM-AM Tuners with TWO meters for micro-accurate tuning — just one of their many unique features. THE FISHER Series 80 FM-AM Tuners enjoy an unparalleled reputation as the leaders in high fidelity. The roster of professionals using THE FISHER tuners include the names of some of the most outstanding organizations in the research, broadcasting, and educational fields. In every case, THE FISHER was chosen because, unquestionably, it provides a level of performance that exceeds even the most critical requirements. "Performance, flexibility, and all-around 'usefulness' are excellent!"—*High Fidelity Magazine*.

Outstanding Features of THE FISHER Series 80

- The Model 80-T features extreme FM sensitivity — 1.5 microvolts for 20 db of quieting. ■ Full limiting on signals as low as one microvolt. ■ Separate FM and AM front ends, completely shielded and shock-mounted. ■ Separate tuning meters for FM and AM. ■ 72-ohm, plus exclusive balanced, 300-ohm antenna inputs for increased signal-to-noise ratio. ■ Supplied with AM loop and FM dipole antennas. ■ Adjustable AM selectivity. ■ AM sensitivity better than one microvolt for full output. ■ Inherent hum non-measurable. ■ Distortion below 0.04% for 1 volt output. ■ Four inputs. ■ Separate tape-head playback preamplifier (with NARTB equalization.) ■ Preamplifier-equalizer has sufficient gain to operate lowest level magnetic cartridges. ■ Six choices of record equalization. ■ Multiplex and cathode follower outputs. Frequency response, on FM, within 0.5 db, 20 to 20,000 cycles. ■ Super-smooth flywheel tuning mechanism. ■ 16 tubes. (Model 80-R: 13 tubes.) ■ EIGHT CONTROLS: Selector, Variable AFC/Line Switch, Station Selector, Bass, Treble, Equalization, Volume, 4-Position Loudness Contour. ■ Self powered. ■ DC on all audio filaments. ■ Beautiful brushed-brass front panel. ■ SIZE: 12¼" wide x 8¾" deep x 6" high. (Model 80-R: 4" high.) ■ WEIGHT: 21 pounds. (Model 80-R: 16 pounds.) ■ NOTE: Model 80-R is identical to the above, but is designed for use with an external audio control, such as THE FISHER Series 80-C Master Audio Control.

MODEL 80-R • FOR USE WITH EXTERNAL AUDIO CONTROL



MODEL 80-T
\$199⁵⁰

MODEL 80-R
\$169⁵⁰

MAHOGANY OR BLONDE
CABINET: **\$17⁹⁵**

Prices Slightly More
In The Far West

Write For FULL Details

FISHER RADIO CORP.

21-25 44th Dr., L.I.C. 1, N.Y.

LETTERS

Continued from preceding page

of his group at Gravesano, Switzerland. Here is a movement in musical electro-acoustics in which musicians and scientists co-operate with no boundaries or cleavage such as distinguish the "electronic" and "*musique concrète*" factions. The Gravesano investigations are as wide and international as the human spirit. Their many pamphlets and technical monographs testify to the large area of musical and scientific probings.

On this side of the globe, in addition to the work of Luening and Ussachevsky mentioned by Forte, reference must be made to Kenneth Kendall of Ottawa, Canada, who takes the fundamental tone of one instrument and combines it with the overtones of other instruments, creating a new tonal character that does not exist in any form as a physical entity. This is a sort of musical hybrid and the combinations are almost infinite for the creation of new tonalities. When used with taste and scholarship it will vastly increase the opportunities for creative composing.

Allen Forte correctly states "... mathematics has a definite place in the musical thinking of such a group." Just how solidly music rests on a mathematical base is being shown by A. H. Frisch of New York, who by solving the expressions for the squares and cubes of binomials and trinomials has produced a means of timing for virtually an unlimited number of rhythm series. . . . Frisch has gone beyond the theoretical work of Schillinger in that he has created the means for mechanically and simply establishing rhythm patterns.

Frisch is now working on a mechanical means of recording pitch and dynamics directly on tape. He is laying the basis for musical composition without recourse to any instruments. The composer will work with unmagnetized tape while sitting at his desk, and by applying to the tape specific *magnetic dyes* will transfer pitch or a theme from his creative innards to the tape. He will also have a means of applying amplitude or dynamics and even vibrato. He will establish rhythm or timing by a pre-selected formula shown as specific intervals on a sort of yardstick over which the tape is manipulated, inch by inch, or foot by foot.

An informal group of musicians and physicists was recently formed in New York to promote all forms of new music. Called the Neo-Phonic Society, they hope to emulate the objectives of the Gravesano group. The society is open to any musician, composer, musicologist, acoustician, and engineer possessing a broad point of view toward creative music. The group is able to look ahead, believes that the future holds a good thing, and is willing to do something about it.

Saul J. White
New Rochelle, N. Y.

SIR:

Thank you very much for publishing my letter (July 1956) requesting a tape recording of "Festival of Music." The response to my plea has been tremendous. I have received letters from all over the United States and parts of Canada making the tape available to me.

You did me a great service and I appreciate it.

Ralph M. Ford, Jr.
Georgetown, S. C.

SIR:

In the October issue, I read with keen interest Alfred Frankenstein's excellently documented review of Bartók's recorded works to date.

In his concise review of the Viola Concerto, I was astonished, as well as pleased, to note his exception to Halsey Stevens' strictures. As a matter of fact, at the time Professor Stevens wrote his book on Bartók, the original manuscript was not—to my knowledge—available to any one but myself.

Tibor Serly
New York, N. Y.

SIR:

May I take the privilege of commending you on a fine, if belated, article on the late great inventor of the FM system, Mr. Edwin Howard Armstrong. This truly great invention which so many music lovers of today enjoy is a magnificent accomplishment through hard and discouraging odds. . . . From our college enthusiasts, may we get more such fine endeavors.

Alfred J. Dube
New York, N. Y.

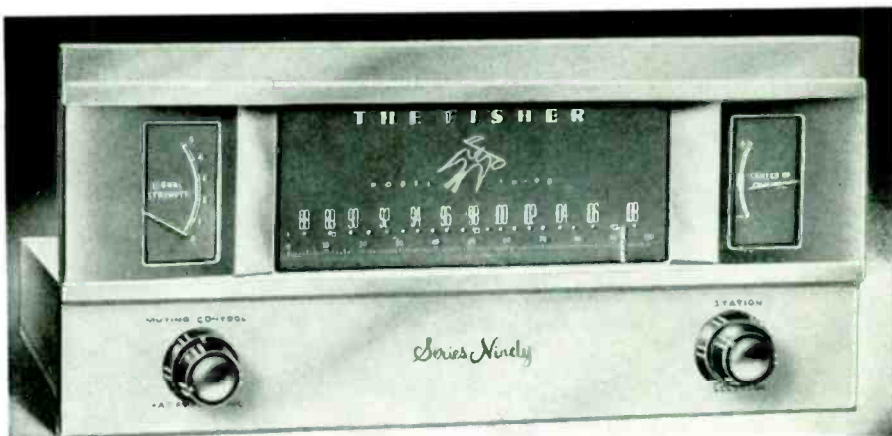

AMERICA'S LEADING FM TUNER • IN SENSITIVITY, APPEARANCE AND WORKMANSHIP

New!

THE 
FISHER
FM TUNER
MODEL FM-90

WHEN WE INTRODUCED our Model FM-80 FM tuner, it immediately established itself as the leader in the field. Today, the FM-80 is standard equipment in many broadcast stations, where its fabulous sensitivity and absolute reliability make it ideal for pickup of distant FM chain programs, for rebroadcast to the local communities. It took FISHER to improve on FISHER and the result is the new Model FM-90. It is some sixteen years since we produced our first FM tuner. The engineering skill and experience that only time, plenty of it, can bestow, are evident in every aspect of THE FISHER FM-90. We can truly say for it that it is the most advanced FM tuner now available.

Remarkable Features of THE FISHER FM-90

- TWO meters, for micro-accurate tuning. ▪ Revolutionary, dual dynamic limiters, assure noise-free reception where all others fail. ▪ Full wide-band detector for maximum capture ratio. ▪ Exclusive, variable inter-station noise eliminator. ▪ Full limiting on signals as low as 1 microvolt. ▪ Dual triode, cascade-tuned RF stage, four IF stages. ▪ Uniform response, 20 to 20,000 cycles. ▪ Three outputs (Main, Recorder and Multiplex). ▪ Dual antenna inputs (72 ohms or 300 ohms balanced). ▪ Four controls. ▪ 10 tubes plus four matched germanium crystal diodes. ▪ Special circuits for meter operation. ▪ Chassis completely shielded and shock-mounted. ▪ Beautiful, die-cast, brushed brass escutcheon and control panel. ▪ Dipole antenna supplied. ▪ SIZE: 13 7/16" w. x 6 1/4" high x 8 3/8" deep (plus 1" for knobs). ▪ WGT: 15 lbs.

Professional FM Tuner • \$149.50

MAHOGANY OR BLONDE CABINET: \$17.95

Prices Slightly Higher in the Far West

WRITE TODAY FOR COMPLETE SPECIFICATIONS

FISHER RADIO CORP., 21-25 44th DRIVE • L. I. CITY 1 • N. Y.

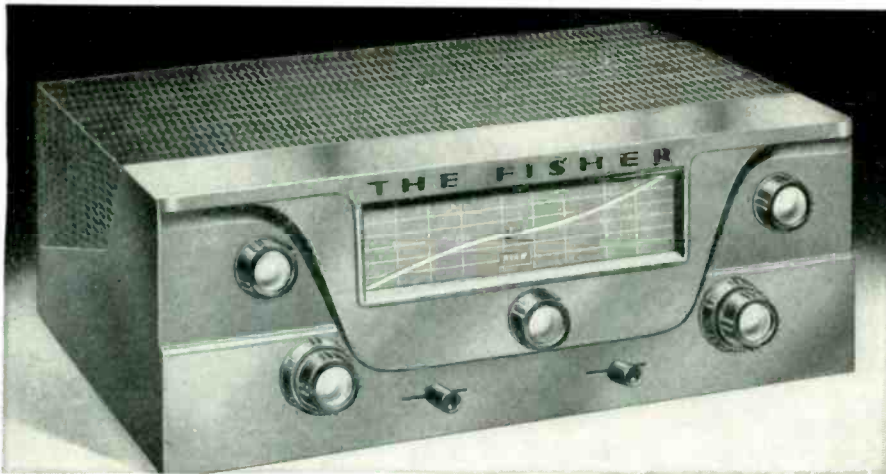

THE FISHER 25-WATT
Master Control-Amplifier · CA-40

■ Complete in every respect — and it's by FISHER! A new 25-watt amplifier with *complete* Audio Controls. Less than 1% distortion at 25 watts! Six inputs. Six equalization positions. *Exclusive* FISHER TONE-SCOPE provides graph-form indication of Tone Control settings. Direct, tape-head playback and microphone preamplifier. Uniform frequency response within 0.5 db, 10 to 90,000 cycles. Less than 1% IM distortion at 15 watts. Hum and noise level better than 90 db below full output. Cathode-follower tape recorder output. Speaker output impedances: 4, 8 and 16-ohms. Nine controls. TUBE COMPLEMENT: 1-12AU7A, 3-12AX7, 4-EL84, 2-6BW4. SIZE: 12¾" wide x 10¾" deep x 5" high. WEIGHT: 24 pounds. **\$139.50**

Two Great Audio Units!
THE FISHER
 MODEL CA-40 · MODEL 80-C

THE FISHER
Master Audio Control · 80-C

■ "Breathtaking!"—*Edward Tainall Canby*. The Master Audio Control can be used with any amplifier. Provides professional phono and tape-head equalization, plus full mixing and fading facilities for from two to five channels. Seven inputs. Two cathode-follower outputs. Uniform response within 0.25 db, 20 to 20,000 cycles. IM distortion and hum virtually non-measurable. DC on all filaments. Separate equalization and preamplification *directly* from tape playback head. Eight controls. TUBE COMPLEMENT: 3-12AX7, 1-12AU7A. SIZE: 12¾" wide x 7¾" deep x 4¼" high. WEIGHT: 10 pounds. **\$99.50**

Prices Slightly Higher In The Far West Mahogany or Blonde Cabinet \$9.95

WRITE TODAY FOR COMPLETE SPECIFICATIONS

FISHER RADIO CORP. · 21-25 44th DRIVE · L. I. CITY 1, N. Y.

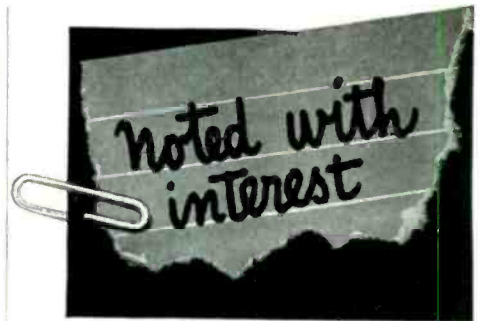

New Product Needed

Manufacturers please note: Rene Willdorff, of San Francisco, wrote us the other day asking why no one manufactured a little clip-on finger guide which could be attached to the arms used on record changers and players.

He says he plays many of his records manually and that he finds it awkward to get hold of the arm or cartridge shell. So, he says, "Why doesn't some manufacturer make a clip-on guide, one that you could clamp or snap or clip onto the arm to the right of the pick-up? It certainly could be made light enough so as not to add appreciably to the weight of the arm."

Sounds like a fine idea to us. How about it, manufacturers?

Record Cataloguing

It was the first or second issue of HIGH FIDELITY which carried an article about cataloguing records. It was a problem then and it is still a problem for most of us. The article was no doubt good, but it didn't solve the little matter of the "spine" of the record jacket. During the last year and a half, record companies have done much to help, since most of them now print the content of the jacket on the spine.

Nevertheless, the problem still largely remains. In our own household, we have the usual shelves of records and the usual card catalogue, cross-indexed and everything else. But we still have to pull out most of the jackets, one after another, until we find the right one.

Now along comes the Old Colony Sound Lab, P.O. Box 91, Roxbury 20, Mass., with what may not be the final answer but certainly looks like a major step forward. And simple, too! Part one of their solution is commonplace: a pressure-sensitive label about one inch high and 1½ inches wide. The labels are \$1.50 per hundred.

Part two of the system is, to our

thinking, the key and the real stroke of genius. It is a rubber stamp running the wrong way around. Thus, instead of printing AE498—two of the rubber stamp's five strips are letters of the alphabet and the remaining three are numerals—it runs the other way, like this:

A
E
4
9
8

Yes, we can see ways of achieving this same effect without using the rubber stamp which is, admittedly, expensive: \$6.50. Old Colony Sound Lab points out that they know the stamps are expensive but they have to be made to order; they are not a stock item. So you could take a label and hand letter the same or different numbers; you might even be able to type the coding on the labels. But it all seems so much easier with the rubber stamp!

The labels are a little bit special since they are ruled and have space to jot down equalization and information of that character. You're supposed to stamp the label in three places: on what would be the back of the jacket, on the spine, and on the front. Then you set up any sort of a card filing system you want and stamp the cards to correspond to the coding on the jacket. Old Colony has a nice bulletin which goes into the whole problem in considerable detail. —We may have more about this system in a later issue; Old Colony said they would send us some labels and a sample stamp for a TITH report. But meantime, it certainly looks like a bright idea.

The Hi and the Fi

We are pleased to report the continued expansion of interest in things high-fidelity. We now have high-fidelity hospital service at the Hospital of the Good Samaritan in Los Angeles, according to a bulletin sent us by Cap Kierulff.

And we have high-fidelity freight service—on the Kansas City Southern Lines, according to an advertisement sent us by Ralph Glover of Jensen Mfg.

Kansas City Southern defines high fidelity as "our responsibility to those who trust us with the movement of their freight." We would like to sug-

Continued on next page



THE FISHER FM Tuner • Model FM-40

■ A beautifully designed FISHER FM Tuner— with all that the name implies — and only \$99.50! Stable circuitry and simplified controls. Meter for micro-accurate tuning. Sensitivity—3 microvolts for 20 db of quieting. Uniform response ± 1 db, 20 to 20,000 cycles. 72 and 300-ohm antenna facilities. Three outputs: Detector/Multiplex, plus cathode follower main output, permitting leads up to 200 feet. Self-powered. Beautiful, brushed-brass front panel. TUBE COMPLEMENT: 1-6BQ7A, 1-6U8, 3-6BH6, 1-6AL5, 1-12AU7A, 1-6X4. SIZE: 12 $\frac{3}{4}$ " wide x 7 $\frac{1}{4}$ " deep x 4" high. WEIGHT: 15 pounds. **\$99.50**

World Leader in Quality THE FISHER MODEL FM-40 • MODEL AM-80

THE FISHER AM Tuner • Model AM-80

■ Combines the pulling power of a professional communications receiver with the broad tuning necessary for high fidelity reception. Features a tuning meter for micro-accurate station selection. Adjustable bandwidth (three-position.) Remarkable sensitivity—less than one microvolt produces maximum output! Elusive and distant stations are brought in with ease. Built-in 10 Kc whistle filter. Dual antenna inputs. Three high-impedance inputs. Cathode follower output permits leads up to 200 feet. Self-powered. Brushed-brass front panel. TUBE COMPLEMENT: 3-6BJ6, 1-6BE6, 1-6AL5, 2-6C4, 1-6X4, SIZE: 12 $\frac{3}{4}$ " wide x 7 $\frac{1}{4}$ " deep x 4" high. WEIGHT: 15 pounds. **\$119.50**

Cabinets Available for FM-40 and AM-80, Blonde or Mahog., \$17.95

WRITE TODAY FOR COMPLETE SPECIFICATIONS

FISHER RADIO CORP. • 21-25 44th DRIVE • L. I. C. 1, N. Y.



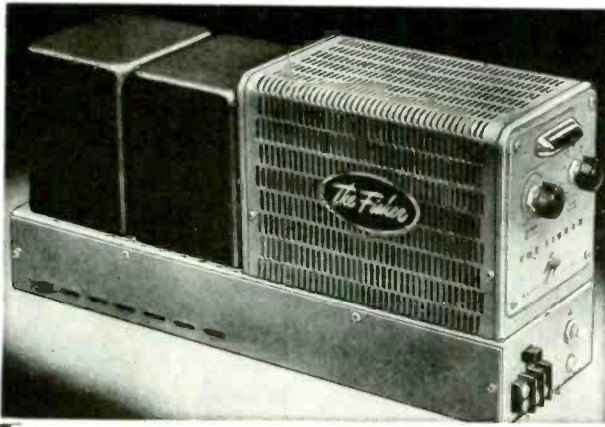

30
WATTS
\$99⁵⁰

THE FISHER
Lab Standard Amplifier · 80-AZ

■ Here is the incomparable FISHER 80-AZ Amplifier with PowerScope, a visual Peak Power Indicator. More clean watts per dollar than any amplifier in its class. 60 watts peak! Three separate feedback loops. Less than 0.5% distortion at 30 watts, 0.05% at 10 watts. IM distortion less than 0.5% at 25 watts. Frequency response uniform within 0.1 db, 20 to 20,000 cycles; within 1 db, 10 to 50,000 cycles. Hum and noise virtually nonmeasurable—96 db below full output! CONTROLS: Z-MATIC, POWERSCOPE, Input Level. TUBE COMPLEMENT: 1-12AT7, 1-12AU7A, 2-EL37, 1-5V4G, 1-PowerScope Indicator, 1-Regulator. SIZE: 15¼" wide x 4¼" deep x 6¾" high. WEIGHT: 22 pounds.

Two Great Audio Amplifiers
THE FISHER
MODEL 80-AZ · MODEL 20-A

THE FISHER
Lab Standard Amplifier · 20-A

■ Low in cost, terrific in quality! The Model 20-A is the 15-watt amplifier thousands of hi-fi enthusiasts have requested. Traditional FISHER workmanship, handsome appearance. Compact, advanced design throughout. Frequency response within 0.1 db, 20 to 20,000 cycles. Less than 0.7% distortion at full output, 0.4% at 10 watts. IM distortion less than 1.5% at 10 watts, 0.75% at 5 watts. Hum and noise better than 90 db below full output! Internal impedance 1 ohm for 16-ohm operation. gives damping factor of 16. Excellent transient response. One volt drives amplifier to full output. Octal socket provides all necessary AC and DC voltages for operating unpowered auxiliary components. Completely enclosed in a protective metal cage. Speaker output impedances: 4, 8, and 16 ohms. Input Level Control. TUBE COMPLEMENT: 1-12AX7, 2-EL84, 1-EZ80. SIZE: 13" wide x 4¼" deep x 6¾" high. SHIPPING WEIGHT: 13 pounds.

THE FISHER LABORATORY STANDARD AMPLIFIER · MODEL 20-A

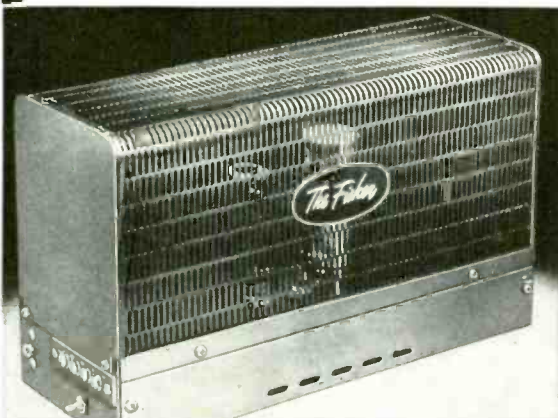

15
WATTS
\$59⁵⁰

Prices Slightly Higher
in the Far West

Write For Full Details
FISHER RADIO CORP.
21-25 44th DRIVE
Long Island City 1, N. Y.

NOTED WITH INTEREST

Continued from preceding page

gest that this might make a good credo for our industry, if the word "freight" were changed to "music." For after all, if some one makes a piece of hi-fi equipment, or a hi-fi record, doesn't that person or manufacturer assume a responsibility to those who trusted him with the movement of their music—from live performance to home reproduction?

Well, all right; maybe we are stretching things a bit, but it's an idea.

Audio Consultants

Not long ago, we relayed the request of a Long Island reader for suggestions about an audio consulting service. We have had two answers so far. Ernest L. Sachs, 29 Chestnut St., Rockville Centre, L. I., N. Y., writes that "such a diagnostic service exists—and has for a number of years, right on Long Island." Mr. Sachs' phone number is Rockville Centre 4-1167.

And Carl Machover, of Audio Advisory, 32 Loring Drive, Yorktown Heights, N. Y., writes: "We established just such a service for Northern Westchester about six months ago. The scope of Audio Advisory is somewhat greater than simply diagnosing existing installations. We are prepared to design or specify components for new installations as well as to indicate possible improvements for existing systems. Audio Advisory does not sell equipment or technicians' services. Our product is individualized, competent advice, based upon a background of engineering and musical training and experience."

Any more consultants? We'll be glad to pass names along, but let's make it tough: For the purposes of this list, and to find out what happens, suppose we define a consultant as someone who does not sell high-fidelity equipment nor is associated with or works for anyone who does. This restriction is going to exclude many highly qualified advisors, but we'd seriously like to find out how many of these rare individuals there are in the high-fidelity business today.

San Diegans Please Note

Everyone around San Diego aware of station KFSD-FM? Dr. Egon Muehlner was kind enough to send us a clipping from the *San Diego Evening*

Tribune for September 17 which told of a thirteen-week cycle of classical and semiclassical music which would be broadcast from 4 to 11 p.m., Mondays through Fridays. Sounds like plenty of worthwhile listening.

Tops for Christmas

True Magazine did a survey of some of its readers, discovered that—we knew this all along—hi-fi equipment ranked first in the miscellaneous classification of most-wanted Christmas gifts. The full survey appeared in the issue of *True* for mid-November, in case you want more details.

Hi-Fi Chickens

An advertisement in the September issue of *Poultry Tribune* proclaims, in large type, "Now Ful-O-Egg Mashers promote Hi-Fi performance." The ad goes on to explain "Hi-Fi means high fidelity, or music recorded with precision. In other words, quality reproduction. Ful-O-Pep . . . gets quality reproduction and top performance from your hens."

Next, please.

European Broadcasting Stations

Wireless World, through Iliffe & Sons, Ltd., has just released the 1956-57 edition of its *Guide to Broadcasting Stations*. This is an 80-page booklet giving complete information about some 3,000 broadcast stations, including long, medium, and short-wave ones. Cost is 2s. 6d. plus 4d. for postage. Iliffe's address: Dorset House, Stamford St., London S. E. 1.

Correction, Please

In the September NWI column we included the names of several sources for disk jacks. We got tangled up on one: it should be Soundings Recording Service, 215 East 12th St., New York 3, N. Y. Raymond Graunke, who runs Soundings, says that disk jacks are really a sideline; their principal work is editing, mastering, dubbing, recording, and so forth.

Paging Hamlet

It's too bad that Hamlet is not alive today. It took him a good many hours, or maybe days or months, to go mad.

Continued on page 24



90
WATTS
\$229.50

THE FISHER Lab Standard Amplifier · 90 - A

At your command—90 watts of audio power, with less than ½% distortion at full output. *Two* power supplies assure optimum amplifier operation. *Exclusive* PERFORMANCE MONITOR meter indicates correct adjustments of tube bias, screen voltage and output balance. It also shows average power output. **FEATURES:** Less than 1% IM distortion at 75 watts! Frequency response ±0.1 db, 20 to 20,000 cycles. Hum and noise better than 92 db below full output. 8 and 16-ohm speaker output impedances. Power socket supplies all necessary voltages for operation of unpowered auxiliary components. **CONTROLS:** Input Level, Speaker Impedance Switch, Meter Switch, Bias, Screen Voltage, Output Balance, Driver Balance, Z-MATIC. **TUBE COMPLEMENT:** 1-12AU7A, 1-12AX7, 4-EL34 (6CA7), 1-6Y6, 1-6AU6, 2-5R4GY, plus 2-NE16 regulators. **SIZE:** 14" wide x 11¼" deep x 8¼" high.

New! And Unequaled! THE FISHER AUDIO AMPLIFIERS

THE FISHER Lab Standard Amplifier · 55 - A

Plenty of power for your present—and any possible *future* needs. THE FISHER Model 55-A is a *laboratory* instrument designed for *home* use. Delivers 55 watts at less than 1% distortion. Drives even the lowest efficiency speaker system to full output. *Exclusive* FISHER POWER MONITOR meter shows correct adjustment of output tube bias, and indicates average power output. IM distortion below 2% at 50 watts, 0.8% at 45 watts, 0.4% at 10 watts. Harmonic distortion less than 0.08% at 10 watts, 0.05% at 5 watts. Frequency response within 0.1 db, 20 to 20,000 cycles. Hum and noise better than 92 db below full output! 8 and 16-ohm speaker outputs. Octal socket supplies all voltages for operating unpowered components. **CONTROLS:** Input Level, Bias, Speaker Impedance Switch, Z-MATIC. **TUBE COMPLEMENT:** 3-12AU7A, 2-6CL6, 2-6X50, 2-5AW4. **SIZE:** 14¼" wide x 9¾" deep x 8¼" high. **WEIGHT:** 50 pounds.

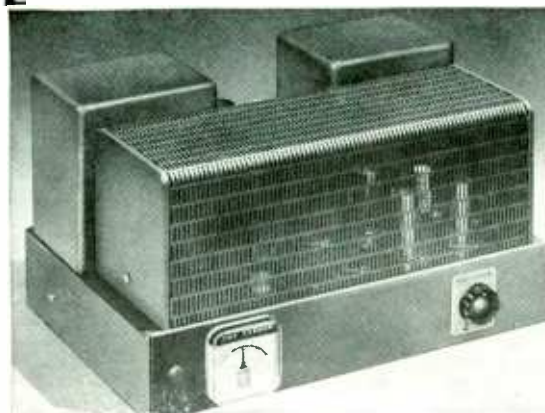

55
WATTS
\$169.50

Write For FULL Details
FISHER RADIO CORP.
21-25 44th DRIVE
Long Island City 1, N. Y.

The Standard of Performance

McIntosh

60 WATT AMPLIFIER

Supreme among amplifiers, McIntosh alone delivers amplification within 0.4 of 1% of theoretical perfection . . . puts quality where it counts most — in the heart of your high fidelity system.

The McIntosh circuit is fundamentally different and technically superior. It possesses an inherent large advantage over conventional circuits, makes compatible *greatest power and lowest distortion*. The McIntosh is a complete, wide-band, *stable* amplifier. It delivers *all* the sound, true and clean, with matchless listening ease. It handles any audio advancement or problem with unwavering performance.

McIntosh *plus* values are a solid investment in your high fidelity future — bring you the finest in reproduced sound now.

THERE IS A DIFFERENCE. . . .

MAKE THE McINTOSH LISTENING TEST

AT YOUR AUTHORIZED McINTOSH DEALER'S.



MC-60
\$198⁵⁰

PERFORMANCE PROVES
McINTOSH OUTCLASSES
EVERY EXISTING AMPLIFIER
ON EVERY SCORE

*Send for free booklet
"Lost Instruments" and complete specifications*

1. **Advanced Audio Design.** The exclusive patented McIntosh circuit is world-renowned for virtually perfect amplification.
2. **Purity of Signal.** Low Harmonic distortion of $\frac{1}{3}$ of 1%, even at full rated output, from 20 to 20,000 c.p.s., and $\frac{1}{2}$ of 1% Intermodulation assures no lost, distorted or intermixed tones.
3. **Adequate Power Reserve.** 60 watts continuous, 120 watts peak to meet the power demands of natural sounds under any room conditions.
4. **Great Stability** contributes clean bass characteristic, no oscillation problem, long dependable life even under adverse operating conditions.
5. **Highest Efficiency** for less heat dissipation and less power consumption for greater output.
6. **Matchless Performance** guaranteed for your protection of quality sound.

McIntosh

LABORATORY, INC.

322 Water Street, Binghamton, N. Y.

Export Division: 25 Warren St., New York 7, N. Y. Cable: SIMONTRICE N. Y.

WORLD PREMIERE



A king can have no better than this "2300" . . . the newest look and performance in High Fidelity amplifiers.

Pictured above is the *new* Bell "2300", twenty watt. Other *new* designs are available in 10 to 40 watts.

The specifications of these *new* Bell amplifiers are the best in the world today.

The controls, all closely grouped in the center panel, present conveniences you've always longed for.

You cannot buy a better engineered or better styled High Fidelity amplifier . . . anywhere.

NOT JUST NEW VERSIONS OF OLD MODELS but . . . COMPLETELY NEW DESIGNS

For "Operation 2300", Bell assembled a group of electronic engineers with knowhow . . . a group of designers with imagination . . . and gave them an order—"Create a line of High Fidelity Amplifiers that will produce breathtakingly-realistic sounds—and will be styled for traditional, contemporary and modern living."

The "2300" line is the result of this far-reaching project. You should see and hear it. Your nearest Bell dealer will gladly demonstrate, for you, a remarkable "2300". Write us for his name and detailed "2300" literature. Bell Sound Systems, Inc., (A subsidiary of Thompson Products, Inc.) 559 Marion Road, Columbus 7, Ohio.

Bell "World Renowned For the Best in Sound"

NOTED WITH INTEREST

Continued from page 21

With the facilities now offered by some high-fidelity dealers, he could get it over with in about thirty seconds. All he would have to do is to decide that he would like to buy a high-fidelity system and then wander into the elegant store of a certain dealer in a certain community. This dealer recently sent us an announcement detailing his facilities. He announced—proudly, believe it or not—that his collection of high-fidelity components was so enormous, and his switching facilities so complete, that he could offer more than 700,000 different phonograph combinations and an *additional* (italics ours—Editor) one million-plus tuner combinations!

We would sincerely like to know how anyone—even Hamlet—could be expected to make up his mind when confronted with nearly two million possible combinations!

Cylinder Records, Please

Harold L. Christopher, 75 West Crescent Ave., Allendale, N. J., would like to know where he can get cylinder records for his 1907 Edison.

This shouldn't be too hard . . . anyone in Mr. Christopher's area able to help?

TV at the Opera

From Pye Ltd., we learn that Pye miniature TV cameras are being installed in the Glyndebourne Opera House, beside the prompter's box, with monitors back stage. No more peering through holes in curtains or scenery for chorus masters . . . just relax and watch the whole thing on television.

Somehow . . . Glyndebourne? Television prompting? . . . well, progress. Let's concentrate on the day when a bright lad ties the monitors to a regular television set, so the chorus can watch a cricket match while waiting for their cue.

Electrostatics

There has been so much discussion of electrostatic loudspeakers of late that we are loath to bring up the subject again. This time, we are on safe grounds because we are not referring to loudspeakers. Had a note

Continued on page 26

HIGH FIDELITY MAGAZINE

from single speaker to 3-way system in easy stages

starting with a

GOODMANS

12-inch AXIOM Full Range
LOUDSPEAKER

and ARU Friction Loaded
ENCLOSURE

Step 1

First you select one of the three 12-inch Goodmans Axiom Full Range Loudspeakers: Axiom 22 Mk II, Axiom 150 Mk II or Axiom 100. You then mount it into a Model B-1200 ARU Enclosure. Assuming that you have chosen the Axiom 22, you now have one of the finest single speaker systems available. The enclosure is only 26 x 20 x 20 inches. Yet, the response goes down to 20 cycles and extends to 15,000 without resonant peaks to mar its smoothness. You could stop here.

Step 2

But you decide to 'put more top on'—extend the response to 20,000 cycles. You simply procure the Goodmans Trebax, pressure driven tweeter with horn, and XO-5000 crossover unit. You remove the back of your ARU Enclosure, and then the block that covers the Trebax opening already cut into the front panel. You screw the Trebax into position, and connect the wires according to the instructions. You now have a 2-way Goodmans system worthy of the finest high fidelity installation. You could stop here.

Step 3

But, the urge for a more 'super system may take hold again. This time you need only procure the Goodmans Midax, pressure-driven, mid-high reproducer with its long flared horn, plus the XO-750 crossover unit. Again you find that provision has been made for including the Midax without modification of the ARU Enclosure. And in a matter of minutes, you have an operating, full-fledged, full-range, 3-way system. The Axiom 22 reproduces the frequencies from 20 to 750 cycles, the Midax from 750 to 5000 cycles, the Trebax from there to 20,000 cycles.

You have done all of this without discarding or modifying a single piece of equipment included in your original single system. Here is progress without waste, improvement without extravagance. And you will agree, enthusiastically that the results were worth it — *every easy step of the way.*

ARU Friction Loaded Enclosures are available in kit form — complete to the last detail — for easy home assembly.



For other Goodmans-ARU systems, see your hi-fi dealer or write to Dept. XA-2

ROCKBAR CORPORATION • 650 Halstead Avenue, Mamaroneck, N. Y.
In Canada: A. C. Simmonds and Sons, Ltd., Toronto, Ontario



the Ultimate

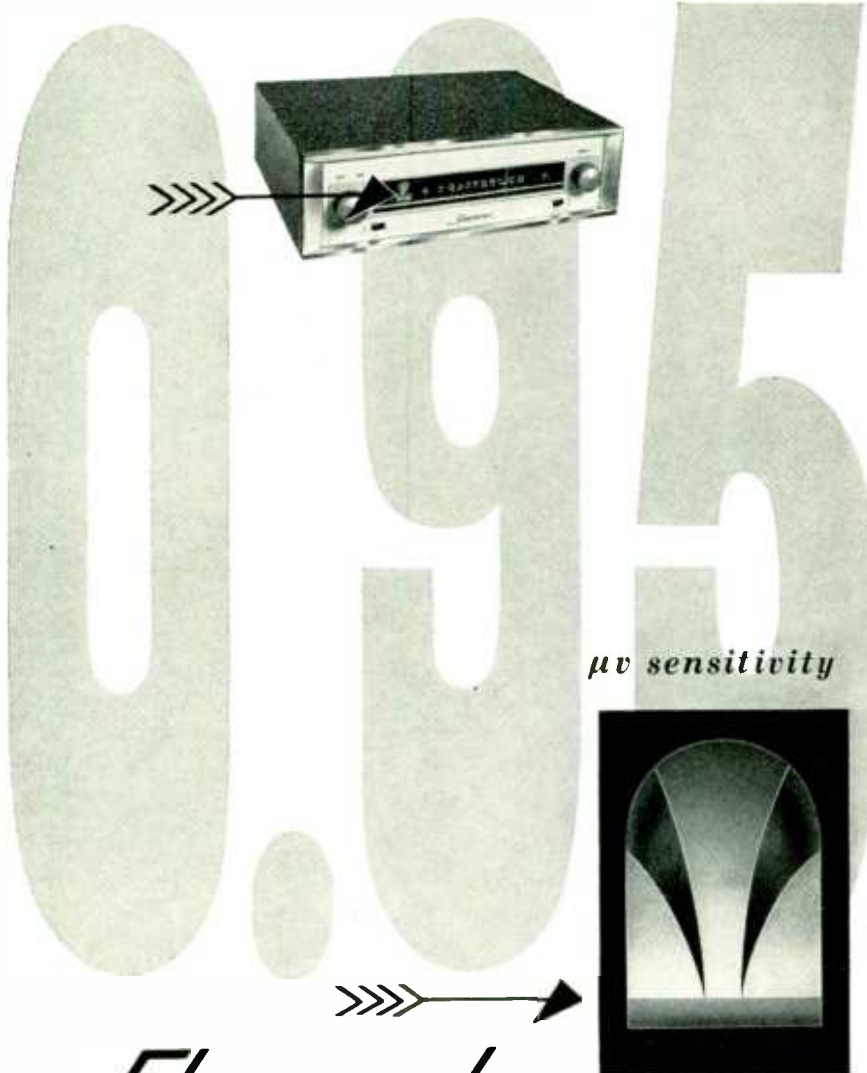

μ v sensitivity



"Feather-Ray" Tuning Eye

Sherwood
MODEL S-3000 FM TUNER

Indeed *the Ultimate!* Under one microvolt sensitivity for 20 db FM quieting increases station range to *over 100 miles* with the newly engineered Sherwood S-3000 FM (only) tuner.* Other important features include the new Feather-Ray tuning eye, a local-distance switch to suppress cross-modulation images, AFC switch, fly-wheel tuning.

\$99⁵⁰ net.

* All Sherwood tuner models now feature 0.95 μ v sensitivity.



Write for literature, Dept. H-1 — 2802 West Cullom Avenue, Chicago 18, Illinois



Sherwood is the "complete high fidelity home music center."

NOTED WITH INTEREST

Continued from page 24

from reader Henry Robbins of New York City with two noteworthy items. One was a clipping of an advertisement for electrostatic printing, developed by IBM. The other item had to do with the fact that he was stuck in a resort hotel with no hi-fi. Suggested we publish a list of resorts which had hi-fi installations for the enjoyment of their customers.

Hill and Dale

Most, but not all, records are cut with a lateral stylus motion. That is, the stylus swings from side to side. Some old records and many broadcast recordings are cut vertically or, as they have been called, hill and dale recordings.

Even if you do not have any hill and dale recordings, you are sure to have a friend who someday will have a friend who does have some and wants to play them back. Then the problem is: where does one get a cartridge? So jot this down in your notebook: Fairchild has just announced a new Model 216B cartridge for vertical recordings. Also: the 216B is available on special order with a 7.5 mil stylus for playing Edison, Parlophone, and other early cylinder records. For further information, write Fairchild.

The FM Front

With apologies to a distinguished author: all quiet on the FM front. That is the latest word. According to an unimpeachable authority, the FM band is safe until further notice. We'll keep you posted of any threats that might arise in the future.

Our Sympathy

Received a nice note from a reader in New Jersey recently, cancelling his subscription to HIGH FIDELITY. We're sorry to lose him, but we sympathize with his problem. He wrote: "Thank you for the trial issue of your magazine. I enjoyed it very much, but I cannot keep up my interest in hi-fi music right now as my wife just had twins. What with running a store in the daytime and feeding the twins at night, I'm too tired to have any interest in anything. Will take your magazine later when things have quieted down."

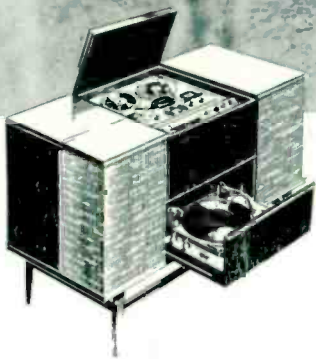
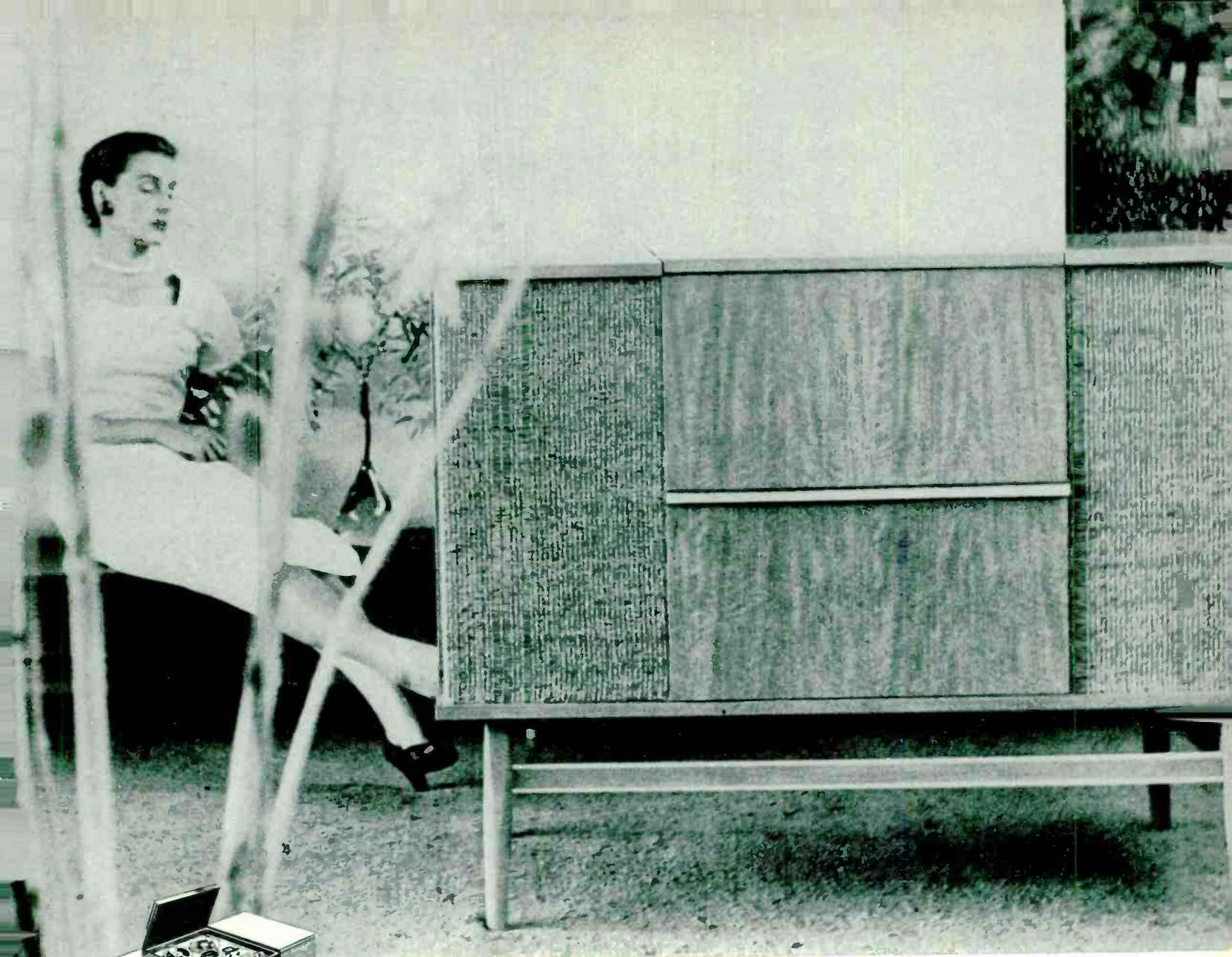

*a new adventure in sound... **AMPEX** magnificent high fidelity tape systems with stereophonic sound*

It's Stereophonic... for startling realism! It's a Tape Recording System... for unsurpassed sound reproduction! It's an Ampex... world renowned! Ampex Stereophonic Series from a magnificent console to a portable recorder. Stereophonic Sound now costs less than monaural sound did last year.

75% TRADE-IN GUARANTEE

Unique Trade-Back Plan

Applies to all popular new or used equipment purchased from audio exchange.

Buy Ampex at audio exchange and take advantage of audio exchange's LIBERAL TRADE INS (may well cover your down payment) • AMPEX TIME PAYMENT PLAN • EXPERT HI-FI CONSULTANTS • FAMED SERVICE DEPARTMENT (only for equipment bought from us.)



Write Dept. HF17 for trading information and catalog

audio exchange

THE TRADING ORGANIZATION OF THE HI-FI FIELD

159-19 Hillside Ave., Jamaica 32, N. Y., near subway, AXtel 7-7577

367 Mamaroneck Ave., White Plains, N. Y., next to Pix theatre, White Plains 8-3380



Bogen



MODEL R775 DELUXE TUNER-PRE

CONTROLS: VOLUME, TUNING, SEPARATE NON-RESONANT FEEDBACK BASS AND TREBLE, 7-POSITION RECORD EQUALIZER, LOUDNESS CONTOUR SELECTOR, SEPARATE HIGH- AND LOW-FREQUENCY FILTERS, FUNCTION SELECTOR, COLORED DOTS INDICATE AVERAGE LISTENING SETTINGS, FLAT FREQUENCY RESPONSE, EXTREME SENSITIVITY (2 MICROVOLTS FOR 30DB QUIETING ON FM), EXTREMELY LOW DISTORTION (0.4% AT RATED OUTPUT), ADJUSTABLE HUM-ELIMINATOR, TAPE-RECORDER OUTPUT, INPUTS FOR MAGNETIC, CERAMIC, AND CRYSTAL CARTRIDGES.

Send 25¢ for new 56-page "Understanding High Fidelity." David Bogen Co., Inc., Box 500, Paramus, N.J.

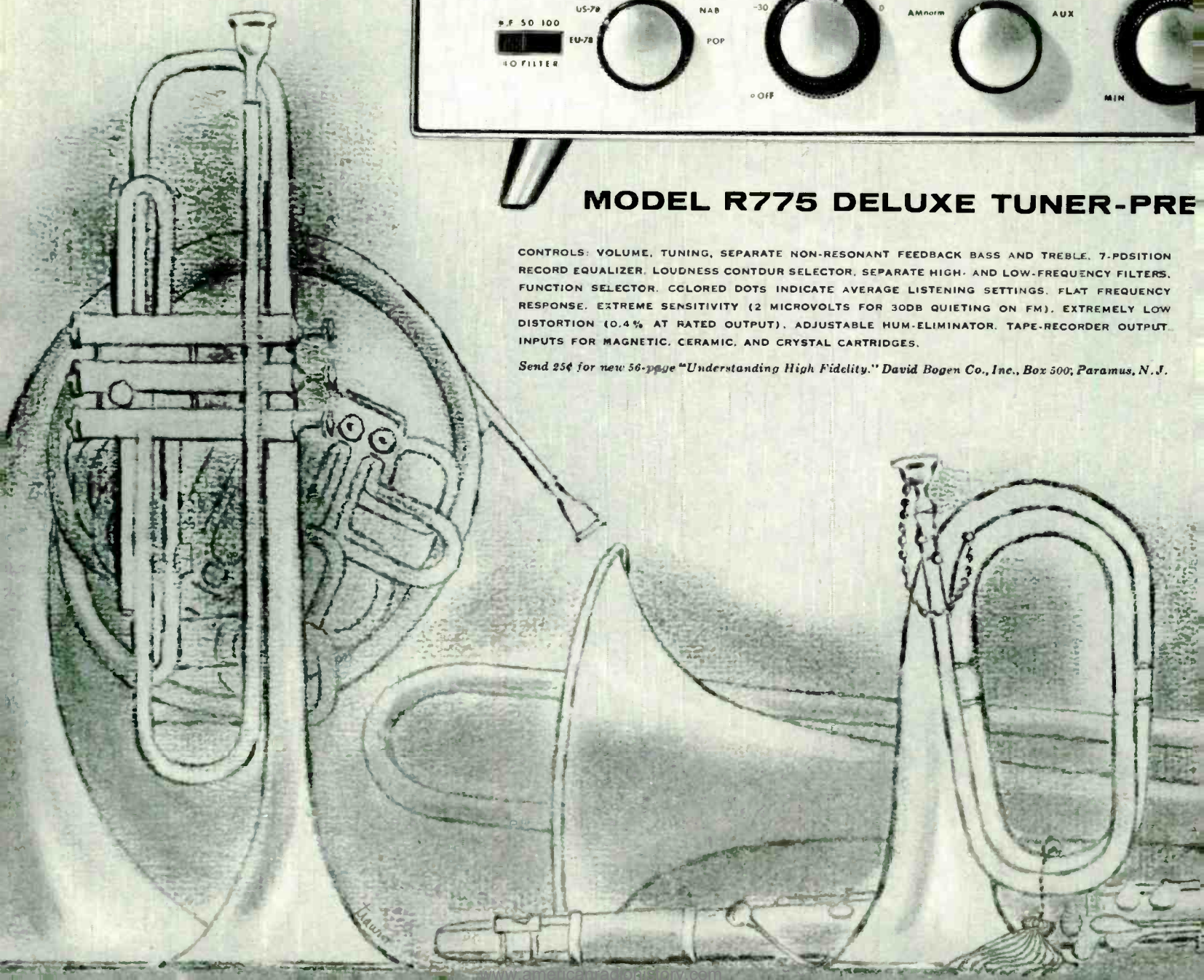



because it sounds better...

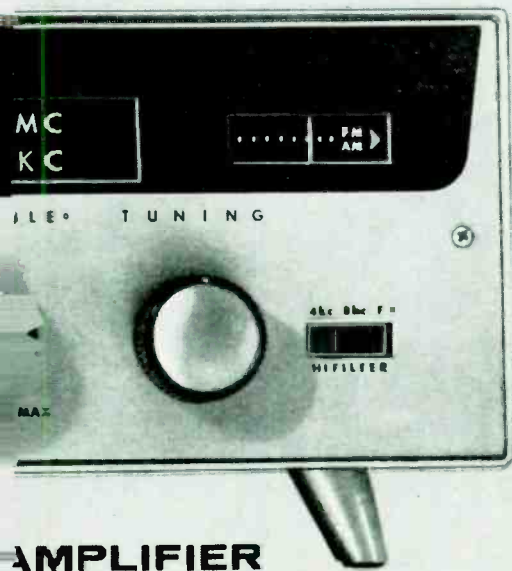

AMPLIFIER

You are looking at the finest tuner money can buy—the tuner that automatically "fine" tunes itself. Just turn the tuning knob until you reach the fringe of the station you want (as indicated by the meter)—then let go. A light goes on to tell you that Bogen is taking over. Walk away. The exclusive Auto-Lock tuning "zeros in" like a homing pigeon. It makes the precise, microscopic adjustments that even the most skilled fingers can only approximate. Then it locks out all unwanted signals — however strong — and locks your station in for keeps. No drift. Pinpoint-perfect reception, even in areas where others fail. All this plus special "squelch" circuit which eliminates inter-station noise. Chassis: \$49.50, worth more. Blonde or mahogany-finished enclosure: \$8.00.

Bogen
HIGH FIDELITY

A UNITRONICS CORPORATION AFFILIATE

what the 'sound men' say...

"At Radio Shack we have no hesitation in recommending Bogen hi-fi equipment when customers ask for our advice. Long experience has shown us that Bogen equipment is exceptionally free of maintenance problems and that Bogen specifications are 'delivered as written.' Other factors include excellent product-design, sensible engineering innovations, and the sales aid of Bogen's consistent advertising and high consumer-magazine reports. Finally, we are secure in selling Bogen components on their 'Investment Value'—products of a company whose substance and reputation have a 'blue chip' connotation in the world of sound."—

Vollmer Hetherington, Radio Shack, Boston. To thousands of New England audiophiles "Vol" is the "dean of sound."

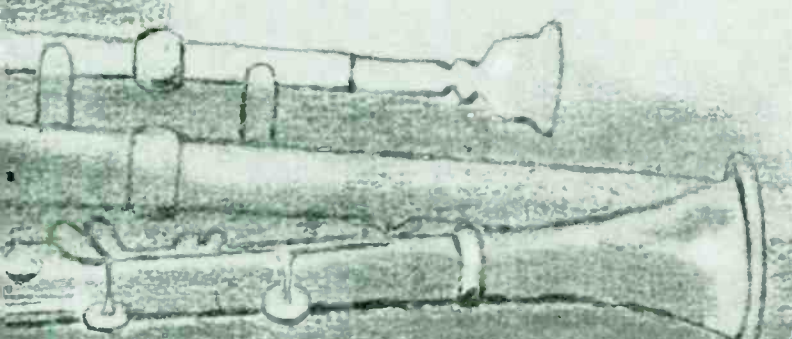

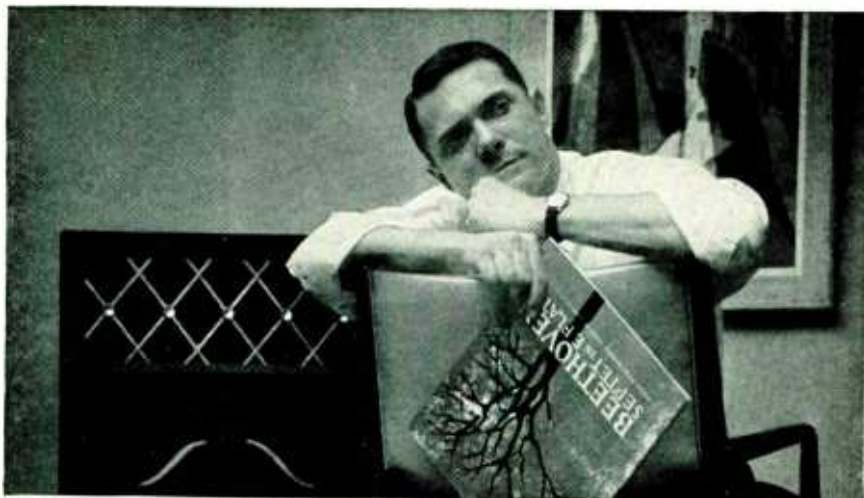

Only planned high fidelity can give you true high fidelity!

Putting together a hi-fi system for your home *can be simple*—and it probably will cost a lot less than you think! Here at MusiCraft we offer the kind of information and guidance that will help you get started right and avoid mistakes.

As you may know, possible combinations of components are practically

limitless. We're happy to help you choose what will best suit your home and your budget. You can start small and add as you wish.

Stop in at MusiCraft soon or write us for further information. Let us help you plan the *kind* of high fidelity system that will give you *true* high fidelity.

Send now for **FREE NEW** **HIGH FIDELITY CATALOG:**

Here's a *special* high fidelity catalog that you'll find particularly useful, because we have included *only* equipment which we at MusiCraft consider the best—from the standpoint of compatibility and stable operating efficiency—in every price range.

Page after page pictures the newest high fidelity equipment with detailed information about characteristics and specifications.



MusiCraft

48-F East Oak St. • Chicago 11, Illinois • DEloware 7-4150

Lowest Prices • Largest Component Selections • Complete Custom Installation Service

ON THE COUNTER

Top of the pile this month is a release from International Scientific Industries of Colorado Springs, Colo., announcing the availability of their TAPE RECORDER. Big feature is the Isimetric drive, which is a magnetic drive giving beautiful smoothness of operation. Basic deck is the model 100, which has half-track erase, record, and playback heads. Mounting space for three additional heads; two-speed hysteresis motor (either 3¾ 7½ or 7½/15 ips); automatic cutoff; tape lifter; these are some of the many standard features. Accessories include VU meters, stereo playback kit, and 10-in. reel adaptors. Model 100 basic price is \$465.

An attractive EQUIPMENT CONSOLE is now available from Concert Cabinetry of Chicago at a net of \$119.00. Over-all dimensions are 44 in. long, 24 high, and 23½ deep. Left-hand half of lid lifts for access to changer; the sloping front panel is half covered by a sliding reed-paneled door; normal position is at right, where it covers knobs.

Sherwood's new FM-only TUNER is said to have achieved a sensitivity of 0.95 microvolts for 20 db of quieting. Other features include a new-type tuning eye, a local-distance switch, and flywheel tuning; price, \$99.50.

Minnesota Mining & Mfg. has announced a new plastic LEADER TAPE which features a special anti-static coating as well as a 50% increase in strength. Known as leader and timing tape No. 43-P, it can be written on with a ball-point pen and has markers every 7½ in. for timing purposes.

Harman-Kardon has added to its long line of components a series of four cabineted or INTEGRATED SYSTEMS. One mounts equipment and speakers in separate cabinets; the other three are all-in-one models. Price range is from \$325 to \$575.

Califone's new Commander (\$214.50) is a complete PORTABLE SOUND SYSTEM. Features include 25-watt amplifier (40 watts peak) rated at 30 to 20,000 cps ±2 db; two heavy-duty speakers; a turntable with continuously variable speed from 16 to 84 rpm; separate tone controls for

Continued on page 32

HIGH FIDELITY MAGAZINE

better
DO IT YOURSELF...

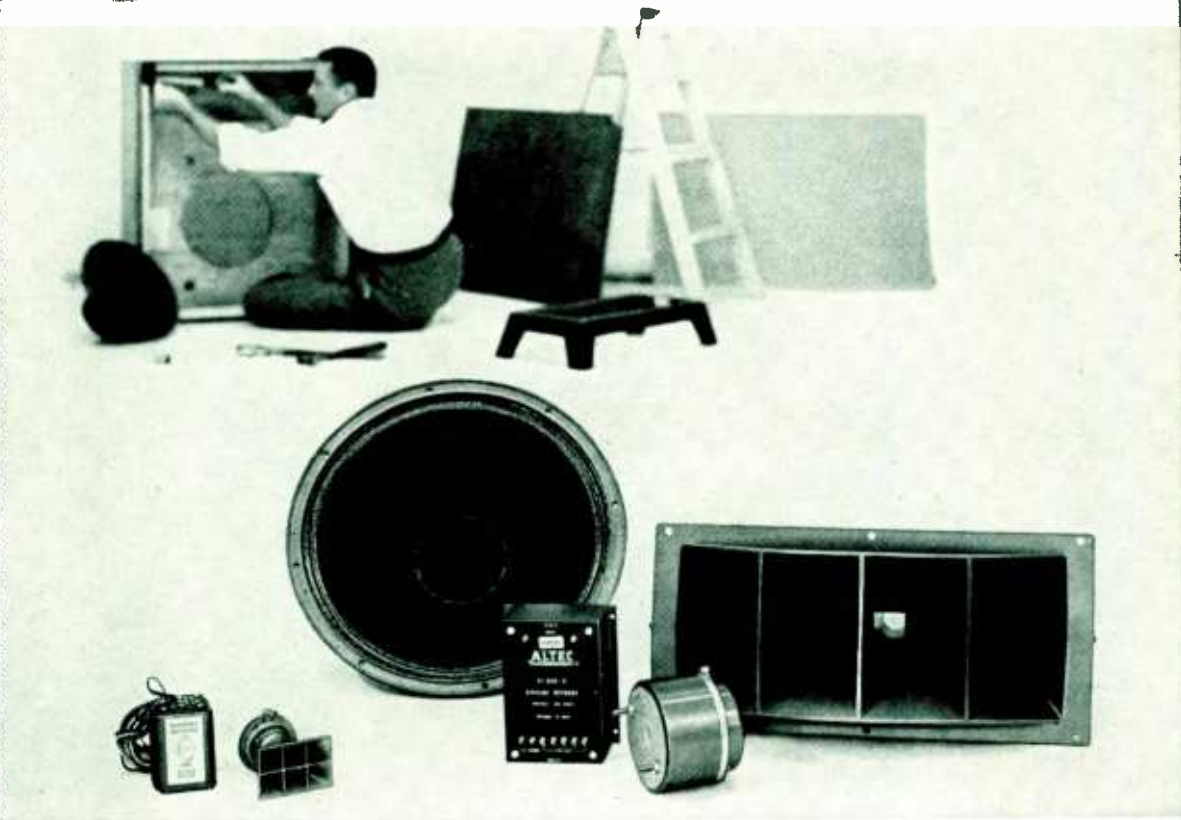

with ALTEC LANSING Components

Often there is no adequate substitute for the custom-built speaker system to answer specific needs. Altec Lansing offers a complete line of components for such speaker systems to cover the full range from 30 to 22,000 cycles. Of course every Altec speaker, driver, horn and network—like *all* Altec products—carries the exclusive Altec "Performance Guarantee"—your assurance that every piece of Altec equipment will literally *out-perform* published specifications.

To assist the custom-builder, Altec has prepared a special brochure on speaker systems, describing the proper methods of enclosure design and construction. The brochure also provides answers to special questions that will enable you to realize the full potential of your Altec home music system.

Complete Altec 2-way speaker system components are priced from \$87.00.

For the special speaker system brochure and for further information on Altec Lansing high fidelity components, see your Altec dealer or write Dept. 1H

802 DRIVER AND 811 HORN Power: 30 watts • Range: 800-22,000 cycles • Impedance: 16 ohms • Distribution: Hor., 90° vert., 40° • Dimensions: 8-5/8" H; 18-3/8" W; 16" D • Price: 802C—\$57.00, 811B—\$27.00
N-8000 NETWORK Impedance: 16 ohms • HF attenuation: 4—1 db steps • Crossover: 800 cycles • Dimensions: 8-1/2"H; 5-1/2" W; 3-1/2" D • Price: \$42.00
803 SPEAKER Power: 30 watts • Impedance: 16 ohms • Range: 30-1600 cycles • Mag. Weight: 2.4 lbs. • V.C. Diam.: 3" • Cone Res.: 45 cycles • Dimensions: Diam., 15-5/16"; Depth, 7" • Price: \$60.00
3000A HIGH FREQUENCY SPEAKER Power: 20 watts • Impedance: 8 ohms • Range: 3000-22,000 cycles • Distribution: Hor., 90° vert., 40° • Dimensions: 2-5/8" H; 2-7/8" W; 3" D • Price: \$36.00
N-3000A NETWORK Impedance: 8 ohms • HF attenuation: 2—2 db steps • Crossover: 3000 cycles • Dimensions: 3-1/8" H; 2/5-8" Square • Price: \$18.00



ALTEC FIDELITY IS HIGHEST FIDELITY

9356 Santa Monica Blvd., Beverly Hills, Calif.
161 Sixth Avenue, New York 13, N. Y.

Discovered! Something new and very fine in compact components

The moment we saw and heard these beautiful new Newcomb "Compacts" we knew immediately these were something very special we could wholeheartedly recommend to an ever growing group of discerning buyers who place their trust in The Sound Corporation. The ever increasing confidence these critical buyers show in Kierulff could not possibly come from isolated customer experiences. It can only be explained by the accumulated satisfaction of many customers over many years.

Likewise, our confidence in Newcomb products stems from many years experience with them... years that have proven time and again the meticulous care with which they are designed and manufactured... years that have proven the genuine value they represent for those who are critical by nature and who seek more than superficial value in whatever they purchase.

If you do not find it convenient to visit us in person to see the extraordinary beauty of these latest Newcomb "Compacts" and listen to the mirror-like realism of their reproduc-

tion, you can order them by mail with complete confidence... and incidentally, save yourself a lot of time and trouble.

Look at the flexibility of the Compact 1020. Separate bass and treble recording curve selectors give up to 36 possible combinations to precisely match any record curve and distortion-free wide ranging tone controls, continuously variable loudness control which gives the most accurate approximation of the normal hearing curve we have yet heard, and a "level" control to insure correctness of the loudness compensation for all conditions of use. The tuner is extraordinarily sensitive, and stability is assured by both A.F.C. and temperature controlled oscillators.

Ladies will love the Newcomb Compact units, not only for their immaculate sound, but for the feeling of luxury they add to the listening room... no dusty clutter of tubes and wires, just unobtrusive, rich elegance. The audiophile will be awed by their clean, beautifully balanced response. These components are truly something very, very special...



Power 20 watts at less than 1%
Distortion at average listening level—
less than .05%
Response within ± 1 db 20-20,000
cycles
Controls—power switch, five position
selector and rumble filter switch, six
position bass crossover selector,
bass tone control, treble tone con-
trol, six position treble rolloff selec-

tor, level control, loudness (contin-
uously variable) control, hum balance
(screwdriver slot) control.
Bass tone control range - -24 db to
+16 db
Treble tone control range - -27 db to
+16 db
Inputs—radio, microphone, low level
magnetic pickup, high level mag-
netic, crystal, tape, auxiliary.
High gain preamp permits use of most

low level pickups without trans-
former
"Output to Tape" jack permits record-
ing while listening
Finish "brushed gold" anodized face
plate and cream-colored case dusted
with gold.
Dimensions: 4 $\frac{1}{2}$ " high, 13 $\frac{3}{4}$ " wide,
9 $\frac{1}{2}$ " deep
Shipping weight 23 lbs
Net Price \$159.50

THE NEWCOMB COMPACT 1020 AMPLIFIER

The 1020 includes an integrally-engineered high gain preamplifier, pure power amplifier, precision control unit. Newcomb's exclusive, patented Adjusta-Panel mounting makes installation in a cabinet a quick and simple matter. U. L. approved.

THE NEWCOMB COMPACT 200 AM-FM TUNER



Sensitivity—FM RF stage—2 microvolts
for 30 db of quieting
AM—5 microvolts
Output (maximum)—10 volts
Distortion—less than 2-10% at 5 volts
Hum—better than 75 db below 10 volts

Oscillator radiation is certified to
be below the limit specified in
part 15 of the applicable FCC
regulations

The 200 Tuner will perform beautifully with any ampli-
fier, but its excellence can best be appreciated by
featuring it with the superb Newcomb Compact 1020
Amplifier. The exceptional sensitivity of the 200 makes
for much better reception in areas where FM signals
are poor. Flywheel tuning gives velvety smooth action.
Equipped with special multiplier output jack. A new
FM detector system with triple limiting action pro-
vides lower distortion at all modulation percentages,
better adjacent channel rejection, and more effective
limiting on weak as well as strong signals. Cathode
follower allows placement up to 200 feet from ampli-
fier. U. L. approved

Patented Adjusta-panel for simple, fast
mounting.
Dimensions 4 $\frac{1}{2}$ " high, 12 $\frac{1}{2}$ " wide,
9" deep.
Shipping weight—18 lbs.
Net Price—\$169.50.

at KIERULFF'S

The West's Largest Hi-Fi
Center—for over thirty years
a trusted name in sound.

To order by mail, simply fill
in the order blank, include
your check or money order and
we will do the rest. The price
by mail is exactly the same as
the price in our store.
Include a generous allowance
for freight or express
charges; we will promptly
refund any excess.
California buyers will, of
course, include 4% for sales
tax. Complete instructions
packed with each unit.



SOUND CORPORATION

To: KIERULFF SOUND CORPORATION Dept. W-1
820 West Olympic Boulevard, Los Angeles 15, California

Gentlemen:

Please send me the items I have checked below:

- Newcomb Compact 1020 Amplifier @ \$159.50
 Newcomb Compact 200 AM-FM Tuner @ \$169.50

Please mail to the address below:

- Catalog of Newcomb High Fidelity Sound Products.
 Other catalog sheets of record players and loudspeakers
you recommend for use with Newcomb Components.

Print or typewrite clearly:

Name _____

Address _____

My check _____

(or)

money order _____

for \$ _____

is enclosed.

ON THE COUNTER

Continued from page 30

microphone and phono channels; mixer controls for one phono and two microphone channels. For further information, write Califone Corp., 1041 N. Sycamore Ave., Hollywood 38, Calif.

A very neat-looking and clever SHIPPING and STORAGE CONTAINER for tape has been developed by Concertapes of 522 Green Bay Rd., Winnetka, Ill. Stor-A-Tape is made of rough, high-impact plastic; the case is round, large enough for a 7-in. reel but with a center pin so smaller reels can be stored equally well. Two small "feet" enable the round case to stand upright on a shelf, without rolling. A large front label and two edge labels are provided, as well as a special mailing label which serves also to seal the package firmly. — Prices not furnished.

Now available from Amplifier Corp. is a portable (15 lb.; 7 by 10 by 11 in.) TAPE RECORDER having four speeds, either: 15-7 $\frac{1}{2}$ -3 $\frac{3}{4}$ -1 $\frac{7}{8}$ or 7 $\frac{1}{2}$ -3 $\frac{3}{4}$ -1 $\frac{7}{8}$ -15/16. Motor is spring-driven. Prices not furnished.

Also in the decidedly portable category is a new PUBLIC ADDRESS SYSTEM announced by Antrex Corp. of Chicago. It uses flashlight batteries and transistors; weighs only 18 lb.; fits into an attaché case measuring 18 in. long by 14 deep by 6 wide. It is said to provide enough volume through its 8-in. speaker to be heard clearly over an area of 6,000 sq. ft. Called the "Redcap," price is \$249.50.

Shure has announced a replacement PICKUP CARTRIDGE for the Chrysler Hiway Hi-Fi system. Response is stated to be to 12,000 cps; has a 3/10-mil stylus which tracks at 2 $\frac{1}{2}$ grams.

The "Heathkits for 1957" CATALOGUE is now available. Contents: 55 pages; 70 kits including a complete line of high-fidelity equipment, amateur radio gear, and service test instruments. Included will be a new speaker kit which features two 15-in. Altec-Lansing speakers covering the range to 500 cps. Above this frequency, a multicellular exponential horn takes over. Price is \$325 and \$345 for this speaker kit, depending on style and finish. Size is approximately 41 in. long, 23 deep, and 33 high. Looks mighty interesting! — Catalogue is

Continued on page 36

R. Muesyart, Inc.

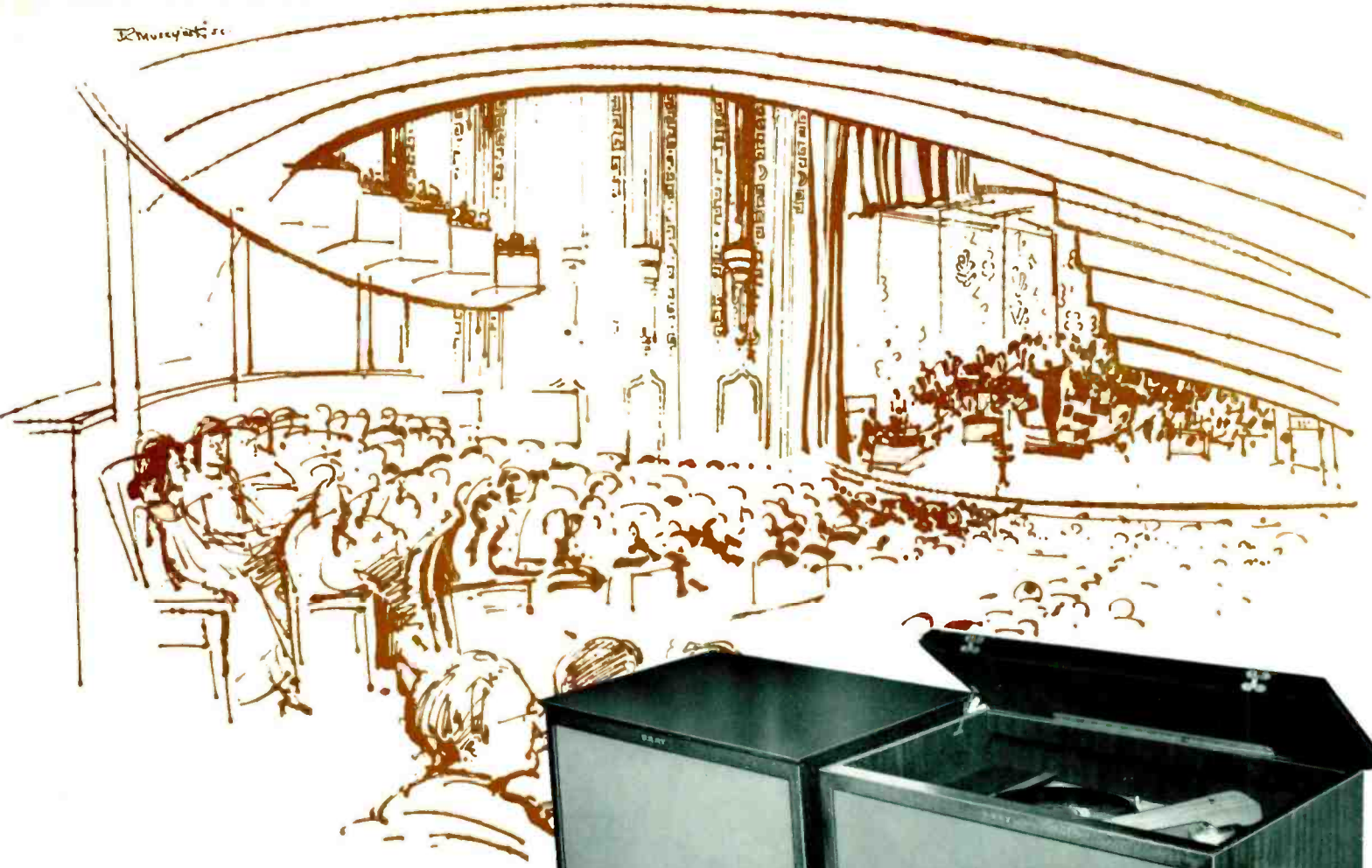

GRAY
Concert Duet

Gray "Concert Duet" in matching twin cabinets with removable legs suggests use as companion pieces or as separates. Available in walnut, blonde or mahogany.



a *Command Performance*

at your leisure . . . your fingertips . . .

Now you can buy the world's finest High Fidelity components, laboratory matched, completely assembled and mounted in the magnificently styled Gray "Concert Duet."

Includes the renowned Gray 108 C Viscous-Damped

Tone Arm, the professional type Gray transcription Turntable, the Gray 50 Watt Power Amplifier, deluxe Gray Pre-Amplifier, plus top quality speaker system. Available at exclusive dealers throughout the U. S.

[See reverse side for full details.]

GRAY RESEARCH AND DEVELOPMENT COMPANY, INC., MANCHESTER, CONN.
Subsidiary of The Gray Manufacturing Company

FIVE good reasons why an Inte-Gray-ted High Fidelity system made from laboratory matched components is superior to the trial and error method of buying and trying separate components.



1 Gray 108C Viscous Damped High Fidelity Tone Arm isolates the cartridge, provides maximum arm compliance, eliminates tone arm resonance, prevents record damage, provides preset precision stylus pressure, and cartridge adapters for all popular cartridges.



2 Gray HF 500 A Turntable with hysteresis motor assembled on $\frac{1}{4}$ " steel plate for complete rigidity, 12 lb. turntable with 4" tapered steel bearing for precision adjustment and elimination of turntable wobble. Due to the mass of turntable and motorboard (ten times that of motor) transmission of all mechanical disturbance is prevented. Cue light for accurate starting groove location. Wow and rumble superior to NARTB specifications. Speeds 33.33 RPM—45 RPM—and 78.26 RPM, accurately achieved with precision drop-on type bushings.

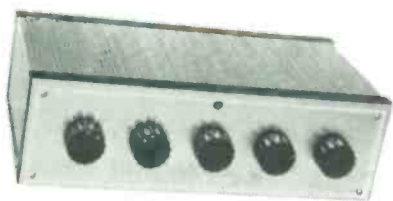

3 Gray AM-2A High Fidelity Pre-amplifier. Input for radio, TV and tape, as well as four low frequency turnover points available on selector switch. Six positions available on high frequency roll-off switch. Continuously variable, separate base and treble control of the variable cross-over negative feed-back type. Compensated type volume control, combined with ON and OFF switch. Tape output, adjustable level control, hum balanced control, (on rear of pre-amp).

Power from Gray AM 50 power Amplifier provides optimum signal to noise ratio.



4 Gray AM 50 High Fidelity 50 watt power Amplifier. Unique and trouble free circuit design. 50 watts of power with less than 1% IM distortion. Exceptional stability. Transient signals controlled through critical damping prevent oscillatory surges, from pulse type signals. Square wave distortion prevented by extremely wide band-pass characteristics. Frequency response 6 to 100,000 cycles. 100 watts peak power. Distortion due to overloading dynamically prevented. Printed circuit wiring assures long, trouble-free life.



5 Gray High Fidelity Speaker. Built for Gray by top quality nationally known speaker manufacturer (Bozak) of the total enclosure type, consisting of woofer, tweeters and cross-over network assembly. Enclosure approximately 7 cubic feet in volume assuring smooth, low frequency response to the lower end of the audio spectrum.

Separate speaker enclosure provides maximum flexibility for placement to eliminate acoustical feed-back.

these
are the
features

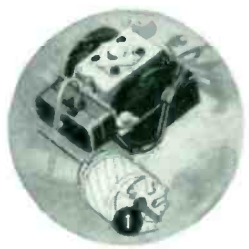

1. 4-POLE SHADED "INDUCTION SURGE" MOTOR gives this changer constant speed with minimum vibration. Will not cause hum even with sensitive pickups. The rotor is dynamically balanced!

2. FULL MANUAL POSITION: Just touch the switch and tone arm is freed for manual play. Returns automatically to its rest at end of record.

3. ADVANCED GARRARD PUSHER PLATFORM: After twenty years still the only device insuring positive, gentle handling of all records, any diameter, thickness or condition of center hole.

4. PERFECTED TRUE-TURRET DRIVE operates directly off motor without belts. Combined with an oversized "soft tread" idler wheel, it gives you unflinching speed without wows or flutter.

5. INTERCHANGEABLE SPINDLES (Manual and Automatic) insert easily, remove instantly. Note that the Garrard one-piece spindle has no moving parts to nick or enlarge center holes.

6. EXCLUSIVE TRUE-TANGENT TONE ARM OF ALUMINUM plays better, provides rigidity, low mass and lightness... It has the easiest stylus pressure adjustment on any changer.

7. HEAVY STEEL PRECISION TURNTABLE with genuine rubber traction mat. A full inch high! Eliminates magnetic hum by strengthening motor shielding. Turns on silent, free-wheeling ball-bearing mount.

8. EXCLUSIVE SENSIMATIC TRIP MECHANISM gives you sure operation even with tone arm set at lowest tracking pressures. Automatic stop after last record.

9. INTERCHANGEABLE PLUG-IN HEADS accommodate your personal choice of high fidelity pickups, fit all cartridges... magnetic, crystal or ceramic; turnover, twist or simple plug-in types.

10. REINFORCED AUTOMATIC MUTING SWITCH eliminates sound through speaker during record change cycle. Also, a special condenser-resistor network eliminates shut-off noise.

that have
made it

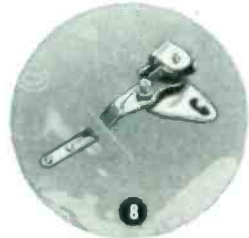
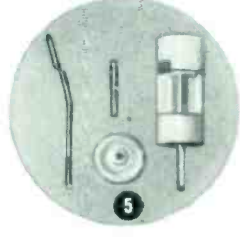

...and
kept it

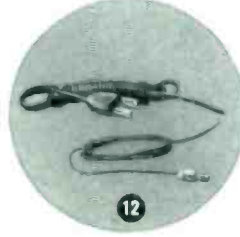
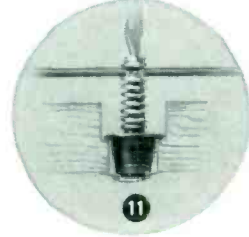
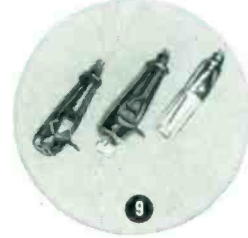

The
WORLD'S
FINEST!

Model **RC 88** *Triumph II*

GARRARD

De Luxe Auto-Manual Record Changer



11. STEEL MONO-BUILT UNIT PLATE keeps changer permanently in line. Exclusive snap-mount springs permit you to mount changer instantly, level it from top with screwdriver.

12. CHANGER COMES READY FOR PLUG IN to any system of high fidelity components. Supplied with full 5 ft. U.L.-approved electrical line cord, and pick-up cable terminating in standard jack.

\$54.50 net
less cartridge

- 
301
Turntable
\$89.00
- 
RC98
Super Changer
\$67.50
- 
RC121
Mixer Changer
\$42.50

Model T
Manual Player
\$32.50

MAIL THIS COUPON for illustrated B.I.C. High Fidelity Plan Book.

Garrard Sales Corp., Dept. GA-27
Port Washington, N. Y.
Send B.I.C. High Fidelity Plan Book.

Name.....
Address.....
City.....Zone.....State.....

Now there's a GARRARD for every high fidelity system! Quality-endorsed product of the B.I.C. Group

Introducing

DFF

DUOTONE FIDELITY FOCUS
Loudspeakers

The SUPREME

15 in. Woofer
Cat. No. 15W-92
Power 25 watts

New Engineering Technique Assures You—Bell-Clear Highs; Vibrant-Undistorted Lows.

DUOTONE—For a quarter of a century, leader in the high fidelity industry, presents for the first time, DFF, DUOTONE FIDELITY FOCUS LOUDSPEAKERS. A new high in manufacturing standards and procedures assures you of a superb quality seldom found in most other loudspeakers. Rigid specifications adhered to and exacting field trials were made before this fine line was presented to the public. It was only the results of these exhaustive tests that assured us of a product worthy of the HI-FI enthusiasts interests. Whether you choose a coaxial speaker such as the Royal or Medalion, or a woofer-tweeter combination like the Supreme and the Duchess, you will be more than satisfied with the excellent response these speakers afford. Stop into your HI-FI dealer's showroom and ask to hear them. Your reward will be the self-satisfaction of hearing excellent high fidelity sound reproduction. There's a DUOTONE FIDELITY FOCUS LOUDSPEAKER to match your system and they are priced to \$53.97.

Write today for our FREE new booklet, "An Objective Study of Loudspeakers". It's designed to help you choose and install your speaker system.

<p>12 in. Coaxial Cat. No. 12CX-62 35 to 18,000 cps. Power: 25 watts Magnet Wt. 1.5 lbs. Efficiency: 14% Res. Freq.: 45 cycles Impedance 8 ohms</p>	<p>The ROYAL</p> 	<p>12 in. Coaxial Cat. No. 12CX-60 35 to 18,000 cps. Power: 15 watts Magnet Wt. 6.8 ozs. Efficiency: 7% Res. Freq.: 45 cycles Impedance 8 ohms</p>	<p>The MEDALION</p> 
<p>The MARQUIS</p> 	<p>8 in. Coaxial Cat. No. 8CX-50 50 to 20,000 cps. Power: 10 watts Magnet Wt. 6.8 ozs. Efficiency: 10% Res. Freq.: 60 cycles Impedance 8 ohms</p>	<p>The VISCOUNT</p> 	<p>8 in. Coaxial Cat. No. 8CX-70 75 to 19,000 cycles Power: 6 watts Magnet Wt. 2.6 ozs. Efficiency: 6% Res. Freq.: 85 cycles Impedance 4 ohms</p>
<p>4 in. Tweeter Cat. No. 4-TX 1000 cycles to beyond audibility Power: 5 watts Magnet Wt. 3.16 ozs. Impedance 8 ohms</p>	<p>The DUKE</p> 	<p>7 in. Tweeter Cat. No. 7-TX 350 cycles to beyond audibility Power: 10 watts Magnet Wt. 6.8 ozs. Impedance 8 ohms</p>	<p>The DUCHESS</p> 

DUOTONE COMPANY INC.
KEYPORT, NEW JERSEY
Exp. Div., Singer Products Co., N. Y., N. Y.

ON THE COUNTER

Continued from page 32

free; write Heath Co., 305 Territorial Rd., Benton Harbor, Mich.

Irish (i.e., Orradio Industries) has a TAPE REEL gimmick which is so simple it makes you wonder why you didn't think of it. It's a "no-spill" reel, made that way by the cutting of two notches on opposite ends of the reel. Slip an elastic band around the reel, through the notches, and . . . no spill, no more.

Permo has announced a new pricing schedule for its Fidelitone DIAMOND NEEDLES, bringing the price down to \$16.95 and up. This, it is stated, "is a reduction of approximately 35% from the generally accepted diamond pricing in the industry."

Ronette has announced a new MICROPHONE, called the Ronomike. It is high impedance; sensitivity stated to be -55.4 db; and (we quote) "the flat response from 30 to 10,000 cycles is peak-free when matched to a 1/2 to 1 megohm input of a triode stage." Price not stated.

Keroes Enterprises, 369 Shurs Lane, Philadelphia 28, Pa., has issued a BOOKLET which presents a detailed study of the theory and operation of the "Ultra-Linear Circuit." Cost is 25¢ per copy.

AUTHORitatively Speaking

Philip Lieson Miller, whose peripatetic interview with Roberto Bauer, famous acoustical record collector, begins on page 60, is assistant director of the Music Division of the New York Public Library, and Curator of the Library's Record Archive. He has reviewed records in almost any periodical you care to mention, and is author of *Vocal Music*, Vol. II of Knopf's *Guide to Long Playing Records*. Trained as a singer, he became something of an expert on art songs, particularly German and old English varieties, but nowadays does more listening than singing.

H. W. Heinsheimer, author of "Arotnt Thee, Obtrusive Melody!" (page 62), is a former Austrian music editor and publisher who is now a New York music editor and publisher (G. Schirmer's). He has written widely on music, his best-known efforts probably being two very amusing books: *Menagerie in F Sharp* and *Fanfare for Two Pigeons*.

Norman H. Crowhurst, who dissects stereophonic theory gently on page 57, is a bearded gentleman (or amateur Schwepesman) trained in electrical engineering and now occupied about equally in writing technical articles and serving as a manufacturers' consultant (one manufacturer wanted to make lifelike robot dolls). Proudest accomplishment: setting up an electronics curriculum for the University of London.

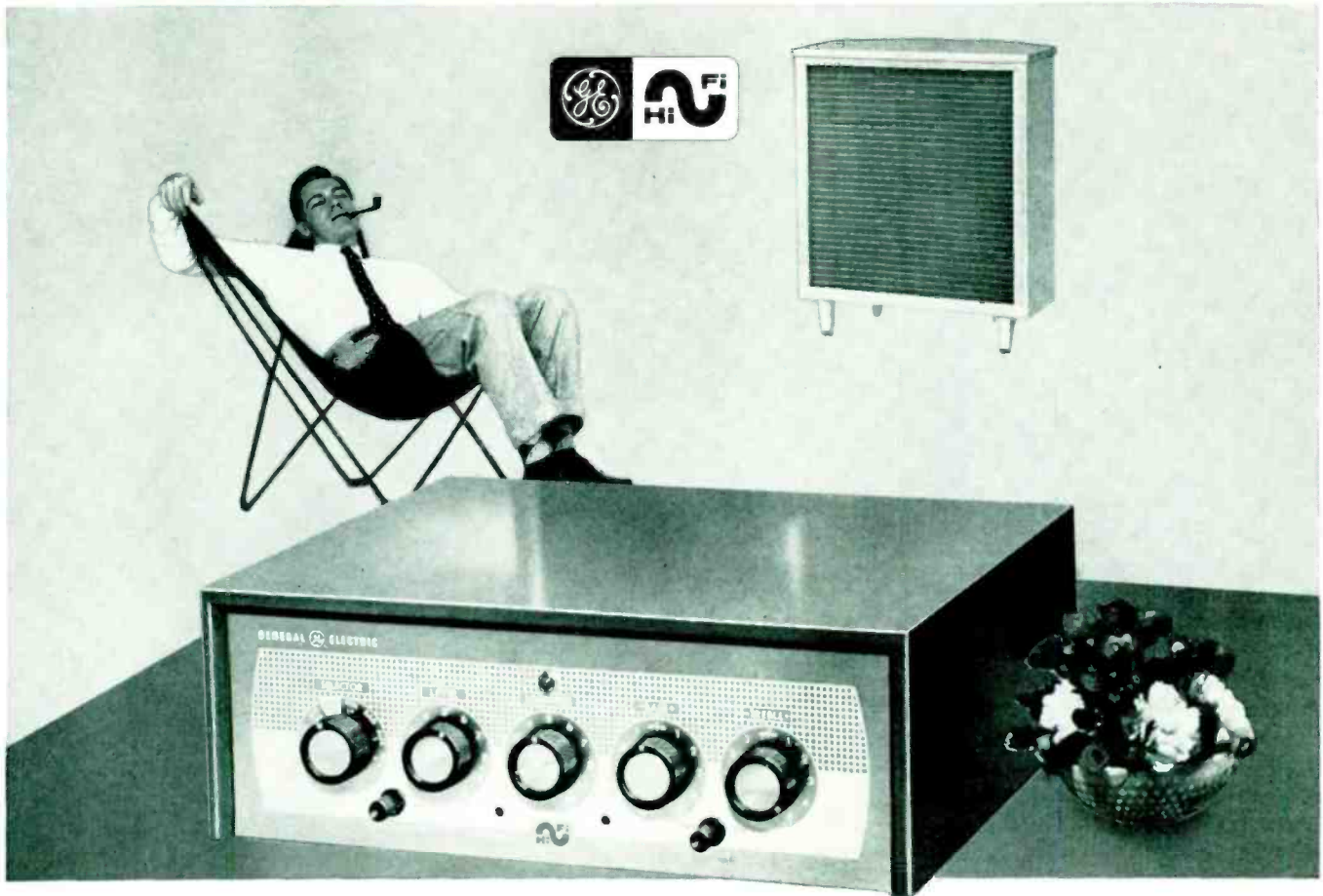

New "Convertible" 20-watt Amplifier and Pre-Amp with controls, in one versatile unit, only \$99⁹⁵

THE new General Electric Convertible is a dual-chassis design. In a single, amazingly flexible and low cost unit there's a powerful amplifier, with 20 watts of undistorted output —plus a pre-amplifier with seven panel-mounted controls. It gives you sound reproduction as it was meant to be heard.

There's New Installation Flexibility, too! With the General Electric dual-chassis design, the ampli-

fier and pre-amp may be mounted independently in built-in systems. Or, as one complete unit, the handsome Convertible cabinet may be placed on a bookshelf or table.

Write today for new hi-fi ideas and the name of your dealer. He can show you the full line of G-E Hi-Fi components. *General Electric Company, Special Products Department, Section R 5417, Electronics Park, Syracuse, New York.*

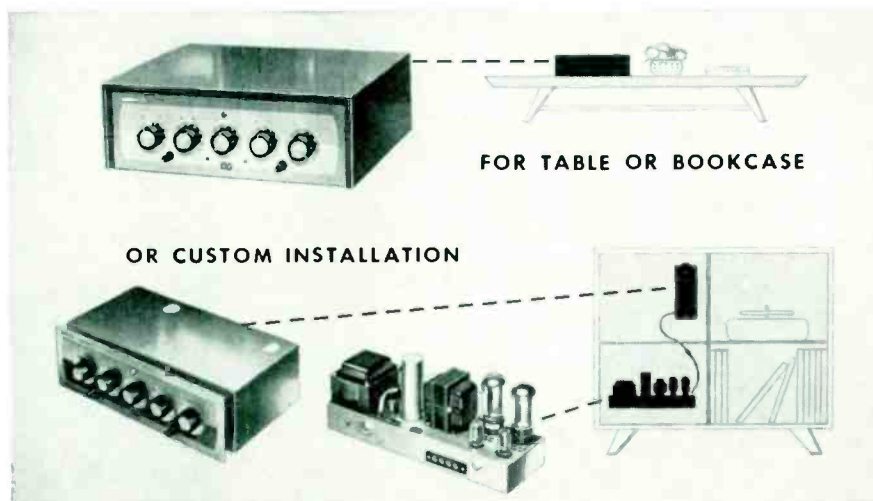

*Progress Is Our
Most Important Product*



GENERAL ELECTRIC

the distinguished

BOZAK B-400

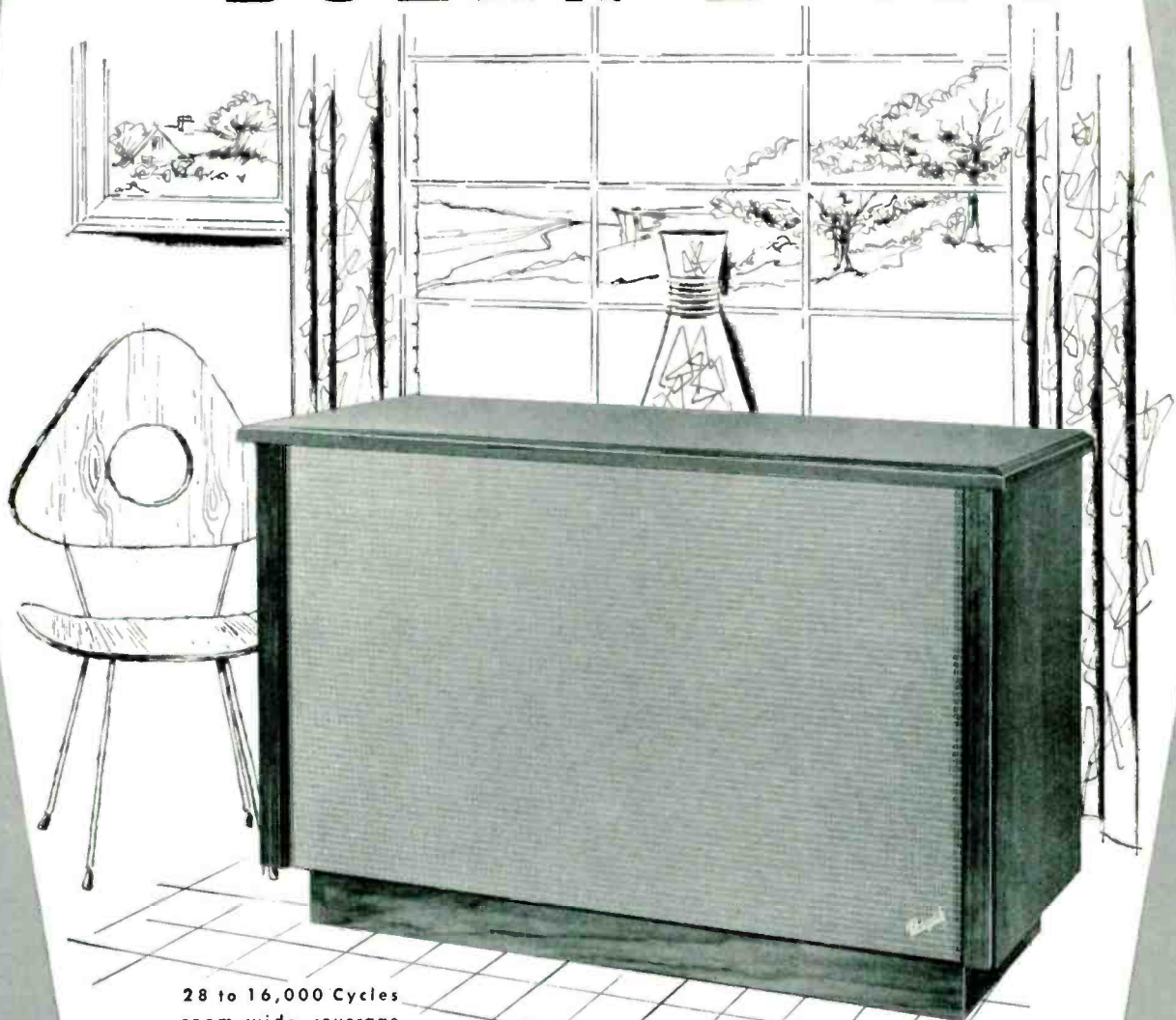

28 to 16,000 Cycles
room-wide coverage
8 Ohms — 50-60 Watts

Fourteen Bozak Loud-
speakers — four Bass, two
Mid-Range, eight Treble
— with infinite baffling to
preserve their unrivalled
precision, balance, purity.

For the first time — a lowboy Speaker
System that is distinguished for both
its quiet elegance and its superb sound.

The Very Best in Sound

THE R. T. BOZAK SALES COMPANY

BOX 966 • DARIEN • CONNECTICUT
EXPORTS: ELECTRONICS MANUFACTURERS'
EXPORT COMPANY, PLAINVIEW, NEW YORK



Books in Review

I DOUBT whether anyone ever can read a good autobiography with detached objectivity. I may be quite naïve in the special relish I find in simultaneously paralleling another's life and my own, spellbound by the marvel of both how alien and akin they can be; but apparently that naïveté is widely shared — for what else can account not only for the general popularity of autobiographies, but the special attraction they hold even for individuals who read comparatively few books or at least few in which they can find so much which is personally meaningful?

It doesn't seem to matter who or how important the autobiographer is, or what particular environments he has come from and moves in. The autobiographer need not try to "tell all" (a manifest impossibility, anyway), but he must tell what he has felt and thought most deeply; and, whatever his external adventures may have been, he must make his reconsiderations of them both articulate enough to be clearly grasped and significant enough to be eagerly shared.

Personal History of a Listener

That is just what Vincent Sheean does in what is described as "an autobiography of his life in music," *First Love and Last* (Random House, \$4.75), and it is what makes the musical experiences and opinions of a man hitherto unknown to me not only deeply absorbing in themselves, but also provocative of fresh re-examinations of my own views. Many other readers will be already interested in Sheean through his *Personal History*, one of the most influential mind-shaping books of the Thirties; many may be drawn to the present volume by the promise of reminiscences of his personal idols and friends, Lotte Lehmann, Toscanini, and other celebrities; still others will be attracted by his first-hand reports of some of the outstanding musical events of our era. But all these lures have meant much less to me than following Sheean's

self-study of his preoccupation with the "most decisive, the most normative and enduring" of his "various and cumulative discoveries," that of "the 'impure' form, the quasi-musical and quasi-dramatic, the distinctly literary and indirect invention known as opera."

Now, I long have been preoccupied myself with one of the most curious dichotomies in all musical experience: what I believe is the sheerly instinctive compulsion of listeners to orient themselves in response to the polar magnetisms of the human voice and of instruments. Certainly no serious listener can plausibly claim that vocal music is more — or less — important than instrumental music, even if he is frank enough to confess that he "likes" one better than the other. Nevertheless, it seems almost invariable that every completely honest investigation of any individual's growth in music clearly reveals one type as the *innate* and the other as the *acquired* taste. And no matter how complete eventual reconciliation may be, the original bias usually colors one's "final" views to a considerable extent.

Hence, it is intriguing and illuminating, for someone like myself, for instance, whose crucial first introductions to the tonal world were via instrumental music, to relive by proxy the young Sheean's electrifying initiation into the delights of listening by way of Midwestern Chautauqua singers and those of the Illinois Theatre and Chicago Opera Company — which drew him as compulsively in his student years as Boston's Symphony Hall did me in mine. In the end, of course, all roads lead to the Rome of the eternal, protean masters. But here, as in comparing many another Pilgrim's Progress with one's own, one discovers anew that the richest delights are perhaps not so much in united worship of the supreme masterpieces as in the recognition, in retrospect, how even the most radically different approaches inevitably bring us all to much the same goal.

Whatever the course of your own

musical coming-of-age, then, you cannot fail to be engrossed in Sheean's. You may or may not envy his later familiarity with professional greats and near-greats, but you surely will admire the efforts of a man who has lived a fantastically active "outer" life to analyze the significant role the art has played in his inner life. And you are sure to find his stories of childhood in a Midwestern small town and of youth in Chicago deeply touching evocations of a forever-lost essence of Americana.

There are other fine things in his book: not least among them his stress on the value of even amateurish score-following as an enhancement of one's record-listening satisfactions; his discerning study of the singular appeals of the Old Pied Piper of Bayreuth and their perversions in Hitlerite Germany; and his heart-warming solution of the uncomfortable problem of listeners' attitudes toward artists accused — rightly or wrongly — of fascist collaboration. There are other emphases, to be sure, which I for one find less sympathetic: notably his depreciation of the harpsichord repertory and indeed his seeming lack of any affinity for pre-Bach music in general — not to mention his insistence on the superiority of public performances over rehearsals and audience-less music making. But as a thoughtful listener and — in the finest sense of the much abused term — music lover, Sheean cannot be read without galvanizing one into fresh thinking about one's own musical attitudes and rewards.

Divas in Fantasy and Reality

Unfortunately, not all musical autobiographers are as self-analytical, as honest, and as discerning as Vincent Sheean. Few others write as well, either; but then one would hardly expect, for example, a one-time prima donna's prose to command as much appeal as either her singing or dramatic ability. Yet, as a matter of

Continued on next page

no other Quality Speaker offers so much for so little



World Famous for consistent good sound
...unequalled Quality features and LOW COST!



LORENZ LP 312
12" WIDE-RANGE LOUSPEAKER

A quality, dual-purpose speaker. Can be used as wide-range reproducer or woofer unit in expanding system. **FEATURES:** EXTRA heavy magnet, long magnetic path, small air gap, long voice coil, non-resonant frame, perfect gap alignment and multi-parameter, tropicalized cone.

SPECIFICATIONS: Impedance — 16 ohms at 800 cps; Response — below 20 to above 14,000 cps; Output — 25 w average, 35 w peak; Magnet Wgt. — 61.5 ozs; Voice Coil Diam. — 1½"; Baffle Opening — 10¾"; Depth — 6¾"; Frame — heavy duty cast aluminum girder construction. **net 39.50**



LORENZ TB-1 and TB-2
TWEETER COMBINATIONS
For all 12" speakers.

Completely assembled and ready for installation. Fits across 12" speakers with out projecting beyond front of speaker mounting baffle. Specially designed steel bracket supports tweeter(s) coaxially. Rigid metal construction discourages resonance in speaker or tweeter.

TB-1 (bracket with single tweeter) **net 11.85**
 TB-2 (bracket and two tweeters) **net 21.69**



LORENZ LP 208
8" WIDE-RANGE LOUSPEAKER

Versatile, 3-purpose reproducer. Designed as wide-range speaker alone or in groups, as high or low end of 2-way system, or as mid-range unit in 3-way system. **FEATURES:** extra heavy Alni magnet, perfect gap alignment, tropicalized cone, oversized voice coil, small air gap, non-resonant frame. **SPECIFICATIONS:** Impedance — 8 ohms at 800 cps; Response — 35 to 14,000 cps; Output — 15 w average, 21 w peak; Magnet Wgt. 28.5 ozs; Voice coil Diam. — 1"; Overall Diam. — 8½"; Baffle Opening — 7¼"; Depth — 4"; Frame — heavy duty cast aluminum girder construction. **net 19.95**



LORENZ LP 312-1 and LP 312-2
12" COAXIAL AND DIAXIAL SPEAKERS

Extended response coaxial or diaxial speakers are obtained by adding Lorenz TB-1 or TB-2 Tweeters to Lorenz 12" wide-range reproducers.

SPECIFICATIONS	LP 312-1	LP 312-2
Impedance (at 800 cps):	16 ohms	16 ohms
Response:	20-17,000	20-17,000
Output:	27 w	27 w
Overall Diam.:	12¼"	12¼"
Baffle Opening:	10¾"	10¾"
Depth:	6¾"	7½"

Price: **net 49.50 net 59.50**
(includes HP-1 Hi Pass Filter)



LORENZ LP 65
HORN-TYPE TWEETER

Fits any enclosure or speaker without the usual interaction. **FEATURES & ADVANTAGES:** solid back permits wide application; round cone design assures even sound dispersion; soft plastic construction prevents metallic overtones. **SPECIFICATIONS:** Impedance — 5.5 ohms at 800 cps; Response (with High Pass Filter HP-1) — 2,000 to 17,000 cps; Sound Dispersion — 120° (in all directions); Output — 2 w; Outside Diam. — 2½"; Cone Diam. — 2¼"; Baffle Mounting Hole — 2¼" flared to 2½" or more. **net 8.50**



LORENZ HP-1
HIGH PASS FILTER

For use with any tweeter. Introduces highs at rate of 3 db per octave starting at 2,000 cps, with nominal crossover at 5,000 cps. Effect increases smoothly to limit of audibility. Installed within speaker enclosure. **DIMENSIONS:** Overall height 2¾"; Mounting (square base) — 1½" between hole centers. **net 4.95**

Exclusive U.S. Distributors **Kingdom PRODUCTS, Ltd.** See and Hear Them At Your Hi-Fi Dealer Now!
 514 Broadway, New York 12, N. Y. • WOrth 6-0800

BOOKS IN REVIEW

Continued from page 40

is admirably free from the stage-door-Johnny breathlessness which commonly prevails. Yet it remains primarily of interest to opera buffs and (except perhaps for its descriptions of the mechanics of broadcasting actual Met performances) is hardly calculated to arouse non-operatically-minded listeners to any burning consciousness of how much they may be missing.

Opera Lovers' Companion...

Those who are interested in opera, as well as the real *aficionados*, may, however, find useful *Introduction to Opera*, edited by Mary Ellis Peltz (Barnes & Noble, paperback, \$1.65), which appears to be a revised and enlarged reprint of *Opera Lovers' Companion* (Ziff-Davis, 1948). The bulk (277 pages) of this book is devoted to documentations (including synopses of the plots) and discussions of some 40 operas from *Aida* to *Die Zauberflöte*. (The ordering by title rather than composer may be significant—at least from a music rather than opera lover's point of view.) As in the earlier edition, most of these annotations (23 to be exact) are supplied by Herbert F. Peyser, while some nine other writers provide the rest. The novel feature of the present paperback edition is a 52-page "guide" to LP recordings of the same 40 operas, in which C. J. Lutten discusses the various disk versions in considerable detail, with notable perceptivity, and (decidedly surprising in a book of this sort) a firm sense of critical values. This section is a definite bonus attraction to a handbook which—by the standards of its ilk and those of the apparently enormous audience which exists for that ilk—is a "must" at a bargain price.

... And a Key to Operatic Drama

In any larger perspective than that of footlight-dazzled fans, the trouble with all opera "introductions," "companions," and "stories" is that they touch only the surfaces and peripheries, never coming to grips with basic aesthetic problems nor advancing any really convincing explanations of the unique appeals and potentialities of this perhaps bastard, but certainly—at its best—transcendental art. A

Continued on page 46

Modern High Fidelity by

Born of 37 Years of Electronic Experience



CHOOSING YOUR AMPLIFIER

Power Output, Frequency Response and Distortion

The most flaunted amplifier features in the world — *high power output, wide frequency response, low distortion* — are virtually meaningless terms unless they are interrelated. Specifications that fail to show this relation, say nothing, and can be quite deceptive.

An amplifier that claims "20 watts of audio power — 20 to 20,000-cycle frequency response — and less than 1% harmonic distortion" may have them all. But, there is nothing to indicate any relationship among them. The distortion may be "less than 1%" ... at 2 watts, and only between 50 and 8000 cycles, beyond and below which the distortion may rise appreciably. At 20 watts the distortion may be as high as 10%. Who knows? The 'facts' are not facts.

Here for example, are the vital specifications of two new Pilot amplifiers with built-in preamps. Note how they are stated. There isn't the slightest chance for misunderstanding.

Both amplifiers have built-in preamps with equalization for tape-head playback as well as for records. Other features include: variable phono input impedance, independent bass and treble tone controls, rumble and scratch filters, separate loudness and volume controls, tape recorder output and use of hum-free dc on tube heaters.

	AA-903B (illustrated)	AA-920
Power Output	14 watts	20 watts
Total Harmonic Distortion at Rated Output	less than 1%	less than 1%
Intermodulation Distortion at Rated Output	1.5%	1.5%
Frequency Response at Rated Output	20-20,000 cycles ± 1db	20-20,000 cycles ± 1db
Price	\$79.95	\$99.50

prices slightly higher west of Rockies

There is a promise of performance in these statements upon which you can really rely in choosing your amplifier — a promise that will be fulfilled the very moment the amplifier is turned on in your high fidelity system.

And, as an added reward for your choice of Pilot, you will enjoy styling that will always bring admiring comment when shown off in your home — handsome metal enclosures finished in contrasting burgundy and burnished brass. A Pilot Amplifier alongside a Pilot Tuner make an attractive pair on an open shelf or table.



At your hi-fi dealer, or write for complete specifications to Dept. F.A-2

RADIO CORPORATION 37-06 36th Street, Long Island City 1, N. Y.
IN CANADA: Atlas Radio Corp., 50 Wingold Avenue, Toronto 10, Ontario



Everything looks better with

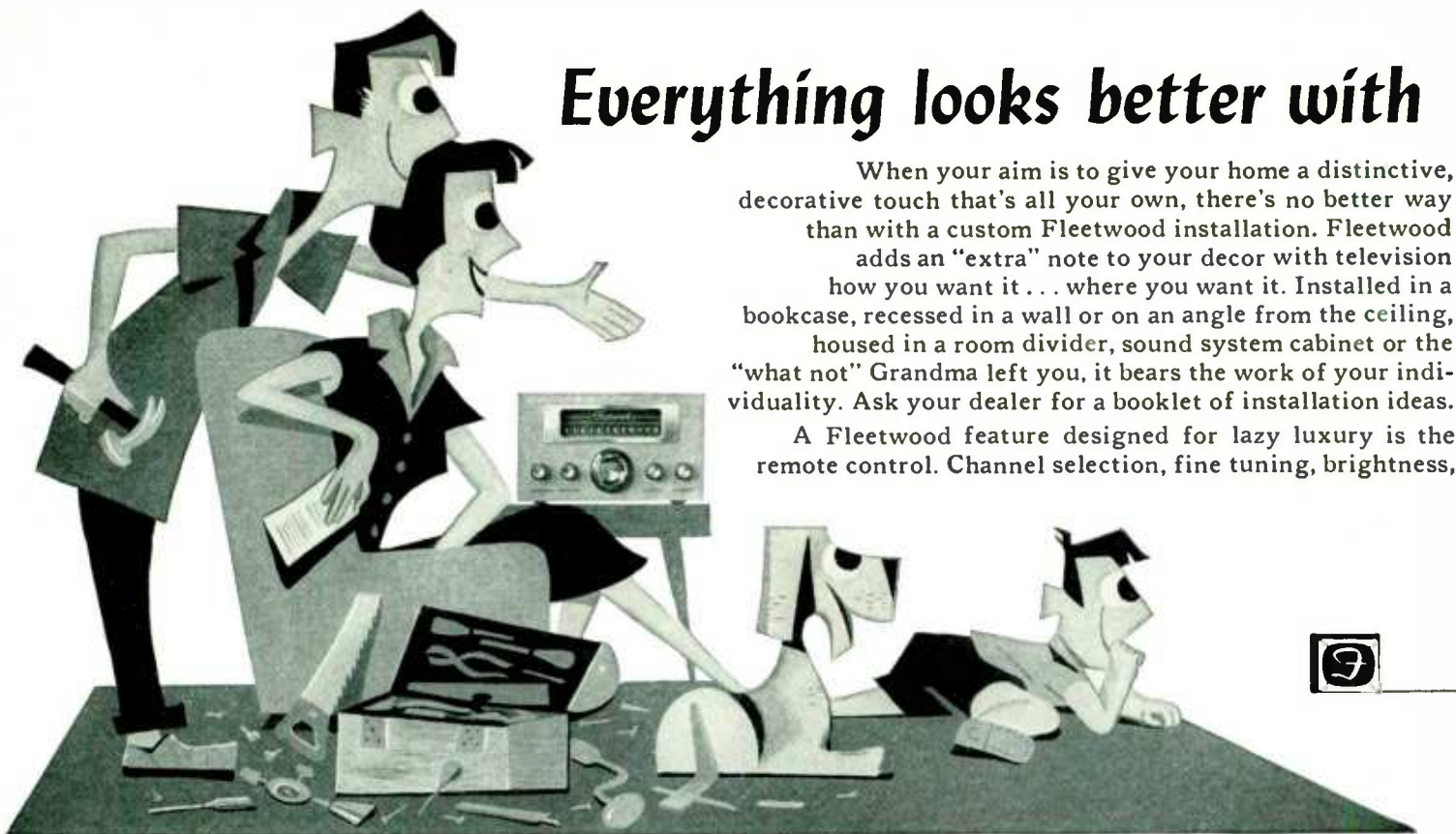

When your aim is to give your home a distinctive, decorative touch that's all your own, there's no better way than with a custom Fleetwood installation. Fleetwood adds an "extra" note to your decor with television how you want it . . . where you want it. Installed in a bookcase, recessed in a wall or on an angle from the ceiling, housed in a room divider, sound system cabinet or the "what not" Grandma left you, it bears the work of your individuality. Ask your dealer for a booklet of installation ideas.

A Fleetwood feature designed for lazy luxury is the remote control. Channel selection, fine tuning, brightness,

ARIZONA

AUDIO SPECIALISTS

333 East Camelback Road, Phoenix
Phone: AMherst 5-0447

ELCO ELECTRICAL COMMUNICATION CO.

202 East Fillmore, Phoenix
Phone: ALpine 2-8248

NILES RADIO & TV CENTER

400 N. 4th Avenue, Tucson
Phone: MA 3-2537

CALIFORNIA

THE AUDIO WORKSHOP

2211 Camino Del Reposo, La Jolla
Phone: GLencourt 4-5378

BUSHNELL ELECTRONICS

12026 Wilshire Blvd., Los Angeles 25
Phone: BRadshaw 2-7537

CRENSHAW HI-FI CENTER

107 Santa Barbara Plaza, Los Angeles 8
Phone: AXminster 3-8201

MIDWAY ELECTRONIC SUPPLY CO.

2817 Crenshaw Blvd., Los Angeles 16
Phone: REpublic 1-2451

BUSHNELL'S HARBOR HI-FI

3333 Newport Blvd., Newport Beach
Phone: HARbor 4681

VALLEY CUSTOM SOUND

5148 Lankershim Blvd.,
North Hollywood
Phone: POplar 2-4184

GENERAL ELECTRONICS

4156 Piedmont Ave., Oakland
Phone: OLYmpic 5-2711

BAY ELECTRONICS

2205½ Redondo Beach Blvd.,
Redondo Beach
Phone: OREGon 8-4668 FR 9-9446

HOLLYWOOD HI-FI

1839 E Street, San Bernardino
Phone: 8-36101

GRACIE'S RECORDS

304 West Third Street, Santa Ana
Phone: KI 3-2684

HI-FI HAVEN

442 So. Greenleaf Avenue, Whittier
Phone: OXFord 414112

COLORADO

ALLEGRO MUSIC SHOP, INC.

262 Fillmore, Denver
Phone: EAST 2-1869

CONNECTICUT

DAVID DEAN SMITH

262 Elm Street, New Haven 11
Phone: UNiversity 5-1101

DISTRICT OF COLUMBIA

CUSTOM HI-FI

1612 Connecticut Ave., N.W.,
Washington
Phone: HUDson 3-3336

SHRADER SOUND, INC.

2803 M Street, N.W., Washington 7
Phone: ADams 4-4730

FLORIDA

GRICE RADIO & ELECTRONIC SUPPLIES, INC.

300 E. Wright Street, Pensacola
Phone: HEMlock 3-4616

BURDETT SOUND & RECORDING CO.

3619 Henderson Blvd., Tampa
Phone: 73-6091

GEORGIA

BAKER FIDELITY CORP.

1140 Peachtree St., N.E., Atlanta
Phone: EMerson 2156

ILLINOIS

THE NEW SOUND

35 E. Springfield Ave., Champaign
Phone: 6-119

ALLIED RADIO CORPORATION

100 N. Western Ave., Chicago 80
Phone: HAYmarket 1-6800

ELECTRONIC EXPEDITERS, INC.

THE HI-FI CENTER
2909 West Devon Ave., Chicago 45
Phone: RO 4-8640

INDIANA

THE GOLDEN EAR, INC.

15 East 16th St., Indianapolis
Phone: MELrose 5-4915

THE GOLDEN EAR, INC.

610 Main Street, Lafayette
Phone: 2-2917

IOWA

WOODBURN SOUND SERVICE

218 East College St., Iowa City
Phone: 8-0151

KANSAS

PHIL WOODBURY SOUND

1103 Commercial, Emporia
Phone: 20

PLAZA TELEVISION

1408 Huntoon, Topeka
Phone: 25007

THE BENNETT MUSIC HOUSE

East Central at Oliver, Wichita
Phone: MURray 2-6578

KENTUCKY

J. M. HISLE AND ASSOCIATES

405-9 South Upper Street, Lexington
Phone: 2-7884

THE GOLDEN EAR, INC.

610 South 3rd Street, Louisville
Phone: CL 4531

LOUISIANA

CUSTOM ELECTRONICS, INC.

4215 S. Claiborne Ave.,
New Orleans 25
Phone: TWInbrook 1-5874

MICHIGAN

AUDIO HOUSE, INCORPORATED

19771 Conant at State Fair E.,
Detroit 34
Phone: TWInbrook 3-3358

K.I.A. LABORATORIES, INC.

7422 Woodward Avenue, Detroit 2
Phone: TRinity 4-1100

R. L. KARNS ELECTRONICS

910 E. Fulton Street, Grand Rapids 3
Phone: GLendale 8-5869

WEST MICHIGAN SOUND CO.

1932 Peck Street, Muskegon
Phone: 2-5910

MINNESOTA

AUDIO EQUIPMENT COMPANY

Highway 65 & St. John Ave.,
Albert Lea
Phone: 3568

AUDIO KING COMPANY

1827 East Lake Street, Minneapolis 7
Phone: PARKway 9-7451

MISSOURI

DAVID BEATTY HIGH FIDELITY SOUND & TV

1616 West 43rd, Kansas City 11
Phone: JEFFerson 1-3109

THE HIGH FIDELITY SHOWROOM, INC.

6383 Clayton Road, St. Louis 17
Phone: PARKview 1-6500

NEW JERSEY

M. & M. ELECTRONICS & TELEVISION CO., INC.

7 Maple Avenue, Morristown
Phone: JEFFerson 8-5274

THE JABBERWOCK

396 George Street, New Brunswick
Phone: CHARter 9-1900

MUSIC AGE, INC.

171 Route #4, Paramus
Phone: DIAMond 3-8200-1

CASEY HI FI INSTALLATION CO.

205 W. Englewood Ave.,
W. Englewood
Phone: TE 6-4200

Free booklet



of installation ideas available from

Fleetwood TELEVISION

contrast, volume, and picture definition are controlled at your chairside. Sound may be played through your high fidelity system.

The picture looks better, too. Fleetwood gets it better — brilliant, sparkling, clear as a professional photographic enlargement* Fleetwood's exclusive definition control lets you adjust the picture to your tastes — soft and diffused or clear and hard. Ask your dealer for a demonstration of this remarkable control.

No matter how you consider it—decor, convenience, picture quality—everything looks better with Fleetwood Television.

**See tested in the Home Report, October 1955 High Fidelity*

Fleetwood®

Crafted by CONRAC, INC. • Department A • Glendora, California

Export Division: Frazar and Hansen Ltd., 301 Clay Street, San Francisco 11, California

©Conrac, Inc. 1956 — CONRAC is the Canadian Name for Fleetwood.



NEW YORK

BUFFALO AUDIO CENTER
161 Genesee Street, Buffalo 3
Phone: MOhawk 1368

NEWMARK & LEWIS, INC.
43 Main Street,
Hempstead, L. I.
Phone: IVanhoe 1-6890

THE AUDIO EXCHANGE, INC.
159-19 Hillside Ave., Jamaica 32
Phone: AXtell 7-7577-8-9

HOUSE OF HI-FI
606 Plandome Road, Manhasset, L. I.
Phone: MA 7-1376

ARROW ELECTRONICS, INC.
65 Cortlandt Street, New York 7
Phone: DIgby 9-4730

ASCO SOUND CORP.
115 West 45th Street (3rd Floor),
New York 36
Phone: JUDson 2-1750

HARVEY RADIO COMPANY, INC.
103 W. 43rd St., 1123 6th Ave.,
New York 36
Phone: JUDson 2-1500

LEONARD RADIO, INC.
"AUDIO MART"
69 Cortlandt Street, New York 7
Phone: CO 7-0315

SUN RADIO & ELECTRONICS CO., INC.
650 Sixth Avenue, New York 11
Phone: ORegon 5-8600

TERMINAL RADIO CORPORATION
85 Cortlandt Street, New York 7
Phone: WOrth 4-3311

CONCERT-CRAFT, INC.
P.O. 66, Brandywine Station,
Schenectady 4
Phone: FR 4-0720

W. G. BROWN SOUND EQUIP. CORP.
349 East Onondaga St., Syracuse 2
Phone: 2-8979

THE AUDIO EXCHANGE

367 Mamaroneck Avenue,
White Plains

NORTH CAROLINA

**DALTON-HEGE RADIO
SUPPLY CO.**
912 W. 4th St., Winston-Salem
Phone: 5-8711

OHIO

AUDIO CRAFT CO.
2915 Prospect Avenue, Cleveland 15
Phone: CHerry 1-5560

PIONEER ELECTRONIC SUPPLY CO.
2115 Prospect Ave., Cleveland 15
Phone: SU 1-9410

**RICHARD J. SAUER
CUSTOM ELECTRONICS, INC.**
1000 South Main Street, Dayton 9
Phone: ADams 3158

CUSTOM CLASSICS
13421 Euclid Avenue,
East Cleveland 12
Phone: GL 1-0256

COUNTERPOINT
20971 Westgate
(Westgate Shopping Center),
Fairview Park 26
Phone: ED 1-6448

R.S.T. LABS
14511 Granger Road, Maple Heights
Phone: MOntrose 2-3213

OREGON

SANDY'S CAMERA SHOPS
635 S.W. Alder, 714 S.W. Washington,
Portland 5
Phone: CApital 8-1345

PENNSYLVANIA

BAKER COMMUNICATIONS
9 South 12th Street, Allentown
Phone: HEEmlock 3-3326

AUDIO LABORATORIES, INC.

808 Mohican Street, Bethlehem
Phone: UNiversity 7-3909

DANBY RADIO CORP.
19 South 21st Street, Philadelphia 3
Phone: RIttenhouse 6-5686

ELECTRONICS OF CITY LINE CENTER, INC.

7644 City Line Avenue (City Line
Center), Philadelphia 31
Phone: GReenwood 7-9535
GReenwood 7-7144

TEN CATE ASSOCIATES
6128 Morton Street, Philadelphia 44
Phone: GERmantown 8-5448

RADER & FASIG, INC.
704 Walnut Street, Reading
Phone: 4-7831

RHODE ISLAND

**AUDIONICS COMPANY
NEW ENGLAND'S HI FI CENTER**
790 North Main Street, Providence
Phone: DEExter 1-4242

GERTZ, INCORPORATED
257 Adelaide Avenue, Providence 7
Phone: STuart 1-4200

TEXAS

MELODY SHOP
466 Pine Street, Abilene
Phone: 4-4848

TOWN NORTH MUSIC CORP.
5328 W. Lovers Lane at Inwood Rd.,
Dallas 9 Phone: ELMhurst 6477

WRYE CO., LTD.
2410 W. Alabama, Houston 6
Phone: JA 3-7874

UTAH

DAYNES MUSIC CO.
15 East 1st So., Salt Lake City
Phone: ELgin 9-7633

WASHINGTON

OLYMPIC ENGINEERING CO.
2008 Westlake Avenue, Seattle 1
Phone: ELiot 4650

WISCONSIN

HI-FI HOUSE, INC.
2630 North Downer Avenue,
Milwaukee 11
Phone: EDgewood 2-1700

THE HI-FI CENTER, INC.
4236 West Capitol Drive,
Milwaukee 16
Phone: UPtown 1-2113

CANADA

PAYETTE RADIO LIMITED
730 St. James Street, W., Montreal 3
Phone: UN 6-6681

H. R. SAVARD RADIO LTD.
910 Bleury St., Montreal
Phone: UNiversity 6-9202

CROBEL, LTD.
790 East Blvd. Charest, Quebec City
Phone: LAfontaine 4-5201

MAGUIRE ELECTRIC LTD.
1330 Maguire, Sillery
Phone: MU 1-2333

ALPHA ARAON RADIO CO., LTD.
29 Adelaide Street, West, Toronto 1
Phone: EM 6-1591

THE HIGH FIDELITY SHOP
557 Mount Pleasant Rd., Toronto 7
Phone: HUdson 8-6443

HAWAII

TELCO LTD.
605-607 South Queen Street, Honolulu
Phone: 50-2964

your Fleetwood® dealer or write: Conrac, Inc., Glendora, Cal.

JANSZEN

Electrostatic

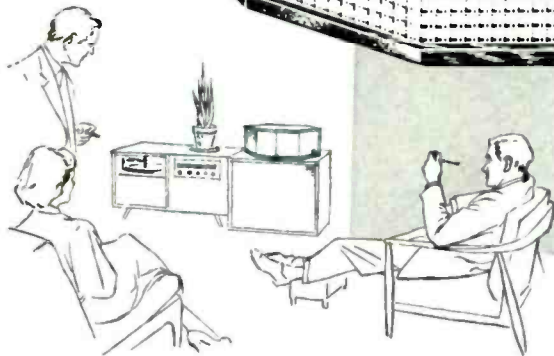
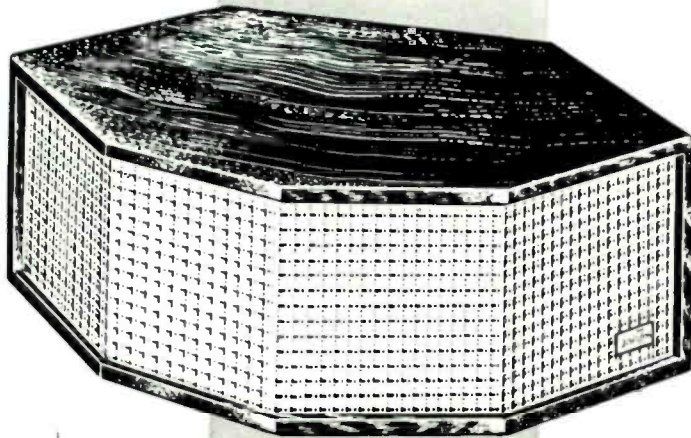

More than a tweeter—its uncanny smoothness extends through the middle frequency ranges.

Nine years of research and development have refined this long recognized principle into what most critical listeners consider the best loudspeaker extant. JansZen's patented design is responsible for this unique achievement in the audio industry. This design plus the necessary hand construction techniques virtually assure that it will never be a mass-produced item.

"With the JansZen speaker, the entire apparent sound source broadened out . . . sparkingly different from other tweeters. Instrumental combinations which had been submerged on other speakers emerged with startling clarity."

—The Audio League Report*

Mahogany, Birch, Walnut and Utility finishes available on request.

Send for complete literature on the JansZen 1-30 Electrostatic as well as the name of your nearest dealer!

*Authorized quotation No. 52. The reader should consult Vol. 1 No. 11 (Jan. 1956) of the Audio League Report, Pleasantville, N. Y., for the complete technical and subjective report.

PRODUCT OF **NESHAMINY ELECTRONIC CORP.** NESHAMINY, PA.

Export Division: 25 Warren St., New York 7, N. Y. Cable: Simontrice, N. Y.

BOOKS IN REVIEW

Continued from page 42

truly serious, disturbingly provocative study is rare. Since Edward J. Dent's little booklet, *Opera* (Penguin, 1940), and trenchant examination of *Mozart's Operas* (Oxford, 2nd ed. 1947), I can't think of anything which approaches the stature of the just published but already hotly discussed *Opera as Drama* by Joseph Kerman (Knopf, \$4.50).

This isn't an easy book to read and its unashamedly solid intellectual substance is hardly made more easily digestible by Mr. Kerman's hot-saucing it to his own strong tastes with savage polemics and irritative prejudices. He not only largely ignores singers and singing, but disdainfully throws most of the popular favorite works out of the window as intolerably crude melodramas; and the handful of operas he recognizes as valid masterpieces are illumined so as to throw into highest relief facets and structural outlines which often will be shockingly strange even to these works' most devoted admirers. Yet for the reader who is willing to stick with him and who is not intimidated by the task of entirely fresh thinking, Kerman provides a bracingly healthful experience.

He is at his best in his driving insistence on—and monumental accumulation of pertinent evidence for—the too-often-forgotten truism that in opera it always is the composer who must be the animating dramatist; and in his revelatory analyses of Mozart's four greatest operas, Wagner's *Die Meistersinger* (seen in the novel light of a drama of "conversion"), Verdi's *Otello*, and Debussy's *Pelléas et Mélisande*. But in addition he gave me a startling new and expanded understanding of *Wozzeck* and *The Rake's Progress*, as well as more tantalizingly incomplete, yet no less provocative, new perspectives on baroque music dramas.

I wish he had delved much more deeply into the latter and those of the Renaissance, and I wish most of all he had mounted a better prepared and more conclusive attack on Puccini and Strauss. My objection is not so much to his devaluations as such (with which I agree, in the main, on purely aesthetic grounds), as it is to his failure to examine the actual

Continued on page 48

HIGH FIDELITY MAGAZINE

the
music
Mozart
wanted
you
to
hear



Most experts hesitate, then take refuge in an old saw when asked to define high fidelity. "Concert hall realism" is the phrase they usually conjure up. Actually, this begs the question.

The concert hall is one special area of musical experience; listening to music in your own home is another. Each has its place for the music lover.

When you want to listen to live music played by live musicians — unless you have a home large enough to accommodate an orchestra — there is clearly no substitute for the concert hall. We don't recommend high fidelity *in place* of the concert hall. It has certain advantages over a live concert but it does not bring live musicians into your home. Nor is high fidelity a mere *substitute* for the concert hall: it stands on its own as the best way to create fine music in your home.

High fidelity is the technique for reproducing music and the spoken word IN YOUR HOME the way the composer himself would wish you to hear it.

A symphony, a concerto, any real musical form, is a wondrous complex of sound and energy, tonal range and loudness, color and balance. This incredibly intricate relationship of sound moved through the composer's mind as he fashioned the music and it is this complex which must be perfectly recaptured if the listener is to experience *all* the music Mozart wanted him to hear.

In a concert hall you hear it all if you're fortunate enough to sit in the right seat. Harman-Kardon high fidelity does it for you every time *in your own home* because it takes perfect program material, created under ideal conditions, and retells it with authenticity. The special sonorities of the instruments and the coloration and balance among them are completely retained. Adjustment is made for the acoustic conditions in your room and for your own hearing characteristics.

The really remarkable thing about Harman-Kardon high fidelity is that it does all of these things in strikingly beautiful and compact instruments — each with a small number of easy to operate controls.

The Harman-Kardon Festival II (Model TA-1040), illustrated above, is an outstanding expression of high fidelity thought and design. Here in a graceful compact unit, only 16-1/8" wide, 14" deep and 4-5/16" high is a complete high fidelity electronic center: Magnificent Armstrong FM with Automatic Frequency Control to insure accurate tuning — automatically — and Automatic Noise Gate to eliminate noise between stations when tuning; sensitive AM with 10KC whistle filter; complete preamplifier and 40 watt distortion free, hum free power amplifier.

Features include: Dynamic Loudness Contour Control to provide precise balance for your own hearing characteristics; separate bass and treble tone controls; selectable record equalization; remote speaker selector switch; illuminated tuning meter and rumble filter. All this expressed in six simple to operate controls.

The cage and control panel are finished in brushed copper; the knobs and escutcheon frame in matte black.

The Festival price is \$225.00. (*Slightly higher in the West*).

FREE: beautiful, new, fully illustrated catalog. Describes complete Harman-Kardon line and includes guides on how and where to buy high fidelity. Send for your copy now. Write: Harman-Kardon, Inc. Department H-01, 520 Main Street, Westbury, New York.

Harman-Kardon also manufactures a group of excellent, integrated high fidelity systems in fine furniture cabinets. For the full story on these instruments write for free catalog H-01.



harman kardon

For High Fidelity That Grows
One Economical Step at a Time



Electro-Voice

SPEAKER

BUILDING

BLOCK PLAN

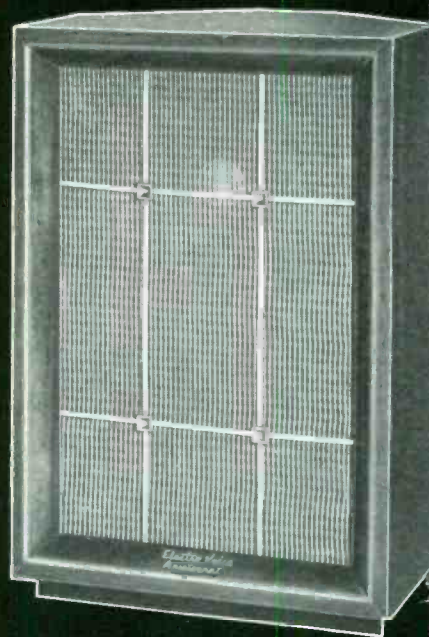

Hear the difference Electro-Voice 'Listeneering' makes in your enjoyment of high-fidelity music—before you spend a dime! Unique E-V Speaker Systems Selector lets you listen to the improvement as you dial from a single speaker to a multi-speaker system. You hear *in advance* how each new speaker component enhances the illusion of musical reality!

Electro-Voice Building Block Plan lets you improve your basic system a step at a time, fitting your purchases to your budget. Here's just one example:



REMEMBER, the Aristocrat cabinet is pre-cut and fitted for each new speaker, each new crossover unit. Just bolt them in place in minutes.

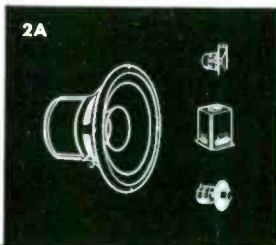
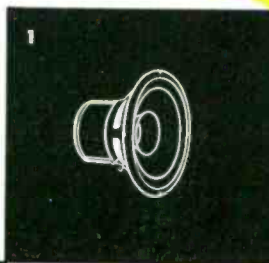

Model SP12B Coaxial Loudspeaker Only..... Net \$33.00
Loudspeaker and Aristocrat Enclosure:
Mahogany..... Total Net \$102.00
Blonde..... Total Net 109.00
Walnut..... Total Net 112.80
Or buy only the ready-to-assemble Aristocrat KD6 enclosure kit..... Net \$39.00

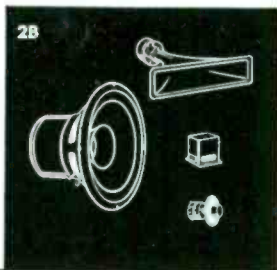

Model SP12B Coaxial Loudspeaker PLUS Speaker Building Block 1..... Model T35B VHF Driver, Model AT37 Level Control and Model X36 Crossover..... Net \$67.50
Components and Aristocrat Enclosure:
Mahogany..... Total Net \$136.50
Blonde..... Total Net 143.50
Walnut..... Total Net 147.30

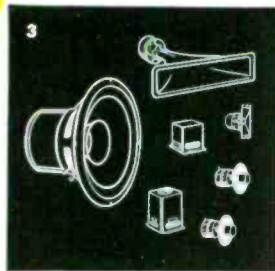

Model SP12B Coaxial Loudspeaker PLUS Speaker Building Block 3..... Model T10A HF Driver with Model 8HD Horn, Model AT37 Level Control and Model X825 Crossover..... Net \$116.50
Components and Aristocrat Enclosure:
Mahogany..... Total Net \$185.50
Blonde..... Total Net 192.50
Walnut..... Total Net 196.30

Model SP12B Coaxial Loudspeaker PLUS Additional Components in both Steps 2A and 2B.
All Components..... Net \$151.00
Components and Aristocrat Enclosure:
Mahogany..... Total Net \$220.00
Blonde..... Total Net 227.00
Walnut..... Total Net 230.80

ELECTRO-VOICE, manufacturer of the most complete high-fidelity product range—speakers, speaker enclosures, systems, amplifiers, preamps, tuners, phono cartridges. Do-It-Yourself enclosure kits and microphones. Available everywhere.

START with the Electro-Voice Aristocrat corner folded-horn speaker enclosure (you'll get an extra octave of bass response) and the E-V Model SP12B coaxial loudspeaker (frequency response, 30 to 13,000 cps).

STEP UP your enjoyment by adding driver, crossover and level control. Now you will hear silky highs, as you *step up* with Model T35B VHF driver, Model AT37 level control and Model X36 crossover. Prefer more mid-range response? Then *step up* with Model T10A HF driver with Model 8HD horn, Model AT37 level control and Model X825 crossover.

COMPLETE your integrated Electro-Voice reproducing system by adding *all* components listed to your basic coaxial speaker in the Aristocrat enclosure. Separate controls for the Brilliance and Presence ranges compensate for room acoustics and individual tastes.

Every step of the way, you'll be enjoying high fidelity with a difference—the *built-in* difference that has made Electro-Voice famous.

SEE YOUR ELECTRO-VOICE DEALER TODAY.
LOOK FOR THE E-V SYSTEMS SELECTOR.

Electro-Voice®

ELECTRO-VOICE, INC. • BUCHANAN, MICHIGAN

CANADA: E-V of Canada Ltd., 1908 Avenue Road, Toronto, Ontario
EXPORT: 13 East 40th Street, New York 16, U. S. A. Cables: ARLAB

The Why and Wherefore

ONCE an evening visitor of ours, a woman of poise and wit, ceased her tastefully critical circuit of our living room in front of my sound system. It is not the tidiest of sound systems, and it takes up most of one wall. She investigated with interest the tape recorder, the preamplifier, the first turntable, the second turntable, the loudspeaker enclosure, the FM tuner, the AM tuner, the spare turntable (these things accumulate), and even the power amplifier in its dimly glowing den. Then she turned around and asked a one-word question. She said: "Why?"

I was wise enough not to answer. Earlier conversation had elicited the fact that the questioner had a weakness for Puccini. Moreover, I knew my acoustico-electronic cohorts were in rare shape. So the whole argument was turned over to Victor de Sabata, Maria Callas, Giuseppe Di Stefano, and La Scala's inspired musketeers. By the time Tosca had made her improbable leap from the Castel Sant' Angelo into the Tiber, our lady guest was satisfied, and had no further query. Now she knew why.

But a multitude of people still don't. And though there is a constant procession of books and magazine articles telling us *how* we may have high fidelity in our homes, precious few try to tell us *why* we should.

Perhaps part, at least, of the reason we should is that we owe it to ourselves. We have been through a quarter-century of recurrent danger, privation, uncertainty, and incessant strain. This is in some ways abating now. Many of us have found adequate dwellings, long a shortage; many have now a little spare money and some leisure at our disposal. Concurrently we have made two other discoveries, or perhaps they are rediscoveries: the pleasures of travel, which are considerable, but irrelevant here, and the pleasures of staying at home, which are pertinent. Travel is for vacations; home leisure occurs every day.

And it is important. The world outside the home's four walls is perhaps no longer—not quite—the almost nightmarish place it lately was, but it is certainly no Elysium, either. It still offers more than ample ugliness and unease. From this, the home must serve as refuge, and more than refuge; it is where the spirit, if you will permit the expression, is repaired and refreshed and strengthened against the next day, and the next week, and the next month.

Tranquilizer pills won't do this, and I am not sure TV quiz shows help much either. Better are avocational interests involving real activity, mental and/or physical. But perhaps the best restorative of all is beauty.

This is no place to essay a definition of beauty, except to make the point that, although it can embody the fruits of the deepest wisdom, it can also be purely sensuous or diverting or soothing. It can reside in a passage of Shakespeare, a jade chessman, a floral centerpiece, the sight and smell of a wood fire.

Perhaps no beauty can be enjoyed in so much of its fullness in the living room, though, as that which is met through the ear. There is music to put iron in the soul, music to relax the nerves, music to set feet tapping. There is even music, involving no human musicians, to turn a winter's evening into a summer dusk alive with the small talk of tree frogs, and this is beauty too. There are plays, poems, and sermons; there are sonic rambles through Scandinavia and through the Australian bush.

Sonic recreation, when it is kinetic at all, is more kinetic than that enjoyed by eye. Or at least it should be, and here enters the importance of high fidelity. Music meant to serve as background to other activity need not be high-fidelity. Music intended to command the attention should be, if it is to take anything like the effect its composer had in mind. And the high-fidelity requirement is dual. The tonal and dynamic range must be great, so that Paganini's violin is truly a violin, with overtones; so that Poulenc's organ pedals are not wasted; so that Haydn's big bass drum remains big. These are the classic requirements, vintage *circa* 1947. Today we must add that distortion should be virtually absent, so that the violin is not a steel violin; so that the first harmonic of Poulenc's bass note is not louder than its fundamental; and so that, even when heard loud, the sound as a whole is comfortable. When you have all that, you have high-fidelity sound, which will not (often, anyway) convey a full symphony orchestra into your living room, but which can quite realistically simulate a live baritone or an actual piano.

There is more to high fidelity than listening, however, at least for some of us (others are content to settle for aural delectation). There is the opportunity, which can be both obsessive and delightful, of assisting in the final delivery of the music, through the choice, assembly, and adjustment of the sound equipment. When I speak here of equipment, I mean of course an array or "rig" of separate components. This implies no disparagement of packaged high fidelity, so-called, as long as it yields true high-fidelity sound. But the eclectic rig can be the focus of endless adventure—in shopping (since a rig is never complete and never perfect); in woodworking and finishing; in fitting the sound to the acoustic personality of a living room; even in maintenance. For solder-steam is not always just solder-steam: sometimes it is incense, expressing a devotion.—A certain complex of sounds is refined for years in a composer's brain. A musician practices half a lifetime to bring it alive and perfect into the air. A recording crew travels across an ocean to capture it. Finally it comes to us, for whom it was created originally. And so my answer to the lady, if I had made one, would have ended with a question: given this perishable treasure, how do we treat it? J.M.C.

A European musical ramble

Halls, Hallowed and Acousticized

BY HAROLD C. SCHONBERG

GENERALLY SPEAKING, opera houses the world over are alike. They have their individual differences, much as one apple differs from another, but most of them were built at a time when gold leaf, red plush, classical pillars, and paintings of the muses in varying states of undress were considered a necessary concomitant to listening.

Nobody has calculated the amount of plush that has gone into the world's opera houses. This tourist, last summer, equipped with slide rule, logarithm tables, and a carton of ball-point pens, did some careful figuring and came up with $P = mc^2$. In concrete terms, the amount of P (plush) is enough to build a highway fourteen feet wide from here to Alpha Centauri, plus or minus 3.1416 feet at a temperature of 167 degrees Fahrenheit (the prevailing temperature inside most European opera houses during the summer months).

Concert halls are somewhat different, and vary from the austere barnlike simplicities of London's Wigmore Hall to the antiseptic modernism of the Pleyel in Paris. But one thing European opera houses and concert halls share, and that is a long tradition embodying the great names of music. Who so blasé that his pulse will not beat a little faster in the Theater an der Wien, where Beethoven himself stood on the podium? Or at La Scala, where Verdi coaxed his singers? Or at the Musikverein in Vienna, where the Joachim Quartet addressed itself to Beethoven?

Otherwise the tourist will find the musical setup geared and running very much *à l'Americaine*. A popular con-

ductor with a popular soloist means a sold-out house anywhere in the world. A program of modern music means empty seats all over the place. Tickets are easy to get for a chorus singing Bach; but a performance of *Don Giovanni* at the Vienna Staatsoper is liable to be sold out weeks in advance if well-known singers are announced.

And some events are impossible to get into, even with a hand grenade. Occasionally, Europe still containing royalty, there will be a gala performance involving HRHs from here and there. To be present at these, you will have to pester your ambassador, present a letter from the President of the United States, and wave lots of dollars (American) in sundry directions. That failing, as it probably will, you go to the concierge or head porter of your hotel, which is what you should have done in the first place. A well-oiled concierge can produce anything. In this case he will simply call his fourth cousin who works in the box office. Then you trot out your white tie and tails. For a gala performance, the whiter the tie and the blacker the tails, the better. This tourist managed to get two tickets (in different locations; wife here, husband there) for the Stockholm gala in honor of Queen Elizabeth last June. In an audience of some 1,600 elegant creatures in full dress, blazing with stars, garters, and assorted trophies, he was the only proletarian naked in black tie, and he sat huddled in his seat during intermission.

There was a time when dress—at least black tie—was *de rigueur* at the opera in Europe. No more, though first nights still attract a very well-dressed audience. These days, even at important premières, a dark business suit will suffice. Europe thinks much too much of its tourist trade to impose barriers on their pleasure. If a couple of Yanks want to go to *Die Walküre* dressed in knickers and army B-1 jackets, the natives will call them eccentric millionaires and let it go at that. But don't try to act like an eccentric millionaire unless you are one. Americans have a bad enough reputation for manners in Europe as it is.

By American standards, ticket prices run somewhat low in most European opera houses, though the best seats are not exactly given away. As you go upstairs there is an immediate, sharp reduction in price; and you can get in the top galleries for a few cents. It is a very good idea to plan your musical activities before leaving America. All the information will be at hand. This magazine, the *Saturday Review*, the *New York Times*, and many other publications often provide, early in the spring, a summary of European musical festivities. Every country has a tourist



ITALIAN STATE TOURIST OFFICE

Famous Teatro alla Scala in Milan: its birthday was in 1776.



HUBMANN

At the Staatsoper in Vienna, champagne and caviar for \$1.20.

bureau in New York, which gladly will show you complete programs of any musical events on the agenda. They also, in many instances, will book seats for you. They will do everything except buy your program (nearly everywhere in Europe programs are not given away, and they can run as high as 56 cents). It would be a shame to go to Vienna and not be able to attend a *Don Giovanni* or *Fidelio*, or to Rome and miss out on a *Bobème* with Lauri-Volpi as Rodolfo (yes, he's still singing—loudly—and is as popular as ever).

Europeans take their music seriously and are used to a lot of it. London, Paris, Berlin, Vienna, Rome—all of these great centers have longer and fuller music seasons than can be found anywhere in America. They support more musical organizations on a full-time basis, offer a greater variety of presentations, and attract soloists of international reputation, many of them (especially the Russians) unknown to America except perhaps through one or two tantalizing recordings. And now that America is emptying into Europe from May through September, there is no let-up anywhere.

And they are more leisurely in Europe, particularly in Italy. At the Rome Opera you can expect the proceedings to start at 9 p.m. or so and run well past midnight. Rome has a fine, impressive opera house, not too dissimilar in shape and décor from the Metropolitan in New York. It also has a bright, active electric clock over the proscenium, an innovation of Il Duce, at which you stare in horrid, hypnotic fashion, waiting for the numbers to change. (It is a number clock, with two rectangles containing figures for the hour and for the minute: 21:31, 21:32, 21:33, and it takes a listener of stupendous will power to keep his eyes on the stage when the clock is blinking at him).

In Florence, at the Teatro Comunale, you sit down-

stairs if you want comfort. The Comunale is more amphitheater than theater, and the upstairs section has all the snug comfort of the bleachers in Lewisohn Stadium on a Belafonte night. Above the orchestra and the first-tier boxes you sit in stone seats in an unpartitioned semi-circle. Cushions can be rented for 30 lire, about 5 cents, and even so well-padded a citizen as this writer was glad to invest the nickel. After three hours of *La Valkiria* (but sung in German, alas, with the *personaggi* of Brunilde and Sigmundo taken by the *interpreti* Birgit Nilsson and Wolfgang Windgassen) those seats got very hard; and even harder were the knobby knees of the Italian Wagnerite jabbing into the back of the American Wagnerite. To alleviate the distress were venders all over the place at intermission, selling *dolce* and score cards.

No such problems assail the listener in Paris. The Opéra there is one of the great ones in Europe, burgeoning all over with paintings and marble sculpture of the academic, "noble" school. But the sweep of those great stairs, the tremendous chandelier dominating the auditorium, the blinding gold leaf (four kilos of it, says the Opéra, proudly), the graceful lines! The Paris Opéra is one with France—with Rimbaud and Victor Hugo, Clemenceau and Hériot, Malliol and Dégas: a breathing distillate of culture and tradition. (The only thing you really won't get there is well-sung opera.) And in the buffet you can get, for 100 francs (28 cents) a bottle of Coca Cola; or, for the same price, a snifter of brandy or a glass of champagne. The French invariably drink Coca Cola there; the Americans, champagne; the British, brandy. And where else can you find the unforgettable synopses in English provided in the official program? Othello, we learn, "arriving unexpectedly, deprives Cassio of his rak . . . Jealousy makes rapid progress in the Moor's head . . . Desdemona tries to calm the growing presentiments which trouble her by prayer."

A glass of champagne is more expensive at the new Staatsoper in Vienna. It costs 60 cents, the same as a caviar sandwich. As you all know, the Staatsoper was gutted during the war and reopened only a few years ago. The dignified interior has a décor of gold and cream; the seats and carpets are red plush; and a great doughnut-



BRITISH INFORMATION SERVICES

London's Royal Festival Hall: modernism and a river view.



SWEDISH NATIONAL TRAVEL OFFICE

Drottningholm Theater, Stockholm: wigs and ruffles for Mozart.

shaped chandelier throws a gentle light. Everything is tasteful and spacious, from the *Zauberflöte* tapestries in the grand foyer to the rich but subdued fittings of the boxes. The only jarring note is the buffet room, with very modern lines, as much out of place as a Mondrian in a Victorian drawing room.

Modernism has little place in Vienna. The famous Musikverein, home of the symphony, represents typical nineteenth-century Teutonic taste with its academic murals, its baroque marble sculpture holding up the wall columns, its ten crystal chandeliers, its air of well-fed gentility. The Volksoper, where operetta is given, is an old hall sadly in need of repair—cavernous, with paint flaking from the ceiling and a melancholy look of having seen better days. The seats, however, are about the widest of any theater in Europe. The Redoutensaal, where Mozart operas are given, is nothing more than a large room, seating about 500 (and none too comfortably) in the Hofburg Palace. Very bad acoustics and sight lines, incidentally.

The oldest theater you are likely to encounter in Europe is Drottningholm, actual home of a royal eighteenth-century theater outside of Stockholm. Built in 1766, it was restored in 1921 according to the original specifications. In an attempt to adhere to the original flavor, the orchestra and ushers wear eighteenth-century dress, complete to white wigs. So does the conductor, who comes out with a shamefaced look, peers over his ruffles, adjusts his horn-rimmed glasses and looks at his wristwatch. But the tourists love it; and it cannot be denied that the smaller Mozart and Cimarosa works sound remarkably authentic here.

Not all of the auditoriums are old. You also can encounter brand-new concert halls all over the place. Most impressive is the Royal Festival Hall in London, the hall with the breathtaking location and the skeletal acoustics.

The building is set on the banks of the Thames and has been architecturally designed to fit into its surroundings. Modern, but not aggressively modern, it reflects British contemporary taste at its best, and is one of the most distinctive halls in Europe—infinitely superior to, say, the dated, chromed and cold modernism of the Salle Pleyel in Paris. And there is a graciousness about its interior—in the buffet lounges facing the river, the acres of walking

space inside, the general air of hospitality. But the acoustics in the Royal Festival Hall take some getting used to. Remember those Studio 8H recordings? Well. . . .

Acoustic problems also plagued the relatively new Concert Hall—a cozy, rectangular room—in Stockholm. This hall has a few unorthodox features. Running along the two sides of the balcony are, instead of boxes, a series of adjacent armchairs, placed parallel like seats in a railroad car. When the hall was opened, all kinds of acoustic bounces were discovered. In an effort to solve the problem, the designers suspended above the stage a series of rectangular glass frames that can be tilted at various angles. Presumably the arrangement works; at least, one notices a different setup for orchestra than for instrumentalists, and both sound fine.

Outside the Concert Hall is the magnificent Orpheus of Carl Milles. It is a prodigious conception. The sculpture must be about twenty feet high and the figure is balanced on one foot, ready to take off. The building also boasts a small auditorium, for chamber music, and it looks as snug and well-paneled as the interior of the Harvard Club—except for the murals, some of them definitely not for the Junior League. The Scandinavians are not an inhibited people.

Stockholm and Copenhagen have their opera houses—small, charming, well bred. Between the acts at the Royal Theater in Stockholm you can be entertained, if you remain in your seat, by colored advertising slides thrown onto a screen on the stage: “Holberg och Holmgren—Gardin-specialisten,” with a colored slide of a flourishing garden. In both houses the pit is too small to take care of a Straussian orchestra; and when large forces are needed the timpani overflow into a pair of side boxes adjacent. In both houses, too, as

Continued on page 129



SWEDISH NATIONAL TRAVEL OFFICE

Stockholm's Concert Hall: you can buy green goods out front.

The Great Highland Bagpipe

by A. R. P. Wrathall



AS JOHANN SEBASTIAN stands in relation to the Bach family, so is the Scottish bagpipe mightiest of the clan. Other pipes are tame domestic instruments, capable at worst of inducing indifference in unsympathetic ears. The Highland pipe, however, is positive and strong—an instrument of love and hate, a source of rapture or horror to the listener. At the risk of raising the hackles of those who hail from Ireland, from Northumbria, or from any number of European and Asian communities who boast bagpipe traditions of their own,¹ let it be said immediately that all further references shall signify the Great Highland Bagpipe.

There is a tale of a wounded Jock, lying in a hospital, who was suddenly restored to health by the sound of the pipes, while all the other patients died. These unfortunates doubtless regarded the music as fit "to tear a cat in; to make all split." If any of that humor have read thus

¹As admirers of Jaromir Weinberger are aware, in Mitteleuropa the term for bagpipes is *Dudelsack*, rather a horrifying thought.

far, they will probably approach the following technical description of the bagpipe in the spirit of morbid curiosity with which we view medieval instruments of torture.

The sheepskin bag is a reservoir for air and is held between the left upper arm and ribs. (The Scots word "oxter," meaning armpit, is occasionally used in this context.) Through a valve-controlled mouthpiece the player fills and refills the bag so that, when pressure is applied by the elbow, air is forced through the cane reeds, both in the chanter on which the melody is fingered, and in each of three blackwood drones which lie on the left shoulder and contribute a harmonic bass. The key of the bagpipe is approximately that of A major, with the C and the F only a few vibrations sharp, and a natural G. Its compass is one octave plus one note and extends from G on the treble stave to A above it. Moreover, these notes cannot vary in pitch, as the pressure of air through the reed is constant. The tenor drones are tuned to A and the bass drone to D. On the chanter the holes are uncovered and the fingers of the piper must stop all the notes above the one he wants to sound, as opposed to the technique for orchestral wood wind where the notes are mechanically sealed.

Alterations to the instrument are from time to time attempted, usually by the English,² and at present a London firm is manufacturing a chromatic bagpipe capable of rendering the British National Anthem. This is a pointless development, however, for a piper has little desire to play English tunes, being, as he is, heir to a wealth of Scottish music to which only the bagpipe can do justice.

This may be broken down into three sections—Little Music comprising marches, strathspeys, and reels; Middle Music being laments and slow marches; and finally the Great Music, known as *Piobaireachd*—a term Anglicized by Sir Walter Scott into pibroch.

This last is the classical music of the pipes, although it expresses the whole predicament of the Highlands. The Macrimmons,³ most famous of all piping families, who for seven generations (1500-1795) held the hereditary office of piper to the Macleod of Macleod, were pri-



ANGEL RECORDS

Members of the Scots Guards dance a reel to pipe and drum.

²Or Sassenachs, as you prefer.

³An alternate and permissible spelling is MacCrimmon.

conveniently filters out the unwanted distortion. This happens to such an extent that we actually need to be trained to hear the distortion.

However it has been proven that the faculty of ignoring sounds we do not want to hear, and listening only to ones that we do, involves strain. The psychological strain incurred in listening to different reproductions varies from individual to individual. This is partly due to differences in individual auditory faculties and partly to differences in conditioning experience.

But there is nothing psychic about the *reproduction* of sound. The more faithfully the reproduced sound field copies the original, the better will be the impression and the less the strain involved in listening.

At one time a flat frequency response was considered the *ne plus ultra* in perfect reproduction. Sound waves of various frequencies, it was thought, should all be reproduced at exactly the same pressure as the original sound at the microphone, to achieve perfection in reproduction. But when this was (almost) attained, somehow more still was needed to give ultimate satisfaction.

It was noticed, for example, that two systems, with identical performance under measurement conditions, would give quite different impressions on various types of program material. One would render strings rather realistically, but the brasses and wood winds would lack some of their proper brilliance. On the other reproducer, the reverse would be true—the brass and wood winds would sound realistic, while the strings seemed to lack something. So attention was turned next to the reduction of harmonic and intermodulation distortion, and to the clarity of transients. As success attended, the millenium was hailed once more.

But progress pushes perfectionists always further forward, and now we began to hear complaints about the Hole in the Wall. With a large program source, such as an orchestra, the use of a small loudspeaker makes the orchestra sound as if you were listening to it through a hole in the wall, however good the reproduction may be. The use of large multiple unit loudspeakers can overcome this difficulty to some extent, and make orchestras sound more realistic. But when a vocal solo, for instance, comes on, the realism is lacking for an opposite reason: the singer appears to have developed a split personality in horrifying degree.

Further, while the multi-unit loudspeaker does give a better impression of the *size* of the orchestra, it does not give the clear definition that is heard in a live performance—the impression that the strings are over to the left, the wind instruments to the right and rear, and various other groups in specific positions. Rather, the multi-unit loudspeaker puts the high frequencies out of the tweeter, the middle frequencies out of the mid-range unit, and the low frequencies out of the woofer, wherever these happen to be located. As some of each of these sounds come from the strings and some from the wind instruments, and so forth, the spatial distribution made by the loudspeakers is quite different from that of the original orchestra.

Observation of deficiencies like this probably led to the

idea that stereophonic reproduction might solve the problem of directional perspective in the living room, and yield to us the ultimate (or at least the practical ultimate) in realistic home music. As was the case with many a past principle, this now has become an article of faith: if you do not subscribe to stereophony, you are low-fi, a heretic, and should have one of your ears cut off.

At the risk of getting involved in a "religious" dispute of this nature, I want here to discuss what a stereophonic system is supposed to be able to do, and whether it really can do it or not, and whether or not the same effect cannot be achieved unstereophonically. This is, quite frankly, an unorthodox approach, and one which may cost me an ear if the cult has the requisite cutlery and initiative.

First, a few facts. Sound waves differ in size enormously. To appreciate this, remember that sound travels at approximately 1,100 feet per second. As the number of waves passing our ears is the same as the frequency of sound heard, this means that the wave lengths must differ according to frequency, but in inverse ratio.

To illustrate, a record-jacket I picked up the other day gave the lowest frequency recorded on that particular disk as 16 cycles. Assuming that I get 16 cycles reproduced (?), then 16 of these waves will occupy 1,100 feet; each wave will be almost 70 feet in length. As my living room is nowhere near 70 feet in any of its dimensions, this means that I cannot hope to have a whole wave of this frequency in my living room at one time. The best I can expect any loudspeaker to do at this frequency is to produce a general fluctuation in pressure throughout the whole area of the living room. It will be impossible to get any sensible impression of direction at this frequency.

At the other end of the scale, the same jacket assured me that the high frequency limit was 25,000 cycles (!). Limit, indeed—I cannot hear above something like 15,000 cycles. Taking what I *can* hear, at 15,000 there will be 15,000 waves in a distance of 1,100 feet, meaning that each wave must be a little less than an inch long. Obviously at this end of the spectrum my living room can accommodate quite a large number of waves.

In the middle of the audio frequency range, say about 1,000 cycles, the waves are about a foot long, since it takes about 1,000 of them to occupy the 1,100 feet they travel every second.

Because of our logarithmic sensory perception, which makes the frequency scale seem like so many octaves rather than the ratio of the lowest frequency to the highest frequency, this tremendous difference in the size of waves used by different frequencies is not at once obvious. But an awareness of it is needed to understand the behavior of stereophonic sound fields.

Some devotees have theorized, using a 1,000 cycle wave for illustrative purposes, that our sense of sonic direction is mainly due to the phase difference at the two ears. As the wave length for 1,000 cycles is about one foot, and the distance between *most* people's ears is less than one foot, the theory looks quite plausible. But how about the extremes?

At 20 cycles the wave length is 50 feet, so the distance between our ears is only about one hundredth of a wave length. To get any *critical* sense of direction at this frequency, we should need to tell the difference in phase, between the two ears, corresponding to about one thousandth of a wave length or cycle. Our hearing faculty, to detect such small differences in phase, would have to act as an incredibly sensitive phase comparator. And I do mean incredibly, for experts agree that the average set of human ears is almost totally insensitive to phase relations of this order.

At the other end of the scale, in the region of, say 10,000 cycles, the wave length is a little less than 2 inches. So there will be 3 or 4 waves' difference between the two ears when a sound comes from one side or the other. If the sense of direction were dependent upon the relative phase at the two ears, there would be considerable ambiguity about the precise position of the sound source at such a frequency. If wave 1 and wave 4 exactly coincide in their arrival at their respective ears, for instance, how are the latter to sense a direction?

And what about standing waves? They never seem to be mentioned in discussions of stereophonics. Standing waves build up in any room or enclosed space, when a continuous tone is generated, because of reflection from wall surfaces. You can check this by listening to a 1,000 cycle tone, or some other frequency, reproduced from a loudspeaker. While the tone is being emitted continuously, try, with your eyes shut, to locate the position of the sound source. If you do not know where the loudspeaker is, you'll find it very difficult to tell because, as soon as you move your head, the apparent position of the sound will change. This is because these standing waves build up the intensity of the sound in the room, or enclosed space, to a point where the waves no longer *travel* but produce pressure alternations all through the area and these pressure areas are *stationary*. The hypothesis telling us how we sense direction assumes the sound to be *traveling*.

So whether we consider our sense of direction to be due to difference in intensity at the two ears, difference in phase, or a combination of both, it must be dependent upon *moving* waves and not stationary or continuous ones.

The only time we encounter definitely moving waves is at the occurrence of transients, when the individual tones *start*. As the tones are sustained, the waves build up to a standing wave. After the tones cease, the waves die away according to the reverberation period of the room.

Now we should have a little better mental picture of how we sense direction on composite program material. When the first wave front of a particular sound reaches us, our critical sense of timing, between the two ears, comes into play and assesses the direction from which *this* wave arrives. As the tone continues, a standing wave builds up but the hearing faculty seems to ignore any confusion that the standing wave might cause, and goes on with the impression conveyed by the *initial* wave front, continuing to imagine that the whole sound comes from the same general direction.

This fact, although not well understood, has been proven

in a number of ways. Experiments with Perspecta Sound, a system that uses only one audio channel, but can move its apparent source around, have proven this fact by producing a quite satisfactory stereophonic illusion. This was achieved by concentrating on the fact that the sense of direction derives from transients only. The relative intensity from different loudspeaker units was switched about rapidly between transients. According to the stereophonic theory usually presented, the follow-through tone should have seemed to drift around, but this second effect could not be detected at all, due to the proclivity of the hearing faculty just mentioned, that ignores the confusing tendency of follow-through tones caused by reverberation, and adheres to its first directional impression.

Another, and perhaps more dramatic, experiment that showed this principle to be true, consisted of playing program material over two separate channels with a few milliseconds time difference, by using separate pickup heads. The first pickup was amplified and fed to a small portable radio loudspeaker, free to be moved about to various positions. The slightly later pickup was fed to a wide-range system using multiple unit loudspeakers.

The effect was extraordinary. The impression was that the high-quality wide-range sound was coming from the small radio loudspeaker, wherever this happened to be at the moment, and the big loudspeakers seemed to be silent!

In other words, direction is sensed from the first sound to reach the ear.

What does all this prove? Well, we're not recommending any Goldbergian devices to produce phony stereophony. There is no known machine, of course, that can predict that the next important transient on your record will be an oboe note, and thus should be emphasized from your left-hand loudspeaker. The purpose of this article is simply to show that much that is being said today about stereophonic reproduction is not based upon valid hypotheses.

Any theory based upon relative phase of *continuous* tones I consider invalid. What the ear uses to determine direction is not the phase of continuous tones but the time and intensity difference of transient components—the wave front where the tones actually begin. Exactly how we are to generate in our living rooms a sound field that accurately reproduces these particular parts of the original sound field is something for engineers and physicists to investigate further.

The fact the "classic" hypothesis is not adequate can be further demonstrated from investigation of the methods used for producing stereophonic recordings. We listeners may fondly imagine that two or three microphones are placed in positions representative of the spacing that will be used between our two or three loudspeakers in playback. This is not always true. The microphones are spaced farther apart in many instances, and the instrumentalists may be grouped around the microphones so as to cause a bigger-than-natural differential between the sounds recorded on the two or three channels. But *when the sound is reproduced*, it still can give the desired effect, a solid array of musicians, not groups

Continued on page 133



by PHILIP L. MILLER

Treasurer of



Roberto Bauer

LAST FALL in Milan, where I found myself with only a day to spend, there was one thing I wanted to do besides visiting the Cathedral and the Galleria and viewing the Last Supper: look up the author of the acoustical record collector's bible, Roberto Bauer. I telephoned from the hotel where I was staying, but the lady who answered obviously did not understand my carefully constructed questions, and I soon found myself cut off. At this point I wondered whether Signor Bauer would have any particular reason for wanting to meet *me*, and almost gave up in discouragement. But there was a way. The young man at the hotel switchboard understood my Italian better than had the lady and did not in the least mind getting Signor Bauer for me, after which it was plain sailing. Bauer speaks excellent English, and he was as cordial as I could have hoped.

He was so sorry he was engaged that evening; would I care to call at eleven the following morning? I would indeed. Our rented car meant that no timetables had to be considered, and the next day I climbed the two flights of stairs to his spacious and comfortable apartment. My host proved to be a man of average build with a suggestion of premature grayness, whose urbane manner assorted well with his fine old Renaissance furniture. Our conversation ranged, not unnaturally, from the singers listed in his monumental discography—*Historical Records 1898/1909*—to the present great in the opera world. He knows them all. They come to his home to hear his priceless records, for he has one of the great collections of the world. And he knows their achievements so well that he has become a representative of our own Metropolitan in Italy and has been responsible for the engagement of more than one important singer. Over glasses of *Punt e Mes* (a delicious Italian vermouth served with lemon) we talked of some of the older singers

Bauer has known—Frida Leider, Sammarco, Boninsegna—and Titta Ruffo, who once in his later years invited him to dinner, then afterward sang for him, a rarely accorded privilege. The latest excitement in the house was the acquisition of a couple of test pressings of recordings by Lola Beeth, a famous German soprano who had one Metropolitan season in the 90s and who was not known to have made any records at all. The selections were trifling songs, the one by Karl Goldmark, the other—astonishingly—Mascagni (though to a German text); but the voice was lovely, the reproduction not bad. Taking my departure, I had reason to hope we would meet again, for Signor Bauer told me he was to make his first visit to the States that season, at the behest of the Metropolitan Opera Association.

It perhaps may seem remarkable that during my visit I learned strangely little about Signor Bauer himself. Every collector on this side of the Atlantic knows as much as I did after a pleasant conversation. And so when we did meet for lunch in New York, I made up for lost time.

Roberto Bauer was born in Milan of a German father and an Italian mother. His mother was not a singer, but was an opera enthusiast; she held a box at La Scala for many years and knew all the celebrities of her time. Roberto's first opera experience was at the age of six, when he was taken to hear *Cavalleria Rusticana* with Luisa Garibaldi and Bernardo de Muro—certainly something to remember. Not long thereafter he heard a *Falstaff* cast that included Sammarco, Garbin, Mansuetto, Concetti, Fabbri, and surely not least, Lucrezia Bori. He also was introduced to *Le Donne Curiose*, *Aida*, and *Carmen*. But like all good things, this period of felicity came to an end. "I was *so* impressed," he says, "that for ten years I was not allowed to go to the opera."

In the course of time Bauer went to Germany for his schooling, first at Wiesbaden, later at Frankfurt am Main, where he entered the University. But then, he recalls, "My mother decided it was good for a young man to see the world, so I was sent to England and France for a

The compiler of the acoustical record collector's bible tells of the making of a monumental discography and promises that, with luck and labor, the second volume will be on its way.

the Golden Age

couple of years. I was about twenty. Then I went back to Milan, where I began to attend all the opera performances. But now mother didn't like the singers at La Scala, always remembering those she had heard when she was young, and so I began to look for records bearing the names she talked about. I studied singing for a while with Giovanni Laura, teacher of Giovanni Gravina, Galiano Masini, and Giuseppina Cobelli, who was one of the finest artists I ever heard, though I believe she was not known in America. But I was intelligent enough to hear myself, and I understood I would never become a Titta Ruffo or a Josef Schwarz."

And here he made a confession. "If I were given a choice between an opera and a good concert, I would go to the concert." His knowledge of the lieder repertoire is large, and he has great admiration for such nonoperatic artists as Julia Culp, Elena Gerhardt, Fritz Steiner, and Helge Lindberg.

I asked about his favorite operas. He replied without hesitation, "*Fidelio*, *Götterdämmerung*, *Elektra*—of Mozart, *Così fan tutte*. I am fond, too, of Rossini, Paisiello, and Verdi. But in my personal, private view, the most perfect opera is *Carmen*. I can't say I like modern music, with a few exceptions, but it interests me very much. I am glad when new operas are performed in Italy or elsewhere, otherwise how would it be possible for them to be judged? The best modern opera—that is, of the postwar period—I consider *Peter Grimes*.

"In 1931 I was back in Milan, where I attended hundreds of performances at La Scala and other opera houses. My mother was less and less satisfied. And so I began my search for records by Litvinne, Tetrizzini, Caruso, Battistini, Ruffo, and others. In those days it was possible to get records in junk shops, flea markets, and such out-of-the-way places. I succeeded quite well. For a long time I had hopes of finding records by Amelia Pinto. When I finally did find one, I was utterly disappointed. I was convinced that Leider was a better Isolde than Pinto ever could have been. Mother objected that the record did not

do Pinto justice, that the equipment we had could not reproduce her voice adequately."

Another incentive to his collecting was his interest in reading. "I used to read everything I could find about singers in countries other than Italy, and then I wanted to get records of them to see how they compared with the Italian singers. Then one day, by chance, in the Mario Levi shop (now Il Disco), I found a copy of *The Gramophone*, and there was *Collectors' Corner*, run by P. G. Hurst; so I began to understand that there were other people just as crazy as I was. I got in touch with Hurst, who put me in contact with many other collectors. Since then I have collected and exchanged in many countries. My idea was to find at least one or two disks of every singer of international importance in all countries. This did not prevent me from collecting singers of the present along with those of the past, or from buying symphonies, quartets, etc. Some singers I admired so much that I tried to collect them complete. During the war I lost some 6,000 records, mostly G & T, Fonotopia, etc. My present collection numbers about 10,000 78s, and about 1,000 LPs. Of course, numerically, it is by no means one of the greatest collections in the world, but I think it is a very interesting one, because of the many unusual things. So far as numbers are concerned there are many much bigger collections. Fortunately most of the rarities I lost during the war I was able to replace again, though a few very rare specimens, such as the Leffler-Burkhardt *Walküre* and the Kousnjetzowa G & T, could not be found again.

"When Hurst's *Recorded Memories* came out I found it quite incomplete, covering only artists known in London. I thought that also America, Italy, France, and the Scandinavian countries would be interested in this kind of book, and it should contain singers who appeared at the Metropolitan, La Scala, Stockholm, Paris, Vienna, Berlin. It would be helpful also to collect numbers, dates, and publishers, and so my catalogue was born. I know it is incomplete; I have enough material for Vol. 2, which will be as big as the first book.

"It may surprise you if I say that I never thought of any date, certainly not 1909, which was the limitation of my first catalogue, as ending the period of 'historical records.' I start from the point of view that even modern records are 'historical,' as in some thirty or forty years they will belong just as much to the past as the records of the beginning of the century. I feel most strongly that collectors of today should bear this in mind, so that anything of musical or historical value, however common it may seem today, will not be lost tomorrow. It is regrettable that so far there does not exist some kind of museum where records are available to everybody who is interested in them (I mean to listen to them) and I hope that in time at some spot in the world such a museum will be founded. I seriously intend to leave in my last will my whole collection to some public institution; if the museum exists, surely to it."

I asked Signor Bauer who were his favorite singers, agreeing that it would be safest to draw a dateline, and consider only those of the

Continued on page 132

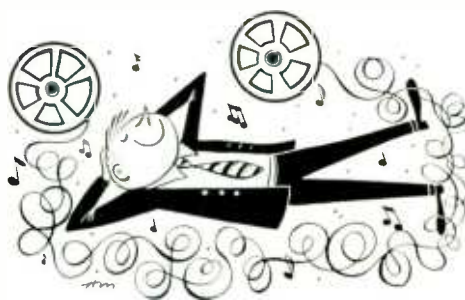

Aroint thee, Obtrusive Melody!

by H. W. HEINSHEIMER

Are there times when the Muse should soothe, and nothing more? Mr. Edward B. Benjamin thinks so, and backs his preference with cash.

HAVING UNLEASHED on the world Elvis Presley and an onerous assortment of others who have filled the psychiatric wards and the waiting rooms of ear specialists throughout the land, the South now offers an antidote not only to the shrieks of its own musical dervishes but to the tensions, strains, and nerve-wrecking hysterics of our time in general. It has introduced to the nation's musical scene one Mr. Edward B. Benjamin, a gentle, slender, energetic, and erudite millionaire who has been, and still is, spending a lot of time, thought, effort, and money to give to this worried, restless world a large and still increasing offering of what he calls with prophetic fervor "Restful Music."

Mr. Benjamin spends a few months every year in Greensboro, North Carolina, to look after some 3,000 acres of family holdings; to approve the building of a few hundred new homes, a golf course or two, and a couple of shopping centers; and to ride up and down Benjamin Parkway before returning to his native New Orleans where he gave up his textile, salt, and chemical endeavors after, as he puts it, "oil came in for us in a very substantial way." At other times during the year Mr. B. and his beautiful wife race their horses in Saratoga and Miami, and gaily

sail up and down the coast from New Orleans to Boston, always heaving-to on Sunday afternoons, when all hands on the ketch *Indra III* are sent below deck and told to pipe down while the skipper and his lady listen to the broadcast of the Philharmonic Orchestra from New York.

That a man of such diversified callings and absorbing enterprises would feel the occasional need for relaxation and rest seems understandable. That Mr. Benjamin turned to music, and not to golf or bridge or deep sea fishing, in order to sooth his mind and relax his body when he emerged from his labors has been a very lucky circumstance and a factor of far reaching consequences. As he went after everything else in life, Mr. B. went after his rest and relaxation in a big way.

It was not pure accident that he chose music, of course. He had been exposed to it from his early childhood, since he came of a family which once — more than a generation ago — supported the musical life of New Orleans almost single-handed, subsidizing concerts and importing symphony orchestras from St. Louis and Minneapolis. Young Edward took up the cello and spent many an evening as the youngest member of the French Opera Club in the old New Orleans opera house. When he went on to Harvard he was provided with a subscription to the Boston Symphony, to become one of fewer than half a dozen undergraduates who went regularly to hear Karl Muck and his band. And when the family acquired a summer home on the New Jersey coast, fate put it next to a house wherein lived a young member of the Guggenheim family whose fancy it was to assemble a complete collection of every Victor Red Seal record in existence.

Today Mr. Benjamin's attitude towards music has changed slightly from his days at Symphony Hall and the Red Seal fiestas at the New Jersey seashore. One day recently I sat opposite him in the beautiful, restful living room of his Starmount Farm in Greensboro, while the third movement of Hindemith's String Quartet No. 3, one of more than 500 selections of "restful music" which he has put on tape, floated gently from a loudspeaker,



hidden in a converted pine kitchen sink of early colonial vintage, pleasantly competing with the pretty warble of the North Carolina birds in the garden and an occasional neigh from one of the horses in the stable down the road. "Music," Mr. B. explained to me, "is something functional, something 'to use.' It is not a sanctification, not just a part of your cultural heritage and make-up or a result of careful training — it is simply and purely a sensuous enjoyment, to be used with discretion, lest it become a vice like any other sensual thrill. From its early beginnings, music has been put to use: it sings babies to sleep, it serenades women into submission, boats are dragged up the Volga and the Yellow River to its relentless sound. It sends armies marching, and teen-agers dancing. It uplifts the hearts of worshippers, sets the pace for a funeral procession, and lohengrins the bride down the aisle. I, too, wish to use music to satisfy my personal functional needs — and as a mature American I find that my primary need in the home is not excitement through music, not stimulation — my primary need, at home, is restful music."

The Hindemith movement came to an end. There was a silence of half a minute or so and then — Mr. Benjamin's tapes of restful music play for over three hours and he has about twenty of them! — music from Handel's *Pastor Fido*, conducted by Sir Thomas Beecham, filled the room. I began to give in, bodily and mentally, to the soothing sensation, to the soft, gentle saturation of the atmosphere with pleasant, beautifully reproduced sound. All the strain and effort seemed to go out of our conversation. My host noticed it and smiled.

"It was never my idea that restful music should replace the excitement and the uplift of music in the concert hall or the opera house," he continued, while the shepherd's lament was filling the house and making me relax deeply in my chair. "But there are many evenings in my busy life when, after dinner, I have to look over reports, read trade papers, work on many matters to which I can give no attention during the day. By playing my beautiful restful music as a background I give myself a treat that nothing else can give me. I help myself overcome my fatigue and the tedium of having to work evenings as every busy American has to do, more frequently than he realizes. The farmer has his farm journal to peruse, young people have to do their homework, the doctor and the attorney have to brush up on their professional knowledge, the teacher pores over examination papers, preachers prepare their sermons, salesmen work on their accounts. My music, I know, will help them to go through their tasks with a free and easy mind, happily separated from the blare of television and the noise of radio commercials."

The Handel music had by now been replaced by a movement from Massenet's *Scènes Alsaciennes*, and as there was so much variety even among these few selections — Hindemith, Handel, Massenet — and as I could see from the list Mr. B. had handed me, Bartók's String Quartet No. 5 was to be next, it was only logical that I wanted to know what, to his

mind, was the common denominator. Just what made a piece eligible? I could think of many a tranquil composition that was missing from the collection.

"We are not talking about *tranquil* music," Mr. Benjamin said a little testily. "I have nothing against it. I usually play some tranquil music while I have dinner with my wife. It gives me a feeling of *Gemütlichkeit*. It acts like a cocktail. A Haydn Symphony, for example, or Ravel's *Mother Goose*, or the *Classical Symphony* by Prokofiev. Tranquil music is music that charms and cheers. But restful music is music that charms and soothes."

He had thought a lot about the sort of music he considers restful and had found from his own experience and by testing and watching and carefully evaluating the reaction of others — his own family, his friends, guests, a carpenter working in the house, the cook coming in from the kitchen, spellbound with wide open eyes — he had found out that restful music could best be defined as soft, slow composition without vocal or marked percussion effects and without obtrusive melody. It might be found in every period of music, and it could be played by a string quartet, an organ, a symphony orchestra, a group of wind players. It had great variety within its limitations.

Once he had defined and tested restful music to his complete satisfaction and taken it deeply and sincerely to his heart, Mr. Benjamin found himself faced with a much more difficult task: first, how to find, out of thousands and thousands of compositions, the music that fitted the theory and then, after he had found piece after piece, movement after movement, how to play the music without constantly changing records, searching for the beginning of a movement on an LP, turning 78s in the middle of a piece, being kept busy all evening in an activity that defied the very purpose it was aimed at. And so Mr. Benjamin's tapes came into existence. He found a man with a staggering knowledge of recorded music and an unfailing memory, Walter Diehl, then on the staff of WQXR in New York, who went to work to research and classify all the restful music he could find in the enormous collection of records in the WQXR library. Later, and with the assistance of Eugene Showalter, an oboist with the New Orleans Symphony, he organized them in pleasant, well-balanced rotation and put them on tapes. I think that nothing could more clearly illustrate the whole principle behind this ambitious undertaking and the tremendous amount of constructive work that went into it, than the contents of one of the reels — Reel 9, Track A and B — from the Benjamin-Diehl Restful Music Library:

- (1) Ture Rangstroem — Divertimento Elegiaco for Strings.
- (2) Tommaso Albinoni — Concerto for 2 Oboes, 2 movements.
- (3) Shostakovich — Violin Concerto. Nocturne (Oistrakh).
- (4) Reger — Three Choral Preludes.
- (5) Haydn — String Quartet Op. 2, No. 3, third movement.
- (6) Bernard Wagenaar — Symphony No. 4, fourth movement. *Continued on page 129*



Fine High-Fidelity is for you too . . .



You *can* enjoy savings *without* sacrificing quality—if you “build-it-yourself” and eliminate labor charges; and if you buy direct from the manufacturer and eliminate extra profit.



MODEL BC-1

Here's what you get:

High-fidelity amplifiers, tuners, and speakers that you *assemble yourself*, from the step-by-step instructions furnished. You get, top-quality parts at lower cost through Heath mass purchasing power. You get the equivalent of systems costing approximately twice the Heathkit price.

MATCHING CABINETS

The Heathkit AM tuner, FM tuner, and preamplifier kits may be stacked one on the other to form a compact "master control" for your hi-fi system.

- BC-1
- FM-3A
- WA-P2



MODEL WA-P2



MODEL W-3M



MODEL W-3M



MODEL FM-3A

HERE'S WHY A **Heathkit**[®] IS FUN TO BUILD:

Instructions are *complete*, and our amazing step-by-step method, tied-in with large pictorial illustrations, guide the beginner through each stage of assembly. If you can follow directions you can succeed, and can build high-fidelity equipment you will be proud to show off to your family and friends.



Here's the proof:

Thousands of Heathkits have been built at home by people just like yourself, and you should treat yourself to this same experience by dealing with the world's largest manufacturer of top-quality electronic kits for home and industry.

Heathkit Model FM-3A High Fidelity FM Tuner Kit

Features A.G.C., and stabilized, temperature-compensated oscillator. Ten uv sensitivity for 20 DB of quieting. Covers standard FM band from 88 to 108 mc. Ratio detector for efficient hi-fi performance. Power supply built in. Illuminated slide rule dial. Pre-aligned coils and front end tuning unit.

\$25⁹⁵*

(With Cabinet)
Shpg. Wt. 7 Lbs.

Heathkit Model BC-1 Broadband AM Tuner Kit

Special AM tuner circuit features broad band width, high sensitivity and good selectivity. Employs special detector for minimum signal distortion. Covers 550 to 1600 kc. RF and IF coils pre-aligned. Power supply is built in.

\$25⁹⁵*

(With Cabinet)
Shpg. Wt. 8 Lbs.

Heathkit Model WA-P2 High Fidelity Preamplifier Kit

Provides 5 inputs, each with individual level controls. Tone controls provide 18 DB boost and 12 DB cut at 50 CPS and 15 DB boost and 20 DB cut at 15,000 CPS. Features four-position turnover and roll-off controls. Derives operating power from the main amplifier, requiring only 6.3 VAC at 1 a. and 300 VDC at 10 ma.

\$19⁷⁵

(With Cabinet)
Shpg. Wt. 7 Lbs.

Heathkit Model W-5M Advanced-Design High Fidelity Amplifier Kit

This 25-watt unit is our finest high-fidelity amplifier. Employs KT-66 output tubes and a Peerless output transformer. Frequency response \pm 1 DB from 5 to 160,000 CPS at one watt. Harmonic distortion less than 1% at 25 watts, and 1M distortion less than 1% at 20 watts. Hum and noise are 99 DB below 25 watts. Output impedance is 4, 8 or 16 ohms. Must be heard to be fully appreciated.

\$59⁷⁵

Shpg. Wt. 31 Lbs.
Express Only

MODEL W-5: Consists of Model W-5M above plus Model WA-P2 preamplifier. Shpg. Wt. 38 Lbs. **\$81.50*** Express only

Heathkit Model W-3M Dual-Chassis High Fidelity Amplifier Kit

This 20-watt Williamson Type amplifier employs the famous Acrosound Model TO-300 "ultra linear" output transformer and uses 5881 output tubes. Two-chassis construction provides additional flexibility in mounting. Frequency response is \pm 1 DB from 6 CPS to 150 kc at 1 watt. Harmonic distortion only 1% at 21 watts, and 1M distortion only 1.3% at 20 watts. Output impedance is 4, 8 or 16 ohms. Hum and noise are 88 DB below 20 watts.

\$49⁷⁵

Shpg. Wt. 29 Lbs.
Express only

MODEL W-3: Consists of Model W-3M above plus Model WA-P2 preamplifier. Shpg. Wt. 37 Lbs. **\$71.50*** Express only

HEATHKIT SPEAKER SYSTEM KITS

These speaker systems are a very vocal demonstration of what can be done with high-quality speakers in enclosures that are designed especially to receive them. Notice, too, that these two enclosures are designed to work together, as your high-fidelity system expands.

Heathkit Model SS-1 High Fidelity Speaker System Kit

Employing two Jensen speakers, the Model SS-1 covers 50 to 12,000 CPS within \pm 5 DB. It can fulfill your present needs, and still provide for future expansion through use of the SS-1B. Cross-over frequency is 1600 CPS and the system is rated at 25 watts. Impedance is 16 ohms. Cabinet is a ducted-port bass-reflex type, and is most attractively styled. Kit includes all components, pre-cut and pre-drilled, for assembly.



\$39⁹⁵

Shpg. Wt. 30 Lbs.

Heathkit Model SS-1B Range Extending Speaker System Kit

This range extending unit uses a 15" woofer and a super-tweeter to cover 35 to 600 CPS and 4000 to 16,000 CPS. Used with the Model SS-1, it completes the audio spectrum for combined coverage of 35 to 16,000 CPS within \pm 5 DB. Made of top-quality furniture-grade plywood. All parts are pre-cut and pre-drilled, ready for assembly and the finish of your choice. Components for cross-over circuit included with kit. Power rating is 35 watts, impedance is 16 ohms.



\$99⁹⁵

Shpg. Wt. 80 Lbs.



MODEL W-4AM



MODEL A-9B



MODEL A-7D



MODEL XO-1

Heathkit Model W-4AM Single-Chassis High Fidelity Amplifier Kit
The 20-watt Model W-4AM Williamson type amplifier combines high performance with economy. Employs special-design output transformer by Chicago Standard, and 5881 output tubes. Frequency response is \pm 1 DB from 10 CPS to 100 kc at 1 watt. Harmonic distortion only 1.5%, and 1M distortion only 2.7% at this same level. Output impedance 4, 8 or 16 ohms. Hum and noise 95 DB below 20 watts.

\$39⁷⁵

Shpg. Wt. 28 Lbs.

MODEL W-4A: Consists of Model W-4AM above plus Model WA-P2 preamplifier. Shpg. Wt. 35 Lbs. **\$61.50*** Express only

Heathkit Model A-9B 20-Watt High Fidelity Amplifier Kit
Features full 20 watt output using push-pull 6L6 tubes. Built-in pre-amplifier provides four separate inputs. Separate bass and treble tone controls provided, and output transformer is tapped at 4, 8, 16 and 500 ohms. Designed for home use, but also fine for public address work. Response is \pm 1 DB from 20 to 20,000 CPS. Harmonic distortion less than 1% at 3 DB below rated output.

\$35⁵⁰

Shpg. Wt. 23 Lbs.

Heathkit Model A-7D 7-Watt High Fidelity Amplifier Kit
Qualifies for high-fidelity even though more limited in power than other Heathkit models. Frequency response is \pm 1 1/2 DB from 20 to 20,000 CPS. Push-pull output, and separate bass and treble tone controls.

\$17⁹⁵*

Shpg. Wt. 10 Lbs.

MODEL A-7E: Same, except that a 12SL7 permits preamplification, two inputs, RIAA compensation, and extra gain. **\$19.95*** Shpg. Wt. 10 Lbs.

Heathkit Model XO-1 Electronic Cross-Over Kit
Separates high and low frequencies electronically, so they may be fed to separate amplifiers and separate speakers. Selectable cross-over frequencies are 100, 200, 400, 700, 1200, 2000, and 35,000 CPS. Separate level control for high and low frequency channels. Minimizes inter-modulation distortion. Attenuation is 12 DB per octave. Handles unlimited power.

\$18⁹⁵

Shpg. Wt. 6 Lbs.

*Price includes Fed. Excise tax where applicable.

HOW TO ORDER:

It's simple—just identify the kit you desire by its model number and send your order to the address listed below. Or, if you would rather budget your purchase, send for details of the HEATH TIME-PAYMENT PLAN! All prices subject to change without notice.



HEATH COMPANY

A Subsidiary of Daystrom, Inc.

BENTON HARBOR 8, MICHIGAN



HEATH COMPANY A Subsidiary of Daystrom, Inc.
BENTON HARBOR 8, MICHIGAN
Please send Free HEATHKIT catalog.

Name _____
Address _____
City & Zone _____ State _____

* simple installation

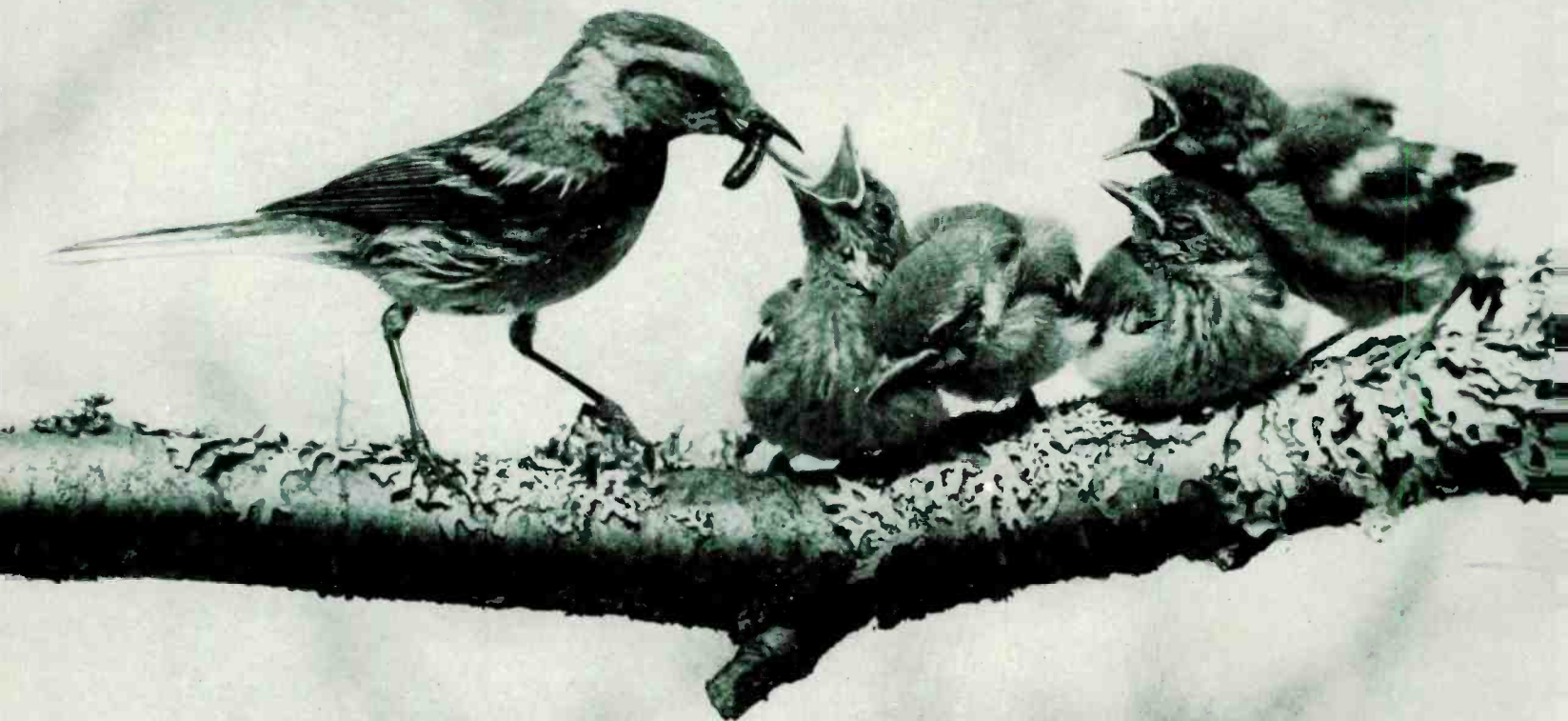

PHOTO BY ALLAN D. CRUICKSHANK



Another reason why today's fastest
selling high fidelity record changer is **Collaro**

* Simple Installation —

the pre-wired audio cable and
the power cord with standard plugs eliminate
need for making solder connections.
Pre-cut mounting board
available.



For other features and new popular price, see your hi-fi dealer or write Dept. PA-2
ROCKBAR CORPORATION 650 Halsted Avenue, Mamaroneck, N. Y.

by  Roland Gelatt

music makers

EARLY JANUARY being a traditional time for sober evaluation of matters of moment, this department has been eliciting opinions on the state of the record industry from officials of several companies. Where do manufacturers of records find themselves today and whither are they going in the coming year? Is it to be the mixture as before, or will 1957 bring cataclysmic innovations? In short, how's business?

All persons queried seem agreed that music on records is thriving, thank you, as never before. More customers are buying more records for more phonographs in more shops, etc., etc. Still, life in the record industry these days is not without its perils. There is, for example, the problem of repertoire. Beethoven's *Eroica* can be heard in twenty-odd different recorded interpretations already, and the question of market saturation naturally arises. Is the time approaching when the record-buying public simply will not support another new *Eroica*? The consensus seems to be that that unhappy prospect is still a long time off.

Lloyd W. Dunn, vice-president of Capitol Records, can foresee the time when "manufacturers will be in a 'survival of the fittest' situation," and this he feels will be "a wholesome state of affairs—good for the public and, in the long run, good for the manufacturer." "However," he quickly adds, "the growing public demand certainly pushes into the distant future any problems concerning this subject." For the present, Mr. Dunn finds the current sales of hi-fi phonographs extremely heartening. He estimates that each new phonograph owner purchases at least thirty-five or forty albums the first year, and that makes for a tremendously expanding market.

Another vice-president, RCA's George R. Marek, agrees that there will be a growing demand for new versions of standard repertoire. "Three fundamental factors," as he sees them, "are at work: (1) New young artists are coming into the field whose interpretations of such a standard piece

as the Rachmaninoff Second Piano Concerto will be of interest to the public. (2) The record industry will continue to find new and better ways of recording, sound will further improve, and stereophonic versions of the standard repertoire will eventually be very much wanted. (3) New young people are being attracted to music, and they are the ones who are buying the new phonographs. They want to know what is the latest, best-sounding version of a Beethoven symphony."

Newness for the sake of newness, however, apparently does not influence the thinking at London Records. According to Remy Van Wyck Farkas, director of artists and repertoire: "We shall continue to update our catalogue in regard to the so-called 'standard' repertoire but we shall do so only if we have the right artists for the right material. We have absolutely no intention of making another Beethoven No. 5 because it happens to be the Fifth of Ludwig Van. Any company looks foolish if they simply issue a popular symphony or concerto regardless of who the interpretive musicians may be, particularly when it is already finely represented by a Toscanini, Heifetz, or Horowitz. But if the new artist(s) happens to have something to say, the success of the rendition is definitely assured. Look at Angel redoing the Beethoven Ninth with Otto Klemperer after having only recently finished with Karajan. This surely makes sense because Klemperer is a truly great conductor, and I would expect collectors to support such releases." As for London's own artists, Mr. Farkas mentions the pianists Backhaus, Curzon, and Gulda as representative of musicians who "have something to say every time they sit down to play." "I am not concerned about the repertoire," he asserts, "only concerned that they give me all the time we would like to make recordings with them."

Westminster operates on the theory that variety is the spice of a phonophile's life. Kurt List, this company's musical director, writes: "For many

professional musicians as well as for the majority of lay record collectors, it is a fascinating experience to avail themselves in their homes of the various interpretations of multifarious performances. Even the growth or the development of one artist and his changed approach to one and the same piece of music, over the years, is a most gratifying experience for the listener. Nor is this restricted to old established performers. For instance, newcomers like Paul Badura-Skoda have recorded for Westminster one piece, such as the Schubert *Moments Musicaux*, twice over a period of four years, and the result of those two different records gives a fascinating insight into the development of the artist. Our established artists will continue to record all those performances which can throw a new and interesting light on a standard piece of music. At the same time, we shall also endeavor to discover new talent and bring names before the American public who previously were unknown."

Decca's classical and chief, Israel Horowitz, stresses the continuing advancement of recording techniques. "If all the elements of the production of musical sound on disks were calculable," he says, "we might then eventually look to a product that would consistently please the most discriminating. But the capture of fidelity is an art as well as a science. The variables are numberless, and human judgment is constantly called upon to temper calculated judgment. Who can say that the last word on sound has yet been uttered? It would be a mistake for the record buyer to assume that before long any major record producer will rest content that he has finally issued the ultimate version of even the most standard masterpiece."

Maynard Solomon, of Vanguard, draws a literary parallel to support his contention that the duplication of standard repertoire on LP has a logical rationale. "It is true," he says, "that there are some magnificent 'classic'

Continued from page 69

All new ultra-compact amplifier SONOTONE HFA-150



15-WATT POWER AT A 10-WATT PRICE!

No amplifier on the market today can compare with the all-new Sonotone HFA-150. Full 15-watt power—superb sound—plus more new, useful “firsts” than any other amplifier at any price.

ONLY 3” HIGH—12” WIDE! For the first time, a complete power *and* control amplifier this compact... without an iota of performance being sacrificed to compactness. The ultra-smart cabinet cover is available in a *choice* of colors—another Sonotone first!

SIX INPUTS! Now, for the first time, you can buy a quality amplifier in this price range that gives you single switch choice of 6 inputs. Three of these in-

puts have *individual pre-set level controls!*

SEPARATE CONTOUR CONTROL! For the first time you get new, exclusive push-pull rumble and noise filters. Bass, treble and volume controls with a *separate* continuous contour control, infinitely variable from flat to 26 db of contour compensation.

The Sonotone HFA-150 is, unquestionably, the greatest value in *fine* high fidelity components in many years. Make seeing and hearing it a “must”!

ONLY \$79⁵⁰ NET Optional cover \$3.50 Net

Write for detailed information without obligation to:

Electronic Applications Division

SONOTONE® CORPORATION

ELMSFORD, N. Y.



performances which make most others sound weak, frivolous, or inadequate. And yet, just as each period writes its own histories and reappraisals of the past, so it has its own fresh and valid viewpoints about past music. And so we intend to be on the lookout for artists who have something fresh, valid, and exciting to say, even about a well-known masterpiece."

Columbia's president, Goddard Lieberson, in a characteristically whimsical mood, believes that "there will continue to be duplication of repertoire unless somebody can resuscitate Beethoven and Brahms and get them to write a few more symphonies apiece." Since this eventuality seems improbable, he suggests that we accept duplication as endemic to the business and realize that there is some good in it. "Records have now trained people to listen to music they have never heard before—new and old music. The next step will be for these listeners to become more discriminating, to listen to more than one version of a particular work and to accept the differences as valid and valuable. This applies both to standard as well as less familiar modern works."

ANGEL's Dorle Soria prefers to be specific rather than general regarding future repertoire. In 1957 the EMI affiliate intends to issue no less than five complete operas with Maria Callas: *Bobème*, *Trovatore*, *Ballo*, *Turandot*, and *Barbieri*. Also promised is a Karajan-directed *Rosenkavalier* with Schwarzkopf and Edelmann. Sir Thomas Beecham will provide the Angel label with *Die Entführung* (Mozart), highlights from *The Bohemian Girl* (Balfe), *The Seasons* (Haydn), *Song of Destiny* (Brahms), and "albums of ballet music of various kinds." Two contemporary German composers are to be well represented—Carl Orff with his celebrated *Triptych* and the opera *Der Mond*, Paul Hindemith with a composer-conducted album of six major works.

Particulars were vouchsafed by a few other companies. RCA Victor will dip into its backlog of Toscanini tapes for a two-LP album called *Verdi and Toscanini* as well as for the long-awaited *Aida*. The last fruits of the expiring alliance with HMV will be coming before May 1 (Boito's *Mefistofele*, Brahms's *German Requiem*, Gay's *Beggar's Opera*, Puccini's *Il Tabarro*, Stravinsky's *L'Histoire du soldat*), also the first fruits of the new

alliance with English Decca (two Strauss tone poems performed by the Vienna Philharmonic under Reiner). Columbia has some Mozart piano concertos performed by Serkin en route, also a *Messiah* conducted by Leonard Bernstein. Vanguard will be publishing several new Alfred Deller recordings, among them Monteverdi's *Il ballo delle ingrate*.

STEREO TAPE is clearly due for considerable promotion during 1957. All the major record producers are now planning to jump aboard the stereo bandwagon, at the proper moment, though all of them will not admit as much. Angel, Columbia, and Decca prefer to keep mum for the time being about stereo projects. Others are willing to talk about stereo, but only in general terms; Capitol, London, Mercury, Vanguard, and Vox fall into this category.

Lloyd Dunn asserts: "Capitol, as a major company, is well prepared to be competitive if and when stereo tapes develop a mass market appeal. However, with the tremendous improvement in phonograph records, and the growing sales of record players, we feel that—at least for the next few years—stereo tape will be a luxury item for those who have the time, interest, and money to obtain the finer

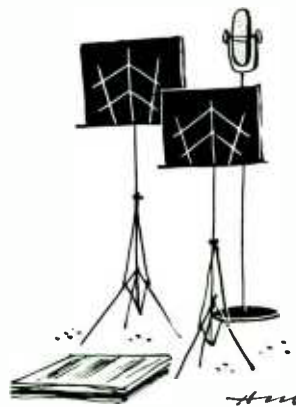

nuances in reproduced music." London's Remy Farkas has no comment to make on stereo "save that we are at least as well prepared for all eventualities as the next company."

Wilma Cozart, vice-president of Mercury Records, explains that "all Mercury Living Presence sessions have been done in both three-channel stereo and binaural form for two years now" and adds parenthetically that Mercury was "the first company to record three-channel stereo." "We feel sure," she concludes, "that the market for stereo-

phonic recording will expand appreciably in the future," but Miss Cozart does not say when Mercury intends to begin wooing this market. Vanguard's Maynard Solomon is likewise sanguine about stereo's potentialities and silent about his company's specific plans. "There will be," he believes, "a steadily rising interest in stereo recording, but not to the extent of transforming the record industry, at least for a decade." Vox's president, George H. Mendelsohn, looks beyond stereo tape to stereo records. He believes that "the day is very close when the problem of stereo records will be solved. As a matter of fact, I believe the problem is solved, and that they are at the present time trying to work out an international standardization of the process of making stereo records."

Two companies, RCA Victor and Westminster, are delighted to get down to cases on the subject of stereo tape. George Marek says that Victor is "already feeling an increase in interest in stereo tape recordings. This interest is, of course, directly dependent on and proportionate to the development of good stereo tape players at a reasonable cost. RCA is working on this problem. All important recording sessions are now being done in stereo. However, don't give anybody the idea that stereo will replace disks. Not for years to come. It is a question of cost." Cost notwithstanding, Victor plans to issue an increasing number of Red Seal recordings on stereo tape during 1957. Like Mercury, Victor is now making three-channel recordings (on half-inch tape), but only for the purpose of better controlling the ultimate monaural and binaural products; no three-channel commercial issues are contemplated.

"Westminster," Kurt List tells us, "will certainly do all of its recording in the future stereophonically as well as monaurally, and will make a certain number of stereophonic tapes available on Sonotape. Obviously the market is still limited, partly because many stereophonic efforts have fallen far short of expectations. However, initial successes of Westminster stereophonic recordings, as released by Sonotape, already prove that a quality tape meets a wide demand."

ALL OF WHICH seems to indicate that the record companies expect to stay solvent in 1957—and to keep the rest of us in poverty.

Capricorn



January

The Gieseeking Legacy

BEETHOVEN SONATA SERIES

Walter Gieseeking had planned to record all the Beethoven Sonatas. When he died in London he had completed 23, including the first 20 — except for Opus 31, No. 1, which he was to have done the day after he was taken ill, and the last movement of Opus 28, which was to have been recorded the night of his fatal attack. . . .

January Release

"Tempest" Sonata No. 17 in D minor, Op. 31, No. 2
Sonata No. 18 in E-flat major, Op. 31, No. 3

One 12" record Angel 35352

Previously Released

"Moonlight" Sonata No. 14 in C sharp minor, Op. 27, No. 2
 "Pathétique" Sonata No. 8 in C minor, Op. 13 Angel 35025

"Appassionata" Sonata No. 23 in F minor, Op. 57
 "Waldstein" Sonata No. 21 in C major, Op. 53 Angel 35024

Coming in March

Sonata No. 30 in E major, Op. 109
 Sonata No. 31 in A-flat major, Op. 110

Oistrakh and Fournier

DAVID OISTRAKH plays

Tartini: "Devil's Trill" Sonata in G minor
 Mozart: Sonata No. 32 in B flat, K.454

Pianist: Vladimir Yampolsky (recorded in London)
 One 12" record Angel 35356

Note: Angel has released a dozen Oistrakh albums, including Oistrakh Encores (35354), Beethoven Concerto (35162), Bruch Concerto No. 1 and Prokofiev Concerto No. 1 (35243), Tanciev Concert Suite (35355). Write for complete list.

PIERRE FOURNIER plays

Schumann: 'Cello Concerto in A minor
 Tchaikovsky: Variations on a Rococo Theme

Philharmonia Orchestra Conductor: Sir Malcolm Sargent
 Note: This is Fournier's first Angel recording.

One 12" record Angel 35397

Karajan - Klemperer - Markevitch

MOZART: CLARINET CONCERTO (soloist: Bernard Walton)
SYMPHONY NO. 39 IN E FLAT, K.543

Herbert von Karajan, conductor. Philharmonia Orchestra.
 One 12" record Angel 35323

Karajan and Philharmonia have also recorded Mozart's Eine Kleine Nachtmusik and Sinfonia Concertante in E flat (35098); Four Horn Concertos, soloist Dennis Brain (35092).

BEETHOVEN: SYMPHONY NO. 7

Otto Klemperer, conductor. Philharmonia Orchestra.
 One 12" record Angel 35330

Klemperer and Philharmonia have also recorded Beethoven's "Eroica" Symphony No. 3 (35328); Overtures "Fidelio" and "Leonore" 1, 2, 3 (35258).

SHOSTAKOVICH: SYMPHONY NO. 1

PROKOFIEV: SCYTHIAN SUITE

Igor Markevitch, conductor.
 Orchestre National de la Radiodiffusion Française.
 One 12" record Angel 35361

Markevitch and Orchestre National have also recorded Haydn Symphonies 101 "Clock" and 102 (35312); Schubert "Unfinished" and Mendelssohn "Italian" Symphonies (35309); Stravinsky Pulcinella Suite and Divertimento (35143); Tchaikovsky's Romeo and Juliet, Moussorgsky's Night on Bald Mountain, Borodin's Polovtsian Dances (35144).

Opera Highlights

"CAVALLERIA RUSTICANA" and "PAGLIACCI"

Highlights from La Scala recordings, conducted by Serafin. Starring MARIA MENEGHINI CALLAS (Santuzza and Nedda), GIUSEPPE DI STEFANO (Turiddu and Canio), TITO GOBBI (Tonio). One 12" record Angel 35345

Previously Released: "NORMA" Highlights, La Scala recording with Callas in title role (35379). "CALLAS SINGS LUCIA", Scenes from Florence May Festival recording, with Di Stefano and Gobbi (35382).

From Ireland: Another Great Play

THE PLAYBOY OF THE WESTERN WORLD

by John Millington Synge

Synge wrote in his preface: "In a good play every speech should be as fully flavoured as a nut or an apple". . . . Dublin recorded, this album preserves all the "flavour" of the Celtic masterpiece.

Starring CYRIL CUSACK as Christy Mahon and SIOBHAN McKENNA as Pegeen Mike

in roles they have richly and eloquently interpreted from Dublin to the International Theatre Festival in Paris.

Also: Maire Kean and Harry Brogan (of the Abbey Theatre), Seamus Kavanagh, Thomas Studley.

Two 12" records Angel Album 3547 B (35357-8)

Factory-Sealed Gala Edition contains illustrated booklet with essay by poet Louis MacNeice, pictures and biographies of cast, excerpts from play, etc.

Reminder: Angel's magnificent recording of Sean O'Casey's "Juno and the Paycock" with Cyril Cusack and Siobhán McKenna (Angel Album 3540 B).

"I Musici" - Early Italian Music

CORELLI: CONCERTO GROSSO NO. 1, OP. 6

VIVALDI: CONCERTO IN A MAJOR FOR VIOLA D'AMORE AND STRINGS

Soloist: Bruno Giuranna.

CONCERTO IN D MINOR, OP. 3, NO. 11 ("L'Estro Armonico")

MARTINI: CONCERTO IN F FOR PIANO, STRINGS

Soloist: Maria Teresa Garatti. One 12" record Angel 35253

Angel's 5th album recorded by Italy's group of superb musician-virtuosi whose name is "The Musicians".

Previously released: Four Vivaldi Concertos (35087); Music of Rossini, Tartini, Galuppi, Marcello (35086); of Albinoni, Gabrieli, Marcello, Vivaldi (35088); Pergolesi two-record album including 6 Concertini for Strings (Album 3538 B).

"Angels In Pigtails"

OBERNKIRCHEN CHILDREN'S CHOIR in FOLK SONGS AND FAIRY TALES

Side One: 6 numbers including The Elfin Friend (Freund Huseh), Wiegenlied, Vespergesang, The Echo, and Medley of German Children's Songs. Side Two: "The Bremen Town Musicians", delightful musical fantasy based on Grimm Fairy Tale, sung in English. . . . this new recording ends with "America the Beautiful" with which the Obernkirchen Children's Choir salutes its friends all over the country who have listened to its songs in concert and on Angel Records. One 12" Blue Label record Angel 65031

Also available: Christmas Songs (65021); The Happy Wanderer (64008); The Little White Hen (64012).

Angel  Records

ANGEL RECORDS, ELECTRIC & MUSICAL INDUSTRIES (U.S.) LIMITED, 38 WEST 48 ST., NEW YORK CITY

a subsidiary of Electric & Musical Industries Ltd., Hayes, Middlesex, England

Records in Review



Reviewed by PAUL AFFELDER NATHAN BRODER C. G. BURKE JOHN M. CONLY
 RAY ERICSON ALFRED FRANKENSTEIN ROLAND GELATT JOAN GRIFFITHS
 JAMES HINTON, JR. HOWARD LAFAY ROBERT C. MARSH
 MURRAY SCHUMACH JOHN S. WILSON

Classical Music	71	Dialing Your Disks	84
Advertising Index	72	The Music Between	86
Recitals and Miscellany	80	Best of Jazz	88

CLASSICAL

BACH: *Concerto for Violin, Oboe, and Strings, in D minor; Concerto for Flute, Violin, Harpsichord, and Strings, in A minor, BWV 1044*

Solisti di Zagreb, Antonio Janigro, cond.
 VANGUARD BG 562. 12-in. \$4.98.

The D minor Concerto is an attempted reconstruction, by Max Seiffert, of the supposed original of the Concerto for Two Harpsichords in C minor, BWV 1060. If the original were ever found, it would very likely differ in detail from this reconstruction, but the music is so glorious that it can be thoroughly enjoyed in its present state, and it is warmly recommended to anyone who prefers the combination of violin and oboe to two harpsichords. The soloists are satisfactory, though hardly of the caliber of Stern and Tabuteau in the Prades Festival series on Columbia, but the recording is more lifelike here. The triple concerto is another fine work well performed, but suffers from improper balance: the harpsichord is generally too weak in relation to the flute and violin. N.B.

BEETHOVEN: *Symphony No. 3, in E-flat ("Eroica"), Op. 55*

Berlin Philharmonic Orchestra, Eugen Jochum, cond.
 DECCA DL 9865. 12-in. \$3.98. ✓

This is Decca's third version. She will not soon surpass it. Nor is it easy to see how and where another conductor and orchestra can contrive a better performance. In the course of time there will be *Eroicas*

more effective in terms of sound alone, although there is none now, but the quality of conducting does not improve in the certain way of scientific progress.

In both performance and sound the newest version seems the most desirable of the thirty recorded. Much of its eminence derives from the conductor's repudiation of a personal style. This is not a fast *Eroica*, nor a slow one, nor an eccentric. The vertical structure is in general more adjusted to beauty than to blaze, and the few departures from regularity of pace have the authority of logic and conviction. This praise is directed primarily at the first allegro, for the other three movements have demonstrations on records quite comparable with Mr. Jochum's; but in the maturity of the steadfast phrasing, the mellow nobility of the shape given to the allegro con brio, there is no comparison entirely adequate. Here the intensity of aspiration is under the restraint of doubtlessness. Under this leadership the Berlin Philharmonic glows as it has not often done on disks, and the sound is excellent in scope, timbre, and dynamics, outstanding in bite and balance. C.G.B.

BRUCKNER: *Symphony No. 4, in E-flat ("Romantic")*

Pittsburgh Symphony Orchestra, William Steinberg, cond.
 CAPITOL P 8352. 12-in. \$3.98. ✓

This is one of the most polished of recorded Bruckner performances. Using the edition of Ferdinand Löwe with its several cuts, Steinberg is able to get the whole symphony onto one disk without rushing or squeezing. His conducting is plastic, always interesting, never heavy and stodgy, as so many Bruckner interpretations are apt to sound. He takes a few liberties; but they are always in good taste and the music benefits from them—a test of their

rightness. Unless you are a stickler for the longer original version of this symphony, as restored in recent years, the present recording is a compact, economical, and highly satisfactory edition, in the ultra-clean, vivid sound we have come to expect from Capitol-Pittsburgh collaboration. P.A.

DELIBES: *Sylvia* ✓
 Philharmonia Orchestra, Robert Irving, cond.
 RCA VICTOR LM 2036. 12-in. \$3.98.

Sylvia is here presented as complete as it need be in what I gather to be the version of the 1952 revival by the Sadler's Wells company at Covent Garden. Robert Irving is, of course, one of the most expert of ballet conductors, and he has at his disposal here the superior orchestral resources of the Philharmonia. The result is very agreeable listening, since the score has ample musical interest to withstand the visual loss of dancing. The recording is resonant, but not to excess, richly colored, and full of the refined effects and robust ensemble passages that characterize a well-trained English orchestra. In the opening of Act III this yields some of the most stunning moments I have heard from a record in recent months. R.C.M.

FAURE: *Requiem, Op. 48; Cantique de Jean Racine, Op. 11; Madrigal, Op. 35; Pavane, Op. 50* ✓

Françoise Ogéas, soprano; Bernard Demigny, baritone; Chorus of Radio-Télévision Française, Orchestre du Théâtre des Champs-Élysées, D. E. Inghelbrecht, cond.
 LONDON DTL 93083. 12-in. \$4.98.

The Fauré Requiem is not lacking in fine recorded performances; all six of those already on the market are more than ac-

ceptable, and so is this latest one from London's Duceyter-Thomson branch. It is interpreted with reverent intimacy, but at the same time is endowed with bright sound that has a good deal of hall resonance. Could it have been recorded in a church, where it belongs? If not, it creates that desirable illusion without the muddiness that so often accompanies such recordings. The solo voices, good though hardly outstanding, are not pushed to the foreground, as so frequently happens, but seem to come from the body of the chorus.

What may decisively give this disk an edge over its six competitors is the extra bonus of three short Fauré choral works. The *Cantique de Jean Racine* is a beautiful, simple song of religious devotion. The lovely *Madrigal* has the charming lilt of a serenade. And the *Pavane*, presented here with its ad-lib choral part, sounds even more enchanting than in the straight orchestral version. P.A.

HOVHANESS: *Prelude and Quadruple Fugue*—See Sessions: *The Black Maskers*.

IBERT: *Suite symphonique ("Impressions of Paris")*
†Rieti: *Madrigale*

M-G-M Chamber Orchestra, Arthur Winograd, cond.
M-G-M E 3414. 12-in. \$3.98.

Jacques Ibert has a remarkable ear for the sounds of ordinary experience—the noises, rustlings, rumbles, and cheap music which we hear about us constantly without paying much attention—and an equal gift for transcribing these aural observations into short, satirically descriptive pieces. That is what he does in *Impressions of Paris*, the movements of which describe a subway rush, a park, a sidewalk café, an excursion boat on the Seine, a mosque, and a street parade. The spirit of the whole is quite like that of René Clair's famous film comedies, with their "types" and their vertiginous chases.

Rieti's *Madrigale* on the other side is a delightful little charm-piece in four movements mingling archaic and modern idioms in an archly amusing way. Recordings and performances could scarcely be improved upon. A.F.

LO PRESTI: *The Masks*—See Sessions: *The Black Maskers*.

MOZART: *Cassation No. 2, in B-flat, K. 99; Divertimento No. 2, in D, K. 131*

American Chamber Orchestra, Robert Scholz, cond.
WESTMINSTER 18261. 12-in. \$3.98.

The Divertimento is the more warmly welcomed because the other three editions are markedly less satisfactory, while the Cassation has had good treatment on Epic 3043, in a more symphonic production than the close and close-knit one here. Although the Divertimento is by far the better piece, both are admirably representative of the informal music of music's most formal period. It is in realizing the implicit dualism that the American Chamber Orchestra makes its mark, giving the

period in clarity of line, and the informality in the subordination of rhetorical effect to natural expressiveness. Neat and precise reproduction at any sensible volume, even for the four horns in the Divertimento, sustains the pleasure in a skillful and unpretentious record. C.G.B.

Department of Fuller Homage to Mozart

In December Nathan Broder reported that RCA Victor's gala album, *Homage to Mozart*, offered, among other selections, the first movement of the Horn Concerto No. 3, played by Aubrey Brain. This was true, but was not RCA Victor's intent. Buyers of the set now will find it contains the entire concerto. Mr. Broder, too, has received a revised version of the recording.

MOZART: *Concertos for Violin and Orchestra: No. 3, in G, K. 216; No. 5, in A, K. 219*

Reinhold Barchet, violin; Pro Musica Orchestra (Stuttgart), Rolf Reinhardt, cond.
VOX PL 10050. 12-in. \$4.98.

The sound is of a kind in which Vox has become a specialist for her Stuttgart product, close and strong for a small ensemble, with little noticeable reverberation. This gives a sting of actuality to chamber music and to music proportioned like these two concertos, which are not chamber music and to music proportioned in a large space. The engineers also are to be congratulated for having supplied butter for the solo strings, the Barchet bow dripping with it, and for having preserved a realistic scale of force for the violin confronting the rest. The musical value is greater in No. 3 than in No. 5, coolly detached here from the melancholy

of its Adagio, and a little restrained in the Turkish revolt which turns the Minuetto upside down. The Adagio in No. 3 loses nothing in refinement while it is permitted to muse prettily in a relaxed luxury of sleek strings, and the Rondo, scoring a number of happy points, seems more successful than any other recorded example. Some enterprising features of phrasing in which soloist and conductor are as one, an orchestral clearness in which details are manifest for the first time, and a warm blessing of assured tone, distinguish this "unimportant" but enchanting movement. In both concertos the solo legato is something to applaud, and it may be that a disinclination to disturb it influenced the manipulation of No. 5. C.G.B.

MOZART: *Divertimentos: No. 1, in E-flat, K. 113; No. 7, in D, K. 205; Minuets with Contretänze, K. 463*

Mozarteum Orchestra (Salzburg), Ernest Märzendorfer, cond.
LONDON LL 1427. 12-in. \$3.98.

Alertness here fills three voids in the repertory. Only K. 205 has been recorded before, and the single version was removed from the catalogue after a very short life. K. 113 at last on a disk means that all the Mozart divertimentos are now available. This was composed two years before No. 7, which is the work of a mature craftsman of seventeen, and both have the freshness of invention and unequaled fluency in decorative thought which make of the lighter Mozart production a mystery of beauty. K. 463, a much later and more serious work, consists of a pair of slow, inquiring minuets each with a flashing contradance as trio, nothing like them in dance music. It is pleasant to note that the conductor has full knowledge of their value.

In fact the playing of all these seductive frivolities is distinguished by an understanding of their nature. The divertimentos disengage an air of informality without being unkempt, and in giving broad expression to the main design the conductor reminds us that for all their refinement of construction these pieces are not exquisite, that people talked through them, and not with bated breath. The dynamics and contrasts sought are the obvious ones, the colors are persistently ripe, and a general impression of good health casually enjoyed is not a detriment to the enjoyment of hearers.

The sound is best when volume is low to maintain a smooth blend of the orchestral choirs, the texture coarsening noticeably with added output, a commonplace of reproduction particularly invidious here where the low-volume texture is particularly pleasant. C.G.B.

RACHMANINOFF: *Sonata for Cello and Piano, in G minor, Op. 19*

Zara Nelsova, cello; Artur Balsam, piano.
LONDON LL 1480. 12-in. \$3.98.

Rachmaninoff's lengthy but frequently seductive Cello Sonata, a product of the same period as the Second Piano Concerto, is here recorded for the third time, though the initial one—by Edmund Kurtz and

ADVERTISING INDEX

Angel Records	70
Audio Fidelity Records	83, 85
Bradley Mfg. Co.	104
Capitol Records	80, 81
Chambers Radio Corp.	104
Concord Record Co.	90
Contemporary Records	103
Dauntless International	83, 85
Decca Records, Inc.	75, 91
Dyer-Bennet Records	104
Elektra Records	104
Esoteric Records	104
Jazztone Society	92
Leslie Creations	104
Livingston Electronic Corp.	105
London International	78
London Records	77, 94
Mercury Record Corp.	89
Nuclear Products Co.	103
RCA Custom Division	101
RCA Victor Division	79, 87, 92
Record Market	104
Record Review Index	103
Replica Records	102
Robins Industries Corp.	104
Smith, H. Royer Co.	104
Unicorn Records	88
Vanguard Recording Corp.	99
Vox Productions, Inc.	96
Walco (Electrovox Co., Inc.)	100
Westminster Recording Co.	98

William Kapell—has already been withdrawn. Zara Nelsova's ardent, rhapsodic style and Mr. Balsam's brilliant collaboration make this new version comparable in over-all quality to that of Joseph Schuster and Leonard Pennario (on Capitol), whose playing is a little more fine-grained. The bright, forward, intimate tone of the London disk is superior to the more distant, if mellow, sound of the two-year-old Capitol recording. R.E.

RACHMANINOFF: *Symphony No. 2, in E minor, Op. 27*

Leningrad Philharmonic Orchestra, Kurt Sanderling, cond.
DECCA DL 9874. 12-in. \$3.98.

This is one of four Decca issues featuring the Leningrad Philharmonic of which Roland Gelatt gave a preview in the November issue. The Rachmaninoff symphony is given a truly superb reading, one

that places it at the head of the list of recorded versions of this work. The new release fully supports the advance praise heaped on the sound and technique of this Russian ensemble, and Kurt Sanderling's full-blown interpretation is as close to the ideal as we are ever likely to get. It has the spaciousness of Steinberg's version, being even slower in the last two movements, and the detail in melodic inflection characteristic of Ormandy's, without seeming artificial or fussy.

The somber glow of the climaxes is particularly memorable, and the mournful beauty of the opening clarinet solo in the Adagio shows a blend of sensitivity and taste that is characteristic of the solo work throughout. The engineering, as a matter of fact, seems to favor the solo instrumentalists, but not at the expense of the supporting sections, and the massed sound is rich and resonant if not ideally transparent. Some might still prefer Steinberg's more

thoughtful, restrained interpretation, but I believe Sanderling's whole-souled, yet discriminating, ideas come to best terms with the work. R.E.

RIETI: *Madrigale*—See **Ibert: *Suite symphonique***.

SESSIONS: *The Black Maskers, Suite*
†Hovhanness: *Prelude and Quadruple Fugue*

†Lo Presti: *The Masks*

Eastman-Rochester Symphony Orchestra, Howard Hanson, cond.
MERCURY MG 50106. 12-in. \$3.98.

With each new record it becomes more and more apparent that Howard Hanson is one of the truly great conductors of the present day. Thanks to him, and to one of the world's ablest technical staffs, Mercury is

Continued on page 76

To RCA Victor — Gratitude for a Gift of Extraordinary Rightness

IT WAS a quarter-century ago, even if it does not seem so, that a young man named Walter Legge, who worked for HMV, thought of a way to sell phonograph records in the midst of the worst depression of modern times.

His idea, a splendidly simple one, was to put forth some records so desirable that certain music lovers would *have* to own them, even if doing so involved larceny. To preclude wasteful overproduction, he devised an advance-pledge subscription plan, whereby the pledged buyers became a "Society." His first project was a Hugo Wolf Society album, of Wolf songs sung by Elena Gerhardt. His second, and largest, was the production, in fifteen albums, of all the major piano works of Beethoven, played by Artur Schnabel.

Mr. Legge's plan worked. I happen to know, because it worked on me. I cannot recall now what the slightly special price of the early Beethoven Society Limited Edition albums was, in dollars and cents. I *can* remember, however, the rosy day when it burst upon me that all I had to do to possess one of them was to abstain from lunch for a mere eight weeks (it figured almost exactly), an expedient which was no sooner conceived than commenced.

Neither was I alone in this enthusiasm, and again I speak from knowledge. My vacant lunch hours I spent being a kadoty. This is a term (of disgust) coined by Remy Van Wyck Farkas, now a London Records executive, then a record shop salesman. A kadoty is a person who comes to listen but not to buy. If I was then (and I think I was) the most proficient Beethoven sonata kadoty in Greater New York, it was not for lack of competition. Rarely was my booth uninvaded by a fellow devotee during a sonata. And most of these, as was disclosed in fiercely whispered conversations, were saving as sedulously as I for the day of ownership. My final score, if any one is curious, was five albums—not bad for a period when \$18 a week was considered an enviable wage.

We were right, of course, whatever the



Schnabel reads Beethoven's intent.

later effect on our digestions. Mr. Legge's project—and we loved him for it without knowing his name—was one of the first demonstrations of the enormous service that records can perform for music. I have spent about forty hours, in the fortnight past, listening to the Beethoven sonatas played by Schnabel and by others. In only a few instances have any of the other pianists' performances been able to yield up the extraordinary sense of *rightness* that the Schnabel interpretations have. When some of the others have done so, I suspect the performers of having, in some degree, benefited by hearing Schnabel themselves. And, oddly, some of them arbitrary *wrongnesses* demonstrated by younger pianists I am sure are caused by their fear of seeming to imitate Schnabel.

The man's virtues and shortcomings as a pianist have been pointed up amply elsewhere. His fingers sometimes failed his head, especially those of his left hand: there are slurs. His sense of time was, apparently, rather marvelous. Critics have remarked on his ability to play slow movements (especially those of the late,

introspective sonatas, though that of the early Opus 10, No. 3 also responds miraculously to the treatment) with such protracted exactness of beat that when he did want to steal a microsecond from the metronome for an inflection (which is permissible), the effect was so subtle as to be at once unaccountable and overpowering. It has been said also that he tended to exaggerate the brusque and structural aspects of Beethoven's music, perhaps in reaction to a century of romantic lily-gilding. Maybe so; I think not. When one hears the various versions of the finales of the *Tempest* or *Waldstein* sonatas, it is Schnabel's urgent gallop that one wants to stay with; the others begin to sound labored or playful.

The day last month on which RCA Victor reissued on microgroove the complete Beethoven sonatas in Schnabel playings was a day I (and many another) had awaited for nine years. I shall not complain because their enormous album-package won't fit record shelves. It incorporates, after all, its *own* little sliding shelf, as well as the Simon & Schuster Schnabel-edited scores of the sonatas. And Victor's engineer, Mr. Daniel Slick, has done a magnificent job of transferring to microgroove the almost incredibly fine job done by HMV's engineer, Mr. Fred Gaisberg, in capturing the sound of Schnabel's piano to begin with. (It is very difficult, listening, to believe that some of these records were made in 1932. It may not be hi-fi, but it is beautiful.) Mostly, I am still suffused with gratitude and admiration toward Walter Legge, for bringing to this task the pianist of our generation who could so unerringly read the intent of Ludwig van Beethoven.

RCA Victor plans to issue the sonatas on separate disks in the course of time. I wouldn't wait. JOHN M. CONLY

BEETHOVEN: *Sonatas (32) for Piano*

Artur Schnabel, piano.
RCA VICTOR LM 9500. Thirteen 12-in. \$80.

Charpentier's *Louise* — the Heart and the Gutters of Paris

ONE of the most glaring gaps in the complete-opera recorded repertoire has finally been filled with the appearance of Epic's brilliant production of Gustave Charpentier's *Louise*. The opera is presented in full except for several minor cuts, now in use at the Paris Opéra-Comique.

It was at this historic theater, on February 2, 1900, that *Louise* first thrilled an audience. André Messager conducted, and the cast included Marthe Riota, Blanche Dechamps-Jehin, Adolphe Maréchal, and Lucien Fugère. Since then, Charpentier's evocation of *la ville lumière* has never been off the billboards of the Opéra-Comique. On June 23, 1956, its 1,000th performance was duly celebrated, and the creatrix, Mlle. Riota, was brought back for a touching ceremony.

With the emergence of Mascagni, Leoncavallo, and Puccini in Italy, during the Nineties, there was much talk about the new *verismo* school. *Louise*, with its mansard roofs and scenes of everyday life in Paris, is surely an opera of the French realist school; its problems and working people are even more down-to-earth than those envisaged by the Italians. Furthermore, the Italian *verismo* seemed never possible without violence and bloodshed. *Louise* sings of the heart and of the gutter, rather than of blood and dagger.

The opera was composed at the very apex of what Parisians fondly refer to as *la belle époque*. This was at the turn of the century — thirty years after the Franco-Prussian war, and fourteen years before the brutal jolt of World War I, from whose repercussions the world of Charpentier never fully recovered. The Paris of this period has been celebrated by many — painters, poets, novelists, composers — but none has better succeeded in getting to the city's very marrow than Charpentier, a real child of the Montmartre streets. Paris was part of Charpentier's blood and bone. Here in *Louise* is her very substance — her derelicts, her nocturnal wanderers, her *midinettes*, her street cries, her preoccupation with love and sensuality. April is also here, bringing new desire and expectation to the great city, after the grip of the long winter.

Charpentier's opera is not only a vast, comprehensive canvas, microscopically alive in its countless detail; it is also a work filled with turbulent excitement, with a shrewdly calculated theatrical impact in its depiction of a city, an era, and an at-

titude. Echoes of *Die Meistersinger* abound, which is not strange when you consider that Wagner, too, created in unforgettable and lofty fashion the heartbeat of a town and the dewy freshness of spring-time lovers. There is also a debt to Charpentier's teacher, Massenet, from whom he learned the inner secrets of Gallic grace and elegance. Charpentier never denied these influences during his long life (he died at the age of ninety-five on February 18, 1956).

It would be more than easy for austere and rigid purists to criticize many pages of this long and varied score as being obvious and commonplace. Julien's song outside the *atelier* and the rowdy celebration on the summit of the Butte Montmartre are cases in point. But Charpentier was well aware of his materials; his instinct in dealing with humble people was unerring, and it is the voice of the people he knew best that speaks with such sincerity. As against banal passages, there are others of charming sentiment, of dramatic appositeness, of a sensitivity to the poetry and passion of life, that can make *Louise* a rewarding experience.

Epic's recording of this kaleidoscopic score is very good and should refute the belief, prevalent in America, that there are no fine voices in France today. Here, it would seem, we have some of the best. The vocal level remains surprisingly high in the twenty-odd supporting roles that give valid character to the score. Americans, trained to dislike any kind of metallic vibrance in the voice, may find some sounds placed too far forward for their taste; but, whatever their reactions, they must also admit that the Comique singers are right for this particular opera. This is an authentic performance.

Berthe Monmart (aptly named) is a lovely Louise, young and vibrant. Her pulsating voice, well equalized throughout, has little trouble in riding the orchestral flood at its height. Her command of pianissimo in the highest register makes the celebrated "*Depuis le jour*" — after a nervous start — a thing of beauty and meaning. Only at the close of the first act, when Louise tearfully reads the newspaper to her father, do I regret that her final "*Paris . . .*" does not suggest all the pent-up longing and frustration that can make this an unforgettable moment. Elsewhere, Mlle. Monmart is ever expressive.

André Laroze, who sings the role of Julien, is less satisfactory. He is the possessor of a splendid, clarion instrument at the service of a rather stolid, unyielding temperament. His middle notes often sound hard in timbre, and in romantic appeal he must bow to Georges Thill of the old Columbia-Entrée excerpts. Would that Thill had been young enough to appear in this version! Solange Michel is a virago of a mother, which is as it should be, but I would have liked a little more dignity and poise during her sudden joy-quelling appearance at the revels of Montmartre. Louis Musy, who made his debut at the Opéra-Comique in 1925, is prob-



FRENCH GOVERNMENT TOURIST OFFICE
Montmartre

ably today's leading exponent of the role of the Father. There is still plenty of quality and power in Musy's voice, and he sings with dominating authority. I wish, however, that there was a greater aura of paternal tenderness in Musy's delineation of the role. André Pernet, in the Columbia excerpts, is far more human and sympathetic, if vocally less massive. Praise is in order for the lovely singing of Andrea Guiot in the brief but important role of Irma; for Gérard Serkoyan's dramatic account of the ragman's lost daughter; for Louis Riolland's finely sung Noctambulist; and for Pierre Giannotti's negotiation of the difficult, sustained measures assigned to the King of the Fools.

Jean Fournet conducts with a blend of refinement and passion that well becomes this opera. His is a vital knowledgeable performance. The orchestra of the Opéra-Comique (one of the best in Europe) gives the impression that its present members have been involved in many of the one thousand performances *Louise* has recently attained. The Comique chorus contributes impressive moments in its sonorous tackling of the festival on the top of Montmartre.

Epic has given its *Louise* up-to-date, brilliant sound, but more attention might have been paid toward giving the listener the illusion of an actual performance. Distances are only occasionally observed, and Louise's tears and other stage sounds are bypassed.

Nevertheless, these regrets are minor ones, and if your heart doesn't beat a bit faster during the tumult and turbulence of the opera's finale, as Louise openly defies her father and is thrown out on the streets, you will have missed a true theatrical thrill.

MAX DE SCHAUENSEE

CHARPENTIER: *Louise*

Berthe Monmart (s), Louise; André Laroze (t), Julien; Louis Musy (b), the Father; Solange Michel (ms), the Mother; Andrea Guiot (s), Irma; Louis Riolland (t), the Noctambulist; Pierre Giannotti (t), King of the Fools; Gérard Serkoyan (bs), the Ragman; and others. Chorus and Orchestra of the Opéra-Comique, Jean Fournet, cond. EPIC SC 6018. Three 12-in. \$11.94.



Jean Fournet

SPAIN LIVES IN THESE FINGERS



The classic Spanish guitar is a proud and passionate instrument and Andrés Segovia is its undisputed master! Segovia's guitar sings of the secret shuttered soul of Spain, but his artistry is lavished equally on music from Bach to Villa-Lobos. You will find Andrés Segovia's Decca Gold Label repertoire a treasury of superb high fidelity listening. Sample his artistry in album collections like *An Evening With Andrés Segovia* (DL 9733), in *Masters of the Guitar* (DL 9794), or in the delightful *Art of Andrés Segovia* (DL 9795). His latest Decca release (with the Quintetto Chigiano) features the new "Guitar Quintet" dedicated to Segovia by composer Mario Castelnuovo-Tedesco (DL 9832).



AUTHENTIC SPANISH MUSIC IN HIGH FIDELITY

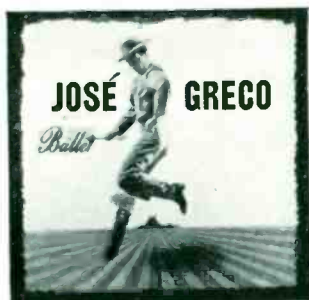

José Greco—Ballet; Orquesta Zarzuela De Madrid; 'Viva Castilla', 'El Baile de Luis Alonso', etc.
DL 9757*

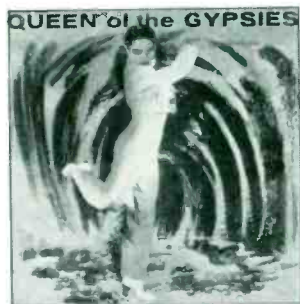

Queen Of The Gypsies: The Rhythms of Carmen Amaya, with Sabicas, Guitarist; 'Ritmo de Carmen Amaya', etc.
DL 9816

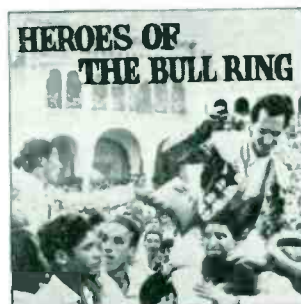

Heroes Of The Bull Ring: Spanish Air Force Military Band; 'Rafael El Gallo', 'Pepe Luis Vazquez', etc.
DL 9840*



Granados: Goyescas—Part 1 and 2: 'Los Majos Enamorados', performed by Alicia De Larrocha, Piano.
DL 9779 (Part 1) DL 9415 (Part 2)*

*"DL" INDICATES 33 1/3 LONG PLAY RECORDS.

*RECORDED IN SPAIN

DECCA  **RECORDS**
® GOLD LABEL... A NEW WORLD OF SOUND®

Continued from page 73

producing the most consistently distinguished series of modern American disks in existence; and this may well be the finest single item in that series.

A good case could be made for the view that American music came into its own as a major creative force with the composition of Roger Sessions' *Black Maskers* in 1923. To be sure, there had been an Ives, but he had worked in isolation and obscurity; the stream that burst forth with *The Black Maskers*, on the other hand, has never ceased to grow in power and breadth, and it was itself responsible for the discovery of Ives.

At all events, this is one of the earliest American orchestral compositions that is indubitably a work of genius. It was originally written to accompany a play of the

same title by Leonid Andreyev, but it is Sessions' music which gives viable expression to the irony, lyricism, and demonic conflict at which the Russian author aimed. As performed and recorded by Hanson, the suite is altogether overwhelming. Here one makes contact with one of those completely authentic creative spirits which appear seldom in any society or era.

The Hovhanness is one of the few recorded works by that composer which have nothing to do with the folklore of the Near East. It is a masterly study in intricate counterpoint, but it flows along with the utmost ease and grace. The pair of short pieces by Ronald Lo Presti introduces a recent graduate of Hanson's Eastman School who clearly has something to say and knows how to say it, but has yet to develop an idiom of any special individuality. A.F.

TCHAIKOVSKY: *Symphony No. 5, in E minor, Op. 64*

Orchestre de la Société des Concerts du Conservatoire de Paris, Georg Solti, cond. LONDON LL 1506. 12-in. \$3.98.

This is a Tchaikovsky Fifth for people (like myself) who are apt to turn green when it is played in the usual hearts-and-flowers manner. Solti does a very musician-like job, supporting my high opinion of him formed during the Chicago opera season last fall. In deciding whether or not this version is for you, remember that the tempos are usually on the fast side, that the manner is brisk and direct, and that the hyperemotional aspects of the score are completely played down. In the slow movement this approach seems unsympathetic. Here, I think, the conductor

Continued on page 78

Landowska's Mozart: Music Ornamented by Mastery

IN THE GREAT OUTPOURING of recorded homage to Mozart during the bicentennial year, his piano music did not fare as well as other categories of his output. This was not surprising. Musicians are well aware that the keyboard pieces, which any child who has studied the piano a few years can play in a fashion, are extremely difficult for expert performers to project convincingly. What is needed is a rare combination of qualities—a profound insight into musical relationships, a thorough knowledge of and true feeling for the Mozartean style, and a perfect control of every finger in both hands. Here, at last, is that combination, in a group of performances that may well serve henceforth as a model of Mozart interpretation. A model, however, that in some respects should not be imitated!

There is hardly any use of the sustaining pedal. Even in relatively full textures, as in portions of the A minor Rondo, everything is clear, as though the sweetness of this work were suffused with bright moonlight. Above all, everything

sings. Not with the cold purity of a Gieseking, nor with the erratic emotionalism of a Lili Kraus, but with the warm nuance of a sensitive artist who, coming from a lifetime of immersion in baroque music, can see the novelty and freshness in Mozart.

Mme. Landowska knows that, unlike modern pianos, the pianos of Mozart's time were so constructed that there was a sharp difference in tone-color among the high, middle, and low registers. She knows that Mozart carefully calculated his effects with this difference in mind, and that when a melody is shifted from one register to another it is as though it were shifted from a flute to a viola, or from a violin to a soft trombone. Somehow, by delicate adjustments of arm and finger weight, she miraculously manages to achieve such differentiations of color on a modern piano.

The pedant will be shocked by some of the things Mme. Landowska does here. She adds ornaments in many places; she may break up a long note into a chain of decorations; she sometimes fills in melod-

ic leaps with embellishments. This is not the disdain of a *grande dame* for the tyranny of the printed page; it is basically a perfectly sound practice. We know that Mozart himself, an inveterate improviser, was accustomed to do the same, and to regard the written form of some of his pieces as merely a kind of outline to be filled in in performance. The only questions here are whether Mme. Landowska's embellishments are convincing, whether they are in correct "taste," whether they add life to the phrase or are merely fussy and consequently superfluous.

In my opinion, most of them seem plausible and effective. When, as in the first section of the opening movement of the E-flat Sonata, Mme. Landowska first plays the music as written and then adds ornaments in the repetition, the result is an enhancement of the music's communicative power. But this is a risky business, and it is not recommended to any pianist who is not as deeply steeped in the Mozart style as Mme. Landowska is. Even she is not always successful at it. When, for example, in the corresponding section of the B-flat Sonata, she embellishes some passages both in the first statement and in its repetition, the results seem less happy, especially when ornaments are applied to a left-hand figure that does not appear to need any. One wonders, incidentally, why Mme. Landowska chooses to play a B in the right-hand part of measure 11 in the Andante of K. 311 when Mozart clearly indicates a D.

But these are small matters in view of the magnitude of the achievement here. The pieces on these disks are like a set of finely cut diamonds mounted so as to bring out every flash of blue-white color. We might wish to remove or simplify a curlicue here and there in the mounting, but the gems sparkle with a unique brightness. NATHAN BRODER

MOZART: *Sonatas: in B-flat, K. 333; in D, K. 311; in E-flat, K. 282; in G, K. 283; Rondo, in A minor K. 511; Contretänze, K. 606 (arr. Landowska)*

Wanda Landowska, piano. RCA VICTOR LM 6044. Two 12-in. \$7.96.



ROGER HAUERT

Landowska at home in Lakeville: "the gems sparkle with a unique brightness."

New Releases

Opera

IL TROVATORE (Verdi)

Leonora.....Renata Tebaldi
 Manrico.....Mario del Monaco
 Azucena.....Giulietta Simionato
 Di Luna.....Ugo Savarese
 Ferrando.....Giorgio Tozzi
 Ines.....Luisa Maragliano
 Ruiz }.....Athos Cesarini
 Messenger }
 Old Gypsy.....Antonio Balbi

Chorus of Maggio Musicale Fiorentino (Director: Andrea Morosini). L'Orchestre de la Suisse Romande, Conductor: Alberto Erede. Free—Complete Vocal Score. XLLA-50 3-12" \$14.94

EUGEN ONEGIN—Complete Recording (Tchaikovsky)

Eugen Oegin.....Dushan Popovich
 Tatiana.....Valeria Heybalova
 Lenski.....Drago Startz
 Prince Gremin.....Miro Changolovich
 Filipjewna.....Melanie Bugarinovich

Chorus and Orchestra of the National Opera, Belgrade (Chorus Master: Milan Bayshansky). Conductor: Oscar Danon. Free—Russian-English Libretto. XLLA-41 3-12" \$14.94

DER FLIEGENDE HOLLÄNDER (The Flying Dutchman)—Complete (Wagner)

Der Holländer.....Hermann Uhde
 Senta.....Astrid Varnay
 Daland.....Ludwig Weber

Chorus and Orchestra of Festspielhaus, Bayreuth (Chorus Master: Wilhelm Pitz). Conductor: Joseph Keilberth. Free—German-English Libretto. XLLA-42 3-12" \$14.94

Concerti

VIOLIN CONCERTO No. 1 (Bruch) (Opus 26).

VIOLIN CONCERTO No. 2 IN D MINOR (Wieniawski) (Opus 22)

Mischa Elman (violin) with The London Philharmonic Orchestra. Conductor: Sir Adrian Boult. LL-1486 \$3.98

Vocal

HILDE GUEDEN SINGS ITALIAN OPERA ARIAS

La Traviata—Ahi fors e Iul and Sempre libera (Verdi); Gianni Schicci—O mio Babbino caro (Puccini); Turandot—Signore ascolta (Puccini); Turandot—Tu che di gel sei cinta (Puccini); Falstaff—Sul fil d'ub soffio etesio (Verdi); La Boheme—Musetta's Waltz (Puccini); L'Elisir d'Amore—Della crudele Isotta (Donizetti); L'Elisir d'Amore—Prendi, per me sei libero (Donizetti); Rigoletto—Caro nome (Verdi); Rigoletto—Tutte le feste al tempio (Verdi); Rigoletto—Piangi, fanciulla "Duet" (Verdi); with Orchestra of Accademia di Santa Cecilia, Rome. Conductor: Alberto Erede. LL-1322 \$3.98

LIEDERKREIS—Song Cycle (Schumann) (Opus 24) MÖRIKE LIEDER (Hugo Wolf)

Gérard Souzay (baritone) and Dalton Baldwin (piano). LL-1476 \$3.98

Orchestra

TOD UND VERKLÄRUNG (Death and Transfiguration) (Richard Strauss) (Opus 24)

DON JUAN (Richard Strauss) (Opus 20)

Hans Knappertsbusch conducting l'Orchestre de la Societe des Concerts du Conservatoire de Paris (Paris Conservatory Orch.). LL-1478 \$3.98

SYMPHONY No. 2 (Opus 17) (Tchaikovsky)

Georg Solti conducting l'Orchestre de la Societe des Concerts du Conservatoire de Paris (Paris Conservatory Orchestra). LL-1507 \$3.98

THE SEASONS—Complete Ballet (Glazunov) (Op. 67)

Albert Wolff conducting l'Orchestre de la Societe des Concerts du Conservatoire de Paris (Paris Conservatory Orchestra). LL-1504 \$3.98

LYRIC SUITE (Grieg) (Opus 54)

FINLANDIA—Tone-Poem (Sibelius) (Opus 26)

MARCHE SLAV (Tchaikovsky) (Opus 31)

HUNGARIAN RHAPSODY No. 4 (Liszt)

Erik Tuxen conducting The Danish State Radio Symphony Orchestra. LL-1313 \$3.98

CONTEMPORARY MUSIC FOR STRING ORCHESTRA

Passacaille for String Orchestra (Frank Martin); Five Pieces for String Orchestra (Paul Hindemith); Serenade for Strings (Lennox Berkeley); Adagio for Strings (Samuel Barber); Karl Münchinger conducting The Stuttgart Chamber Orchestra. LL-1395 \$3.98

LONDON
 RECORDS



539 W. 25th St., New York 1, N. Y.

should have taken his chances with a more conventional tempo and given the music greater opportunity to sing.

The recording is full and resonant, just a little too much so for me, and marred by some warbling tones. A few of them may be tape flutter, but I am inclined to blame one or two of them on the instrumentalists themselves—for example, the first horn, who has quite a tremolo in his first big solo of the second movement. Incidentally, this recording is uncut, which is more than can be said for several of the competing editions. R.C.M.

VIVALDI: *Orchestral Music*

Concerto for Strings in G (*Alla Rustica*), P. 143; Concerto for Oboe and Strings in D minor, P. 259; Sinfonia in C, P. 9; Concerto for Bassoon and Strings in E minor, P. 137; Concerto for Oboe and

Strings in F, P. 306; Sinfonia in G, P. 8. Solisti di Zagreb, Antonio Janigro, cond. VANGUARD BG 560. 12-in. \$4.98.

The D minor Oboe Concerto (No. 9 of the set called *Il Cimento dell'Armonia e dell'Invenzione*, Op. VIII) is apparently on the way to becoming one of Vivaldi's most popular works, outside of *The Seasons*: this is its seventh appearance on LP. Three of the other works in the present group—the F major Oboe Concerto, the E minor Bassoon Concerto, and the *Alla Rustica*—have been recorded before, but this seems to be the first time for the two *sinfonie*. The first of these has two gay fast movements and a lovely Andante; the second has a broadly laid out first movement with some fascinating detail, a slow movement that sings from beginning to end, and an attractive, dancelike finale. The Solisti play with pre-

cision and plenty of vivacity, and the sound is truly excellent. N.B.

More Briefly Noted

WHETHER it is a question of moral obligation towards the arts or just plain garden-variety curiosity, there seems to be among music listeners an interest in recordings by performers and composers, either young in years or relatively unheard, which accounts for some particularly interesting recent releases. A case in point are the disks offered by the Louisville Subscription Series. New among these is LOU-56-6, containing pieces by Henk Badings (*The Louisville Symphony*), Ben Weber (Prelude and Passacaglia), and Leo Sowerby (*All on a Summer's Day*). The sonics are only average, but the Weber work has considerable power and Sowerby's piece a pleasant exuberance. Another example of music, if not *à la mode* at least *de siècle*, is Henry Brant's *Angels and Devils*. This composition (with Fredrick Wilkins, solo flute, and the composer conducting a flute ensemble) is a bit on the tedious side. (but it has its moments of humor; and the upside of this Composers Recordings disk (CRI-106) offers Irving Fine's *Music for Piano and Mutability*), with the author at the piano and Eunice Alberts, contralto—works of considerable elegance. Unfortunately the lyrics of the songs are not intelligible, and their texts are not furnished.

To turn from relatively unknown composers to young performers, the already widely recorded but still youthful Russian, Eugene Malinin, turns in a beautiful performance of the Chopin Nocturne in D-flat, Op. 27, No. 2 on Angel 35396. His rendition of the Rachmaninoff Concerto for Piano and Orchestra, No. 2, in C minor, leaves something to be desired, especially in his choice of tempos and handling of transitions, but Mr. Malinin is rare among contemporary pianists in being a truly lyric virtuoso. Another "young person," this time the young lady violinist Johanna Martzy, acquits herself admirably in the Dvorak Concerto for Violin and Orchestra, in A minor, Op. 53, with Ferenc Fricsay conducting the RIAS Symphony Orchestra (Berlin). Her assured technique, mellow tone, and sympathetic interpretation make this one of the best versions of the Dvorak available. Three encore pieces are also offered on this record (Decca DTL 9858)—Ravel's *Pièce en forme de Habanera* and *Berceuse sur le nom de Gabriel Fauré*, and Milhaud's *Ipanema*—very well played by the pianist Jean Antonietti.

The hope for the future is not, of course, always so bright. *Le Loup*, by the young Frenchman Henri Dutilleux, played by the Orchestre du Théâtre des Champs-Élysées under Paul Bonneau, is totally devoid of interest; and its accompanying piece, Inghelbrecht's *La Nursery*, does not carry much weight (on London DTL 93086). The performances and recording are, however, excellent. Douglas Moore's *Corillion Suite* (Alfredo Antonini

Continued on page 80

FROM FRANCE....

A new study in recorded sound

"MUSIQUE CONCRÈTE"

SURREALISM IN SOUND



"Musique Concrète" is to high fidelity what Dali is to art—Saroyan is to writing—and Le Corbusier is to architecture.

The sounds you hear defy comparison.

The closest comparison is with the motion pictures: just as the film is based on the montage of images, musique concrete "photographs" sounds, manipulates them by techniques of slow and high speed "illuminates" them in different ways, and "mounts" them in an artificial order and juxtaposition. Thus, the sound of an instrument used in standard music may be given new qualities by separating the attack, the vibration and the termination of the sound and by operating on these different aspects.

1 — CLASSICAL: Trifle in C; 2 — INSTRUMENTAL STUDIES: (a) Drum—Fleeting Percussion; (b) Flute—Mexican Flute; (c) Two Aspects of the Piano: (1) Study for Piano; (11) Finale of the Concerto of Ambiguities; 3 — EXPRESSIONISM 1952: Music without a Title—5th and 6th movements; 4 — PRIMITIVE 1948: Study for Whirligigs; 5 — DRAMATIC CANTATA: The Veil of Orpheus; 6 — THREE DIRECTIONS: (a) Sound Effects—Railway Study; (b) Poetic-Pathetic Study; (c) A Single Sound Source; 7 — MUSICAL BOX. DTL-93090 12" — 3.98

Recorded in the studios of La Radio Television Francaise.

At times you'll find the cacophony of sounds weird, surprising, unbelievable, eerie—always exciting and most certainly unusual.

DUCRETET THOMSON

LONDON INTERNATIONAL, INC.
539 W. 25 St., Dept. 1
New York 1, N. Y.

Gentlemen: Please send me DTL-93090.

Enclosed is my check at 3.98 ea. I understand the record will arrive prepaid

NAME _____
ADDRESS _____
CITY _____ STATE _____



***PLAY MELANCHOLY BABY.** Here is Matt Dennis with the kind of warm, spontaneous, supper club entertainment which has made him a favorite everywhere. An exciting array of unhackneyed music: I'm Through With Love, Cottage For Sale, Spring Is Here, Heart of Stone, My Melancholy Baby, and 7 others.

***WONDERFUL ONE.** The big-band sounds of Luis Arcaz and His Orch. featuring the most exciting trumpet section going. Dance tunes, swingin' blues, Latin American rhythms including the fast-paced Merengue. Included in the 12 selections are: Lisbon Antigua, Love Me Or Leave Me, Learning the Blues.



***A NIGHT AT THE COPACABANA.** Tony Martin's sensational in-person show actually recorded at New York's famous Copa! Album includes a hilarious performance of "Security", specially written for the Copa show, plus such favorites as Begin the Beguine, Let's Face the Music and Dance, Goodnight Sweetheart.

***HAPPY HUNTING.** "Happy Hunting" is a hit! Ethel Merman is great! Here you have 'em both in this Original Cast recording! Singing with Miss Merman is Fernando Lamas, and together they cavort through a wealth of exciting, new tunes. Long Play, \$4.98.

NEW SENSATIONS IN SOUND FOR 1957 from **RCA VICTOR**



Brilliant New Orthophonic High Fidelity Recordings.
Only \$3.98 for each Long Play; on 45 EP, of course.*

***RHYTHM WAS HIS BUSINESS.** George Williams and His Orch. play a musical tribute to the great Jimmie Lunceford. 12 selections in Jimmie's own swingin' style. For Dancers Only, Lunceford Special, Margie, Swingin' On C, Uptown Blues.

***WIDE, WIDE WORLD OF JAZZ.** Dave Garroway follows the format of his popular NBC-TV show by leap-frogging over the map—jazz, swing, modern, Dixie, Latin! Hear unforgettable Lee Wiley and Helen Ward for the first time in hi fi, plus jazz greats like Billy Butterfield, Barbara Carroll, Tito Puente.



***TO LOVE AGAIN.** Mexico's Esquivel and His Orch. with an exciting blend of instruments and voices. Here's electrifying new sound in the big band world. Includes: To Love Again, Siboney, Besame Mucho, Jungle Drums and 8 other unusual arrangements.

***LET'S CHA CHA WITH PUENTE.** A great new album by the man who started America dancing the Cha Cha Cha. This master of Latin-American rhythm plays 12 delightful numbers including Lindo Cha-Cha, Cubarama, Cha-Cha Fiesta, It's the Bururu, Habanero.

*Hear these exciting New Orthophonic High Fidelity recordings best on an RCA Victor New Orthophonic High Fidelity "Victrola."®



È Arrivata La Motorboat (putt, putt, putt)

BACK IN THE 16TH CENTURY, 10,000 gondolas majestically toured the canals of Venice. Came the motorboat (putt, putt, putt). Today, there are exactly 428 gondolas. Time and 4-cylinder engines change all things.

Only the music of Venice never changes. Heavy with violins, redolent of mandolins, it is safely harboured in the hearts of lovers of every age.



Italy's famed Dino Olivieri—composer, conductor, arranger—proves this beautifully in his first CAPITOL OF THE WORLD album. Recorded in Venice and called "Two in a Gondola" (No. 10026), it's a collection of all-time Venetian favorites. It's brazenly romantic—but then, isn't Venice?

• • •
"HI-FI VIENNA!" Newly recorded in the city that brought the classic waltz to its most brilliant form. A deluxe two-record album of the finest waltzes ever written, heard now in high fidelity. Fondly played by 80 of Austria's best musicians, it's an ideal gift for lovers of the waltz (No. 10049).

Other CAPITOL OF THE WORLD albums include:
THE SOUNDS OF OLD MEXICO—No. 10044
SWEDISH POLKAS AND HAMBOS—No. 10039
SPANISH GUITARS—No. 10045



leading the Oslo Philharmonic) is simply American Offenbach, and Avery Clafin's *Fishhouse Punch* (Vienna Orchestra under F. Charles Adler) is typical "pops" material. This disk is, however, considerably redeemed by McBride's *Punch and Judy*, a brilliantly zestful composition designed for Martha Graham in one of her comic moods. This variety—of matter and merit—may be found on Composers Recordings CRI 107.

To turn back to the classics, the record buyer is offered a good many bonuses in this direction. Westminster on XWN 18189 has increased the value of its previous versions of Beethoven's Octet in E-flat, Op. 103 and Sextet in E-flat, Op. 71 by adding to them on a single disk the Rondino in E-flat and *Variations on "La ci daren la mano,"* played by the Vienna Philharmonic Wind Group. This company has in general been bountiful with its favors. Many of its deluxe WN recordings now are available in the XWN series, at a reduced price. Among these are Beethoven's Quartet for Strings, in D major, Op. 18, No. 3 and Quartet in C minor, Op. 18, No. 4 (played by the Barylli Quarter on WXN 18122) and Brahms's Symphonies Nos. 2 and 4, under Sir Adrian Boult on XWN 18132 and XWN 18246 respectively. Haydn's Symphonies Nos. 93 and 94 (*Surprise*) and Nos. 95 and 96 (*Miracle*), conducted by Hermann Scherchen, also are available on XWN 18322 and XWN 18323. The same company will let you spend your record savings on Mozart's Piano Concerto No. 24, in C minor, K. 491 and No. 27, in B-flat major, K. 595, interpreted by Paul Badura-Skoda and the Vienna Symphony Orchestra (XWN 18267) and on the *Eine kleine Nachtmusik*, K. 525, and *Ein musikalischer Spass*, K. 522, with the Vienna Konzerthaus Quartet—Josef Hermann playing double bass (XWN 18292). [Other offerings in this series range from Rameau's Complete Harpsichord Works (XWN 18124/18126) to Prokofiev's *Lieutenant Kije* and *Scythian Suite* (XWN 18266), and the canny buyer will browse in his record shop.]

On the other hand, he will find little to interest him in one more version of Grieg's *Peer Gynt* Suites. Decca DL 9869, with Kurt Graunke and the Bavarian Symphony Orchestra, does nothing that hasn't been done better many times before. The same is true for Decca's release (DL 9846) of incidental music to Mendelssohn's *Midsummer Night's Dream*, performed by the Berlin Philharmonic Orchestra and RIAS Chamber Choir, with Fricsay conducting. Rita Streich and Diana Eustrati appear also, and the whole thing is unfortunate for everyone concerned. If one likes Khachaturian, one will, however, want to know of London's release (LL 1521) of the *Masquerade Suite*, played by the Orchestras of the Paris Conservatory and the Opéra-Comique, under Richard Blareau, in a way that defeats the present competition. The disk includes Messager's *The Two Pigeons* and a couple of Chabrier items. Also desirable, even in view of the other good recorded versions, is Kodály's *Háry János Suite*, coupled with Stravinsky's *Baiser de la Fée* and *D'vertimento*, played by the RIAS Symphony led by Ferenc Fricsay, on Decca DL 9855.

Another record holding its own in heavy competition is Period SPL 303, offering Offenbach's *Gaité Parisienne*, played by the Lucerne Festival Orchestra with Ernest Falk conducting. More baller music is provided, again in Westminster reissues, on XWN 18241 (Delibes' Suite from *Coppélia*, Suite from *Sylvia*, and *Naila Waltz* from *La Source*) and on XWN 18278 (Rimsky-Korsakov's *Scheherazade*, Op. 25). Perhaps less familiar are the Weber-Berlioz *Invitation to the Dance* (*Spectre de la rose*) and the *pas de deux* from Minkus' *Don Quixote*, which, with Verdi-Mackerras' *The Lady and the Fool*, have been consolidated from two ten-inch disks on London LL 1518. Anatole Fistoulari and the New Symphony Orchestra of London provide crisp, bright readings of these pleasant tunes. The same company does less well by Tchaikovsky's *Francesca da Rimini* and *Capriccio Italien* on LL 1441, the London Symphony Orchestra under Anthony Collins failing to do justice to the music, and the recorded sound being less than satisfactory.

And for the authentic hi-fi addict, who also happens to like Wagner, Westminster has released an orchestral miscellany (W-1AB 7028) containing, from *Die Meistersinger*, the Preludes to Act I and III, the *Dance of the Apprentices*, and the *Procession of the Mastersingers*; and from *Lobengrin*, the Prelude to Act I (Philharmonic Symphony of London, led by Rodzinski). A triumphant example of the highest high-fidelity sound. The man more interested in his Wagner than in his hi-fi may, however, be just as happy with Decca's orchestral miscellany—providing the same excerpts from *Die Meistersinger* and excerpts from *Die Walküre*, *Tristan*, and *Götterdämmerung*, played by the Württemberg State Orchestra under Ferdinand Leitner, in warm and eloquent interpretations.

RECITALS AND MISCELLANY

ALFRED DELLER: *William Byrd and his Age*

Byrd: *My Sweet Little Darling*; Fantasia for Viols in G minor; *Ye Sacred Muses*; *Lullaby*, *My Sweet Little Baby*; *Come, Pretty Babe*. Whythorne: *Buy New Broom*. Anon.: *Guichardo*; *Ah, Silly Poor Joas*; *O Death, Rock Me Asleep*. Corkine: *What Booteth Love?*. Nicholson: *In a Merry May Morn*. Parsons: *Pandolpho*. Ferrabosco: *Fantasias for Viols in G and in F*.

Alfred Deller, countertenor; Wenzinger Consort of Viols of the Schola Cantorum Basiliensis. August Wenzinger, dir. VANGUARD BG 557. 12-in. \$4.98.

A fragrant bouquet of Elizabethan pieces. Especially attractive to this listener are Byrd's tender lullabies, *My Sweet Little Darling* and *Come, Pretty Babe*, and his noble lament for the death of Thomas Tallis, *Ye Sacred Muses*. Deller's familiar virtues—the purity and flexibility of his

Continued on page 84



He understands the bookbinder's son

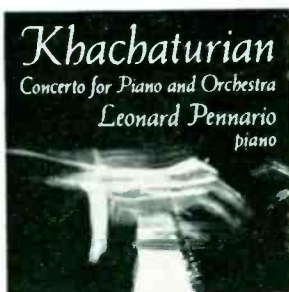

Khachaturian: Concerto for Piano and Orchestra. Soloist Leonard Pennario with The Concert Arts Orchestra conducted by Felix Slatkin. Album P9349

Aram Khachaturian was born in Tiflis, Russia, the son of a bookbinder. Pianist Leonard Pennario, above, was born in Buffalo, New York. They've never met, and they probably never will.

But listen to Leonard Pennario play Aram Khachaturian's *Concerto for Piano and Orchestra*. We don't say the bookbinder's son wrote his concerto for Mr. Pennario to play — merely that it *sounds* as though he did when Pennario plays it.

Consider the kind of music it is. Romantic, in the grand manner of Rachmaninoff and Tchaikovsky, its slow movement is pure melody. The *Allegro* contains oriental moods, rich and colorful and exotic. And through it all, a sense of

impending violence leading to a fantastic series of climaxes. Not only brilliant, not only complex, but a savage test of a pianist's competence.

For the pianist must share the composer's sense of high drama, and his imagination and brilliance, too. Because Pennario does, because he completely *understands* his man, you have a special treat in store.

And every note of his performance, every figuration of sound has been captured by Capitol Records in "Full Dimensional Sound," the highest fidelity known to the recorder's art.

The bookbinder's son has a message. Mr. Pennario delivers it.

Incomparable High Fidelity in Full Dimensional Sound



The Mapleson Cylinders: A Romantic Heritage Richly Preserved

THE romantic story of the Mapleson cylinders, those rowdy but precious souvenirs of the operatic past, is by now fairly well known. In HIGH FIDELITY for August 1955, James Hinton, Jr., recounted the history of these "live" recordings made during performances at the Metropolitan Opera from 1901 to 1903, and reviewed a ten-inch disk (IRCC L 7006) that effectively transferred several of them to microgroove. Evidently the thrill and fascination of these excerpts were widely appreciated, for Mr. W. H. Seltsam, the founder of the International Record Collectors' Club, has now issued a twelve-inch selection, in which only one item (the Jean de Reszke-Lucienne Bréval duet from *L'Africaine*) is taken over from the earlier issue. Of the remainder, some had previously appeared on 78 rpm; but ten of the fragments have never been issued before in any form.

As in his previous LP, Mr. Seltsam has caused to be printed on the back of the envelope "THIS IS NOT A HIGH FIDELITY RECORD." In this brevity there is wit: perhaps only Dame Edith Evans, in the role of Lady Bracknell, could invest that little word "not" with all the meaning it must bear. To get the best from the Mapleson records demands much patience and a degree of aural endurance which few possess: one must listen for faint threads of vocal tone through a considerable racket; one must pore over scores and be prepared to repeat the same fragment again and again for every scrap of information it will yield. The casual listener, in short, will make nothing of these records; but to the student of singing and of operatic history they are priceless.

The first four bands of Side 1 are taken from a 1903 performance of *Tosca*, with Emma Eames, Antonio Scotti, and Emilio de Marchi (the original Cavaradossi). Not much is added to our knowledge of Scotti; but De Marchi's "*Vittoria! Vittoria!*" rings out with quite startling force, and Eames displays a more impassioned style than we find in most of her published Victor records. The end of her "*Vissi d'arte*" shows the expected flawless attack on the three successive high notes; and in the final pages of the opera she launches herself from the battlements with a perfectly poised high B-flat. De Marchi appears again in two fragments from *Cavalleria* which include some temperamental screams and also some fine singing (including, surely, an interpolated high B?) from Calvé; but the voice that comes through most clearly is the pleasing mezzo of Carrie Bridewell in the offstage song of Lola.

In these scraps from the past it is the name of Jean de Reszke which always arouses the most intense interest; and his presence seems also to give the signal for a more than usually furious outburst of incidental noises: no doubt his cylinders were played more often than the rest. There are three excerpts, with Lillian Nordica as Valentine, from the great duet in Act IV of *Les Huguenots*. Oh, for a high-fidelity tape of this! By dint of constant listening, my eyes glued to a score, I have

made out quite a lot. The first fragment is notable for Nordica's brilliant downward scale from the high C; the second fragment, part of the famous *andante amoroso* section in G-flat major, brings us the faint but unmistakable sound of the great tenor throwing his voice up to the high C-flat in a noble, distinguished, leisurely curve. Just after Nordica has entered with her echo of the same theme, the cylinder tantalizingly breaks off—to resume a few pages later, during the *stretta*, from which not very much can be discerned. The rest of Side 1 is given over to Wagner. Nordica sails regally through Brünnhilde's Battle Cry from *Die Walküre*, and (with Georg Anthes) crowns the last page of *Siegfried* with a vivid high C. Better recorded is a passage from Act II of *Lohengrin*, in which Luisa Reuss-Belce sounds a decidedly short-winded Ortrud, Johanna Gadski a radiant Elsa. The side ends with the last pages of *Die Meistersinger*, a fairly well recorded but less interesting choral passage. Mr. Seltsam includes the name of Gadski in his billing of this excerpt; but by this point in the opera neither Eva nor any other character has any solo music left to sing: they are



Jean de Reszke rouses special interest.

simply instructed to join in the final chorus.

Side 2 begins with another of those ensembles which are irritatingly apt to sound better than the more important solo passages; this is the passage from Act I of *Aida* immediately preceding "*Ritorna vincitor*," with Louise Homer prominent as Amneris and Gadski audible as Aida. The next three excerpts are all of Nellie Melba. "*Spargi d'amaro pianto*," the cabaletta from the *Lucia* Mad Scene, remains very distant until the end, when our patience is rewarded by a dazzling down-and-up scale passage (more elaborate than that in the

score) and a full-throated trill on the high B-flat. Next comes a characteristic Jewel Song, which has just moved into the (otherwise unrecorded by Melba) "*Achevons la métamorphose*" section when the cylinder ends; and lastly an unfamiliar passage from Massenet's *Le Cid*. This is not, of course, "*Pleurez mes yeux*" (which Melba recorded for HMV), because she never sang the role of Chimène on the stage, but the Infanta's "*Alleluia*" at the beginning of Act II. It is mostly rather difficult to make out, but again clears up towards the end in time for some brilliant high B-flats.

Far more effective is the next band, which brings us Marcella Sembrich in the latter part of the Queen of the Night's Act II aria. This begins just before the passage in triplets, which she negotiates with absolute ease (it is the point at which almost all modern Queens come to grief). The famous high F's are not heard (they belong in the earlier part of the aria), but the staccato passages are executed with dazzling precision. Sembrich does not end, as the score indicates, on the dominant A; but takes the further leap that was then customary (and was also attempted by Florence Foster Jenkins) to the tonic high D. Then there came several fragments from *L'Africaine*, allowing us to hear more of Jean de Reszke (in the final bars of "*O paradis*") than is to be heard anywhere else on these records. By much grimly attentive listening to this and the *Huguenots* excerpts I have at last arrived at some sort of direct impression of his tone and style of singing: absolutely smooth, very leisurely, rather like an heroic enlargement of Edmond Clément's lyric tenor, or an upward extension of Pol Plançon's bass; perhaps, at this stage of his career, just a little throaty; yet with real brilliance in the B-flat at the end of "*O paradis*." A very brief choral episode from *L'Africaine*, during which we catch the unmistakable tones of Plançon at the final cadence, leads to the above-mentioned redubbing of the Bréval-De Reszke duet, thus presenting the *Africaine* excerpts complete and in correct sequence. Side 2 ends, like Side 1, with Wagnerian excerpts which call for little comment: a star-studded "Ride of the Valkyries," and Nordica in two overlapping passages from Isolde's Liebestod.

If the Mapleson cylinders are hard to decipher, the effort will be magnificently repaid. No praise can be too high for the care taken over such points as correct pitch; we are fortunate that these precious documents have fallen into the hands of so scrupulous an editor as Mr. Seltsam.

DESMOND SHAWE-TAYLOR

ECHOES OF THE GOLDEN AGE OF OPERA: Volume II

Emma Eames, Lillian Nordica, Marcella Sembrich, Nellie Melba, et al.
INTERNATIONAL RECORD COLLECTORS' CLUB L 7004. 12-in. (Available from the club, 318 Reservoir Ave., Bridgeport 6, Conn.)

for the *Ultimate*
in *High Fidelity Listening Pleasure . . .*

AUDIO FIDELITY RECORDINGS

Not just a Hi-Fi Record . . . but each a
Tremendous Emotional Experience!

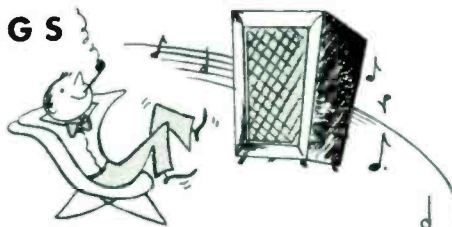

AFLP 1801
12-in. \$5.95

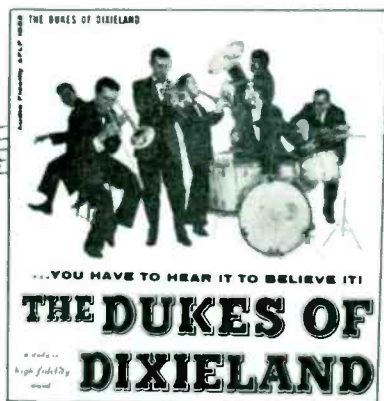

AFLP 1823
12-in. \$5.95



AFLP 1802
12-in. \$5.95



AFLP 1813
12 in. \$5.95



AFLP 1814
12-in. \$5.95

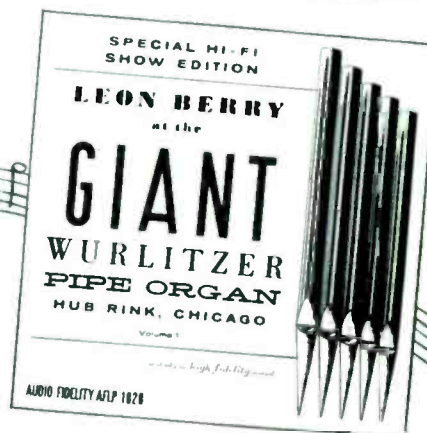

AFLP 1828
12-in. \$5.95



AFLP 1816
12-in. \$5.95



AFLP 1817
12-in. \$5.95



AFLP 1815
12-in. \$5.95

WRITE FOR **FREE CATALOGUE**
Many other unusual and exciting recordings
for the most discriminating collector.

NATIONALLY DISTRIBUTED BY
DAUNTLESS INTERNATIONAL
750 TENTH AVENUE NEW YORK 19, N. Y.

Continued from page 80

voice, his crystal-clear diction—are gratifyingly present. Owing to the melancholy nature of most of the songs (only two of them are merry), listeners may find this disk more enjoyable if they play two or three pieces at a time instead of the whole thing at one sitting. N.B.

REGINALD FOORT: *Intermission at the Mosque*

Reginald Foort, organ.
COOK 1059X. 12-in. \$4.98.

Waltz and Ballet

Reginald Foort, organ.
COOK 1058. 12-in. \$4.98.

Emory Cook was one of the first—perhaps the first—to see that high-fidelity recordings could do justice and give renewed status to theater organs. Reginald Foort, playing in the Mosque Theater in Richmond, Virginia, was his artist at that time. Now, in the flood of current disks devoted to such organs, come two more by Mr. Foort, again on the Mosque organ. (This is not to be confused with the organ in Richmond's Byrd Theater, on which Dick Leibert has recorded, even if the two instruments couldn't be more confusingly alike.)

With popular fare (*Intermission at the Mosque*), Mr. Foort is an old smoothie, as free and splashy as ever in his use of special instrumental effects. But the record entitled *Waltz and Ballet* is, I'm afraid, only for the thick-skinned. Visions arise of elephants dancing at a circus. Luigini, having composed the kind of music he did for *Ballet Egyptienne*, probably would merely shudder in his grave to hear this performance. But Strauss (Richard) would never cease spinning if he heard his *Rosenkavalier* waltzes given the "Mighty Wurlitzer" treatment. Mr. Foort is a Mighty Technician himself, and for the musically nonsqueamish this is an entertaining disk. R.E.

PHILADELPHIA ORCHESTRA: *Virtuosi di Philadelphia*

Paganini-Ormandy: *Moto Perpetuo*, Op. 11. Gabrieli-Fritz Stein: *Sonata Pian e Forte (Symphonicae Sacrae)*. Milhaud: Concerto for Percussion and Small Orchestra. Richard Strauss: Serenade for Wind Instruments, in E-flat, Op. 7. Brahms: Serenade No. 2, in A, Op. 16 (Allegro moderato and Scherzo). Elgar: *Pomp and Circumstance* March, Op. 39, No. 1.

Philadelphia Orchestra, Eugene Ormandy, cond.
COLUMBIA ML 5129. 12-in. \$3.98.

The Virtuosi di Philadelphia (why not Filadelfia?) need to give no further proof of their virtuosity—it is one of the wonderful things in American music (and occasionally a mixed blessing)—but here is additional proof in a grab bag of works, not all of which will please any one person. What the various compositions are designed to show off should be obvious: the dazzling first violins in the Paganini, the luminous brass in the Gabrieli, the agile percussion in the Milhaud, the pliant winds in the Strauss, the rich lower strings in the Brahms, the whole sonorous orchestra in the Elgar. A curious collection, superbly played and recorded, which is worth investigating for whatever values it might turn up for the buyer. R. E.

RITA STREICH: *Coloratura Favorites*

Josef Strauss: *Village Swallows*. Alabieff: *The Nightingale*. Salvatore Marchesi: *La Follietta*. Delibes: *Les filles de Cadix*. Dell'Acqua: *Villanelle*. Flotow: *The Last Rose of Summer*. Czernik: *Chi sa?* Johann Strauss: *Draussen in Sievering*. Arditi: *Il bacio*.

Rita Streich, soprano.
DECCA DL 9873. 12-in. \$3.98.

Continued on page 88

Dialing Your Disks

All LP disks are recorded with treble boost and bass cut, the amount of which often varies from one manufacturer to another. To play a disk, the bass below a certain turnover frequency must be boosted, and the treble must be rolled off a certain number of decibels at 10,000 cycles. Recommended control settings to accomplish this are listed for each manufacturer. Equalizer control panel markings correspond to the

following values in the table below: ROLL-OFF—10.5: LON, FRRR. 12: AES, RCA, Old RCA. 13.7: RIAA, RCA, New RCA, New AES, NARTB, ORTHOphonic. 16: NAB, LP, COL, COL LP, ORTHOacoustic. TURNOVER—400: AES, RCA. 500C: LP, COL, COL LP, Mod NAB, LON, FRRR. 500R. RIAA, ORTHOphonic, NARTB, New AES. 500: NAB. 630: BRS. 800: Old RCA.

All records produced under the following labels are recorded with the industry-standard RIAA curve (500R turnover; 13.7 rolloff): Angel; †Atlantic; Bethlehem; Classic Editions; Clef; EMS; Epic; McIntosh; MGM; Montilla; New Jazz; Norgran; Prestige; Romany; Savoy; Walden. Labels that have used other recording curves are listed below.

RECORD LABEL	NEW		OLD
	Turnover	Rolloff	Record No. or Date: Turnover, Rolloff
Allied	500	16	
Amer. Rec. Soc.	400	12	
Arizona	500R	13.7	To 1955: 400, 12.7
Audio Fidelity	500R	13.7	No. 991-903: 500, 16
Audiophile	500	12	
Bach Guild	500R	13.7	No. 501-529: 500, 16
*Bartok	500R	13.7	No. 901-905, 308, 310, 311: 500R, 13.7 No. 906-920, 301-304, 309: 630, 16
Blue Note Jazz	500R	13.7	To 1955: 400, 12
Boston	500C	16	
*Caedmon	500R	13.7	No. 1001-1022: 630, 16
Canvon	500R	13.7	To No. C6160: 400, 12
Capitol	500R	13.7	To 1955: 400, 12.7
Capitol-Cetra	500R	13.7	To 1955: 400, 12.7
Cetra-Soria	500C	16	
Colosseum	500R	13.7	To January 1954: 500, 16
*Columbia	500R	13.7	To 1955: 500C, 16
Concert Hall	500R	10.5	To 1954: 500C, 16
*Contemporary	500R	13.7	No. 3501, 2501, 2502, 2505, 2507, 2001, 2002: 400, 12. No. 2504: 500, 16
†Cook (SOOT)	500	12-15	
Coral	500	16	
Decca	500R	13.7	To November 1955: 500, 16
Elektra	500R	13.7	No. 2-15, 18-20, 24-26: 630, 16. No. 17, 22: 400, 12. No. 16, 21, 23, 24: 500R, 13.7
Esoteric	500R	13.7	No. ES 500, 517, EST 5, 6: 400, 12
Folkways	500R	13.7	To 1955: 500C, 16
*Good Time Jazz	500R	13.7	No. 1, 5-8: 500, 16. No. 3, 9-19: 400, 12
Haydn Society	500C	16	
HMV	500R	16	
Kapp	500R	13.7	No. 100-103, 1000-1001: 800, 16
Kendall	500	16	
*London, Lon. Int.	500R	13.7	To No. 846: 500C, 10.5
Lyrichord	500	16	
*Mercury	500R	13.7	To October 1954: 400, 12
Nocturne	500R	13.7	No. LP 1-3, 5, XP1-10: 400, 12
Oceanic	500C	16	
*L'Oiseau-Lyre	500R	13.7	To 1954: 500C, 10.5
*Overtone	500R	13.7	No. 1-3: 500, 16
Oxford	500C	16	
Pacific Jazz	500R	13.7	No. 1-13: 400, 12
Philharmonia	400	12	
†Polymusic	500	16	
RCA Victor	500R	13.7	To September 1952: 500 or 800, 12
Remington	500	16	
Riverside	500R	13.7	To 1955: 400, 12
Tempo	500	16	
Transradio	500C	16	
Urania	500R	13.7	No. 7059, 224, 7066, 7063, 7065, 603, 7069: 400, 12. Others: 500C, 16
Vanguard	500R	13.7	No. 411-442, 6000-6018, 7001-7011, 8001-8004: 500, 16
Vox	500R	13.7	500, 16 unless otherwise specified.
*Westminster	500R	13.7	To October 1955: 500C, 16; or if AES specified: 400, 12

*Currently re-recording old masters for RIAA curve.

†Binaural records produced on this label have no treble boost on the inside band, which should be played without any rolloff.

Everybody's talking about...



AUDIO FIDELITY Recordings

and ... the hi's ... the low's ... the color ... the excitement ... the priceless, earth-shaking sounds ... the guaranteed total frequency range ... the absolute noise-free surface ... the luxurious, four-color album jackets ... the overwhelming emotional experience ... the powerful and vital sensuous impact of sound in its purest and most natural form ... the wizardry of engineering techniques ... the fine performance and optimum acoustic conditions.



RENDEZVOUS A PARIS

Jo Basile and his accordion spin a melodic spell of love ... of romance ... of Paris! A captivating recording in high fidelity.

AUDIO FIDELITY AFLP 1821 12-in. \$5.95



CHA CHA CHA

The moon-drenched music of Pedro Garcia and his Del Prado Orchestra. Latin Velvet! Complete with illustrated dance instructions.

AUDIO FIDELITY AFLP 1810 12-in. \$5.95



BAWDY SONGS and BACKROOM BALLADS Vol. 3

Gather 'round, you lovers of lusty lore ... Oscar Brand has done it again! A complete new album of spicy musical folklore in superb Hi-Fi.

AUDIO FIDELITY AFLP 1824 12-in. \$5.95

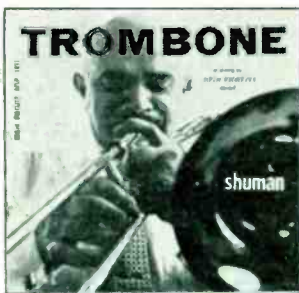

TROMBONE

Davis Shuman, Trombonist

Original compositions by Tibor Serly.
 • Concerto for Trombone and Orchestra
 • Miniature Suite for 12 Wind Instruments

AUDIO FIDELITY AFLP 1811 12-in. \$5.95

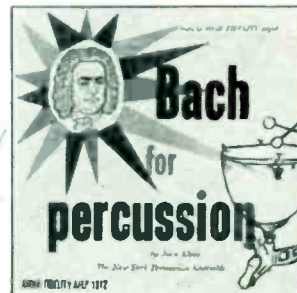

BACH FOR PERCUSSION

- Toccata and Fugue in D Minor
- "Great" Fugue in G Minor
- Toccata in F Major
- Fugue in C Major

AUDIO FIDELITY AFLP 1812 12-in. \$5.95

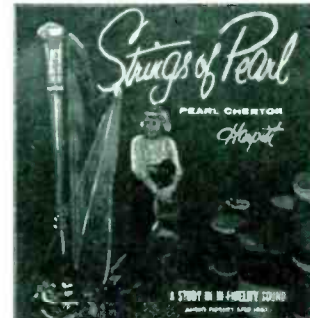

STRINGS OF PEARL

Pearl Chertok plays a rare combination of the sophisticated and the primitive on harp. Drum rhythms by Johnny Rodriguez. Brilliant Hi-Fi!

AUDIO FIDELITY AFLP 1805 12-in. \$5.95

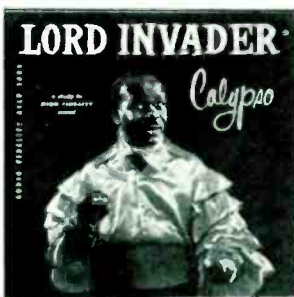

LORD INVADER: CALYPSO

The "Rum and Coca Cola" man from Trinidad in a brilliant high fidelity recording of new calypso songs.

AUDIO FIDELITY AFLP 1808 12-in. \$5.95



TALBOT BROTHERS of Bermuda

Top tourist attraction! Authentic Calypso rhythms and pop favorites in an idyllic tropical setting.

AUDIO FIDELITY AFLP 903 Vol. 2 10-in. \$4.00
 AFLP 1807 Vol. 3 12-in. \$5.95

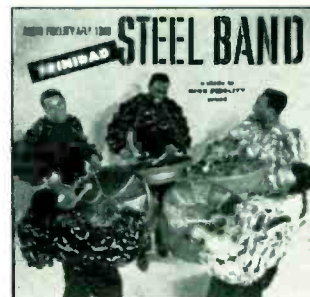

TRINIDAD STEEL BAND

The exciting, throbbing rhythms of the Steel Band, trademark of the West Indies. Oil Drums in Hi-Fi — a 20th century phenomenon.

AUDIO FIDELITY AFLP 1809 12-in. \$5.95

WRITE FOR
 FREE
 CATALOG

NATIONALLY DISTRIBUTED BY

DAUNTLESS INTERNATIONAL

750 TENTH AVENUE NEW YORK 19, N. Y.

The Music Between by Murray Schumach

WOMEN SINGERS have exerted such extraordinary power as record sellers in the "pop" field that they have been sought, coveted, pampered, and displayed with a magnificence accorded only the most famous of classical artists. The slightest hint that a female warbler with a new pop "style" has been discovered touches off among record executives something akin to the old-fashioned gold rush. Through cellar bistros, obscure night clubs, and small radio stations they course, all in the hope of finding a way to cash in on the new "trend." If, as is generally the case, the "discovery" is just a fad, she vanishes within a year or so, leaving only a vague memory to be discussed years later by women—or men—laughing at the curious attachments of adolescence.

But the great stylists in the pop field—and I exclude jazz, though the line between jazz and pop is sometimes hazy—can endure as long as famous singers of concert and opera. There is often a tendency—sometimes impelled by snobbery—to demean all pop singers with such comments as: "What would she do without a mike in her throat?" or: "The sound engineers are her voice." It is true that many jukebox divas have little talent and that even good pop singers lack the range, breath control, volume, pear-shaped tones of the opera star. But the elite among pop singers—such as Ethel Waters, Judy Garland, Ethel Merman, Edith Piaf—are fine artists.

Proof of such artistry abounds, I think, in a few recent recordings by female singers in the pop realm, whose triumph on disks is all the more spectacular because they work at a disadvantage. For though most operatic singers profit by not being seen, the best of the nonoperatic singers have learned to please the eye as well as the ear. That they are also successful even when invisible is attributable to enormous talent, dedicated discipline, and audience-exposure that has guided their instincts into what George Bernard Shaw meant when he wrote: "To kindle art to the whitest heat there must always be some fanaticism behind it."

As Exhibit A in this argument to show how artistic pop singers can be, I offer Judy Garland's latest recording, *Judy* (Capitol T 734). Think how many women have done *Come Rain or Come Shine*, *I Feel a Song Comin' On*, *Life Is Just a Bowl of Cherries*, and *April Showers* without making any impression. But when Miss Garland does these numbers on this record (aided, incidentally, by excellent sonics) she transforms them into fervid emotional experiences that can come only from dedicated study and deep feeling. For instance, when she sings the usually trite and maudlin *Dirty Hands*, *Dirty Face*, she infuses it with a quiet joy and tenderness that raise it almost to folk quality. And it is quite possible that to evoke the pathos of her rendition of *Any Place I Hang My Hat Is Home*

requires as much artistry as, say, Kathleen Ferrier's in *Das Lied von der Erde*.

In the eleven songs on this record—beautifully arranged by Nelson Riddle, who also conducts the orchestra—Miss Garland illustrates brilliantly her ability to do either rhythm song or ballad; to convey drama as well as melody. Perfectionists may quibble that none of these songs is up to *Over the Rainbow*. But does one necessarily disdain an Elisabeth Schwarzkopf recording because it does not include Mozart's *Abendempfindung*?

Ethel Merman is another illustration of greatness among pop singers. Her latest album, *Ethel Merman, a Musical Autobiography* (Decca DX 153), will, I think, bring happiness to its owners for many years. No one would contend that Miss Merman has a beautiful voice, or even a good one. It is strident, grating, bellicose. But, just as Miss Garland can make strong men weep, Miss Merman can bring laughter to the most crabbed of humans with her overpowering jaunty joyousness. A world attacked by Miss Merman's belligerent good nature is suddenly a warm spot in which sentiment and sophistication are always in balance; where mischief is the perfect sauce for intellect.

Miss Merman delivers the thirty-four songs on the two records of this well-annotated album with the flawless rhythm and syllabic purity that have long made her the darling of theater audiences. To show her off to best advantage, this collection of songs has been culled mainly from the works of the Gershwin brothers, Irving Berlin, and Cole Porter. Here Merman addicts will find such favorites as *I Got Rhythm* (from *Girl Crazy*); *Anything Goes* and *You're the Top* (*Anything Goes*); *Ridin' High* (*Red, Hot and Blue*); *Doin' What Comes Natur'ly* and *I Got the Sun in the Morning* (*Annie Get Your Gun*). To songs from nine Merman musicals, two bonuses have been added—*Alexander's Ragtime Band* and *Dearie*. This last is a gem that pairs her with Ray Bolger.

American pop singers have a decided advantage in the field, but no monopoly. This is demonstrated by Edith Piaf, in her latest Columbia record, *La Vie en Rose* (CL 898). This time, singing in English as well as French, the chanteuse is, as always, basically concerned with enriching words and music with her own emotion. When she does *La Vie en Rose* or *Autumn Leaves* she employs even her faults—the pronounced quaver, for instance, to color the bittersweetness; the tormented huskiness to produce the over-all musical personality of the game grisette. With the exception of Lotte Lenya, as typified by her *Lotte Lenya Sings Theatre Songs* by Kurt Weill (Columbia KL 5056), I know of no pop singer in the Continental style who is as dramatically effective as Miss Piaf. Certainly not Patachou on an Audio Fidelity recording called *Paris C'est une Blonde* (AFLP 1814), who, in trying to be dra-

matic, serves up false hysteria. Much more pleasurable than Patachou is the sincere, melodic Jacqueline François, backed up by Michel Legrand's orchestra on Columbia's *April in Paris* (ML 5091).

Lower than the lofty Garland-Merman-Piaf peak are Giselle MacKenzie and Teddi King—the former on *Giselle MacKenzie* (Vik LX 1055), the latter on *To You from Teddi King* (RCA Victor LPM 1313). Both have good voices, taste, and intelligence. Though unable to convey Miss Garland's deep emotion, they show sympathy and understanding. They can't "belt" a tune in the Merman manner, but they both can be delightfully buoyant. And both have the good pop singer's respect for lyrics, melody, and rhythm.

This brings us to the "record voice," the sort of singing which is at its best on records—sometimes, indeed, no good except on records. Basically, I think, these singers concentrate on one of two appeals—wholesomeness and sex.

Representative of the wholesome category are Jo Stafford, on *Ski Trails* (Columbia CL 910); Rosemary Clooney, on *Blue Rose* (Columbia CL 872); Patti Page, in *Patti Page in the Land of Hi-Fi* (Emarcy MG 36074); Ann Gilbert, in *The Many Moods of Ann* (Groove, LG 1004); Vera Lynn, in *If I Am Dreaming* (London LL 1510). The best examples are the Misses Stafford and Clooney. Both have absolute assurance in the stunt of suffusing a room in contentment. Miss Stafford, I think, could have tried a bit for humor in *Baby, It's Cold Outside*, and Miss Clooney could learn from jazz singers to get a touch of the blues in *Sophisticated Lady*. The former is supported by Paul Weston's orchestra and the latter by Duke Ellington's gifted group, both richly recorded.

The war between men and women is well represented this month by Eartha Kitt, on *Thursday's Child* (RCA Victor, LPM 1300); Sarah Vaughan, on *Sassy Sarah Vaughan* (Emarcy MG 36089); and Anita Ellis, on *I Wonder What Became of Me* (Epic LN 3280). I think Miss Kitt, though exciting in the manner of some neon spectaculars, misses true emotion. Her style seems to commingle the American folk singer, French chanteuse, and night club star. Depending on the song, I keep thinking of her as a second-rate Piaf, an imitation Pearl Bailey, or a female Harry Belafonte. Miss Vaughan, despite a horrible tremolo, tosses in such clever vocal gimmicks that at times she sounds almost artistic.

Oddly, Miss Ellis, who excited me most of this group, was also the most exasperating. She has the voice, training, feeling, and provocative style to become a fine pop artist. In her *Wait Till You See Me*, for instance, there is extraordinary know-how. If only she would forget some of the tricks that probably went well when she was a vocal "ghost" for Rita Hayworth she might become something memorable.

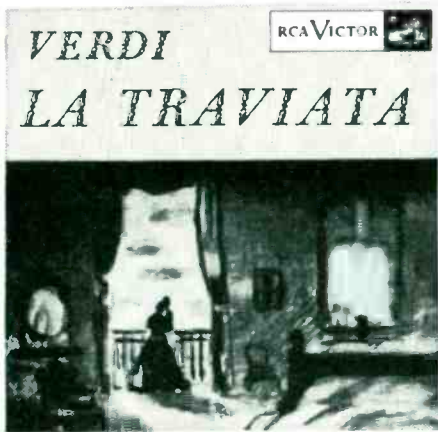

Opera
Highlights
by the
world's greatest
artists
on
RCA VICTOR



Long Play \$3.98;
Also available on 45 EP

Hear opera at its grandest — featuring the greatest names in music! The voices of Bjoerling, Merrill, Peerce, Warren, Albanese, de los Angeles, Milanov, Stevens, Tozzi, Valletti, and the Robert Shaw Chorale . . . conducted by Reiner, Monteux, Beecham and others. These brilliantly recorded Highlights bring you all the vivid clarity of great, live performances . . . on RCA Victor Records, of course!

FREE! FREE! FREE!

Discover other great operatic recordings in RCA Victor's new, complete, illustrated catalog of distinguished operatic and choral performances. It's free! Simply fill in coupon below and mail it — today!

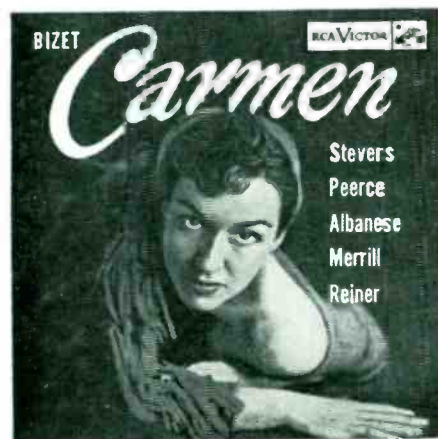

To: **RCA VICTOR**
BOX 484C
PHILADELPHIA 5, PA.

Please send me RCA Victor's new illustrated catalog of outstanding operatic and choral performances. I understand it is free and I am under no obligation. (please print)

NAME _____

ADDRESS _____

CITY _____ ZONE _____ STATE _____

Offer Expires Feb. 15, 1957

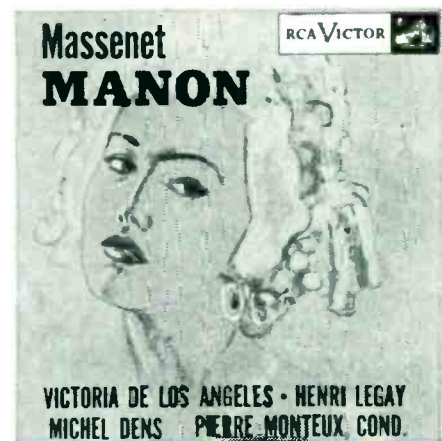

Hear these recordings best on an
RCA Victor New Orthophonic High Fidelity
"Victrola"®
Nationally Advertised Prices

Continued from page 84

The rising young German soprano Rita Streich is as skillful a singer as she is enchanting (and vice versa) in these light-weight display pieces, and she should delight any coloratura fancier. The tone glitters prettily; the technique seems effortless, the melodies blossoming into roudades and the cadenzas cascading as smoothly as could be desired; the less showy passages, particularly in the Strauss waltzes, are meltingly phrased. Of its kind, a superior disk. R.E.

ZIMBLER SINFONIETTA

Ives: *The Unanswered Question*. Milhaud: *Symphony No. 4*. Skalkottas: *Little Suite* for String Orchestra. Bartók: *Divertimento* for Strings.

Zimbler Sinfonietta, Lukas Foss, cond.

UNICORN UNLP 1037. 12-in. \$3.98.

A fetching miscellany of modern pieces, beautifully performed and gorgeously recorded.

Ives's unanswered question is the riddle of existence. The trumpet propounds it; flutes struggle with it; but throughout the entire score the strings sustain a quiet, mysterious background because they are "the Druids, who know, see, and hear nothing"—or perhaps everything. This is not Ives's most important work, but it is significant of the transcendentalist streak in his make-up which often came to the fore in his music but which has in the music so far recorded been overlooked.

The Milhaud is not the Fourth Symphony, or *Te Deum*, for big orchestra and chorus, written to celebrate the liberation of Paris from the Nazis, but the fourth in the series of six little symphonies for

chamber ensemble composed in the early Twenties. Because of their brevity and their rather violent polytonalism these works were regarded as jokes when they were new, and the literature on Milhaud continues to treat them in a light vein. But the Fourth Symphony is no joke. Its *Chorale* is one of the most powerful things Milhaud has ever written, and so is its fugal finale. A grand piece, previously unavailable on records.

Nikos Skalkottas, the Greek disciple of Schoenberg, who died in 1942, makes his debut on records with the *Little Suite*, which proves how well the twelve-tone system can adapt itself to a Mediterranean temperament and an essentially lyrical point of view.

The famous *Divertimento* of Bartók calls for no comment. It is available in four other recordings, but this is one of the best. A.F.



ALL THESE
NEW

UNICORN
RECORDS

CARRY A FULL
MONEY-BACK
GUARANTEE

If you don't agree they're
the finest high fidelity sound
available, just return them
with your sales slip and get
your money back.



UNICORN

75 STATE STREET, BOSTON, MASSACHUSETTS

UNLP 1038 "LIGHT MUSIC" Boyd Neel
conducting the Boyd Neel Orchestra, Ltd.
Composers: Sibelius, Grieg, Handel, Arne,
Agrell, Bull.

UNLP 1040 BRANDENBURG CONCERTOS
No. 1, 2, and 4.

UNLP 1041 BRANDENBURG CONCERTOS
No. 3, 5 and 6. Boyd Neel conducting
the Boyd Neel Orchestra,
Ltd. Soloists: Leon Goossens, G. Gilbert,
E. Hurwitz, Bram Gay, George Malcolm.

UNS 1 HANDEL: "MESSIAH"

(The first Amer. recording)
The Handel and Haydn Society of Boston
and the Zimbler Sinfonietta conducted
by Thompson Stone

Adele Addison, soprano; Lorna Sydney,
contralto; David Lloyd, tenor; Donald
Gramm, bass. Complete — 3-12" records
\$11.98

UNLP 1043 Exerpts from Handel's "MESSIAH."
1-12" record.

MUSIC AT M.I.T.

UNLP 1031 "THE MODERN AGE OF BRASS"
Roger Voisin and His Brass Ensemble.
Composers: Sanders; Dahl; Hindemith;
Berezowski. Recorded at Kresge Auditorium,
M.I.T. Engineered by Peter Bartók.

UNLP 1032 HANDEL ORGAN CONCERTOS
Lawrence Moe, organist. Nos. 1 and 5, Op. 7;
Nos. 2 and 5, Op. 4. Klaus Liepmann
conducting Unicorn Concert Orchestra.
Holtkamp Baroque organ, M.I.T. Chapel.
Engineered by Peter Bartók.

UNLP 1033 BEETHOVEN PIANO SONATAS
E-Major, Opus 109; A-Flat Major, Opus 110.
Ernst Levy, pianist. Recorded at Kresge
Auditorium, M.I.T. Engineered by
Peter Bartók.

UNLP 1034 Beethoven Piano Sonatas
F Minor, Op. 57. (Appassionata); C Minor,
Op. 111. Ernst Levy, pianist. Recorded at
Kresge Auditorium, M.I.T. Engineered
by Peter Bartók.

UNLP 1035 Franz Liszt
piano works, Sonata in B Minor;
Benediction de Dieu dans la Solitude.
Ernst Levy, pianist. Recorded at Kresge
Auditorium, M.I.T. Engineered by
Peter Bartók.

UNLP 1037 Bartók:
Divertimento for String Orchestra;
Charles Ives: *The Unanswered Question*;
Darius Milhaud, *Symphony No. 4* for
Strings; Nikos Skalkottas: *Little Suite*
for Strings. The Zimbler Sinfonietta
conducted by Lukas Foss. Recorded at
Symphony Hall, Boston. Engineered by
Peter Bartók.

All records are 12" L. P.'s at \$3.98 each.

More Briefly Noted

THE Budapest Quartet's offering of *Budapest Quartet Encores* is a record to wax lyrical over. Containing single movements from string music by Tchaikovsky, Haydn, Schubert, Debussy, and Wolf— together with others— it forms a near-perfect introductory sampler for the chamber-music novice, while at the same time its performances must afford exquisite pleasure to the serious lover of the art. This we owe to Columbia (ML 5116).

Less inspiring, but expertly performed and brilliantly recorded (by Capitol on P 8351), are a collection of familiar tunes— *Funiculi, Funicula; Perpetual Motion; Barcarolle* from the *Tales of Hoffmann*; *Finale* from Tchaikovsky's *Capriccio Italien*; etc.— played by the Hollywood Bowl Symphony Orchestra under Carmen Dragon and more or less appropriately entitled *L'Italia*. Distinctly for the specialized taste is Marcel Mule's *The Saxophone, Vol. VI*, in which this past master of the art of the saxophone (accompanied by Solange Robin at the piano) plays some very ordinary music. Paul Creston's sonata, however, is pleasant, and the disk as a whole (excellently recorded) certainly affords opportunity for the full study of Mule's technique.

THE BEST OF JAZZ

by John S. Wilson

THE PAUL DESMOND QUARTET

Jazzabelle; A Watchman's Carroll; Everything Happens to Me; Let's Get Away from It All; Look for the Silver Lining; Sacre Blues; You Go to My Head; Line for Lyons.

Paul Desmond, alto saxophone; Don Elliott, mellophone, trumpet; Norman Bates, bass; Joe Dodge, drums.

FANTASY 3235. 12-in. 42 min. \$3.98.

A couple of months ago, on *Brubeck Plays Brubeck*, Dave Brubeck proved himself a

much more interesting performer when he got away from his quartet and played solo. It would be going a little far to say that Paul Desmond, Brubeck's saxophonist, is also a more interesting performer when he, too, gets away from the Brubeck quartet—his consistently excellent work has often been the saving grace of that group—but it is pleasant to hear him in surroundings in which there is no danger of an intrusion of Brubeck's *Götterdämmerung* fetish. Desmond is one of the very few jazzmen who can work out a really valid solo at some length, a talent which he shows repeatedly on most of these selections (the too slow, too tedious *You Go to My Head* is the major exception). Don Elliott's mellophone is a fascinating complement to Desmond's alto in their passages together and he manages some convincingly swinging solos. But he is tripped by his versatility when, on two occasions, he makes unfortunate switches to trumpet.

DIZZY GILLESPIE AND HIS ORCHESTRA: *Dizzy Gillespie: World Statesman*

Dizzy's Business; Jessica's Day; Tour de Force; I Can't Get Started; Doodlin'; Night in Tunisia; Stella by Starlight; The Champ; My Reverie; Dizzy's Blues.

NORGRAN MG-N-1084. 12-in. 40 min. \$4.98.

This is the band with which Gillespie made his tour of the Middle East under the auspices of the State Department. It is solidly in the tradition of the great ones among the big jazz bands of the past—powerful, flexible, capable of rich sonorities and subtle delicacy, a band that has both a variety of solo stars and strong group feeling. Most of the selections are rooted in a rocking, swinging beat, but occasionally there is a shift to a legato rhythm—*I Can't Get Started*, on which the band creates a rich, smooth sauce for Gillespie's tart trumpet, and *My Reverie*, a showcase for Melba Liston's surprisingly masculine, slightly Kentonish trombone. Gillespie's playing, often dazzling but never exhibitionistic, is a soundly conceived but highly imaginative extension of whatever basic material is being dealt with. Touched as it is by Gillespie's piquant personality, this is a band that is reminiscent of no other big band, a band which is carving out its own directions instead of poking around in the dead wood of the past.

HISTORY OF CLASSIC JAZZ

Backgrounds: *Royal Drums of Abatusi; Abatusi Girls' Songs; Lobertina; Street Cries of Charleston; Shuckin' Sugar* (Blind Lemon Jefferson); *I'm Going to Heaven If It Takes My Life* (Rev. J. G. Gates); *Slidus Trombonus* (Sodero's Military Band); *Ragtime Oriole* (Fred Van Eps).

Ragtime: *At a Georgia Camp Meeting; The Cascades* (Scott Joplin); *Frog Legs Rag* (James Scott); *American Beauty Rag* (Joseph Lamb); *Perfect Rag* (Jelly Roll Morton); *Atlanta Rag* (Cow Cow Davenport).

The Blues: *Titanic Man Blues* (Ma Rainey); *St. Louis Blues* (Bessie Smith); *I've Got the Blues for Rampart Street* (Ida Cox); *Around the Clock Blues* (Chippie Hill); *Risin' High Water* (Blind

MERCURY LIVING PRESENCE

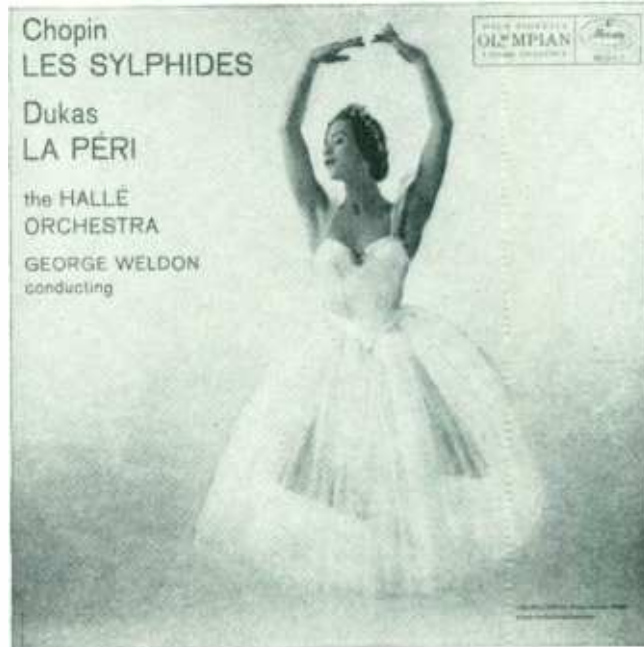

CHOPIN *Les Sylphides*; DUKAS *La Péri*. Hallé Orchestra, George Weldon conducting. MG50117

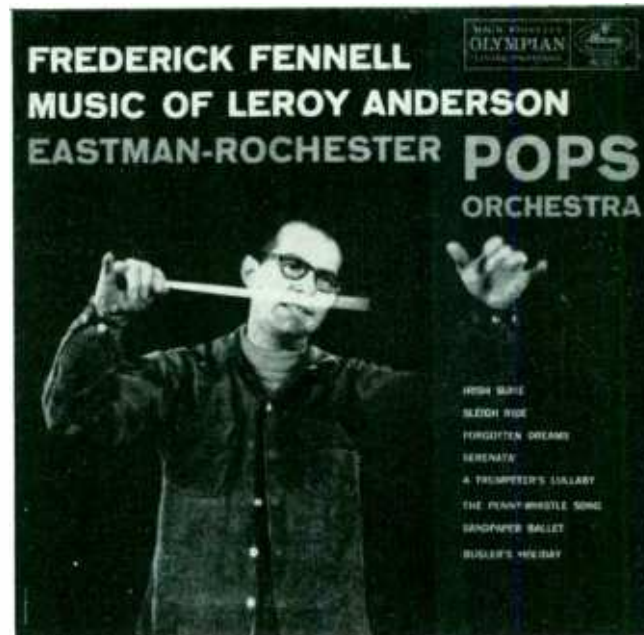

FREDERICK FENNELL conducts the music of LEROY ANDERSON. Eastman-Rochester "POPS" Orchestra, Frederick Fennell conducting. MG50130

MOZART *Eine Kleine Nachtmusik; Symphony in C Major "Linz."* London Symphony Orchestra, Antal Dorati conducting. MG50121

HANSON *Fantasy Variations; ROGERS* *Leaves from "The Tale of Pinocchio"; TRIGGS* *The Bright Land.* Eastman-Rochester Orchestra, Howard Hanson conducting. MG50114

CONCORD JANUARY RELEASES

"ALBERT DaCOSTA OPERA CONCERT"

Hear the Metropolitan Opera's exciting tenor discovery, Albert DaCosta, sing F above High C in FULL VOICE in the Credeasi misera from Puritani! The only recording in the world of such a feat. Symphony Orchestra conducted by Hans Jurgen-Walther.

1. LEONCAVALLO: I Pagliacci: Vesti la Giubba
2. MEYERBEER: Les Huguenots: Plus blanche
3. BIZET: Carmen: Flower Song — La fleur que tu m'avais jetée
4. BELLINI: I Puritani: Credeasi misera
5. MEYERBEER: L'Africain: O Paradis
6. MEYERBEER: Le Prophete: Versez
7. VERDI: Otello: Dio mi potevi scagliar
8. LEONCAVALLO: I Pagliacci: Un tal gioco
9. WAGNER: Die Meistersinger: Preislied
10. WAGNER: Lohengrin: In fernem land
11. WAGNER: Die Walkure: Winterstürme wichen dem wonnemond
12. WAGNER: Siegfried: Schmedlied
13. R. STRAUSS: Der Rosenkavalier: Di rigori armato

Concord 3004 — Long Play 12" Recording — \$3.98

"OFTEN HEARD OFFENBACH"

For a miserable mood! More bubbly than a glass of champagne. Offenbach, performed superbly by L'Orchestre de la Radio-Television Nationale Francaise with Jean Allain conducting.

1. La Vie Parisienne: Quadrille
2. La Vie Parisienne: Polpourri
3. La Belle Helene: Overture
4. Grand Dutchess of Goralstein: Overture
5. Tales of Hoffmann: Minuet
6. Tales of Hoffmann: Barcarolle
7. Tales of Hoffmann: Valse
8. Orpheus in the Underworld: Quadrille
9. Orpheus in the Underworld: Scherzo

Concord 3006 — Long Play 12" Recording — \$3.98

"ORGAN MUSIC OF THE SIXTEENTH AND SEVENTEENTH CENTURIES"

Truly unique! A collector's collection of rare organ music . . . played by Robert Noehren on the Schlicker Baroque organ.

1. ARNOLD SCHLICK: Organ Chorale: "Maria zart von edler Art"
2. SWEELINCK: Six Variations: "Mein junges Leben hat ein End"
3. SWEELINCK: Fantasia super: Ut, Re, Mi, Fa, Sol, La
4. FRESCOBALDI: Messa della Madonna: Canzona dopo l'Epistola
5. FRESCOBALDI: Messa della Madonna: Ricercare dopo il Credo
6. ANTONIO DE CABEZON: Diferencias sobre El canto del caballero
7. SAMUEL SCHEIDT: Organ Chorale: "Da Jesus an dem Kreuze stund" verses 1 and 6
8. PACHELBEL: Organ Chorale: "Vom Himmel hoch da komm ich hier"

Concord 4002 — Long Play 12" Recording — \$4.98

"OLD WINE"

Mellow and heady as old wine . . . from the best vintage years. Dana Lawrence Orchestra.

1. Begin the Beguine
2. Dancing in the Dark
3. In the Still of the Night
4. You Do Something to Me
5. Body and Soul
6. Old Man River
7. The Touch of Your Hand
8. Night and Day
9. That Old Black Magic
10. I Cover the Waterfront
11. You're Devastating
12. Time on My Hands
13. Sweet Lorraine
14. Who's Sorry Now?

Concord 3005 — Long Play 12" Recording — \$3.98

CONCORD RECORDS

... "The Sound Heard 'Round the World!"® Every CONCORD Record is wrapped three ways to protect it from dirt, dust and fingerprints . . . first in a polyethylene sleeve, second in an album container, third in an hermetically sealed plastic outer wrapper
At your dealer or write:

CONCORD RECORD CORPORATION

Bureau 4, 519 S. Fifth Ave., Mt. Vernon, N.Y.

Lemon Jefferson); *Big Bill Blues* (Big Bill Broonzy).

New Orleans Styles: *Froggie Moore* (King Oliver); *The Pearls* (Jelly Roll Morton); *Steady Roll* (Morton); *Liver*; *Stable Blues* (New Orleans Rhythm Kings); *Blue Grass Blues* (Original Memphis Melody Boys); *Cake Walking Babies from Home* (Red Onion Jazz Babies).

Boogie Woogie: No. 29 (Wesley Wallace); *The Fives* (Jimmy Yancey); *Blue Boogie* (Cripple Clarence Lofton); *Far Ago Blues* (Meade Lux Lewis); *South Side Shuffle* (Art Hodes); *Lone Star Blues* (Pete Johnson).

South Side Chicago: *Oh Daddy* (Johnny Dodds and Tiny Parham); *Salty Dog #1* (Freddie Keppard); *Mama Stayed Out* (Barrelhouse Five); *Careless Love* (State Street Ramblers); *Jackass Blues* (Lovie Austin's Blues Serenaders); *The Memphis Maybe Man* (Doc Cook's Dreamland Orchestra).

Chicago Style: *Everybody Loves My Baby* (Stomp Six); *Royal Garden Blues* (The Wolverines); *When My Sugar Walks Down the Street* (Original Wolverines); *China Boy* (Charles Pierce Orchestra); *Friars Point Shuffle* (Jungle Kings); *Up the Country* (Wingy Manone).

Harlem: *Harlem Strut* (James P. Johnson); *Mama's Got the Blues* (Fats Waller); *Hock Shop Blues* (Cliff Jackson); *Midnight Stomp* (Clarence Williams Orchestra); *Rainy Nights* (Duke Ellington's Washingtonians); *Hop Off* (Fletcher Henderson Orchestra).

New York Style: *Sweet Lorin' Mama* (Original Memphis Five); *Sweet Man* (California Ramblers); *Stampede* (Red and Miff's Stompers); *Eccentric* (Wild Bill Davison); *Yank's Blues* (Yank Lawson); *Lonesome Road* (Muggsy Spanier).

New Orleans Revival: *Weary Blues* (Kid Ory); *Make Me a Pallet on the Floor* (Bunk Johnson); *Careless Love* (George Lewis); *Antigua Blues* (Lu Walters); *Dawn Club Joys* (Bob Helm); *St. James Infirmary* (Dixieland Rhythm Kings).

RIVERSIDE SDP 11. Five 12-in. 185 min. \$25.00.

The attempts of the past to make classic jazz readily available on records have been marked more often by good intentions than by actual releases. George Avakian's great ground-breaking project on the Columbia label which produced three multi-disk sets—*The Louis Armstrong Story*, *The Bessie Smith Story*, and *The Bix Beiderbecke Story*—opened hopeful vistas; but, having made these three splendid gestures, Columbia retired to the same sporadic, disjointed reissue basis that also has been followed by both RCA Victor and Decca.

These three companies are mentioned because, until recently, they were the only record companies that had in their files the material with which to document early jazz. True, there were many jazz recordings made in the Twenties and Thirties, by other companies, but most of these were small outfits and have vanished, leaving the rights to the recordings scattered and obscure.

However, it was to these sources that Bill Grauer, Jr. and Orrin Keepnews

turned when they organized Riverside Records three years ago. By industrious investigation and shopping they acquired the rights to masters by such jazz labels of the Twenties as Gennett, Paramount, Black Swan, and Champion, as well as the more recent Solo Art and Circle. With these, Riverside began the most ambitious program of reissues carried out so far in this country. And now, as the ultimate flower of all this effort, representative elements of Riverside's resources have been marshaled to form a magnificent *History of Classic Jazz*.

But, to avoid misunderstanding, let's qualify "magnificent." First, most of these recordings were made in the 1920s by small companies limited in both recording knowledge and equipment. Several are from the days of acoustical recording and even some of the more recent ones (a 1947 Kid Ory, for example) have the dim distorted fuzziness that bespeaks in-expert engineering. This is, therefore, a low-fidelity set, and people whose interests lie with the highest highs and the lowest lows should look elsewhere.

Second, despite their corner on dead jazz labels, there were a couple of things Grauer and Keepnews were not able to get. One was Bessie Smith, who did all of her recording for Columbia. Another was adequate big band representation, possibly because these smaller companies could not afford to record big bands. To give them credit, Grauer and Keepnews have shown ingenuity. Bessie Smith is shoe-horned in by means of a sound track from an ancient film, but it is an atrocious recording. The big bands are represented by a very early (1926), atypical, but historically interesting Duke Ellington small group and a stodgy Fletcher Henderson side. A really flawless history of classic jazz would have to have access to the big companies' files to fill in these two gaps.

Once these points are understood it can be reasserted that this is a magnificent production, right from the attractive simplicity of the album itself to Charles Edward Smith's delightful and informative introductory essay (a remarkably merry piece of scholarship), Orrin Keepnews' complete, explicit discographical notes and comments, and, of course, the records themselves.

Half of the sixty selections which make up this history have never before been issued on LPs (two or three have never been issued at all). A glance at the listing above will show that one side of each disk is devoted to a particular aspect of early jazz history. It will also suggest why it is impossible to discuss the whole set in detail. But some of the high points should be noted. There is a pair of properly classic blues by male singers, Blind Lemon Jefferson's *Shuckin' Sugar* and Big Bill's *Big Bill Blues*, along with performances by Ma Rainey and Ida Cox which are as notable for the accompanying trumpets as for the singing—the beautiful tone of Joe Smith with Ma Rainey and the more rugged style of Tommy Ladnier with Ida Cox. There is Jerry Roll Morton flailing out a fleet and powerful ragtime tune, larding it with typical Jelly Roll phrases; superb King Oliver-Louis Armstrong team-

Continued on page 92

HOW TO KEEP *deliriously* YOUR HI-FI HAPPY!

HI-FI systems stick their chests out with pride when they get Decca Records to play! No wonder they're so happy . . . these are the brilliant high fidelity choices that are demonstrated at Audio Fairs across the country. You'll be deliriously happy, too, when you play these "New World of Sound" Decca Records on *your* HI-FI set-up.



Thrill to the magic and sweep of strings in HI-FI; 'Lisbon Antigua', 'Spanish Violins', 'Monte Carlo Melodie', 'Bistro', 'Caminito', etc. DL 8382†



Caterina Valente makes every HI-FI happy! 'The Breeze And I', 'Begin The Beguine', 'Temptation', 'If Hearts Could Talk', etc. DL 8203*†



The award-winning Westlake College Quintet creates way out jazz; 'Billy Boy', 'La Paz', 'Softly As In A Morning Sunrise', etc. DL 8393



Dr. William D. Revelli raises band music to a new HI-FI; 'On The Esplanade', 'The Showman-March', 'Ballet Of Pleasure', etc. DL 8264*



HI-FI Organ Solos With a Beat; Lenny Dee makes the organ jump in 'Charmaine', 'I'm Beginning To See The Light', 'Coquette', etc. DL 8165*



José Greco—Ballet; Orquesta Zarzuela De Madrid; 'Viva Castilla', 'El Baile de Luis Alonso', etc. DL 8757

DL indicates 33 $\frac{1}{3}$ RPM Long Play. *Available on Extended Play 45. †Recorded in Europe by Deutsche Grammophon

DECCA® RECORDS

a New World of Sound®



JANUARY'S BIGGEST HI FI BUY!

new from **RCA VICTOR**



REGULARLY \$3.98
THIS MONTH ONLY
\$2.98
SPECIAL 45 EP
FORMER \$1.49 VALUE
THIS MONTH ONLY
\$1.29

Here's an album that has everything! The great talent of The Three Suns combines with the world's largest pipe organ, setting a new mood in mood music. Electrifying sound makes this an adventure in Hi Fi you can't afford to miss... all at a special low, low price!

At your Record Dealer's Now!
Nationally Advertised Prices.



Any 3 JAZZ Albums for \$2.98

Choose the greatest jazz classics ever recorded... in the jazz style you like best!



4. Modern Jazz: Modern sounds by Mulligan, others. *Summertime*, *I Hear Music*, etc.



5. Cool Jazz: Great sounds by Charlie Parker and Stan Getz, kings of "modern" sax.



6. Dixieland: *Tiger Rag*, other Dixieland classics, with P. Barbarin, J. McPartland.



7. Swinging Jazz: Jo Jones and Basie alumni swing *Embraceable You*, *Caravan*, etc.



3. Big Band Jazz: Goodman, Dorsey, Basie, Shaw, *St. Louis Baby*, *Flat Foot Floogie*, etc.



2. Intimate Jazz: The soft, breathy voice of Lee Wiley sings *My Romance*, *My Funny Valentine*, etc.



1. Fun in Jazz: Fats Waller, the "Cheerful Little Earful" doing his greatest numbers.

TO INTRODUCE YOU to these superb high-fidelity jazz recordings, The Jazztone Society offers you any THREE hi-fi jazz concerts shown above for only \$2.98! Not one record, but three 12-inch, quiet surface, long-playing vinyl recordings containing up to 36 of the greatest jazz classics ever recorded!

All the Jazz Styles and Big Names Here are today's outstanding jazzmen of our time — interpreting all the great styles. You'll find the big-band jazz of Goodman and Dorsey, the cool sounds of Parker and Getz, the modern, progressive jazz of Gerry Mulligan and many others.

Build a Great Jazz Collection at Huge Cash Savings

With the albums, you'll also obtain a Trial Membership in the Jazztone Society. Each monthly selection will be described in advance. You can AUDITION, any or all the Society's releases for

five days! Return any you don't want. Pay the special Member's price of just \$2.98 each (plus shipping for those you keep!) And you may resign any time — after buying three selections during the first year.

Don't miss this opportunity to get 3 hi-fi jazz "concerts" — for only \$2.98. Mail coupon.

The Jazztone Society, Dept. 3002 71 Fifth Ave., New York 3, N.Y. Send three Long-Play Jazz Albums circled below:

1. 2. 3. 4. 5. 6. 7.
If I keep them, I'll pay only \$2.98 (plus shipping) for all three. Also, enroll me as a Trial Member. Privileges: advance notice of releases; 5 day free trial on any discs. I may reject records before or after hearing them; may cancel membership at any time after buying 3 monthly selections. Future 12" long-play discs are only \$2.98 each plus shipping.

Name _____
Address _____
City _____ State _____
For info. on Can. service:
105 Bond St., Toronto 2, Ont.

work on *Froggie Moore*; Art Hodes' angular and very Chicago piano on *South Side Shuffle*; the rich earthiness of the Barrelhouse Five, Lovie Austin's re'axed *Jackass Blues*, Bix playing with sublime sweetness of tone on *Royal Garden Blues*, Fats Waller tearing up a piano roll with *Mama's Got the Blues* and on down a long and fascinating list.

This set is essential to any comprehensive jazz collection. It will be a well of nostalgia for the gaffers who lived through it and an eye-opener for jazz fledglings. To anyone interested in jazz, now or in the future, it is—and seems bound to remain—a work of tremendous importance in concise, accurate, intelligent, and witty documentation of the beginnings and establishment of jazz.

GEORGE LEWIS IN HI-FI

Original Dixieland One Step; Four or Five Times; Struttin' With Some Barbecue; Salty Dog; That's a Plenty; Move the Body Over; Don't Give Up the Ship; Didn't He Ramble; She's Cryin' for Me; Tishamingo.

George Lewis, clarinet; Thomas Jefferson, trumpet; Bob Thomas, trombone; Alton Purnell, piano; Alcide "Slow Drag" Pavageau, bass; Joe Watkins, drums. CAVALIER 6004. 12-in. 46 min. \$3.98.

From almost every point of view, this is Lewis' best disk. The recording is certainly the best his band has received, and the program, for a change, is not made up of material which it has recorded repeatedly. But the most important differences are the changes which have been made in the personnel of the band. Thomas Jefferson gives the group a more certain, stronger trumpet lead than did his predecessor, Kid Howard, and he adds color with such things as his biting growl chorus on *Four or Five Times*. Bob Thomas, replacing Jim Robinson, has all of Robinson's gruff strength plus a more lyric quality. Along with Lewis himself, whose form never seems to vary, they make an exceptionally strong front line. The departure of banjoist Lawrence Marrero has loosened up the rhythm section and this, along with the good recording, allows the amazing drive of the sixty-eight-year-old bassist, Alcide Pavageau, to become evident. Considering the physical requirements for playing the bass, particularly in a band like this which features a lot of long, fast numbers, Pavageau stands as one of the most amazing men in jazz.

THE LUCKY THOMPSON QUINTET

Thin Ice; Blues for Frank; A Minor Delight; Takin' Care o' Business; Sophisticated Lady; These Foolish Things; When Cool Night.

Lucky Thompson, tenor saxophone; Emmett Berry, trumpet; Henri Renaud, piano; Benoit Quersin, bass; Dave Pochonet, drums.

LONDON DTL 93098. 10-in. 28 min. \$2.98.

There is a good presentation of Lucky Thompson's easy, smooth tenor saxophone throughout this disk, recorded in Paris last year. With each of his recent appearances on records, Thompson has strengthened the impression that he has,

of all the full-voiced, masculine, essentially pre-bop tenors, most fully realized his talents. No other tenor but Coleman Hawkins has improvised with such a steady development of ideas as Thompson consistently shows, and Thompson's playing today has a definite edge over much of Hawkins' current routine work. Thompson's improvisational abilities are at peak form on the superb *Thin Ice* on this disk. On this selection, he plays with only bass and drum accompaniment (a format with which he showed himself to be very happy on his recent ABC-Paramount disk), evolving a long, uninterrupted solo that never falls into banality. The other originals are mostly swinging, medium-tempoed riffs on which Emmett Berry serves as a capable

foil for Thompson, and Henri Renaud contributes several able piano passages.

Other January Jazz

Concert Jazz: In addition to the two disks made at the American Jazz Festival featuring Buck Clayton and Duke Ellington (q.v.), two further disks were taped there, *Louis Armstrong and Eddie Condon at Newport* (Columbia CL 931, 12-in. 44 min. \$3.98) and *Dave Brubeck and Jay and Kai at Newport* (Columbia CL 932, 12-in. 43 min. \$3.98). Armstrong holds to his policy of playing only things which he has already played to death, while Condon's blithe boys (Wild Bill Davison, Peanuts Hucko, Bud Freeman, etc.) under-

score the point by riding lightly through tunes made famous by an earlier, less static Armstrong. There are spots of better-than-average Brubeck on his disk along with consistently good playing by Paul Desmond. The J. J. Johnson-Kai Winding Quintet finishes out one side of this disk with three typically slick, rhythmic but unemotional performances.

A New Orleans appearance by George Girard and His New Orleans Five, *Stomping at the Famous Door* (VIK LX 1063, 12-in. 49 min. \$3.98) brings the sad intelligence that Girard, a young trumpeter who has shown flashes of promise in the past, is now missing the mark woefully. His playing here is a mass of careless flashiness. Two excerpts

Initiate and Uninitiate React to Bernstein's Jazz Lesson

WHEN Leonard Bernstein undertook to explain jazz on the *Omnibus* television program last year, there seemed to be general agreement among his jazz-oriented listeners that he had pulled off a difficult trick with impressive success. However, there was similar agreement that, when he wound up his discussion by playing a jazz composition of his own, he was pressing both his gifts and his luck too far.

On this recorded adaptation of his *Omnibus* talk, Bernstein has allowed discretion to prevail. His own performances are limited to brief illustrative piano and vocal passages (including a delightfully rowdy rendition as a blues of a few lines from *Macbeth* to point up the iambically pentametric nature of blues lyrics). Without his own composition tagging along to raise anticlimactic doubts, he comes through on the disk as a man who knows his subject well and has an unusual ability for discussing it with lucidity, discernment, and wit.

His explanation of the blues and the specifically jazz elements found in the blues, is as clear and comprehensive as anything I have heard or read on a subject that is often misunderstood even by relatively sophisticated listeners. Although there is a good deal of showmanly humor in the purposefully exaggerated stiffness of his piano version of *Empty Bed Blues* as it might sound without blue tonality and of Sherry Ostrus' "straight" singing of this Bessie Smith classic, it is not really necessary to go to comic lengths to make the point. The difference can be heard in almost any classically trained singer's attempts at the blues or, as a particularly pat illustration, in Paul Robeson's efforts on a 1941 Count Basie record, *King Joe*.

On the second side, with *Sweet Sue* as the base of operations, Bernstein touches on simultaneous improvisation, big band jazz, cool jazz, progressive jazz, and the future of jazz. He is somewhat less successful here than on the first side, largely because he directs his attention to recounting developments in jazz instead of explaining them. This is especially apparent when he gets to modern jazz which—simply because it is newer and stranger than anything else in jazz, once the basic elements have been assimilated—needs the kind of explicit description that Bernstein has just given to those basic elements. As Bernstein says, the line between serious music and jazz is growing less and less clear; but when he tells us that a performance of *Sweet Sue* by the Don Butterfield Sextet, which "borders on serious concert music," is really jazz because it is played on jazz instruments by jazzmen and has roots "in the soil of jazz," he leaves more things unexplained than he explains. What, for instance, is a jazz instrument? How does one distinguish a "jazzman"? And how does one recognize the jazz roots in a performance in which they are not readily apparent?

This leaves ample room for a sequel which might be called "What Is Modern Jazz?" If Bernstein can explain that with the same simple, direct clarity with which he has handled basic jazz, nothing less than a statue in his honor at the entrance to Birdland would be adequate recognition of his achievement.

JOHN S. WILSON

LEONARD BERNSTEIN here sets out to elucidate the mysteries of jazz; and to those of us who have long suffered from an acute sense of inferiority before them, what a benevolent act of charity this is. I don't recall exactly when all the bright young men of one's acquaintance stopped taking one "to hear the latest Pole/transmit the Preludes through his hair and fingertips" and substituted instead an evening with the late Art Tatum; or when every "little magazine" began to feel a moral obligation to publish learned essays on such theses as the intellectual parallels between bop and Existentialism; or when so many people never previously interested in cultural anthropology started suddenly to discourse on the Afro-Cuban heritage of Dixieland. In any case, all this has been going on for some years now—and perhaps the music has been blurred by the talk.

Mr. Bernstein has determined to rectify this situation by a labor of love, cleverly conceived to seduce both those who would genuinely like to share in a "uniquely original kind of emotional expression" characterized by the real humor of "play" (in the literal sense of that term) and those who might derive pleasure from joining in a musical *avant-garde*. In fulfillment of his self-appointed task, he provides a lecture demonstration in which the various components of jazz are isolated, explained verbally, and illustrated by various leading jazz performers. Melody, rhythm, tonal coloration, form, and harmony are all treated; and particular emphasis is given to analysis of blue notes and syncopation. Improvisation, that sacred idol of jazzmen, is given due consideration, with Mozart's variations on "Twinkle, twinkle little star" being offered as examples of its classic respectability. The various forms of jazz are demonstrated in brief excerpts, and blues receive a particularly enlightening interpretation.

To state the contents of the record thus bluntly is, however, to consider its pedagogical function only. Mr. Bernstein lacks the high seriousness of the pedantic schoolmaster and the wearying intensity of the crusader in a righteous cause. He simply likes jazz, all kinds, and something of his own responsiveness is communicated to his listeners. Furthermore, his disk conveys its own intrinsic pleasures. The rendition of an African Swahili tune (in Leonard Bernstein's own "horrid voice") may or may not adequately illustrate the note for which the jazz pianist is constantly searching; but it surely has its own grotesque humor. "I woke up this morning with an awful aching head," sung in conventional tenth-rate prima donna fashion, achieves the fine art of parody, whatever it demonstrates about jazz. And when Birnam wood comes to Dunsinane in blues style, the barriers of alienation among the arts are completely undone. The listener is undone too.

I don't know how many postulants will come knocking at the rather formidable doors of jazz as a result of this record; but certainly any hostility must give place, if not to the open heart, at least to the listening ear and the potentially understanding mind.

JOAN GRIFFITHS

LEONARD BERNSTEIN: *What Is Jazz*

COLUMBIA CL 919, 12-in. 48 min. \$3.98.

ffrr full frequency range recording

4 special HIGH FIDELITY releases

London ffrr, has created these four twelve-inch recordings especially for hi-fi enthusiasts. Find out how good your equipment really is with these masterpieces in sound.



TED HEATH SWINGS IN HI-FI

Kings Cross Climax, Boomerang, When a Bodgie Meets a Widgie, Dance of the Dingoes, Malaguena, Ballyhoo, Barber Shop Jump, Lullaby of Birdland, Walking Shoes, Dig Deep, Peg O' My Heart, Bell Bell Boogie, Siboney, Cloudburst. LL 1475

Here are fourteen selections chosen especially to demonstrate the scope of band sounds. The exceptional drive of the Heath band highlights the sound of each instrument and makes this a must for hi-fi addicts



MEN OF BRASS

Nightfall in Camp, Introduction to Act 3 "Lohengrin", The Whistler and his Dog, March "Medallion", 1812 Overture, The Mill in the Dale, Corner Carillon, Grand March "Queen of Sheba", Spanish Gipsy Dance, Cornet Trio "Bugler's Holiday" LL 1456

This unusual recording offers an amazing audio treat, no woodwinds, no strings—instead sixty-nine pieces of brass (with percussion) provide an exciting, different kind of hi-fi sound than you've ever heard before



CHRIS HAMILTON IN HI-FI

Dizzy Fingers, Temptation Rag, Canadian Carpers, Honky Tonk Rag, Tinkle Box Rag, South Rampart Street Parade, Trirsch Tratsch Polka, Cavaquinho, Whistling Rufus, Thunder and Lightning Polka, Amour Amour, Mexican Madness. LL 1437

No previous recording has harnessed the wide range and multiple sound effects of the organ as successfully as does HI-FI with Hamilton. It's acoustical brilliance and crystal clarity will astound you. Listen especially to band one, side one also band four side two



Pipes and Drums of the EDINBURGH CITY POLICE PIPE BAND

The Road to the Isles Angus MacKinnon, Wade's Welcome to Inverness, Miss Elspeth Campbell, Shepherd's Crook, Rejected Suitor, Bonnie Dundee, Royal Scots Polka, and 26 others LL 1484

For years, the bagpipe, with its simultaneous highs and lows and sudden variances of both, has challenged faithful recording by audio engineers. Now, for the first time, a hi-fi recording of this ancient musical instrument, with the percussion of many drums thrown in for good measure

LONDON
RECORDS



LONDON RECORDS INC.

539-0, W. 25 St., N. Y. C. 1

Gentlemen: Please send me the records indicated.

LL. 1484 LL. 1437 LL. 1456 LL. 1475

Enclosed is my check at 3.98 ea. I understand the records will arrive prepaid.

NAME _____

ADDRESS _____

CITY _____ ZONE _____ STATE _____

from a 1955 "Jazz at the Philharmonic" concert are available, *Jazz at the Philharmonic* (American Recording Society 416. 12-in. 44 min. By subscription) and *Jazz at the Philharmonic, Vol. 11*. (Clef MG Vol. 11. Two 12-in. 104 min. \$9.96). These are primarily for that special audience which responds to the long, empty solos which are a JATP hallmark, although there is relief in the more rationally developed work of Oscar Peterson's trio, represented by three identical selections on both disks.

Big Bands: Pete Rugolo's *Music for Hi-Fi Bugs* (EMARCY 36082. 12-in. 37 min. \$3.98) is quite definitely that and at times it is interesting big band jazz, too, although the band is heavier than a good jazz band ought to be. Something closer to the optimum level is produced by Elliot Lawrence's band on *Swinging at the Steel Pier* (Fantasy 3236. 12-in. 39 min. \$3.98), a collection of finger-snapping Al Cohn arrangements highlighted by one of the best Cohn solo performances I know of, a broad, brooding tenor saxophone development of *Alone Together*.

Ted Heath's band continues its explorations of popular composers with *Rodgers for Moderns* (London LL 1500. 12-in. 32 min. \$3.98) and offers a more varied collection on *Ted Heath Swings in Hi-Fi* (London LL 1475. 12-in. 32 min. \$3.98). Both disks have the bright precision, the showmanly qualities, and the superior recording that are usually present on Heath disks, but they also have that bland, anonymous quality that dogs most of his work. This feeling also permeates a pair of Heath offspring, *English Jazz* by Johnny Keating's All-Stars (Bally 12001. 12-in. 35 min. \$3.98) and *Swing Me High* by Reg Owen and his orchestra (Bally 12006. 12-in. 29 min. \$3.98). Keating and Owen are both Heath arrangers. Their bands are made up mostly of Heath sidemen and, with a more careful adjustment of recording balance and some judicious pruning, much of what they play might as well be Heath.

Small and Modern: Paul Chambers, a young bassist, is tremendously impressive on *Chambers' Jazz* (Jazz West 7. 12-in. 33 min. \$3.98), leading a quartet including John Coltrane, tenor saxophone, Kenny Drew, piano, and Philly Joe Jones, drums. Chambers here joins the exclusive company of Jimmy Blanton and Oscar Pettiford as a bassist who can make a solo something to listen to. His facility and grace with the bow is astounding on a relatively fast version of *Easy to Love*, and his plucked passages are clean, definitive, and full of melodic imagination. His colleagues are not on the same level. *The Jazz Messengers* (Columbia CL 897. 12-in. 47 min. \$3.98) is attractive when pianist Horace Silvers is playing or providing the composition, but at other times it is simply a series of long solos prodded by Art Blakey's implacable drumming. On *Musically Yours—Sam Most* (Bethlehem 6008. 12-in. 42 min. \$4.98), Most concentrates on flute although his occasional appearances on clarinet are far superior. Another clarinetist, Tony Scott (billed as A. J. Sciacca) is the saving element on *A Message from Garcia* (Dawn 1106. 12-in. 36 min. \$3.98), played by several different groups led by the guitarist, Dick Garcia.

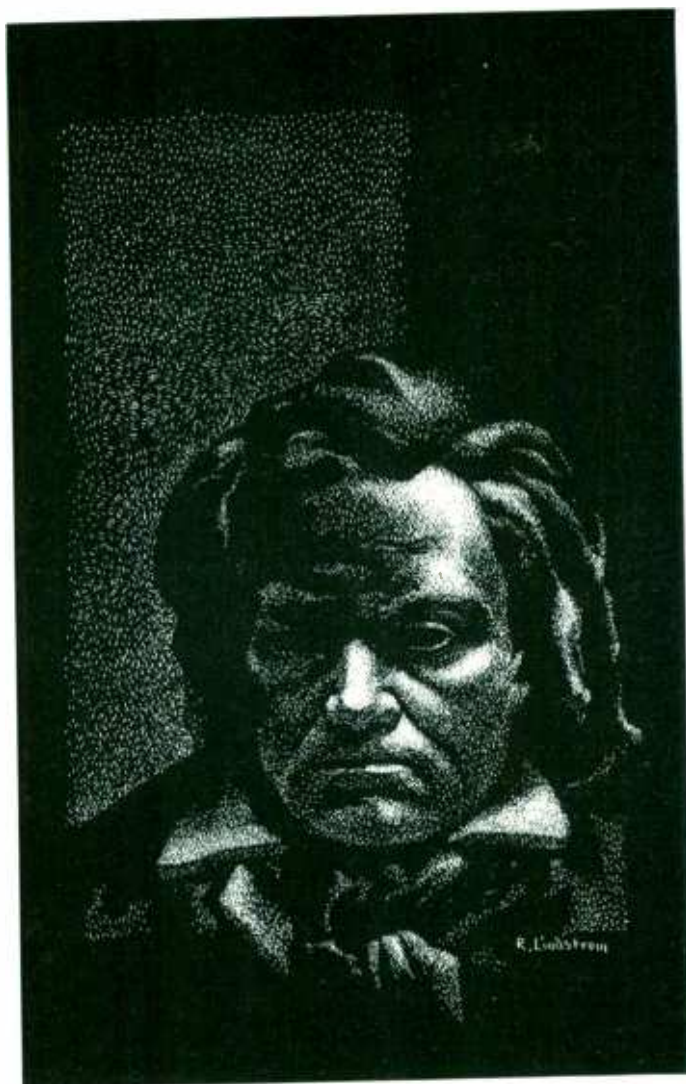

The Beethoven Symphonies Reconsidered

by C. G. Burke

HIGH FIDELITY DISCOGRAPHY No. 31

ANY CRITICISM reflects the aesthetic prejudices of its author, and a discography expresses in large measure the prejudices of some author's phonograph. Neither may be completely trusted, but the intelligent reader can by interpreting the prejudices find some usefulness in discographies. Trustworthy or not, they are indispensable.

Every record noted here was newly compared and estimated, not to establish a championship fundamentally illusory, but to provide a guide for people who would like the most prepossessing editions of the Beethoven Symphonies. Here the writer's favorite is at the top of each list, but brief characterizations are affixed to other versions which may easily be more highly esteemed by other prejudices. The line dividing a list into two parts is meant to show that the versions below are less desirable than those above, and patently. These divisions are not absolute but relative to each other, and many of the versions below the line are good versions. Records officially withdrawn are listed because many of them will be restored to circulation, because many are good records, and because owners of such records may be helped in their wish to have the best by observing the listed position of their present property. Naturally, however, there is no exactitude of comparison in the relative position of the poorer records. A jury might find that number 23 is in fact better than number 17, number 23 containing something poisonous to the discographer but not to the jury; but who cares?

A few changes in relative position since the time of two previous surveys may be noted. Almost all of these reflect changes in the reproducing equipment of the discographer. The more sensitive apparatus discloses defects previously hidden, and brings out of obscurity positive values as well. To be thrifty of space a few common, self-explanatory abbreviations have been used. The preferences expressed or implied refer only to the symphony under discussion and not to other material on the same record. Absence of discussion is a spacesaver denoting only that the slighted record, good or bad, is unimportant in comparison with the first five or six in a list.

No complete edition — there are five — by one conductor is recommended *in toto* for exclusive presentation of the nine symphonies. The great Weingartner performances in their old sound* are for students, and the others, made over a period of years, naturally cannot maintain even values throughout. The basis of judgment for the Toscanini records was the complete edition of seven in RCA Victor LM 6901, which appeared in the spring of 1956. These disks are from revised and improved masters, but for sale separately they bear the same numbers as earlier disks sonically inferior. Collectors should insist upon receiving the latest pressings.

*At press time these were scheduled by Columbia for reissue on the Entre label as a seven-disk, \$14 album.

THE NINE SYMPHONIES

NO. 1, IN C, OP. 21 (21 Versions)

The peculiarities of four versions thwart an objective evaluation. Three are unusual concentrates of style, and the other has a sound to stir the vitals even of those who do not like it. This last is the André, a plain, competent performance from an orchestra with every instrument close to the hearer, giving some impression of a freshly painted billboard within touching range. With volume up and treble down the enveloping sound will not leave a listener indifferent, and the proximity of this instrumental life strengthens an effect of bucolic sport in the performance.

Both Toscanini versions are shining jewels of classical organization. Light, taut, quick, and symmetrical, their progress

is the tracing of a design, not the reading of a biography. Sensuousness is alien to this scheme, and the sweet romantic song of the Andante is austere in the short phrasing given to it by the Italian conductor—hurtfully, if the movement is regarded as an absolute to be enjoyed without reference to the rest; harmoniously, when it is observed how neatly this cool Andante slips into the inclusive symphonic pattern. The version with the NBC Symphony, originally shallow and dry in reproduction, has had for the latest pressings injections of bass, color transfusions, and applications of heat from the RCA doctors, and is now highly satisfactory although not strong in sound, notable in its revelation of the fineness of the instrumental adjustments. The BBC record, not bad, now shows definite inferiority in the new light thrown by the NBC.

Alone in its concept, the Fricsay disk proffers opera buffa, quick and breezy in short bouncing strokes and imperious *sforzatos*, a succession of shining epigrams in shining and exhilarating sound. Like the Toscanini records, this one can by the decision of its style provoke strong attraction or repulsion.

Two versions of prime merit do not risk incurring abuse. The Karajan, forceful but with a fine lift and smooth nicety of shading, capped by a finale of unusual strength, matches the bland and sunny Scherchen record in over-all worth. The latter, whose fluency may cover the delicacy of the workmanship at first hearing, has a particularly engaging naturalness of motion. Both have suave and powerful sound of higher inclusive quality than that attained by any other edition. They would be challenged by the lively, imaginative, and glossy achievement of Mr. Munch, the Boston orchestra molding beautiful blocks of tones, if the very agreeable sound bestowed on that performance included more bite. Closer to them sonically is the big, juicy, uncontrived sort of sound bearing the breezy and cheerful essay of Mr. Pritchard, a record with lots of appeal and no particular refinement. Jolly is the word for it.

Sharply less interesting in performance or sound or both, but serviceable, are the versions conducted by Walter, Schuricht, Anon. for Vox, Ansermet, Goehr, and Weingartner, although the sound of the last would bar a lesser interpretation. The rest are decidedly poor.

The order of the first three below is alphabetical, in the absence of a preponderance of superiorities for any. The fourth in its lightheadedness ought to be ashamed of so high a place; but where it does not affront too strait an antipathy, it does give a tingling pleasure.

—H. von Karajan, Philharmonia Orch. ANGEL 35097 (with Overtures: *Egmont*, *Leonore* No. 3). \$4.98 (or \$3.48).

—H. Scherchen, Vienna Staatsoper Orch. WESTMINSTER 18308 (with Sym. No. 2). \$3.98. (5 other couplings.)

—A. Toscanini, NBC Sym. RCA VICTOR LM 6009 (with Sym. No. 9). Two 12-in. \$7.96.

—F. Fricsay, Berlin Philharmonic Orch. DECCA 9626 (with Sym. No. 8). \$3.98.

—C. Munch, Boston Symphony Orch. RCA VICTOR LM 1200 (with Haydn: Sym. No. 103), retired.

—J. Pritchard, Vienna Symphony Orch. EPIC 3095 (with Sym. No. 8). \$3.98.

—F. André, Belgian National Radio Orch. TELEFUNKEN LGX 66042 (with Schubert: Sym. No. 8). \$4.98.

A. Toscanini, BBC Orch. RCA VICTOR LCT 1023 (with Brahms: *Haydn* Variations), retired. B. Walter, New York Philharmonic-Symphony Orch. COLUMBIA ML 4790 (with Sym. No. 5). \$3.98. Same perf. on COLUMBIA ML 2027, 10-in., retired. C. Schuricht, Vienna Philharmonic Orch. LONDON 1.L 825 (with Sym. No. 8). \$3.98. Same perf. on LONDON LS 631, 10-in. \$2.98. Anon., Bamberg Symphony Orch. VOX 9120 (with Sym. No. 7). \$4.98. E. Ansermet, Suisse Romande Orch. LONDON LL 1493 (with Sym. No. 8). \$3.98. W. Goehr, Frankfurt Opera

The Height
of Fidelity

The world's most beloved piano works

Performed by Guiomar Novaes

Reproduced by VOX

JUST RELEASED!

DEBUSSY: PRELUDES, BOOK I PL 10.180

PERFORMED BY NOVAES ON HER CURRENT U. S. CONCERT TOUR!

MOZART: PIANO CONCERTO NO. 20, D MINOR, K. 466 • PIANO CONCERTO NO. 9, E FLAT MAJOR, K. 271 PL 8430

GRIEG: PIANO CONCERTO, A MINOR, OP. 16 •

DE FALLA: NIGHTS IN THE GARDENS OF SPAIN PL 8520

BEETHOVEN: PIANO CONCERTO NO. 4, G MAJOR, OP. 58 • SONATA NO. 14, C SHARP MINOR, OP. 27, NO. 2 "MOONLIGHT" PL 8530

SCHUMANN: PIANO CONCERTO, A MINOR, OP. 54 • SCENES FROM CHILDHOOD, OP. 15 PL 8540

CHOPIN: ETUDES, OP. 10 & SCHERZO NO. 1, OP. 20 PL 9070
ETUDES, OP. 25 & TROIS NOUVELLES ETUDES PL 7560

for sound reasons



Orch. MMS 2034 (with Syms. No. 8 & 9). Two 12-in. \$5.00. F. Weingartner, Vienna Philharmonic Orch. COLUMBIA ML 4501, retired. W. Furtwängler, Vienna Philharmonic Orch. RCA VICTOR LHMV 700 (appended to *Fidelio*). Three 12-in. \$14.94. W. Mendelberg, Concertgebouw Orch. CAPITOL P 8079 (with Sym. No. 8), retired. E. Ormandy, Philadelphia Orch. CAMDEN 241 (with *Jena* Sym.). \$1.98. Anon., Austrian Symphony Orch. REMINGTON 199-156 (with *Leonore* Ovt. No. 3). \$1.98. H. Ledermann, Sonor Orch. PARADE 2010, retired. A. Rother, Berlin Philharmonic Orch. URANIA 101 (with Sym. No. 9). Two 12-in. \$7.96. Same performance on URANIA RS 7-17 (with Sym. No. 4), retired. A. Rodzinski, Cleveland Orch. COLUMBIA RL 3047 (with Mendelssohn: Excerpts from *A Midsummer Night's Dream*). \$1.98.

NO. 2, IN D, OP. 36 (11 Versions)

Some of the most inviting performances are badly compromised by inferior sound. The ailments of sonic senescence obscure or coarsen the infectious, lively spontaneity of the Reiner leadership, the mannered but telling refinements of the Kleiber, the artful simplicity of the Weingartner, and the disciplined exuberance of the Koussevitzky. A more satisfactory product than these four, which are better than they sound, is the Monteux edition, hearty, rather rough and unconcerned in a cheerful performance whose reproduction is still fair although the years are veiling it. There are some chubby tonal felicities in the registration of the crude and flaccid playing by the Hamburg orchestra.

The foregoing disks have been withdrawn, no need to weep for them. The remainder are all equipped with good sound and issue impressive proof of high orchestral quality. Some of the conductors are restive, particularly Dr. Walter, under the demands of the too-plain prescripts of the Second Symphony which confine the scope of a conductor's personality. In one of his unhappiest displays for the phonograph, the venerable director distends the shape and disjoins the motion of the *Larghetto* by a heavy curb on the gait. The beauty is removed from a ravishing movement—deftly, it is true, for the orchestra follows the strange directions with loyalty and address. If, in extenuation of the limp inflicted, it be urged that Dr. Walter draws a true *larghetto*, the reply must be that not only does a quicker pace sound better but was obliquely recommended by Beethoven. In the Walter projection the last two movements are excellent, the finale the most compelling on records, but the opening *Allegro* emphasizes its muscles at the expense of its pert facility and is disappointing when compared to other versions. The Columbia registration is big and bland and agreeably accurate although five years old.

The *Larghetto* is also the least becoming part of the Toscanini interpretation, because of its swiftness, which congeals what is tender and belittles what is rapturous. Nevertheless, this fits well into the vivid, tidy design given to the whole symphony, and does not incite discomfort as the Walter lagging does. Limpid playing

by the orchestra adjusted for sparkle is clearly exhibited in the revised sonics of the later pressings, commendable in spite of narrow dynamics and occasional incursions of background noise.

After some troublesome measures in the introduction, where deliberation and weight are employed for majesty and produce strain, the Karajan record proceeds through an energetic and fluent statement darker in color than most, thoroughly captured by the engineers and notable for the solidity of the orchestral mass. This is the most forceful version, interesting to compare with another big outpouring, Dr. Schuricht's, plump and amiable, and soft in contour. The inseparable warmth of the Vienna Philharmonic is a rich contributor to the persuasiveness of this most mellow edition. In a prior survey the sound was criticized adversely, unfairly in fact, for the judgment came from the evidence of a defective disk, and a replacement offers the confuting evidence of deep and expansive reproduction, a little astringent in the violins but at high volume imposing. The weakness of the record delays its advent until the finale is well under way, when we slowly realize that there is no culmination but only a conclusion, that the jocularities of this movement are not tempestuous but tepid.

The remaining record, Scherchen, is free of aberration anywhere and offers no Achilles' heel or Siegfried back to invite the stab of criticism. It follows a natural and a steady course with a kind of spry refinement, the orchestra organized to radiate brightness, and adroitly responsive to episodic niceties inside the substantial scheme. The sound, best of all in bite and discrimination, is decidedly appropriate for a performance so explicit in details. The writer's strong conviction gives first preference to this version, by a wider separation from the best of the rest than any version of any other Beethoven symphony can demonstrate or imply.

—H. Scherchen, Philharmonic-Symphony Orch. of London. WESTMINSTER 18308; 18312, 18313, or 18314 (with Syms. No. 1, 4, 5, or 8, respectively). \$3.98.



—H. von Karajan, Philharmonia Orch. ANGEL 35196 (with *Coriolan* Overture). \$4.98 (or \$3.48).

—C. Schuricht, Vienna Philharmonic Orch. LONDON LL 629. \$3.98.

—A. Toscanini, NBC Sym. RCA VICTOR LM 1723. \$3.98.

P. Monteux, San Francisco Symphony Orch. RCA VICTOR LM 1024, retired. F. Reiner, Pittsburgh Symphony Orch. COLUMBIA ML 4085, retired. F. Weingartner, London Symphony Orch. COLUMBIA ML 4502, retired. E. Kleiber, Brussels Radio Orch. CAPITOL P 8116, retired. B. Walter, New York Philharmonic-Symphony Orch. COLUMBIA ML 4596 (with Sym. No. 4). \$3.98. S. Koussevitzky, Boston Symphony

Orch. CAMDEN 157 (with Sym. No. 8). \$1.98. P. Schubert, Hamburg Symphony Orch. REGENT 5010, 10-in., retired.

NO. 3, IN E-FLAT, "EROICA," OP. (25 Versions)

A number of records in this towering pile are admirable and others are admirable in part. The distinction of many is their badness, and if the last are disposed of quickly, appraisal of the good and the part good is facilitated. These are fit for quick disposal:

Both by Koussevitzky, tiresome monkeying with tempos in dull reproduction. Schubert, flabby accent, moribund spirit. Ledermann, vies with Schubert. Horenstein, slow and shapeless, exaggerated dynamics, the orchestra not up to the special demands made on it. The sound is strong and echoic, unrefined but stirring. Some very effective episodes have more interest than the whole. These last three disks all split the Funeral March for the turn of sides. Neumark, despondent performance and confusing echo. Mengelberg, fancy performance alternating splendor and bathos, in musty reproduction. Albert, uneasy orchestra and unbalanced reproduction.

Aspiring upward from that unprepossessing octet, we find a group not susceptible to dogmatic classification. Here are the basically good ravaged by the incidentally bad and the generally bad transfigured in part by superb interludes or superb aspects. Here are also a few virtuous ones neither touched by high glory nor marred by deep error.

Weingartner died too soon for the wonderful *Eroica* he conducted to sound right on records. Columbia's resuscitation of the twenty-year-old sound has a certain corrupt effectiveness, but is overbassed, thick and distorted, unfair to the quick, clear vitality of an imperious performance that never loses grace. Mr. Bernstein gives a well-proportioned statement, naturally phrased and even in tempo, but weak and rather colorless in a reproduction that will be adequate only at high volume, when collateral noises become too apparent. An older Decca conducted by Carl Schuricht piles up too many little sonic disappointments—in timbre, articulation, body and force—not to produce a sonic total disappointing for the *Eroica*. This version and the Busch split the Funeral March, and the latter suffers from a sound only occasionally compelling and usually inclined to roughness. The performance is honorable and smooth, less forceful than most.

The Beecham record and both Furtwängler records are burdened by sad affectations of tempo and force, but are in part redeemed by supple orchestral obedience and good reproduction, especially of the deep, dark curtains of the Royal Philharmonic Orchestra for the baronet. The Urania sound for Furtwängler is brighter and less commanding than the rich sonorities of the HMV for Furtwängler, and the latter amidst its tortured tempos presents the complication of a Finale in its best moments electrifying beyond that of any other edition. The Funeral March is split by HMV but totters uninterrupted to its conclusion on Urania,

it's on W-LAB!



LEINSDORF CONDUCTS THE "JUPITER"

The **GIANT** of Mozart's symphonies...

read by the **GIANT** of Mozart's interpreters...

played by the Philharmonic Symphony Orchestra of London especially for **WESTMINSTER LABORATORY SERIES** recording... W-LAB 7022

*how could your New Year
start more brightly!*



where the first two movements are a little less deliberate.

Establishing an indubitable absolute of disjunctivity in his staccato, Mr. van Kempen evicts joy from the Scherzo and defaces a record in other respects praiseworthy, excellent in its first two movements and impressive throughout in its massive re-enactment of regimented symphonic opulence.

Nine are left, free of patently disqualifying error. Except to accord with individual tastes their performances cannot be arranged in a hierarchy. Sonic values are less pliant and personal, and the following general characterizations of the records as orchestral exhibits are based on careful and repeated hearings:

Klemperer—the newest and the best, everything considered; expansive, substantial and good in detail, with very little stress. Steinberg—very pure and clean, unspectacular but indubitable, smaller than the Klemperer sound. Reiner—beautiful blend of choirs, detail subordinate to mass, imposing at high volume. Leinsdorf—strong, outward, bold and raw, with a pervasive bass and demonstrative timbres. Scherchen—the most noticeable articulation, and commendable in other respects, but needs treble reduction much sharper than that of the RIAA curve recommended. Kleiber—mellow in a smooth wall of fat sound, and pleasing in tonal values when played through instruments capable of compensating for the old London curve. Toscanini—not a large sound, and still a little dry, in the revision found in RCA VICTOR LM 6901, "The Nine Symphonies" (and perhaps by now also in the latest pressings of LM 1042), but warmer and brighter than the old pressings. Basically adequate, and felicitous in the capture of the episodic minutiae ordained by the conductor. Walter—remarkable for its age and still better than most of the recordings of the *Eroica*. Forceful and deep, satisfactory in detail, better in substance than in bite, it is a sturdy vehicle. Karajan—eminent in the fine gradations of force in a potent, striding registration, but with its timbres uniformly altered by the hall. Where familiarity is able to cajole the ear into accepting the tone as natural, there the record will be accounted excellent.

The *Eroica*, like all the major orchestral works of Beethoven, is intolerant of wide deviations from its tempos, which must be sensed. It is so sensitive that even within permissible limits its character changes. Given a beat a little quick, it sounds urgency, combativeness. A little slow, it veers to majesty, to Olympian contemplation. The nature of the accentuation employed will re-enforce or weaken the dominant mood, and thus the Steinberg projection, which is neither fast nor slow, inclines more to majesty than to combat, through the considered measure of the conductor's stroke; and the Kleiber, no faster than several others, sends out a worry of tenseness by a stinging accent seldom relaxed. The other rapid productions are the Reiner, Toscanini, and Leinsdorf. The most contemplative are the Klemperer and Scherchen records. The Walter and Karajan disks are more flexible—but not tricky—in the matter of tempo, and are at no disadvantage for that.

In the clarification of subsidiary material the Toscanini edition has no equal, with the Scherchen and Reiner records vying for a distant second. Orchestral skill is most conspicuous in the Reiner, Toscanini, and Klemperer versions; but this could be a feature of the sonic method, and in no event ought polish to be overestimated in this symphony.

Now objectivity must cede place to proclivity. Some rhetorical inventiveness could compose a tidy brief for any of the nine versions as leader, but the conclusion of sensory response has the virtues of candor and humility, and has not been contrived. The viscera conclude for the Leinsdorf record, more strongly moved by the brusque urgency of that performance in its brawny sound than by the rauter, neater urgency of the smoother Reiner disk or the immaculate vitality of the Toscanini performance in reproduction less seizing. After those, opinion wavers, except for the Karajan record relegated to ninth position by its not-quite-real sound. For the moment, the Walter version, a warm heroism somehow more human than the rest, follows immediately after the first three. The Kleiber is not helped by a divided Funeral March.

—E. Leinsdorf, Rochester Philharmonic Orch. COLUMBIA RL 3069. \$1.98.

—F. Reiner, Chicago Symphony Orch. RCA VICTOR LM 1899. \$3.98.

—A. Toscanini, NBC Sym. RCA VICTOR LM 1042. \$3.98.

—B. Walter, New York Philharmonic Symphony Orch. COLUMBIA ML 4228. \$3.98.

—O. Klemperer, Philharmonia Orch. ANGEL 35328. \$4.98 (or \$3.48).

—W. Steinberg, Pittsburgh Symphony Orch. CAPITOL P 8334. \$3.98.

—H. Scherchen, Vienna Staatsoper Orch. WESTMINSTER 18315. \$3.98.

—E. Kleiber, Concertgebouw Orch. LONDON LL 239. \$3.98.

—H. von Karajan, Philharmonia Orch. ANGEL 35000. \$4.98 (or \$3.48).

P. van Kempen, Berlin Philharmonic Orch. EPIC 3016. \$3.98. L. Bernstein, Stadium Concerts Orch. (New York). DECCA 9697. \$3.98. F. Weingartner, Vienna Philharmonic Orch. COLUMBIA ML 4503, retired. C. Schuricht, Berlin Philharmonic Orch. DECCA 9534. \$3.98. F. Busch, Austrian Symphony Orch. REMINGTON 199-21. \$1.98. W. Furtwängler, Vienna Philharmonic Orch. RCA VICTOR LHMV 1044, retired. T. Beecham, Royal Philharmonic Orch. COLUMBIA ML 4698. \$3.98. W. Furtwängler, Vienna Philharmonic Orch. URANIA 7095. \$3.98. W. Mengelberg, Concertgebouw Orch. CAPITOL P 8002, retired. R. Albert, Turin Symphony Orch. TEMPO 2070 & 2072, two 12-in. (with excerpts from Mozart and Handel). \$10.14. I. Neumark, Utrecht Symphony Orch. MMS 2031. \$2.50. J. Horenstein, Pro Musica Orch. (Vienna). VOX 8070. \$4.98. S. Koussevitsky, Boston Symphony Orch. RCA VICTOR LM 1145, retired. S. Koussevitsky, London Philharmonic Orch. CAMDEN 102. \$1.98. H. Ledermann, Sonor Orch. PARADE 2005, retired. P. Schubert, Hamburg Symphony Orch. REGENT 5007. \$3.98.

(A few days after this study was completed, a new version from Decca arrived

and trumpeted its superiority over most of the others. A preliminary hearing suggests that this is the best *Eroica*. Confirmation or disproof will be found elsewhere in this issue. The disk is Decca DL 9865, entrusted to Eugen Jochum and the Berlin Philharmonic Orchestra.)

Nos. 4, IN B-FLAT, OP. 60 (18 Versions)

A number of these have poor sound by present standards, among them several satisfactory according to the standards of a previous survey. The attenuation of wallets by technical improvements to records is no doubt a doleful thing to wallet owners, but like the martyrs in the lions' jaws they may take a brief comfort in the knowledge that their immolation is a requisite of progress. Here are the records whose sonics are ailing:

Weingartner: Fluid grace and regulated force in a performance of consummate naturalness, inadequately expressed in a reproduction tolerable at best, fair in the *tutti*s but inexact and foggy for the individual voices. Szell: A lively and commanding presentation — one of the best — by conductor and orchestra, in thoroughgoing, lusty sound whose harshness is more conspicuous and less venial than it was eight years ago. Beecham: The registration is too sober to permit more than dull allusion to the refinements in the playing. Harty: This disk revives the first electric recording of the Fourth Symphony, made in 1926. It is something of a marvel that it is as good as it is although of course it is not good, without a true *piano*, with acrid colors and ineradicable noise. It has the merit of distinctness, and the singing appeal of the performance is evident. Furtwängler: A Vox production from a dreadful public performance in the dreadful Germany of 1945, the strange recording seems focused on the timpani. Singer: Clear and substantial with a good bite, but obdurately scrawny violins are fatiguing. Abendroth: Painful violins.

Jumping from the negative sonic extreme to the positive, we find salient reproduction in three versions far above the standard for this symphony and for records in general: André, Scherchen, and Krips. The first has sensational vitality in a compound of high output, nearness, and strong reverberation, the two final features remarkably compatible in effecting the startling synthesis of depth, spaciousness, and transparent discrimination. The performance is many cubits lower than its vehicle: this is playing of hasty, energetic competence, serviceable, but short of grace.

Dr. Scherchen benefits from the fine etching, the exactitude of detail, bestowed on his splendid orchestra. The pp's are something to note here, and the transparent representation of subordinate currents in the symphony attests the delicacy of the delineation and the engraving. It is less a cause of satisfaction that the fine embroidery tends to obscure the chaste line of the Adagio, which seems overworked and far less natural than the other movements in this projection. Compared to this edition — and to the fiery Solti, the exquisite Toscanini, these four being cer-

tainly the champions — the Krips record can evoke no praise for extraordinary aspects or effects, but in the easy ride of its rich choirs in beautiful interadjustment through grooves polished by evenly excellent sound, full and incisive, it exposes a minimum of weaknesses.

The Solti version, constantly fluid in shape and color, is sportive and muscular, rougher than its outstanding competitors, unanswerable in the foam and bluster of its Finale. Good standard sound in this, not disgraced that three are better. Carefully reworked sound in the late pressings gives new value to the crystalline construction of Mr. Toscanini's wizardry with line and light. The sound is not arresting but is clear, strong enough, and very kind to the violins. It is appropriate to the uncontaminated classicism that keeps each movement a pure abstraction, even the seraphic felicity of the Adagio, here an infinitely serene tracing of perfect contours. The fast Trio, assuredly more attractive in itself when allowed to relax, nevertheless slips gracefully into the Toscanini scheme of lightness. The consolidated poise of the orchestra baffles ordinary praise.

The Walter and Monteux records are commendable, the former strong and steady, its Adagio a little fleshy, the latter bland and pleasant, underworked to avoid hazard and greatness. The Walter sound is brighter, but both disks are satisfactory. Good sound, although not Mercury's best, lifts the undistinguished Dorati effort up several rungs. The Perlea performance has no *élan* and gives no lift, while very good reproduction bares cruelly the stuffy pretentiousness of the Karajan and Furtwängler (HMV) leadership.

—A. Toscanini, NBC Sym. RCA VICTOR LM 1723 (with Sym. No. 2). \$3.98.

—G. Solti, London Philharmonic Orch. LONDON LL 316. \$3.98.

—J. Krips, Concertgebouw Orch. LONDON LL 915. \$3.98.

—H. Scherchen, Philharmonic-Symphony Orch. of London. WESTMINSTER 18309, 18312, 18316, or 18317 (with Syms. No. 1, 2, 5, or 8, respectively). \$3.98 each.

—B. Walter, New York Philharmonic-Symphony Orch. COLUMBIA ML 4596 (with Sym. No. 2). \$3.98.

—P. Monteux, San Francisco Symphony Orch. RCA VICTOR LM 1714 (with Schumann: Sym. No. 4), retired.

F. André, Belgian National Radio Orch. TELEFUNKEN LGX 66010. \$4.98. F. Weingartner, London Philharmonic Orch. COLUMBIA ML 4504, retired. A. Dorati, Minneapolis Symphony Orch. MERCURY 50100 (with Sym. No. 8). \$3.98. G. Szell, Cleveland Orch. COLUMBIA ML 4008. \$3.98. J. Perlea, Vienna State Philharmonic. VOX 8740 (with Sym. No. 8). \$4.98. H. Harty, Hallé Orch. COLUMBIA RL 3034. \$1.98. T. Beecham, London Philharmonic Orch. RCA VICTOR LM 1026, retired. G. Singer, Austrian Symphony Orch. REMINGTON 199-51 \$1.98. H. von Karajan, Philharmonia Orch. ANGEL 35203 (with "Ab! Perfidio"). \$4.98 (or \$3.48). W. Furtwängler, Vienna Philharmonic Orch. RCA VICTOR LHMV 1059, retired. H. Abendroth, Leipzig Radio Orch. URANIA RS

VANGUARD
RECORDINGS FOR THE CONNOISSEUR

Masterworks of Four Centuries



17th c.

PURCELL'S
Ode for
St. Cecilia's Day

ALFRED DELLER, counter-tenor, the Deller Consort, Ambrosian Singers, Kalmar Chamber Orchestra of London, Michael Tippett, conductor.

A Bach Guild release 1-12" BG-559

18th c. The Six Last
Symphonies of
HAYDN

Nos. 99 (E flat) and 102 (B flat) VRS-491
Nos. 100 (Military) and 101 (Clock) VRS-492
Nos. 103 (Drum Roll) & 104 (London) VRS-493

MOGENS WÖLDIKE

and the Vienna State Opera Orchestra (Volksoper). Available singly or complete in slip-cover.

3-12" VRS-491/2/3

19th c. The Slavonic
Dances of
DVORAK

Op. 46 and 72.

Complete on one record for the first time!

MARIO ROSSI

and the Vienna State Opera Orchestra (Volksoper). 1-12" VRS-495

20th c.

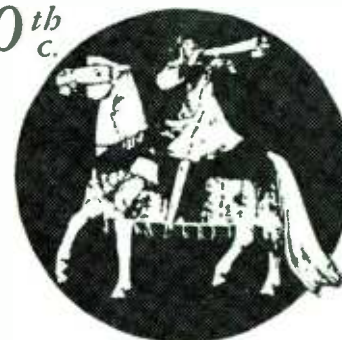

The Tone Poems of
SIBELIUS

En Saga, Finlandia, Swan of Tuonela, Lemminkäinen's Return, Pohjola's Daughter, The Bard, Nightride and Sunrise, Prelude to The Tempest, Oceanides, Tapiola.

SIR ADRIAN BOULT

and the Philharmonic Promenade Orchestra of London. De-luxe album, fully illustrated, notes by A. Veinus. 2-12" VRS-489/90

For Complete Catalogue, write to
VANGUARD RECORDING SOCIETY, INC.
New York 19, N. Y.

**Walco
PRODUCTS**

Just for
the Record



**WALCO
STATI-CLEAN
ANTI-STATIC
RECORD SPRAY**

STOPS STATIC DUST. Walco Stati-Clean is your best defense against dust—major cause of record and needle wear. Stati-Clean spray cleans the disc surface, stops static electricity that attracts dust. Handling and "dusting" no longer builds up static. Stati-Clean improves fidelity, eliminates static "crackle." Lasts dozens of plays, no need to reapply each time. Tested safe—thousands sold. Complete with special applicator cloth.

**WALCO
DISCOVERS
PROTECTIVE SLEEVES
FOR RECORDS**



Walco DISCOVERS—now with the new contoured bottom—are the perfect answer to record protection. You slide your records into DISCOVERS, then into the original jacket. No more scratches, moisture or finger marks from handling. DISCOVERS seal out dust, protect against extremes of temperature, accidental spillage of liquids. They keep the sound safe and sound! Packaged 12 12-in. sleeves or 15 10-in. sleeves.

**WALCO
REPLACEMENT
NEEDLES
FOR LONGER RECORD LIFE**

Osmium and sapphire-tipped styli are rated only about 20 to 60 hours of play, after which they develop chisel-edged flats. These flats shear highs from your records, ruin groove walls. Periodic needle replacement is an absolute necessity for the serious music lover. You replace with the finest when you replace with Walco needles (and the superb Walco Diamond)—first choice of major cartridge manufacturers.

AT LEADING MUSIC DEALERS EVERYWHERE
Send For Free Sample Discover and Strobe Disc To Test Your Turntable Accuracy

Walco Trade Name of Electrovox Co., Inc.
60-H Franklin St., East Orange, N. J.

7-17 (with Sym. No. 1), retired. W. Furtwängler, Berlin Philharmonic Orch. VOX 7210, retired.

NO. 5, IN C MINOR, OP. 67 (27 Versions)

The vastness of the Fifth Symphony has always been compressed and reduced by the phonograph since the first version in 1914. It is not a question of loudness but of depth: the Fifth in good public concert suggests the oceans, mountains, multitudes—and the groove is unable to absorb them. The groove gives back shallower waters, silhouettes of a mountain range, and a crowd. Certain places in the score never fail to sound thin on records: the *ff* exordium at the very beginning, bars 1-5, entrusted to strings and clarinets alone, an asseveration of inexhaustible strength and determination; the impetuous outburst of the horns instigating the development, and the horns again, *ff*, roaring an insistence on the four-note pattern in bars 19-25 of the scherzo, fighting back at the menace of the oozing, insidious *pp* theme that opens the movement. Besides these difficulties, there is a tumultuous life behind the broad patterns of the first and final movements, made of thematic fragments and lively interjections, that transmits a sense of cosmic ferment, but not necessarily on records. Only four of the disks in the heap devoted to the Fifth Symphony manage to give out a fairly continuous semblance of three dimensions, and by ill luck all four have one or more points of insecurity.

These are Page binaural, best in meeting the requirements of sonic depth, and awfully far from the best in musical persuasiveness; Jochum, huge rolling sound diffused with boldly colored detail, but with the bass emphasized beyond probability and to distraction; Kleiber, the sturdiest masonry, overlaid with a mosaic of good color, indisputably the electronic vehicle ("monaural") best fitted for its Herculean freight; and finally Furtwängler, where the imposing weight is in part the contribution of echo, given plenty of time to re-enforce the individual chords far from each other in a performance of astonishing sluggishness.

Anyone who can put out of ear the excess in the Epic bass will find the Jochum presentation a more nearly complete Fifth than any other, not only for its grand canopy of brass, its fat and forward wood, but in the varied, galvanic leadership and authoritative playing. The Kleiber version, free of large fault, would normally be given precedence, but the reviewer confesses both an indifference to that interpretation and an inability to analyze the cause of the indifference.

Estimable performances abound, several carried by estimable sonics. In general merit the Karajan (Angel) and Szell editions lead a larger group by a discernible margin, with the former preferred here because of the quickness of the latter's Finale, which is not, however, nearly so hasty as the dash with which the otherwise very beautiful Scherchen record terminates. Two reliable editions are the Ackermann, a foursquare performance supported by big sound a little too echoic, and the Steinberg, well equipped with everything

needed except sonic bulk. The Mercury is initially effective with its brilliant treble and deep bass, but the torso between them is frail. Three notable and notably different performances, by Messrs. Klemperer, Von Karajan (Columbia), and Konwitschny, ought not to be denied honor because of outmoded sound.

Three versions—Munch, Page, and Wolf—knock themselves out by the omission of the repeat of the exposition in the first movement, one of the few in symphonic literature absolutely indispensable to establish proportion. The Ormandy record has moments of trouble, but the Finale is impressive. Sir John Barbirolli's is an honest product without flash. Both Toscanini records are dry in reproduction and perfervid in leadership. There is no pleasure in the reworked old sound given to Weingartner and Koussevitzky (Camden), and the others are variously faulty.

The ordination of the first four in the following list reflects their relative magnetism for this writer, whose enthusiasm for any of them is well under control. Their superiority over the field is more obvious than over-all superiorities among themselves.

- E. Jochum, Berlin Philharmonic Orch. EPIC 3002. \$3.98.
- H. von Karajan, Philharmonia Orch. ANGEL 35321 (with *Fidelio*: "Abscheulicher!"). \$4.98 (or \$3.48).
- E. Kleiber, Concertgebouw Orch. LONDON LL 912. \$3.98.
- G. Szell, Cleveland Orch. EPIC 3195 (with Schubert: Sym. No. 8). \$3.98.

W. Steinberg, Pittsburgh Symphony Orch. CAPITOL P 8292 (with Sym. No. 8). \$3.98. O. Ackermann, Zurich Tonhalle Orch. MMS 22, 10-in. \$1.89. A. Dorati, Minneapolis Symphony Orch. MERCURY 50017 (with 3 Overtures). \$3.98. H. von Karajan, Vienna Philharmonic Orch. COLUMBIA RL 3068 (with Mozart: Sym. No. 39). \$1.98. O. Klemperer, Vienna Symphony Orch. VOX 7070. \$4.98. H. Scherchen, Philharmonic Symphony Orch. of London. WESTMINSTER 18310 etc. (5 couplings available). \$3.98 per record. A. Toscanini, NBC Sym. RCA VICTOR LM 1757 (with Sym. No. 8). \$3.98. B. Paumgartner, Camerata Accademia (Salzburg). GA 319 (with Haydn: Sym. No. 45). \$3.98. J. Barbirolli, Hallé Orch. RCA VICTOR LBC 1018 (with Mozart: Sym. No. 41). \$2.98. E. Ormandy, Philadelphia Orch. COLUMBIA ML 5098 (with Mozart: Sym. No. 40). \$3.98. W. Mengelberg, Concertgebouw Orch. CAPITOL P 8110, retired. B. Walter, New York Philharmonic-Symphony Orch. COLUMBIA ML 4790 (with Sym. No. 1). \$3.98. C. Schuricht, Paris Conservatory Orch. LONDON LL 7. \$3.98. S. Koussevitzky, Boston Symphony Orch. RCA VICTOR LM 1021. \$3.98. A. Toscanini, NBC Sym. (1940). RCA VICTOR LCT 1041 (with 2 Overtures and 2 movements from Quarter No. 16). \$3.98. F. Konwitschny, Leipzig Radio Orch. URANIA RS 7-6 (with *Leonore* Overture No. 3), retired. F. Weingartner, London Philharmonic Orch. COLUMBIA ML 4505, retired. S. Koussevitzky, London Philharmonic Orch. CAMDEN 103. \$1.98. W. Furtwängler, Vienna Philharmonic Orch. RCA VICTOR LHMV 9 (with *Fidelio* Over-

ture). \$4.98. C. Munch, Boston Symphony Orch. RCA VICTOR LM 1923 (with Schubert: Sym. No. 8). \$3.98. W. Page, Orch. Society of Boston. COOK Binaural 1067. \$5.95. H. Wolf, Austrian Symphony Orch. REMINGTON 149-9, 10-in. \$3.89. W. Page, Orch. Society of Boston. COOK 1067, 10-in. \$3.98.

NO. 6, IN F "PASTORAL," OP. 68 (23 Versions)

The trouble is that an old registration showing its faults carries the most heart-felt *Pastoral*, one with an eloquence of sentiment throughout which none of the others can continuously maintain. Distorted and artificially balanced (to good effect), the reproduction is relatively poor in this company, but the tender shaping of phrase, the aspiring cantabiles, the instinct for natural inflection, and an obscure but real emanation of humbleness mingle to give the Klemperer edition a matchless sentimental expressiveness in the first two movements, and equaled, not surpassed—the conductor's part of it—in the eloquent statement of the last two. Only Mr. Klemperer makes much point of the parody in the central scherzo, the others giving expert assurance to the rustic band.

Nearly as persuasive in the first two movements is the luminous warmth of the Toscanini-NBC record in much better sound, although not strong enough on Side 1 to do justice to the delicacies of the playing. The last three movements are stunners in performance and sound, just a bit below the splendor of the Szell and Kleiber records. The most dazzling scherzo is Szell property, the most tempestuous Storm is Kleiber's. Three—Kleiber, Szell, and Cluytens—have continuously the best sonics, and very good they are, a trifle cleaner than the big sound, with strong bass and lucent woods, to be found in the excellent Van Otterloo version. This and the Cluytens impress by the ease and simplicity of their delivery, more contentedly pastoral by the brook than the Szell and Kleiber. The Steinberg disk is excellent in every particular and outstanding in none. The Karajan refuses to be ensnared by the sentimentality required in the first two movements but is splendid in the remaining three.

Thereafter, sonic or interpretational quality patently droops. Toscanini-BBC has pleasant but murky and unsymphonic sound. The Walter sound is far below the current Columbia standard. The friendly, unforced delivery of Mr. Goehr satisfies without being notable. The Scherchen deprives itself of fluency by artfulness. The Beecham is contrived and bumpy. The Munch is devoid of sentiment. Mr. Paray flees the countryside in an agony of gnats. Mr. Mitropoulos is inventive and interesting (and poorly recorded) but not for one minute bucolic. Dr. Stokowski, that child of nature, is laughing at us: for his Camden brookside he gives a painting of Houris at the Bath, and with the NBC orchestra a Swooning at Schiaparelli's.

The Klemperer disk, first in the list below, is technically weak, and its appeal is perhaps personal to this writer. Among the next three one seems as good as another. Right below them the Kleiber-

Steinberg-Szell trio average about the same in over-all worth.

—O. Klemperer, Vienna Symphony Orch. VOX 6960. \$4.98.

—A. Cluytens, Berlin Philharmonic Orch. ANGEL 35350. \$4.98 (or \$3.48).

—A. Toscanini, NBC Sym. RCA VICTOR LM 1755. \$3.98.

—W. van Otterloo, Vienna Symphony Orch. EPIC 3011. \$3.98.

—E. Kleiber, Concertgebouw Orch. LONDON LL 916. \$3.98.

—W. Steinberg, Pittsburgh Symphony Orch. CAPITOL S 8159. \$3.98.

—G. Szell, New York Philharmonic-Symphony Orch. COLUMBIA ML 5057. \$3.98.

—H. von Karajan, Philharmonia Orch. ANGEL 35080. \$4.98 or (\$3.48).

A. Toscanini, BBC Orch. RCA VICTOR

LCT 1042, retired. B. Walter, Philadelphia Orch. COLUMBIA ML 4010. \$3.98. W. Goehr, Netherlands Philharmonic Orch. MMS 2001 (with *Prometheus* Overture). \$2.50. H. Scherchen, Vienna Staatsoper Orch. WESTMINSTER 18318. \$3.98. F. Weingartner, Royal Philharmonic Orch. COLUMBIA ML 4506, retired. E. Kleiber, London Philharmonic Orch. LONDON LL 33, retired. T. Beecham, Royal Philharmonic Orch. COLUMBIA ML 4828. \$3.98. W. Furtwängler, Vienna Philharmonic Orch. RCA VICTOR LHMV 1066. \$4.98. C. Munch, Boston Symphony Orch. RCA VICTOR LM 1997. \$3.98. P. Paray, Detroit Symphony Orch. MERCURY 50045. \$3.98. K. Wöss, Symphony Orch. REMINGTON 199-7. \$1.98. D. Mitropoulos, Minneapolis Symphony Orch. COLUMBIA RL 3009. \$1.98. H. Leder mann, Sonor

new releases of big-name recordings for 1/2 the big-name price only \$1.98 for each 12" Long Play; only 79¢ for each 45 EP



One of the Met's most celebrated sopranos performing an exciting cross-section of operatic literature. Hear 9 different works by Mozart, Wagner, Verdi, J. Strauss, Von Suppe, Gounod. 12" Long Play (CAL-335) \$1.98



A sort of "Who's Who" of memorable concerts! 9 of the greatest conductors of our time, each with a famous orchestra, play selections especially associated with their careers. 12" Long Play (CAL-336) \$1.98



A dramatic buy for anyone with an eye for value! Complete performance of Verdi's OTELLO featuring Apollo Granforte as Iago, and the La Scala Opera Company, Chorus and Orch. Carlo Sabajno, cond. 3-12" Long Play (CCL-101) \$5.98



Increase your collection of fine jazz at a fraction of the usual cost. 12 tunes by Sidney Bechet, Bud Freeman, Charlie Parker, Pee Wee Russell, Coleman Hawkins, and other jazz greats. 12" Long Play (CAL-339) \$1.98

Other releases you'll want to own

Mutiny in the Parlor. Gene Krupa. On 4 of the 12 tunes his ensemble includes Benny Goodman, Jess Stacey, Roy Eldridge, Chu Berry. 12" Long Play (CAL-340) \$1.98; 4-selection 45 EP (CAE-379) 79¢

Cafe Wien. Mood music with a Continental flavor . . . and in "New Orthophonic" High Fidelity! 12 mellow songs, inspired by Vienna, played by Franz Heller and his Orch. 12" Long (CAL-341) \$1.98; 4-selection 45 EP (CAE-378) 79¢

Dinah Shore. Sings 4 immortal songs with the famed NBC Chamber Music Society of Lower Basin Street — need we say more! Sophisticated Lady, Body and Soul, Mood Indigo, Star Dust. 45 EP (CAE-376) 79¢

Swingin' Marches. Arrangement inspired by the late great Glenn Miller, played by Tex Beneke and His Orch. St. Louis Blues March, Blues In the Night March, Meadowlands, Bye, Bye Blues. 45 EP (CAE-377) 79¢

See your nearest record dealers for these great values.

Nationally Advertised Prices



MORE



**REPLICA
RECORDS**

Is This Melgard?

Indeed it is—breaking through the frequency response barrier to new dimensions of sound entertainment. Again Melgard, but this time so different in pattern and touch—displaying a new virtuosity on the exclusive Replica "King of Instruments," the unit orchestra; everything from Glockenspiel to Wah-wah trumpet—a complete orchestral panoply and then some!

Fabulous Eddie • Vol. 2

A super-sonic organ romp by the hit record performer of the '55-'56 Hi-Fi Show series—performing for the first time at the first of the last great Wurlitzer pipe organs, the only one of its kind ever installed in a special high fidelity sound studio. Actually two great organs skillfully combined into one and played by Eddie Osborn as though a Maestro before a 100 piece symphony. Here's organ music excitement thought dead since the advent of talking pictures—stirring trumpet fanfares, a frenetic reed chorus, melancholy distant chimes, the dazzling snap of military snares.

hi-fimonic —

You'll never believe that three harmonicas, a guitar and bass viol could create such special sounds—bongos, maracas, drums, clavos all pop out and are caught by new, ingenious sound engineering and miking techniques. Sparked by the "aces" of other harmonica acts—Lee Jenner, John Thompson, Earl (Red) Engel, Casey Duda, Billy Garbor—this performance is bound to be a delightful musical treat.

These, and many other fine Replica Records at your local High Fidelity dealer—or write to:

**REPLICA
RECORDS • Des Plaines, Ill.**

Orch. PARADE 2011, retired. L. Stokowski, NBC Orch. RCA VICTOR LM 1830. \$3.98. L. Stokowski, New York City Center Orch. CAMDEN 187. \$1.98.

No. 7, IN A, OP. 92 (20 Versions)

Note to students: Thirty years ago the Philadelphia Orchestra under Leopold Stokowski committed to records a Seventh Symphony beautifully shaped and proportioned, and enchanting in an effect of perpetual freshness. Sadly disfigured, this has found its way to a Camden disk which permits occasional glimpses of the qualities that made a great performance. This is truly terrible sound, and presumably nothing better could be done to perpetuate an achievement whose like has not yet appeared on a modern disk.

The modern disks are not in truth very impressive except in the names of the conductors. The Paray version owes much of its eminence to the successful capture by the engineers of a tramping bass vital in the Seventh if its revels are to be male and stormy. This Paray record is powerful and inclines to roughness, but it is nowhere ambiguous and ends with a Finale of convincing savagery. Without the interference of our old enemy Echo, post and ante, the Leinsdorf edition, just as powerful but smoother and subtler, the cleanest of the strong recordings, would be preferred by collectors capable of closing their ears to the whispered intrusions before and after the roars.

The most sophisticated and efficient sound has been given to Dr. Reiner, whose poised and polished performance is admirable most of the time, but manages to imply sometimes the interaction of shining gears instead of a tangle of arms and legs. Emulating, with Mr. Galliera, the innovation of a more celebrated Italian conductor, the Reiner baton bats out a frisky trio from a tune of deep and simple devotion. Comparison with this excellent Reiner sound puts the Walter record up some notches and drops both Toscaninis lower. Old now, the Walter sound is rich and resonant and surprising in detail, and the fiery reading—to which episodic exception will usually be taken—is calculated to overwhelm criticism in a breathless, tumultuous Finale. The Toscanini-NBC sonics lack guts, and the same conductor's famous performance with the New York Philharmonic now sounds faded.

A robust performance in moderate tempo, enriched by resonant sound with a sturdy bass, digs an elevated position for the Van Kempen record by sheer power. The violins have not quite enough edge to dig it out. A delicately fashioned introduction and a subdued first movement distinguish a Karajan record elsewhere traditional and estimable. The deliberation of the Scherchen first movement becomes more unattractive with familiarity, and other sonics now have a superior actuality. Mr. Ackermann makes a pretty effective record of odd ingredients—moderation, soft accents, imperfect unison—and a steady avoidance of anticlimax, the whole expanded by a roominess of sound decently clear in spite of considerable reverberation.

The rest are mediocre or bad although naturally many have commendable fea-

tures. The Kleiber calls for a special word: bold, positive, and controversial in performance, it has vast sonics in the main muffled and distorted, but with repeated punctuations of full-throated fortes blended into a glory unheard from any other of these disks.

—P. Paray, Detroit Symphony Orch. MERCURY 50022. \$3.98.

—E. Leinsdorf, Rochester Philharmonic Orch. COLUMBIA RL 6622. \$1.98.

—B. Walter, New York Philharmonic-Symphony Orch. COLUMBIA ML 4414. \$3.98.

—P. van Kempen, Berlin Philharmonic Orch. EPIC 3026. \$3.98.

—H. von Karajan, Philharmonia Orch. ANGEL 35005. \$4.98 (or \$3.48).

—F. Reiner, Chicago Symphony Orch. RCA VICTOR LM 1991. \$3.98.

H. Scherchen, Vienna Staatsoper Orch. WESTMINSTER 18319. \$3.98. O. Ackermann, Zurich Tonhalle Orch. MMS 33-10-in. \$1.89. A. Toscanini, NBC Sym.

RCA VICTOR LM 1756. \$3.98. C. Munch, Boston Symphony Orch. RCA VICTOR LM 1034, retired. E. Jochum, Berlin Philharmonic Orch. DECCA 9690. \$3.98. F. Weingartner, Vienna Philharmonic Orch. COLUMBIA ML 4507, retired. W. Furtwängler, Vienna Philharmonic Orch. RCA VICTOR LHMV 1008. \$4.98. A. Toscanini, New York Philharmonic-Symphony Orch. RCA VICTOR LCT 1013, retired. A. Galliera, Philharmonia Orch. COLUMBIA RL 3035. \$1.98. J. Perlea, Vienna State Philharmonia. VOX 9120 (with Sym. No. 1). \$4.98. E. Kleiber, Concertgebouw Orch. LONDON LL 240. \$3.98. K. Wöss, Symphony Orch. REMINGTON 199-8. \$1.98. E. Ormandy, Philadelphia Orch. COLUMBIA ML 4011. \$3.98. L. Stokowski, Philadelphia Orch. CAMDEN 212. \$1.98.

RCA VICTOR LM 1756. \$3.98. C. Munch, Boston Symphony Orch. RCA VICTOR LM 1034, retired. E. Jochum, Berlin Philharmonic Orch. DECCA 9690. \$3.98. F. Weingartner, Vienna Philharmonic Orch. COLUMBIA ML 4507, retired. W. Furtwängler, Vienna Philharmonic Orch. RCA VICTOR LHMV 1008. \$4.98. A. Toscanini, New York Philharmonic-Symphony Orch. RCA VICTOR LCT 1013, retired. A. Galliera, Philharmonia Orch. COLUMBIA RL 3035. \$1.98. J. Perlea, Vienna State Philharmonia. VOX 9120 (with Sym. No. 1). \$4.98. E. Kleiber, Concertgebouw Orch. LONDON LL 240. \$3.98. K. Wöss, Symphony Orch. REMINGTON 199-8. \$1.98. E. Ormandy, Philadelphia Orch. COLUMBIA ML 4011. \$3.98. L. Stokowski, Philadelphia Orch. CAMDEN 212. \$1.98.

RCA VICTOR LCT 1013, retired. A. Galliera, Philharmonia Orch. COLUMBIA RL 3035. \$1.98. J. Perlea, Vienna State Philharmonia. VOX 9120 (with Sym. No. 1). \$4.98. E. Kleiber, Concertgebouw Orch. LONDON LL 240. \$3.98. K. Wöss, Symphony Orch. REMINGTON 199-8. \$1.98. E. Ormandy, Philadelphia Orch. COLUMBIA ML 4011. \$3.98. L. Stokowski, Philadelphia Orch. CAMDEN 212. \$1.98.

RCA VICTOR LCT 1013, retired. A. Galliera, Philharmonia Orch. COLUMBIA RL 3035. \$1.98. J. Perlea, Vienna State Philharmonia. VOX 9120 (with Sym. No. 1). \$4.98. E. Kleiber, Concertgebouw Orch. LONDON LL 240. \$3.98. K. Wöss, Symphony Orch. REMINGTON 199-8. \$1.98. E. Ormandy, Philadelphia Orch. COLUMBIA ML 4011. \$3.98. L. Stokowski, Philadelphia Orch. CAMDEN 212. \$1.98.

RCA VICTOR LCT 1013, retired. A. Galliera, Philharmonia Orch. COLUMBIA RL 3035. \$1.98. J. Perlea, Vienna State Philharmonia. VOX 9120 (with Sym. No. 1). \$4.98. E. Kleiber, Concertgebouw Orch. LONDON LL 240. \$3.98. K. Wöss, Symphony Orch. REMINGTON 199-8. \$1.98. E. Ormandy, Philadelphia Orch. COLUMBIA ML 4011. \$3.98. L. Stokowski, Philadelphia Orch. CAMDEN 212. \$1.98.

RCA VICTOR LCT 1013, retired. A. Galliera, Philharmonia Orch. COLUMBIA RL 3035. \$1.98. J. Perlea, Vienna State Philharmonia. VOX 9120 (with Sym. No. 1). \$4.98. E. Kleiber, Concertgebouw Orch. LONDON LL 240. \$3.98. K. Wöss, Symphony Orch. REMINGTON 199-8. \$1.98. E. Ormandy, Philadelphia Orch. COLUMBIA ML 4011. \$3.98. L. Stokowski, Philadelphia Orch. CAMDEN 212. \$1.98.

RCA VICTOR LCT 1013, retired. A. Galliera, Philharmonia Orch. COLUMBIA RL 3035. \$1.98. J. Perlea, Vienna State Philharmonia. VOX 9120 (with Sym. No. 1). \$4.98. E. Kleiber, Concertgebouw Orch. LONDON LL 240. \$3.98. K. Wöss, Symphony Orch. REMINGTON 199-8. \$1.98. E. Ormandy, Philadelphia Orch. COLUMBIA ML 4011. \$3.98. L. Stokowski, Philadelphia Orch. CAMDEN 212. \$1.98.

RCA VICTOR LCT 1013, retired. A. Galliera, Philharmonia Orch. COLUMBIA RL 3035. \$1.98. J. Perlea, Vienna State Philharmonia. VOX 9120 (with Sym. No. 1). \$4.98. E. Kleiber, Concertgebouw Orch. LONDON LL 240. \$3.98. K. Wöss, Symphony Orch. REMINGTON 199-8. \$1.98. E. Ormandy, Philadelphia Orch. COLUMBIA ML 4011. \$3.98. L. Stokowski, Philadelphia Orch. CAMDEN 212. \$1.98.

RCA VICTOR LCT 1013, retired. A. Galliera, Philharmonia Orch. COLUMBIA RL 3035. \$1.98. J. Perlea, Vienna State Philharmonia. VOX 9120 (with Sym. No. 1). \$4.98. E. Kleiber, Concertgebouw Orch. LONDON LL 240. \$3.98. K. Wöss, Symphony Orch. REMINGTON 199-8. \$1.98. E. Ormandy, Philadelphia Orch. COLUMBIA ML 4011. \$3.98. L. Stokowski, Philadelphia Orch. CAMDEN 212. \$1.98.

RCA VICTOR LCT 1013, retired. A. Galliera, Philharmonia Orch. COLUMBIA RL 3035. \$1.98. J. Perlea, Vienna State Philharmonia. VOX 9120 (with Sym. No. 1). \$4.98. E. Kleiber, Concertgebouw Orch. LONDON LL 240. \$3.98. K. Wöss, Symphony Orch. REMINGTON 199-8. \$1.98. E. Ormandy, Philadelphia Orch. COLUMBIA ML 4011. \$3.98. L. Stokowski, Philadelphia Orch. CAMDEN 212. \$1.98.

RCA VICTOR LCT 1013, retired. A. Galliera, Philharmonia Orch. COLUMBIA RL 3035. \$1.98. J. Perlea, Vienna State Philharmonia. VOX 9120 (with Sym. No. 1). \$4.98. E. Kleiber, Concertgebouw Orch. LONDON LL 240. \$3.98. K. Wöss, Symphony Orch. REMINGTON 199-8. \$1.98. E. Ormandy, Philadelphia Orch. COLUMBIA ML 4011. \$3.98. L. Stokowski, Philadelphia Orch. CAMDEN 212. \$1.98.

RCA VICTOR LCT 1013, retired. A. Galliera, Philharmonia Orch. COLUMBIA RL 3035. \$1.98. J. Perlea, Vienna State Philharmonia. VOX 9120 (with Sym. No. 1). \$4.98. E. Kleiber, Concertgebouw Orch. LONDON LL 240. \$3.98. K. Wöss, Symphony Orch. REMINGTON 199-8. \$1.98. E. Ormandy, Philadelphia Orch. COLUMBIA ML 4011. \$3.98. L. Stokowski, Philadelphia Orch. CAMDEN 212. \$1.98.

RCA VICTOR LCT 1013, retired. A. Galliera, Philharmonia Orch. COLUMBIA RL 3035. \$1.98. J. Perlea, Vienna State Philharmonia. VOX 9120 (with Sym. No. 1). \$4.98. E. Kleiber, Concertgebouw Orch. LONDON LL 240. \$3.98. K. Wöss, Symphony Orch. REMINGTON 199-8. \$1.98. E. Ormandy, Philadelphia Orch. COLUMBIA ML 4011. \$3.98. L. Stokowski, Philadelphia Orch. CAMDEN 212. \$1.98.

RCA VICTOR LCT 1013, retired. A. Galliera, Philharmonia Orch. COLUMBIA RL 3035. \$1.98. J. Perlea, Vienna State Philharmonia. VOX 9120 (with Sym. No. 1). \$4.98. E. Kleiber, Concertgebouw Orch. LONDON LL 240. \$3.98. K. Wöss, Symphony Orch. REMINGTON 199-8. \$1.98. E. Ormandy, Philadelphia Orch. COLUMBIA ML 4011. \$3.98. L. Stokowski, Philadelphia Orch. CAMDEN 212. \$1.98.

RCA VICTOR LCT 1013, retired. A. Galliera, Philharmonia Orch. COLUMBIA RL 3035. \$1.98. J. Perlea, Vienna State Philharmonia. VOX 9120 (with Sym. No. 1). \$4.98. E. Kleiber, Concertgebouw Orch. LONDON LL 240. \$3.98. K. Wöss, Symphony Orch. REMINGTON 199-8. \$1.98. E. Ormandy, Philadelphia Orch. COLUMBIA ML 4011. \$3.98. L. Stokowski, Philadelphia Orch. CAMDEN 212. \$1.98.

RCA VICTOR LCT 1013, retired. A. Galliera, Philharmonia Orch. COLUMBIA RL 3035. \$1.98. J. Perlea, Vienna State Philharmonia. VOX 9120 (with Sym. No. 1). \$4.98. E. Kleiber, Concertgebouw Orch. LONDON LL 240. \$3.98. K. Wöss, Symphony Orch. REMINGTON 199-8. \$1.98. E. Ormandy, Philadelphia Orch. COLUMBIA ML 4011. \$3.98. L. Stokowski, Philadelphia Orch. CAMDEN 212. \$1.98.

RCA VICTOR LCT 1013, retired. A. Galliera, Philharmonia Orch. COLUMBIA RL 3035. \$1.98. J. Perlea, Vienna State Philharmonia. VOX 9120 (with Sym. No. 1). \$4.98. E. Kleiber, Concertgebouw Orch. LONDON LL 240. \$3.98. K. Wöss, Symphony Orch. REMINGTON 199-8. \$1.98. E. Ormandy, Philadelphia Orch. COLUMBIA ML 4011. \$3.98. L. Stokowski, Philadelphia Orch. CAMDEN 212. \$1.98.

RCA VICTOR LCT 1013, retired. A. Galliera, Philharmonia Orch. COLUMBIA RL 3035. \$1.98. J. Perlea, Vienna State Philharmonia. VOX 9120 (with Sym. No. 1). \$4.98. E. Kleiber, Concertgebouw Orch. LONDON LL 240. \$3.98. K. Wöss, Symphony Orch. REMINGTON 199-8. \$1.98. E. Ormandy, Philadelphia Orch. COLUMBIA ML 4011. \$3.98. L. Stokowski, Philadelphia Orch. CAMDEN 212. \$1.98.

RCA VICTOR LCT 1013, retired. A. Galliera, Philharmonia Orch. COLUMBIA RL 3035. \$1.98. J. Perlea, Vienna State Philharmonia. VOX 9120 (with Sym. No. 1). \$4.98. E. Kleiber, Concertgebouw Orch. LONDON LL 240. \$3.98. K. Wöss, Symphony Orch. REMINGTON 199-8. \$1.98. E. Ormandy, Philadelphia Orch. COLUMBIA ML 4011. \$3.98. L. Stokowski, Philadelphia Orch. CAMDEN 212. \$1.98.

RCA VICTOR LCT 1013, retired. A. Galliera, Philharmonia Orch. COLUMBIA RL 3035. \$1.98. J. Perlea, Vienna State Philharmonia. VOX 9120 (with Sym. No. 1). \$4.98. E. Kleiber, Concertgebouw Orch. LONDON LL 240. \$3.98. K. Wöss, Symphony Orch. REMINGTON 199-8. \$1.98. E. Ormandy, Philadelphia Orch. COLUMBIA ML 4011. \$3.98. L. Stokowski, Philadelphia Orch. CAMDEN 212. \$1.98.

RCA VICTOR LCT 1013, retired. A. Galliera, Philharmonia Orch. COLUMBIA RL 3035. \$1.98. J. Perlea, Vienna State Philharmonia. VOX 9120 (with Sym. No. 1). \$4.98. E. Kleiber, Concertgebouw Orch. LONDON LL 240. \$3.98. K. Wöss, Symphony Orch. REMINGTON 199-8. \$1.98. E. Ormandy, Philadelphia Orch. COLUMBIA ML 4011. \$3.98. L. Stokowski, Philadelphia Orch. CAMDEN 212. \$1.98.

RCA VICTOR LCT 1013, retired. A. Galliera, Philharmonia Orch. COLUMBIA RL 3035. \$1.98. J. Perlea, Vienna State Philharmonia. VOX 9120 (with Sym. No. 1). \$4.98. E. Kleiber, Concertgebouw Orch. LONDON LL 240. \$3.98. K. Wöss, Symphony Orch. REMINGTON 199-8. \$1.98. E. Ormandy, Philadelphia Orch. COLUMBIA ML 4011. \$3.98. L. Stokowski, Philadelphia Orch. CAMDEN 212. \$1.98.

RCA VICTOR LCT 1013, retired. A. Galliera, Philharmonia Orch. COLUMBIA RL 3035. \$1.98. J. Perlea, Vienna State Philharmonia. VOX 9120 (with Sym. No. 1). \$4.98. E. Kleiber, Concertgebouw Orch. LONDON LL 240. \$3.98. K. Wöss, Symphony Orch. REMINGTON 199-8. \$1.98. E. Ormandy, Philadelphia Orch. COLUMBIA ML 4011. \$3.98. L. Stokowski, Philadelphia Orch. CAMDEN 212. \$1.98.

RCA VICTOR LCT 1013, retired. A. Galliera, Philharmonia Orch. COLUMBIA RL 3035. \$1.98. J. Perlea, Vienna State Philharmonia. VOX 9120 (with Sym. No. 1). \$4.98. E. Kleiber, Concertgebouw Orch. LONDON LL 240. \$3.98. K. Wöss, Symphony Orch. REMINGTON 199-8. \$1.98. E. Ormandy, Philadelphia Orch. COLUMBIA ML 4011. \$3.98. L. Stokowski, Philadelphia Orch. CAMDEN 212. \$1.98.

RCA VICTOR LCT 1013, retired. A. Galliera, Philharmonia Orch. COLUMBIA RL 3035. \$1.98. J. Perlea, Vienna State Philharmonia. VOX 9120 (with Sym. No. 1). \$4.98. E. Kleiber, Concertgebouw Orch. LONDON LL 240. \$3.98. K. Wöss, Symphony Orch. REMINGTON 199-8. \$1.98. E. Ormandy, Philadelphia Orch. COLUMBIA ML 4011. \$3.98. L. Stokowski, Philadelphia Orch. CAMDEN 212. \$1.98.

RCA VICTOR LCT 1013, retired. A. Galliera, Philharmonia Orch. COLUMBIA RL 3035. \$1.98. J. Perlea, Vienna State Philharmonia. VOX 9120 (with Sym. No. 1). \$4.98. E. Kleiber, Concertgebouw Orch. LONDON LL 240. \$3.98. K. Wöss, Symphony Orch. REMINGTON 199-8. \$1.98. E. Ormandy, Philadelphia Orch. COLUMBIA ML 4011. \$3.98. L. Stokowski, Philadelphia Orch. CAMDEN 212. \$1.98.

RCA VICTOR LCT 1013, retired. A. Galliera, Philharmonia Orch. COLUMBIA RL 3035. \$1.98. J. Perlea, Vienna State Philharmonia. VOX 9120 (with Sym. No. 1). \$4.98. E. Kleiber, Concertgebouw Orch. LONDON LL 240. \$3.98. K. Wöss, Symphony Orch. REMINGTON 199-8. \$1.98. E. Ormandy, Philadelphia Orch. COLUMBIA ML 4011. \$3.98. L. Stokowski, Philadelphia Orch. CAMDEN 212. \$1.98.

RCA VICTOR LCT 1013, retired. A. Galliera, Philharmonia Orch. COLUMBIA RL 3035. \$1.98. J. Perlea, Vienna State Philharmonia. VOX 9120 (with Sym. No. 1). \$4.98. E. Kleiber, Concertgebouw Orch. LONDON LL 240. \$3.98. K. Wöss, Symphony Orch. REMINGTON 199-8. \$1.98. E. Ormandy, Philadelphia Orch. COLUMBIA ML 4011. \$3.98. L. Stokowski, Philadelphia Orch. CAMDEN 212. \$1.98.

RCA VICTOR LCT 1013, retired. A. Galliera, Philharmonia Orch. COLUMBIA RL 3035. \$1.98. J. Perlea, Vienna State Philharmonia. VOX 9120 (with Sym. No. 1). \$4.98. E. Kleiber, Concertgebouw Orch. LONDON LL 240. \$3.98. K. Wöss, Symphony Orch. REMINGTON 199-8. \$1.98. E. Ormandy, Philadelphia Orch. COLUMBIA ML 4011. \$3.98. L. Stokowski, Philadelphia Orch. CAMDEN 212. \$1.98.

RCA VICTOR LCT 1013, retired. A. Galliera, Philharmonia Orch. COLUMBIA RL 3035. \$1.98. J. Perlea, Vienna State Philharmonia. VOX 9120 (with Sym. No. 1). \$4.98. E. Kleiber, Concertgebouw Orch. LONDON LL 240. \$3.98. K. Wöss, Symphony Orch. REMINGTON 199-8. \$1.98. E. Ormandy, Philadelphia Orch. COLUMBIA ML 4011. \$3.98. L. Stokowski, Philadelphia Orch. CAMDEN 212. \$1.98.

RCA VICTOR LCT 1013, retired. A. Galliera, Philharmonia Orch. COLUMBIA RL 3035. \$1.98. J. Perlea, Vienna State Philharmonia. VOX 9120 (with Sym. No. 1). \$4.98. E. Kleiber, Concertgebouw Orch. LONDON LL 240. \$3.98. K. Wöss, Symphony Orch. REMINGTON 199-8. \$1.98. E. Ormandy, Philadelphia Orch. COLUMBIA ML 4011. \$3.98. L. Stokowski, Philadelphia Orch. CAMDEN 212. \$1.98.

benevolent. It is more endearing than the Scherchen projection, technically above it in orchestral sophistication and musical architecture, but the endearingness is forgotten when the Westminster sound is properly reproduced. This is the most effective reproduction to be found of a Beethoven symphony, clean in huge masses of sound and in delicate interlacings of isolated timbres. The electronic responses to the musical demands are so apt that one is sure that the conductor also acted as recording director.

The Toscanini record is impressively endowed, with a performance of blazing rectitude and the most accurate sonics accorded to this conductor in a Beethoven symphony. The closely woven orchestral texture that makes a Toscanini performance always pure and often curt, and gives a finality of authority to the smallest chords, is constantly evident, and the articulation of the strings cannot be unnoticed. The sport is a little severe in the intensity of its drive and the comparative symmetry of its course, but there is a compensating virtue in the obvious reminder that the Eighth is very much a classical symphony. Mr. Dorati's work is deft and flip, with a flashing brightness and deep clear thud of sound to imply the gay tin swords and onrushing chargers in a titanic battle over a jelly bean.

Any taste, except one for (relative) tranquility, should find satisfaction in one of those four editions. The tranquil can take the Ansermet, in a registration without a sore. Nervous and alertant, comfortably resonant, the very commendable Fricsay record shows how to be urgent without being fast. The Karajan, with extremes of burliness and refinement, recorded with full value to both, is tonally a little hard. Among the acceptable but not outstanding versions it is wise not to confuse the Bruno Walter in Columbia SL 186, amazing for its origin in 1942, with an earlier ten-inch resuscitation of the same performance, inferior in sound.

The invulnerable Allegretto scherzando escapes from every record a jewel of incomparably self-possessed art.

—H. Scherchen, Philharmonic Symphony Orch. of London. WESTMINSTER 18314 (with Sym. No. 2; 4 other couplings available). \$3.98 per record.

—P. Monteux, San Francisco Symphony Orch. RCA VICTOR LM 1799 (with works by Bach and Berlioz). \$3.98.

—A. Toscanini, NBC Sym. RCA VICTOR LM 1757 (with Sym. No. 5). \$3.98.

—A. Dorati, Minneapolis Symphony Orch. MERCURY 50100 (with Sym. No. 4). \$3.98.

F. Fricsay, Berlin Philharmonic Orch. DECCA 9626 (with Sym. No. 1). \$3.98.

H. von Karajan, Philharmonia Orch. ANGEL 3544, two 12-in. (with Sym. No. 9). \$9.96 (or \$6.96). E. Ansermet, Suisse Romande Orch. LONDON LL 1493 (with Sym. No. 1). \$3.98.

A. Wallenstein, Los Angeles Philharmonic Orch. DECCA 9726 (with Mendelssohn: Sym. No. 5). \$3.98.

B. Walter, New York Philharmonic-Symphony Orch. COLUMBIA SL 186, two 12-in. (with Sym. No. 9). \$7.96.

W. Goehr, Winterthur Symphony Orch. MMS 2034, two 12-in. (with Syms. No. 1 and 9). \$5.00. W. Steinberg,



if you don't buy another jazz album all year, you must buy Shelly Manne & his Friends* MY FAIR LADY It's the end!

*Andre Previn & Leroy Vinnegar

12" HI-FI LONG-PLAYING C3527

If not available at your local dealer - order it postpaid, \$4.98, from

CONTEMPORARY RECORDS

8481 melrose place, los angeles 46, california

1955

High Fidelity

RECORD REVIEW INDEX

A complete index to all classical, semiclassical, jazz, and spoken word record reviews which appeared in HIGH FIDELITY Magazine in 1955.

Arranged alphabetically by composer or by collection-title, with the issue and page on which you will find the review you wish.

ONLY 50¢ EACH

1954 INDEX also available at 50¢ per copy.

HIGH FIDELITY Magazine
Dept. R24, Publishing House
Great Barrington, Mass.

Enclosed find Please
send me copies of the
1955 Record Review Index.

Name

Address

No C.O.D.s or charge orders please.



Remove static electricity and static-attracted dust and lint from your treasured high fidelity records. Protect their pure sound and increase their length of life. Greatly improve the reproduction on your "collector's items." Use the efficient atomic tool of our atomic age.

STATICMASTERS only \$14.95. Available at your Hi-Fi shop, music store, or order direct. Sent postpaid-cash with order.

NUCLEAR PRODUCTS CO. • 10173 E. Rush St. • El Monte 1, Calif.

Record Market

SET A RECORD player atop this table-sized black wrought iron cabinet, and you'll have a complete music center! Two shelves and 12 individual compartments to file over 250 of your long-playing record albums. Top accommodates largest player made! Sturdy, 30" high x 22" x 17". Please remit \$14.95 with order; shipped express charges collect. © Leslie Creations, Dept. 209D, Latayette Hill, Pa.

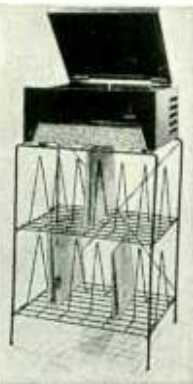

free!
free!

Send For Our
WONDER VALUE CATALOG
OF LONG PLAYING CLASSICAL RECORDS
One Of The Largest Selections In The Whole Country
Write Dept. H

CHAMBERS RADIO CORP.
97 Chambers St., New York 7, N. Y.

**HOLDS
200
RECORDS**



Black wrought-iron cabinet is just waiting for your collection to grow into "Shows-off" over 200 long-playing record albums of either 10" or 12" size; or numerous 78 RPM albums. Ten individual compartments to file your collection by symphonies, operas, ballets, jazz, folk and show music! Substantially constructed and fully-assembled, it measures 25"X22"X10" with vinyl tipped legs. Please remit \$9.95 with order; shipping charges are collect. Every sale bears our famous **\$9.95 AIR-MAIL MONEY-BACK GUARANTEE!**
© LESLIE CREATIONS • Dept. 209E • Latayette Hill, Pa.

TRIAL OFFER
12 for \$1 00
Twelve-Inch Record
COVERS
shipped prepaid
Money Back **GUARANTEE**

Made of Polyethylene Plastic.
Slips Inside Original Jacket

Keep your valuable records free from dust, scratches, finger marks, spilled liquids, etc.

Introductory **SAMPLER DOZEN** and **SURPRISE BONUS \$1.00 Prepaid**
Dealer Inquiries Invited

BRADLEY MFG. INC.
11 W. Magnolia Blvd. Burbank, Calif.



New
ZABALETA
Recording
Anthology of
HARP MUSIC
Vol. 4
17th & 19th
Centuries

ESOTERIC

238 EAST 26th ST., N. Y. C. 10



FIRST REVIEWS OF RICHARD

DYER-BENNET #1:

"Without a doubt, this is the finest album he has yet recorded. Singing is tops. Engineering is superb. A masterpiece of its kind!" Kenneth Goldstein, *The Record Changer*.

"His best recordings . . . I cannot recommend it too highly." . . . Elinor Hughs, *Boston Herald*.

"The best recording (he has) done to date. I hope there will be more." Max de Schaunsee, *Philadelphia Bulletin*.

RICHARD DYER-BENNET #1 includes "Lonesome Valley", "Oft In The Silly Night", "Joys of Love", "Bonnie Earl of Morey", "So We'll Go No More A-Roving", and others \$4.95. (DYB-1000)

RICHARD DYER-BENNET #2 (Just released) includes "Cock Robin", "Blow the Candles Out", "Garden Where the Prairies Grow", "Cockle-shells", and others \$4.95. (DYB-2000)

Sold at leading record shops. If not available at your dealer, send \$4.95 per record (no postage necessary within U.S.), check or money order, to: Dyer-Bennet Records, P.O. Box 235, Woodside 77, N.Y.

the newest and finest FOLK SAMPLER

comes from ELEKTRA—featuring eighteen complete selections from the extensive ELEKTRA catalog. Folk music from England, Spain, Ireland, France, The United States, Zululand, Mexico, Haiti, Italy, Nova Scotia and Israel performed by these outstanding ELEKTRA artists. Josh White, Susan Reed, Jean Leon Destine, Gordon Heath, Lee Payant, Theodore Bikel, Suzanne Robert, Los Gitanillos de Cadiz, Cynthia Gooding, Clarence Cooper, Jean Ritchie, Oscar Brand and Ed McCurdy.

a 12" High Fidelity Long Playing Record with full notes and complete texts only \$2.00 from your ELEKTRA dealer or postpaid from

Elektra RECORDS.

361 Bleecker St., New York City



GIBSON GIRL TAPE SPLICERS

splices in a wink!

NO SCISSORS!
NO RAZOR BLADES!
Disposable rolls tape ends
and trim, saves edges

At Your Dealers

ROBINS INDUSTRIES CORP.

Boyside 61, N. Y.

AUTOMATIC CHANGER NEEDLE BRUSH

KLeeNeedLE

KLeeNeedLE automatically keeps record changer needles clean. It is designed to remove the familiar "dust-blob" from under the needle point. At Your Dealer

ROBINS INDUSTRIES CORP. Boyside 61, N. Y.

Pittsburgh Symphony Orch. CAPITOL P 8292 (with Sym. No. 5). \$3.98. F. Weingartner, Vienna Philharmonic Orch. COLUMBIA SL 165, two 12-in. (with Sym. No. 9), retired. K. Böhm, Vienna Philharmonic Orch. LONDON LL 825 (with Sym. No. 1). \$3.98. T. Beecham, Royal Philharmonic Orch. COLUMBIA ML 4681 (with Mendelssohn: Sym. No. 4). \$3.98. H. von Karajan, Vienna Philharmonic Orch. COLUMBIA EL-51, two 12-in. (with Sym. No. 9). \$3.96. C. Munch, Paris Conservatory Orch. LONDON LS 111, 10-in., retired. J. Perlea, Vienna State Philharmonia. VOX 8740 (with Sym. No. 4). \$4.98. F. Busch, Austria State Symphony. MASTERSEAL 39 (with Haydn: Sym. No. 101), retired. P. van Kempen, Berlin Philharmonic Orch. EPIC 3095 (with Sym. No. 1). \$3.98. S. Koussevitzky, Boston Symphony Orch. CAMDEN 157 (with Sym. No. 2). \$1.98. B. Walter, New York Philharmonic-Symphony Orch. COLUMBIA ML 2001, 10-in., retired. H. Ledermann, Sonor Orch. PARADE 2003, retired. W. Mengelberg, Concertgebouw Orch. CAPITOL P 8079 (with Sym. No. 1), retired.

No. 9, IN D MINOR, WITH CHORAL FINALE ON SCHILLER'S "ODE TO JOY," OP. 125 (14 Versions)

No two performances of the Ninth Symphony are alike, and from the praise given by the same critics to extremely disparate interpretations it is apparent that there is no clear critical point of view on what a performance should be like. Doubtless the composer felt strongly about it, but we do not know in what direction; and many parts of the public with musical cultivation have no public voice to declare their sentiments. In conversation the opinions most strongly held about this music are actuated by personal reflex, and there are more contradictions than agreements.

The choice among records is easier than it looks, because half the candidates for consideration can be ruthlessly eliminated for inadequate sonics. We want no puny, obscure, disproportioned, or wiry reproduction of this music. At the first few bars the Abendroth and Koussevitzky records are dismissed, the former because its sound is hideous, the latter because the sonic fabric is tattered. Two of the four Columbias go next, the overage Weingartner (with regret for its unsalvageable beau-

Protect Your LP Records



H.R.S. LP CASE No. 7

Deluxe dust-proof cases to hold 10 LP records. Available in Red, Blue, Green and Tan and in two sizes for either 10" or 12" records. Rich book-like binding of simulated levant leather is stamped with genuine gold. See your dealer; if not available order direct. Please specify size and color. 10-inch \$2.75 and 12-inch \$2.95 (10-inch \$3 and 12-inch \$3.25 W. of Miss. and in Ala., Fla., La., Miss., Minn.). Two or more cases postpaid in U.S.; add 25c for one case. No COD's please.

H. ROYER SMITH CO.
Dept. H, Philadelphia 7, Pa.

HIGH FIDELITY MAGAZINE

ries), and the Ormandy, which is nearer realism but dull in comparison with the best. Finally we drop the early Columbia Karajan because its sound is thick and reverberant and a little dangerous, in that not being repellent it can accustom listeners to a Ninth Symphony without the liveliness of light. Nine are left after this purging, and after a careful comparison it is pretty plain that the Angel Karajan combines impact and accuracy more thoroughly than any other. The best sound is there, and next come the Toscanini and Scherchen disks notable for cleanliness and detail. The Kleiber sound makes an immediate impression by its bigness and breadth and real grandeur in fortes, but after the ear has cleared it will notice a deficiency in articulation, and a stridency of the violins when they are loud. These sonics are imposing without being first-class, and the less assertive but sleeker Furtwängler registration is better. The Walter records were admirable when they appeared and still are commendable in their power, depth, and facility of adjustment. Backed by a long reverberation, the Horenstein disk imparts a great feeling of strength, but there are oddities of timbre to compromise its early attractiveness. The Goehr recording also is insecure, with the winds generally excellent and the violins generally shrill. These sonic considerations have neglected the chorus, which in no edition has been captured as we would hope. However, the Karajan sonics again have the advantage here. In summary, if one chooses an edition on sonic values, the Karajan, Toscanini, Scherchen, Furtwängler, and — in a meretricious way — Kleiber versions are the ones of first appeal.

Interpretatively, Mr. Goehr has not the exigence for this music. He cannot extort cosmic snarls in the first movement, and it is impossible to be comfortable while he labors through the third. In this movement the Vox conductor too has one stumble after another — never, in fact, manages to get the cantabile going. A spectacular first movement and vigorous scherzo cannot redeem the long subsequent inadequacy.

Furtwängler's is a consummate enterprise in a direction no one else will ever take. Beautifully organized but often incredibly slow, it is a work of awe and reverence, recorded from a ceremony of consecration, and best restricted to such usage.

The Walter performance in COLUMBIA SL 186 is for the first three movements identical with the performance in SL 156, but the finale in the later version was recorded four years later than that in the first, and is a more vital production. Both these sets are forceful, warm, and convincing, and with the still more forceful Angel Karajan represent what we would call the norm for the Ninth Symphony if we believed in such a thing. The late Erich Kleiber's exposition is the most diversified of all, and Mr. Toscanini's — tight, intense, swift, and breathtaking — is the least diversified, the most classic. Dr. Scherchen's studious intellectualization depends for its proper effect on appreciation of subtleties which may not after all be important. Nevertheless, this is not a version that loses interest on rehearing. —A. Toscanini, NBC Sym. RCA VICTOR

LM 6009 (with Sym. No. 1). Two 12-in. \$7.96.
 —H. von Karajan, Philharmonia Orch. ANGEL 3544 (with Sym. No. 8). Two 12-in. \$9.96 (or \$6.96).
 —B. Walter, New York Philharmonic-Symphony Orch. COLUMBIA SL 186 (with Sym. No. 8). Two 12-in. \$7.96.
 —H. Scherchen, Vienna Staatsoper Orch. WESTMINSTER 2213 (with Sym. No. 8; 4 other couplings available). Two 12-in. \$7.96.
 —E. Kleiber, Vienna Philharmonic Orch. LONDON LL 632-3. Two 12-in. \$7.96.
 —B. Walter, New York Philharmonic-Symphony Orch. COLUMBIA SL 156 (with Brahms: *Song of Destiny*). Two 12-in. \$7.96.

F. Weingartner, Vienna Philharmonic

Orch. COLUMBIA SL 165 (with Sym. No. 8). Two 12-in., retired. W. Furtwängler, Bayreuth Festival Orch., 1951. RCA VICTOR LM 6043. Two 12-in. \$7.96. H. von Karajan, Vienna Philharmonic Orch. COLUMBIA EL 51 (with Sym. No. 8). Two 12-in. \$3.96. E. Ormandy, Philadelphia Orch. COLUMBIA SL 50 (with *Leonore Overture No. 3*). Two 12-in. \$7.96. J. Horenstein, Pro Musica Symphony (Vienna). VOX 10,000. \$4.98. W. Goehr, Netherlands Philharmonic Orch. MMS 2034 (with Syms. No. 1 and 8). Two 12-in. \$5.00. H. Abendroth, Leipzig Philharmonic Orch. URANIA C 101 (with Sym. No. 1). Two 12-in. \$7.96. S. Koussevitzky, Boston Symphony Orch. RCA VICTOR 6001 (with *Egmont Overture*). Two 12-in., retired. (All editions have vocal quartet and chorus.)

Here are a few of the outstanding additions to our Stereophonic Catalogue in various categories:

CLASSICAL
 MOZART: Concerto No. 2, 3 for French Horn and Orch. (K.447,417), James Stagliano and Zimblar Sinfonietta Boston 7-4 BN

CHORAL
 STRAUSS, JOHANN: Voices from Vienna, Vol. 1, incl. Blue Danube, Sweets from Vienna, Thunder and Lightning, featuring the 106 voice Vienna Choir with Orchestral Accompaniment. Audiosphere 706 BN

ORGAN
 BACH, J. S.: Toccata and Fugue in d minor, Kurt Raaf playing Piasttenkirche Organ; also contains Mendelssohn's Sonata #2, Franck's Chorale in E major Audiosphere 711 BN

POP
 LENNY HERMAN: Music in Motion, Vol. 1 — Standard dance favorites with striking stereo effects. Livingston T-1088 BN

FOLK
 JOSH WHITE COMES A-VISIT- IN', Josh White with instrumental and choral accompaniment in You Know, Baby; She's Too Much For Me; Bury Me High; Come Along, Charlie and others Livingston T-1085 BN

HAMMOND ORGAN
 BILL THOMSON GOES LATIN, outstanding Latin melodies including Brazil, Poinciana, Carioca, Orchids in the Moonlight and others. One of the most delightful tapes by this highly versatile artist! Livingston T-1091 BN

And for superb Monaural listening:

CARL SANDBURG SINGS NEW SONGS FROM THE AMERICAN SONGBOOK, including Bell Weevil, Foggy, foggy dew, Careless Love, The Horse Named Bill, I'm sad and I'm lonely, and other ageless favorites. Lyrichord LY 5-4 (5")

Largest Tape Treasury in

STEREOPHONIC

First in monaural... first in stereophonic... always the quality leader in recorded tape for home music performance, LIVINGSTON is rapidly adding to its library of new stereophonic releases.

The LIVINGSTON catalogue contains the greatest diversity of recorded works ranging from the monumental classics to Jazz and Dixieland, from Bach's works for the Organ to the folk ballads sung by Josh White. Included in the LIVINGSTON listings is the finest material from such famous independent labels as:

AUDIOSPHERE • BOSTON • ATLANTIC
 EMPIRICAL • ESOTERIC • LIVINGSTON
 ALL LIVINGSTON tapes are 1200', splice-free, on 7" reels, fully guaranteed. All tapes come in attractive individual boxes, immediately identifiable and with complete program annotation.

List Prices

5" Monaural Dual-Track \$6.95
 7" Monaural Dual-Track \$11.95
 Stereophonic (Stacked or Staggered) \$11.95

LIVINGSTON

LIVINGSTON AUDIO PRODUCTS CORP. Livingston, N. J.

FLORENCE MAY FESTIVAL ORCHESTRA in ORCHESTRAL GEMS, VOL. 2. Vittorio Gui conducts symphonic selections by Mussorgsky, Borodin, Massenet, Debussy, Dukas and Rossini. Audiosphere AUD-2 (7")

MELODY CRUISE TO LATIN AMERICA (OC 5-1); TO ITALY (OC 5-2); TO PARIS (OC 5-6); TO SPAIN AND MEXICO (OC 5-7); TO ISRAEL (OC 5-8). A sparkling tape spotlighting the fabulous fingers of Irving Fields and his trio in many well-known and loved songs of each country. Oceanic (all 5")

LIVINGSTON tapes can be auditioned at your High Fidelity—Audio Dealer or Record Shop. Send for our complete catalogue and the name of your nearest dealer.

This is the
year of the...

Viking

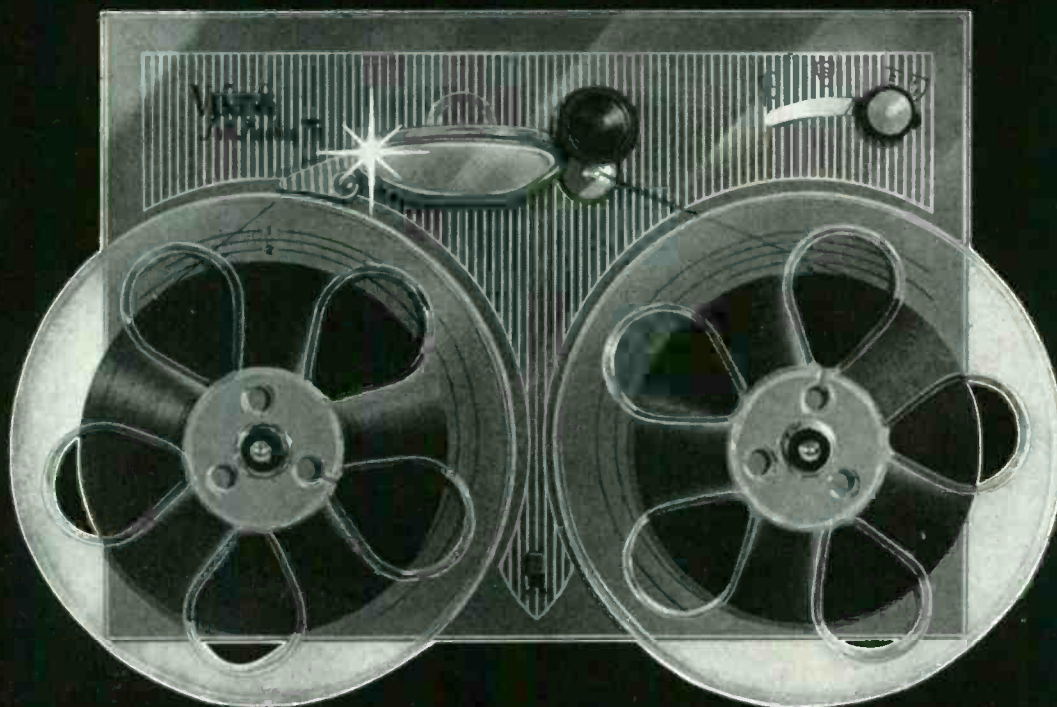

This is the year that you will look to the new concept of music reproduction made possible by tape . . . and this is the year that Viking full-fidelity tape system components make it practical to integrate tape equipment with your own high fidelity music system.

Sold
through
Dealers

Whatever your tape equipment needs may be—monaural, stereophonic, erase/record or playback operation only — you will find Viking tape decks and preamplifiers which exactly meet your requirements. The Viking line is built to exacting specifications, and will exploit fully the capabilities of the finest music system.

SPECIFICATIONS

frequency response, playback: 40 to 14,000 cps \pm 2 db.
distortion (tapes recorded 12 db below saturation): less than 2% within specified frequency range.

frequency response, record-playback cycle: 40 to 12,000 cps \pm 2 db.
signal-to-noise ratio: 50 db nominal all units.



Viking OF MINNEAPOLIS

9600 Aldrich Avenue South, Minneapolis 20, Minnesota

EXPORT DIVISION: 23 Warren Street, New York City 7, New York
Cable: SIMONTRICE, NEW YORK (All Codes)



the Tape Deck

by R. D. Darrell

Note: as usual, all tapes reviewed are 7.5 ips and — unless specifically noted as stereo — are 2-track single-channel recordings. The symbol • • prefixed to a review indicates stereo tapes. If a date in parenthesis is appended to the review, it refers to the issue of HIGH FIDELITY in which the corresponding disk review appeared.

BACH: *Brandenburg Concertos, Nos. 1-6 (Complete)*, BWV 1046-51 ✓

Cento Soli "Orchestra," Hermann Scherchen, cond.

OMEGATAPE OT 8006 and OT 3010. Two 7-in. \$20.90.

When (in reviewing the Horenstein Phonotapes *Brandenburgs* two months ago) I spoke of another version in preparation by the "unpredictable" Scherchen, I scarcely realized how apt that adjective would prove to be. I was prepared to be startled by stylistic idiosyncrasies and unconventional tempos, but in actuality I am more startled by their absence, except for what at first seems like an indefensibly slow pace for the last movement of the Sixth — and with each rehearing I'm less certain that even this is really indefensible. For the outstanding characteristic of Scherchen's readings is their persuasive conviction, not so much of "rightness" perhaps, as of *suitability* to their prime purpose of revealing unsuspected insights into music which many of us have thought held no further surprises. Over-all, this is one of those rarely electrifying performances which reshapes our whole musical thinking and reinvigorates the most jaded listening taste: a miracle all the more remarkable in that it is achieved here without recourse to such extra-musical technological aids as stereo sound.

After any such galvanic experience, I always fear that I may have been carried off my feet by the intoxicating immediacy of a reading whose weaknesses eventually may be disclosed by time and restudy. And it is on this score I must postpone my unqualified endorsement of Scherchen's *Brandenburgs* until I've lived with them a lot longer. But meanwhile they have come closer to overshadowing, if not displacing, Münchinger's LPs than I ever would have thought possible, and I'll be anxious to learn whether my initial enthusiasm is shared by other Bachian devotees. (For better or worse, though, anyone eager to check his own reactions will have to find some access to tape reproduction, for there is no immediate prospect of these recordings appearing on domestic disks.)

From the purist's point of view, Scherchen doesn't hew rigidly to the line of completely authentic scoring: flutes rather than recorders are used (but after hearing Lucien Lavailotte's solo in the second movement of the Fifth, who can regret

that?), and I'm not at all sure that Georges Tessier doesn't play a conventional violin rather than a violino piccolo in the First. Of course a high trumpeter (Roger Dalmotte) is used in the Second, and a harpsichord (Ruggero Gerlin) as soloist in the Fifth as well as in the *continuo* role throughout. Yet the effect of these is arrestingly novel: the brilliant trumpeter is placed so far back that its tones are perfectly integrated in the over-all sonority, while the seemingly smaller-than-usual harpsichord displays a scintillating glitter rather than the usual jangling clatter. The authenticity, then, is to the spirit rather than the letter of the score: I never have been made as keenly conscious of the *chamber* nature of these works as by the present quite distant microphoning of the extremely small, equably poised, and crystal-clearly articulated ensemble employed here. Perhaps stern analysis may expose more questionable elements in Scherchen's treatment, but it will be hard indeed to belittle his superb lucidity and inexhaustibly communicative relish for delicately yet firmly shaping every phrasing and coloristic detail. Whatever the final verdict may be, I for one cannot imagine a more exciting new approach to the *Brandenburgs*.



ERICA. LONDON

Scherchen's Haydn triumphs anew.

BEETHOVEN: *Sonatas: No. 14, in C-sharp minor ("Moonlight"), Op. 27, No. 2; No. 17, in D minor ("Tempest"), Op. 31, No. 2; and No. 26, in E-flat ("Les Adieux"), Op. 83a*

Guimar Novaes, piano.
PHONOTAPES-SONORE PM 117. 7-in. \$8.95.

If anyone can restore the time-tarnished lyric innocence and freshness of the *Moonlight*, it is Novaes, and while other pianists disclose more of the passion and depth of the larger-scaled *Tempest* and *Farewell* sonatas, her poetic eloquence gives them especially heart-warming appeal. More surprisingly, the two latter recordings, de-

spite their considerable age, come close to that of the more recent *Moonlight* in solid authenticity of piano tone and purity of sonic coloring. Originally the two bigger sonatas were released by themselves on Vox LP PL 6270, while the *Moonlight* was coupled with Beethoven's Fourth Piano Concerto on PL 8530; and the same coupling also has been made available on Phonotapes-Sonore PM 121 (7-in., \$8.95). The Novaes idolator will hardly boggle at the sonata duplication in order to get the taped concerto too, but others will find it easier to pass up since, despite some delectable details in the soloist's performance, Hans Swarowsky's orchestral accompaniment lacks comparable delicacy and sweetness. (Vox PL 8530, Feb. 1955)

HAYDN: *Symphony No. 100, in G ("Military")* ✓

Philharmonic Symphony Orchestra of London, Hermann Scherchen cond.
SONOTAPE SW 1042. 7-in. \$7.95.

It's questionable whether the thunder crashes of this work's "Turkish" passages ever again can galvanize the incredulous delight with which they astounded our ears back in 1951 when Scherchen's original version (Westminster WL 5045) first burst to the top of the demonstration-disk best-seller lists. Indeed, it wasn't long before many of us retired this work to our historical-document collections — not so much because its great moments had become less impressive, but that other aspects of the recorded performance began to appear so much less admirable. It must have been this very reason which prompted Scherchen to try again: certainly it is the richer string tone, the brisker tempos of the Minuetto and Finale, and the far finer integration of the work as a whole which make the new version (Westminster W-LAB 7024) more musically satisfactory over-all. Happily, it is this version which is taped here, and while the "Turkish" episodes are more incisively crisp and shattering than ever before, they are paradoxically less overpowering in that they no longer overbalance the effectiveness of the symphony as a whole. Now the work makes not only a more valid and less sensational claim to technical-display honors, but commands a far more lasting and substantial appeal as one of the finest recorded interpretations of the whole Haydn repertory. (Oct. 1956)

• • LEHAR: *The Merry Widow (Highlights)*

Uta Graf (s) and Kurt Herbert (t); Opera Society Orchestra, Walter Goehr, cond.

CONCERT HALL CHT/BN 17. 7-in. \$11.95.

Continued on page 109

Now! **ONE** *Berlant-Concertone Recorder*
does the work of **THREE**

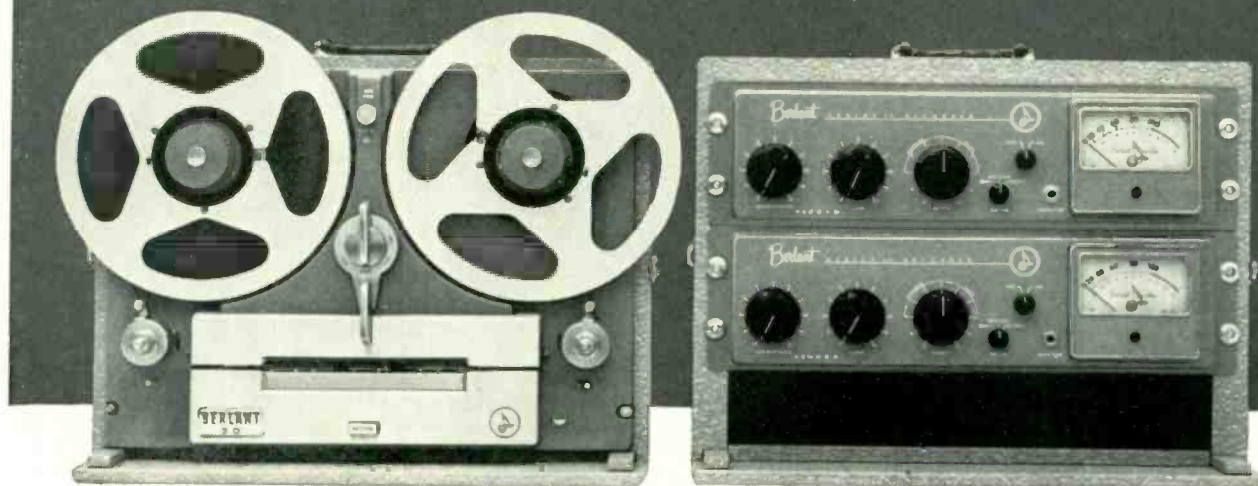

The 36ST Berlant Deluxe Recorder is ideal for radio station use. Delivers performance characteristics for the most exacting quality use. Hysteresis synchronous drive model—(99.8% timing accuracy). Frequency response 40 to 15,000 cps at 15 ips \pm 2db. Save the cost of a second recorder plus savings in space, operator time and tape. Perfect for the station planning stereo tape broadcasts on AM and FM simultaneously.

THIS NEW STEREO TRIPLE PLAY HEAD DOES IT—
Plays Full Track, Half Track, Stereo

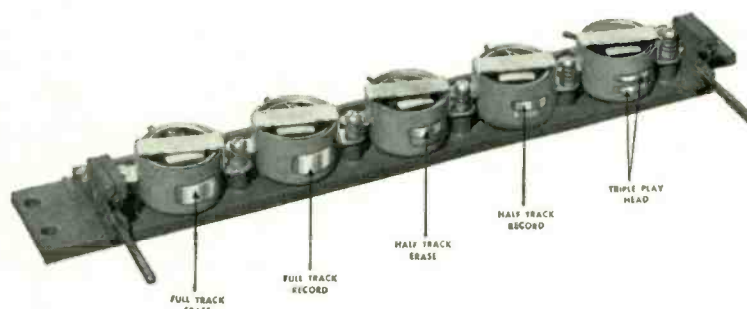

Head Compliment Model 26ST and Model 36ST. Another exclusive development of the superb engineering laboratories of American Electronics — America's foremost manufacturer of electronics for military, home and industrial use.

For the Advanced Audiophile the Concertone Custom Recorders answer recording and playing needs for years to come. Full professional features include use of 10½ reels, editing and cueing, 4½ signal level meter, 3 motors, monitoring from tape while recording, 2 channel input mixer.

Take Time to Pay . . . Terms to meet your budget on all models. (Model 22) As low as \$49.50 down, \$7.50 per week, 24 months to pay. Write for new 6-page brochure No. 4-J.

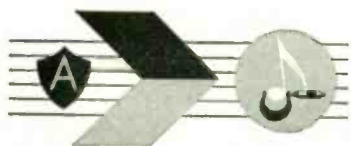

Audio Division,

AMERICAN ELECTRONICS, INC.

655 WEST WASHINGTON BLVD., LOS ANGELES 15, CALIFORNIA

TAPE DECK

Continued from page 107

One of the unexpected minor virtues of stereo is its ability to reinvigorate routine pops materials, such as the present potpourri (or *Querschnitt*, in the expressive German term) of *Lustige Witwe* excerpts. Goehr helps out with lusty, if hardly *Wiener gemütlich*, readings, and the two soloists help out even more with delightfully fresh, steady, and animated voices. Yet it is primarily sparkling, champagne-charged stereo sound which gives this performance the zestful appeal of good light music heard out-of-doors on a breezy summer evening. Later recordings of similar fare probably will exploit the medium more extensively (probably by "spreading" the duettists and surely by adding ensemble and choral passages, which thrive so much better still in stereo), but this release at least clearly points the way to a new and more enlivening era in light-classical home listening.

MENDELSSOHN: *Concerto for Violin and Orchestra, in E minor, Op. 64*
 †**Tchaikovsky:** *Concerto for Violin and Orchestra, in D, Op. 35*

Ivry Gitlis, violin; Pro Musica Symphony Orchestra (Vienna), Hans Swarowsky (in the Mendelssohn) and Heinrich Hollreiser, conds.

PHONOTAPES-SONORE PM 113. 7-in. \$8.95.

Despite the somewhat frenzied attempts to tout the young Israeli violinist as a modern Paganini, his disk debut in the present works (Vox PL 8840) was largely ignored a couple of years ago and it was only with a later Berg concerto release (PL 8660) that Gitlis attracted favorable attention from either critics or discophiles. But while the presumed general verdict that his performances of the two popular war-horses cannot meet the severe competition is fair enough as far as it goes, a single hearing of the present tape is enough to convince me that connoisseurs of violin playing are missing some real thrills if they overlook Gitlis' work here. His "tone," to be sure, is rather small-scaled, if not frankly thin, but it also is exquisitely fine spun, and his playing combines effortless virtuosity with a beautifully poised and restrained expressiveness. Certainly, he demonstrates here that he has the "makings," and I don't know any other young violinist whose future development I shall follow with livelier interest.

PROKOFIEV: *Lieutenant Kije Suite, Op. 60; Scythian Suite, Op. 20*

Vienna Symphony Orchestra, Hermann Scherchen, cond.
 SONOTAPE SW 3005. 7-in. \$9.95.

Symphony No. 1, in D ("Classical"), Op. 25; The Love for Three Oranges: Orchestral Suite, Op. 35a

Philharmonic Symphony Orchestra of London, Artur Rodzinski, cond.
 SONOTAPE SW 1038. 7-in. \$7.95.

Continued on next page

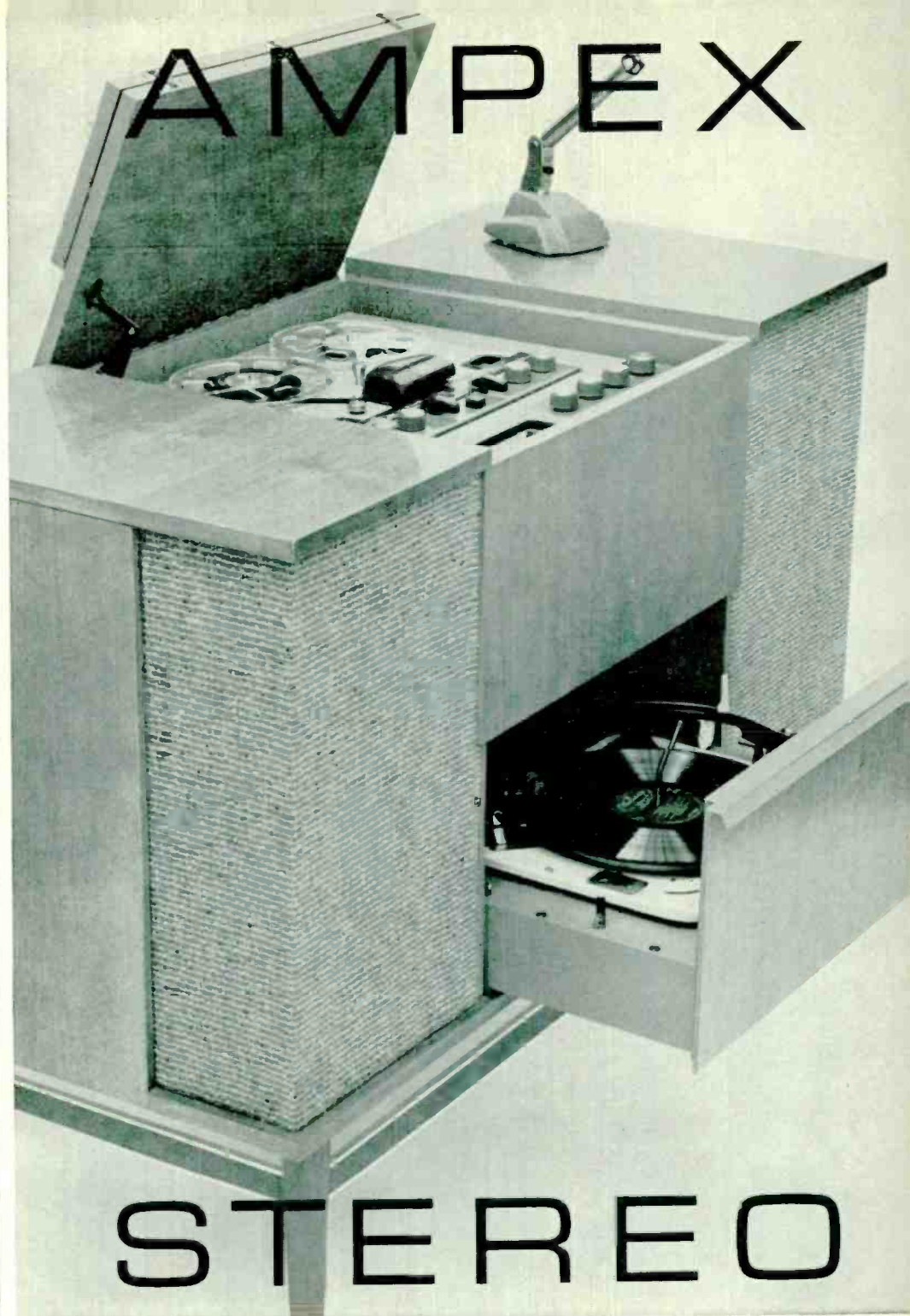

the ultimate achievement in music systems

The new Ampex Console Music System offers the startling experience of stereophonic sound on tape . . . a complete two-speed, half-track tape recorder . . . AM-FM tuner . . . three-speed record changer . . . and two amplifier-speaker systems — each the finest component of its kind, superbly integrated in the most complete sound system obtainable.

Separately, the stereophonic player-tape recorder is available in handsome table-top or portable cases with matching amplifier-speaker systems. Hear an Ampex Stereo System today . . . you'll never be satisfied with less.

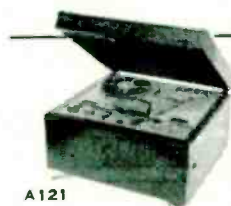

A121



A621



A122



A692

Ampex Corporation 934 Charter Street, Redwood City, California
 Monaural Recorder from \$379.50. For complete A series brochure write Dept. F-3033

4 great high fidelity
tape recorders from a name
that stands for precision...

DeJUR

tape deck for the components owner
portables for people on the go
consolette for music lovers



TMB-820
"Dual Professional" Basic Tape Recorder

Push-button, custom-installation tape deck ready to combine with present sound system. At 7½" equals or exceeds performance of "professional" machines operating at 15"/sec. Also 3¾"/sec. speed. Push-button track reversal. Heavy-duty hysteresis synchronous motor.

\$329.50



CR-820 "Consolette"
with HI-Five Speaker System

"Dual Professional" basic unit housed in furniture-weight Korina cabinet. HI-Five speaker system in special acoustical chamber gives magnificent audio quality. \$499.00



TK-820 "Dual Professional" Portable

Same controls and specs as the TMB-820 but complete with HI-Five Speaker System in travel case. Acclaimed by experts as finest portable under \$500!

\$399.50

PTR-90

"Embassy" Portable

Three-speaker portable dual track with all the classic DeJUR features: superb audio quality, 7½" and 3¾" speeds, magnificent performance. \$299.50



You're always sure with

DeJUR

Audio Equipment

DEJUR-AMSCO CORPORATION,
LONG ISLAND CITY 1, N. Y.
CHICAGO, ILL.
BEVERLY HILLS, CALIF.
DEJUR INTERNATIONALE,
GMBH. WEST GERMANY

SEND COUPON FOR COMPLETE SPECIFICATIONS

DeJUR-AMSCO CORPORATION, Dept. HFI, 45-01 Northern Blvd., L.I.C. 1, N.Y.

Please send me, without obligation, complete specifications.

Name _____

Address _____

City _____ Zone _____ State _____

T
TAPE DECK

Continued from preceding page

There are few of my favorite "display" disks which I'd be happier to have reissued on tape than Scherchen's *Kije* (Westminster WL 5091, or currently WN 18266), for although I never dared go quite as far as C. G. Burke in boldly hailing it "the best orchestral recording ever made," I believed from the first that it contained a number of passages which are ideal illustrations of transient-response cleanliness and sonic-detail authenticity. But in the course of time and incessant use, the disk grooves have become badly cluttered up with gremlins; so it is with special relish that I now play and replay the immaculately taped transfer of the original recording—and am reassured that all the technological miracles of later years haven't dimmed its incomparable vitality. The more heavily orchestrated barbaric terrors of the *Scythian Suite* may present an even greater challenge to the engineer, and one which has been perhaps even more triumphantly mastered, but this is a work too intense for even my long-toughened nerves to undergo except at rare intervals. (Winter 1951)

Except for the extraneous crackles of dirty grooves, I couldn't distinguish any substantial differences between the disk and tape versions of these works, and—again in direct comparison—there were none at all between the Rodzinski couplings heard first via turntable (Westminster W-LAB 7017) and then via tape deck. (Which strikes me as controverting both the pessimists who have held that no 7.5-ips tape can match the high-frequency incandescence of the best LPs, and the optimists who automatically assume the overall superiority of the tape medium.) But while the Rodzinski works may be more sensationally brilliant in some respects than Scherchen's, his orchestral tone qualities are by no means as admirable. And although his acidulous reading is appropriate enough for the *Three Oranges* excerpts, his touch of pompousness and lack of zesty wit are too heavy a burden for the *Classical Symphony*. Even at its best here, this version makes me regret all the more bitterly that Koussevitzky's never was captured with comparable technical skill. (April 1956)

• • PROKOFIEV: *Romeo and Juliet*,
Op. 64: Five Excerpts

Members of the NBC Symphony Orchestra,
Leopold Stokowski, cond.
RCA VICTOR DCS 18. 7-in. \$12.95.

Drawn from all three of the published orchestral suites, this group of excerpts coheres more consistently than many of Stokowski's once-famous "symphonic syntheses," and, although I've never seen the complete ballet either on the stage or in films, I venture to say that the quintessence of the work is distilled here. It may be a somewhat bodiless brew, if compared with a younger Prokofiev's lusty music, yet it commands a delicacy of fragrance, a nostalgia, and a bitter-sweet tenderness which reveal new insights into that prodigally gifted composer's later years. Listening to this tape with its almost ghostly

evocations of Romeo at the Fountain, Juliet, Romeo and Juliet together, Romeo at the Tomb of Juliet, and the Death of Juliet, a half-forgotten line reverberated insistently in my mind: ". . . a poise, a wounding, a beautiful suppression . . ." But when I searched vainly to trace it in e. e. cummings' works (where I'm sure it originates), I came across other lines which are perhaps even more apposite:

it is the autumn of a year
When through the thin air
stooped with fear
across the harvest whitely peer
empty of surprise
death's faultless eyes

The flute of morning stilled in
noon—
noon the implacable bassoon—
now Twilight seeks the thrill of
moon,
washed with a wild and thin
despair of violin

Perhaps for all its poignance Prokofiev's *Romeo and Juliet* score is—in the best sense—"background" or atmosphere-setting music which for more overt drama must be experienced as an inseparable part of the danced ballet. Yet restrained and remote as it may seem when heard without the accompaniment of visual spectacle its feather-light touch quite possibly may be better remembered by some sensibilities than the more powerfully "moving" raw emotionalism of other, quite different, dramatic works. I'm sure of one thing, anyway: the sparse, open-weave tonal textures here, and the constant sense that infinitely more is implied than what is directly stated, imperatively demand the unique qualities of stereo reproduction. I'm fully aware that so perceptive a critic as Alfred Frankenstein unhesitatingly found the single-channel LP version (issued so far only as part of a larger *Romeo and Juliet* miscellany, RCA Victor LM 6028) as "the finest single orchestral recording" in his entire Prokofiev discography, but I still doubt whether other listeners can ever realize the full beauty of Stokowski's performance here until they can know it in the magically expanded yet etherealized aural vistas of stereo sound. There it is very possibly Stokowski's supreme sonic masterpiece—and I haven't forgotten for a minute his great Philadelphia days!

RESPIGHI: *The Pines of Rome; The Fountains of Rome*

Vienna State Opera Orchestra, Argeo Quadri, cond.
SONOTAPE SW 3006. 7-in. \$9.95.

Like the Scherchen Prokofiev coupling, this is another war-horse release of several years back, which LPs did much to establish the fame of Westminster engineering (WL 5167, recently reissued as WN 18271), but here the tape version clearly is more faithful to the original recording in its superior freedom from high-end shrillness, its cleaner crispness, and far more equable and better-blended sonorities.

Continued on next page

PENTRON STEREO- MAGIC!

MONAURAL
RECORDING
and
PLAYBACK

STEREO-
PHONIC
PLAYBACK

● **STEREO-MAGIC
CONVERSION KIT**

Adapts any Pentron tape recorder sold in the past 5 years for stereophonic tape playback.

List: \$16⁹⁵

● **STEREO-MAGIC
STOCK PENTRON MODELS**

These regular in-stock models offer stereophonic playback plus monaural recording and playback.

T-90S: \$219.95, list
HF-400S: \$269.95, list
HFW-500S: \$319.95, list

PENTRON

in Canada: Atlas Radio Ltd., Toronto

PENTRON CORP., 786 S. Tripp Ave., Chicago 24, ILL.
Send details on Stereo-Magic . . .

Name _____

Address _____

City _____ State _____

Travel the complete Sound spectrum with TANDBERG . . . the world's finest tape recorder!



- 3 SPEEDS 1 7/8, 3 3/4, 7 1/2 I.P.S.
- STYLED TO FIT ANY DECOR
- BALANCED PLAYBACK, AMPLIFIER AND SPEAKER
- ABSOLUTELY NO WOW OR FLUTTER AT ANY SPEED

You too can experience the wonder of complete sound dimension with the world famous Tandberg recorder. Off the air recordings made . . . "just fooling around at home," are truly mirrored by the wonder of electronic faithfulness, built right into this amazing tape recorder.

The versatile 3 speed Tandberg will more than pay for itself in tape savings as you discover the superior performance of this recorder at its lower speeds.

Ask Your Dealer For A Demonstration
Write For Full Information To:

TANDBERG

10 East 52nd Street
New York 22, N. Y.
PLaza 9-7190

TAPE DECK

Continued from preceding page

Yet these very virtues make all the more glaring the innate sterility of the works (and perhaps the performances) themselves. I used to think there was considerable poetic atmosphere in the *Fountains* at least, but today I find it only somewhat less intolerable than the gaudy scene painting and bombastic emotionalism of the *Pines*.

• • VERDI: "Requiem" Mass

Corry Bijster (s); Elisabeth Pritchard (ms); David Garen (t); Leonard Wolovsky (bs); Netherlands Philharmonic Choir and Orchestra, Walter Goehr, cond. CONCERT HALL CHT/BN 18. Two 7-in. \$23.90.

At last I'm given tangible proof of my conviction that of all types of music it is the large-scale choral-and-orchestral form which most imperatively demands—and profits by—the stereo medium. Perhaps operas will exploit its potentialities even more dramatically, but at least they have fared better hitherto in single-channel recordings than choral works, which never have been fully satisfactorily captured. I can't imagine why stereo-tape manufacturers are so backward in demonstrating what now can be done in freeing choral textures from the cramped bondage to which disks have condemned them in seeming perpetuity. But don't take my word for it: just compare any LP of the *Mauzoni* Requiem with the present tape—and you'll find out for yourself what it means to add an entirely new dimension (in aesthetics as well as sonic technique) to your experience.

Granted that Goehr, for all the skillful musicianship and sincere feeling he exhibits here (more effectively than in any of his previous releases I know) can't achieve the interpretative stature of Toscanini or De Sabata. Granted too that the soloists here hardly can match many more famous singers who have essayed these roles on LP (although Pritchard's is one of the finest young voices I have come across since Ferrier's, while Bijster's is nearly as admirable and possesses more dramatic "personality"; only the tenor and bass are nondescriptly "adequate"). Nevertheless, this tape marks the first time I ever have wholeheartedly responded to Verdi's deeply moving music outside a concert hall, and I ascribe that less to the fine playing of the orchestra here and the even finer singing of its unfortunately rather small companion chorus than to the superb spaciousness and "lift" with which their composite sonorities are both integrated and differentiated in stereo reproduction.

Curiously enough, it is not necessarily the most obviously dramatic passages (like the almost Polovstian pounding rhythms of the "Dies Irae") which benefit most, but the more serene moments and such lilting ones as the dance-like double fugue of the Sanctus. No attempt has been made here (rather to my regret) to capitalize further on stereo possibilities by antiphonal placement of choir sections or the soloists

in concerted numbers, and (even more regrettably) there is an unimaginative reliance on bringing the soloists as close to the microphone as would be necessary in conventional recording. Hence, the latter sometimes sound disconcertingly "forward" and disengaged from the orchestral background, rather than as closely integrated in it as they can be in stereo and still maintain distinctive individual clarity.

But such quibblings are quite minor considerations, for future reference only. The vital fact is that the Requiem as a whole seems made for stereo—and stereo expressly designed to enable the Requiem to be heard and absorbed as never was possible before on records. I can't resolve the aesthetic dilemma in which a critic finds himself: caught between the choice of a Toscaninian performance, say, and the aural beatitudes of Goehr's stereo sound. I can only chronicle its existence—and hope that many other listeners find themselves in a predicament as fascinatingly delicious in practice as it is perplexing in theory.

REEL MUSIC NOTES

ALPHATAPE: The difficulty of utilizing in a jazz manner a predominantly violin ensemble is indicated by the very title (*Music to What By?*) of a miscellany by Paul Nero and his Hi Fiddles. The livelier pieces, like *Scherzo-Phrenia* and *Just a Minuet* are diverting, escapist chamber-music fare (making the most of the bright, not-too-close recording), but the slower ones, for all their desperately ingenious arrangements, are hardly satisfactory for either background listening or actual dancing (AT 24, 5-in., \$3.95). *Four Moods for Orchestra* is more consistent in style, but here Herbert Pawlicki's attempt to emulate the glistening richness of a Kostelanetz or Mantovani isn't quite within the powers of his Vienna Amusement Orchestra. However, he should satisfy the romantic yearnings of listeners who can languish to the lush strains of Drigo's *Serenade*, Fibich's *Poème*, and the like (AT 13, 5-in., \$3.95).

BEL CANTO: I don't know Dave Remington's standing among jazz *cognoscenti*, and to my ears his band's *Chicago Jazz "Reborn"* sounds more like a modernized refinement of New Orleans styles. But whatever his authority and stylistic derivations, I found this surprisingly long program (for a 5-in. reel) consistently invigorating. There is a fine perky animation throughout, achieving a really jubilant drive in *China Boy* and *Mandy*; the arrangements are imaginative, with distinctive piano, fiddle, and percussion solos, brilliantly recorded; and the combination of rambunctious spirit and sophisticated treatment is for once effectively reconciled (503, 5-in., \$6.95).

CONCERT HALL: The effectiveness of a real barrelhouse piano or band used to depend—when heard *in situ*—as much on beer- and smoke-induced soddiness in its listeners as on its practitioners' lung power and muscularity. But now, thanks to stereo, the first two pieces in *Barrelhouse and Blues* by Sam Price and his Kaycee Stompers can batter even the



MUSIC ON TAPE

for **\$2⁹⁸**
ONLY

Phonotapes-Sonore, leader in the field of recorded tapes, breaks the price barrier to offer complete musical selections, 7½ speed — dual-track, at a bargain price. These are not samplers.

The **CAMEO** Series

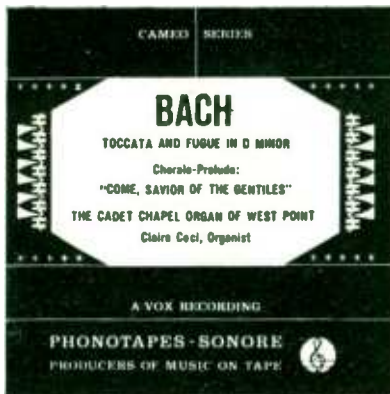

Cameos now available:

MOZART: EINE KLEINE NACHTMUSIK
Pro Musica Chamber Orchestra, Stuttgart, Rolf Reinhardt, conductor **PMC 1001**

PROKOFIEV: CLASSICAL SYMPHONY
Concerts Colonne Orchestra, Jascha Horenstein, conductor **PMC 1002**

BACH: TOCCATA AND FUGUE IN D MINOR
"COME, SAVIOR OF THE GENTILES"
The Cadet Chapel Organ of West Point, Claire Coci, organist **PMC 1003**

GRIEG: NORWEGIAN DANCES, Op. 35
Bamberg Symphony, Edouard van Remoortel, conductor **PMC 1004**

HOLIDAY IN NAPLES (7 Selections)
Gianni Monese and His Orch. **PMC 1005**

BORDDIN: PLOVETSJAN DANCES
CUI: TARANTELLA
Bamberg Symphony, Jonel Perlea, cond. **PMC 1006**

7½ SPEED **\$2⁹⁸** DUAL-TRACK
EACH

Tapes in the Cameo Series are duplicated on Ampex equipment and blue Audiotape, maintaining the same high standard achieved in the regular Phonotapes-Sonore series.

PHONOTAPES INC.
248 West 49th St., N. Y. 19, N. Y.

soberest and most alert hearer into appropriate stupefaction. I don't think I've ever heard a more heavily played and recorded piano than Price's here, yet while he and most of his sidemen (except for Dickenson on trombone and Hinton on string bass) may be short on imagination and subtlety, they certainly can achieve tremendous swinging momentum. Human flesh and blood can't maintain this pile-driving racket long, and after *Jumpin' on 57th* and *Jonah Whales Again* the remaining three pieces slow down to a shuffle, also good of its kind, but with the blowsy-bluesy clichés showing more plainly. A terrific tape of its kind — but definitely not for delicate sensibilities or easily overloaded sound systems (• • CHT/BN 16, 7-in., \$11.95).

JAZZTAPE: The box-labeling doesn't make it clear whether *The Sextet from Hunger* is the program title or the performing band's name, and there are no personnel details; but from the first rowdy bars of the music itself, no one can doubt that this is a group which clings unashamedly to the old Dixieland traditions — energetically strummed banjo, trumpet wa-wa's, trombone slides, plugging piano, and all. Yet staccato, brash, and raucous as the playing is throughout, even its oldest clichés are animated with honest gusto — achieving at its best (as in *Harmony Rag*) an infectiously exuberant lift (JT 4009, 5-in., \$6.95). But after so much high spirit, it's hard to react sympathetically to the coy attempts of the New Animal Crackers Band to reproduce (or is it satirize?) the dance styles of the Twenties in *Cinématographe*. A *Club Français du Disque* recording, and a very bright one technically, this is perhaps corny enough to remind French listeners of a very distant Dixie; but for others it is likely to arouse queasiness (JT 4015, 5-in., \$6.95).

PHONOTAPES-SONORE: A welcome change of pace for a reviewer who thought he had heard almost everything, but who never before had directly encountered the "new" quasi-folk style in children's records, is provided by *Songs to Grow On*. Vols. 1 and 2, long and immensely popular on Folkways LPs FP 5 and FP 20. I like best Woody Guthrie's completely unmaulikish songs and delivery on the first track (*Nursery Days*), and the Pete Seeger and Cisco Houston contributions to *School Days* on the second track, but perhaps the kids of today are catholic enough also to go both for Leadbelly at one extreme and Charity Bailey and Adelaide van Wey at the other. Even the last are still a long way from the mealy-mouthed *Tinny Tunes for Tiny Tots* of an earlier era — and a good thing too! I have never approved of "children's" records as such, but the honest tunes and words here, however naïve, are something else again: I relished my present single hearing and I can't imagine any child likely to exhaust their fascinations even in the interminable repetitions he is sure to demand. Old as the recordings must be, the present transfers to tape are surprisingly satisfactory (if of course far from wide range) and surely should duplicate their LP successes (PM 139, 7-in., \$8.95 — and admirably including a leaflet of the complete song texts).



JOIN THE STEREOPHONIC MUSIC SOCIETY and enjoy these benefits:

- 20% SAVINGS ON STEREOPHONIC TAPES
RCA, HMV, Hi-Fi, AV, Livingston, Concert Hall, Sony Sterecord and others
- 20% SAVINGS ON MONAURAL TAPES
- UP TO 50% SAVINGS ON RECORDING TAPE
- FREE MUSIC MAGAZINE SUBSCRIPTION
- NO MINIMUM PURCHASE REQUIREMENT
- ONE CENTRAL SOURCE FOR EVERY RECORDED TAPE; EVERY STEREO TAPE

AVAILABLE IMMEDIATELY

\$6.00—Half year membership
\$9.00—Full year membership

USE THIS HANDY
MEMBERSHIP
APPLICATION
FORM

TO: STEREOPHONIC MUSIC SOCIETY, Inc
303 Grand Avenue, Palisades Park, N. J.

GENTLEMEN: Please enroll me for a
 6 month
 1 year period as a member of the Stereophonic Music Society. I understand that I am under no obligation to purchase any specified minimum of tapes under the Society's group purchase plan. As part of my membership I am entitled to a free one-year subscription to Hi-Fi Music at Home magazine, as well as quarterly listings of all recorded stereophonic and monaural tapes currently on the market.

My Check for \$6.00 is enclosed herewith (payable to the Stereophonic Music Soc., Inc.)
 Money Order \$9.00

NAME
ADDRESS
CITY ZONE STATE.....
MAKE OF RECORDER
 Stereophonic Staggered
 Stacked Monaural

Please send additional information concerning the Society.

TWO GREAT NAMES... BRILLIANTLY PAIRED..
 a special, high performance Wharfedale speaker
 combined with an authentic R-J shelf-enclosure,
 ready for use... \$57.50*



The Wharfedale

THE SPEAKER was designed and constructed under the personal supervision of G. A. Briggs to offer optimum performance with this R-J enclosure. It is an 8" speaker incorporating all the advanced Wharfedale elements: aluminum voice coil, cast chassis and felt "buffer" between cone and frame. This results in an improved damping factor and remarkably level response. Demand for Wharfedales has always exceeded supply, making them highly valued as components. Now pre-packaged, ready for use, this great speaker lends its brilliance to the only Wharfedale and R-J combination. Flux density is 10,000 lines. Total flux is 39,500 lines, with ample power handling capacity. The frequency response is essentially level from 50 to 16,000 cycles.



THE ENCLOSURE is the original authentic R-J shelf model, the revolutionary idea which established today's trend to small speaker enclosures. There is *only one* R-J enclosure, and never before has any product been so imitated as has the R-J enclosure. The important thing is that although other enclosures may *look* like an R-J in shape and size, they cannot *sound* like an R-J, because it is the interior construction principle that makes the difference. The R-J is so different that it has been granted not one, but two patents by the U. S. Government. This versatile enclosure (only 11" high, 10" deep, 23½" long), will fit the average bookshelf, mantle or table. Look for the authentic R-J emblem in the bottom corner of the enclosure.



*Price quoted for mahogany. Blonde slightly higher.

MAIL THIS COUPON . . .

for your complimentary copy of the B.I.C. High Fidelity Plan Book, an aid in setting up your high fidelity system.

R-J Audio Products, Inc., Dept. RA27
 Port Washington, N.Y.
 Send B.I.C. High Fidelity Plan Book

Name _____
 Address _____
 City _____ Zone _____ State _____



A QUALITY-ENDORSED PRODUCT OF THE B.I.C. GROUP

R-J AUDIO PRODUCTS, INC. • PORT WASHINGTON, N. Y.

TESTED IN THE HOME



Equipment reports appearing in this section are prepared by members of HIGH FIDELITY'S staff, on the basis of actual use in conjunction with a home music system, and the resulting subjective evaluations of equipment are expressed as the opinions of the reviewer only. Reports are usually restricted to items of general interest, and no attempt is made to report on items that are obviously not designed primarily for high-fidelity applications. Each report is sent to the manufacturer before publication; he is free to correct the specifications paragraph, to add a comment at the end of the report, or to request that it be deferred (pending changes in his product), or not be published. Failure of a new product to appear in TITH may mean either that it has not been submitted for review, or that it was submitted and was found to be unsatisfactory. These reports may not be quoted or reproduced, in part or in whole, for any purpose whatsoever, without written permission from the publisher.

Gray AM-50 Amplifier

SPECIFICATIONS (furnished by manufacturer): a single-chassis self-powered power amplifier. Input: one, at high-level high-impedance. Controls: input level; bias adjust. Outputs: 8 and 16 ohms to speaker. Power rating: 50 watts continuous; 100 watts peak. IM distortion: below 0.25% at 30 watts output; below 1.0% at 50 watts output. Power response: ± 1.0 db, 20 to 20,000 cycles at 50 watts at less than 1.0% harmonic distortion. Square wave response: 20 to 20,000 cycles, essentially undistorted. Sensitivity: 1.5 volts in for 50 watts out. Damping factor: 15. Two AC convenience outlets; one switched, one unswitched. Power supply outlet socket for non-powered preamplifier. Metering terminals for bias setting located on front of chassis. Fuse receptacle located on front of chassis. Tubes: 2—6CA7, EL-34, or 6550; 6AN8; 5U4GB or GZ-34. Dimensions: 8 in. deep by 12 wide by 10½ high. Price: \$129.50. **MANUFACTURER:** Gray Research and Development Company, Inc., 658 Hilliard St., Manchester, Conn.

Fifty-watt amplifiers are becoming increasingly popular among perfectionists, and the Gray AM-50 is an outstanding ex-



The Gray AM-50 50-watt power amplifier unit.

ample of why such amplifiers are gaining wide acceptance despite their cost.

A single input connection is provided, and an input level-set control allows the AM-50 to be used either with average low-output control units or with those that require lower-gain power amplifiers. It has two auxiliary AC outlets, one switched and the other unswitched, and the fuse receptacle is readily accessible on the side of the chassis.

Since the B+ supply voltage in the Gray amplifier is

unusually high, the maker has taken the precaution of overrating some of the components, thus lengthening the expected life of these parts.

The AM-50's sound, through my reference system, remained clean, smooth, and transparent at all volume levels up to what I deemed the limit of tolerability. Like other top-quality amplifiers I've heard, the AM-50 seems to add no coloration at all to the sound. Even with a heavily capacitive electrostatic tweeter connected to it (which is a very severe test of high-frequency stability), the Gray maintains its smooth listenability, and still reproduces musical timbres with remarkable accuracy.

Bass performance is equally good—deep, solid, and extremely well controlled, with a definition and body that reflects the very high stability it exhibits in instrument tests. Further evidence of its stability is the disarming ease with which it handles high-volume musical passages.

This amplifier is one I could live happily with . . . one cannot say "forever after" in this business, but I will say long enough to be well worth what it would cost me.—J.G.H.

MANUFACTURER'S COMMENT: This amplifier has been designed to provide exceptionally good transient response with a wide variety of output loads, as well as very low distortion. The total harmonic distortion at full 50 watts output is well below 1% to below 20 cycles.

Concert Cabinetry Turntable Base

SPECIFICATIONS (furnished by manufacturer): wooden pre-cut turntable bases for all popular transcription tables. Finish: two styles, standard and deluxe. Deluxe models have all plywood edges veneer bound; available in Mahogany, Blonde, or Walnut stains. Standard models do not have ply edge veneer, and are available only in clear lacquer on natural plywood finish. Dimensions: 20½ wide by 17½ deep; height as below. **MODELS**—TT-R: 4 5/8 in. high. TT-H: 6 5/8 in. high, for hysteresis motors. Prices: TT-R-DLX \$20.00; TT-R-STD \$16.50; TT-H-DLX \$22.50; TT-H-STD \$19.00. **MANUFACTURER:** E. and R. Scheller, 1630 W. Granville Ave., Chicago 26, Ill.

This turntable base is made by the same company which produces the sturdy equipment rack described in an earlier TITH section. It is equally sturdy; the wood is ¾-in. thick, throughout.

The novel feature here is the felt linings used on the Professional and Deluxe models. The vertical sides of these bases are grooved along their top edges. Strips of felt, ⅜ in. wide and ⅜ in. thick, are glued into the grooves. A matching

Continued on next page

TESTED IN THE HOME

Continued from preceding page

groove is cut into the top piece or motor board. This then simply rests on the strips of felt; it is not screwed down to the sides. Result: acoustic insulation to minimize the danger



The Deluxe model base with turntable and arm.

of acoustic or mechanical feedback. The Standard models have the motor boards fastened to the base with concealed screws, and are not felt-mounted.

Felt-covered adjustable-height feet are provided, and—at least, with the base for the Garrard 301 furnished us—a small spirit level for attachment to the motor board. The motor boards, by the way, are cut out to the specifications supplied by the manufacturer of the turntable; you order a base (and motor board) for a specific turntable, and it is delivered cut for that turntable.

This is another piece of fine cabinetry, and is a fitting companion for the Rack 55 described in the November TITH section. — C.F.

Robins Aud-O-File

DESCRIPTION: a record storage rack holding up to 50 disks in suspended plastic sleeves. **Dimensions:** 15½ in. long × 15½ wide × 14½ high. **Price:** \$24.99, net. **MANUFACTURER:** Robins Industries Corp., 214-26 41st. Ave., Bayside 61, N. Y.

It is a long time since a really new idea in record storage has come along, but this certainly fits that description.

The Robins Aud-O-File consists of a frame of wrought iron and steel rods supporting 50 heavy, clear plastic record



The Robins Aud-O-File stores fifty records in suspended plastic sleeves, minimizing warpage and contamination from dust.

sleeves having curved bottoms conforming to the shape of the disks. Each sleeve is threaded over two hanger rods (in

the same fashion as a window curtain), and these are free to slide along the parallel rods atop the rack. Thus, disks in the Aud-O-File are stored vertically suspended in dust-proof protective sleeves and are relieved of the pressure that is exerted on them when a large stack is stored in a conventional record cabinet. They are protected from damage, while the clear plastic of the sleeves allows the labels to be read without pulling the disks from their sleeves.

Really an ingenious idea, and one of the best schemes I've seen to date for storing disks that have outlived their envelopes or whose envelopes had no pertinent information on them. — J.G.H.

Metzner Starlight Turntable

SPECIFICATIONS (furnished by manufacturer): **MODEL 60**—a transcription turntable having continuously-variable speed control and a built-in stroboscopic speed indicator. **Speed range:** 16 to 83 rpm, continuously variable within a single operating range. **Wow and**



The Starlight variable-speed turntable.

flutter: less than 0.2% RMS. **Rumble:** over 40 db below NARTB standard 7 cm/sec recording level. **Drive motor:** 4-pole induction. **Dimensions:** 13¼ in. long by 11¾ wide. 3¾ in. required below top of motor board. **Turntable height:** 1¼ in. **Price:** \$59.50. **MANUFACTURER:** Metzner Engineering Corporation, 1041 North Sycamore Ave., Hollywood 38, Calif.

This is one of the few turntables I have seen to date which provide completely variable speed control throughout their entire operating range. This means that it can be used not only to correct for speed inaccuracies in disks that should be 33⅓ but aren't, but that it can also provide accurate speed settings for any of the early collector's items that were disked before the 78.26 rpm speed became standard. Add to this the fact that the Starlight's speed control range extends down to that of the new 16⅔-rpm talking books and we begin to get some idea of this turntable's versatility.

The heart of Metzner's variable-speed drive is a neoprene-coated flat drive disk that is driven directly by a worm gear on the motor shaft. At the bottom of the turntable spindle, a knurled aluminum wheel mounted by a spline arrangement contacts the surface of the drive disk. As the speed-change lever above the motor board is varied, the aluminum wheel is moved up or down on the turntable shaft, and the point of contact between the wheel and the drive disk changes, from the center to the outside of the disk, providing a wide range of "gear" ratios.

At the slowest speed, the idler is running near the hub of the drive disk, so the high ratio between them revolves the idler (and hence the turntable) at its slowest speed. As the speed lever is turned up, the idler moves toward the outer edge of the drive disk, increasing the speed up to its limit of about 83 rpm. To facilitate accurate speed setting,

Continued on page 118

*Looks Different...
is Different!*

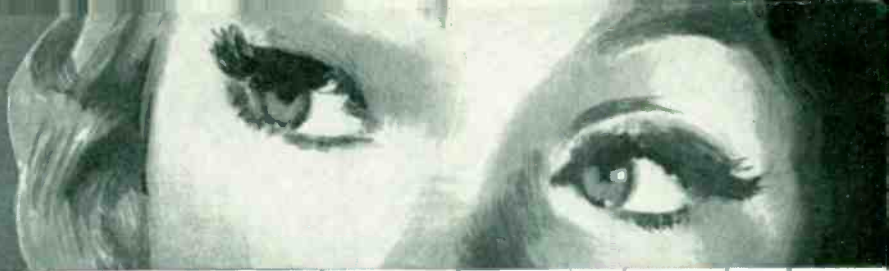

H. H. Scott Model 210-E 30 watt complete amplifier 15 1/2 x 5 x 12 1/2 in mahogany case \$179.95 (Mahogany Case \$19.95) All prices slightly higher west of rockies.

**Exclusive dynamic noise suppressor . . .
new green-dot controls . . .**

Most Versatile . . . Most Complete Combination Amplifier Made Today

Includes 30 watt power amplifier, complete preamplifier, and Dynamic Noise Suppressor.

Dynamic Noise Suppressor makes old and worn records sound new again, protects investments in precious record libraries.

Complete tape facilities: Two special tape output connections that let you record with or without the noise suppressor in the circuit. A Scott owner reports "The noise suppressor lets me record noisy radio broadcasts on tape with perfect results, because with the suppressor I get rid of all the background noise on the broadcast". NARTB pre-recorded tape play-back channel lets you play back direct from tape heads.

Two magnetic cartridge inputs so you can connect both a changer and a turntable to the 210-E. Front-panel switch lets you select between the two.

Variable Damping Control assures a perfect match between speaker and amplifier.

Green Dot Controls simplify your high fidelity installation by marking each control with the best average setting. Anyone in your family can enjoy your music system . . . they just turn to the green dots and play!

Many More Exclusive Features

- Separate three-channel Bass and Treble Controls so you can adjust the sound to room acoustics
- Loudness Control lets you enjoy all the music even at low volume levels
- Frequency response flat from 19 cps to 35,000 cps
- Harmonic Distortion less than 0.5%.

Write for Complete Technical Specifications!



385 Putnam Avenue, Cambridge, Mass.

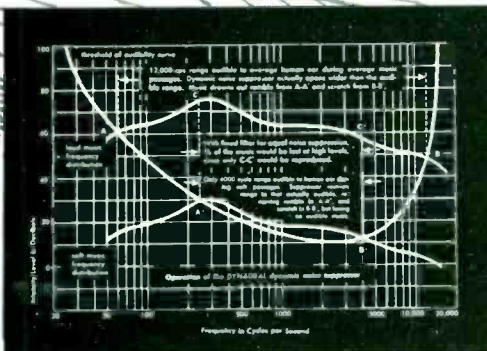

Dynamic Noise Suppressor Knocks Out Noise . . . NOT Music!

Some manufacturers offer fixed filters to remove record scratch and turntable rumble. But these cut off music as well as the noise. H. H. Scott's exclusive Dynamic Noise Suppressor works differently. On quiet and low level musical passages, when noise is noticeable, the suppressor cuts off at noise frequencies. When music becomes loud enough to mask noise, the suppressor automatically and instantaneously lets all the music through. If you are playing a noisy record and have two piano notes with silence between, the suppressor lets the notes through, but filters out the scratch and rumble in the silence between.

WHAT LEADING AUTHORITIES SAY ABOUT H. H. SCOTT COMPONENTS

"... any true high fidelity system . . . should include dynamic noise suppression when the ultimate in record reproduction is required."

Harold Weiler, Author
HIGH FIDELITY SIMPLIFIED

"... the 310-A seems as close to perfection as is practical at this time."

Tested in the Home Report
HIGH FIDELITY Magazine

"... it is the selectivity of the new Scott, its competence in choosing among the many the one station wanted, that has excited the greatest admiration for that unit."

SATURDAY REVIEW
Home Book, 2nd Edition

TESTED IN THE HOME

Continued from page 116

the underside of the turntable is marked with three concentric rings of stroboscope dots, visible in a small mirror recessed under a cutout in the mounting plate. When the motor is switched on, the stroboscope rings are illuminated by a neon bulb, which also acts as a pilot light.

The whole idea is quite ingenious and well executed. The unit I tested had extremely good speed regulation, and was comparable in this respect to the best of the turntables I have tested. Its -40 db rumble level is not as low as that of the most expensive transcription tables, but is fairly close to the practical limit set by the rumble level on many disks. And the nature of the Starlight's drive system suggests that its rumble is not likely to increase with prolonged use; there are no critical drive surfaces to develop flat spots, and the entire drive system (including the turntable) is shock-isolated from the motor board on floating rubber mounts.

A 45-rpm spindle insert is permanently installed over the turntable spindle and is lightly spring loaded, so that it retracts to below turntable level when a 10- or 12-in. disk is placed over it. A cute idea.

The whole unit is smartly styled and is about as compact as a turntable of this type can be. All in all, an excellent buy for a medium-cost high-quality system.—J.G.H.

Norelco Speakers and Enclosures

SPECIFICATIONS (furnished by manufacturer): **MODEL 9762M**—a 12-in. wide-range speaker. Frequency range: 35 to 18,000 cycles, without baffle. Power capacity: 20 watts continuous, 30 watts program. Impedance: 6 to 8 ohms. Efficiency: 14% at 400 cycles. Flux density: 11,000 Gauss. Price: \$59.97. **MODEL 9760M**—a 12-in. wide-range speaker. Frequency range: 35 to 18,000 cycles, without baffle. Power capacity: 20 watts continuous, 30 watts program. Impedance: 6 to 8 ohms. Efficiency: 7% at 400 cycles. Flux density: 8,000 Gauss. Price: \$32.97. **MODEL 9710M**—an 8-in. wide-range speaker. Frequency range: 40 to 20,000 cycles, without baffle. Power capacity: 10 watts continuous, 15 watts program. Impedance: 6 to 8 ohms. Efficiency: 5% at 400 cycles. Flux density: 8,000 Gauss. Price: \$23.97. **MODEL 9750M**—an 8-in. wide-range speaker. Frequency range: 50 to 20,000 cycles, without baffle. Power capacity: 6 watts continuous, 10 watts program. Impedance: 4 to 6 ohms. Efficiency: 10% at 400 cycles. Flux density: 13,500 Gauss. Price: \$22.17. **MODEL 9770M**—an 8-in. wide-range speaker. Frequency range: 75 to 19,000 cycles, without baffle. Power capacity: 6 watts continuous, 10 watts program. Impedance: 4 to 6 ohms. Efficiency: 6% at 400 cycles. Flux density: 11,000 Gauss. Price: \$9.90. **ENCLOSURES**—**FRS-I**: bass reflex enclosure, for 9762M. Dimensions: 34 in. high by 24 wide by 17 deep. Price: \$119.95, mahogany \$109.95. **FRS-II**: bass reflex enclosure, for 9760M, 9750M, or 9710M. Dimensions: 30½ in. high by 16½ wide by 15 deep. Price: blonde or mahogany \$52.50. **FRS-III**: bass reflex enclosure, for 9770M. Dimensions: 21 in. high by 12 wide by 9¼ deep. Price: blonde or mahogany \$33.75. **MANUFACTURER**: North American Philips Co., Inc., 100 East 42nd St., New York 17, N. Y.

These are unusual loudspeakers both in construction and performance. They are essentially single-cone units, in that they use only a single voice coil and magnet assembly, although their high-frequency response is comparable to that of many true two-way speaker systems.

In the usual large-cone speaker, the voice coil actually responds to higher frequencies than the speaker is capable of fully reproducing, because the very slight elasticity of the cone paper prevents the most rapid voice coil vibrations from being converted into cone vibrations. The voice coil is vibrating, but the motion is not fully passed on to the cone, so it is not converted into air vibrations. Philips meets this problem by the addition of a second small cone, which is attached to the perimeter of the voice coil assembly and which is light enough to respond to the rapid vibrations that the

larger cone cannot follow. The result is significantly improved high-frequency range.

Five Norelco twin-cone speakers were submitted to us for testing, along with the three models of FRS enclosure. Since the enclosures were specifically designed for use with these speakers, all speaker tests were conducted in the recommended enclosures, and the comments about them which follow are based upon their performance in the FRS enclosures.

I must admit that I was taken aback by the published frequency response curves on these speakers until I realized that they represented the speakers' response *without* baffles. The 9762M's published curve, for instance, shows very smooth response between 2,000 and 12,000 cycles, but below 2,000 cycles the curve drops off fairly sharply, being at 1,000 cycles about 10 db below the 2,000 cycle level. From there down, it slopes off at about 4 db per octave down to around 80 cycles (where it is 25 db below the 2,000 cycle level). It then rises about 6 db at 50 cycles (the cone resonance frequency) and drops out sharply below that. On paper, these

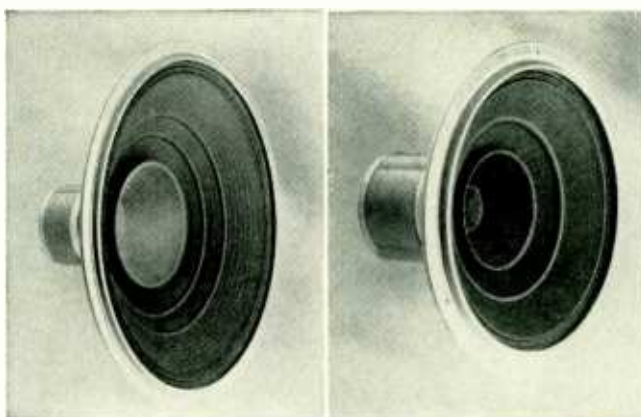

The Norelco 9760M and 9750M loudspeakers.

curves look unpromising, since in terms of frequency response they would show ± 12 db from 35 to 18,000 cycles, but I'm glad to be able to say that they do not represent the way the speakers sound when properly baffled.

Due to their high midrange conversion efficiency (see Specifications), these speakers work best when horn-loaded or baffled in bass reflex enclosures such as the FRS units. When used in its recommended enclosure, the Model 9762M speaker (whose "unusual" response was described above) produces clean, transparent sound. On musical program material, its bass is full, deep, and well defined, and the middle range is smooth and remarkably clean (which is more unusual than it may at first seem). The high range is markedly accentuated (reflecting the 10 db rise above 1,000 cycles), but extends at that level all the way out to beyond 10,000 cycles. Thus, its brightness affects not only the so-called "presence" range, but the full range of overtones as well. This gives the 9762M, like the other Norelco speakers that were tested, a brilliant sound that many people like very much.

The 9762M's efficiency is very high for a direct radiator; comparing it with speakers with which I am very familiar, I would estimate its efficiency to be in the vicinity of 8% throughout most of its range.

The 9760M's sound is quite similar to that of the 9762M, although it is a little less clean at the low end and its highs lack some of the smoothness of the more expensive unit. It has lower efficiency than the 9762M, which is to say that its efficiency is just slightly higher than that of average high-fidelity speakers.

Cone resonance on both of the 12-inch speakers measured identically . . . 51 cycles in free air. This probably accounts

Continued on page 120

*Looks Different...
is Different!*

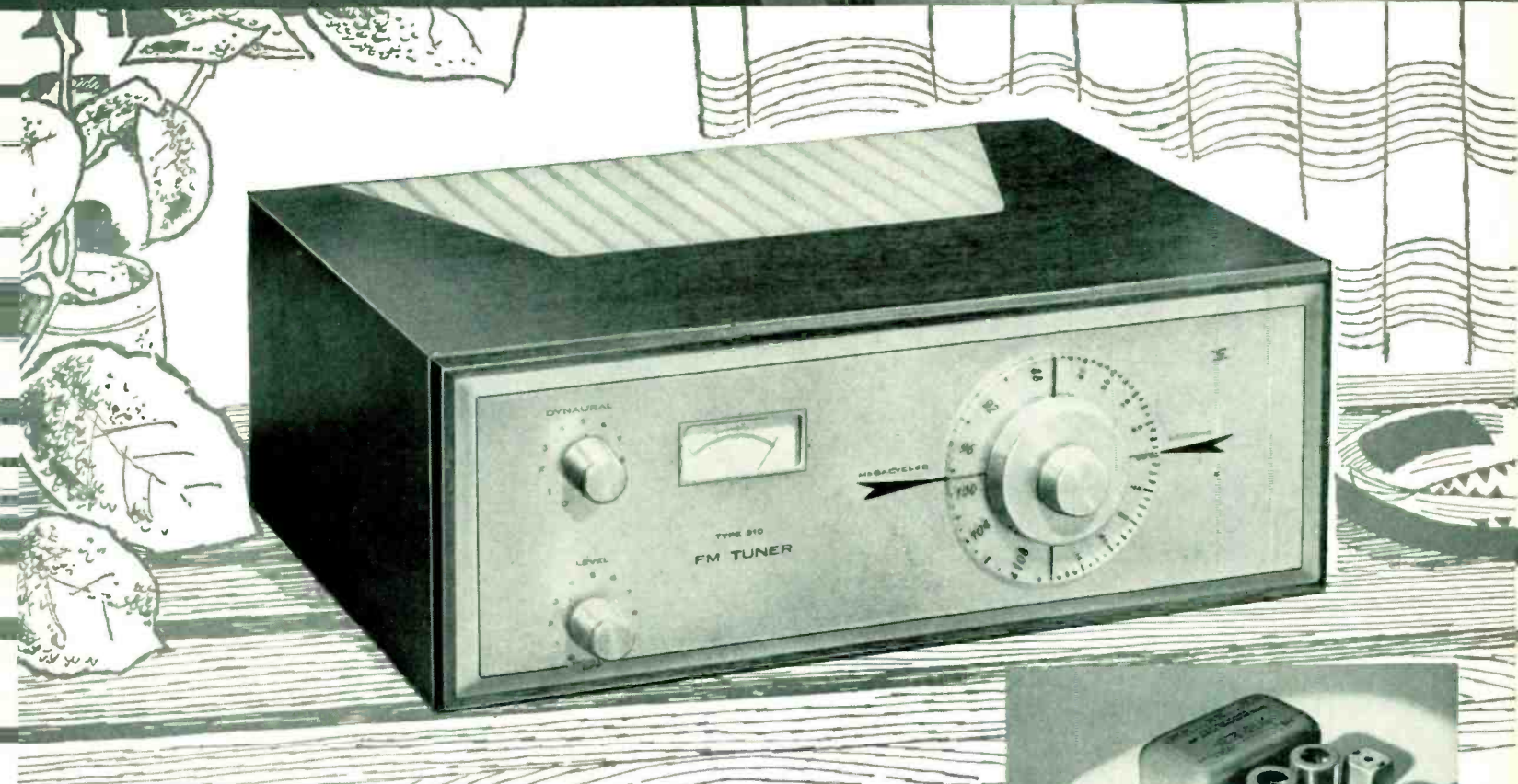

H. H. Scott Model 310-B FM Tuner 13 1/4 x 5 x 9 1/4 \$159.95 Other H. H. Scott tuners from \$119.95 (Mahogany Case \$19.95) All tuners meet FCC radiation specifications. All prices slightly higher west of rockies.

**Exclusive wide band design . . .
new silver sensitive front end . . .**

Most Sensitive . . . Most Selective FM Tuner Available Anywhere!

Wide-Band Design Makes Tuning Drift Free. Once you select a station, the 310 always stays tuned perfectly. As one 310 owner put it: "I tuned my 310 to WXHR, Boston, left it there for several weeks, simply turning it on and off each day. The 310 didn't drift off station once". With wide-band, troublesome AFC is eliminated, weak and strong signals tune alike!

Wide-Band Design Virtually eliminates cross-modulation and co-channel interference. With conventional tuners

you often pick up a strong local station at more than one place on the dial, seriously interfering with stations you want to receive. The 310 completely eliminates this . . . lets you enjoy stations you could not receive before.

Wide-Band Design gives you greater selectivity than is possible with any other tuner. The low capture ratio (2 1/2 db) inherent in wide-band circuitry plus 3 IF stages makes this possible. Now you can separate stations so close together ordinary tuners pass them right by.

Here are other important features:

- Planetary drive tuning with edge lighted dial that provides both quick and vernier tuning
- Dynaural Interstation Noise Suppressor eliminates annoying FM "roar" between stations
- Illuminated Signal Strength and Tuning Meter for accurate station setting on weak signals.

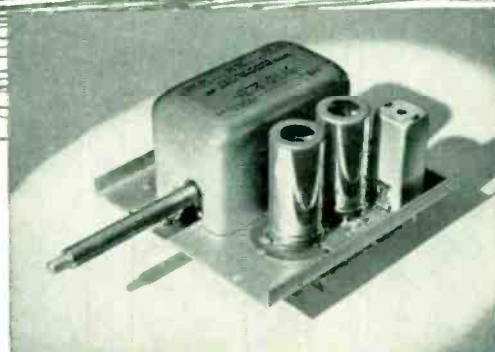

**Silver Sensitive Front End Makes
Distant Stations Sound Close By!**

H. H. Scott never compromises on design. The front end pictured above is a good example. Only H. H. Scott, of all manufacturers, heavily silver-plates their cascode RF section to obtain both maximum sensitivity and most reliable performance. Sensitivity 2 microvolts for 20 db of quieting on 300 ohm antenna terminals (1 microvolt with matched 75 ohm antenna). You'll get perfect reception of stations whose signals are too weak for tuners of conventional design.

Write for Complete Technical Specifications!



H. H. Scott, Inc.
385 Putnam Avenue, Cambridge, Mass.

Rush me your new catalog HF-1 showing the complete H. H. Scott line for 1957, including question and answer selection explaining hi-fi.

Name _____
Address _____
City _____ State _____

Export Dept: Telesco International Corp.
270 Park Avenue, New York 17, N. Y.

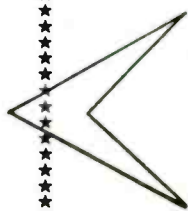

FREE! Send for H. H. Scott's
Informative Photo-Catalog Today!

TESTED IN THE HOME

Continued from page 118

to some extent for the fullness and definition of their bass.

The 8-inch speakers tested exhibited more differences in sound than did the 12-inch units, and the main differences were observed at the low-frequency end. They have in common an over-all cleanliness that is unusual in speakers of their price and size, and their high-frequency range is really remarkable. All of them extend to well beyond my 17,000-cycle hearing limit.

The 9710M is less bright than the 12-inchers, and seems to be a little smoother at the top, even though it exhibits a rising response all the way out to about 10,000 cycles. The free-air cone resonance on this speaker was so slight that it was difficult to determine, but it seemed to occur at around 54 cycles.

The 9750M is about mid-way between the 9710M and the 12-inch units insofar as brightness is concerned, and seems to be somewhat smoother in its middle-to-treble range than the higher-priced units. Its cone resonance is higher than the other units, occurring at about 80 cycles, and while this gives its low end a slightly fuller sound, the speaker obviously does not extend as far down as do the others.

The 9770M, though, was a real surprise. For a \$10 loudspeaker, this is really much better than anyone has a right to expect. Despite its 90-cycle cone resonance and rather unimpressive-looking published response curve, it produces surprisingly full-bodied and wide-range sound. It has a small response peak in the middle-high-frequency vicinity which tends to accentuate the flaws in unclean recordings, but in direct comparison with the higher-priced speakers, this unit fares very well. It is, like the other Norlco speakers, quite bright-sounding, but this is nicely offset by a fairly heavy low end. Used in its recommended FRS III enclosure, this is an ideal small speaker that represents a very good dollar buy. As a matter of fact, the Norelco 9770M when used with a 4,000-cycle crossover network would probably make a fine tweeter for use with a budget-priced two-speaker system.

None of these speakers use standard American mounting centers; the 9710M and the 9750M mount by means of three holes drilled at 120-degree intervals around the perimeter of the speaker frame, while the others attach by means of small clamps around the speaker's edge. There is, of course, no mounting problem if the speakers are used in their FRS enclosures, and since these are precisely matched to the speakers' characteristics, and are very ruggedly constructed and handsomely finished, they are the logical enclosures to use. — J.G.H.

Pedersen PCP-20 Tri-Amp Amplifier

SPECIFICATIONS (furnished by manufacturer): a single-chassis control amplifier. **Rated power:** 20 watts. **Frequency response:** ± 0.5 db, 15 to 30,000 cycles. **IM distortion:** below 1.0% @ 15 watts out; below 0.25% @ 10 watts out. **Inputs:** Tuner, TV, Mag. Phono. **Controls:** selector-equalizer (Radio, TV, Phono . . . AES, COL, RIAA, NAB, Microphone); volume and AC power; bass (± 15 db, 50 cycles); loudness compensation; treble (± 15 db, 10,000 cycles). **Outputs:** 4, 8, 16 ohms and Tape. **Inverse feedback:** 12 db. Excellent transient response. Two switched AC convenience outlets. **Tubes:** 2—12AX7, 12AU7, 2—5881, 5Y3-GT. **Dimensions:** 4 in. high by 14½ wide by 7 deep. **Price:** \$112.50. **Cabinet:** \$10.00 extra. **MANUFACTURER:** Pedersen Electronics, 3667 Mt. Diablo Blvd., Lafayette, Calif.

In operation, the Pedersen Tri-Amp behaves much like several of the better compact amplifiers on the market, as far as freedom from noise and smoothness of tone control

are concerned. The tone controls vary the bass and treble balance (variable slope) rather than affecting the frequency extremes (variable turnover or inflection), and phono equalization is quite accurate.

Hum is very low. It is the PCP-20's sound, however, that distinguishes it. Among the available compact, single-chassis amplifiers this is one of the very sweetest-sounding I have heard. The bass is full and solid, and the over-all sound is pleasantly unforced and uncolored at all levels up to its overload point. In this respect also it behaves very well, having excellent overload recovery characteristics and a high degree of bass and treble stability on a wide variety of loads. These are probably some of the reasons why, despite its rating of 1% IM distortion at 15 watts, the PCP-20 sounds like a much higher-powered amplifier than it actually is.

Three input receptacles on the Tri-Amp amplifier accept four input facilities. Two switched high-level inputs are for a tuner and TV sound (or tape recorder); the third input is

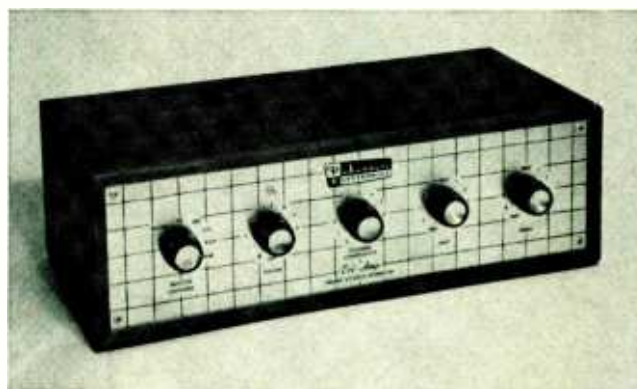

The 20-watt Tri-Amp in its cabinet.

for a magnetic pickup cartridge or a high-impedance microphone.

The selector-equalizer switch provides four equalization positions for the magnetic phono input, while the fifth high-gain position removes the bass boost and treble rolloff so a microphone can be fed into the high-gain input. The phono input receptacle is terminated in 47,000 ohms resistance, which is optimum for most cartridges, although the load resistor is readily accessible should another value be called for.

Two front panel volume controls are provided, one of which functions as a regular level-set control and the other as a loudness contour control. With the contour control set in its full "up" position, the VOLUME control alone can be used for uncompensated level adjustment; if loudness compensation is desired, the VOLUME control and LOUDNESS COMPENSATOR are used together, with the setting of the LOUDNESS control determining the degree of compensation and the VOLUME control determining the over-all listening level. The VOLUME control then operates exactly as would a rear-chassis input level-set control.

A glance at the chassis construction of the Tri-Amp suggests that real thought was devoted to ease of servicing. The entire rear of the chassis is detachable, exposing the underside of the tube sockets along with all the internal components. Since the two output tubes on the unit are mounted very close together, one above the other, care should be taken when installing the Tri-Amp to insure adequate ventilation; otherwise excessive heat may shorten the life of the upper tube and the electrolytic capacitor mounted next to it.

The Tri-Amp would be a good buy at a higher price. At \$112.50, it is an ideal starting point for a moderately-priced system designed to sound like an expensive one. — J.G.H.

At home with the finest...

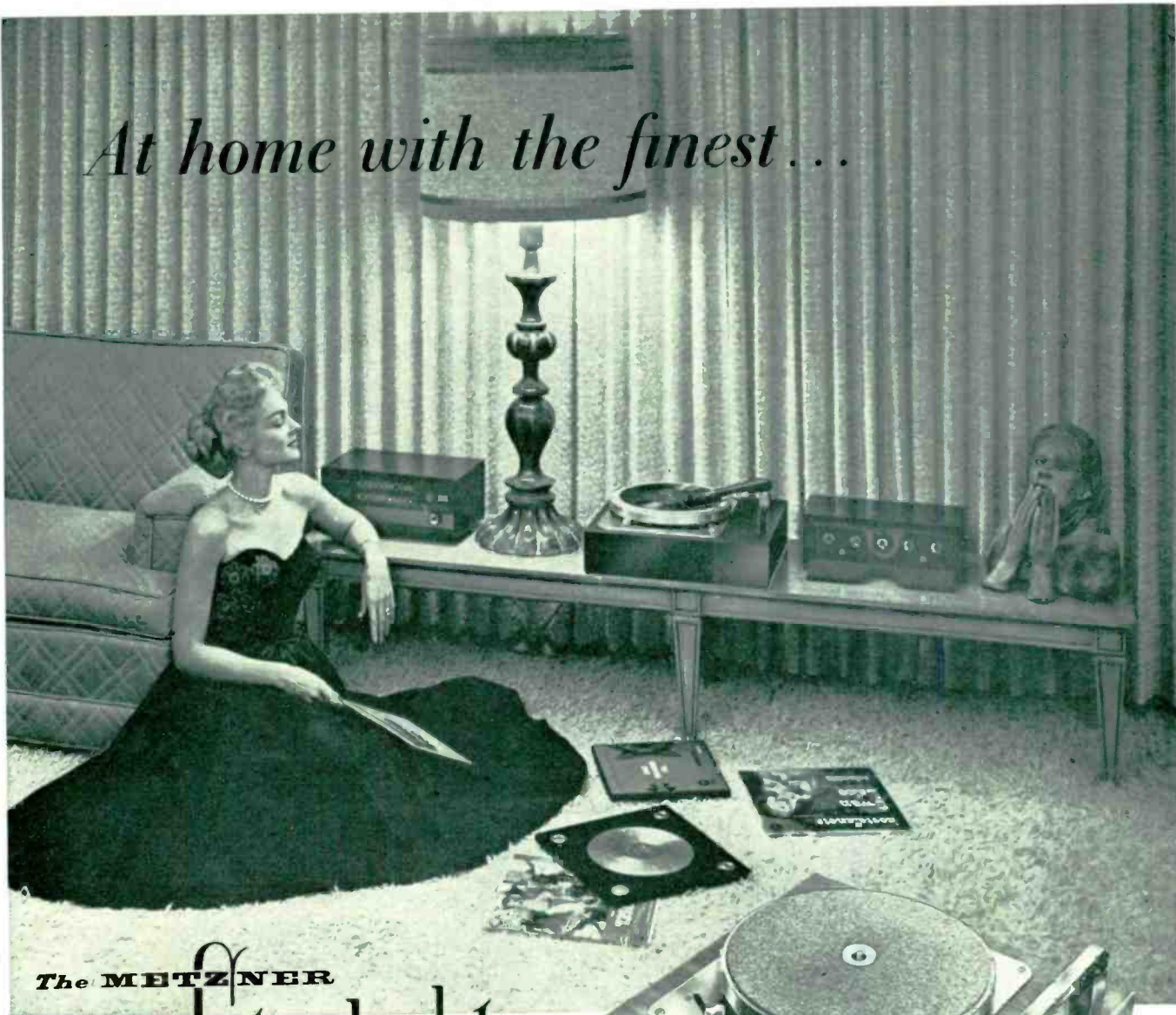

The METZNER

Starlight

HIGH FIDELITY TURNTABLE



Base
Turntable
Transcription Arm
Complete
\$94.50
Inc. Fed. Tax

Stars in her eyes... romance in her heart... music in the air... and not even a whisper from the Starlight Turntable to disturb her reverie! Mechanical noises that snuff out delicate pianissimo passages are a thing of the past when you own the fabulous Starlight with exclusive center-drive system! No slapping belts—no noisy pulleys—no growling idlers... nothing to mar the sheer enjoyment of the music you love to hear.

See Starlight today... you'll learn why it is the first choice of discriminating music lovers!

Sold by Leading Hi Fidelity Dealers... EVERYWHERE!

- ★ Illuminated Stroboscope — reads while the record is playing.
- ★ Continuously variable speed control with exact settings for 16 $\frac{2}{3}$, 33 $\frac{1}{3}$, 45 & 78.26 RPM.
- ★ Rumble and noise more than 40db below NARTB standard reference level of 7 cm/sec. at 500 cps.
- ★ Wow and flutter less than 0.2% RMS.
- ★ Exclusive double wrist action transcription arm with instant adjustment from 4 to 14 grams.
- ★ Massive base of 1 inch laminated hardwood in Blond or Decorator Black finish.

Turntable \$59.50 Arm \$22.50 Base \$17.50

Metzner ENGINEERING CORPORATION
1041 NORTH SYCAMORE AVE., HOLLYWOOD 38, CALIF

only LAFAYETTE can do it!

OUR DIRECT IMPORTATIONS

YOU SAVE IMPORTERS PROFIT!

SAVE 33 1/3-50%

PROFESSIONAL TRANSCRIPTION TURNTABLE AND VISCOUS-DAMPED TONE ARM

THE FINEST TRANSCRIPTION TURNTABLE AND TONE ARM FOR THE PROFESSIONAL USER AND THE AUDIOPHILE



PK-100 TURNTABLE, PK-90 TONE ARM AND G.E. CART-RIDGE WITH GENUINE DIAMOND AND SAPPHIRE STYLUS.

72.50

COMBINATION DEAL

PK-100A TRANSCRIPTION TURNTABLE
New 3-speed instrument with built-in stroboscope and viewer for exact speed determination, and magnetic brake for instantaneous speed variation. Precision engineered to meet professional standards for wow, rumble and flutter content. Heavy 12" cast aluminum rim-driven turntable. Variable speed control permits adjustment of each speed within $\pm 7\%$ using efficient frictionless magnetic brake. Heavy-duty constant speed 4-pole induction motor freely suspended and isolated by shock-mountings to eliminate vibration transfer. R-C filter network suppresses "pop" in speaker. Truly a delight for the connoisseur. Size: 13 1/2" x 14" and requires 2 3/4" clearance above and 3 3/4" below motorboard. For 110-130V and 60/50 cycle AC. Power consumption 12 watts. Handsome hammertone gray finish. Shpg. wt., 20 lbs.

PK-100-A

PK-90 VISCOUS-DAMPED TONE ARM

Net 49.50

This transcription arm assures dependable and stable operation, utilizing the "floating action" principle of "viscous-damping." The arm is supported at a single point by a pivot and jewel bearing having negligible friction. Damping is accomplished by a silicone fluid occupying the gap between a ball and socket. This damping control permits high compliance and negligible tracking error, and prevents damage to either record or stylus should the tone arm be accidentally dropped. Low frequency resonance, skidding and groove-jumping are likewise minimized. The tone arm accepts all records up to 16" and accommodates virtually all hi-fi cartridges by means of precisely engineered adapters which simplify installation and provide proper stylus pressure.

This tone arm is a quality companion to the PK-100 with matching finish. Shpg. wt., 2 1/2 lbs.

PK-90

Net 15.95



NEW! HIGH FREQUENCY TWEETER WITH ACOUSTIC LENS
DIRECT IMPORTATION
MAKES THIS PRICE POSSIBLE!

14.95

- FREQUENCY RESPONSE FROM 2000 CPS TO BEYOND AUDIBILITY
- LOUVERED ACOUSTIC LENS FOR UNIFORM SOUND DISPERSION
- HANDLES 25 WATTS OF POWER
- PRICED EXCEPTIONALLY LOW

New high frequency tweeter featuring a louvered acoustic lens for uniform sound dispersion and capable of handling up to 25 watts of distortion-free power. The directional tendency of high frequency notes is overcome by the natural wide dispersion angle of the short horn and the acoustic lens which disperses and radiates the high notes smoothly throughout the entire listening area. The lens is detachable for panel mounting, with a separate base for the tweeter furnished for external mounting where desired. Aluminum voice coil has 16 ohms impedance. Size: 4 1/4" long x 3" diameter, lens extends 2 1/2". Requires a crossover network, preferably one with a level control, such as the LN-2. With full instructions. Shpg. wt., 5 lbs.

HW-7

Net 14.95

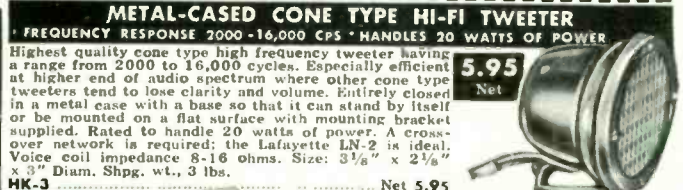

METAL-CASED CONE TYPE HI-FI TWEETER
FREQUENCY RESPONSE 2000-16,000 CPS • HANDLES 20 WATTS OF POWER

5.95
Net

Highest quality cone type high frequency tweeter having a range from 2000 to 16,000 cycles. Especially efficient at higher end of audio spectrum where other cone type tweeters tend to lose clarity and volume. Entirely closed in a metal case with a base so that it can stand by itself or be mounted on a flat surface with mounting bracket supplied. Rated to handle 20 watts of power. A crossover network is required; the Lafayette LN-2 is ideal. Voice coil impedance 8-16 ohms. Size: 3 1/8" x 2 1/8" x 3" Diam. Shpg. wt., 3 lbs.

HK-3

Net 5.95



8.75

CROSSOVER NETWORK

- CAPACITIVE INDUCTIVE NETWORK WITH CROSSOVER AT 2000 CPS
- BUILT-IN LEVEL BRILLIANCE CONTROL

The frequencies above 2000 cycles are channeled to the high frequency tweeter by means of the high-Q inductance and capacitance comprising this efficient crossover network. The highs and lows are brought into acoustic balance by means of a continuously variable level-brilliance control. Control has a 2 1/2 ft. long cable for remote mounting. Network matches 8-16 ohm speakers with insertion loss reduced to a minimum. Enclosed in metal case 6" L x 2 3/8" H x 2 3/8" D. With full instructions. Shpg. wt., 5 lbs.

LN-2

Net 8.75



NEW!
Reg. Price **44.50**
Net **29.50**

IMPORTED 12" HI-FI COAX. SPEAKER

- FREQUENCY RANGE 30-15000 CPS
- HANDLES 20 WATTS OF POWER
- COMPLETE WITH LEVEL CONTROL
- POWERFUL TSK-5 MAGNETS
- SPECIAL SHEEPSKIN-EDGED CONE

A Lafayette exclusive import and exceptional value. Consists of a 12" woofer, coaxially mounted 2 1/2" tweeter and a built-in crossover network. The specially processed fibre cone has a sheepskin edge to suppress unwanted nodal vibrations and insure beautiful tone quality. Highly efficient TSK-5 magnets. Level control provides variation to 6 db cut. Maximum input 20 watts. Impedance 8 ohms. Rugged all-metal frame. If made in this country, would cost at least \$49.50. Shpg. wt., 11 lbs.

SK-58 Net 29.50

3 WAY CROSSOVER NETWORK

Carefully designed and engineered to Lafayettes own specifications. Insertion loss is well below the acceptable minimum. Crossover is at 350 and 5000 cycles. Permits full enjoyment of any 3 way system. Properly balances woofer-mid range speaker and tweeter inputs. Complete with 2 continuously variable "presence" and "brilliance" controls for tonal adjustment and full instructions. 8" L x 3 3/4" H x 2 3/4" W. Shpg. wt., 7 lbs.

LN-3 Net 14.95



3 WAY HI-FI SPEAKER SYSTEM



SK-74

55.50

SK-67

- 15" Woofer with 31.5 oz Magnet
- 8" Mid-range speaker
- Acoustical Lens Tweeter
- 3-Way Crossover Network

A complete 3-way system capable of performance heretofore found only in systems at many times this price. The components were specially selected by Lafayette sound engineers to offer the maximum in audio fidelity at the lowest price possible. Includes continuously variable presence and brilliance controls. Offers superb reproduction across the entire audio spectrum. Shpg. wt., 25 lbs.

SY93 Net 55.50

Lafayette Radio
DEPT WA

165-08 Liberty Ave. JAMAICA 33, N. Y.

SEND FREE LAFAYETTE CATALOG

NAME _____
ADDRESS _____
CITY _____
ZONE _____
STATE _____



CUT OUT AND MAIL TODAY!

Lafayette Radio

100 SIXTH AVE., NEW YORK, N. Y. BOSTON, MASS., 110 Federal St. PLAINFIELD, N. J., 139 West 2nd St. NEWARK, N. J., 24 Central Ave. BRONX, N. Y., 542 E. Fordham Rd.

music listeners' bookshop



Save yourself time and trouble by ordering your books directly from us. Just fill in the coupon below and mail it to us with your remittance.

HIGH FIDELITY RECORD ANNUAL: 1956

Edited by ROLAND GELATT. The second volume in the planned series of *High Fidelity Record Annuals*. Included in this new collection are reviews of classical music and the spoken word which appeared in HIGH FIDELITY Magazine from July 1955 through June 1956. Comparisons with recordings of previous years are emphasized. A performer index is included. \$4.50 237

MAINTAINING HI-FI EQUIPMENT

By JOSEPH MARSHALL. A much needed book on the specialized approach necessary to service high-fidelity equipment. The author discusses not only electronic faults, but the mechanical and acoustical defects which cause a hi-fi system to function less than perfectly. Hard cover, \$5.00 232 Soft cover, \$2.90 233

THE FORMS OF MUSIC

By SIR DONALD FRANCIS TOVEY. Written by one of the most literate and profound of modern interpreters of music—its theory and history, these essays are all drawn from those articles on music which Tovey prepared for the *Encyclopaedia Britannica*. There are in all twenty-eight articles on different kinds and elements of music—aria, chamber music, concerto, harmony, mass, melody, opera, programme music, sonata, symphony, and others. Paper, \$1.35. 239

THE REAL JAZZ OLD AND NEW

By STEPHEN LONGSTREET. This big, lavish book by "the most readable of American writers" (*Time*) tells the whole exciting story of jazz—from Beiderbecke to Brubeck—in the words of the men who made it. Thirty on-the-spot drawings by the author. \$5.00 240

MAN OF HIGH FIDELITY: EDWIN HOWARD ARMSTRONG

By LAWRENCE LESSING. The first full account of the life of one of the great American inventors of our time and the single most important creator of modern radio—the man who gave the world FM radio. \$5.00 241

THE GROWTH OF MUSIC A STUDY IN MUSICAL HISTORY

By H. C. COLLES. This work, first published over 40 years ago, and now revised and brought up to date by Eric Blom, is generally agreed to be among the best of all short histories of music. It provides a sound and lucid guide to the history of European music. 3 volumes in 1, \$7.00 242

HI-FI YEAR BOOK

Edited by MILES HENSLOW of *Hi-Fi News*

The first complete, authoritative handbook about hi-fi in England. Not only the basic concepts of high-fidelity sound reproduction but complete descriptions of all major British hi-fi components.

Percy Wilson in *The Gramophone* says: "I know of no other book like it, or one that is so full of up-to-date and highly informative technical matter." \$2.25 238

HIGH FIDELITY A Practical Guide

By CHARLES FOWLER, Publisher of HIGH FIDELITY Magazine

Whether your budget is small or large, whether you are a beginner or a devotee from way back, this complete and definitive guide can help you get the most enjoyment out of your high-fidelity system.

Here is the practical, expert advice needed by everyone who has, or expects to have, a high-fidelity system. Starting with an introduction to sound, the author then describes the various links in the hi-fi system, explaining their features and specifications so as to provide the most helpful criteria for evaluating, and for selecting and matching components. \$4.95 234

TAPE RECORDERS AND TAPE RECORDING

By HAROLD D. WEILER. Written by the author of the best-selling *High Fidelity Simplified*, this book supplies the amateur and semiprofessional tape recordist with sound, practical, and factual information about all aspects of tape recording—microphones and their placement for both indoor and outdoor recording, room acoustics, sound effects, recording from disks and off-the-air, maintenance, etc. Paper, \$2.95 225 Cloth, \$3.95 243

OPERA AS DRAMA

By JOSEPH KERMAN. In this new book Mr. Kerman rejects the common partial views that opera is a musical score hoisted on the stage or a play with musical adjuncts. He affirms that it is an art form with its own integrity, a type of drama in which the essential imaginative articulation is provided at every step and in the totality by music. Through penetrating musico-dramatic analyses of many central works in the operatic canon, *Opera as Drama* evaluates the successive solutions to the problems of operatic dramaturgy. \$4.50 235

Of this book, Eric Bentley wrote: "I can only say I had dreamed of writing such a book myself, and contemplate Mr. Kerman's fine work with a sweet, painful blend of envy and admiration."

Book Department
HIGH FIDELITY Magazine
Great Barrington, Mass.

I enclose \$ _____ for which please send me, postpaid, the books indicated by the circled numbers below. (No. C.O.D.s or charge orders, please.) Foreign orders sent at buyer's risk. Add 55¢ per book for postage on foreign orders except Canadian.

Binder 6b \$2.95 each

NAME	225	238
.....	232	239
.....	233	240
ADDRESS	234	241
.....	235	242
.....	237	243

the Magnificent

Ferrograph



Model 3A/N
(portable)
with built in
speaker.
3¾-7½ ips
\$379.50

The world's finest hi-fi tape recorder

The ultimate in high-fidelity tape recorders for home and professional use. Dual-speed, dual-track FERROGRAPH recorders are also available in custom models (tape decks available, from \$195.) and with 7½ and 15 ips speeds. Independent field performance tests rate Frequency Response at ± 2 db between 50 and 10,000 cycles with wow and flutter less than 0.2% at 7½ ips.

Quality standards have restricted our production and unforeseen demand may delay delivery, write TODAY for literature.

ERCONA CORPORATION

(Electronic Division)

661 Fifth Ave., Dept. 45, New York 17, N. Y.

In Canada: Astral Electric Co. Ltd.
44 Danforth Road, Toronto 13

If You're a Connoisseur...
you'll want a
Connoisseur
TURNTABLE



\$110.00

Compare the Connoisseur with any turntable and you'll marvel at its performance. Non-magnetic, 12" lathe-turned table; precision ground spindle; phosphor bronze turntable bearing; ±2% variation provided for all 3 speeds; hysteresis motor.

TURNTABLE: Rumble—better than 50 db down; Wow—less than 0.15% of rated speed; Dimensions: 13½x15¼".

PICKUP: Frequency Response — 20-20,000 cps ± 2 db at 33¾ rpm; Effective Mass—4 mg; Impedance—400 ohms at 1000 cps.



"Dynabanced" tone arm with Mark II super-lightweight pickup w/diamond stylus \$49.50 . . . w/sapphire stylus \$34.50.

ERCONA CORPORATION

(Electronic Division)

551 Fifth Ave., Dept. 46, New York 17

In Canada, write Astral Electric Company Limited, 44 Danforth Road, Toronto 13

HIGHLAND BAGPIPE

Continued from page 56

"Hiundratateriri" of the closing section. *Cannaireachd* is now obsolete, but the fact that it existed not only ensured the survival of the pibroch during the period after the '45 when Highlanders were forbidden sword and bagpipe, but also makes it safe to assume that we hear the older pibrochs — and some date back to about 1500 — very much as they were originally played. The eighteenth-century habit among singers and instrumentalists of adding their own *fioriture* to the music they performed did not, it appears, extend to the Highlands, though no doubt it was known in Edinburgh.

The Middle Music of the pipes is a difficult category to determine. It might be defined as abridged pibroch, denoting music of similar serious character but without its length or form. Among laments, those usually heard at civil and military ceremonies of burial or commemoration are *Lochaber No More* and *The Flowers of the Forest*. The former dates from the days when Jacobites found themselves obliged to take exile knowing that they would not again see Lochaber, the area about

Fort William and Glenfinnan. In the 'Seaforth Collection' the tune is described as a funeral salute and the volleys of the firing party are indicated in conjunction with it.

Finally, the Little Music. Strathspeys and Reels are the basis of Scottish national dances, and the traditional, intricate steps have their equivalent in the gay, nimble music to which they are danced. In city and hamlet, wherever there are Scotsmen, dancing takes place. One finds the same care in the execution of the prescribed steps at a ball, where the men wear formal Highland dress, complete with lace jabot and buckled shoes, and the ladies sashes of clan tartan across their gowns; and in the village hall where Big Tam sports shirtsleeves with his kilt and Wee Jean a jumper and tartan skirt. Your foreigner, meanwhile, is conspicuous in tails or gray flannels.

The accompanying music needs to be correctly accented and, for this reason, fiddle and accordion bands, with a rhythm section to emphasize the beat, are commonly found instead of a solo piper, whose tapping foot is a metronome for himself and not for

*This book containing standardized settings, for the Seaforth Highlanders, of a comprehensive selection of pipe tunes is widely used among pipers.

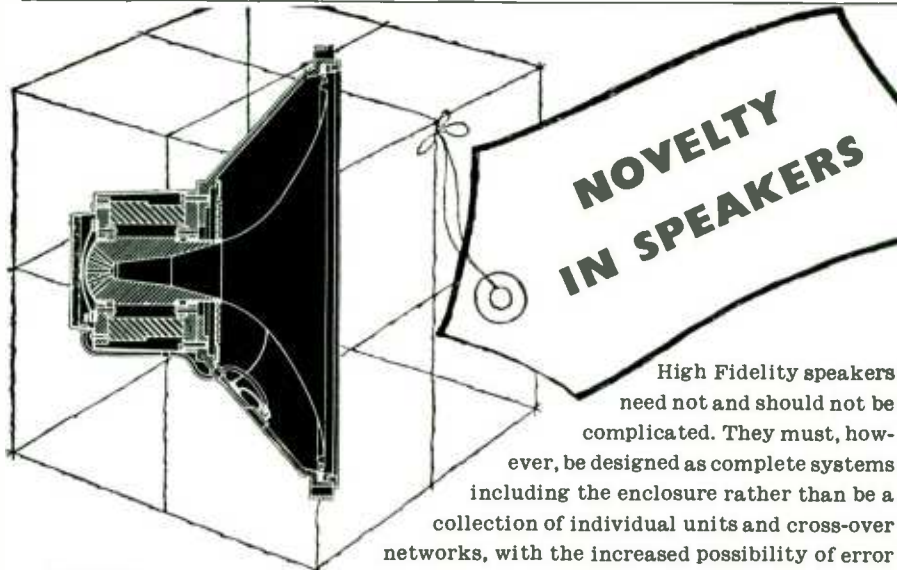

BASIC SPECIFICATION

12" and 15" models

Frequency response
30—20,000 c.p. ± 3dB.

Polar Distribution for
60° inc. angle—4dB.
at 10,000 c.p.s.

Intermodulation
Products
less than 2%

High Fidelity speakers need not and should not be complicated. They must, however, be designed as complete systems including the enclosure rather than be a collection of individual units and cross-over networks, with the increased possibility of error and the lack of necessary equipment for tests in the home when finally assembled. Few people would obtain a motor-car by buying the engine, chassis, body etc. and assembling it at home. They would rightly regard this as a job for expert engineers — and so with loudspeakers, where naturalness not novelty is the desired result.



DUAL CONCENTRIC SPEAKERS

TANNOY (AMERICA) LTD. 38 PEARL STREET, NEW YORK, 4, N.Y., U.S.A.
TANNOY (CANADA) LTD. 36 WELLINGTON STREET EAST, TORONTO 1, ONTARIO, CANADA

STRAIGHT TALK from Lectronics on Power Amplifiers

Many music lovers are terribly confused concerning the power requirements for high quality reproduction in the home. One common misapprehension is expressed: "I would like the quality of a high powered amplifier, but my speaker is rated at only twenty-five watts."

There is, in fact, no direct relation between speaker ratings and total amplifier output. For instance, I have found that my own speaker, which is rated at six watts continuous power, only begins to give real dynamic impact on a true fifty watt amplifier—one capable of furnishing the short duration, dynamic musical pulses that give color and power to music. It is, then, not so much a matter of how many watts one uses continuously, or can on test equipment; as it is a matter of ability to handle faithfully the dynamic power peaks that are part of music. Indeed, I have already measured (by certain new techniques) very short peaks up to fifty watts going into my six watt speaker!

Regardless of the technical controversies, the bigger amplifiers produced more musical quality with any loudspeaker. Every listener, even the casual one, comments on the improvement, on the greater solidity of bass passages, and the smoother, sheenier, string sound. Even the experts who publicly argue for moderate powered amplifiers, on a technical basis, will privately concede that, with a big amplifier, "It sounds better."

The Custom Series amplifiers were designed for better listening, rather than as technical tour de forces. With no gadgets or gimmicks, they definitely fulfill their purpose, to give the music lover better listening at a moderate price. The music lover can now enjoy his system more fully, without bankrupting himself for the sake of useless gadgets that contribute nothing to the musical result. The Custom Series Brochure describes the reasons in greater detail. The Custom "56" has been proven time and again on all kinds of music to outperform any other known amplifier. The Custom "100" is designed expressly for the perfectionist who will always insist on the final refinements. Its unique dual chassis construction, oversized power and output transformers, complete laboratory quality of design and construction show that it is intended to provide final quality under home conditions for years to come. Indeed, each of these amplifiers is covered by a two year unconditional guarantee, without parallel in the industry!

Distribution is naturally restricted to the kind of dealer who is equipped to give you fully personalized attention, and completely experienced technical assistance—the kind of service for which ELECTRONICS has become famous. You can be sure that your franchised CUSTOM SERIES dealer is the kind with whom you will want to do business in general!

Sincerely
Irving M. Fried

A brief resume of specifications. More complete specifications are available in the CUSTOM SERIES Brochure.

The Custom "56" \$119.95

Power: 50 watts continuous at .5% I.M. or lower rapidly decreasing at lower powers

Response: Plus or minus 1/2db. from 6cps to 60KC, with gradual roll-off beyond, for stability on large electrostatic systems

Stability: Virtually absolute

Tubes: 6BA8, 6550(2), 5U4GB

Hum and Noise: less than 2mv. absolute, referred to open circuit

The Custom "100" \$199.50

Power: 100 watts continuous at .5% I.M. or lower 50 watts at .2% I.M. or lower

Response: Same as above, with marginally improved stability on the larger electrostatic systems

Tubes: 6BA8, 6550 (4), 5U4GB(2)

Hum and Noise: same as above

Construction and weight: dual chassis, with separate power supply. All transformers fully encased. 8 7 16 ohm leads fused against continuous speaker overload. Bias and laboratory quadri-balance controls sealed against tampering.

At your franchised CUSTOM SERIES dealer,
or order direct.

ELECTRONICS
CITY LINE CENTER, PHILA. 31, PA.

the dancers. Jimmy Shand of Dundee and Tim Wright of Edinburgh are two who have achieved well-merited fame with their Scottish country dance bands. But let Captain Topham, an English visitor to Scotland in the early eighteenth century, have the last word: "When the company tired of conversation they began to dance reels. They will sit totally unmoved at the most sprightly airs of an English country dance but the moment one of these tunes is played, which is liquid laudnum to my spirits, up they start . . . and you would imagine they had been bit by a tarantula."

And the March—ever since kilted warriors strode in broken file across the hills to settle, with broadsword and shield, a difference with another clan, the bagpipe has been the surest means of lightening exhausted limbs for extra, impossible miles and for summoning the final reserves of strength and courage in war. On the battlefield it achieves mystical stature. No bugle can urge men to deeds of valor as the pipes do. In the blood and spirit of a man they sing the proud song of independence and fortitude. Perhaps the most effective of all fighting tunes is *The Black Bear*, which has in it pauses to be filled with shouts.

Nor is the effect of the pipes limited to terra firma. In 1795, when H. M. S. Colossus, with a Highland regiment aboard, was in action with a French ship, a piper played for three hours, precariously perched in the rigging.

Napoleon, that archperpetrator of military maxims, remarked that in war morale was to manpower as three is to one. Many a Scot has felt the same way. For example there was Fhairshon who

. . . swore a feud

Against the clan M'Tavish,
Marched into their land
To murder and to ravish;
For he did resolve
To extirpate the vipers
With four and twenty men
And five and thirty pipers.

The poem, by W. E. Aytoun, is called *The Massacre of the Macpherson*, who was quietly done in after his men had deserted to round up the local livestock; one supposes that M'Tavish had right on his side, or more pipers. Nevertheless, Macpherson's signal failure must be regarded as a phenomenon, for the value of the pipes in sus-

Continued on next page

Encore! Encore!

You applauded the first volume of reviews from *High Fidelity* . . . Now here's the ALL-NEW 1956 ANNUAL—the only up-to-the-minute book of Long-Play reviews



HIGH FIDELITY Record Annual: 1956

Edited by ROLAND GELATT. Now you can have the second invaluable volume in the planned series of *High Fidelity Record Annuals*. The first volume, which went with a crescendo, was made up of reviews that appeared in *High Fidelity* during 1955. HIGH FIDELITY ANNUAL: 1956 brings you the reviews from your favorite magazine for the current year. These reviews cover both the performances of the artists and the quality of the recordings. All types of serious music—vocal, chamber, orchestra—are reviewed, as well as recordings of the spoken word, drama and poetry.

INDISPENSABLE AND UNIQUE

Edited, and with a foreword, by Roland Gelatt, *High Fidelity's* New York editor, this is the *only new and up-to-the-minute* collection of record reviews of the year. HIGH FIDELITY RECORD ANNUAL: 1956 contains reviews by such well-known and authoritative contributors as C. G. Burke, Alfred Frankenstein, Paul Affelder, John M. Conly, Nathan Broder and Max de Schauensee. Comparisons with recordings of previous years are emphasized, and there is a handy performer index at the back of the book.

MAKE SURE OF HAVING BOTH ANNUALS

When you have the HIGH FIDELITY ANNUALS for 1955 and 1956, you won't have to go to the trouble of looking up back issues of the magazine or fret about mislaid copies. You'll have all the brilliant criticisms (your tested guide to buying Long-Play records) right at your finger tips. We are so sure of the value of these ANNUALS to you that we offer *either or both* of them to you on a MONEY-BACK GUARANTEE. You take no risk—just mail the coupon TODAY!

At your bookstore, or mail the coupon for
TEN DAYS FREE EXAMINATION

J. B. LIPPINCOTT COMPANY, E. Washington
Sq., Philadelphia 5, Pa. HF-J

Please send me:
HIGH FIDELITY RECORD ANNUAL 1956
at \$4.50

HIGH FIDELITY RECORD ANNUAL 1955
at \$4.95

Within ten days I will mail you the price of the book(s), plus a few cents postage, or will return the book(s) postpaid.

Name

Address

City Zone State

SAVE: If cash accompanies order, we pay postage!

*Send today
for your complete
catalog*

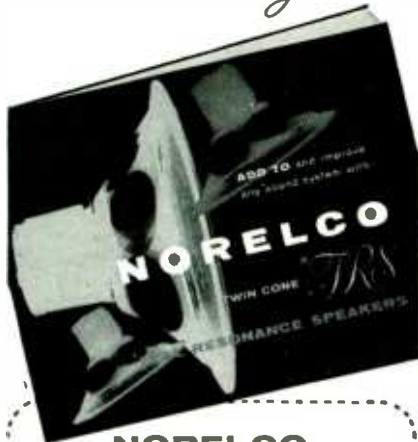

NORELCO
**F.R.S. SERIES*
**FULL RESONANCE
TWIN-CONE
SPEAKERS**



Norelco's twin-cone speakers are designed to meet the problem of high and low frequency dispersion in a single speaker. The large (heavy) cone is designed to produce good bass while the small (light) cone radiates higher frequencies.

Eliminating operating inefficiency experienced in multiple speaker cross over systems, Norelco's twin-cone is driven by a single voice coil—producing a flat response with exceptional reproduction of transients. Based on economy and value any one of the Norelco FRS twin-cone speakers is your best choice. If your neighborhood dealer does not stock Norelco write direct to North American Philips Company, Inc. giving your dealer's name and address.

ADD TO . . . and improve any sound system with **Norelco®**
***FULL RESONANCE SPEAKERS**



Write today to Dept. K-1 for brochures and prices of these unique speakers.

North American Philips Co., Inc.
100 E. 42nd Street
New York 17, N.Y.

HIGHLAND BAGPIPE

Continued from preceding page

taining fighting men is widely recognized.

This accounts for the special position held in Scottish (including Lowland) regiments by the Pipes and Drums. They are in a sense guardians of the regimental tradition, since their music, recalling incidents in peace as well as war, is a more tangible, personal link with the past than the battle honors on the colors. In fact, it harks back further to the clan system on which the original formation of Highland regiments was based.

To belong to the Band is a jealously guarded privilege, and no day passes in a Highland unit without the sound of the pipes. Even if there is no parade they can be heard interpreting for Scotsmen the standard camp-duty calls which punctuate the day, from reveille to lights-out. Then bring all the pipes together and give them drummers too, and the most routine parade becomes a stirring event, even in days of peace when the emotions are less vulnerable. On the order to march, the drums⁵ beat up for eight paces while the pipers blow the bag full. As the elbow applies pressure, there is a brief wail up to the correct pitch, and suddenly the tune is launched. It is an illustration of the temperamental nature of the instrument that sometimes in winter, when the drums have started, not a sound emerges from the pipes—the reeds have frozen in the interval between tuning in the band room and getting on parade.

On formal evenings in the Officers' Mess, music belongs as much to the occasion as the loyal toast. During dinner, three or four pipers play marches, shuffling round the table with their characteristic loping gait. They halt to introduce a strathspey and reel to their selection. From each set of pipes hangs a banner bearing the arms of the senior regimental officers present. Later the Pipe Major returns alone to give his pibroch in the silence always accorded to the Great Music. His performance ends abruptly; it is invariably so for the elbow comes sharply away from the bag at the end of any tune. The ritual is completed only when the Mess President has offered a quail of whisky to the Pipe Major who

⁵Drum settings vary and an expert can distinguish between bands by the drumming figure used in a particular tune.

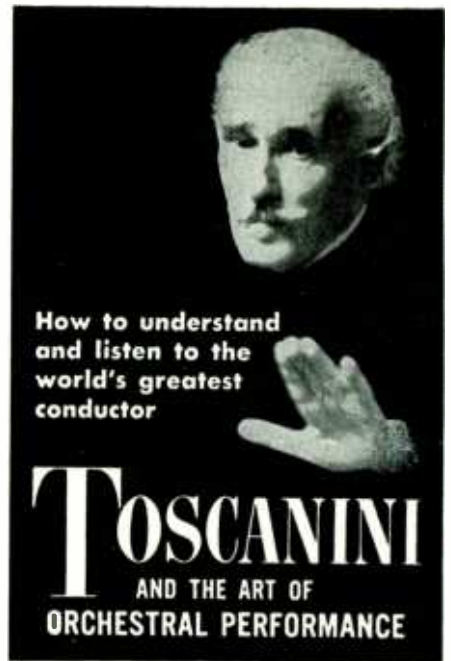

By **ROBERT CHARLES MARSH**

Alone in Toscanini literature, this volume is certain to be a useful and refreshing addition to the library of anyone interested in the musical genius of Toscanini. It presents an aesthetic and technical critical study of every Toscanini recording, perceptively analyzes Toscanini's musicianship and technique, and compares his interpretations with those of other conductors.

Selected Press Comments:

" . . . a work of prime importance"
—Ernest Newman in *The Sunday Times* (London)

" . . . a complete and well-documented survey of Toscanini's recorded music with a perceptive critical appraisal of each record."—*The New Yorker*

" . . . one of the sanest and most rewarding portraits of one of the century's greatest artistic geniuses."
—*The Baltimore Sun*

" . . . the sum total here introduces some perspective, for once, into the Toscanini picture . . ."—*Library Journal*

\$4.50

HIGH FIDELITY Magazine
Great Barrington, Mass.

I enclose \$ Please send me, postpaid, *Toscanini and the Art of Orchestral Performance*. Add 55c for postage on orders outside the U.S. & Canada.

NAME

ADDRESS

(No C.O.D.s or charge orders, please.)

*True
is the word*



MARK 100 EQUIPMENT CONSOLE

An outstanding achievement in design, the Mark 100 houses a complete audio system except speakers and stores over 100 records. Designed to capitalize on attractive self-contained control units now available. The Mark 100 is furnished in the same distinctive finishes as the Mark 8 and 12 speakers. 27" h. 16" d. 36" w. • \$97.50



MARK 12

Two way • 12" bass driver matched to two 5" cone tweeters • Cavity coupled to horn at base of unit • Rigid construction • Essentially flat 50 to audible limits • 23" h. 14" d. 27" w • In Sandalwood, Teak, Mahogany, Walnut • 16 Ohms, 30 Watts • \$97.50



MARK 8

Two way • Matched 8" bass driver and 3" cone tweeter • Slotted grid phase inverter • Essentially flat 60 to 12,000 • 10" h. 12" d. 21" l • In Sandalwood, Teak, Mahogany, Sable • 16 Ohms, 20 Watts • \$49.50

AMERICAN LOUDSPEAKER

DIVISION OF CONTEMPORARY AMERICAN FURN. INC.

725 SOUTH LA SALLE ST.

CHICAGO 5, ILLINOIS

drinks, salutes, and departs to take up again the military responsibilities of his rank.

One of these is the training of young pipers. Unfortunately the Pipe Major does not have the opportunity to keep his pupils under tuition for seven years as the Macrimmons did at their "college of pipers" in Skye. His preoccupation is often to push the learners as quickly as possible, to fit them in the Band, and to qualify them for sharing in the daily piping duties in a unit. But it is he who instills in the young players the principles of breathing, of fingering, of tuning the drones, and of caring for the bag. The last may seem relatively unimportant but if the pipes are not regularly played, the bag must be treated with diluted treacle or sweet thick tea to prevent the sheepskin from splitting through dryness. The Pipe Major is often found surrounded by learners, each at a different point in his training. One will be picking out on the chanter his first tune, probably *The Nut Brown Maiden* or the most celebrated of Jacobite tunes, *The Skye Boat Song*. Even at this elementary stage the teacher insists on the correct grace notes and allows none of the substitutes or omissions which make for tinkie piping. Another will be playing the goose—a bag and chanter without drones, on which the control of air pressure is first practiced. At the same time the more advanced pupil will be red in the face from his first encounter with the complete instrument.

Besides those with service connections there are hundreds of civilian bands. The post-1918 generations have been encouraged to play by fathers who in the war discovered for themselves the power and attendant symbolism of pipe music. Consequently it has spread throughout Scotland. It is paradoxical that the band which today wins more prizes in competition than any other, the Glasgow Police Pipe Band, comes from a city which is actually in the Lowlands. By now, of course, the whole world knows the pipes, and no doubt they frequently enliven the campus at the State University of Iowa, whose Scottish daughters made a great hit over here not long ago.

At this point one should mention the Dagenham Girls; unusual in being the first girls' pipe band, in being pro-

Continued on next page

**IT'S THE BEST...
AN ULTRA-LINEAR**

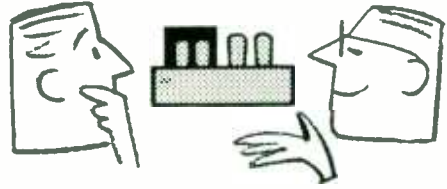

The circuit that is used in more and more amplifiers to insure high power and excellent stability with minimum distortion. Ultra-Linear is the ultimate in high fidelity reproduction, but . . .

**ARE YOU SURE
IT'S ULTRA-LINEAR?**

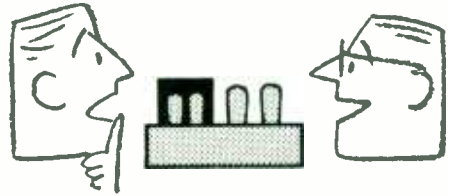

Many manufacturers are claiming Ultra-Linear operation of their amplifiers, even showing a screen tapped output transformer in the schematic as proof . . . but this does not guarantee Ultra-Linear performance.

**HERE'S HOW
YOU CAN TELL**



Look for the black and gold "K" symbol showing that the amplifier is a "Licensed Ultra-Linear." This circuit . . . covered by patent . . . is specifically designed to provide minimum distortion at both high and low levels, high efficiency and good damping. The optimum conditions can be obtained only when the output transformer is tapped within a specific range for the output tubes . . . pentodes or triodes . . . used in the circuit. If the transformer is tapped outside of the specified range, it is not Ultra-Linear, nor can it be claimed as such. The "K" symbol then is your guarantee of true Ultra-Linear performance.

**Get the full story on
ULTRA-LINEAR**

. . . from
*KEROES ENTERPRISES
owner of U.S. Pat. No. 2,710,312

ACRO PRODUCTS CO.
Sole Licensing Agent



Acro Products, 369 Shurs Lane, Phila. 28, Pa.

I am enclosing 25c for your new booklet "Theory and Operation of the Ultra-Linear Circuit."

Name
Address
City State



KEEP RECORDED
MUSIC IN FOCUS
WITH **DFF**

DFF brings your recorded music out of the shadows—into clear focus. Just as a fine camera lens sharpens a picture. DFF is Duotone Fidelity Focus and exclusive. It ends the fuzzy distortions caused by many ordinary needles. Protects your records, too. Test your present needle. Is it robbing you of the best of your recorded music? Get a *free* DFF Home Needle-Tester Card today at your dealer's or write:

DUOTONE COMPANY, INC., KEYPORT, N. J.

TRUE HIGH FIDELITY BEGINS

with a

WEATHERS

FM PICKUP SYSTEM



the **ONLY**
PICKUP
DESIGNED
for a
stylus force
of **ONE GRAM!**

ONLY with a Weathers Pickup can you enjoy full-range true fidelity sound reproduction. The moving mass and motional impedance of the stylus force are so low, it reproduces full-recorded range without tearing the delicately engraved record grooves.

You can increase your record effectiveness by thousands of plays by using a Weathers FM pickup system—the most significant Hi-Fi achievement for the record collector and discriminating music lover.

Hearing is believing. Ask your dealer to demonstrate a Weathers Pickup.



Barrington, New Jersey

- Follows every recorded detail faithfully without damaging delicate record engravings.
- Widest frequency range response.
- Lower distortion than anything previously known.
- A sapphire stylus lasts a 1000 plays longer—a diamond stylus forever!

HIGHLAND BAGPIPE

Continued from preceding page

fessional, and in drawing its members from an English town. It is both a band and an entertainment troupe. Immediately after they had given a first-class demonstration of concerted playing during a village fete in Hampshire, with others from the crowd I joined them in dancing Latin-Americanized reels to some highly unorthodox piping. On one of their trips across the Atlantic, the *Washington Post* made headline reference to "the Mad Band." Maybe "adaptable" is a more accurate description.

Following the improvement in communications over the last fifty years, there has been a marked trend towards collective playing in bands. Some anxiety is felt in case this should lower the level of individual accomplishment, and great pains are taken to keep alive solo piping competitions. Unlike the band contests, these are often part of the games which abound in August and September—Braemar is the best known. The games include other traditional Highland pastimes such as dancing, caber-tossing, and wrestling, as well as ordinary track events, and are nowadays primarily a spectacle for the entertainment of natives and visitors alike. The scene is vibrant with movement and sound, yet the crowning glory is not the parade of massed pipes and drums which the world applauds, but the much more significant solo piping, taking place half-noticed.

Various categories exist in individual competition—march alone; march, strathspey, and reel; and, of course, pibroch. Competitors submit a list of tunes and are called upon to play one of them. This year at the Skye Games, pipers in the pibroch class had to offer any four Macrimmon compositions, a choice as appropriate to the setting as the decision to do without massed bands. Instead, at the end, the competing pipers marched around the gathering ground together. Perhaps their music carried across the island to the western shore where a simple stone cairn commemorates the Macrimmons and, in their name, the bagpipe.



HALLOWED HALLS

Continued from page 54

in others in Europe, the orchestra seats have no center aisle. As a matter of fact, they have no aisle at all. If you come in late, you have to tramp over many pairs of shoes.

Every concert hall in Europe has its own flavor, no matter how similar they may be inside. There is the Concert Hall in the "promenade pavillon" of the Tivoli in Copenhagen — brand-new, ultramodern, with glass sides so that while listening to Brahms you can look out and see the merrymakers eating ice cream and flirting. There is good old Covent Garden, just a shade decrepit these days, with its strange green dome, its gloomy correctness, and its solid, spacious quality. There is the Théâtre des Champs-Élysées, with its frightful ceiling murals and unusual seats (something like plush wicker chairs). In Paris also is the Théâtre de Chaillot, the only hall in existence where you have to walk *down* to get to the balcony. This writer could go on and on, but suggests that the reader go on and on — on to London, Paris, and Vienna, on to Berlin, Munich, and Wiesbaden, on to Rome, Milan, Stockholm, and Copenhagen. And from beyond beckon Moscow, Leningrad, Peiping. As they say, you only live once. But get your tickets in advance, if possible.

OBTRUSIVE MELODY

Continued from page 63

- (7) William Schuman — Symphony for Strings, second movement.
- (8) Haydn — String Quartet Op. 2, No. 4, third movement.
- (9) Albert Roussel — Concerto for Small Orchestra, second movement.
- (10) André Jolivet — Andante for String Orchestra.
- (11) John Blow — *Venus and Adonis*.
- (12) Boccherini — String Quartet Op. 58, No. 2, second movement.
- (13) Vivaldi — Violin Concerto No. 11, Op. 8, second movement.
- (14) Albinoni — Oboe Concerto Op. 9, second movement.
- (15) Carl Nielsen — *Masquerade*, Prelude to Act II.
- (16) Jacques Stehman — *Symphonie de Poche*, third movement.

Continued on next page

marantz

...the ultimate goal
of the
critical listener

Audio Console
preamplifier with cabinet \$168*

Power Amplifier
\$198*

*slightly higher west of the Mississippi

marantz company
44-15 Vernon Boulevard, Long Island City 1, N. Y.

write for literature



BOOM BOOM BOOM

Are you Boom Conscious? . . .

Most people know by this time that many, if not most, loudspeaker enclosures . . . regardless of size or price . . . boom. Boom is that dull, heavy, toneless thud often heard at low frequencies. Boom is also called "one-note bass" or "juke box bass." It is an inherent characteristic of so-called "resonant" enclosures. Boom is nothing but distortion, and any speaker system that booms is not high fidelity.

Notwithstanding this, and believe it or not, there are still people who will spend hundreds, and even thousands, of dollars for prime amplifiers, tuners, etc., and then go out and buy a boom-box. Why?

A noted psychiatrist undertook to find the answer. He found that (1) some people mistake mere loudness (so-called "augmented" bass) for true bass; (2) others are unable to tell the difference between true bass and boom; (3) some think boom *is* bass; (4) others think boom is bass because it comes from large and/or expensive enclosures; (5) others have a fixation for expiring myths, such as, "the bigger the box the better the sound"; (6) some innately resist progress and never seem able to adjust themselves to better things as they come along; (7) others

are impressed by expensive advertising and high-pressure sales promotion.

And so it goes, even though, actually, no one ever heard boom from a live orchestra. And since a live orchestra is not a boom-box, why should anyone want a boom-box in his home? Fortunately, no one has to buy a boom-box.

To those who want live-music facsimile instead of boom, competent sound engineers unequivocally recommend **THE BRADFORD PERFECT BAFFLE. IT DOES NOT BOOM . . . EVER.**

The result is clean, true bass. This is accomplished by a new, patented device based upon a scientific principle. It is not a bass-reflex or folded horn.

Moreover, it satisfies every other criteria of the discriminating audiophile: *Compactness*; 12" x 12" x 9" for 8s and 10s; 17" x 17" x 14" for 12s and 15s. *Finest Construction and Finish*; 3/4" genuine mahogany, korina blond, walnut and ebony veneers; and unfinished birch. *Economy*; from \$34.50 to \$69.50.

If you are boom conscious, want live-music facsimile instead of those dull, heavy, toneless thuds, hie to your dealer or write for literature.

BRADFORD & COMPANY 27 East 38th Street New York 16, New York

COMING to your city HIGH FIDELITY MUSIC SHOWS

See and hear the latest in HIGH FIDELITY from leading high fidelity manufacturers . . .

Don't miss these public showings of Hi-Fi Equipment . . . from the most economical units for the budget-minded to spectacular home music theatres . . . compare and enjoy them all. Components and complete systems will be displayed.

THREE FULL DAYS OF CONTINUOUS DEMONSTRATIONS 1 P.M. to 10 P.M.

Minneapolis-St. Paul	January 11, 12, 13	Dyckmann Hotel
Detroit	February 1, 2, 3	Statler Hotel
Cleveland	February 22, 23, 24	Hollenden Hotel
Pittsburgh	March 8, 9, 10	Penn-Sheraton Hotel
Cincinnati	September 20, 21, 22	Sheraton-Gibson Hotel
Miami	October 18, 19, 20	McAllister Hotel
Dallas	November 15, 16, 17	Adolphus Hotel
St. Louis	November 22, 23, 24	Statler Hotel

Rigo Enterprises, Inc. 500 North Dearborn Street, Chicago 10, Illinois



First Place

Twenty-four leading phono pickups have now been tested by The Audio League. The ESL Professional and Concert Series remain in first place.

These Audio League tests show that ESL electrodynamic cartridges are tops in smoothness, clarity, and naturalness of reproduction.*

In addition, record and stylus life are greatly extended by the ESL, which in this way saves the purchaser many times its own cost.

Join the musicians, engineers, and music lovers who have switched to the world's most advanced cartridge. Write for details and, even better, hear the difference at your dealer's.



FOR LISTENING AT ITS BEST

Electro-Sonic Laboratories, Inc.

Dept. H • 35-54 Thirty-sixth Street • Long Island City 6, N.Y.

Soloist Series from \$14.95 • Concert Series \$35.95 • Professional Series arm and cartridge \$106.50

*Authorized quotation No. 57. Please consult The Audio League Report, Vol. 1, No. 6-7 (March-April 1955) for the complete technical and subjective report. Subscription: 12 issues \$4. from P. O. Box 262, Mt. Vernon, N. Y.

OBTRUSIVE MELODY

Continued from preceding page

- (17) Spohr — Violin Concerto No. 7, second movement.
- (18) Schoenberg — Five Pieces for Orchestra, Op. 16 No. 3.
- (19) Gabrieli — Canzone No. 2 for Double String Orchestra.
- (20) Delius — *North Country Sketches* No. 1.
- (21) Giuseppe Torelli — Concerto Grosso in A minor, Op. 8, second movement.
- (22) Widor — Organ Symphony No. 10, third movement.
- (23) William Byrd — Pavan: *The Earl of Salisbury*.
- (24) Beethoven — String Quartet No. 15, Op. 132, third movement.
- (25) Ibert — Flute Concerto, second movement.
- (26) Mennin — Symphony No. 3, second movement.
- (27) Alfven — *The Mountain King*, Excerpts.
- (28) Templeton — Quartet "Pastorale," third movement.
- (29) J. S. Bach — Organ Fantasia in C major, Adagio.
- (30) Torelli — Violin Concerto Op. 8, No. 12, second movement.

The pieces on these reels average between four and eight minutes. Each reel, with a track of about one hour and forty-five minutes on each side, plays approximately three and a half hours of music. It sounds a little forbidding—but these are all isolated, complete-in-themselves selections and the reel can be stopped (and resumed) at any time without disturbing its effect. Mr. B. even has an electric time clock and an automatic switch attached to his player, and when he goes to bed he sets them so that the player will shut off just when it is time for him to roll over and go to sleep.

Mr. Benjamin has culled about sixty-five hours from the pages of composers of three centuries, which may sound like an awful lot of restful music to the ordinary, restless listener. It doesn't sound so to Mr. Benjamin. "What are fifty or sixty hours of music?" he argued, rewinding Reel No. 6 and looking, longingly, at No. 7. "Translated into the field of opera that would be equivalent to the three popular Puccinis, three or four of the Massenets, a few Verdis and, perhaps, *The Ring*. It will never be enough for a lifetime. It will strangle

itself by repetition. I want to feel restful, not bored."

So what are you going to do about it?

"Plenty," says Mr. B.

A few years ago he began offering awards for the composition of restful music. He gives prizes—substantial prizes—to the composers who win these contests and, even more important, has seen to it that these compositions are also assured a public performance. The Benjamin Awards for Restful Music are offered through the North Carolina Symphony, the Eastman School of Music, the Juilliard School, and the University of Miami, Florida, which maintains a large orchestra. All these institutions have formed juries of competent musicians to select the winning scores and perform them in one of their regular concerts.

Mr. B. played some of these works for me (from tapes he had made when they were broadcast by NBC). All of them were by young American composers, some of them newcomers to the field and unknown to me. I found not only the titles—*Christ Looking Over Jerusalem*, *Serenity*, *Autumn Leaves*, *For Catherine in April*—appealing and suggestive but was impressed with the skill and inventiveness displayed by the composers within the limited framework permitted by the nature of the award. This, Mr. Benjamin says with justified pride, is only a beginning. There will be more awards and a larger crop of new restful music in the years to come.

And while he still looks with suspicion on "tranquil" music and

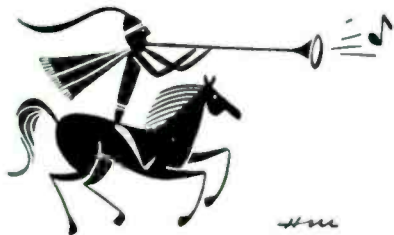

doesn't have his restful heart in it, Mr. B. has taken up a suggestion made by the late Olin Downes and enthusiastically seconded by Alexander Hilsberg, the conductor of the New Orleans Symphony. He offers annually a commission of \$1,000 through the New Orleans orchestra for a tranquil score. Paul Nordoff got it last year and Virgil Thomson is now working on a tranquil composition which will be

Continued on next page

The

WEATHERS Decorator

for Realism, Beauty, Compactness

- An integrated acoustical system with full range natural reproduction of sound.
- Engineered to produce extraordinary presence, clean dynamics and transients, voice reproduction with startling realism.
- Cabinets finished by master craftsmen.



- All done by the same technical magic which produced the world's finest phonograph pickup . . . the famous WEATHERS FM 1-gram pickup.

Ideal for limited space: Weight 42 lbs., only 8 3/4" deep, 32" long, and 26" high.

Audiophile Net: Natural Mahogany \$135.00, Blonde \$139.50.

Write for full information.



66 E. Gloucester Pike,
Barrington, New Jersey

Export: Joseph Plasencia, Inc., 401 Broadway, New York 13, N. Y.

COLBERT ELECTRONIC 3-CHANNEL FREQUENCY DIVIDER

As appears in
TESTED IN THE HOME
November 1956 issue

Over-all output is excellently clean; cut-off rates are 6 to 9 db per octave; levels change somewhat with adjustment of crossover controls; hum and noise are not audible—which is quite an accomplishment for an electronic crossover. Just proves it can be done if enough attention is paid to design and manufacture. All in all, highly commendable. If anyone doubts the value of an electronic frequency divider, this should convince them. — C.F.

MODEL 3-CFD \$154.50

Decorator style case in blonde or mahogany formica finish... **\$15**
Slightly higher in west and deep south



For full specifications see your
dealer or write to Dept. HF17

colbert

LABORATORY, INC.
160-09 Hillside Avenue
Jamaica 32, New York

colbert
LABORATORY, INC.

SPECIFICATION SUMMARY

- Eliminates speaker impedance and efficiency mismatches
- Eliminates resonant filters (fixed crossover networks)
- Three-channel operation results in lowest over-all distortion
- Affords optimum damping of individual loudspeakers
- Features variable cross-over controls for low, mid and high ranges
- Provides individual level controls for each sound channel
- Designed for use on two or three way systems
- Eliminates distortion due to higher frequency harmonics
- For use with regular or electrostatic loudspeakers, or combinations
- Includes high quality 10 watt ultralinear amplifier of great stability

GET BETTER HIGH FIDELITY RESULTS at less cost!



High Fidelity Techniques
by John H. Newitt

The book that says goodbye to guesswork in choosing, building and servicing hi-fi equipment.

512 pages
203 pictures

Whether you specialize in high fidelity service, custom building or simply want to build a top-notch outfit for yourself, this big 512-page book will guide you every step of the way.

Helps you get better results at less cost. Shows what to do, what mistakes to avoid. Gives you a full understanding of the many different methods, circuits, designs, equipment, components and other subjects that are debated whenever hi-fi fans get together.

CASH IN ON HI-FI SERVICE AND CUSTOM BUILDING PROFITS!

High Fidelity Techniques is complete, authentic and easy to understand. From beginning to end, it is chock full of how-to-do-it tips, service data, charts and diagrams of the most helpful sort. The ideal book either for the hi-fi hobbyist or professional.

10-DAY FREE EXAMINATION!

Dept. HF-17, RINEHART & CO., INC.
232 Madison Ave., New York 16, N. Y.
Send HIGH FIDELITY TECHNIQUES for 10-day FREE EXAMINATION. If I like the book, I will then promptly send \$7.50 (plus a few cents postage) in full payment. Otherwise, I will return book postpaid and owe you nothing!

Name

Address

City, Zone, State

OUTSIDE U.S.A.—Price \$8.00 cash with order only. Money back if book is returned in 10 days.

HI-FI LAB

ORIGINATORS OF
DO-IT-YOURSELF HI FI!



COMPLETE STOCK OF HI-FI
EQUIPMENT AND COMPONENT
PARTS AT
WHOLESALE PRICES!



ELECTRO-VOICE
SPEAKER CABINET
KIT ARISTOCRAT
MODEL KD-6 \$39.00
Audiophile net folded
horn corner enclosure finished size: 29 3/8" h. x 19" w. x 15 3/4" d.

HI FI LAB
1069 Massachusetts Avenue, Cambridge, Mass.
Please send me your free Hi Fi Kit Catalogue:

NAME

STREET

CITY ZONE STATE

OBTRUSIVE MELODY

Continued from preceding page

introduced by the orchestra during its current season.

Being only tranquil, the piece will, of course, not be included in Mr. Benjamin's restful tapes. But it will probably be played at dinner together with Haydn, Prokofiev, Ravel, and some other restless (though tranquil) fellows. Having shared a couple of meals at Starmount Farm I can say with conviction that Virgil Thomson need to have neither regrets nor misgivings. If his music contrives to be half as tasty, mysterious, and intriguing as the stuff they send in from the kitchen, it will be a very delicious score indeed.

Editors Note: Any one interested in a complete listing of the Restful Music contained in Mr. Benjamin's tapes (Composer, Title, and indication of the recording from which it was taken) may obtain one by writing to Edward B. Benjamin, P.O. Box 60, Greensboro, N.C. and including \$1.00 for postage and preparation of the material.

GOLDEN AGE

Continued from page 61

past. "The most beautiful voices I ever heard—one of which I never heard in person, another only late in his career—were Caruso, Ruffo, Toresella, Journet, Selma Kurz, Medea Mei-Figner. My later favorites were Frida Leider and Meta Seinemeyer. I heard Seinemeyer, actually, very little, but I knew Leider well. Her repertoire was fantastic, a fact little known outside Germany. She was great in operas like *Tosca* and *Trovatore*. It is remarkable that she made her debut as Brünnhilde. Other recorded favorites are Sammarco, Magini-Colletti, Kruscieniuski, and the early Marconi."

As a final question I put the one uppermost in the minds of all historical collectors: When is Volume 2 coming out? The answer was given thoughtfully: "This all depends on finding a publisher willing to print it. Besides it is very hard work, and will take a long time. At present I am too busy, though I keep working at it continuously; therefore it is impossible to fix any date. The best answer I can give you is that the second volume is on the way."



An Instrument for Music Lovers!

BOHN Phonograph-Radios have been created for those who demand the finest performance from both AM-FM radio and today's Hi-Fi records. Powerful *Professional* Components are featured. Yet these sets are among the most compact High Fidelity Instruments made: The End Table unit is only 25" high! A superb Bohn Loudspeaker System in separate cabinet completes the set. Five finishes available.

BOHN Phonograph-Radio—\$1290
(other models: \$1075 to \$2000)
Expertly Crated, Shipment Worldwide

Ask Your Dealer or Write:

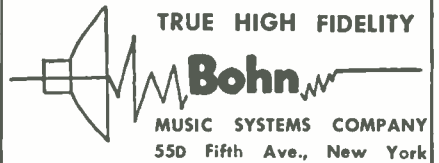

FOR A SOUND INVESTMENT...
USE A QUALITY CRAFTED
DIAMOND STYLUS

only \$10

Our skilled diamond craftsmen convert your present needle to a genuine, unconditionally guaranteed diamond needle! Send or bring your replaceable needle, check or money order for \$10. Specify either 33 or 78 rpm. If desired, new shaft supplied, \$2.75 additional.

DIAMOND STYLUS CO.

DEPT. HJ
31 WEST 47 STREET
N. Y. 36, N. Y.

STEREOPHONIC BROADCASTING

EACH SUNDAY 2:05 P.M.

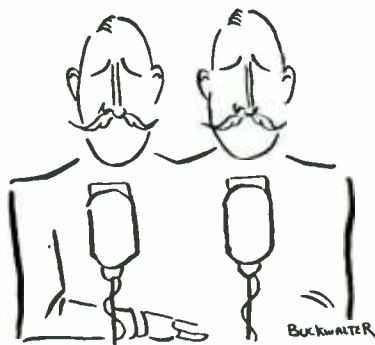

WCRB

1330 AM 102.5 FM

**Boston's
Concert Music Station**

A Good Music Broadcasters Affiliate

TRADER'S MARKETPLACE

Here's the place to buy, swap, or sell audio equipment. Rates are only 35¢ a word (no charge for name and address) and your advertisement will reach more than 75,000 music listeners. Remittance must accompany copy and insertion instructions.

TAPE RECORDERS, tapes, hi-fi components at **WHOLESALE** prices! **FREE** catalogue. CLARSTON, 215 E. 88 St., New York City 28.

FREE MONTHLY HI-FI BULLETIN. Write for quotation on any components. Sound Reproduction, Inc., 34 New St., Newark, N. J. Mitchell 2-6816.

LEARN WHILE ASLEEP with your recorder. Amazing book gives full instructions. \$2.00. Guaranteed. Research Association, Box 610, Omaha.

WRITE FOR SPECIFICATIONS, prices, and sample deal on truly high fidelity **DUBBING, RECORDING, and PRESSING.** Helffrich Recording Service, R #1 Wescoesville, Pa.

6 ELEMENT BROAD BAND FM antennas. All seamless aluminum, \$10.95 ppd. Wholesale Supply Co., Lunenburg, Mass.

HIGH FIDELITY SPEAKERS REPAIRED. Amprite Speaker Service, 70 Vesey St., N. Y. C. 7. BA7-2580.

TEST YOUR RECORDER'S PERFORMANCE. Excerpt Dubbings D-110 Test Tape \$.98* Blank recording tape 3" reel: 3 reels \$1.00.* Free catalog! *Add postage. **AMERTEST PRODUCTS CORP.**, 1280-B Sheridan Ave., Dept. HF 4, New York 56, N. Y.

FOR SALE: Garrard 301 turntable, guaranteed new condition, with all accessories, \$65; Brociner Mark 30C control unit, recently factory overhauled, 6 mo. use, \$50; Heath IM-1 intermodulation analyzer, built up, 90-day guarantee, \$50. Box HG, the Publishing House.

STEREOPHONY

Continued from page 59

of instrumentalists separated by a considerable distance and clustered around separate microphones.*

Sometimes — deplorably — the differential effect between the channels is further augmented by "riding" the gain controls during recording, increasing the intensity of sound in one channel at one time, that on the other channel at another.

These and other tricks are fairly regularly used to produce the strikingly "realistic" stereophonic recording that we hear in the living room. What this implies is that the "classic" stereophonic principle, according to which one simply places two microphones in the right positions, makes a straight recording, and then reproduces it over two loudspeakers in similar positions, has not proven, as a practical matter, entirely adequate (and perhaps not even wholly relevant) to the production of three-dimensional home music.

Of course, there is nothing sinful, however deceitful, about these various tricks in recording *if they give us a better listening experience.* But, realizing that they are sometimes necessary to a satisfactory illusion, we look back to the cause, discussed in this article, and cannot help wondering whether there may not be a simpler method of achieving stereophonic realism, one that does not involve the use of two or three complete separate channels; something that will give us the necessary differential *on the all-important transient effects*, without bothering about incongruous phase and intensity differences on the follow-through tones, which don't matter.

Is it absolutely certain that we must go to the trouble — and expense — of using two or three completely separate channels of recorded sound, if the recording people still feel obliged to exaggerate the effects to make them convincing, and if the effects that really matter, in the first place, are dependent only on a *fractional quantity* of the recorded material? I don't know the answer, but the question, it seems to me, is food for thought.

* Mr. Crowhurst concedes that this is not common practice, especially among major tape-and-disk producers, but points out that it *is* sometimes done, and successfully.—Ed.

McINTOSH 30 Watt Amplifier. Used 50 hours. Excellent. \$100.00. Box RS., Publishing House, Great Barrington, Mass.

World's Most Distinguished High-Fidelity Family

MATCHLESS!



MIRACORD XA-100

2-in-1 Pushbutton Record Changer and Manual Player with Exclusive "Magic Wand" Spindle

5 pushbuttons provide complete control at the touch of a fingertip. Instantly converts to an automatic Manual Player by inserting short spindle. Famous "Magic Wand" spindle intermixes 10" and 12" records, protects your finest recordings.

Complete with plugs and leads attached.
\$67.50 less cartridge

MARVELOUS!



MIRAPHON XM-110A

**Transcription Quality
Manual Player**

The perfect performer! Embraces true High Fidelity construction features usually found only in very expensive units.

Complete with plugs and leads attached.
\$37.50 less cartridge

MAGNIFICENT!



MST-1 Single

MST-2 Turnover

MIRATWIN Cartridges

**Brings Out The Best In
ANY Hi-Fi System**

An extremely wide range magnetic cartridge that recreates all the brilliance and realism of the original sound. Turnover unit consists of two separate and non-reacting movements. Miratwin cartridges remain unaffected by temperature and moisture conditions. Fits all Standard Tone Arms. Instant Fingertip Stylus Replacement. Stylus replacements available from stock.

MST-1D—Single Diamond Stylus\$34.50

MST-1S—Single Sapphire Stylus\$12.50

MST-2D—Turnover Sapphire Stylus
and Diamond Stylus\$45.00

MST-2A—Turnover Sapphire Stylus\$22.50

FAR AHEAD > THE FINEST BY FAR

Write for Complete Brochure



AUDIOGERSH CORP.

514 BROADWAY
NEW YORK 12, N. Y.
WORTH 6-0800

in Canada: Atlas Radio Corp., Ltd. Toronto

PROFESSIONAL DIRECTORY

• CALIFORNIA •

EVERYTHING IN HI-FI SOUND EQUIPMENT

FEATURING  WORLD'S FINEST TAPE RECORDERS

SANTA MONICA SOUND
12436 Santa Monica Blvd.
West Los Angeles 25 Granite 8-2834

the finest in Hi-Fi
featuring *ElectroVoice*®

HIGH FIDELITY COMPONENTS



820 W. Olympic Blvd. • L.A. 15, Calif. • RI 7-8271

Since 1944



HOLLYWOOD ELECTRONICS
HI-FI COMPONENTS EXCLUSIVELY
featuring *ElectroVoice*®

7460 MELROSE AVENUE
Los Angeles 46, Calif. • WE 3-8208

send for famous Bulletin G
it's free!

HIGH-FIDELITY HOUSE

Most complete stock of Audio components in the West

Phone: RYan 1-8171

536 S. Fair Oaks, Pasadena 1, Calif.

• ILLINOIS •

CABINET MAKERS



WE SPECIALIZE IN THE DESIGN AND CONSTRUCTION OF FINER FURNITURE FOR HI-FIDELITY

CONTEMPORARY AMERICAN FURNITURE CO.
725 S. LA SALLE ST., CHICAGO
WE btor 9-2868

ALLIED HI-FI STORES

ALLIED RADIO CORP.
100 N. Western Ave., Chicago 80, Ill.

EVERGREEN ALLIED HIGH FIDELITY, INC.
2025 W. 95th St., Chicago 43, Ill.

VOICE AND VISION, INC.
921 N. Rush St., Chicago 11, Ill.

ALLIED HIGH FIDELITY STORES, INC.
602 Davis St., Evanston, Ill.

WEST SUBURBAN ALLIED HIGH FIDELITY, INC.
7055 W. North Ave., Oak Park, Ill.

• MINNESOTA •

STYLI INSPECTION MICROSCOPES

GSSMS 1 \$25.00 GSS MS 2 \$12.50

See "Tith" report, and ad, High Fidelity Magazine for October 1956

THE GENERAL SCIENCE SERVICE CO.
P.O. Box 8423
St. Louis Park Station
Minneapolis, 16, Minnesota

• NEBRASKA •

In Omaha . . . it's the
"House of Hi-Fi"

- ✓ Fine High Fidelity Components
- ✓ Custom Installation Guidance
- ✓ Personalized Recording Service

"House of Hi-Fi"
4628 Dodge Street
Omaha, Nebraska
Phone GLendale 4434

OR STOP AT WORLD RADIO LABORATORIES
34th & BROADWAY COUNCIL BLUFFS, IOWA

• NEW YORK •

DON'T EXPERIMENT . . .

CONSULT A SPECIALIST IN
TRUE HIGH FIDELITY

SYSTEMS DESIGNED BY MAIL
TO YOUR NEEDS AND BUDGET.

BOHN MUSIC SYSTEMS CO.
550 Fifth Ave., New York 36, N.Y.

• OHIO •

IN CINCINNATI AND THE
TRI-STATE AREA

- * COMPETENT ENGINEERING
- * COMPONENTS AT NET PRICES
- * SERVICE ON ALL HI-FI COMPONENTS

Customcrafters, Inc.

2259 Gilbert Ave., CA 1-3153 - Cincinnati 2, Ohio
"A Component or a Complete System"

• PENNSYLVANIA •

in the PHILADELPHIA area
YOUR COMPLETE SUPPLIER is



**HIGH FIDELITY & COMMERCIAL
SOUND STUDIO**
709 Arch St., Philadelphia 6, Pa.
Phone: LOmbard 3-7390

**DELAWARE VALLEY HDQTRS.
FOR *Wor* HI-FIDELITY
COMPONENTS
CONSOLES**

See & hear all models from \$169.50 to \$1050,
or build them yourself with famous Pilot
components.

Large Record stock • Terms • Trade-ins •
Unlimited parking. Open Mon. • Wed. • &
Fri. eves. • Free catalog. We ship anywhere
U.S.A.

SHRYOCK HI-FIDELITY CO. EST. 1922
RADIO & TV
BONWIT-TELLER BLDG. Midway 2-1929
Opp. Wanamaker's, WYNNWOOD, PA. (Phila. Suburb)

• CANADA •

IN MONTREAL . . . IT'S

PECK'S

FOR HIGH FIDELITY

All the better high fidelity components at net prices. Also a wide selection of Equipment Cabinets and Speaker Enclosures.

TREVOR PECK CO. LIMITED
1498 Sherbrooke St. West, Montreal, Que.

CANADA'S FIRST
HIGH-FIDELITY

RADIO, PHONOGRAPH, RECORD AND
TELEVISION CENTRE

Stromberg-Carlson "Custom 400"
Brociner — Freed-Eisemann — Bogen
Fisher Radio — Concertone Tape Recorder
All Makes of High Fidelity Records

Custom Sound and Vision Ltd.
390 EGLINTON WEST TORONTO, ONT.
Phone HUDson 9-2117

• GREAT BRITAIN •

HI-FI 

from Britain

We stock the finest British Hi-Fi equipment available, and export it to all parts of the world. The cost of this precision built equipment will amaze you. Send for our Special Export Catalogue.

CLASSIC
ELECTRICAL CO. LTD.
352-364 Lower Addiscombe Rd., Croydon, Surrey, England

MUSICRAFT

Can supply all the leading British Hi-Fi Products

Agents for the amazing
Spectone Stereophonic Reproducers
Trade supplied

20/22, High Street, Southall, Middx., England
13 King Street, Richmond, Surrey, England

Just published

**1956
HIGH FIDELITY
RECORD ANNUAL**

see page 123 for details

**CHANGE
OF
ADDRESS**

If you plan to move soon, please notify us six weeks in advance. Give old address as well as new, clipping stencil imprint from wrapper of last copy received.

AUDIO FORUM

SIR:

I have a question regarding your "Dialing Your Disks" chart.

My amplifier has only three compensation settings, for LP, RIAA, and Eur., without separate rolloff and turn-over controls. How can I use my equalizer to obtain other compensation values? For instance, can I get the AES characteristic by using one of my compensation settings and my tone controls?

Richard A. Patton
Willowick, Ohio

Your tone controls can be used in conjunction with the equalizer settings to obtain a fairly close match to any equalization characteristic.

For the AES curve, set the equalizer to Eur. and turn the treble control down to give about 8 or 10 db of cut at 10,000 cycles or until the disk sounds like others of the same brand which are known to be correctly equalized with the positions you have.

Disks requiring straight 500-cycle bass turnover and 16 db rolloff can best be matched by using the RIAA position and then introducing a slight amount (about 2 db at 10 kc) of treble cut. Early London disks can be equalized by setting your control to the LP position and then adding slight (5 db at 10,000 cycles) treble boost.

SIR:

I am bothered by too high a hum level from my system, and have thus far determined the following things:

When I disconnect the phono input to the preamp there is no change in the hum. But when I disconnect the audio input from the preamp to the main amplifier, the hum completely vanishes. Also, removal of any one tube in the preamp completely eliminates the hum.

I believe this localizes the source of hum to the control unit, which is a kit model, and to a particular section thereof. The hum, I find, exists only on the phono and mic. channels, and predominantly on phono. The arm is grounded to the turntable, and the latter to the preamp. Connecting the preamp or amplifier

to a true ground (cold water pipe) makes no change in the hum when the phono input is connected, and aggravates the hum when the phono is disconnected. Disconnecting the shield of the audio input to the main amplifier at either the preamp or the amplifier brings no change. The hum control has been carefully set.

T. Grusec
Toronto, Ont.
Canada

The fact that your hum problem persists with the pickup disconnected but disappears when the preamp tube is removed indicates that the hum is originating in the preamplifier stage of your control unit. Also, your observation that it is more severe on the phono setting than on the mike input position suggests that the hum is originating before the equalization section of the preamplifier stage.

If the hum is a recent development, it is probable that the preamplifier tube in the control unit has become defective and developed a severe heater-cathode leak, or that the electrolytic capacitor in that tube's plate supply has become open-circuited.

If, however, the hum has existed ever since the kit was assembled, the trouble may be almost anything from a ground loop around your input receptacles to a dry-soldered joint. Carefully inspect the wiring in the preamp to make sure that all soldered joints are sound and that no ground connections have been made which were not specified in the control unit's wiring instructions.

SIR:

Can you please tell me the cause of the loud pop or crack heard through my speaker whenever the record changer switches itself off after playing the last record?

A. Edwards
Toronto, Ont.
Canada

The popping noise created by a record changer or turntable when it shuts off is caused by the sudden interruption

Continued on next page

TERMINAL'S
History Making Hi-Fi Buy!

the 'CLASSIC' PHONO SYSTEM
with 30 WATT AMPLIFIER and
GOODMANS 2-WAY SPEAKER SYSTEM

Every Item Brand New! ★ Fully Guaranteed!

Complete system consists of:

REGENCY
HF350P
PRE-AMPLIFIER



A handsome, clean-lined ultra high quality audio pre-amplifier with complete equalization flexibility. Makes the perfect audio control center with separate controls for volume-on-off, loudness, bass, treble, input selector, equalization. Cathode follower permits location anywhere. Frequency response 20-40,000 cps with 1% distortion from 40-7,000 cps. Handsome wood cabinet 16" W, 4 3/4" H, 7 1/2" D. Regular Net \$154.50

REGENCY
350A HI-FI
AMPLIFIER

An extremely high fidelity 30-watt separate power amplifier representing the backbone of this brilliant "Classic" system. Full range frequency response from 20-40,000 cps. brings the complete orchestra into your living room. Less than 2% distortion at 30 watts, 60 watt peak output. Controls: Volume-AC Switch, 8-16 ohm outputs. Handsome gold anodized. Dimensions: 15 1/2" x 8" x 7" Regular Net \$134.50

COLLARO
RC-456GE
4-SPEED
RECORD
CHANGER



Plays every speed record including 16 2/3 rpm. Operates manually, intermixes all size records, has rapid 6-second change cycle, shuts off after last record. Heavy 4-pole motor, weighted turntable. Wow and flutter factory checked for less than 0.25% rms at 33 1/3 rpm. With GE Dual-Sapphire Stylus. Net \$41.46

GOODMANS AUDIOM 60
12" WOOFER SPEAKER

A beautifully performing woofer for rich, full bass response for your home music system. Response down to 20 cycles in recommended enclosure. Handles a full 30 watts of power from the amplifier with perfect fidelity. Net \$50.00

GOODMANS AXIETTE 8" TWEETER SPEAKER

The perfect complement to the Audiom 60 Woofer, supplying the complete upper frequency range to 15,000 cycles. Produces silky highs without piercing harshness. 10 watt power handling capacity. Net \$23.20

GOODMANS X0750 CROSSOVER NETWORK

Efficiently divides the sound from the amplifier at 750 cycles, sending the bass to the woofer and the treble to the tweeter. Full half-section L/C network with 12 db/octave roll-off above 750 cps. 15 ohms. Net \$25.00

The "CLASSIC" Total Regular Net \$428.66

COMPLETE with all tubes, cables and simple instructions
READY TO PLAY... ONLY \$259.66

YOU SAVE \$169.00

TERMS: Prices do not include transportation costs. Send at least \$25.00 deposit with order. We will ship express C.O.D. for balance and transportation charges. SAVE C.O.D. CHARGES—Send full remittance and pay for transportation only on delivery.

MAIL ORDERS SHIPPED PROMPTLY

Phone: WOrth 4-3311
Terminal Radio
CORP.
85 CORTLANDT STREET, NEW YORK 7, N. Y.



If you're EMOTIONALLY MATURE

You'll realize at once that Stereo 3-D Sound is not music alone—it's a distinct and exciting emotional experience. You thrill now to hi-fi music from tape or discs; when you hear stereo sound on tape, the tingling icy fingers will run up and down your spine.

Here's your opportunity to get acquainted, under a low price money-saving offer, with the country's leading recording magazine, starting with a Special Issue devoted exclusively to stereo sound.

4 issues for only \$1.00

Starting with Special Issue on 3-D Sound

In this Special Issue: 10 Ways to Enjoy Stereo; Stereo Sound in the Round; Stereo—Why Bother?—also a complete directory of stereo tapes now available and in addition, a directory of stereo equipment including recorders, playbacks, amplifiers, etc.

USE THIS COUPON—GET PROMPT ACTION

HI-FI TAPE RECORDING
Severna Park 15, Maryland.

Here's my dollar. Send me four issues of Hi-Fi Tape Recording beginning with your Special Stereo 3-D Sound number.

Name

Address

City and State

AUDIO FORUM

Continued from preceding page

of the AC supply current through the drive motor.

It can be prevented by bridging a 0.05 or 0.1 mfd capacitor across the switch connections. The charge left in the capacitor when the switch contacts are opened will minimize the audible effect of the current interruption.

SIR:

I have a very fine loudspeaker system in my living room, which measures 20 by 20 feet with a 15-foot ceiling.

I am persistently bothered by a tremendous, booming bass resonance that seems to occur at about 100 cycles. No matter how I try reinforcing the cabinet or changing its location in the room, I cannot seem to get rid of the resonance. I am convinced that the trouble is due to the shape of the room, since its square shape would be expected to give standing waves of the same frequency in both directions.

What I would like to ask is, what measures can be taken to correct the resonance? Would hanging drapes or treating the walls with acoustic tile help, or am I stuck with an insoluble problem?

Karl Leicester
Philadelphia, Pa.

A member of HIGH FIDELITY's staff has been bothered with exactly the same problem in a square listening room, and while we would like to be able to offer some help we cannot suggest anything that would affect the room's behavior at such a low frequency, without making it look like a broadcast studio.

Drapes and acoustic tile will not efficiently absorb anything below the middle range of sounds. The only thing that might do so would be large, heavy baffles built out at an angle from two adjacent walls, or large areas of so-called peg board set along one or more walls. These may not help the décor of the room, though, and would probably be verboten in a married household. You might refer to the chapter on Room Acoustics in Charles Fowler's book, High Fidelity.

Also, readers' suggestions about acoustic treatment of square rooms would be welcomed.

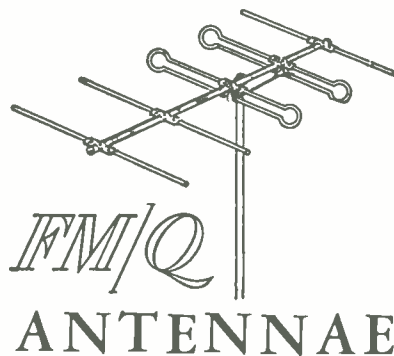

"Indisputably the finest available"

L. F. B. Carini, Ph.D.
Noted F.M. Authority

Both for optimum sensitivity and quality of construction, the FM/Q Antennae offer truly outstanding performance that is unsurpassed by any other.

Don't limit your tuner's sensitivity by using an inefficient antenna. Listen to the many other Good Music Stations on the air and enjoy the full capabilities now dormant in your FM tuner. Obtain increased signal strength and the long distance reception that only an "FM/Q" System can provide.

For advice and information write our consulting correspondent who will be happy to advise you regarding the solution of your particular problem. Send twenty-five cents for our valuable book, entitled "All About FM Antennae and Their Installation," which also includes a complete Directory of All FM Broadcast Stations.

APPARATUS DEVELOPMENT
COMPANY, INC.

WETHERSFIELD 9, CONNECTICUT

Introducing The MUS-ET

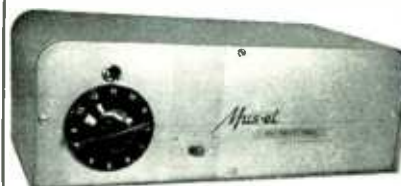

By
TAPETONE

Now

Hear your favorite television programs in high fidelity sound

Using your existing high fidelity equipment

The MUS-ET input is direct from the television antenna. The MUS-ET output is direct to the amplifier of your high fidelity system insuring the most enjoyable listening pleasure **\$69.95**

EXCELLENT FOR TAPE RECORDING

TAPETONE INC.
10 ARDLOCK PLACE, WEBSTER, MASS.



ADD HOLT STEREO!

Guaranteed to improve any Hi Fi or money back.

Works from monaural source, (radio, ordinary single track records and tape.)

See "Tested in the Home" report in the Nov. 1956 issue of High Fidelity magazine.

Order yours today or send for folder. \$62.00 prepaid in U.S.

STEREO by HOLT

4712 W. Magnolia Blvd.
Burbank, California.

Note: Due to the demand for this unit sales will be restricted to the United States until further notice.

pfK
pre-finished
Kits

PFK-120/150 PFK-500 PFK-300

designed by
Paul Klipsch

Now you need only a screw-driver to put together a furniture-finished Klipsch speaker enclosure, indistinguishable from factory-assembled Rebel 3, 4 or 5. Also available as conventional, unfinished kits.

Write for Complete Catalog!
36 pages . . . 16 other hi-fi kits . . . 29
equipment cabinets . . . 4 matched speaker
systems . . . 20 hi-fi accessories.

cabinart '57

57

Cabinart
99 North 11th Street
Brooklyn 11, N. Y.

largest manufacturer of cabinets and kits for hi-fi
a division of G & H Wood Products Co., Inc.

ADVERTISING INDEX

Acoustic Research, Inc.	10
Acro Products, Co.	127
Allied Radio Corp.	9, 134
Altec Lansing Corp.	31
American Electronics, Inc.	108
American Loudspeaker	127
Ampex Corporation	113
Angel Records	Indexed on 72
Apparatus Development Co., Inc. ...	136
Audak Company	138
Audio Devices, Inc. ...	Inside Front Cover
Audio Exchange	27
Audio Fidelity Records	Indexed on 72
Audiogersh Corp.	133
Bell Sound Systems, Inc.	24
Bogen, David, Co., Inc.	28, 29
Bohn Music Systems Co.	132, 134
Book-of-the-Month Club, Inc.	7
Bozak, R. T., Co.	38
Bradford and Co.	129
Bradley Mfg., Inc.	Indexed on 72
British Industries Corp.	35, 114
British Radio Electronics	6
Cabinart	137
Capitol Records	Indexed on 72
Chambers Radio Corp.	Indexed on 72
Classic Electrical Co.	134
Colbert Laboratory, Inc.	131
Collaro	66
Columbia LP Record Club, Inc. ...	5
Concord Record Co.	Indexed on 72
Conrac, Inc.	44, 45
Connoisseur	126
Contemporary American Furniture	127, 134
Customcrafters	134
Custom Sound & Vision, Ltd.	134
Dauntless International	Indexed on 72
Decca Records, Inc.	Indexed on 72
DeJUR-Amsco Corp.	110
Diamond Stylus Co.	132
Duotone Company, Inc.	36, 128
Dyer-Bennet Records	Indexed on 72
Electro-Sonic Laboratories, Inc. ...	130
Electro-Voice, Inc.	Inside Back Cover, 12, 13, 50
Elektra Records	Indexed on 72
Ercona Corp.	124
Esoteric Records	Indexed on 72
Fairchild Recording & Eqpt. Corp. ...	11
Ferrograph	126
Fisher Radio Corp.	15, 16, 17, 18, 19, 20, 21
Fleetwood Television (Conrac, Inc.)	44, 45
Garrard Sales Corp.	35
General Electric	37
General Science Service Co.	134
Goodman's Loudspeakers	25
Gray Research and Development Co.	33, 34
Harman-Kardon, Inc.	47
Heath Co.	64, 65
Hi Fi Lab	132
High-Fidelity House	134
Hollywood Electronics	134
Holt Radio	137
House of Hi-Fi	134
JansZen	46
Jazztone Society	Indexed on 72
Jensen Mfg. Co.	1
Kierulff Sound Corp.	32, 134
Kingdom Products	42
Klipsch & Associates	48

Continued on next page

FOR HI-FI AND TAPE RECORDER FANS!

HOW TO SELECT & USE YOUR TAPE RECORDER
by David Mark
Written for the user of magnetic tape recorders—and to serve as a guide in selecting a machine that most suitably meets his or her individual requirements. For all those who have little or no formal training in the science of electronics.
It's a book which "shows you how"! Illustrates actual "set-ups" for the many different applications of tape recorders . . . Read this book before you buy a tape recorder . . . It will save you many dollars! **NO OTHER BOOK LIKE IT!**
No. 179. 150 pages 5 1/2 x 8 1/2 in. 152 illus. Soft cover \$2.95

HI-FI LOUDSPEAKERS and ENCLOSURES
by Abraham B. Cohen
THE "CLASSIC" IN HI-FI LITERATURE!
Here is a long-needed book. Every question which any hi-fi fan may ask about hi-fidelity loudspeakers and enclosures is answered. This book is supremely authoritative and brilliantly written! The author is a recognized authority—musician—an engineer. Room acoustics are explained and advice is given . . . A **MUST** book for all hi-fi and audio enthusiasts and technicians.
No. 176. 360 pages. 5 1/2 x 8 1/2 in. Leather finish MARCO cover. Hundreds of illustrations. Only \$4.60
No. 176-H. Cloth Bound Only \$5.50

RIDER BOOKS ARE AVAILABLE AT ELECTRONIC PARTS DISTRIBUTORS AND IN TECHNICAL BOOK STORES. IF UNAVAILABLE THERE, ORDER DIRECT.

JOHN F. RIDER Publisher, Inc.
116 W. 14 St., N. Y. 11, N. Y.
In Canada:
Charles W. Poynton, Ltd.
6 Alcina Ave., Toronto, Ontario

**If you're
interested
in true
high fidelity
YOU NEED THIS!**

... The authoritative, easy-to-understand story of how a hi-fi loudspeaker works. Tells you how to judge a good loudspeaker . . . what to look for, listen for. 32 fascinating pages, including dozens of diagrams and delightful cartoons. *Only book like it!* A wonderful guide for everyone who has a hi-fi system. A *must* for everyone who plans to purchase one!
Yours **FREE**—just send a dime to cover cost of mailing.

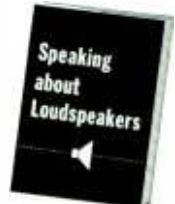

University Loudspeakers, Inc., White Plains, N. Y.



UNIVERSITY LOUDSPEAKERS, INC. Desk P-11
80 South Kensico Ave., White Plains, N. Y.

Gentlemen: Please send me my copy of "Speaking about Loudspeakers." Enclosed is Dime to cover the cost of mailing.

NAME _____

ADDRESS _____

CITY _____ STATE _____

AUDAX TONE ARM NOW IN KIT FORM

Anyone can assemble it in about 10 minutes — and save 50%! Exactly duplicates Audax "Compass-Pivoted" transcription arm, long recognized as top "blue chip". "Selector-Index" permits instant adjustment for any stylus pressure. Newly-designed cartridge housing permits all-important stylus-to-groove alignment at a glance. Accommodates ANY make cartridge.

KT-12 \$14.55 NET
factory-assembled
\$24.00 NET.

KT-16 \$17.55 NET
factory-assembled
\$30.00 NET



LISTENING QUALITY IS EVERYTHING!

Impartial Lab reports on the new Audax Hi-Q7 magnetic cartridge:

A leading recording studio: "Because readings showed an amazing total lack of distortion, check-tests were repeated 3 times"

Consumer sheet: "Good frequency and transient response. Practically no high frequency distortion. Low inter-modulation distortion."

Listening quality is everything — and Audax Hi-Q7 has it to a degree not equalled by any other pickup. But — HEAR it yourself . . . there is no other way! Net \$47.70, with 1 Chromatic Diamond and a Sapphire . . . Other models as low as \$20.70 Net.



STYLUS-BALANCE

"This really works . . ." (Audio Magazine) Stop deformation of record grooves! Only Audax Stylus-Balance can give you the all-important certainty of correct stylus pressure — ALWAYS. Precision-calibrated like a pharmacist's balance. Works with any arm and cartridge. Gold Finish. Net \$4.80 (add 25¢ if shipped from N. Y.)

LISTENING QUALITY CUTTERS

Flat to 14,000 cps. Distortion 0.6% at 1000 cps. Fully modulates groove with input of about 16 db with 220 lines. Z's up to 500 ohms. Two models:

H-5 Net \$111.00
H-4 Net \$75.00



FREE copy of \$1.00, 22-page, 1957 reference guide, "ELECTRONIC PHONO FACTS" — by pioneer Maximilian Weil — at your dealer, or write us.

AUDAX COMPANY
500 Fifth Ave., dept. H, New York 36
Fine audio-electronic apparatus over 30 years

Continued from preceding page

Lafayette Radio 122
Lansing, James B., Sound, Inc. 41
Electronics 125
Leslie Creations Indexed on 72
Lippincott, J. B., Co. 125, 126
Livingston Electronic
Corp. Indexed on 72
London International Indexed on 72
London Records Indexed on 72
Lorenz Speakers 42

Marantz Company 129
McIntosh Laboratory, Inc. 22, 23
Mercury Record Corp. Indexed on 72
Metzner Engineering Corp. 121
Music Box Indexed on 72
Music Listener's Bookshop 123
MusiCraft 30
Musicraft (England) 134

Neshaminy Electric Co. 46
Newcomb Audio Products Co. 32, 49
North American Philips Co., Inc. 126
Nuclear Products Co. Indexed on 72

Peck, Trevor, Co., Ltd. 134
Pentron Corp. 111
Phonotapes, Inc. 109
Pickering & Co., Inc. 2
Pilot Radio Corp. 43
Professional Directory 134
Pye, Ltd. 6

RCA Custom Division Indexed on 72
RCA Victor Division Indexed on 72
R-J Audio Products, Inc. 114
Radio Electric Service 134
Radio Wire Television 122
Record Market Indexed on 72
Record Review Index Indexed on 72
Rek-O-Kut Co. 8
Replica Records Indexed on 72
Rider, John F., Publisher, Inc. 137
Rigo Enterprises, Inc. 130
Rinehart & Co., Inc. 132
Robins Industries Corp. Indexed on 72
Rockbar Corp. 25, 66

Santa Monica Sound 134
Sargent-Rayment Co. 40
Scott, Herman Hosmer, Inc. 117, 119
Sherwood Electronic Laboratories,
Inc. 26
Shure Brothers, Inc. 4
Shryock Company 134
Smith, H. Royer Co. Indexed on 72
Sonotone Corp. 68
Stephens TRU-SONIC INC.

Back Cover
Stereo by Holt 137
Stereophonic Music Society 109
Stromberg-Carlson 14

Tandberg 112
Tannoy, Ltd. 124
Tape Recording Magazine 136
Tapetone, Inc. 136
Terminal Radio Corp. 135
Thorens Co. 138
Trader's Marketplace 133

Unicorn Records Indexed on 72
University Loudspeakers, Inc. 137

Vanguard Recording Society,
Inc. Indexed on 72
Viking of Minneapolis 106
Vox Productions, Inc. Indexed on 72

WCRB 133
Walco (Electrovox Co.,
Inc.) Indexed on 72
Weathers Industries, Inc. 128, 131
Westminster Recording
Co. Indexed on 72
World Radio Lab. 134

for
changer
convenience
and
turntable
performance

the direct-drive

THORENS

CD-43



the only changer with
complete published
wow, flutter, rumble
performance figures

RUMBLE: for E 53 N motor
mounted on CD-43, CBA-83, CB-33
and E-53PA units. (Reference level:
2.6 cm/sec., 1000 cps.)

	Total rumble level	100 cycle rumble	low frequency rumble
Best units.....	-52 db.	-53 db.	-55 db.
Average.....	-50 db.	-51 db.	-53 db.
Lower limit for all units equipped with E 53 N motors	-48 db.	-49 db.	-52 db.

FLUTTER: Less than 0.1%.

WOW: Less than 0.3%. Tests
made with the standard 12" turn-
table weighing 2½ lbs.

These measurements are minimum
quality control standards which
must be met or exceeded by every
THORENS RECORD CHANGER,
PLAYER AND TURNTABLE!

ask your dealer to
demonstrate THORENS

Write for Thorens Catalog.



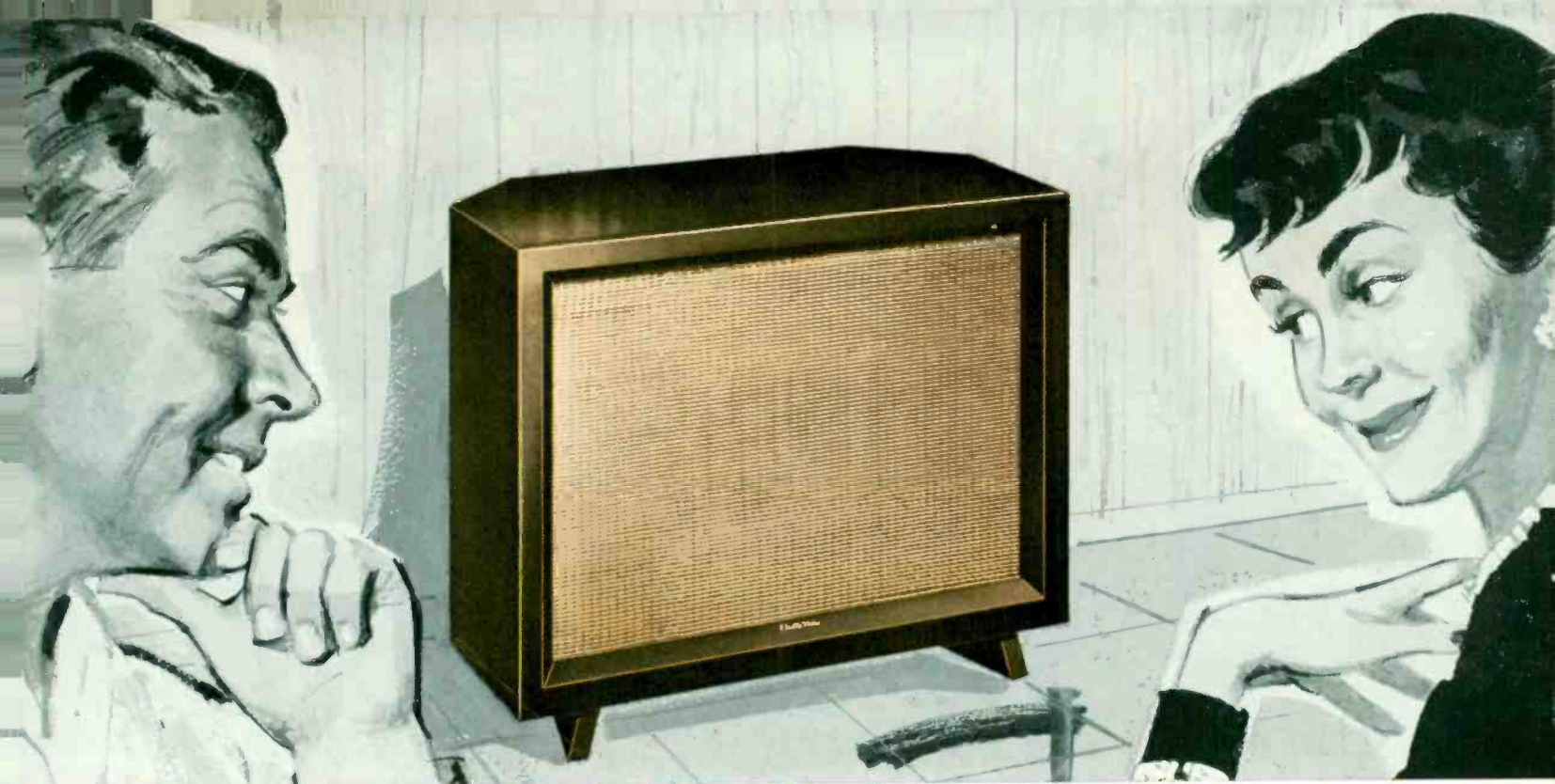

There is a difference in high-fidelity speakers
Hear the Difference! Enjoy the Difference!

In the *Electro-Voice*[®]
Empire BLS* ENCLOSURE

A hi-fi system is only as good as its loudspeaker system and its enclosure. You're sure of the very finest when you insist upon Electro-Voice. In the EMPIRE, E-V speakers, like magic, open a whole new world of listening pleasure. You hear the full musical range—the vibrant, deep bass; the silky, shimmering treble—all the realism and dynamics of a "live" performance. The thrill of high fidelity with a difference is rapturously yours with Electro-Voice Speakers!

*Bilinear Lenticular Slot Enclosure. An acoustically correct principle used to extend and augment lower bass range. Enclosure fits in corner or against wall.

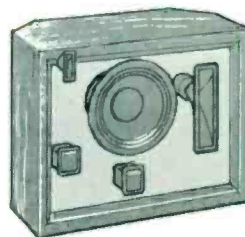

Hi-Fi on a Budget? Do it a step at a time with the economical

Electro-Voice Speaker Building Block Plan!

1 Start with the Electro-Voice Model SP15B 15-in. Two-Way Radax Coaxial Loudspeaker (response, 30-13,000 cps) and the EMPIRE Enclosure.

2A Add, as your budget permits, Speaker Building Block 1 (T35B Super-Sonax VHF, X36 Crossover Network, and AT37 Level Control with wiring harness). Now, you have a separate 2-way system that gives you those smooth, silky, shimmering highs.

2B OR, Add, Speaker Building Block 3 (T10A HF Driver with 8HD Diffraction Horn, X825 1/4-section Crossover Network, and AT37 Level Control with wiring harness). This gives you a separate 2-way system with more mid-range response.

3 A Complete separate 3-way system is yours when you have added both Speaker Building Blocks 1 and 3 to the SP15B Coaxial Loudspeaker in the EMPIRE Enclosure. Note, you haven't obsoleted any of your original components. The Speaker Building Block Plan is the flexible, easy-on-your-budget way to acquire the finest in high fidelity . . . Electro-Voice.

EMPIRE Enclosure only:	Mahogany	Net \$85.00
	Blonde	Net 91.00
	Walnut	Net 95.55
Model SP15B Radax Coaxial Speaker		Net \$43.00
Model 8B1 Speaker Building Block Kit		Net 34.50
Model 8B3 Speaker Building Block Kit		Net 83.50

Model SP15B
Radax Coaxial
15-Inch Speaker



Model T35B
Super-Sonax
VHF Driver

Model T10A HF
Driver with 8HD
Diffraction Horn



Hear the Difference before
You Buy . . .

Unique E-V Systems Selector lets you hear before you choose! Without spending a cent you can listen to the improvement as you dial from a single speaker to a multi-speaker system. You hear in advance how each new speaker component enhances the illusion of musical reality. Your Electro-Voice hi-fi dealer will be happy to demonstrate.

See your Electro-Voice Hi-Fi Dealer Today! Write for Catalog No. 118-F71

Electro-Voice

Electro-Voice, manufacturer of the most complete high-fidelity product range—speakers, speaker enclosures, speaker systems, amplifiers, preamps, tuners, phono cartridges, do-it-yourself enclosure kits and microphones. Available everywhere.

Electro-Voice, Inc., Buchanan, Mich.
Canada: E-V of Canada Ltd., 1908
Avenue Road, Toronto, Ontario
Export: 13 East 40th St., New York
16, U.S.A. Cables: ARLAB



Q U A D R E F L E X

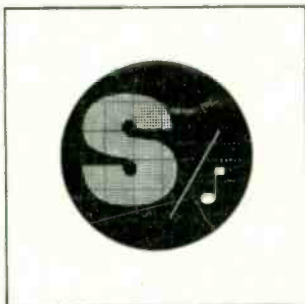
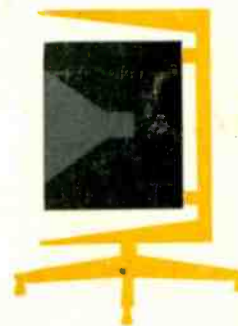

A new sight in sound. A revolutionary new loudspeaker enclosure designed by Charles Eames and the Stephens Tru-Sonic engineering staff. The backloaded coupling on this Instrument actually extends the bass response far below the natural resonance of the speaker system itself... without distortion of the mid or high ranges. Attains a tru-bass down to 30 cycles per second. In handsome, rare hardwood finish or naugahyde. Available in two sizes: one to house Stephens Tru-Sonic 12" coaxial speaker, and the other a 15" coaxial speaker. Your choice of cast aluminum swivel or fixed base. Listen... you'll always hear more from:

STEPHENS **TRU-SONIC** 8538 Warner Drive, Culver City, California

Cable Address: "MORHANEX" Export Address: 458 Broadway, New York 13, N. Y.

©